

MARKS PUBLISHED FOR OPPOSITION

The following marks are published in compliance with section 12(a) of the Trademark Act of 1946. Applications for the registration of marks in more than one class have been filed as provided in section 30 of said act as amended by Public Law 772, 87th Congress, approved Oct. 9, 1962, 76 Stat. 769. Opposition under section 13 may be filed within thirty days of the date of this publication. See rules 2.101 to 2.105.

A separate fee of three hundred dollars (\$300.00) for opposing each mark in each class must accompany the opposition.

SECTION 1.— INTERNATIONAL CLASSIFICATION

The short titles associated below with the international class numbers are terms designed merely for quick identification and are not an official part of the international classification. The full names of international classes are given in section 6.1 of the trademark rules of practice.

The designation "U.S. Cl." appearing in this section refers to the U.S. class in effect prior to Sep. 1, 1973 rather than the international class which applies to applications filed on or after that date. For adoption of international classification see notice in the OFFICIAL GAZETTE of Jun. 26, 1973 (911 O.G. TM 210).

Application in more than one class

SN 76-284,058. BOMBARDIER INC., MONTREAL, QUEBEC, CANADA, FILED 7-12-2001.

BOMBARDIERDIRECT

THE MARK CONSISTS OF STANDARD CHARACTERS WITHOUT CLAIM TO ANY PARTICULAR FONT, STYLE, SIZE, OR COLOR.
PRIORITY CLAIMED UNDER SEC. 44(D) ON CANADA APPLICATION NO. 1088966, FILED 1-12-2001.
OWNER OF U.S. REG. NOS. 939,566 AND 2,413,408.

CLASS 2—PAINTS

FOR PAINTS, VARNISHES, LACQUERS; PRESERVATIVES AGAINST RUST IN THE NATURE OF A COATING (U.S. CLS. 6, 11 AND 16).

CLASS 4—LUBRICANTS AND FUELS

FOR FUELS, FUEL OIL, LUBRICANTS ALL FOR VEHICLES AND APPARATUS FOR LOCOMOTION BY LAND, AIR, OR WATER, NAMELY, TRAINS, PLANES, AND BOATS (U.S. CLS. 1, 6 AND 15).

CLASS 6—METAL GOODS

FOR METAL OBJECTS, NAMELY, KEY CHAINS, FIGURINES, TOOLBOXES, LICENSE PLATES; NON-LUMINOUS AND NON-MECHANICAL METALLIC SIGNS; AND METALLIC PORTABLE BUILDINGS, NAMELY, ICE-FISHING HOUSES (U.S. CLS. 2, 12, 13, 14, 23, 25 AND 50).

CLASS 7—MACHINERY

FOR MOTORS AND ENGINES FOR NON-LAND VEHICLES, AND PARTS THEREFOR; TRACKED UTILITY VEHICLES, NAMELY, SNOW-GROOMERS, SNOW PLOWS, STRUCTURAL PARTS THEREFOR; SNOW-BLOWERS (U.S. CLS. 13, 19, 21, 23, 31, 34 AND 35).

CLASS 8—HAND TOOLS

FOR MANUALLY-OPERATED VEHICLE JACKS AND VEHICLE LIFTS; MULTI-PURPOSE KNIVES, NAMELY, UTILITY KNIVES, HUNTING KNIVES AND POCKET KNIVES; SHOVELS, SNOW-SHOVELS; COOKING AND EATING CUTLERY, NAMELY, FORKS, SPOONS, KNIVES, SUGAR AND ICE TONGS (U.S. CLS. 23, 28 AND 44).

CLASS 9—ELECTRICAL AND SCIENTIFIC APPARATUS

FOR PRE-RECORDED DIGITAL MEDIA FOR THE STORAGE AND REPRODUCTION OF SOUND AND/OR VIDEO, FEATURING MUSIC AND GAME ENTERTAINMENT SOFTWARE, NAMELY, AUDIOCASSETTES, VIDEOCASSETTES, AUDIO DISCS, VIDEO DISCS, COMPACT DISCS, DIGITAL VERSATILE DISCS, DIGITAL VIDEO DISCS, INTERACTIVE COMPACT DISCS, DISKETTES, VIDEO GAME CARTRIDGES; SUNGLASSES, SUNGLASSES CASES, CHAINS FOR SUNGLASSES; DECORATIVE MAGNETS; RECREATIONAL VEHICLE HELMETS, NAMELY, MOTORCYCLE HELMETS, KARATE HELMETS, SNOWMOBILE HELMETS, PERSONAL WATERCRAFT HELMETS, ALL-TERRAIN VEHICLE HELMETS; MAGNETICALLY ENCODED CARDS, NAMELY, CREDIT CARDS, DEBIT CARDS, CASH CARDS, TELEPHONE CARDS; ELECTRONICALLY ENCODED CARDS, NAMELY, CREDIT CARDS, DEBIT CARDS, CASH CARDS, TELEPHONE CARDS; CAMERAS, WATERPROOF CAMERAS, CAMERA CASES; SATELLITE NAVIGATION SYSTEMS, NAMELY, GLOBAL POSITION SYSTEM; ELECTRONIC AND MAGNETIC COMPASSES; PERSONAL DATA ASSISTANTS, HAND-HELD ELECTRONIC ORGANIZERS, HAND-HELD COMPUTERS; COMPUTER PROGRAMS FOR INTERCONNECTING MULTIPLE WIRELESS DEVICES; NEON SIGNS; PORTABLE HAND-HELD WIRELESS RADIOS; ELECTRONIC SAFETY LOCKS; VENDING MACHINES; COMPUTER MOUSE, MOUSE-PADS; THERMOMETERS, BAROMETERS; PERSONAL FLOATION VESTS; WATERPROOF PROTECTIVE CASES FOR CAMERAS AND MOBILE PHONES; BAGS SPECIALLY ADAPTED FOR PROTECTIVE HELMETS; LIFE-SAVING VESTS FOR USE BY DOGS; CASES TO HOLD AUDIOTAPES AND/OR COMPACT DISCS AND/OR DIGITAL VERSATILE DISCS; SAFETY HELMETS; REFLECTIVE ARM BANDS FOR SAFETY PURPOSES; VIDEO GAME MACHINES FOR ATTACHMENT TO TELEVISION (U.S. CLS. 21, 23, 26, 36 AND 38).

CLASS 11—ENVIRONMENTAL CONTROL APPARATUS

FOR SNOWMAKING MACHINES AND PARTS THEREFOR, LAMPS, BARBECUE GRILLS (U.S. CLS. 13, 21, 23, 31 AND 34).

CLASS 12—VEHICLES

FOR VEHICLES, NAMELY, PASSENGER TRAINS; APPARATUS FOR LOCOMOTION BY LAND OR WATER, NAMELY, SNOWMOBILES, PERSONAL WATERCRAFTS, NAMELY, SMALL POWER BOATS AND WATER SCOOTERS, JET BOATS, ALL TERRAIN VEHICLES; ENGINES FOR LAND VEHICLES; VEHICLE ACCESSORIES, NAMELY, FITTED PICKUP TRUCK CAPS AND LINERS, BUG, ROCK AND SALT SHIELDS AS STRUCTURAL PARTS OF VEHICLES, MUD FLAPS, BUMPER GUARDS, ROLL BARS, ROOF RACKS, TAIL GATE PROTECTORS, CUSTOM LICENSE PLATE FRAMES, FENDER TRIM, LICENSE PLATE HOLDERS, VEHICLE ROOF RACK STORAGE CONTAINERS AND CARGO CARRIERS, SKI RACKS AND BICYCLE RACKS, FITTED TIRE COVERS, HITCH COVERS, SEMI-FITTED AND FITTED VEHICLE COVERS; HAND TRUCKS, DOLLIES; CHILDREN'S STROLLERS; TRAILERS; VEHICLE TIRES; RAFTS; AND UTILITY TOBOGGANS FOR TRANSPORT (U.S. CLS. 19, 21, 23, 31, 35 AND 44).

CLASS 16—PAPER GOODS AND PRINTED MATTER

FOR PAPER GOODS AND STATIONERY, NAMELY, POSTERS, LITHOGRAPHS, CALENDARS, DIARIES, MEMO BLOCKS, DECALS, FLAGS, BANNERS, PENNANTS, COLORING BOOKS, PAINTING AND COLORING SETS FOR CHILDREN, COMIC BOOKS, MUSIC BOOKS, SCRAP BOOKS, ADDRESS BOOKS, ADDRESS LABELS, PHOTO ALBUMS, APPOINTMENT BOOKS, LOOSE-LEAF BINDERS, PENS, PENCILS, PEN AND PENCIL SETS, DESK SETS, GIFT WRAPPING PAPER, GIFT WRAPPING BAGS, DECORATIVE BOXES, STATIONERY, NAMELY, WRITING PAPER, NOTE PAPER, ENVELOPES, GREETING CARDS, POST CARDS, NOTE CARDS, COLLECTABLE TRADING CARDS, PAPER MACHE FIGURINES, BOOK ENDS, NON-MAGNETICALLY ENCODED CREDIT-CARDS, BLANK CHECKS; REWARD CERTIFICATES; ARTS AND CRAFT PAINT KITS (U.S. CLS. 2, 5, 22, 23, 29, 37, 38 AND 50).

CLASS 18—LEATHER GOODS

FOR BAGS AND CASES, NAMELY, TOTE BAGS, SPORTS BAGS, TRAVELLING BAGS, DUFFEL BAGS, LUGGAGE, SUITCASES, SUIT BAGS, TRUNKS, CARRYING CASES, HAND BAGS, WALLETS, PURSES, KNAPSACKS, FANNY PACKS, GYM BAGS, KEY CASES, COIN-KEY CASES; UMBRELLAS, LAWN UMBRELLAS, BEACH UMBRELLAS; ANIMAL PRODUCTS, NAMELY, CLOTHING, LEASHES, AND COLLARS; LEATHER KEY-CHAIN TRINKETS (U.S. CLS. 1, 2, 3, 22 AND 41).

CLASS 20—FURNITURE AND ARTICLES NOT OTHERWISE CLASSIFIED

FOR PLASTIC OBJECTS, NAMELY, KEY-CHAIN TRINKETS, FLAGS, BANNERS, PENNANTS; PLASTIC DECORATIVE HOUSEHOLD ORNAMENTS; PICTURE FRAMES; DECORATIVE MOBILES; FIGURINES OF WOOD, WAX, PLASTER, OR PLASTIC; WORKS OF ART OF WOOD, WAX, PLASTER OR PLASTIC; NON-METAL TOOL BOXES; NON-METAL FLOATING KEY FOPS; NON-METAL PORTABLE FUEL CONTAINERS SOLD EMPTY; MIRRORS, DECORATIVE MIRRORS, BACK-LIT MIRRORS; FOLDING CHAIRS, DECK CHAIRS, BEACH CHAIRS, COUNTER STOOLS; METAL WIND CHIMES; CHRISTMAS ORNAMENTS NOT BEING CHRISTMAS TREE ORNAMENTS OF BONE, IVORY, PLASTER, PLASTIC, WAX OR WOOD (U.S. CLS. 2, 13, 22, 25, 32 AND 50).

CLASS 21—HOUSEWARES AND GLASS

FOR HOUSEHOLD AND NOVELTY ITEMS, NAMELY, MUGS, CUPS, GLASSES, PITCHERS, BOTTLES SOLD EMPTY, PLATES, BOWLS, SERVING PLATTERS, TEAPOTS, COFFEE POTS; COOKIE JARS; CANDLESTICKS AND CANDLEHOLDERS; FIGURINES OF PORCELAIN, TERRA-COTTA, OR GLASS; LUNCH BOXES, LUNCH PAILS; THERMAL INSULATED CONTAINERS FOR FOOD AND/OR BEVERAGES, PORTABLE COOLERS; ANIMAL FEEDING BOWLS; CHRISTMAS ORNAMENTS NOT BEING CHRISTMAS TREE ORNAMENTS OF CHINA, CRYSTAL, GLASS OR PORCELAIN (U.S. CLS. 2, 13, 23, 29, 30, 33, 40 AND 50).

CLASS 24—FABRICS

FOR TEXTILE AND PIECE GOODS, NAMELY, BED LINEN, NAMELY, SHEETS AND PILLOWCASES; BATH LINEN, NAMELY, BATH TOWELS, HAND TOWELS, WASHCLOTHS AND FITTED TOILET COVERS; SHOWER CURTAINS; TABLE LINENS, NAMELY, TABLECLOTHS, CLOTH NAPKIN AND PLACE MATS; KITCHEN TOWELS AND DISH RAGS, BEACH TOWELS, GOLF-TOWELS, BED BLANKETS, BEACH BLANKETS, OVEN MITTS, GRILL MITTS, FABRIC FLAGS, BANNERS AND PENNANTS (U.S. CLS. 42 AND 50).

CLASS 25—CLOTHING

FOR CLOTHING, WEARING APPAREL AND ACCESSORIES, NAMELY, SHIRTS, SWEATSHIRTS, T-SHIRTS, JERSEYS, SWEATERS, PULLOVERS, PANTS, SWEAT PANTS, JEANS, SHORTS, BOXER SHORTS, BATHROBES, NIGHTSHIRTS, PAJAMAS, JACKETS, COATS, WIND RESISTANT JACKETS, VESTS, DRESSES, SKIRTS, BLOUSES, UNDERWEAR, BOXER SHORTS, SWIM WEAR, RAINCOATS, CAPES, TIES, ASCOTS, BELTS, SCARVES, GLOVES; FOOTWEAR, NAMELY, SHOES, BOOTS, SANDALS, SOCKS; HEADGEAR, NAMELY, HATS, CAPS AND RAIN HATS; SNOWSPORTSWEAR, NAMELY, HIGH PANTS, PANTS, JACKETS, GLOVES, MITTS, HATS, DICKEYS, TUBE TOPS, BANDANNAS, SKI MASKS, SKI BOOTS, RACING SUITS, WRIST BANDS; WATER-SPORTSWEAR, NAMELY, BODY SUITS, UPPER AND THE LOWER PARTS OF A TWO-PIECE BODY SUIT, SHORTS, HOODS, BATHING SUITS, SARONGS, APRONS (U.S. CLS. 22 AND 39).

CLASS 28—TOYS AND SPORTING GOODS

FOR GAMES, TOYS AND PLAYTHINGS, NAMELY, DIE-CAST TOYS, NAMELY, TOY MODEL VEHICLES AND VEHICLE REPLICAS, DOLLS, DOLL ACCESSORIES, ACTION FIGURINES, HAND-HELD GAMES WITH LIQUID CRYSTAL DISPLAY, RADIO-CONTROLLED TOY VEHICLES, RADIO-CONTROLLED MODEL VEHICLES, PLUSH TOYS, INFLATABLE INNER TUBES FOR AQUATIC RECREATIONAL USE, PET TOYS, SNOW GLOBES, BOARD GAMES, HAND-HELD UNITS FOR PLAYING ELECTRONIC GAMES, TABLETOP UNITS FOR PLAYING ELECTRONIC GAMES OTHER THAN IN CONJUNCTION WITH A TELEVISION OR COMPUTER, ARCADE GAMES, STAND ALONE VIDEO GAME MACHINES, MODEL VEHICLE KITS, BEACH BALLS, SLEDS FOR RECREATIONAL USE, RECREATIONAL TOBOGGANS, GOLF BALLS, CHILDREN'S PUSH TOYS, CHILDREN'S RIDE-ON TOYS, PLUSH ANIMALS, BASEBALLS, FLOATING RECREATIONAL LOUNGE CHAIRS, TRAMPOLINE, WATER TRAMPOLINES, INFLATABLE POOL TOYS, INFLATABLE RIDE-ON POOL TOYS, STRESS RELIEF BALLS FOR HAND EXERCISE, JIGSAW PUZZLES, 3-D PUZZLES, TOY 3-D FILM CARTRIDGES AND VIEWERS, TOY MOBILES, CHRISTMAS TREE DECORATIONS, CHRISTMAS TREE ORNAMENTS, CHILDREN'S BEACH TOYS, NAMELY, PAILS, SHOVELS AND RAKES; PLAYING CARDS (U.S. CLS. 22, 23, 38 AND 50).

CLASS 35—ADVERTISING AND BUSINESS

FOR MARKETING AND ADVERTISING SERVICES FOR DEALERSHIPS FEATURING VEHICLES AND APPARATUS FOR LOCOMOTION BY LAND OR WATER, NAMELY, SNOWMOBILES, PERSONAL WATERCRAFTS, JET BOATS, ALL TERRAIN VEHICLES, TRACKED UTILITY VEHICLES, NAMELY, SNOW-GROOMERS, SNOW PLOWS; RETAIL STORE SERVICES AND CATALOGUE ORDERING SERVICES FEATURING VEHICLES AND APPARATUS FOR LOCOMOTION BY LAND OR WATER, NAMELY, SNOWMOBILES PERSONAL WATERCRAFTS, JET BOATS, ALL TERRAIN VEHICLES, TRACKED UTILITY VEHICLES, NAMELY, SNOW-GROOMERS, SNOW PLOWS; ONLINE SEARCHABLE DATABASE FEATURING THE GOODS AND SERVICES FOR SALE BY OTHERS; DATABASE MANAGEMENT SERVICES; OPERATING ONLINE MARKETPLACE FOR SELLER OF GOODS AND SERVICES; BUYERS' CLUB SERVICES; PROMOTING THE SALE OF GOODS AND SERVICES OF OTHERS BY AWARDING PURCHASE POINTS FOR CREDIT CARD USE (U.S. CLS. 100, 101 AND 102).

FIRST USE 4-9-2001; IN COMMERCE 4-9-2001.

CLASS 36—INSURANCE AND FINANCIAL

FOR FINANCIAL AND BANKING SERVICES, NAMELY, ISSUING OF CREDIT CARDS; REAL ESTATE AGENCIES; SECURITIES TRADING FOR OTHERS VIA THE INTERNET (U.S. CLS. 100, 101 AND 102).

CLASS 37—CONSTRUCTION AND REPAIR

FOR REPAIR AND SERVICE OF VEHICLES AND APPARATUS FOR LOCOMOTION BY LAND, AIR, OR WATER (U.S. CLS. 100, 103 AND 106).

CLASS 39—TRANSPORTATION AND STORAGE

FOR RENTING AND LEASING OF VEHICLES AND APPARATUS FOR LOCOMOTION BY LAND, AIR, OR WATER; PACKAGING OF GOODS FOR TRANSPORTATION AND STORAGE OF GOODS; TRAVEL, EXCURSION AND CRUISE ARRANGEMENT (U.S. CLS. 100 AND 105).

CLASS 41—EDUCATION AND ENTERTAINMENT

FOR ENTERTAINMENT SERVICES, NAMELY, PROVIDING AN ON-LINE COMPUTER GAME; ORGANIZING COMMUNITY SPORTING AND CULTURAL EVENTS (U.S. CLS. 100, 101 AND 107).

CLASS 42—SCIENTIFIC AND COMPUTER SERVICES

FOR RECONSTRUCTION OF DATABASES FOR OTHERS (U.S. CLS. 100 AND 101).
JULIE WATSON, EXAMINING ATTORNEY

SN 76-315,529. SYMBOL TECHNOLOGIES, INC, HOLTSVILLE, NY. FILED 9-21-2001.



The logo for Symbol Technologies, featuring the word "symbol" in a stylized, lowercase font. The letter "o" is replaced by a circular graphic element consisting of vertical bars of varying heights, resembling a barcode or a stylized globe.

OWNER OF U.S. REG. NOS. 1,340,396 AND 2,436,052.

CLASS 37—CONSTRUCTION AND REPAIR

FOR MAINTENANCE AND REPAIR OF COMPUTER SYSTEMS AND NETWORKS; MAINTENANCE AND REPAIR OF COMPUTER HARDWARE; REPAIRING AND MAINTAINING DATA CAPTURE AND MANAGEMENT SYSTEMS AND NETWORKS, NAMELY, BAR CODE READERS, DATA COLLECTION TERMINALS AND WIRELESS LOCAL AREA NETWORKS (U.S. CLS. 100, 103 AND 106).

FIRST USE 12-0-1983; IN COMMERCE 12-0-1983.

CLASS 42—SCIENTIFIC AND COMPUTER SERVICES

FOR MAINTENANCE AND REPAIR OF COMPUTER SOFTWARE; SERVICE FOR PLANNING, DEVELOPING, AND IMPLEMENTING DATA CAPTURE AND MANAGEMENT SYSTEMS AND NETWORKS, NAMELY, BAR CODE READERS, DATA COLLECTION TERMINALS AND WIRELESS LOCAL AREA NETWORKS; TECHNICAL SUPPORT SERVICES, NAMELY, TROUBLESHOOTING IN THE NATURE OF DIAGNOSING PROBLEMS WITH DATA CAPTURE AND MANAGEMENT SYSTEMS AND NETWORKS, NAMELY, BAR CODE READERS, DATA COLLECTION TERMINALS AND WIRELESS LOCAL AREA NETWORKS (U.S. CLS. 100 AND 101).

FIRST USE 12-0-1983; IN COMMERCE 12-0-1983.

MARTHA FROMM, EXAMINING ATTORNEY

SN 76-687,425. PEDIGREE DOLLS & TOYS LIMITED, DEVON, UNITED KINGDOM, FILED 3-5-2008.



The logo for SINDY, featuring the word "SINDY" in a large, bold, serif font. The letters are black with a white outline, giving it a three-dimensional appearance.

OWNER OF ERPN CMNTY TM OFC REG. NO. 238386, DATED 4-24-1996, RENEWED AS REG. NO. 238386, DATED 4-24-2006, EXPIRES 4-24-2016.

OWNER OF ERPN CMNTY TM OFC REG. NO. 5821707, DATED 3-16-2009, EXPIRES 3-16-2019.

OWNER OF U.S. REG. NOS. 1,009,666, 3,006,124 AND 3,399,303.

CLASS 9—ELECTRICAL AND SCIENTIFIC APPARATUS

FOR OPTICAL DISCS AND COMPACT DISCS FEATURING CHILDREN'S ENTERTAINMENT IN THE NATURE OF MUSIC, MUSICAL SOUND RECORDINGS, MOVIES, MOTION PICTURE FILMS, FILMS FOR TELEVISION AND RECORDED ANIMATED CARTOONS; ELECTRONIC PUBLICATIONS, NAMELY, BOOKS FEATURING CHILDREN'S ENTERTAINMENT RECORDED ON COMPUTER MEDIA; ELECTRONIC PUBLICATIONS, NAMELY, E-ZINES FEATURING CHILDREN'S ENTERTAINMENT RECORDED ON COMPUTER MEDIA; DOWNLOADABLE ELECTRONIC PUBLICATIONS IN THE NATURE OF BOOKS AND PAMPHLETS IN THE FIELD OF CHILDREN'S ENTERTAINMENT; PRE-RECORDED AUDIO AND VIDEO CARTRIDGES, AUDIO AND VIDEO CASSETTES, COMPACT DISCS, LASER DISCS, DVDS, AUDIO AND VIDEO TAPES, AND PHONOGRAPHIC RECORDS FEATURING CHILDREN'S ENTERTAINMENT IN THE NATURE OF MUSIC, MUSICAL SOUND RECORDINGS, MOVIES, MOTION PICTURE FILMS, FILMS FOR TELEVISION AND RECORDED ANIMATED CARTOONS; MOBILE TELEPHONES (U.S. CLS. 21, 23, 26, 36 AND 38).

CLASS 16—PAPER GOODS AND PRINTED MATTER

FOR PAPER, CARDBOARD AND GOODS MADE FROM THESE MATERIALS, NAMELY, BOXES OF PAPER OR CARDBOARD, BAGS OF PAPER OR CARDBOARD, CARRYING CASES MADE OF PAPER, FOLDERS FOR PAPER AND STATIONERY, STATIONERY BOXES, PAPER TAGS FOR INDEX CARDS, TABLE MATS OF PAPER, TABLE CLOTHS OF PAPER, TABLE LINERS OF PAPER, NAPKINS OF PAPER, BLANK PAPER NOTEBOOKS, DRAWING PADS, COASTERS OF PAPER, HANDKERCHIEFS OF PAPER, BLANK OR PARTIALLY PRINTED PAPER LABELS, BLANK OR PARTIALLY PRINTED POSTCARDS, COLLAPSIBLE CARDBOARD BOXES, PICTURE MOUNTS OF CARDBOARD; CARDBOARD, PLACECARDS OF PAPER OR CARDBOARD, PRINTED ADVERTISING BOARDS OF PAPER OR CARDBOARD, TRADING CARD DISCS OF PAPER OR CARDBOARD; PAPER; SCHOOL SUPPLIES, NAMELY, SCHOOL WRITING BOOKS, CHALK BOARDS FOR SCHOOL OR HOME USE, CHILDREN'S INTERACTIVE EDUCATIONAL BOOKS, LOOSE LEAF BINDERS; SCHOOL SUPPLY KITS CONTAINING VARIOUS COMBINATIONS OF SELECTED SCHOOL SUPPLIES, NAMELY, WRITING INSTRUMENTS, PENS, PENCILS, MECHANICAL PENCILS, ERASERS, MARKERS, CRAYONS, HIGHLIGHTERS, FOLDERS, NOTEBOOKS, PAPER PROTRACTORS, PAPER CLIPS, PENCIL SHARPENERS, WRITING GRIPS AND BOOK MARKS; PARTY DECORATIONS MADE OF PAPER AND CARDBOARD; PRINTED MATTER, NAMELY, BOOKS, PAMPHLETS, NEWSLETTERS, MAGAZINES, JOURNALS, BOOKLETS, PLAYBOOKS, GUIDES, DIARIES, DICTIONARIES, HANDBOOKS, LEAFLETS, MANUALS, COMIC BOOKS, COMIC STRIPS, ILLUSTRATED STORIES, CHILDREN'S ACTIVITY BOOKS, NEWSPAPERS, NOTEBOOKS, PERIODICALS AND BROCHURES IN THE FIELD OF CHILDREN'S ENTERTAINMENT, PRINTED ART REPRODUCTIONS, EMBROIDERY DESIGN PATTERNS, PATTERNS FOR MAKING CLOTHES, PRINTED AWARDS, PRINTED CALENDARS, PRINTED CERTIFICATES, PRINTED CHARTS, PRINTED INVITATIONS, PRINTED PAPER LABELS, PRINTED PAPER SIGNS, PRINTED PATTERNS, PRINTED TICKETS; CARDS, NAMELY, GREETING CARDS, NOTE POSTCARDS; PUBLICATIONS, NAMELY, BOOKS, PAMPHLETS, NEWSLETTERS, MAGAZINES, JOURNALS, BOOKLETS, PLAYBOOKS AND BROCHURES IN THE FIELD OF CHILDREN'S ENTERTAINMENT; ALBUMS, NAMELY, STICKER ALBUMS, COIN ALBUMS, EVENT ALBUMS, PHOTOGRAPH ALBUMS, SCRAPBOOK ALBUMS; ANNUALS, NAMELY, SCHOOL YEARBOOKS; BOOKLETS, BOOKS AND BROCHURES IN THE FIELD OF CHILDREN'S ENTERTAINMENT; BADGES OF CARDBOARD AND PAPER; BOOKBINDING MATERIALS; CHARGE CARDS, CREDIT CARDS AND DEBIT CARDS WITHOUT MAGNETIC CODING; DOCUMENT FILES AND HOLDERS; LOOSE LEAF BINDERS; PHOTOGRAPHS; STATIONERY; OFFICE REQUISITES, NAMELY, ADHESIVE TAPE DISPENSERS, PAPER CLIPS, CORRECTING FLUID, PAPER EMBOSSERS, PAPER PUNCHES, RUBBER BANDS AND STAPLERS; PRINTED INSTRUCTIONAL AND TEACHING MATERIALS IN THE FIELD OF CHILDREN'S ENTERTAINMENT; ARTWORK, NAMELY, ART ETCHINGS, ART PRINTS, ART PICTURES, GRAPHIC ART REPRODUCTIONS, LITHOGRAPHIC WORKS OF ART, PRINTED ART REPRODUCTIONS; DIAGRAMS FOR CHILDREN'S ENTERTAINMENT; ILLUSTRATIONS; GRAPHIC PRINTS, REPRESENTATIONS AND ART REPRODUCTIONS; ADVERTISING AND PUBLICITY MATERIALS, NAMELY, ADVERTISING SIGNS OF PAPER OR CARDBOARD, ADVERTISING PAMPHLETS; BOOKMARKS; CALENDARS; POSTERS; PAPER KNIVES; PAPER WEIGHTS; PAPER NAPKINS; PENS AND PENCILS; STICKERS; WRITING PADS AND PAPER; WRAPPING PAPER (U.S. CLS. 2, 5, 22, 23, 29, 37, 38 AND 50).

CLASS 25—CLOTHING

FOR CHILDREN'S CLOTHING, NAMELY, SHIRTS, SHORT-SLEEVED SHIRTS, T-SHIRTS, TOPS, SWEATERS, TURTLENECK SWEATERS, V-NECK SWEATERS, CREW NECK SWEATERS, HOODED SWEAT SHIRTS, JUMPERS, CARDIGANS, TOPS, CROP TOPS, HALTER TOPS, TANK TOPS, TUBE TOPS, FLEECE VESTS, VESTS, LONG SLEEVED VESTS, QUILTED VESTS, PANTS, SKIRTS, COSTUMES FOR USE IN CHILDREN'S DRESS UP PLAY, DRESSES, PINAFORES, PINAFORE DRESSES, TROUSERS, JEANS, COATS, JACKETS, SLEEVED OR SLEEVELESS JACKETS, SHORTS, SWEAT SHORTS, SHORT SETS, SHORT PETTICOATS, SHORT TROUSERS, BELTS, ARM WARMERS, FOLK COSTUMES, HAND-WARMERS, KHAKIS, KNEE WARMERS, NECK TUBES, WRAP-AROUNDS, WRAPS, HOODS, GLOVES, SCARVES, HEAD SCARVES, SHOULDER SCARVES, TIGHTS, LEOTARDS AND TIGHTS FOR CHILDREN OF NYLON, COTTON OR OTHER TEXTILE FIBRES, SOCKS AND STOCKINGS, BODY STOCKINGS, KNEE-HIGH STOCKINGS, BRIEFS, UNDERWEAR, BRAS, STRAPS FOR BRAS, FITTED SWIMMING COSTUMES WITH BRA CUPS, SWIMMING COSTUMES, WET SUITS, UNDERPANTS, NIGHT GOWNS, NIGHT SHIRTS, PYJAMAS, NIGHTDRESSES, NIGHTIES, INFANT AND TODDLER ONE PIECE CLOTHING, ONE-PIECE PLAY SUITS, JERSEYS, MUFFLERS, SHOULDER WRAPS, TIES, TRAVEL CLOTHING CONTAINED IN A PACKAGE COMPRISING REVERSIBLE JACKETS, PANTS, SHIRTS, TOPS AND A BELT OR SCARF; CHILDREN'S FOOTWEAR, NAMELY, BOOTS, ANKLE BOOTS, RAIN BOOTS, INFANTS' BOOTS, SNOW BOOTS, SHOES, TAP SHOES, BALLET SHOES, BEACH SHOES, CANVAS SHOES, INFANTS' SHOES, SNEAKERS, ATHLETIC SHOES, SANDALS, FLIP FLOPS, SLIPPERS, BALLET SLIPPERS, BATH SLIPPERS; CHILDREN'S HEADGEAR, NAMELY, HATS, CAPS, HEADWEAR, HEAD SWEATBANDS; CHILDREN'S SPORTS AND ACTIVITY CLOTHING, NAMELY, SPORTS SHIRTS, SPORTS PANTS, SPORTS COATS, SPORTS BRAS, SPORTS OVERUNIFORMS, SPORTS JERSEYS, SPORTS JACKETS; ATHLETIC APPAREL, NAMELY, SHIRTS, PANTS, JACKETS, FOOTWEAR, HATS, CAPS AND ATHLETIC UNIFORMS; CHILDREN'S WATERPROOF CLOTHING, NAMELY, JACKETS AND PANTS; CHILDREN'S BRACES IN THE NATURE OF SUSPENDERS (U.S. CLS. 22 AND 39).

ERNEST SHOSHO, EXAMINING ATTORNEY

SN 76-689,219. CONSCIOUS CONTENT MEDIA, LLC, DBA SPEAKABOOS, NEW YORK, NY. FILED 5-2-2008.

Speakaboos

THE MARK CONSISTS OF STANDARD CHARACTERS WITHOUT CLAIM TO ANY PARTICULAR FONT, STYLE, SIZE, OR COLOR.

CLASS 9—ELECTRICAL AND SCIENTIFIC APPARATUS

FOR PRE-RECORDED AUDIOCASSETTES, VIDEO-CASSETTES, AND COMPACT DISCS, AND DVDS, ALL FEATURING CONTENT FOR CHILDREN, NAMELY, STORIES RECITED AND MUSIC PERFORMED BY WELL-KNOWN ARTISTS; COMPUTER SOFTWARE CONTAINING PROGRAMS FOR CHILDREN CONSISTING OF STORIES IN BOTH WRITTEN AND NARRATED FORM, TO TEACH LITERACY AND LANGUAGE ARTS; LASER VIDEO DISCS AND DOWNLOADABLE VIDEO RECORDINGS ALL FEATURING CONTENT FOR CHILDREN; MUSICAL SOUND RECORDINGS, VIDEO RECORDINGS AND AUDIO RECORDINGS FEATURING AUDIO VISUAL CONTENT FOR CHILDREN; PHONOGRAPHIC RECORDINGS AND AUDIO DISCS ALL FEATURING MUSIC, AND AUDIO VISUAL CONTENT FOR CHILDREN CONSISTING OF STORIES TO TEACH LITERACY AND LANGUAGE ARTS; BLANK AUDIO TAPES; COMPUTER GAME CASSETTES; DATA COMPRESSION SOFTWARE; PRE-RECORDED DVD'S AND PRE-RECORDED DIGITAL AUDIO TAPES ALL IN THE FIELD OF CHILDREN'S PROGRAMS, FEATURING STORIES TO TEACH LITERACY AND LANGUAGE ARTS; VIDEO AND AUDIO GAME TAPE CASSETTES AND VIDEO GAME CARTRIDGES AND VIDEO GAME SOFTWARE, ALL FEATURING MOTION PICTURES, MUSIC, CONSISTING OF WORKSHEETS, DISCUSSION QUESTIONS, INSTRUCTIONS FOR ACTIVITIES COVERING SPELLING, READING COMPREHENSION, RHYMING, VOCABULARY, ARTS AND CRAFTS, ENTERTAINMENT INVOLVING MEMORY AND OBJECT IDENTIFICATION; COMPUTER GAMES, ELECTRONIC GAME SOFTWARE, GAME SOFTWARE, AND/OR VIDEO GAME SOFTWARE FOR CHILDREN FEATURING MEMORY AND/OR IDENTIFICATION CHALLENGES IN THE FIELDS OF SPORTS, NEWS AND/OR CURRENT EVENTS; COMPUTER SOFTWARE TO ENHANCE THE AUDIO-VISUAL CAPABILITIES OF MULTIMEDIA APPLICATIONS, NAMELY, FOR THE INTEGRATION OF TEXT, AUDIO, GRAPHICS, STILL IMAGES AND MOVING PICTURES; DIGITAL VIDEO AND AUDIO TAPE, CASSETTE AND DISC PLAYERS; APPARATUS FOR RECORDING, TRANSMISSION, PROCESSING AND REPRODUCTION OF MUSICAL SOUND RECORDINGS AND/OR MOVING PICTURES; JACKETS FOR VIDEO AND AUDIO CASSETTES, TAPES, AND DISCS; BLANK AUDIO DIGITAL TAPES, VIDEO TAPES AND MAGNETIC DATA CARRIERS; COMPUTER SOFTWARE AND HARDWARE ALLOWING INDIVIDUALS IN THEIR HOMES, THROUGH A STANDARD COMPUTER MICROPHONE, TO RECORD VERSIONS OF STORIES, SONGS AND LULLABIES IN THEIR OWN VOICES AND BURN THEM ONTO A CD OR MP3 TO SHARE WITH THEIR CHILDREN; PRE-RECORDED CDS, DVDS, AUDIO CASSETTES, VIDEO CASSETTES FEATURING STORIES ON LITERACY AND LANGUAGE ARTS FOR CHILDREN FOR USE BY TEACHERS IN THE CLASSROOM (U.S. CLS. 21, 23, 26, 36 AND 38).

FIRST USE 3-1-2007; IN COMMERCE 3-1-2007.

CLASS 41—EDUCATION AND ENTERTAINMENT

FOR ENTERTAINMENT SERVICES, NAMELY, PRODUCTION OF UNIQUE AUDIO-VIDEO TAPES, CASSETTES, CDS, DVDS FOR CHILDREN FEATURING PRE-RECORDED PERFORMANCES BY CELEBRITIES IN THE FIELDS OF EDUCATION, RECREATION AND ENTERTAINMENT (U.S. CLS. 100, 101 AND 107).

FIRST USE 3-1-2007; IN COMMERCE 3-1-2007.
BARBARA A. GOLD, EXAMINING ATTORNEY

SN 76-691,309. POLARIS PROJECT, WASHINGTON, DC. FILED 7-15-2008.

GIVE A SHIFT

THE MARK CONSISTS OF STANDARD CHARACTERS WITHOUT CLAIM TO ANY PARTICULAR FONT, STYLE, SIZE, OR COLOR.

CLASS 26—FANCY GOODS

FOR NOVELTY BUTTONS (U.S. CLS. 37, 39, 40, 42 AND 50).
FIRST USE 12-3-2007; IN COMMERCE 12-3-2007.

CLASS 36—INSURANCE AND FINANCIAL

FOR CHARITABLE FUNDRAISING SERVICES, NAMELY, ORGANIZING FUNDRAISING EVENTS FOR VICTIMS OF HUMAN TRAFFICKING AND MODERN DAY SLAVERY (U.S. CLS. 100, 101 AND 102).
FIRST USE 12-3-2007; IN COMMERCE 12-3-2007.
MEGHAN REINHART, EXAMINING ATTORNEY

SN 76-697,024. AMERINET, INC., ST. LOUIS, MO. FILED 4-22-2009.

NAVIGATE PROFITPOINT

THE MARK CONSISTS OF STANDARD CHARACTERS WITHOUT CLAIM TO ANY PARTICULAR FONT, STYLE, SIZE, OR COLOR.

CLASS 35—ADVERTISING AND BUSINESS

FOR SERVICES PROVIDED TO HOSPITALS, CLINICS, HEALTH CARE CENTERS, PHARMACIES, NURSING HOMES AND MEDICAL INSTITUTIONS IN THE HEALTH CARE FIELD, NAMELY, BUSINESS MANAGEMENT CONSULTATION SERVICES WITH RELATION TO STRATEGY, FEATURING ANALYTIC MODELS FOR UNDERSTANDING AND PREDICTING OF MARKET TRENDS, PROFIT SURVEY AND ANALYSIS WITH RESPECT TO HEALTHCARE PRODUCTS AND SERVICES, AND DEMOGRAPHIC CONSULTATION AND STUDIES PERTAINING TO HEALTHCARE PATIENTS (U.S. CLS. 100, 101 AND 102).

CLASS 44—MEDICAL, BEAUTY AND AGRICULTURAL SERVICES

FOR PROVIDING HEALTHCARE INFORMATION TO MEMBER HOSPITALS, CLINICS, HEALTH CARE CENTERS, PHARMACIES, NURSING HOMES AND MEDICAL INSTITUTIONS CONCERNING HEALTHCARE PRODUCT USAGE AND HEALTHCARE SERVICES (U.S. CLS. 100 AND 101).

AMY ALFIERI, EXAMINING ATTORNEY

SN 76-697,029. AMERINET, INC., ST. LOUIS, MO. FILED 4-22-2009.

NAVIGATE TRENDPOINT

THE MARK CONSISTS OF STANDARD CHARACTERS WITHOUT CLAIM TO ANY PARTICULAR FONT, STYLE, SIZE, OR COLOR.

CLASS 35—ADVERTISING AND BUSINESS

FOR SERVICES PROVIDED TO MEMBER HOSPITALS, CLINICS, HEALTH CARE CENTERS, PHARMACIES, NURSING HOMES AND MEDICAL INSTITUTIONS, NAMELY, BUSINESS MANAGEMENT CONSULTATION SERVICES WITH RELATION TO STRATEGY, FEATURING ANALYTIC MODELS FOR UNDERSTANDING AND PREDICTING OF MARKET TRENDS, AND DEMOGRAPHIC CONSULTATION AND STUDIES PERTAINING TO HEALTHCARE PATIENTS (U.S. CLS. 100, 101 AND 102).

CLASS 44—MEDICAL, BEAUTY AND AGRICULTURAL SERVICES

FOR PROVIDING HEALTHCARE INFORMATION TO MEMBERS OF A GROUP PURCHASING ORGANIZATION INCLUDING HOSPITALS, CLINICS, HEALTH CARE CENTERS, PHARMACIES, NURSING HOMES AND MEDICAL INSTITUTIONS CONCERNING HEALTHCARE PRODUCT USAGE AND HEALTHCARE SERVICES (U.S. CLS. 100 AND 101).
AMY ALFIERI, EXAMINING ATTORNEY

SN 76-698,859. ANGELS HELPING SENIORS VETERANS & MORE..., POTOMAC FALLS, VA. FILED 8-7-2009.



THE COLOR(S) DARK BLUE, LIGHT BLUE, WHITE, YELLOW, BLACK AND GRAY IS/ARE CLAIMED AS A FEATURE OF THE MARK.

THE MARK CONSISTS OF THE DESIGN OF AN ANGEL WITH A HALO OVER ITS HEAD. THE PHRASE "ANGELS HELPING SENIORS VETERANS & MORE..." APPEARS AT THE ANGEL'S FEET AND EXTENDS TO THE RIGHT. A STAR APPEARS AFTER THE WORDS "ANGELS", "HELPING", AND "SENIORS". BELOW THIS PHRASE IS THE WORDING "'ANGELS 4 ANGELS'". THE COLOR DARK BLUE APPEARS IN THE OUTLINE OF THE ANGEL, IN THE OUTLINE OF EACH STAR, AND IN THE WORDING "'ANGELS 4 ANGELS'". IN THE WORDING "ANGELS HELPING SENIORS VETERANS & MORE...", THE COLOR DARK BLUE IS AT THE TOP OF EACH WORD AND FADES TO LIGHT BLUE TOWARD THE BOTTOM. THE COLOR LIGHT BLUE APPEARS IN A LIGHTER, SECONDARY OUTLINE OF THE ANGEL. THE COLOR BLACK APPEARS IN THE OUTLINES OF THE WORDS "ANGELS HELPING SENIORS VETERANS & MORE...". A MIXTURE OF THE COLORS WHITE AND GRAY APPEAR IN THE BACKGROUND OF THE MARK. THE COLOR YELLOW APPEARS IN THE HALO AND IN EACH STAR DESIGN.

CLASS 44—MEDICAL, BEAUTY AND AGRICULTURAL SERVICES

FOR HOME HEALTH CARE SERVICES (U.S. CLS. 100 AND 101).
FIRST USE 6-22-2009; IN COMMERCE 6-22-2009.

CLASS 45—PERSONAL AND LEGAL SERVICES

FOR PERSONAL CARE ASSISTANCE FOR PERSONS AT THEIR OWN HOMES, NAMELY, ASSISTING ELDERLY PERSONS, HOMEBOUND PERSONS, DISABLED VETERANS, AND FRAIL INDIVIDUALS WITH ACTIVITIES OF DAILY LIVING, NAMELY, ASSISTING WITH BATHING AND GROOMING ACTIVITIES; PROVIDING NON-MEDICAL ASSISTED LIVING SERVICES FOR PERSONAL PURPOSES FOR ELDERLY PERSONS, NURSING MOTHERS, HOMEBOUND PERSONS, DISABLED VETERANS, AND FRAIL INDIVIDUALS, ALL IN THE NATURE OF ANSWERING THE TELEPHONE, SORTING MAIL, AND BABYSITTING SERVICES (U.S. CLS. 100 AND 101).

FIRST USE 6-22-2009; IN COMMERCE 6-22-2009.
MAUREEN DALL, EXAMINING ATTORNEY

SN 76-699,386. ARTHRITICISE, LLC, DELRAY BEACH, FL. FILED 9-9-2009.

ARTHRITICISE

THE MARK CONSISTS OF STANDARD CHARACTERS WITHOUT CLAIM TO ANY PARTICULAR FONT, STYLE, SIZE, OR COLOR.

CLASS 5—PHARMACEUTICALS

FOR DIETARY AND NUTRITIONAL SUPPLEMENTS AND DIET AIDS, NAMELY, VITAMINS AND MINERAL SUPPLEMENTS (U.S. CLS. 6, 18, 44, 46, 51 AND 52).

CLASS 9—ELECTRICAL AND SCIENTIFIC APPARATUS

FOR PRERECORDED VIDEO AND AUDIOCASSETTES FEATURING EXERCISE, FITNESS AND DIETARY INFORMATION AND INSTRUCTION TO IMPROVE THE HEALTH AND FITNESS OF INDIVIDUALS; DVDS, CD-ROMS AND CDS AND ELECTRONIC PUBLICATIONS, NAMELY, BOOKS RECORDED ON COMPUTER MEDIA FEATURING EXERCISE, FITNESS AND DIETARY INFORMATION AND INSTRUCTION TO IMPROVE THE HEALTH AND FITNESS OF INDIVIDUALS (U.S. CLS. 21, 23, 26, 36 AND 38).

CLASS 28—TOYS AND SPORTING GOODS

FOR EXERCISE BALLS AND EXERCISE BANDS (U.S. CLS. 22, 23, 38 AND 50).
NAPOLEON SHARMA, EXAMINING ATTORNEY

SN 76-699,925. THE EASTERN COMPANY, DBA EBERHARD MANUFACTURING COMPANY,, NAUGATUCK, CT. FILED 10-19-2009.

VISION & STYLE WE'RE CHANGING THE FUTURE

THE MARK CONSISTS OF STANDARD CHARACTERS WITHOUT CLAIM TO ANY PARTICULAR FONT, STYLE, SIZE, OR COLOR.

CLASS 6—METAL GOODS

FOR METAL LATCHES, LOCKS, HINGES AND HANDLES FOR CABINETS, DRAWERS AND CLOSURES AND COMPONENT PARTS THEREOF; METAL LATCHES FOR MULTI-PURPOSE USE AND COMPONENT PARTS THEREOF; LOCKABLE AND PADLOCKABLE METAL LATCH ASSEMBLIES AND COMPONENT PARTS THEREOF; METAL CAM LATCHES, METAL COMBINATION OPERATED CAM LATCHES, KEY OPERATED CAM LATCHES AND ADJUSTABLE CAM LATCHES AND COMPONENT PARTS THEREOF; METAL SLAM LATCHES, METAL COMPARTMENT LATCHES, METAL HASP LATCHES, METAL DRAW LATCHES AND METAL TAKE-UP LATCHES AND COMPONENT PARTS THEREOF; METAL FLUSH MOUNTABLE, METAL RECESS MOUNTABLE AND SURFACE MOUNTABLE LATCHES AND COMPONENT PARTS THEREOF; METAL QUARTER-TURN AND HALF-TURN LATCHES AND COMPONENT PARTS THEREOF; METAL COMPRESSION AND SWELL LATCHES AND COMPONENT PARTS THEREOF; METAL ROTARY LATCHES, METAL SPRING PROJECTED BOLT LATCHES AND METAL DEAD BOLT LATCHES AND COMPONENT PARTS THEREOF; METAL FINGER PULL AND PULL RING LATCHES AND COMPONENT PARTS THEREOF; METAL SQUEEZE OPERATED, PUSH BUTTON OPERATED, PADDLE HANDLE OPERATED, TOOL OPERATED, TRIGGER OPERATED, LINKAGE OPERATED AND CABLE OPERATED LATCHES AND COMPONENT PARTS THEREOF; METAL SINGLE-POINT, TWO-POINT AND MULTI-POINT LATCHES AND COMPONENT PARTS THEREOF; METAL PIVOTAL HANDLE, SLIDABLE HANDLE, FOLDABLE HANDLE, D-HANDLE, L-HANDLE, T-HANDLE AND PUSH BUTTON TYPE OPERATING ASSEMBLIES FOR METAL LATCHES AND METAL LOCKS AND COMPONENT PARTS THEREOF; METAL LOCKS FOR MULTIPURPOSE USE AND COMPONENT PARTS THEREOF; PIVOTAL DOOR, SLIDING DOOR, FOLDING DOOR, OVERHEAD DOOR AND GATE METAL LOCKS AND COMPONENT PARTS THEREOF; COMBINATION OPERATED AND KEY OPERATED METAL LOCKS AND COMPONENT PARTS THEREOF; FLUSH MOUNTABLE AND SURFACE MOUNTABLE METAL LOCKS AND COMPONENT PARTS THEREOF; METAL CAM LOCKS AND METAL ADJUSTABLE CAM LOCKS AND COMPONENT PARTS THEREOF; PIVOTAL HANDLE OPERATED, PUSH BUTTON OPERATED, PADDLE OPERATED, TOOL OPERATED AND TRIGGER OPERATED METAL LOCKS AND COMPONENT PARTS THEREOF; METAL LOCK CYLINDERS; METAL DOOR LATCH HARDWARE, NAMELY, HASPS; METAL KEYS FOR LOCKS; METAL HANDLES FOR LATCHES AND LOCKS; METAL PULL HANDLES, GRAB HANDLES, DOOR, DRAWER AND CABINET HANDLES; LOCKABLE AND PADLOCKABLE METAL HANDLES; FLUSH MOUNTABLE, RECESS MOUNTABLE AND SURFACE MOUNTABLE METAL HANDLES FOR DOORS, DRAWERS, CABINETS, LATCHES AND LOCKS; METAL FOLDABLE HANDLES, D-HANDLES, L-HANDLES AND T-HANDLES FOR DOORS, DRAWERS, CABINETS, LATCHES AND LOCKS; METAL HINGES FOR GENERAL PURPOSE USE; BUTT, STRAP AND LIFT-OFF METAL HINGES; FLUSH MOUNTABLE, RECESS MOUNTABLE AND SURFACE MOUNTABLE METAL HINGES; METAL DOOR HARDWARE, NAMELY, STRIKES, DOOR GUIDES AND DOOR HOLDERS; CUSTOM METAL STAMPINGS, NAMELY, ROUGH AND SEMIFINISHED MALLEABLE IRON CASTINGS; METAL TIE DOWN BRACKETS; METAL GENERAL PURPOSE ROPE CLEATS; METAL ROPE HOOKS; METAL PULL CLEATS; METAL ESCUTCHEONS FOR USE BEHIND HANDLES OF THE FOREGOING TYPES; METAL CLOSURE RETAINERS FOR HOLDING DOORS IN OPEN AND CLOSED POSITIONS; METAL HARDWARE, NAMELY, FOLDING STEP ASSEMBLIES FOR GENERAL PURPOSE USE AND COMPONENT PARTS THEREOF (U.S. CLS. 2, 12, 13, 14, 23, 25 AND 50).

FIRST USE 9-18-2009; IN COMMERCE 10-1-2009.

CLASS 7—MACHINERY

FOR GAS SPRING UNITS POWERED BY COMPRESSED GAS TO EXERT FORCE FOR REGULATING MOVEMENTS OF CLOSURES, AND MOUNTING COMPONENT PARTS THEREFOR (U.S. CLS. 13, 19, 21, 23, 31, 34 AND 35).

FIRST USE 9-22-2009; IN COMMERCE 10-1-2009.

CLASS 9—ELECTRICAL AND SCIENTIFIC APPARATUS

FOR ELECTRICALLY AND ELECTRONICALLY CONTROLLED LATCHES AND LOCKS, AND COMPONENT PARTS THEREOF; ELECTRO-MECHANICAL LATCHES AND LOCKS, AND COMPONENT PARTS THEREOF; ELECTRICALLY POWERED ACTUATORS FOR MOVING COMPONENTS OF LATCHES AND LOCKS, AND FOR OPERATING LATCHES AND LOCKS, AND COMPONENT PARTS THEREOF; AND ELECTRICAL AND ELECTRONIC LATCHES AND LOCKS AND COMPONENT PARTS THEREOF (U.S. CLS. 21, 23, 26, 36 AND 38).

FIRST USE 10-1-2009; IN COMMERCE 10-1-2009.

CLASS 12—VEHICLES

FOR HARDWARE ADAPTED FOR USE ON LAND VEHICLES, FOR ALL OF THE FOLLOWING GOODS, NAMELY, LATCHES, LOCKS, HINGES AND HANDLES FOR CLOSURES AND COMPONENT PARTS THEREOF; METAL PASSENGER RESTRAINT LATCHES AND COMPONENT PARTS THEREOF; LOCKABLE AND PADLOCKABLE LATCH ASSEMBLIES AND COMPONENT PARTS THEREOF; CAM LATCHES, COMBINATION OPERATED CAM LATCHES, KEY OPERATED CAM LATCHES AND ADJUSTABLE CAM LATCHES AND COMPONENT PARTS THEREOF; SLAM LATCHES, COMPARTMENT LATCHES, HASP LATCHES, DRAW LATCHES AND TAKE-UP LATCHES AND COMPONENT PARTS THEREOF; FLUSH MOUNTABLE, RECESS MOUNTABLE AND SURFACE MOUNTABLE LATCHES AND COMPONENT PARTS THEREOF; QUARTER-TURN AND HALF-TURN LATCHES AND COMPONENT PARTS THEREOF; COMPRESSION AND SWELL LATCHES AND COMPONENT PARTS THEREOF; ROTARY LATCHES, SPRING PROJECTED BOLT LATCHES AND DEAD BOLT LATCHES AND COMPONENT PARTS THEREOF; FINGER PULL AND PULL RING LATCHES AND COMPONENT PARTS THEREOF; SQUEEZE OPERATED, PUSH BUTTON OPERATED, PADDLE HANDLE OPERATED, TOOL OPERATED, TRIGGER OPERATED, LINKAGE OPERATED AND CABLE OPERATED LATCHES AND COMPONENT PARTS THEREOF; SINGLE-POINT, TWO-POINT AND MULTI-POINT LATCHES AND COMPONENT PARTS THEREOF; PIVOTAL HANDLE, SLIDABLE HANDLE, FOLDABLE HANDLE, D-HANDLE, L-HANDLE, T-HANDLE AND PUSH BUTTON TYPE OPERATING ASSEMBLIES FOR LATCHES AND LOCKS AND COMPONENT PARTS THEREOF; LOCKS; PIVOTAL DOOR, SLIDING DOOR AND FOLDING DOOR LOCKS AND COMPONENT PARTS THEREOF; COMBINATION OPERATED AND KEY OPERATED LOCKS AND COMPONENT PARTS THEREOF; FLUSH MOUNTABLE AND SURFACE MOUNTABLE LOCKS AND COMPONENT PARTS THEREOF; CAM LOCKS AND ADJUSTABLE CAM LOCKS AND COMPONENT PARTS THEREOF; PIVOTAL HANDLE OPERATED, PUSH BUTTON OPERATED, PADDLE OPERATED, TOOL OPERATED AND TRIGGER OPERATED LOCKS AND COMPONENT PARTS THEREOF; LOCK CYLINDERS; HASPS; KEYS FOR LOCKS; HANDLES FOR LATCHES AND LOCKS; PULL HANDLES, GRAB HANDLES, DOOR, DRAWER AND CABINET HANDLES; LOCKABLE AND PADLOCKABLE HANDLES; FLUSH MOUNTABLE, RECESS MOUNTABLE AND SURFACE MOUNTABLE HANDLES; FOLDABLE HANDLES, D-HANDLES, L-HANDLES AND T-HANDLES; HINGES, NAMELY, FLUSH MOUNTABLE, RECESS MOUNTABLE AND SURFACE MOUNTABLE HINGES; STRIKES, DOOR GUIDES AND DOOR HOLDERS; TIE DOWN BRACKETS; ROPE CLEATS; ROPE HOOKS; PULL CLEATS; ESCUTCHEONS FOR USE BEHIND HANDLES OF THE FOREGOING TYPES; CLOSURE RETAINER FOR HOLDING DOORS IN OPEN AND CLOSED POSITIONS; FOLDING STEPS AND FOLDING STEP ASSEMBLIES AND COMPONENT

PARTS THEREOF; BODY HANDLES, BRACKETS FOR BODY HANDLES, BUS SEAT HANDLES, SIDE DOOR CONTROLS FOR BUSES AND MOTOR COACHES, EMERGENCY DOOR CONTROLS FOR BUSES AND COACHES, FOLDING STEP IRONS, SEAT IRONS, LADDER HOLDERS, END GATE FASTENERS, PIVOT PLATES FOR END GATES, STAKE RACK FASTENERS, END GATE CATCH HOOKS, TOP HOOD BRACES, SLIDING DOOR GUIDES, YOKE ROD ENDS, FOOTMAN LOOPS, LOCKS, TRAILER HITCHES, STEP PADS AND BRACES (U.S. CLS. 19, 21, 23, 31, 35 AND 44).

FIRST USE 9-18-2009; IN COMMERCE 10-1-2009.
FRED MANDIR, EXAMINING ATTORNEY

SN 76-700,030. LITTLE CAESAR ENTERPRISES, INC., DETROIT, MI. FILED 10-21-2009.

LITTLE CAESARS PIZZA BOWL

THE MARK CONSISTS OF STANDARD CHARACTERS WITHOUT CLAIM TO ANY PARTICULAR FONT, STYLE, SIZE, OR COLOR.

OWNER OF U.S. REG. NO. 2,067,136.
NO CLAIM IS MADE TO THE EXCLUSIVE RIGHT TO USE "BOWL", APART FROM THE MARK AS SHOWN.

CLASS 25—CLOTHING

FOR CLOTHING, NAMELY, T-SHIRTS AND HEADWEAR IN CLASS 25 (U.S. CLS. 22 AND 39).

CLASS 36—INSURANCE AND FINANCIAL

FOR FINANCIAL SPONSORSHIP OF A COLLEGE FOOTBALL BOWL GAME IN CLASS 36 (U.S. CLS. 100, 101 AND 102).
MYRIAH HABEEB, EXAMINING ATTORNEY

SN 76-700,031. LITTLE CAESAR ENTERPRISES, INC., DETROIT, MI. FILED 10-21-2009.



OWNER OF U.S. REG. NO. 2,067,136.
NO CLAIM IS MADE TO THE EXCLUSIVE RIGHT TO USE "BOWL", APART FROM THE MARK AS SHOWN.
THE MARK CONSISTS OF A FANCIFUL DEPICTION OF

THE UPPER TORSO OF A MAN IN PROFILE WEARING A LAUREL WREATH ON HIS HEAD EATING A SLICE OF PIZZA AND HOLDING A SPEAR WITH THE REMAINDER OF THE PIZZA, ENCLOSED IN A ROUNDED TOP SQUARE, ABOVE THE STYLIZED TERM "LITTLE" ABOVE THE STYLIZED TERM "CAESARS", ABOVE THE PHRASE "PIZZA BOWL" SUPERIMPOSED ON TOP OF A FOOTBALL WITH VISIBLE STRIPES ON BOTH ENDS AND LACES AT THE BOTTOM, ALL SUPERIMPOSED ON A DOWNWARD FACING WEDGE REPRESENTING A SLICE OF PIZZA .

CLASS 25—CLOTHING

FOR CLOTHING, NAMELY, T-SHIRTS AND HEADWEAR (U.S. CLS. 22 AND 39).

CLASS 36—INSURANCE AND FINANCIAL

FOR FINANCIAL SPONSORSHIP OF A COLLEGE FOOTBALL BOWL GAME (U.S. CLS. 100, 101 AND 102).
MYRIAH HABEEB, EXAMINING ATTORNEY

SN 76-700,268. M-FIELD ENERGY LTD, DA-AN DIST., TAIPEI CITY, TAIWAN, FILED 11-6-2009.

M-FIELD

THE MARK CONSISTS OF STANDARD CHARACTERS WITHOUT CLAIM TO ANY PARTICULAR FONT, STYLE, SIZE, OR COLOR.

CLASS 7—MACHINERY

FOR DYNAMOS; DC GENERATORS; ELECTRIC GENERATORS AND RELATED EQUIPMENT, NAMELY, AUTOMATIC STANDBY ELECTRIC GENERATOR SETS; HEAT EXCHANGERS BEING PARTS OF MACHINES; ENGINES, OTHER THAN FOR LAND VEHICLES; TRANSMISSIONS FOR MACHINES; SERVO-DRIVES FOR MOTORS; MARINE ENGINES AND PARTS AND FITTINGS THEREOF; STARTERS FOR MOTORS AND ENGINES; MOTORS, OTHER THAN FOR LAND VEHICLES; AC GENERATORS; ALTERNATORS FOR LAND VEHICLES; STARTER ALTERNATORS; BOAT ENGINES (U.S. CLS. 13, 19, 21, 23, 31, 34 AND 35).
FIRST USE 9-1-2009; IN COMMERCE 9-1-2009.

CLASS 9—ELECTRICAL AND SCIENTIFIC APPARATUS

FOR BATTERIES, ACCUMULATOR JARS, ACCUMULATORS, FUEL CELLS, ELECTRICAL POWER SUPPLIES, UNINTERRUPTIBLE ELECTRICAL POWER SUPPLIES (U.S. CLS. 21, 23, 26, 36 AND 38).
FIRST USE 9-1-2009; IN COMMERCE 9-1-2009.

CLASS 11—ENVIRONMENTAL CONTROL APPARATUS

FOR HOT WATER HEATERS; GAS WATER HEATERS; WATER HEATERS; NON-ELECTRIC POCKET WARMERS, NAMELY, CHEMICALLY-ACTIVATED HEATING PACKETS FOR WARMING HANDS, NOT FOR MEDICAL PURPOSES; ELECTRIC FOOT WARMERS; ELECTRIC SPACE HEATERS; ELECTRIC RADIATORS FOR HEATING BUILDINGS (U.S. CLS. 13, 21, 23, 31 AND 34).
FIRST USE 9-1-2009; IN COMMERCE 9-1-2009.

TASNEEM HUSSAIN, EXAMINING ATTORNEY

SN 76-700,335. ADVANCE MAGAZINE PUBLISHERS INC.,
NEW YORK, NY. FILED 11-12-2009.

TEEN VOGUE

THE MARK CONSISTS OF STANDARD CHARACTERS WITHOUT CLAIM TO ANY PARTICULAR FONT, STYLE, SIZE, OR COLOR.

NO CLAIM IS MADE TO THE EXCLUSIVE RIGHT TO USE "TEEN", APART FROM THE MARK AS SHOWN.

CLASS 11—ENVIRONMENTAL CONTROL APPARATUS

FOR TABLE, FLOOR AND OTHER ELECTRIC LAMPS; ELECTRIC NIGHT LIGHTS (U.S. CLS. 13, 21, 23, 31 AND 34).

CLASS 20—FURNITURE AND ARTICLES NOT OTHERWISE CLASSIFIED

FOR PILLOWS; OTTOMANS; BEAN BAG CHAIRS; FABRIC CHAIRS; DRAWERS; HAMPERS; PLASTIC CRATES FOR USE AS STORAGE CUBES; BED RESTS; NON-METAL FABRIC STORAGE BIN ORGANIZER IN THE NATURE OF A COLLAPSIBLE BASKET (U.S. CLS. 2, 13, 22, 25, 32 AND 50).

CLASS 24—FABRICS

FOR BED SHEETS; COMFORTERS; QUILTS; TROWS; BED AND LAP BLANKETS; BLANKET TROWS; BED SKIRTS; WINDOW TREATMENTS, NAMELY, CURTAINS AND DRAPERY (U.S. CLS. 42 AND 50).

CLASS 27—FLOOR COVERINGS

FOR RUGS (U.S. CLS. 19, 20, 37, 42 AND 50).
IRA J. GOODSaid, EXAMINING ATTORNEY

SN 77-005,636. SATELLITE INFORMATION SERVICES LIMITED, LONDON, UNITED KINGDOM, FILED 9-22-2006.

uPod

THE MARK CONSISTS OF STANDARD CHARACTERS WITHOUT CLAIM TO ANY PARTICULAR FONT, STYLE, SIZE, OR COLOR.

OWNER OF UNITED KINGDOM REG. NO. 2432721, DATED 9-15-2006, EXPIRES 9-15-2016.

OWNER OF ERPN CMNTY TM OFC REG. NO. 3604436, DATED 11-16-2005, EXPIRES 12-17-2013.

CLASS 9—ELECTRICAL AND SCIENTIFIC APPARATUS

FOR NON-HAND-HELD ELECTRONIC GOODS, NAMELY, A SATELLITE-LINK UNIT WHICH IS MOUNTED ON A VEHICLE OR A BUILDING OR FIXED TO THE GROUND, COMPRISED OF A COLLAPSIBLE DISH ANTENNA AND RELATED HARDWARE FOR THE CONNECTION VIA SATELLITE OF AUDIO, AUDIO VISUAL AND VISUAL TELEVISION TRANSMISSION FROM REMOTE SITES TO BROADCASTERS' STUDIO FACILITIES, BUT NOT FOR ANY DIRECT TRANSMISSION TO CONSUMERS OR MEMBERS OF THE PUBLIC; NONE OF THE AFORESAID GOODS BEING HAND-HELD (U.S. CLS. 21, 23, 26, 36 AND 38).

CLASS 16—PAPER GOODS AND PRINTED MATTER

FOR PRINTED MATTER IN THE FIELD OF SATELLITE TELECOMMUNICATIONS, NAMELY, BOOKS, MAGAZINES, NEWSLETTERS, PRINTED MANUALS AND USER GUIDES, PRINTED INSTRUCTIONAL AND TEACHING MATERIAL, AND BROCHURES, ALL OF THE AFORESAID GOODS FOR USE IN RELATION TO THE PROVISION OF INFORMATION, DATA, GRAPHICS, SOUND, MUSIC, VIDEOS, ANIMATION AND TEXT; ALL THE AFORESAID GOODS FOR USE IN RELATION TO A NON HAND HELD SATELLITE UP-LINK WHICH IS MOUNTED ON A VEHICLE OR A BUILDING OR FIXED TO THE GROUND, COMPRISED OF A COLLAPSIBLE DISH ANTENNA AND RELATED HARDWARE FOR THE CONNECTION VIA SATELLITE OF AUDIO, AUDIO-VISUAL AND VISUAL TELEVISION TRANSMISSION FROM REMOTE SITES TO BROADCASTERS' STUDIO FACILITIES, BUT NOT FOR ANY DIRECT TRANSMISSION TO CONSUMERS OR MEMBERS OF THE PUBLIC, NONE OF THE GOODS BEING HAND-HELD (U.S. CLS. 2, 5, 22, 23, 29, 37, 38 AND 50).

CLASS 35—ADVERTISING AND BUSINESS

FOR ADVERTISING AND PROMOTION SERVICES, ALL RELATING TO THE PROVISION OF AND/OR BROADCASTING OF INFORMATION, DATA, GRAPHICS, SOUND, MUSIC, VIDEOS, ANIMATION AND TEXT, AND ALL THE AFORESAID SERVICES FOR USE IN RELATION TO A SATELLITE UP-LINK WHICH IS MOUNTED ON A VEHICLE OR A BUILDING OR FIXED TO THE GROUND, COMPRISED OF A COLLAPSIBLE DISH ANTENNA AND RELATED HARDWARE FOR THE CONNECTION VIA SATELLITE OF AUDIO, AUDIO-VISUAL AND VISUAL TELEVISION TRANSMISSION FROM REMOTE SITES TO BROADCASTERS' STUDIO FACILITIES, BUT NOT FOR ANY DIRECT TRANSMISSION TO CONSUMERS OR MEMBERS OF THE PUBLIC; NONE OF THE AFORESAID GOODS BEING HAND-HELD; ADVERTISING, PROMOTIONAL AND MARKETING SERVICES PROVIDED VIA SATELLITE TRANSMISSION, THE INTERNET OR THROUGH OTHER ELECTRONIC MEANS ALL RELATING TO THE PROVISION OF AND/OR BROADCASTING OF INFORMATION, DATA, GRAPHICS, SOUND, MUSIC, VIDEOS, ANIMATION AND TEXT, AND ALL THE AFORESAID SERVICES FOR USE IN RELATION TO A SATELLITE UP-LINK WHICH IS MOUNTED ON A VEHICLE OR A BUILDING OR FIXED TO THE GROUND, COMPRISED OF A COLLAPSIBLE DISH ANTENNA AND RELATED HARDWARE FOR THE CONNECTION VIA SATELLITE OF AUDIO, AUDIO-VISUAL AND VISUAL TELEVISION TRANSMISSION FROM REMOTE SITES TO BROADCASTERS' STUDIO FACILITIES, BUT NOT FOR ANY DIRECT TRANSMISSION TO CONSUMERS OR MEMBERS OF THE PUBLIC; NONE OF THE AFORESAID GOODS BEING HAND-HELD; ADVERTISING AND MARKETING SERVICES INCLUDING THE COMPILATION OF ADVERTISEMENTS, MARKETING AND PROMOTIONAL MATERIAL FOR USE ON THE INTERNET OR BY OTHER ELECTRONIC MEANS, PREPARATION OF AUDIO VISUAL DISPLAYS FOR PROMOTIONAL OR ADVERTISING PURPOSES NOT INCLUDING ILLUMINATED SIGNS, AND PROMOTION OF SPECIAL EVENTS, ALL RELATING TO THE PROVISION OF AND/OR BROADCASTING OF INFORMATION, DATA, GRAPHICS, SOUND, MUSIC, VIDEOS, ANIMATION AND TEXT, AND ALL THE AFORESAID SERVICES FOR USE IN RELATION TO A SATELLITE UP-LINK WHICH IS MOUNTED ON A VEHICLE OR A BUILDING OR FIXED TO THE GROUND, COMPRISED OF A COLLAPSIBLE DISH ANTENNA AND RELATED HARDWARE FOR THE CONNECTION VIA SATELLITE OF AUDIO, AUDIO-VISUAL AND VISUAL TELEVISION TRANSMISSION FROM REMOTE SITES TO BROADCASTERS' STUDIO FACILITIES, BUT NOT FOR ANY DIRECT TRANSMISSION TO CONSUMERS OR MEMBERS OF THE PUBLIC; NONE OF THE AFORESAID GOODS BEING HAND-HELD; PROVISION OF BUSINESS INFORMATION, STORAGE AND PROVISION OF COMPUTERIZED BUSINESS INFORMATION DATA, ALL RELATING TO THE PROVISION OF AND/OR BROADCASTING OF INFORMATION, DATA, GRAPHICS, SOUND, MUSIC, VIDEOS, ANIMATION AND TEXT AND ALL THE AFORESAID SERVICES FOR USE IN RELATION TO A SATELLITE UP-LINK WHICH IS

MOUNTED ON A VEHICLE OR A BUILDING OR FIXED TO THE GROUND, COMPRISED OF A COLLAPSIBLE DISH ANTENNA AND RELATED HARDWARE FOR THE CONNECTION VIA SATELLITE OF AUDIO, AUDIO-VISUAL AND VISUAL TELEVISION TRANSMISSION FROM REMOTE SITES TO BROADCASTERS' STUDIO FACILITIES, BUT NOT FOR ANY DIRECT TRANSMISSION TO CONSUMERS OR MEMBERS OF THE PUBLIC; NONE OF THE AFORESAID GOODS BEING HAND-HELD; INFORMATION, CONSULTANCY AND ADVISORY SERVICES RELATING TO ALL OF THE AFORESAID SERVICES (U.S. CLS. 100, 101 AND 102).

CLASS 37—CONSTRUCTION AND REPAIR

FOR INSTALLATION AND REPAIR OF APPARATUS FOR RECORDING, TRANSMISSION OR REPRODUCTION OF SOUND OR IMAGES FOR THE TRANSMISSION, DISTRIBUTION AND BROADCASTING OF INFORMATION, DATA, GRAPHICS, SOUND, MUSIC, VIDEOS, ANIMATION AND TEXT VIA SATELLITE SYSTEMS OR LAND LINE COMPUTER NETWORKS, ALL THE AFORESAID SERVICES FOR USE IN RELATION TO A SATELLITE UP-LINK UNIT WHICH IS MOUNTED ON A VEHICLE OR A BUILDING OR FIXED TO THE GROUND, COMPRISED OF A COLLAPSIBLE DISH ANTENNA AND RELATED HARDWARE FOR THE CONNECTION VIA SATELLITE OF AUDIO, AUDIO-VISUAL AND VISUAL TELEVISION TRANSMISSION FROM REMOTE SITES TO BROADCASTERS' STUDIO FACILITIES, BUT NOT FOR ANY DIRECT TRANSMISSION TO CONSUMERS OR MEMBERS OF THE PUBLIC; NONE OF THE AFORESAID GOODS BEING HAND-HELD; INSTALLATION AND REPAIR OF DATA PROCESSING EQUIPMENT, COMPUTER HARDWARE, TELECOMMUNICATION APPARATUS, DIGITAL POINT OF SALE MATERIAL AND ELECTRONIC SIGNAGE, ALL THE AFORESAID SERVICES FOR USE IN RELATION TO A SATELLITE UP-LINK UNIT WHICH IS MOUNTED ON A VEHICLE OR A BUILDING OR FIXED TO THE GROUND, COMPRISED OF A COLLAPSIBLE DISH ANTENNA AND RELATED HARDWARE FOR THE CONNECTION VIA SATELLITE OF AUDIO, AUDIO-VISUAL AND VISUAL TELEVISION TRANSMISSION FROM REMOTE SITES TO BROADCASTERS' STUDIO FACILITIES, BUT NOT FOR ANY DIRECT TRANSMISSION TO CONSUMERS OR MEMBERS OF THE PUBLIC; NONE OF THE AFORESAID GOODS BEING HAND-HELD; INFORMATION, CONSULTANCY AND ADVISORY SERVICES RELATING TO ALL OF THE AFORESAID SERVICES (U.S. CLS. 100, 103 AND 106).

CLASS 38—COMMUNICATION

FOR TELECOMMUNICATION SERVICES, NAMELY, TRANSMISSION OF INFORMATION, COMPUTER PROGRAMS, COMPUTER SOFTWARE AND OTHER DATA, ALL THE AFORESAID SERVICES FOR USE IN RELATION TO A SATELLITE UP-LINK UNIT WHICH IS MOUNTED ON A VEHICLE OR A BUILDING OR FIXED TO THE GROUND, COMPRISED OF A COLLAPSIBLE DISH ANTENNA AND RELATED HARDWARE FOR THE CONNECTION VIA SATELLITE OF AUDIO, AUDIO-VISUAL AND VISUAL TELEVISION TRANSMISSION FROM REMOTE SITES TO BROADCASTERS' STUDIO FACILITIES BUT NOT FOR ANY DIRECT TRANSMISSION TO CONSUMERS OR MEMBERS OF THE PUBLIC; NONE OF THE AFORESAID GOODS BEING HAND-HELD; PROVIDING SATELLITE TRANSMISSION OF COMPUTER PROGRAMS AND COMPUTER SOFTWARE, ALL THE AFORESAID SERVICES FOR USE IN RELATION TO A SATELLITE UP-LINK UNIT WHICH IS MOUNTED ON A VEHICLE OR A BUILDING OR FIXED TO THE GROUND, COMPRISED OF A COLLAPSIBLE DISH ANTENNA AND RELATED HARDWARE FOR THE CONNECTION VIA SATELLITE OF AUDIO, AUDIO-VISUAL AND VISUAL TELEVISION TRANSMISSION FROM REMOTE SITES TO BROADCASTERS' STUDIO FACILITIES BUT NOT FOR ANY DIRECT TRANSMISSION TO CONSUMERS OR MEMBERS OF THE PUBLIC; NONE OF THE AFORESAID GOODS BEING HAND-HELD; TELECOMMUNICATION SERVICES, NAMELY, TELEVISION AND RADIO BROADCASTING OF SOUNDS AND IMAGES, ALL THE AFORESAID SERVICES FOR USE IN RELATION TO A SATELLITE UP-LINK UNIT WHICH IS MOUNTED ON A VEHICLE OR A BUILDING OR FIXED TO THE GROUND, COMPRISED OF A COLLAPSIBLE DISH ANTENNA AND RELATED HARDWARE FOR THE CONNECTION VIA SATELLITE OF AUDIO, AUDIO-VISUAL AND VISUAL TELEVISION TRANSMISSION FROM REMOTE SITES TO BROADCASTERS' STUDIO FACILITIES, BUT NOT FOR ANY DIRECT TRANSMISSION TO CONSUMERS OR MEMBERS OF THE PUBLIC; NONE OF THE AFORESAID GOODS BEING HAND-HELD; INFORMATION, CONSULTANCY AND ADVISORY SERVICES RELATING TO ALL OF THE AFORESAID SERVICES (U.S. CLS. 100, 101 AND 104).

MISSION OF COMPUTER PROGRAMS AND COMPUTER SOFTWARE, ALL THE AFORESAID SERVICES FOR USE IN RELATION TO A SATELLITE UP-LINK UNIT WHICH IS MOUNTED ON A VEHICLE OR A BUILDING OR FIXED TO THE GROUND, COMPRISED OF A COLLAPSIBLE DISH ANTENNA AND RELATED HARDWARE FOR THE CONNECTION VIA SATELLITE OF AUDIO, AUDIO-VISUAL AND VISUAL TELEVISION TRANSMISSION FROM REMOTE SITES TO BROADCASTERS' STUDIO FACILITIES BUT NOT FOR ANY DIRECT TRANSMISSION TO CONSUMERS OR MEMBERS OF THE PUBLIC; NONE OF THE AFORESAID GOODS BEING HAND-HELD; SATELLITE BROADCASTING OF GRAPHICS, INFORMATION, DATA, SOUND, MUSIC, VIDEOS, ANIMATION AND TEXT, ALL THE AFORESAID SERVICES FOR USE IN RELATION TO A SATELLITE UP-LINK UNIT WHICH IS MOUNTED ON A VEHICLE OR A BUILDING OR FIXED TO THE GROUND, COMPRISED OF A COLLAPSIBLE DISH ANTENNA AND RELATED HARDWARE FOR THE CONNECTION VIA SATELLITE OF AUDIO, AUDIO-VISUAL AND VISUAL TELEVISION TRANSMISSION FROM REMOTE SITES TO BROADCASTERS' STUDIO FACILITIES BUT NOT FOR ANY DIRECT TRANSMISSION TO CONSUMERS OR MEMBERS OF THE PUBLIC; NONE OF THE AFORESAID GOODS BEING HAND-HELD; TELECOMMUNICATION SERVICES, NAMELY, TELEVISION AND RADIO BROADCASTING OF SOUNDS AND IMAGES, ALL THE AFORESAID SERVICES FOR USE IN RELATION TO A SATELLITE UP-LINK UNIT WHICH IS MOUNTED ON A VEHICLE OR A BUILDING OR FIXED TO THE GROUND, COMPRISED OF A COLLAPSIBLE DISH ANTENNA AND RELATED HARDWARE FOR THE CONNECTION VIA SATELLITE OF AUDIO, AUDIO-VISUAL AND VISUAL TELEVISION TRANSMISSION FROM REMOTE SITES TO BROADCASTERS' STUDIO FACILITIES, BUT NOT FOR ANY DIRECT TRANSMISSION TO CONSUMERS OR MEMBERS OF THE PUBLIC; NONE OF THE AFORESAID GOODS BEING HAND-HELD; INFORMATION, CONSULTANCY AND ADVISORY SERVICES RELATING TO ALL OF THE AFORESAID SERVICES (U.S. CLS. 100, 101 AND 104).

CLASS 41—EDUCATION AND ENTERTAINMENT

FOR TELEVISION AND RADIO ENTERTAINMENT SERVICES, NAMELY, EDITING OF SOUNDS AND IMAGES, TELEVISION PRODUCTION AND RADIO PRODUCTION, ALL THE AFORESAID SERVICES FOR USE IN RELATION TO A SATELLITE UP-LINK UNIT WHICH IS MOUNTED ON A VEHICLE OR A BUILDING OR FIXED TO THE GROUND, COMPRISED OF A COLLAPSIBLE DISH ANTENNA AND RELATED HARDWARE FOR THE CONNECTION VIA SATELLITE OF AUDIO, AUDIO-VISUAL AND VISUAL TELEVISION TRANSMISSION FROM REMOTE SITES TO BROADCASTERS' STUDIO FACILITIES, BUT NOT FOR ANY DIRECT TRANSMISSION TO CONSUMERS OR MEMBERS OF THE PUBLIC; NONE OF THE AFORESAID GOODS BEING HAND-HELD; TELEVISION AND RADIO ENTERTAINMENT SERVICES, NAMELY, PROVIDING NEWS IN THE NATURE OF CURRENT EVENTS REPORTING AND PROVIDING INFORMATION IN THE FIELDS OF BREAKING CURRENT EVENTS NEWS, RECREATION, CULTURE, ENTERTAINMENT, SPORTS AND EDUCATION BY SATELLITE TRANSMISSION, THE INTERNET OR BY OTHER ELECTRONIC MEANS, ALL THE AFORESAID SERVICES FOR USE IN RELATION TO A SATELLITE UP-LINK UNIT WHICH IS MOUNTED ON A VEHICLE OR A BUILDING OR FIXED TO THE GROUND, COMPRISED OF A COLLAPSIBLE DISH ANTENNA AND RELATED HARDWARE FOR THE CONNECTION VIA SATELLITE OF AUDIO, AUDIO-VISUAL AND VISUAL TELEVISION TRANSMISSION FROM REMOTE SITES TO BROADCASTERS' STUDIO FACILITIES, BUT NOT FOR ANY DIRECT TRANSMISSION TO CONSUMERS OR MEMBERS OF THE PUBLIC; NONE OF THE AFORESAID GOODS BEING HAND-HELD; MOTION PICTURE FILM PRODUCTION SERVICES, ALL THE AFORESAID SERVICES FOR USE IN RELATION TO A SATELLITE UP-LINK UNIT WHICH IS MOUNTED ON A VEHICLE OR A BUILDING OR FIXED TO THE GROUND, COMPRISED OF A COLLAPSIBLE DISH ANTENNA AND RELATED HARDWARE FOR THE CONNECTION VIA SATELLITE OF AUDIO, AUDIO-VISUAL AND VISUAL TELEVISION

TRANSMISSION FROM REMOTE SITES TO BROADCASTERS' STUDIO FACILITIES, BUT NOT FOR ANY DIRECT TRANSMISSION TO CONSUMERS OR MEMBERS OF THE PUBLIC; NONE OF THE AFORESAID GOODS BEING HAND-HELD; TELEVISION AND RADIO ENTERTAINMENT SERVICES, NAMELY, PROVIDING NEWS IN THE NATURE OF CURRENT EVENTS REPORTING AND PROVIDING INFORMATION AND DATA ABOUT BREAKING CURRENT EVENTS NEWS, RECREATIONAL, CULTURE, ENTERTAINMENT AND SPORTING EVENTS OF EDUCATIONAL INTEREST, MUSIC PUBLICATION SERVICES, PUBLICATION OF TEXTS, SOUND, MUSIC VIDEO AND ANIMATION PRODUCTION SERVICES, ALL THE AFORESAID SERVICES FOR USE IN RELATION TO A SATELLITE UP-LINK UNIT WHICH IS MOUNTED ON VEHICLE OR A BUILDING OR FIXED TO THE GROUND, COMPRISED OF A COLLAPSIBLE DISH ANTENNA AND RELATED HARDWARE FOR THE CONNECTION VIA SATELLITE OF AUDIO, AUDIO-VISUAL AND VISUAL TELEVISION TRANSMISSION FROM REMOTE SITES TO BROADCASTERS' STUDIO FACILITIES, BUT NOT FOR ANY DIRECT TRANSMISSION TO CONSUMERS OR MEMBERS OF THE PUBLIC; NONE OF THE AFORESAID GOODS BEING HAND-HELD; ALL THE AFORESAID SERVICES FOR USE IN RELATION TO A SATELLITE UP-LINK UNIT WHICH IS MOUNTED ON A VEHICLE OR A BUILDING OR FIXED TO THE GROUND, COMPRISED OF A COLLAPSIBLE DISH ANTENNA AND RELATED HARDWARE FOR THE CONNECTION VIA SATELLITE OF AUDIO, AUDIO-VISUAL AND VISUAL TELEVISION TRANSMISSION FROM REMOTE SITES TO BROADCASTERS' STUDIO FACILITIES, BUT NOT FOR ANY DIRECT TRANSMISSION TO CONSUMERS OR MEMBERS OF THE PUBLIC; NONE OF THE AFORESAID GOODS BEING HAND-HELD; INFORMATION, CONSULTANCY AND ADVISORY SERVICES RELATING TO ALL THE AFORESAID SERVICES (U.S. CLS. 100, 101 AND 107).

CLASS 42—SCIENTIFIC AND COMPUTER SERVICES

FOR COMPUTER PROGRAMMING, ALL THE AFORESAID SERVICES FOR USE IN RELATION TO A SATELLITE UP-LINK UNIT WHICH IS MOUNTED ON A VEHICLE OR A BUILDING OR FIXED TO THE GROUND, COMPRISED OF A COLLAPSIBLE DISH ANTENNA AND RELATED HARDWARE FOR THE CONNECTION VIA SATELLITE OF AUDIO, AUDIO-VISUAL AND VISUAL TELEVISION TRANSMISSION FROM REMOTE SITES TO BROADCASTERS' STUDIO FACILITIES, BUT NOT FOR ANY DIRECT TRANSMISSION TO CONSUMERS OR MEMBERS OF THE PUBLIC; NONE OF THE AFORESAID GOODS BEING HAND-HELD; COMPUTER SOFTWARE DESIGN, ALL THE AFORESAID SERVICES FOR USE IN RELATION TO A SATELLITE UP-LINK UNIT WHICH IS MOUNTED ON A VEHICLE OR A BUILDING OR FIXED TO THE GROUND, COMPRISED OF A COLLAPSIBLE DISH ANTENNA AND RELATED HARDWARE FOR THE CONNECTION VIA SATELLITE OF AUDIO, AUDIO-VISUAL AND VISUAL TELEVISION TRANSMISSION FROM REMOTE SITES TO BROADCASTERS' STUDIO FACILITIES, BUT NOT FOR ANY DIRECT TRANSMISSION TO CONSUMERS OR MEMBERS OF THE PUBLIC; NONE OF THE AFORESAID GOODS BEING HAND-HELD; COMPUTER SYSTEMS ANALYSIS, ALL THE AFORESAID SERVICES FOR USE IN RELATION TO A SATELLITE UP-LINK UNIT WHICH IS MOUNTED ON A VEHICLE OR A BUILDING OR FIXED TO THE GROUND, COMPRISED OF A COLLAPSIBLE DISH ANTENNA AND RELATED HARDWARE FOR THE CONNECTION VIA SATELLITE OF AUDIO, AUDIO-VISUAL AND VISUAL TELEVISION TRANSMISSION FROM REMOTE SITES TO BROADCASTERS' STUDIO FACILITIES, BUT NOT FOR ANY DIRECT TRANSMISSION TO CONSUMERS OR MEMBERS OF THE PUBLIC; NONE OF THE AFORESAID GOODS BEING HAND-HELD; REPAIR, MAINTENANCE, UPDATING AND MONITORING OF COMPUTER SOFTWARE AND COMPUTER PROGRAMS, ALL THE AFORESAID SERVICES FOR USE IN RELATION TO A SATELLITE UP-LINK UNIT WHICH IS MOUNTED ON A VEHICLE OR A BUILDING OR FIXED TO THE GROUND, COMPRISED OF A COLLAPSIBLE DISH ANTENNA AND RELATED HARDWARE FOR THE CONNECTION VIA SATELLITE OF AUDIO, AUDIO-VISUAL AND VISUAL TELEVISION

TRANSMISSION FROM REMOTE SITES TO BROADCASTERS' STUDIO FACILITIES, BUT NOT FOR ANY DIRECT TRANSMISSION TO CONSUMERS OR MEMBERS OF THE PUBLIC; NONE OF THE AFORESAID GOODS BEING HAND-HELD; INFORMATION CONSULTANCY AND ADVISORY SERVICES IN RELATION TO ALL OF THE AFORESAID SERVICES; TECHNICAL CONSULTANCY AND ADVISORY SERVICES PERTAINING TO THE DEVELOPMENT OF NEW PRODUCTS IN THE TECHNOLOGY FIELD OF COMPUTER HARDWARE SYSTEMS AND SATELLITE UP-LINKS, ALL THE AFORESAID SERVICES FOR USE IN RELATION TO A SATELLITE UP-LINK UNIT WHICH IS MOUNTED ON A VEHICLE OR A BUILDING OR FIXED TO THE GROUND, COMPRISED OF A COLLAPSIBLE DISH ANTENNA AND RELATED HARDWARE FOR THE CONNECTION VIA SATELLITE OF AUDIO, AUDIO-VISUAL AND VISUAL TELEVISION TRANSMISSION FROM REMOTE SITES TO BROADCASTERS' STUDIO FACILITIES, BUT NOT FOR ANY DIRECT TRANSMISSION TO CONSUMERS OR MEMBERS OF THE PUBLIC; NONE OF THE AFORESAID GOODS BEING HAND-HELD; MONITORING OF APPARATUS FOR RECORDING, TRANSMISSION OR REPRODUCTION OF SOUND OR IMAGES FOR THE TRANSMISSION, DISTRIBUTION AND BROADCASTING OF INFORMATION, DATA, GRAPHICS, SOUND, MUSIC, VIDEOS, ANIMATION AND TEXT VIA SATELLITE SYSTEMS OR LAND LINE COMPUTER NETWORKS, ALL THE AFORESAID SERVICES FOR USE IN RELATION TO A SATELLITE UP-LINK UNIT WHICH IS MOUNTED ON VEHICLE OR A BUILDING OR FIXED TO THE GROUND, COMPRISED OF A COLLAPSIBLE DISH ANTENNA AND RELATED HARDWARE FOR THE CONNECTION VIA SATELLITE OF AUDIO, AUDIO-VISUAL AND VISUAL TELEVISION TRANSMISSION FROM REMOTE SITES TO BROADCASTERS' STUDIO FACILITIES, BUT NOT FOR ANY DIRECT TRANSMISSION TO CONSUMERS OR MEMBERS OF THE PUBLIC; NONE OF THE AFORESAID GOODS BEING HAND-HELD; MONITORING OF DATA PROCESSING EQUIPMENT, COMPUTER HARDWARE, TELECOMMUNICATION APPARATUS, DIGITAL POINT OF SALE MATERIAL AND ELECTRONIC SIGNAGE, ALL THE AFORESAID SERVICES FOR USE IN RELATION TO A SATELLITE UP-LINK UNIT WHICH IS MOUNTED ON A VEHICLE OR A BUILDING OR FIXED TO THE GROUND, COMPRISED OF A COLLAPSIBLE DISH ANTENNA AND RELATED HARDWARE FOR THE CONNECTION VIA SATELLITE OF AUDIO, AUDIO-VISUAL AND VISUAL TELEVISION TRANSMISSION FROM REMOTE SITES TO BROADCASTERS' STUDIO FACILITIES, BUT NOT FOR ANY DIRECT TRANSMISSION TO CONSUMERS OR MEMBERS OF THE PUBLIC; NONE OF THE AFORESAID GOODS BEING HAND-HELD; MONITORING OF ELECTRONIC APPARATUS AND INSTRUMENTS FOR USE IN CONNECTION WITH THE AFORESAID PURPOSES, INCLUDING SATELLITE DISHES, ANTENNAS AND TOUCH SCREEN CONTROLLERS, ALL THE AFORESAID SERVICES FOR USE IN RELATION TO A SATELLITE UP-LINK UNIT WHICH IS MOUNTED ON A VEHICLE OR A BUILDING OR FIXED TO THE GROUND, COMPRISED OF A COLLAPSIBLE DISH ANTENNA AND RELATED HARDWARE FOR THE CONNECTION VIA SATELLITE OF AUDIO, AUDIO-VISUAL AND VISUAL TELEVISION TRANSMISSION FROM REMOTE SITES TO BROADCASTERS' STUDIO FACILITIES, BUT NOT FOR ANY DIRECT TRANSMISSION TO CONSUMERS OR MEMBERS OF THE PUBLIC; NONE OF THE AFORESAID GOODS BEING HAND-HELD; INFORMATION, CONSULTANCY AND ADVISORY SERVICES RELATING TO ALL OF THE AFORESAID MONITORING SERVICES (U.S. CLS. 100 AND 101).
DEBRA LEE, EXAMINING ATTORNEY

SN 77-044,635. CHIDIAC, CAMILLE, LOS ANGELES, CA. AND CHIDIAC-DUPONT, REMA, PACIFIC PALISADES, CA. FILED 11-15-2006.

SN 77-095,808. TANTUM MEDIA VERLAG GESELLSCHAFT MBH, 1020 VIENNA, AUSTRIA, FILED 1-31-2007.

LEONIE

THE MARK CONSISTS OF STANDARD CHARACTERS WITHOUT CLAIM TO ANY PARTICULAR FONT, STYLE, SIZE, OR COLOR.

"LEONIE" DOES NOT IDENTIFY A LIVING INDIVIDUAL.

CLASS 35—ADVERTISING AND BUSINESS

FOR (BASED UPON USE IN COMMERCE) SECURING AIRTIME ON ALL FORMS OF MEDIA COMMUNICATIONS STATIONS, SYSTEMS, NETWORKS, AND SERVICES FOR THE PURPOSE OF PROMOTING THE GOODS AND SERVICES OF OTHERS; PROMOTING AND MARKETING OF GOODS AND SERVICES THROUGH ALL PUBLIC COMMUNICATION AND MEDIA MEANS; BUSINESS CONSULTATION AND MANAGEMENT REGARDING MARKETING ACTIVITIES AND LAUNCHING OF NEW PRODUCTS; BUSINESS MANAGEMENT CONSULTING WITH RELATION TO STRATEGY, MARKETING, PRODUCTION, PERSONNEL AND RETAIL SALE MATTERS; CONSULTANCY OF PERSONNEL RECRUITMENT; JOB AND PERSONNEL PLACEMENT; CONSULTING SERVICES IN BUSINESS ORGANIZATION AND MANAGEMENT; PREPARING AND PLACING OF ADVERTISEMENTS; PROCURING OF GOVERNMENT AND OTHER CONTRACTS AND SUBCONTRACTS FOR THE PURCHASE AND SALE OF GOODS AND SERVICES; PRODUCT MERCHANDISING; PRODUCTION AND DISTRIBUTION OF RADIO AND TELEVISION COMMERCIALS, PRODUCTION OF PUBLIC SERVICE ANNOUNCEMENTS AND FILMS; PROMOTION AND MARKETING SERVICES AND RELATED CONSULTING; PROVIDING CONSULTING SERVICES IN THE FIELD OF FACILITATING THE PLANNING, BUYING AND SELLING OF MEDIA; PURCHASING AND PROCUREMENT SERVICES, NAMELY, PROCURING OF CONTRACTS FOR THE PURCHASE OF GOODS AND LABOR CONTRACTING SERVICES; AND IMPORT AND EXPORT OF GOODS AND CONSULTING AND STRATEGIC ADVISING REGARDING SAME; INTERNATIONAL BUSINESS CONSULTING SERVICES, NAMELY, AIDING COMPANIES IN DOING BUSINESS IN THE UNITED STATES AND ABROAD (U.S. CLS. 100, 101 AND 102).

FIRST USE 4-23-2001; IN COMMERCE 4-23-2001.

CLASS 40—MATERIAL TREATMENT

FOR (BASED UPON INTENT-TO-USE IN COMMERCE) MANUFACTURING, NAMELY, CONTRACT, CUSTOM, AND SPECIALTY MANUFACTURING IN THE FIELD OF GENERATORS, ELECTRICITY MONITORS, TRANSFORMERS, AND METERS FOR BILLING (U.S. CLS. 100, 103 AND 106).

CLASS 42—SCIENTIFIC AND COMPUTER SERVICES

FOR (BASED UPON INTENT-TO-USE IN COMMERCE) PRODUCT RESEARCH AND DEVELOPMENT AND RELATED CONSULTING SERVICES (U.S. CLS. 100 AND 101).

DAVID C. REIHNER, EXAMINING ATTORNEY



PRIORITY CLAIMED UNDER SEC. 44(D) ON ERPNCMNTY TM OFC APPLICATION NO. 005588215, FILED 12-4-2006, REG. NO. 5588215, DATED 9-29-2008, EXPIRES 12-4-2016.

THE MARK CONSISTS OF THE WORDS "MY WAY" AND A SQUARE CONTAINING A DESIGN OF CURVED LINES LEADING TO A LIGHT.

CLASS 5—PHARMACEUTICALS

FOR FOOD FOR BABIES (U.S. CLS. 6, 18, 44, 46, 51 AND 52).

CLASS 9—ELECTRICAL AND SCIENTIFIC APPARATUS

FOR VIDEOTAPES IN THE FIELD OF LIFE SCIENCES; AUDIO CASSETTES IN THE FIELD OF LIFE SCIENCES; VIDEO AND COMPACT DISCS IN THE FIELD OF LIFE SCIENCES (U.S. CLS. 21, 23, 26, 36 AND 38).

CLASS 14—JEWELRY

FOR OBJECTS OF PRECIOUS METAL, NAMELY, BRACELETS, FIGURINES; JEWELRY; WATCHES (U.S. CLS. 2, 27, 28 AND 50).

CLASS 16—PAPER GOODS AND PRINTED MATTER

FOR GRAPHIC ART REPRODUCTIONS; PHOTOGRAPHS; PRINTED PRODUCTS, NAMELY, PAMPHLETS IN THE FIELD OF THE LIFE SCIENCES; ARTS AND CRAFTS PAINT KITS (U.S. CLS. 2, 5, 22, 23, 29, 37, 38 AND 50).

CLASS 18—LEATHER GOODS

FOR SUIT BAGS; CARRYING CASES; OVERNIGHT CASES; UMBRELLAS, SUN UMBRELLAS, NAMELY, PARASOLS; WALKING STICKS (U.S. CLS. 1, 2, 3, 22 AND 41).

CLASS 20—FURNITURE AND ARTICLES NOT OTHERWISE CLASSIFIED

FOR FURNITURE, MIRRORS, PICTURE FRAMES (U.S. CLS. 2, 13, 22, 25, 32 AND 50).

CLASS 21—HOUSEWARES AND GLASS

FOR BEVERAGE GLASSWARE; PORCELAIN OR EARTHENWARE MUGS, PLATES, BOWLS, CUPS, AND SAUCERS (U.S. CLS. 2, 13, 23, 29, 30, 33, 40 AND 50).

CLASS 24—FABRICS

FOR TEXTILE BED COVERS; TEXTILE GOODS, NAMELY, PLACE MATS, WALL HANGINGS, TABLE-CLOTHS, NAPKINS AND HAND TOWELS (U.S. CLS. 42 AND 50).

CLASS 25—CLOTHING

FOR CLOTHING, NAMELY, SHIRTS, PANTS, AND JACKETS; FOOTWEAR; HEADGEAR, NAMELY, HATS, AND CAPS (U.S. CLS. 22 AND 39).

CLASS 28—TOYS AND SPORTING GOODS

FOR EDUCATIONAL TOYS IN THE NATURE OF ELECTRONIC EDUCATIONAL GAME MACHINES FOR CHILDREN, EDUCATIONAL BOARD GAMES, ARCADE TYPE ELECTRONIC EDUCATION VIDEO GAMES; WOODEN TOYS, NAMELY, BUILDING SETS, PUZZLES (U.S. CLS. 22, 23, 38 AND 50).

CLASS 32—LIGHT BEVERAGES

FOR MINERAL AND AERATED WATERS AND OTHER NON-ALCOHOLIC DRINKS, NAMELY, FRUIT DRINKS, FRUIT FLAVORED DRINKS, VEGETABLE DRINKS, FRUIT JUICES, ENERGY DRINKS, FLAVORED WATERS, CARBONATED SODAS, SPORTS DRINKS, AND ISOTONIC DRINKS (U.S. CLS. 45, 46 AND 48).

CLASS 39—TRANSPORTATION AND STORAGE

FOR TRAVEL ARRANGEMENT (U.S. CLS. 100 AND 105).

CLASS 41—EDUCATION AND ENTERTAINMENT

FOR EDUCATION SERVICES, NAMELY, PROVIDING CLASSES, SEMINARS, AND WORKSHOPS IN THE FIELD OF LIFE SCIENCES; TRAINING SERVICES IN THE FIELD OF LIFE SCIENCES; PUBLICATION OF BOOKS, MANUSCRIPTS AND PERIODICALS; ARRANGEMENT OF FAIRS AND EXPOSITIONS FOR ENTERTAINMENT OR EDUCATIONAL PURPOSES; ENTERTAINMENT, NAMELY, PRODUCTION OF TELEVISION SHOWS, MOVIES, PLAYS, AND STAGE PERFORMANCES; PROVIDING THEME PARK SERVICES; ORGANIZATION OF CONFERENCES AND SYMPOSIA IN THE FIELD OF LIFE SCIENCES; THEME GARDENS AND MEDITATION GARDENS FOR PUBLIC ADMISSION; ENTERTAINMENT IN THE NATURE OF LIVE PERFORMANCES BY MUSICAL BANDS (U.S. CLS. 100, 101 AND 107).

CLASS 42—SCIENTIFIC AND COMPUTER SERVICES

FOR DESIGN OF PRODUCTS FOR OTHERS; DESIGN AND DEVELOPMENT OF COMPUTER HARDWARE AND SOFTWARE (U.S. CLS. 100 AND 101).

CLASS 43—HOTEL AND RESTAURANT SERVICES

FOR RESTAURANT AND HOTEL SERVICES (U.S. CLS. 100 AND 101).
ANDREA BUTLER, EXAMINING ATTORNEY

SN 77-132,662. MY LITTLE SHOEBOX LIMITED, CENTRAL, HONG KONG, FILED 3-16-2007.

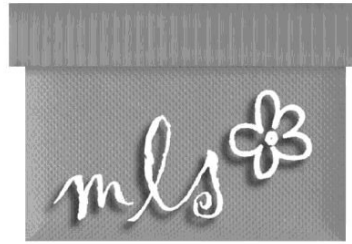

THE MARK CONSISTS OF THE STYLIZED LETTERS "MLS" FOLLOWED BY A FLOWER, ALL WITHIN A RECTANGULAR BOX FEATURING VERTICAL LINES ON THE LID OF THE BOX.

CLASS 16—PAPER GOODS AND PRINTED MATTER

FOR ALBUMS, NAMELY, BABY ALBUMS, PHOTO ALBUMS, SCRAPBOOKS, PRINTED GUIDES FOR BABYSITTERS, GROWTH CHARTS, WEDDING ALBUMS, ANNIVERSARY ALBUMS, GRADUATION ALBUMS, GUEST ALBUMS AND BOOKS, SPIRAL-BOUND NOTEBOOKS, ADDRESS BOOKS, DATE BOOKS, DIARIES, GREETING CARD ORGANIZERS, NAMELY, STICKERS, DECALS, RECEIPT BOOKS, PRINTED RECIPE CARDS, POCKET SECRETARIES, AUTOGRAPH BOOKS, ORGANIZERS FOR STATIONERY USE, CALENDARS, NAMELY, ENGAGEMENT CALENDARS, POSTCARD CALENDARS, DESK DIARIES AND APPOINTMENT BOOKS; GIFT WRAPPING PAPER, GIFT ENCLOSURES, NAMELY, STICKERS, ADHESIVES FOR STATIONERY PURPOSES, AND DECALS, GIFT BOXES, GIFT WRAPPING TISSUES, ALL MADE OF PAPER, GREETING CARDS, GREETING CARDS FEATURING CONTEMPORARY MESSAGES, MINIATURE GREETING CARDS AND ENVELOPES, MINIATURE ADDRESS BOOKS, ADVENT CALENDARS, GREETING CARD BOOKLETS; INVITATION CARDS, PAPER NAPKINS, PAPER DOILIES, COASTERS MADE OF PAPER, TABLE CLOTHS OF PAPER; PAPER NAME TAGS, PLACE CARDS, PAPER GUEST TOWELS; POSTERS; POCKET DIARIES, POCKET ADDRESS BOOKS AND POCKET NOTEBOOKS; WRITING INSTRUMENTS; STATIONERY; WOODEN PENS, PENCILS; ERASERS, PENCIL SHARPENERS; PENCIL LEADS, PEN CASES, GLUE FOR STATIONERY OR HOUSEHOLD USE, ADHESIVE TAPE DISPENSERS, UNGRADUATED RULERS, CORRECTION TAPE, STAPLERS, PAPER CLIPS, WRITING PAPERS, STATIONERY SOLD IN BOXES, ENVELOPES, PENS, ARTS AND CRAFT PAINT KITS, CREDIT CARDS WITHOUT MAGNETIC COATING; RUBBER STAMPS; BINDERS; BLANK WRITING JOURNALS AND SCRAPBOOKS, NAMELY, COLORED PAPER, SPECIALTY PAPERS, NAMELY, VEGETABLE PARCHMENT, FOR USE IN FOOD WRAPPING, PREPARATION, PROCESSING AND PACKAGING APPLICATIONS, BACKGROUND PAPERS, TEXTURE PAPERS, AND CARD STOCK; PAPER BAGS; PAPER BOXES; PAPER TAGS; PAPER BOARDS; BOOKMARKS; NOTE CARDS, CALENDARS; PAPER DOILIES; PRINTED PATTERNS; STENCILS; STAMP INK PADS; STAMPING INKS; WRITING INK; MARKERS, SHEET PROTECTORS; PLASTIC SHEETS, FOLDERS, AND PAGES USED FOR PRESERVING DOCUMENTS AND PHOTOGRAPHS; PHOTO MOUNTING CORNERS; DRAWING RULERS; GLUE AND ADHESIVE FOR STATIONERY OR HOUSEHOLD USE; SCRAPBOOKS, IDEA BOOKS, MAGAZINES FEATURING SCRAPBOOKS, STICKERS, ARTS AND CRAFTS, AND CATALOGS RELATING TO ARTS AND CRAFTS, CALENDARS AND COMPONENTS, TECHNIQUES AND METHODOLOGY FOR ASSEMBLING OR CREATING SCRAPBOOKS; PRODUCTS FOR SCRAP BOOKING, NAMELY, DECORATIVE STICKERS, ALPHABET STICKERS, BORDER STICKERS, PAPER DIE CUT SHAPES, STENCILS, PENS, ADHESIVES, PAPER, THEME KITS COMPRISED OF STICKERS, DECALS, ADHESIVES, BOOKS, NAMELY, HOW-TO-BOOKS, ORGANIZERS FOR STATIONERY USE; ADHESIVE LABELS; ADHESIVES FOR DO-IT-YOURSELF PURPOSES;

ALBUMS FOR STICKERS; ARTS AND CRAFT PAINT KITS; CHILDREN'S ACTIVITY BOOKS; CHILDREN'S INTERACTIVE EDUCATIONAL BOOKS; COLORING BOOKS; DECALS; ELECTROSTATIC PAPER; LETTER PAPER; SCRAPBOOK PAGES; TEMPORARY TATTOOS; THREE DIMENSIONAL MODELS FOR EDUCATIONAL PURPOSES; WORKS OF ART MADE FROM CUSTOM MANUFACTURED PAPER, INSTRUCTIONAL AND PRINTED TEACHING MATERIAL IN THE FIELDS OF SCRAPBOOKING, CRAFT-MAKING, AND TOYS, LABEL HOLDERS, PICTURE BOOKS, PICTURE CARDS, PRINTED ARTWORKS, PRINTED BOOKS IN THE FIELDS OF TOYS, GAMES, ARTS AND CRAFTS, SCRAPBOOKING, GREETING CARD-MAKING, LEARNING AND EDUCATION, PUZZLES, AND HOBBIES; CHILDREN'S BOOKS; PRINTED PAPER LABELS, PRINTED INSTRUCTIONAL MATERIALS IN THE FIELDS OF TOYS, GAMES, ARTS AND CRAFTS, SCRAPBOOKING, GREETING CARD-MAKING, LEARNING AND EDUCATION, PUZZLES, AND HOBBIES; CHILDREN'S BOOKS; PRINTED MATTER, NAMELY, PAPER, CARDSTOCK, PAPER RIBBONS, IN THE FIELDS OF TOYS, GAMES, ARTS AND CRAFTS, SCRAPBOOKING, GREETING CARD-MAKING, PRINTED INSTRUCTIONS SHEETS, ANSWERS SHEETS, MANUALS IN THE FIELDS OF TOYS, GAMES, ARTS AND CRAFTS, SCRAPBOOKING, GREETING CARD-MAKING, PUZZLES, AND HOBBIES; PRINTED STATIONERY, STENCILS, STICKER ACTIVITY BOOKS, STICKERS, NAMELY, DECALS TO TRANSFER PRINTED IMAGES TO WOODEN, CERAMIC, GLASS, AND PLASTIC OBJECTS, STICKERS, STICKERS FOR CARS, STICKERS OF PAPER (U.S. CLS. 2, 5, 22, 23, 29, 37, 38 AND 50).

CLASS 20—FURNITURE AND ARTICLES NOT OTHERWISE CLASSIFIED

FOR PAPER PHOTO FRAMES; PAPER PICTURE FRAMES; PICTURE FRAMES NOT OF PRECIOUS METAL; BLANK PLASTIC ADHESIVE LABELS; PLASTIC LABELS; PARTY ORNAMENTS OF PLASTIC; MINIATURE PICTURE FRAMES (U.S. CLS. 2, 13, 22, 25, 32 AND 50).

CLASS 28—TOYS AND SPORTING GOODS

FOR PUZZLES; CONFETTI; HOBBY CRAFT SETS FOR CARD MAKING AND JOURNAL MAKING; HOBBY CRAFT KITS COMPRISING COMBINATIONS OF CARDS, LABELS, STAMPS AND STICKERS; ACTIVITY SETS IN THE NATURE OF CHILDREN'S MULTIPLE ACTIVITY TOYS FOR READING, COUNTING AND COLORING, BINGO CARDS; CHILDREN'S MULTIPLE ACTIVITY TOYS; TOY MODEL HOBBY CRAFT KITS; TRADING CARD GAMES; PAPER DOLLS, PAPER AIRPLANES; CARD GAMES; TOY MODEL KIT CARDS; TOY MODEL TRAIN SETS (U.S. CLS. 22, 23, 38 AND 50).
SHAUNIA CARLYLE, EXAMINING ATTORNEY

SN 77-161,515. MECALC (PROPRIETARY) LIMITED, CENTURION, SOUTH AFRICA, FILED 4-20-2007.

CHARGED TO INNOVATE

THE MARK CONSISTS OF STANDARD CHARACTERS WITHOUT CLAIM TO ANY PARTICULAR FONT, STYLE, SIZE, OR COLOR.

PRIORITY CLAIMED UNDER SEC. 44(D) ON SOUTH AFRICA APPLICATION NO. 2006/25133, FILED 10-23-2006, REG. NO. 2006/25133, DATED 10-23-2006, EXPIRES 10-23-2016.

PRIORITY CLAIMED UNDER SEC. 44(D) ON SOUTH AFRICA APPLICATION NO. 2006/25132, FILED 10-23-2006, REG. NO. 2006/25132, DATED 10-23-2006, EXPIRES 10-23-2016.

PRIORITY CLAIMED UNDER SEC. 44(D) ON SOUTH AFRICA APPLICATION NO. 2006/25131, FILED 10-23-2006, REG. NO. 2006/25131, DATED 10-23-2006, EXPIRES 10-23-2016.

PRIORITY CLAIMED UNDER SEC. 44(D) ON SOUTH AFRICA APPLICATION NO. 2006/25130, FILED 10-23-2006, REG. NO. 2006/25130, DATED 10-23-2006, EXPIRES 10-23-2016.

CLASS 9—ELECTRICAL AND SCIENTIFIC APPARATUS

FOR COMPUTER SOFTWARE FOR WEIGHING, MEASURING, SIGNALING AND CHECKING OF VIBRATIONS, SOUND, STRAIN, AND TEMPERATURE IN THE FIELDS OF STRUCTURAL, MINING, CHEMICAL, AEROSPACE, MINING, AERONAUTICAL, AGRICULTURAL, CIVIL, ELECTRONIC, ELECTRICAL, MECHANICAL, INDUSTRIAL, COMPUTER, MARITIME, AND METALLURGICAL ENGINEERING; APPARATUS AND INSTRUMENTS, NAMELY, FRONT-END DATA ACQUISITION UNITS, DATA CONTROL UNITS, DATA MONITORING UNITS, AND MEASUREMENT UNITS FOR WEIGHING, MEASURING, SIGNALING AND CHECKING OF VIBRATIONS, SOUND, STRAIN, AND TEMPERATURE, AND PARTS AND FITTINGS THEREFORE (U.S. CLS. 21, 23, 26, 36 AND 38).

CLASS 16—PAPER GOODS AND PRINTED MATTER

FOR PRINTED INSTRUCTIONAL, EDUCATIONAL AND PROMOTIONAL MATERIAL REGARDING THE RESEARCH, INDUSTRIAL ANALYSIS, DESIGN AND DEVELOPMENT OF COMPUTER SOFTWARE, APPARATUS AND INSTRUMENTS FOR WEIGHING, MEASURING, SIGNALING AND CHECKING OF VIBRATIONS, SOUND, STRAIN, AND TEMPERATURE; PRINTED MATTER IN THE NATURE OF SIGNBOARDS OF PAPER OR CARDBOARD, ADVERTISEMENT BOARDS OF PAPER OR CARDBOARD, POSTERS, GREETING CARDS, PAMPHLETS, ALMANACS, ANNOUNCEMENT CARDS, CALENDARS, TEAR-OFF CALENDARS, CARDBOARD PACKAGING TUBES, CATALOGUES, CHARTS, BAGS OF PAPER OR PLASTIC FOR PACKAGING, ENVELOPES, POUCHES OF PAPER OR PLASTIC FOR PACKAGING, BLUEPRINTS, BOOKLETS, BOOKS, PERIODICALS, PICTURES, PAPER TAPES AND CARDS FOR THE RECORDAL OF COMPUTER PROGRAMMES, COPYING PAPER, BOOK COVERS OF PAPER OR PLASTICS, DOCUMENT FILES, FOLDERS FOR PAPERS, PRINTED FORMS, GRAPHIC REPRESENTATIONS, HANDBOOKS, JACKETS FOR PAPERS, MAGAZINES, MANUALS, PAPER MATS FOR BEER GLASSES, NOTE BOOKS, WRITING PADS, PAPER SHEETS, STICKERS OF PAPER OR PLASTIC, CARDBOARD TUBES, FOOD WRAPPERS, WRITING PADS, WRITING PAPER, PLASTIC BUBBLE PACKS FOR WRAPPING OR PACKAGING (U.S. CLS. 2, 5, 22, 23, 29, 37, 38 AND 50).

CLASS 35—ADVERTISING AND BUSINESS

FOR ADVERTISING; BUSINESS MANAGEMENT; BUSINESS ADMINISTRATION; AND PROVIDING OFFICE FUNCTIONS (U.S. CLS. 100, 101 AND 102).

CLASS 42—SCIENTIFIC AND COMPUTER SERVICES

FOR RESEARCH, INDUSTRIAL RESEARCH, DESIGN AND DEVELOPMENT OF COMPUTER SOFTWARE, AND APPARATUS AND INSTRUMENTS FOR WEIGHING, MEASURING, SIGNALING AND CHECKING OF VIBRATIONS, SOUND, STRAIN, AND TEMPERATURE; RESEARCH, INDUSTRIAL RESEARCH AND DESIGN OF COMPUTER HARDWARE AND SOFTWARE SYSTEMS; TECHNICAL SUPPORT SERVICES, NAMELY, TROUBLESHOOTING OF COMPUTER HARDWARE AND SOFTWARE PROBLEMS; CONSULTING SERVICES IN THE FIELD OF DESIGN, SELECTION, IMPLEMENTATION AND USE OF COMPUTER HARDWARE AND SOFTWARE SYSTEMS (U.S. CLS. 100 AND 101).

TINA L. SNAPP, EXAMINING ATTORNEY

SN 77-166,675. TECHNICAL DEVELOPMENT (HK) LIMITED, 183 QUEEN'S RD CENTRAL, HONG KONG, FILED 4-26-2007.



PRIORITY CLAIMED UNDER SEC. 44(D) ON HONG KONG APPLICATION NO. 300843642, FILED 3-30-2007, REG. NO. 300843642, DATED 3-3-2007, EXPIRES 3-29-2017.

CLASS 11—ENVIRONMENTAL CONTROL APPARATUS

FOR ELECTRICAL WINE COOLER, NAMELY, REFRIGERATED CABINETS CONTAINING RACKS FOR WINE BOTTLES AND STORAGE SHELVES; ELECTRICAL KETTLES; APPARATUS FOR STEAM GENERATING, NAMELY, A STEAM GENERATOR; REFRIGERATING MACHINES, NAMELY, CHEST FREEZERS, DELI CASES, FREEZERS; APPARATUS FOR BARBECUES, NAMELY, OVEN RANGES; GRILL ACCESSORIES, NAMELY, A METAL GRILLING SHEET; ELECTRICAL COFFEE MACHINES; ELECTRICAL COOKING UTENSILS, NAMELY, ELECTRICAL RICE COOKER, ELECTRICAL SLOW COOKER, ELECTRICAL BREAD MAKING MACHINES FOR DOMESTIC USE; ELECTRICAL DEEP FRYERS; ELECTRIC GRILLS; COOKING APPLIANCES, NAMELY, MICROWAVE OVENS (U.S. CLS. 13, 21, 23, 31 AND 34).

CLASS 21—HOUSEWARES AND GLASS

FOR CORKSCREWS; BOTTLE OPENER; WINE POURERS, NAMELY, WINE DISPENSERS IN THE NATURE OF WINE PRESERVATION, WINE STATION FOR BAR; WINE POURER COMPOSED OF STEEL; VACUUM PUMPS FOR WINE BOTTLES, NAMELY, WINE VACUUM STOPPER; WINE STOPPER MADE OF CORK; BOTTLE OPENER, NAMELY, CHAMPAGNE OPENER; WINE COOLER; WINE COLLAR, NAMELY, WINE BOTTLE COLLAR; WINE FUNNEL; WINE SHOWER, NAMELY, DECANTERS; COCKTAIL STIRRERS; DECANTERS; ICE BUCKETS; STAND FOR CORKSCREWS; SILICON BRUSH FOR BASTING MEAT; CAKE SERVER; HOUSEHOLD GRATER WITH WOODEN BOARD SOLD AS A UNIT; BAMBOO CHOPPING BOARD FOR KITCHEN USE; SPAGHETTI MEASURE, NAMELY, SPAGHETTI MEASUREMENT TOOL; CARVING BOARD, NAMELY, CHEESE BOARD; CUTTING BOARDS FOR THE KITCHEN; MANUAL PEPPER AND SALT MILL; HAND-OPERATED GRINDERS, NAMELY, SALT GRINDER; WHISK HEAD; WHISKS; HAND-OPERATED COFFEE GRINDERS; MANUALLY ACTUATED PUMP DISPENSERS FOR ATTACHMENT TO CONTAINERS FOR USE IN DISPENSING LIQUIDS, NAMELY, OIL DISPENSERS, OIL SPRAYER AND VINEGAR SPRAYER; SCOOPS; CAKE SERVERS; SALT AND PEPPER SHAKERS; NON-ELECTRIC COFFEE MAKER; COOKING UTENSILS NAMELY, COOKING FORKS AND BASTING, SERVING AND MIXING SPOONS; ELECTRIC TOOTHBRUSHES, AND JUICE MAKER, NAMELY, NON-ELECTRIC JUICERS (U.S. CLS. 2, 13, 23, 29, 30, 33, 40 AND 50).

CLASS 35—ADVERTISING AND BUSINESS

FOR ADVERTISING SERVICES; BUSINESS MANAGEMENT; BUSINESS ADMINISTRATION; PROVIDING OFFICE FUNCTIONS; RETAIL SERVICES, NAMELY, RETAIL STORE SERVICES FEATURING HOUSEWARES, KITCHEN UTENSILS; SALES PROMOTION FOR OTHERS; PROVISION OF BUSINESS INFORMATION, INCLUDING VIA THE INTERNET; ORGANIZING AND CONDUCTING TRADE SHOW EXHIBITIONS IN THE FIELD OF CUTLERY, HOUSEHOLD OR KITCHEN UTENSILS, INCLUDING ELECTRICAL APPLIANCES, HOUSEHOLD OR KITCHEN ARTICLES AND GLASSWARE, PORCELAIN AND EARTHENWARE; THE BRINGING TOGETHER, FOR THE BENEFIT OF OTHERS, OF THE AFORESAID GOODS, ENABLING CUSTOMERS TO CONVENIENTLY VIEW AND PURCHASE THOSE GOODS FROM A GENERAL MERCHANDISE CATALOGUE BY MAIL ORDER OR BY MEANS OF TELECOMMUNICATIONS, FROM A GENERAL MERCHANDISE INTERNET WEB SITE IN A DEPARTMENT STORE (U.S. CLS. 100, 101 AND 102).

BENJAMIN OKEKE, EXAMINING ATTORNEY

SN 77-177,016. ACCENTUS PLC, LONDON, UNITED KINGDOM, FILED 5-9-2007.

ACCENTUS MEDICAL

THE MARK CONSISTS OF STANDARD CHARACTERS WITHOUT CLAIM TO ANY PARTICULAR FONT, STYLE, SIZE, OR COLOR.

PRIORITY CLAIMED UNDER SEC. 44(D) ON ERPN CMNTY TM OFC APPLICATION NO. 005485511, FILED 11-21-2006, REG. NO. 005485511, DATED 11-8-2007, EXPIRES 11-21-2016.

NO CLAIM IS MADE TO THE EXCLUSIVE RIGHT TO USE "MEDICAL", APART FROM THE MARK AS SHOWN.

CLASS 10—MEDICAL APPARATUS

FOR HYDROXYAPATITE COATED ARTICLES FOR IMPLANTATION, NAMELY, ORTHOPAEDIC AND PROSTHETIC IMPLANTS FOR USE IN THE BODY; ORTHOPAEDIC IMPLANTS FOR USE IN THE BODY; PROSTHETIC IMPLANTS FOR USE IN THE BODY (U.S. CLS. 26, 39 AND 44).

CLASS 40—MATERIAL TREATMENT

FOR ANODISING TREATMENT AND SURFACE COATING OF ORTHOPAEDIC IMPLANTS AND OF PROSTHETIC IMPLANTS (U.S. CLS. 100, 103 AND 106).

CLASS 42—SCIENTIFIC AND COMPUTER SERVICES

FOR DESIGN, ENGINEERING, RESEARCH, DEVELOPMENT AND TESTING SERVICES IN THE FIELD OF MATERIALS CUSTOMIZATION FOR MEDICAL APPLICATIONS; MATERIALS TESTING AND MATERIALS EVALUATION SERVICES; TESTING, ANALYSIS AND EVALUATION OF MEDICAL DEVICES OF OTHERS FOR THE PURPOSE OF CERTIFICATION (U.S. CLS. 100 AND 101).

SANJEEV VOHRA, EXAMINING ATTORNEY

SN 77-185,125. WURLDTECH SECURITY INC., VANCOUVER, CANADA, FILED 5-18-2007.



PRIORITY CLAIMED UNDER SEC. 44(D) ON CANADA APPLICATION NO. 1347284, FILED 5-14-2007, REG. NO. TMA746034, DATED 8-24-2009, EXPIRES 8-24-2024.

NO CLAIM IS MADE TO THE EXCLUSIVE RIGHT TO USE "CERTIFIED", APART FROM THE MARK AS SHOWN. THE MARK CONSISTS FOR THE WORDING "CERTIFIED ACHILLES" WITH TWO CONCENTRIC CIRCLES.

CLASS 9—ELECTRICAL AND SCIENTIFIC APPARATUS

FOR NETWORK DEVICES, NAMELY, COMPUTER NETWORKS AND PLATFORMS, COMPRISING COMPUTER HARDWARE, COMPUTER NETWORK ADAPTERS, SWITCHES, ROUTERS AND HUBS, AND COMPUTER FIRMWARE AND COMPUTER SOFTWARE, FOR ENHANCING INDUSTRIAL AUTOMATION AND FOR ASSESSING AND IDENTIFYING VULNERABILITIES AND CYBER SECURITY THREATS AND RISKS IN CONTROL SYSTEM INFRASTRUCTURE, COMPUTER CONTROL SYSTEMS, NETWORKS AND DEVICES, AND FOR TESTING THE EFFECTIVENESS OF CYBER SECURITY APPLICATIONS, DEVICES, AND SYSTEMS TO ACHIEVE OPTIMAL NETWORK SECURITY, ALL IN THE FIELD OF CYBER SECURITY VULNERABILITY TESTING; COMPUTER HARDWARE IN THE FIELD OF CYBER SECURITY VULNERABILITY TESTING OF NETWORKED DEVICES (U.S. CLS. 21, 23, 26, 36 AND 38).

CLASS 42—SCIENTIFIC AND COMPUTER SERVICES

FOR CONSULTING SERVICES IN THE FIELD OF TESTING AND ASSESSING NETWORKED DEVICES FOR CYBER SECURITY VULNERABILITIES AND RISKS; MAINTENANCE AND SUPPORT SERVICES FOR COMPUTER SOFTWARE IN THE FIELD OF CYBER SECURITY VULNERABILITY TESTING OF NETWORKED DEVICES; SUPPORT SERVICES IN THE NATURE OF DIAGNOSING PROBLEMS FOR COMPUTER HARDWARE IN THE FIELD OF CYBER SECURITY VULNERABILITY TESTING OF NETWORKED DEVICES; PROVIDING UPDATES FOR COMPUTER SOFTWARE IN THE FIELD OF CYBER SECURITY VULNERABILITY TESTING OF NETWORKED DEVICES; COMPUTER CONSULTATION IN THE FIELD OF CYBER SECURITY, NAMELY, PROVIDING APPROVALS THAT MINIMUM SECURITY LEVELS HAVE BEEN ACHIEVED IN THE FIELD OF CYBER SECURITY VULNERABILITY TESTING OF NETWORKED DEVICES (U.S. CLS. 100 AND 101).

CLASS 45—PERSONAL AND LEGAL SERVICES

FOR MONITORING OF COMPUTER SYSTEMS FOR SECURITY PURPOSES, NAMELY, TO PROVIDE APPROVALS THAT MINIMUM SECURITY LEVELS HAVE BEEN ACHIEVED IN THE FIELD OF CYBER SECURITY VULNERABILITY TESTING OF NETWORKED DEVICES (U.S. CLS. 100 AND 101).
EVELYN BRADLEY, EXAMINING ATTORNEY

SN 77-194,912. CROCS, INC., NIWOT, CO. FILED 5-31-2007.

CROCS

THE MARK CONSISTS OF STANDARD CHARACTERS WITHOUT CLAIM TO ANY PARTICULAR FONT, STYLE, SIZE, OR COLOR.
OWNER OF U.S. REG. NO. 3,243,038.

CLASS 36—INSURANCE AND FINANCIAL

FOR CHARITABLE AND ELEEMOSYNARY SERVICES, NAMELY, CHARITABLE FUND RAISING; PROVIDING GRANTS TO CHARITIES AND NON-GOVERNMENTAL ORGANIZATIONS (NGOS); ACCEPTING AND ADMINISTERING EMPLOYEE MATCHING MONETARY CHARITABLE CONTRIBUTIONS; CHARITABLE FUND RAISING SERVICES BY MEANS OF DONATION OF A PERCENTAGE OF THE SALE OF FOOTWEAR AND APPAREL TO CHARITIES AND NEEDY PERSONS (U.S. CLS. 100, 101 AND 102).

CLASS 45—PERSONAL AND LEGAL SERVICES

FOR ENCOURAGING EMPLOYEE PARTICIPATION IN CHARITABLE PROGRAMS AND ORGANIZATIONS, NAMELY, ORGANIZING EMPLOYEE GROUPS TO UNDERTAKE PROJECTS TO BENEFIT THE NEEDY AND THE COMMUNITY TO ENCOURAGE LEADERSHIP, CHARACTER, COMPASSION, AND GOOD CITIZENSHIP; CHARITABLE SERVICES, NAMELY, PROVIDING FOOTWEAR AND APPAREL TO NEEDY PERSONS; CHARITABLE SERVICES, NAMELY, PROVIDING FOOTWEAR, APPAREL AND OTHER PRODUCTS MANUFACTURED FROM USED FOOTWEAR, APPAREL AND OTHER MANUFACTURING SCRAP TO NEEDY PERSONS (U.S. CLS. 100 AND 101).
BARBARA RUTLAND, EXAMINING ATTORNEY

SN 77-198,950. TREVES, SAMUEL, MONACO, MONACO, FILED 6-6-2007.

SASS

THE MARK CONSISTS OF STANDARD CHARACTERS WITHOUT CLAIM TO ANY PARTICULAR FONT, STYLE, SIZE, OR COLOR.

CLASS 21—HOUSEWARES AND GLASS

FOR CUPS, SIGNBOARDS OF PORCELAIN OR GLASS (U.S. CLS. 2, 13, 23, 29, 30, 33, 40 AND 50).

CLASS 24—FABRICS

FOR TEXTILE TABLE LINENS; CLOTH TABLE NAPKINS; PLACE MATS NOT OF PAPER; TABLECLOTHS NOT OF PAPER; FACECLOTHS; TOWELS; COVERS FOR CUSHIONS (U.S. CLS. 42 AND 50).

CLASS 28—TOYS AND SPORTING GOODS

FOR GAMES, NAMELY, BILLIARD TABLES, PLAYING CARDS (U.S. CLS. 22, 23, 38 AND 50).

CLASS 34—SMOKERS' ARTICLES

FOR MATCH BOXES; ASHTRAYS FOR SMOKERS (U.S. CLS. 2, 8, 9 AND 17).

CLASS 35—ADVERTISING AND BUSINESS

FOR DIRECT MAIL ADVERTISING, NAMELY, ADVERTISING LEAFLET; ADVERTISING, NAMELY, ONLINE ADVERTISING ON A COMPUTER NETWORK, ADVERTISING BY MAIL ORDER, RADIO ADVERTISING, TELEVISION ADVERTISING; RETAIL STORE SERVICES FEATURING GIFTS AND SOUVENIRS; ONLINE RETAIL STORE SERVICES FEATURING GIFTS AND SOUVENIRS; BUSINESS MANAGEMENT OF HOTELS FOR OTHERS; ARRANGING OF BUSINESS COLLOQUIUMS AND BUSINESS CONFERENCES (U.S. CLS. 100, 101 AND 102).

CLASS 41—EDUCATION AND ENTERTAINMENT

FOR NIGHT CLUBS; ORGANIZATION AND PRODUCTION OF SHOWS AND PARTIES, NAMELY, DANCE SHOWS, MUSICAL SHOWS, AUDIOVISUAL SHOWS AND THEME PARTIES; ARRANGING OF EDUCATIONAL COLLOQUIUMS, CONFERENCES AND SEMINARS; PARTY PLANNING; ARRANGING AND CONDUCTING CONCERTS; PARTY PLANNING SERVICES; CASINO FACILITIES (U.S. CLS. 100, 101 AND 107).

CLASS 43—HOTEL AND RESTAURANT SERVICES

FOR BAR SERVICES; CAFÉS; RESTAURANTS; CAFETERIAS; RENTAL OF MEETING ROOMS; CATERING SERVICES; HOTELS (U.S. CLS. 100 AND 101).
DANIEL BRODY, EXAMINING ATTORNEY

SN 77-206,960. AQUAPAC INTERNATIONAL LIMITED,
LONDON, UNITED KINGDOM, FILED 6-15-2007.

100% Outdoors

PRIORITY CLAIMED UNDER SEC. 44(D) ON EUROPEAN UNION APPLICATION NO. 005990007, FILED 6-11-2007.
NO CLAIM IS MADE TO THE EXCLUSIVE RIGHT TO USE "OUTDOORS", APART FROM THE MARK AS SHOWN.

CLASS 9—ELECTRICAL AND SCIENTIFIC APPARATUS

FOR PROTECTIVE BAGS AND CARRYING CASES ALL SPECIALLY ADAPTED FOR USE WITH ELECTRONIC GOODS AND MOBILE PHONES FOR OUTDOOR PURSUITS AND WATER SPORTS, NAMELY, RADIO APPARATUS, CAMERAS, PERSONAL DIGITAL ASSISTANTS (PDA), MP3 PLAYERS, PORTABLE AND HANDHELD DIGITAL ELECTRONIC DEVICES FOR RECORDING, ORGANIZING, TRANSMITTING, MANIPULATING, AND REVIEWING AUDIO FILES, MOBILE PHONES, TELEPHONE AND COMMUNICATIONS APPARATUS, CASSETTE RECORDERS, CASSETTE PLAYERS, CAMERAS, COMPACT DISC PLAYERS, VIDEO RECORDERS AND CAMCORDERS; SPECIALTY HOLSTERS FOR CARRYING CELLULAR PHONES, PAGERS, AND/OR PERSONAL DIGITAL ASSISTANTS (U.S. CLS. 21, 23, 26, 36 AND 38).

CLASS 16—PAPER GOODS AND PRINTED MATTER

FOR PASSPORT WALLETS (U.S. CLS. 2, 5, 22, 23, 29, 37, 38 AND 50).

CLASS 18—LEATHER GOODS

FOR BAGS MADE OF VARIOUS MATERIALS, NAMELY, BAGS OF LEATHER AND IMITATION OF LEATHER, NAMELY, ALL-PURPOSE CARRYING BAGS, BEACH BAGS, BELT BAGS, CARRY-ALL BAGS, KEY BAGS, SPORTS BAGS, TRAVELING BAGS, ATHLETIC BAGS, BABY BACKPACKS, BOOK BAGS, DUFFEL BAGS, GYM BAGS, TOTE BAGS, COIN PURSES, KNAPSACKS, WAIST PACKS, SHOPPING BAGS, SHOE BAGS FOR TRAVEL, SCHOOL BAGS, SHOULDER BAGS, HANDBAGS, SATCHELS; BAGS, NAMELY, ALL-PURPOSE CARRYING BAGS, BEACH BAGS, BELT BAGS, CARRY-ALL BAGS, KEY BAGS, SPORTS BAGS, TRAVELING BAGS, ATHLETIC BAGS, BABY BACKPACKS, BOOK BAGS, DUFFEL BAGS, GYM BAGS, TOTE BAGS, COIN PURSES, KNAPSACKS, WAIST PACKS, SHOE BAGS FOR TRAVEL, SCHOOL BAGS, SHOULDER BAGS, HANDBAGS; HERMETICALLY SEALABLE WATERPROOF BAGS, NAMELY, ALL-PURPOSE CARRYING BAGS, BEACH BAGS, BELT BAGS, CARRY-ALL BAGS, KEY BAGS, SPORTS BAGS, TRAVELING BAGS, ATHLETIC BAGS, BABY BACKPACKS, BOOK BAGS, DUFFEL BAGS, GYM BAGS, TOTE BAGS, COIN PURSES, KNAPSACKS, WAIST PACKS, SHOE BAGS FOR TRAVEL, SCHOOL BAGS, SHOULDER BAGS, HANDBAGS, SATCHELS; WATER-PROOF BAGS, NAMELY, ALL-PURPOSE CARRYING BAGS, BEACH BAGS, BELT BAGS, CARRY-ALL BAGS, KEY BAGS, SPORTS BAGS, TRAVELING BAGS, ATHLETIC BAGS, BABY BACKPACKS, BOOK BAGS, DUFFEL BAGS, GYM BAGS, TOTE BAGS, COIN PURSES, KNAPSACKS, WAIST PACKS, SHOE BAGS FOR TRAVEL, SCHOOL BAGS, SHOULDER BAGS, HANDBAGS, SATCHELS; TRAVELING BAGS; UMBRELLAS; RUCKSACKS; BUM BAGS; LUGGAGE; TOILETRY CASES SOLD EMPTY; ALL PURPOSE SPORTS BAGS; TOTE BAGS; ATTACHÉ CASES, BRIEFCASE-TYPE PORTFOLIOS AND BRIEFCASES; PURSES, HANDBAGS, SHOULDER BAGS, MAKE-UP BAGS SOLD EMPTY, SUITCASES, CARRY ON LUGGAGE, TRAVEL KITS SOLD EMPTY, BACK PACKS, BOOK BAGS, WAIST PACKS, KEY CASES, POCKET WALLETS; PASSPORT WALLETS; PANNIERS IN THE NATURE OF SPORT PACKS (U.S. CLS. 1, 2, 3, 22 AND 41).

CLASS 24—FABRICS

FOR WATERPROOF FABRICS FOR USE IN THE MANUFACTURE OF GLOVES; WATERPROOF FABRICS FOR USE IN THE MANUFACTURE OF HATS; WATERPROOF FABRICS FOR USE IN THE MANUFACTURE OF JACKETS; WATERPROOF FABRICS FOR USE IN THE MANUFACTURE OF TROUSERS; WATERPROOF FABRICS FOR USE IN THE MANUFACTURE OF PROTECTIVE BAGS, CARRYING CASES, CLOTHING, LUGGAGE; TEXTILE PIECE GOODS, NAMELY, NON-WOVEN TEXTILE FABRICS, CURTAINS, BED SPREADS, TEXTILE WALL HANGINGS, BED LINEN, HOUSEHOLD LINEN; WATERPROOF MATTRESS COVERS; MATTRESS COVERS (U.S. CLS. 42 AND 50).

CLASS 35—ADVERTISING AND BUSINESS

FOR RETAIL STORE SERVICES, ON-LINE RETAIL STORE SERVICES AND RETAIL STORE SERVICES, AVAILABLE THROUGH COMPUTER COMMUNICATIONS AND INTERACTIVE TELEVISION, IN THE FIELD OF BAGS MADE OF VARIOUS MATERIALS, BAGS, WATERPROOF BAGS, WATERPROOF BAGS MADE OF PLASTIC, HERMETICALLY SEALABLE WATERPROOF BAGS, TRAVELING BAGS, UMBRELLAS, RUCKSACKS, BUM BAGS, HOLSTERS, OTHER THAN FOR WEAPONS, LUGGAGE, LUGGAGE FOR BICYCLES, LUGGAGE FOR MOTORBIKES, TOILETRY CASES SOLD EMPTY, ALL PURPOSE SPORTS BAGS, TOTE BAGS, ATTACHÉ CASES, BRIEFCASE-TYPE PORTFOLIOS AND BRIEFCASES, PURSES, HANDBAGS, SHOULDER BAGS, MAKE-UP BAGS SOLD EMPTY, SUITCASES, CARRY ON LUGGAGE, TRAVEL KITS SOLD EMPTY, SHOULDER BAGS, BACK PACKS, BOOK BAGS, WAIST PACKS, KEY CASES, POCKET WALLETS, PASSPORT WALLETS, PANNIERS, PANNIERS FOR BICYCLES, TRAVELING CASES, PANNIERS FOR MOTORCYCLES, FABRICS, BREATHABLE WATERPROOF FABRICS, WATERPROOF FABRICS, WATERPROOF SHEATHS, WATERPROOF FABRICS FOR USE IN THE MANUFACTURE OF GLOVES, WATERPROOF FABRICS FOR USE IN THE MANUFACTURE OF HATS, WATERPROOF FABRICS FOR USE IN THE MANUFACTURE OF JACKETS, WATERPROOF FABRICS FOR USE IN THE MANUFACTURE OF TROUSERS, WATERPROOF TEXTILE FABRICS, SHEATHS MADE OF WATERPROOF FABRIC, WOVEN AND TEXTILE PRODUCTS, TEXTILE PIECE GOODS, PLASTIC SUBSTITUTES FOR FABRICS, TEXTILE TRAVELING RUGS, WATERPROOF RUGS, WATERPROOF MATTRESS COVERS, MATTRESS COVERS; PROVIDING ON-LINE BUSINESS INFORMATION AND ADVICE RELATED TO RETAIL SALES SERVICES (U.S. CLS. 100, 101 AND 102).

TRICIA SONNEBORN, EXAMINING ATTORNEY

SN 77-214,359. MADELEINE'S FUND: LEAVING NO STONE UNTURNED LIMITED, LONDON, EC4M 6YH, UNITED KINGDOM, FILED 6-25-2007.

MADELEINE'S FUND: LEAVING
NO STONE UNTURNED

THE MARK CONSISTS OF STANDARD CHARACTERS WITHOUT CLAIM TO ANY PARTICULAR FONT, STYLE, SIZE, OR COLOR.

OWNER OF ERPN CMNTY TM OFC REG. NO. 005917232, DATED 4-17-2008, EXPIRES 5-18-2017.

NO CLAIM IS MADE TO THE EXCLUSIVE RIGHT TO USE "FUND", APART FROM THE MARK AS SHOWN.

CLASS 9—ELECTRICAL AND SCIENTIFIC APPARATUS

FOR ELECTRONIC PUBLICATIONS, NAMELY, BROCHURES, BOOKLETS, LEAFLETS, ARTICLES, BOOKS, REPORTS, NEWSLETTERS, POSTERS, DIRECTORIES, JOURNALS, PERIODICALS AND MAGAZINES FEATURING INFORMATION TO ASSIST FAMILIES AND OTHERS AFFECTED BY MISSING CHILDREN RECORDED ON COMPUTER MEDIA (U.S. CLS. 21, 23, 26, 36 AND 38).

CLASS 16—PAPER GOODS AND PRINTED MATTER

FOR PRINTED MATTER, NAMELY, BROCHURES, ARTICLES, BOOKLETS, NEWSLETTERS, NEWSPAPERS, LEAFLETS, REPORTS, POSTERS, PAPER BADGES, CALENDARS, GREETING CARDS, POSTCARDS, BOOKS, PHOTOGRAPHS, PAPER BANNERS, COLLECTING BOXES MADE OF PAPER, STATIONERY, MAGAZINES AND INSTRUCTIONAL AND TEACHING MATERIALS FEATURING INFORMATION TO ASSIST FAMILIES AND OTHER INDIVIDUALS AFFECTED BY MISSING CHILDREN (U.S. CLS. 2, 5, 22, 23, 29, 37, 38 AND 50).

CLASS 35—ADVERTISING AND BUSINESS

FOR PROMOTIONAL AND PUBLIC AWARENESS CAMPAIGNS IN THE FIELD OF RAISING AWARENESS ABOUT ISSUES CONNECTED WITH MISSING CHILDREN; COLLECTING, ORGANIZING AND PROVIDING PUBLIC AWARENESS INFORMATION IN ORDER TO ASSIST FAMILIES AND OTHERS AFFECTED BY MISSING CHILDREN (U.S. CLS. 100, 101 AND 102).

CLASS 36—INSURANCE AND FINANCIAL

FOR FINANCIAL SERVICES, NAMELY, FUNDRAISING COLLECTIONS AND THE MANAGEMENT AND MONITORING OF FUNDS; CHARITABLE FUNDRAISING; THE PROVISION OF FINANCIAL ASSISTANCE TO FAMILIES AND OTHERS AFFECTED BY MISSING CHILDREN; PROVIDING FINANCIAL GRANT SERVICES TO FAMILIES AND OTHERS AFFECTED BY MISSING CHILDREN; PROVIDING FINANCIAL ASSISTANCE TO FAMILIES AND OTHERS AFFECTED BY MISSING CHILDREN; ORGANIZING FUNDRAISING EVENTS (U.S. CLS. 100, 101 AND 102).

CLASS 41—EDUCATION AND ENTERTAINMENT

FOR NON-DOWNLOADABLE INTERNET PUBLICATIONS, NAMELY, BROCHURES, BOOKLETS, LEAFLETS, ARTICLES, BOOKS, REPORTS, NEWSLETTERS, POSTERS, DIRECTORIES, JOURNALS, PERIODICALS AND MAGAZINES FEATURING INFORMATION TO ASSIST FAMILIES AND OTHERS AFFECTED BY MISSING CHILDREN (U.S. CLS. 100, 101 AND 107).

CLASS 45—PERSONAL AND LEGAL SERVICES

FOR PASTORAL COUNSELING, ADVICE AND GUIDANCE SERVICES (U.S. CLS. 100 AND 101).

REGINA DRUMMOND, EXAMINING ATTORNEY

SN 77-215.435. BABYTOONZ INC., TORTOLA, BR.VIRGIN ISLANDS, FILED 6-26-2007.

SN 77-215.488. BABYTOONZ INC., TORTOLA, BR.VIRGIN ISLANDS, FILED 6-26-2007.

SMARTOONZ

THE MARK CONSISTS OF STANDARD CHARACTERS WITHOUT CLAIM TO ANY PARTICULAR FONT, STYLE, SIZE, OR COLOR.

PRIORITY CLAIMED UNDER SEC. 44(D) ON ISRAEL APPLICATION NO. 196501, FILED 12-27-2006, REG. NO. 196501, DATED 11-5-2008, EXPIRES 12-27-2016.

PRIORITY CLAIMED UNDER SEC. 44(D) ON ISRAEL APPLICATION NO. 196502, FILED 12-27-2006, REG. NO. 196502, DATED 11-5-2008, EXPIRES 12-27-2016.

CLASS 9—ELECTRICAL AND SCIENTIFIC APPARATUS

FOR PRE-RECORDED AUDIO, VISUAL, AUDIO VISUAL AND MULTIMEDIA MAGNETIC DATA CARRIERS, OPTICAL DATA CARRIERS AND DIGITAL DATA CARRIERS, NAMELY, DIGITAL VERSATILE DISCS (DVD'S), COMPACT DISCS (CD'S), CASSETTE TAPES, AND INTERACTIVE COMPACT DISCS, ALL FEATURING ANIMATION, MOVIES, COMPUTER GAME SOFTWARE, CHILDREN'S EDUCATIONAL SOFTWARE, EDUCATIONAL VIDEOS ABOUT CHILD DEVELOPMENT, ALL FOR BABIES, INFANTS, KIDS AND PARENTS; DOWNLOADABLE AUDIO, VIDEO AND MULTIMEDIA FILES, ALL FEATURING ANIMATION, MOVIES, COMPUTER GAME SOFTWARE, CHILDREN'S EDUCATIONAL SOFTWARE, EDUCATIONAL VIDEOS ABOUT CHILD DEVELOPMENT, ALL FOR BABIES, INFANTS, KIDS AND PARENTS; DOWNLOADABLE COMPUTER SOFTWARE FOR THE INTEGRATION OF TEXT, AUDIO, GRAPHICS, STILL IMAGES AND MOVING PICTURES INTO AN INTERACTIVE DELIVERY FOR MULTIMEDIA APPLICATIONS; DOWNLOADABLE COMPUTER SOFTWARE IN THE NATURE OF INTERACTIVE MULTIMEDIA EDUCATIONAL SOFTWARE AND GAMES FOR BABIES, INFANTS, KIDS AND PARENTS (U.S. CLS. 21, 23, 26, 36 AND 38).

CLASS 41—EDUCATION AND ENTERTAINMENT

FOR EDUCATIONAL AND ENTERTAINMENT SERVICES, NAMELY, PRODUCTION AND DISTRIBUTION OF ENTERTAINMENT AND EDUCATIONAL PROGRAMS TO TELEVISION, CABLE AND SATELLITE TELEVISION SYSTEMS, FOR DISPLAY BY THOSE PROVIDERS VIA VIDEO ON DEMAND (VOD), INTERNET PROTOCOL TELEVISION (IPTV), DIGITAL MULTIMEDIA BROADCASTING (DMB) AND PAY PER VIEW; PROVIDING LIVE STAGE SHOWS IN THE NATURE OF LIVE THEATER, DANCING SHOWS AND MUSICALS; PUBLICATION OF BOOKS AND MAGAZINES; PROVIDING INFORMATION IN THE FIELD OF PARENTING CONCERNING EDUCATION AND ENTERTAINMENT OF CHILDREN, ON-LINE OR VIA CELLULAR NETWORKS; PROVIDING NON-DOWNLOADABLE ELECTRONIC PUBLICATIONS IN THE NATURE OF MAGAZINES, BROCHURES AND ARTICLES IN THE FIELD OF CHILD CARE, PARENTING, CHILD RAISING, CHILD DEVELOPMENT AND CHILD EDUCATION, ON-LINE OR VIA CELLULAR NETWORKS; PROVIDING NON-DOWNLOADABLE COMPUTER GAMES, ON-LINE OR VIA CELLULAR NETWORKS; PROVIDING ENTERTAINMENT, DEVELOPMENTAL AND EDUCATIONAL CONTENT, IN THE NATURE OF A WEBSITE FEATURING NON-DOWNLOADABLE COMPUTER GAMES, RESOURCE GUIDES TO ENTERTAINMENT, RECREATION AND EDUCATION, AND ONLINE COMPUTER GAMES, FOR BABIES, INFANTS, KIDS AND PARENTS, ON-LINE OR VIA CELLULAR NETWORKS (U.S. CLS. 100, 101 AND 107).

JAMES MACFARLANE, EXAMINING ATTORNEY



PRIORITY CLAIMED UNDER SEC. 44(D) ON ISRAEL APPLICATION NO. 196503, FILED 12-26-2006, REG. NO. 196503, DATED 11-5-2008, EXPIRES 12-27-2016.

PRIORITY CLAIMED UNDER SEC. 44(D) ON ISRAEL APPLICATION NO. 196504, FILED 12-27-2006, REG. NO. 196504, DATED 11-5-2008, EXPIRES 12-27-2016.

THE COLOR(S) PURPLE, PINK, ORANGE, GREEN, BLUE, YELLOW AND RED IS/ARE CLAIMED AS A FEATURE OF THE MARK.

THE MARK CONSISTS OF THE WORDING "SMARTOONZ" IN STYLIZED LETTERS, IN WHICH THE COLOR PURPLE APPEARS IN THE OUTSIDE OF THE LETTERS "S" AND "N," AND THE COLOR LIGHT PURPLE APPEARS IN THE INSIDE OF THE LETTERS "S" AND "N." THE COLOR BLUE APPEARS IN THE OUTSIDE OF THE LETTER "M," AND THE COLOR LIGHT BLUE APPEARS IN THE INSIDE OF THE LETTER "M." THE COLOR ORANGE APPEARS IN THE OUTSIDE OF THE LETTERS "A" AND "Z," AND THE COLOR LIGHT ORANGE APPEARS IN THE INSIDE OF THE LETTERS "A" AND "Z." THE COLOR PINK APPEARS IN THE OUTSIDE OF THE LETTER "R," AND THE COLOR DARK PINK APPEARS IN THE INSIDE OF THE LETTER "R." THE COLOR GREEN APPEARS IN THE OUTSIDE OF THE LETTER "T," AND THE COLOR LIGHT GREEN APPEARS IN THE INSIDE OF THE LETTER "T." THE COLOR YELLOW APPEARS IN THE OUTSIDE OF THE FIRST LETTER "O," AND THE COLOR LIGHT YELLOW APPEARS IN THE INSIDE OF THE FIRST LETTER "O." THE COLOR RED APPEARS IN THE OUTSIDE OF THE SECOND LETTER "O," AND THE COLOR LIGHT RED APPEARS IN THE INSIDE OF THE SECOND LETTER "O." THE COLOR WHITE IN THE MIDDLE OF THE LETTERS "O" CONSTITUTES BACKGROUND, OUTLINING, SHADING OR TRANSPARENT AREAS, AND IS NOT PART OF THE MARK.

CLASS 9—ELECTRICAL AND SCIENTIFIC APPARATUS

FOR PRE-RECORDED AUDIO, VISUAL, AUDIO VISUAL AND MULTIMEDIA MAGNETIC DATA CARRIERS, OPTICAL DATA CARRIERS AND DIGITAL DATA CARRIERS, NAMELY, DIGITAL VERSATILE DISCS (DVD'S), COMPACT DISCS (CD'S), CASSETTE TAPES, AND INTERACTIVE COMPACT DISCS, ALL FEATURING ANIMATION, MOVIES, COMPUTER GAME SOFTWARE, CHILDREN'S EDUCATIONAL SOFTWARE, EDUCATIONAL VIDEOS ABOUT CHILD DEVELOPMENT, ALL FOR BABIES, INFANTS, KIDS AND PARENTS; DOWNLOADABLE AUDIO, VIDEO AND MULTIMEDIA FILES, ALL FEATURING ANIMATION, MOVIES, COMPUTER GAME SOFTWARE, CHILDREN'S EDUCATIONAL SOFTWARE, EDUCATIONAL VIDEOS ABOUT CHILD DEVELOPMENT, ALL FOR BABIES, INFANTS, KIDS AND PARENTS; DOWNLOADABLE COMPUTER SOFTWARE FOR THE INTEGRATION OF TEXT, AUDIO, GRAPHICS, STILL IMAGES AND MOVING PICTURES INTO AN INTERACTIVE DELIVERY FOR MULTIMEDIA APPLICATIONS; DOWNLOADABLE COMPUTER SOFTWARE IN THE NATURE OF INTERACTIVE MULTIMEDIA EDUCATIONAL SOFTWARE AND GAMES FOR BABIES, INFANTS, KIDS AND PARENTS (U.S. CLS. 21, 23, 26, 36 AND 38).

CLASS 41—EDUCATION AND ENTERTAINMENT

FOR EDUCATIONAL AND ENTERTAINMENT SERVICES, NAMELY, PRODUCTION AND DISTRIBUTION OF ENTERTAINMENT AND EDUCATIONAL PROGRAMS TO TELEVISION, CABLE AND SATELLITE TELEVISION SYSTEMS, FOR DISPLAY BY THOSE PROVIDERS VIA VIDEO ON DEMAND (VOD), INTERNET PROTOCOL TELEVISION (IPTV), DIGITAL MULTIMEDIA BROADCASTING (DMB) AND PAY PER VIEW; PROVIDING LIVE STAGE SHOWS IN THE NATURE OF LIVE THEATER, DANCING SHOWS AND MUSICALS; PUBLICATION OF BOOKS AND MAGAZINES; PROVIDING INFORMATION IN THE FIELD OF PARENTING CONCERNING EDUCATION AND ENTERTAINMENT OF CHILDREN, ON-LINE OR VIA CELLULAR NETWORKS; PROVIDING NON-DOWNLOADABLE ELECTRONIC PUBLICATIONS IN THE NATURE OF MAGAZINES, BROCHURES AND ARTICLES IN THE FIELD OF CHILD CARE, PARENTING, CHILD RAISING, CHILD DEVELOPMENT AND CHILD EDUCATION, ON-LINE OR VIA CELLULAR NETWORKS; PROVIDING NON-DOWNLOADABLE COMPUTER GAMES, ON-LINE OR VIA CELLULAR NETWORKS; PROVIDING ENTERTAINMENT, DEVELOPMENTAL AND EDUCATIONAL CONTENT, IN THE NATURE OF A WEBSITE FEATURING NON-DOWNLOADABLE COMPUTER GAMES, RESOURCE GUIDES TO ENTERTAINMENT, RECREATION AND EDUCATION, AND ONLINE COMPUTER GAMES, FOR BABIES, INFANTS, KIDS AND PARENTS, ON-LINE OR VIA CELLULAR NETWORKS (U.S. CLS. 100, 101 AND 107).

JAMES MACFARLANE, EXAMINING ATTORNEY

SN 77-255,933. MEDINCO S.P.A., MILANO, ITALY, FILED 8-15-2007.



PRIORITY CLAIMED UNDER SEC. 44(D) ON ERPN CMNTY TM OFC APPLICATION NO. 006130397, FILED 7-24-2007, REG. NO. 6130397, DATED 12-15-2009, EXPIRES 12-15-2019.

THE MARK CONSISTS OF THE WORD "CLAROCHEM" IN STYLIZED LETTERS WITH A DESIGN.

CLASS 1—CHEMICALS

FOR CHEMICALS AND CHEMICALS REAGENTS FOR USE IN THE MANUFACTURE OF PHARMACEUTICALS (U.S. CLS. 1, 5, 6, 10, 26 AND 46).

CLASS 5—PHARMACEUTICALS

FOR CHEMICO-PHARMACEUTICAL PREPARATIONS USED IN THE TREATMENT OF HEART DISEASE; ENZYMES FOR PHARMACEUTICAL PURPOSES, NAMELY, THE TREATMENT OF HEART DISEASE (U.S. CLS. 6, 18, 44, 46, 51 AND 52).

MATTHEW MCDOWELL, EXAMINING ATTORNEY

SN 77-260,358. LATCHWAYS PLC, DEVIZES, WILTSHIRE, UNITED KINGDOM, FILED 8-21-2007.

FULL CONTACT

THE MARK CONSISTS OF STANDARD CHARACTERS WITHOUT CLAIM TO ANY PARTICULAR FONT, STYLE, SIZE, OR COLOR.

OWNER OF ERPN CMNTY TM OFC REG. NO. 006232029, DATED 11-18-2008, EXPIRES 8-13-2017.

CLASS 6—METAL GOODS

FOR METAL LOCKING PAWLS; METAL TOOTH RINGS; METAL FASTENERS, NAMELY, BOLTS, NAILS, RIVETS; METAL CABLE JOINTS; METAL CHAINS; METAL CLIPS FOR CABLE; METAL CLOSURES FOR CONTAINERS; CABLE STRETCHERS AND CINCTURE STRETCHERS OF METAL; METAL RINGS FOR USE WITH FALL PROTECTION EQUIPMENT FOR FALL RESTRAINT AND FALL ARREST; METAL PIPE COUPLINGS AND JOINTS; EYEBOLTS; METAL FLANGES; METAL GUARD RAILS; METAL HINGES; METAL HOOKS; METAL JUNCTIONS FOR PIPES; METAL BRACES FOR LOAD HANDLING; METAL HARNESSSES FOR LOAD HANDLING; METAL STRAPS FOR LOAD HANDLING; METAL SLINGS FOR HANDLING LOADS; NAILS; METAL NUTS; METAL PEGS; METAL POLES; METAL POSTS; BUILDING MATERIAL, NAMELY, PROPS OF METAL; METAL RIVETS; METAL HARDWARE, NAMELY, PULLEYS; SCREW RINGS OF METAL; METAL SCREWS; METAL SEALING CAPS; CABLE JUNCTION SLEEVES OF METAL; METAL SPRING LOCKS; METAL HARDWARE, NAMELY, SPRINGS; SPURS; METAL STEP STOOLS; METAL LADDERS; METAL STRAP HINGES; METAL VALVES, NOT BEING PART OF MACHINES; METAL HARDWARE, NAMELY, WASHERS; REMOVABLE EYE BOLTS FOR ATTACHMENT OF SAFETY HARNESSSES; SPACER BRACKETS OF METAL; PARTS AND FITTINGS FOR ALL THE AFORESAID GOODS (U.S. CLS. 2, 12, 13, 14, 23, 25 AND 50).

CLASS 9—ELECTRICAL AND SCIENTIFIC APPARATUS

FOR FALL PROTECTION EQUIPMENT FOR FALL RESTRAINT AND FALL ARREST, NAMELY, BARS, ANCHORS, HARNESSSES, LINES, LANYARDS, CARABINERS AND ANCHORAGE CONNECTORS, AND LOCKING PAWLS AND FINGERS SOLD AS COMPONENTS OF THE ARRESTERS; SAFETY RESTRAINTS; LIFE BELTS; LIFE NETS; ALL FOR ATTACHING PERSONS OR EQUIPMENT TO STRUCTURES; PARTS AND FITTINGS FOR ALL THE AFORESAID GOODS (U.S. CLS. 21, 23, 26, 36 AND 38).

CLASS 37—CONSTRUCTION AND REPAIR

FOR PROVISION OF INSTALLATION ADVICE RELATING TO INSTALLATION OF PERMANENT AND TEMPORARY EQUIPMENT FOR HEIGHT SAFETY, INCLUDING ATTACHMENT, FASTENING, SECURING, HOISTING, AND TENSIONING DEVICES AND APPARATUS, ARTICLES FOR USE IN TRANSFERRING LOADS, MOBILE FASTENER DEVICES ADAPTED TO TRAVERSE A SUSPENDED SAFETY LINE OR RAIL, MOBILE ANCHORAGES FOR ATTACHMENT OF SAFETY HARNESSSES, SHOCK ABSORBING DEVICES, DEFORMABLE BRACKETS AND PARTS AND FITTINGS FOR ALL THE AFORESAID GOODS (U.S. CLS. 100, 103 AND 106).

CLASS 45—PERSONAL AND LEGAL SERVICES

FOR ADVISORY AND CONSULTANCY SERVICES RELATING TO FALL ARREST AND HEIGHT SAFETY (U.S. CLS. 100 AND 101).

DANNEAN HETZEL, EXAMINING ATTORNEY

SN 77-301,811. YOUMEU AG, BAAR, SWITZERLAND, FILED 10-11-2007.

YoumeU

THE MARK CONSISTS OF STANDARD CHARACTERS WITHOUT CLAIM TO ANY PARTICULAR FONT, STYLE, SIZE, OR COLOR.

OWNER OF ERPN CMNTY TM OFC REG. NO. 005888573, DATED 5-27-2009, EXPIRES 5-10-2017.

SN 77-280,870. BRIDGEWATER SYSTEMS CORPORATION, OTTAWA, ON, CANADA, FILED 9-17-2007.



OWNER OF U.S. REG. NOS. 2,464,790 AND 2,468,663.
NO CLAIM IS MADE TO THE EXCLUSIVE RIGHT TO USE "SYSTEMS", APART FROM THE MARK AS SHOWN.
THE MARK CONSISTS OF THE WORDING "BRIDGEWATER SYSTEMS" AND A DESIGN ELEMENT CREATED BY TWO OVERLAPPING CURVED BANDS, LOCATED TO THE RIGHT OF THE LITERAL ELEMENT.

CLASS 9—ELECTRICAL AND SCIENTIFIC APPARATUS

FOR COMPUTER AND COMMUNICATIONS SOFTWARE FOR USE IN THE CARRIAGE, DELIVERY, CONTROL, MONITORING AND MANAGEMENT OF DATA, VOICE, IMAGES AND VIDEO TRANSMISSIONS OVER COMMUNICATIONS NETWORKS (U.S. CLS. 21, 23, 26, 36 AND 38).

FIRST USE 6-18-2005; IN COMMERCE 6-18-2005.

CLASS 37—CONSTRUCTION AND REPAIR

FOR REPAIR AND INSTALLATION FOR OTHERS OF COMPUTER AND COMMUNICATIONS NETWORKS (U.S. CLS. 100, 103 AND 106).

FIRST USE 6-18-2005; IN COMMERCE 6-18-2005.

CLASS 42—SCIENTIFIC AND COMPUTER SERVICES

FOR CONSULTING AND CUSTOM DESIGN SERVICES FOR OTHERS IN THE FIELD OF COMPUTER AND COMMUNICATIONS SOFTWARE AND SYSTEMS; AND PROVIDING TECHNICAL SUPPORT AND SYSTEMS SOFTWARE AND HARDWARE ARCHITECTURE, DESIGN, IMPLEMENTATION AND DEPLOYMENT INFORMATION ABOUT COMMUNICATIONS NETWORKS AND COMMUNICATIONS NETWORK PRODUCTS VIA A GLOBAL COMPUTER NETWORK; AND REPAIR AND INSTALLATION OF COMPUTER SOFTWARE FOR OTHERS (U.S. CLS. 100 AND 101).

FIRST USE 6-18-2005; IN COMMERCE 6-18-2005.
BENJAMIN OKEKE, EXAMINING ATTORNEY

CLASS 9—ELECTRICAL AND SCIENTIFIC APPARATUS

FOR (BASED ON 44(E) PURSUANT TO EUROPEAN COMMUNITY FOREIGN REGISTRATION NUMBER 00588873) COMPUTER HARDWARE AND SOFTWARE FOR PROCESSING DIGITAL MUSIC FILES; COMPUTER SOFTWARE FOR PROCESSING DIGITAL MUSIC FILES; COMPUTER SOFTWARE PLATFORMS FOR PROCESSING DIGITAL MUSIC FILES AND FOR COMPOSING MUSIC; MOBILE COMPUTING AND OPERATING PLATFORMS CONSISTING OF DATA TRANSCEIVERS, WIRELESS NETWORKS AND GATEWAYS FOR COLLECTION AND MANAGEMENT OF DATA; AUDIO RECORDINGS FEATURING MUSIC; MUSIC-COMPOSITION SOFTWARE; SOUND RECORDINGS FEATURING MUSIC; VIDEO RECORDINGS FEATURING MUSIC; VISUAL RECORDINGS AND AUDIOVISUAL RECORDINGS FEATURING MUSIC AND ANIMATION; WIRELESS COMMUNICATION DEVICE FEATURING VOICE, DATA AND IMAGE TRANSMISSION INCLUDING VOICE, TEXT AND PICTURE MESSAGING, A VIDEO AND STILL IMAGE CAMERA, ALSO FUNCTIONAL TO PURCHASE MUSIC, GAMES, VIDEO AND SOFTWARE APPLICATIONS OVER THE AIR FOR DOWNLOADING TO THE DEVICE; SURVEYING MACHINES AND INSTRUMENTS; PHOTOGRAPHIC APPARATUS, NAMELY, CAMERAS, PHOTOGRAPHIC PROJECTORS; CINEMATOGRAPHIC MACHINES AND APPARATUS; ELECTRONIC AND OPTICAL COMMUNICATIONS INSTRUMENTS AND COMPONENTS, NAMELY, OPTICAL TRANSMITTERS, OPTICAL RECEIVERS, OPTICAL TRANSCEIVERS, DIGITAL TRANSMITTERS; WEIGHING APPARATUS AND INSTRUMENTS; APPARATUS AND INSTRUMENTS FOR CONVEYING, DISTRIBUTING, TRANSFORMING, STORING, REGULATING OR CONTROLLING ELECTRIC CURRENT; APPARATUS FOR RECORDING, TRANSMISSION, OR REPRODUCTION OF SOUND OR IMAGES; BLANK MAGNETIC DATA CARRIERS; PRE-RECORDED MAGNETIC DATA CARRIERS FEATURING SOUND AND IMAGES, NAMELY, ANIMATION AND MUSIC; AUDIO DISCS FEATURING MUSIC; BLANK MAGNETIC DISCS; BLANK OPTICAL DISCS; BLANK COMPUTER DISCS; BLANK RECORD DISKS; COMPACT DISCS FEATURING SOUND AND IMAGES, NAMELY, ANIMATION AND MUSIC; DIGITAL MEDIA, NAMELY, PRE-RECORDED VIDEO CASSETTES, DIGITAL VIDEO DISCS, DIGITAL VERSATILE DISCS, DOWNLOADABLE AUDIO AND VIDEO RECORDINGS, DVDS, AND HIGH DEFINITION DIGITAL DISKS FEATURING SOUND AND IMAGES, NAMELY, ANIMATION AND MUSIC; PRE-RECORDED DIGITAL VIDEO DISKS FEATURING SOUND AND IMAGES, NAMELY, ANIMATION AND MUSIC; PRE-RECORDED CDS, VIDEO TAPES, LASER DISKS AND DVDS FEATURING SOUND AND IMAGES, NAMELY, ANIMATION AND MUSIC; AUTOMATIC VENDING MACHINES AND MECHANISMS FOR COIN-OPERATED APPARATUS; CASH REGISTERS, CALCULATING MACHINES, DATA PROCESSING EQUIPMENT AND COMPUTERS; FIRE-EXTINGUISHING APPARATUS (BASED ON INTENT TO USE) DIGITAL MUSIC DOWNLOADABLE FROM THE INTERNET; DOWNLOADABLE MP3 FILES, MP3 RECORDINGS, ON-LINE DISCUSSION BOARDS, WEBCASTS AND PODCASTS FEATURING MUSIC, AUDIO BOOKS AND NEWS BROADCASTS; DOWNLOADABLE

RING TONES, GRAPHICS AND MUSIC VIA A GLOBAL COMPUTER NETWORK AND WIRELESS DEVICES (U.S. CLS. 21, 23, 26, 36 AND 38).

CLASS 25—CLOTHING

FOR (BASED ON 44(E) PURSUANT TO EUROPEAN COMMUNITY FOREIGN REGISTRATION NUMBER 00588873) BATHING SUITS, BEACHWEAR, BELTS, COATS, DRESSES, EYESHADES, JACKETS, JEANS, LINGERIE, MEN'S SUITS, WOMEN'S SUITS, NIGHTWEAR, OVERALLS, PANTS, PULLOVERS, RAINWEAR, SHIRTS, SHORTS, SOCKS AND STOCKINGS, SWEATERS, TIES, TROUSERS, UNDERWEAR, FOOTWEAR, AND HEADGEAR TO BE WORN AS CLOTHING IN THE NATURE OF HEAD SCARVES, HATS, CAPS, HEADWEAR, ALL OF THE FOREGOING ONLY USED AS MERCHANDISE ARTICLES (U.S. CLS. 22 AND 39).

CLASS 41—EDUCATION AND ENTERTAINMENT

FOR (BASED ON 44(E) PURSUANT TO EUROPEAN COMMUNITY FOREIGN REGISTRATION NUMBER 00588873) EDUCATION IN THE FIELD OF MUSIC RENDERED THROUGH CORRESPONDENCE COURSES; EDUCATION SERVICES, NAMELY, PROVIDING CLASSES, SEMINARS, WORKSHOPS, TUTORING, AND MENTORING IN THE FIELD OF MUSIC; ARRANGING PROFESSIONAL WORKSHOP AND TRAINING COURSES; ENTERTAINMENT IN THE NATURE OF MUSIC, MUSICAL, VARIETY, NEWS AND COMEDY SHOWS, VISUAL AND AUDIO PERFORMANCES, NAMELY, MUSICAL BAND, ROCK GROUP, DANCE AND BALLET PERFORMANCES; ENTERTAINMENT, NAMELY, LIVE PERFORMANCES BY A MUSICAL BAND, BY ROCK GROUPS AND LIVE MUSIC CONCERTS; ENTERTAINMENT SERVICES, NAMELY, MULTIMEDIA PRODUCTION SERVICES, A MULTIMEDIA PROGRAM SERIES FEATURING COMEDY, ACTION AND ADVENTURE DISTRIBUTED VIA VARIOUS PLATFORMS ACROSS MULTIPLE FORMS OF TRANSMISSION MEDIA; ENTERTAINMENT SERVICES, NAMELY, AN ON-LINE ACTIVITY WHERE YOU CREATE YOUR OWN MUSIC AND MUSIC VIDEO; ENTERTAINMENT SERVICES, NAMELY, NON-DOWNLOADABLE RINGTONES, PRE-RECORDED MUSIC, VIDEO AND GRAPHICS PRESENTED TO MOBILE COMMUNICATIONS DEVICES VIA A GLOBAL COMPUTER NETWORK AND WIRELESS NETWORKS; ENTERTAINMENT SERVICES, NAMELY, PROVIDING ON-LINE REVIEWS OF MUSIC, PRE-RECORDED MUSIC, INFORMATION IN THE FIELD OF MUSIC, AND COMMENTARY AND ARTICLES ABOUT MUSIC, ALL ON-LINE VIA A GLOBAL COMPUTER NETWORK; ENTERTAINMENT SERVICES, NAMELY, PROVIDING PRE-RECORDED MUSIC, INFORMATION IN THE FIELD OF MUSIC, AND COMMENTARY AND ARTICLES ABOUT MUSIC, ALL ON-LINE VIA A GLOBAL COMPUTER NETWORK; ENTERTAINMENT SERVICES, NAMELY, PROVIDING AN ON-LINE COMPUTER GAME, A TELEVISION PROGRAM IN THE FIELD OF MUSIC VIA A GLOBAL COMPUTER NETWORK, A WEB SITE FEATURING MUSICAL PERFORMANCES, MUSICAL VIDEOS, RELATED FILM CLIPS, PHOTOGRAPHS, AND OTHER MULTIMEDIA MATERIALS; MULTIMEDIA ENTERTAINMENT SERVICES IN THE NATURE OF RECORDING, PRODUCTION AND POST-PRODUCTION SERVICES IN THE FIELDS OF MUSIC, VIDEO AND FILMS; ENTERTAINMENT AND EDUCATION SERVICES IN THE NATURE OF A SERIES OF SHORT SHOWS FEATURING MUSIC DISTRIBUTED TO MOBILE HANDSETS, WHICH MAY INCLUDE VIDEO, TEXT, PHOTOS, ILLUSTRATIONS OR HYPERTEXT; ENTERTAINMENT AND EDUCATIONAL SERVICES, NAMELY, PROVIDING ADVICE AND INFORMATION FOR MUSIC, VIDEO AND FILM CONCEPT AND SCRIPT DEVELOPMENT; INFORMATION RELATING TO ENTERTAINMENT AND EDUCATION, PROVIDED ON-LINE FROM A COMPUTER DATABASE OR THE INTERNET; PROVIDING A WEB SITE WHERE USERS CAN POST RATINGS, REVIEWS AND RECOMMENDATIONS ON EVENTS AND ACTIVITIES IN THE FIELD OF ENTERTAINMENT AND EDUCATION; MUSIC COMPOSITION FOR OTHERS; MUSIC PRODUCTION SERVICES, MUSIC PUBLISHING SERVICES, MUSIC VIDEO PRODUCTION; PRODUCTION OF SOUND AND

MUSIC VIDEO RECORDINGS; ORGANIZING COMMUNITY SPORTING AND CULTURAL EVENTS (U.S. CLS. 100, 101 AND 107).
LAURIE MAYES, EXAMINING ATTORNEY

SN 77-306,648. DEI HEADQUARTERS, INC., VISTA, CA. FILED 10-17-2007.

VIPER

THE MARK CONSISTS OF STANDARD CHARACTERS WITHOUT CLAIM TO ANY PARTICULAR FONT, STYLE, SIZE, OR COLOR.
OWNER OF U.S. REG. NOS. 1,756,693, 3,000,663 AND OTHERS.

CLASS 9—ELECTRICAL AND SCIENTIFIC APPARATUS

FOR ELECTRIC MONITORING APPARATUS, NAMELY, CELLULAR RADIO MODULES, COMPUTER SOFTWARE AND COMPUTER HARDWARE, SENSORS, TRANSMITTERS AND RECEIVERS; BURGLAR ALARM SYSTEMS COMPRISED OF TRANSMITTERS, RECEIVERS, SENSORS AND AUDIBLE SIRENS FOR RESIDENTIAL OR COMMERCIAL PROPERTY; INTERCOMS; MOTION SENSORS; REMOTE CONTROL TRANSMITTERS AND PARTS THEREFOR USED FOR CONTROLLING THE BURGLAR ALARM SYSTEM (U.S. CLS. 21, 23, 26, 36 AND 38).

CLASS 12—VEHICLES

FOR ANTI-THEFT ALARMS AND SECURITY SYSTEMS FOR VEHICLES IN THE NATURE OF MOTORCYCLES, BOATS, RECREATIONAL WATERCRAFT, SNOWMOBILES AND ALL-TERRAIN VEHICLES, NAMELY, REMOTELY ACTUATED, ELECTRONICALLY-ENERGIZED SECURITY HARDWARE COMPRISING TRANSMITTERS, RECEIVERS, ACTUATORS, AUDIBLE ALARMS AND PARTS THEREFOR (U.S. CLS. 19, 21, 23, 31, 35 AND 44).

KATHLEEN M. VANSTON, EXAMINING ATTORNEY

SN 77-310,489. MEISSNER FILTRATION PRODUCTS, INC., CAMARILLO, CA. FILED 10-22-2007.

BIOFLEX

THE MARK CONSISTS OF STANDARD CHARACTERS WITHOUT CLAIM TO ANY PARTICULAR FONT, STYLE, SIZE, OR COLOR.

CLASS 9—ELECTRICAL AND SCIENTIFIC APPARATUS

FOR DISPOSABLE SINGLE-USE BIOCONTAINERS AND THEIR COMPONENTS, NAMELY, FLEXIBLE PLASTIC TUBING, PLASTIC CONTAINERS, AND FILTERS, FOR USE WITH LIQUIDS AND BIOLOGICALS FOR CULTURING CELLS OR BACTERIA FOR USE IN THE PHARMACEUTICAL INDUSTRY (U.S. CLS. 21, 23, 26, 36 AND 38).

CLASS 17—RUBBER GOODS

FOR DISPOSABLE SINGLE-USE PLASTIC BIOCONTAINER TUBES FOR USE IN THE PROPAGATION OF FLUIDS TO AND FROM A BIOCONTAINER USED IN THE PHARMACEUTICAL INDUSTRY (U.S. CLS. 1, 5, 12, 13, 35 AND 50).

RAUL CORDOVA, EXAMINING ATTORNEY

SN 77-322,819. MILES FARM SUPPLY, LLC, OWENSBORO, KY. FILED 11-6-2007.



THE COLOR(S) GREEN, BLACK AND WHITE IS/ARE CLAIMED AS A FEATURE OF THE MARK.

THE MARK CONSISTS OF A GREEN AND WHITE STYLIZED "M" AND THE TEXT "WE GROW OPPORTUNITIES" IN BLACK.

CLASS 31—NATURAL AGRICULTURAL PRODUCTS

FOR SEEDS FOR AGRICULTURAL PURPOSES (U.S. CLS. 1 AND 46).

FIRST USE 12-31-2006; IN COMMERCE 12-31-2006.

CLASS 35—ADVERTISING AND BUSINESS

FOR RETAIL SHOPS FEATURING AGRICULTURAL PRODUCTS, FERTILIZERS, SEEDS, HERBICIDES, PESTICIDES, NEW AND USED AGRICULTURAL EQUIPMENT AND AGRICULTURAL EQUIPMENT PARTS; WHOLESALE STORES FEATURING LIVESTOCK AND AGRICULTURAL PRODUCTS, FERTILIZERS, SEEDS, HERBICIDES AND PESTICIDES (U.S. CLS. 100, 101 AND 102).

FIRST USE 12-31-2006; IN COMMERCE 12-31-2006.

CLASS 44—MEDICAL, BEAUTY AND AGRICULTURAL SERVICES

FOR AGRICULTURAL ADVICE (U.S. CLS. 100 AND 101).

FIRST USE 12-31-2006; IN COMMERCE 12-31-2006.

RON FAIRBANKS, EXAMINING ATTORNEY

SN 77-323,019. STARLIGHT CHILDREN'S FOUNDATION, LOS ANGELES, CA. FILED 11-6-2007.

STARLIGHT

THE MARK CONSISTS OF STANDARD CHARACTERS WITHOUT CLAIM TO ANY PARTICULAR FONT, STYLE, SIZE, OR COLOR.

OWNER OF U.S. REG. NOS. 3,231,708, 3,235,404 AND OTHERS.

CLASS 9—ELECTRICAL AND SCIENTIFIC APPARATUS

FOR CD-ROMS, AND INTERACTIVE COMPUTER GAME SOFTWARE, ALL FEATURING INFORMATION FOR FAMILIES OF CHILDREN WITH SERIOUS ILLNESS, AND INSTRUCTIONAL MANUALS SOLD AS A UNIT; ROLLING STAND SPECIALLY DESIGNED FOR HOLDING A COMPUTER, TELEVISION, VIDEO CASSETTE RECORDER (VCR), DVD PLAYER, AND ELECTRONIC VIDEO GAME MACHINE FOR USE WITH A MONITOR OR A TELEVISION, FOR USE BY SERIOUSLY ILL CHILDREN IN HOSPITALS; LAPTOP COMPUTERS FOR USE BY SERIOUSLY ILL CHILDREN IN HOSPITALS (U.S. CLS. 21, 23, 26, 36 AND 38).

CLASS 28—TOYS AND SPORTING GOODS

FOR PLUSH TOYS; ROLLING STAND SPECIALLY DESIGNED FOR HOLDING AN ELECTRONIC GAME MACHINE, NAMELY, AMUSEMENT AND VIDEO GAME MACHINES, AND INTERACTIVE AMUSEMENT GAME MACHINE FOR USE IN EDUCATION AND COMMUNICATION BY SERIOUSLY ILL CHILDREN IN HOSPITALS (U.S. CLS. 22, 23, 38 AND 50).

CLASS 35—ADVERTISING AND BUSINESS

FOR CHARITABLE SERVICES, NAMELY, ORGANIZING AND CONDUCTING VOLUNTEER PROGRAMS AND COMMUNITY SERVICE PROJECTS TO PROMOTE THE IMPROVEMENT OF THE QUALITY OF LIFE OF SERIOUSLY ILL CHILDREN AND THEIR FAMILIES THROUGH THE COLLABORATION OF ENTERTAINMENT, EDUCATIONAL AND HEALTHCARE PROFESSIONALS (U.S. CLS. 100, 101 AND 102).

CLASS 36—INSURANCE AND FINANCIAL

FOR CHARITABLE FUND RAISING (U.S. CLS. 100, 101 AND 102).

CLASS 38—COMMUNICATION

FOR PROVIDING FACILITIES AND EQUIPMENT FOR VIDEO CONFERENCING, NAMELY, FOR ALLOWING CHILDREN WHO ARE ILL TO CORRESPOND WITH OTHER CHILDREN; WEB MESSAGING AND ELECTRONIC MAIL SERVICES THAT ALLOW CHILDREN WHO ARE ILL TO CORRESPOND WITH OTHER CHILDREN; PROVIDING ON-LINE CHAT ROOMS FOR TRANSMISSION OF MESSAGES AMONG COMPUTER USERS CONCERNING CHILDREN'S MEDICAL ISSUES; ELECTRONIC MAIL SERVICES FOR CHILDREN WHO ARE ILL; PROVIDING ONLINE CHAT ROOMS AND ELECTRONIC BULLETIN BOARDS FOR TRANSMISSION OF MESSAGES, PHOTOS AND NOTES AMONG CHILDREN WITH SERIOUS ILLNESSES AND THEIR FAMILIES (U.S. CLS. 100, 101 AND 104).

CLASS 41—EDUCATION AND ENTERTAINMENT

FOR EDUCATIONAL SERVICES, NAMELY, PROVIDING INTERACTIVE PRESENTATIONS IN THE NATURE OF SEMINARS AND LECTURES VIA VIDEOTAPE, CD-ROM AND INTERACTIVE WEBSITES TO ASSIST PATIENTS AND THEIR FAMILIES IN UNDERSTANDING AND PARTICIPATING IN MEDICAL TREATMENT PROTOCOLS; EDUCATIONAL SERVICES, NAMELY, GUIDED FIELD TRIPS IN THE NATURE OF GUIDED TOURS OF MEDICAL FACILITIES, MUSEUMS, AND HISTORICAL SITES, FOR SERIOUSLY ILL CHILDREN AND THEIR FAMILIES; ENTERTAINMENT SERVICES, NAMELY, PROVIDING AN ONLINE COMPUTER GAME; PROVIDING FACILITIES FOR RECREATION ACTIVITIES, NAMELY, PROVIDING ROOMS AND OTHER ENVIRONMENTS AT HOSPITALS FOR RELAXATION AND ENTERTAINMENT; CHARITABLE SERVICES, NAMELY, ARRANGING FOR TICKET RESERVATIONS FOR SERIOUSLY ILL CHILDREN AND THEIR FAMILIES TO ATTEND SPORTING EVENTS, AMUSEMENT PARKS, CONCERTS, THEATERS, MUSEUMS AND CELEBRITY MEETINGS; CHARITABLE SERVICES, NAMELY, PROVIDING TOYS TO SERIOUSLY ILL CHILDREN; ENTERTAINMENT SERVICES, NAMELY, ARRANGING PARTIES FOR SERIOUSLY ILL CHILDREN AND THEIR FAMILIES (U.S. CLS. 100, 101 AND 107).

CLASS 42—SCIENTIFIC AND COMPUTER SERVICES

FOR PROVIDING TEMPORARY USE OF NON-DOWNLOADABLE COMPUTER SOFTWARE FEATURING INFORMATION FOR FAMILIES OF CHILDREN WITH SERIOUS ILLNESSES; COMPUTER SERVICES, NAMELY, PROVIDING SEARCH ENGINES FOR OBTAINING DATA ON A GLOBAL COMPUTER NETWORK THAT ALLOW CHILDREN WHO ARE ILL TO LOCATE OTHER CHILDREN (U.S. CLS. 100 AND 101).

CLASS 44—MEDICAL, BEAUTY AND AGRICULTURAL SERVICES

FOR MEDICAL COUNSELING AND CONSULTATION SERVICES FOR SERIOUSLY ILL CHILDREN AND THEIR FAMILIES TO ASSIST IN UNDERSTANDING AND PARTICIPATING IN MEDICAL TREATMENT PROTOCOLS; PROVIDING A WEBSITE FEATURING MEDICAL INFORMATION FOR FAMILIES OF SERIOUSLY ILL CHILDREN (U.S. CLS. 100 AND 101).

CLASS 45—PERSONAL AND LEGAL SERVICES

FOR CHAPERONING GUIDED FIELD TRIPS FOR SERIOUSLY ILL CHILDREN AND THEIR FAMILIES (U.S. CLS. 100 AND 101).

JAMES MACFARLANE, EXAMINING ATTORNEY

SN 77-323,310. AGFG BRANDS LIMTED, LONDON, UNITED KINGDOM, FILED 11-7-2007.

A GIFT FROM THE GODS

THE MARK CONSISTS OF STANDARD CHARACTERS WITHOUT CLAIM TO ANY PARTICULAR FONT, STYLE, SIZE, OR COLOR.

PRIORITY CLAIMED UNDER SEC. 44(D) ON ERPNCMNTY TM OFC APPLICATION NO. 005929518, FILED 5-23-2007, REG. NO. 005929518, DATED 7-23-2009, EXPIRES 5-23-2017.

CLASS 14—JEWELRY

FOR PRECIOUS STONES; HOROLOGICAL AND CHRONOMETRIC INSTRUMENTS; JEWELLERY; JEWELLERY FINDINGS; PENDANTS; LAPEL PINS; ORNAMENTAL LAPEL PINS; PINS BEING JEWELLERY; BODY-PIERCING RINGS AND STUDS; EAR CLIPS; TIE PINS; TIE CLIPS; TIE BARS; TIE TACKS; TIE FASTENERS; CUFF-LINKS; SHIRT STUDS; BADGES OF PRECIOUS METAL; COSTUME JEWELLERY; JEWELLERY CHAINS; JEWELLERY PINS FOR USE ON HATS; HOLIDAY ORNAMENTS OF PRECIOUS METAL; JEWELLERY BOXES AND CASES; KEY HOLDERS OF PRECIOUS METALS; WATCHES; WATCH BRACELETS; WRISTWATCHES; POCKET WATCHES; STOP WATCHES; WATCH STRAPS AND BANDS; WATCH CHAINS AND FOBS; WATCH CASES; WATCH BOXES; CLOCKS; ALARM CLOCKS; CLOCKS INCORPORATING RADIOS; WALL CLOCKS; FIGURINES, BUSTS, FIGURES, STATUES, STATUETTES, ALL OF THE FOREGOING OF PRECIOUS METAL (U.S. CLS. 2, 27, 28 AND 50).

CLASS 18—LEATHER GOODS

FOR LEATHER AND IMITATIONS OF LEATHER AND GOODS MADE OF THESE MATERIALS AND NOT INCLUDED IN OTHER CLASSES, NAMELY, HANDBAGS; ANIMAL SKINS, HIDES; TRUNKS AND TRAVELLING BAGS; UMBRELLAS, PARASOLS AND WALKING STICKS; WHIPS, HARNESS AND SADDLERY; ALL-PURPOSE SPORTS AND ATHLETIC BAGS; BEACH, BOOK, CARRY-ON, DUFFEL, DIAPER, GYM, LEATHER SHOPPING, SHOULDER, TOTE AND TRAVEL BAGS; FANNY PACKS AND WAIST PACKS; BACKPACKS; KNAPSACKS; PURSES; GARMENT BAGS FOR TRAVEL; SATCHELS; LUGGAGE; LUGGAGE TAGS; TRUNKS; SUITCASES; HAT BOXES FOR TRAVEL NOT OF PAPER OR CARDBOARD; COSMETIC CASES AND BAGS SOLD EMPTY; TOILETRY AND VANITY CASES SOLD EMPTY; TOOL BAGS SOLD EMPTY; ATTACHÉ CASES; BRIEFCASES; BRIEFCASE-TYPE PORTFOLIOS; DOCUMENT CASES; MEN'S CLUTCHES; BUSINESS CASES; BUSINESS CARD CASES; CALLING AND CREDIT CARD CASES; KEY CASES; LEATHER KEY CHAINS; WALLETS; BANKNOTE HOLDERS; BILLFOLDS; UMBRELLAS; PARASOLS; WALKING STICKS (U.S. CLS. 1, 2, 3, 22 AND 41).

CLASS 28—TOYS AND SPORTING GOODS

FOR DECORATIONS FOR CHRISTMAS TREES; HAND HELD UNIT FOR PLAYING ELECTRONIC GAMES (U.S. CLS. 22, 23, 38 AND 50).

CLASS 35—ADVERTISING AND BUSINESS

FOR ADVERTISING; BUSINESS MANAGEMENT; BUSINESS ADMINISTRATION; PROVIDING OFFICE FUNCTIONS, RETAIL STORE SERVICES, RETAIL STORE SHOPPING SERVICES AND ELECTRONIC SHOPPING RETAIL STORE SERVICES, FEATURING BLEACHING PREPARATIONS AND OTHER SUBSTANCES FOR LAUNDRY USE, CLEANING, POLISHING, SCOURING AND ABRASIVE PREPARATIONS, SOAPS, PERFUMERY, ESSENTIAL OILS, COSMETICS, HAIR LOTIONS, DENTIFRICES, SOAPS, LIQUID SOAP, SHOWER AND BATH GEL, OILS, SALTS, AND CREAMS, COSMETICS, PERFUMES, COLOGNES, TOILET WATER, ESSENTIAL OILS, TALCUM POWDER, FACIAL CLEANSERS AND SCRUBS, DENTIFRICES, DEODORANTS AND ANTIPERSPIRANTS FOR PERSONAL USE, PREPARATIONS FOR THE CARE OF THE SKIN, NAMELY, FACIAL CREAMS, FACIAL MOISTURIZERS, FACE WASH, FACIAL LOTIONS AND NON-MEDICATED FACIAL TREATMENTS, WRINKLE REMOVING SKIN CARE PREPARATIONS, EYE CREAMS, TONERS, FACIAL EXFOLIANTS, BEAUTY MILKS, SKIN MOISTURIZERS AND SKIN MOISTURIZER MASKS, SKIN CLEANSERS, SKIN CONDITIONERS, SKIN HIGHLIGHTER, HAND CREAMS, MASSAGE OILS, ESSENTIAL OILS FOR PERSONAL USE, PERFUMED POWDERS, NON-MEDICATED TOPICAL SKIN CREAMS, OINTMENTS, GELS, TONERS, LOTIONS, SPRAYS AND POWDERS, AROMATHERAPY CREAMS, LOTIONS AND OILS, BATH BEADS, BATH CRYSTALS, BATH FOAM, BATH POWDERS, BODY SCRUBS, BODY

FRAGRANCES, FRAGRANCES FOR PERSONAL USE, BODY AND HAND LOTIONS, BODY GELS, BODY OILS, BODY POWDERS, BODY EXFOLIANTS, BODY MASKS, BODY MASK CREAMS AND LOTIONS, PROTECTIVE CREAMS FOR THE SKIN AND HANDS, PRE-SHAVE, SHAVING AND AFTER-SHAVE PREPARATIONS, NAMELY, SHAVING CREAM, SHAVING GEL, SHAVING PREPARATIONS, SHAVING BALM, SKIN ABRASIVE PREPARATIONS, AFTER SHAVE LOTIONS AND CREAMS, NON-MEDICATED SKIN CREAMS AND SKIN LOTIONS FOR RELIEVING RAZOR BURNS, NON-MEDICATED TOILET PREPARATIONS, NAMELY, NON-MEDICATED TOILETRIES, BATH PREPARATIONS, BODY SOAKS, BATH SALTS, FOOT POWDER AND CREAMS, SKIN CARE PREPARATIONS, SKIN SERUM, AND STIMULATING LOTIONS FOR THE SKIN, NON-MEDICATED MASSAGE PREPARATIONS IN THE NATURE OF MASSAGE OILS, GELS, CREAMS, LOTIONS, POWDERS, SPRAYS, AND OINTMENTS, DEPILATORIES, COTTON STICKS FOR COSMETIC PURPOSES, COTTON WOOL FOR NON-MEDICAL COSMETIC PURPOSES, SUN-TANNING AND AFTER-SUN PREPARATIONS, NAMELY, SUNSCREEN PREPARATIONS, SUNTANNING PREPARATIONS, AFTER-SUN LOTIONS, COSMETIC SUN-PROTECTING PREPARATIONS, SUN TAN OILS, SELF TANNING MILK AND CREAM, ACCELERATED TANNING CREAM, SELF-TANNING LOTIONS, GELS AND SPRAYS, HAIRCARE PREPARATIONS, NAMELY, SHAMPOOS, CONDITIONERS, MOUSSE, GELS, FROSTS, CREAMS, RINSES, SPRAYS, HAIR COLOUR, HAIR WAVING LOTION, PERMANENT WAVE PREPARATIONS, HAIR LIGHTENERS, HAIR DYES, HAIR EMOLLIENTS, HAIR MAS-CARA, HAIR POMADES, HAIR COLOUR REMOVERS, HAIR COLOURANTS, HAIR RELAXING PREPARATIONS, HAIR STYLING PREPARATIONS, HAIR REMOVING CREAM, AND HAIR CARE PREPARATIONS, NON-MEDICATED SCALP TREATMENT CREAM, NAIL POLISH, NAIL VARNISH FOR COSMETIC PURPOSES, SCENTED ARTICLES ALL FOR PERFUMERY PURPOSES, NAMELY, INCENSE, ROOM FRAGRANCES, FRAGRANCE EMITTING WICKS FOR ROOM FRAGRANCES, SACHETS, SCENTED CERAMIC STONES, SCENTED LINEN SPRAYS AND SCENTED ROOM SPRAYS, SCENTED OILS USED TO PRODUCE AROMAS WHEN HEATED, SCENTED PINE CONES, POTPOURRI, AND AROMATHERAPY PILLOWS COMPRISING POTPOURRI IN FABRIC CONTAINERS, APPARATUS FOR RECORDING, TRANSMISSION OR REPRODUCTION OF SOUND OR IMAGES, MAGNETIC DATA CARRIERS, RECORDING DISCS, AUTOMATIC VENDING MACHINES AND MECHANISMS FOR COIN-OPERATED APPARATUS, CASH REGISTERS, CALCULATING MACHINES, DATA PROCESSING EQUIPMENT AND COMPUTERS, FIRE-EXTINGUISHING APPARATUS, DATA PROCESSING EQUIPMENT AND COMPUTERS, COMPUTER HARDWARE, COMPUTER SOFTWARE, MUSICAL SOUND RECORDINGS, AUDIO-VISUAL RECORDINGS, INCLUDING COMPACT DISCS, TAPE CASSETTES, AUDIO CASSETTES, AUDIO TAPES, AUDIO DISCS, PHONOGRAPH RECORDS, CD-ROMS, VIDEO TAPES, VIDEO CASSETTES, VIDEO DISCS, DVDS, DATS, MP3S, AND LASER DISCS, DOWNLOADABLE MUSICAL SOUND RECORDINGS, DOWNLOADABLE VIDEO RECORDINGS, PROTECTIVE EYEWEAR, SUNGLASSES, EYEGLASSES, EYEGLASS FRAMES, OPERA GLASSES, SPECTACLES, EYEGLASS, SUNGLASS AND SPECTACLE CASES, EYEGLASS, SUNGLASS AND SPECTACLE STRAPS, EYEGLASS, SUNGLASS AND SPECTACLE CHAINS, SURGICAL, MEDICAL, DENTAL AND VETERINARY APPARATUS AND INSTRUMENTS, ARTIFICIAL LIMBS, EYES AND TEETH, ORTHOPAEDIC ARTICLES, SUTURE MATERIALS, CONTRACEPTIVES, MARITAL AIDS, SEX AIDS INCLUDING HANDCUFFS, HARNESS, WHIPS, SEX TOYS, VIBRATORS, CONDOMS, MASSAGE APPARATUS, INSTRUMENTS AND APPLIANCES, ELECTRONIC MASSAGING APPARATUS, INSTRUMENTS AND APPLIANCES, PRECIOUS METALS AND THEIR ALLOYS AND GOODS IN PRECIOUS METALS OR COATED THEREWITH, PRECIOUS STONES, HOROLOGICAL AND CHRONOMETRIC INSTRUMENTS, JEWELLERY, JEWELLERY FINDINGS, PENDANTS, LAPEL PINS, ORNAMENTAL LAPEL PINS, PINS BEING JEWELLERY, BODY-PIERCING RINGS AND STUDS, EAR CLIPS, TIE PINS, TIE CLIPS, TIE BARS, TIE TACKS, TIE FASTENERS, BOLO TIES WITH PRECIOUS METAL TIPS, CUFF-LINKS, SHIRT STUDS, BADGES OF PRECIOUS METAL, COSTUME JEWELLERY, JEWELLERY CHAINS, JEWEL-

ERY PINS FOR USE ON HATS, HOLIDAY ORNAMENTS OF PRECIOUS METAL, JEWELLERY BOXES AND CASES, KEY HOLDERS OF PRECIOUS METALS, WATCHES, WATCH BRACELETS, WATCH ACCESSORIES, INCLUDING PARTS OF WATCHES, WRISTWATCHES, POCKET WATCHES, STOP WATCHES, WATCH STRAPS AND BANDS, WATCH CHAINS AND FOBS, WATCH CASES, WATCH BOXES, CLOCKS, ALARM CLOCKS, CLOCKS INCORPORATING RADIOS, WALL CLOCKS, FIGURINES, SCULPTURES, BUSTS, FIGURES, STATUES, STATUETTES, STIRRING RODS AND BOTTLE CLOSURES, ALL OF THE FOREGOING OF PRECIOUS METAL, PAPER, CARDBOARD, PRINTED MATTER, BOOKBINDING MATERIAL, PHOTOGRAPHS, STATIONERY, ADHESIVES FOR STATIONERY OR HOUSEHOLD PURPOSES, ARTISTS' MATERIALS, PAINT BRUSHES, TYPEWRITERS AND OFFICE REQUISITES EXCEPT FURNITURE, INSTRUCTIONAL AND TEACHING MATERIAL EXCEPT APPARATUS, PLASTIC MATERIALS FOR PACKAGING, PRINTERS' TYPE, PRINTING BLOCKS, BOOKS, MAGAZINES, LEAFLETS, JOURNALS, NEWSLETTERS, BOOKLETS, PAMPHLETS AND BROCHURES, POSTCARDS, PENS, LEATHER AND IMITATIONS OF LEATHER, ANIMAL SKINS, HIDES, TRUNKS AND TRAVELLING BAGS, UMBRELLAS, PARASOLS AND WALKING STICKS, WHIPS, HARNESS AND SADDLERY, ALL-PURPOSE SPORTS AND ATHLETIC BAGS, BEACH BOOK, CARRY-ON, DUFFEL, DIAPER, GYM, LEATHER SHOPPING, SHOULDER, TOTE AND TRAVEL BAGS, FANNY PACKS AND WAIST PACKS, BACKPACKS, KNAPSACKS, PURSES, GARMENT BAGS FOR TRAVEL, SATCHELS, LUGGAGE, LUGGAGE TAGS, TRUNKS, SUITCASES, HAT BOXES FOR TRAVEL NOT OF PAPER OR CARDBOARD, COSMETIC CASES AND BAGS SOLD EMPTY, TOILETRY AND VANITY CASES SOLD EMPTY, TOOL BAGS SOLD EMPTY, ATTACHE CASES, BRIEFCASES, BRIEFCASE-TYPE PORTFOLIOS, DOCUMENT CASES, MEN'S CLUTCHES, BUSINESS CASES, BUSINESS CARD CASES, CALLING AND CREDIT CARD CASES, KEY CASES, LEATHER KEY CHAINS, WALLETS, BANKNOTE HOLDERS, BILLFOLDS, UMBRELLAS, PARASOLS, WALKING STICKS, CLOTHING, FOOTWEAR, HEADGEAR, CLOTHING INCLUDING SHIRTS, T-SHIRTS, UNDER SHIRTS, NIGHT SHIRTS, RUGBY SHIRTS, POLO SHIRTS, CARDIGANS, JERSEYS, UNIFORMS, SCRUBS, SMOCKS, DRESS SHIRTS, PANTS, TROUSERS, SLACKS, JEANS, CULOTTES, CARGO PANTS, STRETCH PANTS, DENIM JEANS, OVERALLS, COVERALLS, JUMPERS, JUMP SUITS, SHORTS, BOXER SHORTS, TOPS, STRETCH TOPS, CROP TOPS, TANK TOPS, HALTER TOPS, SWEAT SHIRTS, SWEAT SHORTS, SWEAT PANTS, WRAPS, WARM-UP SUITS, JOGGING SUITS, TRACK SUITS, PLAY SUITS, BLOUSES, SKIRTS, DRESSES, GOWNS, SWEATERS, VESTS, FLEECE VESTS, PULLOVERS, SNOW SUITS, PARKAS, CAPES, ANORAKS, PONCHOS, JACKETS, REVERSIBLE JACKETS, SHELL JACKETS, COATS, HEAVY COATS, BLAZERS, SUITS, TURTLENECKS, CLOTH SKI BIBS, SWIMWEAR, BEACHWEAR, TENNIS WEAR, SURF WEAR, SKI WEAR, LAYETTES, INFANTWEAR, INFANTS SLEEPERS, BOOTIES, BABY BIBS NOT OF PAPER, CLOTH DIAPERS, CAPS, SWIM CAPS, BERETS, BEANIES, HATS, VISORS, HEADBANDS, WRIST BANDS, SWEAT BANDS, HEADWEAR, EAR MUFFS, APRONS, SCARVES, BANDANAS, BELTS, SUSPENDERS, NECKWEAR, TIES, NECKERCHIEFS, ASCOTS, UNDERWEAR, THERMAL UNDERWEAR, LONG UNDERWEAR, BRIEFS, SWIM AND BATHING TRUNKS, BRAS, SPORTS BRAS, BRASSIERES, BUSTIERS, CORSETS, PANTIES, THONGS, G-STRINGS, GARTERS AND GARTER BELTS, TEDDIES, GIRDLES, FOUNDATION GARMENTS, SINGLET, SOCKS, LOUNGEWEAR, ROBES, SMOCKS, UNDERCLOTHES, PAJAMAS, SLEEPWEAR, NIGHT GOWNS, LINGERIE, CAMISOLES, NEGLIGEES, CHEMISES, CHEMISETTES, SLIPS, SARONGS, LEG WARMERS, HOSIERY, PANTY-HOSE, BODY STOCKINGS, KNEE HIGHS, LEGGINGS, TIGHTS, LEOTARDS, BODY SUITS, UNITARDS, BODY SHAPERS, GLOVES, MITTENS, RAINWEAR, FOOTWEAR, SHOES, SNEAKERS, BOOTS, GALOSHES, SANDALS, FLIP-FLOPS, AND SLIPPERS, GAMES AND PLAYTHINGS, GYMNASTIC AND SPORTING ARTICLES, DECORATIONS FOR CHRISTMAS TREES, HAND-HELD COMPUTER GAMES, COFFEE, TEA, COCOA, SUGAR, RICE, TAPIOCA, SAGO, ARTIFICIAL COFFEE, FLOUR AND PREPARATIONS MADE FROM CEREALS, BREAD, PASTRY AND CONFECTIONERY, ICES, HONEY, TREACLE, YEAST, BAKING-POWDER,

SALT, MUSTARD, VINEGAR, SAUCES IN THE NATURE OF CONDIMENTES, SPICES, ICE, CHOCOLATES, AGRICULTURAL, HORTICULTURAL AND FORESTRY PRODUCTS AND GRAINS, LIVE ANIMALS, FRESH FRUITS AND VEGETABLES, SEEDS, NATURAL PLANTS AND FLOWERS, FOODSTUFFS FOR ANIMALS, MALT, THE BRINGING TOGETHER, FOR THE BENEFIT OF OTHERS, OF A VARIETY OF GOODS, INCLUDING BLEACHING PREPARATIONS AND OTHER SUBSTANCES FOR LAUNDRY USE, CLEANING, POLISHING, SCOURING AND ABRASIVE PREPARATIONS, SOAPS, PERFUMERY, ESSENTIAL OILS, COSMETICS, HAIR LOTIONS, DENTIFRICES, SOAPS, LIQUID SOAP, SHOWER AND BATH GEL, OILS, SALTS, AND CREAMS, COSMETICS, PERFUMES, COLOGNES, TOILET WATER, ESSENTIAL OILS, TALCUM POWDER, FACIAL CLEANSERS AND SCRUBS, DENTIFRICES, DEODORANTS AND ANTIPERSPIRANTS FOR PERSONAL USE, PREPARATIONS FOR THE CARE OF THE SKIN, NAMELY, FACIAL CREAMS, FACIAL MOISTURIZERS, FACE WASH, FACIAL LOTIONS AND NON-MEDICATED FACIAL TREATMENTS, WRINKLE REMOVING SKIN CARE PREPARATIONS, EYE CREAMS, TONERS, FACIAL EXFOLIANTS, BEAUTY MILKS, SKIN MOISTURIZERS AND SKIN MOISTURIZER MASKS, SKIN CLEANSERS, SKIN CONDITIONERS, SKIN HIGHLIGHTER, HAND CREAMS, MASSAGE OILS, ESSENTIAL OILS FOR PERSONAL USE, PERFUMED POWDERS, NON-MEDICATED TOPICAL SKIN CREAMS, OINTMENTS, GELS, TONERS, LOTIONS, SPRAYS AND POWDERS, AROMATHERAPY CREAMS, LOTIONS AND OILS, BATH BEADS, BATH CRYSTALS, BATH FOAM, BATH POWDERS, BODY SCRUBS, BODY FRAGRANCES, FRAGRANCES FOR PERSONAL USE, BODY AND HAND LOTIONS, BODY GELS, BODY OILS, BODY POWDERS, BODY EXFOLIANTS, BODY MASKS, BODY MASK CREAMS AND LOTIONS, PROTECTIVE CREAMS FOR THE SKIN AND HANDS, PRE-SHAVE, SHAVING AND AFTER-SHAVE PREPARATIONS, NAMELY, SHAVING CREAM, SHAVING GEL, SHAVING PREPARATIONS, SHAVING BALM, SKIN ABRASIVE PREPARATIONS, AFTER SHAVE LOTIONS AND CREAMS, NON-MEDICATED SKIN CREAMS AND SKIN LOTIONS FOR RELIEVING RAZOR BURNS, NON-MEDICATED TOILET PREPARATIONS, NAMELY, NON-MEDICATED TOILETRIES, BATH PREPARATIONS, BODY SOAKS, BATH SALTS, FOOT POWDER AND CREAMS, SKIN CARE PREPARATIONS, SKIN SERUM, AND STIMULATING LOTIONS FOR THE SKIN, NON-MEDICATED MASSAGE PREPARATIONS IN THE NATURE OF MASSAGE OILS, GELS, CREAMS, LOTIONS, POWDERS, SPRAYS, AND OINTMENTS, DEPILATORIES, COTTON STICKS FOR COSMETIC PURPOSES, COTTON WOOL FOR NON-MEDICAL COSMETIC PURPOSES, SUN-TANNING AND AFTER-SUN PREPARATIONS, NAMELY, SUNSCREEN PREPARATIONS, SUNTANNING PREPARATIONS, AFTER-SUN LOTIONS, COSMETIC SUN-PROTECTING PREPARATIONS, SUN TAN OILS, SELF TANNING MILK AND CREAM, ACCELERATED TANNING CREAM, SELF-TANNING LOTIONS, GELS AND SPRAYS, HAIRCARE PREPARATIONS, NAMELY, SHAMPOOS, CONDITIONERS, MOUSSE, GELS, FROSTS, CREAMS, RINSES, SPRAYS, HAIR COLOUR, HAIR WAVING LOTION, PERMANENT WAVE PREPARATIONS, HAIR LIGHTENERS, HAIR DYES, HAIR EMOLLIENTS, HAIR MAS-CARA, HAIR POMADES, HAIR COLOUR REMOVERS, HAIR COLOURANTS, HAIR RELAXING PREPARATIONS, HAIR STYLING PREPARATIONS, HAIR REMOVING CREAM, AND HAIR CARE PREPARATIONS, NON-MEDICATED SCALP TREATMENT CREAM, NAIL POLISH, NAIL VARNISH FOR COSMETIC PURPOSES, SCENTED ARTICLES ALL FOR PERFUMERY PURPOSES, NAMELY, INCENSE, ROOM FRAGRANCES, FRAGRANCE EMITTING WICKS FOR ROOM FRAGRANCES, SACHETS, SCENTED CERAMIC STONES, SCENTED LINEN SPRAYS AND SCENTED ROOM SPRAYS, SCENTED OILS USED TO PRODUCE AROMAS WHEN HEATED, SCENTED PINE CONES, POTPOURRI, AND AROMATHERAPY PILLOWS COMPRISING POTPOURRI IN FABRIC CONTAINERS, SCIENTIFIC, NAUTICAL, SURVEYING, PHOTOGRAPHIC, CINEMATOGRAPHIC, OPTICAL, WEIGHING, MEASURING, SIGNALLING, SUPERVISORY CHECKING, LIFE-SAVING AND TEACHING APPARATUS AND INSTRUMENTS, APPARATUS AND INSTRUMENTS FOR CONDUCTING, SWITCHING, TRANSFORMING, ACCUMULATING, REGULATING OR CONTROLLING ELECTRICITY, APPARATUS FOR RECORDING,

TRANSMISSION OR REPRODUCTION OF SOUND OR IMAGES, MAGNETIC DATA CARRIERS, RECORDING DISCS, AUTOMATIC VENDING MACHINES AND MECHANISMS FOR COIN-OPERATED APPARATUS, CASH REGISTERS, CALCULATING MACHINES, DATA PROCESSING EQUIPMENT AND COMPUTERS, FIRE-EXTINGUISHING APPARATUS, DATA PROCESSING EQUIPMENT AND COMPUTERS, COMPUTER HARDWARE, COMPUTER SOFTWARE, MUSICAL SOUND RECORDINGS, AUDIO-VISUAL RECORDINGS, INCLUDING COMPACT DISCS, TAPE CASSETTES, AUDIO CASSETTES, AUDIO TAPES, AUDIO DISCS, PHONOGRAPH RECORDS, CD-ROMS, VIDEO TAPES, VIDEO CASSETTES, VIDEO DISCS, DVDS, DATS, MP3S, AND LASER DISCS, DOWNLOADABLE MUSICAL SOUND RECORDINGS, DOWNLOADABLE VIDEO RECORDINGS, PROTECTIVE EYEWEAR, SUNGLASSES, EYEGLASSES, EYEGLASS FRAMES, OPERA GLASSES, SPECTACLES, EYEGLASS, SUNGLASS AND SPECTACLE CASES, EYEGLASS, SUNGLASS AND SPECTACLE STRAPS, EYEGLASS, SUNGLASS AND SPECTACLE CHAINS, SURGICAL, MEDICAL, DENTAL AND VETERINARY APPARATUS AND INSTRUMENTS, ARTIFICIAL LIMBS, EYES AND TEETH, ORTHOPAEDIC ARTICLES, SUTURE MATERIALS, CONTRACEPTIVES, MARITAL AIDS, SEX AIDS INCLUDING HANDCUFFS, HARNESS, WHIPS, SEX TOYS, VIBRATORS, CONDOMS, MASSAGE APPARATUS, INSTRUMENTS AND APPLIANCES, ELECTRONIC MASSAGING APPARATUS, INSTRUMENTS AND APPLIANCES, PRECIOUS METALS AND THEIR ALLOYS AND GOODS IN PRECIOUS METALS OR COATED THEREWITH, PRECIOUS STONES, HOROLOGICAL AND CHRONOMETRIC INSTRUMENTS, JEWELLERY, JEWELLERY FINDINGS, PENDANTS, LAPEL PINS, ORNAMENTAL LAPEL PINS, PINS BEING JEWELLERY, BODY-PIERCING RINGS AND STUDS, EAR CLIPS, TIE PINS, TIE CLIPS, TIE BARS, TIE TACKS, TIE FASTENERS, BOLO TIES WITH PRECIOUS METAL TIPS, CUFF-LINKS, SHIRT STUDS, BADGES OF PRECIOUS METAL, COSTUME JEWELLERY, JEWELLERY CHAINS, JEWELLERY PINS FOR USE ON HATS, HOLIDAY ORNAMENTS OF PRECIOUS METAL, JEWELLERY BOXES AND CASES, KEY HOLDERS OF PRECIOUS METALS, WATCHES, WATCH BRACELETS, WATCH ACCESSORIES, INCLUDING PARTS OF WATCHES, WRISTWATCHES, POCKET WATCHES, STOP WATCHES, WATCH STRAPS AND BANDS, WATCH CHAINS AND FOBs, WATCH CASES, WATCH BOXES, CLOCKS, ALARM CLOCKS, CLOCKS INCORPORATING RADIOS, WALL CLOCKS, FIGURINES, SCULPTURES, BUSTS, FIGURES, STATUES, STATUETTES, STIRRING RODS AND BOTTLE CLOSURES, ALL OF THE FOREGOING OF PRECIOUS METAL, PAPER, CARDBOARD, PRINTED MATTER, BOOK-BINDING MATERIAL, PHOTOGRAPHS, STATIONERY, ADHESIVES FOR STATIONERY OR HOUSEHOLD PURPOSES, ARTISTS' MATERIALS, PAINT BRUSHES, TYPEWRITERS AND OFFICE REQUISITES EXCEPT FURNITURE, INSTRUCTIONAL AND TEACHING MATERIAL EXCEPT APPARATUS, PLASTIC MATERIALS FOR PACKAGING, PRINTERS' TYPE, PRINTING BLOCKS, BOOKS, MAGAZINES, LEAFLETS, JOURNALS, NEWSLETTERS, BOOKLETS, PAMPHLETS AND BROCHURES, POSTCARDS, PENS, LEATHER AND IMITATIONS OF LEATHER, ANIMAL SKINS, HIDES, TRUNKS AND TRAVELLING BAGS, UMBRELLAS, PARASOLS AND WALKING STICKS, WHIPS, HARNESS AND SADDLERY, ALL-PURPOSE SPORTS AND ATHLETIC BAGS, BEACH, BOOK, CARRY-ON, DUFFEL, DIAPER, GYM, LEATHER SHOPPING, SHOULDER, TOTE AND TRAVEL BAGS, FANNY PACKS AND WAIST PACKS, BACKPACKS, KNAPSACKS, PURSES, GARMENT BAGS FOR TRAVEL, SATCHELS, LUGGAGE, LUGGAGE TAGS, TRUNKS, SUITCASES, HAT BOXES FOR TRAVEL NOT OF PAPER OR CARDBOARD, COSMETIC CASES AND BAGS SOLD EMPTY, TOILETRY AND VANITY CASES SOLD EMPTY, TOOL BAGS SOLD EMPTY, ATTACHE CASES, BRIEFCASES, BRIEFCASE-TYPE PORTFOLIOS, DOCUMENT CASES, MEN'S CLUTCHES, BUSINESS CASES, BUSINESS CARD CASES, CALLING AND CREDIT CARD CASES, KEY CASES, LEATHER KEY CHAINS, WALLETS, BANK-NOTE HOLDERS, BILLFOLDS, UMBRELLAS, PARASOLS, WALKING STICKS, CLOTHING, FOOTWEAR, HEADGEAR, CLOTHING INCLUDING SHIRTS, T-SHIRTS, UNDER SHIRTS, NIGHT SHIRTS, RUGBY SHIRTS, POLO SHIRTS, CARDIGANS, JERSEYS, UNIFORMS, SCRUBS, SMOCKS, DRESS SHIRTS, PANTS, TROUSERS, SLACKS, JEANS, CULOTTES, CARGO

PANTS, STRETCH PANTS, DENIM JEANS, OVERALLS, COVERALLS, JUMPERS, JUMP SUITS, SHORTS, BOXER SHORTS, TOPS, STRETCH TOPS, CROP TOPS, TANK TOPS, HALTER TOPS, SWEAT SHIRTS, SWEAT SHORTS, SWEAT PANTS, WRAPS, WARM-UP SUITS, JOGGING SUITS, TRACK SUITS, PLAY SUITS, BLOUSES, SKIRTS, DRESSES, GOWNS, SWEATERS, VESTS, FLEECE VESTS, PULLOVERS, SNOW SUITS, PARKAS, CAPES, ANORAKS, PONCHOS, JACKETS, REVERSIBLE JACKETS, SHELL JACKETS, COATS, HEAVY COATS, BLAZERS, SUITS, TURTLENECKS, CLOTH SKI BIBS, SWIMWEAR, BEACHWEAR, TENNIS WEAR, SURF WEAR, SKI WEAR, LAYETTES, INFANTWEAR, INFANTS SLEEPERS, BOOTIES, BABY BIBS NOT OF PAPER, CLOTH DIAPERS, CAPS, SWIM CAPS, BERETS, BEANIES, HATS, VISORS, HEADBANDS, WRIST BANDS, SWEAT BANDS, HEADWEAR, EAR MUFFS, APRONS, SCARVES, BANDANAS, BELTS, SUSPENDERS, NECKWEAR, TIES, NECKERCHIEFS, ASCOTS, UNDERWEAR, THERMAL UNDERWEAR, LONG UNDERWEAR, BRIEFS, SWIM AND BATHING TRUNKS, BRAS, SPORTS BRAS, BRASSIERES, BUS-TIERS, CORSETS, PANTIES, THONGS, G-STRINGS, GARTERS AND GARTER BELTS, TEDDIES, GIRDLES, FOUNDATION GARMENTS, SINGLET, SOCKS, LOUNGEWEAR, ROBES, SMOCKS, UNDERCLOTHES, PAJAMAS, SLEEPWEAR, NIGHT GOWNS, LINGERIE, CAMISOLES, NEGLIGES, CHEMISES, CHEMISETTES, SLIPS, SARONGS, LEG WARMERS, HOSIERY, PANTY-HOSE, BODY STOCKINGS, KNEE HIGHS, LEGGINGS, TIGHTS, LEOTARDS, BODY SUITS, UNITARDS, BODY SHAPERS, GLOVES, MITTENS, RAINWEAR, FOOTWEAR, SHOES, SNEAKERS, BOOTS, GALOSHES, SANDALS, FLIP-FLOPS, AND SLIPPERS, GAMES AND PLAYTHINGS, GYMNASTIC AND SPORTING ARTICLES, DECORATIONS FOR CHRISTMAS TREES, HAND-HELD COMPUTER GAMES, COFFEE, TEA, COCOA, SUGAR, RICE, TAPIOCA, SAGO, ARTIFICIAL COFFEE, FLOUR AND PREPARATIONS MADE FROM CEREALS, BREAD, PASTRY AND CONFECTIONERY, ICES, HONEY, TREACLE, YEAST, BAKING-POWDER, SALT, MUSTARD, VINEGAR, SAUCES IN THE NATURE OF CONDIMENTS, SPICES, ICE, CHOCOLATES, AGRICULTURAL, HORTICULTURAL AND FORESTRY PRODUCTS AND GRAINS, LIVE ANIMALS, FRESH FRUITS AND VEGETABLES, SEEDS, NATURAL PLANTS AND FLOWERS, FOODSTUFFS FOR ANIMALS, MALT, ENABLING CUSTOMERS TO CONVENIENTLY VIEW AND PURCHASE THOSE GOODS IN A RETAIL STORE OR BY MAIL OR BY MEANS OF A GLOBAL COMMUNICATIONS NETWORK (U.S. CLS. 100, 101 AND 102).

CLASS 38—COMMUNICATION

FOR COMMUNICATIONS VIA MULTINATIONAL TELECOMMUNICATIONS NETWORKS; PROVIDING TELECOMMUNICATIONS CONNECTIONS TO A GLOBAL COMPUTER NETWORK; STREAMING OF AUDIO AND VIDEO MATERIAL ON THE INTERNET (U.S. CLS. 100, 101 AND 104).

CLASS 41—EDUCATION AND ENTERTAINMENT

FOR ENTERTAINMENT SERVICES IN THE NATURE OF AN ON-GOING REALITY-BASED TELEVISION PROGRAM FEATURING MAKE-OVERS; ARRANGING AND CONDUCTING SPECIAL EVENTS FOR MAKE-OVERS; ARRANGING, ORGANIZING AND CONDUCTING NIGHTCLUB ENTERTAINMENT EVENTS FEATURING MAKE-OVERS; ENTERTAINMENT SERVICES, NAMELY, ORGANIZING AND CONDUCTING LIVE EVENTS AND EXHIBITIONS FEATURING PERSONAL MAKE-OVERS (U.S. CLS. 100, 101 AND 107).

HENRY S. ZAK, EXAMINING ATTORNEY

SN 77-323,442. AGFG BRANDS LIMITED, LONDON, UNITED KINGDOM, FILED 11-7-2007.

A GIFT FROM THE GODS

THE MARK CONSISTS OF STANDARD CHARACTERS WITHOUT CLAIM TO ANY PARTICULAR FONT, STYLE, SIZE, OR COLOR.

PRIORITY CLAIMED UNDER SEC. 44(D) ON ERPNCMNTY TM OFC APPLICATION NO. 005929518, FILED 5-23-2007, REG. NO. 005929518, DATED 7-23-2009, EXPIRES 5-23-2017.

CLASS 3—COSMETICS AND CLEANING PREPARATIONS

FOR SOAPS; PERFUMERY, ESSENTIAL OILS, COSMETICS, HAIR LOTIONS; DENTIFRICES; SOAPS; LIQUID SOAP, SHOWER AND BATH GEL, OILS, SALTS AND CREAMS FOR THE BATH AND THE SHOWER; COSMETICS, PERFUMES, COLOGNES, TOILET WATER; TALCUM POWDER; FACIAL CLEANSERS AND SCRUBS; DENTIFRICES, DEODORANTS AND ANTIPERSPIRANTS FOR PERSONAL USE; PREPARATIONS FOR THE CARE OF THE SKIN, NAMELY, FACIAL CREAMS, FACIAL MOISTURIZERS, FACE WASH, FACIAL LOTIONS AND NON-MEDICATED FACIAL TREATMENTS, WRINKLE REMOVING SKIN CARE PREPARATIONS, EYE CREAMS, TONERS, FACIAL EXFOLIANTS, BEAUTY MILKS, SKIN MOISTURIZERS AND SKIN MOISTURIZER MASKS, SKIN CLEANSERS, SKIN CONDITIONERS, SKIN HIGHLIGHTER, HAND CREAMS, MASSAGE OILS, ESSENTIAL OILS FOR PERSONAL USE, PERFUMED POWDERS, NON-MEDICATED TOPICAL SKIN CREAMS, NON-MEDICATED OINTMENTS, GELS, TONERS, LOTIONS, SPRAYS AND POWDERS, AROMATHERAPY CREAMS, LOTIONS AND OILS, BATH BEADS, BATH CRYSTALS, BATH FOAM, BATH POWDERS, BODY SCRUBS, BODY FRAGRANCES, FRAGRANCES FOR PERSONAL USE, BODY AND HAND LOTIONS, BODY GELS, BODY OILS, BODY POWDERS, BODY EXFOLIANTS, BODY MASKS, BODY MASK CREAMS AND LOTIONS; PROTECTIVE CREAMS FOR THE SKIN AND HANDS; PRE-SHAVE, SHAVING AND AFTER-SHAVE PREPARATIONS, NAMELY, SHAVING CREAM, SHAVING GEL, SHAVING PREPARATIONS, SHAVING BALM, SKIN ABRASIVE PREPARATIONS, AFTER SHAVE LOTIONS AND CREAMS, NON-MEDICATED SKIN CREAMS AND SKIN LOTIONS FOR RELIEVING RAZOR BURNS; NON-MEDICATED TOILET PREPARATIONS, NAMELY, NON-MEDICATED TOILETRIES, BATH PREPARATIONS, BODY SOAKS, BATH SALTS, FOOT POWDER AND CREAMS, SKIN CARE PREPARATIONS, SKIN SERUM, AND STIMULATING LOTIONS FOR THE SKIN; NON-MEDICATED MASSAGE PREPARATIONS IN THE NATURE OF MASSAGE OILS, GELS, CREAMS, LOTIONS, POWDERS, SPRAYS, AND OINTMENTS; DEPILATORIES; COTTON STICKS FOR COSMETIC PURPOSES; COTTON WOOL FOR NON-MEDICAL COSMETIC PURPOSES. SUN-TANNING AND AFTER-SUN PREPARATIONS, NAMELY, SUNSCREEN PREPARATIONS, SUNTANNING PREPARATIONS, AFTER-SUN LOTIONS, COSMETIC SUN-PROTECTING PREPARATIONS, SUN TAN OILS, SELF TANNING MILK AND CREAM, ACCELERATED TANNING CREAM, SELF-TANNING LOTIONS, GELS AND SPRAYS; HAIRCARE PREPARATIONS, NAMELY, SHAMPOOS, CONDITIONERS, MOUSSE, GELS, FROSTS, CREAMS, RINSES, SPRAYS, HAIR COLOUR, HAIR WAVING LOTION, PERMANENT WAVE PREPARATIONS, HAIR LIGHTENERS, HAIR DYES, HAIR EMOLLIENTS, HAIR MASCARA, HAIR POMADES, HAIR COLOUR REMOVERS, HAIR COLOURANTS, HAIR RELAXING PREPARATIONS, HAIR STYLING PREPARATIONS, HAIR REMOVING CREAM, AND HAIR CARE PREPARATIONS; NON-MEDICATED SCALP TREATMENT CREAM; NAIL POLISH, NAIL VARNISH FOR COSMETIC PURPOSES; SCENTED ARTICLES ALL FOR PERFUMERY PURPOSES, NAMELY, INCENSE, ROOM FRAGRANCES, FRAGRANCE EMIT-

TING WICKS FOR ROOM FRAGRANCES, PERFUMING SACHETS, FRAGRANT SACHETS, SCENTED SACHETS, SCENTED CERAMIC STONES, SCENTED LINEN SPRAYS AND SCENTED ROOM SPRAYS, SCENTED OILS USED TO PRODUCE AROMAS WHEN HEATED, SCENTED PINE CONES, POTPOURRI, AND AROMATHERAPY PILLOWS COMPRISING POTPOURRI IN FABRIC CONTAINERS (U.S. CLS. 1, 4, 6, 50, 51 AND 52).

SN 77-327,259. COMCAST CORPORATION, PHILADELPHIA, PA. FILED 11-12-2007.

EVER GREEN

THE MARK CONSISTS OF STANDARD CHARACTERS WITHOUT CLAIM TO ANY PARTICULAR FONT, STYLE, SIZE, OR COLOR.

CLASS 25—CLOTHING

FOR FOOTWEAR, HEADWEAR; CLOTHING, NAMELY, SHIRTS, T-SHIRTS, UNDER SHIRTS, NIGHT SHIRTS, RUGBY SHIRTS, POLO SHIRTS, CARDIGANS, JERSEYS, UNIFORMS, SCRUBS, SMOCKS, DRESS SHIRTS, PANTS, TROUSERS, SLACKS, JEANS, CULOTTES, CARGO PANTS, STRETCH PANTS, DENIM JEANS, OVERALLS, COVERALLS, JUMPERS, JUMP SUITS, SHORTS, BOXER SHORTS, TOPS, STRETCH TOPS, CROP TOPS, TANK TOPS, HALTER TOPS, SWEAT SHIRTS, SWEAT SHORTS, SWEAT PANTS, WRAPS, WARM-UP SUITS, JOGGING SUITS, TRACK SUITS, PLAY SUITS, BLOUSES, SKIRTS, DRESSES, GOWNS, SWEATERS, VESTS, FLEECE VESTS, PULLOVERS, SNOW SUITS, PARKAS, CAPES, ANORAKS, PONCHOS, JACKETS, REVERSIBLE JACKETS, SHELL JACKETS, COATS, HEAVY COATS, BLAZERS, SUITS, TURTLE-NECKS, CLOTH SKI BIBS, SWIMWEAR, BEACHWEAR, TENNIS WEAR, SURF WEAR, SKI WEAR, LAYETTES, INFANTWEAR, INFANTS SLEEPERS, BOOTIES, BABY BIBS NOT OF PAPER, CLOTH DIAPERS, CAPS, SWIM CAPS, BERETS, BEANIES, HATS, VISORS, HEADBANDS, WRIST BANDS, SWEAT BANDS, HEADWEAR, EAR MUFFS, APRONS, SCARVES, BANDANAS, BELTS, SUSPENDERS, NECKWEAR, TIES, NECKERCHIEFS, ASCOTS, UNDERWEAR, THERMAL UNDERWEAR, LONG UNDERWEAR, BRIEFS, SWIM AND BATHING TRUNKS, BRAS, SPORTS BRAS, BRASSIERES, BUSTIERS, CORSETS, PANTIES, THONGS, G-STRINGS, GARTERS AND GARTER BELTS, TEDDIES, GIRDLES, FOUNDATION GARMENTS, SINGLET, SOCKS, LOUNGEWEAR, ROBES, SMOCKS, UNDERCLOTHES, PAJAMAS, SLEEPWEAR, NIGHT GOWNS, LINGERIE, CAMISOLES, NEGLIGEEES, CHEMISES, CHEMISSETTES, SLIPS, SARONGS, LEG WARMERS, HOSE, PANTY-HOSE, BODY STOCKINGS, KNEE HIGHS, LEGGINGS, TIGHTS, LEOTARDS, BODY SUITS, UNITARDS, BODY SHAPERS, GLOVES, MITTENS, RAINWEAR, FOOTWEAR, SHOES, SNEAKERS, BOOTS, GALOSHES, SANDALS, FLIP-FLOPS, AND SLIPPERS; BOLO TIES WITH PRECIOUS METAL TIPS (U.S. CLS. 22 AND 39).

CLASS 41—EDUCATION AND ENTERTAINMENT

FOR EDUCATIONAL AND ENTERTAINMENT SERVICES, NAMELY, PROVIDING CONTINUING AUDIO AND VIDEO CLIPS ABOUT ENVIRONMENTAL ISSUES ACCESSIBLE BY VIDEO-ON-DEMAND SERVICE, TELEVISION, AND GLOBAL COMPUTER NETWORKS (U.S. CLS. 100, 101 AND 107).

FIRST USE 1-6-2009; IN COMMERCE 1-6-2009.

CLASS 42—SCIENTIFIC AND COMPUTER SERVICES

FOR PROVIDING INFORMATION IN THE FIELD OF ENVIRONMENTAL CONSERVATION, NAMELY, INFORMATION ABOUT SCIENTIFIC RESEARCH IN THE FIELD OF ENVIRONMENTAL PROTECTION, AND ENVIRONMENTALLY-FRIENDLY PRACTICES, GOODS, AND SERVICES IN THE NATURE OF SCIENTIFIC AND TECHNOLOGICAL INFORMATION ABOUT ENVIRONMENTALLY-FRIENDLY GOODS AND SERVICES AND ABOUT RESEARCH AND DEVELOPMENT OF ENVIRONMENTALLY FRIENDLY PRODUCTS VIA A GLOBAL COMPUTER NETWORK (U.S. CLS. 100 AND 101).

FIRST USE 1-6-2009; IN COMMERCE 1-6-2009.

APRIL ROACH, EXAMINING ATTORNEY

SN 77-330,844. VIRTUAL FREEHOLD LIMITED, LONDON, UNITED KINGDOM, FILED 11-15-2007.

THREEBOX

THE MARK CONSISTS OF STANDARD CHARACTERS WITHOUT CLAIM TO ANY PARTICULAR FONT, STYLE, SIZE, OR COLOR.

PRIORITY CLAIMED UNDER SEC. 44(D) ON ERPN CMNTY TM OFC APPLICATION NO. 6443469, FILED 11-15-2007, REG. NO. 6443469, DATED 1-21-2009, EXPIRES 1-15-2017.

CLASS 30—STAPLE FOODS

FOR COFFEE, TEA, COCOA, SUGAR, RICE, TAPIOCA, SAGO, ARTIFICIAL COFFEE; FLOUR, BREAD, PASTRY AND CONFECTIONERY, ICE CONFECTIONS; HONEY, TREACLE; YEAST, BAKING-POWDER; SALT, MUSTARD; VINEGAR, SAUCES, SPICES; ICE; CHOCOLATES (U.S. CL. 46).

CLASS 31—NATURAL AGRICULTURAL PRODUCTS

FOR LIVE ANIMALS; FRESH FRUITS AND VEGETABLES; SEEDS, NATURAL PLANTS AND FLOWERS; FOODSTUFFS FOR ANIMALS, MALT FOR BREWING AND DISTILLING (U.S. CLS. 1 AND 46).

HENRY S. ZAK, EXAMINING ATTORNEY

CLASS 9—ELECTRICAL AND SCIENTIFIC APPARATUS

FOR SOFTWARE, NAMELY, A DIGITAL PLATFORM ON WHICH TO BUILD VIRTUAL ENVIRONMENTS AND WORLDS, NAMELY, INTERACTIVE ENVIRONMENTS AND WORLDS AND SOFTWARE THAT IS USED FOR PROVIDING ACCESS TO ON-LINE VIRTUAL ENVIRONMENTS AND WORLDS, NAMELY, INTERACTIVE ENVIRONMENTS AND WORLDS; COMPUTER SOFTWARE FOR PROVIDING MULTI-USER ACCESS TO ON-LINE 3-DIMENSIONAL VIRTUAL ENVIRONMENT TO ALLOW USERS TO PERFORM ELECTRONIC BUSINESS TRANSACTIONS VIA A GLOBAL COMPUTER NETWORK; VIRTUAL REALITY SOFT-

WARE FOR PROVIDING MULTI-USER ACCESS TO AN ON-LINE 3-DIMENSIONAL VIRTUAL ENVIRONMENT AND FOR USE IN CREATING, MANIPULATING, AND PARTICIPATING IN 3-DIMENSIONAL VIRTUAL ENVIRONMENTS; 3-DIMENSIONAL MODELING SOFTWARE FOR USE IN BUILDING 3-DIMENSIONAL VIRTUAL ENVIRONMENTS IN THE FIELD OF ELECTRONIC BUSINESS TRANSACTIONS; INTERACTIVE COMPUTER SOFTWARE FOR INTERACTIVE COMPUTER GAMES; INTERACTIVE COMPUTER SOFTWARE WHICH ENABLES USERS TO PERFORM INTERACTIVE ELECTRONIC BUSINESS TRANSACTIONS VIA A GLOBAL COMPUTER NETWORK; SECURITY SOFTWARE FOR PROVIDING MULTI-USER ACCESS TO AN ON-LINE 3-DIMENSIONAL VIRTUAL ENVIRONMENT TO ALLOW USERS TO PERFORM ELECTRONIC BUSINESS TRANSACTIONS VIA A GLOBAL COMPUTER NETWORK; HOSTING SOFTWARE FOR PROVIDING MULTI-USER ACCESS TO AN ON-LINE 3-DIMENSIONAL VIRTUAL ENVIRONMENT TO ALLOW USERS TO PERFORM ELECTRONIC BUSINESS TRANSACTIONS VIA A GLOBAL COMPUTER NETWORK; COMPUTER GRAPHICS SOFTWARE; COMPUTER PROGRAMS FOR PROVIDING MULTI-USER ACCESS TO AN ON-LINE 3-DIMENSIONAL VIRTUAL ENVIRONMENT TO ALLOW USERS TO PERFORM ELECTRONIC BUSINESS TRANSACTION VIA A GLOBAL COMPUTER NETWORK; DOWNLOADABLE SOFTWARE FOR PROVIDING MULTI-USER ACCESS TO AN ON-LINE 3-DIMENSIONAL VIRTUAL ENVIRONMENT TO ALLOW USERS TO PERFORM ELECTRONIC BUSINESS TRANSACTION VIA A GLOBAL COMPUTER NETWORK; COMPUTER SOFTWARE AND COMPUTER PROGRAMS FOR DISTRIBUTION TO, AND FOR USE BY, USERS OF A VIRTUAL ENVIRONMENT FOR PROVIDING MULTI-USER ACCESS TO AN ON-LINE 3-DIMENSIONAL VIRTUAL ENVIRONMENT TO ALLOW USERS TO PERFORM ELECTRONIC BUSINESS TRANSACTIONS VIA A GLOBAL USER NETWORK; SOFTWARE TO ENABLE THE TRANSMISSION OF ADVERTISEMENTS, THE VIEWING AND PURCHASE OF GOODS AND SERVICES, THE DESIGN OF VIRTUAL BUILDINGS AND PROPERTY; IMAGING AND PLANNING SOFTWARE FOR USE IN THE FIELD OF ON-LINE 3-DIMENSIONAL VIRTUAL ENVIRONMENTS AND ELECTRONIC BUSINESS TRANSACTIONS VIA A GLOBAL USER NETWORK; SOFTWARE TO ENABLE THE MONITORING AND ANALYSIS OF CONSUMER AND USER TRENDS WHETHER IN REAL TIME OR OTHERWISE; SOFTWARE TO ENABLE INTERACTION AND COMMUNICATION WITH OTHER USERS OR TERMINALS; DOWNLOADABLE ELECTRONIC PUBLICATIONS IN THE NATURE OF PRODUCT AND SERVICE CATALOGUES AND 3-DIMENSIONAL VIRTUAL ENVIRONMENT GUIDES; MAGNETICALLY ENCODED CREDIT CARDS; MAGNETICALLY ENCODED LOYALTY CARD DATA PROCESSORS; COMPUTERS; COMPUTER FIRMWARE FOR PROVIDING MULTI-USER ACCESS TO AN ON-LINE 3-DIMENSIONAL VIRTUAL ENVIRONMENT TO ALLOW USERS TO PERFORM ELECTRONIC BUSINESS TRANSACTIONS VIA A GLOBAL USER NETWORK; SECURITY EQUIPMENT, NAMELY, USB DONGLES, CARD READERS, BIOMETRIC SENSORS AND SCANNERS FOR SECURITY ACCESS, IDENTIFICATION AND ELECTRONIC BUSINESS TRANSACTIONS; COMPUTER SOFTWARE FOR ONLINE INTERACTION BETWEEN MULTIPLE USERS AND TERMINALS; COMPUTER SOFTWARE FOR GENERATING AND PROVIDING ADVERTISING AND ADVERTISING SERVICES; COMPUTER SOFTWARE FOR ONLINE SHOPPING AND ADVERTISING (U.S. CLS. 21, 23, 26, 36 AND 38).

CLASS 35—ADVERTISING AND BUSINESS

FOR ADVERTISING, BUSINESS MANAGEMENT AND BUSINESS ADMINISTRATION; OPERATING AN ON-LINE SHOPPING SITE IN THE FIELD OF COMPUTER SOFTWARE; ON-LINE ADVERTISING ON A COMPUTER NETWORK; ELECTRONIC PROCESSING OF ORDERS FOR OTHERS; REAL ESTATE ADVERTISING SERVICES; ON-LINE REAL ESTATE ADVERTISING SERVICES; PROVIDING ON-LINE SEARCHABLE GUIDES AND DATABASES, ALL FEATURING RETAIL SALES INFORMATION; REAL ESTATE MARKETING SERVICES IN THE FIELD OF CONDOMINIUMS, APARTMENTS, LUXURY APARTMENTS, HOMES, COMMERCIAL BUILDINGS AND STOREFRONTS; ON-LINE REAL ESTATE MARKETING SERVICES IN THE FIELD OF CONDOMINIUMS, APARTMENTS, LUXURY APARTMENTS, HOMES, COMMERCIAL BUILDINGS AND STOREFRONTS (U.S. CLS. 100, 101 AND 102).

CLASS 36—INSURANCE AND FINANCIAL

FOR ELECTRONIC PAYMENT, NAMELY, ELECTRONIC PROCESSING AND TRANSMISSION OF BILL PAYMENT DATA; REAL ESTATE BROKERAGE; ON-LINE REAL ESTATE BROKERAGE; REAL ESTATE ACQUISITION SERVICES; ON-LINE REAL ESTATE ACQUISITION SERVICES; PROVIDING FINANCIAL SERVICES TO SUPPORT THE SALE, TRANSFER, ACQUISITION OF REAL ESTATE; PROVIDING ON-LINE FINANCIAL SERVICES TO SUPPORT THE SALE, TRANSFER, ACQUISITION OF REAL ESTATE; PROVIDING ON-LINE SEARCHABLE GUIDES AND DATABASES, ALL FEATURING FINANCIAL AND REAL ESTATE INFORMATION (U.S. CLS. 100, 101 AND 102).

CLASS 38—COMMUNICATION

FOR TELECOMMUNICATION SERVICES, NAMELY, INFORMATION TRANSMISSION BY ELECTRONIC COMMUNICATION NETWORKS; PROVIDING AN ON-LINE INTERACTIVE BULLETIN BOARD FOR THE TRANSMISSION OF MESSAGES AMONG COMPUTER USERS CONCERNING HOBBIES, COLLECTIBLES, TRADING AND THE SALE OF GOODS AND SERVICES, VIA A GLOBAL COMMUNICATIONS NETWORK; TRANSMISSION AND COMMUNICATION SERVICES IN THE NATURE OF TEXT MESSAGING AND ELECTRONIC MAIL SERVICES USED IN PLAYING ON-LINE COMPUTER GAMES; COMMUNICATION SERVICES IN THE NATURE OF TEXT AND VOICE MESSAGING AND ELECTRONIC MAIL SERVICES; PROVIDING LIVE ON-LINE CHAT ROOMS FOR TRANSMISSION OF MESSAGES AMONG COMPUTER USERS CONCERNING GENERAL MERCHANDISE, PRODUCT REVIEWS, AND PRODUCT PURCHASING INFORMATION; COMMUNICATIONS BY COMPUTER TERMINALS; COMPUTER AIDED TRANSMISSION OF MESSAGES, SOUNDS, MEDIA AND IMAGES; ELECTRONIC MAIL; PAGING SERVICES; PROVIDING ACCESS TO DATABASES; PROVIDING TELECOMMUNICATION CHANNELS FOR TEleshopping SERVICES; MESSAGING SERVICES, NAMELY, SENDING, RECEIVING, ANALYZING AND FORWARDING MESSAGES IN THE FORM OF TEXT, AUDIO, GRAPHIC IMAGES OR VIDEO OR ANY COMBINATION OF THESE FORMATS; INSTANT MESSAGING; ELECTRONIC TRANSMISSION OF MESSAGES, NAMELY, SHORT MESSAGE SERVICES (SMS), MULTIMEDIA MESSAGING SERVICES (MMS), AND UNIFIED MESSAGING SERVICES; VOICEMAIL AND VIDEO MAIL SERVICES; PROVIDING ACCESS TO TELECOMMUNICATIONS INFRASTRUCTURES FOR THIRD PARTIES; WEB CONFERENCING SERVICES; PROVIDING ON-LINE CHAT ROOMS FOR TRANSMISSION OF MESSAGES AMONG COMPUTER USERS CONCERNING TOPICS OF GENERAL INTEREST; TELECOMMUNICATION SERVICES, NAMELY, PROVISION OF ACCESS TO THE INTERNET; INFORMATION TRANSMISSION VIA ELECTRONIC COMMUNICATIONS NETWORKS; PROVIDING MULTIPLE-USER ACCESS TO A GLOBAL COMPUTER INFORMATION NETWORK TO ACCESS ADVERTISING AND RETAILING OF GOODS AND SERVICES THROUGH INTERACTIVE COMMUNICATIONS; PROVIDING MULTIPLE-USER ACCESS TO A GLOBAL COMPUTER INFORMATION NETWORK TO ACCESS ON-LINE SERVICES, FORUMS, ENVIRONMENTS, VIRTUAL WORLDS, WEBSITES, AND ACTIVITIES; TRANSMISSION OF INFORMATION, DATA,

GRAPHICS, AUDIO AND/OR AUDIO-VISUAL CONTENT FROM A RESTRICTED GROUP OF INTERNET WEBSITES OR PORTALS; PROVIDING MULTIPLE-USER ACCESS TO INTERACTIVE MULTIMEDIA NETWORKS; PROVIDING MULTIPLE-USER ACCESS TO A GLOBAL COMPUTER INFORMATION NETWORK FEATURING VIRTUAL INTERACTIVE ENVIRONMENTS INCLUDING TO INTERACTIVE GAMES, INTERACTIVE NEWS, INTERACTIVE SPORT, INTERACTIVE ENTERTAINMENT, INTERACTIVE RETAILING OF GOODS AND SERVICES, INTERACTIVE COMPETITIONS AND INTERACTIVE ADVERTISING; ELECTRONIC TRANSMISSION OF RECORDINGS OF MUSIC, SOUNDS, VIDEOS, IMAGES, TEXT AND INFORMATION AND DISTRIBUTION OR TRANSMISSION OF THE SAME BY A TELECOMMUNICATIONS NETWORK, BY ON-LINE DELIVERY AND BY WAY OF THE INTERNET AND/OR THE WORLD-WIDE WEB OR OTHER WIRELESS COMMUNICATIONS NETWORK; PROVIDING AN ON-LINE, INTERACTIVE BULLETIN BOARD FOR TRANSMISSION OF MESSAGES AMONG COMPUTER USERS CONCERNING THE POSTING, PROMOTION AND SALE OF RETAIL, FINANCIAL, MEDICAL, TOURISM AND REAL ESTATE GOODS AND SERVICES; ELECTRONIC EXCHANGE OF DATA STORED IN DATABASES ACCESSIBLE VIA TELECOMMUNICATION NETWORKS; PROVIDING AN ON-LINE INTERACTIVE BULLETIN BOARD FOR THE POSTING, PROMOTION AND SALE OF GOODS AND SERVICES; THE TRANSMISSION OF OR RECORDINGS OF MUSIC, SOUNDS, VIDEO, IMAGES, TEXT AND INFORMATION AND DISTRIBUTION OR TRANSMISSION OF THE SAME BY WAY OF COMMUNICATION NETWORK (U.S. CLS. 100, 101 AND 104).

CLASS 41—EDUCATION AND ENTERTAINMENT

FOR ENTERTAINMENT SERVICES, NAMELY, ON-LINE REAL ESTATE MARKETING SERVICES IN THE FIELD OF CONDOMINIUMS, APARTMENTS, LUXURY APARTMENTS, HOMES, COMMERCIAL BUILDINGS AND STOREFRONTS FOR THREE DIMENSIONAL VIRTUAL ON-LINE COMMUNITIES (U.S. CLS. 100, 101 AND 107).

CLASS 42—SCIENTIFIC AND COMPUTER SERVICES

FOR COMPUTER SOFTWARE DESIGN; HOSTING COMPUTER SITES, WEB SITES AND VIRTUAL ON-LINE COMMUNITIES FOR OTHERS; INSTALLATION OF COMPUTER SOFTWARE AND FIRMWARE; MAINTENANCE OF COMPUTER SOFTWARE AND FIRMWARE; UPDATING OF COMPUTER SOFTWARE AND FIRMWARE; PROVIDING SEARCH ENGINES FOR OBTAINING DATA ON THE INTERNET; COMPUTER SERVICES, NAMELY, DESIGNING VIRTUAL ON-LINE COMMUNITIES IN THE FIELDS OF EMERGENCY SERVICES DISPATCH, RETAIL SERVICES, FINANCIAL SERVICES, MEDICAL SERVICES, TOURISM AND REAL ESTATE SERVICES; DESIGN SERVICES FOR PROPERTY, BUILDINGS, STREET PLANNING, SHOPPING COMPLEXES, AND PROPERTY DEVELOPMENTS; HOSTING OF DIGITAL CONTENT ON THE INTERNET ON BEHALF OF USERS; COMPUTER SERVICES, NAMELY, CREATING VIRTUAL ON-LINE COMMUNITIES FOR TRADING VIRTUAL REAL ESTATE (U.S. CLS. 100 AND 101).

TRACY CROSS, EXAMINING ATTORNEY

SN 77-348,747. AMAZON BIOGUARD LIMITED, DBA BIO K US LIMITED, CLINTON TOWNSHIP, MI. FILED 12-11-2007.

eradic8

THE MARK CONSISTS OF STANDARD CHARACTERS WITHOUT CLAIM TO ANY PARTICULAR FONT, STYLE, SIZE, OR COLOR.

OWNER OF ENGLAND REG. NO. 2385914, DATED 2-3-2005, EXPIRES 2-3-2015.

CLASS 1—CHEMICALS

FOR CELLULASE USED IN DETERGENT MANUFACTURE; DETERGENT ADDITIVE FOR USE WITH MOTOR OIL; DETERGENT FOR USE IN THE MANUFACTURE OF HAIR SHAMPOO; DETERGENTS FOR INDUSTRIAL USE; ENZYME PREPARATIONS FOR USE IN THE DETERGENTS INDUSTRY; FUEL INJECTION CLEANER CHEMICAL ADDITIVE; SURFACTANTS FOR USE IN THE MANUFACTURE OF SYNTHETIC DETERGENTS (U.S. CLS. 1, 5, 6, 10, 26 AND 46).

CLASS 3—COSMETICS AND CLEANING PREPARATIONS

FOR ALL-PURPOSE CLEANERS; AUTOMATIC DISHWASHING DETERGENTS; AUTOMOBILE CLEANERS; CARPET CLEANERS; CARPET CLEANERS WITH DEODORIZER; CHEMICAL CLEANERS DIRECTED TO THE PULP AND PAPER INDUSTRIES AND THE METAL FINISHING INDUSTRIES; CLEANER FOR COSMETIC BRUSHES; CLEANER FOR USE ON HARD SURFACES; COMBINATION CLEANER AND DEODORIZER FOR LITTER BOXES; DENTURE CLEANERS; DETERGENT SOAP; DETERGENTS FOR AUTOMOBILES; DETERGENTS FOR MACHINE DISHWASHING; DETERGENTS PREPARED FROM PETROLEUM; DISH DETERGENTS; DISHWASHER DETERGENTS; DISHWASHING DETERGENTS; DISINFECTANT SOAPS; DISINFECTING PERFUMED SOAPS; GERMICIDAL DETERGENTS; GLASS CLEANERS; HAND CLEANERS; LAUNDRY DETERGENT; LAUNDRY DETERGENTS; NON-MEDICATED SKIN CARE PREPARATIONS, NAMELY, CREAMS, LOTIONS, GELS, TONERS, CLEANERS AND PEELS; OVEN CLEANERS; PRE-MOISTENED TOWELETTS IMPREGNATED WITH DISHWASHING DETERGENT; SOAPS AND DETERGENTS; TOILET BOWL DETERGENTS; UPHOLSTERY CLEANERS; WHITEWALL CLEANERS; WINDSHIELD CLEANER FLUIDS (U.S. CLS. 1, 4, 6, 50, 51 AND 52).

CLASS 5—PHARMACEUTICALS

FOR ALL PURPOSE DISINFECTANTS; ALL PURPOSE DISINFECTING AND DEODORIZING PREPARATIONS; ANTIBACTERIAL CLEANERS; CONTACT LENS DISINFECTANTS; DISINFECTANT BATHROOM CLEANERS; DISINFECTANT TOILET BOWL CLEANERS; DISINFECTANTS FOR CHEMICAL TOILETS; DISINFECTANTS FOR CONTACT LENSES; DISINFECTANTS FOR HYGIENE PURPOSES; DISINFECTANTS FOR HYGIENIC PURPOSES; DISINFECTANTS FOR MEDICAL INSTRUMENTS; DISINFECTANTS FOR SANITARY PURPOSES; DISINFECTING HANDWASH; MEDICATED SKIN CARE PREPARATIONS, NAMELY, CREAMS, LOTIONS, GELS, TONERS, CLEANERS AND PEELS (U.S. CLS. 6, 18, 44, 46, 51 AND 52).

HOWARD B. LEVINE, EXAMINING ATTORNEY

SN 77-356,192. VIRTUAL FREEHOLD LIMITED, LONDON, UNITED KINGDOM, FILED 12-19-2007.

VTAIL

THE MARK CONSISTS OF STANDARD CHARACTERS WITHOUT CLAIM TO ANY PARTICULAR FONT, STYLE, SIZE, OR COLOR.

PRIORITY CLAIMED UNDER SEC. 44(D) ON ERPNCMNTY TM OFC APPLICATION NO. 6528285, FILED 12-19-2007, REG. NO. 006528285, DATED 5-13-2009, EXPIRES 12-19-2017.

CLASS 9—ELECTRICAL AND SCIENTIFIC APPARATUS

FOR SOFTWARE, NAMELY, A DIGITAL PLATFORM ON WHICH TO BUILD VIRTUAL ENVIRONMENTS AND WORLDS, NAMELY, INTERACTIVE ENVIRONMENTS AND WORLDS AND SOFTWARE THAT IS USED FOR PROVIDING ACCESS TO ON-LINE VIRTUAL ENVIRONMENTS AND WORLDS, NAMELY, INTERACTIVE ENVIRONMENTS AND WORLDS; COMPUTER SOFTWARE FOR PROVIDING MULTI-USER ACCESS TO ON-LINE 3-DIMENSIONAL VIRTUAL ENVIRONMENT TO ALLOW USERS TO PERFORM ELECTRONIC BUSINESS TRANSACTIONS VIA A GLOBAL COMPUTER NETWORK; VIRTUAL REALITY SOFTWARE FOR PROVIDING MULTI-USER ACCESS TO AN ON-LINE 3-DIMENSIONAL VIRTUAL ENVIRONMENT AND FOR USE IN CREATING, MANIPULATING, AND PARTICIPATING IN 3-DIMENSIONAL VIRTUAL ENVIRONMENTS; 3-DIMENSIONAL MODELING SOFTWARE FOR USE IN BUILDING 3-DIMENSIONAL VIRTUAL ENVIRONMENTS IN THE FIELD OF ELECTRONIC BUSINESS TRANSACTIONS; INTERACTIVE COMPUTER SOFTWARE FOR INTERACTIVE COMPUTER GAMES; INTERACTIVE COMPUTER SOFTWARE WHICH ENABLES USERS TO PERFORM INTERACTIVE ELECTRONIC BUSINESS TRANSACTIONS VIA A GLOBAL COMPUTER NETWORK; SECURITY SOFTWARE FOR PROVIDING MULTI-USER ACCESS TO AN ON-LINE 3-DIMENSIONAL VIRTUAL ENVIRONMENT TO ALLOW USERS TO PERFORM ELECTRONIC BUSINESS TRANSACTIONS VIA A GLOBAL COMPUTER NETWORK; HOSTING SOFTWARE FOR PROVIDING MULTI-USER ACCESS TO AN ON-LINE 3-DIMENSIONAL VIRTUAL ENVIRONMENT TO ALLOW USERS TO PERFORM ELECTRONIC BUSINESS TRANSACTIONS VIA A GLOBAL COMPUTER NETWORK; COMPUTER GRAPHICS SOFTWARE; COMPUTER PROGRAMS FOR PROVIDING MULTI-USER ACCESS TO AN ON-LINE 3-DIMENSIONAL VIRTUAL ENVIRONMENT TO ALLOW USERS TO PERFORM ELECTRONIC BUSINESS TRANSACTION VIA A GLOBAL COMPUTER NETWORK; COMPUTER SOFTWARE AND COMPUTER PROGRAMS FOR DISTRIBUTION TO, AND FOR USE BY, USERS OF A VIRTUAL ENVIRONMENT FOR PROVIDING MULTI-USER ACCESS TO AN ON-LINE 3-DIMENSIONAL VIRTUAL ENVIRONMENT TO ALLOW USERS TO PERFORM ELECTRONIC BUSINESS TRANSACTIONS VIA A GLOBAL USER NETWORK; SOFTWARE TO ENABLE THE TRANSMISSION OF ADVERTISEMENTS, THE VIEWING AND PURCHASE OF GOODS AND SERVICES, THE DESIGN OF VIRTUAL BUILDINGS AND PROPERTY; IMAGING AND PLANNING SOFTWARE FOR USE IN THE FIELD OF ON-LINE 3-DIMENSIONAL VIRTUAL ENVIRONMENTS AND ELECTRONIC BUSINESS TRANSACTIONS VIA A GLOBAL USER NETWORK; SOFTWARE TO ENABLE THE MONITORING AND ANALYSIS OF CONSUMER AND USER TRENDS WHETHER IN REAL TIME OR OTHERWISE; SOFTWARE TO ENABLE INTERACTION AND COMMUNICATION WITH OTHER USERS OR TERMINALS; DOWNLOADABLE ELECTRONIC PUBLICATIONS IN

THE NATURE OF PRODUCT AND SERVICE CATALOGUES AND 3-DIMENSIONAL VIRTUAL ENVIRONMENT GUIDES; MAGNETICALLY ENCODED CREDIT CARDS; MAGNETICALLY ENCODED LOYALTY CARD DATA PROCESSORS; COMPUTERS; COMPUTER FIRMWARE FOR PROVIDING MULTI-USER ACCESS TO AN ON-LINE 3-DIMENSIONAL VIRTUAL ENVIRONMENT TO ALLOW USERS TO PERFORM ELECTRONIC BUSINESS TRANSACTIONS VIA A GLOBAL USER NETWORK; SECURITY EQUIPMENT, NAMELY, USB DONGLES, CARD READERS, BIOMETRIC SENSORS AND SCANNERS FOR SECURITY ACCESS, IDENTIFICATION AND ELECTRONIC BUSINESS TRANSACTIONS; COMPUTER SOFTWARE FOR ONLINE INTERACTION BETWEEN MULTIPLE USERS AND TERMINALS; COMPUTER SOFTWARE FOR GENERATING AND PROVIDING ADVERTISING AND ADVERTISING SERVICES; COMPUTER SOFTWARE FOR ONLINE SHOPPING AND ADVERTISING (U.S. CLS. 21, 23, 26, 36 AND 38).

CLASS 35—ADVERTISING AND BUSINESS

FOR ADVERTISING, BUSINESS MANAGEMENT AND BUSINESS ADMINISTRATION; OPERATING AN ON-LINE SHOPPING SITE IN THE FIELD OF COMPUTER SOFTWARE; ON-LINE ADVERTISING ON A COMPUTER NETWORK; ELECTRONIC PROCESSING OF ORDERS FOR OTHERS; REAL ESTATE ADVERTISING SERVICES; ON-LINE REAL ESTATE ADVERTISING SERVICES; PROVIDING ON-LINE SEARCHABLE GUIDES AND DATABASES, ALL FEATURING RETAIL SALES INFORMATION; REAL ESTATE MARKETING SERVICES IN THE FIELD OF CONDOMINIUMS, APARTMENTS, LUXURY APARTMENTS, HOMES, COMMERCIAL BUILDINGS AND STOREFRONTS; ON-LINE REAL ESTATE MARKETING SERVICES IN THE FIELD OF CONDOMINIUMS, APARTMENTS, LUXURY APARTMENTS, HOMES, COMMERCIAL BUILDINGS AND STOREFRONTS (U.S. CLS. 100, 101 AND 102).

CLASS 36—INSURANCE AND FINANCIAL

FOR ELECTRONIC PAYMENT, NAMELY, ELECTRONIC PROCESSING AND TRANSMISSION OF BILL PAYMENT DATA; REAL ESTATE BROKERAGE; ON-LINE REAL ESTATE BROKERAGE; REAL ESTATE ACQUISITION SERVICES; ON-LINE REAL ESTATE ACQUISITION SERVICES; PROVIDING FINANCIAL SERVICES TO SUPPORT THE SALE, TRANSFER, ACQUISITION OF REAL ESTATE; PROVIDING ON-LINE FINANCIAL SERVICES TO SUPPORT THE SALE, TRANSFER, ACQUISITION OF REAL ESTATE; PROVIDING ON-LINE SEARCHABLE GUIDES AND DATABASES, ALL FEATURING FINANCIAL AND REAL ESTATE INFORMATION (U.S. CLS. 100, 101 AND 102).

CLASS 38—COMMUNICATION

FOR TELECOMMUNICATION SERVICES, NAMELY, INFORMATION TRANSMISSION BY ELECTRONIC COMMUNICATION NETWORKS; PROVIDING AN ON-LINE INTERACTIVE BULLETIN BOARD FOR THE TRANSMISSION OF MESSAGES AMONG COMPUTER USERS CONCERNING HOBBIES, COLLECTIBLES, TRADING AND THE SALE OF GOODS AND SERVICES, VIA A GLOBAL COMMUNICATIONS NETWORK; TRANSMISSION AND COMMUNICATION SERVICES IN THE NATURE OF TEXT MESSAGING AND ELECTRONIC MAIL SERVICES USED IN PLAYING ON-LINE COMPUTER GAMES; COMMUNICATION SERVICES IN THE NATURE OF TEXT AND VOICE MESSAGING AND ELECTRONIC MAIL SERVICES; PROVIDING LIVE ON-LINE CHAT ROOMS FOR TRANSMISSION OF MESSAGES AMONG COMPUTER USERS CONCERNING GENERAL MERCHANDISE, PRODUCT REVIEWS, AND PRODUCT PURCHASING INFORMATION; COMMUNICATIONS BY COMPUTER TERMINALS; COMPUTER AIDED TRANSMISSION OF MESSAGES, SOUNDS, MEDIA AND IMAGES; ELECTRONIC MAIL; PAGING SERVICES; PROVIDING ACCESS TO DATABASES; PROVIDING TELECOMMUNICATION CHANNELS FOR TEleshopping SERVICES; MESSAGING SERVICES, NAMELY, SENDING, RECEIVING, ANALYZING AND FORWARDING MESSAGES IN THE FORM OF TEXT, AUDIO, GRAPHIC IMAGES OR VIDEO OR ANY COMBINATION OF THESE FORMATS; INSTANT MESSA-

GING; ELECTRONIC TRANSMISSION OF MESSAGES, NAMELY, SHORT MESSAGE SERVICES (SMS), MULTIMEDIA MESSAGING SERVICES (MMS), AND UNIFIED MESSAGING SERVICES; VOICEMAIL AND VIDEO MAIL SERVICES; PROVIDING ACCESS TO TELECOMMUNICATIONS INFRASTRUCTURES FOR THIRD PARTIES; WEB CONFERENCING SERVICES; PROVIDING ON-LINE CHAT ROOMS FOR TRANSMISSION OF MESSAGES AMONG COMPUTER USERS CONCERNING TOPICS OF GENERAL INTEREST; TELECOMMUNICATION SERVICES, NAMELY, PROVISION OF ACCESS TO THE INTERNET; INFORMATION TRANSMISSION VIA ELECTRONIC COMMUNICATIONS NETWORKS; PROVIDING MULTIPLE-USER ACCESS TO A GLOBAL COMPUTER INFORMATION NETWORK TO ACCESS ADVERTISING AND RETAILING OF GOODS AND SERVICES THROUGH INTERACTIVE COMMUNICATIONS; PROVIDING MULTIPLE-USER ACCESS TO A GLOBAL COMPUTER INFORMATION NETWORK TO ACCESS ON-LINE SERVICES, FORUMS, ENVIRONMENTS, VIRTUAL WORLDS, WEBSITES, AND ACTIVITIES; TRANSMISSION OF INFORMATION, DATA, GRAPHICS, AUDIO AND/OR AUDIO-VISUAL CONTENT FROM A RESTRICTED GROUP OF INTERNET WEBSITES OR PORTALS; PROVIDING MULTIPLE-USER ACCESS TO INTERACTIVE MULTIMEDIA NETWORKS; PROVIDING MULTIPLE-USER ACCESS TO A GLOBAL COMPUTER INFORMATION NETWORK FEATURING VIRTUAL INTERACTIVE ENVIRONMENTS INCLUDING TO INTERACTIVE GAMES, INTERACTIVE NEWS, INTERACTIVE SPORT, INTERACTIVE ENTERTAINMENT, INTERACTIVE RETAILING OF GOODS AND SERVICES, INTERACTIVE COMPETITIONS AND INTERACTIVE ADVERTISING; ELECTRONIC TRANSMISSION OF RECORDINGS OF MUSIC, SOUNDS, VIDEOS, IMAGES, TEXT AND INFORMATION AND DISTRIBUTION OR TRANSMISSION OF THE SAME BY A TELECOMMUNICATIONS NETWORK, BY ON-LINE DELIVERY AND BY WAY OF THE INTERNET AND/OR THE WORLD-WIDE WEB OR OTHER WIRELESS COMMUNICATIONS NETWORK; PROVIDING AN ON-LINE, INTERACTIVE BULLETIN BOARD FOR TRANSMISSION OF MESSAGES AMONG COMPUTER USERS CONCERNING THE POSTING, PROMOTION AND SALE OF RETAIL, FINANCIAL, MEDICAL, TOURISM AND REAL ESTATE GOODS AND SERVICES; ELECTRONIC EXCHANGE OF DATA STORED IN DATABASES ACCESSIBLE VIA TELECOMMUNICATION NETWORKS; PROVIDING AN ON-LINE INTERACTIVE BULLETIN BOARD FOR THE POSTING, PROMOTION AND SALE OF GOODS AND SERVICES; THE TRANSMISSION OF OR RECORDINGS OF MUSIC, SOUNDS, VIDEO, IMAGES, TEXT AND INFORMATION AND DISTRIBUTION OR TRANSMISSION OF THE SAME BY WAY OF COMMUNICATION NETWORK (U.S. CLS. 100, 101 AND 104).

CLASS 41—EDUCATION AND ENTERTAINMENT

FOR ENTERTAINMENT SERVICES, NAMELY, ON-LINE REAL ESTATE MARKETING SERVICES IN THE FIELD OF CONDOMINIUMS, APARTMENTS, LUXURY APARTMENTS, HOMES, COMMERCIAL BUILDINGS AND STOREFRONTS FOR THREE DIMENSIONAL VIRTUAL ON-LINE COMMUNITIES (U.S. CLS. 100, 101 AND 107).

CLASS 42—SCIENTIFIC AND COMPUTER SERVICES

FOR COMPUTER SOFTWARE DESIGN; HOSTING COMPUTER SITES, WEB SITES AND VIRTUAL ON-LINE COMMUNITIES FOR OTHERS; INSTALLATION OF COMPUTER SOFTWARE AND FIRMWARE; MAINTENANCE OF COMPUTER SOFTWARE AND FIRMWARE; UPDATING OF COMPUTER SOFTWARE AND FIRMWARE; PROVIDING SEARCH ENGINES FOR OBTAINING DATA ON THE INTERNET; COMPUTER SERVICES, NAMELY, DESIGNING VIRTUAL ON-LINE COMMUNITIES IN THE FIELDS OF EMERGENCY SERVICES DISPATCH, RETAIL SERVICES, FINANCIAL SERVICES, MEDICAL SERVICES, TOURISM AND REAL ESTATE SERVICES; DESIGN SERVICES FOR PROPERTY, BUILDINGS, STREET PLANNING, SHOPPING COMPLEXES, AND PROPERTY DEVELOPMENTS; HOSTING OF DIGITAL CONTENT ON THE INTERNET ON BEHALF OF USERS; COMPUTER SERVICES, NAMELY, CREATING VIRTUAL ON-LINE COMMUNITIES FOR TRADING VIRTUAL REAL ESTATE (U.S. CLS. 100 AND 101).

TRACY CROSS, EXAMINING ATTORNEY

SN 77-380,933. PENKY LLC, WILMINGTON, DE. FILED 1-25-2008.

TERRAPOWER

THE MARK CONSISTS OF STANDARD CHARACTERS WITHOUT CLAIM TO ANY PARTICULAR FONT, STYLE, SIZE, OR COLOR.

CLASS 7—MACHINERY

FOR ENERGY TRANSMISSION AND ENERGY DISTRIBUTION MACHINES (U.S. CLS. 13, 19, 21, 23, 31, 34 AND 35).

CLASS 35—ADVERTISING AND BUSINESS

FOR WHOLESALE DISTRIBUTORSHIPS FEATURING EQUIPMENT IN THE FIELD OF ENERGY PRODUCTION AND DELIVERY, NAMELY, ELECTRICAL, THERMAL AND CHEMICAL ENERGY DERIVED DIRECTLY OR INDIRECTLY FROM CONTROLLED NUCLEAR REACTIONS AND WATER PRODUCTION, AND DELIVERY THROUGH DESALINATION; AND PUBLIC AND GOVERNMENT ADVOCACY IN THE NATURE OF LOBBYING SERVICES TO PROMOTE AWARENESS OF ENERGY DERIVED FROM CONTROLLED NUCLEAR REACTIONS AND WATER PRODUCTION AND DELIVERY (U.S. CLS. 100, 101 AND 102).

CLASS 42—SCIENTIFIC AND COMPUTER SERVICES

FOR NEW PRODUCT DESIGN AND PRODUCTION FACILITIES DESIGN FOR OTHERS IN THE FIELDS OF ENERGY PRODUCTION AND DELIVERY, NAMELY, ELECTRICAL, THERMAL AND CHEMICAL ENERGY DERIVED DIRECTLY OR INDIRECTLY FROM CONTROLLED NUCLEAR REACTIONS, AND WATER PRODUCTION AND DELIVERY THROUGH DESALINATION; CONSULTATION IN THE FIELD OF NEW PRODUCT DESIGN AND PRODUCTION FACILITIES DESIGN IN THE FIELDS OF ENERGY PRODUCTION AND DELIVERY, NAMELY, ELECTRICAL, THERMAL AND CHEMICAL ENERGY DERIVED DIRECTLY OR INDIRECTLY FROM CONTROLLED NUCLEAR REACTIONS, AND WATER PRODUCTION AND DELIVERY THROUGH DESALINATION; AND DEVELOPMENT FOR OTHERS OF INTELLECTUAL PROPERTY RELATING DIRECTLY OR INDIRECTLY TO ENERGY DEVELOPMENT, PRODUCTION AND DISTRIBUTION (U.S. CLS. 100 AND 101).

CLASS 45—PERSONAL AND LEGAL SERVICES

FOR LICENSING OF INTELLECTUAL PROPERTY RELATING DIRECTLY OR INDIRECTLY TO ENERGY DEVELOPMENT, PRODUCTION AND DISTRIBUTION (U.S. CLS. 100 AND 101).

EVELYN BRADLEY, EXAMINING ATTORNEY

CLASS 9—ELECTRICAL AND SCIENTIFIC APPARATUS

FOR LED (LIGHT EMITTING DIODE) DISPLAYS, LED (LIGHT EMITTING DIODE) PANELS FOR DISPLAYING VIDEO OR IMAGES, ELECTRONIC REGULATING AND CONTROL DEVICES FOR THE OPERATION OF LEDS (LIGHT EMITTING DIODES); APPARATUS AND INSTRUMENTS FOR CONTROLLING LIGHTING, NAMELY, ELECTRONIC CONTROLLERS FOR CONTROLLING STAGE LIGHTING, COMPUTER CONTROLS FOR LIGHTING APPARATUS AND INSTRUMENTS, ELECTRONIC CONTROL CONSOLES FOR LIGHTING APPARATUS AND INSTRUMENTS, PROGRAMMABLE ELECTRONIC CONTROLLERS AND REMOTE CONTROLS FOR LIGHTING APPARATUS AND INSTRUMENTS, REMOTE CONTROLS FOR LIGHTING APPARATUS AND INSTRUMENTS, AUDIO SENSITIVE ELECTRONIC CONTROLLERS FOR LIGHTING APPARATUS AND INSTRUMENTS; LIGHTING CONTROL SOFTWARE, NAMELY, LIGHTING CONTROL SOFTWARE FOR USE IN COMMERCIAL AND INDUSTRIAL FACILITIES, IN THEATRES, IN NIGHT CLUBS AND AT CONCERTS, LIGHTING CONTROL SOFTWARE FOR USE IN STAGE LIGHTING APPARATUS AND INSTRUMENTS AND FOR CONTROLLING STAGE LIGHTING APPARATUS AND INSTRUMENTS; ELECTRIC CONNECTION CABLES, ELECTRIC CONNECTORS AND ELECTRIC SWITCHES FOR STAGE LIGHTING APPARATUS AND INSTRUMENTS; CARRYING CASES AND FLIGHT CASES SPECIALLY ADAPTED FOR INSTRUMENTS FOR CONTROLLING LIGHTING APPARATUS (U.S. CLS. 21, 23, 26, 36 AND 38).

CLASS 11—ENVIRONMENTAL CONTROL APPARATUS

FOR APPARATUS AND INSTRUMENTS FOR LIGHTING, NAMELY, STAGE LIGHTING APPARATUS AND INSTRUMENTS, NAMELY, FLOOD LIGHTS, PARABOLIC ALUMINIZED REFLECTOR LIGHTS, STRIP LIGHTS IN THE NATURE OF LIGHTING TRACKS AND TUBE LIGHTS, SPOTLIGHTS, ELLIPSOIDAL REFLECTOR SPOTLIGHTS, FRESNEL LANTERNS, FOLLOW SPOTLIGHTS, LASER AND LIGHT BEAM PROJECTORS, MOVING HEADS, NAMELY, STAGE LIGHTING FIXTURES; FILTERS FOR LIGHTING APPARATUS AND LIGHTING INSTRUMENTS, FILTERS FOR USE WITH LIGHTING APPARATUS AND LIGHTING INSTRUMENTS, COLOR FILTERS FOR USE IN LIGHTING APPARATUS AND LIGHTING INSTRUMENTS, GOBOS AND COCULORIS, NAMELY, FILTERS FOR USE WITH LIGHTING APPARATUS AND LIGHTING INSTRUMENTS; APPARATUS AND INSTRUMENTS FOR LIGHTING, NAMELY, APPARATUS AND INSTRUMENTS FOR EFFECT LIGHTING, NAMELY, MOVING HEADS BEING EFFECT LIGHTING FIXTURES, ROLLERSCANNERS LIGHT FIXTURES FOR LIGHT EFFECTS, STROBE LIGHTS FOR LIGHT EFFECTS, LASER LIGHT PROJECTORS FOR EFFECT LIGHTING; COMPUTER CONTROLLED LIGHTING APPARATUS AND LIGHTING INSTRUMENTS, NAMELY, COMPUTER CONTROLLED LASER LIGHT PROJECTORS, COMPUTER CONTROLLED FLOOD LIGHTS, COMPUTER CONTROLLED PARABOLIC ALUMINIZED REFLECTOR LIGHTS, COMPUTER CONTROLLED STRIP LIGHTS IN THE NATURE OF LIGHTING TRACKS AND TUBE LIGHTS, COMPUTER CONTROLLED SPOTLIGHTS, COMPUTER CONTROLLED ELLIPSOIDAL REFLECTOR SPOTLIGHTS, COMPUTER CONTROLLED FRESNEL LANTERNS, COMPUTER CONTROLLED FOLLOW SPOTLIGHTS, COMPUTER CONTROLLED LASER AND LIGHT BEAM PROJECTORS AND COMPUTER CONTROLLED MOVING HEADS, NAMELY, STAGE LIGHTING FIXTURES; DECORATIVE ELECTRIC LIGHTING APPARATUS, NAMELY, FLOOD LIGHTS, PARABOLIC ALUMINIZED REFLECTOR LIGHTS, STRIP LIGHTS IN THE NATURE OF LIGHTING TRACKS AND TUBE LIGHTS, SPOTLIGHTS, ELLIPSOIDAL REFLECTOR SPOTLIGHTS, FRESNEL LANTERNS, LASER AND LIGHT BEAM PROJECTORS; LED (LIGHT EMITTING DIODES) LUMINARIES AND LED (LIGHT EMITTING DIODES) LIGHTING FIXTURES FOR STAGE LIGHTING OR ARCHITECTURAL LIGHTING; HID (HIGH INTENSITY DISCHARGE) LUMINARIES AND HID (HIGH INTENSITY DISCHARGE) LIGHTING FIXTURES FOR STAGE

SN 77-388,045. MARTIN PROFESSIONAL A/S, 8200 AARHUS N, DENMARK, FILED 2-4-2008.

MAC III

THE MARK CONSISTS OF STANDARD CHARACTERS WITHOUT CLAIM TO ANY PARTICULAR FONT, STYLE, SIZE, OR COLOR.

PRIORITY CLAIMED UNDER SEC. 44(D) ON ERP N CMNTY TM OFC APPLICATION NO. 006517353, FILED 12-14-2007, REG. NO. 006517353, DATED 7-1-2009, EXPIRES 12-14-2017.

LIGHTING OR ARCHITECTURAL LIGHTING; HALOGEN LUMINARIES AND HALOGEN LIGHTING FIXTURES FOR STAGE LIGHTING OR ARCHITECTURAL LIGHTING; LIGHTING FIXTURES FOR USE IN DISPLAY, COMMERCIAL, INDUSTRIAL, RESIDENTIAL, AND ARCHITECTURAL ACCENT LIGHTING APPLICATIONS; INDOOR AND OUTDOOR ARCHITECTURAL WASHLIGHTS, NAMELY, LIGHTING FIXTURES FOR USE IN LIGHTING OF BUILDINGS AND FOR USE IN PROJECTION OF PATTERNS, IMAGES, LOGOS, TEXT OR SHAPES; ARCHITECTURAL UP-LIGHTS FOR INSTALLATION IN THE GROUND; IMAGE PROJECTORS, NAMELY, LIGHTING FIXTURES FOR USE IN PROJECTION OF PATTERNS, IMAGES, LOGOS, TEXT OR SHAPES; FLUORESCENT LUMINARIES FOR STAGE LIGHTING OR ARCHITECTURAL LIGHTING; FIBRE ILLUMINATORS, NAMELY, LIGHT SOURCES FOR FIBRE OPTIC CABLES; ELECTRIC FANS FOR USE WITH SMOKE GENERATING MACHINES; CARRYING CASES AND FLIGHT CASES SPECIALLY ADAPTED FOR LIGHTING APPARATUS AND LIGHTING INSTRUMENTS (U.S. CLS. 13, 21, 23, 31 AND 34).

LEIGH LOWRY, EXAMINING ATTORNEY

SN 77-396,420. HAMILTON BONADUZ AG, 7402 BONADUZ, SWITZERLAND, FILED 2-13-2008.

VENUS

THE MARK CONSISTS OF STANDARD CHARACTERS WITHOUT CLAIM TO ANY PARTICULAR FONT, STYLE, SIZE, OR COLOR.

PRIORITY CLAIMED UNDER SEC. 44(D) ON SWITZERLAND APPLICATION NO. 50904/2008, FILED 1-23-2008, REG. NO. 585781, DATED 4-23-2009, EXPIRES 1-23-2018.

CLASS 5—PHARMACEUTICALS

FOR PHARMACEUTICAL AND VETERINARY PREPARATIONS FOR TREATING DIABETES, SKIN DISORDERS, RESPIRATORY DISEASE AND ASTHMA, AND COMMON COLDS; PAIN RELIEF MEDICATION; SANITARY PREPARATIONS FOR MEDICAL PURPOSES; DIETETIC SUBSTANCES, NAMELY, FOOD, ADAPTED FOR MEDICAL USE, FOOD FOR BABIES; MEDICAL PLASTERS, MATERIALS FOR DRESSINGS, NAMELY, GAUZE, BANDAGE FOR DRESSINGS AND SKIN WOUNDS; DISINFECTANTS; HERBICIDES (U.S. CLS. 6, 18, 44, 46, 51 AND 52).

CLASS 7—MACHINERY

FOR AIR DISPLACEMENT PIPETTING MACHINES FOR USE IN HIGH PRECISION PIPETTING OF FLUID AND SOLID MATERIALS; MACHINE TOOLS, NAMELY, ARMS, ROCKER ARMS, GRIPPERS FOR AIR DISPLACEMENT PIPETTING MACHINES FOR USE IN HIGH PRECISION PIPETTING OF FLUID AND SOLID MATERIALS; AIR FILTERS FOR MECHANICAL PURPOSES, ELECTRIC WASHING MACHINES FOR INDUSTRIAL PURPOSES, MOTORS AND ENGINES OTHER THAN FOR LAND VEHICLES; MACHINE COUPLING AND TRANSMISSION COMPONENTS OTHER THAN FOR LAND VEHICLES; TRACTOR-TOWED AGRICULTURAL IMPLEMENTS, NAMELY, HARROWS, HARVESTERS; INCUBATORS FOR EGGS (U.S. CLS. 13, 19, 21, 23, 31, 34 AND 35).

CLASS 9—ELECTRICAL AND SCIENTIFIC APPARATUS

FOR SCIENTIFIC INSTRUMENTS, NAMELY, BAR CODE SCANNERS; PHOTOGRAPHIC INSTRUMENTS, NAMELY, CAMERAS; INSTRUMENTS FOR MEASURING LENGTH, DISTANCE AND TWO-DIMENSIONAL DISTRIBUTION OF FORCE AND PRESSURE; WEIGHING INSTRUMENTS, NAMELY, SCALES; BLANK MAGNETIC DATA CARRIERS, DATA PROCESSORS AND COMPUTERS; COMPUTER PROGRAMS AND SOFTWARE FOR THE CONTROLLING AND SURVEYING OF ALL PROCEDURES OF PIPETTING MACHINES; TEMPERATURE REGULATORS FOR AIR DISPLACEMENT PIPETTING TECHNOLOGY TO BE USED IN THE FIELD OF HIGH PRECISION PIPETTING OF FLUID AND SOLID MATTERS; PIPETTES; TEST TUBES; LABORATORY STORAGE TUBES (U.S. CLS. 21, 23, 26, 36 AND 38).

CLASS 42—SCIENTIFIC AND COMPUTER SERVICES

FOR DESIGN AND DEVELOPMENT OF COMPUTER HARDWARE AND SOFTWARE (U.S. CLS. 100 AND 101).
STEVEN R. FINE, EXAMINING ATTORNEY

SN 77-396,066. HERMES INTERIEUR & DESIGN, 75008 PARIS, FRANCE, FILED 2-13-2008.



PRIORITY CLAIMED UNDER SEC. 44(D) ON ERPNCMNTY TM OFC APPLICATION NO. 6305494, FILED 9-24-2007, REG. NO. 006305494, DATED 9-24-2007, EXPIRES 9-24-2017.

THE MARK CONSISTS OF A RIBBON.

CLASS 12—VEHICLES

FOR HELICOPTERS, AIRPLANES, BOATS AND AUTOMOBILES (U.S. CLS. 19, 21, 23, 31, 35 AND 44).

CLASS 40—MATERIAL TREATMENT

FOR TREATMENT OF MATERIALS FOR USE IN THE INTERIORS OF HELICOPTERS, AIRPLANES, BOATS AND AUTOMOBILES; TREATMENT OF MATERIALS FOR USE IN SADDLERY (U.S. CLS. 100, 103 AND 106).

CLASS 42—SCIENTIFIC AND COMPUTER SERVICES

FOR INTERIOR DECORATION AND DESIGN SERVICES FOR HELICOPTERS, AIRPLANES, BOATS AND AUTOMOBILES; INDUSTRIAL RESEARCH AND DESIGN SERVICES IN THE FIELDS OF AIRCRAFTS, BOATS AND AUTOMOBILES; DESIGN AND DEVELOPMENT OF COMPUTER HARDWARE AND SOFTWARE (U.S. CLS. 100 AND 101).

PRISCILLA MILTON, EXAMINING ATTORNEY

SN 77-397,351. NIPRO BREWERY CO., LTD., RICHMOND, CANADA, FILED 2-14-2008.

Keyopé

PRIORITY CLAIMED UNDER SEC. 44(D) ON CANADA APPLICATION NO. 1383467, FILED 2-14-2008.

OWNER OF CANADA REG. NO. TMA761928, DATED 3-17-2010, EXPIRES 3-17-2025.

THE MARK CONSISTS OF THE WORD "KEYOPE". A SKELETON KEY DESIGN APPEARS INSIDE THE LETTER "O". A LOCK DESIGN APPEARS ABOVE THE SECOND LETTER "E". A SMALL RECTANGLE WITH SLANTED SIDES APPEARS ABOVE AND TO THE RIGHT OF THE LETTER "K".

CLASS 33—WINES AND SPIRITS

FOR SAKE (U.S. CLS. 47 AND 49).

CLASS 40—MATERIAL TREATMENT

FOR BREWERY SERVICES (U.S. CLS. 100, 103 AND 106).

DAVID MILLER, EXAMINING ATTORNEY

SN 77-402,360. TACO TRUCK LLC, THE, HOBOKEN, NJ, FILED 2-21-2008.

THE TACO TRUCK

THE MARK CONSISTS OF STANDARD CHARACTERS WITHOUT CLAIM TO ANY PARTICULAR FONT, STYLE, SIZE, OR COLOR.

NO CLAIM IS MADE TO THE EXCLUSIVE RIGHT TO USE "TACO" IN CONNECTION WITH CLASSES 30 AND 43 ONLY, APART FROM THE MARK AS SHOWN.

CLASS 21—HOUSEWARES AND GLASS

FOR CUPS; CUPS AND MUGS; PLATES; BOWLS (U.S. CLS. 2, 13, 23, 29, 30, 33, 40 AND 50).

CLASS 25—CLOTHING

FOR GOLF SHIRTS; KNIT SHIRTS; LONG-SLEEVED SHIRTS; NIGHT SHIRTS; OPEN-NECKED SHIRTS; POLO SHIRTS; SHIRTS; SHORT-SLEEVED OR LONG-SLEEVED T-SHIRTS; SHORT-SLEEVED SHIRTS; SPORT SHIRTS; SWEAT SHIRTS; T-SHIRTS; SHORTS; HATS (U.S. CLS. 22 AND 39).

CLASS 29—MEATS AND PROCESSED FOODS

FOR CHILI (U.S. CL. 46).

CLASS 30—STAPLE FOODS

FOR SALSA; QUESADILLAS; CHILI SAUCE; CHEESE SAUCE; DIPPING SAUCES; HOT SAUCE; PICANTE SAUCE; SAUCES; PICO DE GALLO SAUCE; BURRITOS; ENCHILADAS; FAJITAS; DRIED CORN HUSKS FOR TAMALES; TAMALES; NACHOS; RICE; RICE SALAD; BEVERAGES MADE OF COFFEE; BEVERAGES MADE OF TEA; TACO CHIPS; TACO SEASONING; TACO SHELLS; TACOS; TORTILLA CHIPS; TORTILLA SHELLS; TORTILLAS; CHILI SEASONING; DRIED CHILI PEPPERS; DRY SEASONING MIXES FOR TACOS, ENCHILADAS, BURRITOS, FAJITAS, AND TAMALES; SEASONED COATING FOR MEAT, FISH, POULTRY; SEASONED COATING MIXTURES FOR FOODS (U.S. CL. 46).

CLASS 43—HOTEL AND RESTAURANT SERVICES

FOR BAR AND RESTAURANT SERVICES; CAFE AND RESTAURANT SERVICES; CAFE-RESTAURANTS; CARRY-OUT RESTAURANTS; FAST FOOD AND NON-STOP RESTAURANT SERVICES; FAST-FOOD RESTAURANTS; RESTAURANT; RESTAURANT AND BAR SERVICES; RESTAURANT AND CAFE SERVICES; RESTAURANT SERVICES; RESTAURANTS; ALL OF THE FORGOING BEING BRICK AND MORTAR ESTABLISHMENTS (U.S. CLS. 100 AND 101).

MATTHEW EINSTEIN, EXAMINING ATTORNEY

SN 77-412,672. PHARMASOL GMBH, 12307 BERLIN, FED REP GERMANY, FILED 3-4-2008.

NLC

THE MARK CONSISTS OF STANDARD CHARACTERS WITHOUT CLAIM TO ANY PARTICULAR FONT, STYLE, SIZE, OR COLOR.

OWNER OF FED REP GERMANY REG. NO. 30130331, DATED 3-13-2002, EXPIRES 5-31-2011.

CLASS 2—PAINTS

FOR PAINTS, VARNISHES, LACQUERS; PRESERVATIVES AGAINST RUST AND AGAINST DETERIORATION OF WOOD, NAMELY, WOOD PRESERVATIVES AND RUST PREVENTATIVES IN THE NATURE OF A COATING; COLORANTS; MORDANT DYES; RAW NATURAL RESINS; METALS IN FOIL AND POWDER FORM FOR PAINTERS, DECORATORS, PRINTERS AND ARTISTS (U.S. CLS. 6, 11 AND 16).

CLASS 3—COSMETICS AND CLEANING PREPARATIONS

FOR BLEACHING PREPARATIONS AND OTHER SUBSTANCES FOR LAUNDRY USE, NAMELY, SOFTENERS FOR WASHING PROCESSES; CLEANING, POLISHING, SCOURING AND ABRASIVE PREPARATIONS; SOAPS; PERFUMERY; ESSENTIAL OILS; BODY AND BEAUTY CARE PREPARATIONS, NAMELY, COSMETICS; HAIR LOTIONS; DENTIFRICES (U.S. CLS. 1, 4, 6, 50, 51 AND 52).

CLASS 5—PHARMACEUTICALS

FOR NON-ORALLY ADMINISTERED PHARMACEUTICAL AND VETERINARY PREPARATIONS CONTAINING A PRESCRIPTION DRUG AND A TOPICAL, OCULAR, INTRANASAL, OR PARENTARALLY ADMINISTERED DRUG DELIVERY AGENT IN THE FORM OF A LIPID CARRIER THAT INCREASES DRUG EFFICIENCY AND/OR REDUCES SIDE EFFECTS, EXCLUDING NUTRITIONAL AND FOOD SUPPLEMENTS; NON-ORALLY ADMINISTERED PHARMACEUTICAL AND VETERINARY PREPARATIONS IN THE FORM OF A PRESCRIPTION DRUG CARRIED BY A TOPICAL, OCULAR, INTRANASAL, OR PARENTARALLY ADMINISTERED DRUG DELIVERY AGENT IN THE FORM OF A LIPID CARRIER THAT INCREASES DRUG EFFICIENCY AND/OR REDUCES SIDE EFFECTS, EXCLUDING NUTRITIONAL AND FOOD SUPPLEMENTS; MEDICAL PLASTERS; MATERIALS FOR DRESSINGS; MATERIAL FOR STOPPING TEETH; DENTAL WAX; DISINFECTANTS FOR HYGIENIC PURPOSES; PREPARATIONS FOR DESTROYING VERMIN; FUNGICIDES; HERBICIDES (U.S. CLS. 6, 18, 44, 46, 51 AND 52).
 WILLIAM ROSSMAN, EXAMINING ATTORNEY

SN 77-440,024. HEIDELBERGER DRUCKMASCHINEN AG, HEIDELBERG, FED REP GERMANY, FILED 4-4-2008.

iStitch

THE MARK CONSISTS OF STANDARD CHARACTERS WITHOUT CLAIM TO ANY PARTICULAR FONT, STYLE, SIZE, OR COLOR.

PRIORITY CLAIMED UNDER SEC. 44(D) ON ERPNTY TM OFC APPLICATION NO. 006408892, FILED 11-6-2007, REG. NO. 006408892, DATED 10-9-2008, EXPIRES 11-6-2017.

CLASS 7—MACHINERY

FOR MACHINERY FOR THE GRAPHIC ARTS INDUSTRY, NAMELY, PHOTOGRAVURE PRINTING PRESSES, MACHINERY FOR EXPOSING PRINTING PLATES; MACHINERY FOR PROCESSING PRINTED PRODUCTS, NAMELY, SADDLE STITCHERS, INDUSTRIAL PAPER BINDING MACHINES AND STRUCTURAL PADS FOR THE AFOREMENTIONED GOODS (U.S. CLS. 13, 19, 21, 23, 31, 34 AND 35).

CLASS 9—ELECTRICAL AND SCIENTIFIC APPARATUS

FOR COMPUTER SOFTWARE FOR CONTROLLING AND NETWORKING OF MACHINERY AND DEVICES FOR THE GRAPHICS ARTS INDUSTRY; COMPUTER SOFTWARE FOR CONTROLLING AND NETWORKING OF MACHINERY FOR PROCESSING PRINTED PRODUCTS; DIGITAL DATA CARRIERS, NAMELY, CDS, DVDS AND USB STICKS CARRYING AFOREMENTIONED COMPUTER SOFTWARE; ELECTRIC AND ELECTRONIC DEVICES FOR CONTROLLING, REGULATING AND NETWORKING MACHINERY FOR FURTHER PROCESSING OF PRINTED PRODUCTS, NAMELY, ELECTRONIC CONTROL PANELS FOR OPERATING SADDLE STITCHERS, DATA PROCESSING PROGRAMS FOR CONTROLLING AND NETWORKING OF MACHINERY FOR PROCESSING PRINTED PRODUCTS; DATA PROCESSING PROGRAMS FOR CONTROLLING THE MANUFACTURING PROCESS IN CONNECTION WITH THE PRODUCTION OF PRINTED PRODUCTS; DATA PROCESSING PROGRAMS FOR TRANSFERRING INFORMATION FOR THE FURTHER PROCESSING OF PRINTED PRODUCTS (U.S. CLS. 21, 23, 26, 36 AND 38).

LEIGH LOWRY, EXAMINING ATTORNEY

SN 77-434,357. BPD L PRECAST CONCRETE INTERNATIONAL INC., ALMA, QUEBEC, CANADA, FILED 3-28-2008.

BPD L

THE MARK CONSISTS OF STANDARD CHARACTERS WITHOUT CLAIM TO ANY PARTICULAR FONT, STYLE, SIZE, OR COLOR.

PRIORITY CLAIMED UNDER SEC. 44(D) ON CANADA APPLICATION NO. 1388612, FILED 3-25-2008, REG. NO. TMA750,107, DATED 10-14-2009, EXPIRES 10-14-2024.

CLASS 19—NON-METALLIC BUILDING MATERIALS

FOR CONCRETE BUILDING MATERIALS, NAMELY, ARCHITECTURAL AND STRUCTURAL PRE-CAST CONCRETE SLABS, PANELS AND BEAMS AND COMPONENTS THEREFOR, NAMELY, DOUBLE-T-BEAMS, BLEACHERS, AND HANDSET PIECES (U.S. CLS. 1, 12, 33 AND 50).

FIRST USE 1-1-1984; IN COMMERCE 1-1-1984.

CLASS 42—SCIENTIFIC AND COMPUTER SERVICES

FOR DESIGN AND ENGINEERING OF ARCHITECTURAL AND/OR STRUCTURAL PRECAST CONCRETE BUILDING MATERIALS (U.S. CLS. 100 AND 101).

FIRST USE 1-1-1984; IN COMMERCE 1-1-1984.
 SUSAN LESLIE DUBOIS, EXAMINING ATTORNEY

SN 77-448,900. VOLT INFORMATION SCIENCES, INC., ORANGE, CA. FILED 4-15-2008.



VOLTDELTA
 CONNECTING PEOPLE & INFORMATION

OWNER OF U.S. REG. NOS. 2,375,195, 2,892,341 AND OTHERS.

THE MARK CONSISTS OF A STYLIZED TRIANGULAR DESIGN, WITH AN ARROW DESIGN IN EACH OF THE THREE TRIANGLES THAT COMPRISE THE TRIANGULAR DESIGN, AND TO THE RIGHT OF THIS, THE WORDING "VOLTDELTA CONNECTING PEOPLE & INFORMATION" IN STYLIZED FORM.

CLASS 35—ADVERTISING AND BUSINESS

FOR ADVERTISING SERVICES, NAMELY, TELE-MARKETING; PROFESSIONAL BUSINESS CONSULTANCY, NAMELY, DEVISING ADVERTISING CONCEPTS FOR INFORMATION SYSTEMS PURVEYORS, AND ADVERTISING CONCEPTS INTENDED TO BE INCORPORATED INTO ADVERTISING BY OTHERS AND TRANSMITTED OVER THE INTERNET TO PROMOTE E-COMMERCE AND E-BUSINESS FOR CLIENTS; TELEPHONE DIRECTORY ASSISTANCE AND BUSINESS DIRECTORY INFORMATION SERVICES; PROVIDING DIRECTORY ASSISTANCE AND DIRECTORY INFORMATION SERVICE DATABASES; TELEPHONE OPERATOR SERVICES; TELEPHONE DIRECTORY SERVICES FOR NATIONAL AND INTERNATIONAL NUMBERS AND ADDRESSES AND DIRECTORY INFORMATION; OPERATION OF TELEPHONE AND INFORMATION SWITCHBOARDS FOR OTHERS; DATA PROCESSING SERVICES; DATA MANAGEMENT SERVICES FOR USE IN TELEPHONE DIRECTORIES AND BUSINESS DIRECTORIES, PROVIDING AN ON-LINE CLASSIFIED TELEPHONE DIRECTORY DATABASE FEATURING BUSINESS AND CONSUMER INFORMATION; TELEPHONE DIRECTORY ASSISTANCE FEATURING RESIDENTIAL, BUSINESS AND GOVERNMENT LISTINGS AVAILABLE TO TELECOMMUNICATIONS PROVIDERS (U.S. CLS. 100, 101 AND 102).

FIRST USE 10-0-2006; IN COMMERCE 10-0-2006.

CLASS 38—COMMUNICATION

FOR TELECOMMUNICATIONS SERVICES, NAMELY, CALL, MESSAGES, AND EMAIL FORWARDING SERVICES, INTERNET PROVIDER SERVICES, NAMELY, RENTAL OF ACCESS TIME TO GLOBAL COMPUTER NETWORKS; TECHNICAL CONSULTANCY IN THE FIELD OF TELECOMMUNICATIONS; RENTAL AND LEASING OF TELECOMMUNICATIONS EQUIPMENT FOR OPERATING DIRECTORY INQUIRY AND INFORMATION SERVICES WITH OPERATOR SUPPORT; RENTAL TO OTHERS OF OPERATING EXTERNAL TELEPHONE SWITCH EQUIPMENT; PROFESSIONAL MESSAGE FORWARDING SERVICES; TECHNICAL CONSULTATION IN THE FIELD OF TELECOMMUNICATIONS (U.S. CLS. 100, 101 AND 104).

FIRST USE 10-0-2006; IN COMMERCE 10-0-2006.

CLASS 42—SCIENTIFIC AND COMPUTER SERVICES

FOR DATA MINING SERVICES (U.S. CLS. 100 AND 101).

FIRST USE 10-0-2006; IN COMMERCE 10-0-2006.
NANCY CLARKE, EXAMINING ATTORNEY

SN 77-472,142. NISTEVO, LLC, OLYMPIA, WA. FILED 5-12-2008.

LUIGINO

THE MARK CONSISTS OF STANDARD CHARACTERS WITHOUT CLAIM TO ANY PARTICULAR FONT, STYLE, SIZE, OR COLOR.

THE NAME(S), PORTRAIT(S), AND/OR SIGNATURE(S) SHOWN IN THE MARK IDENTIFIES "LUIGINO VERDUCI", WHOSE CONSENT(S) TO REGISTER IS MADE OF RECORD.

CLASS 18—LEATHER GOODS

FOR BACKPACKS (U.S. CLS. 1, 2, 3, 22 AND 41).
FIRST USE 0-0-2006; IN COMMERCE 0-0-2006.

CLASS 25—CLOTHING

FOR JERSEYS, T-SHIRTS, SHORTS AND WIND-RESISTANT JACKETS; BOOTS, TOE STRAPS AND ANKLE STRAPS, ALL FOR ROLLER SKATES AND INLINE SKATES (U.S. CLS. 22 AND 39).

FIRST USE 0-0-2006; IN COMMERCE 0-0-2006.

CLASS 28—TOYS AND SPORTING GOODS

FOR ROLLER SKATES; INLINE SKATES; PARTS FOR THE AFORESAID, NAMELY, WHEELS, FRAMES, AND BALL BEARINGS (U.S. CLS. 22, 23, 38 AND 50).

CLASS 36—INSURANCE AND FINANCIAL

FOR FINANCIAL SPONSORSHIP OF ATHLETIC RACING TEAMS (U.S. CLS. 100, 101 AND 102).
FIRST USE 0-0-2006; IN COMMERCE 0-0-2006.
RON FAIRBANKS, EXAMINING ATTORNEY

SN 77-480,925. THE AMERICAN TRIAL LAWYERS ASSOCIATION, BIRMINGHAM, AL. FILED 5-22-2008.

THEATLA

THE MARK CONSISTS OF STANDARD CHARACTERS WITHOUT CLAIM TO ANY PARTICULAR FONT, STYLE, SIZE, OR COLOR.

CLASS 35—ADVERTISING AND BUSINESS

FOR ASSOCIATION SERVICES, NAMELY, PROMOTING THE INTERESTS OF LAWYERS (U.S. CLS. 100, 101 AND 102).

CLASS 45—PERSONAL AND LEGAL SERVICES

FOR PROVIDING INFORMATION IN THE LEGAL FIELD (U.S. CLS. 100 AND 101).
MATTHEW KLINE, EXAMINING ATTORNEY

SN 77-487,585. PROJECTEZE, INC., CALGARY, ALBERTA, CANADA, FILED 5-30-2008.

PROJECTEZE

THE MARK CONSISTS OF STANDARD CHARACTERS WITHOUT CLAIM TO ANY PARTICULAR FONT, STYLE, SIZE, OR COLOR.

PRIORITY CLAIMED UNDER SEC. 44(D) ON CANADA APPLICATION NO. 1397030, FILED 5-27-2008, REG. NO. TMA746113, DATED 8-25-2009, EXPIRES 8-25-2024.

CLASS 9—ELECTRICAL AND SCIENTIFIC APPARATUS

FOR COMPUTER-BASED PROJECT MANAGEMENT SYSTEMS, PROGRAM MANAGEMENT SYSTEMS AND TIME MANAGEMENT SYSTEMS, NAMELY, KITS COMPRISING COMPUTER APPLICATION SOFTWARE FEATURING TABLES WITHIN WORD PROCESSORS FOR CAPTURING AND ORGANIZING COMMITMENTS AND ACTION ITEMS ON PROJECTS AND PROGRAMS, NAMELY, TASKS TO BE COMPLETED; PRE-RECORDED CDS, DVDS AND AUDIO TAPES FEATURING INFORMATION ON PROJECT MANAGEMENT, PROGRAM MANAGEMENT AND TIME MANAGEMENT (U.S. CLS. 21, 23, 26, 36 AND 38).

CLASS 16—PAPER GOODS AND PRINTED MATTER

FOR PRINTED MATERIALS, NAMELY, INSTRUCTIONAL BOOKS AND WORKBOOKS FOR INSTRUCTING CLIENTS IN THE FIELD OF STRATEGIES FOR EFFICIENT TIME ORGANIZATION AND TASK PLANNING AND MANAGEMENT, NEWSLETTERS IN THE FIELD OF TASK AND TIME PLANNING AND MANAGEMENT, PRINTED PERIODICALS IN THE FIELD OF TASK AND TIME PLANNING AND MANAGEMENT, NOTE CARDS, JOURNALS IN THE FIELD OF TASK AND TIME PLANNING AND MANAGEMENT, POCKET SECRETARIES, CALENDARS, DAY AND DESKTOP PLANNERS FOR STATIONERY USE, PRINTED AWARDS AND CERTIFICATES, AND POSTERS (U.S. CLS. 2, 5, 22, 23, 29, 37, 38 AND 50).

CLASS 35—ADVERTISING AND BUSINESS

FOR TIME MANAGEMENT SERVICES FOR OTHERS, NAMELY, EFFICIENCY EXPERTS FOR ASSISTING OTHERS IN THE EFFICIENT USE OF THEIR TIME IN THE FIELDS OF ENGINEERING, GEOLOGY, GEOPHYSICS, TECHNOLOGY, BUSINESS MANAGEMENT, ADMINISTRATION, LEGAL PRACTICE MANAGEMENT, REAL PROPERTY, EDUCATION, MEDICINE, ACCOUNTANCY, OIL AND GAS, HOUSEHOLD MANAGEMENT, MANUFACTURING, HEALTH CARE, TRANSPORTATION, GOVERNMENT, BANKING, SMALL BUSINESS ADMINISTRATION AND MANAGEMENT, CONSTRUCTION, BUSINESS CONSULTING, LAW ENFORCEMENT, WRITING AND PUBLISHING, SOCIAL SERVICES, PSYCHOLOGY, COMPUTER TECHNOLOGY, COMPUTER SOFTWARE, SOFTWARE ENGINEERING, AND COMPUTER NETWORK MANAGEMENT; BUSINESS MANAGEMENT SERVICES; BUSINESS MANAGEMENT CONSULTANCY AND ADVISORY SERVICES; ASSISTANCE, ADVISORY SERVICES AND CONSULTANCY WITH REGARD TO BUSINESS PLANNING, BUSINESS ANALYSIS, BUSINESS MANAGEMENT, AND BUSINESS ORGANIZATION; PROVIDING BUSINESS MANAGEMENT INFORMATION IN CONNECTION WITH CONSULTING AND ADVISORY SERVICES IN THE FIELD OF STRATEGIC PLANNING (U.S. CLS. 100, 101 AND 102).

CLASS 41—EDUCATION AND ENTERTAINMENT

FOR EDUCATIONAL SERVICES, NAMELY, PROVIDING CLASSES, SEMINARS, AND WORKSHOPS IN THE FIELDS OF PROJECT MANAGEMENT, PROGRAM MANAGEMENT, AND TIME MANAGEMENT (U.S. CLS. 100, 101 AND 107).

CLASS 45—PERSONAL AND LEGAL SERVICES

FOR PROVIDING TASK MANAGEMENT SERVICES, NAMELY, PROVIDING NON-MEDICAL ASSISTANT SERVICES FOR OTHERS IN INITIATING, PLANNING, ORGANIZING, COORDINATING, MONITORING AND COMPLETING DAILY TASKS; PROGRAM MANAGEMENT, NAMELY, PROVIDING NON-MEDICAL ASSISTANT SERVICES FOR OTHERS IN PLANNING, IMPLEMENTING AND OVERSEEING MULTIPLE ONGOING AND INTER-RELATED DAILY TASKS (U.S. CLS. 100 AND 101).

BILL DAWE, EXAMINING ATTORNEY

SN 77-489,642. JAMBA JUICE COMPANY, EMERYVILLE, CA. FILED 6-3-2008.

JAMBA

THE MARK CONSISTS OF STANDARD CHARACTERS WITHOUT CLAIM TO ANY PARTICULAR FONT, STYLE, SIZE, OR COLOR.

OWNER OF U.S. REG. NOS. 3,296,446, 3,367,108 AND OTHERS.

CLASS 9—ELECTRICAL AND SCIENTIFIC APPARATUS

FOR DOWNLOADABLE ELECTRONIC PUBLICATIONS, NAMELY, NEWSLETTERS, MANUALS, AND PAMPHLETS IN THE FIELDS OF ENTERTAINMENT, NEWS, SPORTS, VIDEO GAMING, HEALTH, FOOD AND NUTRITION (U.S. CLS. 21, 23, 26, 36 AND 38).

CLASS 38—COMMUNICATION

FOR STREAMING SERVICES VIA THE INTERNET AND WIRELESS NETWORKS FEATURING MUSIC, MUSIC VIDEOS, TELEVISION PROGRAMMING CLIPS IN THE FIELDS OF ENTERTAINMENT, NEWS, SPORTS, VIDEO GAMING, HEALTH, FOOD AND NUTRITION; STREAMING TRANSMISSION OF LIVE AND ON-DEMAND AUDIO AND VIDEO CONTENT VIA THE INTERNET AND WIRELESS NETWORKS; PROVIDING ON-LINE CHAT-ROOMS AND BULLETIN BOARDS FOR TRANSMISSION OF MESSAGES AMONG USERS IN THE FIELD OF GENERAL INTEREST; TELECOMMUNICATIONS SERVICES, NAMELY, TRANSMISSION OF VOICE, DATA, GRAPHICS, IMAGES, AUDIO AND VIDEO CONTENT VIA THE INTERNET AND WIRELESS NETWORKS (U.S. CLS. 100, 101 AND 104).

CYNTHIA TRIPI, EXAMINING ATTORNEY

SN 77-496,031. BALENCIAGA, PARIS, FRANCE, FILED 6-11-2008.

SN 77-496,347. BAINS ULTRA INC., SAINT-NICOLAS, QUEBEC, CANADA, FILED 6-11-2008.

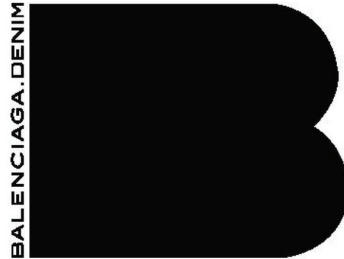

PRIORITY CLAIMED UNDER SEC. 44(D) ON FRANCE APPLICATION NO. 083581092, FILED 6-10-2008, REG. NO. 083581092, DATED 6-10-2008, EXPIRES 6-10-2018.

OWNER OF U.S. REG. NOS. 3,044,207, 3,122,532 AND 3,322,476.

NO CLAIM IS MADE TO THE EXCLUSIVE RIGHT TO USE "DENIM", APART FROM THE MARK AS SHOWN.

THE MARK CONSISTS OF A STYLIZED LETTER "B" WITH THE WORDS "BALENCIAGA.DENIM".

CLASS 25—CLOTHING

FOR MEN'S, WOMEN'S AND CHILDREN'S CLOTHING, NAMELY, CRAVATS, BANDANAS, NECKERCHIEFS, BATHROBES, BATHING SUITS, SCARVES, COLLARS, CORSETS, FUR SHAWLS; FURS, NAMELY, FUR COATS, FUR MITTENS, FUR GLOVES, FUR HEADBANDS; FUR NECKLETS, NAMELY, FUR BOAS; FUR HATS; FUR HEADWEAR, NAMELY, FUR CAPS, FUR COLLARS; HEADBANDS, HEELS, HOODS, INNER SOLES, LAYETTES; BODY HUGGING, NAMELY, BODY SHAPERS, BODY STOCKINGS, BODY SUITS; SHAPEWEAR, NAMELY, GIRDLES; LINEN TOPS, MANTILLAS, TIES, PYJAMAS, BOAS, SHAWLS, SINGLETS, SOCKS, STOCKINGS, SUSPENDERS, TIE UP SHIRTS, PAREOS, UNDERCLOTHES, VEILS, APRONS, BATHING COSTUMES, BERETS, HIP-HUGGING BODICES, BRACES FOR CLOTHING, SUSPENDERS, BRASSIERES, BREECHES, CAMISOLES, CHASUBLES, CHEMISSETTES, SHIRT FRONTS, COATS, COMBINATIONS, DETACHABLE COLLARS, PANTIES, DRESSING GOWNS, GABARDINE TROUSERS, GAITER STRAPS, GAITERS, GIRDLES, JACKETS, JERSEYS, LEGGINGS, OVERALLS, OVERCOATS, PANTS, PARKAS, PETTICOATS, PULLOVERS, SARIS, SHIRTS, SKIRTS, SLIPS, SMOCKS, SUITS, SWEATERS, TEDDIES, T-SHIRTS, TIGHTS, TROUSER STRAPS, TURBANS, UNDERPANTS, UNIFORMS; BELTS FOR CLOTHING; GLOVES; FOOTWEAR; HEADWEAR; CLOTHING FOR GYMNASTICS, NAMELY, ATHLETIC UNIFORMS, HEADBANDS, LEOTARDS, BELTS, BRASSIERES, JACKETS, JERSEYS, JUMPERS; BEACH CLOTHING, NAMELY, SHIRTS AND SHORTS; KNITWEAR, NAMELY, KNIT HATS, KNIT SWEATERS, KNIT UNDERWEAR, AND KNIT SOCKS; THE FOREGOING IN WHOLE OR IN PART OF DENIM (U.S. CLS. 22 AND 39).

CLASS 26—FANCY GOODS

FOR BUTTONS OF METAL FOR PANTS AND JEANS (U.S. CLS. 37, 39, 40, 42 AND 50).
KAPIL BHANOT, EXAMINING ATTORNEY



The quest for your wellness

PRIORITY CLAIMED UNDER SEC. 44(D) ON CANADA APPLICATION NO. 1398202, FILED 6-4-2008, REG. NO. TMA759230, DATED 2-10-2010, EXPIRES 2-10-2025.

OWNER OF U.S. REG. NOS. 2,896,706, 3,018,986 AND OTHERS.

NO CLAIM IS MADE TO THE EXCLUSIVE RIGHT TO USE "BAIN", APART FROM THE MARK AS SHOWN.

THE MARK CONSISTS OF A SPIRAL DESIGN AT LEFT OF "BAIN ULTRA", THE QUEST FOR YOUR WELLNESS BENEATH.

THE ENGLISH TRANSLATION OF "BAIN" IN THE MARK IS BATH.

CLASS 10—MEDICAL APPARATUS

FOR THERAPEUTIC APPARATUS, NAMELY, A CARE UNIT WHICH CAN BE BUILT INTO A SHOWER FOR HEAT THERAPY, SOUND THERAPY, LIGHT THERAPY AND CHROMOTHERAPY (U.S. CLS. 26, 39 AND 44).

CLASS 11—ENVIRONMENTAL CONTROL APPARATUS

FOR THERAPEUTIC BATHTUBS AND SHOWERS (U.S. CLS. 13, 21, 23, 31 AND 34).

CYNTHIA SLOAN, EXAMINING ATTORNEY

SN 77-501,775. L.M. TILMAN & CO., INC., NEW YORK, NY. FILED 6-18-2008.

FINANCIAL DARWINISM

THE MARK CONSISTS OF STANDARD CHARACTERS WITHOUT CLAIM TO ANY PARTICULAR FONT, STYLE, SIZE, OR COLOR.

NO CLAIM IS MADE TO THE EXCLUSIVE RIGHT TO USE "FINANCIAL", APART FROM THE MARK AS SHOWN.

CLASS 35—ADVERTISING AND BUSINESS

FOR PROVIDING A WEB SITE THAT OFFERS INFORMATION ON AND INTERPRETATION OF BUSINESS AND POLITICAL NEWS (U.S. CLS. 100, 101 AND 102).

CLASS 36—INSURANCE AND FINANCIAL

FOR PROVIDING A WEB SITE THAT OFFERS INFORMATION ON AND INTERPRETATION OF FINANCIAL NEWS (U.S. CLS. 100, 101 AND 102).

CLASS 41—EDUCATION AND ENTERTAINMENT

FOR PROVIDING A WEB SITE THAT OFFERS INFORMATION ON AND INTERPRETATION OF WORLD, NATIONAL AND LOCAL CURRENT EVENTS NEWS (U.S. CLS. 100, 101 AND 107).

HOWARD B. LEVINE, EXAMINING ATTORNEY

CLASS 9—ELECTRICAL AND SCIENTIFIC APPARATUS

FOR LIFE SAVING EQUIPMENT, NAMELY, FOLDABLE PRESSURE CONTAINERS FOR DIVERS IN THE NATURE OF HYPERBARIC OXYGEN CHAMBERS FOR NON-MEDICAL PURPOSES, PIT BAGS FOR RESCUE OF PERSONS WHO HAVE FALLEN IN WELLS, NAMELY, INFLATABLE FLOATATION BAGS USED TO ELEVATE INDIVIDUALS FROM WELLS, LIFTING BAGS FOR RESCUE OF PERSONS, NAMELY, INFLATABLE FLOATATION BAGS USED TO RAISE COLLAPSED STRUCTURES, EQUIPMENT, OR AIRCRAFT TO THEREBY PERMIT THE REMOVAL OF PERSONS, FLOATING BAGS, NAMELY, INFLATABLE FLOATING PLATFORMS THAT PROVIDE A FLOATING SURFACE ON WATER FOR DISTRESSED INDIVIDUALS, ESCAPE SLIDE AND JUMPING SHEETS, NAMELY, FLEXIBLE ESCAPE SLIDES AND FLEXIBLE JUMPING SHEETS USED IN CONNECTION WITH AIRCRAFT AND BOATS TO PROVIDE A MEANS FOR ESCAPING THE AIRCRAFT OR BOAT, ESCAPE CHUTES AND RESCUE ISLANDS, NAMELY, FLEXIBLE SHEETS PROVIDING A MEANS TO ESCAPE A STRUCTURE, AIRCRAFT, OR SHIP, AND INFLATABLE FLOATING PLATFORMS THAT PROVIDE A FLOATING SURFACE ON WATER FOR DISTRESSED INDIVIDUALS; FIRE EXTINGUISHERS; SAFETY HELMETS; SAFETY GOGGLES; PROTECTIVE GAS MASKS; POTENTIOMETERS, NAMELY, INSTRUMENTS FOR MEASURING ELECTROMOTIVE FORCE; AUTOMATIC BY-PASS VALVES, GATE PRESSURE RELIEF VALVES, PRESSURE RELIEF VALVES, AUTOMATIC INTERRUPTION VALVES, AUTOMATIC RELIEF VALVES, AND AUTOMATIC SAFETY CHECK AND SAFETY VALVES, ALL FOR CONTROLLING AND MONITORING PRESSURE IN RESCUE AND RECOVERY EQUIPMENT SYSTEMS; AUTOMATIC VALVES FOR USE IN BY-PASS, GATE PRESSURE, PRESSURE REDUCTION, RELIEF, AUTOMATIC SAFETY CHECK; AUTOMATIC SAFETY VALVE FOR FLOW SHUTOFF IN RESCUE AND RECOVERY EQUIPMENT; PLASTIC AUTOMATIC NOZZLES (U.S. CLS. 21, 23, 26, 36 AND 38). FIRST USE 1-15-1972; IN COMMERCE 1-15-1972.

SN 77-507,420. VETTER GMBH, ZUELPICH, FED REP GERMANY, FILED 6-25-2008.

VETTER

THE MARK CONSISTS OF STANDARD CHARACTERS WITHOUT CLAIM TO ANY PARTICULAR FONT, STYLE, SIZE, OR COLOR.

CLASS 7—MACHINERY

FOR MECHANICAL POWER JACKS; PUMPS, NAMELY, COMPRESSED AIR, ROTARY, ACID AND VACUUM PUMPS; LIFTING INSTALLATIONS FOR THE TRANSPORT OF PERSONS AND GOODS, NAMELY, MECHANICAL, PNEUMATIC AND HYDRAULIC LIFTS, AND VIBRATION DAMPERS BEING MACHINE PARTS FOR USE IN CONTROLLING VIBRATIONS OCCURRING IN THE LIFTS DURING OPERATION; LIFTING INSTALLATIONS FOR THE TRANSPORT OF GOODS IN THE NATURE OF PLASTIC INFLATABLE BAGS FOR LIFTING AND CONVEYING SUNKEN EQUIPMENT; LIFTING INSTALLATIONS FOR THE TRANSPORT OF GOODS, NAMELY, INFLATABLE, CYLINDRICAL CUSHIONS USED TO LIFT AND ROLL HEAVY LOADS IN THE NATURE OF AIRCRAFTS AND AUTOMOBILES; AND SHOCK ABSORBANT BAGS USED AS VIBRATION DAMPERS USED IN CONJUNCTION WITH SCIENTIFIC APPARATUS AND MACHINES, NAMELY, A SHOCK ABSORBER FOR SCIENTIFIC MACHINES IN THE NATURE OF SHOCK ABSORBENT VIBRATION DAMPER BAGS; LIQUID AND DUST VACUUM CLEANERS FOR INDUSTRIAL USE (U.S. CLS. 13, 19, 21, 23, 31, 34 AND 35). FIRST USE 1-15-1972; IN COMMERCE 1-15-1972.

CLASS 17—RUBBER GOODS

FOR MOLDABLE COMPOUNDS FOR USE IN PACKAGING AND JOINTING; NON-METALLIC HOSES AND PIPES; SEMI-FINISHED PLASTIC CASINGS, NAMELY, PROTECTIVE INSULATION COVERS FOR INDUSTRIAL MACHINERY IN THE NATURE OF PUMPS, WINCHES, MEASURING APPARATUS, SCALES, TARIFF INDICATORS, LIQUID AND DUST EXHAUSTERS; NONMETALLIC HOSES AND PIPES; NON-METAL INTERIOR LININGS FOR CONTAINERS IN THE NATURE OF ADHESIVE SEALANTS; LEAK SEALING PATCHES IN THE NATURE OF POLYMER-BASED PATCHING COMPOUNDS FOR MASONRY AND WOOD; INFLATABLE NON-METAL SEALS FOR USE IN SEALING OR REPAIRING LEAKS IN PIPES, HOSES, AND CONTAINERS; FLOATING ANTIPOLLUTION BARRIERS (U.S. CLS. 1, 5, 12, 13, 35 AND 50). FIRST USE 1-15-1972; IN COMMERCE 1-15-1972.

Laura Hammel, Examining Attorney

SN 77-508,094. WOOD WYANT CANADA INC., MONTREAL, CANADA, FILED 6-25-2008.

ENVIROLOGIC

THE MARK CONSISTS OF STANDARD CHARACTERS WITHOUT CLAIM TO ANY PARTICULAR FONT, STYLE, SIZE, OR COLOR.

PRIORITY CLAIMED UNDER SEC. 44(D) ON CANADA APPLICATION NO. 650894(2), FILED 1-21-2008, REG. NO. TMA379,007, DATED 3-9-2010, EXPIRES 3-9-2025. OWNER OF U.S. REG. NO. 1,673,419.

CLASS 3—COSMETICS AND CLEANING PREPARATIONS

FOR DISPOSABLE WIPES IMPREGNATED WITH CLEANING CHEMICALS OR COMPOUNDS FOR INDUSTRIAL USE; CLEANING AND DEGREASING PREPARATIONS FOR ALL TYPES OF SURFACES FOR INDUSTRIAL AND INSTITUTIONAL USE AND FOR USE IN FOOD PLANT AREAS; HAND CLEANERS; NON-MEDICATED SKIN CARE PREPARATIONS, NAMELY, CLEANERS; WIPING PRODUCTS, NAMELY, DISPOSABLE WIPES IMPREGNATED WITH CLEANSING COMPOUNDS FOR USE ON HANDS AND FACE; BIOTECHNOLOGICAL CLEANING SOLUTION FOR ELIMINATING ODORS, BREAKING DOWN ORGANICS, AND REMOVING STAINS (U.S. CLS. 1, 4, 6, 50, 51 AND 52).

CLASS 5—PHARMACEUTICALS

FOR DISINFECTANT BATHROOM CLEANERS; HAND-SANITIZING PREPARATIONS; HOUSEHOLD DEODORIZER (U.S. CLS. 6, 18, 44, 46, 51 AND 52).

CLASS 16—PAPER GOODS AND PRINTED MATTER

FOR PAPER PRODUCTS, NAMELY, HAND TOWELS AND PAPER TOWELS FOR KITCHEN USE (U.S. CLS. 2, 5, 22, 23, 29, 37, 38 AND 50).

NELSON SNYDER, EXAMINING ATTORNEY

SN 77-512,798. HARD ROCK CAFE INTERNATIONAL (USA), INC., ORLANDO, FL. FILED 7-1-2008.

ALL IS ONE

THE MARK CONSISTS OF STANDARD CHARACTERS WITHOUT CLAIM TO ANY PARTICULAR FONT, STYLE, SIZE, OR COLOR.

CLASS 14—JEWELRY

FOR JEWELRY, NAMELY, ORNAMENTAL PINS AND BUTTONS, WATCHES, NECKLACES, BRACELETS, AND EARRINGS (U.S. CLS. 2, 27, 28 AND 50).
FIRST USE 0-0-1994; IN COMMERCE 0-0-1994.

CLASS 25—CLOTHING

FOR CLOTHING, NAMELY, T-SHIRTS, SWEAT-SHIRTS, POLO SHIRTS, SPORT SHIRTS, JACKETS, HATS, CAPS, BELTS (U.S. CLS. 22 AND 39).
FIRST USE 0-0-1994; IN COMMERCE 0-0-1994.
EUGENIA MARTIN, EXAMINING ATTORNEY

SN 77-514,399. CASA SANTIVERI, S.L., 08038 BARCELONA, SPAIN, FILED 7-3-2008.



THE MARK CONSISTS OF THE LITERAL ELEMENT "SANTIVERI" IN A STYLIZED FONT OVER THE TOP OF A SHADED RECTANGLE CARRIER, ABOVE A HORIZONTAL LINE.

CLASS 5—PHARMACEUTICALS

FOR TABLETS AND PREPARATIONS, NAMELY, ANALGESIC PREPARATIONS, CALCIUM SUPPLEMENTS IN TABLETS, COUGH TREATMENT PREPARATIONS, DIURETIC PREPARATIONS; MEAL REPLACEMENT AND DIETARY SUPPLEMENTS, NAMELY, DRINK MIXES, BARS, POWDERS AND SHAKES; MENSTRUAL SYMPTOM TREATMENT PREPARATIONS, MIXED VITAMIN PREPARATIONS, VITAMIN TABLETS, MINERAL TABLETS, PROPOLIS FOR MEDICINAL PURPOSES; GLUTEN FREE FOOD PRODUCTS FOR CELIACS, NAMELY, CORN FLOURS, CORN BASED PASTAS AND CORN PREPARATION FOR BREAD; FOODS FOR WEIGHT CONTROL, NAMELY, DIETARY FIBERS; GLUCOMANANA, CHITOSAN, ALGA FUCUS, HERB TEAS FOR MEDICAL PURPOSES; FOOD FOR SPORTSMEN NAMELY, SOY PROTEIN WITH VITAMINS A, B1, B2, B3, B12, B5, B6, B9 - FOLIC ACID - C, K, AND E AND AMINOACIDS, NAMELY, ISOLEUCINA, LEUCINA, VALINA, FENILALANINA, METIONINA, TREONINA, LISINA, ARGININA, HISTIDINA; FOOD FOR DIET SUPPLEMENT PURPOSES NAMELY, WHEATGERM, SOY LECITHIN, CAPSULES OF GARLIC, ONION, ARTICHOKE AND OTHER VEGETABLES, PREBIOTICS, ALFALFA TABLETS, BRAN, PAPAYA, PROPOLIS, BORAJE, PRIMROSE, SOY, MACA, POLLEN, BEER YEAST, TEA AND INFUSIONS FOR DIETETIC PURPOSES, MEDICINAL PLANTS, HERBAL TEAS FOR MEDICAL PURPOSES, DIETETIC SNACK BARS, GINSENG, GUARANA, ALOE VERA; PLANT AND PLANT INFUSIONS FOR MEDICINAL PURPOSES, NAMELY, CAMOMILLE, GREEN TEA, RED TEA, WHITE TEA, MINT, FENNEL, ANISEED, HORSE TAIL, ROOIBOS TEA, TILE, FRUITS TEA ALGAE FOR MEDICINAL PURPOSES, NAMELY, FUCUS, SPIRULINA, CHLORELLA, KELP, PLANT EXTRACTS FOR MEDICAL USE NAMELY, VALERIANA, EUCALYPHTHUS, LION'S TOOTH, ECHINACEA, FUCUS, PASIFLORA, GREEN ANISSETTE, HORSE TAIL, SATIVA OAT, ARTICHOKE, GINGKO BILOBA, JAMS FOR DIABETICS, GLUTEN FREE BISCUITS, GLUTEN FREE BREAD, GLUTEN FREE PASTA, GLUTEN FREE TOASTS TO ACCOMMODATE SPECIAL MEDICAL AND HEALTH CONDITIONS (U.S. CLS. 6, 18, 44, 46, 51 AND 52).

CLASS 29—MEATS AND PROCESSED FOODS

FOR JAMS, JELLIES, MARMALADES AND COMPOTES; PROCESSED QUINCE JELLY, PROCESSED PEACH JELLY (U.S. CL. 46).

CLASS 30—STAPLE FOODS

FOR SUGAR, TEA, COCOA, RICE, CORN CAKES, CEREAL CAKES, FLOURS AND PREPARATIONS MADE FROM CEREAL, BREAD, PASTRY, TREACLE, YEAST, SALT, APPLE AND CIDER VINEGAR, KETCHUP, SAUCES, PASTA, POLENTA, OAT AND WHEAT BRAN, BROWN SUGAR, ROYAL JELLY FOR FOOD PURPOSES; INSTANT MALT FOR USE AS A CEREAL COFFEE SUBSTITUTE (U.S. CL. 46).

CLASS 32—LIGHT BEVERAGES

FOR FRUIT JUICES, NAMELY, ORANGE, GRAPEFRUIT, APPLE JUICE, CARROT JUICE, MIXED FRUITS JUICE, PLUM JUICE, SYRUPS AND CONCENTRATED DRINK, NAMELY, CRANBERRIES, PAPAYA, ALOE VERA, APPLE MUST, GRAPE MUST (U.S. CLS. 45, 46 AND 48).

THOMAS MANOR, EXAMINING ATTORNEY

SN 77-515,610. GOLDEN YACHTS LTD., MAJURO, MARSHALL ISLANDS, FILED 7-7-2008.

GOLDEN YACHTS

THE MARK CONSISTS OF STANDARD CHARACTERS WITHOUT CLAIM TO ANY PARTICULAR FONT, STYLE, SIZE, OR COLOR.

OWNER OF ERPN CMNTY TM OFC REG. NO. 006989974, DATED 6-3-2009, EXPIRES 6-3-2019.

NO CLAIM IS MADE TO THE EXCLUSIVE RIGHT TO USE "YACHTS", APART FROM THE MARK AS SHOWN.

CLASS 35—ADVERTISING AND BUSINESS

FOR SHIP MANAGEMENT SERVICES IN THE NATURE OF BUSINESS MANAGEMENT FOR OTHERS IN THE FIELDS OF LEASING OF SHIPS, REFUELING OF SHIPS, SHIP LOADING, PILOTING OF SHIPS, SHIPBORNE STORAGE, UNLOADING AND REFLOATING OF SHIPS, RENTAL OF BERTHS FOR SHIPS, SHIP RENTAL, SALVAGE OF SHIPS, SALVAGE OF SHIPS' CARGO, TOWAGE OF SHIPS; SHIP MANAGEMENT SERVICES IN THE NATURE OF BUSINESS MANAGEMENT FOR OTHERS IN THE FIELDS OF MOTOR YACHTS, SAILING YACHTS AND SMALL SHIPS (U.S. CLS. 100, 101 AND 102).

CLASS 39—TRANSPORTATION AND STORAGE

FOR SHIP MANAGEMENT SERVICES IN THE NATURE OF CHARTERING OF MOTOR YACHTS, SAILING YACHTS AND SMALL SHIPS; TRANSPORTATION OF PASSENGERS BY SHIP (U.S. CLS. 100 AND 105).

DAWN HAN, EXAMINING ATTORNEY

SN 77-530,230. PROWELL TECHNOLOGIES LTD., D.N ARAVA, ISRAEL, FILED 7-24-2008.

AIRSHOCK

THE MARK CONSISTS OF STANDARD CHARACTERS WITHOUT CLAIM TO ANY PARTICULAR FONT, STYLE, SIZE, OR COLOR.

PRIORITY CLAIMED UNDER SEC. 44(D) ON ISRAEL APPLICATION NO. 210770, FILED 4-27-2008.

PRIORITY CLAIMED UNDER SEC. 44(D) ON ISRAEL APPLICATION NO. 210771, FILED 4-27-2008.

CLASS 7—MACHINERY

FOR MACHINES AND MACHINE TOOLS FOR REPAIR, REHABILITATION, RESTORATION, STIMULATION, REFURBISHMENT, AND CLEANING OF WATER, OIL, AND GAS WELLS; MACHINES AND MACHINE TOOLS FOR FRACTURING AND CEMENTATION OF OIL, GAS, AND WATER WELLS; MACHINES AND MACHINE TOOLS FOR CLEANING OF INDUSTRIAL FACILITIES, PIPELINES, AND SILOS; MACHINES AND MACHINE TOOLS FOR SOLIDS FLOW STIMULATION IN SILOS AND OTHER INDUSTRIAL FACILITIES (U.S. CLS. 13, 19, 21, 23, 31, 34 AND 35).

CLASS 37—CONSTRUCTION AND REPAIR

FOR REPAIR, REHABILITATION, RESTORATION, STIMULATION, REFURBISHMENT, AND CLEANING OF WATER, OIL, AND GAS WELLS; CEMENTATION OF OIL, GAS, AND WATER WELLS; CLEANING OF INDUSTRIAL FACILITIES, PIPELINES, AND SILOS; SOLIDS FLOW STIMULATION IN SILOS AND OTHER INDUSTRIAL FACILITIES (U.S. CLS. 100, 103 AND 106).

SHAUNIA CARLYLE, EXAMINING ATTORNEY

SN 77-534,633. NAPIER, JEFF, KATY, TX. FILED 7-30-2008.

CHESTERFIELD

THE MARK CONSISTS OF STANDARD CHARACTERS WITHOUT CLAIM TO ANY PARTICULAR FONT, STYLE, SIZE, OR COLOR.

CLASS 8—HAND TOOLS

FOR CAN OPENERS, SCISSORS, NON-ELECTRIC VEGETABLE PEELERS, NAIL CLIPPERS, TABLEWARE, NAMELY, KNIVES, FORKS AND SPOONS (U.S. CLS. 23, 28 AND 44).

FIRST USE 12-0-2006; IN COMMERCE 12-0-2006.

CLASS 9—ELECTRICAL AND SCIENTIFIC APPARATUS

FOR MEASURING CUPS AND SPOONS, TAPE MEASURES, CALCULATORS (U.S. CLS. 21, 23, 26, 36 AND 38).

FIRST USE 12-0-2006; IN COMMERCE 12-0-2006.

CLASS 16—PAPER GOODS AND PRINTED MATTER

FOR STICKERS; PAPER WINE GIFT BAGS; TEXTILE WINE GIFT BAGS (U.S. CLS. 2, 5, 22, 23, 29, 37, 38 AND 50).

FIRST USE 12-0-2006; IN COMMERCE 12-0-2006.

CLASS 18—LEATHER GOODS

FOR UMBRELLAS; BAGS FOR CARRYING BABIES' ACCESSORIES (U.S. CLS. 1, 2, 3, 22 AND 41).

FIRST USE 12-0-2006; IN COMMERCE 12-0-2006.

CLASS 20—FURNITURE AND ARTICLES NOT OTHERWISE CLASSIFIED

FOR SLEEPING BAGS, DRINKING STRAWS (U.S. CLS. 2, 13, 22, 25, 32 AND 50).

FIRST USE 12-0-2006; IN COMMERCE 12-0-2006.

CLASS 21—HOUSEWARES AND GLASS

FOR COOKWARE, NAMELY, POTS AND PANS, COOKING SKEWERS, CAKE AND PIE SERVERS, SCOOPS, ICE CREAM SCOOPS, DOG FOOD SCOOPS, SLOTTED SPOONS, BRUSHES FOR BASTING MEAT, WINE BOTTLE CRADLES, CLOTHES PINS, CHEESE GRATERS, COFFEE STIRRERS, CONDIMENT DISPENSERS, FLY SWATTERS, PLASTIC GROCERY BAG DISPENSERS IN THE NATURE OF STATIONARY DISPENSERS FOR DISPENSING PLASTIC GROCERY STORE BAGS FOR REUSE AS WASTE CONTAINERS, HAIR BRUSHES, NON-WOVEN DISPOSABLE TEXTILE WIPES NOT IMPREGNATED WITH CHEMICALS OR COMPOUNDS FOR LCD CLEANING, PLASTIC ICE POP FORMS FOR FROZEN TREATS, UTENSILS FOR BARBECUES, NAMELY, FORKS, TONGS, TURNERS, HIP FLASKS, CAMPING GRILLS (U.S. CLS. 2, 13, 23, 29, 30, 33, 40 AND 50).

FIRST USE 12-0-2006; IN COMMERCE 12-0-2006.
MARCIE MILONE, EXAMINING ATTORNEY

SN 77-537,171. PREMIER FARNELL PLC, LEEDS, WEST YORKSHIRE, UNITED KINGDOM, FILED 8-1-2008.



SN 77-537,162. PREMIER FARNELL PLC, LEEDS, WEST YORKSHIRE, UNITED KINGDOM, FILED 8-1-2008.



THE COLOR(S) YELLOW, GREEN, RED, FUCHSIA, ORANGE, PINK, PURPLE, BLUE AND WHITE IS/ARE CLAIMED AS A FEATURE OF THE MARK.

THE MARK CONSISTS OF AN OBTUSE ABSTRACT DESIGN CONSISTING OF COLORED RINGS IN YELLOW, GREEN, RED, FUCHSIA, ORANGE, PINK, PURPLE AND BLUE; WITH A WHITE CENTER.

THE COLOR(S) YELLOW, GREEN, RED, FUCHSIA, ORANGE, PINK, PURPLE, BLUE AND WHITE IS/ARE CLAIMED AS A FEATURE OF THE MARK.

THE MARK CONSISTS OF AN OBTUSE ABSTRACT DESIGN CONSISTING OF COLORED RINGS IN YELLOW, GREEN, RED, FUCHSIA, ORANGE, PINK, PURPLE AND BLUE; WITH A WHITE CENTER.

CLASS 35—ADVERTISING AND BUSINESS

FOR ORGANISATION OF BUSINESS COMPETITIONS; ARRANGING OF COMPETITIONS FOR BUSINESS, COMMERCIAL AND TRADE PURPOSES; ORGANISATION AND MANAGEMENT OF COMPETITIONS IN THE FIELD OF BUSINESS, COMMERCE AND TRADE; BUSINESS MANAGEMENT SERVICES, NAMELY, ADMINISTRATION OF COMPETITIONS FOR BUSINESS, COMMERCE AND TRADE; ARRANGING AND CONDUCTING INCENTIVE REWARD PROGRAMMES TO PROMOTE THE SALE OF ELECTRONIC COMPONENTS AND APPARATUS; PROVIDING INFORMATION AND ADVISORY SERVICES RELATING TO ALL THE AFORESAID SERVICES (U.S. CLS. 100, 101 AND 102).

CLASS 41—EDUCATION AND ENTERTAINMENT

FOR ORGANIZATION OF GAMES; ORGANIZATION OF COMPETITIONS ONLINE FOR EDUCATION OR ENTERTAINMENT IN THE NATURE OF ELECTRONIC GAMES OF SKILL AND CHANCE; EDUCATIONAL AND TRAINING SERVICES, NAMELY, CONDUCTING ONLINE CLASSES, SEMINARS, CONFERENCES AND WORKSHOPS IN THE FIELD OF ELECTRONICS; INFORMATION AND ADVISORY SERVICES RELATING TO THE AFORESAID SERVICES (U.S. CLS. 100, 101 AND 107).

NAKWAMA ANKRAH, EXAMINING ATTORNEY

CLASS 35—ADVERTISING AND BUSINESS

FOR ORGANISATION OF BUSINESS COMPETITIONS; ARRANGING OF COMPETITIONS FOR BUSINESS, COMMERCIAL AND TRADE PURPOSES; ORGANISATION AND MANAGEMENT OF COMPETITIONS IN THE FIELD OF BUSINESS, COMMERCE AND TRADE; BUSINESS MANAGEMENT SERVICES, NAMELY, ADMINISTRATION OF COMPETITIONS FOR BUSINESS, COMMERCE AND TRADE; ARRANGING AND CONDUCTING INCENTIVE REWARD PROGRAMMES TO PROMOTE THE SALE OF ELECTRONIC COMPONENTS AND APPARATUS; PROVIDING INFORMATION AND ADVISORY SERVICES RELATING TO ALL THE AFORESAID SERVICES (U.S. CLS. 100, 101 AND 102).

CLASS 41—EDUCATION AND ENTERTAINMENT

FOR ORGANIZATION OF GAMES; ORGANIZATION OF COMPETITIONS ONLINE FOR EDUCATION OR ENTERTAINMENT IN THE NATURE OF ELECTRONIC GAMES OF SKILL AND CHANCE; EDUCATIONAL AND TRAINING SERVICES, NAMELY, CONDUCTING ONLINE CLASSES, SEMINARS, CONFERENCES AND WORKSHOPS IN THE FIELD OF ELECTRONICS; INFORMATION AND ADVISORY SERVICES RELATING TO THE AFORESAID SERVICES (U.S. CLS. 100, 101 AND 107).

NAKWAMA ANKRAH, EXAMINING ATTORNEY

SN 77-537,178. PREMIER FARNELL PLC, LEEDS, WEST YORKSHIRE, UNITED KINGDOM, FILED 8-1-2008.



THE COLOR(S) YELLOW, GREEN, RED, FUCHSIA, ORANGE, PINK, PURPLE, BLUE AND WHITE IS/ARE CLAIMED AS A FEATURE OF THE MARK.

THE MARK CONSISTS OF AN OBTUSE ABSTRACT DESIGN CONSISTING OF COLORED RINGS IN YELLOW, GREEN, RED, FUCHSIA, ORANGE, PINK, PURPLE AND BLUE; WITH A WHITE CENTER.

CLASS 35—ADVERTISING AND BUSINESS

FOR ORGANISATION OF BUSINESS COMPETITIONS; ARRANGING OF COMPETITIONS FOR BUSINESS, COMMERCIAL AND TRADE PURPOSES; ORGANISATION AND MANAGEMENT OF COMPETITIONS IN THE FIELD OF BUSINESS, COMMERCE AND TRADE; BUSINESS MANAGEMENT SERVICES, NAMELY, ADMINISTRATION OF COMPETITIONS FOR BUSINESS, COMMERCE AND TRADE; ARRANGING AND CONDUCTING INCENTIVE REWARD PROGRAMMES TO PROMOTE THE SALE OF ELECTRONIC COMPONENTS AND APPARATUS; PROVIDING INFORMATION AND ADVISORY SERVICES RELATING TO ALL THE AFORESAID SERVICES (U.S. CLS. 100, 101 AND 102).

CLASS 41—EDUCATION AND ENTERTAINMENT

FOR ORGANIZATION OF GAMES; ORGANIZATION OF COMPETITIONS ONLINE FOR EDUCATION OR ENTERTAINMENT IN THE NATURE OF ELECTRONIC GAMES OF SKILL AND CHANCE; EDUCATIONAL AND TRAINING SERVICES, NAMELY, CONDUCTING ONLINE CLASSES, SEMINARS, CONFERENCES AND WORKSHOPS IN THE FIELD OF ELECTRONICS; INFORMATION AND ADVISORY SERVICES RELATING TO THE AFORESAID SERVICES (U.S. CLS. 100, 101 AND 107).

NAAKWAMA ANKRAH, EXAMINING ATTORNEY

SN 77-538,662. KABUSHIKI KAISHA BANDAI NAMCO GAMES, DBA NAMCO BANDAI GAMES INC., TOKYO, JAPAN, FILED 8-4-2008.

NIRIN

THE MARK CONSISTS OF STANDARD CHARACTERS WITHOUT CLAIM TO ANY PARTICULAR FONT, STYLE, SIZE, OR COLOR.

OWNER OF JAPAN REG. NO. 5211103, DATED 3-6-2009, EXPIRES 3-6-2019.

THE ENGLISH TRANSLATION OF "NIRIN" IN THE MARK IS "TWO WHEELS".

CLASS 9—ELECTRICAL AND SCIENTIFIC APPARATUS

FOR VIDEO GAME MACHINES FOR USE WITH VIDEO MONITORS FOR COMMERCIAL USE IN AMUSEMENT PARKS AND AMUSEMENT CENTERS; VIDEO GAME MACHINE CABINETS FOR USE WITH VIDEO MONITORS FOR COMMERCIAL USE; ELECTRONIC CIRCUITS AND OTHER MEMORY MEDIA ENCODED WITH COMPUTER OPERATING SYSTEM PROGRAMS FOR VIDEO GAME MACHINES FOR USE WITH VIDEO MONITORS, ALL FOR COMMERCIAL USE; PARTS AND ACCESSORIES FOR VIDEO GAME MACHINES FOR USE WITH VIDEO MONITORS FOR COMMERCIAL USE, NAMELY, CONTROL PANELS, BUTTONS AND SEATS IN THE SHAPE OF MOTORCYCLE SEATS; DOWNLOADABLE VIDEO GAME PROGRAMS FOR VIDEO GAME MACHINES FOR USE WITH VIDEO MONITORS AND ASSOCIATED DATA FOR COMMERCIAL USE IN AMUSEMENT PARKS AND AMUSEMENT CENTERS; DOWNLOADABLE COMPUTER PROGRAMS ALL FOR MOBILE PHONES, NAMELY, VIDEO GAME PROGRAMS; VIDEO GAME COMPUTER PROGRAMS RECORDED ON ELECTRONIC CIRCUITS, MAGNETIC TAPES, MAGNETIC CARDS, MAGNETIC DISKS AND OPTICAL DISKS FOR USE WITH ELECTRONIC DEVICES; MOUSE PADS, COVERS FOR KEYBOARDS AND COMPUTER PERIPHERALS; DOWNLOADABLE COMPUTER GAME PROGRAMS; ELECTRICAL COMMUNICATION APPARATUS PARTS AND ACCESSORIES THEREFOR, NAMELY, MOBILE PHONES AND MOBILE PHONE STRAPS; VIDEO GAME MACHINES FOR USE WITH TELEVISION RECEIVERS FOR DOMESTIC USE; VIDEO GAME PROGRAMS ON READ-ONLY ELECTRONIC CIRCUIT CARTRIDGES, MAGNETIC TAPES, MAGNETIC CARDS, MAGNETIC DISKS, OPTICAL DISKS OR OTHER MEMORY MEDIA, ALL FOR DOMESTIC USE; DOWNLOADABLE VIDEO GAME PROGRAMS AND ASSOCIATED DATA FOR DOMESTIC USE; ELECTRONIC CIRCUITS, CD-ROMS OR OTHER MEMORY MEDIA, ALL FEATURING RECORDED COMPUTER PROGRAMS FOR HAND-HELD GAMES WITH LIQUID CRYSTAL DISPLAYS; DOWNLOADABLE COMPUTER PROGRAMS AND ASSOCIATED DATA FOR HAND-HELD GAMES WITH LIQUID CRYSTAL DISPLAYS; RECORDED AUDIO MEDIA, NAMELY, COMPACT DISCS FEATURING MUSIC AND VIDEO GAME SOUND EFFECTS; ELECTRONIC CIRCUITS, CD-ROMS AND OTHER MEMORY MEDIA FEATURING AUTOMATED PERFORMANCE PROGRAMS FOR ELECTRONIC MUSICAL INSTRUMENTS; DOWNLOADABLE MUSIC AND SOUND FILES VIA MOBILE COMMUNICATION NETWORKS AND INTERNET; EXPOSED CINEMATOGRAPHIC FILMS; EXPOSED SLIDE FILMS; SLIDE FILM MOUNTS; DOWNLOADABLE IMAGE FILES PRESENTED VIA MOBILE COMMUNICATION NETWORKS AND INTERNET; PRE-RECORDED VIDEO DISCS AND VIDEO TAPES FEATURING COMPUTER GAMES; ELECTRONIC PUBLICATIONS, NAMELY, BOOKS OR MAGAZINES FEATURING COMPUTER GAMES; DOWNLOADABLE ELECTRONIC PUBLICATIONS, NAMELY, BOOKS OR MAGAZINES FEATURING COMPUTER GAMES; VENDING MACHINES; COIN CHANGERS FOR EXCHANGING COINS FOR TOKENS; ROBOTS FOR PERSONAL OR HOBBY USE; GAMING MACHINES, NAMELY, SLOT MACHINES AND VIDEO LOTTERY TERMINALS (U.S. CLS. 21, 23, 26, 36 AND 38).

CLASS 28—TOYS AND SPORTING GOODS

FOR STAND ALONE GAME MACHINES FOR COMMERCIAL USE; STAND ALONE GAME MACHINE CABINETS FOR COMMERCIAL USE; STAND ALONE GAME MACHINE PARTS AND PERIPHERALS FOR COMMERCIAL USE, NAMELY, CONTROL PANELS, BUTTONS AND SEATS IN THE SHAPE OF MOTORCYCLE SEATS; TOY ROBOTS; BILLIARD EQUIPMENT; JAPANESE GO GAMES; JAPANESE UTAKARUTA CARD GAMES; JAPANESE SHOGI CHESS GAMES; DICE; JAPANESE SUGOROKU BOARD GAMES; DICE GAME CUPS; CHINESE CHECKERS BOARD GAMES; CHESS GAMES; CHECKER GAMES; MAGIC TRICKS; DOMINOES; JAPANESE KARUTA CARD GAMES; PLAYING CARDS; JAPANESE HANAFUDA CARD

GAMES; PLAYING CARDS AND CARD GAMES; MAH-JONG GAMES; EQUIPMENT SOLD AS A UNIT FOR PLAYING BOARD GAMES; TOYS, NAMELY, HAND-HELD GAMES WITH LIQUID CRYSTAL DISPLAYS; ACCESSORIES AND PARTS SOLD AS A UNIT OR SPECIALLY ADAPTED FOR HAND-HELD GAMES WITH LIQUID CRYSTAL DISPLAYS, NAMELY, STYLUS-TYPE DEVICE FOR USE IN CONJUNCTION WITH HAND-HELD GAMES WITH TOUCH SCREENS, ELECTRICAL ADAPTERS, BATTERY PACKS, REMOTE CONTROLS, CONNECTION CABLES, LCD PANEL PROTECTIVE SEALS, AND MEMORY CARDS (U.S. CLS. 22, 23, 38 AND 50).

HOWARD SMIGA, EXAMINING ATTORNEY

SN 77-545,094. DOCTORS OF THE WORLD - U.S.A., INC., NEW YORK, NY. FILED 8-12-2008.

HEALTHRIGHT

THE MARK CONSISTS OF STANDARD CHARACTERS WITHOUT CLAIM TO ANY PARTICULAR FONT, STYLE, SIZE, OR COLOR.

CLASS 35—ADVERTISING AND BUSINESS

FOR PROMOTING PUBLIC AWARENESS OF THE NEEDS OF AT-RISK POPULATIONS; PUBLIC ADVOCACY TO PROMOTE AWARENESS OF THE HEALTH NEEDS OF UNDERSERVED COMMUNITIES (U.S. CLS. 100, 101 AND 102).

CLASS 36—INSURANCE AND FINANCIAL

FOR CHARITABLE FUNDRAISING SERVICES FOR INTERNATIONAL DEVELOPMENT PROJECTS; CHARITABLE FUNDRAISING SERVICES FOR THE PURPOSE OF PROVIDING ASSISTANCE TO GOVERNMENTS AND LOCAL COMMUNITIES IN BUILDING SUSTAINABLE HEALTH CARE DELIVERY SYSTEMS (U.S. CLS. 100, 101 AND 102).

CLASS 43—HOTEL AND RESTAURANT SERVICES

FOR SOCIAL SERVICES FOR UNDERSERVED COMMUNITIES, NAMELY, CREATING AND SUPPORTING CHARITABLE HOUSING AND SHELTER, NAMELY, PROVIDING TEMPORARY SHELTER AND TEMPORARY HOUSING ACCOMMODATIONS (U.S. CLS. 100 AND 101).

CLASS 44—MEDICAL, BEAUTY AND AGRICULTURAL SERVICES

FOR HUMANITARIAN RELIEF SERVICES, NAMELY, PROVIDING CHARITABLE HEALTHCARE-RELATED SERVICES TO UNDERSERVED COMMUNITIES, NAMELY, PROVIDING MEDICAL EQUIPMENT AND SERVICES TO UNDERSERVED COMMUNITIES; HEALTH CONSULTING SERVICES IN THE FIELD OF INFECTIOUS DISEASE CONTROL AND OTHER PUBLIC HEALTH ISSUES; PROVIDING HEALTHCARE SERVICES FOR VULNERABLE AND AT-RISK POPULATIONS THAT INCLUDE WOMEN AND YOUTH; SOCIAL SERVICES FOR UNDERSERVED COMMUNITIES, NAMELY, PROVIDING HEALTH INFORMATION ACROSS COMMUNITIES (U.S. CLS. 100 AND 101).

CLASS 45—PERSONAL AND LEGAL SERVICES

FOR SOCIAL SERVICES FOR UNDERSERVED COMMUNITIES, NAMELY, CHARITABLE SERVICES IN THE NATURE OF PROVIDING CLOTHING AND SHOES TO NEEDY PERSONS AND AT-RISK POPULATIONS (U.S. CLS. 100 AND 101).

MARLENE BELL, EXAMINING ATTORNEY

SN 77-559,524. SOCIETE FRANCAISE D'ASSAINISSEMENT-SFA, 75002 PARIS, FRANCE, FILED 8-30-2008.

SANIFLO

THE MARK CONSISTS OF STANDARD CHARACTERS WITHOUT CLAIM TO ANY PARTICULAR FONT, STYLE, SIZE, OR COLOR.

CLASS 35—ADVERTISING AND BUSINESS

FOR WHOLESALE AND RETAIL STORE SERVICES FEATURING MACERATORS, GRAY WATER PUMPS AND SANITARY INSTALLATIONS (U.S. CLS. 100, 101 AND 102).

CLASS 37—CONSTRUCTION AND REPAIR

FOR INSTALLATION AND MAINTENANCE SERVICES FOR MACERATORS, GRAY WATER PUMPS AND SANITARY INSTALLATIONS (U.S. CLS. 100, 103 AND 106).

CHRISTINE BLOMQUIST, EXAMINING ATTORNEY

SN 77-562,778. MANUFACTURE ALMO-DANTE (CANADA) LTEE/ALMO-DANTE MFG. (CANADA) LTD., MONTREAL, QUEBEC, CANADA, FILED 9-4-2008.

MAGIC CREATIONS

THE MARK CONSISTS OF STANDARD CHARACTERS WITHOUT CLAIM TO ANY PARTICULAR FONT, STYLE, SIZE, OR COLOR.

PRIORITY CLAIMED UNDER SEC. 44(D) ON CANADA APPLICATION NO. 1405204, FILED 7-29-2008, REG. NO. TMA750554, DATED 10-20-2009, EXPIRES 10-20-2024.

CLASS 21—HOUSEWARES AND GLASS

FOR (BASED ON USE IN COMMERCE AND BASED ON 44(E)) CERAMIC MUGS; (BASED ON 44(E)) CERAMIC PLATES, CERAMIC PIGGY-BANKS, CERAMIC DOGS, CERAMIC CATS, CERAMIC HORSES, CERAMIC BIRDS, DECORATIVE CERAMIC TILES NOT FOR USE AS BUILDING MATERIALS, DECORATIVE CERAMIC NAME-PLATES AND SIGNS, AND CERAMIC FIGURINES (U.S. CLS. 2, 13, 23, 29, 30, 33, 40 AND 50).

FIRST USE 0-0-2004; IN COMMERCE 0-0-2004.

CLASS 28—TOYS AND SPORTING GOODS

FOR (BASED ON 44(E)) CERAMIC CHRISTMAS TREE ORNAMENTS (U.S. CLS. 22, 23, 38 AND 50).

MARIA-VICTORIA SUAREZ, EXAMINING ATTORNEY

SN 77-564,713. TDB SOLUTIONS LIMITED, WARGRAVE, BERKSHIRE, ENGLAND, FILED 9-8-2008.

FEDEROS

THE MARK CONSISTS OF STANDARD CHARACTERS WITHOUT CLAIM TO ANY PARTICULAR FONT, STYLE, SIZE, OR COLOR.

PRIORITY CLAIMED UNDER SEC. 44(D) ON ERPNTY TM OFC APPLICATION NO. 006854723, FILED 4-22-2008, REG. NO. 006854723, DATED 1-21-2009, EXPIRES 4-22-2018.

CLASS 9—ELECTRICAL AND SCIENTIFIC APPARATUS

FOR COMPUTER SOFTWARE AND COMPUTER PROGRAMS FOR THE MANAGEMENT OF INFORMATION TECHNOLOGY AND BUSINESS SYSTEMS; COMPUTER SOFTWARE AND COMPUTER PROGRAMS TO INTEGRATE COMPUTER OPERATING SUPPORT SYSTEMS (U.S. CLS. 21, 23, 26, 36 AND 38).

CLASS 42—SCIENTIFIC AND COMPUTER SERVICES

FOR CREATION, DESIGN, AND DEVELOPMENT OF COMPUTER SOFTWARE, COMPUTER PROGRAMS AND COMPUTER SYSTEMS, NAMELY, MULTI-VENDOR INFORMATION TECHNOLOGY MANAGEMENT SYSTEMS; INFORMATION, ADVICE, AND CONSULTANCY RELATING TO THE AFORESAID; TECHNICAL SUPPORT SERVICES, NAMELY, TROUBLESHOOTING OF COMPUTER SOFTWARE PROBLEMS (U.S. CLS. 100 AND 101).

KATHLEEN LORENZO, EXAMINING ATTORNEY

SN 77-565,470. MANZANILLA LA PASTORA, S.A. DE C.V., D.F., MIGUEL HIDALGO, MEXICO, FILED 9-9-2008.

LA PASTORA

THE MARK CONSISTS OF STANDARD CHARACTERS WITHOUT CLAIM TO ANY PARTICULAR FONT, STYLE, SIZE, OR COLOR.

OWNER OF U.S. REG. NO. 3,623,666.

THE ENGLISH TRANSLATION OF "LA PASTORA" IN THE MARK IS "THE SHEPHERDESS" OR THE FEMININE FORM OF "THE PASTOR".

CLASS 5—PHARMACEUTICALS

FOR HERBAL TEAS FOR MEDICINAL PURPOSES; BEVERAGES FORMULATED FOR BABIES, NAMELY, TEA (U.S. CLS. 6, 18, 44, 46, 51 AND 52).

CLASS 29—MEATS AND PROCESSED FOODS

FOR OLIVE OIL (U.S. CL. 46).

CLASS 30—STAPLE FOODS

FOR TEA; HERBAL TEA; BLACK TEA; CINNAMON TEA; LEMON TEA; CHAMOMILE TEA; READY-TO-EAT CEREALS, READY TO EAT, CEREAL DERIVED FOOD BARS; GRANOLA-BASED SNACK BARS; SAUCES; HOT SAUCE; SAUCE MIXES; POPCORN (U.S. CL. 46).
STEVEN PEREZ, EXAMINING ATTORNEY

SN 77-568,284. AVID CENTER, SAN DIEGO, CA. FILED 9-11-2008.

AVID

THE MARK CONSISTS OF STANDARD CHARACTERS WITHOUT CLAIM TO ANY PARTICULAR FONT, STYLE, SIZE, OR COLOR.

OWNER OF U.S. REG. NOS. 2,372,132, 2,735,956 AND OTHERS.

CLASS 35—ADVERTISING AND BUSINESS

FOR ON-LINE RETAIL STORE SERVICES, WHOLESALE STORE SERVICES, CATALOG ORDERING SERVICES, MAIL ORDER SERVICES AND RETAIL STORE BOOTHS AT TRADE SHOWS AND CONFERENCES FEATURING BOOKS, SCHOOL SUPPLIES, SCHOOL COURSEWARE, PRINTED AND ELECTRONIC INSTRUCTIONAL, EDUCATIONAL, TEACHING AND TRAINING MATERIALS, POSTERS, PENCILS, PRERECORDED VIDEO, ELECTRONIC AND OPTICAL MEDIA FEATURING EDUCATIONAL AND TEACHER TRAINING MATERIALS, EDUCATIONAL SOFTWARE FEATURING EDUCATION IN THE FIELDS OF STUDENT SUCCESS SKILLS, STUDENT ORGANIZATIONAL SKILLS, WRITING, READING, AND PROMOTING STUDENT COLLABORATION AND PARTNERSHIP AND TEACHING AND TRAINING MATERIALS FOR TEACHERS AND COUNSELORS, HATS, CLOTHES, SHIRTS, VISORS, SWEATSHIRTS, LAPEL PINS, TOTE BAGS; ADVERTISING, MARKETING AND PROMOTING THE GOODS AND SERVICES OF OTHERS BY OPERATING AN ON-LINE RETAIL WEBSITE PROVIDING PRODUCTS FOR PURCHASE AND LINKS TO THE WEBSITES OF OTHERS; PROVIDING AN ONLINE SEARCHABLE COMPUTER DATABASE FEATURING CONSUMER INFORMATION ABOUT EDUCATIONAL MATERIALS AND SCHOOL SUPPLIES (U.S. CLS. 100, 101 AND 102).

CLASS 41—EDUCATION AND ENTERTAINMENT

FOR ARRANGING AND CONDUCTING CONFERENCES IN THE FIELD OF EDUCATION, NAMELY, CONDUCTING EDUCATIONAL CONFERENCES IN THE FIELD OF ELEMENTARY, MIDDLE AND HIGH SCHOOL EDUCATION; PROVIDING AN ON-LINE SEARCHABLE COMPUTER DATABASE IN THE FIELD OF EDUCATIONAL COURSES AND EDUCATIONAL CONFERENCES AT THE ELEMENTARY, MIDDLE AND HIGH SCHOOL LEVELS (U.S. CLS. 100, 101 AND 107).

MARY CRAWFORD, EXAMINING ATTORNEY

SN 77-568,424. LEADER DRUGSTORES, INC., DUBLIN, OH.
FILED 9-12-2008.

SN 77-572,679. ALAMANDA POLYMERS, INC., MADISON,
AL. FILED 9-17-2008.



OWNER OF U.S. REG. NOS. 2,351,269, 3,116,212 AND 3,527,296.

THE MARK CONSISTS OF CONCENTRIC OBLONG DESIGNS CONTAINING THE TERM "LEADER".
SEC. 2(F).

CLASS 3—COSMETICS AND CLEANING PREPARATIONS

FOR MOUTHWASH, SKIN CLEANSER, SKIN LOTION (U.S. CLS. 1, 4, 6, 50, 51 AND 52).
FIRST USE 12-31-1994; IN COMMERCE 12-31-1994.

CLASS 5—PHARMACEUTICALS

FOR PHARMACEUTICAL PREPARATIONS, NAMELY, ACNE CREAM, ASPIRIN, ANTIBIOTIC CREAM AND OINTMENT, PEDIATRIC ELECTROLYTE, ANTIHISTAMINES AND VITAMINS (U.S. CLS. 6, 18, 44, 46, 51 AND 52).

FIRST USE 12-31-1994; IN COMMERCE 12-31-1994.

CLASS 35—ADVERTISING AND BUSINESS

FOR RETAIL PHARMACY SERVICES; THIRD PARTY PHARMACEUTICAL PRESCRIPTION PLAN SERVICES OFFERED TO MEMBER DRUG STORES, NAMELY, ADVERTISING, MARKETING, BUSINESS CONSULTING AND PURCHASING PHARMACEUTICALS; BUSINESS CONSULTATION IN THE FIELD OF PHARMACY (U.S. CLS. 100, 101 AND 102).

FIRST USE 12-31-1994; IN COMMERCE 12-31-1994.

CLASS 36—INSURANCE AND FINANCIAL

FOR ADMINISTRATION OF PHARMACEUTICAL PRESCRIPTION BENEFIT PLANS FOR EMPLOYERS (U.S. CLS. 100, 101 AND 102).

FIRST USE 12-31-1994; IN COMMERCE 12-31-1994.
TARA PATE, EXAMINING ATTORNEY

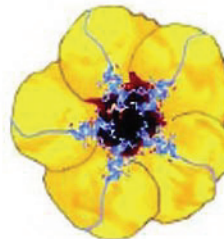

THE COLOR(S) YELLOW, BLUE, BLACK AND MAROON IS/ARE CLAIMED AS A FEATURE OF THE MARK.

THE MARK CONSISTS OF THE COLOR YELLOW ON THE PETALS, THE COLOR BLUE ON THE OUTLINE OF THE PETALS AND LINES RUNNING TO THE MIDDLE OF THE FLOWER, AND THE COLORS BLACK AND MAROON BLEND TOGETHER IN THE CENTER OF THE FLOWER.

CLASS 1—CHEMICALS

FOR CHEMICALS, NAMELY, BUFFER AND STANDARD SOLUTIONS USED IN ANALYTICAL CHEMISTRY; DIAGNOSTIC REAGENTS FOR IN VITRO USE IN BIOCHEMISTRY, CLINICAL CHEMISTRY AND MICROBIOLOGY (U.S. CLS. 1, 5, 6, 10, 26 AND 46).

FIRST USE 6-1-2008; IN COMMERCE 7-5-2008.

CLASS 42—SCIENTIFIC AND COMPUTER SERVICES

FOR CHEMISTRY CONSULTATION; LABORATORY RESEARCH IN THE FIELD OF POLYMERS; PROFESSIONAL CONSULTING SERVICES AND ADVICE ABOUT AGRICULTURAL CHEMISTRY; RESEARCH IN THE FIELD OF CHEMISTRY (U.S. CLS. 100 AND 101).

FIRST USE 6-1-2008; IN COMMERCE 7-5-2008.

ANN E. SAPPENFIELD, EXAMINING ATTORNEY

SN 77-574,685. GILMORE, DOVIE, MILWAUKEE, WI. FILED 9-19-2008.

cheezeboy heroes

THE MARK CONSISTS OF STANDARD CHARACTERS WITHOUT CLAIM TO ANY PARTICULAR FONT, STYLE, SIZE, OR COLOR.

CLASS 9—ELECTRICAL AND SCIENTIFIC APPARATUS

FOR EYE GLASS FRAMES WITH HOLES THROUGH WITH A BANDANA CAN BE SECURED (U.S. CLS. 21, 23, 26, 36 AND 38).

CLASS 25—CLOTHING

FOR CLOTHING, NAMELY, BANDANNAS CONSTRUCTED OF FABRIC, PLASTIC OR LEATHER WHICH ARE SPECIALLY ADAPTED FOR SECURING EYE GLASSES HAVING FRAMES WITH HOLES IN THE FRAME THROUGH WHICH A BANDANNA CAN BE SECURED (U.S. CLS. 22 AND 39).

HOWARD SMIGA, EXAMINING ATTORNEY

SN 77-580,162. IMATION CORP., OAKDALE, MN. FILED 9-26-2008.

OWNER OF U.S. REG. NOS. 2,483,822, 2,802,233 AND OTHERS.

THE MARK CONSISTS OF THE WORDING "MEMOREX" WITH THE LETTER "O" IN "MEMOREX" IN A DESIGN, NAMELY, EIGHT SHADED CIRCLES IN THE SHAPE OF THE LETTER "O".

SN 77-578,593. MODERN HOUSECALLS, INC., TAUTON, MA. FILED 9-25-2008.

CLASS 3—COSMETICS AND CLEANING PREPARATIONS

FOR CLEANING AND SCRATCH REPAIR KITS FOR OPTICAL DISCS, PLAYERS, COMPUTER MICE AND KEYBOARDS, COMPRISED PRIMARILY OF CLEANING SOLUTIONS, CLOTHS, WIPES, AND LASER LENS CLEANERS (U.S. CLS. 1, 4, 6, 50, 51 AND 52).

WORKS FOR WOMEN

THE MARK CONSISTS OF STANDARD CHARACTERS WITHOUT CLAIM TO ANY PARTICULAR FONT, STYLE, SIZE, OR COLOR.

NO CLAIM IS MADE TO THE EXCLUSIVE RIGHT TO USE "FOR WOMEN", APART FROM THE MARK AS SHOWN.

CLASS 29—MEATS AND PROCESSED FOODS

FOR PRE-PACKAGED MEALS CONSISTING PRIMARILY OF MEAT, FISH, POULTRY, VEGETABLES, FRUITS, AND/OR NUTS; PREPARED NUTS; PROCESSED FRUITS; NUT AND SEED BASED SNACK BARS (U.S. CL. 46).

CLASS 44—MEDICAL, BEAUTY AND AGRICULTURAL SERVICES

FOR PROVIDING DIETARY AND NUTRITIONAL CONSULTATION; PROVIDING INFORMATION REGARDING FOOD NUTRITION, FOOD PREPARATION, FOOD PROCESSING AND FOOD COMBINATIONS; PROVIDING SERVICES FOR DIET PLANNING AND DIET SUPERVISION, NAMELY, CONDUCTING WEIGHT LOSS PROGRAMS INCORPORATING MEDICAL CONSULTATION, NUTRITIONAL CONSULTATION, BEHAVIORAL CONSULTATION AND EXERCISE CONSULTATION TO ASSIST PROGRAM PARTICIPANTS TO ACHIEVE AND MAINTAIN PROPER BODY WEIGHT; PROVIDING DIET PLANNING SERVICES AND NUTRITIONAL PROGRAMS INCORPORATING MEDICAL CONSULTATION, NUTRITIONAL CONSULTATION, BEHAVIORAL CONSULTATION AND EXERCISE CONSULTATION TO PROMOTE HEALTHY LIVING (U.S. CLS. 100 AND 101).

SUZANNE BLANE, EXAMINING ATTORNEY

CLASS 9—ELECTRICAL AND SCIENTIFIC APPARATUS

FOR AUDIO AND VIDEO EQUIPMENT, NAMELY, BLANK AUDIO, DIGITAL AUDIO AND VIDEO TAPES, DVD PLAYERS AND RECORDERS, COMPACT DISC PLAYERS AND RECORDERS, AUDIO/VIDEO CASSETTE PLAYERS AND RECORDERS, MP3 PLAYERS, AMPLIFIERS AND SPEAKER SYSTEMS, AND BASE STATIONS, NAMELY, AUDIO TRANSMITTERS FOR USE WITH PORTABLE MULTIMEDIA PLAYERS, NAMELY, CONSUMER ELECTRONIC DEVICES CAPABLE OF STORING AND PLAYING DIGITAL MEDIA, NAMELY, MP3 PLAYERS; LOUDSPEAKERS, HEADPHONES AND EARPHONES; MICROPHONES; VIDEO CAMERAS, CAMCORDERS; DIGITAL VOICE RECORDERS, BLANK MAGNETIC TAPES FOR STORING DATA, AUDIO AND VIDEO; BLANK VIDEO TAPES AND BLANK CASSETTES, BLANK FLOPPY DISCS, BLANK OPTICAL DISCS, NAMELY, ALL BLANK, COMPACT DISCS, CD-ROMS, RECORDABLE COMPACT DISCS, RECORDABLE AND REWRITEABLE DVD DISCS, HIGH DENSITY OPTICAL DISCS READ AND WRITTEN BY SHORT WAVE LENGTH BLUE LASERS, NAMELY, BLANK, BD-R AND BD-RE DISCS, BLANK MINIDISKS, PLAYERS AND DRIVES THEREFOR; FLASH MEMORY DEVICES, NAMELY, MEMORY CARDS, CARD READERS AND DRIVES, AND USB FLASH DRIVES; SOLID STATE DRIVES, PORTABLE AND EXTERNAL HARD DISK DRIVES; TELEVISION SETS, LCD DISPLAYS, PLASMA DISPLAYS, AND COMBINATIONS WITH VIDEO CASSETTE RECORDER/DVD/BD-ROM VIDEO PLAYER/RECORDERS AND WALL MOUNTING SYSTEMS THEREFOR; PHONOGRAPH RECORD PLAYERS, PORTABLE STEREO SYSTEMS COMPRISING AUDIO SPEAKERS, AND ONE OR MORE OF THE FOLLOWING: AM/FM RADIO RECEIVER, AUDIO CASSETTE PLAYER/RECORDER, AND COMPACT DISC PLAYER; AND MINI SYSTEM, NAMELY, DIGITAL AM/FM RADIO WITH CD PLAYER, CASSETTE PLAYER AND RECORDER AND REMOTE CONTROL; DIGITAL DATA ORGANIZERS, NAMELY, HAND HELD COMPUTERS AND PERSONAL DIGITAL ASSISTANTS; BOOMBOXES; SOUND SPEAKERS; ELECTRICAL CONNECTORS, WIRES, CABLES AND CABLE ADAPTORS; AUDIO AND VIDEO REMOTE CONTROL UNITS; ANTENNAS; CORDED AND CORDLESS TELEPHONES, MOBILE PHONES, ANSWERING MACHINES; RADIOS, 2-WAY RADIOS, RADIO AND SATELLITE RECEIVERS; ELECTRONIC DOCKING STATIONS; DIGITAL CAMERAS; KARAOKE SYSTEMS, NAMELY, KARAOKE

MACHINES, MICROPHONES, AND SOFTWARE, NAMELY, COMPACT DISCS FEATURING MUSIC WITH ACCOMPANYING LYRICS AND GRAPHICS; AUDIO AND VIDEO MEDIA PROTECTIVE STORAGE DEVICES, NAMELY, CD JEWEL CASES, BOXES, PROTECTIVE CARRYING CASES FOR PORTABLE MULTIMEDIA PLAYERS, NAMELY, MP3 PLAYERS; ELECTRONIC MOTORIZED DEVICE FOR CLEANING AND REPAIRING SCRATCHES ON INSERTED DISCS; HEAD CLEANING TAPES FOR AUDIO CASSETTE PLAYERS AND RECORDERS; RADIOS INCORPORATING ELECTRONIC CLOCKS; AM/FM RADIOS INCORPORATING CLOCKS, RADIO INCORPORATING CLOCK AND CD PLAYER, RADIO INCORPORATING CLOCK AND CD PLAYER FOR USE IN THE SHOWER; COMPUTER MICE AND KEYBOARDS; COMPUTER HARDWARE AND PERIPHERALS; DIGITAL PHOTO FRAMES FOR DISPLAYING PHOTOS WITH OR WITHOUT REMOTE CONTROL; ACCESSORIES FOR PORTABLE MULTIMEDIA PLAYERS, NAMELY, MP3 PLAYERS, NAMELY, COMPUTER DOCKING STATIONS, AUDIO SPEAKERS, COVERS OR SLEEVES THAT COVER DEVICE TO PROVIDE PROTECTION AND A SCRATCH RESISTANT BARRIER; AND BATTERIES (U.S. CLS. 21, 23, 26, 36 AND 38).

WANDA KAY PRICE, EXAMINING ATTORNEY

SN 77-580,388. HER ROYAL HIGHNESS PRINCESS SIRIVANNAVARI NARIRATANA, DUSIT DUSIT, THAILAND, FILED 9-26-2008.



OWNER OF U.S. REG. NO. 3,505,790.
THE MARK CONSISTS OF A STYLIZED PEACOCK WITH THE NAME "SIRIVANNAVARI".
THE TERM "SIRIVANNAVARI" IS THE ROYAL FAMILY'S NAME IN THAILAND.

CLASS 3—COSMETICS AND CLEANING PREPARATIONS

FOR SOAPS; ESSENTIAL OILS; COSMETICS FOR NOURISHING SKIN; PERFUMES (U.S. CLS. 1, 4, 6, 50, 51 AND 52).

CLASS 16—PAPER GOODS AND PRINTED MATTER

FOR BAGS OF PAPER; PENCILS; PENS; BINDERS (U.S. CLS. 2, 5, 22, 23, 29, 37, 38 AND 50).

CLASS 20—FURNITURE AND ARTICLES NOT OTHERWISE CLASSIFIED

FOR BEDROOM FURNITURE; MIRRORS; FRAMES, NAMELY, PHOTO FRAMES, MIRROR FRAMES, AND FRAMES FOR PAINTINGS (U.S. CLS. 2, 13, 22, 25, 32 AND 50).

CLASS 21—HOUSEWARES AND GLASS

FOR POTTERY WARE, NAMELY, DECORATIVE BOWLS; GLASS WARE, NAMELY, BEVERAGE GLASS WARE; PORCELAIN WARE, NAMELY, PORCELAIN FIGURINES AND PORCELAIN TABLEWARE, NAMELY, BOWLS, PLATES, DISHES, AND SAUCERS (U.S. CLS. 2, 13, 23, 29, 30, 33, 40 AND 50).

CLASS 24—FABRICS

FOR BED LINEN; TABLE LINEN; TEXTILE TAPETRIES; CURTAINS (U.S. CLS. 42 AND 50).

CLASS 26—FANCY GOODS

FOR LACE TRIMMING; EMBROIDERY NEEDLES; BUTTONS (U.S. CLS. 37, 39, 40, 42 AND 50).

CLASS 27—FLOOR COVERINGS

FOR FLOOR MATS; ANTI-SLIP FLOOR COVERINGS (U.S. CLS. 19, 20, 37, 42 AND 50).

CLASS 32—LIGHT BEVERAGES

FOR MINERAL WATER; AERATED WATER; FRUIT BEVERAGES (U.S. CLS. 45, 46 AND 48).

CLASS 35—ADVERTISING AND BUSINESS

FOR RETAIL STORE SERVICES FEATURING SOAPS, COSMETICS, PERFUMES, JEWELRY, STATIONERY, FURNITURE, POTTERY, BEVERAGE GLASSWARE, PORCELAIN, NAMELY, PORCELAIN FIGURINES AND PORCELAIN TABLEWARE, TEXTILES, CLOTHING, AND NON-ALCOHOLIC BEVERAGES (U.S. CLS. 100, 101 AND 102).

AMY ALFIERI, EXAMINING ATTORNEY

SN 77-582,099. INTERNATIONAL PAYMENTS FRAMEWORK, LLC, HERNDON, VA. FILED 9-30-2008.



THE MARK CONSISTS OF THE LETTERS "IPF" WITH A STYLIZED LINE AND BALL DESIGN UNDERNEATH THE LETTERS.

CLASS 16—PAPER GOODS AND PRINTED MATTER

FOR MANUALS RELATING TO THE OPERATION AND PROCESSING OF ELECTRONIC PAYMENTS (U.S. CLS. 2, 5, 22, 23, 29, 37, 38 AND 50).

CLASS 35—ADVERTISING AND BUSINESS

FOR ASSOCIATION SERVICES, NAMELY, PROMOTING THE INTERESTS OF ASSOCIATIONS REPRESENTING FINANCIAL INSTITUTIONS FOR SAFE AND RELIABLE ELECTRONIC PAYMENT (U.S. CLS. 100, 101 AND 102).

CLASS 41—EDUCATION AND ENTERTAINMENT

FOR EDUCATION SERVICES, NAMELY, PROVIDING CONFERENCES, WORKSHOPS, AND TELECONFERENCES IN THE FIELD OF ELECTRONIC PAYMENT (U.S. CLS. 100, 101 AND 107).

MAYUR VAGHANI, EXAMINING ATTORNEY

SN 77-582,666. MULTY HOME LP, CONCORD L4K 4X9, CANADA, FILED 9-30-2008.

ECO-TREND

THE MARK CONSISTS OF STANDARD CHARACTERS WITHOUT CLAIM TO ANY PARTICULAR FONT, STYLE, SIZE, OR COLOR.

OWNER OF CANADA REG. NO. TMA744355, DATED 7-30-2009, EXPIRES 7-30-2024.

CLASS 19—NON-METALLIC BUILDING MATERIALS

FOR INTERLOCKING FLOOR TILES, NAMELY, RUBBER FLOOR TILES; PLASTIC FLOOR TILES (U.S. CLS. 1, 12, 33 AND 50).

CLASS 27—FLOOR COVERINGS

FOR FLOOR COVERINGS; CARPET FLOOR TILES; VINYL FLOOR COVERINGS; CARPET FLOORING TILES; DOOR MATS, INDOOR MATS, NAMELY, BATH MATS, DOOR MATS AND OUTDOOR MATS, NAMELY, DOOR MATS; FLOOR COVERINGS, NAMELY, MATS, DOOR MATS, AND FLOOR RUNNERS MADE OF CARPET; ROLL RUNNERS MADE OF CARPET; AND PRE-CUT RUNNERS MADE OF CARPET; FITTED EDGE COVERS FOR FLOOR COVERINGS, NAMELY, FOR CARPETS; FLOOR MATS, NAMELY, VINYL MATS; FLOOR RUNNERS MADE OF RUBBER, VINYL, PLASTIC; ROLL RUNNERS FOR FLOORS MADE OF RUBBER, VINYL, PLASTIC; AND PRE-CUT RUNNERS FOR FLOORS MADE OF RUBBER, VINYL, AND PLASTIC; FITTED EDGE COVERS FOR FLOOR COVERINGS, NAMELY, FOR VINYL, RUBBER AND PLASTIC FLOOR COVERINGS (U.S. CLS. 19, 20, 37, 42 AND 50).

NAKIA HENRY, EXAMINING ATTORNEY

SN 77-583,617. MATTEL, INC., EL SEGUNDO, CA. FILED 10-1-2008.

BATTLE FORCE 5

THE MARK CONSISTS OF STANDARD CHARACTERS WITHOUT CLAIM TO ANY PARTICULAR FONT, STYLE, SIZE, OR COLOR.

CLASS 28—TOYS AND SPORTING GOODS

FOR TOYS, GAMES AND PLAYTHINGS, NAMELY, TOY VEHICLES AND ACCESSORIES THEREFOR; TOY VEHICLE TRACK SETS AND ACCESSORIES THEREFOR; TOY ACTION FIGURES AND ACCESSORIES THEREFOR (U.S. CLS. 22, 23, 38 AND 50).

FIRST USE 9-8-2009; IN COMMERCE 9-8-2009.

CLASS 41—EDUCATION AND ENTERTAINMENT

FOR ENTERTAINMENT SERVICES, NAMELY, THE PRODUCTION OF AN ANIMATED TELEVISION SERIES; PROVIDING ENTERTAINMENT SERVICES IN THE NATURE OF A WEBSITE FEATURING GAMES, PRODUCT TRIVIA AND ACTIVITIES INTENDED FOR CONSUMERS OF ALL AGES (U.S. CLS. 100, 101 AND 107).

FIRST USE 8-31-2009; IN COMMERCE 8-31-2009.

NAKIA HENRY, EXAMINING ATTORNEY

SN 77-585,323. THE ANDERSON CHEMICAL COMPANY, LITCHFIELD, MN. FILED 10-3-2008.



OWNER OF U.S. REG. NOS. 904,882 AND 1,717,291.
THE MARK CONSISTS OF THE SHAPE OF A BEEKER INSIDE AN OVAL SHAPED DESIGN INSIDE A SQUARE SHAPED DESIGN.

CLASS 1—CHEMICALS

FOR WATER TREATMENT CHEMICALS FOR USE IN HEATING, COOLING, AND WASTE WATER TREATMENT SYSTEMS (U.S. CLS. 1, 5, 6, 10, 26 AND 46).

CLASS 3—COSMETICS AND CLEANING PREPARATIONS

FOR ALL PURPOSE CLEANERS FEATURING SANITIZERS, FOR USE IN FOOD PROCESSING, INSTITUTIONAL LAUNDRY, WARE WASHING, DRAIN MAINTENANCE, AND HOUSEKEEPING; DETERGENTS, AND CLEANING PREPARATIONS FOR USE IN FOOD PROCESSING, INSTITUTIONAL LAUNDRY, WARE WASHING, DRAIN MAINTENANCE, AND HOUSEKEEPING (U.S. CLS. 1, 4, 6, 50, 51 AND 52).

CLASS 37—CONSTRUCTION AND REPAIR

FOR INSTALLATION AND MAINTENANCE OF SANITATION AND DETERGENT SYSTEMS; MAINTENANCE OF WATER MANAGEMENT SYSTEMS; CONSULTING SERVICES IN CONNECTION WITH INSTITUTIONAL/INDUSTRIAL LAUNDRY, WARE WASHING, DRAIN MAINTENANCE AND HOUSEKEEPING PROGRAMS (U.S. CLS. 100, 103 AND 106).

CLASS 40—MATERIAL TREATMENT

FOR CONSULTING SERVICES IN CONNECTION WITH FOOD PROCESSING AND WATER TREATMENT PROGRAMS (U.S. CLS. 100, 103 AND 106).
THEODORE MCBRIDE, EXAMINING ATTORNEY

CLASS 42—SCIENTIFIC AND COMPUTER SERVICES

FOR IT SERVICES, NAMELY, DESIGN AND DEVELOPMENT OF SOFTWARE ALLOWING DIAGNOSTIC EQUIPMENT TO UPLOAD ITS DATA ON THE WEB; SOFTWARE INSTALLATIONS, SERVICING AND MAINTENANCE; HARDWARE AND SOFTWARE RENTAL (U.S. CLS. 100 AND 101).
AMY ALFIERI, EXAMINING ATTORNEY

SN 77-586,215. CENTERVUE S.P.A., PADOVA, ITALY, FILED 10-6-2008.

SN 77-587,318. AUDI AG, INGOLSTADT, FED REP GERMANY, FILED 10-7-2008.



PRIORITY CLAIMED UNDER SEC. 44(D) ON ERPN CMNTY TM OFC APPLICATION NO. 7240906, FILED 9-18-2008, REG. NO. 007240906, DATED 6-10-2009, EXPIRES 9-18-2018.

NO CLAIM IS MADE TO THE EXCLUSIVE RIGHT TO USE "EYE" AND "NETWORK", APART FROM THE MARK AS SHOWN.

THE MARK CONSISTS OF THE IMAGE OF AN EYE, COMPRISED IN PART OF A STYLIZED GLOBE DESIGN, WITH THE WORDS "EYE KNOWLEDGE NETWORK" BELOW, ALONG WITH A SHADOW FORMED BY THE WORDING.

CLASS 35—ADVERTISING AND BUSINESS

FOR ADVERTISING, BUSINESS MANAGEMENT, BUSINESS ADMINISTRATION; COMPUTERIZED FILE MANAGEMENT (U.S. CLS. 100, 101 AND 102).

CLASS 38—COMMUNICATION

FOR TELECOMMUNICATIONS, NAMELY, ELECTRONIC TRANSMISSION OF MEDICAL DATA AND DIAGNOSTICALLY RELEVANT INFORMATION; MULTIMEDIA SERVICES, NAMELY, PROVIDING MULTIPLE USER ACCESS TO A GLOBAL COMPUTER INFORMATION NETWORK IN ORDER TO ALLOW USERS TO ACCESS AUDIO AND VIDEO CONTENTS STORED ONLINE; ELECTRONIC EMAIL SERVICES; PROVIDING ACCESS TO ONLINE BULLETIN BOARDS AND ONLINE FORUMS FOR USERS TO RETRIEVE SPECIFIC INFORMATION ON THE TOPICS OF INTEREST IN THE FIELDS OF EYE-CARE AND MEDICAL DIAGNOSES (U.S. CLS. 100, 101 AND 104).

CLASS 41—EDUCATION AND ENTERTAINMENT

FOR EDUCATIONAL AND TRAINING SERVICES, NAMELY, ONLINE CLASSES, SEMINARS, TUTORIAL SESSIONS, AND EDUCATIONAL INTERVIEWS IN THE NATURE OF LIVE AND PRE-RECORDED INTERVIEWS WITH EXPERTS AND DOCTORS, ALL IN THE FIELD OF EYE-CARE; INSTRUCTING AND TRAINING THROUGH GLOBAL NETWORKS, NAMELY, ONLINE CLASSES, SEMINARS, TUTORIAL SESSIONS, AND EDUCATIONAL INTERVIEWS IN THE NATURE OF LIVE AND PRE-RECORDED INTERVIEWS WITH EXPERTS AND DOCTORS, ALL IN THE FIELD OF EYE-CARE; ARRANGING AND CONDUCTING ONLINE CONFERENCES, SYMPOSIA AND WORKSHOPS IN THE FIELD OF EYE-CARE (U.S. CLS. 100, 101 AND 107).

S1

THE MARK CONSISTS OF STANDARD CHARACTERS WITHOUT CLAIM TO ANY PARTICULAR FONT, STYLE, SIZE, OR COLOR.

PRIORITY CLAIMED UNDER SEC. 44(D) ON FED REP GERMANY APPLICATION NO. 302008039139, FILED 6-17-2008, REG. NO. 302008039139, DATED 8-7-2008, EXPIRES 6-30-2018.

OWNER OF U.S. REG. NOS. 1,917,829, 3,324,676 AND OTHERS.

CLASS 12—VEHICLES

FOR VEHICLES, NAMELY, AUTOMOBILES (U.S. CLS. 19, 21, 23, 31, 35 AND 44).

CLASS 28—TOYS AND SPORTING GOODS

FOR GAMES AND PLAYTHINGS, NAMELY, TOY CARS AND MODEL CARS (U.S. CLS. 22, 23, 38 AND 50).
CARYN GLASSER, EXAMINING ATTORNEY

SN 77-587,632. MIYASAKA BREWERY CO., LTD., NAKANO-KU, TOKYO, JAPAN, FILED 10-7-2008.

TOKYO KITCHEN

THE MARK CONSISTS OF STANDARD CHARACTERS WITHOUT CLAIM TO ANY PARTICULAR FONT, STYLE, SIZE, OR COLOR.

NO CLAIM IS MADE TO THE EXCLUSIVE RIGHT TO USE "TOKYO", APART FROM THE MARK AS SHOWN.

CLASS 29—MEATS AND PROCESSED FOODS

FOR SOYBEAN PASTE INSTANT SOUP (U.S. CL. 46).

CLASS 30—STAPLE FOODS

FOR SOYBEAN PASTE (U.S. CL. 46).
JIM RINGLE, EXAMINING ATTORNEY

SN 77-588,354. PV DOYLE HOTELS LIMITED, BALLS-BRIDGE, DUBLIN, IRELAND, FILED 10-8-2008.

The Dupont Hotel

WASHINGTON



PRIORITY CLAIMED UNDER SEC. 44(D) ON ERPNCMNTY TM OFC APPLICATION NO. 007291041, FILED 10-6-2008, REG. NO. 007291041, DATED 8-4-2009, EXPIRES 10-6-2018.

NO CLAIM IS MADE TO THE EXCLUSIVE RIGHT TO USE "HOTEL WASHINGTON DC", APART FROM THE MARK AS SHOWN.

THE MARK CONSISTS OF THE WORDS "THE DUPONT HOTEL" ABOVE THE TERM "WASHINGTON" WHICH IS ABOVE A DESIGN COMPOSED OF THE LETTERS "D" AND "C".

CLASS 41—EDUCATION AND ENTERTAINMENT

FOR LEISURE SERVICES PROVIDED BY HOTELS, NAMELY, PROVIDING SPORTS FACILITIES; PROVIDING FITNESS FACILITIES (U.S. CLS. 100, 101 AND 107).

CLASS 43—HOTEL AND RESTAURANT SERVICES

FOR PROVIDING HOTEL, RESTAURANT, CATERING AND BAR SERVICES; PROVIDING TEMPORARY ACCOMMODATION; PROVIDING FACILITIES FOR BANQUETS; MAKING HOTEL RESERVATIONS FOR OTHERS; PROVIDING CONFERENCE, EXHIBITION AND MEETING FACILITIES AND HOTEL ACCOMMODATION THEREFOR (U.S. CLS. 100 AND 101).

CLASS 44—MEDICAL, BEAUTY AND AGRICULTURAL SERVICES

FOR PROVIDING BEAUTY AND THERAPEUTIC SERVICES BY HOTELS, NAMELY, HEALTH SPA SERVICES IN THE NATURE OF BODY WRAPS, MUD TREATMENTS, SEAWEED TREATMENTS, HYDROTHERAPY BATHS, BODY SCRUBS, AROMATHERAPY, HYDROTHERAPY FOOT BATHS, FOOT BATHING MASSAGES, HEALTH AND BEAUTY SPA SERVICES IN THE NATURE OF NAIL CARE, MANICURES, PEDICURES AND NAIL ENHANCEMENT, SKIN TREATMENT FOR HANDS, NAMELY, THE INJECTION OF DERMAL FILLERS TO REDUCE THE APPEARANCE OF HAND LINES AND WRINKLES, BODY WAXING SERVICES, HEALTH SPA SERVICES FOR HEALTH AND WELLNESS OF BODY AND SPIRIT, HAIR SALON SERVICES, MASSAGE AND HEALTH SPA SERVICES IN THE NATURE OF PROVIDING STEAM ROOM FACILITIES (U.S. CLS. 100 AND 101).

MARLENE BELL, EXAMINING ATTORNEY

SN 77-590,390. ALTIMETER GROUP, LLC, SAN MATEO, CA, FILED 10-10-2008.

THE ALTIMETER

THE MARK CONSISTS OF STANDARD CHARACTERS WITHOUT CLAIM TO ANY PARTICULAR FONT, STYLE, SIZE, OR COLOR.

CLASS 9—ELECTRICAL AND SCIENTIFIC APPARATUS

FOR DOWNLOADABLE MULTIMEDIA FILE CONTAINING ARTWORK, TEXT, AUDIO, VIDEO AND INTERNET WEB LINKS RELATING TO TOPICS OF BUSINESS CONSULTING AND INTERNET SERVICES RELATED TO THE IMPLEMENTATION AND USAGE OF NEW TECHNOLOGY (U.S. CLS. 21, 23, 26, 36 AND 38).

FIRST USE 9-4-2008; IN COMMERCE 9-4-2008.

CLASS 35—ADVERTISING AND BUSINESS

FOR BUSINESS CONSULTING RELATED TO THE IMPLEMENTATION AND USAGE OF NEW TECHNOLOGY; PROVIDING A SEARCHABLE ONLINE DIRECTORY OF ADVERTISING, MARKETING AND TECHNOLOGY GOODS AND SERVICES OF OTHER VENDORS AND CLIENTS; PROVIDING AN ON-LINE COMMERCIAL INFORMATION DIRECTORY ON THE INTERNET; PROVIDING A WEB SITE FEATURING AN ONLINE MARKETPLACE FEATURING REFERRAL SERVICES, NAMELY, MATCHING CONSULTANCY AGENCIES WITH PROSPECTIVE CLIENTS; PROVIDING AN ON-LINE COMMERCIAL INFORMATION DIRECTORY ON THE INTERNET; PROVIDING A WEB SITE FEATURING BUSINESS RESEARCH IN TEXT, AUDIO AND VIDEO FORMATS, RELATED TO BUSINESS CONSULTING AND THE IMPLEMENTATION AND USAGE OF NEW TECHNOLOGY FOR BUSINESSES (U.S. CLS. 100, 101 AND 102).

FIRST USE 9-4-2008; IN COMMERCE 9-4-2008.

CLASS 38—COMMUNICATION

FOR PROVIDING ON-LINE CHAT ROOMS AND ELECTRONIC BULLETIN BOARDS FOR TRANSMISSION OF MESSAGES AMONG USERS IN THE FIELDS OF BUSINESS CONSULTING AND INTERNET SERVICES RELATED TO THE IMPLEMENTATION AND USAGE OF NEW TECHNOLOGY (U.S. CLS. 100, 101 AND 104).

FIRST USE 9-4-2008; IN COMMERCE 9-4-2008.

CLASS 41—EDUCATION AND ENTERTAINMENT

FOR EDUCATIONAL SERVICES, NAMELY, PROVIDING PUBLIC SPEAKING SERVICES IN THE FIELD OF BUSINESS CONSULTING AND INTERNET SERVICES RELATED TO THE IMPLEMENTATION AND USAGE OF NEW TECHNOLOGY; PROVIDING NEWSLETTERS IN THE FIELD OF BUSINESS CONSULTING AND INTERNET SERVICES RELATED TO THE IMPLEMENTATION AND USAGE OF NEW TECHNOLOGY VIA EMAIL (U.S. CLS. 100, 101 AND 107).

FIRST USE 9-4-2008; IN COMMERCE 9-4-2008.

CLASS 42—SCIENTIFIC AND COMPUTER SERVICES

FOR COMPUTER SERVICES, NAMELY, HOSTING ON-LINE WEB FACILITIES FOR OTHERS FOR ORGANIZING AND CONDUCTING ONLINE MEETINGS, GATHERINGS, AND INTERACTIVE DISCUSSIONS; COMPUTER SERVICES IN THE NATURE OF CONTENT CUSTOMIZED WEB PAGES FEATURING USER-DEFINED INFORMATION, PERSONAL PROFILES AND INFORMATION; HOSTING OF DIGITAL CONTENT ON THE INTERNET, NAMELY, TEXT, AUDIO AND VIDEO; APPLICATION SERVICE PROVIDER (ASP) FEATURING SOFTWARE FOR COLLABORATION, COMMUNICATION AND NETWORKING IN BUSINESS CONSULTING AND INTERNET SERVICES RELATED TO THE IMPLEMENTATION AND USAGE OF NEW TECHNOLOGY; PROVIDING ON-LINE NON-DOWNLOADABLE SOFTWARE FOR COLLABORATION, COMMUNICATION AND NETWORKING FOR BUSINESS CONSULTING AND INTERNET SERVICES RELATED TO THE IMPLEMENTATION AND USAGE OF NEW TECHNOLOGY; PROVIDING A WEB SITE FEATURING TECHNOLOGY RESEARCH IN TEXT, AUDIO AND VIDEO FORMATS, RELATED TO THE IMPLEMENTATION AND USAGE OF NEW TECHNOLOGY FOR BUSINESSES (U.S. CLS. 100 AND 101).

FIRST USE 9-4-2008; IN COMMERCE 9-4-2008.
DAVID I, EXAMINING ATTORNEY

SN 77-593,128. SOARING AMERICA, LLC, DURANGO, CO. FILED 10-15-2008.

SKY RANGER

THE MARK CONSISTS OF STANDARD CHARACTERS WITHOUT CLAIM TO ANY PARTICULAR FONT, STYLE, SIZE, OR COLOR.

CLASS 25—CLOTHING

FOR CLOTHING, NAMELY, RAIN JACKETS, UNIFORMS AND SWEATSHIRTS (U.S. CLS. 22 AND 39).
FIRST USE 0-0-2006; IN COMMERCE 0-0-2006.

CLASS 41—EDUCATION AND ENTERTAINMENT

FOR GUIDE SERVICES IN THE FIELDS OF RAPPELLING, HIKING, CLIMBING AND SWINGING WITH THE USE OF CABLES, HARNESSSES AND ROPES; PROVIDING CANOPY TOURS (U.S. CLS. 100, 101 AND 107).
FIRST USE 0-0-2006; IN COMMERCE 0-0-2006.
TARA PATE, EXAMINING ATTORNEY

SN 77-593,125. SOARING AMERICA, LLC, DURANGO, CO. FILED 10-15-2008.



THE MARK CONSISTS OF A STYLIZED BIRD DESIGN.

CLASS 25—CLOTHING

FOR CLOTHING, NAMELY SWEATSHIRTS, COATS, HATS, SHIRTS, RAIN JACKETS, AND UNIFORMS (U.S. CLS. 22 AND 39).

FIRST USE 0-0-2008; IN COMMERCE 0-0-2008.

CLASS 41—EDUCATION AND ENTERTAINMENT

FOR GUIDE SERVICES IN THE FIELDS OF RAPPELLING, HIKING, CLIMBING AND SWINGING WITH THE USE OF CABLES, HARNESSSES AND ROPES; PROVIDING CANOPY TOURS (U.S. CLS. 100, 101 AND 107).

FIRST USE 0-0-2008; IN COMMERCE 0-0-2008.
TARA PATE, EXAMINING ATTORNEY

SN 77-596,136. LF, LLC, WILMINGTON, DE. FILED 10-20-2008.

KOBALT

THE MARK CONSISTS OF STANDARD CHARACTERS WITHOUT CLAIM TO ANY PARTICULAR FONT, STYLE, SIZE, OR COLOR.

OWNER OF U.S. REG. NOS. 2,913,915, 3,276,835 AND OTHERS.

CLASS 6—METAL GOODS

FOR PADLOCKS MADE OF METAL; RIVETS MADE OF METAL; STAPLES MADE OF METAL FOR CONSTRUCTION OR INDUSTRIAL USE; METAL GROMMETS (U.S. CLS. 2, 12, 13, 14, 23, 25 AND 50).

CLASS 7—MACHINERY

FOR ELECTRIC INFLATORS IN THE NATURE OF ELECTRIC AIR PUMPS; ELECTRIC GLUE GUNS (U.S. CLS. 13, 19, 21, 23, 31, 34 AND 35).

CLASS 8—HAND TOOLS

FOR HAND TOOLS, NAMELY, FILES, FLAT FILES, ROUND FILES, WOODCRAFT FILES, HALF ROUND FILES, FOUR-IN-ONE FILES, HANDY FILES, MILL FILES, SLIM FILES, SPECIAL PURPOSE CHAIN SAW FILE SET; HAND TOOLS, NAMELY, ONE HAND PEX CLINCH CLAMP FASTENING TOOLS; HAND TOOLS, NAMELY, PEX RING REMOVAL TOOLS, PEX CRIMP TOOL KITS CONSISTING OF HAND-OPERATED CRIMPING TOOLS FOR USE WITH CROSS LINKED POLYETHELENE PIPES AND HAND OPERATED PEX RING REMOVAL TOOLS; PEX TOOL CASES SPECIALLY DESIGNED FOR CARRYING AND STORING HAND OPERATED TOOLS FOR USE WITH CROSS-LINKED POLYETHELENE PIPES; HAND TOOLS, NAMELY, QUICK CLINCH FASTENING TOOLS, HAND POWERED RIVET GUNS; HAMMER TACKERS; HAND POWERED STAPLE GUNS; HAND TOOLS, NAMELY, HAND OPERATED SCRIBERS WITH ATTACHED MAGNETS FOR PICKING UP METAL SHAVINGS; HAND TOOLS, NAMELY, HAND-OPERATED REACHING DEVICES IN THE NATURE OF MAGNETIC PICK-UPS NOT FOR TESTING THE OPERATION OF TELECOMMUNICATION APPARATUS; HAND TOOLS, NAMELY, INSPECTION MIRRORS; HAND TOOLS, NAMELY, MECHANICAL PICK-UPS IN THE NATURE OF HAND-OPERATED REACHING DEVICES FOR PICKING UP OBJECTS; HAND TOOLS, NAMELY, REVOLVING PUNCHES; AUTOMATIC CENTER PUNCHES; HAND TOOLS, NAMELY, SCRATCH AWLS; HAND TOOLS, NAMELY, PRECISION OILERS; HAND TOOLS FOR LAMINATION, NAMELY, PLASTIC LAMINATE ROLLERS AND EXTENSION HANDLE ROLLERS; FILE HANDLES; TWEEZERS; TOOL HOLDERS, NAMELY, HOLSTERS FOR TOOLS; HAND TOOLS FOR INSTALLING CERAMIC TILE, NAMELY, TILE LIFTERS, GROUT SAWS, GROUT BLADES, GROUT SPREADERS, GROUT FINISHERS; CHALK LINE REELS AND CHALK REFILLS FOR CHALK LINE REELS (U.S. CLS. 23, 28 AND 44).

CLASS 9—ELECTRICAL AND SCIENTIFIC APPARATUS

FOR ELECTRONIC CALIPER WITH DIGITAL DISPLAY FOR MEASURING; LASER LEVELS; FOLDING AND GRADUATED RULERS; PRECISION VERNIER CALIPERS; CARBON FIBER DIGITAL CALIPERS; DIGITAL CALIPERS; SLIDING BAR CALIPERS; PROTRACTORS; STEEL MEASURING RULES; DRILL GAUGES; CONTOUR GAUGES; PRECISION MICROMETERS (U.S. CLS. 21, 23, 26, 36 AND 38).

CLASS 16—PAPER GOODS AND PRINTED MATTER

FOR DRAFTING INSTRUMENTS, NAMELY, PENCIL COMPASS SCRIBERS (U.S. CLS. 2, 5, 22, 23, 29, 37, 38 AND 50).

JOHN KELLY, EXAMINING ATTORNEY

SN 77-597,321. METABOLI SA, PARIS, FRANCE, FILED 10-21-2008.

METABOLI

THE MARK CONSISTS OF STANDARD CHARACTERS WITHOUT CLAIM TO ANY PARTICULAR FONT, STYLE, SIZE, OR COLOR.

OWNER OF ERPN CMNTY TM OFC REG. NO. 004190567, DATED 6-30-2006, EXPIRES 12-2-2014.

CLASS 35—ADVERTISING AND BUSINESS

FOR ADVERTISING, NAMELY, ADVERTISING INCLUDING THE PROMOTION OF GOODS AND SERVICES (FOR OTHERS) BY PLACING ADVERTISEMENTS AND BANNERS ON AN ELECTRONIC SITE ACCESSIBLE VIA COMPUTER NETWORKS; STATISTICAL OR COMMERCIAL DATABANK AND DATABASE OPERATION AND MANAGEMENT; DISSEMINATION OF ADVERTISEMENTS; SALES PROMOTIONS FOR OTHERS; DEMONSTRATION OF COMPUTER GOODS; COMPUTERIZED FILE MANAGEMENT; COLLECTION AND SYSTEMATIC ORDERING OF DATA IN A CENTRAL FILE; SUBSCRIPTION TO DATA TRANSMISSION SERVICES; ARRANGING SUBSCRIPTIONS TO A PROVIDER GIVING ACCESS TO A COMPUTER TELECOMMUNICATIONS OR DATA TRANSMISSION NETWORK; ARRANGING SUBSCRIPTIONS TO MULTIMEDIA PROGRAMS (COMPUTERIZATION OF TEXT AND/OR STILL OR MOVING IMAGES AND/OR SOUND, WHETHER OR NOT MUSICAL), WHETHER OR NOT FOR INTERACTIVE PURPOSES, IN PARTICULAR TO REMOTE-ACCESS VIDEO GAMES; ARRANGING SUBSCRIPTIONS TO TELECOMMUNICATIONS SERVICES (U.S. CLS. 100, 101 AND 102).

CLASS 38—COMMUNICATION

FOR COMMUNICATIONS BY AND/OR BETWEEN COMPUTERS AND COMPUTER TERMINALS; INFORMATION ABOUT TELECOMMUNICATIONS VIA COMMUNICATIONS AND TELECOMMUNICATIONS MEDIA OF ALL KINDS; COMMUNICATIONS VIA COMPUTER NETWORKS IN GENERAL; TRANSMISSION OF INFORMATION VIA COMPUTER NETWORKS OR ANY OTHER COMMUNICATIONS MEDIA IN THE FIELD OF VIDEO GAMES, AUDIOVISUAL ENTERTAINMENT, MUSIC AND MULTIMEDIA; TRANSMISSION OF INFORMATION CONTAINED IN DATABANKS; SENDING AND TRANSMISSION OF TELEGRAMS, MESSAGES AND IMAGES; BROADCASTING OF TELEVISION PROGRAMS AND MULTIMEDIA PROGRAMS FEATURING TEXT AND/OR OF STILL OR MOVING IMAGES OR SOUND, WHETHER OR NOT MUSICAL AND WHETHER OR NOT FOR INTERACTIVE PURPOSES; INFORMATION RELATING TO TELECOMMUNICATIONS; RENTAL OF APPARATUS FOR THE TRANSMISSION OF INFORMATION ONLINE, IN PARTICULAR RELATING TO REMOTE ACCESS VIDEO GAMES; ELECTRONIC MAIL, ELECTRONIC MAIL EXCHANGE, PROVIDING ACCESS TO NATIONAL AND INTERNATIONAL SERVER CENTRES AND TO GLOBAL COMPUTER TELECOMMUNICATIONS NETWORKS; LEASING ACCESS TIME TO A DATABASE OR DATABANK SERVER, IN PARTICULAR FOR TELECOMMUNICATIONS NETWORKS; LEASING ACCESS TIME TO A COMPUTER FOR DATA HANDLING, LEASING ACCESS TIME TO ONLINE SERVICES (U.S. CLS. 100, 101 AND 104).

CLASS 41—EDUCATION AND ENTERTAINMENT

FOR EDUCATION, NAMELY, PROVIDING OF TRAINING AND ADVANCED TRAINING IN THE FIELDS OF COMPUTING, TELECOMMUNICATIONS AND MULTIMEDIA; SOCIAL CLUB SERVICES, NAMELY, ARRANGING, ORGANIZING AND HOSTING SOCIAL EVENTS, TOURNAMENTS, GET-TOGETHERS AND PARTIES FOR CLUB MEMBERS; ARRANGING AND CONDUCTING OF COLLOQUIUMS, CONFERENCES AND CONGRESSES ON COMPUTING, TELECOMMUNICATIONS AND VIDEO GAMES; ENTERTAINMENT SERVICES, NAMELY, PRODUCTION AND DISTRIBUTION OF COMPUTER GAMES OR FILMS VIA A GLOBAL COMPUTER NETWORK, ENTERTAINMENT SERVICES, NAMELY, PROVIDING AN ONLINE INTERACTIVE DATABASE OF VIDEOS AND FILMS IN THE FIELD OF COMPUTER GAMES, ENTERTAINMENT SERVICES, NAMELY, PROVIDING VIRTUAL ENVIRONMENTS IN WHICH USERS CAN INTERACT FOR RECREATIONAL, LEISURE OR ENTERTAINMENT PURPOSES, ENTERTAINMENT SERVICES, NAMELY, ONLINE VIDEO GAMES, ONLINE

ELECTRONIC GAMES; ORGANIZATION OF COMPETITIONS, TOURNAMENTS AND LOTTERIES RELATING TO ENTERTAINMENT OR EDUCATION, PUBLICATION OF BOOKS, MAGAZINES AND TEXTS OTHER THAN PUBLICITY TEXTS; RENTAL OF AUDIO APPARATUS, SOUND RECORDINGS, VIDEO GAMES AND VIDEOTAPES; PRODUCTION OF MULTIMEDIA FILMS AND PROGRAMS FEATURING TEXT AND/OR STILL OR MOVING IMAGES OR SOUND, WHETHER MUSICAL OR NOT, AND WHETHER OR NOT FOR INTERACTIVE PURPOSES, RECORDED ON VIDEOTAPES OR COMPUTER MEDIA (U.S. CLS. 100, 101 AND 107).

CLASS 42—SCIENTIFIC AND COMPUTER SERVICES

FOR RENTAL OF COMPUTER, REMOTE PROCESSING AND DATA TRANSMISSION APPARATUS AND INSTRUMENTS, COMPUTER SOFTWARE PACKAGES AND VIDEO GAMES; RENTAL OF COMPUTERS, COMPUTER SOFTWARE AND VIDEO GAMES; INFORMATION IN THE FIELD OF COMPUTERS, COMPUTER SOFTWARE DESIGN, IN PARTICULAR OF LEISURE SOFTWARE; CONSULTANCY RELATING TO COMPUTERS, COMPUTER PERIPHERALS, COMPUTER SOFTWARE AND COMPUTER SOFTWARE PACKAGES, COMPUTER PROGRAMMING, DESIGN, DEVELOPMENT AND OPERATION OF DATABANKS AND DATABASES IN THE FIELD OF TELECOMMUNICATIONS AND LEISURE SOFTWARE; PROGRAMMING OF MULTIMEDIA EQUIPMENT (U.S. CLS. 100 AND 101).

CLASS 45—PERSONAL AND LEGAL SERVICES

FOR LICENSING, COPYRIGHT MANAGEMENT (U.S. CLS. 100 AND 101).
JOHN WILKE, EXAMINING ATTORNEY

SN 77-598,197. REFRAME-IT, INC., STANFORD, CA. FILED 10-22-2008.

REFRAME IT

THE MARK CONSISTS OF STANDARD CHARACTERS WITHOUT CLAIM TO ANY PARTICULAR FONT, STYLE, SIZE, OR COLOR.

CLASS 38—COMMUNICATION

FOR PROVIDING ON-LINE ELECTRONIC BULLETIN BOARDS FOR TRANSMISSION OF MESSAGES AMONG COMPUTER USERS CONCERNING CURRENT EVENTS AND NEWS (U.S. CLS. 100, 101 AND 104).

CLASS 41—EDUCATION AND ENTERTAINMENT

FOR PROVIDING INFORMATION, NEWS AND COMMENTARY IN THE FIELD OF CURRENT EVENTS (U.S. CLS. 100, 101 AND 107).
MEGHAN REINHART, EXAMINING ATTORNEY

SN 77-599,114. HOLMEN AKTIEBOLAG, 114 84 STOCKHOLM, SWEDEN, FILED 10-23-2008.

INVERCOTE!

YOUR DREAMS

PRIORITY CLAIMED UNDER SEC. 44(D) ON ERPN CMNTY TM OFC APPLICATION NO. 007015688, FILED 6-25-2008, REG. NO. 007015688, DATED 6-8-2009, EXPIRES 6-25-2016.

NO CLAIM IS MADE TO THE EXCLUSIVE RIGHT TO USE "THE REGISTERED TRADEMARK SYMBOL", APART FROM THE MARK AS SHOWN.

THE MARK CONSISTS OF THE WORDS "INVERCOTE YOUR DREAMS" WITH A STYLIZED EXCLAMATION POINT AT THE END OF THE WORD "INVERCOTE" AND WITH THE WORDS "YOUR DREAMS" BENEATH THE WORD "INVERCOTE". THE REGISTERED TRADEMARK SYMBOL APPEARS INSIDE THE PERIOD AT THE BOTTOM OF THE EXCLAMATION POINT.

CLASS 16—PAPER GOODS AND PRINTED MATTER

FOR PAPER, PAPERBOARD AND CARDBOARD FOR GRAPHICS AND PACKAGING (U.S. CLS. 2, 5, 22, 23, 29, 37, 38 AND 50).

CLASS 35—ADVERTISING AND BUSINESS

FOR RETAIL AND WHOLESALE STORE SERVICES FEATURING PAPER PRODUCTS, PAPER, PAPERBOARD AND CARDBOARD (U.S. CLS. 100, 101 AND 102).

CLASS 40—MATERIAL TREATMENT

FOR PAPER AND CARDBOARD TREATING, PATTERN PRINTING (U.S. CLS. 100, 103 AND 106).
LESLIE RICHARDS, EXAMINING ATTORNEY

SN 77-600,502. IMDB.COM, INC., SEATTLE, WA. FILED 10-24-2008.

CRITICALMASSTICKETING

THE MARK CONSISTS OF STANDARD CHARACTERS WITHOUT CLAIM TO ANY PARTICULAR FONT, STYLE, SIZE, OR COLOR.

CLASS 35—ADVERTISING AND BUSINESS

FOR RETAIL STORE SERVICES FEATURING A WIDE VARIETY OF CONSUMER GOODS OF OTHERS; RETAIL STORE SERVICES IN THE FIELD OF ENTERTAINMENT-RELATED PRODUCTS, NAMELY, MOVIES, FILMS, TELEVISION SHOWS, ELECTRONIC GAMES, AUDIO, VISUAL AND AUDIOVISUAL WORKS, ELECTRONIC AND COMMUNICATIONS DEVICES, AND PERIPHERAL DEVICES FOR ELECTRONIC AND COMMUNICATIONS DEVICES; PROVIDING CONSUMER PRODUCT INFORMATION VIA THE INTERNET OR OTHER COMPUTER OR COMMUNICATIONS NETWORKS; PROVIDING A WEBSITE WHERE USERS CAN POST RATINGS, REVIEWS AND RECOMMENDATIONS ON PRODUCTS AND SERVICES; BUSINESS CONSULTING IN THE ENTERTAINMENT FIELD; COMPUTERIZED ONLINE ORDERING SERVICES FEATURING ELECTRONIC GAMES, AUDIO, VISUAL, AND AUDIOVISUAL WORKS, ELECTRONIC AND COMMUNICATIONS DEVICES, PERIPHERAL DEVICES FOR ELECTRONIC AND COMMUNICATIONS DEVICES, AND A WIDE VARIETY OF CONSUMER GOODS OF OTHERS; PROVIDING AN ONLINE SEARCHABLE DATABASE FEATURING RETAIL LISTINGS FOR A WIDE VARIETY OF ENTERTAINMENT-RELATED CONSUMER GOODS OF OTHERS AND ADVERTISEMENTS FOR ENTERTAINMENT-RELATED SERVICES OF OTHERS; DIRECTORY SERVICES TO HELP LOCATE PEOPLE, PLACES, AND ORGANIZATIONS IN THE ENTERTAINMENT FIELD; PROVIDING AN ONLINE DIRECTORY INFORMATION SERVICE FEATURING ENTERTAINMENT-RELATED INFORMATION; PROVIDING A SEARCHABLE ONLINE ADVERTISING GUIDE FEATURING THE PRODUCTS AND SERVICES OF OTHERS; MARKET RESEARCH; RENTAL OF ADVERTISING SPACE; ADVERTISING, MARKETING, PROMOTION AND PUBLICITY SERVICES; RESUME CONSULTING AND PREPARATION SERVICES; EMPLOYMENT SERVICES IN THE NATURE OF CASTING IN THE FIELDS OF TELEVISION, FILM, MUSIC AND OTHER VISUAL, AUDIO AND AUDIOVISUAL WORKS; ONLINE TRADING SERVICES IN WHICH SELLER POSTS ENTERTAINMENT TICKETS TO BE AUCTIONED AND BIDDING IS DONE VIA THE INTERNET; ORGANIZING AND CONDUCTING CHARITY AUCTIONS FOR CHARITABLE FUND RAISING PURPOSES; PROMOTION SERVICES, NAMELY, THE PROMOTION OF FILMS, TELEVISION SHOWS, AND OTHER VISUAL, AUDIO AND AUDIOVISUAL WORKS (U.S. CLS. 100, 101 AND 102).

CLASS 38—COMMUNICATION

FOR PROVIDING AN ONLINE WEBSITE FORUM FOR TRANSMISSION OF MESSAGES AMONG COMPUTER USERS CONCERNING PRODUCT REVIEWS, RATINGS AND RECOMMENDATIONS; PROVIDING MULTIPLE-USER ACCESS TO COMPUTER NETWORKS FOR THE ELECTRONIC TRANSMISSION OF INFORMATION, DOCUMENTS, VISUAL, AUDIO AND AUDIOVISUAL WORKS, DATA AND IMAGES; PROVIDING ONLINE ACCESS TO CURRENT EVENTS AND REFERENCE MATERIAL IN THE ENTERTAINMENT FIELD; PROVIDING ONLINE CHAT ROOMS, INTERNET FORUMS AND ONLINE COMMUNITIES FOR THE TRANSMISSION OF INFORMATION, DOCUMENTS, VISUAL, AUDIO, AND AUDIOVISUAL WORKS, DATA AND IMAGES; PROVIDING ACCESS TO ONLINE DIRECTORIES AND DATABASES RELATING TO INFORMATION AND DATA IN THE ENTERTAINMENT FIELD; BROADCASTING OF MUSIC, MOVIES, TELEVISION SHOWS AND OTHER VISUAL, AUDIO AND AUDIOVISUAL WORKS VIA THE INTERNET; STREAMING OF VISUAL, AUDIO AND AUDIOVISUAL WORKS VIA THE INTERNET OR OTHER COMPUTER OR COMMUNICATIONS NETWORK; PROVIDING ACCESS TO ELECTRONIC GAMES VIA THE INTERNET OR OTHER COMPUTER OR COMMUNICATIONS NETWORK; TRANSMISSION OF PODCASTS; TRANSMISSION OF WEBCASTS (U.S. CLS. 100, 101 AND 104).

CLASS 39—TRANSPORTATION AND STORAGE

FOR TRAVEL ARRANGEMENT SERVICES; TRAVEL BOOKING SERVICES; TRAVEL AND TOUR TICKET RESERVATION SERVICE; PROVIDING TRAVEL INFORMATION SERVICES VIA THE INTERNET OR OTHER COMPUTER OR COMMUNICATIONS NETWORKS; TRAVEL INFORMATION SERVICES; TRANSPORTATION, STORAGE, SHIPPING AND DELIVERY OF GOODS; ELECTRONIC STORAGE OF DATA (U.S. CLS. 100 AND 105).

CLASS 41—EDUCATION AND ENTERTAINMENT

FOR PRODUCTION AND DISTRIBUTION OF MUSIC, MOVIES, TELEVISION SHOWS, AND OTHER VISUAL, AUDIO AND AUDIO VISUAL WORKS, NAMELY, PODCASTS; ARRANGING FOR TICKET RESERVATIONS FOR ENTERTAINMENT EVENTS; ENTERTAINMENT TICKET AGENCY SERVICES; ORGANIZING AND ARRANGING EXHIBITIONS FOR ENTERTAINMENT PURPOSES, NAMELY, MOVIE EXHIBITIONS; PROVIDING, HOSTING AND ORGANIZING AWARD PROGRAM IN THE ENTERTAINMENT FIELD; CONSULTATION IN THE FIELD OF THE PRODUCTION AND DISTRIBUTION OF FILM AND TELEVISION SHOWS; ORGANIZING AND CONDUCTING FILM FESTIVALS; FILM, TELEVISION SHOW AND OTHER AUDIOVISUAL WORK RENTAL; PLANNING AND ARRANGING THE DISPLAY OF MOVIES, TELEVISION SHOWS AND OTHER VISUAL, AUDIO AND AUDIOVISUAL WORKS; PROVIDING LISTING, SCHEDULING AND PROGRAMMING INFORMATION REGARDING TELEVISION SHOWS, FILMS AND OTHER VISUAL, AUDIO AND AUDIOVISUAL WORKS; PROVIDING ONLINE COMPUTER GAMES; EDUCATIONAL SERVICES, NAMELY, PROVIDING CLASSES, WORKSHOPS, SEMINARS, CONFERENCES AND ONE-ON-ONE TRAINING IN THE FIELD OF ORGANIZING OPERATING, ENTERING AND PARTICIPATING IN FILM FESTIVALS, ORGANIZING AND OPERATING MOVIE EXHIBITIONS, WRITING, PRODUCTION AND DISTRIBUTION OF MOVIES AND FILMS, POST-PRODUCTION EDITING OF MOVIES, FILMS AND TELEVISION SHOWS, FILM HISTORY AND FILM ANALYSIS, WRITING, PRODUCTION AND DISTRIBUTION OF TELEVISION SHOWS, PRODUCTION AND DISTRIBUTION OF ELECTRONIC GAMES, PLAYING ELECTRONIC GAMES, STUDY OF ELECTRONIC GAMES, ORGANIZING SPORTING EVENTS, BROADCASTING SPORTING EVENTS, HOSTING SPORTING EVENTS, COMMENTATING, ART, MUSIC, RADIO, THEATRE, LITERATURE, DANCE, WRITING AND PRODUCTION OF MUSICALS, COMEDY, PUBLISHING, ANIMATION, ORGANIZING AND HOSTING OF FASHION SHOWS, AND ORGANIZING AND HOSTING OF CULTURAL EVENTS; PROVIDING NON-DOWNLOADABLE RINGTONES, PRE-RECORDED AUDIO, VISUAL AND AUDIOVISUAL WORKS TO MOBILE COMMUNICATIONS DEVICES VIA WIRELESS NETWORKS; BOOKING OF ENTERTAINMENT HALLS; TICKET RESERVATION AND BOOKING SERVICES FOR ENTERTAINMENT, SPORTING AND CULTURAL EVENTS; TICKET AGENCY SERVICES FOR ENTERTAINMENT, SPORTING AND CULTURAL EVENTS; PROVIDING AN INTERNET WEBSITE PORTAL FEATURING LINKS TO ENTERTAINMENT ARTIST WEBSITES AND PERFORMANCE TICKET INFORMATION; PROVIDING AN INTERNET WEBSITE PORTAL IN THE FIELD OF TELEVISION, FILM, ENTERTAINMENT, CULTURAL AND SPORTING EVENTS; PROVIDING A WEBSITE THAT ALLOWS USERS TO SCHEDULE SCREENINGS OF FILMS AND BOOK TICKETS IN RELATION THERETO (U.S. CLS. 100, 101 AND 107).

CLASS 42—SCIENTIFIC AND COMPUTER SERVICES

FOR PROVIDING TEMPORARY USE OF ONLINE NONDOWNLOADABLE SOFTWARE THAT ALLOWS USERS TO SUBMIT FILMS TO FILM FESTIVALS; PROVIDING TEMPORARY USE OF ONLINE NONDOWNLOADABLE SOFTWARE THAT ALLOWS USERS TO DESIGN PROMOTIONAL MATERIALS FOR MOVIES; APPLICATION SERVICE PROVIDER (ASP) FEATURING SOFTWARE FOR USE IN THE CREATION OF INTERNET PORTALS FOR FILM FESTIVALS; WEBSITE HOSTING SERVICES; TECHNICAL CONSULTANCY REGARDING DESIGNING, DEVELOPING, HOSTING, MAINTAINING, OPERATING AND MANAGING OF WEB SITES; HOSTING OF DIGITAL CONTENT ON THE INTERNET, NAMELY, HOSTING DATABASES FOR TRACKING FILM RIGHTS; PROVIDING A WEBSITE THAT GIVES COMPUTER USERS THE ABILITY TO UPLOAD, EXCHANGE, AND SHARE PHOTOS AND RESUMES; COMPUTER SERVICES, NAMELY, CREATING AN ON-LINE VIRTUAL ENVIRONMENT FOR TRADING ENTERTAINMENT TICKETS (U.S. CLS. 100 AND 101).

CLASS 45—PERSONAL AND LEGAL SERVICES

FOR INTRODUCTION AND SOCIAL NETWORKING SERVICES PROVIDED VIA THE INTERNET OR OTHER COMPUTER OR COMMUNICATIONS NETWORK; PROVIDING ON-LINE COMPUTER DATABASES AND ON-LINE SEARCHABLE DATABASES IN THE FIELDS OF SOCIAL NETWORKING; PROVIDING USER AUTHENTICATION SERVICES FOR E-COMMERCE TRANSACTIONS; LICENSING OF INTELLECTUAL PROPERTY FOR MUSIC, MOVIES, TELEVISION SHOWS AND OTHER VISUAL, AUDIO AND AUDIOVISUAL WORKS (U.S. CLS. 100 AND 101).

STEPHEN AQUILA, EXAMINING ATTORNEY

SN 77-603,016. BIOTRONIK SE & CO. KG, BERLIN, FED REP GERMANY, FILED 10-29-2008.

ENTICOS

THE MARK CONSISTS OF STANDARD CHARACTERS WITHOUT CLAIM TO ANY PARTICULAR FONT, STYLE, SIZE, OR COLOR.

PRIORITY CLAIMED UNDER SEC. 44(D) ON FED REP GERMANY APPLICATION NO. 302008052288, FILED 8-12-2008, REG. NO. 302008052288, DATED 11-12-2008, EXPIRES 8-31-2018.

CLASS 10—MEDICAL APPARATUS

FOR SURGICAL AND MEDICAL INSTRUMENTS AND APPARATUS, NAMELY, PACEMAKERS (U.S. CLS. 26, 39 AND 44).

CLASS 38—COMMUNICATION

FOR TELECOMMUNICATIONS SERVICES, NAMELY, ELECTRONIC TRANSMISSION OF DATA; REMOTE DATA TRANSMISSION FROM AND TO MEDICAL APPARATUS AND APPARATUS FOR COLLECTING, FORWARDING, STORING, EDITING OR PROCESSING MEDICAL DATA FROM OR TO MEDICAL APPARATUS; WIRELESS TRANSMISSION OF ELECTRICAL SIGNALS TO AND FROM MEDICAL IMPLANTS (U.S. CLS. 100, 101 AND 104).

CLASS 44—MEDICAL, BEAUTY AND AGRICULTURAL SERVICES

FOR MEDICAL SERVICES, NAMELY, REMOTE MONITORING AND REMOTE DIAGNOSIS OF CIRCULATORY AND CARDIOLOGICAL DATA FOR MEDICAL CARE; TELEMETRIC AND DIRECT RECORDING OF PATIENT- AND IMPLANT-RELATED DATA FOR DIAGNOSTIC AND THERAPEUTIC PURPOSES; INTERNET SERVICES, NAMELY, PROVIDING MEDICAL DATA ABOUT PATIENTS AND MEDICAL IMPLANTS VIA THE INTERNET; RENTING OUT MEDICAL APPARATUS; PERFORMING MEDICAL AND CLINICAL EXAMINATIONS; MEDICAL CARE BY TELEMETRIC MEANS, INCLUDING LOCALIZATION, OF PATIENTS AND MEDICAL IMPLANTS (U.S. CLS. 100 AND 101).

KIMBERLY FRYE, EXAMINING ATTORNEY

SN 77-603,048. BIOTRONIK SE & CO. KG, BERLIN, FED REP GERMANY, FILED 10-29-2008.

ENTOVIS

THE MARK CONSISTS OF STANDARD CHARACTERS WITHOUT CLAIM TO ANY PARTICULAR FONT, STYLE, SIZE, OR COLOR.

PRIORITY CLAIMED UNDER SEC. 44(D) ON FED REP GERMANY APPLICATION NO. 302008052287, FILED 8-12-2008, REG. NO. 302008052287, DATED 11-12-2008, EXPIRES 8-13-2018.

CLASS 10—MEDICAL APPARATUS

FOR SURGICAL AND MEDICAL INSTRUMENTS AND APPARATUS, NAMELY, PACEMAKERS (U.S. CLS. 26, 39 AND 44).

CLASS 38—COMMUNICATION

FOR TELECOMMUNICATIONS SERVICES, NAMELY, ELECTRONIC TRANSMISSION OF DATA; REMOTE DATA TRANSMISSION FROM AND TO MEDICAL APPARATUS AND APPARATUS FOR COLLECTING, FORWARDING, STORING, EDITING OR PROCESSING MEDICAL DATA FROM OR TO MEDICAL APPARATUS; WIRELESS TRANSMISSION OF ELECTRICAL SIGNALS TO AND FROM MEDICAL IMPLANTS (U.S. CLS. 100, 101 AND 104).

CLASS 44—MEDICAL, BEAUTY AND AGRICULTURAL SERVICES

FOR MEDICAL SERVICES, NAMELY, REMOTE MONITORING AND REMOTE DIAGNOSIS OF CIRCULATORY AND CARDIOLOGICAL DATA FOR MEDICAL CARE; TELEMETRIC AND DIRECT RECORDING OF PATIENT- AND IMPLANT-RELATED DATA FOR DIAGNOSTIC AND THERAPEUTIC PURPOSES; INTERNET SERVICES, NAMELY, PROVIDING MEDICAL DATA ABOUT PATIENTS AND MEDICAL IMPLANTS VIA THE INTERNET; RENTING OUT MEDICAL APPARATUS; PERFORMING MEDICAL AND CLINICAL EXAMINATIONS; MEDICAL CARE BY TELEMETRIC MEANS, INCLUDING LOCALIZATION, OF PATIENTS AND MEDICAL IMPLANTS (U.S. CLS. 100 AND 101).

KIMBERLY FRYE, EXAMINING ATTORNEY

SN 77-603,316. THE RITEDOSE CORPORATION, COLUMBIA, SC. FILED 10-29-2008.

TRC

THE MARK CONSISTS OF STANDARD CHARACTERS WITHOUT CLAIM TO ANY PARTICULAR FONT, STYLE, SIZE, OR COLOR.

CLASS 3—COSMETICS AND CLEANING PREPARATIONS

FOR TOOTHPASTES, NON-MEDICATED MOUTH WASHES, TEETH WHITENING PREPARATIONS (U.S. CLS. 1, 4, 6, 50, 51 AND 52).

CLASS 5—PHARMACEUTICALS

FOR PHARMACEUTICAL ORAL LIQUIDS FOR THE TREATMENT OF COLDS, ALLERGIES, COUGHS, SINUS AILMENTS, ANALGESICS FOR PAIN MANAGEMENT, FEVERS, GASTROINTESTINAL AND DIGESTIVE AILMENTS, CARDIOVASCULAR AND CIRCULATORY AILMENTS, BLOOD ANOMALIES, RESPIRATORY AILMENTS, MUSCULAR-SKELETAL DISORDERS, EYE DISORDERS, ORAL-EAR-NOSE AND THROAT PROBLEMS, PARASITIC PROBLEMS, ENDOCRINE PROBLEMS, MALE AND FEMALE SEXUAL PERFORMANCE PROBLEMS, REPRODUCTIVE SYSTEM PROBLEMS, ORAL CONTRACEPTIVES, UROLOGIC AND URINARY TRACT PROBLEMS, HORMONE DEFICIENCIES, SKIN DISORDERS, INFECTIONS AND INFESTATIONS, NEUROLOGICAL PROBLEMS, INSOMNIA, HAIR LOSS AND IMMUNOLOGIC AILMENTS; MEDICAL LIQUIDS, NAMELY, ORAL ANTIBIOTICS, OTIC ANTIBIOTICS, NASAL SALINE DROPS AND SPRAYS, TOPICAL HAND SANITIZING PREPARATIONS FOR USE IN CONNECTION WITH THE DELIVERY OF ORAL, EYE, NASAL, EAR, RECTAL, AND VAGINAL PREPARATIONS, FOR TOPICAL USE, AND FOR EXTERNAL DELIVERY BY SYRINGES, CRUCIBLES AND CUPS; VETERINARY MEDICINE FOR DOGS, CATS, BIRDS, FISH AND REPTILES FOR THE TREATMENT OF VITAMIN AND MINERAL DEFICIENCIES, NUTRITIONAL SUPPLEMENTS, ORAL SYSTEMIC AND TOPICAL SKIN AND EAR ANTIBIOTICS, PARASITE TREATMENT, JOINT AND MUSCULAR ISSUES, ORAL AND DENTAL CARE, SKIN AND COAT CARE, AND DIGESTIVE AIDS AND ISSUES, NAMELY, DEWORMING PREPARATIONS, ALLERGY PREPARATIONS, BEHAVIORAL PROBLEM PREPARATIONS, EYE AND EAR PROBLEM PREPARATIONS; DENTAL AND PERIODONTAL CARE PRODUCTS, NAMELY, PHARMACEUTICAL ORAL LIQUIDS FOR THE TREATMENT OF PLAQUE, GINGIVITIS, PERIODONTITIS AND GUM HEALTH ISSUES IN HUMANS, FELINES, AND CANINES, ORAL DENTAL RINSES, MEDICATED MOUTH WASH FOR PLAQUE PREVENTION, DENTURE ADHESIVES, AND ANTI-CAVITY DENTAL COATING PREPARATIONS CONTAINING FLUORIDE; LIQUID MEDICAL FOOD, NAMELY, PROCESSED FOOD ADAPTED FOR MEDICAL PURPOSES AND FOR INFANT GAS RELIEF, INFANT FORMULA, AND DIETARY FIBER AS AN ADDITIVE FOR FOOD PRODUCTS FOR TUBE FEEDING, WEIGHT CONTROL AND/OR NUTRITIONAL FEEDING AND THE TREATMENT OF VITAMIN AND MINERAL DEFICIENCIES, FIBER DEFICIENCIES, AND DIGESTIVE ISSUES (U.S. CLS. 6, 18, 44, 46, 51 AND 52).

CLASS 10—MEDICAL APPARATUS

FOR MEDICAL APPARATUS, NAMELY, CONTAINERS ESPECIALLY MADE FOR PHARMACEUTICAL ORAL LIQUIDS, NUTRACEUTICALS, MEDICAL LIQUIDS, VETERINARY MEDICINE, DENTAL CARE PRODUCTS, AND LIQUID MEDICAL FOODS (U.S. CLS. 26, 39 AND 44).

CLASS 35—ADVERTISING AND BUSINESS

FOR MARKETING CONSULTATION IN THE FIELD OF PHARMACEUTICALS (U.S. CLS. 100, 101 AND 102).

CLASS 39—TRANSPORTATION AND STORAGE

FOR PACKAGING ARTICLES FOR TRANSPORTATION; PACKAGING ARTICLES TO THE ORDER AND SPECIFICATION OF OTHERS (U.S. CLS. 100 AND 105).

CLASS 40—MATERIAL TREATMENT

FOR MANUFACTURING SERVICES FOR OTHERS IN THE FIELD OF PHARMACEUTICAL ORAL LIQUIDS, MEDICAL LIQUIDS, VETERINARY MEDICINE, DENTAL CARE PRODUCTS, AND LIQUID MEDICAL FOOD (U.S. CLS. 100, 103 AND 106).

TINA L. SNAPP, EXAMINING ATTORNEY

SN 77-605,139. THE RITEDOSE CORPORATION, COLUMBIA, SC. FILED 10-31-2008.

THE MARK CONSISTS OF THE LETTERS "TRC" AND THREE SMALL CIRCLES COMING FROM THE LETTER "C".

CLASS 3—COSMETICS AND CLEANING PREPARATIONS

FOR TOOTHPASTES, NON-MEDICATED MOUTH WASHES, TEETH WHITENING PREPARATIONS (U.S. CLS. 1, 4, 6, 50, 51 AND 52).

CLASS 5—PHARMACEUTICALS

FOR PHARMACEUTICAL ORAL LIQUIDS FOR THE TREATMENT OF COLDS, ALLERGIES, COUGHS, SINUS AILMENTS, ANALGESICS FOR PAIN MANAGEMENT, FEVERS, GASTROINTESTINAL AND DIGESTIVE AILMENTS, CARDIOVASCULAR AND CIRCULATORY AILMENTS, BLOOD ANOMALIES, RESPIRATORY AILMENTS, MUSCULAR-SKELETAL DISORDERS, EYE DISORDERS, ORAL-EAR-NOSE AND THROAT PROBLEMS, PARASITIC PROBLEMS, ENDOCRINE PROBLEMS, MALE AND FEMALE SEXUAL PERFORMANCE PROBLEMS, REPRODUCTIVE SYSTEM PROBLEMS, ORAL CONTRACEPTIVES, UROLOGIC AND URINARY TRACT PROBLEMS, HORMONE DEFICIENCIES, SKIN DISORDERS, INFECTIONS AND INFESTATIONS, NEUROLOGICAL PROBLEMS, INSOMNIA, HAIR LOSS AND IMMUNOLOGIC AILMENTS; MEDICAL LIQUIDS, NAMELY, ORAL ANTIBIOTICS, OTIC ANTIBIOTICS, NASAL SALINE DROPS AND SPRAYS, TOPICAL HAND SANITIZING PREPARATIONS FOR USE IN CONNECTION WITH THE DELIVERY OF ORAL, EYE, NASAL, EAR, RECTAL, AND VAGINAL PREPARATIONS, FOR TOPICAL USE, AND FOR EXTERNAL DELIVERY BY SYRINGES, CRUCIBLES AND CUPS; VETERINARY MEDICINE FOR DOGS, CATS, BIRDS, FISH AND REPTILES FOR THE TREATMENT OF VITAMIN AND MINERAL DEFICIENCIES, NUTRITIONAL SUPPLEMENTS, ORAL SYSTEMIC AND TOPICAL SKIN AND EAR ANTIBIOTICS, PARASITE TREATMENT, JOINT AND MUSCULAR ISSUES, ORAL AND DENTAL CARE, SKIN AND COAT CARE, AND DIGESTIVE AIDS AND ISSUES, NAMELY, DEWORMING PREPARATIONS, ALLERGY PREPARATIONS, BEHAVIORAL PROBLEM PREPARATIONS, EYE AND EAR PROBLEM PREPARATIONS; DENTAL AND PERIODONTAL CARE PRODUCTS, NAMELY, PHARMACEUTICAL ORAL LIQUIDS FOR THE TREATMENT OF PLAQUE, GINGIVITIS, PERIODONTITIS AND GUM HEALTH ISSUES IN HUMANS, FELINES, AND CANINES, ORAL DENTAL RINSES, MEDICATED MOUTH WASH FOR PLAQUE PREVENTION, DENTURE ADHESIVES, AND ANTI-CAVITY DENTAL COATING PREPARATIONS CONTAINING FLUORIDE; LIQUID MEDICAL FOOD, NAMELY, PROCESSED FOOD ADAPTED FOR MEDICAL PURPOSES AND FOR INFANT GAS RELIEF, INFANT FORMULA, AND DIETARY FIBER AS AN ADDITIVE FOR FOOD PRODUCTS FOR TUBE FEEDING, WEIGHT CONTROL AND/OR NUTRITIONAL FEEDING AND THE TREATMENT OF VITAMIN AND MINERAL DEFICIENCIES, FIBER DEFICIENCIES, AND DIGESTIVE ISSUES (U.S. CLS. 6, 18, 44, 46, 51 AND 52).

CLASS 10—MEDICAL APPARATUS

FOR MEDICAL APPARATUS, NAMELY, CONTAINERS ESPECIALLY MADE FOR PHARMACEUTICAL ORAL LIQUIDS, NUTRACEUTICALS, MEDICAL LIQUIDS, VETERINARY MEDICINE, DENTAL CARE PRODUCTS, AND LIQUID MEDICAL FOODS (U.S. CLS. 26, 39 AND 44).

CLASS 35—ADVERTISING AND BUSINESS

FOR MARKETING CONSULTATION IN THE FIELD OF PHARMACEUTICALS (U.S. CLS. 100, 101 AND 102).

CLASS 39—TRANSPORTATION AND STORAGE

FOR PACKAGING ARTICLES FOR TRANSPORTATION; PACKAGING ARTICLES TO THE ORDER AND SPECIFICATION OF OTHERS (U.S. CLS. 100 AND 105).

CLASS 40—MATERIAL TREATMENT

FOR MANUFACTURING SERVICES FOR OTHERS IN THE FIELD OF PHARMACEUTICAL ORAL LIQUIDS, MEDICAL LIQUIDS, VETERINARY MEDICINE, DENTAL CARE PRODUCTS, AND LIQUID MEDICAL FOOD (U.S. CLS. 100, 103 AND 106).

TINA L. SNAPP, EXAMINING ATTORNEY

SN 77-605,202. AMERICAN BANKNOTE CORPORATION, FORT LEE, NJ. FILED 10-31-2008.



NO CLAIM IS MADE TO THE EXCLUSIVE RIGHT TO USE "BANKNOTE", APART FROM THE MARK AS SHOWN.

THE MARK CONSISTS OF THE WORDS "ABNOTE AMERICANBANKNOTE" IN STYLIZED FORM, AND LOGO.

CLASS 9—ELECTRICAL AND SCIENTIFIC APPARATUS

FOR MAGNETICALLY ENCODED PLASTIC TRANSACTION CARDS FOR USE AS CREDIT CARDS, DEBIT CARDS, GIFT CARDS, PHONE CARDS, LOYALTY CARDS, DRIVERS' LICENSES, TRANSIT PASSES, IDENTIFICATION CARDS, PROMOTIONAL CARDS, SECURITY ACCESS CARDS, AND FREQUENT BUYER INCENTIVE CARDS (U.S. CLS. 21, 23, 26, 36 AND 38).

CLASS 16—PAPER GOODS AND PRINTED MATTER

FOR NON-MAGNETICALLY ENCODED PLASTIC TRANSACTION CARDS FOR USE AS LOYALTY CARDS, MEMBERSHIP CARDS, PROMOTIONAL CARDS, AND IDENTIFICATION CARDS; BANK CHECKS; PRINTED SECURITY AND FINANCIAL DOCUMENTS, NAMELY, PAPER CERTIFICATES, TRAVELERS CHECKS, PASSPORTS, STATE TITLES, NAMELY, VEHICLE TITLES; CERTIFICATES OF ORIGIN, NAMELY, AUTHENTICITY CERTIFICATES; AND STOCK CERTIFICATES (U.S. CLS. 2, 5, 22, 23, 29, 37, 38 AND 50).

CURTIS FRENCH, EXAMINING ATTORNEY

SN 77-605,252. ION SYSTEMS, INC., ALAMEDA, CA. FILED 10-31-2008.

ION SYSTEMS

THE MARK CONSISTS OF STANDARD CHARACTERS WITHOUT CLAIM TO ANY PARTICULAR FONT, STYLE, SIZE, OR COLOR.

OWNER OF U.S. REG. NO. 2,762,179.

NO CLAIM IS MADE TO THE EXCLUSIVE RIGHT TO USE "SYSTEMS", APART FROM THE MARK AS SHOWN. SEC. 2(F).

CLASS 9—ELECTRICAL AND SCIENTIFIC APPARATUS

FOR ELECTRONIC MONITORS AND MONITOR MODULES FOR MONITORING ELECTRIC CURRENT AND ELECTRICAL SIGNALS (U.S. CLS. 21, 23, 26, 36 AND 38).

FIRST USE 1-1-1979; IN COMMERCE 1-1-1979.

CLASS 11—ENVIRONMENTAL CONTROL APPARATUS

FOR AIR PURIFYING APPARATUS (U.S. CLS. 13, 21, 23, 31 AND 34).

FIRST USE 1-1-1979; IN COMMERCE 1-1-1979.
JEFF DEFORD, EXAMINING ATTORNEY

SN 77-607,750. TURF ALLIANCE, LLC, WELLAND, CANADA, FILED 11-5-2008.



THE MARK CONSISTS OF THE LETTERS "TI" IN A BOX WITH FOUR BANDS EXTENDING FROM THE BOTTOM EDGE OF THE BOX.

SN 77-607,066. SUNPORCH STRUCTURES, INC., WESTPORT, CT. FILED 11-4-2008.

CLASS 27—FLOOR COVERINGS

FOR CONSULTING IN THE FIELD OF SELECTING SYNTHETIC TURF (U.S. CLS. 19, 20, 37, 42 AND 50).

CLASS 37—CONSTRUCTION AND REPAIR

FOR CONSULTING IN THE FIELD OF INSTALLATION AND MAINTENANCE OF SYNTHETIC TURF (U.S. CLS. 100, 103 AND 106).

CLASS 41—EDUCATION AND ENTERTAINMENT

FOR EDUCATIONAL SERVICES, NAMELY, PROVIDING LECTURES IN THE FIELD OF SYNTHETIC TURF (U.S. CLS. 100, 101 AND 107).

SAIMA MAKHDOOM, EXAMINING ATTORNEY



OWNER OF U.S. REG. NOS. 1,930,493 AND 2,655,856.
THE MARK CONSISTS OF THE STYLIZED WORDING "SUNPORCH" WITH A STYLIZED SUN OVER THE LETTER "H". THE RAYS OF THE STYLIZED SUN FORM A CURVED, ARCHING SHAPE ABOVE THE "ORCH" PORTION OF THE WORDING "PORCH".
SEC. 2(F) AS TO "SUNPORCH".

CLASS 6—METAL GOODS

FOR PREFABRICATED METAL SUNROOMS (U.S. CLS. 2, 12, 13, 14, 23, 25 AND 50).

FIRST USE 1-0-2000; IN COMMERCE 1-0-2000.

CLASS 19—NON-METALLIC BUILDING MATERIALS

FOR PREFABRICATED NON-METAL SUNROOMS (U.S. CLS. 1, 12, 33 AND 50).

FIRST USE 1-0-2000; IN COMMERCE 1-0-2000.
JULIE VEPPUMTHARA, EXAMINING ATTORNEY

SN 77-609,711. CRYO-CELL INTERNATIONAL, INC., OLDSMAR, FL. FILED 11-7-2008.

BANK THE SAVINGS

THE MARK CONSISTS OF STANDARD CHARACTERS WITHOUT CLAIM TO ANY PARTICULAR FONT, STYLE, SIZE, OR COLOR.

CLASS 39—TRANSPORTATION AND STORAGE

FOR STORAGE OF HUMAN CELLS, BLOOD, AND TISSUE FOR THERAPEUTIC, BIOTECHNOLOGICAL, COSMETIC, PHARMACEUTICAL AND MEDICAL USE (U.S. CLS. 100 AND 105).

CLASS 44—MEDICAL, BEAUTY AND AGRICULTURAL SERVICES

FOR HUMAN BLOOD, CELL, AND TISSUE BANKING SERVICES FOR MEDICAL, THERAPEUTIC, BIOTECHNOLOGICAL, COSMETIC, AND PHARMACEUTICAL USE; COLLECTION AND PRESERVATION OF HUMAN BLOOD, CELLS AND TISSUE FOR MEDICAL, THERAPEUTIC, BIOTECHNOLOGICAL, COSMETIC, AND PHARMACEUTICAL USE (U.S. CLS. 100 AND 101).

DAVID I, EXAMINING ATTORNEY

SN 77-615,503. NEUMANN COLLEGE, ASTON, PA. FILED 11-17-2008.

NEUMANN UNIVERSITY

THE MARK CONSISTS OF STANDARD CHARACTERS WITHOUT CLAIM TO ANY PARTICULAR FONT, STYLE, SIZE, OR COLOR.

OWNER OF U.S. REG. NO. 2,590,509.

NO CLAIM IS MADE TO THE EXCLUSIVE RIGHT TO USE "UNIVERSITY, IN CLASSES 9, 16 AND 41," APART FROM THE MARK AS SHOWN.

SEC. 2(F) AS TO "NEUMANN".

CLASS 9—ELECTRICAL AND SCIENTIFIC APPARATUS

FOR DOWNLOADABLE ELECTRONIC PUBLICATIONS, NAMELY, BOOKS, MAGAZINES, JOURNALS, LEAFLETS, MANUALS, CATALOGS, BROCHURES, PERIODICALS, PAMPHLETS, TEXTBOOKS, REPORTS AND MANUALS RELATING TO INSTRUCTION AND RESEARCH AT THE COLLEGIATE UNDERGRADUATE AND GRADUATE LEVELS ALL IN THE FIELDS OF ACCOUNTING, ARTS PRODUCTION AND PERFORMANCE, ATHLETIC TRAINING, BIOLOGY, BUSINESS ADMINISTRATION, COMMUNICATION AND MEDIA ARTS, COMPUTER AND INFORMATION MANAGEMENT, CRIMINAL JUSTICE, EDUCATION, ENGLISH, ENVIRONMENTAL EDUCATION CERTIFICATION, INTERNATIONAL BUSINESS, LIBERAL ARTS, MARKETING, NURSING, PASTORAL CARE AND COUNSELING, POLITICAL SCIENCE, PSYCHOLOGY, PHYSICAL THERAPY, SPORTS MANAGEMENT, AND STRATEGIC LEADERSHIP (U.S. CLS. 21, 23, 26, 36 AND 38).

CLASS 16—PAPER GOODS AND PRINTED MATTER

FOR NEWSPAPERS; POSTERS; SHEET MUSIC; BOOKS, MAGAZINES, JOURNALS, LEAFLETS, MANUALS, CATALOGS, BROCHURES, PERIODICALS, PAMPHLETS, TEXTBOOKS, AND REPORTS RELATING TO INSTRUCTION AND RESEARCH AT THE COLLEGIATE UNDERGRADUATE AND GRADUATE LEVELS IN THE FIELDS OF ACCOUNTING, ARTS PRODUCTION AND PERFORMANCE, ATHLETIC TRAINING, BIOLOGY, BUSINESS ADMINISTRATION, COMMUNICATION AND MEDIA ARTS, COMPUTER AND INFORMATION MANAGEMENT, CRIMINAL JUSTICE, EDUCATION, ENGLISH, ENVIRONMENTAL EDUCATION CERTIFICATION, INTERNATIONAL BUSINESS, LIBERAL ARTS, MARKETING, NURSING, PASTORAL CARE AND COUNSELING, POLITICAL SCIENCE, PSYCHOLOGY, PHYSICAL THERAPY, SPORTS MANAGEMENT, AND STRATEGIC LEADERSHIP (U.S. CLS. 2, 5, 22, 23, 29, 37, 38 AND 50).

CLASS 18—LEATHER GOODS

FOR BOOK BAGS AND TOTE BAGS (U.S. CLS. 1, 2, 3, 22 AND 41).

CLASS 24—FABRICS

FOR BED THROWS AND BLANKETS FOR BEDS AND OUTDOOR USE (U.S. CLS. 42 AND 50).

CLASS 25—CLOTHING

FOR CLOTHING, NAMELY, HEADWEAR, FOOTWEAR, SLEEPWEAR, BEACHWEAR, RAINWEAR, NECKWEAR, SHIRTS, PANTS, SHORTS, JERSEYS, GLOVES, MITTENS, MUFFS, HEADBANDS, WRISTBANDS, JACKETS, WIND SUITS, WARM-UP SUITS, TOPS, BOTTOMS, BABY BIBS NOT OF PAPER, BABY BOTTOMS, BABY TOPS, BASEBALL CAPS, COATS, FLEECE PULLOVERS, FLEECE VESTS, HATS, NECKTIES, NIGHT SHIRTS, SLEEPWEAR, PAJAMAS, SCARVES, TANK TOPS AND T-SHIRTS (U.S. CLS. 22 AND 39).

CLASS 41—EDUCATION AND ENTERTAINMENT

FOR EDUCATIONAL SERVICES, NAMELY, CONDUCTING CLASSES AT THE UNDERGRADUATE AND GRADUATE LEVELS; ENTERTAINMENT SERVICES, NAMELY, CONDUCTING COLLEGIATE ATHLETIC AND SPORTS EVENTS; AND PROVIDING INFORMATION IN THE FIELD OF COLLEGIATE UNDERGRADUATE AND GRADUATE STUDIES AND STUDENT ACTIVITIES VIA AN ONLINE WEBSITE (U.S. CLS. 100, 101 AND 107).

KELLEY WELLS, EXAMINING ATTORNEY

SN 77-616,352. SUN, PAMELA J, AKA AVANU, SAN JOSE, CA. FILED 11-18-2008.



OWNER OF U.S. REG. NO. 2,378,801.

THE COLOR(S) NAVY BLUE AND YELLOW IS/ARE CLAIMED AS A FEATURE OF THE MARK.

THE MARK CONSISTS OF THE NAVY BLUE WORD "AVANU", TO THE LEFT OF WHICH ARE TWO CURVED LINES, THE RIGHTMOST IN THE COLOR NAVY BLUE AND THE LEFTMOST IN NAVY BLUE THAT CHANGES TO YELLOW WHEN VIEWED LEFT TO RIGHT.

THE WORDING "AVANU" HAS NO MEANING IN A FOREIGN LANGUAGE.

CLASS 9—ELECTRICAL AND SCIENTIFIC APPARATUS

FOR COMPUTER HARDWARE AND SOFTWARE FOR SETTING UP AND CONFIGURING LOCAL AREA NETWORKS; COMPUTER HARDWARE AND SOFTWARE FOR SETTING UP AND CONFIGURING WIDE AREA NETWORKS (U.S. CLS. 21, 23, 26, 36 AND 38).

CLASS 35—ADVERTISING AND BUSINESS

FOR ADVICE AND INFORMATION ABOUT CUSTOMER SERVICES AND PRODUCT MANAGEMENT AND PRICES ON INTERNET SITES IN CONNECTION WITH PURCHASES MADE OVER THE INTERNET; COOPERATIVE ADVERTISING AND MARKETING SERVICES BY WAY OF SOLICITATION, CUSTOMER SERVICE AND PROVIDING MARKETING INFORMATION VIA WEB SITES ON A GLOBAL COMPUTER NETWORK; PROMOTING THE GOODS AND SERVICES OF OTHERS BY PROVIDING A WEB SITE AT WHICH USERS CAN LINK TO PRODUCT SPECIFICATIONS PAGES (U.S. CLS. 100, 101 AND 102).

FIRST USE 3-3-2006; IN COMMERCE 3-3-2006.
MICHAEL LITZAU, EXAMINING ATTORNEY

SN 77-618,840. STYLE UNVEILED, EDMONDS, WA. FILED 11-20-2008.

Style Unveiled

THE MARK CONSISTS OF STANDARD CHARACTERS WITHOUT CLAIM TO ANY PARTICULAR FONT, STYLE, SIZE, OR COLOR.

NO CLAIM IS MADE TO THE EXCLUSIVE RIGHT TO USE "STYLE", APART FROM THE MARK AS SHOWN.

CLASS 35—ADVERTISING AND BUSINESS

FOR ADVERTISING AND DIRECTORY SERVICES, NAMELY, PROMOTING THE SERVICES OF OTHERS BY PROVIDING A WEB PAGE FEATURING LINKS TO THE WEBSITES OF OTHERS (U.S. CLS. 100, 101 AND 102).

FIRST USE 10-20-2008; IN COMMERCE 10-22-2008.

CLASS 42—SCIENTIFIC AND COMPUTER SERVICES

FOR HOSTING AN ONLINE WEBSITE FEATURING WEDDING PLANNING TIPS AND LINKS TO WEDDING LOCAL VENDORS PROVIDING WEDDING SERVICES (U.S. CLS. 100 AND 101).

FIRST USE 10-20-2008; IN COMMERCE 10-22-2008.
MICHAEL SOUDERS, EXAMINING ATTORNEY

SN 77-619,662. TW (GIB) IP LIMITED, GIBRALTAR, GIBRALTAR, FILED 11-21-2008.

TAYLOR WIMPEY

THE MARK CONSISTS OF STANDARD CHARACTERS WITHOUT CLAIM TO ANY PARTICULAR FONT, STYLE, SIZE, OR COLOR.

OWNER OF ERPN CMNTY TM OFC REG. NO. 5787271, DATED 1-31-2008, EXPIRES 3-26-2017.

THE NAME "TAYLOR WIMPEY" DOES NOT IDENTIFY A LIVING INDIVIDUAL.

CLASS 19—NON-METALLIC BUILDING MATERIALS

FOR BUILDINGS, NAMELY, NONMETALLIC TRANSPORTABLE BUILDINGS AND PREFABRICATED NON-METAL BUILDINGS, NON-METAL FENCE PANELS, NON-METAL FENCE POSTS, EROSION CONTROL FENCING, PREFABRICATED HOMES, MODULAR HOMES, AND NON-METAL SWIMMING POOLS (U.S. CLS. 1, 12, 33 AND 50).

CLASS 36—INSURANCE AND FINANCIAL

FOR RENTAL OF BUILDINGS FOR PERMANENT OCCUPANCY; CAPITAL INVESTMENTS; REAL ESTATE MANAGEMENT SERVICES; MARINA, DOCKS AND HARBOR REAL ESTATE MANAGEMENT; FINANCIAL MANAGEMENT RELATING TO MARINA, DOCKS AND HARBORS; FUND INVESTMENT; REAL ESTATE AGENCY SERVICES; RENTAL, LETTING AND LEASING OF REAL PROPERTY INCLUDING RESIDENTIAL, COMMERCIAL, INDUSTRIAL, INSTITUTIONAL, AND RECREATIONAL BUILDINGS, RECREATIONAL GROUNDS, LAND FOR AGRICULTURAL USE, LAND FOR COMMERCIAL USE, AND LAND FOR RESIDENTIAL USE; MORTGAGE BANKING; REAL ESTATE APPRAISAL (U.S. CLS. 100, 101 AND 102).

CLASS 37—CONSTRUCTION AND REPAIR

FOR BUILDING CONSTRUCTION AND REPAIR SERVICES; CONSTRUCTION AND REPAIR OF ROADS, BRIDGES, TUNNELS, DAMS, SEWERAGE WORKS, PIPE LINES AND HARBORS; DRILLING OF WELLS; MAINTENANCE AND REPAIR OF BUILDINGS, AND MAINTENANCE AND REPAIR OF UTILITIES OF BUILDINGS, NAMELY, BOILER CLEANING AND REPAIR; MAINTENANCE AND REPAIR OF BUILDING INSULATION; BUILDING RENOVATION; MAINTENANCE AND REPAIR OF OIL BURNERS, AIR CONDITIONING, BURGLAR AND FIRE ALARMS, ELECTRIC APPLIANCES, AND ELEVATORS; CLEANING AND DREDGING SWIMMING POOLS; CLEANING AND REPAIR OF DRAINAGE, PLUMBING, AND ELECTRICAL SYSTEMS; MAINTAINING AND REPAIR OF GOLF COURSES, TENNIS COURTS, AND PLAYGROUND AREAS; CONSTRUCTION AND REPAIR OF RECREATIONAL AND SPORTS GROUNDS INCLUDING CHILDREN'S PLAYGROUND EQUIPMENT, SPORTS FIELDS INCLUDING BASEBALL, HOCKEY, FOOTBALL, SOCCER, AND RUGBY FIELDS, TENNIS COURTS, SWIMMING POOLS, CLUB HOUSES, GOLF COURSES INCLUDING IRRIGATION SYSTEMS FOR GOLF COURSES, GREEN KEEPERS HUTS, CONSTRUCTION AND REPAIR OF GOLF COURSE HOLES AND BUNKERS; INSTALLATION OF AIR CONDITIONING EQUIPMENT, BURGLAR ALARMS, ELECTRIC APPLIANCES, ELEVATORS, FIRE ALARMS, AND KITCHEN EQUIPMENT; REAL ESTATE DEVELOPMENT SERVICES; LAND DEVELOPMENT SERVICES FOR HOUSING AND COMMERCIAL USE, NAMELY, PLANNING AND LAYING OUT OF RESIDENTIAL AND COMMERCIAL COMMUNITIES; CONSTRUCTION OF ROADS, BRIDGES, WAREHOUSES, AND GOLF COURSES; CONSTRUCTION OF SPORTS AND RECREATIONAL BUILDINGS SUCH AS INDOOR GYMS AND HEALTH CLUB FACILITIES; CLEANING SERVICES FOR THE INTERIOR OF COMMERCIAL, RESIDENTIAL, INDUSTRIAL AND INSTITUTIONAL BUILDINGS; CLEANING SERVICES FOR THE EXTERIOR SURFACES OF COMMERCIAL, RESIDENTIAL, INDUSTRIAL AND INSTITUTIONAL BUILDINGS; CLEANING SERVICES FOR THE EXTERIOR GROUNDS OF COMMERCIAL, RESIDENTIAL, INDUSTRIAL AND INSTITUTIONAL BUILDINGS; POOL CLEANING SERVICES; INFORMATION AND ADVISORY SERVICES RELATING TO ALL THE AFORESAID SERVICES (U.S. CLS. 100, 103 AND 106).

CLASS 42—SCIENTIFIC AND COMPUTER SERVICES

FOR ARCHITECTURE, NAMELY, DESIGN OF COMMERCIAL, RESIDENTIAL, INDUSTRIAL, INSTITUTIONAL AND RECREATIONAL BUILDINGS; DESIGN OF CLUB HOUSES; DESIGN OF SWIMMING POOLS; DESIGN OF SWIMMING POOL HOUSES; ARCHITECTURAL CONSULTANCY SERVICES; ENGINEERING; ENGINEERING CONSULTANCY SERVICES; INTERIOR DESIGN SERVICES; PREPARATION OF ENGINEERING DRAWINGS; LAND SURVEYING; BUILDING SURVEYING; QUANTITY SURVEYING; PROVISION OF SURVEYS AND SURVEYING SERVICES; OIL FIELD SURVEYS; CONDUCTING OF FEASIBILITY STUDIES, NAMELY, TECHNICAL PROJECT STUDIES RELATING TO REAL ESTATE, CONSTRUCTION OF RESIDENTIAL, COMMERCIAL, INSTITUTIONAL AND INDUSTRIAL BUILDINGS AND PROPERTY, LAND MANAGEMENT AND DEVELOPMENT; CONDUCTING OF FEASIBILITY STUDIES, NAMELY, PROVISION OF REAL ESTATE PROJECT STUDY SERVICES RELATING TO THE CONSTRUCTION OF RESIDENTIAL, COMMERCIAL, INSTITUTIONAL AND INDUSTRIAL BUILDINGS AND PROPERTY; CONDUCTING OF FEASIBILITY STUDIES, NAMELY, PROVISION OF REAL ESTATE PROJECT STUDY SERVICES AND REPORTS RELATING TO THE CONSTRUCTION OF BUILDING AND PROPERTY; PROFESSIONAL CONSULTANCY AND ADVISORY SERVICES RELATING TO STRUCTURES, NAMELY, TESTING, ANALYZING AND EVALUATING THE STRUCTURAL PROPERTIES OF MASONRY AND CONCRETE STRUCTURES (U.S. CLS. 100 AND 101).

CLASS 44—MEDICAL, BEAUTY AND AGRICULTURAL SERVICES

FOR LANDSCAPE GARDENING DESIGN SERVICES FOR OTHERS; GOLF COURSE DESIGN SERVICES; LANDSCAPE DESIGN SERVICES; GARDENING AND HORTICULTURAL SERVICES; LANDSCAPE GARDENING; GOLF COURSE LANDSCAPING, NAMELY, LAWN MOWING SERVICES, TREE AND BUSH TRIMMING SERVICES, TREE PLANTING AND GREEN KEEPING; LANDSCAPING FOR RESIDENTIAL COMMUNITIES AND COMMERCIAL PROPERTIES, NAMELY, GARDENING SERVICES INCLUDING REMOVAL OF VEGETATION AND PLANTING OF VEGETATION; TREE SURGERY (U.S. CLS. 100 AND 101).

KRISTIN DAHLING, EXAMINING ATTORNEY

SN 77-622,214. IDEAL VACUUM PRODUCTS, LLC, ALBUQUERQUE, NM. FILED 11-26-2008.



OWNER OF U.S. REG. NO. 3,730,667.

NO CLAIM IS MADE TO THE EXCLUSIVE RIGHT TO USE "VACUUM PRODUCTS", APART FROM THE MARK AS SHOWN.

THE MARK CONSISTS OF THE WORD "IDEAL" CONTAINING AN OVERSIZED LETTER "I", UNDERNEATH OF WHICH IS THE TERM "VACUUM PRODUCTS" IN LOWERCASE LETTERS; AN ARCH DESIGN UNDERLIES THE LETTERS "DEAL" IN "IDEAL" AND OVERLAPS WITH THE LETTER "I".

CLASS 7—MACHINERY

FOR VACUUM AND EVACUATED FLUID PUMPS USED TO CREATE AND MAINTAIN EVACUATED AIR, GAS AND OTHER FLUID SYSTEMS IN INDUSTRIAL, COMMERCIAL AND SCIENTIFIC MANUFACTURING AND RESEARCH PROCESSES, AND INTERNAL COMPONENTS THEREOF, NAMELY, ELECTRIC MOTORS, POWER SUPPLIES FOR SUPPLYING ELECTRICAL POWER FOR VACUUMS, VACUUM HOSES AND GASKETS FOR VACUUMS (U.S. CLS. 13, 19, 21, 23, 31, 34 AND 35).

FIRST USE 4-1-2008; IN COMMERCE 4-1-2008.

CLASS 9—ELECTRICAL AND SCIENTIFIC APPARATUS

FOR INSTRUMENTS AND GAUGES FOR DETECTING AND MEASURING TWO-DIMENSIONAL DISTRIBUTION OF FORCE AND PRESSURE IN VACUUMS (U.S. CLS. 21, 23, 26, 36 AND 38).

FIRST USE 4-1-2008; IN COMMERCE 4-1-2008.

CLASS 17—RUBBER GOODS

FOR ADHESIVE SEALANTS FOR VACUUMS (U.S. CLS. 1, 5, 12, 13, 35 AND 50).

FIRST USE 4-1-2008; IN COMMERCE 4-1-2008.

MICHAEL LITZAU, EXAMINING ATTORNEY

SN 77-622,655. DEBORAH KETTNER, MENDOCINO, CA. FILED 11-26-2008.

EARTH FRIENDS

THE MARK CONSISTS OF STANDARD CHARACTERS WITHOUT CLAIM TO ANY PARTICULAR FONT, STYLE, SIZE, OR COLOR.

OWNER OF U.S. REG. NO. 2,340,843.

CLASS 9—ELECTRICAL AND SCIENTIFIC APPARATUS

FOR DOWNLOADABLE PUBLICATIONS IN THE NATURE OF BOOKS IN THE FIELD OF ENVIRONMENTAL EDUCATION, EARTH FRIENDLY LIFESTYLE TIPS, ENTERTAINING STORIES FOR CHILDREN AND FAMILIES, CHILDREN'S PICTURE BOOKS, AND NOVELS; PRE-RECORDED DVDS AND ELECTRONIC AND DIGITAL MEDIA FEATURING SHORT AND FULL LENGTH MOVIES FOR CHILDREN AND FAMILIES FEATURING DOLLS, ANIMATION, CLAYMATION, PUPPETS AND LIVE ACTORS; INTERACTIVE VIDEO GAME PROGRAMS; GAME SOFTWARE (U.S. CLS. 21, 23, 26, 36 AND 38).

CLASS 16—PAPER GOODS AND PRINTED MATTER

FOR PRINT PUBLICATIONS, NAMELY, BOOKS IN THE FIELD OF ENVIRONMENTAL EDUCATION, EARTH FRIENDLY LIFESTYLE TIPS, ENTERTAINING STORIES FOR KIDS AND FAMILIES; CHILDREN'S PICTURE BOOKS, AND NOVELS; TRADING CARDS (U.S. CLS. 2, 5, 22, 23, 29, 37, 38 AND 50).

CLASS 18—LEATHER GOODS

FOR BAGS, NAMELY, ALL-PURPOSE CARRYING BAGS, BACKPACKS, BOOK BAGS, SPORTS BAGS, SCHOOL BOOK BAGS, TRAVEL BAGS (U.S. CLS. 1, 2, 3, 22 AND 41).

CLASS 25—CLOTHING

FOR CLOTHING AND APPAREL, NAMELY, T-SHIRTS, SWEATSHIRTS, DRESSES, PANTS, SHIRTS, UNDERWEAR, SOCKS, JACKETS FOR KIDS AND ADULTS, FOOTWEAR, HEAD WEAR, HATS, CAPS (U.S. CLS. 22 AND 39).

CLASS 28—TOYS AND SPORTING GOODS

FOR TOYS, NAMELY, DOLLS, DOLL CLOTHING, DOLL ACCESSORIES, STUFFED ANIMALS, STUFFED TOYS, PLUSH TOYS, BOARD GAMES, ACTION FIGURES (U.S. CLS. 22, 23, 38 AND 50).

CHRIS WELLS, EXAMINING ATTORNEY

SN 77-624,640. SWORTZEL, RICHARD C, CHELSEA, MI. FILED 12-2-2008.



THE MARK CONSISTS OF STYLIZED WORDS AND DRAWING OF AN EAGLE.

CLASS 35—ADVERTISING AND BUSINESS

FOR (BASED ON INTENT TO USE) BUSINESS MANAGEMENT CONSULTING WITH RELATION TO STRATEGY, MARKETING, SALES, OPERATION, PRODUCT DESIGN PARTICULARLY SPECIALIZING IN THE USE OF ANALYTIC AND STATISTIC MODELS FOR THE UNDERSTANDING AND PREDICTING OF CONSUMERS, BUSINESSES, AND MARKET TRENDS AND ACTIONS; PROMOTIONAL MARKETING AND REPRESENTATION SERVICES FOR SALES TO THE PUBLIC SECTOR; SALES PROMOTION FOR THIRD PARTIES; SALES PROMOTION SERVICES; THE BRINGING TOGETHER, FOR THE BENEFIT OF OTHERS, OF A VARIETY OF GOODS AND SERVICES, ENABLING CUSTOMERS TO CONVENIENTLY VIEW AND PURCHASE THOSE GOODS AND SERVICES FROM AN INTERNET WEB SITE PARTICULARLY SPECIALIZING IN THE MARKETING OF THE SALE OF GOODS AND SERVICES OF OTHERS (U.S. CLS. 100, 101 AND 102).

CLASS 42—SCIENTIFIC AND COMPUTER SERVICES

FOR (BASED ON USE IN COMMERCE) PRODUCT DEVELOPMENT AND ENGINEERING SERVICES FOR OTHERS; PRODUCT DEVELOPMENT CONSULTATION (U.S. CLS. 100 AND 101).

FIRST USE 1-1-2009; IN COMMERCE 1-1-2009.
ALLISON HOLTZ, EXAMINING ATTORNEY

SN 77-624,050. FM FACILITY MAINTENANCE, FORMERLY IPT, LLC, HARTFORD, CT. FILED 12-1-2008.



THE COLOR(S) GREEN, SILVER, GRAY AND BLACK IS/ARE CLAIMED AS A FEATURE OF THE MARK.

THE MARK CONSISTS OF A VERTICAL GRAY, SILVER AND BLACK ADJUSTABLE WRENCH BEHIND A GREEN HORIZONTAL BAND.

CLASS 35—ADVERTISING AND BUSINESS

FOR BUSINESS MANAGEMENT AND ADMINISTRATION; COMMERCIAL AND INDUSTRIAL MANAGEMENT ASSISTANCE; VENDOR MANAGEMENT, NAMELY, PROCUREMENT IN THE NATURE OF PURCHASING MAINTENANCE SERVICES FOR OTHERS; BUSINESS MANAGEMENT OF SERVICE DELIVERY; OPERATIONAL AND FINANCIAL REPORTING, NAMELY, PREPARING BUSINESS REPORTS FOR OTHERS, AND ON-LINE ADVERTISING ON A COMPUTER NETWORK (U.S. CLS. 100, 101 AND 102).

CLASS 37—CONSTRUCTION AND REPAIR

FOR BUILDING MAINTENANCE AND REPAIR SERVICES, NAMELY, EXTERIOR AND INTERIOR MAINTENANCE, SNOW REMOVAL, GLASS SERVICES IN THE NATURE OF PLATE GLASS INSTALLATION AND REPAIR; ELECTRICAL REPAIRS AND INSTALLATION OF WIRING AND MACHINERY; FIRE PROTECTION IN THE NATURE OF REPAIR AND MAINTENANCE OF FIRE ALARMS; SIGNAGE REPAIR; REPAIR OR MAINTENANCE OF ELECTRICAL LIGHTING APPARATUS; PEST CONTROL; PLUMBING; ROOFING; FLOOR CARE IN THE NATURE OF FLOOR POLISHING, CLEANING AND REPAIRS, AND JANITORIAL SERVICES (U.S. CLS. 100, 103 AND 106).

DAVID COLLIER, EXAMINING ATTORNEY

SN 77-625,870. ONCIMMUNE LIMITED, NOTTINGHAM, UNITED KINGDOM, FILED 12-3-2008.



PRIORITY CLAIMED UNDER SEC. 44(D) ON ERP N CMNTY TM OFC APPLICATION NO. 7421852, FILED 11-26-2008, REG. NO. 007421852, DATED 8-6-2009, EXPIRES 11-26-2018.

THE COLOR(S) BLUE AND BLACK IS/ARE CLAIMED AS A FEATURE OF THE MARK.

THE MARK CONSISTS OF THE WORD "ONCIMMUNE" WITH "ONC" IN BLACK AND "IMMUNE" IN BLUE ABOVE 5 BLACK GEOMETRICAL SHAPES.

CLASS 10—MEDICAL APPARATUS

FOR MEDICAL APPARATUS, NAMELY, BLOOD COLLECTION KITS FOR MEDICAL TESTING RELATING TO IMMUNOLOGICAL DETECTION OF ANTI-BODIES IN THE SERUM OF PATIENTS, COMPRISING A SERUM TRANSFER TUBE, BIOHAZARD RETURN BAG WITH POCKET, ABSORBENT SHEET, BUBBLE POCKET, INTEGRITY SEAL FOR THE TRANSFER TUBE, AND A STERILE DISPOSABLE PIPETTE (U.S. CLS. 26, 39 AND 44).

CLASS 44—MEDICAL, BEAUTY AND AGRICULTURAL SERVICES

FOR MEDICAL SERVICES; MEDICAL TESTING; INFORMATION AND ADVISORY SERVICES RELATING TO BLOOD COLLECTION KITS FOR MEDICAL TESTING RELATING TO IMMUNOLOGICAL DETECTION OF ANTIBODIES IN THE SERUM OF PATIENTS (U.S. CLS. 100 AND 101).

DAVID ELTON, EXAMINING ATTORNEY

SN 77-626,326. GARDEN ZONE, LLC, GREER, SC. FILED 12-4-2008.

JOINFORCE

THE MARK CONSISTS OF STANDARD CHARACTERS WITHOUT CLAIM TO ANY PARTICULAR FONT, STYLE, SIZE, OR COLOR.

CLASS 6—METAL GOODS

FOR METAL SCREWS; METAL SPECIALTY SCREWS; METAL FASTENERS, NAMELY, NAILS, WASHERS, BOLTS, NUTS, ANCHORS, THREADED FASTENERS, AND METAL STAPLES FOR CONSTRUCTION OR INDUSTRIAL USE (U.S. CLS. 2, 12, 13, 14, 23, 25 AND 50).

CLASS 17—RUBBER GOODS

FOR NON-METAL FASTENERS, NAMELY, WASHERS OF RUBBER (U.S. CLS. 1, 5, 12, 13, 35 AND 50).

CLASS 20—FURNITURE AND ARTICLES NOT OTHERWISE CLASSIFIED

FOR NON-METAL FASTENERS, NAMELY, SCREWS, NAILS, WASHERS OF PLASTIC, BOLTS, NUTS, ANCHORS, THREADED FASTENERS (U.S. CLS. 2, 13, 22, 25, 32 AND 50).

AISHA SALEM, EXAMINING ATTORNEY

SN 77-630,067. MCCALL & SMITH B.V., 5047 TW TILBURG, NETHERLANDS, FILED 12-10-2008.

VITILITY

THE MARK CONSISTS OF STANDARD CHARACTERS WITHOUT CLAIM TO ANY PARTICULAR FONT, STYLE, SIZE, OR COLOR.

OWNER OF ERPN CMNTY TM OFC REG. NO. 007443781, DATED 12-24-2009, EXPIRES 12-5-2018.

OWNER OF ERPN CMNTY TM OFC REG. NO. 006398655, DATED 12-11-2008, EXPIRES 10-26-2017.

CLASS 5—PHARMACEUTICALS

FOR PHARMACEUTICAL PREPARATIONS FOR TREATING DIABETES; BATH SALTS FOR MEDICAL PURPOSES; SANITARY NAPKINS; SANITARY PREPARATIONS FOR MEDICAL USE; FIRST AID KITS; SANITARY TOWELS; DIETETIC FOODS ADAPTED FOR MEDICAL USE; DIETETIC SUGAR FOR MEDICAL USE; PLASTERS FOR MEDICAL PURPOSES; BANDAGES FOR DRESSINGS; DISINFECTANTS FOR HYGIENIC PURPOSES; DISINFECTANTS FOR MEDICAL INSTRUMENTS (U.S. CLS. 6, 18, 44, 46, 51 AND 52).

CLASS 8—HAND TOOLS

FOR HAND TOOLS, NAMELY, SCISSORS, NAIL FILES, NAIL CLIPPERS, AND NAIL SETS; CUTLERY, NAMELY, FORKS, SPOONS AND KNIVES; ELECTRIC RAZORS; NON-ELECTRIC RAZORS, AND NON-ELECTRIC CAN OPENERS (U.S. CLS. 23, 28 AND 44).

CLASS 10—MEDICAL APPARATUS

FOR SURGICAL, MEDICAL, DENTAL AND VETERINARY APPARATUS AND INSTRUMENTS, NAMELY, MEDICAL TEST KITS FOR HOME USE FOR DIABETES MONITORING; PILL SPLITTERS FOR DISPENSING UNIT DOSES OF MEDICINE; BRACES FOR LIMBS AND JOINTS; MEDICAL DRAINAGE TUBES; MEDICAL INJECTION NEEDLES; ELECTRIC BLANKETS FOR MEDICAL PURPOSES; LANCETS; BLOOD GLUCOSE METERS; MEDICAL AND SURGICAL CATHETERS; MASSAGE APPARATUS AND INSTRUMENTS; INHALERS FOR MEDICAL PURPOSES SOLD EMPTY; TOILETS ADAPTED FOR MEDICAL PATIENTS OR FOR USE BY HANDICAPPED PERSONS; WALKING AIDS FOR MEDICAL PURPOSES AND FOR THE HANDICAPPED, NAMELY, WALKING FRAMES AND ROLLATORS; ELECTRIC HEARING AIDS; ELASTIC STOCKINGS FOR MEDICAL PURPOSES; MEDICAL, SURGICAL AND DENTAL GLOVES; SUTURE NEEDLES; AND SUTURE MATERIALS (U.S. CLS. 26, 39 AND 44).

CLASS 11—ENVIRONMENTAL CONTROL APPARATUS

FOR BATHS, BATHTUBS, WHIRLPOOL BATHS AND BATH INSTALLATIONS (U.S. CLS. 13, 21, 23, 31 AND 34).

CLASS 21—HOUSEWARES AND GLASS

FOR HOUSEHOLD UTENSILS FOR USE BY THE DISABLED, NAMELY, DOMESTIC STORAGE CONTAINERS FOR FOOD, BEVERAGES AND MEDICATIONS; CUTTING BOARDS; BOTTLES FOR DRINKS AND LIQUIFIED FOODS, SOLD EMPTY; DINNERWARE, NAMELY, PLATES, EATING BOWLS, CUPS, MUGS, SAUCERS AND SERVING TRAYS; COOKING UTENSILS FOR USE BY THE DISABLED, NAMELY, POTS AND PANS, GRATERS AND ICE CREAM SCOOPS; PERSONAL GROOMING AIDS FOR USE BY THE DISABLED, NAMELY, COMBS, FACIAL CLEANING SPONGES, AND NAIL BRUSHES; COSMETIC CLEANING AIDS, NAMELY, NON-WOVEN FABRIC WIPES AND SPONGES, AND SPONGE MASSAGERS (U.S. CLS. 2, 13, 23, 29, 30, 33, 40 AND 50).

WENDY JUN, EXAMINING ATTORNEY

SN 77-630,302. ON-TRACE AGRI-FOOD TRACEABILITY (ONTARIO), GUELPH, CANADA, FILED 12-10-2008.



PRIORITY CLAIMED UNDER SEC. 44(D) ON CANADA APPLICATION NO. 1405549, FILED 7-31-2008, REG. NO. TMA762,555, DATED 3-24-2010, EXPIRES 3-24-2025.

THE MARK CONSISTS OF THE WORDING "ONTRACE" WITH A DESIGN ELEMENT ABOVE THE WORDING.

CLASS 9—ELECTRICAL AND SCIENTIFIC APPARATUS

FOR COMPUTER SOFTWARE FOR USE IN DATABASE MANAGEMENT OF DATA FOR USE IN TRACING PLANT AND ANIMAL PRODUCTS (U.S. CLS. 21, 23, 26, 36 AND 38).

CLASS 42—SCIENTIFIC AND COMPUTER SERVICES

FOR TECHNICAL SUPPORT SERVICES, NAMELY, TROUBLESHOOTING OF COMPUTER SOFTWARE PROBLEMS (U.S. CLS. 100 AND 101).

KAPIL BHANOT, EXAMINING ATTORNEY

CLASS 25—CLOTHING

FOR CLOTHING, NAMELY, TOPS, BLOUSES, SHIRTS, T-SHIRTS, TANK TOPS, KNIT SHIRTS, KNIT TOPS, SWEATERS, BLAZERS, JACKETS, VESTS, COATS, SKIRTS, PANTS, JEANS, SHORTS, JUMPSUITS, DRESSES, SOCKS, HOSIERY, SWIMWEAR, ONE-PIECE GARMENTS FOR INFANTS AND TODDLERS, HATS, BATHROBES, BEACH COVER-UPS, BELTS, SHOES, BOOTS, SANDALS, FLIP FLOPS, BRAS, BUSTIERS, CAMISOLES, LINGERIE, NEGLIGEEES, NIGHT GOWNS, NIGHT SHIRTS, PAJAMAS, PANTIES, SLIPS, SCARVES, MITTENS, GLOVES, SLIPPERS AND SWEAT SHIRTS (U.S. CLS. 22 AND 39).

CHERYL CLAYTON, EXAMINING ATTORNEY

SN 77-632,692. PAMER, KERRILYNN HUNT, BROOKLYN, NY. FILED 12-14-2008.

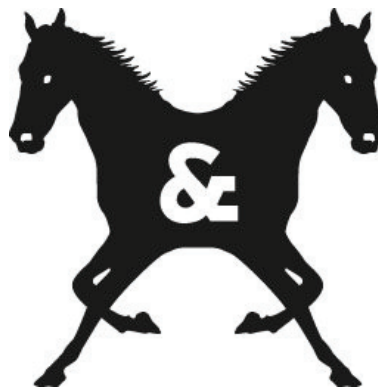

THE MARK CONSISTS OF MIRROR IMAGE HORSE DESIGN, DISPLAYING THE HORSE HEADS AND FRONT LEGS AND HOOVES, SEPARATED BY AN AMPERSAND, WHICH IS PLACED IN THE CENTER.

SN 77-632,686. PAMER, KERRILYNN HUNT, BROOKLYN, NY. FILED 12-14-2008.

Castor & Pollux

THE MARK CONSISTS OF STANDARD CHARACTERS WITHOUT CLAIM TO ANY PARTICULAR FONT, STYLE, SIZE, OR COLOR.

THE NAME(S), PORTRAIT(S), AND/OR SIGNATURE(S) SHOWN IN THE MARK DOES NOT IDENTIFY A PARTICULAR LIVING INDIVIDUAL.

CLASS 18—LEATHER GOODS

FOR HANDBAGS, KEY CASES, LUGGAGE, WALLET, PURSES, BRIEFCASES, SCHOOL BAGS, BEACH BAGS, TRAVEL BAGS, TOTE BAGS, SUITCASES (U.S. CLS. 1, 2, 3, 22 AND 41).

CLASS 18—LEATHER GOODS

FOR HANDBAGS, KEY CASES, LUGGAGE, WALLET, PURSES, BRIEFCASES, SCHOOL BAGS, BEACH BAGS, TRAVEL BAGS, TOTE BAGS, SUITCASES (U.S. CLS. 1, 2, 3, 22 AND 41).

CLASS 25—CLOTHING

FOR CLOTHING, NAMELY, TOPS, BLOUSES, SHIRTS, T-SHIRTS, TANK TOPS, KNIT SHIRTS, KNIT TOPS, SWEATERS, BLAZERS, JACKETS, VESTS, COATS, SKIRTS, PANTS, JEANS, SHORTS, JUMPSUITS, DRESSES, SOCKS, HOSIERY, SWIMWEAR, ONE-PIECE GARMENTS FOR INFANTS AND TODDLERS, HATS, BATHROBES, BEACH COVER-UPS, BELTS, SHOES, BOOTS, SANDALS, FLIP FLOPS, BRAS, BUSTIERS, CAMISOLES, LINGERIE, NEGLIGEEES, NIGHT GOWNS, NIGHT SHIRTS, PAJAMAS, PANTIES, SLIPS, SCARVES, MITTENS, GLOVES, SLIPPERS AND SWEAT SHIRTS (U.S. CLS. 22 AND 39).

CHERYL CLAYTON, EXAMINING ATTORNEY

SN 77-633,553. LIFE TECHNOLOGIES CORPORATION, FORMERLY INVITROGEN CORPORATION, CARLSBAD, CA. FILED 12-15-2008.

NEON

THE MARK CONSISTS OF STANDARD CHARACTERS WITHOUT CLAIM TO ANY PARTICULAR FONT, STYLE, SIZE, OR COLOR.

CLASS 1—CHEMICALS

FOR RESUSPENSION BUFFERS AND ELECTROLYTIC BUFFERS FOR USE WITH AN ELECTROPORATION INSTRUMENT FOR THE DELIVERY OF NUCLEIC ACID, BIOSENSORS, OR OTHER BIOLOGICAL MOLECULES INTO CELLS FOR RESEARCH USE, SOLD INDIVIDUALLY OR IN KITS (U.S. CLS. 1, 5, 6, 10, 26 AND 46).

CLASS 9—ELECTRICAL AND SCIENTIFIC APPARATUS

FOR ELECTROPORATION INSTRUMENT CONSISTING OF A PULSE GENERATOR, SAFETY CHAMBER, AND A HAND-HELD PIPETTE-TYPE ELECTROPORATION DEVICE FOR THE DELIVERY OF NUCLEIC ACID, BIOSENSORS, OR OTHER BIOLOGICAL MOLECULES INTO CELLS FOR RESEARCH USE (U.S. CLS. 21, 23, 26, 36 AND 38).

JILL C. ALT, EXAMINING ATTORNEY

SN 77-633,592. JOHN LANGE, STUART, FL. FILED 12-15-2008.



NO CLAIM IS MADE TO THE EXCLUSIVE RIGHT TO USE "CHOPPERS", APART FROM THE MARK AS SHOWN. THE MARK CONSISTS OF A WOMAN WITH HER LEG AND ARMS CLASPED AROUND A VERTICAL LINE. THIS WOMAN IS INSIDE OF THE WORDING "STRIP CLUB CHOPPERS" WRITTEN IN A CIRCULAR FORM AROUND HER. THERE ARE TWO WOMEN ON EACH SIDE OF THE CIRCULAR DESIGN WITH THEIR LEGS AND ARMS CLASPED AROUND A VERTICAL LINE.

CLASS 12—VEHICLES

FOR MOTORCYCLES (U.S. CLS. 19, 21, 23, 31, 35 AND 44).

CLASS 25—CLOTHING

FOR WEARABLE GARMENTS AND CLOTHING, NAMELY, SHIRTS (U.S. CLS. 22 AND 39).
INGA ERVIN, EXAMINING ATTORNEY

SN 77-636,189. BETH ISRAEL DEACONESS MEDICAL CENTER, INC., BOSTON, MA. FILED 12-18-2008.

FLARE

THE MARK CONSISTS OF STANDARD CHARACTERS WITHOUT CLAIM TO ANY PARTICULAR FONT, STYLE, SIZE, OR COLOR.

CLASS 5—PHARMACEUTICALS

FOR CONTRAST AGENTS FOR USE IN SURGICAL AND MEDICAL IMAGING AND VISUALIZATION; FLUORESCENT CONTRAST AGENTS FOR USE IN SURGICAL AND MEDICAL IMAGING AND VISUALIZATION; EXOGENOUS CONTRAST AGENTS FOR USE IN SURGICAL AND MEDICAL IMAGING AND VISUALIZATION; NEAR-INFRARED CONTRAST AGENTS FOR USE IN SURGICAL AND MEDICAL IMAGING AND VISUALIZATION; EXOGENOUS NEAR-INFRARED CONTRAST AGENTS FOR USE IN SURGICAL AND MEDICAL IMAGING AND VISUALIZATION; NEAR-INFRARED CONTRAST AGENTS FOR USE IN SURGICAL PROCEDURES; EXOGENOUS NEAR-INFRARED CONTRAST AGENTS FOR USE IN SURGICAL PROCEDURES; NEAR-INFRARED CONTRAST AGENTS FOR USE IN MEDICAL IMAGING AND VISUALIZATION; EXOGENOUS NEAR-INFRARED CONTRAST AGENTS FOR USE IN MEDICAL IMAGING AND VISUALIZATION; NEAR-INFRARED CONTRAST AGENTS FOR USE IN REAL-TIME SURGICAL IMAGING AND VISUALIZATION; EXOGENOUS NEAR-INFRARED CONTRAST AGENTS FOR USE IN REAL-TIME SURGICAL IMAGING AND VISUALIZATION (U.S. CLS. 6, 18, 44, 46, 51 AND 52).

CLASS 10—MEDICAL APPARATUS

FOR MEDICAL AND SURGICAL EQUIPMENT FOR USE IN SURGICAL PROCEDURES, NAMELY, CAMERAS AND NEAR-INFRARED CAMERAS, AND OPERATING SOFTWARE USED THEREWITH, ALL SOLD AS A UNIT; MEDICAL AND SURGICAL EQUIPMENT FOR USE IN MEDICAL PROCEDURES, NAMELY, CAMERAS AND NEAR-INFRARED CAMERAS; MEDICAL AND SURGICAL EQUIPMENT FOR USE IN MEDICAL IMAGING AND VISUALIZATION, NAMELY, CAMERAS AND NEAR-INFRARED CAMERAS, AND OPERATING SOFTWARE USED THEREWITH, ALL SOLD AS A UNIT; MEDICAL AND SURGICAL EQUIPMENT FOR USE IN REAL-TIME SURGICAL IMAGING AND VISUALIZATION, NAMELY, CAMERAS AND NEAR-INFRARED CAMERAS, AND OPERATING SOFTWARE USED THEREWITH, ALL SOLD AS A UNIT; MEDICAL AND SURGICAL EQUIPMENT FOR USE IN REAL-TIME SURGICAL IMAGING AND VISUALIZATION, NAMELY, CAMERAS AND NEAR-INFRARED CAMERAS; MEDICAL IMAGING AND VISUALIZATION SYSTEMS CONSISTING OF IMAGING APPARATUS

AND OPERATING SOFTWARE USED THEREWITH, ALL SOLD AS A UNIT; SURGICAL IMAGING AND VISUALIZATION SYSTEMS CONSISTING OF IMAGING APPARATUS AND OPERATING SOFTWARE USED THEREWITH, ALL SOLD AS A UNIT; REAL-TIME MEDICAL IMAGING AND VISUALIZATION SYSTEMS CONSISTING OF IMAGING APPARATUS AND OPERATING SOFTWARE USED THEREWITH, ALL SOLD AS A UNIT; REAL-TIME SURGICAL IMAGING AND VISUALIZATION SYSTEMS CONSISTING OF IMAGING APPARATUS AND OPERATING SOFTWARE USED THEREWITH, ALL SOLD AS A UNIT; ONCOLOGICAL IMAGING AND VISUALIZATION SYSTEMS CONSISTING OF IMAGING APPARATUS AND OPERATING SOFTWARE USED THEREWITH, ALL SOLD AS A UNIT; REAL-TIME ONCOLOGICAL IMAGING AND VISUALIZATION SYSTEMS CONSISTING OF IMAGING APPARATUS AND OPERATING SOFTWARE USED THEREWITH, ALL SOLD AS A UNIT (U.S. CLS. 26, 39 AND 44).

CLASS 16—PAPER GOODS AND PRINTED MATTER

FOR TOOLS FOR USE IN THE INSTRUCTION OF MEDICAL IMAGING AND VISUALIZATION, NAMELY, IMAGING PHANTOMS IN THE NATURE OF REPLICATIONS OF HUMAN OR ANIMAL BODY PARTS OR TISSUE, ANATOMICAL REPLICAS OF HUMAN BODIES, ANATOMICAL REPLICAS OF ANIMAL BODIES, SYNTHETIC ORGANS AND TISSUE FOR INSTRUCTIONAL USE (U.S. CLS. 2, 5, 22, 23, 29, 37, 38 AND 50).

DOMINIC FATHY, EXAMINING ATTORNEY

SN 77-636.971. PLANT EQUIPMENT INC., DBA PLANTCML, TEMECULA, CA. FILED 12-19-2008.

VESTA IPALLAS

THE MARK CONSISTS OF STANDARD CHARACTERS WITHOUT CLAIM TO ANY PARTICULAR FONT, STYLE, SIZE, OR COLOR.

OWNER OF U.S. REG. NO. 2,071,022.

CLASS 9—ELECTRICAL AND SCIENTIFIC APPARATUS

FOR COMPUTER HARDWARE AND SOFTWARE FOR USE IN ORGANIZING, TRANSMITTING, RECEIVING, COMMUNICATING, MANIPULATING, AND REVIEWING TEXT, DATA, AND AUDIO FILES THROUGH A GLOBAL INFORMATION NETWORK, NAMELY, VOICE OVER INTERNET PROTOCOL (VOIP) COMMUNICATION; COMPUTER HARDWARE AND SOFTWARE FOR ENABLING VOICE OVER INTERNET PROTOCOL (VOIP), ALL OF THE AFOREMENTIONED USED IN PUBLIC SAFETY ANSWER POINTS AND CALL MANAGEMENT CENTERS (U.S. CLS. 21, 23, 26, 36 AND 38).

CLASS 42—SCIENTIFIC AND COMPUTER SERVICES

FOR COMMUNICATION SOFTWARE DEVELOPMENT FOR OTHERS; MAINTENANCE AND INSTALLATION OF COMPUTER SOFTWARE; DESIGNING COMPUTER NETWORKS; UPDATING OF COMPUTER SOFTWARE; AND TECHNICAL SUPPORT SERVICES, NAMELY, TROUBLESHOOTING COMPUTER SOFTWARE PROBLEMS (U.S. CLS. 100 AND 101).

ALEXANDER L. POWERS, EXAMINING ATTORNEY

SN 77-639.244. OBRASCON HUARTE LAIN, S.A., MADRID, SPAIN, FILED 12-23-2008.

OHL UNIQUE RESORTS

THE MARK CONSISTS OF STANDARD CHARACTERS WITHOUT CLAIM TO ANY PARTICULAR FONT, STYLE, SIZE, OR COLOR.

PRIORITY CLAIMED UNDER SEC. 44(D) ON SPAIN APPLICATION NO. 2.848.787, FILED 10-22-2008, REG. NO. 2848787, DATED 5-21-2009, EXPIRES 10-22-2018.

NO CLAIM IS MADE TO THE EXCLUSIVE RIGHT TO USE "RESORTS", APART FROM THE MARK AS SHOWN.

CLASS 39—TRANSPORTATION AND STORAGE

FOR TRANSPORT, STORAGE AND DELIVERY OF GOODS, NAMELY, DOCUMENTS, MONEY AND VALUABLES, PACKAGES, RAW MATERIALS, LUGGAGE, AND OTHER FREIGHT FOR OTHERS BY ROAD, RAIL, SEA AND AIR; PORTER SERVICES; TRAVEL ORGANIZATION SERVICES, NAMELY, BOOKING AND ARRANGEMENT OF EXCURSIONS AND CRUISES; RESERVATION AND BOOKING OF SEATS FOR TRAVEL; TRANSPORTATION RESERVATION SERVICES; ORGANIZATION, BOOKING AND ARRANGEMENT OF EXCURSIONS, DAY TRIPS AND SIGHTSEEING TOURS; TRAVEL CONSULTANCY, NAMELY, THE PROVISION OF TRAVEL INFORMATION; ESCORTING OF TRAVELERS; RENTAL OF AIRCRAFT, SHIPS, SAILING VESSELS AND CANOES, MOTOR VEHICLES AND BICYCLES, HORSES AND DEEP WATER DIVING SUITS; TRAVEL AGENCY SERVICES, NAMELY, MAKING RESERVATIONS AND BOOKINGS FOR TRANSPORTATION BY AIRCRAFT, SHIPS, SAILING VESSELS AND CANOES, MOTOR VEHICLES AND BICYCLES; ORGANIZATION OF TRIPS, EXCURSIONS AND SIGHTSEEING TOURS; TRAVEL AGENCY SERVICES, NAMELY, MAKING RESERVATIONS AND BOOKINGS FOR TRANSPORTATION; PROVIDING INFORMATION ABOUT TRAVEL; COORDINATING TRAVEL ARRANGEMENTS FOR INDIVIDUALS AND FOR GROUPS; PROVIDE A WEBSITE FOR THE ARRANGEMENT, RESERVATION AND BOOKING OF SEATS IN THE TOURISM AND BUSINESS TRAVEL SECTORS; ONLINE TRAVEL BOOKING AGENCIES; PROVIDING HORSEBACK RIDING FACILITIES (U.S. CLS. 100 AND 105).

CLASS 41—EDUCATION AND ENTERTAINMENT

FOR TEACHING IN THE FIELD OF CORRESPONDENCE AND LANGUAGE COURSES; ENTERTAINMENT SERVICES, NAMELY, PROVIDING LIVE PERFORMANCES BY A MUSICAL GROUP, AIR SHOWS, FASHION SHOWS, LIGHT SHOWS, MAGIC SHOWS; FILM PRODUCTION, VIDEOTAPE FILM PRODUCTION; ORGANIZATION OF FASHION SHOWS; MODELING FOR ARTISTS; ENTERTAINMENT IN THE NATURE OF THEATER PRODUCTIONS; ARRANGEMENT OF TEACHING AND TRAINING COURSES IN THE FIELD OF SPORTS, LANGUAGES, FILM AND MUSICAL PERFORMANCES; HEALTH CLUB SERVICES, NAMELY, PROVIDING INSTRUCTION AND EQUIPMENT IN THE FIELD OF PHYSICAL EXERCISE; PROVIDING FITNESS AND EXERCISE FACILITIES, NAMELY, PROVIDING ATHLETIC TRAINING, PHYSICAL FITNESS INSTRUCTION, GOLF COURSES AND TENNIS COURTS CINEMA STUDIOS; CINEMA THEATERS DISCOTHEQUES; MUSEUMS; PROVIDING SPORTS CAMPS AND SPORTS FACILITIES; ORGANIZATION OF CULTURAL AND SPORTING EVENTS (U.S. CLS. 100, 101 AND 107).

CLASS 43—HOTEL AND RESTAURANT SERVICES

FOR (BASED ON INTENT TO USE) PROVIDING TEMPORARY HOTEL ROOM ACCOMMODATIONS, PROVIDING OF FOOD AND DRINKS FOR GUESTS; HOTEL ACCOMMODATION BUREAU SERVICES, NAMELY, RESERVATION SERVICES FOR TRAVELERS; PROVIDING TEMPORARY HOUSING ACCOMMODATIONS VIA TRAVEL AGENCIES AND BROKERS; PROVIDING TEMPORARY HOUSING ACCOMMODATIONS, NAMELY, RENTAL OF HOLIDAY HOMES, HOLIDAY FLATS AND APARTMENT; PROVIDING ROOM RESERVATION AND HOTEL RESERVATION SERVICES; PROVIDING HOTEL, BOARDING HOUSE AND MOTEL SERVICES; CATERING; PROVIDING CONFERENCE ROOMS; PROVIDING RESTAURANT AND BAR SERVICES; PROVIDING OF FOOD AND DRINKS IN INTERNET CAFES; TEMPORARY ROOM AND BOARD ACCOMMODATION BUREAU SERVICES, NAMELY, ARRANGING TEMPORARY HOUSING ACCOMMODATIONS VIA CONSULTATION BY TELEPHONE CALL CENTERS AND HOTLINES; PROVIDING TEMPORARY ACCOMMODATION, NAMELY, RENTAL OF HOLIDAY HOMES, HOUSING ACCOMMODATION AND HOTEL RESERVATIONS; CATERING FOR GUESTS; RESORT LODGING SERVICES AT HOLIDAY CAMPS; BOARDING FOR DOMESTIC ANIMALS (U.S. CLS. 100 AND 101).

SKYE YOUNG, EXAMINING ATTORNEY

SN 77-640,879. UNIRAC INC., ALBUQUERQUE, NM. FILED 12-29-2008.

BRIGHT THINKING IN SOLAR

THE MARK CONSISTS OF STANDARD CHARACTERS WITHOUT CLAIM TO ANY PARTICULAR FONT, STYLE, SIZE, OR COLOR.

CLASS 6—METAL GOODS

FOR (BASED ON INTENT TO USE) METAL MOUNTING BRACKETS MADE OF METAL FOR USE WITH SOLAR AND WIND ENERGY EQUIPMENT EQUIPMENT (U.S. CLS. 2, 12, 13, 14, 23, 25 AND 50).

CLASS 19—NON-METALLIC BUILDING MATERIALS

FOR (BASED ON INTENT TO USE) NON-METAL STRUCTURES FOR MOUNTING SOLAR EQUIPMENT (U.S. CLS. 1, 12, 33 AND 50).

CLASS 20—FURNITURE AND ARTICLES NOT OTHERWISE CLASSIFIED

FOR (BASED ON INTENT TO USE) NON-METAL MOUNTING BRACKETS FOR USE WITH SOLAR EQUIPMENT (U.S. CLS. 2, 13, 22, 25, 32 AND 50).

CLASS 42—SCIENTIFIC AND COMPUTER SERVICES

FOR DESIGN, ENGINEERING, RESEARCH, DEVELOPMENT AND TESTING SERVICES IN THE FIELD OF MOUNTING AND SUPPORT BRACKETS AND STRUCTURES FOR USE WITH SOLAR EQUIPMENT (U.S. CLS. 100 AND 101).

FIRST USE 5-31-2008; IN COMMERCE 5-31-2008.
LINDA ORNDORFF, EXAMINING ATTORNEY

SN 77-642,326. ADVANCED CONCEPTS AND TECHNOLOGIES INTERNATIONAL, LLC, WACO, TX. FILED 12-31-2008.



THE MARK CONSISTS OF THE LITERAL TERM "ACT I" WITH A STYLIZED ARROW SYMBOL APPEARING ABOVE THE "A".

CLASS 35—ADVERTISING AND BUSINESS

FOR CONDUCTING BUSINESS AND MARKET RESEARCH SURVEYS; BUSINESS LOGISTICS PLANNING, NAMELY, LOGISTICS MANAGEMENT FOR THE DEPARTMENT OF DEFENSE IN THE FIELD OF DEFENSE, WATER, AND ENERGY AND LIFE-CYCLE MANAGEMENT; COST PRICE ANALYSIS; CONSULTATION IN THE FIELD OF BUSINESS ACQUISITIONS (U.S. CLS. 100, 101 AND 102).

CLASS 40—MATERIAL TREATMENT

FOR PROTOTYPE TESTING, NAMELY, PROTOTYPE FABRICATION OF NEW PHYSICAL MODELS FOR ENGINEERING PURPOSES AND FOR OTHERS (U.S. CLS. 100, 103 AND 106).

CLASS 42—SCIENTIFIC AND COMPUTER SERVICES

FOR SCIENTIFIC ANALYSIS AND DESIGN ENGINEERING SERVICES, NAMELY, PROVIDING ILLUSTRATIONS AND MODELING OF VEHICLES THROUGH THE UTILIZATION OF ELECTRONIC CAD DRAWINGS; TESTING, ANALYSIS AND EVALUATION SERVICES OF THE GOODS AND SERVICE OF OTHERS, NAMELY, PHYSICAL MODELS FOR THE PURPOSE OF CERTIFICATION; COMPUTER SERVICES, NAMELY, ACTING AS AN APPLICATION SERVICE PROVIDER IN THE FIELD OF KNOWLEDGE MANAGEMENT FOR COMPUTER NETWORKS AND DATABASES THAT SEARCH, RETRIEVE, AND OPTIMIZE ELECTRONIC INFORMATION AND DATA; CONSULTING SERVICES IN THE FIELD OF COMPUTER-BASED INFORMATION SYSTEMS FOR BUSINESSES (U.S. CLS. 100 AND 101).

AMEEN IMAM, EXAMINING ATTORNEY

SN 77-642,329. ADVANCED CONCEPTS AND TECHNOLOGIES INTERNATIONAL, LLC, WACO, TX. FILED 12-31-2008.

ADVANCED CONCEPTS AND
TECHNOLOGIES
INTERNATIONAL, LLC

THE MARK CONSISTS OF STANDARD CHARACTERS WITHOUT CLAIM TO ANY PARTICULAR FONT, STYLE, SIZE, OR COLOR.

NO CLAIM IS MADE TO THE EXCLUSIVE RIGHT TO USE "TECHNOLOGIES INTERNATIONAL, LLC", APART FROM THE MARK AS SHOWN.

CLASS 35—ADVERTISING AND BUSINESS

FOR CONDUCTING BUSINESS AND MARKET RESEARCH SURVEYS; BUSINESS LOGISTICS PLANNING, NAMELY, LOGISTICS MANAGEMENT FOR THE DEPARTMENT OF DEFENSE IN THE FIELD OF DEFENSE, WATER, AND ENERGY AND LIFE-CYCLE MANAGEMENT; COST PRICE ANALYSIS; CONSULTATION IN THE FIELD OF BUSINESS ACQUISITIONS (U.S. CLS. 100, 101 AND 102).

CLASS 40—MATERIAL TREATMENT

FOR PROTOTYPE TESTING, NAMELY, PROTOTYPE FABRICATION OF NEW PHYSICAL MODELS FOR ENGINEERING PURPOSES AND FOR OTHERS (U.S. CLS. 100, 103 AND 106).

CLASS 42—SCIENTIFIC AND COMPUTER SERVICES

FOR SCIENTIFIC ANALYSIS AND DESIGN ENGINEERING SERVICES, NAMELY, PROVIDING ILLUSTRATIONS AND MODELING OF VEHICLES THROUGH THE UTILIZATION OF ELECTRONIC CAD DRAWINGS; TESTING, ANALYSIS AND EVALUATION SERVICES OF THE GOODS AND SERVICE OF OTHERS, NAMELY, PHYSICAL MODELS FOR THE PURPOSE OF CERTIFICATION; COMPUTER SERVICES, NAMELY, ACTING AS AN APPLICATION SERVICE PROVIDER IN THE FIELD OF KNOWLEDGE MANAGEMENT FOR COMPUTER NETWORKS AND DATABASES THAT SEARCH, RETRIEVE, AND OPTIMIZE ELECTRONIC INFORMATION AND DATA; CONSULTING SERVICES IN THE FIELD OF COMPUTER-BASED INFORMATION SYSTEMS FOR BUSINESSES (U.S. CLS. 100 AND 101).

AMEEN IMAM, EXAMINING ATTORNEY

SN 77-649,929. ASTOS SOLUTIONS GMBH, UNTERKIRNACH, FED REP GERMANY, FILED 1-15-2009.

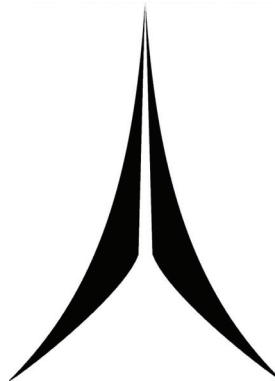

THE MARK CONSISTS OF A WING DESIGN.

SN 77-648,588. RYAN, INC., DALLAS, TX. FILED 1-13-2009.

RYAN ECAPTURE

THE MARK CONSISTS OF STANDARD CHARACTERS WITHOUT CLAIM TO ANY PARTICULAR FONT, STYLE, SIZE, OR COLOR.

OWNER OF U.S. REG. NOS. 3,491,984, 3,534,879 AND OTHERS.

NO CLAIM IS MADE TO THE EXCLUSIVE RIGHT TO USE "ECAPTURE", APART FROM THE MARK AS SHOWN.

CLASS 35—ADVERTISING AND BUSINESS

FOR EXTRACTING FINANCIAL DOCUMENTS AND INFORMATION, NAMELY, ELECTRONIC DATA COLLECTION FOR BUSINESS PURPOSES (U.S. CLS. 100, 101 AND 102).

CLASS 42—SCIENTIFIC AND COMPUTER SERVICES

FOR DATA CONVERSION OF ELECTRONIC INFORMATION (U.S. CLS. 100 AND 101).

LINDA ESTRADA, EXAMINING ATTORNEY

CLASS 9—ELECTRICAL AND SCIENTIFIC APPARATUS

FOR COMPUTER SOFTWARE USED FOR THE SIMULATION, OPTIMIZATION, AND VISUALIZATION OF PARAMETERS FOR THE CONTROL OF STATIC AND DYNAMIC SYSTEMS, NAMELY, AERONAUTICAL SYSTEMS, ASTRONAUTICAL SYSTEMS, ROBOTIC SYSTEMS, MECHANICAL SYSTEMS, AUTOMOTIVE SYSTEMS, MEDICAL SYSTEMS, AND BIO-MECHANICAL SYSTEMS (U.S. CLS. 21, 23, 26, 36 AND 38).

FIRST USE 3-31-2007; IN COMMERCE 3-31-2007.

CLASS 41—EDUCATION AND ENTERTAINMENT

FOR PROVIDING OF TRAINING FOR THE USE OF OPTIMIZATION, SIMULATION, ANALYSIS AND VISUALIZATION SOFTWARE (U.S. CLS. 100, 101 AND 107).

FIRST USE 3-31-2007; IN COMMERCE 3-31-2007.

CLASS 42—SCIENTIFIC AND COMPUTER SERVICES

FOR SCIENTIFIC RESEARCH; SCIENTIFIC DESIGN IN THE FIELDS OF AERONAUTICS, ASTRONAUTICS, AUTOMOTIVE TECHNOLOGY, BIO-ENGINEERING, AND ROBOTICS; TECHNOLOGY CONSULTATION IN THE FIELDS OF AERONAUTICS, ASTRONAUTICS, AUTOMOTIVE TECHNOLOGY, BIO-ENGINEERING, ROBOTICS, AND MEDICAL RESEARCH, NAMELY, THE APPLICATION OF PARAMETER AND CONTROL OPTIMIZATION TO MEDICAL SYSTEMS; INDUSTRIAL RESEARCH IN THE FIELDS OF AERONAUTICS, ASTRONAUTICS, AUTOMOTIVE TECHNOLOGY, BIO-ENGINEERING, AND ROBOTICS; DESIGN AND DEVELOPMENT OF COMPUTER HARDWARE AND SOFTWARE (U.S. CLS. 100 AND 101).

FIRST USE 3-31-2007; IN COMMERCE 3-31-2007.

AMY ALFIERI, EXAMINING ATTORNEY

SN 77-652,661. DASH FITNESS, LLC, SALT LAKE CITY, UT.
FILED 1-20-2009.

OBSIDIAN

THE MARK CONSISTS OF STANDARD CHARACTERS WITHOUT CLAIM TO ANY PARTICULAR FONT, STYLE, SIZE, OR COLOR.

CLASS 9—ELECTRICAL AND SCIENTIFIC APPARATUS

FOR DIGITAL MEDIA, NAMELY, PRE-RECORDED VIDEO CASSETTES, DIGITAL VIDEO DISCS, DIGITAL VERSATILE DISCS, DOWNLOADABLE AUDIO AND VIDEO RECORDINGS, DVDS, AND HIGH DEFINITION DIGITAL DISKS FEATURING INFORMATION ON EXERCISE, FITNESS AND NUTRITION (U.S. CLS. 21, 23, 26, 36 AND 38).

CLASS 28—TOYS AND SPORTING GOODS

FOR EXERCISE EQUIPMENT, NAMELY, EXERCISE EQUIPMENT FOR LATERAL MOVEMENT; PORTABLE SUPPORT STRUCTURES FOR DANCE AND OTHER EXERCISES; MANUALLY-OPERATED EXERCISE EQUIPMENT (U.S. CLS. 22, 23, 38 AND 50).

CLASS 44—MEDICAL, BEAUTY AND AGRICULTURAL SERVICES

FOR HEALTH SPA SERVICES FOR HEALTH AND WELLNESS OF THE BODY AND SPIRIT OFFERED AT A HEALTH CLUB FACILITY; PROVIDING A WEB SITE FEATURING INFORMATION ON NUTRITION (U.S. CLS. 100 AND 101).

LINDSEY RUBIN, EXAMINING ATTORNEY

SN 77-653,511. KUBIK INC., MISSISSAUGA, CANADA,
FILED 1-21-2009.



PRIORITY CLAIMED UNDER SEC. 44(D) ON CANADA APPLICATION NO. 1404493, FILED 7-23-2008, REG. NO. TMA757298, DATED 1-19-2010, EXPIRES 1-19-2025.

THE MARK CONSISTS OF A SMALL CASE LETTER "M" WITHIN A SQUARE OF CONTRASTING COLOR.

CLASS 35—ADVERTISING AND BUSINESS

FOR ADVERTISING SERVICES, NAMELY, PROMOTING AND MARKETING THE GOODS AND SERVICES OF OTHERS THROUGH ALL PUBLIC COMMUNICATION MEANS; ARRANGING AND CONDUCTING OF EXHIBITIONS FOR BUSINESS AND ADVERTISING PURPOSES FOR OTHERS (U.S. CLS. 100, 101 AND 102).
FIRST USE 3-31-2007; IN COMMERCE 3-31-2007.

CLASS 37—CONSTRUCTION AND REPAIR

FOR CONSTRUCTION AND INSTALLATION OF EXHIBITS FOR OTHERS FOR TRADE SHOWS, MUSEUMS, RETAIL STORES AND VISITOR CENTERS (U.S. CLS. 100, 103 AND 106).
FIRST USE 3-31-2007; IN COMMERCE 3-31-2007.

CLASS 42—SCIENTIFIC AND COMPUTER SERVICES

FOR DESIGNING EXHIBITS FOR OTHERS FOR TRADE SHOWS, MUSEUMS, RETAIL STORES, BUSINESS OFFICES AND VISITOR CENTERS (U.S. CLS. 100 AND 101).

FIRST USE 3-31-2007; IN COMMERCE 3-31-2007.
HELENE LIWINSKI, EXAMINING ATTORNEY

SN 77-653,558. KUBIK INC., MISSISSAUGA, CANADA,
FILED 1-21-2009.

MALTBIE A KUBIK COMPANY

THE MARK CONSISTS OF STANDARD CHARACTERS WITHOUT CLAIM TO ANY PARTICULAR FONT, STYLE, SIZE, OR COLOR.

PRIORITY CLAIMED UNDER SEC. 44(D) ON CANADA APPLICATION NO. 1404492, FILED 7-23-2008, REG. NO. TMA757310, DATED 1-19-2010, EXPIRES 1-19-2025.

OWNER OF U.S. REG. NOS. 2,700,101, 2,700,102 AND OTHERS.

NO CLAIM IS MADE TO THE EXCLUSIVE RIGHT TO USE "COMPANY", APART FROM THE MARK AS SHOWN.

CLASS 35—ADVERTISING AND BUSINESS

FOR ADVERTISING SERVICES, NAMELY, PROMOTING AND MARKETING THE GOODS AND SERVICES OF OTHERS THROUGH ALL PUBLIC COMMUNICATION MEANS; ARRANGING AND CONDUCTING OF EXHIBITIONS FOR BUSINESS AND ADVERTISING PURPOSES FOR OTHERS (U.S. CLS. 100, 101 AND 102).
FIRST USE 3-31-2007; IN COMMERCE 3-31-2007.

CLASS 37—CONSTRUCTION AND REPAIR

FOR CONSTRUCTION AND INSTALLATION OF EXHIBITS FOR OTHERS FOR TRADE SHOWS, MUSEUMS, RETAIL STORES AND VISITOR CENTERS (U.S. CLS. 100, 103 AND 106).

FIRST USE 3-31-2007; IN COMMERCE 3-31-2007.

CLASS 42—SCIENTIFIC AND COMPUTER SERVICES

FOR DESIGNING EXHIBITS FOR OTHERS FOR TRADE SHOWS, MUSEUMS, RETAIL STORES, BUSINESS OFFICES AND VISITOR CENTERS (U.S. CLS. 100 AND 101).

FIRST USE 3-31-2007; IN COMMERCE 3-31-2007.
HELENE LIWINSKI, EXAMINING ATTORNEY

SN 77-655,402. MORALES, JOSEPH, ELMHURST, NY. FILED 1-23-2009.



THE MARK CONSISTS OF THE WORD "MORALES" IN STYLIZED FORM WITH A FANCIFUL LINE UNDERNEATH AND TO THE LEFT. THE MARK ALSO INCLUDES AN EYE-SHAPED DESIGN WITHIN A DIAMOND.

CLASS 16—PAPER GOODS AND PRINTED MATTER

FOR PRINTED PAPER GOODS MADE FROM ORGANIC MATERIAL CONTAINING ART PRINTS, NAMELY, INFORMATION FLYERS FEATURING BUSINESS PRICING AMENDMENTS, FEATURED ITEMS AND SPECIAL OFFERS, NEWSLETTERS FEATURING INFORMATION ABOUT BUSINESS INITIATIVES AND ACCOMPLISHMENTS AND BUSINESS POLICIES, POSTCARDS, STICKERS, BUSINESS CARDS, CALENDARS AND LETTERHEAD PAPER (U.S. CLS. 2, 5, 22, 23, 29, 37, 38 AND 50).

CLASS 18—LEATHER GOODS

FOR TOTE BAGS AND MESSENGER BAGS MADE OF LEATHER, IMITATION LEATHER, CANVAS, AND ANIMAL SKINS (U.S. CLS. 1, 2, 3, 22 AND 41).

CLASS 25—CLOTHING

FOR MEN'S, WOMEN'S AND CHILDREN'S CLOTHING MADE OF ORGANIC COTTON, NAMELY, UNISEX T-SHIRTS, T-SHIRT DRESSES, TANK TOPS, TANK DRESSES, LEGGINGS, SCARVES, KNIT CAPS, ZIP-UP AND HOODED PULLOVERS, TRACK TOPS AND FOOTWEAR (U.S. CLS. 22 AND 39).

DAWN HAN, EXAMINING ATTORNEY

SN 77-655,603. BOWMAN MANUFACTURING CO., INC., ARLINGTON, WA. FILED 1-23-2009.

BOWMAN

THE MARK CONSISTS OF STANDARD CHARACTERS WITHOUT CLAIM TO ANY PARTICULAR FONT, STYLE, SIZE, OR COLOR.
SEC. 2(F).

CLASS 6—METAL GOODS

FOR COMMERCIAL DISPENSERS OF METAL SOLD EMPTY FOR SANITARY OR HYGIENIC MEDICAL GLOVES (U.S. CLS. 2, 12, 13, 14, 23, 25 AND 50).
FIRST USE 7-0-1990; IN COMMERCE 7-0-1990.

CLASS 10—MEDICAL APPARATUS

FOR RECEPTACLES IN THE NATURE OF CONTAINERS SPECIALLY ADAPTED FOR HOLDING MEDICAL MASKS SOLD EMPTY FOR USE BY HEALTH CARE PROVIDERS; COMMERCIAL DISPENSERS SOLD EMPTY SPECIALLY ADAPTED FOR HOLDING SANITARY OR HYGIENIC MEDICAL GLOVES; AEROSOL DISPENSERS FOR MEDICAL USE (U.S. CLS. 26, 39 AND 44).

FIRST USE 7-0-1990; IN COMMERCE 7-0-1990.
ZHALEH DELANEY, EXAMINING ATTORNEY

SN 77-655,721. CAPSA SOLUTIONS, LLC, WOODINVILLE, WA. FILED 1-23-2009.

CapsaSolutions

THE MARK CONSISTS OF STANDARD CHARACTERS WITHOUT CLAIM TO ANY PARTICULAR FONT, STYLE, SIZE, OR COLOR.

CLASS 12—VEHICLES

FOR CARTS; HOSPITAL AND HEALTHCARE FACILITY CARTS; MOTORIZED HOSPITAL AND HEALTHCARE FACILITIES CARTS FOR DELIVERING OR DISPENSING MEDICATION; MOTORIZED CART MOVERS; DOLLY TRUCKS AND HAND TRUCKS (U.S. CLS. 19, 21, 23, 31, 35 AND 44).

CLASS 20—FURNITURE AND ARTICLES NOT OTHERWISE CLASSIFIED

FOR TABLES; WORKSTATIONS HAVING MULTI-USE WORK SURFACES FOR USE IN A WIDE VARIETY OF FIELDS; SHELVING AND STORAGE SYSTEMS COMPRISING SHELVES, SHELF LINERS OF METAL AND NON-METAL, SHELF DIVIDERS, SUPPORT FRAMES OF METAL, BINS OF NON-METAL, BIN DIVIDERS OF METAL AND NON-METAL, SUPPORT POSTS OF METAL, AND POST CLAMPS OF NON-METAL, SOLD AS A UNIT; SHELVING; MOBILE SHELVING; ROLLING SHELVING FOR FILING AND STORAGE; SECURITY CABINETS; STORAGE RACKS FOR GARMENTS, DISPLAY RACKS FOR GARMENTS AND FREESTANDING MOBILE GARMENT RACKS; AND HANGER MANAGEMENT SYSTEMS COMPRISING STORAGE RACKS AND HANGER RETAINER BARS (U.S. CLS. 2, 13, 22, 25, 32 AND 50).

TARA PATE, EXAMINING ATTORNEY

SN 77-655,722. CAPSA SOLUTIONS, LLC, WOODINVILLE, WA. FILED 1-23-2009.



THE MARK CONSISTS OF TWO OPPOSING BLOCK LETTER "C"'S EACH FLANKED BY THREE "S"'S OF DIMINISHING SIZE AND DARKNESS.

CLASS 12—VEHICLES

FOR CARTS; HOSPITAL AND HEALTHCARE FACILITY CARTS; MOTORIZED HOSPITAL AND HEALTHCARE FACILITIES CARTS FOR DELIVERING OR DISPENSING MEDICATION; MOTORIZED CART MOVERS; DOLLY TRUCKS AND HAND TRUCKS (U.S. CLS. 19, 21, 23, 31, 35 AND 44).

SN 77-670,281. JAGGED PEAK, INC., TAMPA, FL. FILED 2-13-2009.

CLASS 20—FURNITURE AND ARTICLES NOT OTHERWISE CLASSIFIED

FOR TABLES; WORKSTATIONS HAVING MULTI-USE WORK SURFACES FOR USE IN A WIDE VARIETY OF FIELDS; SHELVING AND STORAGE SYSTEMS COMPRISING SHELVES, SHELF LINERS OF METAL AND NON-METAL, SHELF DIVIDERS, SUPPORT FRAMES OF METAL, BINS OF NON-METAL, BIN DIVIDERS OF METAL AND NON-METAL, SUPPORT POSTS OF METAL, AND POST CLAMPS OF NON-METAL, SOLD AS A UNIT; SHELVING; MOBILE SHELVING; ROLLING SHELVING FOR FILING AND STORAGE; SECURITY CABINETS; STORAGE RACKS FOR GARMENTS, DISPLAY RACKS FOR GARMENTS AND FREESTANDING MOBILE GARMENT RACKS; AND HANGER MANAGEMENT SYSTEMS COMPRISING STORAGE RACKS AND HANGER RETAINER BARS (U.S. CLS. 2, 13, 22, 25, 32 AND 50).

TARA PATE, EXAMINING ATTORNEY

EDGE

THE MARK CONSISTS OF STANDARD CHARACTERS WITHOUT CLAIM TO ANY PARTICULAR FONT, STYLE, SIZE, OR COLOR.

CLASS 9—ELECTRICAL AND SCIENTIFIC APPARATUS

FOR COMPUTER SOFTWARE FOR ELECTRONIC BUSINESS MANAGEMENT, NAMELY, COMPUTER SOFTWARE FOR ORDER MANAGEMENT AND SUPPLY CHAIN MANAGEMENT (U.S. CLS. 21, 23, 26, 36 AND 38).

FIRST USE 8-1-2001; IN COMMERCE 8-1-2001.

SN 77-667,004. CALIFORNIA INNOVATIONS INC., TORONTO, ONTARIO, CANADA, FILED 2-10-2009.



THE MARK CONSISTS OF A LIGHTBULB, OVERLAID BY AN APPLE, BOTH OF WHICH ARE OVERLAID BY AN EXCLAMATION POINT, TO THE RIGHT OF WHICH APPEARS THE WORDS "BRAIN FUEL", UNDERNEATH OF WHICH THE WORDS "MAXIMIZE LEARNING POTENTIAL" APPEAR.

CLASS 42—SCIENTIFIC AND COMPUTER SERVICES

FOR APPLICATION SERVICE PROVIDER (ASP) FEATURING SOFTWARE FOR USE IN ELECTRONIC BUSINESS MANAGEMENT, NAMELY, COMPUTER SOFTWARE FOR ORDER MANAGEMENT AND SUPPLY CHAIN MANAGEMENT (U.S. CLS. 100 AND 101).

FIRST USE 8-1-2001; IN COMMERCE 8-1-2001.
LESLIE RICHARDS, EXAMINING ATTORNEY

CLASS 16—PAPER GOODS AND PRINTED MATTER

FOR PRINTED MATERIALS, NAMELY, INFORMATIONAL MATERIALS IN THE FORM OF PAMPHLETS AND BROCHURES, IN THE FIELD OF NUTRITION AND EXERCISE TO HELP IMPROVE INDIVIDUAL LEARNING POTENTIAL THAT DIRECT PEOPLE TO RELATED INTERNET WEBSITES, ALL SOLD AS A UNIT WITH LUNCH BOXES AND THERMAL INSULATED CONTAINERS FOR FOOD AND BEVERAGES (U.S. CLS. 2, 5, 22, 23, 29, 37, 38 AND 50).

SN 77-671,790. DDN/OBERGFEL, LLC, MENOMONEE FALLS, WI. FILED 2-17-2009.

DDN

CLASS 21—HOUSEWARES AND GLASS

FOR THERMAL INSULATED CONTAINERS FOR FOOD AND BEVERAGES; THERMAL INSULATED LUNCH BOXES (U.S. CLS. 2, 13, 23, 29, 30, 33, 40 AND 50).

EUGENIA MARTIN, EXAMINING ATTORNEY

THE MARK CONSISTS OF STANDARD CHARACTERS WITHOUT CLAIM TO ANY PARTICULAR FONT, STYLE, SIZE, OR COLOR.

OWNER OF U.S. REG. NO. 2,694,490.

CLASS 35—ADVERTISING AND BUSINESS

FOR BUSINESS MANAGEMENT SERVICES, NAMELY, MANAGING LOGISTICS, REVERSE LOGISTICS, SUPPLY CHAIN SERVICES, SUPPLY CHAIN VISIBILITY AND SYNCHRONIZATION, AND PRODUCT DISTRIBUTION PROCESSES FOR OTHERS; INFORMATION MANAGEMENT SERVICES, NAMELY, SHIPMENT PROCESSING, PREPARING SHIPPING DOCUMENTS AND INVOICES, TRACKING DOCUMENTS, PACKAGES AND FREIGHT OVER COMPUTER NETWORKS; BUSINESS ADMINISTRATION AND MANAGEMENT SERVICES, NAMELY, ADMINISTRATION AND MANAGEMENT OF CONTRACTS AND MANAGED CARE CONTRACTS AND FEDERAL SUPPLY SCHEDULE CONTRACTS, PROCESSING MEDICAID, FEDERAL SUPPLY SCHEDULE, AND PHARMACEUTICAL AND MEDICAL SERVICES REBATES, GOVERNMENT COST PRICE ANALYSIS; BUSINESS INFORMATION MANAGEMENT, NAMELY, REPORTING GOVERNMENT AND CUSTOMER BUSINESS INFORMATION; ACCOUNTS RECEIVABLE SERVICES; PREPARING CUSTOMIZED BUSINESS REPORTS; TRACKING AND RECONCILIATION OF CHARGEBACK ACCOUNTS ON BEHALF OF OTHERS; OPERATION OF TELEPHONE CALL CENTERS FOR OTHERS, NAMELY, TAKING PRODUCT ORDERS VIA PHONE, FAX, EMAIL, AND ELECTRONIC DATA EXCHANGE, RELEASING ORDERS AND CONFIRMING INVENTORY CHANGES, PROCESSING RETURNS, HANDLING GENERAL CUSTOMER INQUIRES; COLLECTION OF ACCOUNTS, NAMELY, ADMINISTRATION, BILLING AND RECONCILIATION OF ACCOUNTS ON BEHALF OF OTHERS (U.S. CLS. 100, 101 AND 102).

FIRST USE 4-4-1992; IN COMMERCE 4-4-1992.

CLASS 36—INSURANCE AND FINANCIAL

FOR HEALTHCARE AND PRESCRIPTION BENEFIT CHARGEBACK PAYMENT PROCESSING AND REPORTING ON BEHALF OF OTHERS (U.S. CLS. 100, 101 AND 102).

FIRST USE 4-4-1992; IN COMMERCE 4-4-1992.

CLASS 39—TRANSPORTATION AND STORAGE

FOR SUPPLY CHAIN, LOGISTICS AND REVERSE LOGISTICS SERVICES, NAMELY, STORAGE TRANSPORTATION AND DELIVERY OF DOCUMENTS, PACKAGES, RAW MATERIALS, AND OTHER FREIGHT FOR OTHERS BY AIR, RAIL, SHIP OR TRUCK; TRANSPORTATION AND STORAGE OF GOODS IN REFRIGERATED AND FROZEN CONDITIONS (U.S. CLS. 100 AND 105).

FIRST USE 4-4-1992; IN COMMERCE 4-4-1992.

TARA PATE, EXAMINING ATTORNEY

SN 77-673,739. PAMCO MACHINE COMPANY, INC., LEWISTON, ME. FILED 2-19-2009.



THE MARK CONSISTS OF AN OVAL GLOBE, WITH LATITUDE AND LONGITUDE LINES, AND THE WORD "INTERNATIONAL" AT THE CENTER.

CLASS 7—MACHINERY

FOR MACHINES FOR MAKING FOOTWEAR AND PARTS THEREFOR (U.S. CLS. 13, 19, 21, 23, 31, 34 AND 35).

CLASS 17—RUBBER GOODS

FOR RUBBER AND LATEX FOR USE IN THE MANUFACTURE OF FOOTWEAR (U.S. CLS. 1, 5, 12, 13, 35 AND 50).

HAI-LY LAM, EXAMINING ATTORNEY

SN 77-675,118. FACECAKE MARKETING TECHNOLOGIES, INC., CALABASAS, CA. FILED 2-20-2009.

GET FRAMED!

THE MARK CONSISTS OF STANDARD CHARACTERS WITHOUT CLAIM TO ANY PARTICULAR FONT, STYLE, SIZE, OR COLOR.

CLASS 9—ELECTRICAL AND SCIENTIFIC APPARATUS

FOR COMPUTER SOFTWARE FOR MANIPULATING, ANIMATING, ENHANCING, UPLOADING, AND DOWNLOADING DIGITAL CONTENT, DOCUMENTS, PHOTOGRAPHS, IMAGES, VIDEO, AND AUDIO; COMPUTER SOFTWARE FOR LINKING METADATA TAGS WITH PHOTOGRAPHIC AND OTHER MEDIA FILES TO ENABLE SEARCH ENGINE RETRIEVAL AND DATABASE SOFTWARE COLLECTIONS OF FILES AND THEIR ON-LINE SHARING, AND FOR LINKING METADATA TAGS WITH WEB PAGES VISITED, TO CREATE LINKS WHICH USERS CAN MAINTAIN FOR THEMSELVES AND SHARE WITH ON-LINE GROUPS AND WEBSITE TAGGING, FOUND ON FIXED LINE, MOBILE AND WIRELESS DEVICES, NAMELY COMPUTERS, CELL PHONES, AND HANDHELD DIGITAL ELECTRONIC DEVICES (U.S. CLS. 21, 23, 26, 36 AND 38).

CLASS 38—COMMUNICATION

FOR ELECTRONIC TRANSMISSION OF MESSAGES, IMAGES, DATA AND VIDEOS, VIA FIXED LINE, MOBILE AND WIRELESS DEVICES, NAMELY COMPUTERS, CELL PHONES, AND HANDHELD DIGITAL ELECTRONIC DEVICES; TELECOMMUNICATIONS SERVICES, NAMELY, ELECTRONIC MAIL SERVICES; PROVIDING ONLINE FORUMS FOR DISCUSSION, ELECTRONIC BULLETIN BOARDS, AND ELECTRONIC MESSAGE BOARDS FOR TRANSMISSION OF MESSAGES AMONG USERS IN THE FIELD OF GENERAL INTEREST; PROVIDING ON-LINE ELECTRONIC BULLETIN BOARDS FOR TRANSMISSION OF MESSAGES AMONG USERS CONCERNING PHOTOGRAPHS (U.S. CLS. 100, 101 AND 104).

CLASS 42—SCIENTIFIC AND COMPUTER SERVICES

FOR PROVIDING TEMPORARY USE OF NON-DOWNLOADABLE COMPUTER SOFTWARE FOR THE TRANSMISSION, REPRODUCTION, RECEIVING, ACCESSING, SEARCHING, INDEXING, MANIPULATION, AND RETRIEVING OF DIGITAL CONTENT, DOCUMENTS, PHOTOGRAPHS, IMAGES, VIDEO, AND AUDIO, ALL FOR USE IN RELATION TO FIXED LINE, MOBILE AND WIRELESS DEVICES, NAMELY COMPUTERS, CELL PHONES, AND HANDHELD DIGITAL ELECTRONIC DEVICES (U.S. CLS. 100 AND 101).

KIM SAITO, EXAMINING ATTORNEY

SN 77-676,649. BABY BESPOKE BY KATHRYN BEACH, LLC,
NEW YORK, NY. FILED 2-24-2009.

BABY BESPOKE BY KATHRYN
BEACH

THE MARK CONSISTS OF STANDARD CHARACTERS WITHOUT CLAIM TO ANY PARTICULAR FONT, STYLE, SIZE, OR COLOR.

NO CLAIM IS MADE TO THE EXCLUSIVE RIGHT TO USE "BABY BESPOKE", APART FROM THE MARK AS SHOWN.

THE NAME(S), PORTRAIT(S), AND/OR SIGNATURE(S) SHOWN IN THE MARK IDENTIFIES "KATHRYN BEACH", WHOSE CONSENT(S) TO REGISTER IS MADE OF RECORD.

CLASS 16—PAPER GOODS AND PRINTED MATTER

FOR STATIONERY (U.S. CLS. 2, 5, 22, 23, 29, 37, 38 AND 50).

CLASS 18—LEATHER GOODS

FOR DIAPER BAGS (U.S. CLS. 1, 2, 3, 22 AND 41).

CLASS 20—FURNITURE AND ARTICLES NOT OTHERWISE CLASSIFIED

FOR BASSINETS; DIAPER CHANGING MATS (U.S. CLS. 2, 13, 22, 25, 32 AND 50).

CLASS 24—FABRICS

FOR CHILDREN'S BEDDING, NAMELY, BED SHEETS, PILLOW CASES, TOWELS, WASHCLOTHS AND BLANKETS (U.S. CLS. 42 AND 50).

CLASS 25—CLOTHING

FOR CHILDREN'S CLOTHING, NAMELY, COVERS, ALLS, INFANT BODY SUITS, VESTS, SWEATERS, COATS, KIMONOS, SHIRTS, PANTS, LEGGINGS, DRESSES, SKIRTS, SLEEPWEAR, SOCKS, STOCKINGS, UNDERGARMENTS, DIAPER COVERS, BOOTIES, CLOTH BIBS, HATS, MITTENS AND SHOES; BABY BUNTING (U.S. CLS. 22 AND 39).

JOHN DWYER, EXAMINING ATTORNEY

SN 77-682,249. SNOW PEAK, INC., SANJO-SHI, NIIGATA,
JAPAN, FILED 3-3-2009.

snow peak

THE MARK CONSISTS OF STANDARD CHARACTERS WITHOUT CLAIM TO ANY PARTICULAR FONT, STYLE, SIZE, OR COLOR.

OWNER OF U.S. REG. NO. 2,355,588.

CLASS 4—LUBRICANTS AND FUELS

FOR SILICON GREASE FOR GASOLINE BURNER; GASEOUS FUELS PACKED IN SMALL CONTAINER FOR PORTABLE GAS COOKING STOVE; LIQUEFIED PETROLEUM GASES (U.S. CLS. 1, 6 AND 15).

FIRST USE 12-0-1993; IN COMMERCE 12-0-1999.

CLASS 8—HAND TOOLS

FOR BLADED OR POINTED HAND TOOLS, NAMELY, FIELD KITCHEN KNIVES AND FISHING KNIVES; SCISSORS; SCREWDRIVERS; HAMMERS; SPOONS; FORKS; SMALL SHOVELS FOR CARRYING CHARCOAL OR ASHES; FIREPLACE POKERS; FIREPLACE FIRE TONGS (U.S. CLS. 23, 28 AND 44).

FIRST USE 12-0-1993; IN COMMERCE 12-0-1999.

CLASS 11—ENVIRONMENTAL CONTROL APPARATUS

FOR NON-ELECTRIC, GAS COOKING HEATERS; BARBECUE GRILLS; ELECTRIC COOKING STOVE FOR HOUSE HOLD PURPOSES; GAS LAMPS, HANDLES FOR GAS LAMPS, SHADE FOR GAS LAMPS AND CARRY CASE FOR GAS LAMPS; CHIMNEYS FOR OIL LAMPS; FIRE PLACES; IGNITION INSTRUMENT FOR CHARCOAL GRILLS FOR OUTDOOR USE, NAMELY, GAS BURNER; STANDS FOR PORTABLE COOKING STOVES (U.S. CLS. 13, 21, 23, 31 AND 34).

FIRST USE 12-0-1993; IN COMMERCE 12-0-1999.

CLASS 18—LEATHER GOODS

FOR DOG COLLARS; DOG LEADS; CARRY-ON BAGS; POUCHES OF LEATHER AND OF FELT; REUSABLE SHOPPING BAGS, VANITY CASES, NOT FITTED; UMBRELLAS AND THEIR PARTS; TELESCOPIC UMBRELLAS; TOILETRY CASES SOLD EMPTY (U.S. CLS. 1, 2, 3, 22 AND 41).

FIRST USE 12-0-1993; IN COMMERCE 12-0-1999.

CLASS 20—FURNITURE AND ARTICLES NOT OTHERWISE CLASSIFIED

FOR JAPANESE FLOOR CUSHIONS (ZABUTON); MATTRESSES; PILLOWS; TABLES; CHAIRS; PORTABLE COLLAPSIBLE BEDS; BENCHES; SLEEPING BAGS FOR CAMPING; KITCHEN WORKTOPS (U.S. CLS. 2, 13, 22, 25, 32 AND 50).

FIRST USE 12-0-1993; IN COMMERCE 12-0-1999.

CLASS 21—HOUSEWARES AND GLASS

FOR NON-ELECTRIC COOKING POTS; NON-ELECTRIC COOKING PANS; FRYING PANS; NON-ELECTRIC COFFEE POTS; NON-ELECTRIC KETTLES; NON-ELECTRIC GRIDDLES; TABLEWARE, NAMELY, DISHES AND PLATES; DRINKING CUPS; JAPANESE STYLE SOUP SERVING BOWLS (WAN); MUGS; NON-ELECTRIC PORTABLE COLDBOXES; DRINKING FLASKS FOR TRAVELERS; COOKING UTENSILS, NAMELY, GRILLS; CHOPPING BOARDS FOR KITCHEN USE; CHOPSTICKS; HOUSEHOLD CONTAINERS FOR STORING SEASONINGS AND CONDIMENTS; PORTABLE COOKING KITS FOR OUTDOOR USE (U.S. CLS. 2, 13, 23, 29, 30, 33, 40 AND 50).

FIRST USE 12-0-1993; IN COMMERCE 12-0-1999.

CLASS 22—CORDAGE AND FIBERS

FOR TARPAULINS FOR CAMPING; TENTS FOR MOUNTAINEERING OR CAMPING (U.S. CLS. 1, 2, 7, 19, 22, 42 AND 50).

FIRST USE 12-0-1993; IN COMMERCE 12-0-1999.

CLASS 25—CLOTHING

FOR GLOVES; HEADGEAR FOR WEAR, NAMELY, HATS AND CAPS FOR OUTDOOR (U.S. CLS. 22 AND 39).

FIRST USE 12-0-1993; IN COMMERCE 12-0-1999.

ELISSA GARBER KON, EXAMINING ATTORNEY

SN 77-682,724. MURPHY & MILLER, INC., CHICAGO, IL.
FILED 3-3-2009.



THE COLOR(S) DARK GREEN, LIGHT GREEN, YELLOW GREEN, BLACK AND WHITE IS/ARE CLAIMED AS A FEATURE OF THE MARK.

THE MARK CONSISTS OF A WAVED BAND COMPRISED OF THREE GREEN STRIPES, DARK GREEN ON TOP, LIGHT GREEN IN THE MIDDLE, AND YELLOW GREEN ON THE BOTTOM. TRANPOSED ON TOP OF THE WAVED BAND IS A TECHNICIAN FIGURE WEARING GREEN AND BLACK, WITH A WHITE FACE, HANDS, FEET, AND TOOL BOX. THE TECHNICIAN APPEARS INSIDE A YELLOW GREEN CIRCLE WITH A BLACK AND DARK GREEN BORDER.

CLASS 37—CONSTRUCTION AND REPAIR

FOR HVAC CONTRACTOR SERVICES, NAMELY, THE INSTALLATION, MAINTENANCE AND REPAIR OF HVAC SYSTEMS; CONSULTING IN THE FIELD OF HVAC CONTRACTOR SERVICES (U.S. CLS. 100, 103 AND 106).

FIRST USE 12-31-1997; IN COMMERCE 12-31-1997.

CLASS 42—SCIENTIFIC AND COMPUTER SERVICES

FOR DESIGN OF HVAC SYSTEMS (U.S. CLS. 100 AND 101).

FIRST USE 12-31-1997; IN COMMERCE 12-31-1997.

LAURIE KAUFMAN, EXAMINING ATTORNEY

SN 77-682,729. MURPHY & MILLER, INC., CHICAGO, IL.
FILED 3-3-2009.



THE MARK CONSISTS OF THE STYLIZED PRESENTATION OF THE WORD "MURF" ON THE LEFT BREAST OF A TECHNICIAN FIGURE. THE TECHNICIAN FIGURE IS INSIDE OF A CIRCLE.

CLASS 37—CONSTRUCTION AND REPAIR

FOR HVAC CONTRACTOR SERVICES, NAMELY, THE INSTALLATION, MAINTENANCE AND REPAIR OF HVAC SYSTEMS; CONSULTING IN THE FIELD OF HVAC CONTRACTOR SERVICES (U.S. CLS. 100, 103 AND 106).

FIRST USE 12-31-1997; IN COMMERCE 12-31-1997.

CLASS 42—SCIENTIFIC AND COMPUTER SERVICES

FOR DESIGN OF HVAC SYSTEMS (U.S. CLS. 100 AND 101).

FIRST USE 12-31-1997; IN COMMERCE 12-31-1997.

SUNG IN, EXAMINING ATTORNEY

SN 77-682,741. FACECAKE MARKETING TECHNOLOGIES, INC., CALABASAS, CA. FILED 3-3-2009.

FRAMEWIZARD

THE MARK CONSISTS OF STANDARD CHARACTERS WITHOUT CLAIM TO ANY PARTICULAR FONT, STYLE, SIZE, OR COLOR.

CLASS 9—ELECTRICAL AND SCIENTIFIC APPARATUS

FOR DIGITAL PHOTO FRAMES, ALBUMS, KEY CHAINS, CLOCKS, MAGNETS, ORNAMENTS AND CUBES FOR VIEWING DIGITAL PHOTOGRAPHS, IMAGES, VIDEO, PLAYING AUDIO AND RUNNING INTERACTIVE SOFTWARE; COMPUTER PROGRAMS, NAMELY, COMPUTER SOFTWARE OPERATING SYSTEM ENHANCEMENT ADD-ON PROGRAMS; ACCESSORIES FOR DIGITAL PHOTO FRAMES, ALBUMS, KEY CHAINS, CLOCKS, MAGNETS, ORNAMENTS AND CUBES FOR VIEWING DIGITAL PHOTOGRAPHS, IMAGES, VIDEO, PLAYING AUDIO AND RUNNING INTERACTIVE SOFTWARE, NAMELY, POWER ADAPTORS, CARRYING CASES AND POUCHES, USB CABLES, BATTERIES, MEMORY CARDS, HEADPHONES, AUDIO SPEAKERS, VEHICLE POWER ADAPTORS, AND REMOTE CONTROLS; COMPUTER SOFTWARE FOR MANIPULATING, ANIMATING, ENHANCING, UPLOADING, AND DOWNLOADING DIGITAL CONTENT, DOCUMENTS, PHOTOGRAPHS, IMAGES, VIDEO, AND AUDIO; COMPUTER SOFTWARE FOR LINKING WITH PHOTOGRAPHIC AND OTHER MEDIA FILES TO ENABLE SEARCH ENGINE RETRIEVAL AND DATABASE SOFTWARE COLLECTIONS OF FILES AND THEIR ON-LINE SHARING, AND FOR LINKING WITH WEB PAGES VISITED, TO CREATE LINKS WHICH USERS CAN MAINTAIN FOR THEMSELVES AND SHARE WITH ON-LINE GROUPS AND WEBSITE TAGGING, FOUND ON FIXED LINE, MOBILE AND WIRELESS DEVICES, NAMELY COMPUTERS, CELL PHONES, AND HANDHELD DIGITAL ELECTRONIC DEVICES (U.S. CLS. 21, 23, 26, 36 AND 38).

CLASS 42—SCIENTIFIC AND COMPUTER SERVICES

FOR COMPUTER SERVICES, NAMELY, HOSTING AND MAINTAINING AN ONLINE WEBSITE FOR OTHERS TO UPLOAD DIGITAL PHOTOGRAPHS, IMAGES, VIDEOS AND AUDIO, OVER A GLOBAL COMPUTER NETWORK AND CREATE A VIRTUAL ONLINE BOOK OR ALBUM FOR VIEWING DIGITAL PHOTOGRAPHS, IMAGES, VIDEO, PLAYING AUDIO AND RUNNING INTERACTIVE SOFTWARE (U.S. CLS. 100 AND 101).

KIM SAITO, EXAMINING ATTORNEY

SN 77-683,283. VAUTO, INC., OAK BROOK, IL. FILED 3-4-2009.

SN 77-687,400. SEQUIN, TAMIKO, WAIANAE, HI. FILED 3-10-2009.

REAL DEAL

THE MARK CONSISTS OF STANDARD CHARACTERS WITHOUT CLAIM TO ANY PARTICULAR FONT, STYLE, SIZE, OR COLOR.

CLASS 16—PAPER GOODS AND PRINTED MATTER

FOR RESEARCH REPORT FEATURING ANALYSIS OF USED VEHICLES FOR SALE IN A DEALERS' INVENTORY, FOR THE PURPOSE OF VALUATION, ADVERTISING, COMPETITION, STOCKING, INVENTORY AND PRICING (U.S. CLS. 2, 5, 22, 23, 29, 37, 38 AND 50).

CLASS 35—ADVERTISING AND BUSINESS

FOR PROVIDING BUSINESS AND CONSUMER INFORMATION IN THE FIELD OF MOTOR VEHICLE HISTORY INFORMATION IN A DEALER'S INVENTORY FOR THE PURPOSE OF VALUATION, ADVERTISING, COMPETITION, STOCKING, INVENTORY AND PRICING (U.S. CLS. 100, 101 AND 102).
TAMARA FRAZIER, EXAMINING ATTORNEY

SN 77-684,395. PROTECH, LLC, TAMPA, FL. FILED 3-5-2009.

AMERICA'S BEST INVESTMENT

THE MARK CONSISTS OF STANDARD CHARACTERS WITHOUT CLAIM TO ANY PARTICULAR FONT, STYLE, SIZE, OR COLOR.

CLASS 16—PAPER GOODS AND PRINTED MATTER

FOR PRINTED MATERIALS, NAMELY, BOOKS, MAGAZINES, AND BROCHURES, IN THE FIELD OF SLEEP AND SLEEP PRODUCTS, NAMELY, ADJUSTABLE BEDS, MATTRESSES, BOX SPRINGS, PILLOWS, MATTRESS PADS, MATTRESS COVERS, COMFORTERS, COMFORTER COVERS, DUVETS, DUVET COVERS, BED SHEETS, PILLOW CASES AND BLANKETS (U.S. CLS. 2, 5, 22, 23, 29, 37, 38 AND 50).

CLASS 20—FURNITURE AND ARTICLES NOT OTHERWISE CLASSIFIED

FOR ADJUSTABLE BEDS, MATTRESSES, BOX SPRINGS, AND PILLOWS (U.S. CLS. 2, 13, 22, 25, 32 AND 50).

CLASS 24—FABRICS

FOR MATTRESS PADS, MATTRESS COVERS, COMFORTERS, COMFORTER COVERS, DUVETS, DUVET COVERS, BED SHEETS, PILLOW CASES AND BED BLANKETS (U.S. CLS. 42 AND 50).
JEFF DEFORD, EXAMINING ATTORNEY

Poi Kids

THE MARK CONSISTS OF STANDARD CHARACTERS WITHOUT CLAIM TO ANY PARTICULAR FONT, STYLE, SIZE, OR COLOR.

NO CLAIM IS MADE TO THE EXCLUSIVE RIGHT TO USE "KIDS", APART FROM THE MARK AS SHOWN.

CLASS 16—PAPER GOODS AND PRINTED MATTER

FOR CHILDREN'S ACTIVITY BOOKS; CHILDREN'S BOOKS; CHILDREN'S STORYBOOKS; COLORING BOOKS (U.S. CLS. 2, 5, 22, 23, 29, 37, 38 AND 50).

CLASS 18—LEATHER GOODS

FOR BACKPACKS, BOOK BAGS, SPORTS BAGS, BUM BAGS, WALLETS AND HANDBAGS; SCHOOL BAGS; TOTE BAGS; UMBRELLAS (U.S. CLS. 1, 2, 3, 22 AND 41).

CLASS 25—CLOTHING

FOR KNIT SHIRTS; SHIRTS; T-SHIRTS (U.S. CLS. 22 AND 39).

CLASS 28—TOYS AND SPORTING GOODS

FOR DOLLS; DOLLS AND DOLLS' CLOTHING (U.S. CLS. 22, 23, 38 AND 50).
RONALD MCMORROW, EXAMINING ATTORNEY

SN 77-688,126. ADIDAS AG, HERZOGENAURACH, FED REP GERMANY, FILED 3-11-2009.



THE MARK CONSISTS OF THE WORD "MI" WITHIN A STYLIZED LOWER-CASE LETTER "A".

CLASS 9—ELECTRICAL AND SCIENTIFIC APPARATUS

FOR ELECTRONIC SENSORS FOR SENSING PHYSICAL EXERCISE DATA DURING EXERCISE, NAMELY, ACCELERATION, SPEED, DISTANCE, CALORIES BURNED, STRIDE RATE AND NUMBER OF STEPS; ELECTRONIC DISPLAY DEVICES, NAMELY, LIQUID CRYSTAL DISPLAYS FOR DISPLAYING PHYSICAL EXERCISE DATA DURING EXERCISE, NAMELY, ACCELERATION, HEART RATE, SPEED, DISTANCE, CALORIES BURNED, STRIDE RATE AND NUMBER OF STEPS; ELECTRONIC PORTABLE DEVICES, NAMELY, DATA RECORDERS AND WIRELESS PHONES FOR STORING, TRANSFERRING AND SYNCHRONIZING PHYSICAL EXERCISE DATA AND STORING, TRANSFERRING, SYNCHRONIZING AND VIEWING TRAINING INSTRUCTIONS DURING EXERCISE; ELECTRONIC PORTABLE DEVICES, NAMELY, DATA RECORDERS AND WIRELESS PHONES FOR PROVIDING AUDIBLE TRAINING INSTRUCTIONS DURING EXERCISE (U.S. CLS. 21, 23, 26, 36 AND 38).

CLASS 25—CLOTHING

FOR FOOTWEAR; APPAREL, NAMELY, SHIRTS, SWEATERS, VESTS, JACKETS, COATS, PANTS, SHORTS, TIGHTS, BRAS, GLOVES; HEADWEAR, NAMELY, HATS (U.S. CLS. 22 AND 39).

CLASS 26—FANCY GOODS

FOR ARMBANDS (U.S. CLS. 37, 39, 40, 42 AND 50).
MARK PILARO, EXAMINING ATTORNEY

CLASS 35—ADVERTISING AND BUSINESS

FOR BUSINESS MANAGEMENT SERVICES, NAMELY, MANAGING LOGISTICS, REVERSE LOGISTICS, SUPPLY CHAIN SERVICES, SUPPLY CHAIN VISIBILITY AND SYNCHRONIZATION, AND PRODUCT DISTRIBUTION PROCESSES FOR OTHERS; INFORMATION MANAGEMENT SERVICES, NAMELY, SHIPMENT PROCESSING, PREPARING SHIPPING DOCUMENTS AND INVOICES, TRACKING DOCUMENTS, PACKAGES AND FREIGHT OVER COMPUTER NETWORKS; BUSINESS ADMINISTRATION AND MANAGEMENT SERVICES, NAMELY, ADMINISTRATION AND MANAGEMENT OF CONTRACTS AND MANAGED CARE CONTRACTS AND FEDERAL SUPPLY SCHEDULE CONTRACTS, PROCESSING MEDICAID, FEDERAL SUPPLY SCHEDULE, AND PHARMACEUTICAL AND MEDICAL SERVICES REBATES, GOVERNMENT COST PRICE ANALYSIS; BUSINESS INFORMATION MANAGEMENT, NAMELY, REPORTING GOVERNMENT AND CUSTOMER BUSINESS INFORMATION; ACCOUNTS RECEIVABLE SERVICES; PREPARING CUSTOMIZED BUSINESS REPORTS; TRACKING AND RECONCILIATION OF CHARGE-BACK ACCOUNTS ON BEHALF OF OTHERS; OPERATION OF TELEPHONE CALL CENTERS FOR OTHERS, NAMELY, TAKING PRODUCT ORDERS VIA PHONE, FAX, EMAIL, AND ELECTRONIC DATA EXCHANGE, RELEASING ORDERS AND CONFIRMING INVENTORY CHANGES, PROCESSING RETURNS, HANDLING GENERAL CUSTOMER INQUIRES; COLLECTION OF ACCOUNTS, NAMELY, ADMINISTRATION, BILLING AND RECONCILIATION OF ACCOUNTS ON BEHALF OF OTHERS (U.S. CLS. 100, 101 AND 102).

FIRST USE 8-20-2008; IN COMMERCE 8-20-2008.

CLASS 36—INSURANCE AND FINANCIAL

FOR HEALTHCARE AND PRESCRIPTION BENEFIT CHARGEBACK PAYMENT PROCESSING AND REPORTING ON BEHALF OF OTHERS (U.S. CLS. 100, 101 AND 102).

FIRST USE 8-20-2008; IN COMMERCE 8-20-2008.

CLASS 39—TRANSPORTATION AND STORAGE

FOR SUPPLY CHAIN, LOGISTICS AND REVERSE LOGISTICS SERVICES, NAMELY, STORAGE TRANSPORTATION AND DELIVERY OF DOCUMENTS, PACKAGES, RAW MATERIALS, AND OTHER FREIGHT FOR OTHERS BY AIR, RAIL, SHIP OR TRUCK; TRANSPORTATION AND STORAGE OF GOODS IN REFRIGERATED AND FROZEN CONDITIONS; STORAGE OF PHARMACEUTICAL, HEALTH AND PERSONAL CARE PRODUCTS (U.S. CLS. 100 AND 105).

FIRST USE 8-20-2008; IN COMMERCE 8-20-2008.
TARA PATE, EXAMINING ATTORNEY

SN 77-689,077. DDN/OBERGFEL, LLC, MENOMONEE FALLS, WI. FILED 3-12-2009.

SN 77-689,260. DEAR, MATTHEW, BROOKLYN, NY. FILED 3-12-2009.



OWNER OF U.S. REG. NO. 2,694,490.
THE MARK CONSISTS OF A CIRCLE WITH TWO WAVY LINES AND THE WORDS "DDN" OVER "PROPELLING LIFE SCIENCE" TO THE RIGHT OF THE CIRCLE.

MATTHEW DEAR

THE MARK CONSISTS OF STANDARD CHARACTERS WITHOUT CLAIM TO ANY PARTICULAR FONT, STYLE, SIZE, OR COLOR.

THE NAME(S), PORTRAIT(S), AND/OR SIGNATURE(S) SHOWN IN THE MARK IDENTIFIES "MATTHEW DEAR", A LIVING INDIVIDUAL, WHOSE CONSENT(S) TO REGISTER IS MADE OF RECORD.

CLASS 9—ELECTRICAL AND SCIENTIFIC APPARATUS

FOR PRE-RECORDED CDS AND PHONOGRAPH RECORDS FEATURING MUSIC; DOWNLOADABLE MUSIC AND VIDEO RECORDINGS (U.S. CLS. 21, 23, 26, 36 AND 38).

FIRST USE 1-0-2000; IN COMMERCE 1-0-2000.

CLASS 41—EDUCATION AND ENTERTAINMENT

FOR ENTERTAINMENT SERVICES IN THE NATURE OF LIVE MUSICAL PERFORMANCES; ENTERTAINMENT SERVICES IN THE NATURE OF DISC JOCKEY SERVICES FOR PARTIES, SPECIAL EVENTS, FESTIVALS, NIGHTCLUBS AND DANCE CLUBS (U.S. CLS. 100, 101 AND 107).

FIRST USE 10-14-2000; IN COMMERCE 10-14-2000.
ROBIN CHOSID, EXAMINING ATTORNEY

CLASS 36—INSURANCE AND FINANCIAL

FOR BROKERAGE AND TRADING OF ENERGY AND EMISSION REDUCTIONS (U.S. CLS. 100, 101 AND 102).

CLASS 42—SCIENTIFIC AND COMPUTER SERVICES

FOR SOFTWARE AS A SERVICE (SAAS) SERVICES, NAMELY, HOSTING SOFTWARE FOR USE BY OTHERS FOR USE AS A MANAGEMENT PLATFORM TO EVALUATE, TRACK, MONITOR AND MANAGE CARBON EMISSIONS (U.S. CLS. 100 AND 101).

DAVID TOOLEY, EXAMINING ATTORNEY

SN 77-689,833. VAUTO, INC., OAK BROOK, IL. FILED 3-12-2009.

SN 77-695,267. C28, INC., CORONA, CA. FILED 3-19-2009.

REAL DEAL REPORT

THE MARK CONSISTS OF STANDARD CHARACTERS WITHOUT CLAIM TO ANY PARTICULAR FONT, STYLE, SIZE, OR COLOR.

NO CLAIM IS MADE TO THE EXCLUSIVE RIGHT TO USE "REPORT", APART FROM THE MARK AS SHOWN.

CLASS 16—PAPER GOODS AND PRINTED MATTER

FOR RESEARCH REPORT FEATURING ANALYSIS OF USED VEHICLES FOR SALE IN A DEALERS' INVENTORY, FOR THE PURPOSE OF VALUATION, ADVERTISING, COMPETITION, STOCKING, INVENTORY AND PRICING (U.S. CLS. 2, 5, 22, 23, 29, 37, 38 AND 50).

CLASS 35—ADVERTISING AND BUSINESS

FOR PROVIDING BUSINESS AND CONSUMER INFORMATION IN THE FIELD OF MOTOR VEHICLE HISTORY INFORMATION IN A DEALER'S INVENTORY FOR THE PURPOSE OF VALUATION, ADVERTISING, COMPETITION, STOCKING, INVENTORY AND PRICING (U.S. CLS. 100, 101 AND 102).

TAMARA FRAZIER, EXAMINING ATTORNEY

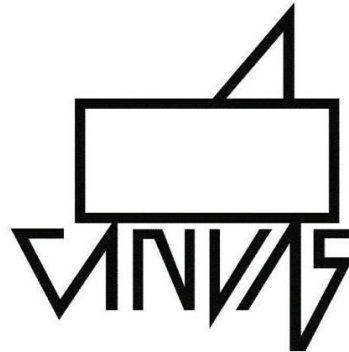

NO CLAIM IS MADE TO THE EXCLUSIVE RIGHT TO USE "CANVAS" IN INTERNATIONAL CLASS 25, APART FROM THE MARK AS SHOWN.

THE MARK CONSISTS OF THE WORD CANVAS WRITTEN IN FANTASY LETTERING WITH A RECTANGLE ABOVE THE WORD CANVAS AND A TRIANGLE LYING ON TOP OF THE RECTANGLE.

SN 77-693,237. CARBONETWORKS CORPORATION, VICTORIA, BC, CANADA, FILED 3-17-2009.

CLASS 25—CLOTHING

FOR CLOTHING, NAMELY, SHIRTS, JACKETS, SWEATSHIRTS, PANTS, SWEATPANTS, SHORTS, BELTS, JUMPSUITS, WRISTBANDS, BANDANAS, HEADWEAR AND FOOTWEAR (U.S. CLS. 22 AND 39).

CARBONETWORKS

THE MARK CONSISTS OF STANDARD CHARACTERS WITHOUT CLAIM TO ANY PARTICULAR FONT, STYLE, SIZE, OR COLOR.

SEC. 2(F).

CLASS 38—COMMUNICATION

FOR PROVIDING ONLINE FORUMS FOR ELECTRONIC SUBMISSION OF ARTISTIC WORKS FOR CRITIQUE AND FOR TRANSMISSION OF MESSAGES AMONG COMPUTER USERS IN THE FIELD OF JUDGING THE ARTISTIC WORKS SUBMITTED ELECTRONICALLY TO THE ONLINE FORUMS (U.S. CLS. 100, 101 AND 104).

ELLEN PERKINS, EXAMINING ATTORNEY

SN 77-696,906. NATIONAL WILDLIFE FEDERATION, RESTON, VA. FILED 3-23-2009.

WILD ANIMAL BABY

THE MARK CONSISTS OF STANDARD CHARACTERS WITHOUT CLAIM TO ANY PARTICULAR FONT, STYLE, SIZE, OR COLOR.

OWNER OF U.S. REG. NOS. 2,770,532 AND 2,962,948. SEC. 2(F).

CLASS 9—ELECTRICAL AND SCIENTIFIC APPARATUS

FOR DIGITAL MEDIA, NAMELY, DVDS, FEATURING ANIMATION AND LIVE ACTION RELATING TO THE ENVIRONMENT, WILDLIFE, AND NATURE-RELATED SUBJECT MATTER (U.S. CLS. 21, 23, 26, 36 AND 38).

FIRST USE 10-27-2003; IN COMMERCE 10-27-2003.

CLASS 41—EDUCATION AND ENTERTAINMENT

FOR ENTERTAINMENT SERVICES, NAMELY, PRODUCTION OF DVDS, DIGITAL MEDIA, AND TELEVISION PROGRAMS FEATURING ANIMATION AND LIVE ACTION RELATING TO THE ENVIRONMENT, WILDLIFE, AND NATURE-RELATED SUBJECT MATTER (U.S. CLS. 100, 101 AND 107).

FIRST USE 10-27-2003; IN COMMERCE 10-27-2003. REGINA DRUMMOND, EXAMINING ATTORNEY

SN 77-698,841. FISCHER, SEBASTIAN, WÜRZBURG, FED REP GERMANY, FILED 3-25-2009.

TURBO PRODUKTE

PRIORITY CLAIMED UNDER SEC. 44(D) ON FED REP GERMANY APPLICATION NO. 007282701, FILED 10-2-2008, REG. NO. 007282701, DATED 6-30-2009, EXPIRES 10-2-2018.

NO CLAIM IS MADE TO THE EXCLUSIVE RIGHT TO USE "PRODUKTE", APART FROM THE MARK AS SHOWN.

THE MARK CONSISTS OF THE TERMS "TURBO PRODUKTE" WITHIN THE DESIGN OF AN OBLONG DIVIDED INTO TWO PARTS WITH "TURBO" IN LIGHT LETTERS IN THE LEFT SHADED PART AND "PRODUKTE" IN DARK LETTERS IN THE RIGHT PART, WHICH IS NOT SHADED.

THE ENGLISH TRANSLATION OF "PRODUKTE" IN THE MARK IS "PRODUCTS."

CLASS 8—HAND TOOLS

FOR HAND-OPERATED FOOD PROCESSORS; HAND-OPERATED KITCHEN APPLIANCES FOR DICING, MINCING, SLICING, CHOPPING, GRATING AND PEELING FOOD; MANDOLIN SLICERS; MANDOLIN BOARDS; EXCHANGEABLE INSERTS AND BLADES FOR HAND-OPERATED KITCHEN APPLIANCES FOR DICING, MINCING, SLICING, CHOPPING, GRATING AND PEELING FOOD AND FOR MANDOLIN SLICERS; HOUSEHOLD KNIVES (U.S. CLS. 23, 28 AND 44).

CLASS 21—HOUSEWARES AND GLASS

FOR MANDOLIN SLICING BOARDS; COOKWARE FOR PREPARING BREAKFAST EGGS IN THE MICROWAVE; ALL PURPOSE PORTABLE HOUSEHOLD CONTAINERS; HAND-OPERATED FOOD GRINDERS (U.S. CLS. 2, 13, 23, 29, 30, 33, 40 AND 50).

CLASS 35—ADVERTISING AND BUSINESS

FOR WHOLESALE DISTRIBUTORSHIPS AND RETAIL STORE SERVICES FEATURING: HAND-OPERATED FOOD PROCESSORS; HAND-OPERATED KITCHEN APPLIANCES FOR DICING, MINCING, SLICING, CHOPPING, GRATING AND PEELING FOOD; MANDOLIN SLICERS; MANDOLIN BOARDS; EXCHANGEABLE INSERTS AND BLADES FOR HANDOPERATED KITCHEN APPLIANCE FOR DICING, MINCING, SLICING, CHOPPING, GRATING AND PEELING FOOD AND FOR MANDOLIN SLICERS; HOUSEHOLD KNIVES; BAG CLOSURES; CONTAINERS FOR PREPARING BREAKFAST EGGS IN THE MICROWAVE; ALL PURPOSE PORTABLE HOUSEHOLD CONTAINERS; HAND-OPERATED FOOD GRINDERS (U.S. CLS. 100, 101 AND 102).

BARBARA A. GOLD, EXAMINING ATTORNEY

SN 77-699,506. BRIGHTLINE PARTNERS LLC, NEW YORK, NY. FILED 3-26-2009.

BRIGHTLINE TV

THE MARK CONSISTS OF STANDARD CHARACTERS WITHOUT CLAIM TO ANY PARTICULAR FONT, STYLE, SIZE, OR COLOR.

NO CLAIM IS MADE TO THE EXCLUSIVE RIGHT TO USE "TV", APART FROM THE MARK AS SHOWN.

CLASS 35—ADVERTISING AND BUSINESS

FOR PROVIDING ADVERTISING, MARKETING, AND PROMOTIONAL SERVICES, NAMELY, DEVELOPMENT OF ADVERTISING CAMPAIGNS FOR TELEVISION AND INTERNET MEDIA OUTLETS; ADVERTISING SERVICES AND MARKETING SERVICES, NAMELY, PROMOTING AND MARKETING THE GOODS AND SERVICES OF OTHERS THROUGH INTERACTIVE TELEVISION CAMPAIGNS AND SERVICES (U.S. CLS. 100, 101 AND 102).

CLASS 38—COMMUNICATION

FOR BROADCASTING SERVICES, NAMELY, TRANSMISSION OF ADVERTISING PROGRAMS AND MEDIA ADVERTISING COMMUNICATIONS VIA DIGITAL COMMUNICATIONS NETWORKS; ELECTRONIC MAIL AND MESSAGING SERVICES; ELECTRONIC EXCHANGE OF DATA STORED IN DATABASES ACCESSIBLE VIA TELECOMMUNICATION NETWORKS; TRANSFER OF DATA BY TELECOMMUNICATIONS (U.S. CLS. 100, 101 AND 104).

CLASS 39—TRANSPORTATION AND STORAGE

FOR ELECTRONIC STORAGE OF DATA (U.S. CLS. 100 AND 105).

DEIRDRE ROBERTSON, EXAMINING ATTORNEY

SN 77-699,507. BRIGHTLINE PARTNERS LLC, NEW YORK, NY. FILED 3-26-2009.

THE MARK CONSISTS OF A STYLIZED SPHERE CONTAINING THREE PARTIAL ELIPSES.

BRIGHTLINE ITV

THE MARK CONSISTS OF STANDARD CHARACTERS WITHOUT CLAIM TO ANY PARTICULAR FONT, STYLE, SIZE, OR COLOR.

NO CLAIM IS MADE TO THE EXCLUSIVE RIGHT TO USE "ITV", APART FROM THE MARK AS SHOWN.

CLASS 35—ADVERTISING AND BUSINESS

FOR PROVIDING ADVERTISING, MARKETING, AND PROMOTIONAL SERVICES, NAMELY, DEVELOPMENT OF ADVERTISING CAMPAIGNS FOR TELEVISION AND INTERNET MEDIA OUTLETS; ADVERTISING SERVICES AND MARKETING SERVICES, NAMELY, PROMOTING AND MARKETING THE GOODS AND SERVICES OF OTHERS THROUGH INTERACTIVE TELEVISION CAMPAIGNS AND SERVICES (U.S. CLS. 100, 101 AND 102).

FIRST USE 12-31-2003; IN COMMERCE 12-31-2003.

CLASS 38—COMMUNICATION

FOR BROADCASTING SERVICES, NAMELY, TRANSMISSION OF ADVERTISING PROGRAMS AND MEDIA ADVERTISING COMMUNICATIONS VIA DIGITAL COMMUNICATIONS NETWORKS; ELECTRONIC MAIL AND MESSAGING SERVICES; ELECTRONIC EXCHANGE OF DATA STORED IN DATABASES ACCESSIBLE VIA TELECOMMUNICATION NETWORKS; TRANSFER OF DATA BY TELECOMMUNICATIONS (U.S. CLS. 100, 101 AND 104).

FIRST USE 12-31-2003; IN COMMERCE 12-31-2003.

CLASS 39—TRANSPORTATION AND STORAGE

FOR ELECTRONIC STORAGE OF DATA (U.S. CLS. 100 AND 105).

FIRST USE 12-31-2003; IN COMMERCE 12-31-2003.

DEIRDRE ROBERTSON, EXAMINING ATTORNEY

SN 77-701,427. MOVEA, SA, GRENOBLE, FRANCE, FILED 3-27-2009.



PRIORITY CLAIMED UNDER SEC. 44(D) ON ERPN CMNTY TM OFC APPLICATION NO. 001011142-00, FILED 9-29-2008, REG. NO. 001011142-00, DATED 9-29-2008, EXPIRES 9-29-2018.

THE STIPPLING IS FOR SHADING PURPOSES ONLY.

CLASS 9—ELECTRICAL AND SCIENTIFIC APPARATUS

FOR DISTRIBUTED AND COMPACT ELECTRONIC DEVICES FOR MEASURING, INTERPRETING, RECORDING PARAMETERS AND DATA, NAMELY, OF MOVEMENT, OF DISPLACEMENT AND OF ORIENTATION OF A HUMAN BODY, ADAPTED, IN PARTICULAR, TO THE CAPTURING OF KINEMATICS AND DYNAMICS, OF PHYSICAL OR PHYSIOLOGICAL HUMAN MOTOR ACTIVITY; PORTABLE DEVICES, NAMELY, FOR THE PURPOSE OF BIO-MECHANICAL ANALYSIS OF HUMAN MOVEMENT, NAMELY, PORTABLE ELECTRONIC SENSORS AND INTEGRATED ELECTRONIC SENSORS; ELECTRONIC DEVICES FOR ANALYZING AND MONITORING HUMAN MOVEMENTS WITH A VIEW TO THEIR QUANTIFICATION OR PERFORMANCE; APPARATUS FOR RECORDING, TRANSMISSION, PROCESSING OR REPRODUCTION DATA, MEASURING, SOUND, IMAGES COMPRISING GESTURE INTERACTION DATA TO EXAMINE AND MEASURE INTERNAL AND EXTERNAL FORCES ACTING ON THE HUMAN BODY AND THE EFFECTS PRODUCED BY THESE FORCES; ELECTRONIC MOTION DETECTORS OF EVENTS LINKED TO MOVEMENT; COMPUTER AND GAME CONSOLE PERIPHERALS, PARTICULARLY FOR THE INTERACTION OF MOVEMENT WITH MULTIMEDIA CONTENT; GESTURE-CONTROLLED ELECTRONIC DEVICES, NAMELY, MICE AND REMOTE CONTROLS FOR HUMAN MOTION MEASUREMENT; ELECTRONIC MEASURING CALCULATOR OF GEOMETRIC SHAPES; CLOTHING FOR USE IN LABORATORIES EQUIPPED WITH ELECTRONIC MEASURING, AND MOVEMENT ANALYSIS DEVICES; ELECTRONIC BRACELETS OR NECKLACES TO MEASURE HUMAN BODY MOVEMENT; SOFTWARE, NAMELY, SOFTWARE TO MONITOR HUMAN BODY MOVEMENTS AND TO PROCESS THE MEASURE OF INFORMATION RELATIVE TO MOVEMENT; SOFTWARE FOR DATABASE CREATION, MANAGEMENT, UPDATE AND USE; SOFTWARE INSTALLED IN PORTABLE DEVICES, NAMELY, MOBILE PHONES OR PERSONAL ELECTRONIC ASSISTANTS, OR ELECTRONIC NAVIGATION DEVICES FOR MEASURING, ANALYZING AND REPORTING MOVEMENT; SOFTWARE TO ENABLE ACCESS TO AN ELECTRONIC MESSAGING SERVICE; SOFTWARE TO ENABLE ACCESS TO AN INFORMATION TECHNOLOGY AND DATA TRANSMISSION NETWORK, NAMELY, A GLOBAL COMMUNICATION NETWORK OR A PRIVATE OR RESERVED NETWORK; DATA TRANSMISSION SOFTWARE OF ALL KINDS VIA A FIXED TRANSMISSION NETWORK; DIAGNOSTIC APPARATUS FOR TESTING HUMAN BODY MOVEMENT NOT FOR MEDICAL USE (U.S. CLS. 21, 23, 26, 36 AND 38).

CLASS 10—MEDICAL APPARATUS

FOR SURGICAL, MEDICAL APPARATUS AND INSTRUMENTS AND APPARATUS FOR BIOMECHANICAL ANALYSIS OF HUMAN MOVEMENT; APPARATUS FOR MEDICAL USE, NAMELY, APPARATUS FOR PHYSIOLOGICAL MEASUREMENT, NAMELY OF HUMAN MOVEMENT ENABLING ASSISTANCE WITH MEDICAL DIAGNOSIS, HEALTH RISK PREVENTION, PHYSICAL RE-EDUCATION; GONIOMETRIC MEASURING APPARATUS, NAMELY, TO EVALUATE STRETCHED JOINTS; ELECTRONIC DEVICES TO MEASURE HUMAN MOVEMENT FOR APPARATUS USED TO WORK PHYSICAL MOBILITY; ELECTRONIC DEVICES TO MEASURE MOVEMENT FOR HUMAN MOTOR FUNCTION RE-EDUCATION; ELECTRONIC PATCHES TO MEASURE HUMAN MOVEMENT ADAPTED IN PARTICULAR TO THE ANALYSIS OF MOVEMENT, TO THE MEASURING OF DIURNAL OR NOCTURNAL ACTIVITY, TO THE DETECTION OF A FALL, TO THE ANALYSIS OF THE PHYSICAL CONDITION FOR SPORT (U.S. CLS. 26, 39 AND 44).

CLASS 42—SCIENTIFIC AND COMPUTER SERVICES

FOR TECHNICAL FEASIBILITY STUDIES, RESEARCH AND DEVELOPMENT IN THE FIELD OF MEASURING AND ANALYSIS OF BIOMETRIC MOVEMENT APPARATUS; TECHNICAL FEASIBILITY STUDIES, RESEARCH AND DEVELOPMENT IN THE FIELD OF SOFTWARE FOR THE MONITORING OF HUMAN MOVEMENT; ENGINEERING SERVICES, NAMELY, EVALUATIONS, ESTIMATIONS AND RESEARCH PERFORMED IN THE SCIENTIFIC AND TECHNOLOGICAL FIELDS; DESIGN AND DEVELOPMENT OF COMPUTERS AND SOFTWARE; RESEARCH AND DEVELOPMENT OF NEW PRODUCTS; ENGINEERING SERVICES, PARTICULARLY TECHNICAL PROJECT PLANNING AND DESIGN ENGINEERING OF MOVEMENT MEASURING MACHINES; ELECTRONIC COMPUTER SYSTEMS ARCHITECTURE SERVICES; SOFTWARE DEVELOPMENT, INSTALLATION, MAINTENANCE, AND UPDATE; COMPUTER PROGRAMMING; DATA CONVERSION OF COMPUTER PROGRAMS, NOT PHYSICAL CONVERSION (U.S. CLS. 100 AND 101).
WILLIAM BRECKENFELD, EXAMINING ATTORNEY

SN 77-703,283. BUSINESS CONSORTIUM FUND, INC., NEW YORK, NY. FILED 3-31-2009.

BUSINESS CONSORTIUM FUND,
INC.

THE MARK CONSISTS OF STANDARD CHARACTERS WITHOUT CLAIM TO ANY PARTICULAR FONT, STYLE, SIZE, OR COLOR.
NO CLAIM IS MADE TO THE EXCLUSIVE RIGHT TO USE "BUSINESS" AND "FUND, INC.", APART FROM THE MARK AS SHOWN.
SEC. 2(F).

CLASS 35—ADVERTISING AND BUSINESS

FOR BUSINESS ADVISORY AND CONSULTING SERVICES (U.S. CLS. 100, 101 AND 102).
FIRST USE 0-0-1984; IN COMMERCE 0-0-1987.

CLASS 36—INSURANCE AND FINANCIAL

FOR FINANCIAL SERVICES, NAMELY, PROVIDING FINANCING TO BUSINESSES; FINANCIAL ADVISORY AND CONSULTING SERVICES (U.S. CLS. 100, 101 AND 102).
FIRST USE 0-0-1984; IN COMMERCE 0-0-1987.
MARGARET POWER, EXAMINING ATTORNEY

SN 77-704,204. A BISMARCK COMPANY, FALL RIVER, MA. FILED 4-1-2009.

"We are Industrial Grade"

THE MARK CONSISTS OF STANDARD CHARACTERS WITHOUT CLAIM TO ANY PARTICULAR FONT, STYLE, SIZE, OR COLOR.
NO CLAIM IS MADE TO THE EXCLUSIVE RIGHT TO USE "INDUSTRIAL GRADE", APART FROM THE MARK AS SHOWN.

CLASS 16—PAPER GOODS AND PRINTED MATTER

FOR DECALS AND DOMED DECALS MADE OF VINYL, POLYURETHANE, AND POLYESTER FOR USE ON COMMERCIAL AND/OR CONSUMER PRODUCTS FOR BRANDING, WARNING, INSTRUCTION AND/OR DECORATION (U.S. CLS. 2, 5, 22, 23, 29, 37, 38 AND 50).

CLASS 20—FURNITURE AND ARTICLES NOT OTHERWISE CLASSIFIED

FOR LABEL AND TAGS MADE OF VINYL OR POLYURETHANE FOR USE ON COMMERCIAL AND/OR CONSUMER PRODUCTS FOR BRANDING, WARNING, INSTRUCTION AND/OR DECORATION (U.S. CLS. 2, 13, 22, 25, 32 AND 50).

CLASS 24—FABRICS

FOR LABELS AND TAGS MADE OF POLYESTER FOR USE ON COMMERCIAL AND/OR CONSUMER PRODUCTS FOR BRANDING, WARNING, INSTRUCTION AND/OR DECORATION (U.S. CLS. 42 AND 50).
TINA L. SNAPP, EXAMINING ATTORNEY

SN 77-704,477. TANDBERG TELECOM AS, LYSAKER, NORWAY, FILED 4-1-2009.

Telepresence Champion

THE MARK CONSISTS OF STANDARD CHARACTERS WITHOUT CLAIM TO ANY PARTICULAR FONT, STYLE, SIZE, OR COLOR.
PRIORITY CLAIMED UNDER SEC. 44(D) ON NORWAY APPLICATION NO. 200812378, FILED 10-3-2008, REG. NO. 249977, DATED 2-25-2009, EXPIRES 2-25-2019.
NO CLAIM IS MADE TO THE EXCLUSIVE RIGHT TO USE "TELEPRESENCE", APART FROM THE MARK AS SHOWN.

CLASS 9—ELECTRICAL AND SCIENTIFIC APPARATUS

FOR VIDEOCONFERENCING SYSTEMS COMPRISING VIDEO SCREENS, SOFTWARE AND DOWNLOADABLE WEB-BASED SOFTWARE APPLICATIONS FOR REAL-TIME MULTIMEDIA AND MULTIPARTY COMMUNICATIONS OVER COMPUTER NETWORKS; VIDEOCONFERENCING APPARATUS AND EQUIPMENT, NAMELY, VIDEO SCREENS, SOFTWARE AND DOWNLOADABLE WEB-BASED SOFTWARE APPLICATIONS FOR REAL-TIME MULTIMEDIA AND MULTIPARTY COMMUNICATIONS OVER COMPUTER NETWORKS; SOFTWARE AND WEB-BASED SOFTWARE APPLICATIONS FOR REAL-TIME, MULTIMEDIA AND MULTIPARTY COMMUNICATIONS OVER COMPUTER NETWORKS; APPARATUS FOR THE RECEPTION, STORAGE, REPRODUCTION, PLAYBACK, RECORDING AND TRANSMISSION OF SOUNDS AND IMAGES, NAMELY, CAMERAS, MICROPHONES, TELEVISION MONITORS, VIDEO MONITORS, COMPUTER MONITORS, DESKTOP VIDEO SYSTEMS COMPRISING VIDEO SCREENS, SOFTWARE AND DOWNLOADABLE WEB-BASED SOFTWARE APPLICATIONS FOR REAL-TIME MULTIMEDIA AND MULTIPARTY COMMUNICATIONS OVER COMPUTER NETWORKS, AMPLIFIERS, ECHO CANCELLERS, SOUND MIXERS, LOUDSPEAKERS, REMOTE CONTROL TRANSMITTERS, TELEVISION SETS, RADIO SETS, COMPACT AND VIDEO DISC PLAYERS, MEMORY-BASED MEDIA PLAYERS, TELEPHONES, VIDEO TELEPHONES, MOBILE TELEPHONES AND PORTABLE TELEPHONE TERMINALS; SOFTWARE APPLICATIONS AND WEB-BASED SOFTWARE APPLICATIONS FOR COMMUNICATION; INTEGRATION OF TEXT, AUDIO, GRAPHICS, STILL IMAGES AND MOVING PICTURES INTO AN INTERACTIVE DELIVERY FOR MULTI-MEDIA APPLICATIONS, AND DATA SHARING; ANALOG TO DIGITAL AND DIGITAL TO ANALOG CONVERTERS; SYSTEMS COMPRISING SOFTWARE AND DOWNLOADABLE WEB-BASED SOFTWARE APPLICATIONS AND EQUIPMENT FOR DIGITAL BROADCASTING OF AUDIO, DATA AND VIDEO ACROSS CABLE, SATELLITE, TERRESTRIAL, INTERNET PROTOCOL AND TELECOMMUNICATIONS NETWORKS; SYSTEMS COMPRISING SOFTWARE AND DOWNLOADABLE WEB-BASED SOFTWARE APPLICATIONS AND EQUIPMENT FOR STREAMING OF AUDIO, DATA AND VIDEO ACROSS CABLE, SATELLITE, TERRESTRIAL, INTERNET PROTOCOL AND TELECOMMUNICATIONS NETWORKS; SYSTEMS COMPRISING SOFTWARE AND DOWNLOADABLE WEB-BASED SOFTWARE APPLICATIONS AND EQUIPMENT FOR COMMUNICATION INFRASTRUCTURE, NAMELY, COMMUNICATIONS SERVERS, DATA ARCHIVES, MULTIPOINT CONTROL UNITS, SWITCHES, MIXERS, GATEWAYS, GATEKEEPERS, FIREWALLS AND NETWORK MANAGEMENT SOFTWARE; SYSTEMS, EQUIPMENT AND SOFTWARE FOR SURVEILLANCE, SECURITY, ENCRYPTION AND AUTHENTICATION OF DATA; COMPUTER HARDWARE AND SOFTWARE FOR MANAGEMENT OF TIME, APPOINTMENTS, SCHEDULES, ASSETS AND MEETING ROOM MANAGEMENT; DOWNLOADABLE ELECTRONIC PUBLICATIONS IN THE NATURE OF BOOKS, MANUALS AND BROCHURES IN THE FIELD OF VIDEOCONFERENCING; ELECTRONIC PUBLICATIONS, NAMELY, BOOKS, MANUALS, AND BROCHURES IN THE FIELD OF VIDEOCONFERENCING, RECORDED ON COMPUTER MEDIA (U.S. CLS. 21, 23, 26, 36 AND 38).

CLASS 35—ADVERTISING AND BUSINESS

FOR ARRANGING AND CONDUCTING OF VIDEOCONFERENCES FOR BUSINESS PURPOSES IN THE FIELDS OF EDUCATION, BUSINESS, TELEMEDICINE, FIELD OPERATIONS, JUDICIARY AND HEALTHCARE (U.S. CLS. 100, 101 AND 102).

CLASS 38—COMMUNICATION

FOR TELECOMMUNICATIONS AND TELECOMMUNICATIONS SERVICES, NAMELY, PROVIDING REAL-TIME, MULTIMEDIA AND MULTIPARTY COMMUNICATIONS OVER COMPUTER NETWORKS, TELECONFERENCING AND VIDEO CONFERENCING SERVICES; TRANSMISSION OF AUDIO, VIDEO, DATA AND GRAPHICS BY CABLE, SATELLITE, TERRESTRIAL, INTERNET PROTOCOL AND TELECOMMUNICATIONS NETWORKS; COLLABORATION SERVICES, NAMELY, PROVIDING REAL-TIME, MULTIMEDIA AND MULTIPARTY COMMUNICATIONS OVER COMPUTER NETWORKS; TELECOMMUNICATIONS SERVICES FOR MEDIA AND DATA CREATION, MAINTENANCE EXCHANGE AND COLLABORATIVE SERVICES, NAMELY, INSTANT MESSAGING, APPLICATION AND FILE SHARING; COMMUNICATIONS SERVICES, NAMELY, PROVIDING REAL-TIME, MULTIMEDIA AND MULTIPARTY COMMUNICATIONS VIA INTRANETS, EXTRANETS, INTERNET AND OTHER ELECTRONIC AND OPTICAL MEANS; COMMUNICATIONS SERVICES, NAMELY, TRANSMITTING STREAMED SOUND AND AUDIO-VISUAL RECORDINGS VIA THE INTERNET; STREAMING OF AUDIO AND VIDEO MATERIAL VIA THE INTERNET; PROVIDING INFORMATION ABOUT COMMUNICATION AND BROADCASTING BY ELECTRONIC MEDIA (U.S. CLS. 100, 101 AND 104).

CLASS 41—EDUCATION AND ENTERTAINMENT

FOR EDUCATION IN THE FIELD OF VIDEOCONFERENCING AND BUSINESS RENDERED THROUGH VIDEO CONFERENCES, ON-LINE TUTORIALS AND COURSES; PROVIDING OF VIDEOCONFERENCING AND BUSINESS TRAINING; PROVIDING OF TRAINING, NAMELY, ON-LINE VIDEOCONFERENCING AND BUSINESS TRAINING; ARRANGING AND CONDUCTING OF VIDEOCONFERENCES NOT FOR BUSINESS PURPOSES IN THE FIELDS OF EDUCATION, TELEMEDICINE, FIELD OPERATIONS, JUDICIARY AND HEALTHCARE; RENTAL OR LEASING OF VIDEOCONFERENCE APPARATUS AND EQUIPMENT, NAMELY, CAMERAS, MICROPHONES, TELEVISION MONITORS, VIDEO MONITORS, COMPUTER MONITORS, AMPLIFIERS, ECHO CANCELLERS, SOUND MIXERS, LOUDSPEAKERS, REMOTE CONTROL TRANSMITTERS, TELEVISION SETS, RADIO SETS, MEMORY-BASED MEDIA PLAYERS, TELEPHONES, VIDEO TELEPHONES, MOBILE TELEPHONES AND PORTABLE TELEPHONE TERMINALS (U.S. CLS. 100, 101 AND 107).

CLASS 42—SCIENTIFIC AND COMPUTER SERVICES

FOR RENTAL AND LEASING OF COMPUTER DATABASE AND COMPUTER SERVERS TO OTHERS; RENTAL OF MULTIMEDIA AND MULTIPARTY COMMUNICATIONS APPARATUS AND EQUIPMENT, NAMELY, COMPUTERS AND COMPUTER SOFTWARE; RENTAL OR LEASING OF DATA NETWORKS AND TELECOMMUNICATION EQUIPMENT, INFRASTRUCTURE, SOFTWARE AND EQUIPMENT, NAMELY, SYSTEMS COMPRISING SOFTWARE AND DOWNLOADABLE WEB-BASED SOFTWARE APPLICATIONS AND EQUIPMENT FOR COMMUNICATION INFRASTRUCTURE, NAMELY, COMMUNICATIONS SERVERS, DATA ARCHIVES, MULTIPOINT CONTROL UNITS, SWITCHES, MIXERS, GATEWAYS, GATEKEEPERS, FIREWALLS AND NETWORK MANAGEMENT SOFTWARE (U.S. CLS. 100 AND 101).

JULIE VEPPUMTHARA, EXAMINING ATTORNEY

SN 77-704,584. TANDBERG TELECOM AS, LYSAKER 1366, NORWAY, FILED 4-1-2009.

Video Champion

THE MARK CONSISTS OF STANDARD CHARACTERS WITHOUT CLAIM TO ANY PARTICULAR FONT, STYLE, SIZE, OR COLOR.

PRIORITY CLAIMED UNDER SEC. 44(D) ON NORWAY APPLICATION NO. 200812330, FILED 10-1-2008, REG. NO. 251751, DATED 7-10-2009, EXPIRES 7-10-2019.

NO CLAIM IS MADE TO THE EXCLUSIVE RIGHT TO USE "VIDEO", APART FROM THE MARK AS SHOWN.

CLASS 9—ELECTRICAL AND SCIENTIFIC APPARATUS

FOR VIDEOCONFERENCING SYSTEMS COMPRISING VIDEO SCREENS, SOFTWARE AND DOWNLOADABLE WEB-BASED SOFTWARE APPLICATIONS FOR REAL-TIME MULTIMEDIA AND MULTIPARTY COMMUNICATIONS OVER COMPUTER NETWORKS; VIDEOCONFERENCING APPARATUS AND EQUIPMENT, NAMELY, VIDEO SCREENS, SOFTWARE AND DOWNLOADABLE WEB-BASED SOFTWARE APPLICATIONS FOR REAL-TIME MULTIMEDIA AND MULTIPARTY COMMUNICATIONS OVER COMPUTER NETWORKS; SOFTWARE AND DOWNLOADABLE WEB-BASED SOFTWARE APPLICATIONS FOR REAL-TIME MULTIMEDIA AND MULTIPARTY COMMUNICATIONS OVER COMPUTER NETWORKS; APPARATUS FOR THE RECEPTION, STORAGE, REPRODUCTION, PLAYBACK, RECORDING AND TRANSMISSION OF SOUNDS AND IMAGES, NAMELY, CAMERAS, MICROPHONES, TELEVISION MONITORS, VIDEO MONITORS, COMPUTER MONITORS, DESKTOP VIDEO SYSTEMS COMPRISING VIDEO SCREENS, SOFTWARE AND DOWNLOADABLE WEB-BASED SOFTWARE APPLICATIONS FOR REAL-TIME MULTIMEDIA AND MULTIPARTY COMMUNICATIONS OVER COMPUTER NETWORKS, AMPLIFIERS, ECHO CANCELLERS, SOUND MIXERS, LOUDSPEAKERS, REMOTE CONTROL TRANSMITTERS, TELEVISION SETS, RADIO SETS, COMPACT AND VIDEO DISC PLAYERS, MEMORY-BASED MEDIA PLAYERS, TELEPHONES, VIDEO TELEPHONES, MOBILE TELEPHONES AND PORTABLE TELEPHONE TERMINALS; SOFTWARE APPLICATIONS AND DOWNLOADABLE WEB-BASED SOFTWARE APPLICATIONS FOR COMMUNICATION, INTEGRATION OF TEXT, AUDIO, GRAPHICS, STILL IMAGES AND MOVING PICTURES INTO AN INTERACTIVE DELIVERY FOR MULTI-MEDIA APPLICATIONS, AND DATA SHARING; ANALOG TO DIGITAL AND DIGITAL TO ANALOG CONVERTERS; SYSTEMS COMPRISING SOFTWARE AND DOWNLOADABLE WEB-BASED SOFTWARE APPLICATIONS AND EQUIPMENT FOR DIGITAL BROADCASTING OF AUDIO, DATA AND VIDEO ACROSS CABLE, SATELLITE, TERRESTRIAL, INTERNET PROTOCOL AND TELECOMMUNICATIONS NETWORKS; SYSTEMS COMPRISING SOFTWARE AND DOWNLOADABLE WEB-BASED SOFTWARE APPLICATIONS AND EQUIPMENT FOR STREAMING OF AUDIO, DATA AND VIDEO ACROSS CABLE, SATELLITE, TERRESTRIAL, INTERNET PROTOCOL AND TELECOMMUNICATIONS NETWORKS; SYSTEMS COMPRISING SOFTWARE AND DOWNLOADABLE WEB-BASED SOFTWARE APPLICATIONS AND EQUIPMENT FOR COMMUNICATION INFRASTRUCTURE, NAMELY, COMMUNICATIONS SERVERS, DATA ARCHIVES, MULTIPOINT CONTROL UNITS, SWITCHES, MIXERS, GATEWAYS, GATEKEEPERS, FIREWALLS AND NETWORK MANAGEMENT SOFTWARE; SYSTEMS, EQUIPMENT AND SOFTWARE FOR SURVEILLANCE, SECURITY, ENCRYPTION AND AUTHENTICATION OF DATA; COMPUTER HARDWARE AND SOFTWARE FOR MANAGEMENT OF TIME, APPOINTMENTS, SCHEDULES, ASSETS AND MEETING ROOM MANAGEMENT; DOWNLOADABLE ELECTRONIC PUBLICATIONS IN THE NATURE OF BOOKS, MANUALS AND BROCHURES IN THE FIELD OF VIDEOCONFERENCING; ELECTRONIC PUBLICATIONS, NAMELY, BOOKS, MANUALS, BROCHURES IN THE FIELD OF VIDEOCONFERENCING, RECORDED ON COMPUTER MEDIA (U.S. CLS. 21, 23, 26, 36 AND 38).

CLASS 35—ADVERTISING AND BUSINESS

FOR ARRANGING AND CONDUCTING OF VIDEO-CONFERENCES FOR BUSINESS PURPOSES IN THE FIELDS OF EDUCATION, BUSINESS, TELEMEDICINE, FIELD OPERATIONS, JUDICIARY AND HEALTHCARE (U.S. CLS. 100, 101 AND 102).

CLASS 38—COMMUNICATION

FOR TELECOMMUNICATIONS AND TELECOMMUNICATIONS SERVICES, NAMELY, PROVIDING REAL-TIME, MULTIMEDIA AND MULTIPARTY COMMUNICATIONS OVER COMPUTER NETWORKS, TELECONFERENCING AND VIDEO CONFERENCING SERVICES; TRANSMISSION OF AUDIO, VIDEO, DATA AND GRAPHICS BY CABLE, SATELLITE, TERRESTRIAL, INTERNET PROTOCOL AND TELECOMMUNICATIONS NETWORKS; COLLABORATION SERVICES, NAMELY, PROVIDING REAL-TIME, MULTIMEDIA AND MULTIPARTY COMMUNICATIONS OVER COMPUTER NETWORKS; TELECOMMUNICATIONS SERVICES FOR MEDIA AND DATA CREATION, MAINTENANCE EXCHANGE AND COLLABORATIVE SERVICES, NAMELY, INSTANT MESSAGING, APPLICATION AND FILE SHARING; COMMUNICATIONS SERVICES, NAMELY, PROVIDING REAL-TIME, MULTIMEDIA AND MULTIPARTY COMMUNICATIONS VIA INTRANETS, EXTRANETS, INTERNET AND OTHER ELECTRONIC AND OPTICAL MEANS; COMMUNICATIONS SERVICES, NAMELY, TRANSMITTING STREAMED SOUND AND AUDIO-VISUAL RECORDINGS VIA THE INTERNET; STREAMING OF AUDIO AND VIDEO MATERIAL VIA THE INTERNET; PROVIDING INFORMATION ABOUT COMMUNICATION AND BROADCASTING BY ELECTRONIC MEDIA (U.S. CLS. 100, 101 AND 104).

CLASS 41—EDUCATION AND ENTERTAINMENT

FOR EDUCATION IN THE FIELD OF VIDEOCONFERENCING AND BUSINESS RENDERED THROUGH VIDEO CONFERENCES, ON-LINE TUTORIALS AND COURSES; PROVIDING OF VIDEOCONFERENCING AND BUSINESS TRAINING; PROVIDING OF TRAINING, NAMELY, ON-LINE VIDEOCONFERENCING AND BUSINESS TRAINING; ARRANGING AND CONDUCTING OF VIDEOCONFERENCES NOT FOR BUSINESS PURPOSES IN THE FIELDS OF EDUCATION, TELEMEDICINE, FIELD OPERATIONS, JUDICIARY AND HEALTHCARE; RENTAL OR LEASING OF VIDEOCONFERENCE APPARATUS AND EQUIPMENT, NAMELY, CAMERAS, MICROPHONES, TELEVISION MONITORS, VIDEO MONITORS, COMPUTER MONITORS, AMPLIFIERS, ECHO CANCELLERS, SOUND MIXERS, LOUDSPEAKERS, REMOTE CONTROL TRANSMITTERS, TELEVISION SETS, RADIO SETS, MEMORY-BASED MEDIA PLAYERS, TELEPHONES, VIDEO TELEPHONES, MOBILE TELEPHONES AND PORTABLE TELEPHONE TERMINALS (U.S. CLS. 100, 101 AND 107).

CLASS 42—SCIENTIFIC AND COMPUTER SERVICES

FOR RENTAL AND LEASING OF COMPUTER DATABASE AND COMPUTER SERVERS TO OTHERS; RENTAL OF MULTIMEDIA AND MULTIPARTY COMMUNICATIONS APPARATUS AND EQUIPMENT, NAMELY, COMPUTERS AND COMPUTER SOFTWARE; RENTAL OR LEASING OF DATA NETWORKS AND TELECOMMUNICATION EQUIPMENT, INFRASTRUCTURE, SOFTWARE AND EQUIPMENT, NAMELY, SYSTEMS COMPRISING SOFTWARE AND DOWNLOADABLE WEB-BASED SOFTWARE APPLICATIONS AND EQUIPMENT FOR COMMUNICATION INFRASTRUCTURE, NAMELY, COMMUNICATIONS SERVERS, DATA ARCHIVES, MULTIPOINT CONTROL UNITS, SWITCHES, MIXERS, GATEWAYS, GATEKEEPERS, FIREWALLS AND NETWORK MANAGEMENT SOFTWARE (U.S. CLS. 100 AND 101).

JULIE VEPPUMTHARA, EXAMINING ATTORNEY

SN 77-705,557. STRIPE-A-ZONE, INC., GRAND PRAIRIE, TX. FILED 4-2-2009.

SN 77-706,573. 2720 CORPORATE PARKWAY, LLC, CHICAGO, IL. FILED 4-3-2009.

STRIPE-A-ZONE

THE MARK CONSISTS OF STANDARD CHARACTERS WITHOUT CLAIM TO ANY PARTICULAR FONT, STYLE, SIZE, OR COLOR.

CLASS 37—CONSTRUCTION AND REPAIR

FOR INSTALLATION AND MAINTENANCE OF TRAFFIC BARRICADES AND TRAFFIC SIGNS; AND PAVEMENT MARKING SERVICES (U.S. CLS. 100, 103 AND 106).

FIRST USE 10-31-1952; IN COMMERCE 12-31-1969.

CLASS 40—MATERIAL TREATMENT

FOR MANUFACTURE OF TRAFFIC BARRICADES AND TRAFFIC SIGNS TO THE ORDER AND/OR SPECIFICATION OF OTHERS (U.S. CLS. 100, 103 AND 106).

FIRST USE 10-31-1952; IN COMMERCE 12-31-1969.
RONALD MCMORROW, EXAMINING ATTORNEY

SN 77-705,595. STRIPE-A-ZONE, INC., GRAND PRAIRIE, TX. FILED 4-2-2009.

PAVEMENT MARKING SPECIALISTS

THE MARK CONSISTS OF STANDARD CHARACTERS WITHOUT CLAIM TO ANY PARTICULAR FONT, STYLE, SIZE, OR COLOR.

NO CLAIM IS MADE TO THE EXCLUSIVE RIGHT TO USE "PAVEMENT MARKING", APART FROM THE MARK AS SHOWN.

SEC. 2(F).

CLASS 37—CONSTRUCTION AND REPAIR

FOR INSTALLATION AND MAINTENANCE OF TRAFFIC BARRICADES AND TRAFFIC SIGNS; AND PAVEMENT MARKING SERVICES (U.S. CLS. 100, 103 AND 106).

FIRST USE 10-31-1952; IN COMMERCE 12-31-1969.

CLASS 40—MATERIAL TREATMENT

FOR MANUFACTURE OF TRAFFIC BARRICADES AND TRAFFIC SIGNS TO THE ORDER AND/OR SPECIFICATION OF OTHERS (U.S. CLS. 100, 103 AND 106).

FIRST USE 10-31-1952; IN COMMERCE 12-31-1969.
RONALD MCMORROW, EXAMINING ATTORNEY

WHOLE EARTH DENTAL

THE MARK CONSISTS OF STANDARD CHARACTERS WITHOUT CLAIM TO ANY PARTICULAR FONT, STYLE, SIZE, OR COLOR.

NO CLAIM IS MADE TO THE EXCLUSIVE RIGHT TO USE "DENTAL", APART FROM THE MARK AS SHOWN.

CLASS 3—COSMETICS AND CLEANING PREPARATIONS

FOR CLEANING SOLUTIONS FOR CLEANING DENTAL EQUIPMENT (U.S. CLS. 1, 4, 6, 50, 51 AND 52).

CLASS 10—MEDICAL APPARATUS

FOR DENTAL PRODUCTS USED IN DENTAL INDUSTRY IN THE NATURE OF DENTAL CLEANING INSTRUMENTS, NAMELY, TOOTHBRUSHES AND APPARATUS USED FOR CLEANING TEETH AND GUMS USED IN DENTISTS' OFFICES DURING DENTAL PROCEDURES (U.S. CLS. 26, 39 AND 44).

JENNY PARK, EXAMINING ATTORNEY

SN 77-707,329. PHOENIX HOUSE FOUNDATION, INC., NEW YORK, NY. FILED 4-6-2009.

PHOENIX HOUSE

THE MARK CONSISTS OF STANDARD CHARACTERS WITHOUT CLAIM TO ANY PARTICULAR FONT, STYLE, SIZE, OR COLOR.

OWNER OF U.S. REG. NO. 997,702.

NO CLAIM IS MADE TO THE EXCLUSIVE RIGHT TO USE "HOUSE", APART FROM THE MARK AS SHOWN.

CLASS 35—ADVERTISING AND BUSINESS

FOR PROMOTING PUBLIC AWARENESS ON THE SUBJECTS OF TREATMENT AND PREVENTION OF ADDICTION, ADDICTIVE BEHAVIOR, AND SUBSTANCE ABUSE (U.S. CLS. 100, 101 AND 102).

FIRST USE 0-0-1967; IN COMMERCE 0-0-1967.

CLASS 41—EDUCATION AND ENTERTAINMENT

FOR EDUCATIONAL SERVICES, NAMELY, CONDUCTING PROGRAMS IN THE FIELDS OF TREATMENT AND PREVENTION OF ADDICTION, ADDICTIVE BEHAVIOR, AND SUBSTANCE ABUSE; EDUCATIONAL SERVICES, NAMELY, ARRANGING AND PROVIDING COURSES OF INSTRUCTION AT THE HIGH SCHOOL LEVEL; VOCATIONAL EDUCATION IN THE FIELDS OF BUILDING MAINTENANCE, CARPENTRY, COSMETOLOGY, COUNSELING IN SUBSTANCE ABUSE PREVENTION AND TREATMENT, CULINARY ARTS, AND OFFICE MANAGEMENT (U.S. CLS. 100, 101 AND 107).

FIRST USE 0-0-1967; IN COMMERCE 0-0-1967.

CLASS 44—MEDICAL, BEAUTY AND AGRICULTURAL SERVICES

FOR SUBSTANCE ABUSE TREATMENT SERVICES; COUNSELING AND TREATMENT SERVICES IN THE FIELDS OF ADDICTION, ADDICTIVE BEHAVIOR, AND BEHAVIORAL HEALTH; MEDICAL CLINICS; DENTAL CLINICS (U.S. CLS. 100 AND 101).

FIRST USE 0-0-1967; IN COMMERCE 0-0-1967.
MARY BOAGNI, EXAMINING ATTORNEY

SN 77-707,830. FEEDBACK SPORTS, LLC, GOLDEN, CO.
FILED 4-6-2009.

FEEDBACK

THE MARK CONSISTS OF STANDARD CHARACTERS WITHOUT CLAIM TO ANY PARTICULAR FONT, STYLE, SIZE, OR COLOR.

CLASS 8—HAND TOOLS

FOR BICYCLE REPAIR HAND TOOLS, NAMELY, HAND OPERATED WRENCHES; BICYCLE REPAIR TOOLS, NAMELY, SCREW DRIVERS, WRENCHES, HEX WRENCHES, SOCKET WRENCHES, BICYCLE CHAIN REPAIR TOOL, SPOKE WRENCHES, TORQUE WRENCHES, PEDAL WRENCHES, MULTI-FUNCTION HAND TOOLS COMPRISED OF SCREWDRIVERS, WRENCHES, HEX WRENCHES AND PLIERS, LEVERS FOR REMOVING AND REPAIRING BICYCLE TIRES, CABLE WIRE CUTTERS (U.S. CLS. 23, 28 AND 44).

CLASS 9—ELECTRICAL AND SCIENTIFIC APPARATUS

FOR MEASURING DEVICES, NAMELY, PRESSURE GAUGES, ANGLE MEASURERS IN THE NATURE OF GONIOMETERS, THERMOMETERS; BICYCLE METERS FOR MEASURING OUTPUT POWER OF THE RIDER, CYCLING COMPUTER FOR MEASURING THE RIDER'S SPEED, DISTANCE TRAVELED, TIME, HEART RATE AND ALTITUDE (U.S. CLS. 21, 23, 26, 36 AND 38).

CLASS 35—ADVERTISING AND BUSINESS

FOR ONLINE WHOLESALE STORE FEATURING BICYCLE-RELATED GOODS, MEASURING TOOLS, WEIGHING SCALES, AND HEART RATE MONITORS (U.S. CLS. 100, 101 AND 102).

Laurie Mayes, Examining Attorney

SN 77-709,084. UNIVERSITY COLLEGE OF CHAPMAN UNIVERSITY, ORANGE, CA. FILED 4-7-2009.

BRANDMAN UNIVERSITY

THE MARK CONSISTS OF STANDARD CHARACTERS WITHOUT CLAIM TO ANY PARTICULAR FONT, STYLE, SIZE, OR COLOR.

NO CLAIM IS MADE TO THE EXCLUSIVE RIGHT TO USE "UNIVERSITY", APART FROM THE MARK AS SHOWN.

CLASS 6—METAL GOODS

FOR METAL KEY CHAINS, METAL LICENSE PLATES (U.S. CLS. 2, 12, 13, 14, 23, 25 AND 50).

CLASS 16—PAPER GOODS AND PRINTED MATTER

FOR STATIONERY, STATIONERY TYPE PORTFOLIOS, NOTE BOOKS, PENCILS AND PENS, LOOSE LEAF BINDERS, ADDRESS BOOKS, BOOK COVERS, BOOK MARKERS, BUMPER STICKERS, STICKERS AND DECALS, CALENDARS, DESK CALENDARS AND DIARIES, CHECKBOOK COVERS, CLIP BOARDS, COASTERS MADE OF PAPER, DESK BLOTTERS AND DESK SETS, NOTE PADS AND NOTE PAD HOLDERS, PAPERWEIGHTS, PEN AND PENCIL CASES AND PEN AND PENCIL HOLDERS, PHOTO ALBUMS, PRINTED LECTURES, PROTECTIVE COVERS FOR BOOKS; METAL MONEY CLIPS (U.S. CLS. 2, 5, 22, 23, 29, 37, 38 AND 50).

CLASS 21—HOUSEWARES AND GLASS

FOR GLASSWARE, NAMELY, BEVERAGEWARE; COASTERS, NOT OF PAPER AND OTHER THAN TABLE LINEN; GLASS AND NON-GLASS COFFEE CUPS AND MUGS (U.S. CLS. 2, 13, 23, 29, 30, 33, 40 AND 50).

CLASS 25—CLOTHING

FOR CLOTHING, NAMELY, SWEATSHIRTS, SWEATPANTS, SHORTS, JACKETS, HATS, JERSEYS AND T-SHIRTS (U.S. CLS. 22 AND 39).

Jessica Fathy, Examining Attorney

SN 77-709,705. PIRAMAL HOLDINGS (SUISSE) S.A., CH 1204 GENEVA, SWITZERLAND, FILED 4-8-2009.

TRAKPACK

THE MARK CONSISTS OF STANDARD CHARACTERS WITHOUT CLAIM TO ANY PARTICULAR FONT, STYLE, SIZE, OR COLOR.

PRIORITY CLAIMED UNDER SEC. 44(D) ON UNITED KINGDOM APPLICATION NO. 2500341, FILED 10-17-2008, REG. NO. 2500341, DATED 6-12-2009, EXPIRES 10-17-2018.

CLASS 9—ELECTRICAL AND SCIENTIFIC APPARATUS

FOR COMPUTER SOFTWARE AND COMPUTER PROGRAMMES FOR USE IN MONITORING THE DEVELOPMENT, PRODUCTION, PACKAGING AND DISTRIBUTION OF PHARMACEUTICALS AND CLINICAL TRIAL KITS AND ALSO MONITORING THE RESULTS OF CLINICAL TRIALS; DOWNLOADABLE COMPUTER SOFTWARE FOR USE IN MONITORING THE DEVELOPMENT, PRODUCTION, PACKAGING AND DISTRIBUTION OF PHARMACEUTICALS AND CLINICAL TRIAL KITS AND ALSO MONITORING THE RESULTS OF CLINICAL TRIALS; COMPUTER SOFTWARE FOR SHARING AND MONITORING INFORMATION, IN PARTICULAR INFORMATION RELATING TO CLINICAL TRIALS AND PATIENT HEALTH OUTCOMES AND THE DEVELOPMENT, PRODUCTION, PACKAGING AND DISTRIBUTION OF PHARMACEUTICALS AND CLINICAL TRIAL KITS; DOWNLOADABLE ELECTRONIC PUBLICATIONS IN THE NATURE OF BOOKS, MAGAZINES, JOURNALS AND ARTICLES IN THE FIELDS OF PHARMACEUTICALS AND CLINICAL TRIALS; ELECTRONIC DATABASES IN THE FIELD OF CLINICAL TRIALS, DRUG DEVELOPMENT AND THE PRODUCTION, PACKAGING AND DISTRIBUTION OF PHARMACEUTICALS AND CLINICAL TRIAL KITS RECORDED ON COMPUTER MEDIA; COMPUTER PROGRAMMES FOR USE IN DATABASE MANAGEMENT IN THE FIELD OF CLINICAL TRIALS; BLANK MAGNETIC DATA CARRIERS; MULTIMEDIA SOFTWARE RECORDED ON CD-ROMS FEATURING DATA RESULTING FROM CLINICAL TRIALS; PRE-RECORDED LASER DISCS AND CDS FEATURING DATA RESULTING FROM CLINICAL TRIALS (U.S. CLS. 21, 23, 26, 36 AND 38).

SN 77-711,350. ONDRA LLP, LONDON, UNITED KINGDOM, FILED 4-10-2009.

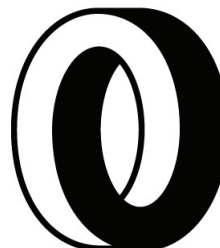

OWNER OF UNITED KINGDOM REG. NO. 2512227, DATED 7-3-2009, EXPIRES 3-26-2019.

THE MARK CONSISTS OF THE LETTER "O" IN A THREE-D SHAPE THAT APPEARS TO BE TWO CIRCLES INTERTWINED WITH THE FIRST HALF APPEARING UNSHADED AND THE OTHER, OVERLAPPING CIRCLE APPEARING SHADED.

CLASS 9—ELECTRICAL AND SCIENTIFIC APPARATUS

FOR COMPUTER SOFTWARE AND COMPUTER PROGRAMS FOR USE IN DATABASE MANAGEMENT IN THE FIELDS OF FINANCIAL AFFAIRS, BUSINESS APPRAISALS, BUSINESS ACQUISITION DISPOSAL AND STRUCTURING, BUSINESS MANAGEMENT, ECONOMIC FORECASTING AND ECONOMIC RESEARCH; BLANK MAGNETIC DATA MEDIA; BLANK OPTICAL DATA MEDIA; COMPUTER SOFTWARE RECORDED ON DATA MEDIA FOR DATABASE MANAGEMENT IN THE FIELDS OF FINANCIAL AFFAIRS, BUSINESS APPRAISALS, BUSINESS ACQUISITION DISPOSAL AND STRUCTURING, BUSINESS MANAGEMENT, ECONOMIC FORECASTING AND ECONOMIC RESEARCH; DOWNLOADABLE DIGITAL MEDIA FILES, NAMELY, DOWNLOADABLE PHOTOGRAPHIC, VIDEO, AUDIO, AND TEXT FILES FEATURING FINANCIAL AFFAIRS, BUSINESS APPRAISALS, BUSINESS ACQUISITION DISPOSAL AND STRUCTURING, BUSINESS MANAGEMENT, ECONOMIC FORECASTING AND RESEARCH; DOWNLOADABLE ELECTRONIC PUBLICATIONS IN THE NATURE OF NEWSLETTERS, MAGAZINES, BROCHURES, REPORTS, BOOKLETS, FACT SHEETS, CHARTS, AND GRAPHS IN THE FIELDS OF FINANCIAL AFFAIRS, BUSINESS APPRAISALS, BUSINESS ACQUISITION DISPOSAL AND STRUCTURING, BUSINESS MANAGEMENT, ECONOMIC FORECASTING AND ECONOMIC RESEARCH (U.S. CLS. 21, 23, 26, 36 AND 38).

CLASS 42—SCIENTIFIC AND COMPUTER SERVICES

FOR SCIENTIFIC RESEARCH SERVICES IN THE FIELD OF CLINICAL TRIALS AND PHARMACEUTICAL DEVELOPMENT AND PACKAGING; ORGANISING, ARRANGING AND CONDUCTING OF CLINICAL TRIALS; MEDICAL AND SCIENTIFIC RESEARCH AND DEVELOPMENT IN THE FIELD OF PHARMACEUTICALS AND CLINICAL TRIALS; PHARMACEUTICAL DRUG DEVELOPMENT SERVICES; LABORATORY SERVICES RELATING TO PHARMACEUTICAL PRODUCTION; COMPUTER PROGRAMMING IN THE FIELD OF CLINICAL TRIALS; THE DESIGN AND DEVELOPMENT OF SOFTWARE RELATING TO CLINICAL TRIALS, PATIENT HEALTH OUTCOMES AND THE DEVELOPMENT, PRODUCTION, PACKAGING AND DISTRIBUTION OF PHARMACEUTICALS AND CLINICAL TRIAL KITS; PROVIDING TEMPORARY USE OF NON-DOWNLOADABLE COMPUTER SOFTWARE FOR USE IN MONITORING THE DEVELOPMENT, PRODUCTION, PACKAGING AND DISTRIBUTION OF PHARMACEUTICALS AND CLINICAL TRIAL KITS AND ALSO MONITORING THE RESULTS OF CLINICAL TRIALS (U.S. CLS. 100 AND 101).

CIMMERIAN COLEMAN, EXAMINING ATTORNEY

CLASS 35—ADVERTISING AND BUSINESS

FOR BUSINESS APPRAISALS AND RESEARCH; BUSINESS INVESTIGATIONS; PROFESSIONAL BUSINESS CONSULTANCY; BUSINESS ADVISORY AND CONSULTANCY SERVICES RELATING TO MERGERS AND ACQUISITIONS; ADVISORY AND CONSULTANCY SERVICES RELATING TO BUSINESS STRUCTURING, NAMELY, PROVIDING ASSISTANCE AND ADVICE REGARDING BUSINESS OPERATIONS, BUSINESS ORGANIZATION, BUSINESS MANAGEMENT, BUSINESS ANALYSIS PLANNING, BUSINESS STRATEGIES, BUSINESS MARKETING AND CUSTOMER ANALYSIS, BUSINESS LOANS, BUSINESS FINANCE AND BUSINESS CAPITAL; COMMERCIAL AND INDUSTRIAL MANAGEMENT ASSISTANCE; ECONOMIC FORECASTING; MARKET RESEARCH AND MARKET STUDIES (U.S. CLS. 100, 101 AND 102).

CLASS 36—INSURANCE AND FINANCIAL

FOR INSURANCE BROKERAGE; FINANCIAL AFFAIRS, NAMELY, FINANCIAL RISK MANAGEMENT, FINANCIAL ASSET MANAGEMENT, FINANCIAL PLANNING, LOAN FINANCING AND MANAGEMENT, AND FINANCIAL INVESTMENT MANAGEMENT AND ADVICE; MONETARY AFFAIRS, NAMELY, MONETARY STRATEGY CONSULTATION AND RESEARCH; REAL ESTATE AFFAIRS, NAMELY, ARRANGING REAL ESTATE INVESTMENT AND FINANCING; FINANCIAL SERVICES, NAMELY, FINANCIAL MANAGEMENT; BANKING SERVICES; INVESTMENT SERVICES, NAMELY, ARRANGEMENT OF INVESTMENT TRANSACTIONS IN RELATION TO STOCKS, BONDS, SHARES, DEBENTURES, COMMODITIES, FUTURES, OPTIONS AND OTHER SECURITIES; FINANCING SERVICES; FINANCIAL EXCHANGE SERVICES; SECURITIZATION SERVICES, NAMELY, ARRANGEMENT OF TRANSACTIONS INVOLVING ASSET BACKED SECURITIES; SECURITIES BROKERAGE; SECURITIES INVESTMENT AND MANAGEMENT, NAMELY, FINANCIAL INVESTMENT IN THE FIELD OF SECURITIES AND MANAGEMENT OF SECURITIES OF OTHERS; STOCKS AND BONDS BROKERAGE; CAPITAL AND FUND INVESTMENT; MANAGEMENT OF A CAPITAL INVESTMENT FUND; COLLATERAL MANAGEMENT, NAMELY, MANAGEMENT OF FINANCIAL ASSETS AND REAL ESTATE PROPERTIES USED TO SECURE LOANS; FINANCIAL MANAGEMENT; FINANCIAL CONSULTANCY, ADVISORY AND FINANCIAL INFORMATION SERVICES RELATING TO THE AFORESAID SERVICES (U.S. CLS. 100, 101 AND 102).

MEGHAN REINHART, EXAMINING ATTORNEY

CLASS 42—SCIENTIFIC AND COMPUTER SERVICES

FOR PROVIDING TEMPORARY USE OF NON-DOWNLOADABLE COMPUTER SOFTWARE FOR COLLABORATION, MANAGEMENT, SECURITY, DATA SHARING AND ACCESS BETWEEN ENTERPRISE SYSTEMS AND MOBILE DEVICES; PROVIDING TEMPORARY USE OF NON-DOWNLOADABLE SOFTWARE FOR COMPUTERS AND MOBILE DEVICES FOR USE IN ENHANCING SECURITY, MANAGING DATA, APPLICATIONS, AND COMMUNICATIONS, AND CONTROLLING COSTS AND SERVICE QUALITY ASSOCIATED WITH MOBILE DEVICES (U.S. CLS. 100 AND 101).

NAKIA HENRY, EXAMINING ATTORNEY

SN 77-712,950. WALSH, MOLLY P, DBA MOLLY'S SKIN CARE BOUTIQUE, HERMOSA BEACH, CA. FILED 4-13-2009.

SN 77-711,790. MOBILE IRON, INC., SUNNYVALE, CA. FILED 4-10-2009.

MYPHONE@WORK



**Molly's
Skin Care
Boutique**

THE MARK CONSISTS OF STANDARD CHARACTERS WITHOUT CLAIM TO ANY PARTICULAR FONT, STYLE, SIZE, OR COLOR.

CLASS 9—ELECTRICAL AND SCIENTIFIC APPARATUS

FOR COMPUTER SOFTWARE FOR COLLABORATION, MANAGEMENT, SECURITY, DATA SHARING AND ACCESS BETWEEN ENTERPRISE SYSTEMS AND MOBILE DEVICES (U.S. CLS. 21, 23, 26, 36 AND 38).

CLASS 41—EDUCATION AND ENTERTAINMENT

FOR ONLINE JOURNALS, NAMELY, BLOGS FEATURING INFORMATION REGARDING TECHNICAL AND HUMAN IMPACT OF MOBILE DEVICES ON COMPUTER USE (U.S. CLS. 100, 101 AND 107).

NO CLAIM IS MADE TO THE EXCLUSIVE RIGHT TO USE "SKIN CARE BOUTIQUE", APART FROM THE MARK AS SHOWN.

THE COLOR(S) YELLOW, GREEN, BLACK, BROWN, GOLD IS/ARE CLAIMED AS A FEATURE OF THE MARK.

THE MARK CONSISTS OF THE WORDING "MOLLY'S SKIN CARE BOUTIQUE" IN BLACK AND THE DESIGN OF A YELLOW AND GOLD SUNFLOWER WITH GREEN BUDS INSIDE, A DARK GREEN STALK AND LEAVES, BROWN AND GREEN DIRT AND A YELLOW AND GOLD PETAL ON THE BOTTOM.

CLASS 35—ADVERTISING AND BUSINESS

FOR RETAIL APOTHECARY STORE SERVICES; RETAIL STORE AND ON-LINE RETAIL STORE SERVICES FEATURING SKIN CARE PRODUCTS AND COSMETICS; RETAIL STORE SERVICES FEATURING SKIN CARE PRODUCTS AND COSMETICS (U.S. CLS. 100, 101 AND 102).

FIRST USE 10-15-2002; IN COMMERCE 10-15-2002.

CLASS 44—MEDICAL, BEAUTY AND AGRICULTURAL SERVICES

FOR BODY WAXING SERVICES; BODY WAXING SERVICES FOR THE HUMAN BODY; COSMETOLOGY SERVICES; FACIAL TREATMENT SERVICES, NAMELY, COSMETIC PEELS; HEALTH SPA SERVICES FOR HEALTH AND WELLNESS OF THE BODY AND SPIRIT, NAMELY, PROVIDING MASSAGE, FACIAL AND BODY TREATMENT SERVICES, COSMETIC BODY CARE SERVICES; HYGIENIC AND BEAUTY CARE; MASSAGE THERAPY SERVICES; MICRODERMABRASION, NAMELY, A TOPICAL SKIN TREATMENT INVOLVING ABRASION OF THE SKIN WITH A HIGH-PRESSURE FLOW OF CRYSTALS; REFLEXOLOGY SERVICES; SKIN CARE SALONS; SKIN CARE SALON SERVICES; FACIAL TREATMENT SERVICES, NAMELY, COSMETIC PEELS; BODY WAXING SERVICES; MASSAGE SERVICES; SUNLESS TANNING SALON SERVICES; SKIN TANNING SERVICE FOR HUMANS FOR COSMETIC PURPOSES (U.S. CLS. 100 AND 101).

FIRST USE 10-15-2002; IN COMMERCE 10-15-2002.
MARGARET POWER, EXAMINING ATTORNEY

SN 77-713,442. WABASH VALLEY POWER ASSOCIATION, INDIANAPOLIS, IN. FILED 4-14-2009.



Wabash Valley Power
energy smart

OWNER OF U.S. REG. NO. 3,383,926.
NO CLAIM IS MADE TO THE EXCLUSIVE RIGHT TO USE "POWER AND ENERGY SMART", APART FROM THE MARK AS SHOWN.

THE COLOR(S) GRAY, GREEN AND WHITE IS/ARE CLAIMED AS A FEATURE OF THE MARK.

THE MARK CONSISTS OF THE WORDING "WABASH VALLEY" IN THE COLOR GRAY, THE WORD "POWER" IN THE COLOR GREEN AS WELL AS THE WORDING "ENERGY SMART" IN THE COLOR GREEN ALONG WITH NINE DASH MARKS IN THE COLOR GREEN, WHICH GREEN IN THE DASH MARKS IS FADING OUT TOWARDS THE FINAL DASH MARK, WHICH FINAL DASH MARK IS LIGHT GREEN AND WHITE.

SEC. 2(F) AS TO "WABASH VALLEY POWER".

CLASS 35—ADVERTISING AND BUSINESS

FOR BUSINESS CONSULTING SERVICES PROVIDED TO ELECTRIC COOPERATIVES AND THEIR MEMBERS, NAMELY, RESIDENTIAL, COMMERCIAL AND INDUSTRIAL CUSTOMERS, IN THE FIELD OF HOW ELECTRICITY IS GENERATED, TRENDS IN THE ENERGY INDUSTRY, GENERATION AND TRANSMISSION, AND STRATEGIES FOR MORE EFFICIENT ENERGY USE AND ASSOCIATED COSTS SAVINGS; PROMOTION OF ENERGY EFFICIENCY BY PROVIDING INFORMATION IN THE FIELD OF EFFICIENT ENERGY USE FOR CONSUMERS AND BUSINESSES; PROVIDING INFORMATION IN THE FIELD OF ENERGY ASSESSMENT SERVICES FOR THE PURPOSE OF DETERMINING ENERGY USAGE MANAGEMENT IN CONNECTION WITH COMMERCIAL STRUCTURES AND OPERATIONS AND INDUSTRIAL STRUCTURES AND OPERATIONS (U.S. CLS. 100, 101 AND 102).

FIRST USE 12-9-2007; IN COMMERCE 12-9-2007.

CLASS 37—CONSTRUCTION AND REPAIR

FOR PROVIDING INFORMATION IN THE FIELD OF ENERGY ASSESSMENT SERVICES FOR THE PURPOSE OF DETERMINING HOME IMPROVEMENTS NEEDED TO IMPROVE ENERGY USE AND EFFICIENCY; PROVIDING INFORMATION IN THE FIELD OF ENERGY ASSESSMENT SERVICES FOR THE PURPOSE OF DETERMINING BUILDING IMPROVEMENTS, NAMELY, LIGHTING IMPROVEMENTS, NEEDED TO IMPROVE ENERGY EFFICIENCY OR USAGE MANAGEMENT IN CONNECTION WITH COMMERCIAL STRUCTURES AND OPERATIONS AND INDUSTRIAL STRUCTURES AND OPERATIONS (U.S. CLS. 100, 103 AND 106).

FIRST USE 12-9-2007; IN COMMERCE 12-9-2007.

CLASS 42—SCIENTIFIC AND COMPUTER SERVICES

FOR PROVIDING INFORMATION IN THE FIELD OF ENERGY ASSESSMENT SERVICES FOR THE PURPOSE OF DETERMINING ENGINEERING IMPROVEMENTS, NAMELY, MOTOR EFFICIENCY IMPROVEMENTS AND SWITCH EFFICIENCY IMPROVEMENTS, NEEDED TO IMPROVE ENERGY EFFICIENCY OR USAGE MANAGEMENT IN CONNECTION WITH COMMERCIAL STRUCTURES AND OPERATIONS AND INDUSTRIAL STRUCTURES AND OPERATIONS (U.S. CLS. 100 AND 101).

FIRST USE 12-9-2007; IN COMMERCE 12-9-2007.
LINDA ESTRADA, EXAMINING ATTORNEY

SN 77-716,717. GENERAL ELECTRIC COMPANY, SCHENECTADY, NY. FILED 4-17-2009.

HEALTHYMAGINATION

THE MARK CONSISTS OF STANDARD CHARACTERS WITHOUT CLAIM TO ANY PARTICULAR FONT, STYLE, SIZE, OR COLOR.

CLASS 42—SCIENTIFIC AND COMPUTER SERVICES

FOR PROVIDING MEDICAL RESEARCH INFORMATION IN THE FIELD OF DIAGNOSTIC, PROPHYLACTIC AND THERAPEUTIC PROPERTIES OF PHARMACEUTICALS (U.S. CLS. 100 AND 101).

CLASS 44—MEDICAL, BEAUTY AND AGRICULTURAL SERVICES

FOR CONSULTING SERVICES IN THE FIELD OF MEDICAL AND DIAGNOSTIC MEDICAL IMAGING; COMPREHENSIVE MEDICAL SERVICES IN THE MEDICAL FIELD CONSISTING OF DIAGNOSIS AND TREATMENT THROUGHOUT A HOSPITAL THAT IS DIRECTED TO IMPROVING AND MAINTAINING QUALITY OF PATIENT CARE (U.S. CLS. 100 AND 101).

SUSAN LESLIE DUBOIS, EXAMINING ATTORNEY

SN 77-716,897. ALLMYBIZ, INC., BROOKLYN, NY. FILED 4-18-2009.



NO CLAIM IS MADE TO THE EXCLUSIVE RIGHT TO USE "BIZ", APART FROM THE MARK AS SHOWN.

THE MARK CONSISTS OF THE WORDING "ALLMYBIZ" FEATURING THE TERM "BIZ" ON A STYLIZED SQUARE BACKGROUND.

CLASS 35—ADVERTISING AND BUSINESS

FOR ADVERTISING AND PUBLICITY SERVICES, NAMELY, PROMOTING THE GOODS, SERVICES, BRAND IDENTITY AND COMMERCIAL INFORMATION AND NEWS OF THIRD PARTIES THROUGH PRINT, AUDIO, VIDEO, DIGITAL AND ON-LINE MEDIUM; ADVERTISING BY TRANSMISSION OF ON-LINE PUBLICITY FOR THIRD PARTIES THROUGH ELECTRONIC COMMUNICATIONS NETWORKS; ADVERTISING, MARKETING AND PROMOTIONAL SERVICES RELATED TO ALL INDUSTRIES FOR THE PURPOSE OF FACILITATING NETWORKING AND SOCIALIZING OPPORTUNITIES FOR BUSINESS PURPOSES; AUCTION MANAGEMENT SERVICES PROVIDED TO OTHERS OVER AN ON-LINE WEB SITE ACCESSED THROUGH A GLOBAL COMPUTER NETWORK; INFORMATION, ADVISORY AND CONSULTANCY SERVICES RELATING TO BUSINESS AND MANAGEMENT OR BUSINESS ADMINISTRATION, INCLUDING SUCH SERVICES PROVIDED ON LINE OR VIA THE INTERNET; ON-LINE ADVERTISING ON COMPUTER COMMUNICATION NETWORKS; ON-LINE BUSINESS NETWORKING SERVICES; OPERATING ON-LINE MARKETPLACES FOR SELLERS OF GOODS AND/OR SERVICES; PROMOTING, ADVERTISING AND MARKETING OF THE ON-LINE WEB SITES OF OTHERS; PROMOTION, ADVERTISING AND MARKETING OF ON-LINE WEBSITES; PROVIDING A WEB SITE THAT ENABLES USERS TO POST ITEMS FOR SALE THROUGH ON-LINE CLASSIFIED ADVERTISEMENTS; PROVIDING A WEB SITE THAT FEATURES AN ON-LINE MARKET FOR USERS TO LIST OFFERED OR WANTED PERSONAL AND BUSINESS ASSETS AND SKILLS FOR HIRE, RENT, SALE OR AUCTION TRANSACTED ON THE BASIS OF PREDEFINED PERFORMANCE AND CLOSING TERMS AND CONDITIONS; PROVIDING AN ON-LINE COMMERCIAL INFORMATION DIRECTORY ON THE INTERNET; PROVIDING AN ON-LINE SEARCHABLE DATABASE FEATURING CLASSIFIED AD LISTINGS AND EMPLOYMENT OPPORTUNITIES (U.S. CLS. 100, 101 AND 102).

FIRST USE 10-1-2006; IN COMMERCE 11-1-2008.

CLASS 38—COMMUNICATION

FOR COMPUTER SERVICES, NAMELY, PROVIDING ON-LINE FACILITIES FOR REAL-TIME INTERACTION WITH OTHER COMPUTER USERS CONCERNING TOPICS OF GENERAL INTEREST; ON-LINE SERVICES, NAMELY, MESSAGE SENDING; PROVIDING ON-LINE CHAT ROOMS AND ELECTRONIC BULLETIN BOARDS FOR TRANSMISSION OF MESSAGES AMONG USERS IN THE FIELD OF GENERAL INTEREST (U.S. CLS. 100, 101 AND 104).

FIRST USE 10-1-2006; IN COMMERCE 11-1-2008.

CLASS 42—SCIENTIFIC AND COMPUTER SERVICES

FOR COMPUTER SERVICE, ACTING AS AN APPLICATION SERVICE PROVIDER IN THE FIELD OF KNOWLEDGE MANAGEMENT TO HOST COMPUTER APPLICATION SOFTWARE FOR CREATING SEARCHABLE DATABASES OF INFORMATION AND DATA TO ALLOW USERS TO PERFORM, ON-LINE, THE COLLECTING AND ANALYZING OF DIFFERENT TYPES OF OPINION SURVEYS; COMPUTER SERVICES, NAMELY, CREATING AN ON-LINE COMMUNITY FOR REGISTERED USERS TO PARTICIPATE IN DISCUSSIONS, GET FEEDBACK FROM THEIR PEERS, FORM VIRTUAL COMMUNITIES, AND ENGAGE IN SOCIAL NETWORKING; COMPUTER SERVICES, NAMELY, HOSTING ON-LINE WEB FACILITIES FOR OTHERS FOR ORGANIZING AND CONDUCTING ON-LINE MEETINGS, GATHERINGS, AND INTERACTIVE DISCUSSIONS; COMPUTER SERVICES, NAMELY, INTERACTIVE HOSTING SERVICES WHICH ALLOW THE USER TO PUBLISH AND SHARE THEIR OWN CONTENT AND IMAGES ON-LINE; DESIGN AND DEVELOPMENT OF ON-LINE COMPUTER SOFTWARE SYSTEMS (U.S. CLS. 100 AND 101).

FIRST USE 10-1-2006; IN COMMERCE 11-1-2008.

CLASS 45—PERSONAL AND LEGAL SERVICES

FOR INTERNET BASED SOCIAL NETWORKING, INTRODUCTION, AND DATING SERVICES; INTERNET-BASED DATING, SOCIAL INTRODUCTION AND SOCIAL NETWORKING SERVICES (U.S. CLS. 100 AND 101).

FIRST USE 10-1-2006; IN COMMERCE 11-1-2008.

B. PARADEWELAI, EXAMINING ATTORNEY

SN 77-717,269. E-NSURANCE SOLUTIONS, INC., CORAL GABLES, FL. FILED 4-20-2009.

TANDICORP

THE MARK CONSISTS OF STANDARD CHARACTERS WITHOUT CLAIM TO ANY PARTICULAR FONT, STYLE, SIZE, OR COLOR.

CLASS 9—ELECTRICAL AND SCIENTIFIC APPARATUS

FOR SOFTWARE FOR CALCULATING INSURANCE CLAIMS, FOR USE IN DATABASE MANAGEMENT OF INSURANCE UNDERWRITING, FOR CALCULATING INSURANCE PRICING, FOR ASSESSING INSURANCE RATING, FOR USE IN DATABASE MANAGEMENT OF INSURANCE ACCOUNTS RECEIVABLE, FOR CALCULATING INSURANCE BILLING, FOR USE IN DATABASE MANAGEMENT OF INSURANCE CLAIMS AND FOR DESIGNING INSURANCE I.D. CARDS (U.S. CLS. 21, 23, 26, 36 AND 38).

CLASS 36—INSURANCE AND FINANCIAL

FOR ONLINE SERVICES, NAMELY, PROVIDING A WEBSITE FEATURING INSURANCE ADMINISTRATION AND INSURANCE INFORMATION (U.S. CLS. 100, 101 AND 102).

AMEEN IMAM, EXAMINING ATTORNEY

SN 77-717,292. MODULAR SPACE CORPORATION, BERWYN, PA. FILED 4-20-2009.

SN 77-719,947. ALBERT BARTLETT & SONS (AIRDRIE) LIMITED, AIRDIRE LANARKSHIRE, UNITED KINGDOM, FILED 4-22-2009.



ANYA

OWNER OF U.S. REG. NOS. 1,123,065, 3,133,642 AND 3,151,456.

THE MARK CONSISTS OF THE STYLIZED WORDING "MODSAFE" BELOW AN OVAL DESIGN CONTAINING THREE PARTIALLY SHADED SHAPES IN VARIOUS SIZES.

CLASS 36—INSURANCE AND FINANCIAL

FOR LEASING OF PORTABLE METAL AND PORTABLE NON-METAL BUILDINGS (U.S. CLS. 100, 101 AND 102).

CLASS 39—TRANSPORTATION AND STORAGE

FOR PROVIDING SELF-STORAGE FACILITIES FOR OTHERS (U.S. CLS. 100 AND 105).

TIMOTHY FINNEGAN, EXAMINING ATTORNEY

THE MARK CONSISTS OF STANDARD CHARACTERS WITHOUT CLAIM TO ANY PARTICULAR FONT, STYLE, SIZE, OR COLOR.

THE ENGLISH TRANSLATION OF "ANYA" IN THE MARK IS "GRACEFUL".

CLASS 29—MEATS AND PROCESSED FOODS

FOR PROCESSED POTATOES; FRENCH FRIED POTATOES; POTATO CHIPS; POTATO FLAKES; PREPARATIONS WITH A POTATO BASE, NAMELY, POTATO PANCAKES; POTATO BASED SNACK MEALS AND MIXES CONSISTING WHOLLY OR PRINCIPALLY OF POTATOES AND POTATO SALADS CONSISTING WHOLLY OR PRINCIPALLY OF POTATOES; FRIED POTATO PRODUCTS, NAMELY, POTATO CHIPS, POTATO CRISPS AND FRENCH FRIED POTATOES; FROZEN POTATO PRODUCTS, NAMELY, FROZEN HASH BROWN POTATOES, POTATO WAFFLES, FROZEN MASHED POTATO, FROZEN FRENCH FRIED POTATOES, FROZEN ROAST POTATOES, FROZEN WHOLE OR SEGMENTED POTATOES, POTATOES IN THE SHAPE OF VISAGES AND IMAGES, LETTERS NUMBERS AND OTHER SIMILAR CHARACTERS, AND OTHER PREFORMED POTATO SHAPES FOR OVEN BAKING OR FRYING MADE FROM RECONSTITUTED POTATO; HASH BROWN POTATOES; INSTANT MASHED POTATOES; INSTANT POTATOES; POTATO BASED SNACK FOOD; POTATO CAKES; POTATO CROQUETTES; POTATO FRIES; POTATO FRITTERS; POTATO GRANULES; POTATO PANCAKES; POTATO STICKS; POTATO CHIPS; POTATO PRODUCTS BEING DEHYDRATED, INSTANT POTATOES; POTATO FRITTERS, POTATO GNOCCHI, POTATO CAKES; GERMAN POTATO PANCAKES, POTATO DUMPLINGS; POTATO PRODUCTS IN EXTRUDED FORM, NAMELY, VISAGES AND IMAGES, LETTERS NUMBERS AND OTHER SIMILAR CHARACTERS, AND OTHER PREFORMED POTATO SHAPES MADE WHOLLY OR PRINCIPALLY OF POTATO; POTATO PRODUCTS IN THE FORM OF SNACK FOODS, NAMELY, POTATO CHIPS AND POTATO CRISPS; POTATO-BASED SNACK FOODS; POTATOES BEING DRIED; POTATOES BEING PRESERVED; POTATOES BEING PROCESSED; TINNED RAW POTATOES; PRECOOKED POTATOES; MEAL ACCOMPANIMENTS AND PREPARED MEAL COMPONENTS MADE WHOLLY OR PRINCIPALLY FROM POTATOES, NAMELY, POTATO DUMPLINGS, POTATO GNOCCHI, POTATO PIE TOPPINGS, POTATO DAUPHINOISE, POTATO COBBLER, POTATO PANCAKES, POTATO CAKES; MASHED POTATOES, POTATO CAKES, POTATO PASTRY, PREPARED READY MEALS CONSISTING WHOLLY OR PRINCIPALLY OF POTATOES, NAMELY, POTATO HOT POTS, POTATO SOUPS, POTATO BASED CHOWDER, POTATO HASH, PROCESSED POTATOES; PEELED POTATOES, POTATO BASED SNACK FOODS, EXTRUDED FOOD PRODUCTS MADE OF POTATOES, NAMELY, POTATO STICKS AND SHAPED FIGURES; POTATO TERRINES, ROAST POTATOES, SAUTÉ POTATOES, RISsoles, PREPARED JACKET POTATOES, PREPARED POTATO SALADS, BAKED POTATO SKINS (U.S. CL. 46).

SN 77-717,480. MODULAR SPACE CORPORATION, BERWYN, PA. FILED 4-20-2009.



OWNER OF U.S. REG. NOS. 1,123,065, 3,133,642 AND 3,151,456.

THE MARK CONSISTS OF THE STYLIZED WORDING "MODSAFE" BELOW AN OVAL DESIGN CONTAINING THREE PARTIALLY SHADED SIDES IN VARIOUS SIZES.

CLASS 36—INSURANCE AND FINANCIAL

FOR LEASING OF PORTABLE METAL AND PORTABLE NON-METAL BUILDINGS FOR USE AS COMMERCIAL SPACE AND CONSTRUCTION OFFICES (U.S. CLS. 100, 101 AND 102).

CLASS 39—TRANSPORTATION AND STORAGE

FOR PROVIDING SELF-STORAGE FACILITIES FOR OTHERS FOR COMMERCIAL AND CONSTRUCTION STORAGE (U.S. CLS. 100 AND 105).

TIMOTHY FINNEGAN, EXAMINING ATTORNEY

CLASS 30—STAPLE FOODS

FOR POTATO FLOUR; POTATO PRODUCTS FOR USE IN MAKING SNACK FOOD, NAMELY, POTATO FLOUR; POTATO PRODUCTS AND SNACK FOODS IN EXTRUDED FORM MADE FROM POTATO FLOUR, NAMELY, THOSE DERIVED FROM POTATO OR SWEET POTATO IN CHIP, STICK, CRACKER, BREADSTICK OR FORMED SHAPES FORM; POTATO CRACKERS; PREPARATIONS WITH A POTATO BASE, NAMELY, POTATO BREAD; POTATO BREAD; POTATO PASTRY; SNACK FOODS CONTAINING POTATO FLOUR AS PRINCIPAL INGREDIENT, NAMELY, THOSE DERIVED FROM POTATO OR SWEET POTATO IN CHIP, STICK, CRACKER, BREADSTICK OR FORMED SHAPES FORM; POTATO FLOUR FOR FOOD; POTATO STARCH FOR FOOD; POTATO BREAD AND POTATO PASTRY MADE FROM POTATO FLOUR; POTATO PRODUCTS WITH POTATO AS THE PRINCIPAL INGREDIENT EITHER IN FRESH OR RECONSTITUTED FORM, NAMELY, POTATO SCONES, POTATO MUFFINS, POTATO BREAD; POTATO BASED BLINIS (U.S. CL. 46).

CLASS 31—NATURAL AGRICULTURAL PRODUCTS

FOR RAW POTATOES, POTATO SEEDS, UNPROCESSED POTATOES (U.S. CLS. 1 AND 46).

CLASS 44—MEDICAL, BEAUTY AND AGRICULTURAL SERVICES

FOR POTATO FARMING; HORTICULTURAL SERVICES; INFORMATION, ADVISORY AND CONSULTANCY SERVICES RELATING TO AGRICULTURE, HORTICULTURE AND FARMING (U.S. CLS. 100 AND 101).

STEVEN R. FINE, EXAMINING ATTORNEY

CLASS 9—ELECTRICAL AND SCIENTIFIC APPARATUS

FOR LOUDSPEAKERS; SET-TOP-BOXES; APPARATUS, DEVICES, INSTRUMENTS AND MEDIA FOR THE RECORDING, REPRODUCTION, RECEPTION, STORAGE, CONVERTING, PROCESSING, TRANSMISSION, BROADCASTING, RETRIEVING OF MUSIC, SOUNDS, IMAGES, TEXT, SIGNALS, SOFTWARE, INFORMATION, DATA AND CODES, NAMELY, AUDIO-VISUAL RECEIVERS, DIGITAL MEDIA RECEIVERS, BLANK MAGNETIC DATA CARRIERS, BLANK CDROMS, AND BLANK RECORDABLE DVDS; DEVICES FOR THE RECEPTION OF ENCODED AND COMPRESSED SOUND, IMAGE AND DATA SIGNALS, NAMELY, AUDIOVISUAL RECEIVERS AND DIGITAL MEDIA RECEIVERS; APPARATUS FOR CONVERTING OF DATA IN RELATION TO IMAGES OR SOUND-TRACKS, NAMELY, CDROM BURNERS AND DVD BURNERS; CD RECORDING APPARATUS; IMAGE AND SLIDE PROJECTORS; APPARATUS FOR PROCESSING IMAGES; MUSICAL COMPACT DISC RECORDING APPARATUS; CD PLAYER AND RECORDER; COMPUTER GAME SOFTWARE RECORDED ON CD-ROMS; CD-ROM DRIVES; COMPUTER SOFTWARE FOR THE SECURE TRANSMISSION AND RECEPTION OF DATA, SIGNALS, IMAGES AND SOUND; DECODER FOR TELEVISION SETS; BLANK AUDIO AND VIDEO DISCS, RECORD DISCS AND TAPES FOR RECORDING OF SOUND AND/OR IMAGES; DVD-PLAYERS; DVD RECORDING APPARATUS; ELECTRONIC 3-D-EYEGLASSES; TELEVISION RECEIVERS AND SCREENS; FLAT PANEL DISPLAY SCREENS; DOWNLOADABLE MUSICAL SOUND RECORDINGS; HI-FI SYSTEMS, UNITS AND DEVICES FOR CARS, NAMELY, STEREO TUNERS, STEREO RECEIVERS AND CD PLAYERS; BLANK INTEGRATED CIRCUIT CARDS WITH SWITCHING NETWORKS; BLANK MAGNETIC DATA CARRIERS; MICROPROCESSORS; HEADPHONES; MICROPHONES; MAGNETIC CARDS; SIGNAL ENCODER AND DECODER; SOUND CARDS; RADIOS INCORPORATING CLOCKS; FURNITURE SPECIFICALLY ADAPTED FOR HOLDING DEVICES FOR THE RECORDING, TRANSMISSION AND REPRODUCTION OF SOUND AND IMAGE (U.S. CLS. 21, 23, 26, 36 AND 38).

CLASS 35—ADVERTISING AND BUSINESS

FOR PRODUCT MERCHANDISING, NAMELY, THE PLACEMENT OF A WIDE VARIETY OF GOODS OF OTHERS FOR PROMOTIONAL PURPOSES; ONLINE ORDERING SERVICES FEATURING AUDIOVISUAL RECEIVERS, LOUDSPEAKERS, ELECTRONICS, STEREO EQUIPMENT HI-FI SYSTEMS; ONLINE RETAIL STORE SERVICES FEATURING AUDIOVISUAL RECEIVERS, LOUDSPEAKERS, ELECTRONICS AND STEREO EQUIPMENT HI-FI SYSTEMS; ADMINISTRATIVE PROCESSING OF PURCHASE ORDERS; ADVERTISING; ADVERTISING IN ALL MEDIA, NAMELY, RADIO, TV, CINEMA, PRINT MEDIA, VIDEOTEXT, ONLINE AND TELETXT ADVERTISING; DISTRIBUTION AND DISSEMINATION OF ADVERTISING MATERIAL IN THE NATURE OF FLYERS, HANDOUTS, BROCHURES, PRINTED MATTERS, AND TEST SAMPLES, PRODUCT DEMONSTRATION BY ELECTRONIC MEANS FOR THE BENEFIT OF TELE-SHOPPING AND HOME SHOPPING SERVICES; UPDATING OF ADVERTISING MATERIAL; ADVERTISING MEDIATION; ADVERTISING SERVICES, PUBLIC RELATIONS AND MARKETING SERVICES, NAMELY, PROMOTING AND MARKETING THE GOODS AND SERVICES OF OTHERS THROUGH ALL PUBLIC COMMUNICATION MEANS; ORGANIZATION AND OPERATING MARKETING PROMOTIONAL EVENTS OF OTHERS; ORGANIZATION OF EXHIBITIONS AND TRADE FAIRS FOR BUSINESS AND PROMOTIONAL PURPOSES (U.S. CLS. 100, 101 AND 102).

CLASS 39—TRANSPORTATION AND STORAGE

FOR DISTRIBUTION SERVICES, NAMELY, DELIVERY OF AUDIOVISUAL RECEIVERS, LOUDSPEAKERS, ELECTRONICS, STEREO EQUIPMENT AND HI-FI SYSTEMS (U.S. CLS. 100 AND 105).

SN 77-720,435. LAUTSPRECHER TEUFEL GMBH, BERLIN, FED REP GERMANY, FILED 4-23-2009.

TEUFEL

THE MARK CONSISTS OF STANDARD CHARACTERS WITHOUT CLAIM TO ANY PARTICULAR FONT, STYLE, SIZE, OR COLOR.

PRIORITY CLAIMED UNDER SEC. 44(D) ON ERP CMNTY TM OFC APPLICATION NO. 007530157, FILED 1-16-2009, REG. NO. 007530157, DATED 1-16-2009, EXPIRES 1-16-2019.

THE ENGLISH TRANSLATION OF THE WORD "TEUFEL" IN THE MARK IS "DEVIL".

CLASS 41—EDUCATION AND ENTERTAINMENT

FOR ORGANIZING COMMUNITY CULTURAL AND SPORTING EVENTS; ENTERTAINMENT, SPORTING AND CULTURAL ACTIVITIES, NAMELY, LIVE PERFORMANCES BY A MUSICAL BAND, LIGHT SHOWS; PROVIDING AN INTERNET WEBSITE PORTAL IN THE FIELD OF ENTERTAINMENT, CULTURAL AND SPORTING EVENTS (U.S. CLS. 100, 101 AND 107).

ELI HELLMAN, EXAMINING ATTORNEY

SN 77-720,456. LAUTSPRECHER TEUFEL GMBH, BERLIN, FED REP GERMANY, FILED 4-23-2009.



PRIORITY CLAIMED UNDER SEC. 44(D) ON ERP N CMNTY TM OFC APPLICATION NO. 007530157, FILED 1-16-2009, REG. NO. 007533011, DATED 1-19-2009, EXPIRES 1-19-2019.

OWNER OF U.S. REG. NO. 3,318,589.

THE COLOR(S) RED IS/ARE CLAIMED AS A FEATURE OF THE MARK.

THE COLOR RED APPEARS IN THE TEXT OF THE WORDING "TEUFEL".

THE ENGLISH TRANSLATION OF THE WORD "TEUFEL" IN THE MARK IS DEVIL.

CLASS 9—ELECTRICAL AND SCIENTIFIC APPARATUS

FOR LOUDSPEAKERS; SET-TOP-BOXES; APPARATUS, DEVICES, INSTRUMENTS AND MEDIA FOR THE RECORDING, REPRODUCTION, RECEPTION, STORAGE, CONVERTING, PROCESSING, TRANSMISSION, BROADCASTING, RETRIEVING OF MUSIC, SOUNDS, IMAGES, TEXT, SIGNALS, SOFTWARE, INFORMATION, DATA AND CODES, NAMELY, AUDIOVISUAL RECEIVERS, DIGITAL MEDIA RECEIVERS, BLANK MAGNETIC DATA CARRIERS, BLANK CDROMS, AND BLANK RECORDABLE DVDS; DEVICES FOR THE RECEPTION OF ENCODED AND COMPRESSED SOUND, IMAGE AND DATA SIGNALS, NAMELY, AUDIOVISUAL RECEIVERS AND DIGITAL MEDIA RECEIVERS; APPARATUS FOR CONVERTING OF DATA IN RELATION TO IMAGES OR SOUNDTRACKS, NAMELY, CDROM BURNERS AND DVD BURNERS; CD RECORDING APPARATUS; IMAGE AND SLIDE PROJECTORS; APPARATUS FOR PROCESSING IMAGES; MUSICAL COMPACT DISC RECORDING APPARATUS; CD PLAYER AND RECORDER; COMPUTER GAME SOFTWARE RECORDED ON CDROMS; CD-ROM DRIVES; COMPUTER SOFTWARE FOR THE SECURE TRANSMISSION AND RECEPTION OF DATA, SIGNALS, IMAGES AND SOUND; DECODER FOR TELEVISION SETS; BLANK AUDIO AND VIDEO DISCS, RECORD DISCS AND TAPES FOR RECORDING OF SOUND AND/OR IMAGES; DVD-PLAYERS; DVD RECORDING APPARATUS; ELECTRONIC 3-D-EYEGLASSES; TELEVISION RECEIVERS AND SCREENS; FLAT PANEL DISPLAY SCREENS; DOWNLOADABLE MUSICAL SOUND RECORDINGS; HI-FI SYSTEMS, UNITS AND DEVICES FOR CARS, NAMELY, STEREO TUNERS, STEREO RECEIVERS AND CD PLAYERS; BLANK INTEGRATED CIRCUIT CARDS WITH SWITCHING NETWORKS; BLANK MAGNETIC DATA CARRIERS; MICROPROCESSORS; HEADPHONES; MICROPHONES; MAGNETIC CARDS; SIGNAL ENCODER AND DECODER; SOUND CARDS; RADIOS INCORPORATING CLOCKS; FURNITURE SPECIFICALLY ADAPTED FOR HOLDING DEVICES FOR THE RECORDING, TRANSMISSION AND REPRODUCTION OF SOUND AND IMAGE (U.S. CLS. 21, 23, 26, 36 AND 38).

CLASS 35—ADVERTISING AND BUSINESS

FOR PRODUCT MERCHANDISING, NAMELY, THE PLACEMENT OF A WIDE VARIETY OF GOODS OF OTHERS FOR PROMOTIONAL PURPOSES; ONLINE ORDERING SERVICES FEATURING AUDIOVISUAL RECEIVERS, LOUDSPEAKERS, ELECTRONICS, STEREO EQUIPMENT HI-FI SYSTEMS; ONLINE RETAIL STORE SERVICES FEATURING AUDIOVISUAL RECEIVERS, LOUDSPEAKERS, ELECTRONICS AND STEREO EQUIPMENT HI-FI SYSTEMS; ADMINISTRATIVE PROCESSING OF PURCHASE ORDERS; ADVERTISING; ADVERTISING IN ALL MEDIA, NAMELY RADIO, TV, CINEMA, PRINT MEDIA, VIDEOTEXT, ONLINE AND TELETEXT ADVERTISING; DISTRIBUTION AND DISSEMINATION OF ADVERTISING MATERIAL IN THE NATURE OF FLYERS, HANDOUTS, BROCHURES, PRINTED MATTERS, AND TEST SAMPLES, PRODUCT DEMONSTRATION BY ELECTRONIC MEANS FOR THE BENEFIT OF TELE-SHOPPING AND HOME SHOPPING SERVICES; UPDATING OF ADVERTISING MATERIAL; ADVERTISING MEDIATION; ADVERTISING SERVICES, PUBLIC RELATIONS AND MARKETING SERVICES, NAMELY, PROMOTING AND MARKETING THE GOODS AND SERVICES OF OTHERS THROUGH ALL PUBLIC COMMUNICATION MEANS; ORGANIZATION AND OPERATING MARKETING PROMOTIONAL EVENTS OF OTHERS; ORGANIZATION OF EXHIBITIONS AND TRADE FAIRS FOR BUSINESS AND PROMOTIONAL PURPOSES (U.S. CLS. 100, 101 AND 102).

CLASS 39—TRANSPORTATION AND STORAGE

FOR DISTRIBUTION SERVICES, NAMELY, DELIVERY OF AUDIOVISUAL RECEIVERS, LOUDSPEAKERS, ELECTRONICS, STEREO EQUIPMENT AND HI-FI SYSTEMS (U.S. CLS. 100 AND 105).

CLASS 41—EDUCATION AND ENTERTAINMENT

FOR ORGANIZING COMMUNITY CULTURAL AND SPORTING EVENTS; ENTERTAINMENT, SPORTING AND CULTURAL ACTIVITIES, NAMELY, LIVE PERFORMANCES BY A MUSICAL BAND, LIGHT SHOWS; PROVIDING AN INTERNET WEBSITE PORTAL IN THE FIELD OF ENTERTAINMENT, CULTURAL AND SPORTING EVENTS (U.S. CLS. 100, 101 AND 107).

ELI HELLMAN, EXAMINING ATTORNEY

SN 77-721,626. CATAMOUNT RESEARCH & DEVELOPMENT COMPANY, ST. ALBANS, VT. FILED 4-24-2009.



NO CLAIM IS MADE TO THE EXCLUSIVE RIGHT TO USE "RESEARCH AND DEVELOPMENT INC.", APART FROM THE MARK AS SHOWN.

THE MARK CONSISTS OF A STYLIZED DEPICTION OF A PAW PRINT WITH THE WORD "CATAMOUNT" TO THE RIGHT, AND THE WORDS "RESEARCH AND DEVELOPMENT INC." SUPERIMPOSED ON A RECTANGULAR BACKGROUND BELOW THE WORD "CATAMOUNT".

CLASS 9—ELECTRICAL AND SCIENTIFIC APPARATUS

FOR COMPUTER SOFTWARE FOR USE WITH LABORATORY ANALYZING, MEASURING, AND TESTING INSTRUMENTS, NAMELY, OPERATING SOFTWARE FOR THE AFOREMENTIONED LABORATORY INSTRUMENTS AND SOFTWARE FOR STORING AND ANALYZING RESEARCH DATA; COMPUTER HARDWARE FOR USE WITH LABORATORY ANALYZING, MEASURING, AND TESTING INSTRUMENTS; DOWNLOADABLE COMPUTER SOFTWARE FOR USE WITH LABORATORY ANALYZING, MEASURING, AND TESTING INSTRUMENTS, NAMELY, OPERATING SOFTWARE FOR THE AFOREMENTIONED LABORATORY INSTRUMENTS AND SOFTWARE FOR STORING AND ANALYZING RESEARCH DATA; LABORATORY ANALYZING, MEASURING, AND TESTING EQUIPMENT IN THE FIELD OF PHYSIOLOGICAL RESEARCH, NAMELY, COMPUTER HARDWARE, DISTANCE MEASURING APPARATUS, AND LABORATORY INSTRUMENTS AND APPARATUS FOR MEASURING CONTRACTILITY, PULSE RATE, OXYGEN SATURATION, GASTROINTESTINAL MOTILITY, PERISTALTIC REFLEX, UROLOGICAL FUNCTION INCLUDING CYSTOMETRY, AND THE PRESSURE OF GASES AND LIQUIDS; LABORATORY INSTRUMENTS FOR CARDIOVASCULAR DIAGNOSTICS, NAMELY, FOR MEASURING CONTRACTILITY, PULSE RATE, PRESSURE OF GASES AND LIQUIDS, AND THE FLOW OF GASES AND LIQUIDS, AND OXYGEN MEASURING APPARATUS AND ARTERIOGRAPHS, BLOOD VESSEL CHAMBERS, AND OXYGENATORS, WITH THE AFOREMENTIONED BEING FOR LABORATORY RESEARCH PURPOSES AND NOT BEING FOR MEDICAL DIAGNOSIS; LABORATORY INSTRUMENTS FOR USE IN PRE-CLINICAL DIAGNOSTICS AND RESEARCH OF BLOOD VESSELS, SIMULATIONS AND TESTING OF VESSELS, REGULATING THE FLOW OF BLOOD, AND MEASUREMENT SYSTEMS ALL RELATED TO BLOOD VESSELS, NAMELY, FOR MEASURING CONTRACTILITY, PULSE RATE, PRESSURE OF GASES AND LIQUIDS, AND THE FLOW OF GASES AND LIQUIDS, AND OXYGEN MEASURING APPARATUS AND ARTERIOGRAPHS, BLOOD VESSEL CHAMBERS, AND OXYGENATORS, WITH THE AFOREMENTIONED BEING FOR PRE-CLINICAL LABORATORY RESEARCH PURPOSES AND NOT BEING FOR MEDICAL DIAGNOSIS (U.S. CLS. 21, 23, 26, 36 AND 38).

FIRST USE 12-18-2006; IN COMMERCE 12-18-2006.

CLASS 42—SCIENTIFIC AND COMPUTER SERVICES

FOR CONSULTING SERVICES IN THE FIELDS OF BEHAVIORAL, NEUROLOGICAL, PSYCHOLOGICAL, PHARMACOLOGICAL, AND PHYSIOLOGICAL RESEARCH AND DEVELOPMENT; CONSULTING SERVICES IN THE FIELDS OF BIOTECHNOLOGY, PHARMACEUTICAL RESEARCH AND DEVELOPMENT, LABORATORY TESTING, DIAGNOSTICS, AND PHARMACOGENOMICS; LABORATORY RESEARCH IN THE FIELDS OF BEHAVIOR, NEUROLOGY, PSYCHOLOGY, PHARMACOLOGY, AND PHYSIOLOGIC RESEARCH; MEDICAL AND SCIENTIFIC RESEARCH, NAMELY, CONDUCTING PRE-CLINICAL AND CLINICAL TRIALS; PROVIDING MEDICAL AND SCIENTIFIC RESEARCH INFORMATION IN THE FIELD OF PRE-CLINICAL AND CLINICAL TRIALS (U.S. CLS. 100 AND 101).

FIRST USE 12-18-2006; IN COMMERCE 12-18-2006.
KEVIN CORWIN, EXAMINING ATTORNEY

SN 77-721,747. HEWLETT-PACKARD DEVELOPMENT COMPANY, L.P., HOUSTON, TX. FILED 4-24-2009.

CREATE AMAZING

THE MARK CONSISTS OF STANDARD CHARACTERS WITHOUT CLAIM TO ANY PARTICULAR FONT, STYLE, SIZE, OR COLOR.

CLASS 9—ELECTRICAL AND SCIENTIFIC APPARATUS

FOR COMPUTERS; COMPUTER HARDWARE; COMPUTER PERIPHERALS; COMPUTER AND COMMUNICATIONS NETWORKING HARDWARE; DATA PROCESSING AND DATA STORAGE SYSTEMS COMPRISED OF SERVERS FOR PROCESSING AND STORING INFORMATION, DATA, SOUND OR IMAGES; PRINTERS; FACSIMILE MACHINES; SCANNERS; PHOTOCOPIERS; CALCULATORS; TELEPHONES; AND PARTS FOR ALL OF THE FOREGOING; RECORDABLE AND REWRITEABLE BLANK OPTICAL DISCS; BLANK RECORDABLE CD-RS AND DVD-RS; CD-ROM AND DVD DRIVES; CD-ROM AND DVD WRITERS; SOFTWARE FOR USE IN MANAGING AND CONTROLLING DATA IN A TELECOMMUNICATIONS NETWORK AND FOR MANAGING, RUNNING AND FACILITATING THE USE OF PROGRAMS THAT CONTROL END USER SERVICES IN A TELECOMMUNICATIONS NETWORK; SOFTWARE FOR COMPUTER NETWORK MANAGEMENT, MONITORING, MAINTENANCE AND ADMINISTRATION; SOFTWARE FOR MANAGEMENT, CONTROL, DIAGNOSIS AND ANALYSIS FOR COMPUTERS AND COMPUTER NETWORKS; SOFTWARE FOR USE IN MANAGING ELECTRONIC DATA AND DATA STORAGE AND RETRIEVAL FUNCTIONS; SOFTWARE FOR PROVIDING HARDWARE SET-UP, CONFIGURATION AND DIAGNOSTIC FUNCTIONS; SOFTWARE FOR CREATING AND INSCRIBING TEXT AND IMAGES ONTO OPTICAL RECORDING MEDIA; SOFTWARE FOR USE IN MANAGING ELECTRONIC CASH REGISTERS AND RELATED HARDWARE; SOFTWARE FOR OPTIMIZING IMAGE QUALITY AND PRINTING SPEED; SOFTWARE FOR ORGANIZING AND VIEWING DIGITAL IMAGES AND PHOTOGRAPHS; NETWORKING MANAGEMENT SOFTWARE FOR CONTROLLING SWITCHES AND TRANSCEIVERS; SOFTWARE FOR DATA STORAGE MANAGEMENT AND ARCHIVING; SOFTWARE FOR ENTERPRISE RESOURCE MANAGEMENT, FOR INFRASTRUCTURE MANAGEMENT, FOR PROJECT MANAGEMENT, FOR HUMAN RESOURCE MANAGEMENT; SOFTWARE FOR ASSISTING IN THE DEVELOPMENT AND TESTING OF BUSINESS-BASED SOFTWARE APPLICATIONS; SOFTWARE FOR FINANCIAL ANALYSIS, CREDIT RISK CONTROL AND FRAUD PREVENTION AND MANAGEMENT; SOFTWARE FOR USE IN ENTERPRISE-WIDE ELECTRONIC RECORDKEEPING AND DOCUMENT MANAGEMENT IN SUPPORT OF ELECTRONIC BUSINESS; SOFTWARE FOR ADMINISTRATION OF INSURANCE AND INVESTMENT HOLDINGS; SOFTWARE FOR CONTROLLING AND MANAGING THE STORAGE OF DATA AND INFORMATION ON COMPUTER STORAGE DEVICES AND CLUSTERED COMPUTERS; PRINT HEADS FOR COMPUTER PRINTERS AND FOR PLOTTERS (U.S. CLS. 21, 23, 26, 36 AND 38).

CLASS 16—PAPER GOODS AND PRINTED MATTER

FOR PAPER; BROCHURES FEATURING TECHNOLOGICAL DEVELOPMENTS IN THE FIELD OF COMPUTERS AND INFORMATION TECHNOLOGY; REFERENCE GUIDES IN THE FIELD OF COMPUTERS AND INFORMATION TECHNOLOGY; TECHNICAL BULLETINS IN THE FIELD OF COMPUTERS AND INFORMATION TECHNOLOGY; DATA SHEETS IN THE FIELD OF COMPUTERS AND INFORMATION TECHNOLOGY; PRODUCT CATALOGS FEATURING COMPUTERS, COMPUTER PERIPHERALS, COMPUTER HARDWARE, AND ACCESSORIES FOR THE FOREGOING; PRODUCT OPERATING AND SERVICE GUIDES FOR COMPUTERS, COMPUTER SOFTWARE, COMPUTER HARDWARE, COMPUTER PERIPHERALS (U.S. CLS. 2, 5, 22, 23, 29, 37, 38 AND 50).

CLASS 35—ADVERTISING AND BUSINESS

FOR BUSINESS CONSULTING SERVICES; BUSINESS MANAGEMENT CONSULTING SERVICES; STRATEGIC PLANNING SERVICES; ONLINE RETAIL STORE SERVICES AND ORDERING SERVICES FEATURING COMPUTERS, PRINTERS AND TELECOMMUNICATIONS EQUIPMENT AND SUPPLIES; SERVICES IN THE FIELD OF ALLIANCE, PARTNER AND SOLUTION DEVELOPER PROGRAMS INCLUDING AFFINITY AND AFFILIATE PROGRAMS, NAMELY, DEVELOPING COMMERCIAL PARTNER STRATEGIES, IDENTIFYING APPROPRIATE PARTNER COMPANIES TO GO TO MARKET WITH, PROVIDING BUSINESS RELATIONSHIP, PLANNING, COLLABORATION, MARKETING AND SALES SUPPORT TOOLS AND SERVICES; ADVERTISING SERVICES; MARKETING AND PROMOTIONAL PROGRAM SERVICES IN THE FIELD OF ELECTRONIC COMMERCE AND ELECTRONIC BUSINESS; HUMAN RESOURCES AND HUMAN CAPITAL MANAGEMENT OUTSOURCING SERVICES; ADMINISTRATION OF BUSINESS PAYROLL FOR OTHERS; HUMAN RESOURCES CONSULTATION SERVICES; BUSINESS AND EMPLOYEE RELOCATION AND INFORMATION SERVICES; DATABASE MANAGEMENT SERVICES; BUSINESS PROCESS OUTSOURCING SERVICES IN THE FIELDS OF COMPUTERS AND INFORMATION TECHNOLOGY; CUSTOMER RELATIONSHIP MANAGEMENT SERVICES (U.S. CLS. 100, 101 AND 102).

CLASS 42—SCIENTIFIC AND COMPUTER SERVICES

FOR COMPUTER SERVICES, NAMELY, COMPUTER SYSTEMS ANALYSIS, COMPUTER SYSTEMS PLANNING, COMPUTER SYSTEMS INTEGRATION, COMPUTER SYSTEMS DESIGN; COMPUTER CONSULTATION, NAMELY, PROVIDING ASSISTANCE TO OTHERS IN THE DEVELOPMENT OF INTERNET PORTALS AND IN THE DESIGN AND DEVELOPMENT OF COMPUTER SOFTWARE FOR THE IMPROVEMENTS OF PURCHASING FUNCTIONS OF BUSINESS FOR USE IN THE FIELD OF ELECTRONIC COMMERCE; COMPUTER CONSULTING SERVICES IN THE FIELD OF INTERNET AND INTRANET NETWORK SECURITY; RENTAL OF COMPUTER SOFTWARE, COMPUTER HARDWARE AND COMPUTER PERIPHERALS TO OTHERS ON A SUBSCRIPTION OR PAY-PER-USE BASIS; COMPUTER TECHNOLOGY SUPPORT SERVICES, NAMELY, HELP DESK SERVICES PROVIDED ON A SUBSCRIPTION OR PAY-PER-USE BASIS; HOSTING OF DIGITAL CONTENT ON THE INTERNET; SOFTWARE AS A SERVICE (SAAS) SERVICES, NAMELY, HOSTING SOFTWARE FOR USE BY OTHERS IN THE FIELD OF INFORMATION TECHNOLOGY; COMPUTER SERVICES, NAMELY, REMOTE AND ON-SITE MANAGEMENT OF THE INFORMATION TECHNOLOGY (IT) SYSTEMS OF OTHERS; INFORMATION TECHNOLOGY CONSULTATION; DESIGN, INSTALLATION, MAINTENANCE AND REPAIR OF COMPUTER SOFTWARE; INTEGRATION OF COMPUTER SYSTEMS AND NETWORKS; COMPUTER NETWORK MANAGEMENT SERVICES IN THE NATURE OF PLANNING, DEVELOPMENT AND TECHNICAL SUPPORT FOR ELECTRONIC COMMUNICATIONS NETWORKS; DATABASE DEVELOPMENT SERVICES; COMPUTER PROGRAMMING SERVICES; CONSULTING SERVICES FOR OTHERS IN THE SELECTION, IMPLEMENTATION AND USE OF COMPUTER SOFTWARE

USED TO MONITOR AND MANAGE TRANSACTIONS AND ACTIVITIES IN A MISSION CRITICAL ENVIRONMENT; TECHNICAL SUPPORT SERVICES, NAMELY, TROUBLESHOOTING OF COMPUTER SOFTWARE PROBLEMS; DATA MINING SERVICES; TAXONOMY SERVICES, NAMELY, CLASSIFICATION AND ORGANIZATION OF DATA; INFORMATION MANAGEMENT SERVICES, NAMELY, ACTING AS AN APPLICATION SERVICE PROVIDER IN THE FIELD OF KNOWLEDGE MANAGEMENT TO HOST COMPUTER APPLICATION SOFTWARE FOR THE COLLECTION, EDITING, ORGANIZING, MODIFYING, BOOK MARKING, TRANSMISSION, STORAGE AND SHARING OF DATA AND INFORMATION; CUSTOM DESIGN OF COMPUTERS FOR OTHERS; CUSTOM DESIGN OF COMPUTERS FOR OTHERS; DATA BACKUP AND DATA RESTORATION SERVICES; DATA MIGRATION SERVICES; DATA ENCRYPTION SERVICES; RENTAL AND LEASING SERVICES OF COMPUTER HARDWARE AND COMPUTER PERIPHERALS; PROVIDING GRAPHIC ART DESIGN SERVICES VIA COMMUNICATIONS NETWORKS; SCIENTIFIC AND INDUSTRIAL RESEARCH IN THE FIELD OF COMPUTER SCIENCE AND INFORMATION TECHNOLOGY (U.S. CLS. 100 AND 101).

DAVID TAYLOR, EXAMINING ATTORNEY

SN 77-721,801. DFI TECHNOLOGIES, LLC, SACRAMENTO, CA. FILED 4-24-2009.

 The logo for dfi tech features the lowercase letters "dfi" in a bold, blue, sans-serif font, followed by the word "tech" in a bold, green, sans-serif font. The letters are closely spaced and the overall style is modern and clean.

OWNER OF U.S. REG. NO. 1,382,166.

NO CLAIM IS MADE TO THE EXCLUSIVE RIGHT TO USE "TECH", APART FROM THE MARK AS SHOWN.

THE COLOR(S) 302 BLUE AND 368 GREEN IS/ARE CLAIMED AS A FEATURE OF THE MARK.

THE MARK CONSISTS OF THE WORDS "DFI TECH" IN LOWERCASE CUSTOM FONT WITH THE WORD "DFI" IN 302 BLUE AND THE WORD "TECH" IN 368 GREEN. THE DOT A THE TOP OF THE LETTER "I" IN THE WORD "DFI" IS ALSO 368 GREEN.

CLASS 9—ELECTRICAL AND SCIENTIFIC APPARATUS

FOR INTERFACE BOARDS FOR ENHANCING PERSONAL COMPUTERS (U.S. CLS. 21, 23, 26, 36 AND 38). FIRST USE 11-1-2008; IN COMMERCE 11-1-2008.

CLASS 42—SCIENTIFIC AND COMPUTER SERVICES

FOR TECHNOLOGICAL SERVICES, NAMELY, PROVIDING SOFTWARE AND SYSTEMS INTEGRATION SERVICES TO IMPROVE BUSINESS MANAGEMENT AND OFFICE FUNCTIONS; PROVIDING TECHNICAL SUPPORT SERVICES, NAMELY, TROUBLESHOOTING IN THE NATURE OF DIAGNOSING COMPUTER HARDWARE AND SOFTWARE PROBLEMS; MONITORING OF COMPUTER NETWORK SYSTEMS; COMPUTER CONSULTING AND TECHNICAL SUPPORT SERVICES IN THE FIELD OF THE DESIGN AND USE OF COMPUTER PROGRAMS, COMPUTER HARDWARE AND COMPUTER SYSTEMS; COMPUTER SYSTEMS INTEGRATION SERVICES; COMPUTER SYSTEMS DESIGN SERVICES FOR THIRD PARTIES; COMPUTER SYSTEMS ANALYSIS; SOFTWARE INSTALLATION; UPDATING AND MAINTENANCE; TECHNICAL PROJECT STUDIES IN THE FIELD OF COMPUTER HARDWARE AND SOFTWARE REGARDING SCIENTIFIC AND INDUSTRIAL RESEARCH; PROVIDING ADVICE ON COMPUTERS REGARDING INFORMATION CONCERNING COMPUTERS AND COMPUTER SOFTWARE OVER COMPUTER NETWORKS AND GLOBAL COMMUNICATION NETWORKS; RENTAL OF COMPUTERS AND OF COMPUTER SOFTWARE; DUPLICATION OF COMPUTER PROGRAMS; SCIENTIFIC AND INDUSTRIAL RESEARCH SERVICES, NAMELY, ASSESSMENTS, ESTIMATES AND RESEARCH IN SCIENTIFIC AND TECHNOLOGICAL FIELDS REGARDING COMPUTER VIRUS PROTECTION SERVICES PROVIDED BY ENGINEERS; RESEARCH AND DEVELOPMENT OF NEW PRODUCTS; DESIGNING, UPDATING AND MAINTAINING WEB SITES ON THE INTERNET; CONSULTATION IN THE FIELD OF COMPUTER HARDWARE AND SOFTWARE, NAMELY, CONTRACT SERVICES, NEEDS ANALYSIS, PRODUCT SELECTION, SYSTEMS INTEGRATION, IMPLEMENTATION, HOT-LINE ASSISTANCE SERVICES, AND AFTER-SALES SUPPORT; ALL OF THE FOREGOING SERVICES ARE FOR USE IN THE MARITIME FIELD (U.S. CLS. 100 AND 101).

FIRST USE 11-1-2008; IN COMMERCE 11-1-2008.
MICHAEL ENGEL, EXAMINING ATTORNEY

SN 77-722,062. TALLEY ENVIRONMENTAL CARE LTD, ROMSEY, UNITED KINGDOM, FILED 4-24-2009.



PRIORITY CLAIMED UNDER SEC. 44(D) ON ERPNTY TM OFC APPLICATION NO. 007510051, FILED 1-9-2009, REG. NO. 007510051, DATED 12-10-2009, EXPIRES 1-9-2019.

THE MARK CONSISTS OF THE TERM "TECCARE" IN A STYLIZED FONT.

CLASS 3—COSMETICS AND CLEANING PREPARATIONS

FOR CLEANING AND WASHING PREPARATIONS; LAUNDRY DETERGENTS; TOILET BOWL DETERGENTS; DISINFECTANT, ANTIBACTERIAL AND ANTIMICROBIAL SOAPS; PET SHAMPOOS (U.S. CLS. 1, 4, 6, 50, 51 AND 52).

CLASS 5—PHARMACEUTICALS

FOR ANTISEPTICS; ANTIBACTERIAL SKIN CLEANERS; ANTIBACTERIAL AND ANTIMICROBIAL PHARMACEUTICALS; ANTI-URIC PREPARATIONS; BIOCIDES; ANTIBACTERIAL SUBSTANCES FOR MEDICAL PURPOSES; CHEMICAL REAGENTS FOR MEDICAL OR VETERINARY PURPOSES; CLEANING PREPARATIONS FOR CONTACT LENSES; HOUSEHOLD DEODORANTS; DETERGENTS FOR MEDICAL PURPOSES, DISINFECTANTS FOR CHEMICAL TOILETS, DISINFECTANTS FOR HYGIENE PURPOSES, MEDICAL AND SURGICAL DRESSINGS; PREPARATIONS FOR DESTROYING DRY ROT FUNGUS; FUMIGATION PREPARATIONS FOR MEDICAL PURPOSES, FUNGICIDES, GERMICIDES, PHARMACEUTICAL PREPARATIONS FOR SKIN CARE; STERILIZING SANITARY PREPARATIONS, TISSUES IMPREGNATED WITH PHARMACEUTICAL LOTIONS; VETERINARY PREPARATIONS, NAMELY, MEDICATED PET SHAMPOOS, LOTIONS AND WASHES; PHARMACEUTICAL PREPARATIONS FOR SKIN AND FUR CARE FOR ANIMALS (U.S. CLS. 6, 18, 44, 46, 51 AND 52).

RAUL CORDOVA, EXAMINING ATTORNEY

SN 77-722,063. TALLEY ENVIRONMENTAL CARE LTD, ROMSEY, UNITED KINGDOM, FILED 4-24-2009.



THE MARK CONSISTS OF STANDARD CHARACTERS WITHOUT CLAIM TO ANY PARTICULAR FONT, STYLE, SIZE, OR COLOR.

PRIORITY CLAIMED UNDER SEC. 44(D) ON ERPNTY TM OFC APPLICATION NO. 007510126, FILED 1-9-2009, REG. NO. 007510126, DATED 12-10-2009, EXPIRES 1-9-2019.

CLASS 3—COSMETICS AND CLEANING PREPARATIONS

FOR CLEANING AND WASHING PREPARATIONS; LAUNDRY DETERGENTS; TOILET BOWL DETERGENTS; DISINFECTANT, ANTIBACTERIAL AND ANTIMICROBIAL SOAPS; PET SHAMPOOS (U.S. CLS. 1, 4, 6, 50, 51 AND 52).

CLASS 5—PHARMACEUTICALS

FOR ANTISEPTICS; ANTIBACTERIAL SKIN CLEANERS; ANTIBACTERIAL AND ANTIMICROBIAL PHARMACEUTICALS; ANTI-URIC PREPARATIONS; BIOCIDES; ANTIBACTERIAL SUBSTANCES FOR MEDICAL PURPOSES; CHEMICAL REAGENTS FOR MEDICAL OR VETERINARY PURPOSES; CLEANING PREPARATIONS FOR CONTACT LENSES; HOUSEHOLD DEODORANTS; DETERGENTS FOR MEDICAL PURPOSES, DISINFECTANTS FOR CHEMICAL TOILETS, DISINFECTANTS FOR HYGIENE PURPOSES, MEDICAL AND SURGICAL DRESSINGS; PREPARATIONS FOR DESTROYING DRY ROT FUNGUS; FUMIGATION PREPARATIONS FOR MEDICAL PURPOSES, FUNGICIDES, GERMICIDES, PHARMACEUTICAL PREPARATIONS FOR SKIN CARE; STERILIZING SANITARY PREPARATIONS, TISSUES IMPREGNATED WITH PHARMACEUTICAL LOTIONS; VETERINARY PREPARATIONS, NAMELY, MEDICATED PET SHAMPOOS, LOTIONS AND WASHES; PHARMACEUTICAL PREPARATIONS FOR SKIN AND FUR CARE FOR ANIMALS (U.S. CLS. 6, 18, 44, 46, 51 AND 52).

EUGENIA MARTIN, EXAMINING ATTORNEY

SN 77-722,239. BENCHMARKWELLNESS LLC, KAILUA, HI.
FILED 4-24-2009.

SN 77-724,232. USA SEVENS LLC, ORANGEBURG, NY.
FILED 4-28-2009.

Benchmark Wellness

THE MARK CONSISTS OF STANDARD CHARACTERS WITHOUT CLAIM TO ANY PARTICULAR FONT, STYLE, SIZE, OR COLOR.

NO CLAIM IS MADE TO THE EXCLUSIVE RIGHT TO USE "WELLNESS", APART FROM THE MARK AS SHOWN.

CLASS 35—ADVERTISING AND BUSINESS

FOR ASSISTANCE, ADVISORY SERVICES AND CONSULTANCY WITH REGARD TO BUSINESS PLANNING, BUSINESS ANALYSIS, BUSINESS MANAGEMENT, AND BUSINESS ORGANIZATION; PROVIDING ASSISTANCE, FITNESS EVALUATION AND CONSULTATION TO CORPORATE CLIENTS TO HELP THEIR EMPLOYEES MAKE HEALTH, WELLNESS AND NUTRITIONAL CHANGES IN THEIR DAILY LIVING TO INCREASE PRODUCTIVITY AND LOWER HEALTH CARE COSTS (U.S. CLS. 100, 101 AND 102).

FIRST USE 1-2-2009; IN COMMERCE 1-2-2009.

CLASS 41—EDUCATION AND ENTERTAINMENT

FOR ARRANGING PROFESSIONAL WORKSHOP AND TRAINING COURSES; CONDUCTING WORKSHOPS AND SEMINARS IN EMPLOYEE BENEFITS DESIGN; EDUCATION SERVICES, NAMELY, PROVIDING LIVE AND ON-LINE SEMINARS AND WEBINARS IN THE FIELD OF CORPORATE AND EMPLOYEE WELLNESS; EDUCATION SERVICES, NAMELY, PROVIDING MENTORING, TUTORING, CLASSES, SEMINARS AND WORKSHOPS IN THE FIELD OF CORPORATE AND EMPLOYEE WELLNESS; EDUCATION SERVICES, NAMELY, PROVIDING CLASSES, WORKSHOPS, SEMINARS AND CONFERENCES IN THE FIELDS OF EMPLOYEE HEALTH AND WELLNESS; EDUCATIONAL SERVICES, NAMELY, CONDUCTING LIVE WORKSHOPS IN THE FIELD OF CORPORATE AND EMPLOYEE WELLNESS AND DISTRIBUTION OF COURSE MATERIAL IN CONNECTION THEREWITH; EDUCATIONAL SERVICES, NAMELY, CONDUCTING LIVE WORKSHOPS IN THE FIELD OF HUMAN RESOURCES AND DISTRIBUTION OF TRAINING MATERIAL IN CONNECTION THEREWITH; PROVIDING ON-LINE TRAINING SEMINARS AND WEBINARS IN THE FIELD OF WELLNESS PROGRAM EVALUATION (U.S. CLS. 100, 101 AND 107).

FIRST USE 1-2-2009; IN COMMERCE 1-2-2009.

CLASS 44—MEDICAL, BEAUTY AND AGRICULTURAL SERVICES

FOR PROVIDING ASSISTANCE, FITNESS EVALUATION AND CONSULTATION TO CORPORATE CLIENTS TO HELP THEIR EMPLOYEES MAKE HEALTH, WELLNESS AND NUTRITIONAL CHANGES IN THEIR DAILY LIVING TO IMPROVE HEALTH (U.S. CLS. 100 AND 101).

FIRST USE 1-2-2009; IN COMMERCE 1-2-2009.
ELIZABETH KAJUBI, EXAMINING ATTORNEY

RUGBY MAGAZINE ALL AMERICANS

THE MARK CONSISTS OF STANDARD CHARACTERS WITHOUT CLAIM TO ANY PARTICULAR FONT, STYLE, SIZE, OR COLOR.

NO CLAIM IS MADE TO THE EXCLUSIVE RIGHT TO USE "RUGBY MAGAZINE", APART FROM THE MARK AS SHOWN.

CLASS 16—PAPER GOODS AND PRINTED MATTER

FOR ADVERTISING SIGNS OF PAPER OR CARDBOARD; APPLIQUES IN THE FORM OF DECALS; AUTOGRAPH BOOKS; BOOK COVERS; BOOKS IN THE FIELD OF RUGBY; BUMPER STICKERS; CALENDARS; COLOR PRINTS; COLORING BOOKS; DECALS; GIFT CARDS; GREETING CARDS; ILLUSTRATED NOTEPADS; NEWSLETTERS IN THE FIELD OF RUGBY; PAMPHLETS IN THE FIELD OF RUGBY; PAPER BANNERS; PAPER CONTAINERS; PAPER LABELS; PAPER RIBBONS; PAPER STATIONERY; PAPER TAGS; PAPER TAKE-OUT CARTONS FOR FOOD; PLACE MATS OF PAPER; POST CARDS; POSTERS; PRINTED PAPER SIGNS; SCORE CARDS; SPORTS TRADING CARDS; STATIONERY; WALL CALENDARS (U.S. CLS. 2, 5, 22, 23, 29, 37, 38 AND 50).

CLASS 25—CLOTHING

FOR CLOTHING, NAMELY, BELTS; BLAZERS; BOTTOMS; CAPS; COATS; GOLF SHIRTS; HATS; HEADBANDS AGAINST SWEATING; HOODED SWEAT SHIRTS; HOODS; HOSIERY; JACKETS; JERSEYS; MUFFLERS; PANTS; RUGBY SHORTS; SHIRTS; SHORTS; SWEAT PANTS; SWEAT SHIRTS; SWEAT SHORTS; SWEAT SUITS; SWEATBANDS; SWEATERS; T-SHIRTS; TIES; TOPS; WALKING SHORTS; WRAPS (U.S. CLS. 22 AND 39).

CLASS 41—EDUCATION AND ENTERTAINMENT

FOR EDUCATIONAL SERVICES, NAMELY, CONDUCTING ON-LINE EXHIBITIONS AND DISPLAYS AND INTERACTIVE EXHIBITS IN THE FIELD OF RUGBY; EDUCATIONAL SERVICES, NAMELY, CONDUCTING PROGRAMS IN THE FIELD OF RUGBY; EDUCATIONAL SERVICES, NAMELY, CONDUCTING CLASSES, SEMINARS, CONFERENCES, WORKSHOPS IN THE FIELD OF RUGBY; ENTERTAINMENT SERVICES, NAMELY, ARRANGING AND CONDUCTING OF COMPETITIONS FOR SPORTING EVENTS; ENTERTAINMENT SERVICES, NAMELY, CONDUCTING CONTESTS; ENTERTAINMENT, NAMELY, PRODUCTION OF RUGBY FOOTBALL GAMES AND TOURNAMENTS LIVE IN STADIUMS AND BROADCAST VIA SATELLITE AND CABLE; ORGANIZATION OF SPORTS COMPETITIONS (U.S. CLS. 100, 101 AND 107).

JILL C. ALT, EXAMINING ATTORNEY

SN 77-724,259. EVERYTHING MARY, LLC, FAYETTEVILLE, AR. FILED 4-28-2009.

EVERYTHING MARY

THE MARK CONSISTS OF STANDARD CHARACTERS WITHOUT CLAIM TO ANY PARTICULAR FONT, STYLE, SIZE, OR COLOR.

CLASS 14—JEWELRY

FOR JEWELRY ORGANIZERS; JEWELRY ROLL CASES (U.S. CLS. 2, 27, 28 AND 50).
FIRST USE 6-1-2007; IN COMMERCE 6-1-2007.

CLASS 18—LEATHER GOODS

FOR BAGS AND CASES FOR CRAFT ITEMS AND PERSONAL ITEMS, NAMELY, ALL PURPOSE CARRYING BAGS, TOTE BAGS, TRAVELLING BAGS, SHOULDER BAGS, MESSENGER BAGS, CARRY-ALL BAGS, DRAWSTRING BAGS, BACKPACKS, AND COSMETIC BAGS SOLD EMPTY (U.S. CLS. 1, 2, 3, 22 AND 41).
FIRST USE 6-1-2007; IN COMMERCE 6-1-2007.

CLASS 20—FURNITURE AND ARTICLES NOT OTHERWISE CLASSIFIED

FOR DISPLAY CASES; NON-METAL DECORATIVE FABRIC STORAGE BIN ORGANIZERS AND BOXES (U.S. CLS. 2, 13, 22, 25, 32 AND 50).
FIRST USE 6-1-2007; IN COMMERCE 6-1-2007.
SOPHIA S. KIM, EXAMINING ATTORNEY

SN 77-724,357. USA SEVENS LLC, ORANGEBURG, NY. FILED 4-28-2009.

RUGBY MAGAZINE ALL WORLD TEAM

THE MARK CONSISTS OF STANDARD CHARACTERS WITHOUT CLAIM TO ANY PARTICULAR FONT, STYLE, SIZE, OR COLOR.

NO CLAIM IS MADE TO THE EXCLUSIVE RIGHT TO USE "RUGBY MAGAZINE", APART FROM THE MARK AS SHOWN.

CLASS 16—PAPER GOODS AND PRINTED MATTER

FOR ADVERTISING SIGNS OF PAPER OR CARDBOARD; APPLIQUES IN THE FORM OF DECALS; AUTOGRAPH BOOKS; BOOK COVERS; BOOKS IN THE FIELD OF RUGBY; BUMPER STICKERS; CALENDARS; COLOR PRINTS; COLORING BOOKS; DECALS; GIFT CARDS; GREETING CARDS; ILLUSTRATED NOTEPADS; NEWSLETTERS IN THE FIELD OF RUGBY; PAMPHLETS IN THE FIELD OF RUGBY; PAPER BANNERS; PAPER CONTAINERS; PAPER LABELS; PAPER RIBBONS; PAPER STATIONERY; PAPER TAGS; PAPER TAKE-OUT CARTONS FOR FOOD; PLACE MATS OF PAPER; POST CARDS; POSTERS; PRINTED PAPER SIGNS; SCORE CARDS; SPORTS TRADING CARDS; STATIONERY; WALL CALENDARS (U.S. CLS. 2, 5, 22, 23, 29, 37, 38 AND 50).

CLASS 25—CLOTHING

FOR CLOTHING, NAMELY, BELTS; BLAZERS; BOTTOMS; CAPS; COATS; GOLF SHIRTS; HATS; HEADBANDS AGAINST SWEATING; HOODED SWEAT SHIRTS; HOODS; HOSIERY; JACKETS; JERSEYS; MUFFLERS; PANTS; RUGBY SHORTS; SHIRTS; SHORTS; SWEAT PANTS; SWEAT SHIRTS; SWEAT SHORTS; SWEAT SUITS; SWEATBANDS; SWEATERS; T-SHIRTS; TIES; TOPS; WALKING SHORTS; WRAPS (U.S. CLS. 22 AND 39).

CLASS 41—EDUCATION AND ENTERTAINMENT

FOR EDUCATIONAL SERVICES, NAMELY, CONDUCTING ON-LINE EXHIBITIONS AND DISPLAYS AND INTERACTIVE EXHIBITS IN THE FIELD OF RUGBY; EDUCATIONAL SERVICES, NAMELY, CONDUCTING PROGRAMS IN THE FIELD OF RUGBY; EDUCATIONAL SERVICES, NAMELY, CONDUCTING CLASSES, SEMINARS, CONFERENCES, WORKSHOPS IN THE FIELD OF RUGBY; ENTERTAINMENT SERVICES, NAMELY, ARRANGING AND CONDUCTING OF COMPETITIONS FOR SPORTING EVENTS; ENTERTAINMENT SERVICES, NAMELY, CONDUCTING CONTESTS; ENTERTAINMENT, NAMELY, PRODUCTION OF RUGBY FOOTBALL GAMES AND TOURNAMENTS LIVE IN STADIUMS AND BROADCAST VIA SATELLITE AND CABLE; ORGANIZATION OF SPORTS COMPETITIONS (U.S. CLS. 100, 101 AND 107).

JILL C. ALT, EXAMINING ATTORNEY

SN 77-724,888. MIRAMAR MUSIC TOURING INC., DBA TERROR SQUAD ENTERTAINMENT, NEW YORK, NY. FILED 4-29-2009.

FAT JOE

THE MARK CONSISTS OF STANDARD CHARACTERS WITHOUT CLAIM TO ANY PARTICULAR FONT, STYLE, SIZE, OR COLOR.

THE NAME "FAT JOE" IDENTIFIES THE STAGE NAME OF "JOSEPH CARTAGENA" A LIVING INDIVIDUAL WHOSE CONSENT IS OF RECORD.

CLASS 9—ELECTRICAL AND SCIENTIFIC APPARATUS

FOR ELECTRONIC GREETING CARDS DOWNLOADABLE FROM THE INTERNET; DOWNLOADABLE RINGTONES AND GRAPHICS VIA A GLOBAL COMPUTER NETWORK AND WIRELESS DEVICES; AUDIO AND VIDEO RECORDINGS FEATURING PERFORMANCES BY MUSICAL ARTISTS; DIGITAL MUSIC DOWNLOADABLE FROM THE INTERNET; DOWNLOADABLE MP3 FILES AND MP3 RECORDINGS FEATURING PERFORMANCES BY MUSICAL ARTISTS; PRE-RECORDED COMPACT DISCS, DVDS, CD-ROMS, VIDEO DISCS FEATURING MUSIC AND MUSICAL ENTERTAINMENT; PRE-RECORDED DIGITAL MEDIA FEATURING MUSIC; PRE-RECORDED ELECTRONIC MEDIA FEATURING MUSIC AND MUSICAL ENTERTAINMENT (U.S. CLS. 21, 23, 26, 36 AND 38).

FIRST USE 0-0-1992; IN COMMERCE 0-0-1992.

CLASS 41—EDUCATION AND ENTERTAINMENT

FOR ENTERTAINMENT SERVICES, NAMELY, PROVIDING A WEBSITE FEATURING MUSICAL PERFORMANCES, MUSICAL VIDEOS, RELATED FILM CLIPS IN THE FIELD OF MUSIC, PHOTOGRAPHS, AND OTHER MULTIMEDIA MATERIALS FEATURING MUSIC AND MUSICAL ENTERTAINMENT; PROVIDING NON-DOWNLOADABLE MULTIMEDIA FILES CONTAINING MUSIC, VIDEO, AUDIO, GRAPHIC IMAGES RELATING TO MUSIC PROVIDED OVER A GLOBAL COMPUTER NETWORK; ENTERTAINMENT SERVICES, NAMELY, PRODUCTION OF VIDEO DISCS FOR OTHERS; ENTERTAINMENT IN THE NATURE OF A LIVE MUSICAL ARTIST; ENTERTAINMENT IN THE NATURE OF LIVE PERFORMANCES BY A MUSICAL ARTIST, ENTERTAINMENT IN THE NATURE OF VISUAL AND AUDIO PERFORMANCES BY A MUSICAL ARTIST; ENTERTAINMENT, NAMELY, LIVE MUSIC CONCERTS; ENTERTAINMENT, NAMELY, PERSONAL APPEARANCES BY A MUSICAL ARTIST (U.S. CLS. 100, 101 AND 107).

FIRST USE 0-0-1992; IN COMMERCE 0-0-1992.
MARC LEIPZIG, EXAMINING ATTORNEY

SN 77-726,130. JUS-MADE, LP, DALLAS, TX. FILED 4-30-2009.

Mas Sabrosa

THE MARK CONSISTS OF STANDARD CHARACTERS WITHOUT CLAIM TO ANY PARTICULAR FONT, STYLE, SIZE, OR COLOR.

THE ENGLISH TRANSLATION OF "MAS SABROSA" IN THE MARK IS "MORE TASTE" OR "TASTIER".

CLASS 32—LIGHT BEVERAGES

FOR CONCENTRATES, SYRUPS OR POWDERS USED IN THE PREPARATION OF SOFT DRINKS; PREPARATIONS FOR MAKING BEVERAGES, NAMELY, VEGETABLE BASED BEER COCKTAIL MIXES; SOFT DRINKS (U.S. CLS. 45, 46 AND 48).

CLASS 33—WINES AND SPIRITS

FOR ALCOHOLIC FRUIT COCKTAIL DRINKS (U.S. CLS. 47 AND 49).
SAMUEL E. SHARPER JR., EXAMINING ATTORNEY

SN 77-726,027. BERKELEY EXOTECH, INC., BERKELEY, CA. FILED 4-30-2009.

MANTONOMOUS

THE MARK CONSISTS OF STANDARD CHARACTERS WITHOUT CLAIM TO ANY PARTICULAR FONT, STYLE, SIZE, OR COLOR.

CLASS 9—ELECTRICAL AND SCIENTIFIC APPARATUS

FOR HUMAN EXOSKELETONS AND BODY ARMOR, NAMELY, BULLET-PROOF VESTS, BALLISTIC PLATES FOR USE WITH BULLET-PROOF VESTS AND PROTECTIVE CLOTHING (U.S. CLS. 21, 23, 26, 36 AND 38).

CLASS 10—MEDICAL APPARATUS

FOR ORTHOPEDIC BRACES (U.S. CLS. 26, 39 AND 44).

CLASS 18—LEATHER GOODS

FOR BACKPACKS (U.S. CLS. 1, 2, 3, 22 AND 41).

CLASS 25—CLOTHING

FOR CLOTHING, NAMELY, SHOES, BOOTS, PANTS, SHIRTS, JACKETS, AND VESTS (U.S. CLS. 22 AND 39).
LOURDES AYALA, EXAMINING ATTORNEY

SN 77-726,521. THE NATURAL SOLUTION, MOUNT VERNON, WA. FILED 4-30-2009.

The Natural Solution

THE MARK CONSISTS OF STANDARD CHARACTERS WITHOUT CLAIM TO ANY PARTICULAR FONT, STYLE, SIZE, OR COLOR.

NO CLAIM IS MADE TO THE EXCLUSIVE RIGHT TO USE "NATURAL", APART FROM THE MARK AS SHOWN.

CLASS 1—CHEMICALS

FOR NATURAL ENZYME WATER TREATMENT CHEMICALS FOR POOLS AND HOT TUBS (U.S. CLS. 1, 5, 6, 10, 26 AND 46).
FIRST USE 4-1-2004; IN COMMERCE 4-1-2004.

CLASS 35—ADVERTISING AND BUSINESS

FOR RETAIL STORE AND ON-LINE RETAIL STORE SERVICES FEATURING NATURAL PRODUCTS, NAMELY, ENZYME WATER TREATMENT CHEMICALS FOR POOLS AND SPAS, AND POOL AND SPA PRODUCTS; WHOLESALE DISTRIBUTORSHIPS FEATURING NATURAL PRODUCTS, NAMELY, ENZYME WATER TREATMENT CHEMICALS FOR POOLS AND SPAS, AND POOL AND SPA PRODUCTS (U.S. CLS. 100, 101 AND 102).

FIRST USE 4-1-2004; IN COMMERCE 4-1-2004.
LEIGH CAROLINE CASE, EXAMINING ATTORNEY

SN 77-727,433. B & H FOTO & ELECTRONICS CORP., NEW YORK, NY. FILED 5-1-2009.

JAMES LOVELACE, EXAMINING ATTORNEY

THE PROFESSIONAL'S SOURCE

THE MARK CONSISTS OF STANDARD CHARACTERS WITHOUT CLAIM TO ANY PARTICULAR FONT, STYLE, SIZE, OR COLOR.

CLASS 16—PAPER GOODS AND PRINTED MATTER

FOR PRINTED PRODUCT CATALOGS AND INFORMATIONAL RESOURCE CATALOGS IN THE FIELDS OF PHOTOGRAPHY, AUDIO AND VIDEO EQUIPMENT, POST PRODUCTION EQUIPMENT RELATED THERETO, AND DIGITAL IMAGING EQUIPMENT (U.S. CLS. 2, 5, 22, 23, 29, 37, 38 AND 50).

FIRST USE 0-0-1990; IN COMMERCE 0-0-1990.

CLASS 35—ADVERTISING AND BUSINESS

FOR RETAIL STORE SERVICES, ONLINE RETAIL STORE SERVICES, AND CATALOG ORDERING SERVICES, ALL FEATURING THE FULL RANGE OF PHOTOGRAPHY, VIDEOGRAPHY, AND AUDIO EQUIPMENT, AUDIO VISUAL PRODUCTION EQUIPMENT, DIGITAL IMAGING EQUIPMENT, AND HOME ENTERTAINMENT EQUIPMENT (U.S. CLS. 100, 101 AND 102).

FIRST USE 0-0-1990; IN COMMERCE 0-0-1990.

CLASS 37—CONSTRUCTION AND REPAIR

FOR INSTALLATION AND REPAIR OF PHOTOGRAPHY, AUDIO AND VIDEO EQUIPMENT, AND POST PRODUCTION EQUIPMENT RELATED THERETO (U.S. CLS. 100, 103 AND 106).

FIRST USE 0-0-1995; IN COMMERCE 0-0-1995.

CLASS 41—EDUCATION AND ENTERTAINMENT

FOR EDUCATIONAL SERVICES, NAMELY, PROVIDING A WEBSITE FEATURING INSTRUCTIONAL INFORMATION AND EDUCATIONAL RESOURCES IN THE NATURE OF NONDOWNLOADABLE INSTRUCTIONAL VIDEO CLIPS AND ARTICLES ON TOPICS RELATED TO PHOTOGRAPHY, VIDEOGRAPHY, AUDIO, DIGITAL IMAGING EQUIPMENT, SERVICES AND PRODUCTION, HOME ENTERTAINMENT ELECTRONICS EQUIPMENT, CONSUMER ELECTRONICS EQUIPMENT, AND COMPUTER EQUIPMENT; PROVIDING A WEBSITE FEATURING ON-LINE NEWSLETTERS IN THE FIELDS OF PHOTOGRAPHY, VIDEOGRAPHY, AUDIO, DIGITAL IMAGING EQUIPMENT, SERVICES AND PRODUCTION, HOME ENTERTAINMENT ELECTRONICS EQUIPMENT, CONSUMER ELECTRONICS EQUIPMENT, AND COMPUTER EQUIPMENT; EDUCATIONAL SERVICES, NAMELY, PROVIDING WORKSHOPS, SEMINARS, AND LECTURES TO OTHERS IN THE FIELDS OF PHOTOGRAPHY, VIDEOGRAPHY, AUDIO, AND DIGITAL IMAGING EQUIPMENT, SERVICES AND PRODUCTION; PROVIDING VIA E-MAIL NEWSLETTERS ON TOPICS RELATED TO PHOTOGRAPHY, VIDEOGRAPHY, AUDIO, AND DIGITAL IMAGING EQUIPMENT, SERVICES AND PRODUCTION (U.S. CLS. 100, 101 AND 107).

FIRST USE 0-0-1996; IN COMMERCE 0-0-1996.

CLASS 42—SCIENTIFIC AND COMPUTER SERVICES

FOR CONSULTATION AND DESIGN SERVICES IN THE FIELD OF AUDIO AND VIDEO SYSTEMS DESIGN AND INTEGRATION (U.S. CLS. 100 AND 101).

FIRST USE 0-0-2001; IN COMMERCE 0-0-2001.

SN 77-727,502. TROFIMA CORPORATION, GUAYNABO, PUERTO RICO, FILED 5-1-2009.



THE COLOR(S) ORANGE, RED AND WHITE IS/ARE CLAIMED AS A FEATURE OF THE MARK.

THE MARK CONSISTS OF AN ORANGE OVAL WITH THE WORD PHRASE "DEL PATIO" INSIDE. THE COLOR ORANGE APPEARS ON THE BACKGROUND OF THE OVAL; THE COLOR RED APPEARS ON EACH CHARACTER OF THE WORD PHRASE "DEL PATIO"; THE COLOR WHITE APPEARS ON THE BORDER OF EACH CHARACTER OF THE WORD PHRASE "DEL PATIO".

THE ENGLISH TRANSLATION OF "DEL PATIO" IN THE MARK IS FROM THE SOWN FIELD.

CLASS 30—STAPLE FOODS

FOR (BASED ON USE IN COMMERCE) COFFEE; COFFEE BASED BEVERAGES; GROUND COFFEE BEANS (U.S. CL. 46).

FIRST USE 4-14-2007; IN COMMERCE 4-14-2007.

CLASS 32—LIGHT BEVERAGES

FOR (BASED ON INTENT TO USE) FRUIT JUICES (U.S. CLS. 45, 46 AND 48).

DAVID I, EXAMINING ATTORNEY

SN 77-727,651. UNITED STUDENT AID FUNDS, INC., INDIANAPOLIS, IN. FILED 5-2-2009.

ALARIS FINANCIAL LITERACY

THE MARK CONSISTS OF STANDARD CHARACTERS WITHOUT CLAIM TO ANY PARTICULAR FONT, STYLE, SIZE, OR COLOR.

NO CLAIM IS MADE TO THE EXCLUSIVE RIGHT TO USE "FINANCIAL LITERACY", APART FROM THE MARK AS SHOWN.

CLASS 9—ELECTRICAL AND SCIENTIFIC APPARATUS

FOR COMPUTER SOFTWARE USED TO PROVIDE TRAINING AND EDUCATION IN THE FIELDS OF FINANCE, FINANCIAL MANAGEMENT AND PERSONAL FINANCIAL MANAGEMENT; AUDIO, VIDEO, AND AUDIOVISUAL RECORDINGS FEATURING FINANCIAL, FINANCIAL MANAGEMENT, PERSONAL FINANCIAL MANAGEMENT, AND FINANCIAL SUPPORT FOR EDUCATIONAL PURSUITS TOPICS; DIGITAL MEDIA, NAMELY, PRE-RECORDED, OPTICAL DISCS, DIGITAL VIDEO DISCS, DIGITAL VERSATILE DISCS, DOWNLOADABLE AUDIO AND VIDEO RECORDINGS, DVDS, AND/OR HIGH DEFINITION DIGITAL DISCS FEATURING FINANCE, FINANCIAL MANAGEMENT AND PERSONAL FINANCIAL MANAGEMENT; DIGITAL MATERIALS, NAMELY, PRE-RECORDED, OPTICAL DISCS, DIGITAL VIDEO DISCS, DIGITAL VERSATILE DISCS, DOWNLOADABLE AUDIO AND VIDEO RECORDINGS, DVDS, AND/OR HIGH DEFINITION DIGITAL DISCS FEATURING FINANCE, FINANCIAL MANAGEMENT, PERSONAL FINANCIAL MANAGEMENT, AND FINANCIAL SUPPORT FOR EDUCATIONAL PURSUITS TOPICS; DOWNLOADABLE AUDIO FILES, MULTIMEDIA FILES, SOFTWARE FILES, TEXT FILES, E-MAILS, WRITTEN DOCUMENTS, AUDIO MATERIAL, VIDEO MATERIAL AND GAMES FEATURING INFORMATION RELATING TO EDUCATION AND TRAINING IN THE FIELDS OF FINANCE, FINANCIAL MANAGEMENT, PERSONAL FINANCIAL MANAGEMENT, AND FINANCIAL SUPPORT FOR EDUCATIONAL PURSUITS; COMPUTER SOFTWARE FEATURING INSTRUCTION IN THE FIELDS OF FINANCE, FINANCIAL MANAGEMENT, PERSONAL FINANCIAL MANAGEMENT, AND FINANCIAL SUPPORT FOR EDUCATIONAL PURSUITS (U.S. CLS. 21, 23, 26, 36 AND 38).

CLASS 36—INSURANCE AND FINANCIAL

FOR PROVIDING INFORMATION TO OTHERS VIA A GLOBAL COMPUTER NETWORK IN THE FIELDS OF FINANCE, FINANCIAL MANAGEMENT, PERSONAL FINANCIAL MANAGEMENT, AND FINANCING FOR EDUCATIONAL PURSUITS (U.S. CLS. 100, 101 AND 102).

CLASS 41—EDUCATION AND ENTERTAINMENT

FOR PROVIDING TRAINING AND INSTRUCTION IN THE FIELDS OF FINANCE, MANAGEMENT OF FINANCIAL AFFAIRS AND PERSONAL FINANCIAL MANAGEMENT; EDUCATION SERVICES, NAMELY, PROVIDING TRAINING AND INSTRUCTION IN THE FIELDS OF FINANCE, FINANCIAL MANAGEMENT AND PERSONAL FINANCIAL MANAGEMENT; INTERACTIVE EDUCATIONAL AND ENTERTAINMENT SERVICES, NAMELY, PROVIDING EDUCATIONAL PROGRAMS IN THE FIELDS OF FINANCE, FINANCIAL MANAGEMENT, AND PERSONAL FINANCIAL MANAGEMENT; PRODUCTION OF DVDS AND OTHER DIGITAL MEDIA IN THE NATURE OF OPTICAL MEDIA, FLASH DRIVES AND FLASH MEMORY FEATURING EDUCATIONAL COURSES IN THE FIELDS OF FINANCE, FINANCIAL MANAGEMENT AND PERSONAL FINANCIAL MANAGEMENT (U.S. CLS. 100, 101 AND 107).

CYNTHIA SLOAN, EXAMINING ATTORNEY

SN 77-728,657. CRYSTAL ROCK OLGA AUDIGIER IRREVOCABLE TRUST, BEVERLY HILLS, CA. FILED 5-4-2009.



OWNER OF U.S. REG. NO. 3,548,146.

THE MARK CONSISTS OF THE WORDS "CRYSTAL ROCK" IN STYLIZED FORM; A STAR IS SUPERIMPOSED ON EACH LETTER "R" IN THE WORDS "CRYSTAL" AND "ROCK"; A REPRESENTATION OF A WING APPEARS IMMEDIATELY UNDER THE WORD "CRYSTAL" AND PRECEDING THE WORD "ROCK".

CLASS 9—ELECTRICAL AND SCIENTIFIC APPARATUS

FOR SUNGLASSES, EYEGLASSES, EYEGLASS FRAMES, EYEGLASS CASES, SKI GOGGLES, GOGGLES FOR SPORTS, EYEGLASS CHAINS, COMPUTER SCREENSAVER SOFTWARE, HELMETS FOR RIDING TWO-WHEELED VEHICLES, HELMETS FOR SKIING AND SNOWBOARDING, HELMETS FOR SKATEBOARDING, AND VIDEO RECORDINGS FEATURING FASHION, ENTERTAINMENT INDUSTRY, AND CELEBRITY EVENTS (U.S. CLS. 21, 23, 26, 36 AND 38).

CLASS 18—LEATHER GOODS

FOR PURSES, HANDBAGS, BACKPACKS, ANIMAL CARRIERS, PET CLOTHING, PET COLLARS, PET LEASHES, PET HARNESSSES (U.S. CLS. 1, 2, 3, 22 AND 41).

CLASS 24—FABRICS

FOR BEDSHEETS AND PILLOWCASES, BED LINENS, PILLOW SHAMS, BEDSPREADS, BED BLANKETS, COMFORTERS, DUVET COVERS, COVERS FOR CUSHIONS, FITTED AND NON-FITTED COVERS FOR FUTONS NOT OF PAPER, COVERLETS, TROWS, BED SKIRTS AND DUST RUFFLES, DAYBED LINEN SETS, TOWELS, BATH SHEETS, WASHCLOTHS, SHOWER CURTAINS (U.S. CLS. 42 AND 50).

ERNEST SHOSHO, EXAMINING ATTORNEY

SN 77-729,987. RECKITT BENCKISER INC., PARSIPPANY, NJ. FILED 5-6-2009.



THE COLOR(S) WHITE, BLUE AND PINK, RED AND YELLOW IS/ARE CLAIMED AS A FEATURE OF THE MARK.

THE MARK CONSISTS OF A STYLIZED BUBBLE SPHERE DESIGN WITH WHITE HIGHLIGHTS ENCAPSULATING A STACK OF WHITE LINENS SURROUNDED BY FLOWERS HAVING WHITE PETALS WITH THE INNERMOST PART OF THE PETALS SHOWING PINK AND RED WITH YELLOW ANthers AND FILAMENTS AND A YELLOW STIGMA APPEARING AGAINST A BLUE SKY WITH WHITE CLOUDS.

THE MARK CONSISTS OF A STYLIZED BUBBLE SPHERE DESIGN WITH WHITE HIGHLIGHTS THAT ENCAPSULATES THE SCENERY OF A TROPICAL RAIN FOREST WITH GREEN FOLIAGE AND SMALL FLOWERING TREES WITH TAN TRUNKS AND LEAVES, PINK FLOWERS AND A WATERFALL IN THE DISTANCE APPEARING IN BLUE AND WHITE AND A BLUE SKY ABOVE WITH WHITE CLOUDS.

CLASS 3—COSMETICS AND CLEANING PREPARATIONS

CLASS 3—COSMETICS AND CLEANING PREPARATIONS

FOR PERFUMING PREPARATIONS FOR THE ATMOSPHERE, NAMELY, ROOM FRAGRANCES; ESSENTIAL OILS; PREPARATIONS FOR PERFUMING OR FRAGRANCING THE AIR, NAMELY, INCENSE, INCENSE CONES, INCENSE STICKS, INCENSE SACHETS, INCENSE ROOM SPRAYS, POTPOURRI AND ROOM PERFUME SPRAYS (U.S. CLS. 1, 4, 6, 50, 51 AND 52).

FOR PERFUMING PREPARATIONS FOR THE ATMOSPHERE, NAMELY, ROOM FRAGRANCES; ESSENTIAL OILS; PREPARATIONS FOR PERFUMING OR FRAGRANCING THE AIR, NAMELY, INCENSE, INCENSE CONES, INCENSE STICKS, INCENSE SACHETS, INCENSE ROOM SPRAYS, POTPOURRI AND ROOM PERFUME SPRAYS (U.S. CLS. 1, 4, 6, 50, 51 AND 52).

CLASS 4—LUBRICANTS AND FUELS

CLASS 4—LUBRICANTS AND FUELS

FOR CANDLES, FRAGRANCED OR SCENTED CANDLES; CANDLE WICKS (U.S. CLS. 1, 6 AND 15).

FOR CANDLES, FRAGRANCED OR SCENTED CANDLES; CANDLE WICKS (U.S. CLS. 1, 6 AND 15).

CLASS 5—PHARMACEUTICALS

CLASS 5—PHARMACEUTICALS

FOR AIR FRESHENING PREPARATIONS; AIR PURIFYING PREPARATIONS IN THE NATURE OF AIR DEODORIZERS; PREPARATIONS FOR PERFUMING OR FRAGRANCING THE AIR, NAMELY, ROOM AIR FRESHENERS; HOUSEHOLD AND ROOM DEODORANTS; ODOR NEUTRALIZING PREPARATIONS FOR USE ON CARPETS, TEXTILES AND IN THE AIR (U.S. CLS. 6, 18, 44, 46, 51 AND 52).

FOR AIR FRESHENING PREPARATIONS; AIR PURIFYING PREPARATIONS IN THE NATURE OF AIR DEODORIZERS; PREPARATIONS FOR PERFUMING OR FRAGRANCING THE AIR, NAMELY, ROOM AIR FRESHENERS; HOUSEHOLD AND ROOM DEODORANTS; ODOR NEUTRALIZING PREPARATIONS FOR USE ON CARPETS, TEXTILES AND IN THE AIR (U.S. CLS. 6, 18, 44, 46, 51 AND 52).

CLASS 11—ENVIRONMENTAL CONTROL APPARATUS

CLASS 11—ENVIRONMENTAL CONTROL APPARATUS

FOR APPARATUS AND INSTRUMENTS, NAMELY, ELECTRIC AND BATTERY OPERATED DISPENSERS, DISPENSING UNITS, AND DIFFUSERS FOR ROOM FRAGRANCES, AIR FRESHENERS AND ROOM DEODORANTS, ALL FOR SCENTING, PURIFYING OR FRESHENING THE ATMOSPHERE; PARTS AND FITTINGS FOR ALL THE AFORESAID GOODS SOLD AS A UNIT THEREWITH (U.S. CLS. 13, 21, 23, 31 AND 34).
LEIGH LOWRY, EXAMINING ATTORNEY

FOR APPARATUS AND INSTRUMENTS, NAMELY, ELECTRIC AND BATTERY OPERATED DISPENSERS, DISPENSING UNITS, AND DIFFUSERS FOR ROOM FRAGRANCES, AIR FRESHENERS AND ROOM DEODORANTS, ALL FOR SCENTING, PURIFYING OR FRESHENING THE ATMOSPHERE; PARTS AND FITTINGS FOR ALL THE AFORESAID GOODS SOLD AS A UNIT THEREWITH (U.S. CLS. 13, 21, 23, 31 AND 34).
LEIGH LOWRY, EXAMINING ATTORNEY

SN 77-730,034. RECKITT BENCKISER INC., PARSIPPANY, NJ. FILED 5-6-2009.

SN 77-730,041. RECKITT BENCKISER INC., PARSIPPANY, NJ. FILED 5-6-2009.



THE COLOR(S) GREEN, WHITE, BLUE, TAN AND PINK IS/ARE CLAIMED AS A FEATURE OF THE MARK.

THE COLOR(S) PURPLE, GREEN, BROWN, WHITE, BLUE AND GRAY IS/ARE CLAIMED AS A FEATURE OF THE MARK.

THE MARK CONSISTS OF A STYLIZED BUBBLE SPHERE DESIGN WITH WHITE HIGHLIGHTS THAT ENCAPSULATING THE SCENERY OF A MOUNTAIN-SIDE FIELD OF PURPLE AND WHITE FLOWERS WITH GREEN AND BROWN GRASS, A BLUE RIVER, GRAY ROCKY MOUNTAINS AND WHITE SNOW COVERED PEAKS APPEARING IN THE DISTANCE UNDER A BLUE SKY WITH WHITE CLOUDS AND A WHITE GLARING SUN.

CLASS 3—COSMETICS AND CLEANING PREPARATIONS

FOR PERFUMING PREPARATIONS FOR THE ATMOSPHERE, NAMELY, ROOM FRAGRANCES; ESSENTIAL OILS; PREPARATIONS FOR PERFUMING OR FRAGRANCING THE AIR, NAMELY, INCENSE, INCENSE CONES, INCENSE STICKS, INCENSE SACHETS, INCENSE ROOM SPRAYS, POTPOURRI AND ROOM PERFUME SPRAYS (U.S. CLS. 1, 4, 6, 50, 51 AND 52).

CLASS 4—LUBRICANTS AND FUELS

FOR CANDLES, FRAGRANCED OR SCENTED CANDLES; CANDLE WICKS (U.S. CLS. 1, 6 AND 15).

CLASS 5—PHARMACEUTICALS

FOR AIR FRESHENING PREPARATIONS; AIR PURIFYING PREPARATIONS IN THE NATURE OF AIR DEODORIZERS; PREPARATIONS FOR PERFUMING OR FRAGRANCING THE AIR, NAMELY, ROOM AIR FRESHENERS; HOUSEHOLD AND ROOM DEODORANTS; ODOR NEUTRALIZING PREPARATIONS FOR USE ON CARPETS, TEXTILES AND IN THE AIR (U.S. CLS. 6, 18, 44, 46, 51 AND 52).

CLASS 11—ENVIRONMENTAL CONTROL APPARATUS

FOR APPARATUS AND INSTRUMENTS, NAMELY, ELECTRIC AND BATTERY OPERATED DISPENSERS, DISPENSING UNITS, AND DIFFUSERS FOR ROOM FRAGRANCES, AIR FRESHENERS AND ROOM DEODORANTS, ALL FOR SCENTING, PURIFYING OR FRESHENING THE ATMOSPHERE; PARTS AND FITTINGS FOR ALL THE AFORESAID GOODS SOLD AS A UNIT THEREWITH (U.S. CLS. 13, 21, 23, 31 AND 34).
LEIGH LOWRY, EXAMINING ATTORNEY

SN 77-730,044. RECKITT BENCKISER INC., PARSIPPANY, NJ. FILED 5-6-2009.



THE COLOR(S) BLACK, GREEN, YELLOW, WHITE AND BLUE IS/ARE CLAIMED AS A FEATURE OF THE MARK.

THE MARK CONSISTS OF A STYLIZED BUBBLE SPHERE DESIGN WITH WHITE HIGHLIGHTS THAT ENCAPSULATING THE SCENERY OF A FOREST CREEK WITH WHITE AND BLUE WATER RAPIDLY FLOWING OVER AND FLANKED BY BLACK RIVER ROCKS WITH YELLOW HIGHLIGHTING AND GREEN AND YELLOW FOLIAGE APPEARING IN THE BACKGROUND WITH PART OF A GREEN AND YELLOW FERN PLANT APPEARING AT THE TOP OF THE DESIGN WITH WHITE AND YELLOW SUN RAYS.

CLASS 3—COSMETICS AND CLEANING PREPARATIONS

FOR PERFUMING PREPARATIONS FOR THE ATMOSPHERE, NAMELY, ROOM FRAGRANCES; ESSENTIAL OILS; PREPARATIONS FOR PERFUMING OR FRAGRANCING THE AIR, NAMELY, INCENSE, INCENSE CONES, INCENSE STICKS, INCENSE SACHETS, INCENSE ROOM SPRAYS, POTPOURRI AND ROOM PERFUME SPRAYS (U.S. CLS. 1, 4, 6, 50, 51 AND 52).

CLASS 4—LUBRICANTS AND FUELS

FOR CANDLES, FRAGRANCED OR SCENTED CANDLES; CANDLE WICKS (U.S. CLS. 1, 6 AND 15).

CLASS 5—PHARMACEUTICALS

FOR AIR FRESHENING PREPARATIONS; AIR PURIFYING PREPARATIONS IN THE NATURE OF AIR DEODORIZERS; PREPARATIONS FOR PERFUMING OR FRAGRANCING THE AIR, NAMELY, ROOM AIR FRESHENERS; HOUSEHOLD AND ROOM DEODORANTS; ODOR NEUTRALIZING PREPARATIONS FOR USE ON CARPETS, TEXTILES AND IN THE AIR (U.S. CLS. 6, 18, 44, 46, 51 AND 52).

CLASS 11—ENVIRONMENTAL CONTROL APPARATUS

FOR APPARATUS AND INSTRUMENTS, NAMELY, ELECTRIC AND BATTERY OPERATED DISPENSERS, DISPENSING UNITS, AND DIFFUSERS FOR ROOM FRAGRANCES, AIR FRESHENERS AND ROOM DEODORANTS, ALL FOR SCENTING, PURIFYING OR FRESHENING THE ATMOSPHERE; PARTS AND FITTINGS FOR ALL THE AFORESAID GOODS SOLD AS A UNIT THEREWITH (U.S. CLS. 13, 21, 23, 31 AND 34).
LEIGH LOWRY, EXAMINING ATTORNEY

SN 77-730,669. KISSCLIMBER, LLC, DENVER, CO. FILED 5-6-2009.

KISSCLIMBER

THE MARK CONSISTS OF STANDARD CHARACTERS WITHOUT CLAIM TO ANY PARTICULAR FONT, STYLE, SIZE, OR COLOR.

CLASS 42—SCIENTIFIC AND COMPUTER SERVICES

FOR COMPUTER SERVICE, ACTING AS AN APPLICATION SERVICE PROVIDER IN THE FIELD OF KNOWLEDGE MANAGEMENT TO HOST COMPUTER APPLICATION SOFTWARE FOR CREATING SEARCHABLE DATABASES OF INFORMATION AND DATA TO ALLOW USERS TO PERFORM, ON-LINE, THE COLLECTING AND ANALYZING OF DIFFERENT TYPES OF OPINION SURVEYS; COMPUTER SERVICES, NAMELY, CREATING AN ON-LINE COMMUNITY FOR REGISTERED USERS TO PARTICIPATE IN COMPETITIONS, SHOWCASE THEIR SKILLS, GET FEEDBACK FROM THEIR PEERS, FORM VIRTUAL COMMUNITIES, ENGAGE IN SOCIAL NETWORKING AND IMPROVE THEIR TALENT; COMPUTER SERVICES, NAMELY, HOSTING ON-LINE WEB FACILITIES FOR OTHERS FOR ORGANIZING AND CONDUCTING ONLINE MEETINGS, GATHERINGS, AND INTERACTIVE DISCUSSIONS; DESIGN, CREATION, HOSTING AND MAINTENANCE OF INTERNET SITES FOR THIRD PARTIES (U.S. CLS. 100 AND 101).

FIRST USE 10-9-2006; IN COMMERCE 4-1-2007.

CLASS 45—PERSONAL AND LEGAL SERVICES

FOR INTERNET-BASED DATING, SOCIAL INTRODUCTION AND SOCIAL NETWORKING SERVICES; PROVIDING A SOCIAL NETWORKING WEBSITE FOR ENTERTAINMENT PURPOSES; PROVIDING ON-LINE COMPUTER DATABASES AND ON-LINE SEARCHABLE DATABASES IN THE FIELD OF SOCIAL NETWORKING (U.S. CLS. 100 AND 101).

FIRST USE 10-9-2006; IN COMMERCE 4-1-2007.

RONALD MCMORROW, EXAMINING ATTORNEY

SN 77-730,936. TABLEHOPPER, LLC, SAN FRANCISCO, CA. FILED 5-6-2009.

tablehopper

THE MARK CONSISTS OF STANDARD CHARACTERS WITHOUT CLAIM TO ANY PARTICULAR FONT, STYLE, SIZE, OR COLOR.

CLASS 41—EDUCATION AND ENTERTAINMENT

FOR PROVIDING NEWSLETTERS FEATURING NEWS AND REVIEWS OF RESTAURANTS, BARS AND CULINARY EVENTS VIA E-MAIL; PROVIDING ON-LINE REVIEWS AND NEWS REGARDING WINE AND FOOD TASTINGS (U.S. CLS. 100, 101 AND 107).

FIRST USE 2-16-2006; IN COMMERCE 2-16-2006.

CLASS 43—HOTEL AND RESTAURANT SERVICES

FOR PROVIDING ON-LINE REVIEWS AND NEWS REGARDING RESTAURANTS AND BARS (U.S. CLS. 100 AND 101).

FIRST USE 2-16-2006; IN COMMERCE 2-16-2006.

MICHAEL SOUDERS, EXAMINING ATTORNEY

SN 77-731,586. ATVENT SOLUTIONS INC., MONTREAL, QUEBEC, CANADA, FILED 5-7-2009.

NAVALYTICS

THE MARK CONSISTS OF STANDARD CHARACTERS WITHOUT CLAIM TO ANY PARTICULAR FONT, STYLE, SIZE, OR COLOR.

PRIORITY CLAIMED UNDER SEC. 44(D) ON CANADA APPLICATION NO. 1436815, FILED 5-4-2009.

CLASS 35—ADVERTISING AND BUSINESS

FOR DIGITAL BUSINESS INFORMATION MANAGEMENT SERVICES USED IN MOBILE WORKFORCE OPERATIONS, CALL CENTERS, CUSTOMER SERVICE, MARKETING AND SALES STRATEGIES (U.S. CLS. 100, 101 AND 102).

CLASS 42—SCIENTIFIC AND COMPUTER SERVICES

FOR CONSULTING SERVICES, TECHNICAL SUPPORT SERVICES IN THE NATURE OF TROUBLESHOOTING OF COMPUTER SOFTWARE PROBLEMS, AND COMPUTER PROGRAMMING SERVICES ALL RELATING TO COMPUTER SOFTWARE PROGRAMS IN THE FIELD OF BUSINESS INTELLIGENCE; COMPUTER SOFTWARE APPLICATION SERVICES PROVIDER FEATURING SOFTWARE FOR USE IN THE FIELD OF BUSINESS DATA COLLECTION AND STORAGE; MULTI-PLATFORM ONLINE NONDOWNLOADABLE BUSINESS INTELLIGENCE COMPUTER SOFTWARE PROVIDING ACCESS, STORAGE, MONITORING, MANAGEMENT, ANALYSIS AND DASHBOARD REPORTING OF DIGITAL INFORMATION USED IN MOBILE WORKFORCE OPERATIONS, FACILITY MANAGEMENT, CALL CENTERS, CUSTOMERS SERVICE, MARKETING AND SALES STRATEGIES (U.S. CLS. 100 AND 101).

WILLIAM P. SHANAHAN, EXAMINING ATTORNEY

SN 77-731,955. HAWK DESIGNS, INC., HUNTINGTON BEACH, CA. FILED 5-8-2009.

HAWK

THE MARK CONSISTS OF STANDARD CHARACTERS WITHOUT CLAIM TO ANY PARTICULAR FONT, STYLE, SIZE, OR COLOR.

CLASS 18—LEATHER GOODS

FOR BACKPACKS, WALLETS, AND DUFFEL BAGS (U.S. CLS. 1, 2, 3, 22 AND 41).

CLASS 25—CLOTHING

FOR CLOTHING AND HEADGEAR, NAMELY, SHIRTS, T-SHIRTS, SWEATSHIRTS, SWEAT PANTS, TANK TOPS, SHORTS, BOARD SHORTS, BOXERS, PANTS, JACKETS, SWEATERS, SOCKS, BELTS, GLOVES, THERMAL T-SHIRTS, HATS, CAPS, VISORS, AND SNOW HATS (U.S. CLS. 22 AND 39).

KATHRYN COWARD, EXAMINING ATTORNEY

SN 77-733,086. COREMD, LLC, CALIFORNIA, CA. FILED 5-8-2009.

COREMD

THE MARK CONSISTS OF STANDARD CHARACTERS WITHOUT CLAIM TO ANY PARTICULAR FONT, STYLE, SIZE, OR COLOR.

CLASS 35—ADVERTISING AND BUSINESS

FOR PROVIDING ONLINE RETAIL STORE SERVICES FEATURING HEALTH FOODS, DIETARY SUPPLEMENTS, NUTRITIONAL SUPPLEMENTS, HERBS, VITAMINS, SPORTS NUTRITION PRODUCTS, FITNESS EQUIPMENT AND APPAREL, COSMETICS, BODY CARE PRODUCTS, PREPRINTED AND PRERECORDED FITNESS REGIMENS, DIAGNOSTIC EQUIPMENT AND AROMATHERAPY PRODUCTS; APPOINTMENT SCHEDULING SERVICES WITH LABORATORIES AND HEALTH PRACTITIONERS (U.S. CLS. 100, 101 AND 102).

CLASS 44—MEDICAL, BEAUTY AND AGRICULTURAL SERVICES

FOR PROVIDING HEALTH CARE AND MEDICAL INFORMATION; HEALTH CARE SERVICES IN THE FIELD OF PREVENTATIVE HEALTH CARE AND HEALTH MAINTENANCE, NAMELY, PROVIDING INDIVIDUAL HEALTH PROFILES IN THE NATURE OF PERSONALIZED HEALTH INFORMATION, ANALYSIS OF PERSONALIZED MEDICAL LABORATORY TESTS, COMPREHENSIVE HEALTH AND WELLNESS EVALUATIONS, AND ONGOING WELLNESS PLANNING AND SUPPORT IN THE NATURE OF WELLNESS PROGRAMS TO AID AWARENESS AND UNDERSTANDING OF HEALTH, NUTRITION, SKIN CARE AND FITNESS; MAINTAINING PATIENT MEDICAL RECORDS (U.S. CLS. 100 AND 101).

ELLEN PERKINS, EXAMINING ATTORNEY

SN 77-733,641. CHROMA TECHNOLOGY CORP., ROCKINGHAM, VT. FILED 5-11-2009.

CHROMA

THE MARK CONSISTS OF STANDARD CHARACTERS WITHOUT CLAIM TO ANY PARTICULAR FONT, STYLE, SIZE, OR COLOR.

OWNER OF U.S. REG. NOS. 2,620,255 AND 2,620,256.

CLASS 9—ELECTRICAL AND SCIENTIFIC APPARATUS

FOR ACCESSORIES FOR APPARATUS AND INSTRUMENTS IN THE FIELDS OF MICROSCOPY, FLUORESCENCE MICROSCOPY, ASTRONOMY, FLOW CYTOMETRY, AND OPTICS, NAMELY, OPTICAL FILTERS, NEUTRAL DENSITY FILTERS, ABSORPTION GLASS FILTERS, DIFFUSION GLASS FILTERS, GLASS MICROSCOPE SLIDES, MICROSCOPE COMPONENT PARTS, NAMELY, FILTER CUBES, RETAINING RINGS, AND DICHOIC MIRRORS (U.S. CLS. 21, 23, 26, 36 AND 38).

CLASS 16—PAPER GOODS AND PRINTED MATTER

FOR PRINTED EDUCATIONAL MATERIALS IN THE FIELDS OF FLUORESCENCE MICROSCOPY, OPTICS, AND OPTICAL FILTERS (U.S. CLS. 2, 5, 22, 23, 29, 37, 38 AND 50).

CLASS 42—SCIENTIFIC AND COMPUTER SERVICES

FOR PRODUCT ENGINEERING AND SCIENTIFIC RESEARCH AND DEVELOPMENT OF ACCESSORIES IN THE FIELDS OF MICROSCOPY, FLUORESCENCE MICROSCOPY, FLOW CYTOMETRY, AND OPTICS, NAMELY, OPTICAL FILTERS, OPTICAL INTERFERENCE FILTERS, NEUTRAL DENSITY FILTERS, ABSORPTION GLASS FILTERS, DIFFUSION GLASS FILTERS, GLASS MICROSCOPE SLIDES, MICROSCOPE COMPONENT PARTS, NAMELY, FILTER CUBES, RETAINING RINGS, AND DICHOIC MIRRORS; DESIGN FOR OTHERS IN THE FIELD OF OPTICAL INTERFERENCE FILTERS (U.S. CLS. 100 AND 101).

GENE MACIOL, EXAMINING ATTORNEY

SN 77-733,773. FLEETWOOD GROUP, INC., HOLLAND, MI. FILED 5-11-2009.

FLEETWOOD GROUP

THE MARK CONSISTS OF STANDARD CHARACTERS WITHOUT CLAIM TO ANY PARTICULAR FONT, STYLE, SIZE, OR COLOR.

NO CLAIM IS MADE TO THE EXCLUSIVE RIGHT TO USE "GROUP", APART FROM THE MARK AS SHOWN.

CLASS 9—ELECTRICAL AND SCIENTIFIC APPARATUS

FOR WIRELESS ELECTRONIC POLLING SYSTEMS COMPRISING COMPUTER HARDWARE AND SOFTWARE USED TO TRANSMIT RESPONSES ENTERED BY USERS; RADIO FREQUENCY IDENTIFICATION SYSTEMS COMPRISING RADIO FREQUENCY IDENTIFICATION TAGS AND READERS FOR RADIO FREQUENCY IDENTIFICATION TAGS; PATIENT MONITORING SENSORS AND ALARMS; COMPUTER HARDWARE AND SOFTWARE FOR USE WITH PERSONS AND PHYSICAL ASSET MONITORING EQUIPMENT FOR RECEIVING, PROCESSING, TRANSMITTING AND DISPLAYING DATA; LABORATORY FURNITURE (U.S. CLS. 21, 23, 26, 36 AND 38).

CLASS 20—FURNITURE AND ARTICLES NOT OTHERWISE CLASSIFIED

FOR FURNITURE; LIBRARY FURNITURE; SCHOOL FURNITURE; CHURCH FURNITURE; OFFICE FURNITURE; CABINETS; MOBILE CABINETS; COMPUTER FURNITURE; MOBILE AUDIO AND VIDEO EQUIPMENT CARTS; TABLES (U.S. CLS. 2, 13, 22, 25, 32 AND 50).

CLASS 40—MATERIAL TREATMENT

FOR CONTRACT MANUFACTURING IN THE FIELD OF ELECTRONIC CIRCUITS (U.S. CLS. 100, 103 AND 106).

CLASS 42—SCIENTIFIC AND COMPUTER SERVICES

FOR ENGINEERING; ENGINEERING SERVICES, NAMELY, ENGINEERING FOR DATA AND AUDIO COMMUNICATIONS FIELD; CIRCUIT DESIGN (U.S. CLS. 100 AND 101).

MICHAEL ENGEL, EXAMINING ATTORNEY

SN 77-734,518. RECKITT BENCKISER INC., PARSIPPANY, NJ. FILED 5-12-2009.



SN 77-734,425. ASICS CORPORATION, CHUO-KU, KOBE, JAPAN, FILED 5-11-2009.

AYAMI

THE MARK CONSISTS OF STANDARD CHARACTERS WITHOUT CLAIM TO ANY PARTICULAR FONT, STYLE, SIZE, OR COLOR.

THE WORDING "AYAMI" HAS NO MEANING IN A FOREIGN LANGUAGE.

CLASS 9—ELECTRICAL AND SCIENTIFIC APPARATUS

FOR SAFETY PRODUCTS, NAMELY, REFLECTIVE VESTS AND REFLECTIVE ANKLE, WRIST AND ARM BANDS (U.S. CLS. 21, 23, 26, 36 AND 38).

CLASS 25—CLOTHING

FOR ATHLETIC APPAREL, NAMELY, ATHLETIC JERSEYS, SINGLET, RUNNING TOPS, ATHLETIC CAPS, ATHLETIC SHORTS, ATHLETIC SHIRTS, EXERCISE COMPRESSION SHIRTS, EXERCISE COMPRESSION TIGHTS, ATHLETIC TANK TOPS, ATHLETIC JACKETS, ATHLETIC VESTS, ATHLETIC TIGHTS, RUNNING PANTS, ATHLETIC BRAS, ATHLETIC BRIEFS, EXERCISE COMPRESSION BRAS, BERMUDA SHORTS, ATHLETIC T-SHIRTS, ATHLETIC SOCKS, ATHLETIC CAPS, ATHLETIC VISORS, ATHLETIC HATS, ATHLETIC BEANIES, ATHLETIC SKULL CAPS, ATHLETIC HEADBANDS, ATHLETIC GLOVES, ATHLETIC WRISTBANDS, ATHLETIC ANKLE BANDS (U.S. CLS. 22 AND 39).

BRIAN CALLAGHAN, EXAMINING ATTORNEY

NO CLAIM IS MADE TO THE EXCLUSIVE RIGHT TO USE THE PICTORIAL REPRESENTATION OF THE MAGNOLIA BLOOM AND CHERRY BLOSSOMS, APART FROM THE MARK AS SHOWN.

THE COLOR(S) PINK, YELLOW, WHITE, RED AND BLUE IS/ARE CLAIMED AS A FEATURE OF THE MARK.

THE MARK CONSISTS OF A STYLIZED BUBBLE SPHERE DESIGN WITH WHITE HIGHLIGHTS AND A BLUE SILHOUETTE ENCAPSULATING THE IMAGE OF A LARGE FLOWER WITH WHITE PETALS AND A YELLOW PISTIL AND STAMENS, WITH SMALLER PINK FLOWERS APPEARING ABOVE WITH RED ANTERS, AND YELLOW FILAMENTS AND PISTILS, WITH BLURRED PINK FLOWERS APPEARING ON A BLURRED WHITE BACKGROUND.

CLASS 3—COSMETICS AND CLEANING PREPARATIONS

FOR PERFUMING PREPARATIONS FOR THE ATMOSPHERE, NAMELY, ROOM FRAGRANCES; ESSENTIAL OILS; PREPARATIONS FOR PERFUMING OR FRAGRANCING THE AIR, NAMELY, INCENSE, INCENSE CONES, INCENSE STICKS, INCENSE SACHETS, INCENSE ROOM SPRAYS, POTPOURRI AND ROOM PERFUME SPRAYS (U.S. CLS. 1, 4, 6, 50, 51 AND 52).

CLASS 4—LUBRICANTS AND FUELS

FOR CANDLES, FRAGRANCED OR SCENTED CANDLES; CANDLE WICKS (U.S. CLS. 1, 6 AND 15).

CLASS 5—PHARMACEUTICALS

FOR AIR FRESHENING PREPARATIONS; AIR PURIFYING PREPARATIONS IN THE NATURE OF AIR DEODORIZERS; PREPARATIONS FOR PERFUMING OR FRAGRANCING THE AIR, NAMELY, ROOM AIR FRESHENERS; HOUSEHOLD AND ROOM DEODORANTS; ODOR NEUTRALIZING PREPARATIONS FOR USE ON CARPETS, TEXTILES AND IN THE AIR (U.S. CLS. 6, 18, 44, 46, 51 AND 52).

CLASS 11—ENVIRONMENTAL CONTROL APPARATUS

FOR APPARATUS AND INSTRUMENTS, NAMELY, ELECTRIC AND BATTERY OPERATED DISPENSERS, DISPENSING UNITS, AND DIFFUSERS FOR ROOM FRAGRANCES, AIR FRESHENERS AND ROOM DEODORANTS, ALL FOR SCENTING, PURIFYING OR FRESHENING THE ATMOSPHERE; PARTS AND FITTINGS FOR ALL THE AFORESAID GOODS SOLD AS A UNIT THEREWITH (U.S. CLS. 13, 21, 23, 31 AND 34).

LEIGH LOWRY, EXAMINING ATTORNEY

SN 77-734,665. RECKITT BENCKISER INC., PARSIPPANY, NJ. FILED 5-12-2009.

SN 77-734,696. VISION INFORMATION TECHNOLOGIES, INC., DETROIT, MI. FILED 5-12-2009.



NO CLAIM IS MADE TO THE EXCLUSIVE RIGHT TO USE THE PICTORIAL REPRESENTATION OF THE FREESIA AND JASMINE FLOWERS, APART FROM THE MARK AS SHOWN.

THE COLOR(S) WHITE, GREEN, YELLOW, BLACK AND BLUE IS/ARE CLAIMED AS A FEATURE OF THE MARK.

THE MARK CONSISTS OF A STYLIZED BUBBLE SPHERE DESIGN WITH WHITE HIGHLIGHTS AND A BLUE SILHOUETTE ENCAPSULATING THE IMAGE OF A LARGE WHITE FREESIA FLOWER WITH WHITE STAMENS AND SMALLER WHITE JASMINE FLOWERS WITH YELLOW CENTERS APPEARING ON GREEN STEMS AND LEAVES, ALL UPON A BLURRED BACKGROUND OF WHITE, BLUE AND GREEN FLOWERS AND A BLACK STEM.

CLASS 3—COSMETICS AND CLEANING PREPARATIONS

FOR PERFUMING PREPARATIONS FOR THE ATMOSPHERE, NAMELY, ROOM FRAGRANCES; ESSENTIAL OILS; PREPARATIONS FOR PERFUMING OR FRAGRANCING THE AIR, NAMELY, INCENSE, INCENSE CONES, INCENSE STICKS, INCENSE SACHETS, INCENSE ROOM SPRAYS, POTPOURRI AND ROOM PERFUME SPRAYS (U.S. CLS. 1, 4, 6, 50, 51 AND 52).

CLASS 4—LUBRICANTS AND FUELS

FOR CANDLES, FRAGRANCED OR SCENTED CANDLES; CANDLE WICKS (U.S. CLS. 1, 6 AND 15).

CLASS 5—PHARMACEUTICALS

FOR AIR FRESHENING PREPARATIONS; AIR PURIFYING PREPARATIONS IN THE NATURE OF AIR DEODORIZERS; PREPARATIONS FOR PERFUMING OR FRAGRANCING THE AIR, NAMELY, ROOM AIR FRESHENERS; HOUSEHOLD AND ROOM DEODORANTS; ODOR NEUTRALIZING PREPARATIONS FOR USE ON CARPETS, TEXTILES AND IN THE AIR (U.S. CLS. 6, 18, 44, 46, 51 AND 52).

CLASS 11—ENVIRONMENTAL CONTROL APPARATUS

FOR APPARATUS AND INSTRUMENTS, NAMELY, ELECTRIC AND BATTERY OPERATED DISPENSERS, DISPENSING UNITS, AND DIFFUSERS FOR ROOM FRAGRANCES, AIR FRESHENERS AND ROOM DEODORANTS, ALL FOR SCENTING, PURIFYING OR FRESHENING THE ATMOSPHERE; PARTS AND FITTINGS FOR ALL THE AFORESAID GOODS SOLD AS A UNIT THEREWITH (U.S. CLS. 13, 21, 23, 31 AND 34).
LEIGH LOWRY, EXAMINING ATTORNEY

URBAN ONSHORE

THE MARK CONSISTS OF STANDARD CHARACTERS WITHOUT CLAIM TO ANY PARTICULAR FONT, STYLE, SIZE, OR COLOR.

CLASS 35—ADVERTISING AND BUSINESS

FOR EMPLOYMENT HIRING, RECRUITING, PLACEMENT, STAFFING AND CAREER NETWORKING SERVICES; EMPLOYMENT STAFFING IN THE FIELD OF INFORMATION TECHNOLOGY; PROVIDING AN ONLINE SEARCHABLE DATABASE FEATURING EMPLOYMENT OPPORTUNITIES; OUTSOURCING IN THE FIELD OF INFORMATION TECHNOLOGY; BUSINESS MANAGEMENT SERVICES, NAMELY, MANAGING THE SUPPLY OF CONTRACTED EMPLOYEES FOR OTHERS; BUSINESS SERVICES, NAMELY, MANAGING THIRD PARTY VENDORS, SUPPLIERS, AND CONTRACTORS ON BEHALF OF OTHERS; ADMINISTRATION OF BUSINESS PAYROLL FOR OTHERS (U.S. CLS. 100, 101 AND 102).

CLASS 42—SCIENTIFIC AND COMPUTER SERVICES

FOR COMPUTER SERVICES, NAMELY, REMOTE AND ON-SITE MANAGEMENT OF THE INFORMATION TECHNOLOGY (IT) SYSTEMS OF OTHERS; PRODUCT TESTING OF SOFTWARE APPLICATIONS FOR OTHERS; PROVIDING QUALITY ASSURANCE SERVICES IN THE FIELD OF COMPUTER SOFTWARE; PRODUCT TESTING IN THE FIELD OF WEB APPLICATIONS, ENTERPRISE APPLICATIONS AND ELECTRONIC DEVICES; WEB SITE DEVELOPMENT; DESIGN, CREATION, HOSTING, MAINTENANCE OF WEB SITES FOR OTHERS; COMPUTER SERVICES, NAMELY, COMPUTER SYSTEM ADMINISTRATION FOR OTHERS; COMPUTER COLOCATION SERVICES, NAMELY, PROVIDING FACILITIES FOR THE LOCATION OF COMPUTER SERVERS WITH THE EQUIPMENT OF OTHERS; APPLICATION SERVICE PROVIDER, NAMELY, PROVIDING, HOSTING, MANAGING, DEVELOPING, AND MAINTAINING APPLICATIONS, SOFTWARE, WEB SITES, AND DATABASES FOR OTHERS; COMPUTER TECHNOLOGY SUPPORT SERVICES, NAMELY, HELP DESK SERVICES; TECHNICAL SUPPORT SERVICES, NAMELY, TROUBLESHOOTING OF COMPUTER SOFTWARE PROBLEMS AND DIAGNOSING COMPUTER HARDWARE PROBLEMS (U.S. CLS. 100 AND 101).

GEOFFREY FOSDICK, EXAMINING ATTORNEY

SN 77-735,139. PRICE LEBLANC, INC., BATON ROUGE, LA. FILED 5-12-2009.

PRICE LEBLANC

THE MARK CONSISTS OF STANDARD CHARACTERS WITHOUT CLAIM TO ANY PARTICULAR FONT, STYLE, SIZE, OR COLOR.

THE NAME "V. PRICE LEBLANC" IDENTIFIES A LIVING INDIVIDUAL WHOSE CONSENT IS OF RECORD.

CLASS 35—ADVERTISING AND BUSINESS

FOR AUTOMOBILE DEALERSHIPS (U.S. CLS. 100, 101 AND 102).
FIRST USE 3-4-1975; IN COMMERCE 3-4-1975.

CLASS 37—CONSTRUCTION AND REPAIR

FOR REPAIR AND MAINTENANCE OF VEHICLES (U.S. CLS. 100, 103 AND 106).
FIRST USE 3-4-1975; IN COMMERCE 3-4-1975.
RAUL CORDOVA, EXAMINING ATTORNEY

CLASS 9—ELECTRICAL AND SCIENTIFIC APPARATUS

FOR SOUND RECORDINGS FEATURING MUSIC; VIDEO RECORDINGS FEATURING MUSIC; PRE-RECORDED CDS, AUDIO TAPES AND DVDS FEATURING MUSIC AND MUSIC ENTERTAINMENT; DOWNLOADABLE AUDIO RECORDINGS AND DOWNLOADABLE AUDIOVISUAL RECORDINGS FEATURING MUSIC VIA GLOBAL COMPUTER NETWORK AND WIRELESS DEVICES (U.S. CLS. 21, 23, 26, 36 AND 38).

CLASS 41—EDUCATION AND ENTERTAINMENT

FOR ENTERTAINMENT SERVICES, NAMELY, PRODUCTION OF VIDEO AND AUDIO RECORDINGS FEATURING MUSIC AND MUSIC ENTERTAINMENT; PROVIDING NONDOWNLOADABLE PRERECORDED MUSIC AND VIDEO FEATURING MUSIC ALL ONLINE VIA A GLOBAL COMPUTER NETWORK (U.S. CLS. 100, 101 AND 107).

HAI-LY LAM, EXAMINING ATTORNEY

SN 77-736,676. BAY CONVERTING INC., GREEN BAY, WI.
FILED 5-14-2009.

EARTH DELICATE

THE MARK CONSISTS OF STANDARD CHARACTERS WITHOUT CLAIM TO ANY PARTICULAR FONT, STYLE, SIZE, OR COLOR.

CLASS 3—COSMETICS AND CLEANING PREPARATIONS

FOR LAUNDRY DRYER SHEETS IMPREGNATED WITH FABRIC SOFTENER (U.S. CLS. 1, 4, 6, 50, 51 AND 52).

CLASS 16—PAPER GOODS AND PRINTED MATTER

FOR PARCHMENT DUTCH OVEN LINERS (U.S. CLS. 2, 5, 22, 23, 29, 37, 38 AND 50).
JILL PRATER, EXAMINING ATTORNEY

SN 77-738,366. WOMEN SUPPORTING WOMEN, INC.,
RANCHO MIRAGE, CA. FILED 5-15-2009.

WOMEN SUPPORTING WOMEN

THE MARK CONSISTS OF STANDARD CHARACTERS WITHOUT CLAIM TO ANY PARTICULAR FONT, STYLE, SIZE, OR COLOR.

CLASS 14—JEWELRY

FOR JEWELRY (U.S. CLS. 2, 27, 28 AND 50).

CLASS 25—CLOTHING

FOR CLOTHING, NAMELY, UNDERGARMENTS, SWIMWEAR, HEADWEAR, SHIRTS, TOPS, AND BOTTOMS (U.S. CLS. 22 AND 39).

CLASS 36—INSURANCE AND FINANCIAL

FOR CHARITABLE FUND RAISING; CHARITABLE FUNDRAISING SERVICES, NAMELY, SHARING PROFITS FROM SALES OF RETAIL ITEMS WITH NON-PROFIT ORGANIZATIONS, FOUNDATIONS, AND INSTITUTIONS; CHARITABLE SERVICES, NAMELY, GRANTING FUNDS TO FOUNDATIONS, INSTITUTIONS, AND ORGANIZATIONS IN THE FIELD OF BREAST CANCER RESEARCH, EDUCATION, AND AWARENESS; CHARITABLE SERVICES, NAMELY, PROVIDING FINANCIAL ASSISTANCE FOR FOUNDATIONS, INSTITUTIONS, AND ORGANIZATIONS IN THE FIELD OF BREAST CANCER RESEARCH, EDUCATION, AND AWARENESS (U.S. CLS. 100, 101 AND 102).

HEATHER BIDDULPH, EXAMINING ATTORNEY

SN 77-737,816. JB STARR PRODUCTIONS, INC., NEW YORK, NY. FILED 5-15-2009.



NO CLAIM IS MADE TO THE EXCLUSIVE RIGHT TO USE "PRODUCTIONS", APART FROM THE MARK AS SHOWN.

THE NAME(S), PORTRAIT(S), AND/OR SIGNATURE(S) SHOWN IN THE MARK DOES NOT IDENTIFY A PARTICULAR LIVING INDIVIDUAL.

THE MARK CONSISTS OF THE INITIALS "JB" FOLLOWED BY A STAR DESIGN ON TOP OF THE WORDING "STARR" WHICH IS UNDERLINED AND APPEARS ON TOP OF THE WORDING "PRODUCTIONS".

SN 77-738,452. ABBOTT LABORATORIES, ABBOTT PARK, ILL. FILED 5-15-2009.

REVIGOR

THE MARK CONSISTS OF STANDARD CHARACTERS WITHOUT CLAIM TO ANY PARTICULAR FONT, STYLE, SIZE, OR COLOR.

OWNER OF U.S. REG. NO. 3,464,189.

CLASS 1—CHEMICALS

FOR CHEMICAL COMPOUNDS FOR USE IN THE MANUFACTURING OF FOODS AND BEVERAGES (U.S. CLS. 1, 5, 6, 10, 26 AND 46).

CLASS 5—PHARMACEUTICALS

FOR NUTRACEUTICAL USED IN FOOD PRODUCTS AND BEVERAGES; DIETARY VITAMIN AND MINERAL PREPARATIONS FOR USE AS INGREDIENTS IN THE FOOD AND BEVERAGE INDUSTRIES; NUTRITIONAL SUPPLEMENTS; DIETARY SUPPLEMENTS; MEAL REPLACEMENT BARS AND BEVERAGES; NUTRACEUTICALS FOR THE TREATMENT OF MUSCLE LOSS, BONE LOSS, MUSCLE DETERIORATION, AND MUSCLE WASTING; AND NUTRITIONALLY FORTIFIED BEVERAGES (U.S. CLS. 6, 18, 44, 46, 51 AND 52).

CLASS 30—STAPLE FOODS

FOR NUTRITIONALLY FORTIFIED PROCESSED CEREALS; AND NUTRITIONALLY FORTIFIED GRANOLA-BASED SNACK BARS (U.S. CL. 46).
TINA L. SNAPP, EXAMINING ATTORNEY

SN 77-738,511. GEOPLAST S.P.A., GRANTORTO (PD), ITALY, FILED 5-15-2009.

GEOPLAST

THE MARK CONSISTS OF STANDARD CHARACTERS WITHOUT CLAIM TO ANY PARTICULAR FONT, STYLE, SIZE, OR COLOR.

CLASS 6—METAL GOODS

FOR FRAMEWORK OF METAL FOR BUILDING; REINFORCING MATERIAL OF METAL FOR BUILDING; BUILDING PANELS OF METAL, NAMELY, FLOOR PANELS, CEILING PANELS (U.S. CLS. 2, 12, 13, 14, 23, 25 AND 50).

CLASS 19—NON-METALLIC BUILDING MATERIALS

FOR BUILDING MATERIALS NOT OF METAL, NAMELY, MATERIALS FOR CEILINGS AND FLOORS; BUILDING PANELS NOT OF METAL, NAMELY, FLOOR PANELS, CEILING PANELS; FACINGS NOT OF METAL FOR BUILDING; FRAMEWORKS NOT OF METAL FOR BUILDING; REINFORCING MATERIALS NOT OF METALS FOR BUILDING; SURFACING NOT OF METAL FOR BUILDING, NAMELY, NON-METAL ROOFING, NON-METAL FLOORING; TILES NOT OF METAL FOR BUILDING; NON-METAL FORMWORKS FOR FOUNDATIONS; NON-METAL FORMWORKS FOR VENTILATED FOUNDATIONS; PLASTIC FORMWORK FOR COLUMNS; STAY-IN-PLACE PLASTIC FORMWORKS FOR FLOORS, WALLS, CEILINGS, SLABS; STAY-IN-PLACE PLASTIC FORMWORKS FOR COLUMNS; MODULAR PLASTIC FORMWORKS FOR FLOORS, CEILINGS AND SLABS; NON-METAL FORMWORKS FOR SLABS; NON-METAL MODULAR ELEMENTS FOR DRAINAGE BASINS, NAMELY, PLASTIC CONDUIT FOR DRAINAGE; POURED CONCRETE TANKS; NON-METAL GRID FOR DRIVABLE LAWNS, NAMELY, NON-METAL LATTICES; NON-METAL PRE-VEGETATED SYSTEM FOR ROOF GARDENS COMPOSED OF MODULAR ELEMENTS MADE OF THERMOFORMED PLASTIC SUITED TO CONTAIN A LAYER OF SOIL AND PLANTS; PLASTIC TILES FOR SPORT SURFACES; NON-METAL GRID FOR WATER-PERMEABLE FLOORING FOR AREAS DEDICATED TO HOOFED ANIMALS, NAMELY, NON-METAL LATTICES (U.S. CLS. 1, 12, 33 AND 50).

CLASS 42—SCIENTIFIC AND COMPUTER SERVICES

FOR ENGINEERING; ARCHITECTURE DESIGN SERVICES; TECHNICAL PROJECT STUDIES IN THE FIELD OF BUILDING CONSTRUCTION; TECHNICAL RESEARCH IN THE FIELD OF BUILDING CONSTRUCTION; RESEARCH AND DEVELOPMENT FOR OTHERS IN THE FIELD OF BUILDING CONSTRUCTION; COMPUTER SOFTWARE CONSULTANCY; CONSULTANCY IN THE FIELD OF COMPUTER HARDWARE (U.S. CLS. 100 AND 101).

LINDSEY RUBIN, EXAMINING ATTORNEY

SN 77-738,680. GRUPO AVAL ACCIONES Y VALORES S.A., SANTAFE DE BOGOTA, COLOMBIA, FILED 5-16-2009.

GRUPO AVAL MORE THAN A BANK

THE MARK CONSISTS OF STANDARD CHARACTERS WITHOUT CLAIM TO ANY PARTICULAR FONT, STYLE, SIZE, OR COLOR.

OWNER OF U.S. REG. NOS. 2,548,694 AND 2,704,910.

THE MARK TRANSLATES TO "GROUP AVAL." THE WORD "AVAL" MEANS - (1) "THE SIGNATURE AT THE END OF A LETTER OR ANY OTHER CREDIT DOCUMENT, TO ASSURE ITS PAYMENT IN CASE THE PERSON WHO IS PRINCIPALLY OBLIGATED DOES NOT PAY"; (2) "WRITTEN DOCUMENT THROUGH WHICH A PERSON RESPONDS FOR SOMEONE ELSE'S BEHAVIOR, ESPECIALLY IN POLITICAL ISSUES."

CLASS 35—ADVERTISING AND BUSINESS

FOR ADVERTISING AND BUSINESS MANAGEMENT CONSULTANCY (U.S. CLS. 100, 101 AND 102).

CLASS 36—INSURANCE AND FINANCIAL

FOR BANKING AND FINANCING SERVICES; ELECTRONIC BANKING VIA A GLOBAL COMPUTER NETWORK; INVESTMENT BANKING SERVICES; MERCHANT BANKING AND INVESTMENT BANKING SERVICES; MORTGAGE BANKING; ON-LINE BANKING SERVICES (U.S. CLS. 100, 101 AND 102).

STEVEN R. FINE, EXAMINING ATTORNEY

SN 77-741,261. QUIKSILVER, INC., HUNTINGTON BEACH, CA. FILED 5-20-2009.

QUIKSILVER WATERMAN COLLECTION

THE MARK CONSISTS OF STANDARD CHARACTERS WITHOUT CLAIM TO ANY PARTICULAR FONT, STYLE, SIZE, OR COLOR.

OWNER OF U.S. REG. NOS. 1,431,266, 1,800,150 AND OTHERS.

NO CLAIM IS MADE TO THE EXCLUSIVE RIGHT TO USE "COLLECTION", APART FROM THE MARK AS SHOWN.

SN 77-740,869. DESCHENAUX, MARC R, LOS ANGELES, CA. FILED 5-20-2009.

FRACTAL

THE MARK CONSISTS OF STANDARD CHARACTERS WITHOUT CLAIM TO ANY PARTICULAR FONT, STYLE, SIZE, OR COLOR.

CLASS 25—CLOTHING

FOR JEANS; SHORT-SLEEVED OR LONG-SLEEVED T-SHIRTS; T-SHIRTS (U.S. CLS. 22 AND 39).

CLASS 29—MEATS AND PROCESSED FOODS

FOR DAIRY-BASED BEVERAGES; FRUIT-BASED FOOD BEVERAGE; MILK BEVERAGES CONTAINING FRUITS; MILK DRINKS CONTAINING FRUITS (U.S. CL. 46).

CLASS 30—STAPLE FOODS

FOR BEVERAGES MADE OF COFFEE; BEVERAGES MADE OF TEA; COFFEE BEVERAGES WITH MILK (U.S. CL. 46).

CLASS 32—LIGHT BEVERAGES

FOR ALCOHOL FREE APERITIFS; FRUIT DRINKS; FRUIT DRINKS AND FRUIT JUICES; FRUIT DRINKS AND JUICES; FRUIT FLAVORED DRINKS; FRUIT FLAVORED SOFT DRINKS; FRUIT JUICES AND FRUIT DRINKS; GRAPE JUICE BEVERAGES; ICED FRUIT BEVERAGES; NON-ALCOHOLIC BEER; NON-ALCOHOLIC BEVERAGES CONTAINING FRUIT JUICES; NON-ALCOHOLIC BEVERAGES WITH TEA FLAVOR; NON-ALCOHOLIC BEVERAGES, NAMELY, CARBONATED BEVERAGES; NON-ALCOHOLIC COCKTAILS, NAMELY, MOCKTAILS; SOFT DRINKS (U.S. CLS. 45, 46 AND 48).

CLASS 33—WINES AND SPIRITS

FOR ALCOHOLIC APERITIF BITTERS; ALCOHOLIC BEVERAGES CONTAINING FRUIT; ALCOHOLIC BEVERAGES EXCEPT BEERS; ALCOHOLIC BEVERAGES OF FRUIT; ALCOHOLIC BEVERAGES, NAMELY, WHISKY, VODKA, TEQUILA, GIN; ALCOHOLIC ENERGY DRINKS; ALCOHOLIC FRUIT COCKTAIL DRINKS; ALCOHOLIC FRUIT EXTRACTS; ALCOHOLIC MALT COOLERS; ALCOHOLIC PUNCH; ALCOHOLIC PUNCHES; ALCOHOLIC TEA-BASED BEVERAGE (U.S. CLS. 47 AND 49).

BRENDAN REGAN, EXAMINING ATTORNEY

CLASS 18—LEATHER GOODS

FOR BAGS, NAMELY, TRAVEL BAGS, CARRY-ON BAGS, HANDBAGS, BEACH BAGS, ALL PURPOSE SPORT BAGS, DUFFEL BAGS, BACK PACKS, WALLET, SATCHELS, SUITCASES, FANNY PACKS AND UMBRELLAS (U.S. CLS. 1, 2, 3, 22 AND 41).

CLASS 25—CLOTHING

FOR CLOTHING, NAMELY, SHIRTS, T-SHIRTS, SWEATSHIRTS, CASUAL TOPS WITH LONG AND SHORT SLEEVES, TANK TOPS, VESTS, COATS, JACKETS, SWEATERS, WETSUITS, PANTS, SWEATPANTS, SHORTS, SWIMWEAR, BOARDSHORTS, JEANS, LEISURE WEAR IN THE NATURE OF LOUNGEWEAR, BOXER SHORTS, SOCKS AND BELTS; FOOTWEAR, NAMELY, SHOES, SANDALS AND BOOTS; HEADWEAR, NAMELY, HATS, BEANIES, CAPS AND VISORS (U.S. CLS. 22 AND 39).

LESLEY LAMOTHE, EXAMINING ATTORNEY

SN 77-741,784. MAREN CORPORATION, NEW PHILADELPHIA, OH. FILED 5-21-2009.

MAREN

THE MARK CONSISTS OF STANDARD CHARACTERS WITHOUT CLAIM TO ANY PARTICULAR FONT, STYLE, SIZE, OR COLOR.

CLASS 7—MACHINERY

FOR REPLACEMENT AND COMPONENT PARTS FOR HYDRAULIC MACHINES, NAMELY, PUMPS, MOTORS, VALVES, CYLINDERS, HOSES, FITTINGS, TANKS, TRANSMISSIONS, GEAR BOXES, TRANSFER CASES, AND DRIVE TRAIN COMPONENTS (U.S. CLS. 13, 19, 21, 23, 31, 34 AND 35).

CLASS 37—CONSTRUCTION AND REPAIR

FOR REPAIR AND MAINTENANCE OF REPLACEMENT AND COMPONENT PARTS FOR HYDRAULIC MACHINES (U.S. CLS. 100, 103 AND 106).

ERNEST SHOSHO, EXAMINING ATTORNEY

SN 77-742,417. DPN, ENCINITAS, CA. FILED 5-21-2009.

SNAPSHO

THE MARK CONSISTS OF STANDARD CHARACTERS WITHOUT CLAIM TO ANY PARTICULAR FONT, STYLE, SIZE, OR COLOR.

CLASS 9—ELECTRICAL AND SCIENTIFIC APPARATUS

FOR INTERACTIVE PHOTO KIOSKS FOR CAPTURING, UPLOADING DIGITAL IMAGES FOR FUTURE USE AND FOR RECORDING VIDEO AND STREAM LIVE VIDEO FOR FUTURE USE; INTERACTIVE COMPUTER KIOSKS COMPRISING COMPUTERS, COMPUTER HARDWARE, COMPUTER PERIPHERALS, AND COMPUTER OPERATING SOFTWARE TO ENABLE UPLOADING, POSTING, SHOWING, DISPLAYING, TAGGING, BLOGGING, SHARING AND OTHERWISE PROVIDING ELECTRONIC MEDIA AND INFORMATION OVER THE INTERNET AND OTHER COMMUNICATION NETWORKS, FOR USE IN ENTERTAINMENT PURPOSES AT PRIVATE AND PUBLIC ESTABLISHMENTS AND EVENTS (U.S. CLS. 21, 23, 26, 36 AND 38).

CLASS 35—ADVERTISING AND BUSINESS

FOR ADVERTISING AND INFORMATION DISTRIBUTION SERVICES, NAMELY, PROVIDING CLASSIFIED ADVERTISING SPACE VIA THE GLOBAL COMPUTER NETWORK; ONLINE ADVERTISING ON COMPUTER NETWORKS, PROMOTING THE GOODS AND SERVICES OF OTHERS OVER THE INTERNET; ADVERTISING SERVICES, NAMELY, PROVIDING ADVERTISING SPACE ON INTERACTIVE PHOTO KIOSKS (U.S. CLS. 100, 101 AND 102).

CLASS 38—COMMUNICATION

FOR COMMUNICATION SERVICES BY ELECTRONIC COMPUTER TERMINALS AND CELL PHONES; TELECOMMUNICATION SERVICES BY E-MAIL; ELECTRONIC MAIL SERVICES, ELECTRONIC TRANSMISSION OF MESSAGES AND IMAGES VIA COMPUTER TERMINALS AND CELL PHONES; ELECTRONIC DELIVERY OF IMAGES AND PHOTOGRAPHS VIA A GLOBAL COMPUTER NETWORK; ELECTRONIC TRANSMISSION AND STREAMING OF DIGITAL MEDIA CONTENT FOR OTHERS VIA GLOBAL AND LOCAL COMPUTER NETWORKS; COMPUTER SERVICES, NAMELY, PROVIDING ON-LINE FACILITIES FOR REAL-TIME INTERACTION WITH OTHER COMPUTER USERS CONCERNING TOPICS OF GENERAL INTEREST; PROVIDING ON-LINE CHAT ROOMS FOR SOCIAL NETWORKING AND TRANSMISSION OF MESSAGES AMONG COMPUTER USERS CONCERNING TOPICS OF GENERAL INTEREST WHICH ALSO ALLOW PHOTO SHARING AND TRANSMISSION OF PHOTOGRAPHIC IMAGES AMONG USERS; PROVIDING ON-LINE FORUMS FOR DISCUSSION OF TOPICS OF GENERAL INTEREST AMONG COMPUTER USERS AND PROVIDING ELECTRONIC BULLETIN/MESSAGE BOARDS FOR TRANSMISSION OF MESSAGES AMONG USERS IN THE FIELD OF GENERAL INTEREST; PROVIDING ON-LINE ELECTRONIC BULLETIN BOARDS FOR TRANSMISSION OF MESSAGES AMONG COMPUTER USERS CONCERNING PERSONAL PHOTOGRAPHS (U.S. CLS. 100, 101 AND 104).

CLASS 41—EDUCATION AND ENTERTAINMENT

FOR PHOTOGRAPHIC SERVICES, NAMELY, PHOTOGRAPHIC CAPTURE; ONLINE JOURNALS, NAMELY, BLOGS CONCERNING ENTERTAINMENT INFORMATION; PHOTOGRAPHY SERVICES; PROVIDING ONLINE COMPUTER DATABASES, ON-LINE SEARCHABLE DATABASES AND INFORMATION IN THE FIELD OF ENTERTAINMENT FEATURING PHOTOS, VIDEOS, EVENT LISTINGS, ACTIVITY LISTINGS, ATTRACTION LISTINGS, ENTERTAINMENT FACILITY LISTINGS IN PARTICULAR GEOGRAPHIC LOCATIONS (U.S. CLS. 100, 101 AND 107).

REBECCA GILBERT, EXAMINING ATTORNEY

SN 77-742,517. MYWV, LLC, GLENCOE, IL. FILED 5-21-2009.



THE MARK CONSISTS OF THE WORD "MYWRIGLEYVILLE" WITH A SOLID LINE UNDERNEATH IT WITH THE WORD ".COM" INSIDE THE LINE ON THE RIGHT HAND SIDE.

CLASS 35—ADVERTISING AND BUSINESS

FOR PROMOTING THE GOODS AND SERVICES OF LOCAL, NEIGHBORHOOD, BRICK-AND-MORTAR BUSINESSES INCLUDING BARS, RESTAURANTS AND OTHER BUSINESSES, BY LISTING THEIR GOODS AND SERVICES ON AN INTERNET WEBSITE; RETAIL STORE SERVICES FEATURING GENERAL CONSUMER MERCHANDISE, PHOTOS AND DISCOUNTED CONSUMER GOODS FROM MERCHANTS THROUGHOUT CHICAGO AND NATIONAL VENDORS; PROVIDING HOTEL RATE COMPARISON INFORMATION (U.S. CLS. 100, 101 AND 102).

FIRST USE 9-0-2008; IN COMMERCE 9-0-2008.

CLASS 41—EDUCATION AND ENTERTAINMENT

FOR PROVIDING INTERACTIVE INFORMATION ON SPORTING EVENTS, CONCERTS, MUSEUMS, ENTERTAINMENT OR CULTURAL EXHIBITIONS, FESTIVALS TO TOURISTS AND VISITORS TO THE NORTH SIDE OF CHICAGO ILLINOIS, VIA THE INTERNET; ARRANGING FOR TICKET RESERVATIONS FOR THEATRICAL PERFORMANCES, SPORTING EVENTS, MUSICAL CONCERTS AND OTHER ENTERTAINMENT EVENTS; PROVIDING INFORMATION RELATING TO THEATRICAL PERFORMANCES, SPORTING EVENTS, MUSICAL CONCERTS AND OTHER ENTERTAINMENT EVENTS VIA THE INTERNET; BOOKING OF RESERVATIONS FOR ENTERTAINMENT, SPORTING AND CULTURAL EVENTS; ONLINE THEATRICAL TICKET AGENCY SERVICES; TICKET AGENCY SERVICES FOR SPORTING EVENTS, MUSICAL CONCERTS AND OTHER ENTERTAINMENT EVENTS; PROVIDING INFORMATION RELATING TO ENTERTAINMENT EVENT TICKETS VIA THE INTERNET (U.S. CLS. 100, 101 AND 107).

FIRST USE 9-0-2008; IN COMMERCE 9-0-2008.

CLASS 45—PERSONAL AND LEGAL SERVICES

FOR PROVIDING A SOCIAL NETWORKING WEBSITE FOR ENTERTAINMENT PURPOSES WHERE VISITORS SHARE PHOTOS, VIDEOS AND OPINIONS (U.S. CLS. 100 AND 101).

FIRST USE 9-0-2008; IN COMMERCE 9-0-2008.

CAROLINE WOOD, EXAMINING ATTORNEY

SN 77-742,524. PETSMART STORE SUPPORT GROUP, INC.,
PHOENIX, AZ. FILED 5-21-2009.

SN 77-742,522. MYWV, LLC, GLENCOE, IL. FILED 5-21-2009.



MyWrigleyville

THE MARK CONSISTS OF STANDARD CHARACTERS WITHOUT CLAIM TO ANY PARTICULAR FONT, STYLE, SIZE, OR COLOR.

CLASS 35—ADVERTISING AND BUSINESS

FOR PROMOTING THE GOODS AND SERVICES OF LOCAL, NEIGHBORHOOD, BRICK-AND-MORTAR BUSINESSES INCLUDING BARS, RESTAURANTS AND OTHER BUSINESSES, BY LISTING THEIR GOODS AND SERVICES ON AN INTERNET WEBSITE; RETAIL STORE SERVICES FEATURING GENERAL CONSUMER MERCHANDISE, PHOTOS AND DISCOUNTED CONSUMER GOODS FROM MERCHANTS THROUGHOUT CHICAGO AND NATIONAL VENDORS; PROVIDING HOTEL RATE COMPARISON INFORMATION (U.S. CLS. 100, 101 AND 102).

FIRST USE 9-0-2008; IN COMMERCE 9-0-2008.

CLASS 41—EDUCATION AND ENTERTAINMENT

FOR PROVIDING INTERACTIVE INFORMATION ON SPORTING EVENTS, CONCERTS, MUSEUMS, ENTERTAINMENT OR CULTURAL EXHIBITIONS, FESTIVALS TO TOURISTS AND VISITORS TO THE NORTH SIDE OF CHICAGO ILLINOIS, VIA THE INTERNET; ARRANGING FOR TICKET RESERVATIONS FOR THEATRICAL PERFORMANCES, SPORTING EVENTS, MUSICAL CONCERTS AND OTHER ENTERTAINMENT EVENTS; PROVIDING INFORMATION RELATING TO THEATRICAL PERFORMANCES, SPORTING EVENTS, MUSICAL CONCERTS AND OTHER ENTERTAINMENT EVENTS VIA THE INTERNET; BOOKING OF RESERVATIONS FOR ENTERTAINMENT, SPORTING AND CULTURAL EVENTS; ONLINE THEATRICAL TICKET AGENCY SERVICES; TICKET AGENCY SERVICES FOR SPORTING EVENTS, MUSICAL CONCERTS AND OTHER ENTERTAINMENT EVENTS; PROVIDING INFORMATION RELATING TO ENTERTAINMENT EVENT TICKETS VIA THE INTERNET (U.S. CLS. 100, 101 AND 107).

FIRST USE 9-0-2008; IN COMMERCE 9-0-2008.

CLASS 45—PERSONAL AND LEGAL SERVICES

FOR PROVIDING A SOCIAL NETWORKING WEBSITE FOR ENTERTAINMENT PURPOSES WHERE VISITORS SHARE PHOTOS, VIDEOS AND OPINIONS (U.S. CLS. 100 AND 101).

FIRST USE 9-0-2008; IN COMMERCE 9-0-2008.
CAROLINE WOOD, EXAMINING ATTORNEY

OWNER OF U.S. REG. NOS. 3,196,334, 3,196,335 AND OTHERS.

NO CLAIM IS MADE TO THE EXCLUSIVE RIGHT TO USE "AQUARIUM SERVICES", APART FROM THE MARK AS SHOWN.

THE MARK CONSISTS OF "PETSMART" WITH BALL AND BOUNCE DESIGN AND A WAVY LINE UNDER THE WORDS "AQUARIUM SERVICES".

CLASS 37—CONSTRUCTION AND REPAIR

FOR AQUARIUM SET-UP AND INSTALLATION, CLEANING AND WATER CHANGES PROVIDED TO BUSINESS AND RESIDENTIAL CUSTOMERS (U.S. CLS. 100, 103 AND 106).

FIRST USE 10-1-2008; IN COMMERCE 10-1-2008.

CLASS 39—TRANSPORTATION AND STORAGE

FOR AQUARIUM DELIVERY; MOVING OF AQUARIUMS AND THEIR CONTENTS, INCLUDING PLANTS, WATER AND FISH, FROM ONE LOCATION TO ANOTHER (U.S. CLS. 100 AND 105).

FIRST USE 10-1-2008; IN COMMERCE 10-1-2008.

CLASS 44—MEDICAL, BEAUTY AND AGRICULTURAL SERVICES

FOR VACATION SERVICE, NAMELY, FEEDING OF FISH OF ABSENT OWNERS AND PERFORMING REQUIRED CLEANING AND WATER CHANGES; EMERGENCY CARE FOR FISH PROVIDED TO BUSINESS AND RESIDENTIAL CUSTOMERS (U.S. CLS. 100 AND 101).

FIRST USE 10-1-2008; IN COMMERCE 10-1-2008.

WARREN L. OLANDRIA, EXAMINING ATTORNEY

SN 77-742,702. MARCHANT, BENJAMIN, LOS ANGELES, CA. AND MARCHANT, MILFORD, LOS ANGELES, CA. FILED 5-21-2009.

CODENAME MIKE

THE MARK CONSISTS OF STANDARD CHARACTERS WITHOUT CLAIM TO ANY PARTICULAR FONT, STYLE, SIZE, OR COLOR.

THE NAME "CODENAME MIKE" DOES NOT IDENTIFY A LIVING INDIVIDUAL.

CLASS 9—ELECTRICAL AND SCIENTIFIC APPARATUS

FOR PRE-RECORDED COMPACT DISCS, CD-ROMS, DVDS, DVD-ROMS, VIDEO TAPES, AND VIDEO AND AUDIO CASSETTE TAPES, FEATURING MUSIC AND MUSICAL PERFORMANCES; DOWNLOADABLE MUSICAL AUDIO AND VIDEO RECORDINGS FEATURING MUSIC AND MUSICAL PERFORMANCES, AND INFORMATION ABOUT A MUSICAL PERFORMER AND RECORDING ARTIST; DOWNLOADABLE MUSICAL SOUND RECORDINGS; COMPUTER GAME EQUIPMENT CONTAINING MEMORY DEVICES, NAMELY DISCS; ELECTRONIC PUBLICATIONS, NAMELY, BOOKS AND MAGAZINES FEATURING INFORMATION ABOUT MUSIC, MUSICIANS AND MUSICAL PERFORMANCES DOWNLOADABLE AND RECORDED ON COMPUTER MEDIA; A SERIES OF PRE-RECORDED COMPACT DISCS, LASER DISCS, CD ROMS, DVDS, DVD ROMS, VIDEO TAPES, CASSETTES, AND OTHER PRE-RECORDED OPTICAL, ELECTRONIC, AND MAGNETIC MEDIA FEATURING MUSIC AND PERFORMANCES BY MUSICIANS; A SERIES OF AUDIO AND VISUAL RECORDINGS IN ALL FORMS FEATURING MUSIC, MUSICAL PERFORMANCES AND ENTERTAINMENT, NAMELY, MUSIC RECORDINGS, MUSIC VIDEOS AND MUSICAL PERFORMANCES; A SERIES OF DOWNLOADABLE MUSICAL SOUND RECORDINGS; A SERIES OF DOWNLOADABLE VIDEO RECORDINGS FEATURING MUSICAL PERFORMANCES; VIDEO GAME MACHINES FOR USE WITH TELEVISIONS (U.S. CLS. 21, 23, 26, 36 AND 38).

CLASS 25—CLOTHING

FOR CLOTHING AND WEARING APPAREL, NAMELY, MEN'S, WOMEN'S AND CHILDREN'S CLOTHING, NAMELY, SHIRTS, JACKETS, COATS, SWEATERS, SPORTS SHIRTS, TANK TOPS, T-SHIRTS, SWEATSHIRTS, JERSEYS, AND MEN'S WOMEN'S AND CHILDREN'S AND INFANT'S HEADWEAR, NAMELY, HATS, CAPS, NIGHTCAPS, BERETS, HEADBANDS, AND SUN VISORS; CLOTHING, NAMELY, RAINWEAR, T-SHIRTS, SWEAT SHIRTS, JERSEYS, SHORTS, SWEAT PANTS, JACKETS, HATS, CAPS, SCARVES, GLOVES, HOSIERY, NECKTIES, HEAD BANDS, WRIST BANDS, SWIM SUITS, SKIRTS, SHIRTS, TANK TOPS, PANTS, COATS, SWEATERS, SOCKS, PANTY HOSE, TIGHTS, BELTS, FOOTWEAR, NAMELY, SHOES, ATHLETIC SHOES, SLIPPERS, BOOTS, SANDALS; AND HEADWEAR, NAMELY, HATS AND CAPS (U.S. CLS. 22 AND 39).

CLASS 41—EDUCATION AND ENTERTAINMENT

FOR ENTERTAINMENT SERVICES, NAMELY, LIVE, TELEVISED AND MOVIE APPEARANCES BY PROFESSIONAL ENTERTAINERS; PERSONAL APPEARANCES BY MEDIA CELEBRITIES AND MUSICIANS; ENTERTAINMENT SERVICES, NAMELY, PRESENTATION OF LIVE PERFORMANCES FEATURING MUSIC; PLANNING AND ARRANGEMENT OF LIVE MUSICAL PERFORMANCES; AUDIO AND VIDEO RECORDING AND PRODUCTION SERVICES; MUSIC PRODUCTION AND RECORD PRODUCTION SERVICES; SONGWRITING, MUSIC COMPOSITION AND TRANSCRIPTION OF MUSIC FOR OTHERS; MOTION PICTURE SONG PRODUCTION; FILM, TELEVISION, AND AUDIOVISUAL INTERACTIVE MULTIMEDIA PRODUCTION SERVICES; PROVIDING INFORMATION IN THE FIELD OF ENTERTAINMENT VIA A GLOBAL COMPUTER NETWORK (U.S. CLS. 100, 101 AND 107).

BRIAN CALLAGHAN, EXAMINING ATTORNEY

SN 77-743,220. RONIN SYNDICATE, LLC, SCOTTSDALE, AZ. FILED 5-22-2009.

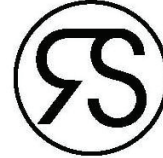

RONIN SYNDICATE

THE MARK CONSISTS OF THE LETTERS RS IN A CIRCLE, WITH THE R APPEARING BACKWARD AND THE WORDS RONIN SYNDICATE APPEARING BENEATH THE CIRCLE.

CLASS 28—TOYS AND SPORTING GOODS

FOR TOYS, NAMELY TOY VEHICLES AND ACCESSORIES THEREFOR; TOY FIGURES; TOY ACTION FIGURES AND ACCESSORIES THEREFOR (U.S. CLS. 22, 23, 38 AND 50).

CLASS 35—ADVERTISING AND BUSINESS

FOR DISTRIBUTORSHIP SERVICES IN THE FIELD OF TOYS (U.S. CLS. 100, 101 AND 102).

CLASS 42—SCIENTIFIC AND COMPUTER SERVICES

FOR DESIGN OF TOYS; DESIGN OF PACKAGING FOR TOYS (U.S. CLS. 100 AND 101).

STEVEN R. FINE, EXAMINING ATTORNEY

SN 77-743,227. RONIN SYNDICATE, LLC, SCOTTSDALE, AZ. FILED 5-22-2009.

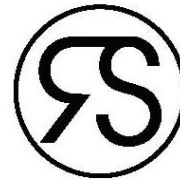

THE MARK CONSISTS OF THE LETTERS RS IN A CIRCLE WITH THE LETTER R FACING BACKWARD.

CLASS 28—TOYS AND SPORTING GOODS

FOR TOYS, NAMELY TOY VEHICLES AND ACCESSORIES THEREFOR; TOY FIGURES; TOY ACTION FIGURES AND ACCESSORIES THEREFOR (U.S. CLS. 22, 23, 38 AND 50).

CLASS 35—ADVERTISING AND BUSINESS

FOR DISTRIBUTORSHIP SERVICES IN THE FIELD OF TOYS (U.S. CLS. 100, 101 AND 102).

CLASS 42—SCIENTIFIC AND COMPUTER SERVICES

FOR DESIGN OF TOYS; DESIGN OF PACKAGING FOR TOYS (U.S. CLS. 100 AND 101).
STEVEN R. FINE, EXAMINING ATTORNEY

SN 77-744,363. SCHOOL JURIDICAL PERSON WASEDA UNIVERSITY, TOKYO, JAPAN, FILED 5-26-2009.



SN 77-743,605. BHAKTI, INC., SOUTH PASADENA, CA. FILED 5-22-2009.



NO CLAIM IS MADE TO THE EXCLUSIVE RIGHT TO USE "RUNNERS", APART FROM THE MARK AS SHOWN. THE STIPPLING IS A FEATURE OF THE MARK AND DOES NOT INDICATE COLOR.

THE COLOR(S) RED, WHITE, BLACK, GRAY AND TAN IS/ARE CLAIMED AS A FEATURE OF THE MARK.

THE MARK CONSISTS OF THE WORDS "SOLE" AND "RUNNERS" PLACED ON TOP OF ONE ANOTHER AND IN BLOCK LETTERS. RED IS THE MAIN COLOR OF THE WORDS, WHICH ARE STIPPLED TO INDICATE STITCHING. AN IMAGE OF A PAIR OF SHOES APPEARS IN THE TOP RIGHT CORNER OF THE MARK, MAINLY IN THE COLOR RED, BUT WITH THE COLOR WHITE COMPRISING THE SHOE LACES AND ALSO APPEARING IN THE UPPER RIGHT PORTION OF THE SHOES, THE COLOR GRAY APPEARING IN THE BOTTOM FRONT PORTION OF THE SHOES, THE COLOR TAN COMPRISING THE SHOE TABS AND ALSO APPEARING INSIDE THE SHOES, AND THE COLOR BLACK OUTLINING SOME DETAILS OF THE SHOES.

CLASS 35—ADVERTISING AND BUSINESS

FOR CLUB SERVICES, NAMELY, PROMOTING THE INTERESTS OF RUNNERS AND WALKERS (U.S. CLS. 100, 101 AND 102).

FIRST USE 2-1-2009; IN COMMERCE 2-1-2009.

CLASS 41—EDUCATION AND ENTERTAINMENT

FOR PROVIDING A WEBSITE FEATURING ONLINE SPORTS TRAINING AND TRAINING ADVICE AND THE RECORDING OF TRAINING AND WORKOUTS (U.S. CLS. 100, 101 AND 107).

FIRST USE 2-1-2009; IN COMMERCE 2-1-2009.
MATTHEW PAPPAS, EXAMINING ATTORNEY

NO CLAIM IS MADE TO THE EXCLUSIVE RIGHT TO USE THE NON-LATIN CHARACTERS THAT TRANSLITERATE TO DAIGAKU AND TRANSLATE AS UNIVERSITY, APART FROM THE MARK AS SHOWN.

THE MARK CONSISTS OF THE JAPANESE WORD DAIGAKU PRESENTED IN VERTICALLY ORIENTED KANJI CHARACTERS WITH CURVING DESIGNS OF LEAVES AND RICE STALKS ON EITHER SIDE AND A STYLIZED BOW BENEATH.

THE NON-LATIN CHARACTERS IN THE MARK TRANSLITERATE TO DAIGAKU AND THIS MEANS UNIVERSITY IN ENGLISH.

CLASS 41—EDUCATION AND ENTERTAINMENT

FOR EDUCATION SERVICES IN THE NATURE OF COURSES AT THE UNIVERSITY LEVEL; INFORMATION ABOUT EDUCATION (U.S. CLS. 100, 101 AND 107).
FIRST USE 10-31-1913; IN COMMERCE 4-30-1999.

CLASS 42—SCIENTIFIC AND COMPUTER SERVICES

FOR SCIENTIFIC RESEARCH AND STUDIES IN THE FIELDS OF LIFE SCIENCE AND MEDICAL BIOSCIENCE (U.S. CLS. 100 AND 101).

FIRST USE 4-30-2007; IN COMMERCE 4-30-2009.
STEVEN PEREZ, EXAMINING ATTORNEY

SN 77-745,084. PILKINGTON GROUP LIMITED, ST. HELENS, MERSEYSIDE, UNITED KINGDOM, FILED 5-27-2009.

OETECH

THE MARK CONSISTS OF STANDARD CHARACTERS WITHOUT CLAIM TO ANY PARTICULAR FONT, STYLE, SIZE, OR COLOR.

OWNER OF U.S. REG. NO. 3,332,277.

CLASS 7—MACHINERY

FOR MACHINE AND HANDHELD POWER TOOLS USED IN CONNECTION WITH THE FITTING OR REPAIR OF GLASS FOR VEHICLE WINDOWS, NAMELY, RIVETERS, SANDERS, URETHANE GUNS AND CAULKING GUNS (U.S. CLS. 13, 19, 21, 23, 31, 34 AND 35).

CLASS 8—HAND TOOLS

FOR HAND TOOLS USED IN CONNECTION WITH THE FITTING OR REPAIR OF GLASS FOR VEHICLE WINDOWS, NAMELY, KNIFE BLADES FOR UTILITY KNIVES, RAZOR BLADES, TOOL APRONS, DAUBING TOOLS FOR APPLICATION OF ADHESIVES, HAND OPERATED WINDSHIELD LIFTING DEVICES, AND WINDSHIELD REPAIR KITS COMPRISING ONE OR MORE OF THE FOREGOING ITEMS SOLD AS A UNIT FOR LAND VEHICLES (U.S. CLS. 23, 28 AND 44).

CLASS 12—VEHICLES

FOR PLASTIC COMPONENTS USED FOR INTERIOR AUTOMOTIVE TRIM, NAMELY, DASH AND INSTRUMENTATION PANEL TRIM, DOOR TRIM, CONSOLE TRIM, DOME LIGHT TRIM, GLOVE BOX TRIM AND ASHTRAY TRIM; MOLDED AND EXTRUDED PRODUCTS FOR USE IN CONNECTION WITH REPAIR AND REPLACEMENT OF VEHICLE WINDOWS, NAMELY, AUTOMOTIVE EXTERIOR AND INTERIOR METAL AND PLASTIC DECORATIVE AND PROTECTIVE TRIM AND MOLDINGS AND MOUNTING CLIPS THEREFOR SOLD AS A UNIT (U.S. CLS. 19, 21, 23, 31, 35 AND 44).

CLASS 37—CONSTRUCTION AND REPAIR

FOR VEHICLE WINDOW REPLACEMENT SERVICES, NAMELY, ADVISORY AND CONSULTANCY SERVICES RELATED TO THE MAINTENANCE AND REPAIR OF VEHICLE WINDOWS (U.S. CLS. 100, 103 AND 106).
ANDREW LEASER, EXAMINING ATTORNEY

SN 77-745,613. IMMERSION CORPORATION, SAN JOSE, CA.
FILED 5-27-2009.

IMMERSIVE MESSAGING

THE MARK CONSISTS OF STANDARD CHARACTERS WITHOUT CLAIM TO ANY PARTICULAR FONT, STYLE, SIZE, OR COLOR.

NO CLAIM IS MADE TO THE EXCLUSIVE RIGHT TO USE "MESSAGING", APART FROM THE MARK AS SHOWN.

CLASS 9—ELECTRICAL AND SCIENTIFIC APPARATUS

FOR COMPUTER HARDWARE AND PORTABLE DEVICES AND FEATURES THEREOF, NAMELY, MOBILE AND PORTABLE TOUCHSCREENS, TOUCH PANELS, CELL AND MOBILE PHONES, PDAS (PERSONAL DIGITAL ASSISTANTS), SMART PHONES, ELECTRIC, PORTABLE GAMING MACHINES, AND ELECTROMECHANICAL AND ELECTRONIC TELECOMMUNICATIONS HARDWARE IN THE NATURE OF TOUCH-ENABLED DEVICES FOR PROVIDING TACTILE, TOUCH, HAPTIC, AND FORCE FEEDBACK SENSATIONS; COMPUTER HARDWARE AND SOFTWARE FEATURING HAPTICS TECHNOLOGY USED TO CONNECT, MANAGE AND CONTROL REAL TIME VISUAL, AUDIO AND HAPTIC COMMUNICATION BETWEEN MULTIPLE HAPTIC ENABLED DEVICES FOR GESTURE BASED COMMUNICATION; ELECTRIC, ELECTROMECHANICAL AND ELECTRONIC TELECOMMUNICATIONS HARDWARE IN THE NATURE OF TOUCH-ENABLED DEVICES FOR PROVIDING TACTILE, TOUCH, HAPTIC, AND FORCE FEEDBACK SENSATIONS; ELECTRIC CONTROL PANELS; GRAPHICAL, MECHANICAL, KEYBOARD-BASED, VOICE-BASED, TEXT, AND TOUCH-BASED USER INTERFACE SOFTWARE, FOR USE IN MANAGING, OPERATING AND CONTROLLING MOBILE AND PORTABLE TOUCHSCREENS, TOUCH PANELS, CELL AND MOBILE PHONES, PDAS (PERSONAL DIGITAL ASSISTANTS), SMART PHONES, ELECTRIC, PORTABLE GAMING DEVICES, AND ELECTROMECHANICAL AND ELECTRONIC TELECOMMUNICATIONS HARDWARE IN THE NATURE OF TOUCH-ENABLED DEVICES FOR PROVIDING TACTILE, TOUCH, HAPTIC, AND FORCE FEEDBACK SENSATIONS (U.S. CLS. 21, 23, 26, 36 AND 38).

CLASS 38—COMMUNICATION

FOR TELECOMMUNICATION SERVICES, NAMELY, TRANSMISSION OF VISUAL, AUDIO AND HAPTIC COMMUNICATION BETWEEN MULTIPLE HAPTIC ENABLED DEVICES FOR GESTURE BASED COMMUNICATION (U.S. CLS. 100, 101 AND 104).

CLASS 42—SCIENTIFIC AND COMPUTER SERVICES

FOR COMPUTER AND TECHNOLOGY CONSULTING SERVICES IN THE HAPTICS TECHNOLOGY FIELD, COMPUTER SOFTWARE DEVELOPMENT SERVICES IN THE HAPTICS TECHNOLOGY FIELD, NAMELY, GESTURE BASED REAL TIME VISUAL, AUDIO AND HAPTIC COMMUNICATION BETWEEN MULTIPLE DEVICES, INCLUDING PORTABLE DEVICES AND MOBILE PHONES, GAMING DEVICES, PDAS AND SMART PHONES (U.S. CLS. 100 AND 101).
REBECCA GILBERT, EXAMINING ATTORNEY

SN 77-746,443. TARDIEU GROUP, INC., MIAMI, FL. FILED
5-28-2009.

BONA FIDE GENIUS

THE MARK CONSISTS OF STANDARD CHARACTERS WITHOUT CLAIM TO ANY PARTICULAR FONT, STYLE, SIZE, OR COLOR.

CLASS 25—CLOTHING

FOR MEN'S SHIRTS; CLOTHING, NAMELY, SHIRTS, T-SHIRTS, TOPS, BLOUSES (U.S. CLS. 22 AND 39).
FIRST USE 6-13-2008; IN COMMERCE 6-13-2008.

CLASS 35—ADVERTISING AND BUSINESS

FOR (BASED ON INTENT TO USE) ON-LINE RETAIL STORE SERVICES, FEATURING CLOTHING AND ACCESSORIES (U.S. CLS. 100, 101 AND 102).

SOPHIA S. KIM, EXAMINING ATTORNEY

SN 77-746,767. DONOR NETWORK ALLIANCE, LLC, NORTHBROOK, IL. FILED 5-28-2009.

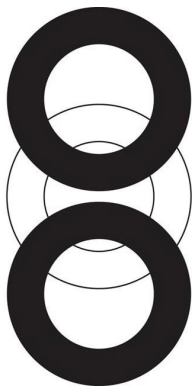

THE MARK CONSISTS OF THREE CIRCLES OF ALTERNATING DARK AND LIGHT SHADING INTERSECTING IN A VERTICAL ARRAY.

CLASS 40—MATERIAL TREATMENT

FOR CRYOPRESERVATION OF HUMAN EGGS (U.S. CLS. 100, 103 AND 106).

CLASS 44—MEDICAL, BEAUTY AND AGRICULTURAL SERVICES

FOR MATERNAL SURROGACY SERVICES; SPERM BANKS (U.S. CLS. 100 AND 101).

TIMOTHY FINNEGAN, EXAMINING ATTORNEY

SN 77-747,713. CAPITAL AREA IMMIGRANTS' RIGHTS COALITION, AKA CAIR COALITION, WASHINGTON, DC. FILED 5-29-2009.



OWNER OF U.S. REG. NOS. 2,702,007 AND 3,097,388.
NO CLAIM IS MADE TO THE EXCLUSIVE RIGHT TO USE "CAPITAL AREA IMMIGRANTS' RIGHTS COALITION", APART FROM THE MARK AS SHOWN.

THE MARK CONSISTS OF A PERSON AND VERTICAL BARS WITH THE WORDS "CAIR CAPITAL AREA IMMIGRANTS' RIGHTS COALITION".

CLASS 35—ADVERTISING AND BUSINESS

FOR PUBLIC ADVOCACY TO PROMOTE AWARENESS OF IMMIGRATION POLICY (U.S. CLS. 100, 101 AND 102).

FIRST USE 10-22-2008; IN COMMERCE 10-22-2008.

CLASS 45—PERSONAL AND LEGAL SERVICES

FOR LEGAL SERVICES, NAMELY, REPRESENTATION OF IMMIGRANTS BEFORE GOVERNMENT AGENCIES AND U.S. COURTS, AND COORDINATION OF PRO BONO LEGAL REPRESENTATION OF IMMIGRANTS (U.S. CLS. 100 AND 101).

FIRST USE 10-22-2008; IN COMMERCE 10-22-2008.
NICHOLAS ALTREE, EXAMINING ATTORNEY

SN 77-747,923. DANE SCARBOROUGH, MALIBU, CA. FILED 5-29-2009.

ÜBERTROPOLIS

THE MARK CONSISTS OF STANDARD CHARACTERS WITHOUT CLAIM TO ANY PARTICULAR FONT, STYLE, SIZE, OR COLOR.

CLASS 16—PAPER GOODS AND PRINTED MATTER

FOR COMIC STRIPS, COMIC BOOKS, A SERIES OF BOOKS IN THE FIELDS OF FICTION AND SCIENCE FICTION, GRAPHIC NOVELS (U.S. CLS. 2, 5, 22, 23, 29, 37, 38 AND 50).

CLASS 28—TOYS AND SPORTING GOODS

FOR TOY CONSTRUCTION SETS, TOY ACTION FIGURES AND ACCESSORIES THEREFOR, AND PLAY SETS FOR ACTION FIGURES (U.S. CLS. 22, 23, 38 AND 50).

CLASS 41—EDUCATION AND ENTERTAINMENT

FOR PRODUCTION AND DISTRIBUTION OF MOVIES; ENTERTAINMENT IN THE NATURE OF ONGOING TELEVISION PROGRAMS IN THE FIELD OF ANIMATED CARTOONS (U.S. CLS. 100, 101 AND 107).

CIMMERIAN COLEMAN, EXAMINING ATTORNEY

SN 77-748,104. ADVANCED CONCRETE TECHNOLOGIES LLC, OREM, UT. FILED 5-29-2009.

NANOLITHIUM

THE MARK CONSISTS OF STANDARD CHARACTERS WITHOUT CLAIM TO ANY PARTICULAR FONT, STYLE, SIZE, OR COLOR.

CLASS 1—CHEMICALS

FOR CHEMICAL PREPARATIONS FOR USE AS A HARDENER AND DENSIFIER FOR CONCRETE, MASONRY, OR STONE SURFACES (U.S. CLS. 1, 5, 6, 10, 26 AND 46).

CLASS 2—PAINTS

FOR CHEMICAL PREPARATIONS FOR USE AS A SEALER, COATING, OR PAINT FOR CONCRETE, MASONRY, OR STONE SURFACES (U.S. CLS. 6, 11 AND 16).
FRED CARL, EXAMINING ATTORNEY

SN 77-750,642. THE REPUBLIK CORPORATION, DURHAM, NC. FILED 6-3-2009.

SANCTION

THE MARK CONSISTS OF STANDARD CHARACTERS WITHOUT CLAIM TO ANY PARTICULAR FONT, STYLE, SIZE, OR COLOR.

CLASS 36—INSURANCE AND FINANCIAL

FOR COMMERCIAL ADMINISTRATION, NAMELY, PROVIDING ELECTRONIC PROCESSING OF CREDIT CARD TRANSACTIONS AND ELECTRONIC PAYMENTS VIA A GLOBAL COMPUTER NETWORK (U.S. CLS. 100, 101 AND 102).
FIRST USE 11-1-2007; IN COMMERCE 11-1-2007.

CLASS 42—SCIENTIFIC AND COMPUTER SERVICES

FOR COMMERCIAL ART DESIGN, GRAPHIC DESIGN, TEXTILE AND FASHION DESIGN FOR OTHERS, NAMELY, PACKAGE DESIGN, GRAPHIC DESIGN OF BUSINESS STATIONERY, GRAPHIC DESIGN OF BUSINESS PROMOTIONAL CLOTHING AND PRODUCTS; COMPUTER CONSULTATION SERVICES, NAMELY, DESIGNING AND DEVELOPING WEBSITES FOR OTHERS ON A GLOBAL COMPUTER NETWORK; COMPUTER CONSULTATION SERVICES, NAMELY, DESIGNING AND DEVELOPING VIRTUAL STORE FRONTS FOR OTHERS FOR USE ON A GLOBAL COMPUTER NETWORK (U.S. CLS. 100 AND 101).
FIRST USE 11-1-2007; IN COMMERCE 11-1-2007.
ALLISON SCHRODY, EXAMINING ATTORNEY

SN 77-749,477. JONES, JASON, OSWEGO, IL. FILED 6-1-2009.

DrSanGuinary.org

THE MARK CONSISTS OF STANDARD CHARACTERS WITHOUT CLAIM TO ANY PARTICULAR FONT, STYLE, SIZE, OR COLOR.

CLASS 25—CLOTHING

FOR CLOTHING, NAMELY, SHIRTS, HOODS, HATS, CAPS, INFANT AND TODDLER ONE-PIECE CLOTHING, JERSEYS, ATHLETIC UNIFORMS, AND BANDANAS (U.S. CLS. 22 AND 39).

CLASS 41—EDUCATION AND ENTERTAINMENT

FOR ENTERTAINMENT SERVICES IN THE NATURE OF LIVE PERFORMANCES BY DR. SAN GUINARY AND TELEVISION APPEARANCES BY DR. SAN GUINARY; PRODUCTION OF DVDS, VIDEOTAPES AND TELEVISION PROGRAMS FEATURING DR. SAN GUINARY (U.S. CLS. 100, 101 AND 107).
CHRISTOPHER BUONGIORNO, EXAMINING ATTORNEY

SN 77-751,076. WILD FLAVORS, INC., ERLANGER, KY. FILED 6-3-2009.

SUPERVEGGIE

THE MARK CONSISTS OF STANDARD CHARACTERS WITHOUT CLAIM TO ANY PARTICULAR FONT, STYLE, SIZE, OR COLOR.

CLASS 5—PHARMACEUTICALS

FOR MATERIAL FOR STOPPING TEETH (U.S. CLS. 6, 18, 44, 46, 51 AND 52).

CLASS 29—MEATS AND PROCESSED FOODS

FOR MEAT, FISH, POULTRY AND GAME, MEAT EXTRACTS, PRESERVED, DRIED AND COOKED FRUIT AND VEGETABLES, JELLIES, JAMS, APPLE SAUCE, CRANBERRY SAUCE (U.S. CL. 46).

SN 77-750,589. COLLEEN CAMPBELL REID, PARK CITY, UT. FILED 6-3-2009.

GREEN TRUMPET

THE MARK CONSISTS OF STANDARD CHARACTERS WITHOUT CLAIM TO ANY PARTICULAR FONT, STYLE, SIZE, OR COLOR.

CLASS 19—NON-METALLIC BUILDING MATERIALS

FOR NON-LUMINOUS AND NON-MECHANICAL NON-METAL SIGNS FOR IDENTIFYING GREEN BUILDING FEATURES IN A STRUCTURE AND CONTAINING INFORMATION ABOUT GREEN BUILDING FEATURES, ECOLOGICAL PRINCIPLES AND GREEN PRODUCTS (U.S. CLS. 1, 12, 33 AND 50).

CLASS 30—STAPLE FOODS

FOR SUGAR, RICE, TAPIOCA, SAGO, FLOUR, BREAD, PASTRY, HONEY, TREACLE, YEAST, BAKING-POWDER, SALT, MUSTARD, VINEGAR, SAUCES, SPICES, FRUIT SAUCES EXCLUDING CRANBERRY SAUCE AND APPLESAUCE (U.S. CL. 46).

CLASS 35—ADVERTISING AND BUSINESS

FOR PROMOTING PUBLIC AWARENESS ABOUT THE NEED TO USE ENVIRONMENTAL AND ECOLOGICAL PRODUCTS (U.S. CLS. 100, 101 AND 102).
ESTHER A. BORSUK, EXAMINING ATTORNEY

CLASS 32—LIGHT BEVERAGES

FOR BEER, MINERAL AND AERATED WATERS, FRUIT DRINKS AND FRUIT JUICES, SYRUPS AND OTHER PREPARATIONS FOR MAKING BEVERAGES (U.S. CLS. 45, 46 AND 48).

JULIE GUTTADAURO, EXAMINING ATTORNEY

SN 77-751,090. WILD FLAVORS, INC., ERLANGER, KY. FILED 6-3-2009.

SUPERVEGGIES

THE MARK CONSISTS OF STANDARD CHARACTERS WITHOUT CLAIM TO ANY PARTICULAR FONT, STYLE, SIZE, OR COLOR.

CLASS 5—PHARMACEUTICALS

FOR MATERIAL FOR STOPPING TEETH (U.S. CLS. 6, 18, 44, 46, 51 AND 52).

CLASS 29—MEATS AND PROCESSED FOODS

FOR MEAT, FISH, POULTRY AND GAME, MEAT EXTRACTS, PRESERVED, DRIED AND COOKED FRUIT AND VEGETABLES, JELLIES, JAMS, APPLE SAUCE, CRANBERRY SAUCE (U.S. CL. 46).

CLASS 30—STAPLE FOODS

FOR SUGAR, RICE, TAPIOCA, SAGO, FLOUR, BREAD, PASTRY, HONEY, TREACLE, YEAST, BAKING-POWDER, SALT, MUSTARD, VINEGAR, SAUCES, SPICES, FRUIT SAUCES EXCLUDING CRANBERRY SAUCE AND APPLESAUCE (U.S. CL. 46).

CLASS 32—LIGHT BEVERAGES

FOR BEER, MINERAL AND AERATED WATERS, FRUIT DRINKS AND FRUIT JUICES, SYRUPS AND OTHER PREPARATIONS FOR MAKING BEVERAGES (U.S. CLS. 45, 46 AND 48).

JULIE GUTTADAURO, EXAMINING ATTORNEY

SN 77-751,094. MIAMI UNIVERSITY, OXFORD, OH. FILED 6-3-2009.



OWNER OF U.S. REG. NO. 2,889,381.
THE MARK CONSISTS OF A HAWK'S HEAD AND NECK.

CLASS 9—ELECTRICAL AND SCIENTIFIC APPARATUS

FOR DECORATIVE MAGNETS (U.S. CLS. 21, 23, 26, 36 AND 38).

FIRST USE 4-18-1997; IN COMMERCE 4-18-1997.

CLASS 14—JEWELRY

FOR JEWELRY, NAMELY, CHARMS AND ORNAMENTAL PINS (U.S. CLS. 2, 27, 28 AND 50).

FIRST USE 4-18-1997; IN COMMERCE 4-18-1997.

CLASS 16—PAPER GOODS AND PRINTED MATTER

FOR DECALS, WIRE BOUND NOTEBOOKS, PENS; GOODS MADE OF PAPER, NAMELY, POSTERS, FOLDERS, NOTEBOOKS, SOUVENIR PROGRAMS CONCERNING SPORTING EVENTS, MAGAZINES ON THE SUBJECT OF SPORTING EVENTS, AND BOOKS ON THE SUBJECT OF SPORTING EVENTS; STATIONERY; MOUNTED AND UNMOUNTED PHOTOGRAPHS (U.S. CLS. 2, 5, 22, 23, 29, 37, 38 AND 50).

FIRST USE 4-18-1997; IN COMMERCE 4-18-1997.

CLASS 18—LEATHER GOODS

FOR UMBRELLAS; BAGS, NAMELY, SCHOOL, ATHLETIC, BOOK AND TOTE BAGS (U.S. CLS. 1, 2, 3, 22 AND 41).

FIRST USE 4-18-1997; IN COMMERCE 4-18-1997.

CLASS 20—FURNITURE AND ARTICLES NOT OTHERWISE CLASSIFIED

FOR WOOD BOXES, CHAIRS, NON-METAL PICTURE FRAMES AND PLASTIC KEY CHAIN TAGS (U.S. CLS. 2, 13, 22, 25, 32 AND 50).

FIRST USE 4-18-1997; IN COMMERCE 4-18-1997.

CLASS 21—HOUSEWARES AND GLASS

FOR MUGS AND BEVERAGE GLASSWARE (U.S. CLS. 2, 13, 23, 29, 30, 33, 40 AND 50).

FIRST USE 4-18-1997; IN COMMERCE 4-18-1997.

CLASS 24—FABRICS

FOR FABRIC FLAGS AND PENNANTS; BED BLANKETS (U.S. CLS. 42 AND 50).

FIRST USE 4-18-1997; IN COMMERCE 4-18-1997.

CLASS 25—CLOTHING

FOR CLOTHING, NAMELY, T-SHIRTS, SWEATSHIRTS, SWEAT PANTS, SPORT SHIRTS, GOLF SHIRTS, POLO SHIRTS, SWEATERS, BELTS, TIES, NIGHTSHIRTS, PARKAS, COATS, CAPS, HATS, HEADBANDS, WRIST BANDS, PANTS, SOCKS, JERSEYS, JACKETS, SHORTS, WARM-UP SUITS, SCARVES, APRONS, CHILDREN'S CLOTH EATING BIBS AND FOOT WEAR (U.S. CLS. 22 AND 39).

FIRST USE 4-18-1997; IN COMMERCE 4-18-1997.

CLASS 28—TOYS AND SPORTING GOODS

FOR GOLF BALLS, FOOTBALLS, BASEBALLS, BASEBALL BATS, GOLF CLUB COVERS, CARD GAMES, BOARD GAMES, AND CHRISTMAS TREE DECORATIONS (U.S. CLS. 22, 23, 38 AND 50).

FIRST USE 4-18-1997; IN COMMERCE 4-18-1997.

CLASS 41—EDUCATION AND ENTERTAINMENT

FOR EDUCATIONAL SERVICES, NAMELY PROVIDING COURSES OF INSTRUCTION AT THE COLLEGE LEVEL AND ORGANIZING EDUCATIONAL AND CULTURAL EXHIBITIONS; ORGANIZING AND CONDUCTING COLLEGIATE SPORTING EVENTS IN THE NATURE OF BASEBALL, BASKETBALL, CROSS COUNTRY, FOOTBALL, GOLF, ICE HOCKEY, SWIMMING, DIVING, TRACK AND FIELD, FIELD HOCKEY, SOCCER, SOFTBALL, SYNCHRONIZED SKATING, TENNIS AND VOLLEYBALL COMPETITIONS; DIRECTION AND PRESENTATION OF PLAYS; PRESENTATION OF MUSICAL PERFORMANCE; RECREATIONAL SERVICES IN THE NATURE OF INTRAMURAL SPORTS FACILITIES, CLUB SPORTS FACILITIES, POOLS AND FITNESS CENTER FACILITIES (U.S. CLS. 100, 101 AND 107).

FIRST USE 4-18-1997; IN COMMERCE 4-18-1997.
WENDY GOODMAN, EXAMINING ATTORNEY

SN 77-751,622. MANNKIND CORPORATION, VALENCIA, CA. FILED 6-3-2009.

SIMPLAIR

THE MARK CONSISTS OF STANDARD CHARACTERS WITHOUT CLAIM TO ANY PARTICULAR FONT, STYLE, SIZE, OR COLOR.

CLASS 10—MEDICAL APPARATUS

FOR MEDICAL DEVICES, NAMELY, INHALERS PROVIDED EMPTY; MEDICAL DEVICES, NAMELY, CARTRIDGES FOR USE WITH INHALERS, PROVIDED EMPTY; MEDICAL DEVICES, NAMELY, INHALER SYSTEMS COMPRISING INHALERS AND CARTRIDGES FOR ADMINISTRATION OF PHARMACEUTICALS, PROVIDED EMPTY; MEDICAL DEVICES, NAMELY, INSTRUMENTS AND APPARATUS PROVIDED EMPTY USED FOR THE INHALATION OF PHARMACEUTICALS (U.S. CLS. 26, 39 AND 44).

CLASS 45—PERSONAL AND LEGAL SERVICES

FOR LICENSING TO OTHERS OF TECHNOLOGY AND INTELLECTUAL PROPERTY IN CONNECTION WITH MEDICAL DEVICES (U.S. CLS. 100 AND 101).
BARNEY CHARLON, EXAMINING ATTORNEY

SN 77-752,119. CONCEDE, LLC, WATERFORD, WI. FILED 6-4-2009.

CONCEDE

THE MARK CONSISTS OF STANDARD CHARACTERS WITHOUT CLAIM TO ANY PARTICULAR FONT, STYLE, SIZE, OR COLOR.

CLASS 25—CLOTHING

FOR SHIRTS, T-SHIRTS, TANK TOPS, SWEATSHIRTS, JACKETS, SHORTS, PANTS AND HATS (U.S. CLS. 22 AND 39).

CLASS 41—EDUCATION AND ENTERTAINMENT

FOR PROVIDING A WEBSITE FEATURING SPORTS NEWS AND INFORMATION IN THE FIELD OF MIXED MARTIAL ARTS (U.S. CLS. 100, 101 AND 107).
STEVEN PEREZ, EXAMINING ATTORNEY

SN 77-752,285. SCHWARTZ, JENNIFER, 50127 FIRENZE, ITALY, FILED 6-4-2009.

pom613

THE MARK CONSISTS OF STANDARD CHARACTERS WITHOUT CLAIM TO ANY PARTICULAR FONT, STYLE, SIZE, OR COLOR.

CLASS 39—TRANSPORTATION AND STORAGE

FOR ARRANGING AND COORDINATING OF LUXURY AND EXCLUSIVE TRAVEL ARRANGEMENTS FOR OTHERS SPECIFICALLY GEARED TOWARD ENOGASTRONOMIC EXPERIENCES; ARRANGING OF GUIDED TOURS BY TRAIN, PLANE, CAR OR BOAT SPECIFICALLY GEARED TOWARD ENOGASTRONOMIC EXPERIENCES (U.S. CLS. 100 AND 105).
FIRST USE 12-0-2008; IN COMMERCE 12-0-2008.

CLASS 41—EDUCATION AND ENTERTAINMENT

FOR EDUCATIONAL SERVICES, NAMELY, PROVIDING INTERNSHIPS FOR CULINARY PROFESSIONALS IN THE FIELD OF CULINARY ARTS; CONDUCTING COOKING CLASSES; ENTERTAINMENT SERVICES, NAMELY, FOOD AND WINE TASTINGS (U.S. CLS. 100, 101 AND 107).
FIRST USE 12-0-2008; IN COMMERCE 12-0-2008.

CLASS 43—HOTEL AND RESTAURANT SERVICES

FOR ARRANGING LUXURY HOTEL AND RESTAURANT RESERVATIONS (U.S. CLS. 100 AND 101).
FIRST USE 12-0-2008; IN COMMERCE 12-0-2008.
JOHN WILKE, EXAMINING ATTORNEY

SN 77-752,315. ACALLMI, VINCENNES, FRANCE, FILED 6-4-2009.

LIPIDAMIX

THE MARK CONSISTS OF STANDARD CHARACTERS WITHOUT CLAIM TO ANY PARTICULAR FONT, STYLE, SIZE, OR COLOR.

PRIORITY CLAIMED UNDER SEC. 44(D) ON FRANCE APPLICATION NO. 093652755, FILED 5-26-2009, REG. NO. 093652755, DATED 5-26-2009, EXPIRES 5-26-2019.

SN 77-752,800. ENVIRONMENTAL DEFENSE FUND, INCORPORATED, NEW YORK, NY. FILED 6-5-2009.

CLASS 1—CHEMICALS

FOR MIXTURES OF LIPOSOLUBLE BOTANICAL EXTRACTS FOR USE IN MAKING COSMETICS AND DIETARY FOOD SUPPLEMENTS (U.S. CLS. 1, 5, 6, 10, 26 AND 46).

CLASS 3—COSMETICS AND CLEANING PREPARATIONS

FOR MIXTURES OF LIPOSOLUBLE BOTANICAL EXTRACTS SOLD AS AN INTEGRAL COMPONENT OF COSMETICS (U.S. CLS. 1, 4, 6, 50, 51 AND 52).

CLASS 5—PHARMACEUTICALS

FOR MIXTURES OF LIPOSOLUBLE BOTANICAL EXTRACTS SOLD AS AN INTEGRAL COMPONENT OF DIETARY FOOD SUPPLEMENTS; MIXTURES OF MEDICINAL LIPOSOLUBLE BOTANICAL EXTRACTS FOR USE IN FOOD SUPPLEMENTS FOR MEDICAL PURPOSES (U.S. CLS. 6, 18, 44, 46, 51 AND 52).
TRACY FLETCHER, EXAMINING ATTORNEY



OWNER OF U.S. REG. NOS. 1,744,459, 2,493,215 AND 2,532,606.

THE MARK CONSISTS OF THE WORDS "EDF ENVIRONMENTAL DEFENSE FUND FINDING THE WAYS THAT WORK" TO THE LEFT OF A DESIGN ELEMENT CONSISTING OF A SEMI-CIRCLE WHICH APPEARS AT A DIAGONAL ANGLE WITH FOUR WAVY BARS BELOW THE SEMI-CIRCLE.

SEC. 2(F) AS TO "ENVIRONMENTAL DEFENSE FUND".

CLASS 16—PAPER GOODS AND PRINTED MATTER

FOR PUBLICATIONS, NAMELY, REPORTS, BROCHURES AND NEWSLETTERS CONTAINING INFORMATION RELATING TO THE PRESERVATION AND CONSERVATION OF NATURAL RESOURCES AND THE ENHANCEMENT OF ENVIRONMENTAL QUALITY (U.S. CLS. 2, 5, 22, 23, 29, 37, 38 AND 50).

CLASS 35—ADVERTISING AND BUSINESS

FOR PROMOTING THE PUBLIC AWARENESS OF THE NEED FOR THE PRESERVATION AND CONSERVATION OF NATURAL RESOURCES AND THE ENHANCEMENT OF ENVIRONMENTAL QUALITY (U.S. CLS. 100, 101 AND 102).

MICHAEL LITZAU, EXAMINING ATTORNEY

SN 77-752,796. ENVIRONMENTAL DEFENSE FUND, INCORPORATED, NEW YORK, NY. FILED 6-5-2009.

EDF ENVIRONMENTAL DEFENSE
FUND

THE MARK CONSISTS OF STANDARD CHARACTERS WITHOUT CLAIM TO ANY PARTICULAR FONT, STYLE, SIZE, OR COLOR.

OWNER OF U.S. REG. NOS. 1,744,459 AND 2,493,215.
SEC. 2(F) AS TO "ENVIRONMENTAL DEFENSE FUND".

CLASS 16—PAPER GOODS AND PRINTED MATTER

FOR PUBLICATIONS, NAMELY, REPORTS, BROCHURES AND NEWSLETTERS CONTAINING INFORMATION RELATING TO THE PRESERVATION AND CONSERVATION OF NATURAL RESOURCES AND THE ENHANCEMENT OF ENVIRONMENTAL QUALITY (U.S. CLS. 2, 5, 22, 23, 29, 37, 38 AND 50).

CLASS 35—ADVERTISING AND BUSINESS

FOR PROMOTING THE PUBLIC AWARENESS OF THE NEED FOR THE PRESERVATION AND CONSERVATION OF NATURAL RESOURCES AND THE ENHANCEMENT OF ENVIRONMENTAL QUALITY (U.S. CLS. 100, 101 AND 102).

MICHAEL LITZAU, EXAMINING ATTORNEY

SN 77-752,806. WORLD OMNI FINANCIAL CORP., DEERFIELD BEACH, FL. FILED 6-5-2009.



OWNER OF U.S. REG. NO. 2,713,944.

NO CLAIM IS MADE TO THE EXCLUSIVE RIGHT TO USE "FINANCIAL SERVICES", APART FROM THE MARK AS SHOWN.

THE MARK CONSISTS OF A HIGHLY STYLIZED LETTER "C" AND THE WORDS "CENTERONE FINANCIAL SERVICES"

CLASS 35—ADVERTISING AND BUSINESS

FOR VEHICLE REMARKETING SERVICES FOR OTHERS, NAMELY, MARKETING VEHICLES OWNED BY OTHERS (U.S. CLS. 100, 101 AND 102).

FIRST USE 3-11-2002; IN COMMERCE 3-11-2002.

CLASS 36—INSURANCE AND FINANCIAL

FOR ORIGINATION, PROCESSING, SERVICING, AND COLLECTIONS OF VEHICLE LOANS FOR THIRD PARTY LENDERS; ORIGINATION, PROCESSING, SERVICING, AND COLLECTIONS OF COMMERCIAL LOANS TO VEHICLE DEALERS FOR THIRD PARTY LENDERS; DEBT COLLECTION SERVICES FOR VEHICLE LEASES FOR THIRD PARTY LENDERS; DEBT RECOVERY, NAMELY, VEHICLE REPOSSESSION SERVICES FOR OTHERS (U.S. CLS. 100, 101 AND 102).
FIRST USE 3-11-2002; IN COMMERCE 3-11-2002.
DOUGLAS LEE, EXAMINING ATTORNEY

SN 77-752,836. WATERS MEDICAL SYSTEMS, INC., ROCHESTER, MN. FILED 6-5-2009.

WATERS IGL

THE MARK CONSISTS OF STANDARD CHARACTERS WITHOUT CLAIM TO ANY PARTICULAR FONT, STYLE, SIZE, OR COLOR.
OWNER OF U.S. REG. NO. 1,777,762.

CLASS 5—PHARMACEUTICALS

FOR PHARMACEUTICAL AND VETERINARY PREPARATIONS FOR USE AS AN EXTRACELLULAR STATIC HYPOTHERMIC PRESERVING SOLUTION FOR ORGAN PRESERVATION AND FOR ORGAN TRANSPLANTS; HYGIENIC PREPARATIONS AND DISINFECTANTS, NAMELY, DISINFECTANTS FOR MEDICAL INSTRUMENTS; TRANSPLANT THERAPY PREPARATIONS TO PROLONG THE LIFE OF A SKIN GRAFT, NAMELY, AN EXTRACELLULAR STATIC HYPOTHERMIC PRESERVING SOLUTION; SOLUTIONS FOR CONSERVING, RINSING AND TRANSPORTING TISSUE AND OR ORGANS IN ORDER TO TRANSPLANT THEM; SURGICAL IMPLANTS COMPRISING LIVING TISSUE (U.S. CLS. 6, 18, 44, 46, 51 AND 52).

CLASS 10—MEDICAL APPARATUS

FOR SURGICAL AND MEDICAL APPARATUS AND INSTRUMENTS FOR SAMPLING AND CONSERVING ORGANS PRIOR TO TRANSPLANT, NAMELY, CONTAINERS SURROUNDED WITH ICE FOR TRANSPORTING MEDICAL SPECIMENS; ICE-BOX FOR TRANSPORTING MEDICAL SPECIMENS (U.S. CLS. 26, 39 AND 44).
TINA BROWN, EXAMINING ATTORNEY

SN 77-752,973. CURRAN, TIMOTHY, BROOKLYN, NY. FILED 6-5-2009.



THE MARK CONSISTS OF THE STYLIZED WORDS "FORTUNE KEEPER" INSIDE A RECTANGULAR SHAPED BOX. TO THE LEFT OF THE STYLIZED WORDS IS AN IMAGE OF A CHINESE CHARACTER.

THE NON-LATIN CHARACTERS IN THE MARK TRANSLITERATE TO FAT CHOY AND THIS MEANS FORTUNE IN ENGLISH.

CLASS 9—ELECTRICAL AND SCIENTIFIC APPARATUS

FOR DECORATIVE MAGNETS (U.S. CLS. 21, 23, 26, 36 AND 38).

CLASS 14—JEWELRY

FOR JEWELRY (U.S. CLS. 2, 27, 28 AND 50).

CLASS 20—FURNITURE AND ARTICLES NOT OTHERWISE CLASSIFIED

FOR NON-METAL AND NON-LEATHER KEY CHAINS (U.S. CLS. 2, 13, 22, 25, 32 AND 50).
CAROLYN CATALDO, EXAMINING ATTORNEY

SN 77-753,023. KEVIN KENNEDY & ASSOCIATES, INC., INDIANAPOLIS, IN. FILED 6-5-2009.

EXPERTLY ORCHESTRATED GENIUS

THE MARK CONSISTS OF STANDARD CHARACTERS WITHOUT CLAIM TO ANY PARTICULAR FONT, STYLE, SIZE, OR COLOR.

CLASS 35—ADVERTISING AND BUSINESS

FOR CONSULTING SERVICES, NAMELY, BUSINESS CONSULTING SERVICES WITH RELATION TO PROJECT MANAGEMENT (U.S. CLS. 100, 101 AND 102).

CLASS 42—SCIENTIFIC AND COMPUTER SERVICES

FOR TECHNOLOGY CONSULTING SERVICES IN THE FIELD OF ENGINEERING (U.S. CLS. 100 AND 101).
ANDREW LEASER, EXAMINING ATTORNEY

SN 77-753,565. KAY GROUP NO. 6 PTY LTD, PORT MELBOURNE, VIC, AUSTRALIA, FILED 6-5-2009.

LEARN AND WIN

THE MARK CONSISTS OF STANDARD CHARACTERS WITHOUT CLAIM TO ANY PARTICULAR FONT, STYLE, SIZE, OR COLOR.

CLASS 16—PAPER GOODS AND PRINTED MATTER

FOR BROCHURES, PAMPHLETS, INFORMATION FLYERS, CATALOGUES AND MAGAZINES CONCERNING OTHERS' PRODUCTS IN THE FIELDS OF FOOD, BEVERAGES, KITCHEN AND HOUSEHOLD PRODUCTS AND PHARMACEUTICAL PRODUCTS (U.S. CLS. 2, 5, 22, 23, 29, 37, 38 AND 50).

CLASS 35—ADVERTISING AND BUSINESS

FOR ADVERTISING SERVICES; ADVERTISING SERVICES VIA DIGITAL AND ON-LINE MEDIA; ON-LINE ADVERTISING ON DATA COMMUNICATIONS NETWORKS; PUBLICITY OF ADVERTISING MATERIAL ON-LINE, NAMELY, ADVERTISING BY TRANSMISSION OF ON-LINE PUBLICITY FOR THIRD PARTIES THROUGH ELECTRONIC COMMUNICATIONS NETWORKS; ADVERTISING SERVICES, NAMELY, PROMOTION OF ON-LINE WEBSITES OF OTHERS; ADVERTISING SERVICES, NAMELY, PROVIDING CONSUMER PRODUCT NEWS AND INFORMATION IN THE FIELDS OF PACKAGED GOODS AND PHARMACEUTICAL PRODUCTS VIA A GLOBAL COMPUTER NETWORK; PROVIDING RADIO AND TELEVISION ADVERTISING FOR OTHERS; ADVERTISING SERVICES, NAMELY, ONLINE INFORMATION SERVICES CONCERNING THE PRODUCTS OF THIRD PARTIES (U.S. CLS. 100, 101 AND 102).

CLASS 41—EDUCATION AND ENTERTAINMENT

FOR SWEEPSTAKE SERVICES PROVIDED OVER A GLOBAL COMPUTER NETWORK (U.S. CLS. 100, 101 AND 107).

FLORENTINA BLANDU, EXAMINING ATTORNEY

SN 77-754,094. YORK COUNTY SOCIETY FOR THE PREVENTION OF CRUELTY TO ANIMALS, DBA YORK COUNTY SPCA DBA SPCA OF YORK COUNTY, YORK, PA. FILED 6-8-2009.



of York County
A New Leash on Life

OWNER OF U.S. REG. NO. 3,497,079.

THE MARK CONSISTS OF A STYLIZED PAW PRINT WITH A LINE UNDERNEATH AND THE WORD "SPCA" BENEATH THE PAW; A LINE BENEATH "SPCA" AND THE WORDS "OF YORK COUNTY A NEW LEASH ON LIFE" BELOW THE LINE.

SEC. 2(F) AS TO "SPCA OF YORK COUNTY".

CLASS 25—CLOTHING

FOR T-SHIRTS, TANK TOPS, SHORTS, SWEAT PANTS, SWEAT SUITS AND BANDANNAS (U.S. CLS. 22 AND 39).

FIRST USE 6-0-2006; IN COMMERCE 6-0-2006.

CLASS 45—PERSONAL AND LEGAL SERVICES

FOR ADOPTION SERVICES FOR DOMESTIC ANIMALS; ANIMAL CRUELTY INVESTIGATION; TRACKING, LOCATING AND MONITORING SERVICES FOR RECOVERING LOST ANIMALS; AND ARRANGING FOSTER CARE FOR ANIMALS (U.S. CLS. 100 AND 101).

FIRST USE 3-0-2003; IN COMMERCE 3-0-2003.
SANJEEV VOHRA, EXAMINING ATTORNEY

SN 77-754,141. AUGELLO-COOK, ALICIA, LOS ANGELES, CA. FILED 6-8-2009.

BARBER'S DAUGHTER

THE MARK CONSISTS OF STANDARD CHARACTERS WITHOUT CLAIM TO ANY PARTICULAR FONT, STYLE, SIZE, OR COLOR.

CLASS 14—JEWELRY

FOR JEWELRY (U.S. CLS. 2, 27, 28 AND 50).

CLASS 25—CLOTHING

FOR CLOTHING, NAMELY, BATHING SUITS, BATHROBES, BELTS, BLOUSES, BRAS, COATS, DRESSES, FOOTWEAR, GLOVES, HOSIERY, INFANT WEAR, JACKETS, JEANS, JERSEYS, JUMPSUITS, LEGGINGS, LEOTARDS, LINGERIE, MITTENS, NECKTIES, PAJAMAS, PULLOVERS, RAINWEAR, SCARVES, SHIRTS, SHORTS, SKIRTS, SLACKS, SOCKS, SUITS, T-SHIRTS, SUSPENDERS, SWEAT PANTS, SWEAT SHIRTS, SWEAT SUITS, SWEATERS, TANK TOPS, TOPS, TURTLE-NECKS, BANDANNAS, UNDERGARMENTS, VESTS, WARM-UP SUITS, HEADWEAR (U.S. CLS. 22 AND 39).

ROBERT C. CLARK JR., EXAMINING ATTORNEY

SN 77-754,165. AUGELLO-COOK, ALICIA, LOS ANGELES, CA. FILED 6-8-2009.

FIND YOUR INSPIRATION

THE MARK CONSISTS OF STANDARD CHARACTERS WITHOUT CLAIM TO ANY PARTICULAR FONT, STYLE, SIZE, OR COLOR.

CLASS 14—JEWELRY

FOR JEWELRY (U.S. CLS. 2, 27, 28 AND 50).

CLASS 25—CLOTHING

FOR CLOTHING, NAMELY, BATHING SUITS, BATH-ROBES, BELTS, BLOUSES, BRAS, COATS, DRESSES, FOOTWEAR, GLOVES, HOSIERY, INFANT WEAR, JACKETS, JEANS, JERSEYS, JUMPSUITS, LEGGINGS, LEOTARDS, LINGERIE, MITTENS, NECKTIES, PAJAMAS, PULLOVERS, RAINWEAR, SCARVES, SHIRTS, SHORTS, SKIRTS, SLACKS, SOCKS, SUITS, T-SHIRTS, SUSPENDERS, SWEAT PANTS, SWEAT SHIRTS, SWEAT SUITS, SWEATERS, TANK TOPS, TOPS, TURTLE-NECKS, BANDANAS, UNDERGARMENTS, VESTS, WARM-UP SUITS, HEADWEAR (U.S. CLS. 22 AND 39).
ROBERT C. CLARK JR., EXAMINING ATTORNEY

SN 77-754,539. WATERS INDUSTRIES, INC., WEST DUNDEE, IL. FILED 6-8-2009.

LIGHTS WHERE YOU LOOK

THE MARK CONSISTS OF STANDARD CHARACTERS WITHOUT CLAIM TO ANY PARTICULAR FONT, STYLE, SIZE, OR COLOR.

CLASS 9—ELECTRICAL AND SCIENTIFIC APPARATUS

FOR EYEWEAR (U.S. CLS. 21, 23, 26, 36 AND 38).

CLASS 25—CLOTHING

FOR HEADWEAR WITH INTEGRATED LIGHTS (U.S. CLS. 22 AND 39).
MARK SHINER, EXAMINING ATTORNEY

SN 77-754,384. NATIONAL ASSOCIATION OF BLACK ACCOUNTANTS, INC., GREENBELT, MD. FILED 6-8-2009.



“Lifting As We Climb”

OWNER OF U.S. REG. NOS. 3,519,892, 3,614,792 AND OTHERS.

NO CLAIM IS MADE TO THE EXCLUSIVE RIGHT TO USE "NATIONAL ASSOCIATION" OR "INC.", APART FROM THE MARK AS SHOWN.

THE MARK CONSISTS OF TWO HANDS CLASPED THAT ARE ENCIRCLED WITH THE WORDS "NATIONAL ASSOCIATION OF BLACK ACCOUNTANTS, INC." AROUND THE OUTSIDE PERIMETER OF THE CIRCLE THEN THE WORDS "LIFTING AS WE CLIMB" IN ITALICS UNDERNEATH THE CIRCLE.

CLASS 21—HOUSEWARES AND GLASS

FOR COASTERS, NON-PAPER, NON-FABRIC; DRINKING GLASSES (U.S. CLS. 2, 13, 23, 29, 30, 33, 40 AND 50).

FIRST USE 5-31-2001; IN COMMERCE 5-31-2001.

CLASS 25—CLOTHING

FOR CLOTHING, NAMELY, T-SHIRTS, POLO SHIRTS, AND CAPS (U.S. CLS. 22 AND 39).

FIRST USE 5-21-2001; IN COMMERCE 5-21-2001.
SEAN CROWLEY, EXAMINING ATTORNEY

SN 77-754,574. WATERS INDUSTRIES, INC., WEST DUNDEE, IL. FILED 6-8-2009.

THE BEST WAY TO READ IN THE DARK!

THE MARK CONSISTS OF STANDARD CHARACTERS WITHOUT CLAIM TO ANY PARTICULAR FONT, STYLE, SIZE, OR COLOR.

CLASS 9—ELECTRICAL AND SCIENTIFIC APPARATUS

FOR EYEWEAR (U.S. CLS. 21, 23, 26, 36 AND 38).

CLASS 25—CLOTHING

FOR HEADWEAR WITH INTEGRATED LIGHTS (U.S. CLS. 22 AND 39).
MARK SHINER, EXAMINING ATTORNEY

SN 77-754,673. HAIER AMERICA TRADING, LLC, NEW YORK, NY. FILED 6-8-2009.

HEC

THE MARK CONSISTS OF THE LETTERS "HEC" IN A STYLIZED FONT WITH THE CROSS PART OF THE "H" AND THE MIDDLE LINE OF THE "E" SHARING THE SAME LINE.

CLASS 9—ELECTRICAL AND SCIENTIFIC APPARATUS

FOR DVD PLAYERS; PORTABLE DVD PLAYERS; TVS, NAMELY, TELEVISION RECEIVERS; HEADPHONES; HD RADIOS; DIGITAL PHOTO FRAMES FOR DISPLAYING DIGITAL PICTURES, VIDEO CLIPS AND MUSIC; REMOTE CONTROLS, NAMELY, UNIVERSAL REMOTE CONTROLS FOR USE ON DVD PLAYERS, VCRS, TVS, CD PLAYERS, MP3 PLAYERS AND RADIOS; ELECTRONIC BOOK READERS; DIGITAL CAMERAS; DIGITAL VIDEO RECORDERS; AUDIO AND VIDEO ACCESSORIES, NAMELY, AUDIO AND VIDEO CABLES AND AUDIO SPEAKERS; CELL PHONES; COMPUTER HARDWARE; COMPUTER SERVERS; HEADSET OR EARPHONES FOR WIRELESS CONTROL OF AND COMMUNICATION BETWEEN A MOBILE PHONE OR PERSONAL COMPUTERS, NAMELY, HEADSETS FOR CELLULAR OR MOBILE PHONES AND HEADSETS FOR USE WITH COMPUTERS; PORTABLE MEDIA PLAYERS; CAR KITS FOR USE IN VEHICLE HANDS FREE COMMUNICATION, NAMELY, CAR MOUNTED UNITS INCORPORATING LOUDSPEAKER TO ALLOW A TELEPHONE HANDSET TO BE USED HANDS-FREE; ELECTRONIC DOCKING STATIONS (U.S. CLS. 21, 23, 26, 36 AND 38).

CLASS 14—JEWELRY

FOR CLOCKS INCORPORATING RADIOS (U.S. CLS. 2, 27, 28 AND 50).
DAVID I, EXAMINING ATTORNEY

CLASS 16—PAPER GOODS AND PRINTED MATTER

FOR CHILDREN'S ACTIVITY BOOKS; ADDRESS BOOKS; NOVELS FOR ADULTS; ART BOOKS; ARTIST'S MATERIALS, NAMELY, PENS AND PENCILS; BANK CHECKS; BOOK COVERS; BOOK MARKS; BOOK PLATES; BOOKS CONTAINING PUZZLES AND GAMES; BOOKS CONTAINING SCREENPLAYS; BOOKS FEATURING PHOTOGRAPHS; BOOKS FOR ROLE-PLAYING, NAMELY ROLE GAME EQUIPMENT IN THE NATURE OF GUIDE BOOKS, CARDS AND INSTRUCTION SHEETS; BOOKS ON MOVIE-MAKING; CALENDARS; CARDBOARD FIGURES; CHECKBOOK HOLDERS AND COVERS; CHILDREN'S BOOKS; CHILDREN'S BOOKS COMBINED WITH TOYS AND SOLD AS A UNIT; CHILDREN'S READ-ALONG BOOKS AND PRE-RECORDED TAPES SOLD AS A UNIT; CHILDREN'S STORY BOOKS; COFFEE TABLE BOOKS FEATURING MOVIE CHARACTERS; COLORING BOOKS; COMIC BOOKS; COMIC MAGAZINES; COOKBOOKS; DIARIES; ERASERS; PAPER GIFT BAGS; GIFT BOOKS FEATURING SCIENCE FICTION; PAPER GIFT TAGS; PAPER GIFT WRAP; GRAPHIC NOVELS; GREETING CARDS; PRINTED INSTRUCTIONAL MANUALS AND STRATEGY GUIDES IN THE FIELD OF COMPUTER GAMES AND SCIENCE FICTION; PRINTED INVITATIONS; IRON-ON TRANSFERS; JUVENILE BOOKS FEATURING SCIENCE FICTION; MAGAZINES IN THE FIELD OF SCIENCE FICTION ENTERTAINMENT; MARKERS; NON-ELECTRONIC PERSONAL PLANNERS AND ORGANIZERS; NOTEBOOKS; NOVELS FOR JUVENILES; PAPER CAKE DECORATIONS; PAPER DECORATIONS IN THE NATURE OF DOORKNOB HANGERS; PAPER NAPKINS; PAPER PARTY BAGS; PAPER PARTY DECORATIONS; PAPER TABLE CLOTHS; PENCIL CASES; PENCIL SHARPENERS; PERSONAL ORGANIZERS; POSTCARDS; POSTERS; PUZZLE BOOKS; READ-ALONG CHILDREN'S BOOKS; REFERENCE BOOKS IN THE FIELD OF ENTERTAINMENT; REFERENCE BOOKS IN THE FIELD OF SCIENCE FICTION; SCHOOL AND OFFICE SUPPLIES, NAMELY, PENS AND PENCILS; SCRAPBOOK ALBUMS; SCRAPBOOKS; SCRIPT BOOKS; SERIES OF FICTION BOOKS; SHEET MUSIC; STATIONERY TYPE PORTFOLIOS; STICKER ALBUMS; STICKER BOOKS; STICKERS; STORY BOOKS; TEMPORARY TATTOOS; TRADING CARDS; BUSINESS CARDS; ART PRINTS; ANIMATION CELLS; COLLECTIBLE CARDS; LITHOGRAPHIC PRINTS; ORIGINAL WORKS OF ART CREATED FROM PAPER, PHOTOGRAPHIC PRINTS; PRINTED ART REPRODUCTIONS; REPLICAS OF FILM PROPS IN THE NATURE OF PAPER CUT OUTS, AND POSTERS FEATURING PRINTED REPLICAS OF CHARACTERS FROM MOVIES (U.S. CLS. 2, 5, 22, 23, 29, 37, 38 AND 50).

SN 77-754,740. LUCASFILM LTD., SAN FRANCISCO, CA.
FILED 6-8-2009.

SITH

CLASS 25—CLOTHING

FOR CLOTHING, NAMELY, ANORAKS; ATHLETIC SHOES; BATHROBES; BELTS; BOXER SHORTS; CAPS; CHILDREN'S FOOTWEAR; COATS; COSTUME ACCESSORIES, NAMELY, HEADWEAR AND BELTS; CROP TOPS; DRESSES; FITNESS TOPS; FOOTWEAR; GLOVES; HATS; HEAD WEAR; HEADBANDS; HOSIERY; JACKETS; JOGGING SUITS; JUMPSUITS; KNIT CAPS; LEATHER JACKETS; LEOTARDS; LONG UNDERWEAR; MASQUERADE COSTUMES AND MASKS SOLD IN CONNECTION THEREWITH; MITTENS; OVERALLS; PAJAMAS; PANTS; PARKAS; RAINWEAR; SCARVES; SHIRTS; SHORTS; SINGLETS; SLEEPWEAR; SLIPPERS; SOCKS; SUSPENDERS; SWEATSHIRTS; SWEATPANTS; TENNIS WEAR; TIES; TIGHTS; T-SHIRTS; UNDERWEAR; UNITARDS; VISORS; WARM-UP SUITS; WIND-RESISTANT JACKETS; WRISTBANDS (U.S. CLS. 22 AND 39).

THE MARK CONSISTS OF STANDARD CHARACTERS WITHOUT CLAIM TO ANY PARTICULAR FONT, STYLE, SIZE, OR COLOR.

OWNER OF U.S. REG. NO. 2,625,341.

CLASS 41—EDUCATION AND ENTERTAINMENT

FOR CARTOONS IN THE NATURE OF AN ONGOING TELEVISION SERIES; ENTERTAINMENT SERVICES IN THE NATURE OF AN ON-GOING SERIES OF ANIMATED TELEVISION AUDIOVISUAL PROGRAMS; ENTERTAINMENT SERVICES, NAMELY, PROVIDING NEWS AND INFORMATION ABOUT INTERACTIVE COMPUTER GAMES, INTERACTIVE VIDEO GAME SOFTWARE AND INTERACTIVE COMPUTER GAMES AND INTERACTIVE VIDEO GAMES OVER TELEVISION, SATELLITE, AUDIO VIDEO, AND GLOBAL COMPUTER NETWORKS FOR OTHERS IN THE VIDEO GAME INDUSTRY; FAN CLUB SERVICES; ENTERTAINMENT SERVICES, NAMELY, PROVIDING ONLINE INTERACTIVE COMPUTER GAMES AND INTERACTIVE VIDEO GAMES OVER TELEVISION, SATELLITE, OR GLOBAL COMPUTER NETWORKS; AND PROVIDING ONGOING SERIES OF NEWS SHOWS DISTRIBUTED OVER TELEVISION, SATELLITES, AUDIO, VIDEO, AND GLOBAL COMPUTER NETWORKS; PROVIDING AN ONGOING SERIES OF ENTERTAINMENT PROGRAMS FEATURING PEOPLE PORTRAYING OR DISCUSSING FICTIONAL CHARACTERS AND ENTERTAINMENT TOPICS DISTRIBUTED OVER TELEVISION, SATELLITES, AUDIO, VIDEO, AND GLOBAL COMPUTER NETWORKS; PROVIDING AN ONGOING SERIES OF ENTERTAINMENT PROGRAMS FEATURING PERFORMANCES BY ENTERTAINMENT PERSONALITIES DISTRIBUTED OVER TELEVISION, SATELLITES, AUDIO, VIDEO, AND GLOBAL COMPUTER NETWORKS; PROVIDING AN ONGOING SERIES OF SCIENCE FICTION SHOWS DISTRIBUTED OVER TELEVISION, SATELLITES, AUDIO, VIDEO, GLOBAL COMPUTER NETWORKS; PROVIDING AN ONGOING SERIES OF VARIETY SHOWS DISTRIBUTED OVER TELEVISION, SATELLITES, AUDIO, VIDEO, GLOBAL COMPUTER NETWORKS (U.S. CLS. 100, 101 AND 107).
KEVIN DINALLO, EXAMINING ATTORNEY

SN 77-754,881. BPS MANAGEMENT COMPANY LLC, CHAPEL HILL, NC. FILED 6-8-2009.

BILLY'S PIT STOP

THE MARK CONSISTS OF STANDARD CHARACTERS WITHOUT CLAIM TO ANY PARTICULAR FONT, STYLE, SIZE, OR COLOR.

NO CLAIM IS MADE TO THE EXCLUSIVE RIGHT TO USE "PIT STOP", APART FROM THE MARK AS SHOWN.

THE NAME SHOWN IN THE MARK IDENTIFIES "WILLIAM T. MARSHALL, JR.", WHOSE CONSENT TO REGISTER IS MADE OF RECORD.

CLASS 29—MEATS AND PROCESSED FOODS

FOR SEASONED SMOKED MEAT WITH VEGETABLE SIDE DISHES (U.S. CL. 46).

CLASS 35—ADVERTISING AND BUSINESS

FOR RETAIL STORE SERVICES FEATURING CONVENIENCE STORE ITEMS AND GASOLINE (U.S. CLS. 100, 101 AND 102).
TINA BROWN, EXAMINING ATTORNEY

SN 77-755,043. AUGELLO-COOK, ALICIA, LOS ANGELES, CA. FILED 6-9-2009.

LIVE YOUR INSPIRATION

THE MARK CONSISTS OF STANDARD CHARACTERS WITHOUT CLAIM TO ANY PARTICULAR FONT, STYLE, SIZE, OR COLOR.

CLASS 14—JEWELRY

FOR JEWELRY (U.S. CLS. 2, 27, 28 AND 50).

CLASS 25—CLOTHING

FOR CLOTHING, NAMELY, BATHING SUITS, BATHROBES, BELTS, BLOUSES, BRAS, COATS, DRESSES, FOOTWEAR, GLOVES, HOSIERY, INFANT WEAR, JACKETS, JEANS, JERSEYS, JUMPSUITS, LEGGINGS, LEOTARDS, LINGERIE, MITTENS, NECKTIES, PAJAMAS, PULLOVERS, RAINWEAR, SCARVES, SHIRTS, SHORTS, SKIRTS, SLACKS, SOCKS, SUITS, T-SHIRTS, SUSPENDERS, SWEAT PANTS, SWEAT SHIRTS, SWEAT SUITS, SWEATERS, TANK TOPS, TOPS, TURTLENECKS, BANDANAS, UNDERGARMENTS, VESTS, WARM-UP SUITS, HEADWEAR (U.S. CLS. 22 AND 39).
ROBERT C. CLARK JR., EXAMINING ATTORNEY

SN 77-755,365. WIEBECKE, ADOLF, OBERALM, AUSTRIA, FILED 6-9-2009.

GEONADO

THE MARK CONSISTS OF STANDARD CHARACTERS WITHOUT CLAIM TO ANY PARTICULAR FONT, STYLE, SIZE, OR COLOR.

OWNER OF AUSTRIA REG. NO. 236260, DATED 1-25-2007, EXPIRES 1-25-2017.

CLASS 9—ELECTRICAL AND SCIENTIFIC APPARATUS

FOR MEASURING INSTRUMENTS FOR BIOLOGICAL AND PHYSICAL ANALYSIS, NAMELY, FOR MEASURING THE HOMEOSTATIC STATE; MEASURING INSTRUMENTS FOR DETECTING INTERFERING FIELDS (U.S. CLS. 21, 23, 26, 36 AND 38).

CLASS 10—MEDICAL APPARATUS

FOR MEDICAL INSTRUMENTS AND APPARATUS USED FOR SHIELDING INTERFERING FIELDS AND ELECTROMAGNETIC RADIATION (U.S. CLS. 26, 39 AND 44).

CLASS 25—CLOTHING

FOR CLOTHING, NAMELY, SHIRTS, JEANS, PANTS, JACKETS, DRESSES, SOCKS; FOOTWEAR USED FOR INFLUENCING THE HUMAN BODY ENERGETICALLY (U.S. CLS. 22 AND 39).

CLASS 42—SCIENTIFIC AND COMPUTER SERVICES

FOR BIOLOGICAL AND SCIENTIFIC RESEARCH AND ANALYSIS, NAMELY, CONDUCTING RESEARCH AND PHYSICAL ANALYSIS FOR DETECTING ELECTROMAGNETIC OR GEOPHYSICAL INTERFERING FIELDS; MEDICAL RESEARCH, NAMELY, CONDUCTING MEDICAL SURVEYS IN THE COURSE OF SCIENTIFIC INVESTIGATIONS (U.S. CLS. 100 AND 101).
JOHN WILKE, EXAMINING ATTORNEY

SN 77-755,440. PPL GENERATION, LLC, ALLENTOWN, PA. FILED 6-9-2009.

ROYAL MANCHESTER GOLF LINKS

THE MARK CONSISTS OF STANDARD CHARACTERS WITHOUT CLAIM TO ANY PARTICULAR FONT, STYLE, SIZE, OR COLOR.

NO CLAIM IS MADE TO THE EXCLUSIVE RIGHT TO USE "GOLF LINKS", APART FROM THE MARK AS SHOWN.

CLASS 35—ADVERTISING AND BUSINESS

FOR RETAIL STORE SERVICES FEATURING APPAREL, SPORTING GOODS, TRAINING MATERIALS, BOOKS, PRERECORDED MUSIC, MAGAZINES, NEWSPAPERS, AND SOUVENIRS; PROVIDING FACILITIES FOR BUSINESS MEETINGS (U.S. CLS. 100, 101 AND 102).

CLASS 41—EDUCATION AND ENTERTAINMENT

FOR GOLF CLUB SERVICES; GOLF COURSES; PROVIDING GOLF INSTRUCTION; TRAINING SERVICES IN THE FIELD OF GOLF; EDUCATION SERVICES, NAMELY, PROVIDING CLASSES, SEMINARS, AND WORKSHOPS IN THE FIELD OF GOLF AND PERSONAL FITNESS; MEETING ARRANGING; WEDDING ARRANGING, NAMELY, WEDDING PLANNING AND COORDINATION SERVICES (U.S. CLS. 100, 101 AND 107).

CLASS 43—HOTEL AND RESTAURANT SERVICES

FOR PROVIDING BANQUET FACILITIES FOR WEDDINGS; PROVIDING SOCIAL MEETING, BANQUET, AND SOCIAL FUNCTION FACILITIES; PROVIDING RESTAURANT FACILITIES (U.S. CLS. 100 AND 101).
DAVID I, EXAMINING ATTORNEY

SN 77-755,749. ECOTELLIGENT, LLC, SONOMA, CA. FILED 6-9-2009.



THE MARK CONSISTS OF THE WORD "ECOTELLIGENT" CONTAINING THE LETTER "O" WITH THREE LEAVES INSIDE OF IT.

CLASS 35—ADVERTISING AND BUSINESS

FOR PROVIDING CONSUMER INFORMATION, ADVICE, AND CONSULTATION CONCERNING CONSUMER PRODUCTS AND SERVICES IN THE FIELD OF CLEAN AND RENEWABLE ENERGY; PROMOTING PUBLIC AWARENESS OF THE NEED FOR THE IMPLEMENTATION AND USE OF CLEAN AND RENEWABLE ENERGY PRODUCTS, SYSTEMS, AND SERVICES (U.S. CLS. 100, 101 AND 102).

CLASS 37—CONSTRUCTION AND REPAIR

FOR LANDSCAPE CONSTRUCTION SERVICES; INSTALLATION, MAINTENANCE, AND REPAIR OF CLEAN AND RENEWABLE ENERGY SYSTEMS, NAMELY, SOLAR WIND, AND GEOTHERMAL ENERGY GENERATING SYSTEMS; PROVIDING INFORMATION, ADVICE, AND CONSULTATION CONCERNING THE INSTALLATION, MAINTENANCE, AND REPAIR OF CLEAN AND RENEWABLE ENERGY SYSTEMS (U.S. CLS. 100, 103 AND 106).

CLASS 44—MEDICAL, BEAUTY AND AGRICULTURAL SERVICES

FOR PROFESSIONAL LANDSCAPE DESIGN AND MAINTENANCE SERVICES; LANDSCAPE DESIGN CONSULTATION (U.S. CLS. 100 AND 101).

DANNEAN HETZEL, EXAMINING ATTORNEY

SN 77-755,891. JOHNSON & JOHNSON, NEW BRUNSWICK, NJ. FILED 6-10-2009.

KNOWLEDGE IS POWER

THE MARK CONSISTS OF STANDARD CHARACTERS WITHOUT CLAIM TO ANY PARTICULAR FONT, STYLE, SIZE, OR COLOR.

CLASS 16—PAPER GOODS AND PRINTED MATTER

FOR PUBLICATIONS, NAMELY, BROCHURES, BOOKLETS AND TEACHING MATERIALS PROVIDING INFORMATION TO HEALTH CARE PROVIDERS AND PATIENTS ABOUT ANEMIA MANAGEMENT (U.S. CLS. 2, 5, 22, 23, 29, 37, 38 AND 50).

CLASS 41—EDUCATION AND ENTERTAINMENT

FOR EDUCATIONAL SERVICES, NAMELY, CONDUCTING PROGRAMS FOR HEALTH CARE PROVIDERS AND PATIENTS IN THE FIELD OF ANEMIA MANAGEMENT (U.S. CLS. 100, 101 AND 107).

CLASS 44—MEDICAL, BEAUTY AND AGRICULTURAL SERVICES

FOR PROVIDING MEDICAL INFORMATION FOR HEALTH CARE PROVIDERS AND PATIENTS ABOUT ANEMIA MANAGEMENT (U.S. CLS. 100 AND 101).
JOHN SCHUYLER YARD, EXAMINING ATTORNEY

SN 77-756,040. BEAUTY BY DANNA, INC., NEWCASTLE, WA. FILED 6-10-2009.

ALOEFORMOCHA

THE MARK CONSISTS OF STANDARD CHARACTERS WITHOUT CLAIM TO ANY PARTICULAR FONT, STYLE, SIZE, OR COLOR.

THE WORDING "ALOEFORMOCHA" HAS NO MEANING IN A FOREIGN LANGUAGE.

CLASS 3—COSMETICS AND CLEANING PREPARATIONS

FOR SKIN CLEANSER, SKIN TONER, SKIN MOISTURIZING MASK, MOISTURIZING CREAM, OATMEAL BEAUTY MASK, SKIN REVITALIZING ESSENCE LOTION, DARK CIRCLE EYE ESSENCE LOTION, LIP BALM, AND LIP GLOSS (U.S. CLS. 1, 4, 6, 50, 51 AND 52).

CLASS 5—PHARMACEUTICALS

FOR MEDICATED ACNE ELIMINATING GEL (U.S. CLS. 6, 18, 44, 46, 51 AND 52).
BILL DAWE, EXAMINING ATTORNEY

SN 77-756,087. BANIUSZEWICZ, OLIVIA, NEW YORK, NY. AND GOLDSTEIN, DEBRA, NEW YORK, NY. FILED 6-10-2009.

FLIRTEXTING

THE MARK CONSISTS OF STANDARD CHARACTERS WITHOUT CLAIM TO ANY PARTICULAR FONT, STYLE, SIZE, OR COLOR.

CLASS 41—EDUCATION AND ENTERTAINMENT

FOR PROVIDING AN INTERACTIVE WEB BLOG AND ONLINE JOURNAL THAT FEATURE INFORMATION ON DATING, RELATIONSHIPS AND SOCIAL NETWORKING (U.S. CLS. 100, 101 AND 107).

FIRST USE 3-1-2009; IN COMMERCE 3-1-2009.

CLASS 45—PERSONAL AND LEGAL SERVICES

FOR PROVIDING AN INTERACTIVE WEBSITE FEATURING INFORMATION ON DATING, PERSONAL RELATIONSHIPS AND SOCIAL NETWORKING (U.S. CLS. 100 AND 101).

FIRST USE 3-1-2009; IN COMMERCE 3-1-2009.

DOMINIC J. FERRAIUOLO, EXAMINING ATTORNEY

SN 77-756,089. HNTB HOLDINGS, LTD, KANSAS CITY, MO. FILED 6-10-2009.



THE MARK CONSISTS OF LAYERED IMAGERY WITH THREE PROGRESSIVELY-SIZED RECTANGULAR SHAPES WITH ROUNDED CORNERS, ANOTHER SIMILAR, BUT LARGER RECTANGULAR SHAPE WITH A CURVED SIDE, AND TWO CURVED LINES CROSSING ALL THE RECTANGULAR SHAPES TO END IN A TRIANGLE SIMULATING A DOWNWARD ARROW.

CLASS 9—ELECTRICAL AND SCIENTIFIC APPARATUS

FOR COMPUTER SOFTWARE FOR SCHEDULING RESOURCES AND FACILITIES IN A GEOSPATIALLY REFERENCED ENVIRONMENT, FORECASTING DEMAND AND AVAILABILITY OF RESOURCES AND FACILITIES, PRESENTING INFORMATION RELATED TO SCHEDULING, DEMAND AND AVAILABILITY OF RESOURCES AND FACILITIES, AND PLANNING USE OF RESOURCES (U.S. CLS. 21, 23, 26, 36 AND 38).
FIRST USE 10-1-2008; IN COMMERCE 10-1-2008.

CLASS 42—SCIENTIFIC AND COMPUTER SERVICES

FOR COMPUTER SERVICES, NAMELY, COMPUTER SOFTWARE INSTALLATION AND OPERATION FOR OTHERS; COMPUTER SOFTWARE DESIGN, COMPUTER PROGRAMMING, AND MAINTENANCE OF COMPUTER SOFTWARE (U.S. CLS. 100 AND 101).
FIRST USE 2-14-2007; IN COMMERCE 2-14-2007.
LINDA ESTRADA, EXAMINING ATTORNEY

SN 77-756,368. KNOX, SHAHEEN, NEW YORK, NY. FILED 6-10-2009.

ANY WOMAN

THE MARK CONSISTS OF STANDARD CHARACTERS WITHOUT CLAIM TO ANY PARTICULAR FONT, STYLE, SIZE, OR COLOR.

CLASS 16—PAPER GOODS AND PRINTED MATTER

FOR BOOKS AND MAGAZINES IN THE FIELDS OF FASHION, BEAUTY, CELEBRITY, CULTURE, ENTERTAINMENT, AND WOMEN'S INTEREST (U.S. CLS. 2, 5, 22, 23, 29, 37, 38 AND 50).

CLASS 41—EDUCATION AND ENTERTAINMENT

FOR PROVIDING A WEBSITE FEATURING INFORMATION OF INTEREST TO WOMEN, NAMELY, INFORMATION ABOUT CELEBRITIES, POP CULTURE, AND OTHER ENTERTAINMENT TOPICS (U.S. CLS. 100, 101 AND 107).

CLASS 45—PERSONAL AND LEGAL SERVICES

FOR PROVIDING A WEBSITE FEATURING FASHION INFORMATION (U.S. CLS. 100 AND 101).
TOBY BULLOFF, EXAMINING ATTORNEY

SN 77-756,435. WHITE KNIGHT ENGINEERED PRODUCTS INC., CHARLOTTE, NC. FILED 6-10-2009.

EVEN THE TOUGHEST PROBLEMS
HAVE A SOLUTION

THE MARK CONSISTS OF STANDARD CHARACTERS WITHOUT CLAIM TO ANY PARTICULAR FONT, STYLE, SIZE, OR COLOR.

CLASS 24—FABRICS

FOR BED BLANKETS; BED COVERS; BED LINEN; BED PADS; BED SHEETS; BED THROWS; BLANKETS FOR OUTDOOR USE; FURNISHING AND UPHOLSTERY FABRICS; LAP BLANKETS; MATTRESS COVERS; MATTRESS PADS; PILLOW CASES; PILLOW COVERS; UPHOLSTERY FABRICS; HYPOALLERGENIC BED LINENS (U.S. CLS. 42 AND 50).

CLASS 25—CLOTHING

FOR CLOTHING, NAMELY, CLEAN ROOM APPAREL, NAMELY, SHIRTS, PANTS, BOOTS, BOOTIES, FOOTWEAR, FOOTIES; BOOTS; BOOTIES; FOOTWEAR; FOOTIES; PANTS; SHIRTS (U.S. CLS. 22 AND 39).
AISHA CLARKE, EXAMINING ATTORNEY

SN 77-756,526. FACEVISION TECHNOLOGY INC., TAIPEI CITY, TAIWAN, FILED 6-10-2009.

FVFFONE

THE MARK CONSISTS OF STANDARD CHARACTERS WITHOUT CLAIM TO ANY PARTICULAR FONT, STYLE, SIZE, OR COLOR.

CLASS 9—ELECTRICAL AND SCIENTIFIC APPARATUS

FOR DIGITAL ENHANCED CORDLESS TECHNOLOGY TELEPHONES (U.S. CLS. 21, 23, 26, 36 AND 38).

CLASS 38—COMMUNICATION

FOR VOICE OVER INTERNET PROTOCOL SERVICES AND VISUAL COMMUNICATION SERVICES, NAMELY, VIDEO BROADCASTING SERVICES (U.S. CLS. 100, 101 AND 104).

EUGENIA MARTIN, EXAMINING ATTORNEY

SN 77-756,559. JENSEN-NOGGLE, CANDICE, OAKLAND, CA. FILED 6-10-2009.

RECYCLE RESTYLE

THE MARK CONSISTS OF STANDARD CHARACTERS WITHOUT CLAIM TO ANY PARTICULAR FONT, STYLE, SIZE, OR COLOR.

CLASS 9—ELECTRICAL AND SCIENTIFIC APPARATUS

FOR DVDS FEATURING RESTORATION, REFINISHING AND RENOVATION OF FURNITURE, CLOTHING AND ACCESSORIES (U.S. CLS. 21, 23, 26, 36 AND 38).

CLASS 16—PAPER GOODS AND PRINTED MATTER

FOR BOOKS IN THE FIELD OF RESTORATION, REFINISHING AND RENOVATION OF FURNITURE, CLOTHING AND ACCESSORIES; MAGAZINES IN THE FIELD OF RESTORATION, REFINISHING AND RENOVATION OF FURNITURE, CLOTHING AND ACCESSORIES (U.S. CLS. 2, 5, 22, 23, 29, 37, 38 AND 50).

CLASS 41—EDUCATION AND ENTERTAINMENT

FOR ENTERTAINMENT SERVICES, NAMELY, PROVIDING A WEB SITE FEATURING PHOTOGRAPHIC, AUDIO, VIDEO AND PROSE PRESENTATIONS FEATURING RESTORATION, REFINISHING AND RENOVATION OF FURNITURE, CLOTHING AND ACCESSORIES; ENTERTAINMENT, NAMELY, PRODUCTION OF TELEVISION SHOWS FEATURING RESTORATION, REFINISHING AND RENOVATION OF FURNITURE, CLOTHING AND ACCESSORIES (U.S. CLS. 100, 101 AND 107).

FONG HSU, EXAMINING ATTORNEY

SN 77-757,011. HARDEN THERAPY LLC, DBA MBS REHAB, AUSTIN, TX. FILED 6-11-2009.

REHAB SMART

THE MARK CONSISTS OF STANDARD CHARACTERS WITHOUT CLAIM TO ANY PARTICULAR FONT, STYLE, SIZE, OR COLOR.

NO CLAIM IS MADE TO THE EXCLUSIVE RIGHT TO USE "REHAB", APART FROM THE MARK AS SHOWN.

CLASS 43—HOTEL AND RESTAURANT SERVICES

FOR PROVIDING ASSISTED LIVING FACILITIES (U.S. CLS. 100 AND 101).

CLASS 44—MEDICAL, BEAUTY AND AGRICULTURAL SERVICES

FOR PROVIDING SENIOR PHYSICAL REHABILITATION SERVICES; NURSING HOME FACILITIES (U.S. CLS. 100 AND 101).

MARILYN IZZI, EXAMINING ATTORNEY

SN 77-757,022. HARDEN THERAPY LLC, DBA MBS REHAB, AUSTIN, TX. FILED 6-11-2009.



NO CLAIM IS MADE TO THE EXCLUSIVE RIGHT TO USE "REHAB", APART FROM THE MARK AS SHOWN.

THE COLOR(S) NAVY BLUE, LIGHT BLUE, WHITE IS/ARE CLAIMED AS A FEATURE OF THE MARK.

THE MARK CONSISTS OF A PARTIAL SUNBURST DESIGN IN LIGHT BLUE AND NAVY BLUE APPEARING TO THE LEFT OF THE WORD "REHAB" IN LIGHT BLUE ABOVE THE WORD "SMART" IN NAVY BLUE, ALL BEFORE A WHITE BACKGROUND.

CLASS 43—HOTEL AND RESTAURANT SERVICES

FOR PROVIDING ASSISTED LIVING FACILITIES (U.S. CLS. 100 AND 101).

CLASS 44—MEDICAL, BEAUTY AND AGRICULTURAL SERVICES

FOR PROVIDING SENIOR PHYSICAL REHABILITATION SERVICES; NURSING HOME FACILITIES (U.S. CLS. 100 AND 101).

MARILYN IZZI, EXAMINING ATTORNEY

SN 77-757,196. KEY ELECTRONICS, INC., JEFFERSONVILLE, IN. FILED 6-11-2009.

KEY ELECTRONICS

THE MARK CONSISTS OF STANDARD CHARACTERS WITHOUT CLAIM TO ANY PARTICULAR FONT, STYLE, SIZE, OR COLOR.

NO CLAIM IS MADE TO THE EXCLUSIVE RIGHT TO USE "ELECTRONICS", APART FROM THE MARK AS SHOWN.

CLASS 35—ADVERTISING AND BUSINESS

FOR SUPPLY CHAIN MANAGEMENT SERVICES (U.S. CLS. 100, 101 AND 102).

FIRST USE 2-14-1996; IN COMMERCE 2-14-1996.

CLASS 37—CONSTRUCTION AND REPAIR

FOR DEPOT REPAIR SERVICES, NAMELY, CONTRACT REPAIR OF ELECTRONIC DEVICES FOR OTHERS (U.S. CLS. 100, 103 AND 106).

FIRST USE 2-14-1996; IN COMMERCE 2-14-1996.

CLASS 40—MATERIAL TREATMENT

FOR MANUFACTURING AND ASSEMBLY SERVICES FOR OTHERS IN THE FIELD OF ELECTRONICS (U.S. CLS. 100, 103 AND 106).

FIRST USE 2-14-1996; IN COMMERCE 2-14-1996.

CLASS 42—SCIENTIFIC AND COMPUTER SERVICES

FOR ENGINEERING AND CONFIGURATION SERVICES, NAMELY, PROTOTYPE FABRICATION, DESIGN FOR MANUFACTURABILITY AND DESIGN FOR TESTABILITY FOR ORIGINAL EQUIPMENT MANUFACTURERS AND ORIGINAL EQUIPMENT DESIGNERS (U.S. CLS. 100 AND 101).

FIRST USE 2-14-1996; IN COMMERCE 2-14-1996.

RON FAIRBANKS, EXAMINING ATTORNEY

SN 77-757,216. LEE FRY ENTERTAINMENT, LLC, WESTMONT, IL. FILED 6-11-2009.

TEEN BRAVE

THE MARK CONSISTS OF STANDARD CHARACTERS WITHOUT CLAIM TO ANY PARTICULAR FONT, STYLE, SIZE, OR COLOR.

NO CLAIM IS MADE TO THE EXCLUSIVE RIGHT TO USE "TEEN", APART FROM THE MARK AS SHOWN.

CLASS 41—EDUCATION AND ENTERTAINMENT

FOR EDUCATIONAL AND ENTERTAINMENT SERVICES, NAMELY, A CONTINUING PROGRAM ABOUT TEEN, ADOLESCENT, SOCIAL, PSYCHOLOGICAL, FAMILY, SUBSTANCE ABUSE, SEXUALITY AND SEXUAL ISSUES, ACCESSIBLE BY RADIO, TELEVISION, CABLE TELEVISION, SATELLITE, AUDIO, VIDEO, COMPUTER NETWORKS AND ELECTRONIC COMMUNICATIONS NETWORKS; PRODUCTION AND DISTRIBUTION OF TELEVISION SHOWS (U.S. CLS. 100, 101 AND 107).

CLASS 45—PERSONAL AND LEGAL SERVICES

FOR PROVIDING A SOCIAL NETWORKING WEBSITE FOR ENTERTAINMENT AND EDUCATIONAL PURPOSES (U.S. CLS. 100 AND 101).

CHRISIE B. KING, EXAMINING ATTORNEY

SN 77-757,301. BOOZ ALLEN HAMILTON INC., MCLEAN, VA. FILED 6-11-2009.

BOOZ ALLEN

THE MARK CONSISTS OF STANDARD CHARACTERS WITHOUT CLAIM TO ANY PARTICULAR FONT, STYLE, SIZE, OR COLOR.

OWNER OF U.S. REG. NOS. 888,837, 1,634,966 AND 2,653,981.

"BOOZ ALLEN" DOES NOT IDENTIFY A PARTICULAR LIVING INDIVIDUAL.

CLASS 35—ADVERTISING AND BUSINESS

FOR BUSINESS MANAGEMENT CONSULTING SERVICES (U.S. CLS. 100, 101 AND 102).
FIRST USE 5-1-2009; IN COMMERCE 5-1-2009.

CLASS 42—SCIENTIFIC AND COMPUTER SERVICES

FOR TECHNOLOGY CONSULTING SERVICES IN THE FIELD OF COMPUTER SYSTEMS DEVELOPMENT, ENGINEERING AND INTEGRATION (U.S. CLS. 100 AND 101).

FIRST USE 5-1-2009; IN COMMERCE 5-1-2009.
WARREN L. OLANDRIA, EXAMINING ATTORNEY

SN 77-757,331. PREGIS INNOVATIVE PACKAGING, INC., DEERFIELD, IL. FILED 6-11-2009.

ABSOLUTE

THE MARK CONSISTS OF STANDARD CHARACTERS WITHOUT CLAIM TO ANY PARTICULAR FONT, STYLE, SIZE, OR COLOR.

CLASS 17—RUBBER GOODS

FOR TAPE FOR ATTACHING POLYETHYLENE FOAM CUSHIONING TO INDOOR FLOORING SURFACE (U.S. CLS. 1, 5, 12, 13, 35 AND 50).
FIRST USE 6-2-2009; IN COMMERCE 6-2-2009.

CLASS 19—NON-METALLIC BUILDING MATERIALS

FOR POLYETHYLENE FOAM CUSHIONING FOR USE AS AN UNDERLAYMENT FOR INDOOR LAMINATE FLOORING (U.S. CLS. 1, 12, 33 AND 50).
FIRST USE 6-2-2009; IN COMMERCE 6-2-2009.
DEIRDRE ROBERTSON, EXAMINING ATTORNEY

SN 77-757,311. MOVIECLIPS, INC., SANTA MONICA, CA. FILED 6-11-2009.



SN 77-757,437. LEE FRY ENTERTAINMENT, LLC, WESTMONT, IL. FILED 6-11-2009.

COUNTRY MUSIC SMART

THE MARK CONSISTS OF A SCISSOR WITH SCISSOR BLADES RESEMBLING FILM CLIPS.

CLASS 9—ELECTRICAL AND SCIENTIFIC APPARATUS

FOR DOWNLOADABLE MULTIMEDIA FILE CONTAINING TEXT, AUDIO, VIDEO, GAMES AND INTERNET WEB LINKS RELATING TO MOTION PICTURES, FILMS, MOVIES, DVDS AND TELEVISION PROGRAMS (U.S. CLS. 21, 23, 26, 36 AND 38).

CLASS 41—EDUCATION AND ENTERTAINMENT

FOR ENTERTAINMENT SERVICES, NAMELY, PROVIDING ONLINE COMPUTER GAMES (U.S. CLS. 100, 101 AND 107).

CLASS 42—SCIENTIFIC AND COMPUTER SERVICES

FOR COMPUTER SERVICES, NAMELY, CREATING AN ONLINE COMMUNITY FOR USERS TO UPLOAD, VIEW AND EVALUATE MOTION PICTURES, FILMS, MOVIES, DVDS AND TELEVISION PROGRAMS, PARTICIPATE IN DISCUSSIONS, FORM VIRTUAL COMMUNITIES, AND ENGAGE IN SOCIAL NETWORKING (U.S. CLS. 100 AND 101).
ALLISON SCHRODY, EXAMINING ATTORNEY

THE MARK CONSISTS OF STANDARD CHARACTERS WITHOUT CLAIM TO ANY PARTICULAR FONT, STYLE, SIZE, OR COLOR.

NO CLAIM IS MADE TO THE EXCLUSIVE RIGHT TO USE "COUNTRY MUSIC", APART FROM THE MARK AS SHOWN.

CLASS 41—EDUCATION AND ENTERTAINMENT

FOR EDUCATIONAL AND ENTERTAINMENT SERVICES, NAMELY, A CONTINUING GAME SHOW AND TRIVIA SHOW BROADCAST OVER RADIO, TELEVISION, CABLE TELEVISION, SATELLITE, AUDIO, VIDEO, COMPUTER NETWORKS AND ELECTRONIC COMMUNICATIONS NETWORKS; ENTERTAINMENT SERVICES, NAMELY, PRODUCTION AND DISTRIBUTION OF GAME SHOWS AND TRIVIA SHOWS; PROVIDING INFORMATION IN THE FIELD OF MUSIC AND ENTERTAINMENT BY MEANS OF ELECTRONIC COMMUNICATION NETWORKS; ENTERTAINMENT SERVICES, NAMELY, PROVIDING ONLINE ELECTRONIC TRIVIA GAMES (U.S. CLS. 100, 101 AND 107).

CLASS 45—PERSONAL AND LEGAL SERVICES

FOR PROVIDING A SOCIAL NETWORKING WEBSITE FOR ENTERTAINMENT AND EDUCATIONAL PURPOSES (U.S. CLS. 100 AND 101).
CHRISIE B. KING, EXAMINING ATTORNEY

SN 77-757,715. JEMERC, INC., HUNTINGTON, NY. FILED 6-11-2009.

SN 77-757,741. LYTESYDE, LLC, HENDERSON, NV. FILED 6-11-2009.

JOHN EDWARD PRESENTS INFINITE QUEST

THE MARK CONSISTS OF STANDARD CHARACTERS WITHOUT CLAIM TO ANY PARTICULAR FONT, STYLE, SIZE, OR COLOR.

OWNER OF U.S. REG. NOS. 3,221,773 AND 3,670,934.

THE NAME(S), PORTRAIT(S), AND/OR SIGNATURE(S) SHOWN IN THE MARK IDENTIFIES "JOHN EDWARD", WHOSE CONSENT(S) TO REGISTER IS MADE OF RECORD.

CLASS 4—LUBRICANTS AND FUELS

FOR CANDLES (U.S. CLS. 1, 6 AND 15).

CLASS 9—ELECTRICAL AND SCIENTIFIC APPARATUS

FOR DIGITAL MATERIALS, NAMELY, CDS AND DVDS FEATURING PRERECORDED TELEVISION PROGRAMS, SEMINARS AND CONTENT FEATURING INSPIRATIONAL, MOTIVATIONAL AND SPIRITUAL MESSAGES AND INFORMATION RELATING TO EXTRASENSORY PERCEPTION, AFTER-LIFE EXPERIENCES, AND PSYCHIC PHENOMENA, CONSULTATIONS AND FORECASTING (U.S. CLS. 21, 23, 26, 36 AND 38).

CLASS 14—JEWELRY

FOR JEWELRY (U.S. CLS. 2, 27, 28 AND 50).

CLASS 16—PAPER GOODS AND PRINTED MATTER

FOR PRINTED MATTER, NAMELY, BOOKS, NEWSLETTERS, CALENDARS, MAGAZINES, AND BROCHURES FEATURING INSPIRATIONAL, MOTIVATIONAL AND SPIRITUAL MESSAGES AND INFORMATION RELATING TO EXTRASENSORY PERCEPTION, AFTER-LIFE EXPERIENCES, AND PSYCHIC PHENOMENA, CONSULTATIONS AND FORECASTING (U.S. CLS. 2, 5, 22, 23, 29, 37, 38 AND 50).

CLASS 38—COMMUNICATION

FOR BROADCASTING OF TELEVISION PROGRAMS, SEMINARS, AND ONLINE CONTENT FEATURING INSPIRATIONAL, MOTIVATIONAL AND SPIRITUAL MESSAGES AND INFORMATION RELATING TO EXTRASENSORY PERCEPTION, AFTER-LIFE EXPERIENCES, AND PSYCHIC PHENOMENA, CONSULTATIONS AND FORECASTING (U.S. CLS. 100, 101 AND 104).

CLASS 41—EDUCATION AND ENTERTAINMENT

FOR EDUCATIONAL AND ENTERTAINMENT SERVICES, NAMELY, PRODUCING TELEVISION PROGRAMS, SEMINARS AND ONLINE CONTENT FEATURING INSPIRATIONAL, MOTIVATIONAL AND SPIRITUAL MESSAGES AND INFORMATION RELATING TO EXTRASENSORY PERCEPTION, AFTER-LIFE EXPERIENCES, AND PSYCHIC PHENOMENA, CONSULTATIONS AND FORECASTING WHICH ARE BROADCASTED OVER TELEVISION, SATELLITE, INTERNET, MOBILE DEVICES, AUDIO, AND VIDEO MEDIA (U.S. CLS. 100, 101 AND 107).

MICHAEL LITZAU, EXAMINING ATTORNEY

NANOGASIFIER

THE MARK CONSISTS OF STANDARD CHARACTERS WITHOUT CLAIM TO ANY PARTICULAR FONT, STYLE, SIZE, OR COLOR.

CLASS 7—MACHINERY

FOR INTERNAL COMBUSTION, DIESEL, CYCLE, GASOLINE-ELECTRIC HYBRID, AND TURBINE ENGINES NOT FOR LAND VEHICLES; LIQUID REDUCTION DEVICES THAT REDUCE LIQUIDS OF ALL TYPES INTO SMALL MICRON AND SUB-MICRON SIZED PARTICLES, NAMELY, GASIFIERS (U.S. CLS. 13, 19, 21, 23, 31, 34 AND 35).

CLASS 12—VEHICLES

FOR INTERNAL COMBUSTION, DIESEL, CYCLE, GASOLINE-ELECTRIC HYBRID, AND TURBINE ENGINES ALL FOR LAND VEHICLES (U.S. CLS. 19, 21, 23, 31, 35 AND 44).

MICHAEL KEATING, EXAMINING ATTORNEY

SN 77-757,770. PREMIER FARNELL CORP, INDEPENDENCE, OH. FILED 6-11-2009.

NEWARK

THE MARK CONSISTS OF STANDARD CHARACTERS WITHOUT CLAIM TO ANY PARTICULAR FONT, STYLE, SIZE, OR COLOR.

OWNER OF U.S. REG. NOS. 1,562,710 AND 2,960,097.

CLASS 16—PAPER GOODS AND PRINTED MATTER

FOR CATALOGS, MANUALS AND PURCHASING GUIDES FOR THE SALE AND DISTRIBUTION OF SEMICONDUCTORS, ELECTRONIC COMPONENTS, PASSIVE COMPONENTS, INTERCONNECTORS AND WIRECABLES, OPTOELECTRONICS, CIRCUIT AND LINE PROTECTIONS, ELECTRO-MECHANICAL COMPONENTS, INDUSTRIAL CONTROL COMPONENTS, TOOLS, ELECTRICAL TEST EQUIPMENT AND SECURITY SYSTEMS; TRADE JOURNALS IN THE FIELD OF THE SALE AND DISTRIBUTION OF SEMICONDUCTORS, ELECTRONIC COMPONENTS, PASSIVE COMPONENTS, INTERCONNECTORS AND WIRECABLES, OPTOELECTRONICS, CIRCUIT AND LINE PROTECTIONS, ELECTRO-MECHANICAL COMPONENTS, INDUSTRIAL CONTROL COMPONENTS, TOOLS, ELECTRICAL TEST EQUIPMENT AND SECURITY SYSTEMS (U.S. CLS. 2, 5, 22, 23, 29, 37, 38 AND 50).

FIRST USE 1-0-2007; IN COMMERCE 1-0-2007.

CLASS 35—ADVERTISING AND BUSINESS

FOR COMPUTERIZED ONLINE RETAIL STORE SERVICES, MAIL ORDER CATALOG AND ELECTRONIC ORDER CATALOG ORDERING SERVICES, AND DISTRIBUTORSHIP SERVICES ALL IN THE FIELD OF SEMICONDUCTORS, ELECTRONIC COMPONENTS, PASSIVE COMPONENTS, INTERCONNECTORS AND WIRECABLES, OPTOELECTRONICS, CIRCUIT AND LINE PROTECTIONS, ELECTRO-MECHANICAL COMPONENTS, INDUSTRIAL CONTROL COMPONENTS, TOOLS, ELECTRICAL TEST EQUIPMENT AND SECURITY SYSTEMS; ELECTRONIC COMMERCE SERVICES, NAMELY, PROVIDING INFORMATION ABOUT PRODUCTS VIA TELECOMMUNICATION NETWORKS FOR ADVERTISING AND SALES PURPOSES; RETAIL COMPONENT KITTING SERVICES, NAMELY, CREATING CUSTOM PACKAGES OF GOODS TO THE SPECIFICATION OF CUSTOMERS IN THE FIELD OF SEMICONDUCTORS, ELECTRONIC COMPONENTS, PASSIVE COMPONENTS, INTERCONNECTORS AND WIRECABLES, OPTOELECTRONICS, CIRCUIT AND LINE PROTECTIONS, ELECTRO-MECHANICAL COMPONENTS, INDUSTRIAL CONTROL COMPONENTS, TOOLS, ELECTRICAL TEST EQUIPMENT AND SECURITY SYSTEMS; PROVIDING AN E-PROCUREMENT SYSTEM WHICH CONNECTS THIRD PARTIES VIA A COMPUTERIZED WEB SYSTEM TO ALLOW THOSE PARTIES TO BUY AND SELL GOODS FROM AND TO EACH OTHER; PROVISION OF ADVISORY AND CONSULTANCY SERVICES RELATING TO THE CONDUCTING OF BUSINESS ON THE INTERNET; IMPLEMENTATION OF A BUSINESS-TO-BUSINESS MARKETPLACE, NAMELY, PROVIDING AN E-PROCUREMENT SYSTEM WHICH CONNECTS THIRD PARTIES VIA A COMPUTERIZED WEB SYSTEM TO ALLOW THOSE PARTIES TO BUY AND SELL GOODS FROM AND TO EACH OTHER (U.S. CLS. 100, 101 AND 102).

FIRST USE 1-0-2007; IN COMMERCE 1-0-2007.

CLASS 40—MATERIAL TREATMENT

FOR CUSTOM MANUFACTURE OF PANEL METERS AND CABLE ASSEMBLIES (U.S. CLS. 100, 103 AND 106).

FIRST USE 1-0-2007; IN COMMERCE 1-0-2007.

CLASS 41—EDUCATION AND ENTERTAINMENT

FOR EDUCATION AND TRAINING SERVICES, NAMELY, PROVIDING SEMINARS, COURSES, AND WORKSHOPS OFFERED ELECTRONICALLY, OFFLINE AND ONLINE, BY BOOKS, EBOOKS, WORKBOOKS, TELECLASSES, TELECONFERENCE, VIDEO CONFERENCE, INTERNET, PODCAST, WEBSITE AND WEBINAR IN THE FIELD OF ELECTRONIC PRODUCTS; DISTRIBUTION OF COURSE MATERIALS THEREWITH; PROVIDING ON-LINE TRAINING IN THE FORM OF WEBINARS IN THE FIELD OF PRODUCT TRAINING, NAMELY, TRAINING FOR SEMICONDUCTORS, ELECTRONIC COMPONENTS, PASSIVE COMPONENTS, INTERCONNECTORS AND WIRECABLES, OPTOELECTRONICS, CIRCUIT AND LINE PROTECTIONS, ELECTRO-MECHANICAL COMPONENTS, INDUSTRIAL CONTROL COMPONENTS, TOOLS, ELECTRICAL TEST EQUIPMENT AND SECURITY SYSTEMS (U.S. CLS. 100, 101 AND 107).

FIRST USE 1-0-2007; IN COMMERCE 1-0-2007.

CLASS 42—SCIENTIFIC AND COMPUTER SERVICES

FOR CALIBRATION SERVICES (U.S. CLS. 100 AND 101).

FIRST USE 1-0-2007; IN COMMERCE 1-0-2007.
DAVID TOOLEY, EXAMINING ATTORNEY

SN 77-757,899. NOW HEALTH GROUP, INC., BLOOMINGDALE, IL. FILED 6-11-2009.

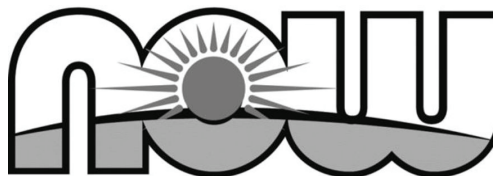

OWNER OF U.S. REG. NOS. 976,015 AND 1,850,515.

THE MARK CONSISTS OF THE WORD "NOW" IN STYLIZED FONT WITH A SUN IN THE MIDDLE OF THE LETTER "O" AND A HORIZON BELOW THE SUN AND EXTENDING THROUGH THE LETTERS "NOW".

CLASS 3—COSMETICS AND CLEANING PREPARATIONS

FOR COSMETICS, SOAPS, ESSENTIAL OILS, TOOTH-PASTE; PERSONAL CARE PRODUCTS, NAMELY, DEODORANTS FOR PERSONAL USE, VEGETABLE AND FRUIT OILS FOR COSMETIC PURPOSES, BODY BUTTERS, AND SKIN MOISTURIZING CREAMS AND LOTIONS; HAIR CARE PRODUCTS, NAMELY, SHAMPOOS AND CONDITIONERS; SHOWER AND BATH GELS (U.S. CLS. 1, 4, 6, 50, 51 AND 52).

FIRST USE 6-0-2001; IN COMMERCE 6-0-2001.

CLASS 5—PHARMACEUTICALS

FOR VITAMINS AND MINERALS; HERBAL AND DIETARY SUPPLEMENTS; NUTRITIONAL FOOD BARS FOR USE AS A MEAL REPLACEMENT AND MEAL REPLACEMENT BARS (U.S. CLS. 6, 18, 44, 46, 51 AND 52).

FIRST USE 6-0-2001; IN COMMERCE 6-0-2001.

CLASS 29—MEATS AND PROCESSED FOODS

FOR DRIED FRUITS; EDIBLE OILS, NAMELY, OLIVE, COCONUT, MACADAMIA AND RICE BRAN OILS; UNFLAVORED AND UNSWEETENED GELATIN FOR FOOD; PREPARED NUTS; PROCESSED EDIBLE SEEDS AND SOYBEANS; PROCESSED EDIBLE FLAX SEEDS AND SPROUTING SEEDS FOR FOOD (U.S. CL. 46).

FIRST USE 6-0-2001; IN COMMERCE 6-0-2001.

CLASS 30—STAPLE FOODS

FOR TEA, COCOA; NATURAL SWEETENERS; PREPARATIONS MADE FROM CEREALS, NAMELY, OAT AND WHEAT BRAN; FLOUR, PROCESSED HUSKED GRAINS; SESAME STICK SNACKS; FLAVOR ENHANCERS USED IN FOOD AND BEVERAGE PRODUCTS; WHEAT GERM; PROCESSED OAT AND WHEAT BRAN (U.S. CL. 46).

FIRST USE 6-0-2001; IN COMMERCE 6-0-2001.

CLASS 31—NATURAL AGRICULTURAL PRODUCTS

FOR UNPROCESSED OAT AND WHEAT GRAINS, FLAX, NUTS AND EDIBLE SEEDS (U.S. CLS. 1 AND 46).

FIRST USE 6-0-2001; IN COMMERCE 6-0-2001.
LAURA KOVALSKY, EXAMINING ATTORNEY

SN 77-758,066. HUSTON, DANIEL C., BOW, NH. FILED 6-12-2009.

COMMUNICATING Mindfully 

NO CLAIM IS MADE TO THE EXCLUSIVE RIGHT TO USE "COMMUNICATING", APART FROM THE MARK AS SHOWN.

THE STIPPLING IS FOR SHADING PURPOSES ONLY. THE MARK CONSISTS OF THE STYLIZED WORDING "COMMUNICATING MINDFULLY" TO THE LEFT OF A FLOWER DESIGN WITH AN EYE FORMING THE TOP OF THE FLOWER. THE INNER PORTION OF THE EYE RESEMBLES A WEDGE SECTION FROM A PIE CHART.

CLASS 16—PAPER GOODS AND PRINTED MATTER

FOR EDUCATIONAL PUBLICATIONS, NAMELY, BOOKS AND HANDOUTS IN THE FIELDS OF COMMUNICATION, WELL-BEING (U.S. CLS. 2, 5, 22, 23, 29, 37, 38 AND 50).

CLASS 45—PERSONAL AND LEGAL SERVICES

FOR PROVIDING A WEBSITE FEATURING INFORMATION IN THE FIELD OF PERSONAL DEVELOPMENT, NAMELY, INTERPERSONAL COMMUNICATION AND WELL-BEING; PROVIDING INFORMATION IN THE FIELD OF PERSONAL DEVELOPMENT, NAMELY, SELF-IMPROVEMENT, SELF-FULFILLMENT, AND INTERPERSONAL COMMUNICATION (U.S. CLS. 100 AND 101).

NELSON SNYDER, EXAMINING ATTORNEY

SN 77-758,255. FORYOU GROUP CO., LTD., GUANGDONG, CHINA, FILED 6-12-2009.

Adayo

THE MARK CONSISTS OF STANDARD CHARACTERS WITHOUT CLAIM TO ANY PARTICULAR FONT, STYLE, SIZE, OR COLOR.

THE WORDING ADAYO HAS NO MEANING IN A FOREIGN LANGUAGE.

CLASS 2—PAINTS

FOR AUTOMOBILE PAINT; ANTI-FORGERY INK; PRINTING INK; ALUMINUM SILVER PASTE PIGMENTS; COATINGS, NAMELY, CLEAR AND PIGMENTED COATINGS USED IN THE NATURE OF PAINT; LACQUERS IN THE NATURE OF COATING; SILVER POWDER FOR PAINTING; UNDERCOATING FOR VEHICLE CHASSIS; PIGMENTS NOT FOR FOOD AND INSULATION PURPOSES; ALUMINUM POWDER FOR PAINTING; PIGMENTS, NAMELY, SILVER EMULSIONS; INK FOR LEATHER, NAMELY, LEATHER STAINS; DRY INK FOR LEATHER; PRINTING INK FOR LEATHER; INK PRINTING COMPOSITIONS; PAINTS, AND SUBSIDIARY MATERIALS EXCLUDING INSULATING PAINTS, NAMELY, THINNERS FOR PAINT, THICKENERS FOR PAINTS AND AGGLUTINATES FOR PAINTS; PAINTS; ALUMINUM PAINTS (U.S. CLS. 6, 11 AND 16).

CLASS 9—ELECTRICAL AND SCIENTIFIC APPARATUS

FOR BLINKERS BEING SIGNALING LIGHTS; COMPUTERS; DATA PROCESSING APPARATUS; COMPUTER MEMORIES; LAPTOP COMPUTERS; DATA PROCESSING EQUIPMENT, NAMELY, COUPLERS; NOTEBOOK COMPUTERS; DOWNLOADABLE ELECTRONIC PUBLICATIONS IN THE NATURE OF BOOK, MAGAZINE AND MANUAL IN THE FIELD OF AUTOMOBILE, CHEMICAL INDUSTRY AND MEDICINES; WALKIE-TALKIES; AMUSEMENT APPARATUS ADAPTED FOR USE WITH AN EXTERNAL DISPLAY SCREEN OR MONITOR; ELECTRIC ACCUMULATORS FOR VEHICLES; LITHIUM IRON PHOSPHATE BATTERIES; ELECTRONIC VIDEO SURVEILLANCE PRODUCTS FOR SECURITY AND GUARD PURPOSES, NAMELY, ELECTRONIC COMPONENTS OF SECURITY SYSTEMS; AUTOMATED SELF-CONTAINED ELECTRONIC SURVEILLANCE DEVICES THAT CAN BE DEPLOYED TO GATHER EVIDENCE OR INTELLIGENCE IN REMOTE LOCATIONS FOR SECURITY OR GUARD PURPOSES; IDENTITY AUTHENTICATION SYSTEM, COMPRISED OF COMPUTER HARDWARE AND/OR SOFTWARE AND CARDS; LITHIUM-ION BATTERIES; OPTICAL COMMUNICATION EQUIPMENT, NAMELY, OPTICAL RECEIVERS AND OPTICAL TRANSMITTERS; CARRIER WAVE FACILITY, NAMELY, WAVEGUIDES FOR HIGH POWER BEAM DELIVERY; AERIALS; DISTANCE RECORDING APPARATUS, NAMELY, DISTANCE MEASURING APPARATUS; TELEMETERS; PETROL GAUGES FOR MEASURING LEVEL AND PRESSURE; CAR CD PLAYERS; CAR DVD PLAYERS (U.S. CLS. 21, 23, 26, 36 AND 38).

CLASS 11—ENVIRONMENTAL CONTROL APPARATUS

FOR LIGHT BULBS; ELECTRIC LIGHT BULBS; ELECTRIC LAMPS; LAMPS; LANTERNS FOR LIGHTING; POCKET SEARCHLIGHTS; ELECTRIC POCKET TORCHES FOR LIGHTING; PROJECTOR LAMPS; CHANDELIERS; CEILING LIGHTS; ELECTRIC LIGHTING FIXTURES, NAMELY, POWER FAILURE BACKUP SAFETY LIGHTING; LUMINOUS TUBES FOR LIGHTING; MINERS' LAMPS; FLASHLIGHTS; SEARCHLIGHTS; ELECTRIC TORCHES FOR LIGHTING; STANDARD LAMPS; STREET LAMPS; AQUARIUM LIGHTS; DIVING LIGHTS; ELECTRIC STAGE LIGHTING FIXTURE; STUDIO REFLECTING LAMPS; FLUORESCENT ELECTRIC LIGHT BULBS; FLUORESCENT LAMP AND LIGHTING TUBES; LIGHTS FOR VEHICLES; DYNAMO LAMPS FOR VEHICLES; HEADLIGHTS FOR AUTOMOBILES; BICYCLE LIGHTS; LIGHT BULBS FOR DIRECTIONAL SIGNALS FOR VEHICLES; CYCLE LIGHTS; VEHICLE HEADLIGHTS; LIGHTING APPARATUS FOR VEHICLES; LIGHTING APPARATUS FOR AUTOMOBILES; LAMPS FOR DIRECTIONAL SIGNALS OF AUTOMOBILES; LIGHTS FOR AUTOMOBILES (U.S. CLS. 13, 21, 23, 31 AND 34).

CLASS 12—VEHICLES

FOR ELECTRIC VEHICLES, NAMELY, ELECTRIC LAND VEHICLES; DIRECTION SIGNALS FOR VEHICLES; TURN SIGNALS FOR VEHICLES; DIRECTION SIGNALS FOR AUTOMOBILES; ANTI-GLARE DEVICES FOR VEHICLES, NAMELY, AUTOMOTIVE SHADE SCREENS AND WINDSHIELDS; STEERING GEARS FOR SHIPS; DRIVING MOTORS FOR LAND VEHICLES; ELECTRIC MOTORS FOR LAND VEHICLES (U.S. CLS. 19, 21, 23, 31, 35 AND 44).

TRICIA SONNEBORN, EXAMINING ATTORNEY

SN 77-758,376. HELEN GEORGAKLIS, MONTREAL, QUEBEC, CANADA, AND MYRON WELIK, AKA MICHAEL WELLS, MT. ROYAL, QUEBEC, CANADA, FILED 6-12-2009.

99 THINGS . . . WISH . . . KNEW BEFORE . . .

THE MARK CONSISTS OF STANDARD CHARACTERS WITHOUT CLAIM TO ANY PARTICULAR FONT, STYLE, SIZE, OR COLOR.

CLASS 16—PAPER GOODS AND PRINTED MATTER

FOR A SERIES OF BOOKS AND WRITTEN ARTICLES IN THE FIELD OF PRACTICAL AND INSPIRATIONAL ADVICE AND SELF-HELP GUIDES; BOOKS IN THE FIELD OF PRACTICAL AND INSPIRATIONAL ADVICE AND SELF-HELP GUIDES; SERIES OF NON-FICTION BOOKS IN THE FIELD OF PRACTICAL AND INSPIRATIONAL ADVICE AND SELF-HELP GUIDES (U.S. CLS. 2, 5, 22, 23, 29, 37, 38 AND 50).

CLASS 41—EDUCATION AND ENTERTAINMENT

FOR CONTINUING PUBLIC SERVICE PROGRAMS IN THE FIELD OF INSPIRATIONAL ADVICE AND SELF-HELP GUIDANCE PRODUCED AND DISTRIBUTED OVER TELEVISION, SATELLITE, FILM, AUDIO, VIDEO, INTERNET, AND 3-D VIRTUAL REALITY MEDIA; ENTERTAINMENT SERVICES, NAMELY, A MULTIMEDIA PROGRAM SERIES FEATURING COMEDY, ACTION AND ADVENTURE DISTRIBUTED VIA VARIOUS PLATFORMS ACROSS MULTIPLE FORMS OF TRANSMISSION MEDIA; ENTERTAINMENT SERVICES, NAMELY, AN ON-GOING SERIES FEATURING INSPIRATIONAL ADVICE AND SELF-HELP GUIDANCE PROGRAMMING PROVIDED THROUGH TELEVISION, CABLE TELEVISION, WEB CASTS, RADIO BROADCASTS, SATELLITE BROADCASTS, FILM, AUDIO, VIDEO, INTERNET, AND 3-D VIRTUAL REALITY MEDIA (U.S. CLS. 100, 101 AND 107).

DORITT L. CARROLL, EXAMINING ATTORNEY

SN 77-758,404. CHEMICAL DIRECT INC., PATERSON, NJ. FILED 6-12-2009.

QUICKFOS

THE MARK CONSISTS OF STANDARD CHARACTERS WITHOUT CLAIM TO ANY PARTICULAR FONT, STYLE, SIZE, OR COLOR.

CLASS 1—CHEMICALS

FOR FOOD PRESERVATIVE COMPOSITIONS; AND CHEMICAL AGENTS FOR CHELATING (U.S. CLS. 1, 5, 6, 10, 26 AND 46).

CLASS 3—COSMETICS AND CLEANING PREPARATIONS

FOR INDUSTRIAL CLEANING AGENTS FOR CHELATING IN DETERGENTS AND CLEANING PRODUCTS (U.S. CLS. 1, 4, 6, 50, 51 AND 52).

ZACHARY BELLO, EXAMINING ATTORNEY

SN 77-758,596. ALANOD ALUMINIUM-VEREDLUNG GMBH & CO. KG, ENNEPETAL 58256, FED REP GERMANY, FILED 6-12-2009.

MIRO-SUN

THE MARK CONSISTS OF STANDARD CHARACTERS WITHOUT CLAIM TO ANY PARTICULAR FONT, STYLE, SIZE, OR COLOR.

OWNER OF FED REP GERMANY REG. NO. 39952114, DATED 11-11-1999, RENEWED AS REG. NO. 39952114, DATED 9-1-2009, EXPIRES 8-31-2019.

OWNER OF U.S. REG. NOS. 2,162,287, 3,624,646 AND OTHERS.

CLASS 6—METAL GOODS

FOR TAPES, STRIPS AND BLANKS OF METAL, IN PARTICULAR OF ALUMINIUM HAVING A SURFACE COATING FOR ENHANCEMENT OF REFLECTION (U.S. CLS. 2, 12, 13, 14, 23, 25 AND 50).

CLASS 11—ENVIRONMENTAL CONTROL APPARATUS

FOR THERMAL SOLAR COLLECTORS (U.S. CLS. 13, 21, 23, 31 AND 34).

TRACY CROSS, EXAMINING ATTORNEY

SN 77-758,924. 3BA INTERNATIONAL, LLC, WALLA WALLA, WA. FILED 6-12-2009.

3BA

THE MARK CONSISTS OF STANDARD CHARACTERS WITHOUT CLAIM TO ANY PARTICULAR FONT, STYLE, SIZE, OR COLOR.

OWNER OF U.S. REG. NOS. 2,499,830 AND 2,940,640.

CLASS 25—CLOTHING

FOR ATHLETIC APPAREL, NAMELY, SHIRTS, PANTS, JACKETS, FOOTWEAR, HATS AND CAPS, ATHLETIC UNIFORMS; HEADWEAR; SHIRTS; SHORTS; SWEAT PANTS; SWEAT SHIRTS; TANK TOPS (U.S. CLS. 22 AND 39).

CLASS 28—TOYS AND SPORTING GOODS

FOR BASKETBALLS (U.S. CLS. 22, 23, 38 AND 50).

CLASS 38—COMMUNICATION

FOR STREAMING OF VIDEO MATERIAL ON THE INTERNET (U.S. CLS. 100, 101 AND 104).

CLASS 41—EDUCATION AND ENTERTAINMENT

FOR ENTERTAINMENT IN THE NATURE OF BASKETBALL GAMES; PROVIDING A WEB SITE FEATURING SPORTING INFORMATION; PROVIDING A WEB SITE THAT PROVIDES SPORTS LEAGUE PLAYER STATISTICS (U.S. CLS. 100, 101 AND 107).
MARILYN IZZI, EXAMINING ATTORNEY

SN 77-759,618. YG LABORATORIES, INC., HUNTINGTON BEACH, CA. FILED 6-15-2009.



NO CLAIM IS MADE TO THE EXCLUSIVE RIGHT TO USE "LABORATORIES", APART FROM THE MARK AS SHOWN.
THE MARK CONSISTS OF A CONICAL LABORATORY FLASK BETWEEN THE LETTERS "YG" AND THE WORD "LABORATORIES" AND A HORIZONTAL BAR OVER THE FIRST LETTER "O" IN THE WORD "LABORATORIES".

SN 77-759,542. YG LABORATORIES, INC., HUNTINGTON BEACH, CA. FILED 6-15-2009.

YG Laboratories

THE MARK CONSISTS OF STANDARD CHARACTERS WITHOUT CLAIM TO ANY PARTICULAR FONT, STYLE, SIZE, OR COLOR.
NO CLAIM IS MADE TO THE EXCLUSIVE RIGHT TO USE "LABORATORIES", APART FROM THE MARK AS SHOWN.

CLASS 9—ELECTRICAL AND SCIENTIFIC APPARATUS

FOR ELECTRONIC DOWNLOADABLE PUBLICATIONS, NAMELY, BROCHURES, BOOKLETS, AND TEACHING MATERIALS IN THE FIELDS OF SKIN CARE AND BRANDING; DIGITAL MEDIA, NAMELY, DVDS AND DOWNLOADABLE PODCASTS FEATURING INFORMATION ABOUT SKIN CARE AND BRANDING (U.S. CLS. 21, 23, 26, 36 AND 38).

CLASS 35—ADVERTISING AND BUSINESS

FOR PROVIDING A WEBSITE FEATURING INFORMATION ABOUT BRANDING (U.S. CLS. 100, 101 AND 102).

CLASS 40—MATERIAL TREATMENT

FOR CONTRACT MANUFACTURING IN THE FIELD OF SKINCARE PRODUCTS (U.S. CLS. 100, 103 AND 106).

CLASS 9—ELECTRICAL AND SCIENTIFIC APPARATUS

FOR ELECTRONIC DOWNLOADABLE PUBLICATIONS, NAMELY, BROCHURES, BOOKLETS, AND TEACHING MATERIALS IN THE FIELDS OF SKIN CARE AND BRANDING (U.S. CLS. 21, 23, 26, 36 AND 38).

CLASS 41—EDUCATION AND ENTERTAINMENT

FOR EDUCATION SERVICES, NAMELY, PROVIDING CLASSES, SEMINARS AND WORKSHOPS IN THE FIELDS OF SKIN CARE, COSMETIC CHEMISTRY AND BRANDING (U.S. CLS. 100, 101 AND 107).

CLASS 35—ADVERTISING AND BUSINESS

FOR PROVIDING A WEBSITE FEATURING INFORMATION ABOUT BRANDING (U.S. CLS. 100, 101 AND 102).

CLASS 42—SCIENTIFIC AND COMPUTER SERVICES

FOR PRODUCT DEVELOPMENT CONSULTATION; DESIGN OF BROCHURES, ADVERTISING COLLATERAL AND TRAINING MATERIALS FOR OTHERS; PROVIDING A WEBSITE FEATURING INFORMATION ABOUT COSMETIC CHEMISTRY (U.S. CLS. 100 AND 101).

CLASS 40—MATERIAL TREATMENT

FOR CONTRACT MANUFACTURING IN THE FIELD OF SKINCARE PRODUCTS (U.S. CLS. 100, 103 AND 106).

CLASS 44—MEDICAL, BEAUTY AND AGRICULTURAL SERVICES

FOR PROVIDING A WEBSITE FEATURING INFORMATION ABOUT SKIN CARE (U.S. CLS. 100 AND 101).
NICHOLAS ALTREE, EXAMINING ATTORNEY

CLASS 41—EDUCATION AND ENTERTAINMENT

FOR EDUCATION SERVICES, NAMELY, PROVIDING CLASSES, SEMINARS AND WORKSHOPS IN THE FIELDS OF SKIN CARE, COSMETIC CHEMISTRY AND BRANDING (U.S. CLS. 100, 101 AND 107).

CLASS 42—SCIENTIFIC AND COMPUTER SERVICES

FOR PRODUCT DEVELOPMENT CONSULTATION; DESIGN OF BROCHURES, ADVERTISING COLLATERAL AND TRAINING MATERIALS FOR OTHERS; PROVIDING A WEBSITE FEATURING INFORMATION ABOUT COSMETIC CHEMISTRY (U.S. CLS. 100 AND 101).

SN 77-760,147. XCEL ENERGY INC., MINNEAPOLIS, MN. FILED 6-15-2009.

ENERGY INNOVATION CORRIDOR

CLASS 44—MEDICAL, BEAUTY AND AGRICULTURAL SERVICES

FOR PROVIDING A WEBSITE FEATURING INFORMATION ABOUT SKIN CARE (U.S. CLS. 100 AND 101).
NICHOLAS ALTREE, EXAMINING ATTORNEY

THE MARK CONSISTS OF STANDARD CHARACTERS WITHOUT CLAIM TO ANY PARTICULAR FONT, STYLE, SIZE, OR COLOR.

NO CLAIM IS MADE TO THE EXCLUSIVE RIGHT TO USE "ENERGY" AND "CORRIDOR", APART FROM THE MARK AS SHOWN.

SN 77-760,154. PROMETHEUS LABORATORIES INC., SAN DIEGO, CA. FILED 6-15-2009.

CLASS 35—ADVERTISING AND BUSINESS

FOR CONSULTATION IN THE FIELD OF ENERGY EFFICIENCY; PROMOTING PUBLIC AWARENESS OF THE NEED FOR ENERGY CONSERVATION AND EFFICIENT ELECTRICITY UTILIZATION, ENERGY EFFICIENT TRANSPORTATION, LIGHT RAIL TRANSPORTATION AND RECYCLING; ENERGY COST ANALYSIS; LOBBYING SERVICES, NAMELY, PROMOTING THE INTERESTS OF ELECTRIC POWER COMPANIES AND THEIR CUSTOMERS IN THE FIELDS OF LEGISLATION, CONSUMER EDUCATION, CONSUMER PUBLIC RELATIONS, REGULATION, ENERGY, POWER TRANSMISSION AND NEEDS THEREFOR, ENERGY EFFICIENT TRANSPORTATION, LIGHT RAIL TRANSPORTATION AND RECYCLING (U.S. CLS. 100, 101 AND 102).

CLASS 37—CONSTRUCTION AND REPAIR

FOR INSTALLATION AND MAINTENANCE OF ELECTRIC TRANSMISSION LINES (U.S. CLS. 100, 103 AND 106).

CLASS 39—TRANSPORTATION AND STORAGE

FOR CONSULTATION IN THE FIELD OF ENERGY EFFICIENT LIGHT RAIL TRANSPORTATION; PUBLIC UTILITY SERVICES IN THE NATURE OF ELECTRICITY AND NATURAL GAS DISTRIBUTION; PUBLIC UTILITY SERVICES IN THE NATURE OF NATURAL GAS AND LIQUEFIED NATURAL GAS DISTRIBUTION THROUGH PIPELINE; STORAGE OF NATURAL GAS AND LIQUEFIED NATURAL GAS; PROVISION OF INFORMATION IN THE FIELD OF ENERGY DISTRIBUTION, ENERGY EFFICIENT TRANSPORTATION, LIGHT RAIL TRANSPORTATION (U.S. CLS. 100 AND 105).

CLASS 40—MATERIAL TREATMENT

FOR CONSULTATION IN THE FIELD OF RECYCLING; INFORMATION IN THE FIELD OF RECYCLING (U.S. CLS. 100, 103 AND 106).

CLASS 41—EDUCATION AND ENTERTAINMENT

FOR EDUCATIONAL SERVICES, NAMELY, CONDUCTING LIVE AND ONLINE CLASSES, SEMINARS, WORKSHOPS, AND CONFERENCES IN THE FIELDS OF ENERGY, THE ENVIRONMENT, AND THE CONSERVATION OF RESOURCES, ENERGY EFFICIENT TRANSPORTATION, LIGHT RAIL TRANSPORTATION AND RECYCLING, AND DISTRIBUTING COURSE MATERIALS IN CONNECTION THEREWITH, EDUCATIONAL SERVICES, NAMELY, PROVIDING CLASSES, SEMINARS, WORKSHOPS IN THE FIELDS OF ENERGY, POWER TRANSMISSION AND NEEDS THEREFOR, ENERGY EFFICIENT TRANSPORTATION, LIGHT RAIL TRANSPORTATION AND RECYCLING AND UTILITY REGULATION (U.S. CLS. 100, 101 AND 107).

CLASS 42—SCIENTIFIC AND COMPUTER SERVICES

FOR TECHNOLOGICAL CONSULTATION IN THE TECHNOLOGY FIELDS OF ELECTRICITY TRANSMISSION INFRASTRUCTURE, ENERGY EFFICIENT TRANSPORTATION, LIGHT RAIL TRANSPORTATION AND RECYCLING (U.S. CLS. 100 AND 101).
GEOFFREY FOSDICK, EXAMINING ATTORNEY

IBD FIRST STEP

THE MARK CONSISTS OF STANDARD CHARACTERS WITHOUT CLAIM TO ANY PARTICULAR FONT, STYLE, SIZE, OR COLOR.

NO CLAIM IS MADE TO THE EXCLUSIVE RIGHT TO USE "IBD", APART FROM THE MARK AS SHOWN.

CLASS 5—PHARMACEUTICALS

FOR MEDICAL DIAGNOSTIC REAGENTS AND SPECIMEN KITS SOLD AS A UNIT (U.S. CLS. 6, 18, 44, 46, 51 AND 52).

CLASS 44—MEDICAL, BEAUTY AND AGRICULTURAL SERVICES

FOR GENETIC TESTING FOR MEDICAL PURPOSES; PROVIDING INFORMATION, REPORTS AND TEST RESULTS FOR MEDICAL TESTING, GENETIC TESTING, AND GASTROINTESTINAL DISEASE TESTING; MEDICAL DIAGNOSTIC AND REPORTING SERVICES FOR GASTROINTESTINAL DISEASES (U.S. CLS. 100 AND 101).

JULIE WATSON, EXAMINING ATTORNEY

SN 77-760,302. MXSECURE, INC., SCOTTSDALE, AZ. FILED 6-15-2009.

MxChart

THE MARK CONSISTS OF STANDARD CHARACTERS WITHOUT CLAIM TO ANY PARTICULAR FONT, STYLE, SIZE, OR COLOR.

CLASS 35—ADVERTISING AND BUSINESS

FOR MEDICAL TRANSCRIPTION SERVICES (U.S. CLS. 100, 101 AND 102).

CLASS 38—COMMUNICATION

FOR ONLINE DOCUMENT DELIVERY VIA A GLOBAL COMPUTER NETWORK; ELECTRONIC MAIL AND MESSAGING SERVICES (U.S. CLS. 100, 101 AND 104).

CLASS 39—TRANSPORTATION AND STORAGE

FOR ELECTRONIC STORAGE OF DOCUMENTS IN THE NATURE OF MEDICAL RECORDS; DOCUMENT DELIVERY, NAMELY, MEDICAL RECORDS (U.S. CLS. 100 AND 105).

CLASS 44—MEDICAL, BEAUTY AND AGRICULTURAL SERVICES

FOR MAINTAINING PATIENT MEDICAL RECORDS AND FILES (U.S. CLS. 100 AND 101).
SALLY SHIH, EXAMINING ATTORNEY

SN 77-760,312. MXSECURE, INC., SCOTTSDALE, AZ. FILED 6-15-2009.

SN 77-760,649. INFINITE APE LLC, IPSWICH, MA. FILED 6-16-2009.

MxNotes

THE MARK CONSISTS OF STANDARD CHARACTERS WITHOUT CLAIM TO ANY PARTICULAR FONT, STYLE, SIZE, OR COLOR.

CLASS 35—ADVERTISING AND BUSINESS

FOR MEDICAL TRANSCRIPTION SERVICES (U.S. CLS. 100, 101 AND 102).

CLASS 38—COMMUNICATION

FOR ONLINE DOCUMENT DELIVERY VIA A GLOBAL COMPUTER NETWORK; ELECTRONIC MAIL AND MESSAGING SERVICES (U.S. CLS. 100, 101 AND 104).

CLASS 39—TRANSPORTATION AND STORAGE

FOR ELECTRONIC STORAGE OF DOCUMENTS IN THE NATURE OF MEDICAL RECORDS; DOCUMENT DELIVERY, NAMELY, MEDICAL RECORDS (U.S. CLS. 100 AND 105).

CLASS 44—MEDICAL, BEAUTY AND AGRICULTURAL SERVICES

FOR MAINTAINING PATIENT MEDICAL RECORDS AND FILES (U.S. CLS. 100 AND 101).
SALLY SHIH, EXAMINING ATTORNEY

SN 77-760,641. INFINITE APE LLC, IPSWICH, MA. FILED 6-16-2009.

A PLANET'S EVOLUTION

THE MARK CONSISTS OF STANDARD CHARACTERS WITHOUT CLAIM TO ANY PARTICULAR FONT, STYLE, SIZE, OR COLOR.

CLASS 25—CLOTHING

FOR MEN'S AND WOMEN'S CLOTHING, NAMELY, T-SHIRTS, SHIRTS, SWEATSHIRTS, SWEATERS, HATS, PANTS, GOLF TROUSERS, SHORTS, JACKETS, TANK TOPS, JERSEYS, COATS, SWIMWEAR, FLEECE PULL-OVERS, SWEAT SUITS, JOGGING SUITS, CAPS, VISORS, HEAD BANDS, SUITS, BLAZERS, SCARVES, SLEEPWEAR, AND LOUNGEWEAR (U.S. CLS. 22 AND 39).

CLASS 28—TOYS AND SPORTING GOODS

FOR TOYS, GAMES, AND PLAYTHINGS, NAMELY, STUFFED ANIMALS, BOARD GAMES, TRADING CARD GAMES, ACTION FIGURES AND ACCESSORIES, PLUSH TOYS, JIGSAW AND MANIPULATIVE PUZZLES, AND DOLLS (U.S. CLS. 22, 23, 38 AND 50).
JOHN DWYER, EXAMINING ATTORNEY

INFINITE APE

THE MARK CONSISTS OF STANDARD CHARACTERS WITHOUT CLAIM TO ANY PARTICULAR FONT, STYLE, SIZE, OR COLOR.

CLASS 9—ELECTRICAL AND SCIENTIFIC APPARATUS

FOR VIDEO GAME CARTRIDGES, CASSETTES, DISCS, AND SOFTWARE FOR USE WITH COMPUTERS, VIDEO GAME PROGRAM SYSTEMS AND COMPUTER NETWORKS; MOTION PICTURE FILMS IN THE FIELDS OF DRAMA AND SCIENCE FICTION (U.S. CLS. 21, 23, 26, 36 AND 38).

CLASS 16—PAPER GOODS AND PRINTED MATTER

FOR COMIC BOOKS, COMIC STRIPS (U.S. CLS. 2, 5, 22, 23, 29, 37, 38 AND 50).

CLASS 25—CLOTHING

FOR MEN'S AND WOMEN'S CLOTHING, NAMELY, T-SHIRTS, SHIRTS, SWEATSHIRTS, SWEATERS, HATS, PANTS, GOLF TROUSERS, SHORTS, JACKETS, TANK TOPS, JERSEYS, COATS, SWIMWEAR, FLEECE PULL-OVERS, SWEAT SUITS, JOGGING SUITS, CAPS, VISORS, HEAD BANDS, SUITS, BLAZERS, SCARVES, SLEEPWEAR, AND LOUNGEWEAR (U.S. CLS. 22 AND 39).

CLASS 36—INSURANCE AND FINANCIAL

FOR CHARITABLE FUNDRAISING SERVICES (U.S. CLS. 100, 101 AND 102).
JOHN DWYER, EXAMINING ATTORNEY

SN 77-760,692. POST GLOVER RESISTORS, INC., ERLANGER, KY. FILED 6-16-2009.

PULSERPLUS.NET

THE MARK CONSISTS OF STANDARD CHARACTERS WITHOUT CLAIM TO ANY PARTICULAR FONT, STYLE, SIZE, OR COLOR.

OWNER OF U.S. REG. NO. 2,730,006.

CLASS 37—CONSTRUCTION AND REPAIR

FOR PROVIDING A WEBSITE FEATURING INSTALLATION INFORMATION IN THE FIELD OF HIGH RESISTANCE GROUNDING (U.S. CLS. 100, 103 AND 106).

CLASS 42—SCIENTIFIC AND COMPUTER SERVICES

FOR PROVIDING A WEBSITE FEATURING APPLICATION INFORMATION IN THE FIELD OF HIGH RESISTANCE GROUNDING (U.S. CLS. 100 AND 101).

WILLIAM P. SHANAHAN, EXAMINING ATTORNEY

SN 77-760,801. RON JON SURF SHOP OF FLA., INC., COCOA BEACH, FL. FILED 6-16-2009.

PHOEBE PHIN

THE MARK CONSISTS OF STANDARD CHARACTERS WITHOUT CLAIM TO ANY PARTICULAR FONT, STYLE, SIZE, OR COLOR.

"PHOEBE PHIN" IS A FICTIONAL CHILDREN'S CHARACTER AND NOT THE NAME OF A LIVING INDIVIDUAL.

CLASS 25—CLOTHING

FOR CLOTHING AND SPORTSWEAR FOR INFANTS, TODDLERS AND GIRLS, NAMELY, T-SHIRTS, SHORTS, PANTS, SWEATSHIRTS, SWEAT PANTS, SWEAT SHORTS, SHIRTS, BATHING SUITS, DRESSES, BLOUSES, SKIRTS, BEACH COVER-UPS, SHOES, SANDALS, SOCKS, HEADBANDS, CAPS, HATS, VISORS, WET SUITS, JACKETS, PONCHOS, CLOTH BABY BIBS, BABY TOPS, BABY BOTTOMS, BABY BOOTIES AND BABY BODYSUITS, PAJAMAS, NIGHT GOWNS, SLEEP SHIRTS, LOUNGE WEAR, BATHROBES, AND PANTS AND SHORTS SETS (U.S. CLS. 22 AND 39).

CLASS 28—TOYS AND SPORTING GOODS

FOR SPORTING GOODS AND EQUIPMENT, NAMELY, BODY BOARDS, BOOGEY BOARDS, SURFBOARDS, SKATEBOARDS, SKIM BOARDS, PADDLE BALL SETS, AND TOYS, NAMELY, DOLLS, STUFFED ANIMALS, BEAN BAGS, TOY STUFFED PILLOWS, TOY BALLS, BEACH BALLS, SAND TOY SETS AND TOY FLYING DISKS (U.S. CLS. 22, 23, 38 AND 50).

ANTHONY RINKER, EXAMINING ATTORNEY

SN 77-761,280. SPIRAL FOODS PTY. LTD., CHULLORA, NSW, AUSTRALIA, FILED 6-16-2009.

SPIRAL FOODS

THE MARK CONSISTS OF STANDARD CHARACTERS WITHOUT CLAIM TO ANY PARTICULAR FONT, STYLE, SIZE, OR COLOR.

NO CLAIM IS MADE TO THE EXCLUSIVE RIGHT TO USE "FOODS", APART FROM THE MARK AS SHOWN.

CLASS 29—MEATS AND PROCESSED FOODS

FOR PRESERVED, DRIED, CANNED AND COOKED FRUITS AND VEGETABLES; JELLIES, JAMS; EGGS, NON-DAIRY YOGHURTS AND CREAMS; EDIBLE OILS AND FATS; MEAT EXCLUDING BEEF, FISH, POULTRY AND GAME; MEAT EXTRACTS, PRESERVED AND PROCESSED SOYBEANS; BLENDED VEGETABLE CHIPS; COCONUT AND NON-DAIRY CREAM POWDERS; CRANBERRY AND APPLE SAUCE (U.S. CL. 46).

CLASS 30—STAPLE FOODS

FOR COFFEE, TEA, COCOA, SUGAR, RICE, TAPIOCA, SAGO, ARTIFICIAL COFFEE; FLOUR ; RICE CRACKERS, BREAD, PASTRY, HONEY, YEAST, BAKING POWDER; SALT, MUSTARD, VINEGAR, SAUCES, SPICES, SOYBEAN PASTES, BAKING POWDER, FLOUR AND SAUCES; MALT FOR FOOD PURPOSES; PROCESSED GRAINS, NAMELY, WHEAT, RYE AND BUCKWHEAT (U.S. CL. 46).

CLASS 31—NATURAL AGRICULTURAL PRODUCTS

FOR AGRICULTURAL, HORTICULTURAL AND FORESTRY PRODUCTS AND GRAINS, NAMELY, UN-PROCESSED WHEAT, RYE AND BUCKWHEAT; NATURAL PLANTS AND FLOWERS, FOODSTUFFS FOR ANIMALS, MALT FOR BREWING AND DISTILLING, FRESH SOYBEANS (U.S. CLS. 1 AND 46).

CLASS 32—LIGHT BEVERAGES

FOR BEERS; MINERAL AND AERATED WATERS AND OTHER NON-ALCOHOLIC DRINKS, NAMELY, HERBAL TONICS; FRUIT DRINKS AND FRUIT JUICES; SYRUPS FOR MAKING SOYBEAN-BASED BEVERAGES (U.S. CLS. 45, 46 AND 48).

TRACY CROSS, EXAMINING ATTORNEY

SN 77-761,692. REM SYSTEMS, INC., PAOLI, PA. FILED 6-17-2009.

RANDEX

THE MARK CONSISTS OF STANDARD CHARACTERS WITHOUT CLAIM TO ANY PARTICULAR FONT, STYLE, SIZE, OR COLOR.

CLASS 7—MACHINERY

FOR AUTOMATED STORAGE AND RETRIEVAL SYSTEMS FOR DOCUMENTS AND MATERIALS CONSISTING PRIMARILY OF MOTORIZED SHELVES, MOTORIZED STORAGE RACKS AND PARTS THEREFOR (U.S. CLS. 13, 19, 21, 23, 31, 34 AND 35).

CLASS 20—FURNITURE AND ARTICLES NOT OTHERWISE CLASSIFIED

FOR STORAGE AND RETRIEVAL SYSTEMS FOR DOCUMENTS AND MATERIALS CONSISTING PRIMARILY OF SHELVES, STORAGE RACKS AND PARTS THEREFOR THAT IS AUTOMATED BY COMPUTER TO FACILITATE THE INSERTION AND EXTRACTION OF THE STORED MATERIALS (U.S. CLS. 2, 13, 22, 25, 32 AND 50).

CLASS 42—SCIENTIFIC AND COMPUTER SERVICES

FOR STORAGE AND RETRIEVAL SYSTEM SERVICES, NAMELY, DESIGN FOR OTHERS IN THE FIELD OF BUSINESS SOLUTIONS TO SPACE, STORAGE, MATERIAL HANDLING, AUTOMATION AND ENGINEERING (U.S. CLS. 100 AND 101).

ANN E. SAPPENFIELD, EXAMINING ATTORNEY

SN 77-761,795. LG CORP., SEOUL, REPUBLIC OF KOREA, FILED 6-17-2009.



THE MARK CONSISTS OF THE STYLIZED LETTERS "LG", TO THE LEFT OF WHICH IS A SHADED CIRCLE CONTAINING A GEOMETRIC DESIGN THAT LOOKS LIKE A FACE WITH ONE EYE.

CLASS 6—METAL GOODS

FOR METAL BRACKETS FOR MOUNTING CLOSED-CIRCUIT TELEVISION CAMERAS (U.S. CLS. 2, 12, 13, 14, 23, 25 AND 50).

CLASS 9—ELECTRICAL AND SCIENTIFIC APPARATUS

FOR SECURE TERMINALS FOR ELECTRONIC TRANSACTIONS EQUIPPED IN VEHICLE; ELECTRONIC AUTHENTICATION EQUIPMENT COMPRISING COMPUTER PERIPHERALS AND SOFTWARE FOR CALCULATING A TOLL; ELECTRONIC PAYMENT TERMINAL; ELECTRONIC CREDIT OR DEBIT CARD TERMINAL; ELECTRONIC CARD READERS; COMMUNICATIONS APPARATUS FOR VEHICLES; NAVIGATION APPARATUS FOR VEHICLES; SATELLITE NAVIGATIONAL APPARATUS; NAVIGATIONAL INSTRUMENTS FOR VEHICLES; BLANK ELECTRONIC CHIP CARDS; CHIP CARD READERS; CARD READING EQUIPMENT; CARDS WITH INTEGRATED CIRCUITS; ZOOM CAMERAS; CAMERAS FOR SECURITY AND GUARD; CLOSED-CIRCUIT TELEVISION CAMERAS; INTERNET PROTOCOL SPEED DOME CAMERAS; NETWORK MONITORING CAMERAS; ZOOM CAMERAS WITH CCTV; DIVISIBLE CAMERAS; DOME CAMERAS; CAMERA LENS; ZOOM MODULATE CAMERAS; SECURITY CAMERAS; ELECTRICAL CONTROLLERS FOR CLOSED-CIRCUIT TELEVISION CAMERAS; VIDEO MONITORS FOR CLOSED-CIRCUIT TELEVISION; RECORDERS FOR DIGITAL VIDEO; HOUSINGS FOR CLOSED-CIRCUIT TELEVISION CAMERAS; IRIS RECOGNITION DOOR LOCKS; IRIS RECOGNITION AUTOMATIC DOOR OPENING AND CLOSING APPARATUS; IRIS RECOGNITION AUTOMATIC CAMERAS; IRIS RECOGNITION CONTROLLERS, RIDING EQUIPMENT FOR SPORTS, NAMELY, BICYCLE HELMETS (U.S. CLS. 21, 23, 26, 36 AND 38).

CLASS 10—MEDICAL APPARATUS

FOR MASSAGE APPARATUS; VIBROMASSAGE APPARATUS; ELECTRIC MASSAGE APPARATUS FOR HOUSEHOLD USE; MASSAGE APPARATUS FOR HUMAN BODY; BED VIBRATORS; ELECTRIC MASSAGE CHAIRS; ESTHETIC MASSAGE APPARATUS (U.S. CLS. 26, 39 AND 44).

CLASS 11—ENVIRONMENTAL CONTROL APPARATUS

FOR WATER PURIFIERS FOR HOUSEHOLD PURPOSES; ELECTRIC WATER PURIFIERS FOR HOUSEHOLD USE; WATER IONIZERS FOR HOUSEHOLD PURPOSES; NON-ELECTRIC WATER PURIFIERS FOR HOUSEHOLD PURPOSES; WATER PURIFYING APPARATUS; ELECTRIC FOOTWARMERS (U.S. CLS. 13, 21, 23, 31 AND 34).

CLASS 28—TOYS AND SPORTING GOODS

FOR EXERCISE EQUIPMENT, NAMELY, HORSEBACK RIDING MACHINE FOR HEALTH AND FITNESS; FIXED-TYPE RIDING EQUIPMENT FOR HEALTHCARE, NAMELY, STATIONARY EXERCISE BICYCLES (U.S. CLS. 22, 23, 38 AND 50).

CLASS 35—ADVERTISING AND BUSINESS

FOR THE BRINGING TOGETHER FOR THE BENEFIT OF OTHERS A VARIETY OF GOODS EXCLUDING THE TRANSPORT THEREOF, ENABLING CUSTOMERS TO CONVENIENTLY VIEW AND PURCHASE THOSE GOODS IN THE FIELD OF GENERAL MERCHANDISE AND CONSUMER GOODS; WHOLE SALE DISTRIBUTORSHIPS FEATURING GENERAL MERCHANDISE AND CONSUMER GOODS; RETAIL STORE SERVICES FEATURING GENERAL MERCHANDISE AND CONSUMER GOODS; ARRANGING AND CONDUCTING OF AUCTION SALES; BUSINESS INTERMEDIARY AND ADVISORY SERVICES IN THE FIELD OF SELLING PRODUCTS AND RENDERING SERVICES (U.S. CLS. 100, 101 AND 102).

CIMMERIAN COLEMAN, EXAMINING ATTORNEY

SN 77-761,904. D3 AIR AND SPACE OPERATIONS, INC., ST. AUGUSTINE, FL. FILED 6-17-2009.

D3

THE MARK CONSISTS OF STANDARD CHARACTERS WITHOUT CLAIM TO ANY PARTICULAR FONT, STYLE, SIZE, OR COLOR.

CLASS 35—ADVERTISING AND BUSINESS

FOR PERSONNEL STAFFING SERVICES FOR EXECUTIVE POSITIONS, OPERATIONS CENTERS, LOGISTICS AND MANAGEMENT POSITIONS IN THE AVIATION INDUSTRY; AND FUEL MANAGEMENT SERVICES IN THE FIELD OF AVIATION (U.S. CLS. 100, 101 AND 102).

FIRST USE 9-0-2006; IN COMMERCE 9-0-2006.

CLASS 37—CONSTRUCTION AND REPAIR

FOR AIRCRAFT REPAIR AND MAINTENANCE; AIRCRAFT ENGINE AND AIRFRAME MAINTENANCE; AIRCRAFT FUELING; AIRCRAFT EXTERIOR FINISHING; AVIONICS INSTALLATION AND REPAIR; AND AIRCRAFT GROUND SUPPORT EQUIPMENT MAINTENANCE (U.S. CLS. 100, 103 AND 106).

FIRST USE 9-0-2006; IN COMMERCE 9-0-2006.

CLASS 39—TRANSPORTATION AND STORAGE

FOR AERONAUTICAL RADIO NAVIGATION AND AIR TRAFFIC CONTROL SERVICES FOR OTHERS; LOADING AND UNLOADING OF AIRPLANES; AND AIRCRAFT TOWING SERVICES (U.S. CLS. 100 AND 105).

FIRST USE 9-0-2006; IN COMMERCE 9-0-2006.

CLASS 41—EDUCATION AND ENTERTAINMENT

FOR EDUCATIONAL SERVICES, NAMELY, TRAINING IN THE FIELD OF AVIATION, AIRCRAFT MAINTENANCE AND AIR TRAFFIC CONTROL; EDUCATION SERVICES, NAMELY, TRAINING FOR AIR TRAFFIC CONTROLLERS IN THE FIELD OF JOINT TERMINAL ATTACK (U.S. CLS. 100, 101 AND 107).

FIRST USE 9-0-2006; IN COMMERCE 9-0-2006.

CLASS 42—SCIENTIFIC AND COMPUTER SERVICES

FOR AIRCRAFT INSPECTION (U.S. CLS. 100 AND 101).

FIRST USE 9-0-2006; IN COMMERCE 9-0-2006.
BARNEY CHARLON, EXAMINING ATTORNEY

CLASS 21—HOUSEWARES AND GLASS

FOR DISPOSABLE DINNERWARE, NAMELY, TABLE PLATES, DESSERT PLATES, SALAD PLATES, LUNCHEON PLATES, DINNER PLATES, PLASTIC PLATES, PLASTIC BOWLS, AND DECORATIVE PLATES; TRAYS, NAMELY, SERVING TRAYS AND CATERING TRAYS; SERVING WARE FOR SERVING FOOD, NAMELY, PLATTERS, DOME LIDS FOR SERVING PLATTERS, AND PLASTIC LIDS FOR SERVING PLATTERS; DISPOSABLE TABLEWARE, NAMELY, BOWLS; DISHES, NAMELY, SERVING DISHES, SERVING PLATES, PLATTERS AND SERVING TRAYS; DISPOSABLE DRINK WARE, NAMELY, DRINKING CUPS, TUMBLERS, STEMWARE, SHOT GLASSES, MARTINI GLASSES, MARGARITA GLASSES, COFFEE MUGS, SOUVENIR CUPS, WRAPPED CUPS, LODGING CUPS, DISPOSABLE PLASTIC DESSERT CUPS; DISPOSABLE TONGS FOR SERVING FOOD; DISPOSABLE PLASTIC SPECIALTY CONTAINERS FOR SERVING FOOD; DISPOSABLE COFFEE AND BEVERAGE CONTAINERS; BEVERAGE STIRRERS; DISPOSABLE PITCHERS; DISPOSABLE LIDS, NAMELY, FOR DRINKING CUPS, DISPOSABLE BOWLS, DISPOSABLE FOOD STORAGE CONTAINERS, SOUVENIR CUPS (U.S. CLS. 2, 13, 23, 29, 30, 33, 40 AND 50).

FIRST USE 4-1-2008; IN COMMERCE 4-1-2008.

CLASS 40—MATERIAL TREATMENT

FOR CUSTOM MANUFACTURING OF PLASTIC CONTAINERS FOR FOODS, NAMELY, TO-GO CONTAINERS (U.S. CLS. 100, 103 AND 106).

FIRST USE 4-1-2008; IN COMMERCE 4-1-2008.

CLASS 42—SCIENTIFIC AND COMPUTER SERVICES

FOR CUSTOM DESIGNING OF PLASTIC CONTAINERS FOR FOODS, NAMELY, "TO-GO CONTAINERS" (U.S. CLS. 100 AND 101).

FIRST USE 4-1-2008; IN COMMERCE 4-1-2008.
STEPHEN AQUILA, EXAMINING ATTORNEY

SN 77-761,924. WADDINGTON NORTH AMERICA, INC., CHELMSFORD, MA. FILED 6-17-2009.



THE MARK CONSISTS OF THE LETTERS "WNA" SUPERIMPOSED UPON A STYLIZED SPOON WITH THE HANDLE ABOVE THE "W" AND THE BOWL OF THE SPOON UNDER THE "A".

CLASS 8—HAND TOOLS

FOR DISPOSABLE TABLEWARE, NAMELY, FORKS, SPOONS, KNIVES; CAKE CUTTERS; DISPOSABLE PLASTIC CUTLERY KITS PRIMARILY CONSISTING OF DISPOSABLE SPOONS, FORKS AND KNIVES, AND ALSO CONTAINING DISPOSABLE NAPKINS AND SALT AND PEPPER PACKETS (U.S. CLS. 23, 28 AND 44).

FIRST USE 4-1-2008; IN COMMERCE 4-1-2008.

CLASS 20—FURNITURE AND ARTICLES NOT OTHERWISE CLASSIFIED

FOR DRINKING STRAWS (U.S. CLS. 2, 13, 22, 25, 32 AND 50).

FIRST USE 4-1-2008; IN COMMERCE 4-1-2008.

SN 77-762,065. MOMENTIVE PERFORMANCE MATERIALS INC., ALBANY, NY. FILED 6-17-2009.

THE SCIENCE BEHIND THE SOLUTIONS

THE MARK CONSISTS OF STANDARD CHARACTERS WITHOUT CLAIM TO ANY PARTICULAR FONT, STYLE, SIZE, OR COLOR.

CLASS 35—ADVERTISING AND BUSINESS

FOR WHOLESALE AND RETAIL STORE SERVICES IN THE FIELD OF CHEMICAL PRODUCTS, QUARTZ PRODUCTS AND SILICONES (U.S. CLS. 100, 101 AND 102).

FIRST USE 11-30-2007; IN COMMERCE 11-30-2007.

CLASS 42—SCIENTIFIC AND COMPUTER SERVICES

FOR PROVISION OF TECHNICAL CONSULTATION IN THE FIELDS OF CHEMISTRY, CHEMICAL ENGINEERING AND MATERIALS ENGINEERING IN CONNECTION WITH DEVELOPMENT OF CHEMICAL, SILICONE AND QUARTZ PRODUCTS; DEVELOPMENT AND RESEARCH SERVICES IN THE FIELD OF CHEMICAL, SILICONE AND QUARTZ PRODUCTS (U.S. CLS. 100 AND 101).

FIRST USE 11-30-2007; IN COMMERCE 11-30-2007.
SUSAN LESLIE DUBOIS, EXAMINING ATTORNEY

SN 77-762,161. THE MUSICIAN NETWORK, LLC, OVERLAND PARK, KS. FILED 6-17-2009.

SET THE MUSIC FREE

THE MARK CONSISTS OF STANDARD CHARACTERS WITHOUT CLAIM TO ANY PARTICULAR FONT, STYLE, SIZE, OR COLOR.

CLASS 38—COMMUNICATION

FOR INTERNET BROADCASTING SERVICES FOR PROFESSIONAL AND AMATEUR MUSICIANS AND MUSIC ENTHUSIASTS (U.S. CLS. 100, 101 AND 104).

CLASS 41—EDUCATION AND ENTERTAINMENT

FOR FILM AND VIDEO PRODUCTION SERVICES IN THE NATURE OF PRODUCTION OF AUDIO-VISUAL PROGRAMMING AND SHOWS SPECIFIC TO PROFESSIONAL AND AMATEUR MUSICIANS AND MUSIC ENTHUSIASTS FOR DISTRIBUTION ON GLOBAL COMPUTER NETWORKS (U.S. CLS. 100, 101 AND 107).

CLASS 45—PERSONAL AND LEGAL SERVICES

FOR ONLINE SOCIAL NETWORKING AND INTRODUCTION SERVICES FOR PROFESSIONAL AND AMATEUR MUSICIANS AND MUSIC ENTHUSIASTS (U.S. CLS. 100 AND 101).

RUSS HERMAN, EXAMINING ATTORNEY

SN 77-763,242. LA FRANCE DU NORD AU SUD, PARIS, FRANCE, FILED 6-18-2009.



OWNER OF ERPN CMNTY TM OFC REG. NO. 006034706, DATED 5-15-2008, EXPIRES 6-15-2017.

THE MARK IS COMPRISED OF A RECTANGLE WITH THE WORDS "DU NORD AU SUD.FR" WITHIN IT.

THE ENGLISH TRANSLATION OF "DU NORD AU SUD" IN THE MARK IS FROM NORTH TO SOUTH.

CLASS 39—TRANSPORTATION AND STORAGE

FOR TRAVEL AND TOURIST AGENCIES EXCEPTING FOR HOTEL AND GUEST HOUSE RESERVATIONS, NAMELY, MAKING RESERVATIONS AND BOOKINGS FOR TRANSPORTATION; TRAVEL ARRANGEMENT, NAMELY, ARRANGING TRAVEL TOURS, COORDINATING TRAVEL ARRANGEMENTS FOR INDIVIDUALS AND FOR GROUPS; ARRANGING CRUISES, EXCURSIONS AND SIGHTSEEING TOURS; ESCORTING OF TRAVELERS; TRANSPORT RESERVATION FOR TRIPS; RENTAL OF VEHICLES (U.S. CLS. 100 AND 105).

CLASS 43—HOTEL AND RESTAURANT SERVICES

FOR AGENCY SERVICES FOR THE RESERVATION OF TEMPORARY ACCOMMODATION, HOTELS AND GUEST HOUSES, HOLIDAY HOMES, AND ACCOMMODATION IN HOLIDAY CAMPS; HOTEL SERVICES; BAR SERVICES; CAFE-RESTAURANTS; CAFETERIAS; CATERING; PROVISION OF CAMPGROUND FACILITIES (U.S. CLS. 100 AND 101).

LAURIE KAUFMAN, EXAMINING ATTORNEY

SN 77-763,357. CHOMP, INC., EL SEGUNDO, CA. FILED 6-18-2009.

DARKSTAR

THE MARK CONSISTS OF STANDARD CHARACTERS WITHOUT CLAIM TO ANY PARTICULAR FONT, STYLE, SIZE, OR COLOR.

OWNER OF U.S. REG. NO. 3,526,106.

CLASS 9—ELECTRICAL AND SCIENTIFIC APPARATUS

FOR PROTECTIVE HELMETS FOR SPORTS (U.S. CLS. 21, 23, 26, 36 AND 38).

CLASS 28—TOYS AND SPORTING GOODS

FOR PROTECTIVE PADDING FOR SPORTS, NAMELY, ELBOW PADS, KNEE PADS, SHIN PADS, WRIST PADS, LEG PADS, BODY PADS, ANKLE PADS, SHOULDER PADS, KNEE GUARDS, SHIN GUARDS, WRIST GUARDS, AND ELBOW GUARDS (U.S. CLS. 22, 23, 38 AND 50).

HENRY S. ZAK, EXAMINING ATTORNEY

SN 77-763,529. UBER ENTERTAINMENT INC., KIRKLAND, WA. FILED 6-18-2009.

UBER ENTERTAINMENT

THE MARK CONSISTS OF STANDARD CHARACTERS WITHOUT CLAIM TO ANY PARTICULAR FONT, STYLE, SIZE, OR COLOR.

NO CLAIM IS MADE TO THE EXCLUSIVE RIGHT TO USE "ENTERTAINMENT", APART FROM THE MARK AS SHOWN.

THE ENGLISH TRANSLATION OF "UBER" IN THE MARK IS OVER.

CLASS 9—ELECTRICAL AND SCIENTIFIC APPARATUS

FOR COMPUTER SOFTWARE AND PROGRAMS FOR USE IN DATA MANAGEMENT, VIDEO GAME SOFTWARE AND PROGRAMS, AND ELECTRONIC AND MOBILE APPLICATIONS FOR COMPUTER GAMES AND DATA MANAGEMENT FOR PERSONAL COMPUTERS, HANDHELD COMPUTERS AND MOBILE DEVICES, HOME VIDEO GAME CONSOLES, PORTABLE GAMING SYSTEMS, AND ARCADE-BASED VIDEO GAME CONSOLES (U.S. CLS. 21, 23, 26, 36 AND 38).
FIRST USE 3-3-2008; IN COMMERCE 3-3-2008.

CLASS 42—SCIENTIFIC AND COMPUTER SERVICES

FOR COMPUTER SOFTWARE DEVELOPMENT AND DESIGN IN THE FIELD OF COMPUTER GAMES, VIDEO GAMES, AND ELECTRONIC AND MOBILE APPLICATIONS (U.S. CLS. 100 AND 101).
FIRST USE 3-3-2008; IN COMMERCE 3-3-2008.
LEIGH CAROLINE CASE, EXAMINING ATTORNEY

SN 77-763,774. FHI HEAT, INC., SOLON, OH. FILED 6-19-2009.

EPS

THE MARK CONSISTS OF STANDARD CHARACTERS WITHOUT CLAIM TO ANY PARTICULAR FONT, STYLE, SIZE, OR COLOR.
THE WORDING "EPS" HAS NO MEANING IN A FOREIGN LANGUAGE.

CLASS 9—ELECTRICAL AND SCIENTIFIC APPARATUS

FOR ELECTRIC HAIR STRAIGHTENING IRONS (U.S. CLS. 21, 23, 26, 36 AND 38).

CLASS 11—ENVIRONMENTAL CONTROL APPARATUS

FOR HAIR DRYERS (U.S. CLS. 13, 21, 23, 31 AND 34).
WENDY JUN, EXAMINING ATTORNEY

SN 77-763,791. FHI HEAT, INC., SOLON, OH. FILED 6-19-2009.

GO

THE MARK CONSISTS OF STANDARD CHARACTERS WITHOUT CLAIM TO ANY PARTICULAR FONT, STYLE, SIZE, OR COLOR.

CLASS 9—ELECTRICAL AND SCIENTIFIC APPARATUS

FOR ELECTRIC HAIR STRAIGHTENING IRONS (U.S. CLS. 21, 23, 26, 36 AND 38).

CLASS 11—ENVIRONMENTAL CONTROL APPARATUS

FOR HAIR DRYERS (U.S. CLS. 13, 21, 23, 31 AND 34).
WENDY JUN, EXAMINING ATTORNEY

SN 77-764,511. JASON BUCKINGHAM CHEN, ALEXANDRIA, VA. FILED 6-20-2009.

VentureScope

THE MARK CONSISTS OF STANDARD CHARACTERS WITHOUT CLAIM TO ANY PARTICULAR FONT, STYLE, SIZE, OR COLOR.

CLASS 35—ADVERTISING AND BUSINESS

FOR ACQUISITION AND MERGER CONSULTATION; ASSISTANCE, ADVISORY SERVICES AND CONSULTANCY WITH REGARD TO BUSINESS PLANNING, BUSINESS ANALYSIS, BUSINESS MANAGEMENT, BUSINESS ORGANIZATION, MARKETING AND CUSTOMER ANALYSIS; BRANDING SERVICES, NAMELY, CONSULTING, DEVELOPMENT, MANAGEMENT AND MARKETING OF BRANDS FOR BUSINESSES; BUSINESS ACQUISITION AND MERGER CONSULTATION; BUSINESS ACQUISITIONS CONSULTATION; BUSINESS ADMINISTRATION CONSULTANCY; BUSINESS ADVISORY SERVICES, CONSULTANCY AND INFORMATION; BUSINESS APPRAISAL CONSULTATION; BUSINESS CONSULTATION; BUSINESS CONSULTATION AND MANAGEMENT REGARDING MARKETING ACTIVITIES AND LAUNCHING OF NEW PRODUCTS; BUSINESS CONSULTATION SERVICES; BUSINESS CONSULTING SERVICES IN THE FIELD OF ORGANIZATIONAL CHANGE MANAGEMENT; BUSINESS CONSULTING SERVICES RELATING TO THE INTEGRATION OF THE AREAS OF BUSINESS PROCESS TECHNOLOGY, ORGANIZATIONAL LEARNING, CHANGE MANAGEMENT, AND OPERATIONAL SUSTAINABILITY; BUSINESS CONSULTING SERVICES, NAMELY, PROVIDING ASSISTANCE IN DEVELOPMENT OF BUSINESS STRATEGIES AND CREATIVE IDEATION; BUSINESS DEVELOPMENT SERVICES, NAMELY, PROVIDING START-UP SUPPORT FOR BUSINESSES OF OTHERS; BUSINESS MANAGEMENT CONSULTANCY AND ADVISORY SERVICES; BUSINESS MANAGEMENT CONSULTANCY AS WELL AS DEVELOPMENT OF PROCESSES FOR THE ANALYSIS AND THE IMPLEMENTATION OF STRATEGY PLANS AND MANAGEMENT PROJECTS; BUSINESS MANAGEMENT CONSULTANCY SERVICES; BUSINESS MANAGEMENT CONSULTATION; BUSINESS MANAGEMENT CONSULTING; BUSINESS MANAGEMENT CONSULTING AND ADVISORY SERVICES; BUSINESS MANAGEMENT CONSULTING WITH RELATION TO STRATEGY, MARKETING, PRODUCTION, PERSONNEL AND RETAIL SALE MATTERS; BUSINESS MANAGEMENT CONSULTING WITH RELATION TO STRATEGY, MARKETING, SALES, OPERATION, PRODUCT DESIGN PARTICULARLY SPECIALIZING IN THE USE OF ANALYTIC AND STATISTIC MODELS FOR THE UNDERSTANDING AND PREDICTING OF CONSUMERS, BUSINESSES, AND MARKET TRENDS AND ACTIONS; BUSINESS SERVICES, NAMELY, MATCHING POTENTIAL PRIVATE INVESTORS WITH ENTREPRENEURS NEEDING FUNDING; BUSINESS SUPPORT SERVICES, NAMELY, BUSINESS CONSULTING TO FREELANCERS, START-UPS, EXISTING BUSINESSES AND NON-PROFIT ORGANIZATIONS; BUSINESS VENTURE DEVELOPMENT AND FORMATION CONSULTING SERVICES FOR THE RENEWABLE ENERGY INDUSTRY; CONSULTANCY SERVICES REGARDING BUSINESS STRATEGIES; CONSUMER STRATEGY BUSINESS CONSULTING IN THE FIELDS OF MARKETING, SALES, OPERATION, AND PRODUCT DESIGN PARTICULARLY SPECIALIZING IN THE USE OF ANALYTIC MODELS FOR THE UNDER-

STANDING AND PREDICTING OF CONSUMER, BUSINESS, AND RETAIL MARKET TRENDS AND ACTIONS; CREATION OF MARKETING TOOLS DESIGNED TO INCREASE A CLIENT COMPANY'S KNOWLEDGE OF CUSTOMER NEEDS, AND ITS COMPETITORS' PRODUCTS AND SERVICES, PRICING, ADVERTISING STRATEGY AND SALES STRATEGY; DEVELOPMENT OF MARKETING STRATEGIES AND CONCEPTS; INCUBATION SERVICES, NAMELY, PROVIDING WORK SPACE CONTAINING BUSINESS EQUIPMENT TO FREELANCERS, START-UPS, EXISTING BUSINESSES AND NON-PROFITS; MANAGEMENT SERVICES, NAMELY, ON-LINE BUSINESS DEVELOPMENT SERVICES, NAMELY, PROVIDING START-UP SUPPORT FOR BUSINESSES OF OTHERS; MARKET RESEARCH CONSULTATION; MARKET SEGMENTATION CONSULTATION; MARKETING AND BRANDING SERVICES, NAMELY, PERFORMING CONSUMER INSIGHT AND BRAND STRATEGY OF COMPANY LOGOS; NEW BUSINESS VENTURE DEVELOPMENT AND FORMATION CONSULTING SERVICES; PROFESSIONAL BUSINESS CONSULTATION; PROFESSIONAL BUSINESS CONSULTING; PROVIDING A WEBSITE AT WHICH ENTREPRENEURS POST COMPANY PROFILES TO ATTRACT VENTURE CAPITAL; PROVIDING PUBLIC SECTOR CHANNEL STRATEGY DEVELOPMENT AND MANAGEMENT SERVICES; PROVIDING PUBLIC SECTOR GO-TO-MARKET ADVICE AND STRATEGIES (U.S. CLS. 100, 101 AND 102).

FIRST USE 10-20-2007; IN COMMERCE 10-26-2007.

SN 77-764,734. BIG BOX INTERNATIONAL PTE LTD, SINGAPORE, SINGAPORE, FILED 6-22-2009.

breadou
Freshly baked by Chef Breadou for your fun indulgence

THE NAME(S), PORTRAIT(S), AND/OR SIGNATURE(S) SHOWN IN THE MARK DOES NOT IDENTIFY A PARTICULAR LIVING INDIVIDUAL.

THE MARK CONSISTS OF THE STYLIZED WORDING "BREADOU" ABOVE THE WORDING "FRESHLY BAKED BY CHEF BREADOU FOR YOUR FUN INDULGENCE".

CLASS 28—TOYS AND SPORTING GOODS

FOR BOXING GLOVES; DOLLS; PLUSH TOYS; SQUEEZE TOYS; STRESS RELIEF BALLS FOR HAND EXERCISE; STUFFED TOYS; TOY ACTION FIGURES; TOY ACTION FIGURES AND ACCESSORIES THEREFOR; TOY FIGURES; TOY VEHICLES (U.S. CLS. 22, 23, 38 AND 50).

CLASS 36—INSURANCE AND FINANCIAL

FOR BUSINESS BROKERAGE SERVICES AND RELATED CONSULTING PERTAINING TO PROCUREMENT, BUYING, SELLING AND TENDERING INFORMATION AND OPPORTUNITIES; CAPITAL INVESTMENT CONSULTATION; EQUITY CAPITAL INVESTMENT; FINANCIAL ANALYSIS AND CONSULTATION; FINANCIAL DUE DILIGENCE; FINANCIAL RISK MANAGEMENT CONSULTATION; FINANCIAL SERVICES, NAMELY, INVESTMENT ADVICE, INVESTMENT MANAGEMENT, INVESTMENT CONSULTATION AND INVESTMENT OF FUNDS FOR OTHERS, INCLUDING PRIVATE AND PUBLIC EQUITY AND DEBT INVESTMENT SERVICES; FORMATION, OFFERING AND MANAGEMENT OF LIMITED PARTNERSHIPS; FUND INVESTMENT CONSULTATION; FUNDS INVESTMENT; INCUBATION SERVICES, NAMELY, PROVIDING FINANCING TO FREELANCERS, START-UPS, EXISTING BUSINESSES AND NON-PROFITS; INCUBATION SERVICES, NAMELY, RENTAL OF OFFICE SPACE TO FREELANCERS, START-UPS, EXISTING BUSINESSES AND NON-PROFITS; INVESTMENT ADVICE; INVESTMENT ADVISORY SERVICES; INVESTMENT BANKING SERVICES; INVESTMENT CONSULTATION; INVESTMENT MANAGEMENT SERVICES IN THE FIELD OF ACQUIRING JOINT VENTURES; INVESTMENT OF FUNDS FOR OTHERS; INVESTMENT SERVICES, NAMELY, ASSET ACQUISITION, CONSULTATION, DEVELOPMENT AND MANAGEMENT SERVICES; LEVERAGED BUY OUTS AND INVESTMENTS IN FINANCIALLY DISTRESSED OR UNDERPERFORMING COMPANIES; MANAGEMENT OF A CAPITAL INVESTMENT FUND; PRIVATE EQUITY FUND INVESTMENT SERVICES; PUBLIC EQUITY INVESTMENT MANAGEMENT; VENTURE CAPITAL FUNDING SERVICES TO EMERGING AND START-UP COMPANIES; VENTURE CAPITAL SERVICES, NAMELY, PROVIDING FINANCING TO EMERGING AND START-UP COMPANIES (U.S. CLS. 100, 101 AND 102).

FIRST USE 10-20-2007; IN COMMERCE 10-26-2007.
LINDA ESTRADA, EXAMINING ATTORNEY

CLASS 38—COMMUNICATION

FOR COMMUNICATION SERVICES, NAMELY, TRANSMISSION OF VOICE, AUDIO, VISUAL IMAGES AND DATA BY TELECOMMUNICATIONS NETWORKS, WIRELESS COMMUNICATION NETWORKS, THE INTERNET, INFORMATION SERVICES NETWORKS AND DATA NETWORKS; ELECTRONIC DATA TRANSMISSION; ELECTRONIC DELIVERY OF IMAGES AND PHOTOGRAPHS VIA A GLOBAL COMPUTER NETWORK; INTERNET SERVICE PROVIDER (ISP); PROVIDING ELECTRONIC TRANSMISSION OF CREDIT CARD TRANSACTION DATA AND ELECTRONIC PAYMENT DATA VIA A GLOBAL COMPUTER NETWORK; PROVIDING INTERNET ACCESS; PROVIDING INTERNET CHATROOMS; PROVIDING MULTIPLE-USER ACCESS TO A GLOBAL COMPUTER INFORMATION NETWORK; PROVIDING ON-LINE CHAT ROOMS AND ELECTRONIC BULLETIN BOARDS FOR TRANSMISSION OF MESSAGES AMONG USERS IN THE FIELD OF GENERAL INTEREST; PROVIDING ON-LINE ELECTRONIC BULLETIN BOARDS FOR TRANSMISSION OF MESSAGES AMONG COMPUTER USERS CONCERNING HOBBIES, COLLECTIBLES, TRADING AND THE SALE OF GOODS AND SERVICES VIA A GLOBAL COMMUNICATIONS NETWORK; PROVIDING TELECOMMUNICATION CHANNELS FOR TEleshopping SERVICES; PROVISION OF ACCESS TO A GLOBAL COMPUTER NETWORK; TELECOMMUNICATION ACCESS SERVICES; TELECOMMUNICATION SERVICES, NAMELY, TRANSMISSION OF VOICE, DATA, GRAPHICS, IMAGES, AUDIO AND VIDEO BY MEANS OF TELECOMMUNICATIONS NETWORKS, WIRELESS COMMUNICATION NETWORKS, AND THE INTERNET; TRANSMISSION AND DISTRIBUTION OF DATA OR AUDIO VISUAL IMAGES VIA A GLOBAL COMPUTER NETWORK OR THE INTERNET; TRANSMISSION OF INFORMATION BY ELECTRONIC COMMUNICATIONS NETWORKS; TRANSMISSION OF INFORMATION VIA NATIONAL AND INTERNATIONAL NETWORKS (U.S. CLS. 100, 101 AND 104).

CHRISTINA SOBRAL, EXAMINING ATTORNEY

SN 77-764,763. COLORMATRIX HOLDINGS, INC., WILMINGTON, DE. FILED 6-22-2009.

SN 77-765,411. AMERICAN NUTRACEUTICALS, INC., SEDRO WOOLLEY, WA. FILED 6-22-2009.

LACTRA

THE MARK CONSISTS OF STANDARD CHARACTERS WITHOUT CLAIM TO ANY PARTICULAR FONT, STYLE, SIZE, OR COLOR.

PRIORITY CLAIMED UNDER SEC. 44(D) ON ERPNCMNTY TM OFC APPLICATION NO. 008242711, FILED 4-24-2009, REG. NO. 008242711, DATED 11-22-2009, EXPIRES 4-24-2019.

CLASS 1—CHEMICALS

FOR CHEMICALS USED IN INDUSTRY; CHEMICAL ADDITIVES FOR PLASTICS MATERIALS (U.S. CLS. 1, 5, 6, 10, 26 AND 46).

CLASS 2—PAINTS

FOR COLORANTS (U.S. CLS. 6, 11 AND 16).
JACQUELINE A. LAVINE, EXAMINING ATTORNEY

SN 77-765,280. ADVANCED MEDICAL PRODUCTIONS, INC., CARRBORO, NC. FILED 6-22-2009.

FIGURE 8 FILMS

THE MARK CONSISTS OF STANDARD CHARACTERS WITHOUT CLAIM TO ANY PARTICULAR FONT, STYLE, SIZE, OR COLOR.

NO CLAIM IS MADE TO THE EXCLUSIVE RIGHT TO USE "FILMS", APART FROM THE MARK AS SHOWN.

CLASS 9—ELECTRICAL AND SCIENTIFIC APPARATUS

FOR PRE-RECORDED VIDEO TAPES AND VIDEO DISCS FEATURING DOCUMENTARIES, HUMAN INTEREST DRAMAS AND REALITY SHOWS (U.S. CLS. 21, 23, 26, 36 AND 38).
FIRST USE 12-29-1997; IN COMMERCE 12-29-1997.

CLASS 41—EDUCATION AND ENTERTAINMENT

FOR ENTERTAINMENT SERVICES, NAMELY, VIDEO PRODUCTION AND FILM PRODUCTION; ENTERTAINMENT SERVICES, NAMELY, PRODUCTION AND DISTRIBUTION OF MOTION PICTURE FILMS AND FILMS ON THE SUBJECT OF HUMAN INTEREST DRAMAS AND DOCUMENTARIES (U.S. CLS. 100, 101 AND 107).
FIRST USE 12-29-1997; IN COMMERCE 12-29-1997.
MAUREEN DALL, EXAMINING ATTORNEY

Quality by Nature

THE MARK CONSISTS OF STANDARD CHARACTERS WITHOUT CLAIM TO ANY PARTICULAR FONT, STYLE, SIZE, OR COLOR.

CLASS 3—COSMETICS AND CLEANING PREPARATIONS

FOR COSMETICS (U.S. CLS. 1, 4, 6, 50, 51 AND 52).
FIRST USE 11-1-2003; IN COMMERCE 1-15-2004.

CLASS 5—PHARMACEUTICALS

FOR DIETARY SUPPLEMENTS; PHARMACEUTICAL SKIN LOTIONS; TOPICAL ANALGESICS (U.S. CLS. 6, 18, 44, 46, 51 AND 52).
FIRST USE 11-1-2003; IN COMMERCE 1-15-2004.
MARLENE BELL, EXAMINING ATTORNEY

SN 77-765,508. PAPER SO PRETTY, LLC, HOUSTON, TX. FILED 6-22-2009.



NO CLAIM IS MADE TO THE EXCLUSIVE RIGHT TO USE "PAPER", APART FROM THE MARK AS SHOWN.

THE MARK CONSISTS OF THE WORDING "PAPER SO PRETTY" BENEATH A FLOWER DESIGN.

CLASS 16—PAPER GOODS AND PRINTED MATTER

FOR (BASED ON INTENT TO USE) BLANK JOURNAL BOOKS; PAPER GIFT BAGS; PAPER GIFT TAGS; PAPER GIFT WRAP; PAPER NAPKINS; (BASED ON USE IN COMMERCE) GREETING CARDS; PAPER DIE CUT SHAPES; PRINTED INVITATIONS; PRINTING PAPERS; STATIONERY; NOTE PADS (U.S. CLS. 2, 5, 22, 23, 29, 37, 38 AND 50).
FIRST USE 3-1-2003; IN COMMERCE 3-1-2003.

CLASS 21—HOUSEWARES AND GLASS

FOR (BASED ON INTENT TO USE) PAPER PLATES AND PAPER CUPS (U.S. CLS. 2, 13, 23, 29, 30, 33, 40 AND 50).
STEPHEN AQUILA, EXAMINING ATTORNEY

SN 77-765,625. SYNERTEL, SAN FRANCISCO, CA. FILED 6-22-2009.

SN 77-766,512. DALE SQUEGLIA O'MALLEY, DBA WHISPERING KNOWLEDGE EVENTS, SNOHOMISH, WA. FILED 6-23-2009.

SYNERTEL

THE MARK CONSISTS OF STANDARD CHARACTERS WITHOUT CLAIM TO ANY PARTICULAR FONT, STYLE, SIZE, OR COLOR.

CLASS 35—ADVERTISING AND BUSINESS

FOR BUSINESS CONSULTATION IN THE FIELD OF TELECOMMUNICATIONS AND INFORMATION TECHNOLOGY EXPENSE MANAGEMENT; EXPENSE AUDITING AND BUSINESS CONSULTATION IN THE NATURE OF COST REDUCTION OPTIMIZATION SERVICES IN THE FIELD OF TELECOMMUNICATIONS, DATA NETWORKING, AND INFORMATION TECHNOLOGY; OPERATION, MANAGEMENT, AND ADMINISTRATION OF TELECOMMUNICATIONS, DATA NETWORKING, AND INFORMATION TECHNOLOGY SYSTEMS FOR OTHERS (U.S. CLS. 100, 101 AND 102).

CLASS 37—CONSTRUCTION AND REPAIR

FOR INSTALLATION, MAINTENANCE, AND REPAIR SERVICES FOR TELECOMMUNICATIONS, DATA NETWORKING, AND INFORMATION TECHNOLOGY SYSTEMS AND EQUIPMENT; TELECOMMUNICATIONS AND DATA NETWORKING WIRING SERVICES; INSTALLATION OF TELECOMMUNICATIONS SYSTEMS AND EQUIPMENT AND TELECOMMUNICATIONS REPEATER SYSTEMS (U.S. CLS. 100, 103 AND 106).

CLASS 38—COMMUNICATION

FOR TELECOMMUNICATIONS CONSULTATION; CONSULTING IN THE FIELD OF TELECOMMUNICATIONS (U.S. CLS. 100, 101 AND 104).

CLASS 42—SCIENTIFIC AND COMPUTER SERVICES

FOR COMPUTER SERVICES, NAMELY, CONSULTATION, DESIGN, PROJECT MANAGEMENT, IMPLEMENTATION, MAINTENANCE, AND MONITORING OF COMPUTER, DATA NETWORK, AND INFORMATION TECHNOLOGY SYSTEMS; COMPUTER SERVICES, NAMELY, DESIGN AND CONFIGURATION OF TELECOMMUNICATIONS SYSTEMS AND EQUIPMENT AND TELECOMMUNICATIONS REPEATER SYSTEMS; CONSULTING IN THE FIELD OF COMPUTERS, DATA NETWORKS, AND INFORMATION TECHNOLOGY; DESIGN, IMPLEMENTATION, AND MONITORING OF DATA NETWORK AND INFORMATION TECHNOLOGY SYSTEMS TO DETECT SPAM, UNWANTED EMAILS, VIRUSES, ADWARE, MALWARE, INSTANT MESSAGE WORMS, PHISHING, DIRECTORY HARVEST ATTACKS, AND OTHER ELECTRONIC DATA THREATS; DESIGN, IMPLEMENTATION, AND MONITORING OF COMPUTER BACKUP AND DATA PRESERVATION SYSTEMS; ARRANGING FOR LEASING OF INFORMATION TECHNOLOGY SYSTEMS, TELECOMMUNICATIONS SYSTEMS, EQUIPMENT AND APPARATUS FOR OTHERS; TECHNICAL CONSULTATION IN THE FIELD OF DATA NETWORKING, INFORMATION TECHNOLOGY AND TELECOMMUNICATIONS INDUSTRIES, NAMELY, EQUIPMENT AND SYSTEMS TESTING AND ASSESSMENT OF DATA NETWORK, INFORMATION TECHNOLOGY SYSTEMS, AND TELECOMMUNICATIONS SYSTEMS FOR OTHERS (U.S. CLS. 100 AND 101).
JILL PRATER, EXAMINING ATTORNEY

Whispering Knowledge

THE MARK CONSISTS OF STANDARD CHARACTERS WITHOUT CLAIM TO ANY PARTICULAR FONT, STYLE, SIZE, OR COLOR.

CLASS 9—ELECTRICAL AND SCIENTIFIC APPARATUS

FOR DIGITAL MATERIALS, NAMELY, AUDIO AND VIDEO CDS, FEATURING MUSIC AND VIDEOS OF METAPHYSICAL EVENTS, SPIRITUAL LECTURES, METAPHYSICAL AND SPIRITUAL CLASSES AND TEACHINGS (U.S. CLS. 21, 23, 26, 36 AND 38).

CLASS 16—PAPER GOODS AND PRINTED MATTER

FOR PUBLICATIONS, NAMELY, BOOKS AND HAND-OUTS IN THE FIELD OF METAPHYSICAL EVENTS AND TEACHINGS IN METAPHYSICS (U.S. CLS. 2, 5, 22, 23, 29, 37, 38 AND 50).

CLASS 41—EDUCATION AND ENTERTAINMENT

FOR ENTERTAINMENT IN THE NATURE OF LECTURES AND CLASSES FEATURING METAPHYSICAL EVENTS AND METAPHYSICAL TEACHINGS (U.S. CLS. 100, 101 AND 107).
JANET LEE, EXAMINING ATTORNEY

SN 77-766,735. UNITED COLORS INTERNATIONAL LIMITED, KWAI CHUNG, HONG KONG, FILED 6-24-2009.

Blue Family

THE MARK CONSISTS OF STANDARD CHARACTERS WITHOUT CLAIM TO ANY PARTICULAR FONT, STYLE, SIZE, OR COLOR.

PRIORITY CLAIMED UNDER SEC. 44(D) ON HONG KONG APPLICATION NO. 301370079, FILED 6-23-2009.

PRIORITY CLAIMED UNDER SEC. 44(D) ON HONG KONG APPLICATION NO. 301360890, FILED 6-11-2009.

OWNER OF ERPN CMNTY TM OFC REG. NO. 008385049, DATED 12-24-2009, EXPIRES 6-24-2019.

CLASS 3—COSMETICS AND CLEANING PREPARATIONS

FOR COSMETIC SKINS CARE PRODUCTS, NAMELY, SKIN MOISTURIZING LOTIONS AND CREAMS; PREPARATIONS FOR SKIN CARE AND HAIR CARE NAMELY, SKIN MOISTURIZING LOTIONS AND CREAMS, SHAMPOO; MAKE-UP REMOVING PREPARATION; PERFUMES; COSMETICS; BODY CREAM; DEODORANT FOR PERSONAL USE; ESSENTIAL OILS; HAIR LOTIONS; OILS FOR PERFUMES AND SCENTS; PERFUMERY; SHAVING PREPARATIONS AND SOAPS (U.S. CLS. 1, 4, 6, 50, 51 AND 52).

CLASS 18—LEATHER GOODS

FOR HANDBAGS; WHEELED SHOPPING BAGS; BAGS; BACKPACKS; BAGS FOR CAMPERS, NAMELY, BACKPACKS; BAGS FOR CLIMBERS, NAMELY, BACKPACKS; BAGS FOR SPORTS; BAGS FOR SHOPPING, NOT OF PAPER OR PLASTIC; CARRYING CASES; HOLDALLS; WALLETS; PURSES; BELT BAGS; TRAVELING BAGS; UMBRELLAS; PARASOLS; GOODS MADE OF LEATHER AND OF IMITATION LEATHER, NAMELY, BAGS, WALLETS AND PURSES; BRIEF-CASES (U.S. CLS. 1, 2, 3, 22 AND 41).

SN 77-768,450. ULTIMATE ESCAPES HOLDINGS, LLC, KISSIMMEE, FL. FILED 6-25-2009.

**CLASS 25—CLOTHING**

FOR CLOTHING, NAMELY, TOPS, BOTTOMS, PANTS, SHIRTS, UNDERWEAR; FOOTWEAR; HEADGEAR, NAMELY, HATS AND CAPS; CAMISOLES, CLOTHING FOR GYMNASTICS, NAMELY, TOPS, BOTTOMS, PANTS, SHIRTS; HOSIERY, JACKETS, KNITWEAR, PYJAMAS, PANTS, PULLOVERS, DENIMS, DENIM SHIRTS, DENIM JACKETS, DENIM SKIRTS, GLOVES, JERSEYS, JUMPERS, SPORTSWEAR, NAMELY, TOPS, BOTTOMS, PANTS, SHIRTS; SWEATERS, READY-MADE CLOTHING, NAMELY, TOPS, BOTTOMS, PANTS, SHIRTS; SHIRTS, SKIRTS, SPORTS JERSEYS, TEE-SHIRTS, TROUSERS, UNIFORMS, VESTS, UNDERGARMENTS (U.S. CLS. 22 AND 39).

THE COLOR(S) BLUE AND LIGHT-BLUE IS/ARE CLAIMED AS A FEATURE OF THE MARK.

THE MARK CONSISTS OF TWO OVERLAPPING BLUE HANDS THAT OVERLAP WITH A COMMON PINKY FINGER, WITH A LIGHT-BLUE HEART LOCATED SYMMETRICALLY WHERE THE TWO BLUE HANDS OVERLAP.

CLASS 35—ADVERTISING AND BUSINESS

FOR CHARITABLE SERVICES, NAMELY, ORGANIZING AND CONDUCTING VOLUNTEER PROGRAMS AND COMMUNITY SERVICE PROJECTS TO SUPPORT NON-PROFIT ORGANIZATIONS; ORGANIZING AND CONDUCTING CHARITY AUCTIONS FOR CHARITABLE FUNDRAISING PURPOSES (U.S. CLS. 100, 101 AND 102).

FIRST USE 6-15-2009; IN COMMERCE 6-15-2009.

CLASS 36—INSURANCE AND FINANCIAL

FOR CHARITABLE FUNDRAISING; ORGANIZING AND CONDUCTING SPECIAL EVENTS FOR CHARITABLE FUNDRAISING PURPOSES (U.S. CLS. 100, 101 AND 102).

FIRST USE 6-15-2009; IN COMMERCE 6-15-2009.
ELISSA GARBER KON, EXAMINING ATTORNEY

CLASS 35—ADVERTISING AND BUSINESS

FOR RETAIL AND WHOLESALE STORE SERVICES FEATURING CLOTHING, FOOTWEAR AND HEADGEAR, CAMISOLES, CLOTHING FOR GYMNASTICS, HOSIERY, JACKETS, KNITWEAR, PYJAMAS, PANTS, PULLOVERS, DENIMS, DENIM SHIRTS, DENIM JACKETS, DENIM SKIRTS, GLOVES, JERSEYS, JUMPERS, SPORTSWEAR, SWEATERS, READY-MADE CLOTHING, SHIRTS, SKIRTS, SPORTS JERSEYS, TEE-SHIRTS, TROUSERS, UNDERWEAR, UNIFORMS AND VESTS, COSMETIC SKINS CARE PRODUCTS, PREPARATIONS FOR SKIN CARE AND HAIR CARE, MAKE-UP REMOVING PREPARATION, PERFUMES, COSMETICS, COSMETIC CREAM, DEODORANT, ESSENTIAL OILS, HAIR LOTIONS, OILS FOR PERFUMES AND SCENTS, PERFUMERY, SHAVING PREPARATIONS AND SOAPS, HANDBAGS, WHEELED SHOPPING BAGS, BAGS, BACKPACKS, BAGS FOR CAMPERS, BAGS FOR CLIMBERS, BAGS FOR SPORTS, BAGS FOR SHOPPING; CASES, HOLDALLS, WALLETS, PURSES, BELTS, TRAVELING BAGS, UMBRELLAS, PARASOLS, GOODS MADE OF LEATHER AND OF IMITATION LEATHER, BRIEFCASES; ADVERTISING AND PROMOTIONAL SERVICES; BUSINESS MANAGEMENT SERVICES; ADVISORY CONSULTANCY, INFORMATION AND MANAGEMENT SERVICES IN THE FIELD OF ADVERTISING, PROMOTION AND BUSINESS (U.S. CLS. 100, 101 AND 102).

DAVID HOFFMAN, EXAMINING ATTORNEY

SN 77-768,738. LMFAO, LLC, BEVERLY HILLS, CA. FILED 6-25-2009.

Party Rock

NO CLAIM IS MADE TO THE EXCLUSIVE RIGHT TO USE "ROCK" AS TO CLASS 9 & 41 ONLY, APART FROM THE MARK AS SHOWN.

THE MARK CONSISTS OF "PARTY ROCK" IN STYLIZED FONT.

CLASS 9—ELECTRICAL AND SCIENTIFIC APPARATUS

FOR DIGITAL MATERIALS, NAMELY, CDS, DVDS AND MP3S, FEATURING MUSIC; DOWNLOADABLE MUSIC AND MUSIC VIDEOS PROVIDED VIA TELEVISION, CABLE, SATELLITE, INTERNET, CELL PHONES, VIDEO GAMING SYSTEMS AND PORTABLE ELECTRONIC DEVICES FOR RECORDING, ORGANIZING, TRANSMITTING, MANIPULATING, AND REVIEWING TEXT, DATA, AUDIO, IMAGE, AND VIDEO FILES; SUNGLASSES AND EYEGLASS FRAMES (U.S. CLS. 21, 23, 26, 36 AND 38).

CLASS 25—CLOTHING

FOR APPAREL, NAMELY, T-SHIRTS, SWEAT SHIRTS, SWEAT PANTS, TANKS TOPS, JACKETS, SUITS, VESTS, PANTS, SHORTS, LEGGINGS, SKIRTS, DRESSES, BATHING SUITS, BANDANAS, BRAS, UNDERWEAR, SOCKS, SCARVES, WRISTBANDS, BELTS FOR CLOTHING, FOOTWEAR, HEADWEAR, HATS, HEADBANDS, CAPS, VISORS, STOCKINGS, TIGHTS, PANTYHOSE, BOARD SHORTS, AND BEACH COVER UPS (U.S. CLS. 22 AND 39).

CLASS 41—EDUCATION AND ENTERTAINMENT

FOR MUSIC PUBLISHING SERVICES (U.S. CLS. 100, 101 AND 107).

JULIE VEPPUMTHARA, EXAMINING ATTORNEY

SN 77-768,821. POLICHEM S.A., L-1526, LUXEMBOURG, FILED 6-26-2009.

PHYTOGYNE

THE MARK CONSISTS OF STANDARD CHARACTERS WITHOUT CLAIM TO ANY PARTICULAR FONT, STYLE, SIZE, OR COLOR.

CLASS 3—COSMETICS AND CLEANING PREPARATIONS

FOR NON-MEDICATED COSMETICS FOR GYNECOLOGICAL USE, NAMELY, GELS, CREMES, AND SOLUTIONS (U.S. CLS. 1, 4, 6, 50, 51 AND 52).

CLASS 5—PHARMACEUTICALS

FOR GYNECOLOGICAL PHARMACEUTICALS; GELS AND CREMES FOR VAGINAL LUBRICATION (U.S. CLS. 6, 18, 44, 46, 51 AND 52).

JANET LEE, EXAMINING ATTORNEY

SN 77-769,230. DODA COSTRUZIONE MACCHINE AGRICOLE DI DODA ALSO & C. S.N.C., MARCARIA (MANTOVA), ITALY, FILED 6-26-2009.

DODA

THE MARK CONSISTS OF STANDARD CHARACTERS WITHOUT CLAIM TO ANY PARTICULAR FONT, STYLE, SIZE, OR COLOR.

THE WORDING "DODA" HAS NO MEANING IN A FOREIGN LANGUAGE.

CLASS 7—MACHINERY

FOR SEWAGE SPECIAL PUMPS AND PUMPS FOR BIOGAS DIGESTERS; MACHINES AND MACHINE TOOLS FOR THE CUTTING AND FORMING OF MATERIALS; MACHINE TOOLS, NAMELY, DIES, LATHES AND GEAR CUTTERS; MOTORS AND ENGINES EXCEPT FOR LAND VEHICLES AND MACHINE COUPLING AND TRANSMISSION COMPONENTS EXCEPT FOR LAND VEHICLES; AGRICULTURAL IMPLEMENTS OTHER THAN HAND-OPERATED, NAMELY, CHOPPERS AND SEPARATORS FOR PROCESSING FOOD-RELATED ORGANIC RESIDUALS; MECHANICAL WASTE DISPOSALS; INCUBATORS FOR EGGS (U.S. CLS. 13, 19, 21, 23, 31, 34 AND 35).

FIRST USE 1-0-1970; IN COMMERCE 1-0-1975.

CLASS 11—ENVIRONMENTAL CONTROL APPARATUS

FOR MIXERS AND OXYGENATORS FOR WASTE FLUID AND SEWAGE TREATMENT; WATER PURIFICATION MACHINES (U.S. CLS. 13, 21, 23, 31 AND 34).

FIRST USE 1-1-1970; IN COMMERCE 1-1-1975.

AISHA CLARKE, EXAMINING ATTORNEY

SN 77-769,271. GREEN BADGE LLC, DBA ADVANCED SENSOR TECHNOLOGY, INC., KING OF PRUSSIA, PA. FILED 6-26-2009.



THE MARK CONSISTS OF DEPICTION OF A DOG WITH THE WORD "UGMO".

THE WORDING "UGMO" HAS NO MEANING IN A FOREIGN LANGUAGE.

CLASS 9—ELECTRICAL AND SCIENTIFIC APPARATUS

FOR COMPUTER HARDWARE AND SOFTWARE USED TO ANALYZE, INTERPRET AND/OR ACT ON DATA RECEIVED FROM WIRELESS SENSORS AND COMMUNICATIONS NETWORK SYSTEMS FOR MONITORING, CONTROLLING, AND/OR REGULATING THE PHYSICAL AND/OR CHEMICAL PROPERTIES AND/OR CONDITIONS OF SOIL, TURF, AND WATER, AND THE METEOROLOGICAL AND ENVIRONMENTAL CONDITIONS OF THE SAME (U.S. CLS. 21, 23, 26, 36 AND 38).

FIRST USE 2-28-2009; IN COMMERCE 2-28-2009.

CLASS 35—ADVERTISING AND BUSINESS

FOR DATA PROCESSING SERVICES RELATING TO DATA RECEIVED FROM WIRELESS SENSORS USED TO MONITOR, CONTROL AND/OR REGULATE THE PHYSICAL AND/OR CHEMICAL PROPERTIES AND/OR CONDITIONS OF SOIL, TURF, AND WATER, AND METEOROLOGICAL AND ENVIRONMENTAL CONDITIONS OF THE SAME (U.S. CLS. 100, 101 AND 102).

FIRST USE 2-28-2009; IN COMMERCE 2-28-2009.

CLASS 42—SCIENTIFIC AND COMPUTER SERVICES

FOR TECHNICAL SUPPORT, NAMELY, MONITORING OF WIRELESS SENSORS USED TO MONITOR, CONTROL AND/OR REGULATE THE PHYSICAL AND/OR CHEMICAL PROPERTIES AND/OR CONDITIONS OF SOIL, TURF, AND WATER, AND METEOROLOGICAL AND ENVIRONMENTAL CONDITIONS OF THE SAME (U.S. CLS. 100 AND 101).

FIRST USE 2-28-2009; IN COMMERCE 2-28-2009.

BILL DAWE, EXAMINING ATTORNEY

SN 77-771,014. SEED CO., LTD, OSAKA, JAPAN, FILED 6-30-2009.

THE MARK CONSISTS OF THE STYLIZED WORD "SEED".

CLASS 7—MACHINERY

FOR MACHINERY FOR THE MECHANICAL RECYCLING OF USED PAPER, NAMELY, MACHINES FOR PULP MAKING, PAPER SHREDDING MACHINES, CRUSHING UNITS AND BEATING UNITS FOR PULP MAKING MACHINES, AND BEATING MACHINES AND MASHING MACHINES FOR USE IN BEATING UNITS; MACHINES FOR PAPER MAKING; PAPER-MAKING MACHINERY, NAMELY, PAPER PULP FEEDING UNITS, PAPER MAKING NET CONVEYOR UNITS, DEWATERING ROLL UNITS, DRYING BELT CONVEYOR UNITS, SMOOTH SURFACE FINISHING ROLL UNITS AND HEATER PLATE UNITS FOR PAPER MAKING APPARATUS, MESH BELTS FOR PAPER MAKING NET CONVEYOR UNITS, DEWATERING ROLLS AND PRESS ROLLS FOR DEWATERING ROLL UNITS, SMOOTH SURFACE BELTS FOR DRYING BELT CONVEYOR UNITS (U.S. CLS. 13, 19, 21, 23, 31, 34 AND 35).

CLASS 16—PAPER GOODS AND PRINTED MATTER

FOR OFFICE EQUIPMENT, NAMELY, PAPER SHREDDERS FOR OFFICE USE (U.S. CLS. 2, 5, 22, 23, 29, 37, 38 AND 50).

HEATHER THOMPSON, EXAMINING ATTORNEY

SN 77-771,044. JACKSON JR, EDWARD D., DBA ISOMA COSMETICS, PALISADES PARK, NJ. FILED 6-30-2009.

ISOMA COSMETICS

THE MARK CONSISTS OF STANDARD CHARACTERS WITHOUT CLAIM TO ANY PARTICULAR FONT, STYLE, SIZE, OR COLOR.

NO CLAIM IS MADE TO THE EXCLUSIVE RIGHT TO USE "COSMETICS", APART FROM THE MARK AS SHOWN.

CLASS 3—COSMETICS AND CLEANING PREPARATIONS

FOR BODY AND BEAUTY CARE COSMETICS (U.S. CLS. 1, 4, 6, 50, 51 AND 52).

FIRST USE 1-1-2005; IN COMMERCE 1-1-2005.

CLASS 21—HOUSEWARES AND GLASS

FOR FACIAL SPONGES FOR APPLYING MAKE-UP; MAKE-UP BRUSHES (U.S. CLS. 2, 13, 23, 29, 30, 33, 40 AND 50).

FIRST USE 1-1-2005; IN COMMERCE 1-1-2005.

KATHERINE M. DUBRAY, EXAMINING ATTORNEY

SN 77-771,458. EZOSE SCIENCES, INC., PINE BROOK, NJ.
FILED 6-30-2009.

SN 77-771,500. SIKICH LLP, AURORA, IL. FILED 6-30-2009.

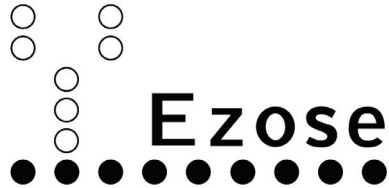

THE MARK CONSISTS OF A SERIES OF DOTS ARRANGED TO RESEMBLE THE LETTER "Y". THE STYLIZED WORDS "EZOSE" APPEAR TO THE LEFT OF THE "Y"-FORMATION; A SECOND SERIES OF DOTS UNDERLINE THE WORD "EZOSE".

CLASS 1—CHEMICALS

FOR DIAGNOSTIC REAGENTS FOR RESEARCH, CLINICAL, OR MEDICAL LABORATORY USE; DIAGNOSTIC KITS COMPRISED OF REAGENTS AND ASSAYS FOR RESEARCH, SCIENTIFIC, CLINICAL, AND MEDICAL PURPOSES (U.S. CLS. 1, 5, 6, 10, 26 AND 46).

CLASS 35—ADVERTISING AND BUSINESS

FOR WHOLESALE DISTRIBUTORSHIP SERVICES OF PHARMACEUTICAL PREPARATIONS, VACCINES, AND DIAGNOSTIC AND THERAPEUTIC APPLICATIONS (U.S. CLS. 100, 101 AND 102).

CLASS 42—SCIENTIFIC AND COMPUTER SERVICES

FOR SCIENTIFIC RESEARCH AND DEVELOPMENT; RESEARCH AND DEVELOPMENT OF VACCINES, MEDICINES, AND PHARMACEUTICAL PREPARATIONS FOR MEDICAL AND DIAGNOSTIC PURPOSES; SCIENTIFIC AND BIOTECHNOLOGY LABORATORY RESEARCH SERVICES; PROVIDING MEDICAL AND SCIENTIFIC RESEARCH INFORMATION IN THE FIELD OF PHARMACEUTICALS AND CLINICAL TRIALS; PROVIDING ANALYSIS OF CLINICAL TRIAL DATA IN THE PHARMACEUTICAL AND BIOTECHNOLOGY INDUSTRIES (U.S. CLS. 100 AND 101).

CLASS 45—PERSONAL AND LEGAL SERVICES

FOR LICENSING OF INTELLECTUAL PROPERTY, NAMELY, GRANTING LICENSES IN THE FIELD OF BIOTECHNOLOGY (U.S. CLS. 100 AND 101).
NATALIE POLZER, EXAMINING ATTORNEY

DEFINITELY DIFFERENT

THE MARK CONSISTS OF STANDARD CHARACTERS WITHOUT CLAIM TO ANY PARTICULAR FONT, STYLE, SIZE, OR COLOR.

CLASS 35—ADVERTISING AND BUSINESS

FOR BUSINESS CONSULTATION SERVICES; ACCOUNTING SERVICES; PERSONNEL MANAGEMENT CONSULTING SERVICES; MANAGEMENT OF THE OFFICES OF HEALTHCARE PROVIDERS; AND ADVERTISING AND MARKETING SERVICES, NAMELY, PREPARING DIRECT MAIL ADVERTISING AND BUSINESS MARKETING CONSULTING SERVICES; TRADEMARK AND LOGO DESIGN SERVICES (U.S. CLS. 100, 101 AND 102).

CLASS 36—INSURANCE AND FINANCIAL

FOR ASSET MANAGEMENT SERVICES, NAMELY, INVESTMENT ADVISORY SERVICES, INVESTMENT ANALYSIS, PORTFOLIO MANAGEMENT AND RETIREMENT PLAN INVESTMENT MANAGEMENT (U.S. CLS. 100, 101 AND 102).

CLASS 42—SCIENTIFIC AND COMPUTER SERVICES

FOR INFORMATION TECHNOLOGY SERVICES, NAMELY, DEVELOPING CUSTOMIZED SOFTWARE FOR USE ON A GLOBAL COMPUTER NETWORK AND ON PERSONAL COMPUTERS, DESIGNING LOCAL AND WIDE AREA COMPUTER NETWORKS; PACKAGING DESIGN SERVICES; DESIGNING AND DEVELOPING COMPUTER SOFTWARE AND COMPUTER NETWORKS FOR OTHERS; AND CONSULTATION IN THE FIELD OF DESIGNING AND DEVELOPING COMPUTER SOFTWARE AND COMPUTER NETWORKS; TECHNICAL SUPPORT, NAMELY, MONITORING OF NETWORK SYSTEMS (U.S. CLS. 100 AND 101).
ALLISON HOLTZ, EXAMINING ATTORNEY

SN 77-771,699. GOOGLE INC., MOUNTAIN VIEW, CA.
FILED 6-30-2009.

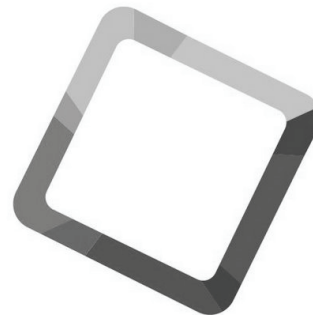

THE MARK CONSISTS OF AN OUTLINE OF A SQUARE/DIAMOND SHAPE, WITH THE OUTLINE ITSELF COMPRISED OF VARYING SHADED BANDS OR MISCELLANEOUS GEOMETRIC SHAPES, WITHOUT CLAIM TO ANY PARTICULAR SIZE OR COLOR.

CLASS 38—COMMUNICATION

FOR TELECOMMUNICATIONS SERVICES, NAMELY, ELECTRONIC TRANSMISSION OF DATA, MESSAGES, AND INFORMATION OVER THE GLOBAL COMPUTER NETWORK AND WIRELESS COMMUNICATION NETWORKS; PROVIDING MULTIPLE USER ACCESS OVER THE GLOBAL COMPUTER NETWORK AND WIRELESS COMMUNICATION NETWORKS TO ONLINE BLOGS FOR UPLOADING, POSTING, DISPLAYING, AND ELECTRONICALLY TRANSMITTING DATA, INFORMATION, AUDIO, VIDEO IN THE FIELD OF GENERAL INTEREST (U.S. CLS. 100, 101 AND 104).

CLASS 41—EDUCATION AND ENTERTAINMENT

FOR PROVISION OF ON-LINE JOURNALS, NAMELY, BLOGS FEATURING USER-DEFINED CONTENT IN THE FIELD OF GENERAL INTEREST; ELECTRONIC PUBLISHING SERVICES FOR OTHERS, NAMELY, PUBLICATION OF TEXT, AUDIO, VIDEO, AND GRAPHIC WORKS OF OTHERS ON-LINE FEATURING USER-DEFINED CONTENT IN THE FIELD OF GENERAL INTEREST (U.S. CLS. 100, 101 AND 107).

CLASS 45—PERSONAL AND LEGAL SERVICES

FOR ON-LINE SOCIAL NETWORKING SERVICES (U.S. CLS. 100 AND 101).
KAELE KUNG, EXAMINING ATTORNEY

CLASS 3—COSMETICS AND CLEANING PREPARATIONS

FOR 3-IN-1 HAIR SHAMPOOS; AFTER-SUN GELS; AFTER-SUN MILKS; AFTER-SUN OILS; BATH OILS FOR COSMETIC PURPOSES; BATH POWDER; BODY AND BEAUTY CARE COSMETICS; CLEANSING CREAMS; COLOGNES, PERFUMES AND COSMETICS; SKIN CONCEALERS; COSMETIC CREAMS; COSMETIC CREAMS FOR SKIN CARE; COSMETIC MASKS; COSMETIC MILKS; COSMETIC OILS; COSMETIC OILS FOR THE EPIDERMIS; COSMETIC OLIVE OIL FOR THE FACE AND BODY; COSMETIC PENCILS; COSMETIC PREPARATIONS; COSMETIC PREPARATIONS AGAINST SUNBURN; COSMETIC PREPARATIONS FOR BODY CARE; COSMETIC PREPARATIONS FOR EYE LASHES; COSMETIC PREPARATIONS FOR SKIN RENEWAL; COSMETIC PREPARATIONS FOR THE CARE OF MOUTH AND TEETH; COSMETIC PREPARATIONS FOR THE HAIR AND SCALP; COSMETIC PREPARATIONS, NAMELY, FIRMING CREAMS; COSMETIC PREPARATIONS, NAMELY, FIRMING LOTIONS; COSMETIC PREPARATIONS, NAMELY, SKIN BALSAMS; COSMETIC PRODUCTS IN THE FORM OF AEROSOLS FOR SKIN CARE; COSMETIC PRODUCTS IN THE FORM OF AEROSOLS FOR SKINCARE; COSMETIC ROUGES; COSMETIC SOAPS; COSMETIC SUN-PROTECTING PREPARATIONS; COSMETIC SUN-TANNING PREPARATIONS; COSMETIC SUNTAN LOTIONS; COSMETICS; COSMETICS AND COSMETIC PREPARATIONS; COSMETICS AND MAKE-UP; COSMETICS FOR ANIMALS; COSMETICS IN GENERAL, INCLUDING PERFUMES; COSMETICS IN THE FORM OF MILKS, LOTIONS AND EMULSIONS; COSMETICS, NAMELY, COMPACTS; DETERGENT SOAP; DETERGENTS FOR HOUSEHOLD USE; EYEBROW COSMETICS; FACE CREAMS FOR COSMETIC USE; HAIR SHAMPOO; HAIR SHAMPOOS AND CONDITIONERS; LAUNDRY DETERGENT; LAUNDRY DETERGENTS; NAIL VARNISH FOR COSMETIC PURPOSES; NUTRITIONAL OILS FOR COSMETIC PURPOSES; PENCILS FOR COSMETIC PURPOSES; PERFUME OILS FOR THE MANUFACTURE OF COSMETIC PREPARATIONS; PRE-MOISTENED COSMETIC TISSUES; ROSE OIL FOR COSMETIC PURPOSES; SELF-TANNING PREPARATIONS; SKIN AND BODY TOPICAL LOTIONS, CREAMS AND OILS FOR COSMETIC USE; SKIN CONDITIONING CREAMS FOR COSMETIC PURPOSES; SKIN FRESHENERS; SOAPS; SOAPS AND DETERGENTS; SOLID POWDER FOR COMPACTS; SUNTAN OILS FOR COSMETIC PURPOSES; TANNING AND AFTER-SUN MILKS, GELS AND OILS; TANNING GELS; TANNING MILKS; TANNING OILS (U.S. CLS. 1, 4, 6, 50, 51 AND 52).

SN 77-771,789. CHINA DRAGONS LIMITED, MAURITIUS, MAURITIUS, FILED 6-30-2009.

Crosscity

CLASS 14—JEWELRY

FOR BODY-PIERCING RINGS; BOXES OF PRECIOUS METAL; BRACELETS; BRACELETS OF PRECIOUS METAL; CASES FOR CLOCK AND WATCH-MAKING; CASES FOR WATCHES AND CLOCKS; CLOCKS AND WATCHES; CUFF LINKS; CUFF LINKS AND TIE CLIPS; CUFF LINKS OF PRECIOUS METAL; DRESS WATCHES; JEWEL CASES OF PRECIOUS METAL; JEWELRY AND WATCHES; JEWELRY PLATED WITH PRECIOUS METALS; JEWELRY, CLOCKS AND WATCHES; JEWELRY BOXES NOT OF METAL; JEWELRY BOXES OF METAL; JEWELRY CHAINS; JEWELRY RING HOLDERS; JEWELRY WATCHES; KEY CHAINS OF PRECIOUS METAL; KEY HOLDERS OF PRECIOUS METALS; KEY RINGS OF PRECIOUS METAL; LAPEL PINS; MECHANICAL AND AUTOMATIC WATCHES; NECK CHAINS; NECKLACES; ORNAMENTAL LAPEL PINS; PERSONAL ORNAMENTS OF PRECIOUS METAL; PRECIOUS METAL ALLOYS; RINGS; SMALL JEWELRY BOXES OF PRECIOUS METALS; TIE PINS; TIE-PINS OF PRECIOUS METAL; WATCH BOXES; WATCH BRACELETS; WATCH CHAINS; WATCH STRAPS MADE OF METAL OR LEATHER OR PLASTIC; WRIST WATCHES (U.S. CLS. 2, 27, 28 AND 50).

THE MARK CONSISTS OF STANDARD CHARACTERS WITHOUT CLAIM TO ANY PARTICULAR FONT, STYLE, SIZE, OR COLOR.

CLASS 18—LEATHER GOODS

FOR BACKPACKS, BOOK BAGS, SPORTS BAGS, BUM BAGS, WALLETS AND HANDBAGS; BAGS FOR UMBRELLAS; BEACH BAGS; BELT BAGS; CARD WALLETS; CARRY-ON BAGS; CLUTCH BAGS; CLUTCH PURSES; CLUTCHES; COIN HOLDERS IN THE NATURE OF WALLETS; DUFFEL BAGS; GARMENT BAGS FOR TRAVEL; GARMENT BAGS FOR TRAVEL MADE OF LEATHER; GENERAL PURPOSE BAGS FOR CARRYING YOGA EQUIPMENT; GYM BAGS; HANDBAGS, PURSES AND WALLETS; JEWELRY ORGANIZERS FOR TRAVEL; KEY WALLETS; LEATHER AND IMITATION LEATHER BAGS; LEATHER BAGS AND WALLETS; LEATHER BAGS, SUITCASES AND WALLETS; LEATHER BINDERS FOR TRAVEL PURPOSES; LEATHER CREDIT CARD WALLETS; LEATHER PURSES; LEATHER SHOPPING BAGS; MAKE-UP BAGS SOLD EMPTY; MEN'S CLUTCH BAGS; MILITARY DUFFLE BAGS, GARMENT BAGS FOR TRAVEL, TOTE BAGS, SHOULDER BAGS AND BACKPACKS; MULTI-PURPOSE PURSES; POCKET WALLETS; PURSES AND WALLETS; PURSES AND WALLETS OF PRECIOUS METAL; PURSES MADE OF PRECIOUS METAL; SUIT BAGS; TRAVEL BAGS; WAIST BAGS; WALLETS; WHEELED BAGS (U.S. CLS. 1, 2, 3, 22 AND 41).

CLASS 35—ADVERTISING AND BUSINESS

FOR ADVERTISING AND BUSINESS MANAGEMENT CONSULTANCY; ASSISTANCE AND ADVICE REGARDING BUSINESS ORGANIZATION AND MANAGEMENT; CATALOG ORDERING SERVICE FEATURING CLOTHING, FOOTWEAR AND HEADWEAR; MAIL ORDER SERVICES FEATURING CLOTHING AND FOOTWEAR; BUSINESS CONSULTATION; PUBLIC RELATIONS, ADVERTISING AND MARKETING SERVICES FOR THE TOURISM AND CONVENTION INDUSTRY, NAMELY, ORGANIZING AND HOSTING SITE INSPECTIONS AND FAMILIARIZATION TOURS FOR WHOLESALERS, TOUR OPERATORS, TRAVEL AGENTS, MEETING AND INCENTIVE TRAVEL PLANNERS AND TRAVEL MEDIA; RENTAL OF ADVERTISING SPACE; RENTAL OF ADVERTISING SPACE ON WEB SITES; RENTAL OF ALL PUBLICITY AND MARKETING PRESENTATION MATERIALS; RETAIL CLOTHING BOUTIQUES; RETAIL CLOTHING STORES; WHOLESALE AND RETAIL STORE SERVICES FEATURING CLOTHING, FOOTWEAR; WHOLESALE DISTRIBUTORSHIPS FEATURING CLOTHING, FOOTWEAR (U.S. CLS. 100, 101 AND 102).
BARBARA A. GOLD, EXAMINING ATTORNEY

SN 77-771,885. AWESUN RENEWABLE ENERGY, INC.,
LITTLETON, CO. FILED 6-30-2009.

AWESUN

CLASS 25—CLOTHING

FOR ATHLETIC APPAREL, NAMELY, SHIRTS, PANTS, JACKETS, FOOTWEAR, HATS AND CAPS, ATHLETIC UNIFORMS; ATHLETIC FOOTWEAR; BEACH FOOTWEAR; BELTS; BELTS FOR CLOTHING; BOMBER JACKETS; BOTTOMS; CLOTHING, NAMELY, WRAP-AROUNDS; COATS; COATS FOR MEN AND WOMEN; COATS MADE OF COTTON; COATS OF DENIM; DENIM JACKETS; DOWN JACKETS; DRESS SHIRTS; DRESS SUITS; DRESSES; DRESSING GOWNS; DUST COATS; EVENING DRESSES; FLIP FLOPS; FOOTWEAR; FOOTWEAR FOR MEN AND WOMEN; FOOTWEAR FOR WOMEN; FUR COATS; FUR COATS AND JACKETS; FUR JACKETS; GLOVES AS CLOTHING; HEADGEAR, NAMELY, HATS, CAPS; HEAVY JACKETS; HOODED SWEAT SHIRTS; JACKETS; JACKETS AND SOCKS; JERSEYS; JOGGING PANTS; KNIT SHIRTS; LEATHER BELTS; LEATHER COATS; LEATHER JACKETS; LEATHER PANTS; LIGHT-REFLECTING JACKETS; LONG JACKETS; LONG-SLEEVED SHIRTS; MEN'S AND WOMEN'S JACKETS, COATS, TROUSERS, VESTS; MEN'S DRESS SOCKS; MOTORCYCLE JACKETS; OPEN-NECKED SHIRTS; OUTER JACKETS; OVER COATS; PANTS; PIQUE SHIRTS; POLO SHIRTS; RAIN COATS; RAIN JACKETS; RAINPROOF JACKETS; REVERSIBLE JACKETS; SCARFS; SHIRTS AND SHORT-SLEEVED SHIRTS; SHIRTS FOR SUITS; SHORT SETS; SKI JACKETS; SKI PANTS; SKIRT SUITS; SKIRTS; SKIRTS AND DRESSES; SNOWBOARD PANTS; SPORTS JACKETS; SPORTS PANTS; STRETCH PANTS; SUEDE JACKETS; SUIT COATS; SWEAT JACKETS; SWEAT PANTS; SWEAT SHIRTS; T-SHIRTS; TEE SHIRTS; TIES; TOP COATS; TOPS; TRENCH COATS; TURTLE NECK SHIRTS; WATERPROOF JACKETS AND PANTS; WEARABLE GARMENTS AND CLOTHING, NAMELY, SHIRTS; WIND RESISTANT JACKETS; WIND-JACKETS; WRAPS (U.S. CLS. 22 AND 39).

THE MARK CONSISTS OF STANDARD CHARACTERS WITHOUT CLAIM TO ANY PARTICULAR FONT, STYLE, SIZE, OR COLOR.

CLASS 37—CONSTRUCTION AND REPAIR

FOR HOME ENERGY ASSESSMENT SERVICES FOR THE PURPOSE OF DETERMINING HOME IMPROVEMENTS NEEDED TO IMPROVE ENERGY USE AND EFFICIENCY; INSTALLATION AND MAINTENANCE OF RENEWABLE ENERGY SYSTEM, NAMELY, SOLAR AND PHOTOVOLTAIC ENERGY SYSTEMS; ASSOCIATED MECHANICAL, ELECTRICAL AND ELECTRONIC EQUIPMENT; AND ASSOCIATED ENERGY STORAGE, DISTRIBUTION AND MONITORING EQUIPMENT (U.S. CLS. 100, 103 AND 106).

CLASS 42—SCIENTIFIC AND COMPUTER SERVICES

FOR DESIGN OF SOLAR PHOTOVOLTAIC SYSTEMS; RESEARCH AND DEVELOPMENT AND CONSULTATION RELATED THERETO IN THE FIELD OF SOLAR RENEWABLE ENERGY FACILITIES, NAMELY, SOLAR PHOTOVOLTAIC SYSTEMS; SUSTAINABLE BUILDING CONSTRUCTION CONSULTATION; AND PERFORMANCE OF BUILDING ENERGY EFFICIENCY AUDITS; TECHNICAL PLANNING OF PHOTOVOLTAIC INSTALLATIONS; TECHNICAL PLANNING OF SOLAR ENERGY BASED POWER PLANTS (U.S. CLS. 100 AND 101).

SHARON MEIER, EXAMINING ATTORNEY

SN 77-773,375. THE INGREDIENTS COMPANY B.V., 3016 DR ROTTERDAM, NETHERLANDS, FILED 7-2-2009.



OWNER OF BENELUX REG. NO. 0867161, DATED 11-10-2009, EXPIRES 6-24-2019.

THE MARK CONSISTS OF THE LETTERS "D E" WITH THE LEFT STEM OF THE LETTER "D" APPEARING WITH A DELETED PORTION AND THE MIDDLE OF THE RIGHT STEM OF THE LETTER "D" AND THE MIDDLE OF THE LEFT STEM OF THE LETTER "E" INTERSECTED WITH THE WORDING "DE KLOMPEN" AND A DESIGN OF A PAIR OF SHOES.

THE ENGLISH TRANSLATION OF "DE KLOMPEN" IN THE MARK IS THE WOODEN SHOES OR CLOGS.

CLASS 29—MEATS AND PROCESSED FOODS

FOR MEAT, FISH, POULTRY AND GAME; MEAT EXTRACTS; PRESERVED, FROZEN, DRIED AND COOKED FRUITS AND VEGETABLES; JELLIES, JAMS, COMPOTES; EGGS, MILK AND MILK PRODUCTS EXCLUDING ICE CREAM, ICE MILK AND FROZEN YOGURT; EDIBLE OILS AND FATS (U.S. CL. 46).

CLASS 30—STAPLE FOODS

FOR COFFEE, TEA, COCOA, SUGAR, RICE, TAPIOCA, SAGO, ARTIFICIAL COFFEE; FLOUR AND PREPARATIONS MADE FROM CEREALS, NAMELY, NOODLES, CEREAL-BASED SNACK FOOD, PROCESS CEREALS AND BAKERY DESSERTS; MIXES FOR BAKERY GOODS; BREAD, PASTRY AND FROZEN CONFECTIONERY, CONFECTIONERY CHIPS FOR BAKING; HONEY, TREACLE; YEAST, BAKING-POWDER; SALT, MUSTARD; VINEGAR, SAUCES, CONDIMENTS, NAMELY, PEPPER SAUCE, MUSTARD, KETCHUP, AND HORSERADISH; SPICES; ICE (U.S. CL. 46).

CLASS 35—ADVERTISING AND BUSINESS

FOR BUSINESS MANAGEMENT; GOODS IMPORT-EXPORT AGENCIES; IMPORT AND EXPORT AGENCIES; RETAIL AND WHOLESALE GROCERY STORES; MEDIATION OF TRADE BUSINESS FOR THIRD PARTIES AND BUSINESS ADVISORY SERVICES IN THE FIELD OF GROCERY PRODUCTS; CONSULTANCY REGARDING BUSINESS ORGANIZATION AND DEVELOPMENT OF CONCEPTS FOR BUSINESS ECONOMY; BUSINESS RISK MANAGEMENT CONSULTATION AND BUSINESS INFORMATION SERVICES; MARKETING AND PROMOTION SERVICES, MARKET ANALYSIS AND RESEARCH SERVICES; BUSINESS ADMINISTRATION (U.S. CLS. 100, 101 AND 102).

SAMUEL E. SHARPER JR., EXAMINING ATTORNEY

SN 77-773,686. DORMA PROPERTIES, INC., WILMINGTON, DE. FILED 7-2-2009.

SKC

THE MARK CONSISTS OF STANDARD CHARACTERS WITHOUT CLAIM TO ANY PARTICULAR FONT, STYLE, SIZE, OR COLOR.

OWNER OF U.S. REG. NOS. 1,557,624, 2,655,540 AND OTHERS.

CLASS 6—METAL GOODS

FOR METAL KEYS FOR LOCKS; METAL LOCKS; METAL SECURITY LOCK CYLINDERS (U.S. CLS. 2, 12, 13, 14, 23, 25 AND 50).

CLASS 45—PERSONAL AND LEGAL SERVICES

FOR ONLINE SECURITY SERVICES IN THE NATURE OF PROVIDING INFORMATION RELATED TO THE TRACKING, LOCATING AND MONITORING OF ENCODED KEYS; PROVIDING ONLINE TRACKING, LOCATING AND MONITORING SERVICES FOR RECOVERING LOST KEYS (U.S. CLS. 100 AND 101).

MORGAN WYNNE, EXAMINING ATTORNEY

SN 77-774,877. LEGATUM FOUNDATION LIMITED, DUBAI, UNITED ARAB EMIR., FILED 7-6-2009.

LEGATUM PROSPERITY INDEX

THE MARK CONSISTS OF STANDARD CHARACTERS WITHOUT CLAIM TO ANY PARTICULAR FONT, STYLE, SIZE, OR COLOR.

OWNER OF ERP N CMNTY TM OFC REG. NO. 007422827, DATED 6-16-2009, EXPIRES 11-26-2018.

OWNER OF U.S. REG. NO. 3,540,408.

NO CLAIM IS MADE TO THE EXCLUSIVE RIGHT TO USE "PROSPERITY INDEX", APART FROM THE MARK AS SHOWN.

CLASS 35—ADVERTISING AND BUSINESS

FOR ECONOMIC FORECASTING AND ANALYSIS; PROVIDING AN ON-LINE COMMERCIAL INFORMATION DIRECTORY ON THE INTERNET; PROVIDING ON-LINE COMPUTER DATABASES IN THE FIELD OF CHARITIES, NAMELY, PROVIDING AN INTERACTIVE COMPUTER DATABASE THAT ALLOWS USERS TO SEARCH AND RETRIEVE INFORMATION REGARDING CHARITABLE ORGANIZATIONS SO THAT USERS CAN MATCH THEIR INTERESTS WITH CHARITIES (U.S. CLS. 100, 101 AND 102).

CLASS 36—INSURANCE AND FINANCIAL

FOR FINANCIAL SERVICES, NAMELY, FINANCIAL EVALUATION, RESEARCH AND ANALYSIS; PROVISION OF FINANCIAL INFORMATION, NAMELY, INFORMATION IN THE FORM OF FINANCIAL REPORTS; FINANCIAL PLANNING; FINANCIAL STRATEGY SERVICES, NAMELY, THE CREATION OF PERSONALIZED STRATEGIES TO ACHIEVE FINANCIAL INDEPENDENCE; CONDUCTING FINANCIAL STUDIES, NAMELY, STUDIES INTO ECONOMIC WEALTH AND THE ENVIRONMENTAL AND SOCIOLOGICAL FACTORS INFLUENCING WEALTH; INVESTMENT SERVICES, NAMELY, INVESTMENT ADVISORY SERVICES, INVESTMENT BANKING SERVICES AND CAPITAL INVESTMENT SERVICES; FINANCIAL SERVICES RELATING TO CHARITABLE GIVING, NAMELY, PROVIDING ONLINE INFORMATION IN THE FIELD OF CHARITABLE MONETARY GIVING THROUGH FINANCIAL AND ESTATE PLANNING; FINANCIAL SERVICES RELATING TO ECONOMIC DEVELOPMENT, NAMELY, THE DEVELOPMENT OF FINANCIAL STRATEGIES TO INCREASE WEALTH OF INDIVIDUALS, PROFESSIONAL GROUPS AND COMPANIES AND GOVERNMENT BODIES; FINANCIAL SERVICES RELATING TO THIRD WORLD DEVELOPMENT, NAMELY, THE DEVELOPMENT OF FINANCIAL STRATEGIES TO ASSIST IN THE ECONOMIC DEVELOPMENT OF THIRD WORLD COUNTRIES; PROVIDING ON-LINE COMPUTER DATABASES IN THE FIELD OF FINANCE; PROVIDING ON-LINE COMPUTER DATABASES IN THE FIELD OF FINANCE; ADVISORY AND CONSULTANCY SERVICES RELATING TO THE AFORESAID SERVICES (U.S. CLS. 100, 101 AND 102).

SN 77-774,992. SOCIÉTÉ DES PRODUITS NESTLÉ S.A., 1800 VEVEY, SWITZERLAND, FILED 7-6-2009.



OWNER OF SWITZERLAND REG. NO. 572795, DATED 4-6-2008, EXPIRES 4-6-2018.

THE MARK CONSISTS OF TWO CONCENTRIC CIRCLES WITH THE LARGER CIRCLE FORMING INTO ARMS AND HANDS AT BOTTOM CRADLING THE SMALLER CIRCLE, PARTIALLY IMPOSED OVER A RECTANGLE.

CLASS 41—EDUCATION AND ENTERTAINMENT

FOR EDUCATIONAL SERVICES, NAMELY, ARRANGING AND CONDUCTING CONFERENCES, CONVENTIONS, SEMINARS AND EDUCATIONAL EVENTS IN THE NATURE OF WORKSHOPS, CLASSES AND SEMINARS IN THE FIELDS OF FINANCE AND CHARITIES; EDUCATION SERVICES IN THE NATURE OF CLASSES, SEMINARS AND WORKSHOPS RELATING TO FINANCE; EDUCATIONAL SERVICES IN THE NATURE OF CLASSES, SEMINARS AND WORKSHOPS RELATING TO ECONOMIC DEVELOPMENT; EDUCATIONAL SERVICES IN THE NATURE OF CLASSES, SEMINARS AND WORKSHOPS RELATING TO THIRD WORLD DEVELOPMENT; CONDUCTING EDUCATIONAL STUDIES, NAMELY, CLASSES, SEMINARS AND WORKSHOPS AND EDUCATIONAL RESEARCH RELATING TO ECONOMIC WEALTH AND DEVELOPMENT; BOOK PUBLISHING, PERIODICAL PUBLISHING, MAGAZINE PUBLISHING, NEWSPAPER PUBLISHING, BROCHURE PUBLISHING; ELECTRONIC-PUBLISHING, NAMELY, PUBLISHING OF ELECTRONIC PUBLICATIONS, ON-LINE ELECTRONIC PUBLISHING OF BOOKS, PERIODICALS, MAGAZINES, NEWSPAPERS AND BROCHURES; PROVIDING ON-LINE NON-DOWNLOADABLE PUBLICATIONS IN THE NATURE OF BOOKS AND JOURNALS IN THE FIELD OF ECONOMIC WEALTH AND DEVELOPMENT AND ECONOMIC DEVELOPMENT OF THIRD WORLD COUNTRIES; LIBRARY SERVICES; INFORMATION AND ADVISORY SERVICES RELATING TO ALL THE AFORESAID SERVICES (U.S. CLS. 100, 101 AND 107).

ALEXANDER L. POWERS, EXAMINING ATTORNEY

CLASS 5—PHARMACEUTICALS

FOR FOOD AND FOOD SUBSTANCES FOR BABIES; FOOD AND FOOD SUBSTANCES FOR MEDICAL USE FOR CHILDREN; FOODS AND FOOD SUBSTANCES FOR NURSING MOTHERS FOR MEDICAL USE; NUTRITIONAL AND DIETETIC SUPPLEMENTS FOR MEDICAL USE; VITAMIN PREPARATIONS; PREPARATIONS MADE WITH MINERALS, NAMELY, MINERAL SUPPLEMENTS (U.S. CLS. 6, 18, 44, 46, 51 AND 52).

CLASS 29—MEATS AND PROCESSED FOODS

FOR FREEZE-DRIED FRUITS AND VEGETABLES; PRE-PACKAGED MEALS CONSISTING PRIMARILY OF MEAT, POULTRY, VEGETABLES, CHEESE AND FRUIT; FRUIT BASED SNACK FOOD; FRUIT AND YOGURT BASED SNACK FOOD; DAIRY-BASED BEVERAGES; MILK; CHOCOLATE MILK; SOY MILK; CREAM; BUTTER; CHEESES; EGGS; MILK PROTEINS; MILK SUBSTITUTES, NAMELY, SOY-BASED FOOD BEVERAGE USED AS A MILK SUBSTITUTE; MILK PRODUCTS EXCLUDING ICE CREAM, ICE MILK AND FROZEN YOGURT; YOGURTS; PROCESSED MEAT (U.S. CL. 46).

CLASS 30—STAPLE FOODS

FOR PRE-PACKAGED MEALS CONSISTING PRIMARILY OF PASTA WITH MEAT SAUCE, PASTA AND SAUCE; PROCESSED CEREAL; CEREAL BARS, NAMELY, READY TO EAT, CEREAL DERIVED FOOD BARS; READY-TO-EAT CEREALS; BAKERY PRODUCTS, NAMELY, CRACKERS, COOKIES, CAKES, BISCUITS, PASTRIES, MUFFINS, BREADS, WAFERS; WHOLE GRAIN SNACKS, NAMELY, GRAIN-BASED SNACK FOODS (U.S. CL. 46).

JAY FLOWERS, EXAMINING ATTORNEY

SN 77-775,251. SONY CORPORATION, TOKYO, JAPAN,
FILED 7-7-2009.

SN 77-777,894. INTUIT INC., MOUNTAIN VIEW, CA. FILED
7-9-2009.



THE MARK CONSISTS OF A SNOWFLAKE DESIGN AND
THE WORDING "CROSS YOU".

CLASS 9—ELECTRICAL AND SCIENTIFIC APPARATUS

FOR MOBILE PHONES; COMPUTER DISPLAYS, NAMELY, MONITORS; HARD DISC DRIVES; PRINTERS; INTEGRATED CIRCUIT (IC) RECORDERS; TELEVISIONS; HOME THEATER PRODUCTS, NAMELY, TELEVISION SETS, DVD PLAYERS AND RECORDERS, DVD PLAYERS, DVD RECORDERS, HARD DISC DRIVE AUDIO-VIDEO PLAYERS AND RECORDERS, HARD DISC DRIVE AUDIO-VIDEO PLAYERS, HARD DISC DRIVE AUDIO-VIDEO RECORDERS, AUDIO-VIDEO PLAYERS AND RECORDERS, AUDIO PLAYERS, AND AUDIO RECORDERS, AV AMPLIFIER, AUDIO SPEAKERS, ELECTRIC AUDIO-VIDEO TRANSMITTERS AND RECEIVERS, DIGITAL MEDIA SERVERS, DVD PLAYERS; DVD RECORDERS; OPTICAL DISC PLAYERS AND RECORDERS FOR AUDIO AND VIDEO; CAMCORDERS; DIGITAL STILL CAMERAS; PORTABLE DIGITAL AUDIO PLAYERS; STEREO SYSTEMS, NAMELY, AMPLIFIERS, RECEIVERS, TUNERS, SPEAKERS AND HEADPHONES; CAR AUDIO SYSTEMS COMPRISED OF STEREOS, SPEAKERS, AMPLIFIERS, EQUALIZERS AND SPEAKER HOUSING; CAR NAVIGATION SYSTEMS IN THE NATURE OF A GLOBAL POSITIONING SYSTEM; GAME APPARATUS ADAPTED FOR USE WITH AN EXTERNAL DISPLAY SCREEN OR MONITOR FOR HOME USE; GAME APPARATUS ADAPTED FOR USE WITH AN EXTERNAL DISPLAY SCREEN OR MONITOR FOR PROFESSIONAL USE; PERSONAL COMPUTERS; ELECTRIC COMMUNICATION APPARATUS TERMINALS, NAMELY, COMPUTER TERMINALS, MOBILE TERMINALS; APPLICATIONS SOFTWARE FOR ELECTRIC COMMUNICATION APPARATUS TERMINAL (U.S. CLS. 21, 23, 26, 36 AND 38).

CLASS 28—TOYS AND SPORTING GOODS

FOR HAND-HELD GAMES WITH LIQUID CRYSTAL DISPLAYS (U.S. CLS. 22, 23, 38 AND 50).
MARILYN IZZI, EXAMINING ATTORNEY

QUICKRECEIPTS

THE MARK CONSISTS OF STANDARD CHARACTERS WITHOUT CLAIM TO ANY PARTICULAR FONT, STYLE, SIZE, OR COLOR.

OWNER OF U.S. REG. NOS. 2,528,282, 2,707,353 AND 2,905,457.

CLASS 9—ELECTRICAL AND SCIENTIFIC APPARATUS

FOR COMPUTER SOFTWARE FOR ORGANIZING AND MANAGING PURCHASE RECEIPTS, ELECTRONIC TRANSACTION AND PAYMENT INFORMATION, TAX DEDUCTION INFORMATION, AND OTHER FINANCIAL RECORDS; COMPUTER SOFTWARE FOR TRACKING, REPORTING, AND MANAGING EXPENSES; COMPUTER SOFTWARE FOR TAX PLANNING, TAX CALCULATION, AND TAX RETURN PREPARATION AND FILING (U.S. CLS. 21, 23, 26, 36 AND 38).

CLASS 36—INSURANCE AND FINANCIAL

FOR PROVIDING FINANCIAL INFORMATION ON-LINE TO ENABLE USERS TO RETRIEVE, AGGREGATE, ANALYZE, AND REPORT ACCOUNT, TRANSACTION, AND BALANCE INFORMATION FROM A WIDE VARIETY OF SOURCES, INCLUDING BANKS AND OTHER FINANCIAL INSTITUTIONS, CREDIT CARD AND DEBIT CARD ISSUERS, AND RETAILERS (U.S. CLS. 100, 101 AND 102).

CLASS 42—SCIENTIFIC AND COMPUTER SERVICES

FOR PROVIDING TEMPORARY USE OF ON-LINE NON-DOWNLOADABLE COMPUTER SOFTWARE FOR ORGANIZING AND MANAGING PURCHASE RECEIPTS, ELECTRONIC TRANSACTION AND PAYMENT INFORMATION, TAX DEDUCTION INFORMATION, AND OTHER FINANCIAL RECORDS; PROVIDING TEMPORARY USE OF ON-LINE NON-DOWNLOADABLE COMPUTER SOFTWARE FOR TRACKING, REPORTING, AND MANAGING EXPENSES; PROVIDING TEMPORARY USE OF ON-LINE NON-DOWNLOADABLE COMPUTER SOFTWARE FOR TAX PLANNING, TAX CALCULATION, AND TAX RETURN PREPARATION AND FILING; APPLICATION SERVICE PROVIDER (ASP) FEATURING SOFTWARE FOR USE BY OTHERS, TO RETRIEVE, AGGREGATE, ANALYZE, AND REPORT ACCOUNT, TRANSACTION, AND BALANCE INFORMATION FROM A WIDE VARIETY OF SOURCES, INCLUDING BANKS AND OTHER FINANCIAL INSTITUTIONS, CREDIT CARD AND DEBIT CARD ISSUERS, AND RETAILERS; SOFTWARE AS A SERVICE (SAAS) SERVICES, NAMELY, HOSTING SOFTWARE FOR USE BY OTHERS, USED TO RETRIEVE, AGGREGATE, ANALYZE, AND REPORT ACCOUNT, TRANSACTION, AND BALANCE INFORMATION FROM A WIDE VARIETY OF SOURCES, INCLUDING BANKS AND OTHER FINANCIAL INSTITUTIONS, CREDIT CARD AND DEBIT CARD ISSUERS, AND RETAILERS; PROVIDING TEMPORARY USE OF ON-LINE NON-DOWNLOADABLE SOFTWARE FOR ORGANIZING AND MANAGING PURCHASE RECEIPTS, ELECTRONIC TRANSACTION AND PAYMENT INFORMATION, TAX DEDUCTION INFORMATION, AND OTHER FINANCIAL RECORDS; PROVIDING TEMPORARY USE OF ON-LINE NON-DOWNLOADABLE SOFTWARE FOR TRACKING, REPORTING, AND MANAGING EXPENSES; PROVIDING TEMPORARY USE OF ON-LINE NON-DOWNLOADABLE SOFTWARE

FOR TAX PLANNING, TAX CALCULATION, AND TAX RETURN PREPARATION AND FILING (U.S. CLS. 100 AND 101).

ELLEN B. AWRICH, EXAMINING ATTORNEY

SN 77-778,783. G-III LEATHER FASHIONS, INC., NEW YORK, NY. FILED 7-10-2009.

ANDREW MARC

THE MARK CONSISTS OF STANDARD CHARACTERS WITHOUT CLAIM TO ANY PARTICULAR FONT, STYLE, SIZE, OR COLOR.

OWNER OF U.S. REG. NOS. 1,221,846, 3,614,832 AND OTHERS.

THE NAME(S), PORTRAIT(S), AND/OR SIGNATURE(S) SHOWN IN THE MARK IDENTIFIES "ANDREW MARC", WHOSE CONSENT(S) TO REGISTER IS MADE OF RECORD.

CLASS 6—METAL GOODS

FOR METAL KEY CHAINS; METAL BOXES (U.S. CLS. 2, 12, 13, 14, 23, 25 AND 50).

CLASS 9—ELECTRICAL AND SCIENTIFIC APPARATUS

FOR SUNGLASSES; BRIEFCASES SPECIALLY ADAPTED FOR HOLDING LAPTOP COMPUTERS; BACKPACKS ESPECIALLY ADAPTED FOR HOLDING LAPTOPS; HOLDERS FOR ELECTRONIC PRODUCTS, NAMELY, HOLDERS FOR COMPACT DISKS (U.S. CLS. 21, 23, 26, 36 AND 38).

CLASS 12—VEHICLES

FOR CUP HOLDERS FOR USE IN VEHICLES (U.S. CLS. 19, 21, 23, 31, 35 AND 44).

CLASS 14—JEWELRY

FOR TRAVEL ALARM CLOCKS; CUFFLINKS; CUFFLINK BOXES; WATCH BOXES; JEWELRY BOXES (U.S. CLS. 2, 27, 28 AND 50).

CLASS 16—PAPER GOODS AND PRINTED MATTER

FOR PASSPORT HOLDERS; AGENDAS; DOCUMENT PORTFOLIOS; NOTEPADS; NOTEPAD COVERS; DESK FILE TRAYS; DESK PADS; DESK ACCESSORIES, NAMELY, DESK SETS, DESK BLOTTERS, DESK CALENDARS AND DESKTOP ORGANIZERS; PEN AND PENCIL HOLDERS; BOXES OF PAPER; CARDBOARD BOXES; TRAYS, NAMELY, FILE TRAYS AND LETTER TRAYS (U.S. CLS. 2, 5, 22, 23, 29, 37, 38 AND 50).

CLASS 18—LEATHER GOODS

FOR (BASED ON USE IN COMMERCE) DUFFLE BAGS; CABIN BAGS; (BASED ON INTENT TO USE) BRIEFCASE-LIKE PORTFOLIOS; TRAVEL ACCESSORIES, NAMELY, SHOE BAGS FOR TRAVEL, JEWELRY ORGANIZERS FOR TRAVEL; TRAVEL KITS COMPRISING TRAVEL CASES, TRAVEL COSMETIC CASES SOLD EMPTY; LUGGAGE TAGS; DOCUMENT CASES; BUSINESS CARD CASES; KEY CASES; LEATHER KEY CHAINS; PET LEASHES; PET COLLARS; CARRYING BAGS FOR PETS; TRAVELING BAGS FOR CARRYING PETS; PET CARRIERS; PET CLOTHES; LEATHER OR LEATHER BOARD BOXES (U.S. CLS. 1, 2, 3, 22 AND 41).

FIRST USE 0-0-2006; IN COMMERCE 0-0-2006.

CLASS 20—FURNITURE AND ARTICLES NOT OTHERWISE CLASSIFIED

FOR LEATHER KEY FOBs; NON-METAL AND NON-LEATHER KEY CHAINS; PET CARRIERS, NAMELY, PET CRATES; PLASTIC BOXES; PICTURE FRAMES (U.S. CLS. 2, 13, 22, 25, 32 AND 50).

CLASS 21—HOUSEWARES AND GLASS

FOR BATH ACCESSORIES, NAMELY, CUP HOLDERS; TRAYS, NAMELY, PAPER TRAYS AND VANITY TRAYS (U.S. CLS. 2, 13, 23, 29, 30, 33, 40 AND 50).

CLASS 25—CLOTHING

FOR BELTS, HEADWEAR (U.S. CLS. 22 AND 39).

CLASS 28—TOYS AND SPORTING GOODS

FOR GAMES, NAMELY, CARD GAMES (U.S. CLS. 22, 23, 38 AND 50).

CLASS 35—ADVERTISING AND BUSINESS

FOR ON-LINE RETAIL STORE AND RETAIL STORE SERVICES FEATURING BELTS, HEADWEAR, BAGS, TRAVELING BAGS, CARRYING CASES, BRIEF-CASE PORTFOLIOS, GOODS OF LEATHER AND IMITATION LEATHER, TRAVEL ACCESSORIES, TRAVEL KITS, TRAVEL ALARM CLOCKS, CARD CASES, KEY CASES, KEY CHAINS, PET GOODS, SUNGLASSES, AGENDAS, DOCUMENT PORTFOLIOS, BUSINESS ACCESSORIES, DESK ACCESSORIES, STATIONERY GOODS, JEWELRY BOXES, WATCH BOXES, GAMES, CUP HOLDERS, BOXES, TRAYS, PICTURE FRAMES, LAPTOP HOLDERS, HOLDERS FOR ELECTRONIC PRODUCTS, PERFUMES; ON-LINE RETAIL STORE SERVICES, FEATURING FRAGRANCES, COLOGNE, NON-MEDICATED TOILETRIES, EYEWEAR, JEWELRY, WATCHES, LUGGAGE, VALISES, WALLETS, HANDBAGS, PURSES, CREDIT CARD CASES, MAKE-UP CASES SOLD EMPTY, TOILETRY CASES SOLD EMPTY, SMALL LEATHER GOODS, MESSENGER BAGS, BRIEFCASES, LEATHER AGENDA CASES, ALL PURPOSE SPORTS BAGS, FOOTWEAR, SHOES AND BOOTS, CLOTHING (U.S. CLS. 100, 101 AND 102).

Laurie Kaufman, Examining Attorney

SN 77-778,836. SONY ONLINE ENTERTAINMENT LLC, SAN DIEGO, CA. FILED 7-10-2009.

THE MARK CONSISTS OF STYLIZED WORDS "THE AGENCY" CONTAINED WITHIN A SUPERIMPOSED OUTLINE OF THE LARGER STYLIZED WORD "AGENCY" WITH TWO STRAIGHT HORIZONTAL LINES FOLLOWED BY A BULLET DESIGN DEPICTING A BULLET PROPELLING THROUGH THE WORDS "THE AGENCY".

CLASS 9—ELECTRICAL AND SCIENTIFIC APPARATUS

FOR SOFTWARE FOR COMPUTER GAME AND VIDEO GAMES; PROVIDING DOWNLOADABLE MULTIPLAYER, ROLE PLAYING REAL TIME COMPUTER GAME AND VIDEO GAME SOFTWARE AND ENHANCEMENTS FOR ENTERTAINMENT (U.S. CLS. 21, 23, 26, 36 AND 38).

CLASS 41—EDUCATION AND ENTERTAINMENT

FOR ENTERTAINMENT SERVICES, NAMELY, OPERATING A REAL TIME, MULTIPLAYER, ROLE PLAYING, COMPUTER GAME AND VIDEO GAME FOR OTHERS VIA THE INTERNET AND LOCAL AREA COMPUTER NETWORKS; PROVIDING A WEBSITE FEATURING NEWS AND INFORMATION IN THE FIELD OF COMPUTER GAMES, VIDEO GAMES AND GAMING FOR ENTERTAINMENT PURPOSES (U.S. CLS. 100, 101 AND 107).

DOMINIC J. FERRAIUOLO, EXAMINING ATTORNEY

SN 77-779,194. EASTERN US BUDDAH'S STUDY (FALUN DAFA) ASSOCIATION, INC., NEW YORK, NY. FILED 7-12-2009.

OWNER OF U.S. REG. NO. 3,182,920.
THE MARK CONSISTS OF THE WORDS "FALUN DAFA" FOLLOWED BY CHINESE CHARACTERS.

THE ENGLISH TRANSLATION OF "FALUN DAFA" IN THE MARK IS GREAT WAY OF THE LAW WHEEL.

THE NON-LATIN CHARACTERS IN THE MARK TRANSLITERATE TO "FALUN DAFA" AND THIS MEANS GREAT WAY OF THE LAW WHEEL IN ENGLISH.

CLASS 16—PAPER GOODS AND PRINTED MATTER

FOR PUBLICATIONS, NAMELY, BROCHURES, BOOKS, NEWSLETTERS, INFORMATIONAL FLYERS AND PAMPHLETS RELATING TO A SYSTEM OF CULTIVATION PRACTICE FOR THE BODY, MIND AND SPIRIT BASED ON TRUTHFULNESS, BENEVOLENCE AND TOLERANCE AS ITS GUIDING PRINCIPLES (U.S. CLS. 2, 5, 22, 23, 29, 37, 38 AND 50).

FIRST USE 5-13-1992; IN COMMERCE 10-12-1996.

CLASS 41—EDUCATION AND ENTERTAINMENT

FOR PROVIDING EDUCATIONAL COURSES, WORKSHOPS, TRAINING CLASSES AND CONFERENCES IN THE FIELD OF A SYSTEM OF CULTIVATION PRACTICE FOR THE BODY, MIND AND SPIRIT BASED ON TRUTHFULNESS, BENEVOLENCE AND TOLERANCE AS ITS GUIDING PRINCIPLES (U.S. CLS. 100, 101 AND 107).

FIRST USE 5-13-1992; IN COMMERCE 10-12-1996.
MARILYN IZZI, EXAMINING ATTORNEY

SN 77-779,610. AFFINITY LABS INC., SAN FRANCISCO, CA. FILED 7-13-2009.

INSIDETECH

THE MARK CONSISTS OF STANDARD CHARACTERS WITHOUT CLAIM TO ANY PARTICULAR FONT, STYLE, SIZE, OR COLOR.

CLASS 35—ADVERTISING AND BUSINESS

FOR PROVIDING NEWS AND INFORMATION ON JOB OPPORTUNITIES AND CAREERS TO PERSONS IN THE FIELD OF INFORMATION TECHNOLOGY (U.S. CLS. 100, 101 AND 102).

FIRST USE 1-19-2000; IN COMMERCE 1-19-2000.

CLASS 42—SCIENTIFIC AND COMPUTER SERVICES

FOR PROVIDING NEWS AND INFORMATION ON MATTERS OF INTEREST TO PERSONS IN THE FIELD OF INFORMATION TECHNOLOGY (U.S. CLS. 100 AND 101).

FIRST USE 1-19-2000; IN COMMERCE 1-19-2000.

CLASS 45—PERSONAL AND LEGAL SERVICES

FOR PROVIDING ONLINE SOCIAL NETWORKING SERVICES TO PERSONS IN THE FIELD OF INFORMATION TECHNOLOGY (U.S. CLS. 100 AND 101).

FIRST USE 1-19-2000; IN COMMERCE 1-19-2000.

RENEE MCCRAY, EXAMINING ATTORNEY

SN 77-779,617. AFFINITY LABS INC., SAN FRANCISCO, CA. FILED 7-13-2009.

THE MARK CONSISTS OF WORDING AND AN ABSTRACT DESIGN CONSISTING OF THREE ROWS OF THIRTEEN CIRCLES IN VARIOUS SHAPES ARRANGED IN A TRIANGULAR FORMATION AS IF RADIATING FROM THE LEFT SIDE OF THE WORDING "INSIDETECH" IN STYLIZED FORMAT.

CLASS 35—ADVERTISING AND BUSINESS

FOR PROVIDING NEWS AND INFORMATION ON JOB OPPORTUNITIES AND CAREERS TO PERSONS IN THE FIELD OF INFORMATION TECHNOLOGY (U.S. CLS. 100, 101 AND 102).

FIRST USE 1-19-2000; IN COMMERCE 1-19-2000.

CLASS 42—SCIENTIFIC AND COMPUTER SERVICES

FOR PROVIDING NEWS AND INFORMATION ON MATTERS OF INTEREST TO PERSONS IN THE FIELD OF INFORMATION TECHNOLOGY (U.S. CLS. 100 AND 101).

FIRST USE 1-19-2000; IN COMMERCE 1-19-2000.

CLASS 45—PERSONAL AND LEGAL SERVICES

FOR PROVIDING ONLINE SOCIAL NETWORKING SERVICES TO PERSONS IN THE FIELD OF INFORMATION TECHNOLOGY (U.S. CLS. 100 AND 101).

FIRST USE 1-19-2000; IN COMMERCE 1-19-2000.
RENEE MCCRAY, EXAMINING ATTORNEY

SN 77-780,448. REVERE SECURITY CORPORATION, ADDISON, TX. FILED 7-14-2009.

REVERE SECURITY

THE MARK CONSISTS OF STANDARD CHARACTERS WITHOUT CLAIM TO ANY PARTICULAR FONT, STYLE, SIZE, OR COLOR.

NO CLAIM IS MADE TO THE EXCLUSIVE RIGHT TO USE "SECURITY", APART FROM THE MARK AS SHOWN.

CLASS 9—ELECTRICAL AND SCIENTIFIC APPARATUS

FOR CRYPTOGRAPHIC PROTECTION SOFTWARE FEATURING CRYPTOGRAPHIC ALGORITHMS; COMPUTER HARDWARE INCORPORATING CRYPTOGRAPHIC ALGORITHMS; COMPUTER SOFTWARE IN THE FIELD OF CRYPTOGRAPHY AND DATA ENCRYPTION (U.S. CLS. 21, 23, 26, 36 AND 38).

CLASS 42—SCIENTIFIC AND COMPUTER SERVICES

FOR RESEARCH IN THE FIELD OF CRYPTOGRAPHY AND DATA ENCRYPTION; RESEARCH AND DEVELOPMENT OF COMPUTER SOFTWARE IN THE FIELD OF CRYPTOGRAPHY AND DATA ENCRYPTION (U.S. CLS. 100 AND 101).

CLASS 45—PERSONAL AND LEGAL SERVICES

FOR LICENSING OF CRYPTOGRAPHIC ALGORITHMS (U.S. CLS. 100 AND 101).
HOWARD SMIGA, EXAMINING ATTORNEY

SN 77-782,438. PLANET 9 STUDIOS, INC., SAN FRANCISCO, CA. FILED 7-16-2009.

RayGun

THE MARK CONSISTS OF STANDARD CHARACTERS WITHOUT CLAIM TO ANY PARTICULAR FONT, STYLE, SIZE, OR COLOR.

CLASS 9—ELECTRICAL AND SCIENTIFIC APPARATUS

FOR (BASED ON USE IN COMMERCE) COMPUTER APPLICATION SOFTWARE FOR MOBILE PHONES (U.S. CLS. 21, 23, 26, 36 AND 38).

FIRST USE 10-26-2006; IN COMMERCE 2-1-2007.

CLASS 28—TOYS AND SPORTING GOODS

FOR (BASED ON INTENT TO USE) ACTION SKILL GAMES (U.S. CLS. 22, 23, 38 AND 50).

CLASS 39—TRANSPORTATION AND STORAGE

FOR (BASED ON USE IN COMMERCE) PROVISION OF TRAVEL INFORMATION (U.S. CLS. 100 AND 105).

FIRST USE 10-26-2006; IN COMMERCE 2-1-2007.

CLASS 41—EDUCATION AND ENTERTAINMENT

FOR (BASED ON INTENT TO USE) ENTERTAINMENT SERVICES, NAMELY, PROVIDING ON-LINE COMPUTER GAMES (U.S. CLS. 100, 101 AND 107).

CLASS 45—PERSONAL AND LEGAL SERVICES

FOR (BASED ON USE IN COMMERCE) ON-LINE SOCIAL NETWORKING SERVICES (U.S. CLS. 100 AND 101).

FIRST USE 10-26-2006; IN COMMERCE 2-1-2007.

MARY BOAGNI, EXAMINING ATTORNEY

SN 77-782,610. NUBECO, LLC, CONCORD, CA. FILED 7-16-2009.

TASTE THE WORLD

THE MARK CONSISTS OF STANDARD CHARACTERS WITHOUT CLAIM TO ANY PARTICULAR FONT, STYLE, SIZE, OR COLOR.

OWNER OF U.S. REG. NO. 3,119,018.

CLASS 30—STAPLE FOODS

FOR SALAD DRESSINGS, SAUCES, GLAZES FOR MEATS, MARINADES, SPICES, CHUTNEYS, AND BEVERAGES MADE OF COFFEE (U.S. CL. 46).

FIRST USE 0-0-1998; IN COMMERCE 0-0-1998.

CLASS 32—LIGHT BEVERAGES

FOR SYRUPS FOR BEVERAGES; NON-ALCOHOLIC COCKTAIL MIXES, NON-ALCOHOLIC COCKTAILS, NON-ALCOHOLIC COCKTAIL BASES, AND SYRUPS FOR MAKING NON-ALCOHOLIC BEVERAGES (U.S. CLS. 45, 46 AND 48).

FIRST USE 0-0-1998; IN COMMERCE 0-0-1998.

CLASS 33—WINES AND SPIRITS

FOR ALCOHOLIC BEVERAGES EXCEPT BEERS (U.S. CLS. 47 AND 49).

CLASS 43—HOTEL AND RESTAURANT SERVICES

FOR RESTAURANTS, BAR SERVICES, CATERING, AND PROVIDING BANQUET-FACILITY SERVICES (U.S. CLS. 100 AND 101).

BRENDAN REGAN, EXAMINING ATTORNEY

SN 77-783,415. THEREFORE CORPORATION GMBH, MODLING, AUSTRIA, FILED 7-17-2009.

People + Process = Profit

THE MARK CONSISTS OF STANDARD CHARACTERS WITHOUT CLAIM TO ANY PARTICULAR FONT, STYLE, SIZE, OR COLOR.

CLASS 9—ELECTRICAL AND SCIENTIFIC APPARATUS

FOR RECORDED AND DOWNLOADABLE COMPUTER SOFTWARE AND COMPUTER PROGRAMS FOR THE ARCHIVING, INDEXING, MANAGEMENT, STORAGE, RETRIEVAL AND REPRODUCTION OF DOCUMENTS OF ALL KINDS; ELECTRONIC COMPUTER COMPONENTS FOR THE IDENTIFICATION AND CLASSIFICATION OF DOCUMENTS FOR DATA PROCESSING AND DOCUMENT MANAGEMENT PURPOSES; APPARATUS FOR RECORDING TEXTS, SOUND, GRAPHICS AND IMAGES; DISPLAYS, NAMELY, FLAT PANEL DISPLAY SCREENS; SCANNERS; ELECTRONIC PUBLICATIONS, NAMELY, MAGAZINES, BOOKS, MANUALS, PERIODICALS AND NEWSLETTERS FEATURING THE ARCHIVING, INDEXING, MANAGEMENT, STORAGE, RETRIEVAL AND REPRODUCTION OF DOCUMENTS OF ALL KINDS RECORDED ON COMPUTER MEDIA; BLANK OPTICAL DATA CARRIERS; BLANK OPTICAL DISCS; COMPUTER SECURITY SOFTWARE AND AUTHENTICATION SOFTWARE FOR CONTROLLING ACCESS TO, AND COMMUNICATION WITH, COMPUTERS; BUSINESS SOFTWARE FOR DATABASES, DATA CAPTURE, DATA ANALYSIS, GRAPHICS, CAD/CAM PRESENTATIONS; COMPUTER PROGRAMS FOR MANAGING COMMUNICATIONS AND DATA AND INFORMATION EXCHANGE OVER COMPUTER NETWORKS, WIRELESS NETWORKS AND GLOBAL COMMUNICATION NETWORKS; COMPUTER SOFTWARE FOR RECORDING, ORGANIZING, EDITING AND TRANSMITTING INFORMATION IN TYPED, HAND WRITTEN AND VOICE FORMAT; COMPUTER SOFTWARE FOR ACCESSING WEB MESSAGING AND SHARED DOCUMENTS (U.S. CLS. 21, 23, 26, 36 AND 38).

SN 77-783,330. AB HOLDINGS, LLC, BOISE, ID. FILED 7-17-2009.

WESTERN KIWAMI

THE MARK CONSISTS OF STANDARD CHARACTERS WITHOUT CLAIM TO ANY PARTICULAR FONT, STYLE, SIZE, OR COLOR.

OWNER OF U.S. REG. NOS. 3,069,052 AND 3,203,749.

THE ENGLISH TRANSLATION OF "KIWAMI" IN THE MARK IS "EXTREME" OR "ULTIMATE".

CLASS 31—NATURAL AGRICULTURAL PRODUCTS

FOR LIVE ANIMALS, NAMELY, CATTLE (U.S. CLS. 1 AND 46).

CLASS 35—ADVERTISING AND BUSINESS

FOR PROVIDING BUSINESS CONSULTATION SERVICES REGARDING BEEF CATTLE PRODUCTION AND SALES OF LIVESTOCK (U.S. CLS. 100, 101 AND 102).

CLASS 44—MEDICAL, BEAUTY AND AGRICULTURAL SERVICES

FOR CATTLE RANCHING; FEEDING OF CATTLE; BREEDING AND STUD SERVICES FOR CATTLE; ANIMAL BREEDING (U.S. CLS. 100 AND 101).

MATTHEW PAPPAS, EXAMINING ATTORNEY

CLASS 16—PAPER GOODS AND PRINTED MATTER

FOR BOOKS IN THE FIELD OF THE ARCHIVING, INDEXING, MANAGEMENT, STORAGE, RETRIEVAL AND REPRODUCTION OF DOCUMENTS OF ALL KINDS; PRINTED PERIODICALS IN THE FIELD OF THE ARCHIVING, INDEXING, MANAGEMENT, STORAGE, RETRIEVAL AND REPRODUCTION OF DOCUMENTS OF ALL KINDS; COMPUTER PROGRAM USER MANUALS FOR THE ARCHIVING, INDEXING, MANAGEMENT, STORAGE, RETRIEVAL AND REPRODUCTION OF DOCUMENTS OF ALL KINDS; REFERENCE MANUALS IN THE FIELD OF THE ARCHIVING, INDEXING, MANAGEMENT, STORAGE, RETRIEVAL AND REPRODUCTION OF DOCUMENTS OF ALL KINDS; TECHNICAL MANUALS IN THE FIELD OF THE ARCHIVING, INDEXING, MANAGEMENT, STORAGE, RETRIEVAL AND REPRODUCTION OF DOCUMENTS OF ALL KINDS; DRAFTING TEMPLATES; PRINTED PERIODICALS, MAGAZINES AND NEWSLETTERS IN THE FIELD OF THE ARCHIVING, INDEXING, MANAGEMENT, STORAGE, RETRIEVAL AND REPRODUCTION OF DOCUMENTS OF ALL KINDS; PAPER AND SYNTHETIC LABELS AND HOLOGRAPHIC PAPER AND SYNTHETIC LABELS (U.S. CLS. 2, 5, 22, 23, 29, 37, 38 AND 50).

CLASS 35—ADVERTISING AND BUSINESS

FOR SERVICES IN THE FIELD OF, AND IN CONNECTION WITH, ELECTRONIC DATA PROCESSING, NAMELY, MANAGEMENT OF DATA, IN PARTICULAR DOCUMENTS AND INFORMATION; COMPUTERIZED FILE MANAGEMENT, COMPILATION AND SYSTEMIZATION OF DATA IN COMPUTER DATABASES; UPDATING AND MAINTENANCE OF DATA IN COMPUTER DATABASES, NAMELY, DATA ENTRY; MANAGEMENT OF COMPUTERIZED FILES FOR OTHERS; ELECTRONIC DATA PROCESSING CONSULTANCY; ORGANIZING AND OPERATING DATABASES, NAMELY, SYSTEMIZATION AND COMPILATION OF DATA IN COMPUTER DATABASES; BUSINESS ONLINE INFORMATION SERVICES, NAMELY, PROVIDING WEBSITE LINKS TO OTHER CONTENT PROVIDERS IN THE FIELD OF BUSINESS ISSUES (U.S. CLS. 100, 101 AND 102).

CLASS 38—COMMUNICATION

FOR COMPUTER SERVICES, NAMELY, TRANSMISSION OF TEXTS, SOUND, GRAPHICS AND IMAGES FOR USE ON COMPUTER NETWORKS, WIRELESS NETWORKS AND GLOBAL COMMUNICATIONS NETWORKS; CONSULTING SERVICES IN THE FIELDS OF TELECOMMUNICATIONS (U.S. CLS. 100, 101 AND 104).

CLASS 39—TRANSPORTATION AND STORAGE

FOR ELECTRONIC STORAGE, ARCHIVING AND RETRIEVAL OF DATA; PHYSICAL STORAGE, ARCHIVING AND RETRIEVAL OF ELECTRONICALLY-STORED, ELECTRONICALLY-ARCHIVED AND ELECTRONICALLY-RETRIEVED DATA OR DOCUMENTS; CONSULTANCY IN THE FIELD OF THE ELECTRONIC STORAGE, ARCHIVING AND RETRIEVAL OF DATA IN PARTICULAR DOCUMENTS (U.S. CLS. 100 AND 105).

CLASS 42—SCIENTIFIC AND COMPUTER SERVICES

FOR CREATION AND DESIGN OF COMPUTER PROGRAMS FOR OTHERS; COMPUTER SOFTWARE DESIGN FOR OTHERS; COMPUTER SYSTEMS ANALYSIS; COMPUTER PROGRAMMING; COMPUTER SOFTWARE DESIGN; CONVERSION OF DATA OR DOCUMENTS FROM PHYSICAL TO ELECTRONIC MEDIA; MAINTENANCE OF COMPUTER SOFTWARE; CONSULTANCY IN THE FIELD OF COMPUTER HARDWARE; TECHNICAL MAINTENANCE OF DATABASES; HOSTING OF WEB SITES AND DATABASES; TECHNICAL CONSULTANCY WITH REGARD TO ELECTRONIC DOCUMENT MANAGEMENT; DEVELOPMENT OF COMPUTER ARCHIVING SYSTEMS; UPDATING OF COMPUTER SOFTWARE; INSTALLATION AND MAINTENANCE OF SOFTWARE; INSTALLATION AND MAINTENANCE OF SOFTWARE FOR INTERNET ACCESS; HOSTING OF WEBSITES OF OTHERS (U.S. CLS. 100 AND 101).

FONG HSU, EXAMINING ATTORNEY

SN 77-784,582. 1-REX, INC., FORT WORTH, TX. FILED 7-20-2009.

RX-1 EFILL

THE MARK CONSISTS OF STANDARD CHARACTERS WITHOUT CLAIM TO ANY PARTICULAR FONT, STYLE, SIZE, OR COLOR.

OWNER OF U.S. REG. NO. 3,464,093.

CLASS 9—ELECTRICAL AND SCIENTIFIC APPARATUS

FOR COMPUTER SOFTWARE PROVIDING A NETWORK BASED PHARMACY MANAGEMENT PROGRAM THAT ALLOWS A PHARMACY TO FILL PRESCRIPTIONS, CHECK DRUG INTERACTIONS AND PRINT LABELS FOR PATIENTS ONLINE IN THE EVENT OF A DISASTER (U.S. CLS. 21, 23, 26, 36 AND 38).

CLASS 42—SCIENTIFIC AND COMPUTER SERVICES

FOR APPLICATION SERVICE PROVIDER (ASP) FEATURING A NETWORK BASED PHARMACY MANAGEMENT SOFTWARE PROGRAM ACCESSIBLE VIA THE INTERNET THAT ALLOWS A PHARMACY TO FILL PRESCRIPTIONS, CHECK DRUG INTERACTIONS AND PRINT LABELS FOR PATIENTS ONLINE IN THE EVENT OF A DISASTER; PROVIDING AN ON-LINE NON-DOWNLOADABLE NETWORK BASED PHARMACY MANAGEMENT SOFTWARE PROGRAM THAT ALLOWS A PHARMACY TO FILL PRESCRIPTIONS, CHECK DRUG INTERACTIONS AND PRINT LABELS FOR PATIENTS ONLINE IN THE EVENT OF A DISASTER (U.S. CLS. 100 AND 101).

LINDSEY RUBIN, EXAMINING ATTORNEY

SN 77-784,733. ANAMAR MEDICAL AB, 411 36 GOTEBOG, SWEDEN, FILED 7-20-2009.

ANAMAR

THE MARK CONSISTS OF STANDARD CHARACTERS WITHOUT CLAIM TO ANY PARTICULAR FONT, STYLE, SIZE, OR COLOR.

THE WORDING "ANAMAR" HAS NO MEANING IN A FOREIGN LANGUAGE.

CLASS 1—CHEMICALS

FOR ASSAYS FOR RESEARCH PURPOSES; DIAGNOSTIC REAGENTS FOR CLINICAL OR MEDICAL LABORATORY USE; DIAGNOSTIC REAGENTS FOR ANIMALS FOR SCIENTIFIC AND RESEARCH PURPOSES (U.S. CLS. 1, 5, 6, 10, 26 AND 46).

CLASS 5—PHARMACEUTICALS

FOR DRUGS AND CHEMICAL PREPARATIONS FOR MEDICAL PURPOSES, NAMELY, PHARMACEUTICALS FOR TREATMENT OF IMMUNOLOGICAL DISEASES AND PAIN; DRUGS AND CHEMICAL PREPARATIONS FOR DIAGNOSTIC PURPOSES, NAMELY, MEDICAL DIAGNOSTIC REAGENTS; BIOMARKERS, NAMELY, CARTILAGE MARKERS FOR DIAGNOSTIC AND PROGNOSTIC AND THERANOSTIC USE; ASSAYS, NAMELY, MEDICAL DIAGNOSTIC ASSAYS FOR TESTING OF BODY FLUIDS; DIAGNOSTIC REAGENTS FOR MEDICAL USE (U.S. CLS. 6, 18, 44, 46, 51 AND 52).

CLASS 42—SCIENTIFIC AND COMPUTER SERVICES

FOR SCIENTIFIC RESEARCH; MEDICAL RESEARCH; RESEARCH AND DEVELOPMENT OF DRUGS AND CHEMICAL PREPARATIONS FOR DIAGNOSTIC PURPOSES AND TREATMENT OF DISEASES; RESEARCH AND DEVELOPMENT OF DRUGS AND CHEMICAL PREPARATIONS FOR DIAGNOSTIC PURPOSES AND TREATMENT OF DISEASES FOR ANIMALS (U.S. CLS. 100 AND 101).

ALEX KEAM, EXAMINING ATTORNEY

SN 77-784,748. PAUL HARTMANN AKTIENGESELLSCHAFT, HEIDENHEIM, FED REP GERMANY, FILED 7-20-2009.

SN 77-784,743. PAUL HARTMANN AKTIENGESELLSCHAFT, HEIDENHEIM, FED REP GERMANY, FILED 7-20-2009.

VivanoTec

THE MARK CONSISTS OF STANDARD CHARACTERS WITHOUT CLAIM TO ANY PARTICULAR FONT, STYLE, SIZE, OR COLOR.

OWNER OF ERPN CMNTY TM OFC REG. NO. 008372328, DATED 1-21-2010, EXPIRES 6-18-2019.

CLASS 5—PHARMACEUTICALS

FOR MEDICAL PLASTERS, STICKING PLASTERS FOR MEDICAL USE, MATERIALS FOR DRESSING, NAMELY, ADHESIVE FOR BANDAGES FOR SKIN WOUNDS, BANDAGES FOR DRESSINGS, BANDAGES FOR SKIN WOUNDS, BANDAGES IMPREGNATED WITH HYDROGEL AND HYDROCOLLOID, MOLE SKIN FOR USE AS A MEDICAL BANDAGE, SURGICAL BANDAGES, BURN DRESSINGS, GAUZE FOR DRESSINGS, SELF ADHESIVE DRESSINGS, SELF-ADHESIVE DRESSINGS, NAMELY, TRANSPARENT FILM DRESSINGS, SURGICAL DRESSINGS, DRESSINGS FOR WOUNDS, BURNS, SURGERY; MEDICATED COMPRESSES, COTTON SWABS FOR MEDICAL PURPOSES, TAMPONS, MEDICAL COTTON; MATERIAL FOR MEDICAL CARE OF WOUNDS, NAMELY, ANTI-ADHESION GELS FOR USE WITH WOUND DRAINAGE DEVICES, DRESSINGS FOR WOUNDS, BURNS, SURGERY, MEDICAL ADHESIVES FOR BINDING WOUNDS, GAUZE FOR DRESSINGS, SELF ADHESIVE DRESSINGS; GRANULAR INSERT AND PADDING MATERIAL FOR MEDICAL PURPOSES, NAMELY, WOUND DRESSING, MEDICAL AND SURGICAL DRESSINGS, NAMELY, THERMOPLASTIC RESIN DRESSINGS (U.S. CLS. 6, 18, 44, 46, 51 AND 52).

CLASS 10—MEDICAL APPARATUS

FOR PLASTER CASTS FOR ORTHOPEDIC PURPOSES, FIXING BANDAGES, NAMELY, SELF ADHESIVE ELASTIC BANDAGES FOR SUPPORTIVE OR ORTHOPEDIC PURPOSES, SUPPORT BANDAGES; BANDAGES FOR ANATOMICAL JOINTS, COMPRESSION BANDAGES, ELASTIC BANDAGES, ORTHOPEDIC SUPPORT BANDAGES, UNIVERSAL BANDAGES FOR ORTHOPEDIC SUPPORT; SLEEVE AND GAUZE BANDAGES FOR ORTHOPEDIC SUPPORT; ZINC PASTE BANDAGES ALL FOR SUPPORTIVE OR ORTHOPEDIC PURPOSES; MEDICAL COMPRESSION STOCKINGS AND TIGHTS; PADDING MATERIAL FOR ORTHOPEDIC PURPOSES; SURGICAL INSTRUMENTS AND APPARATUS; SURGICAL APPARATUS AND INSTRUMENTS FOR MEDICAL, DENTAL OR VETERINARY USE; MEDICAL AND SURGICAL APPARATUS AND INSTRUMENTS, NAMELY, WOUND DRAINAGE APPARATUS FOR ENHANCING WOUND HEALING; WOUND SUCTION APPARATUS FOR THE TREATMENT OF WOUNDS; MEDICAL AND SURGICAL APPARATUS AND INSTRUMENTS, NAMELY, LOW PRESSURE ASSISTED AND VACUUM WOUND SUCTION APPARATUS (U.S. CLS. 26, 39 AND 44).

AISHA CLARKE, EXAMINING ATTORNEY

VivanoMed

THE MARK CONSISTS OF STANDARD CHARACTERS WITHOUT CLAIM TO ANY PARTICULAR FONT, STYLE, SIZE, OR COLOR.

OWNER OF ERPN CMNTY TM OFC REG. NO. 008372344, DATED 1-21-2010, EXPIRES 6-18-2019.

CLASS 5—PHARMACEUTICALS

FOR MEDICAL PLASTERS, STICKING PLASTERS FOR MEDICAL USE, MATERIALS FOR DRESSING, NAMELY, ADHESIVE FOR BANDAGES FOR SKIN WOUNDS, BANDAGES FOR DRESSINGS, BANDAGES FOR SKIN WOUNDS, BANDAGES IMPREGNATED WITH HYDROGEL AND HYDROCOLLOID, MOLE SKIN FOR USE AS A MEDICAL BANDAGE, SURGICAL BANDAGES, BURN DRESSINGS, GAUZE FOR DRESSINGS, SELF ADHESIVE DRESSINGS, SELF-ADHESIVE DRESSINGS, NAMELY, TRANSPARENT FILM DRESSINGS, SURGICAL DRESSINGS, DRESSINGS FOR WOUNDS, BURNS, SURGERY; MEDICATED COMPRESSES, COTTON SWABS FOR MEDICAL PURPOSES, TAMPONS, MEDICAL COTTON; MATERIAL FOR MEDICAL CARE OF WOUNDS, NAMELY, ANTI-ADHESION GELS FOR USE WITH WOUND DRAINAGE DEVICES, DRESSINGS FOR WOUNDS, BURNS, SURGERY, MEDICAL ADHESIVES FOR BINDING WOUNDS, GAUZE FOR DRESSINGS, SELF ADHESIVE DRESSINGS; GRANULAR INSERT AND PADDING MATERIAL FOR MEDICAL PURPOSES, NAMELY, WOUND DRESSING, MEDICAL AND SURGICAL DRESSINGS, NAMELY, THERMOPLASTIC RESIN DRESSINGS (U.S. CLS. 6, 18, 44, 46, 51 AND 52).

CLASS 10—MEDICAL APPARATUS

FOR PLASTER CASTS FOR ORTHOPEDIC PURPOSES, FIXING BANDAGES, NAMELY, SELF ADHESIVE ELASTIC BANDAGES FOR SUPPORTIVE OR ORTHOPEDIC PURPOSES, SUPPORT BANDAGES; BANDAGES FOR ANATOMICAL JOINTS, COMPRESSION BANDAGES, ELASTIC BANDAGES, ORTHOPEDIC SUPPORT BANDAGES, UNIVERSAL BANDAGES FOR ORTHOPEDIC SUPPORT; SLEEVE AND GAUZE BANDAGES FOR ORTHOPEDIC SUPPORT; ZINC PASTE BANDAGES ALL FOR SUPPORTIVE OR ORTHOPEDIC PURPOSES; MEDICAL COMPRESSION STOCKINGS AND TIGHTS; PADDING MATERIAL FOR ORTHOPEDIC PURPOSES; SURGICAL INSTRUMENTS AND APPARATUS; SURGICAL APPARATUS AND INSTRUMENTS FOR MEDICAL, DENTAL OR VETERINARY USE; MEDICAL AND SURGICAL APPARATUS AND INSTRUMENTS, NAMELY, WOUND DRAINAGE APPARATUS FOR ENHANCING WOUND HEALING; WOUND SUCTION APPARATUS FOR THE TREATMENT OF WOUNDS; MEDICAL AND SURGICAL APPARATUS AND INSTRUMENTS, NAMELY, LOW PRESSURE ASSISTED AND VACUUM WOUND SUCTION APPARATUS (U.S. CLS. 26, 39 AND 44).

AISHA CLARKE, EXAMINING ATTORNEY

SN 77-784,749. PAUL HARTMANN AKTIENGESELLSCHAFT, HEIDENHEIM, FED REP GERMANY, FILED 7-20-2009.

SN 77-784,862. SOCK LAKE GROUP, LLC, SHOREVIEW, MN. FILED 7-20-2009.

VivanoSorb

ANESTHESIAHQ

THE MARK CONSISTS OF STANDARD CHARACTERS WITHOUT CLAIM TO ANY PARTICULAR FONT, STYLE, SIZE, OR COLOR.

OWNER OF ERPN CMNTY TM OFC REG. NO. 008372427, DATED 2-15-2010, EXPIRES 6-18-2019.

CLASS 5—PHARMACEUTICALS

FOR MEDICAL PLASTERS, STICKING PLASTERS FOR MEDICAL USE, MATERIALS FOR DRESSING, NAMELY, ADHESIVE FOR BANDAGES FOR SKIN WOUNDS, BANDAGES FOR DRESSINGS, BANDAGES FOR SKIN WOUNDS, BANDAGES IMPREGNATED WITH HYDROGEL AND HYDROCOLLOID, MOLE SKIN FOR USE AS A MEDICAL BANDAGE, SURGICAL BANDAGES, BURN DRESSINGS, GAUZE FOR DRESSINGS, SELF ADHESIVE DRESSINGS, SELF-ADHESIVE DRESSINGS, NAMELY, TRANSPARENT FILM DRESSINGS, SURGICAL DRESSINGS, DRESSINGS FOR WOUNDS, BURNS, SURGERY; MEDICATED COMPRESSES, COTTON SWABS FOR MEDICAL PURPOSES, TAMPONS, MEDICAL COTTON; MATERIAL FOR MEDICAL CARE OF WOUNDS, NAMELY, ANTI-ADHESION GELS FOR USE WITH WOUND DRAINAGE DEVICES, DRESSINGS FOR WOUNDS, BURNS, SURGERY, MEDICAL ADHESIVES FOR BINDING WOUNDS, GAUZE FOR DRESSINGS, SELF ADHESIVE DRESSINGS; GRANULAR INSERT AND PADDING MATERIAL FOR MEDICAL PURPOSES, NAMELY, WOUND DRESSING, MEDICAL AND SURGICAL DRESSINGS, NAMELY, THERMOPLASTIC RESIN DRESSINGS (U.S. CLS. 6, 18, 44, 46, 51 AND 52).

CLASS 10—MEDICAL APPARATUS

FOR PLASTER CASTS FOR ORTHOPEDIC PURPOSES, FIXING BANDAGES, NAMELY, SELF ADHESIVE ELASTIC BANDAGES FOR SUPPORTIVE OR ORTHOPEDIC PURPOSES, SUPPORT BANDAGES; BANDAGES FOR ANATOMICAL JOINTS, COMPRESSION BANDAGES, ELASTIC BANDAGES, ORTHOPEDIC SUPPORT BANDAGES, UNIVERSAL BANDAGES FOR ORTHOPEDIC SUPPORT; SLEEVE AND GAUZE BANDAGES FOR ORTHOPEDIC SUPPORT; ZINC PASTE BANDAGES ALL FOR SUPPORTIVE OR ORTHOPEDIC PURPOSES; MEDICAL COMPRESSION STOCKINGS AND TIGHTS; PADDING MATERIAL FOR ORTHOPEDIC PURPOSES; SURGICAL INSTRUMENTS AND APPARATUS; SURGICAL APPARATUS AND INSTRUMENTS FOR MEDICAL, DENTAL OR VETERINARY USE; MEDICAL AND SURGICAL APPARATUS AND INSTRUMENTS, NAMELY, WOUND DRAINAGE APPARATUS FOR ENHANCING WOUND HEALING; WOUND SUCTION APPARATUS FOR THE TREATMENT OF WOUNDS; MEDICAL AND SURGICAL APPARATUS AND INSTRUMENTS, NAMELY, LOW PRESSURE ASSISTED AND VACUUM WOUND SUCTION APPARATUS (U.S. CLS. 26, 39 AND 44).

AISHA CLARKE, EXAMINING ATTORNEY

THE MARK CONSISTS OF STANDARD CHARACTERS WITHOUT CLAIM TO ANY PARTICULAR FONT, STYLE, SIZE, OR COLOR.

CLASS 9—ELECTRICAL AND SCIENTIFIC APPARATUS

FOR DIGITAL MATERIALS, NAMELY, CDS, DVDS, DOWNLOADABLE FILES FEATURING STUDY GUIDES, PRACTICE EXAMS AND PRACTICE CASE SCENARIOS USED IN PREPARATION FOR WRITTEN AND ORAL PROFESSIONAL LICENSING AND CERTIFICATION EXAMS IN THE FIELD OF MEDICINE; AUDIO AND VIDEO RECORDINGS THAT PROVIDE STUDY GUIDES, PRACTICE EXAMS AND PRACTICE CASE SCENARIOS USED IN PREPARATION FOR WRITTEN AND ORAL PROFESSIONAL LICENSING AND CERTIFICATION EXAMS IN THE FIELD OF MEDICINE; COMPUTER SOFTWARE FEATURING EDUCATIONAL INSTRUCTION AND PROGRAMS AND TEST PREPARATION IN THE FIELD OF MEDICINE (U.S. CLS. 21, 23, 26, 36 AND 38).

FIRST USE 3-1-2005; IN COMMERCE 6-5-2006.

CLASS 16—PAPER GOODS AND PRINTED MATTER

FOR PRINTED MATTER, NAMELY, BOOKS, STUDY GUIDES, PRACTICE EXAMS AND PRACTICE CASE SCENARIOS USED IN PREPARATION FOR WRITTEN AND ORAL PROFESSIONAL LICENSING AND CERTIFICATION EXAMS IN THE FIELD OF MEDICINE; PRINTED MATTER, NAMELY, BOOKS, STUDY GUIDES, PRACTICE EXAMS, AND PRACTICE CASE SCENARIOS FEATURING EDUCATIONAL INSTRUCTION AND PROGRAMS AND TEST PREPARATION IN THE FIELD OF MEDICINE (U.S. CLS. 2, 5, 22, 23, 29, 37, 38 AND 50).

FIRST USE 3-1-2005; IN COMMERCE 3-24-2005.

CLASS 41—EDUCATION AND ENTERTAINMENT

FOR PROVIDING INFORMATION ON TEST PREPARATION AND EDUCATIONAL RESOURCES IN THE FIELD OF MEDICINE; PROVIDING AN INTERACTIVE WEB SITE FEATURING EDUCATIONAL INFORMATION AND SAMPLE TEST QUESTIONS AND ANSWERS IN THE FIELD OF MEDICINE (U.S. CLS. 100, 101 AND 107).

FIRST USE 6-15-2009; IN COMMERCE 6-15-2009.
EUGENIA MARTIN, EXAMINING ATTORNEY

SN 77-784,922. HKS INTELLECTUAL PROPERTIES LIMITED, ROAD TOWN, TORTOLA, BR. VIRGIN ISLANDS, FILED 7-20-2009.

SMART-SKIN

THE MARK CONSISTS OF STANDARD CHARACTERS WITHOUT CLAIM TO ANY PARTICULAR FONT, STYLE, SIZE, OR COLOR.

CLASS 23—YARNS AND THREADS

FOR YARNS AND THREADS FOR TEXTILE USE (U.S. CL. 43).

CLASS 25—CLOTHING

FOR CLOTHING, NAMELY, SWEATERS, CARDIGANS, PULLOVERS, COATS, GLOVES, HATS, HOSIERY, JACKETS, LEGGINGS, SCARFS, SHAWLS, SOCKS, STOCKINGS, SUITS, AND TROUSERS (U.S. CLS. 22 AND 39).

JUSTINE D. PARKER, EXAMINING ATTORNEY

SN 77-785,645. GORDON, MOISES MARTINEZ, MEXICO, MEXICO, FILED 7-21-2009.

ETHNO FIT

THE MARK CONSISTS OF STANDARD CHARACTERS WITHOUT CLAIM TO ANY PARTICULAR FONT, STYLE, SIZE, OR COLOR.

PRIORITY CLAIMED UNDER SEC. 44(D) ON MEXICO APPLICATION NO. 1019161, FILED 7-10-2009, REG. NO. 1111770, DATED 7-10-2009, EXPIRES 7-10-2019.

PRIORITY CLAIMED UNDER SEC. 44(D) ON MEXICO APPLICATION NO. 1019162, FILED 7-10-2009, REG. NO. 1111771, DATED 7-10-2009, EXPIRES 7-10-2019.

PRIORITY CLAIMED UNDER SEC. 44(D) ON MEXICO APPLICATION NO. 1019160, FILED 7-10-2009, REG. NO. 1111769, DATED 7-10-2009, EXPIRES 7-10-2019.

NO CLAIM IS MADE TO THE EXCLUSIVE RIGHT TO USE "FIT", APART FROM THE MARK AS SHOWN.

CLASS 9—ELECTRICAL AND SCIENTIFIC APPARATUS

FOR (BASED ON 44(E) PURSUANT TO MEXICAN FOREIGN REGISTRATION NUMBER 1111769) DIGITAL MEDIA, NAMELY, CDS, DVDS AND DOWNLOADABLE AUDIO AND VIDEO FILES FEATURING INSTRUCTION ON DANCE AND GROUP PHYSICAL FITNESS (U.S. CLS. 21, 23, 26, 36 AND 38).

CLASS 25—CLOTHING

FOR (BASED ON 44(E) PURSUANT TO MEXICAN FOREIGN REGISTRATION NUMBER 1111771) CLOTHING, NAMELY, SHORTS, PANTS, T-SHIRTS, TOPS, BLOUSES, TIGHTS, HEADWEAR, HEADBANDS, WRISTBANDS, SWEATSHIRTS, FOOTWEAR (U.S. CLS. 22 AND 39).

CLASS 41—EDUCATION AND ENTERTAINMENT

FOR (BASED ON 44(E) PURSUANT TO MEXICAN FOREIGN REGISTRATION NUMBER 1111770) EDUCATION SERVICES, NAMELY, PROVIDING CLASSES AND INSTRUCTION IN THE FIELD OF DANCE; ENTERTAINMENT SERVICES IN THE NATURE OF DANCE PERFORMANCES; TRAINING OF DANCE INSTRUCTORS; PHYSICAL FITNESS INSTRUCTION; PROVIDING A WEBSITE FEATURING INFORMATION ON EXERCISE AND FITNESS; ENTERTAINMENT AND EDUCATION SERVICES IN THE NATURE OF LIVE DANCE AND MUSICAL PERFORMANCES; PROVIDING ASSISTANCE, PERSONAL TRAINING AND PHYSICAL FITNESS CONSULTATION TO INDIVIDUALS TO HELP THEM MAKE PHYSICAL FITNESS, STRENGTH, CONDITIONING, AND EXERCISE IMPROVEMENT IN THEIR DAILY LIVING BY USING A SYSTEM OF DANCE AND TRAINING CONFORMED BY TECHNIQUES, STYLES AND ETHNIC RHYTHMS OF THE ENTIRE WORLD (U.S. CLS. 100, 101 AND 107).

JAY BESCH, EXAMINING ATTORNEY

SN 77-785,947. BOARD OF TRUSTEES, ILLINOIS STATE UNIVERSITY, NORMAL, IL. FILED 7-21-2009.

STATE YOUR PASSION

THE MARK CONSISTS OF STANDARD CHARACTERS WITHOUT CLAIM TO ANY PARTICULAR FONT, STYLE, SIZE, OR COLOR.

CLASS 25—CLOTHING

FOR CLOTHING, NAMELY, SHIRTS, SWEATSHIRTS, SWEATERS, PANTS, SHORTS, JACKETS, AND HATS (U.S. CLS. 22 AND 39).

FIRST USE 3-1-2009; IN COMMERCE 3-1-2009.

CLASS 41—EDUCATION AND ENTERTAINMENT

FOR EDUCATIONAL SERVICES IN THE NATURE OF COURSES AT THE UNIVERSITY LEVEL; ENTERTAINMENT SERVICES IN THE NATURE OF BASKETBALL, FOOTBALL, BASEBALL, AND VOLLEYBALL GAMES; RECREATIONAL SERVICES IN THE NATURE OF LIVE MUSICAL CONCERTS AND THEATER PRODUCTIONS; AND CONDUCTING SOCIAL ENTERTAINMENT EVENTS IN THE NATURE OF HOMECOMING AND PARENTS WEEKENDS (U.S. CLS. 100, 101 AND 107).

FIRST USE 3-1-2009; IN COMMERCE 3-1-2009.

MEGHAN REINHART, EXAMINING ATTORNEY

SN 77-786,146. CLEARONE COMMUNICATIONS, SALT LAKE CITY, UT. FILED 7-21-2009.

CLEARPRESENCE

THE MARK CONSISTS OF STANDARD CHARACTERS WITHOUT CLAIM TO ANY PARTICULAR FONT, STYLE, SIZE, OR COLOR.

CLASS 9—ELECTRICAL AND SCIENTIFIC APPARATUS

FOR ELECTRONIC HARDWARE, NAMELY, LOUD SPEAKERS, SPEAKERPHONES, TELEPHONE INTERFACES, AMPLIFIERS, AUDIO MIXERS, AND MICROPHONES AND COMPUTER SOFTWARE AND FIRMWARE FOR AUDIO PROCESSING, AUDIO CONFERENCING AND VIDEO CONFERENCING (U.S. CLS. 21, 23, 26, 36 AND 38).

CLASS 12—VEHICLES

FOR MOBILE STORAGE CARTS FOR COMMERCIAL USE (U.S. CLS. 19, 21, 23, 31, 35 AND 44).
ADA HAN, EXAMINING ATTORNEY

SN 77-786,770. SHEILA MIKHAIL, CHAPEL HILL, NC.
FILED 7-22-2009.

NOVATI

THE MARK CONSISTS OF STANDARD CHARACTERS WITHOUT CLAIM TO ANY PARTICULAR FONT, STYLE, SIZE, OR COLOR.

CLASS 5—PHARMACEUTICALS

FOR PHARMACEUTICAL PREPARATIONS AND SUBSTANCES FOR THE TREATMENT OF VIRAL, METABOLIC, ENDOCRINE, MUSCULOSKELETAL, CARDIOVASCULAR, CARDIOPULMONARY, GENITOURINARY, SEXUAL DYSFUNCTION, ONCOLOGICAL, HEPATOLOGICAL, OPHTHALMIC, RESPIRATORY, NEUROLOGICAL, GASTROINTESTINAL, HORMONAL, DERMATOLOGICAL, PSYCHIATRIC AND IMMUNE SYSTEM RELATED DISEASES AND DISORDERS (U.S. CLS. 6, 18, 44, 46, 51 AND 52).

CLASS 10—MEDICAL APPARATUS

FOR MEDICAL APPARATUS FOR INTRODUCING PHARMACEUTICAL PREPARATIONS INTO THE HUMAN BODY (U.S. CLS. 26, 39 AND 44).
BARNEY CHARLON, EXAMINING ATTORNEY

SN 77-786,862. AMERICAN LICORICE CO., BEND, OR.
FILED 7-22-2009.

NO DRAWING-SENSORY MARK

OWNER OF U.S. REG. NOS. 1,904,559, 2,736,530 AND OTHERS.

THE MARK IS A SOUND. THE MARK CONSISTS OF THREE SEQUENTIAL SOUNDS ELEMENTS. THE FIRST SOUND ELEMENT IS A NOISE SWEEP THAT ENDS IN A SHARP SLAM (SIMILAR TO THE SWOOSH AND CRACK OF A WHIP)(APPROXIMATELY .5 SECONDS). THE SECOND SOUND ELEMENT IS THAT OF LIPS PUCKERING INTO A KISS (APPROXIMATELY .5 SECONDS). THE THIRD SOUND ELEMENT IS THAT OF A FEMALE CHOIR SINGING THE WORD PUNCH IN AN ANGELIC FASHION IN THE CHORD OF D-MAJOR TRIAD WITH THE THIRD ON TOP (F#) (APPROXIMATELY 1.3 SECONDS). TOTAL SOUND MARK TIME: 2.3 SECONDS.

CLASS 9—ELECTRICAL AND SCIENTIFIC APPARATUS

FOR DIGITAL MEDIA, NAMELY, DOWNLOADABLE IMAGE FILES CONTAINING PHOTOGRAPHS AND ARTWORK RELATING TO CANDY, AS WELL AS DOWNLOADABLE AUDIO FILES FEATURING MUSIC, COMEDY, OR SOUND EFFECTS, WHICH ALL FEATURE A CUSTOMER LOYALTY PROGRAM THAT ALLOWS REGISTERED MEMBERS TO ENTER CONTESTS AND EARN AND REDEEM POINTS FOR AWARDS (U.S. CLS. 21, 23, 26, 36 AND 38).
FIRST USE 3-23-2009; IN COMMERCE 3-23-2009.

CLASS 30—STAPLE FOODS

FOR CANDY (U.S. CL. 46).
FIRST USE 3-23-2009; IN COMMERCE 3-23-2009.

CLASS 41—EDUCATION AND ENTERTAINMENT

FOR ENTERTAINMENT SERVICES, NAMELY, PROVIDING ONLINE COMPUTER GAMES AND CONDUCTING ONLINE CONTESTS; ENTERTAINMENT SERVICES, NAMELY, PROVIDING A WEBSITE FEATURING ONLINE COMPUTER GAMES AND COMPUTER GAMES THAT INCORPORATE DOWNLOADING IMAGE AND AUDIO FILES AND VIEWING NON-DOWNLOADABLE VIDEO FILES FROM THE WEBSITE, WHICH INCORPORATES A CUSTOMER LOYALTY PROGRAM THAT ALLOWS REGISTERED MEMBERS TO ENTER CONTESTS AND EARN AND REDEEM POINTS FOR AWARDS (U.S. CLS. 100, 101 AND 107).
FIRST USE 3-23-2009; IN COMMERCE 3-23-2009.
JASON BLAIR, EXAMINING ATTORNEY

SN 77-787,130. ZAPMYTV.COM, INC., WILMINGTON, DE.
FILED 7-22-2009.

ZAPMYTV

THE MARK CONSISTS OF STANDARD CHARACTERS WITHOUT CLAIM TO ANY PARTICULAR FONT, STYLE, SIZE, OR COLOR.

CLASS 35—ADVERTISING AND BUSINESS

FOR PROMOTING THE GOODS AND SERVICES OF OTHERS BY MEANS OF OPERATING AN ON-LINE SHOPPING MALL WITH LINKS TO THE RETAIL WEBSITES OF OTHERS; PROVIDING A WEBSITE AT WHICH USERS CAN OFFER GOODS FOR SALE AND BUY GOODS OFFERED BY OTHERS (U.S. CLS. 100, 101 AND 102).

CLASS 38—COMMUNICATION

FOR VIDEO BROADCASTING OVER THE INTERNET; BROADCASTING OF VIDEO PROGRAMMING OVER THE INTERNET; BROADCASTING SERVICES AND PROVISION OF TELECOMMUNICATION ACCESS TO VIDEO CONTENT PROVIDED VIA A VIDEO-ON-DEMAND SERVICES VIA THE INTERNET; COMMUNICATIONS SERVICES, NAMELY, TRANSMITTING STREAMED AUDIOVISUAL RECORDINGS VIA THE INTERNET; INTERNET BROADCASTING SERVICES; PROVIDING INTERNET CHATROOMS; STREAMING OF VIDEO MATERIAL ON THE INTERNET; VIDEO BROADCASTING SERVICES VIA THE INTERNET; VIDEO-ON-DEMAND TRANSMISSION SERVICES VIA THE INTERNET; DISTRIBUTION OF TELEVISION PROGRAMMING OVER THE INTERNET; PROVIDING EMAIL SERVICES; VIDEO CONFERENCING SERVICES (U.S. CLS. 100, 101 AND 104).

CLASS 41—EDUCATION AND ENTERTAINMENT

FOR PROVIDING AN INTERNET WEBSITE FEATURING TELEVISION PROGRAMMING (U.S. CLS. 100, 101 AND 107).

CLASS 42—SCIENTIFIC AND COMPUTER SERVICES

FOR PROVIDING A WEBSITE FEATURING A MEDIA AGGREGATOR AND SEARCH ENGINE FOR INTERNET CONTENT; PROVISION OF A SEARCH ENGINE FOR THE INTERNET; APPLICATION SERVICE PROVIDER ASP FEATURING SOFTWARE TO ENABLE UPLOADING, POSTING, SHOWING, DISPLAYING, TAGGING, BLOGGING, SHARING OR OTHERWISE PROVIDING ELECTRONIC MEDIA OR INFORMATION OVER THE INTERNET OR OTHER COMMUNICATIONS NETWORK; COMPUTER SERVICES, NAMELY, CREATING AN ON-LINE COMMUNITY FOR REGISTERED USERS TO PARTICIPATE IN DISCUSSIONS, GET FEEDBACK FROM THEIR PEERS, FORM VIRTUAL COMMUNITIES, AND ENGAGE IN SOCIAL NETWORKING (U.S. CLS. 100 AND 101).

ELI HELLMAN, EXAMINING ATTORNEY

SN 77-788,450. DUBLIN AIRPORT AUTHORITY PLC, COUNTY DUBLIN, IRELAND, FILED 7-23-2009.

STRATEGIC COMMERCIAL GREEN
ZONE

THE MARK CONSISTS OF STANDARD CHARACTERS WITHOUT CLAIM TO ANY PARTICULAR FONT, STYLE, SIZE, OR COLOR.

NO CLAIM IS MADE TO THE EXCLUSIVE RIGHT TO USE "STRATEGIC COMMERCIAL GREEN", APART FROM THE MARK AS SHOWN.

CLASS 37—CONSTRUCTION AND REPAIR

FOR CONSTRUCTION, PLANNING AND REAL ESTATE DEVELOPMENT OF COMMERCIAL BUILDINGS AND OFFICE PARKS (U.S. CLS. 100, 103 AND 106).

CLASS 42—SCIENTIFIC AND COMPUTER SERVICES

FOR BUILDING DESIGN OF COMMERCIAL BUILDINGS (U.S. CLS. 100 AND 101).

DANIEL CAPSHAW, EXAMINING ATTORNEY

SN 77-788,456. DUBLIN AIRPORT AUTHORITY PLC, COUNTY DUBLIN, IRELAND, FILED 7-23-2009.

SCGZ

THE MARK CONSISTS OF STANDARD CHARACTERS WITHOUT CLAIM TO ANY PARTICULAR FONT, STYLE, SIZE, OR COLOR.

CLASS 37—CONSTRUCTION AND REPAIR

FOR CONSTRUCTION, PLANNING AND REAL ESTATE DEVELOPMENT OF COMMERCIAL BUILDINGS AND OFFICE PARKS (U.S. CLS. 100, 103 AND 106).

CLASS 42—SCIENTIFIC AND COMPUTER SERVICES

FOR BUILDING DESIGN OF COMMERCIAL BUILDINGS (U.S. CLS. 100 AND 101).

DANIEL CAPSHAW, EXAMINING ATTORNEY

SN 77-788,712. GOMEZ ASSOCIATES, INC., NEW YORK, NY, FILED 7-24-2009.

MARIETTE HIMES GOMEZ

THE MARK CONSISTS OF STANDARD CHARACTERS WITHOUT CLAIM TO ANY PARTICULAR FONT, STYLE, SIZE, OR COLOR.

OWNER OF U.S. REG. NO. 2,739,564.

THE NAME "MARIETTE HIMES GOMEZ" IDENTIFIES A LIVING INDIVIDUAL WHOSE CONSENT IS OF RECORD.

CLASS 9—ELECTRICAL AND SCIENTIFIC APPARATUS

FOR TELEPHONE STANDS (U.S. CLS. 21, 23, 26, 36 AND 38).

FIRST USE 12-31-1999; IN COMMERCE 12-31-1999.

CLASS 11—ENVIRONMENTAL CONTROL APPARATUS

FOR LAMPS (U.S. CLS. 13, 21, 23, 31 AND 34).

FIRST USE 12-31-1999; IN COMMERCE 12-31-1999.

CLASS 20—FURNITURE AND ARTICLES NOT OTHERWISE CLASSIFIED

FOR FURNITURE, NAMELY, TABLES, BENCHES, CUPBOARDS, DRESSERS, CHAIRS, SOFAS, CHAISE LOUNGES, OTTOMANS AND STOOLS (U.S. CLS. 2, 13, 22, 25, 32 AND 50).

FIRST USE 12-31-1999; IN COMMERCE 12-31-1999.

CLASS 24—FABRICS

FOR UPHOLSTERY FABRICS (U.S. CLS. 42 AND 50).

FIRST USE 12-31-1999; IN COMMERCE 12-31-1999.

CLASS 35—ADVERTISING AND BUSINESS

FOR RETAIL AND WHOLESALE CATALOG SERVICES FEATURING FURNITURE SUCH AS TABLES, BENCHES, STORAGE BOXES, TELEPHONE STANDS, CUPBOARDS, DRESSERS, CHAIRS, SOFAS, CHAISE LOUNGES, OTTOMANS, TRAYS, STOOLS, LAMPS, LANTERNS, AND UPHOLSTERY FABRICS (U.S. CLS. 100, 101 AND 102).

FIRST USE 12-31-1999; IN COMMERCE 12-31-1999.

CLASS 42—SCIENTIFIC AND COMPUTER SERVICES

FOR INTERIOR DESIGN AND FURNITURE DESIGN SERVICES FOR OTHERS TO THE ORDER AND SPECIFICATION OF OTHERS (U.S. CLS. 100 AND 101).

FIRST USE 12-31-1999; IN COMMERCE 12-31-1999.
CHARLES L. JENKINS, EXAMINING ATTORNEY

SN 77-789,543. RMA SALES CO., INC., NEWTOWN, PA.
FILED 7-24-2009.

Prostart

THE MARK CONSISTS OF STANDARD CHARACTERS WITHOUT CLAIM TO ANY PARTICULAR FONT, STYLE, SIZE, OR COLOR.

CLASS 7—MACHINERY

FOR HYDRAULIC JACKS; ENGINE HOISTS; JACK STANDS, NAMELY, STANDS FOR MAINTAINING A VEHICLE IN A RAISED POSITION AFTER IT HAS BEEN LIFTED BY A HYDRAULIC JACK (U.S. CLS. 13, 19, 21, 23, 31, 34 AND 35).

CLASS 8—HAND TOOLS

FOR MANUALLY OPERATED JACKS AND JACK STANDS, NAMELY, STANDS FOR MAINTAINING A VEHICLE IN A RAISED POSITION AFTER IT HAS BEEN LIFTED BY A HAND JACK (U.S. CLS. 23, 28 AND 44).

HAI-LY LAM, EXAMINING ATTORNEY

SN 77-789,364. TOTAL SYSTEM SERVICES, INC., COLUMBUS, GA. FILED 7-24-2009.

KIOSKPASS

THE MARK CONSISTS OF STANDARD CHARACTERS WITHOUT CLAIM TO ANY PARTICULAR FONT, STYLE, SIZE, OR COLOR.

CLASS 36—INSURANCE AND FINANCIAL

FOR BANKING AND FINANCING SERVICES; ATM BANKING SERVICES; MONEY ORDER SERVICES; ELECTRONIC PAYMENT SERVICES, NAMELY, ELECTRONIC PROCESSING AND TRANSMISSION OF BILL PAYMENT DATA; CHECK CASHING SERVICES; ISSUING STORED VALUE CARDS; PROVISION OF PREPAID RECHARGE SERVICES, NAMELY, PAYMENT OF PREPAID MOBILE CELLULAR TELEPHONES AND LONG-DISTANCE CALLING CARDS; ELECTRONIC TRANSFER OF MONEY SERVICES (U.S. CLS. 100, 101 AND 102).

FIRST USE 12-0-2008; IN COMMERCE 1-0-2009.

CLASS 42—SCIENTIFIC AND COMPUTER SERVICES

FOR PROVIDING A COMPUTERIZED NETWORK OF SELF-SERVICE TRANSACTIONAL SYSTEMS FOR RENDERING AUTOMATED FINANCIAL AND COMMERCIAL SERVICES; APPLICATION SERVICE PROVIDER (ASP) FEATURING SOFTWARE FOR USE IN DATABASE MANAGEMENT IN THE FIELDS OF ELECTRONIC PAYMENT PROCESSING AND ONLINE SECURITY SERVICES; DATA WAREHOUSING, DATA MINING, DATA ENCRYPTION SERVICE; APPLICATION SERVICE PROVIDER (ASP) SERVICES, NAMELY, PROVIDING INTERNET BASED ACCESS TO CREDIT AND DEBIT CARD TRANSACTION DATA FOR USE IN AUTHORIZATION AND CAPTURE BY PROVIDING SOFTWARE FOR PAYMENT WORKFLOW MANAGEMENT AND DATA RETRIEVAL (U.S. CLS. 100 AND 101).

FIRST USE 12-0-2008; IN COMMERCE 1-0-2009.
MARC LEIPZIG, EXAMINING ATTORNEY

SN 77-790,465. GANNETT SATELLITE INFORMATION NETWORK, INC., MCLEAN, VA. FILED 7-27-2009.

HOME & DECOR IDEAS

THE MARK CONSISTS OF STANDARD CHARACTERS WITHOUT CLAIM TO ANY PARTICULAR FONT, STYLE, SIZE, OR COLOR.

NO CLAIM IS MADE TO THE EXCLUSIVE RIGHT TO USE "HOME & DECOR", APART FROM THE MARK AS SHOWN.

CLASS 16—PAPER GOODS AND PRINTED MATTER

FOR MAGAZINES CONTAINING ADVERTISEMENTS AND PROMOTIONS, INCLUDING REDEEMABLE COUPONS FOR THE GOODS AND SERVICES OF OTHERS (U.S. CLS. 2, 5, 22, 23, 29, 37, 38 AND 50).

FIRST USE 5-20-2009; IN COMMERCE 5-20-2009.

CLASS 35—ADVERTISING AND BUSINESS

FOR BUSINESS SERVICES, NAMELY, PROMOTING THE GOODS AND SERVICES OF OTHERS THROUGH THE PLACING OF ADVERTISEMENTS AND PROMOTIONS, INCLUDING THE DISTRIBUTION OF COUPONS (U.S. CLS. 100, 101 AND 102).

FIRST USE 5-20-2009; IN COMMERCE 5-20-2009.
DOMINIC J. FERRAIUOLO, EXAMINING ATTORNEY

SN 77-790,933. PENNWELL CORPORATION, TULSA, OK. FILED 7-28-2009.

Photovoltaics
WORLD

NO CLAIM IS MADE TO THE EXCLUSIVE RIGHT TO USE "PHOTOVOLTAICS", APART FROM THE MARK AS SHOWN.

THE MARK CONSISTS OF THE WORDS "PHOTOVOLTAICS WORLD" WITH THE WORD "PHOTOVOLTAICS" ON THE FIRST LINE AND THE WORD "WORLD" BENEATH AND TO THE RIGHT OF "PHOTOVOLTAICS" WITH A STYLIZED GLOBE DESIGN IN THE LETTER "O".

CLASS 16—PAPER GOODS AND PRINTED MATTER

FOR MAGAZINE RELATING TO THE SOLAR PHOTOVOLTAICS MANUFACTURING INDUSTRY (U.S. CLS. 2, 5, 22, 23, 29, 37, 38 AND 50).
FIRST USE 3-1-2009; IN COMMERCE 3-1-2009.

CLASS 35—ADVERTISING AND BUSINESS

FOR ARRANGING AND CONDUCTING BUSINESS CONFERENCES IN THE FIELD RELATING TO THE SOLAR PHOTOVOLTAICS MANUFACTURING INDUSTRY (U.S. CLS. 100, 101 AND 102).
FIRST USE 6-15-2009; IN COMMERCE 6-15-2009.

CLASS 41—EDUCATION AND ENTERTAINMENT

FOR PROVIDING ONLINE NEWSLETTERS RELATING TO THE SOLAR PHOTOVOLTAICS MANUFACTURING INDUSTRY (U.S. CLS. 100, 101 AND 107).
FIRST USE 2-9-2009; IN COMMERCE 2-9-2009.
MARK SPARACINO, EXAMINING ATTORNEY

SN 77-790,949. ATIGEO LLC, BELLEVUE, WA. FILED 7-28-2009.

 **geogive**

THE MARK CONSISTS OF INTERLOCKING CIRCLES GROUPED TOGETHER IN A CLUSTER AND THE WORDING "GEOGIVE".

CLASS 36—INSURANCE AND FINANCIAL

FOR CHARITABLE FUND RAISING SERVICES, NAMELY, PROVIDING INDIVIDUALS WITH THE INFORMATION AND OPPORTUNITY TO MAKE MONETARY DONATIONS TO THEIR FAVORITE CHARITY ONLINE AND VIA MOBILE DEVICE (U.S. CLS. 100, 101 AND 102).
FIRST USE 4-0-2009; IN COMMERCE 4-0-2009.

CLASS 42—SCIENTIFIC AND COMPUTER SERVICES

FOR APPLICATION SERVICE PROVIDER FEATURING SOFTWARE THAT MATCHES DONORS TO THEIR CHARITIES OF INTEREST AND ALLOWS ONE TO DONATE VIA WEBSITE AND MOBILE DEVICES (U.S. CLS. 100 AND 101).

FIRST USE 4-0-2009; IN COMMERCE 4-0-2009.
LESLEY LAMOTHE, EXAMINING ATTORNEY

SN 77-791,879. ST. ANDREWS OF SCOTLAND INTERNATIONAL, LLC, VERO BEACH, FL. FILED 7-29-2009.



THE COLOR(S) BLACK AND RED IS/ARE CLAIMED AS A FEATURE OF THE MARK.

THE MARK CONSISTS OF A FRONT VIEW OF THE FACE OF A MALE INDIVIDUAL FORMED AND SHADOWED IN BLACK WITH THE INDIVIDUAL WEARING A BLACK BERET HAVING A RED HACKLE, WHEREIN THE BACKGROUND BEHIND THE INDIVIDUAL'S LEFT EAR IS BLACK AND BLACK LETTERS "BW" ARE DISPOSED BELOW THE INDIVIDUAL'S LOWER LEFT CHEEK BONE. THE COLOR WHITE REPRESENTS A BACKGROUND, OUTLINING, SHADING AND/OR TRANSPARENT AREAS AND IS NOT PART OF THE MARK OF THE PRESENT APPLICATION.

CLASS 3—COSMETICS AND CLEANING PREPARATIONS

FOR NON-MEDICATED TOILETRIES; SOAPS; PERFUMERY, ESSENTIAL OILS, COSMETICS, HAIR LOTIONS (U.S. CLS. 1, 4, 6, 50, 51 AND 52).

CLASS 9—ELECTRICAL AND SCIENTIFIC APPARATUS

FOR SUNGLASSES; SPECTACLE CASES; COMPUTER GAME PROGRAMS; COMPUTER HARDWARE FOR GAMES ADAPTED FOR USE WITH TELEVISION RECEIVERS ONLY; CALCULATORS FOR KEEPING TRACK OF GOLF SCORE; COMPUTERS; COMPUTER PERIPHERAL DEVICES; PORTABLE TELEPHONES; ELECTRICAL COMMUNICATION APPARATUS, NAMELY, MICROPHONES, DEVICES FOR HANDS-FREE USE OF MOBILE PHONES, AND PORTABLE TELECOMMUNICATION INSTANT MESSAGING DEVICES; ELECTRICAL APPARATUS AND INSTRUMENTS FOR RECEIVING, SENDING, STORING, RECORDING AND REPRODUCING SOUND, VIDEO SIGNALS AND INFORMATION, NAMELY, TELEVISION SETS, TELEPHONES, DVD PLAYERS, DVD RECORDERS, MP3 PLAYERS, MEMORY CHIPS, RADIOS, FAX MACHINES, VIDEO CAMERAS, CAMERAS, AND VIDEO RECORDERS, AND REMOTE CONTROLS FOR TELEVISIONS, NAUTICAL INSTRUMENTS, NAMELY, RADARS, SATELLITE NAVIGATIONAL INSTRUMENTS, NAVAL SIGNALLING INSTRUMENTS, NAMELY, TRANSMITTERS OF ELECTRONIC SIGNALS, SOUND RECORDING DEVICES, SOUND REPRODUCTION DEVICES; MEASURING APPARATUS AND INSTRUMENTS, NAMELY, SCALES, CHRONOGRAPHS FOR USE AS SPECIALIZED TIME RECORDING APPARATUS, DISTANCE MEASURING DEVICES, SPEED CHECKING INDICATORS FOR VEHICLES; CELL PHONES, CASES FOR MOBILE PHONES, DEVICES FOR HANDS-FREE USE OF MOBILE PHONES, KEYBOARDS FOR MOBILE PHONES, MOBILE PHONE STRAPS (U.S. CLS. 21, 23, 26, 36 AND 38).

CLASS 14—JEWELRY

FOR JEWELRY; WATCHES; COLLECTIBLE COINS; MEDALLIONS BEING JEWELRY; PINS BEING JEWELRY; PRECIOUS METAL TROPHIES (U.S. CLS. 2, 27, 28 AND 50).

CLASS 16—PAPER GOODS AND PRINTED MATTER

FOR PRINTED GUIDES FOR CITIES; GEOGRAPHICAL MAPS; POSTERS; REFERENCE BOOKS, NAMELY, REPRODUCTIONS OF HISTORY BOOKS; PRINTS AND PRINT ENGRAVINGS; GRAPHIC PRINTS; PAPERWEIGHTS; GOLF SCORE PADS; WRITING PADS; SCHOOL WRITING BOOKS; DRAWING PADS; PAPER CUTTERS; PHOTOGRAPHS; STATIONERY (U.S. CLS. 2, 5, 22, 23, 29, 37, 38 AND 50).

CLASS 25—CLOTHING

FOR CLOTHING, NAMELY, GOLF SHIRTS, DRESS SHIRTS, T-SHIRTS, SWEAT SHIRTS, KNIT SHIRTS, POLO SHIRTS, RUGBY SHIRTS, SLEEP SHIRTS, WIND SHIRTS, JERSEYS, MUFFLERS, TIES, SWEAT PANTS, SLACKS, WIND PANTS, CARGO PANTS, CAPRI PANTS, DENIM PANTS, SKI PANTS, JACKETS, PARKAS, SWEATERS, PULLOVERS, ANORAKS, SOCKS, UNDERWEAR, FOOTWEAR, HEADGEAR, NAMELY, HATS, CAPS, BASEBALL CAPS, SKI HATS, CHEFS HATS; GOLF FOOTWEAR; NECKTIES; SUN VISORS; HEADWEAR, NAMELY, CAPS; VISORS; WRIST BANDS (U.S. CLS. 22 AND 39).

CLASS 33—WINES AND SPIRITS

FOR ALCOHOLIC DRINKS, NAMELY, WINES, HARD CIDER, BRANDY, CURACAO, GIN, KIRSCH, BITTERS, RICE ALCOHOL, NAMELY, DISTILLED SPIRITS OF RICE, SAKE, RUM, WHISKEY, VODKA AND LIQUEURS (U.S. CLS. 47 AND 49).

JENNIFER DIXON, EXAMINING ATTORNEY

SN 77-791,895. ST. ANDREWS OF SCOTLAND INTERNATIONAL, LLC, VERO BEACH, FL. FILED 7-29-2009.



THE COLOR(S) BLACK AND RED IS/ARE CLAIMED AS A FEATURE OF THE MARK.

THE MARK CONSISTS OF A FRONT VIEW OF THE FACE OF A MALE INDIVIDUAL FORMED AND SHADOWED IN BLACK WITH THE INDIVIDUAL WEARING A BLACK BERET HAVING A RED HACKLE, WHEREIN THE BACKGROUND BEHIND THE INDIVIDUAL'S LEFT EAR IS BLACK AND THE PHRASE "BLACK WATCH" IS DISPOSED IN BLACK LETTERS BELOW THE FACE OF THE INDIVIDUAL. THE COLOR WHITE REPRESENTS BACKGROUND, OUTLINING, SHADING AND/OR TRANSPARENT AREAS AND IS NOT PART OF THE MARK OF THE PRESENT APPLICATION.

CLASS 36—INSURANCE AND FINANCIAL

FOR FINANCIAL AFFAIRS, NAMELY, BANKING SERVICES, CREDIT AND DEBIT CARD SERVICES, ISSUING OF TRAVELERS' CHECKS, STOCK EXCHANGE QUOTATIONS, DEPOSITS OF VALUABLES, NAMELY, SAFE DEPOSIT BOX SERVICES, SECURITIES BROKERAGE, FINANCIAL INFORMATION, FINANCIAL ANALYSIS, FINANCIAL CONSULTANCY, FINANCIAL SPONSORSHIP OF EDUCATIONAL, SPORTING, CULTURAL AND CHARITABLE EVENTS, FINANCING SERVICES, EXCHANGING MONEY, CAPITAL INVESTMENTS, LOAN FINANCING, FINANCIAL MANAGEMENT, SAFETY DEPOSIT BOX SERVICES; REAL ESTATE MANAGEMENT, NAMELY, MANAGEMENT OF GOLF FACILITIES AND GOLF RESORTS (U.S. CLS. 100, 101 AND 102).

CLASS 42—SCIENTIFIC AND COMPUTER SERVICES

FOR DESIGN AND DEVELOPMENT OF GAMES PLAYED ON ELECTRIC OR ELECTRONIC DEVICES (U.S. CLS. 100 AND 101).

JENNIFER DIXON, EXAMINING ATTORNEY

SN 77-792,025. GARTNER STUDIOS, INC., STILLWATER, MN. FILED 7-29-2009.

story maker

THE MARK CONSISTS OF STANDARD CHARACTERS WITHOUT CLAIM TO ANY PARTICULAR FONT, STYLE, SIZE, OR COLOR.

CLASS 9—ELECTRICAL AND SCIENTIFIC APPARATUS

FOR DVDS FEATURING CUSTOM CREATED PHOTOGRAPH ALBUMS CONTAINING PHOTOGRAPHS PROVIDED BY A CUSTOMER (U.S. CLS. 21, 23, 26, 36 AND 38).

CLASS 16—PAPER GOODS AND PRINTED MATTER

FOR BOOKS IN THE FIELD OF CUSTOM CREATED PHOTOGRAPH ALBUMS CONTAINING PHOTOGRAPHS PROVIDED BY A CUSTOMER (U.S. CLS. 2, 5, 22, 23, 29, 37, 38 AND 50).

JUSTINE D. PARKER, EXAMINING ATTORNEY

CLASS 37—CONSTRUCTION AND REPAIR

FOR JANITORIAL SERVICES; COMMERCIAL PROPERTY FACILITIES SERVICES, NAMELY, JANITORIAL SERVICES AND BUILDING MAINTENANCE AND REPAIR; INSTALLATION AND MAINTENANCE OF IRRIGATION SYSTEMS; PEST CONTROL; SNOW REMOVAL SERVICES; AMUSEMENT PARK RIDE MAINTENANCE SERVICES; PARKING LOT MAINTENANCE SERVICES (U.S. CLS. 100, 103 AND 106).

CLASS 44—MEDICAL, BEAUTY AND AGRICULTURAL SERVICES

FOR LANDSCAPE DESIGN; LANDSCAPE GARDENING; GROUNDS MAINTENANCE SERVICES, NAMELY, SEASONAL GROUNDS MAINTENANCE AND CLEAN UP SERVICES; LANDSCAPING AND GROUNDS MAINTENANCE SERVICES IN THE COMMERCIAL, RESIDENTIAL AND GOVERNMENT SECTORS, NAMELY, LAWN MOWING, LAWN CARE, TREE REMOVAL, AND PLANT CARE SERVICES; GARDENER AND GARDENING SERVICES, NAMELY, GOLF COURSE CARE AND MAINTENANCE; LAWN CARE AND LAWN MOWING SERVICES; GARDENER AND GARDENING SERVICES, NAMELY, ATHLETIC FIELD MAINTENANCE AND RENOVATION; TREE CARE SERVICES; GARDEN OR FLOWER BED CARE; GARDEN PLANT INSTALLATION AND CARE SERVICES FOR INDOOR AND OUTDOOR AREAS; FERTILIZER SPREADING (U.S. CLS. 100 AND 101).

DEIRDRE ROBERTSON, EXAMINING ATTORNEY

SN 77-792,175. THE PROCTER & GAMBLE COMPANY, CINCINNATI, OH. FILED 7-29-2009.

PRO HEALTH FOR ME

THE MARK CONSISTS OF STANDARD CHARACTERS WITHOUT CLAIM TO ANY PARTICULAR FONT, STYLE, SIZE, OR COLOR.

CLASS 3—COSMETICS AND CLEANING PREPARATIONS

FOR TOOTHPASTE, MOUTHWASH (U.S. CLS. 1, 4, 6, 50, 51 AND 52).

CLASS 21—HOUSEWARES AND GLASS

FOR MANUAL TOOTHBRUSHES; BATTERY OPERATED TOOTHBRUSHES; DENTAL FLOSS; AND, DENTAL FLOSS PICKS (U.S. CLS. 2, 13, 23, 29, 30, 33, 40 AND 50).

MATTHEW KLINE, EXAMINING ATTORNEY

SN 77-792,665. ABM INDUSTRIES INCORPORATED, NEW YORK, NY. FILED 7-29-2009.

ONESOURCE

SN 77-792,595. ABM INDUSTRIES INCORPORATED, NEW YORK, NY. FILED 7-29-2009.



THE MARK CONSISTS OF STANDARD CHARACTERS WITHOUT CLAIM TO ANY PARTICULAR FONT, STYLE, SIZE, OR COLOR.

OWNER OF U.S. REG. NOS. 2,426,108, 2,925,496 AND OTHERS.

OWNER OF U.S. REG. NOS. 2,426,108, 2,925,496 AND OTHERS.

NO CLAIM IS MADE TO THE EXCLUSIVE RIGHT TO USE "LANDSCAPE & GOLF SERVICES, INC." AND "COMPANY", APART FROM THE MARK AS SHOWN.

THE MARK CONSISTS OF THE WORDS "ONESOURCE LANDSCAPE & GOLF SERVICES, INC. AN ABM COMPANY" ALL TO THE RIGHT OF A CIRCLE CONTAINING TWO CURVED LINES.

CLASS 37—CONSTRUCTION AND REPAIR

FOR JANITORIAL SERVICES; COMMERCIAL PROPERTY FACILITIES SERVICES, NAMELY, JANITORIAL SERVICES AND BUILDING MAINTENANCE AND REPAIR; INSTALLATION AND MAINTENANCE OF IRRIGATION SYSTEMS; PEST CONTROL; SNOW REMOVAL SERVICES; AMUSEMENT PARK RIDE MAINTENANCE SERVICES; PARKING LOT MAINTENANCE SERVICES (U.S. CLS. 100, 103 AND 106).

FIRST USE 1-6-1999; IN COMMERCE 1-6-1999.

CLASS 44—MEDICAL, BEAUTY AND AGRICULTURAL SERVICES

FOR LANDSCAPE DESIGN; LANDSCAPE GARDENING; GROUNDS MAINTENANCE SERVICES, NAMELY, SEASONAL GROUNDS MAINTENANCE AND CLEAN UP SERVICES; LANDSCAPING AND GROUNDS MAINTENANCE SERVICES IN THE COMMERCIAL, RESIDENTIAL AND GOVERNMENT SECTORS, NAMELY, LAWN MOWING, LAWN CARE, TREE REMOVAL, AND PLANT CARE SERVICES; GARDENER AND GARDENING SERVICES, NAMELY, GOLF COURSE CARE AND MAINTENANCE; LAWN CARE AND LAWN MOWING SERVICES; GARDENER AND GARDENING SERVICES, NAMELY, ATHLETIC FIELD MAINTENANCE AND RENOVATION; TREE CARE SERVICES; GARDEN OR FLOWER BED CARE; GARDEN PLANT INSTALLATION AND CARE SERVICES FOR INDOOR AND OUTDOOR AREAS; FERTILIZER SPREADING (U.S. CLS. 100 AND 101).

FIRST USE 2-1-1999; IN COMMERCE 2-1-1999.
DEIRDRE ROBERTSON, EXAMINING ATTORNEY

SN 77-793,665, MANCHENO, JOSEPH, METUCHEN, NJ.
FILED 7-30-2009.

NURSEJOE

THE MARK CONSISTS OF STANDARD CHARACTERS WITHOUT CLAIM TO ANY PARTICULAR FONT, STYLE, SIZE, OR COLOR.

CLASS 10—MEDICAL APPARATUS

FOR NURSES APPAREL, NAMELY, ARMY COMBAT UNIFORM MARPAT MEDICAL SCRUB SHIRTS; CAMOUFLAGE MEDICAL SCRUB SHIRTS; MILITARY MEDICAL SCRUB SHIRTS; ARMY COMBAT UNIFORM MARPAT MEDICAL SCRUB PANTS; CAMOUFLAGE MEDICAL SCRUB PANTS; MILITARY MEDICAL SCRUB PANTS; MARPAT AND CAMOUFLAGE SURGICAL SCRUB HATS; FRONT CLOSURE MEDICAL SHIRTS WITH SELF ADHERING PANELS (U.S. CLS. 26, 39 AND 44).

FIRST USE 10-6-1999; IN COMMERCE 11-10-2003.

CLASS 25—CLOTHING

FOR MARPAT AND CAMOUFLAGE JACKETS; BELTS; SHOES; JACKETS; COATS; OVERALLS; APRONS (U.S. CLS. 22 AND 39).

FIRST USE 10-6-1999; IN COMMERCE 11-10-2003.
MORGAN WYNNE, EXAMINING ATTORNEY

SN 77-793,919, ONEMEDNET CORPORATION, HONOLULU, HI. FILED 7-30-2009.

BEAM

THE MARK CONSISTS OF STANDARD CHARACTERS WITHOUT CLAIM TO ANY PARTICULAR FONT, STYLE, SIZE, OR COLOR.

CLASS 38—COMMUNICATION

FOR TRANSFER OF PATIENT AND MEDICAL DATA BY TELECOMMUNICATIONS (U.S. CLS. 100, 101 AND 104).

CLASS 39—TRANSPORTATION AND STORAGE

FOR STORAGE SERVICES FOR ARCHIVING PATIENT AND MEDICAL DATABASES AND IMAGE TRANSFER (U.S. CLS. 100 AND 105).

NAKIA HENRY, EXAMINING ATTORNEY

SN 77-794,383, PAUL HARTMANN, HEIDENHEIM, FED REP GERMANY, FILED 7-31-2009.

Vivano-System

THE MARK CONSISTS OF STANDARD CHARACTERS WITHOUT CLAIM TO ANY PARTICULAR FONT, STYLE, SIZE, OR COLOR.

PRIORITY CLAIMED UNDER SEC. 44(D) ON ERPNCMNTY TM OFC APPLICATION NO. 008417644, FILED 7-10-2009, REG. NO. 008417644, DATED 1-9-2010, EXPIRES 7-10-2019.

CLASS 5—PHARMACEUTICALS

FOR MEDICAL PLASTERS, STICKING PLASTERS FOR MEDICAL USE, MATERIALS FOR DRESSING, NAMELY, ADHESIVE FOR BANDAGES FOR SKIN WOUNDS, BANDAGES FOR DRESSINGS, BANDAGES FOR SKIN WOUNDS, BANDAGES IMPREGNATED WITH HYDROGEL AND HYDROCOLLOID, MOLE SKIN FOR USE AS A MEDICAL BANDAGE, SURGICAL BANDAGES, BURN DRESSINGS, GAUZE FOR DRESSINGS, SELF ADHESIVE DRESSINGS, SELF-ADHESIVE DRESSINGS, NAMELY, TRANSPARENT FILM DRESSINGS, SURGICAL DRESSINGS, DRESSINGS FOR WOUNDS, BURNS, SURGERY; MEDICATED COMPRESSES, COTTON SWABS FOR MEDICAL PURPOSES, TAMPONS, MEDICAL COTTON; MATERIAL FOR MEDICAL CARE OF WOUNDS, NAMELY, ANTI-ADHESION GELS FOR USE WITH WOUND DRAINAGE DEVICES, DRESSINGS FOR WOUNDS, BURNS, SURGERY, MEDICAL ADHESIVES FOR BINDING WOUNDS, GAUZE FOR DRESSINGS, SELF ADHESIVE DRESSINGS; GRANULAR INSERT AND PADDING MATERIAL FOR MEDICAL PURPOSES, NAMELY, WOUND DRESSING; MEDICAL AND SURGICAL DRESSINGS, NAMELY, THERMOPLASTIC RESIN DRESSINGS (U.S. CLS. 6, 18, 44, 46, 51 AND 52).

CLASS 10—MEDICAL APPARATUS

FOR PLASTER CASTS FOR ORTHOPEDIC PURPOSES, FIXING BANDAGES, NAMELY, SELF ADHESIVE ELASTIC BANDAGES FOR SUPPORTIVE OR ORTHOPEDIC PURPOSES, SUPPORT BANDAGES; BANDAGES FOR ANATOMICAL JOINTS, COMPRESSION BANDAGES, ELASTIC BANDAGES, ORTHOPEDIC SUPPORT BANDAGES, UNIVERSAL BANDAGES FOR ORTHOPEDIC SUPPORT; SLEEVE AND GAUZE BANDAGES FOR ORTHOPEDIC SUPPORT; ZINC PASTE BANDAGES ALL FOR SUPPORTIVE OR ORTHOPEDIC PURPOSES; MEDICAL COMPRESSION STOCKINGS AND TIGHTS; PADDING MATERIAL FOR ORTHOPEDIC PURPOSES; SURGICAL INSTRUMENTS AND APPARATUS; SURGICAL APPARATUS AND INSTRUMENTS FOR MEDICAL, DENTAL OR VETERINARY USE; MEDICAL AND SURGICAL APPARATUS AND INSTRUMENTS, NAMELY, WOUND DRAINAGE APPARATUS FOR ENHANCING WOUND HEALING; WOUND SUCTION APPARATUS FOR THE TREATMENT OF WOUNDS; LOW PRESSURE ASSISTED WOUND SUCTION APPARATUS (U.S. CLS. 26, 39 AND 44).

CLASS 41—EDUCATION AND ENTERTAINMENT

FOR CONDUCTING INSTRUCTIONAL COURSES ON WOUND CARE, INCONTINENCE AND COMPRESSION THERAPY, AND TAPE COURSES, NAMELY, PROVIDING INSTRUCTION ON TAPE DRESSINGS (U.S. CLS. 100, 101 AND 107).

CLASS 44—MEDICAL, BEAUTY AND AGRICULTURAL SERVICES

FOR MEDICAL SERVICES; HYGIENIC AND BEAUTY CARE FOR HUMAN BEINGS OR ANIMALS; MEDICAL ADVISORY SERVICES; SANITARY CARE, NAMELY, HEALTHCARE, GERIATRIC HEALTHCARE MANAGEMENT SERVICES; MEDICAL ADVISORY SERVICES (U.S. CLS. 100 AND 101).

AISHA CLARKE, EXAMINING ATTORNEY

SN 77-794,411. AMERICAN FARM BUREAU FEDERATION, WASHINGTON, DC. FILED 7-31-2009.



THE MARK CONSISTS OF THE LETTERS "FB" ABOVE THE STYLIZED WORDS "FB ACT INSIDER".

CLASS 38—COMMUNICATION

FOR PROVIDING ON-LINE FORUMS FOR TRANSMISSION OF MESSAGES AMONG APPLICANT'S MEMBERS AND MEMBERS OF THE AGRICULTURAL COMMUNITY REGARDING LEGISLATIVE, POLITICAL, REGULATORY AND POLICY INFORMATION IN THE FIELD OF AGRICULTURE AND REGARDING CONTACT INFORMATION FOR NEWSPAPERS AND ELECTED OFFICIALS IN THE FIELD OF AGRICULTURE (U.S. CLS. 100, 101 AND 104).

CLASS 44—MEDICAL, BEAUTY AND AGRICULTURAL SERVICES

FOR PROVIDING NEWS IN THE FIELD OF AGRICULTURE, TO OTHERS, VIA SATELLITE AND ELECTRONIC TRANSMISSION (U.S. CLS. 100 AND 101).

JACQUELINE A. LAVINE, EXAMINING ATTORNEY

SN 77-794,430. AMERICAN FARM BUREAU FEDERATION, WASHINGTON, DC. FILED 7-31-2009.

FBACT INSIDER

THE MARK CONSISTS OF STANDARD CHARACTERS WITHOUT CLAIM TO ANY PARTICULAR FONT, STYLE, SIZE, OR COLOR.

CLASS 38—COMMUNICATION

FOR PROVIDING ON-LINE FORUMS FOR TRANSMISSION OF MESSAGES AMONG APPLICANT'S MEMBERS AND MEMBERS OF THE AGRICULTURAL COMMUNITY REGARDING LEGISLATIVE, POLITICAL, REGULATORY AND POLICY INFORMATION IN THE FIELD OF AGRICULTURE AND REGARDING CONTACT INFORMATION FOR NEWSPAPERS AND ELECTED OFFICIALS IN THE FIELD OF AGRICULTURE (U.S. CLS. 100, 101 AND 104).

CLASS 44—MEDICAL, BEAUTY AND AGRICULTURAL SERVICES

FOR PROVIDING NEWS IN THE FIELD OF AGRICULTURE, TO OTHERS, VIA SATELLITE AND ELECTRONIC TRANSMISSION (U.S. CLS. 100 AND 101).

JACQUELINE A. LAVINE, EXAMINING ATTORNEY

SN 77-794,440. AMERICAN FARM BUREAU FEDERATION, WASHINGTON, DC. FILED 7-31-2009.

FBACT

THE MARK CONSISTS OF STANDARD CHARACTERS WITHOUT CLAIM TO ANY PARTICULAR FONT, STYLE, SIZE, OR COLOR.

CLASS 38—COMMUNICATION

FOR PROVIDING ON-LINE FORUMS FOR TRANSMISSION OF MESSAGES AMONG APPLICANT'S MEMBERS AND MEMBERS OF THE AGRICULTURAL COMMUNITY REGARDING LEGISLATIVE, POLITICAL, REGULATORY AND POLICY INFORMATION IN THE FIELD OF AGRICULTURE AND REGARDING CONTACT INFORMATION FOR NEWSPAPERS AND ELECTED OFFICIALS IN THE FIELD OF AGRICULTURE (U.S. CLS. 100, 101 AND 104).

CLASS 44—MEDICAL, BEAUTY AND AGRICULTURAL SERVICES

FOR PROVIDING NEWS IN THE FIELD OF AGRICULTURE, TO OTHERS, VIA SATELLITE AND ELECTRONIC TRANSMISSION (U.S. CLS. 100 AND 101).

JACQUELINE A. LAVINE, EXAMINING ATTORNEY

SN 77-795,534. PFIZER INC., NEW YORK, NY. FILED 8-3-2009.

SN 77-794,467. PAUL HARTMANN AKTIENGESELLSCHAFT, HEIDENHEIM, FED REP GERMANY, FILED 7-31-2009.

VivanoTouch

THE MARK CONSISTS OF STANDARD CHARACTERS WITHOUT CLAIM TO ANY PARTICULAR FONT, STYLE, SIZE, OR COLOR.

OWNER OF FED REP GERMANY REG. NO. 008409385, DATED 12-24-2009, EXPIRES 7-7-2019.

CLASS 5—PHARMACEUTICALS

FOR MEDICAL PLASTERS, STICKING PLASTERS FOR MEDICAL USE, MATERIALS FOR DRESSING, NAMELY, ADHESIVE FOR BANDAGES FOR SKIN WOUNDS, BANDAGES FOR DRESSINGS, BANDAGES FOR SKIN WOUNDS, BANDAGES IMPREGNATED WITH HYDROGEL AND HYDROCOLLOID, MOLE SKIN FOR USE AS A MEDICAL BANDAGE, SURGICAL BANDAGES, BURN DRESSINGS, GAUZE FOR DRESSINGS, SELF ADHESIVE DRESSINGS, SELF-ADHESIVE DRESSINGS, NAMELY, TRANSPARENT FILM DRESSINGS, SURGICAL DRESSINGS, DRESSINGS FOR WOUNDS, BURNS, SURGERY; MEDICATED COMPRESSES, COTTON SWABS FOR MEDICAL PURPOSES, TAMPONS, MEDICAL COTTON; MATERIAL FOR MEDICAL CARE OF WOUNDS, NAMELY, ANTI-ADHESION GELS FOR USE WITH WOUND DRAINAGE DEVICES, DRESSINGS FOR WOUNDS, BURNS, SURGERY, MEDICAL ADHESIVES FOR BINDING WOUNDS, GAUZE FOR DRESSINGS, SELF ADHESIVE DRESSINGS; GRANULAR INSERT AND PADDING MATERIAL FOR MEDICAL PURPOSES, NAMELY, WOUND DRESSING, MEDICAL AND SURGICAL DRESSINGS, NAMELY, THERMOPLASTIC RESIN DRESSINGS (U.S. CLS. 6, 18, 44, 46, 51 AND 52).

CLASS 10—MEDICAL APPARATUS

FOR PLASTER CASTS FOR ORTHOPEDIC PURPOSES, FIXING BANDAGES, NAMELY, SELF ADHESIVE ELASTIC BANDAGES FOR SUPPORTIVE OR ORTHOPEDIC PURPOSES, SUPPORT BANDAGES; BANDAGES FOR ANATOMICAL JOINTS, COMPRESSION BANDAGES, ELASTIC BANDAGES, ORTHOPEDIC SUPPORT BANDAGES, UNIVERSAL BANDAGES FOR ORTHOPEDIC SUPPORT; SLEEVE AND GAUZE BANDAGES FOR ORTHOPEDIC SUPPORT; ZINC PASTE BANDAGES ALL FOR SUPPORTIVE OR ORTHOPEDIC PURPOSES; MEDICAL COMPRESSION STOCKINGS AND TIGHTS; PADDING MATERIAL FOR ORTHOPEDIC PURPOSES; SURGICAL INSTRUMENTS AND APPARATUS; SURGICAL APPARATUS AND INSTRUMENTS FOR MEDICAL, DENTAL OR VETERINARY USE; MEDICAL AND SURGICAL APPARATUS AND INSTRUMENTS, NAMELY, WOUND DRAINAGE APPARATUS FOR ENHANCING WOUND HEALING; WOUND SUCTION APPARATUS FOR THE TREATMENT OF WOUNDS; MEDICAL AND SURGICAL APPARATUS AND INSTRUMENTS, NAMELY, LOW PRESSURE ASSISTED AND VACUUM WOUND SUCTION APPARATUS (U.S. CLS. 26, 39 AND 44).

AISHA CLARKE, EXAMINING ATTORNEY

UPBRIGHT

THE MARK CONSISTS OF STANDARD CHARACTERS WITHOUT CLAIM TO ANY PARTICULAR FONT, STYLE, SIZE, OR COLOR.

CLASS 5—PHARMACEUTICALS

FOR PHARMACEUTICAL PREPARATIONS FOR THE TREATMENT OF CARDIOVASCULAR DISEASE, CENTRAL NERVOUS SYSTEM DISEASES AND DISORDERS, NEUROLOGICAL DISORDERS, UROLOGICAL DISORDERS, UROGENITAL DISORDERS, GASTROINTESTINAL DISORDERS, MUSCULOSKELETAL DISORDERS, ALLERGIES, DIABETES, HYPERTENSION, ERECTILE DYSFUNCTION, SEXUAL DYSFUNCTION, STROKE, CANCER, MIGRAINES, PAIN, OBESITY, INFLAMMATION, INFLAMMATORY DISEASES, RESPIRATORY DISEASES, INFECTIOUS DISEASES, IMMUNOLOGICAL DISORDERS, VIRAL DISORDERS, FUNGAL DISORDERS; PHARMACEUTICAL PREPARATIONS, NAMELY, CHOLESTEROL PREPARATIONS, SMOKING CESSATION PREPARATIONS, DERMATOLOGICAL PREPARATIONS, GYNECOLOGICAL PREPARATIONS, OSTEOPOROSIS PREPARATIONS, OPHTHALMOLOGICAL PREPARATIONS, INHALERS FILLED WITH PHARMACEUTICAL PREPARATIONS FOR TREATING THE ABOVE DISEASES, DISORDERS AND CONDITIONS (U.S. CLS. 6, 18, 44, 46, 51 AND 52).

CLASS 10—MEDICAL APPARATUS

FOR INHALERS FOR THE INHALATION OF MEDICINE, PARTS AND FITTINGS THEREFOR (U.S. CLS. 26, 39 AND 44).

TOBY BULLOFF, EXAMINING ATTORNEY

SN 77-797,024. SONOSITE, INC., BOTHELL, WA. FILED 8-4-2009.

SONOACCESS

THE MARK CONSISTS OF STANDARD CHARACTERS WITHOUT CLAIM TO ANY PARTICULAR FONT, STYLE, SIZE, OR COLOR.

CLASS 9—ELECTRICAL AND SCIENTIFIC APPARATUS

FOR SOFTWARE FOR WIRELESS CONTENT DELIVERY; COMPUTER APPLICATION SOFTWARE FOR MOBILE PHONES; SOFTWARE, NAMELY, MOBILE PHONE AND PDA APPLICATIONS AND DOWNLOADABLE APPLICATIONS, ALL FOR CREATING, DISPLAYING, ACCESSING, AND USING ARTICLES, TUTORIALS, NEWS, NEWSLETTERS, JOURNALS, MAGAZINES, GUIDES, PAMPHLETS, BROCHURES, PRODUCT INFORMATION, REVIEWS, ADVICE, AUDIO CONTENT, AND VIDEOS; EDUCATIONAL SOFTWARE FEATURING INSTRUCTION IN THE FIELDS OF MEDICINE, MEDICAL IMAGING, AND HEALTH CARE; DOWNLOADABLE AUDIO, VIDEO, MULTIMEDIA, AND TEXT FILES FEATURING ARTICLES, TUTORIALS, NEWS, NEWSLETTERS, JOURNALS, MAGAZINES, GUIDES, PAMPHLETS, BROCHURES, PRODUCT INFORMATION, REVIEWS, ADVICE, AUDIO CONTENT, AND VIDEOS, ON THE SUBJECTS OF MEDICINE, MEDICAL IMAGING, HEALTH CARE, AND A WIDE RANGE OF TOPICS OF GENERAL INTEREST (U.S. CLS. 21, 23, 26, 36 AND 38).

CLASS 42—SCIENTIFIC AND COMPUTER SERVICES

FOR PROVIDING ONLINE, NON-DOWNLOADABLE SOFTWARE, NAMELY, MOBILE PHONE AND PDA APPLICATIONS FOR CREATING, DISPLAYING, ACCESSING, AND USING ARTICLES; TUTORIALS, NEWS, NEWSLETTERS, JOURNALS, MAGAZINES, GUIDES, PAMPHLETS, BROCHURES, PRODUCT INFORMATION, REVIEWS, ADVICE, AUDIO CONTENT, AND VIDEOS (U.S. CLS. 100 AND 101).

REBECCA EISINGER, EXAMINING ATTORNEY

SN 77-797,070. SONOSITE, INC., BOTHELL, WA. FILED 8-4-2009.

SONOACCESS

THE MARK CONSISTS OF STANDARD CHARACTERS WITHOUT CLAIM TO ANY PARTICULAR FONT, STYLE, SIZE, OR COLOR.

CLASS 41—EDUCATION AND ENTERTAINMENT

FOR EDUCATIONAL SERVICES, NAMELY, PROVIDING ON-LINE INSTRUCTION, CLASSES, WORKSHOPS, SEMINARS, AND PROVIDING COURSE MATERIALS THEREWITH IN THE FIELDS OF MEDICINE, MEDICAL IMAGING, AND HEALTH CARE; ONLINE JOURNALS, NAMELY, BLOGS FEATURING INFORMATION IN THE FIELDS OF MEDICINE, MEDICAL IMAGING, AND HEALTH CARE; PROVIDING CONTINUING MEDICAL EDUCATION COURSES (U.S. CLS. 100, 101 AND 107).

CLASS 44—MEDICAL, BEAUTY AND AGRICULTURAL SERVICES

FOR PROVIDING ONLINE EDUCATIONAL INFORMATION IN THE FIELDS OF MEDICINE, MEDICAL IMAGING, AND HEALTH CARE (U.S. CLS. 100 AND 101).

REBECCA EISINGER, EXAMINING ATTORNEY

SN 77-797,333. WILLIAMS, HOWARD JONES III, ATLANTA, GA. FILED 8-5-2009.

Dr. Pain

THE MARK CONSISTS OF STANDARD CHARACTERS WITHOUT CLAIM TO ANY PARTICULAR FONT, STYLE, SIZE, OR COLOR.

NO CLAIM IS MADE TO THE EXCLUSIVE RIGHT TO USE "DR." IN INTERNATIONAL CLASS 44 OR "PAIN" IN INTERNATIONAL CLASS 41, APART FROM THE MARK AS SHOWN.

THE NAME(S), PORTRAIT(S), AND/OR SIGNATURE(S) SHOWN IN THE MARK IDENTIFIES HOWARD J WILLIAMS, WHOSE CONSENT(S) TO REGISTER IS MADE OF RECORD.

CLASS 41—EDUCATION AND ENTERTAINMENT

FOR ARRANGING AND CONDUCTING EDUCATIONAL CONFERENCES; CONDUCTING WORKSHOPS AND SEMINARS IN PAIN MANAGEMENT; DEVELOPMENT AND DISSEMINATION OF EDUCATIONAL MATERIALS OF OTHERS IN THE FIELD OF ANESTHESIOLOGY; ORGANIZATION OF SEMINARS, WORKING GROUPS, RESEARCH GROUPS AND CONVENTIONS, IN THE FIELD OF MEDICINE; PROVIDING A WEB SITE THAT FEATURES INFORMAL INSTRUCTION ON CHRONIC PAIN MANAGEMENT (U.S. CLS. 100, 101 AND 107).

FIRST USE 5-1-1994; IN COMMERCE 7-2-2008.

CLASS 44—MEDICAL, BEAUTY AND AGRICULTURAL SERVICES

FOR CONSULTING SERVICES IN THE FIELD OF HEALTH; HEALTH CARE; MEDICAL CONSULTATIONS; MEDICAL SERVICES, NAMELY, ANESTHESIOLOGY; PHYSICIAN SERVICES; PROVIDING HEALTH INFORMATION (U.S. CLS. 100 AND 101).

FIRST USE 5-1-1993; IN COMMERCE 9-25-2008.
DEZMONA MIZELLE, EXAMINING ATTORNEY

SN 77-797,408. HOBBY LOBBY STORES, INC., OKLAHOMA CITY, OK. FILED 8-5-2009.

**THE PROMISE OF CHRISTMAS
BY ROBERT STANLEY**

THE MARK CONSISTS OF STANDARD CHARACTERS WITHOUT CLAIM TO ANY PARTICULAR FONT, STYLE, SIZE, OR COLOR.

OWNER OF U.S. REG. NOS. 3,215,090 AND 3,243,794.

THE NAME(S), PORTRAIT(S), AND/OR SIGNATURE(S) SHOWN IN THE MARK IDENTIFIES "ROBERT STANLEY LETT", WHOSE CONSENT(S) TO REGISTER IS MADE OF RECORD.

CLASS 6—METAL GOODS

FOR FIGURINES OF COMMON METAL (U.S. CLS. 2, 12, 13, 14, 23, 25 AND 50).

CLASS 20—FURNITURE AND ARTICLES NOT OTHERWISE CLASSIFIED

FOR FIGURINES OF PLASTIC AND WOOD (U.S. CLS. 2, 13, 22, 25, 32 AND 50).

CLASS 21—HOUSEWARES AND GLASS

FOR CANDLE HOLDERS; CERAMIC FIGURINES; DISHES; FIGURINES OF GLASS AND PORCELAIN (U.S. CLS. 2, 13, 23, 29, 30, 33, 40 AND 50).

CLASS 28—TOYS AND SPORTING GOODS

FOR CHRISTMAS TREE ORNAMENTS AND DECORATIONS; WATER GLOBES (U.S. CLS. 22, 23, 38 AND 50).

BARBARA RUTLAND, EXAMINING ATTORNEY

SN 77-798,324. CHARITABLE LEADERSHIP FOUNDATION, COMPRISING RICHARD C. LIEBICH, A U.S. CITIZEN, CLIFTON PARK, NY. FILED 8-6-2009.

SEAL Sustaining
Educational Achievement in
Literacy

THE MARK CONSISTS OF STANDARD CHARACTERS WITHOUT CLAIM TO ANY PARTICULAR FONT, STYLE, SIZE, OR COLOR.

NO CLAIM IS MADE TO THE EXCLUSIVE RIGHT TO USE "SUSTAINING EDUCATIONAL ACHIEVEMENT IN LITERACY", APART FROM THE MARK AS SHOWN.

CLASS 16—PAPER GOODS AND PRINTED MATTER

FOR PRINTED INSTRUCTIONAL, ASSESSMENT, EDUCATIONAL AND TEACHING MATERIALS IN THE FIELD OF LITERACY; PRINTED MATERIALS, NAMELY, EDUCATIONAL BOOKS, REPORTS, TEACHING MATERIALS, BOOKS, BROCHURES, NEWSLETTERS, TESTING AND ASSESSMENT MATERIALS, ALL FOR USE IN EDUCATIONAL INSTRUCTION, TESTING, ASSESSMENT, CURRICULUM DEVELOPMENT AND IMPLEMENTATION (U.S. CLS. 2, 5, 22, 23, 29, 37, 38 AND 50).

FIRST USE 9-1-2005; IN COMMERCE 9-1-2005.

CLASS 41—EDUCATION AND ENTERTAINMENT

FOR EDUCATIONAL SERVICES, NAMELY, CONDUCTING AND PROVIDING CLASSES, WORKSHOPS, INSTITUTES, COACHING AND TRAINING FOR TEACHERS, PRINCIPALS AND SCHOOL ADMINISTRATORS IN THE FIELDS OF LITERACY AND EDUCATION; ASSESSMENT OF EDUCATIONAL CURRICULUMS; DEVELOPING CURRICULUM AND INSTRUCTION STRATEGIES FOR TEACHERS AND STUDENTS; EDUCATIONAL RESEARCH SERVICES; DISTRIBUTION OF ONLINE OR PRINTED RESOURCE GUIDES FOR USE IN CONNECTION WITH ALL OF THE ABOVE (U.S. CLS. 100, 101 AND 107).

FIRST USE 9-1-2005; IN COMMERCE 9-1-2005.
JOHN WILKE, EXAMINING ATTORNEY

SN 77-799,683. GAY MEN'S HEALTH CRISIS, NEW YORK, NY. FILED 8-7-2009.



THE MARK CONSISTS OF A CENTAUR/MINOTAUR HOLDING A TAMBOURINE BEHIND HIS HEAD WITH THE WORDS "PARADISE GARAGE" APPEARING ON HIS BICEP.

CLASS 9—ELECTRICAL AND SCIENTIFIC APPARATUS

FOR PHONOGRAPH RECORDS, COMPACT DISCS AND PRE-RECORDED AUDIO TAPES FEATURING MUSIC; PRE-RECORDED VIDEO TAPES AND VIDEO DISCS FEATURING MUSICAL PERFORMANCES AND MOTION PICTURES FEATURING MUSIC, CONCERTS AND MUSICAL ARTISTS, FOR ENTERTAINMENT AND EDUCATION (U.S. CLS. 21, 23, 26, 36 AND 38).

FIRST USE 12-1-1998; IN COMMERCE 12-1-1998.

CLASS 25—CLOTHING

FOR APPAREL, NAMELY, T-SHIRTS, SHIRTS, SWEATSHIRTS (U.S. CLS. 22 AND 39).

FIRST USE 12-1-1992; IN COMMERCE 12-1-1992.

WILLIAM BRECKENFELD, EXAMINING ATTORNEY

SN 77-800,595. SONY CORPORATION, TOKYO, JAPAN, FILED 8-10-2009.

Beau-Reflective

THE MARK CONSISTS OF STANDARD CHARACTERS WITHOUT CLAIM TO ANY PARTICULAR FONT, STYLE, SIZE, OR COLOR.

CLASS 9—ELECTRICAL AND SCIENTIFIC APPARATUS

FOR LOW-TEMPERATURE POLYSILICON LCD PANELS; TELEVISION SETS; PERSONAL DIGITAL ASSISTANTS (PDAS); PERSONAL COMPUTERS; COMPUTER DISPLAYERS; COMPUTER PRINTERS; MOBILE PHONES; VIDEO CAMERAS; DIGITAL STILL CAMERAS; NAVIGATION DEVICES FOR CAR AND PORTABLE USE COMPRISED OF RECEIVERS, TRANSMITTERS, DECODERS, DISC PLAYERS AND MONITORS FOR SIGNALS FROM GLOBAL POSITIONING SYSTEM SATELLITES (U.S. CLS. 21, 23, 26, 36 AND 38).

CLASS 28—TOYS AND SPORTING GOODS

FOR HAND-HELD GAME MACHINES WITH LCD MOUNTING LOW-TEMPERATURE POLYSILICON LCD PANELS (U.S. CLS. 22, 23, 38 AND 50).
MARILYN IZZI, EXAMINING ATTORNEY

SN 77-803,755. REVERE SECURITY CORPORATION, ADDISON, TX. FILED 8-13-2009.



NO CLAIM IS MADE TO THE EXCLUSIVE RIGHT TO USE "SECURITY", APART FROM THE MARK AS SHOWN. THE MARK CONSISTS OF AN IMAGE OF CHAIN LINK ABOVE THE WORDS "REVERE SECURITY".

CLASS 9—ELECTRICAL AND SCIENTIFIC APPARATUS

FOR CRYPTOGRAPHIC PROTECTION SOFTWARE FEATURING CRYPTOGRAPHIC ALGORITHMS; COMPUTER HARDWARE INCORPORATING CRYPTOGRAPHIC ALGORITHMS; COMPUTER SOFTWARE IN THE FIELD OF CRYPTOGRAPHY AND DATA ENCRYPTION (U.S. CLS. 21, 23, 26, 36 AND 38).

CLASS 42—SCIENTIFIC AND COMPUTER SERVICES

FOR RESEARCH IN THE FIELD OF CRYPTOGRAPHY AND DATA ENCRYPTION; RESEARCH AND DEVELOPMENT OF COMPUTER SOFTWARE IN THE FIELD OF CRYPTOGRAPHY AND DATA ENCRYPTION (U.S. CLS. 100 AND 101).

CLASS 45—PERSONAL AND LEGAL SERVICES

FOR LICENSING OF CRYPTOGRAPHIC ALGORITHMS (U.S. CLS. 100 AND 101).
HOWARD SMIGA, EXAMINING ATTORNEY

SN 77-803,803. KARSHIEV, ERGASH M, AKA KARSHIEV, ERIC, CHICAGO, IL. FILED 8-13-2009.



THE COLOR(S) BLUE AND RED IS/ARE CLAIMED AS A FEATURE OF THE MARK.
THE MARK CONSISTS OF THE WORD "ERGOZONE" IN IS BLUE AND THE SURROUNDING OVAL IS IN RED.

CLASS 9—ELECTRICAL AND SCIENTIFIC APPARATUS

FOR DOWNLOADABLE MP3 FILES, MP3 RECORDINGS, ON-LINE DISCUSSION BOARDS, WEBCASTS AND PODCASTS FEATURING MUSIC, AUDIO BOOKS AND NEWS BROADCASTS; DOWNLOADABLE MUSICAL SOUND RECORDINGS (U.S. CLS. 21, 23, 26, 36 AND 38).

CLASS 41—EDUCATION AND ENTERTAINMENT

FOR MULTIMEDIA ENTERTAINMENT SERVICES IN THE NATURE OF RECORDING, PRODUCTION AND POST-PRODUCTION SERVICES IN THE FIELDS OF MUSIC, VIDEO, AND FILMS; MUSIC COMPOSITION AND TRANSCRIPTION FOR OTHERS; MUSIC COMPOSITION FOR OTHERS; MUSIC PRODUCTION SERVICES; MUSIC VIDEO PRODUCTION; POST-PRODUCTION EDITING SERVICES IN THE FIELD OF MUSIC, VIDEOS AND FILMS; PRODUCTION OF SOUND AND MUSIC VIDEO RECORDINGS (U.S. CLS. 100, 101 AND 107).
ANGELA M. MICHELI, EXAMINING ATTORNEY

SN 77-804,240. ANDALON JIMENEZ, JUAN ANTONIO, ARLETA, CA. FILED 8-13-2009.

Conjunto Majestad

THE MARK CONSISTS OF STANDARD CHARACTERS WITHOUT CLAIM TO ANY PARTICULAR FONT, STYLE, SIZE, OR COLOR.

NO CLAIM IS MADE TO THE EXCLUSIVE RIGHT TO USE "CONJUNTO", APART FROM THE MARK AS SHOWN. THE ENGLISH TRANSLATION OF THE WORD "CONJUNTO MAJESTAD" IN THE MARK IS MAJESTY GROUP.

CLASS 9—ELECTRICAL AND SCIENTIFIC APPARATUS

FOR COMPACT DISCS FEATURING MUSIC (U.S. CLS. 21, 23, 26, 36 AND 38).
FIRST USE 7-29-2005; IN COMMERCE 7-29-2005.

CLASS 41—EDUCATION AND ENTERTAINMENT

FOR ENTERTAINMENT, NAMELY, LIVE PERFORMANCES BY A MUSICAL BAND (U.S. CLS. 100, 101 AND 107).
FIRST USE 7-29-2005; IN COMMERCE 7-29-2005.
KARANENDRA S. CHHINA, EXAMINING ATTORNEY

SN 77-804,698. CARE NET, LANSDOWNE, VA. FILED 8-14-2009.



OWNER OF U.S. REG. NO. 2,064,575.

THE MARK CONSISTS OF THE WORDS "CARE" AND "NET", WHEREIN A HEART DESIGN APPEARS BETWEEN THE WORDS "CARE" AND "NET", AND WHEREIN A DOTTED LINE EXTENDS HORIZONTALLY BELOW THE LENGTH OF THE WORDS "CARE" AND "NET".

SN 77-809,022. MITCHELL HILL, BURLINGTON, KY. FILED 8-20-2009.

CLASS 9—ELECTRICAL AND SCIENTIFIC APPARATUS

FOR PRERECORDED DIGITAL VIDEO DISCS (DVDS), COMPACT DISCS (CDS) AND VIDEOCASSETTES FEATURING INFORMATION AND EDUCATION ON COUNSELING ON PREGNANCY AND CHILDBIRTH TOPICS (U.S. CLS. 21, 23, 26, 36 AND 38).

FIRST USE 1-15-1995; IN COMMERCE 1-15-1995.

CLASS 16—PAPER GOODS AND PRINTED MATTER

FOR PRINTED MATTER, NAMELY, MANUALS, NEWSLETTERS AND INFORMATIONAL PAMPHLETS FEATURING INFORMATION ON PREGNANCY AND CHILDBIRTH AND ON COUNSELING ON PREGNANCY AND CHILD BIRTH TOPICS (U.S. CLS. 2, 5, 22, 23, 29, 37, 38 AND 50).

FIRST USE 1-15-1995; IN COMMERCE 1-15-1995.

CLASS 41—EDUCATION AND ENTERTAINMENT

FOR EDUCATIONAL SERVICES, NAMELY, CONDUCTING WORKSHOPS, SEMINARS, AND CONFERENCES IN THE FIELD OF COUNSELING ON PREGNANCY AND CHILDBIRTH TOPICS AND DISTRIBUTING COURSE MATERIALS IN CONNECTION THEREWITH (U.S. CLS. 100, 101 AND 107).

FIRST USE 1-15-1995; IN COMMERCE 1-15-1995.

FLORENTINA BLANDU, EXAMINING ATTORNEY

CALL MITCH

THE MARK CONSISTS OF STANDARD CHARACTERS WITHOUT CLAIM TO ANY PARTICULAR FONT, STYLE, SIZE, OR COLOR.

CLASS 36—INSURANCE AND FINANCIAL

FOR REAL ESTATE SERVICES, NAMELY, RENTAL PROPERTY MANAGEMENT SERVICES (U.S. CLS. 100, 101 AND 102).

CLASS 45—PERSONAL AND LEGAL SERVICES

FOR CONCIERGE SERVICES FOR OTHERS COMPRISING OF MAKING REQUESTED PERSONAL ARRANGEMENTS AND PROVIDING CUSTOMER SPECIFIC INFORMATION TO MEET THE NEEDS OF INDIVIDUALS, ALL RENDERED IN BUSINESS ESTABLISHMENTS, OFFICE BUILDINGS, HOTELS, RESIDENTIAL COMPLEXES AND HOMES (U.S. CLS. 100 AND 101).

TARA PATE, EXAMINING ATTORNEY

SN 77-805,065. YAHOO! INC., SUNNYVALE, CA. FILED 8-14-2009.

CENTMAIL

THE MARK CONSISTS OF STANDARD CHARACTERS WITHOUT CLAIM TO ANY PARTICULAR FONT, STYLE, SIZE, OR COLOR.

CLASS 36—INSURANCE AND FINANCIAL

FOR CHARITABLE FUNDRAISING SERVICES (U.S. CLS. 100, 101 AND 102).

CLASS 45—PERSONAL AND LEGAL SERVICES

FOR COMPUTER SECURITY SERVICES IN THE NATURE OF PROVIDING AN INTERNET TRUST CENTER, NAMELY, COMPUTER SECURITY ASSURANCE AND ADMINISTRATION OF DIGITAL KEYS AND DIGITAL CERTIFICATES (U.S. CLS. 100 AND 101).

MARK SHINER, EXAMINING ATTORNEY

SN 77-810,817. MOSAIC INTERNATIONAL LLC, SAN RAMON, CA. FILED 8-23-2009.

MIA

THE MARK CONSISTS OF STANDARD CHARACTERS WITHOUT CLAIM TO ANY PARTICULAR FONT, STYLE, SIZE, OR COLOR.

OWNER OF U.S. REG. NOS. 3,385,199 AND 3,406,889.

CLASS 9—ELECTRICAL AND SCIENTIFIC APPARATUS

FOR ELECTRIC HAND-HELD HAIR STYLING IRONS (U.S. CLS. 21, 23, 26, 36 AND 38).

CLASS 11—ENVIRONMENTAL CONTROL APPARATUS

FOR HAIR DRYERS (U.S. CLS. 13, 21, 23, 31 AND 34).

BARBARA GAYNOR, EXAMINING ATTORNEY

SN 77-810,957. LYDALL TRANSPORT, LTD., GLEN ALLEN, VA. FILED 8-24-2009.

CROSSGLOBE

THE MARK CONSISTS OF STANDARD CHARACTERS WITHOUT CLAIM TO ANY PARTICULAR FONT, STYLE, SIZE, OR COLOR.

CLASS 35—ADVERTISING AND BUSINESS

FOR TRANSPORTATION LOGISTICS SERVICES, NAMELY, ARRANGING THE TRANSPORTATION OF GOODS FOR OTHERS; ARRANGING FOR DELIVERY AND TRANSPORTATION OF CONTAINERS AND THEIR CONTENT (U.S. CLS. 100, 101 AND 102).

CLASS 39—TRANSPORTATION AND STORAGE

FOR CONTAINERIZATION SERVICES, NAMELY, PACKAGING ARTICLES IN CONTAINERS FOR TRANSPORTATION; DISTRIBUTION SERVICES, NAMELY, DELIVERY OF GOODS, CARGO AND FREIGHT; DELIVERY, TRANSPORTATION AND STORAGE OF GOODS, CARGO AND FREIGHT; DRAYAGE SERVICES; FREIGHT BROKERAGE AND CONSULTATION; FREIGHT FORWARDING; SUPPLY CHAIN LOGISTICS AND REVERSE LOGISTICS SERVICES, NAMELY, STORAGE, TRANSPORTATION AND DELIVERY OF GOODS FOR OTHERS BY AIR, RAIL, SHIP OR TRUCK; RENTAL OF STORAGE CONTAINERS; TRANSPORTATION AND DELIVERY SERVICES OF GOODS, CARGO, FREIGHT AND CONTAINERS; WAREHOUSE STORAGE; RENTAL OF WAREHOUSES (U.S. CLS. 100 AND 105).

LAKEISHA LEWIS, EXAMINING ATTORNEY

SN 77-811,427. DSLRU, LLC., MORAGA, CA. FILED 8-24-2009.



NO CLAIM IS MADE TO THE EXCLUSIVE RIGHT TO USE "DSLRL", APART FROM THE MARK AS SHOWN.

THE MARK CONSISTS OF THE STYLIZED LETTERS "D", "S", "L", "R" AND "U".

CLASS 9—ELECTRICAL AND SCIENTIFIC APPARATUS

FOR DIGITAL MATERIALS, NAMELY, DOWNLOADABLE VIDEO AND AUDIO FILES FEATURING IMAGES, TEXT AND STUDENT/TEACHER INTERACTION ALL FEATURING MIXED-MEDIA PHOTOGRAPHY AND VIDEOGRAPHY-RELATED EDUCATION AND PUBLISHING (U.S. CLS. 21, 23, 26, 36 AND 38).

CLASS 41—EDUCATION AND ENTERTAINMENT

FOR EDUCATIONAL SERVICES, NAMELY, PROVIDING LIVE AND ON-LINE CLASSES, SEMINARS, AND WORKSHOPS, ALL FEATURING STUDENT/TEACHER INTERACTION, IN THE FIELD OF MIXED-MEDIA PHOTOGRAPHY, VIDEOGRAPHY AND PUBLISHING (U.S. CLS. 100, 101 AND 107).

JOHN E. MICHOS, EXAMINING ATTORNEY

SN 77-812,286. SEENERGY FOODS LIMITED, WOOBRIDGE, CANADA, FILED 8-25-2009.

GRAIN EFFECTS

THE MARK CONSISTS OF STANDARD CHARACTERS WITHOUT CLAIM TO ANY PARTICULAR FONT, STYLE, SIZE, OR COLOR.

NO CLAIM IS MADE TO THE EXCLUSIVE RIGHT TO USE "GRAIN", APART FROM THE MARK AS SHOWN.

CLASS 29—MEATS AND PROCESSED FOODS

FOR COOKED, UNCOOKED, FROZEN AND SHELF STABLE PULSES AND MEATS; FROZEN, PREPARED AND PACKAGED MEALS CONSISTING PRIMARILY OF MEAT, PULSES AND VEGETABLES; PROCESSED VEGETABLES, NAMELY, COOKED, UNCOOKED, FROZEN AND SHELF STABLE VEGETABLES (U.S. CL. 46).

CLASS 30—STAPLE FOODS

FOR PROCESSED RICE AND GRAINS, NAMELY, COOKED, UNCOOKED, FROZEN AND SHELF STABLE RICE AND GRAINS; SEASONINGS; FROZEN, PREPARED AND PACKAGED MEALS CONSISTING PRIMARILY OF RICE AND GRAINS (U.S. CL. 46).

CLASS 31—NATURAL AGRICULTURAL PRODUCTS

FOR UNPROCESSED RICE, GRAINS AND VEGETABLES (U.S. CLS. 1 AND 46).

RONALD MCMORROW, EXAMINING ATTORNEY

SN 77-813,359. BOOZMANHOF REGIONAL EYE CLINIC P.A., DBA BOOZMANHOF, ROGERS, AR. FILED 8-26-2009.



THE MARK CONSISTS OF AN ARC ABOVE THE OUTLINE OF A CIRCLE.

CLASS 9—ELECTRICAL AND SCIENTIFIC APPARATUS

FOR OPTICAL FRAMES, OPTICAL LENSES, CONTACT LENSES, CONTAINERS FOR CONTACT LENS, AND CONTACT LENS CASES (U.S. CLS. 21, 23, 26, 36 AND 38).

FIRST USE 7-31-2009; IN COMMERCE 7-31-2009.

CLASS 44—MEDICAL, BEAUTY AND AGRICULTURAL SERVICES

FOR OPTOMETRY SERVICES; COSMETIC ANALYSIS AND SKIN CARE SERVICES (U.S. CLS. 100 AND 101).

FIRST USE 7-31-2009; IN COMMERCE 7-31-2009.
CAROL SPILS, EXAMINING ATTORNEY

SN 77-813,417. BOOZMANHOF REGIONAL EYE CLINIC P.A., DBA BOOZMANHOF, ROGERS, AR. FILED 8-26-2009.

BoozmanHof
World Class Eye Care. Hometown Service.

NO CLAIM IS MADE TO THE EXCLUSIVE RIGHT TO USE "WORLD CLASS EYE CARE" AND "HOMETOWN SERVICE", APART FROM THE MARK AS SHOWN.

THE MARK CONSISTS OF THE WORD "BOOZMANHOF" ABOVE THE WORDS "WORLD CLASS EYE CARE. HOMETOWN SERVICE." THE FIRST "O" IN "BOOZMANHOF" HAS AN ARC ABOVE THE LETTER.

CLASS 9—ELECTRICAL AND SCIENTIFIC APPARATUS

FOR OPTICAL FRAMES, OPTICAL LENSES, CONTACT LENSES, CONTAINERS FOR CONTACT LENS, AND CONTACT LENS CASES (U.S. CLS. 21, 23, 26, 36 AND 38).

FIRST USE 7-31-2009; IN COMMERCE 7-31-2009.

CLASS 44—MEDICAL, BEAUTY AND AGRICULTURAL SERVICES

FOR OPTOMETRY SERVICES; COSMETIC ANALYSIS AND SKIN CARE SERVICES (U.S. CLS. 100 AND 101).
FIRST USE 7-31-2009; IN COMMERCE 7-31-2009.
CAROL SPILS, EXAMINING ATTORNEY

SN 77-813,705. MAMA SITA HOLDINGS CO. INC., SAN JUAN CITY, PHILIPPINES, FILED 8-27-2009.



THE COLOR(S) WHITE, REDDISH BROWN AND ORANGE OCHRE IS/ARE CLAIMED AS A FEATURE OF THE MARK.

THE MARK CONSISTS OF THE NAMES "VINCE" AND "PEET" BOTH WHITE, TOGETHER WITH SYMBOL "&" IN REDDISH BROWN (COLOR PANTONE MATCHING SYSTEM 723 C) ENCASED IN AN ORANGE OCHRE (COLOR PANTONE MATCHING SYSTEM 7407 U) RECTANGULAR BOX.

CLASS 29—MEATS AND PROCESSED FOODS

FOR PROCESSED MEAT AND SEAFOODS; PRESERVED, DRIED, COOKED FRUITS AND VEGETABLES (U.S. CL. 46).

CLASS 30—STAPLE FOODS

FOR SPICES; CONDIMENTS, SPECIFICALLY SEASONING; SAUCES; FLAVORING SYRUPS (U.S. CL. 46).

CLASS 32—LIGHT BEVERAGES

FOR FRUIT JUICES (U.S. CLS. 45, 46 AND 48).
MATTHEW PAPPAS, EXAMINING ATTORNEY

SN 77-813,743. NEUTROGENA CORPORATION, LOS ANGELES, CA. FILED 8-27-2009.

NEUTROGENA CLINICAL

THE MARK CONSISTS OF STANDARD CHARACTERS WITHOUT CLAIM TO ANY PARTICULAR FONT, STYLE, SIZE, OR COLOR.

OWNER OF U.S. REG. NOS. 590,385, 1,597,057 AND OTHERS.

NO CLAIM IS MADE TO THE EXCLUSIVE RIGHT TO USE "CLINICAL", APART FROM THE MARK AS SHOWN.

CLASS 3—COSMETICS AND CLEANING PREPARATIONS

FOR NON-MEDICATED SKIN CARE PREPARATIONS (U.S. CLS. 1, 4, 6, 50, 51 AND 52).

CLASS 5—PHARMACEUTICALS

FOR MEDICATED SKIN CARE PREPARATIONS (U.S. CLS. 6, 18, 44, 46, 51 AND 52).
SHAILA SETTLES, EXAMINING ATTORNEY

SN 77-813,780. SESAME WORKSHOP, NEW YORK, NY.
FILED 8-27-2009.

ABBY'S FLYING FAIRY SCHOOL

THE MARK CONSISTS OF STANDARD CHARACTERS WITHOUT CLAIM TO ANY PARTICULAR FONT, STYLE, SIZE, OR COLOR.

CLASS 9—ELECTRICAL AND SCIENTIFIC APPARATUS

FOR AUDIO RECORDINGS, VIDEO RECORDINGS, COMPACT DISCS, MULTIMEDIA SOFTWARE, DVDS, DOWNLOADABLE RECORDINGS OF TELEVISION PROGRAMS, ALL FEATURING EDUCATIONAL THEMES AND ENTERTAINMENT DIRECTED TO CHILDREN, PARENTS AND FAMILIES; DOWNLOADABLE MULTIMEDIA CONTENT, NAMELY, MUSIC, GRAPHICS, TEXT, AUDIO AND VIDEO RECORDINGS FEATURING EDUCATIONAL THEMES AND ENTERTAINMENT DIRECTED TO CHILDREN, PARENTS AND FAMILIES; COMPUTER GAME PROGRAMS, CARTRIDGES, CASSETTES, DISCS AND SOFTWARE; DOWNLOADABLE WIRELESS GAME AND ENTERTAINMENT SOFTWARE, NAMELY, DOWNLOADABLE COMPUTER GAMES, RING TONES, AND GRAPHICS VIA A GLOBAL COMPUTER NETWORK AND WIRELESS DEVICES; DOWNLOADABLE COMPUTER SOFTWARE FOR USE AS SCREENSAVERS AND WALLPAPER; COMPUTER SOFTWARE FOR USE IN THE DESIGN AND DEVELOPMENT OF WIRELESS GAME AND ENTERTAINMENT PROGRAMS AND APPLICATIONS; DOWNLOADABLE ELECTRONIC PUBLICATIONS, NAMELY, BOOKS, MAGAZINES AND NEWSLETTERS FEATURING EDUCATIONAL THEMES AND ENTERTAINMENT DIRECTED TO CHILDREN, PARENTS AND FAMILIES; COMPUTERS AND COMPUTER PERIPHERALS, COMPUTER PERIPHERAL MOUSE PADS; CD PLAYERS; DVD PLAYERS; RADIOS; RADIOS INCORPORATING CLOCKS; DECORATIVE REFRIGERATOR MAGNETS; SCALES; BABY MONITORS; BICYCLE HELMETS; SUNGLASSES; EYEGASSES; DOWNLOADABLE INTERACTIVE GAME PROGRAMS FOR USE ON COMPUTERS, CELL PHONES AND OTHER MOBILE DEVICES; HAND-HELD UNITS FOR PLAYING ELECTRONIC GAMES FOR USE WITH EXTERNAL DISPLAY SCREEN OR MONITOR (U.S. CLS. 21, 23, 26, 36 AND 38).

CLASS 16—PAPER GOODS AND PRINTED MATTER

FOR BOOKS, MAGAZINES AND NEWSLETTERS FEATURING EDUCATIONAL THEMES AND ENTERTAINMENT DIRECTED TO CHILDREN, PARENTS AND FAMILIES; CHILDREN'S BOOKS, CHILDREN'S ACTIVITY BOOKS, CRAFT BOOKS, COLORING BOOKS, COMIC BOOKS, COMIC STRIPS; ADDRESS BOOKS, APPOINTMENT BOOKS, PERSONAL ORGANIZERS, AUTOGRAPH BOOKS, DIARIES; PAPER BOOK COVERS, BOOKENDS, BOOKMARKS, PAPERWEIGHTS, PHOTO ALBUMS; WRITING PAPER, NOTE CARDS, NOTE PADS, NOTEBOOKS, RING BINDERS, FOLDERS, STATIONERY PORTFOLIOS, POSTCARDS, GREETING CARDS; PENS, PENCILS, PENCIL CASES, PENCIL SHARPENERS, CALENDARS, ERASERS, RUBBER STAMPS, DRAWING RULERS, STAMP PADS, STAPLERS, STATIONERY, ADHESIVE TAPES FOR STATIONERY OR HOUSEHOLD PURPOSES, ADHESIVE TAPE DISPENSERS FOR HOUSEHOLD OR STATIONERY USE; CONSTRUCTION PAPER, CRAYONS, MARKERS, MODELING CLAY, PAINTING SETS FOR CHILDREN, ARTS AND CRAFTS PAINT KITS; POSTERS, STICKERS, VINYL COATED MEMORANDUM BOARDS, CREPE PAPER, PAPER GIFT TAGS, GIFT WRAPPING PAPER, PAPER BAGS, PAPER BOXES, PAPER NAPKINS, PAPER PARTY DÉCORATIONS, PAPER PARTY FAVORS, PRINTED PAPER PARTY INVITATIONS, PAPER PLACE MATS, PAPER TABLECLOTHS; PAPER BABY BIBS (U.S. CLS. 2, 5, 22, 23, 29, 37, 38 AND 50).

CLASS 25—CLOTHING

FOR CLOTHING FOR MEN, WOMEN, CHILDREN AND INFANTS, NAMELY, SHIRTS, SWEATSHIRTS, TANK TOPS, T-SHIRTS, PANTS, LOUNGEWEAR, OVERALLS, JEANS, SHORTS, VESTS, SOCKS, LEGGINGS, SLEEPWEAR, INFANTS' SLEEPERS, PAJAMAS, NIGHTGOWNS, ROBES, DRESSES, JUMPERS, SKIRTS, SWEATERS, UNDERWEAR, SWIMWEAR, BEACHWEAR, PLAYSUITS, BABY BIBS NOT MADE OF PAPER, SCARVES, BELTS, NECKWEAR, SUSPENDERS, HEADWEAR, FOOTWEAR, MITTENS, GLOVES, COATS, PONCHOS, SMOCKS, HALLOWEEN AND MASQUERADE COSTUMES; PLAY COSTUMES FOR USE IN ROLE-PLAYING GAMES (U.S. CLS. 22 AND 39).

CLASS 28—TOYS AND SPORTING GOODS

FOR TOYS, GAMES AND PLAYTHINGS, NAMELY, PLUSH TOYS, DOLLS, DOLL CLOTHING AND COSTUMES, DOLL ACCESSORIES, YO-YOS, HOBBY CRAFT KITS COMPRISING PAINTING SETS, ACTION SKILL GAMES, BOARD GAMES, CARD GAMES, MANIPULATIVE PUZZLES, MANIPULATIVE GAMES, HAND HELD UNITS FOR PLAYING ELECTRONIC GAMES OTHER THAN THOSE ADAPTED FOR USE WITH AN EXTERNAL DISPLAY SCREEN OR MONITOR, ELECTRONIC LEARNING TOYS, TOY FILM CARTRIDGES AND VIEWERS, SQUEEZE TOYS, BATH TOYS, BEACH TOYS, NAMELY, TOY PAILS AND SHOVELS, MULTIPLE ACTIVITY BABY TOYS, INFANT TOYS, CHILDREN'S EDUCATIONAL TOYS FOR DEVELOPING FINE MOTOR, ORAL LANGUAGE, NUMBERS, COUNTING, COLORS AND ALPHABET SKILLS, BABY RATTLES, BABY RATTLES INCORPORATING TEETHING RINGS, PUPPETS, BEAN BAGS, PULL TOYS, RIDE-ON TOYS, TOY VEHICLES, TOY SCOOTERS, SPORTS BALLS, BEACH BALLS, PLAYGROUND BALLS, TOY FOAM BALLS, FLYING DISCS, JUMP ROPES, KITES, WIND UP TOYS, BALLOONS, TOY BUILDING BLOCKS, CONSTRUCTION TOYS, TOY BANKS, TOY SHOVELS, TOY PAILS, TOYS DESIGNED TO BE ATTACHED TO CAR SEATS, CRIBS AND HIGH CHAIRS, TOY MUSICAL INSTRUMENTS, TOY TELEPHONES, TOY MUSIC BOXES; TOY BUILDING STRUCTURES, TOY PLASTIC FIGURINES, PLASTIC CHARACTER TOYS, TOY ACTION FIGURES AND ACCESSORIES THEREFOR, CASES FOR PLAY ACCESSORIES, TOY ENVIRONMENTS FOR USE WITH ACTION FIGURES, PLAY SETS FOR ACTION FIGURES,

ROLE PLAYING GAME SETS, TOY FURNITURE, TOY TOOLS; PLAY COSTUME MASKS; PLAY DOLL COSTUMES, MASQUERADE GAMES, AIR MATTRESSES FOR RECREATIONAL USE, INFLATABLE SWIMMING POOLS, SWIMMING AIDS, NAMELY, POOL RINGS, ARM FLOATS FOR RECREATIONAL USE, AND SWIM FLOATS FOR RECREATIONAL USE; PARTY FAVORS IN THE NATURE OF SMALL TOYS; EASTER EGG COLORING KITS; CHRISTMAS TREE DECORATIONS, ORNAMENTS, AND SKIRTS; HOBBY NEEDLE CRAFT KITS COMPRISED OF NEEDLEWORK (U.S. CLS. 22, 23, 38 AND 50).

CLASS 41—EDUCATION AND ENTERTAINMENT

FOR ONGOING TELEVISION PROGRAM FEATURING EDUCATIONAL THEMES AND ENTERTAINMENT DIRECTED TO CHILDREN, PARENTS AND FAMILIES; ENTERTAINMENT SERVICES, NAMELY, PROVIDING NON-DOWNLOADABLE AUDIO OR AUDIO VISUAL IMAGES, NAMELY SOUND, PHOTOS, PICTURES AND TEXT, IN THE FIELDS OF ENTERTAINMENT AND EDUCATION PRESENTED TO MOBILE COMMUNICATION DEVICES VIA A GLOBAL COMPUTER NETWORK AND WIRELESS NETWORKS; ENTERTAINMENT SERVICES, NAMELY, PROVIDING PODCASTS AND WEBCASTS, ALL FEATURING EDUCATIONAL THEMES AND ENTERTAINMENT DIRECTED TO CHILDREN, PARENTS AND FAMILIES; PROVIDING ONLINE INFORMATION FEATURING EDUCATIONAL THEMES AND ENTERTAINMENT DIRECTED TO CHILDREN, PARENTS AND FAMILIES; PROVIDING WIRELESS AND ONLINE COMPUTER GAMES, ACTIVITIES, AND IMAGES FOR ENTERTAINMENT PURPOSES DIRECTED TO CHILDREN, PARENTS, AND FAMILIES; PROVIDING ON-LINE NON-DOWNLOADABLE INTERACTIVE VIDEO GAMES AND MULTIMEDIA COMPUTER GAMES; PROVIDING ON-LINE PUBLICATIONS IN THE NATURE OF BOOKS, MAGAZINES, TEXTS AND NEWSLETTERS FEATURING EDUCATIONAL THEMES AND ENTERTAINMENT DIRECTED TO CHILDREN, PARENTS AND FAMILIES; AMUSEMENT PARKS; LIVE THEATRICAL PERFORMANCES (U.S. CLS. 100, 101 AND 107).

ANGELA M. MICHELI, EXAMINING ATTORNEY

SN 77-813,792. UNIVERSITY OF CENTRAL FLORIDA RESEARCH FOUNDATION, INC., ORLANDO, FL. FILED 8-27-2009.

BOLD & GOLD GREENROOF

THE MARK CONSISTS OF STANDARD CHARACTERS WITHOUT CLAIM TO ANY PARTICULAR FONT, STYLE, SIZE, OR COLOR.

NO CLAIM IS MADE TO THE EXCLUSIVE RIGHT TO USE "GREENROOF", APART FROM THE MARK AS SHOWN.

CLASS 1—CHEMICALS

FOR GROWING MEDIA FOR THE GROWTH AND VEGETATION AND RETENTION OF POLLUTANTS; MEDIA, NAMELY, EXPANDED CLAY AND ORGANICS USED AS A GROWING MEDIA FOR PLANTS (U.S. CLS. 1, 5, 6, 10, 26 AND 46).

CLASS 17—RUBBER GOODS

FOR ENVIRONMENTAL CONTROL MEDIA MADE OF RUBBER TIRE CRUMBS COMBINED WITH EXPANDED CLAY AND WOOD SAW DUST TO RETAIN POLLUTANTS FOR POLLUTION CONTROL (U.S. CLS. 1, 5, 12, 13, 35 AND 50).

ANGELA M. MICHELI, EXAMINING ATTORNEY

SN 77-814,960. FRIENDS OF THE ISRAEL DEFENSE FORCES, NEW YORK, NY. FILED 8-28-2009.

FRIENDS OF THE ISRAEL DEFENSE FORCES

THE MARK CONSISTS OF STANDARD CHARACTERS WITHOUT CLAIM TO ANY PARTICULAR FONT, STYLE, SIZE, OR COLOR.
SEC. 2(F).

CLASS 35—ADVERTISING AND BUSINESS

FOR CHARITABLE SERVICES, NAMELY, ORGANIZING AND CONDUCTING VOLUNTEER PROGRAMS AND COMMUNITY SERVICE PROJECTS AIMED AT INCREASING SUPPORT AND MORALE OF FAMILIES OF DECEASED VETERANS, VETERANS, CURRENT MEMBERS AND FUTURE MEMBERS OF THE ISRAELI MILITARY (U.S. CLS. 100, 101 AND 102).

FIRST USE 0-0-1981; IN COMMERCE 0-0-1981.

CLASS 36—INSURANCE AND FINANCIAL

FOR CHARITABLE FUNDRAISING SERVICES; PROVIDING EDUCATIONAL SCHOLARSHIPS TO FORMER ISRAELI COMBAT SOLDIERS (U.S. CLS. 100, 101 AND 102).

FIRST USE 0-0-1981; IN COMMERCE 0-0-1981.

KHANH LE, EXAMINING ATTORNEY

SN 77-814,983. HOLLEY PERFORMANCE PRODUCTS, INC., BOWLING GREEN, KY. FILED 8-28-2009.

AVENGER EFI

THE MARK CONSISTS OF STANDARD CHARACTERS WITHOUT CLAIM TO ANY PARTICULAR FONT, STYLE, SIZE, OR COLOR.

NO CLAIM IS MADE TO THE EXCLUSIVE RIGHT TO USE "EFI", APART FROM THE MARK AS SHOWN.

CLASS 7—MACHINERY

FOR FUEL INJECTION SYSTEMS FOR AUTOMOBILES COMPRISING FUEL INJECTORS, THROTTLE BODIES, FUEL PUMPS, FUEL LINES, INTAKE MANIFOLDS, AND INSTRUCTIONAL MANUALS FOR USE THEREWITH SOLD AS A UNIT (U.S. CLS. 13, 19, 21, 23, 31, 34 AND 35).

CLASS 9—ELECTRICAL AND SCIENTIFIC APPARATUS

FOR ELECTRONIC FUEL INJECTION AND VEHICLE MANAGEMENT SYSTEM COMPONENTS FOR INTERNAL COMBUSTION ENGINES, NAMELY, ELECTRONIC CONTROL UNITS ("ECUS"), ELECTRONIC PRESSURE, POSITION, TEMPERATURE, VACUUM, AIR/FUEL RATIO, AND AIRFLOW GAUGES, ELECTRONIC SENSORS AND CONTROL DEVICES FOR MONITORING AND CONTROLLING PRESSURE, POSITION, TEMPERATURE, VACUUM, AIR/FUEL RATIO, AND AIRFLOW, ELECTRONIC TOUCH COMPUTER DISPLAY SCREENS, COMPUTER SOFTWARE FOR CONTROLLING ENGINE AND TRANSMISSION FUNCTIONS AND ELECTRIC WIRING HARNESSES THEREFOR, AND INSTRUCTIONAL MANUALS FOR USE THEREWITH SOLD AS A UNIT (U.S. CLS. 21, 23, 26, 36 AND 38).

CAROL SPILS, EXAMINING ATTORNEY

SN 77-815,367. SONOSITE, INC., BOTHELL, WA. FILED 8-28-2009.

SOUNDCARING

THE MARK CONSISTS OF STANDARD CHARACTERS WITHOUT CLAIM TO ANY PARTICULAR FONT, STYLE, SIZE, OR COLOR.

CLASS 41—EDUCATION AND ENTERTAINMENT

FOR CHARITABLE SERVICES, NAMELY, PROVIDING TRAINING IN THE FIELD OF MEDICAL IMAGING TO THOSE IN NEED (U.S. CLS. 100, 101 AND 107).

CLASS 44—MEDICAL, BEAUTY AND AGRICULTURAL SERVICES

FOR CHARITABLE SERVICES, NAMELY, PROVIDING MEDICAL EQUIPMENT AND MEDICAL INFORMATION TO THOSE IN NEED (U.S. CLS. 100 AND 101).
REBECCA EISINGER, EXAMINING ATTORNEY

SN 77-814,999. HOLLEY PERFORMANCE PRODUCTS, INC., BOWLING GREEN, KY. FILED 8-28-2009.

SN 77-815,900. AMAZON PLANET, INC., SAN DIEGO, CA. FILED 8-29-2009.

DOMINATOR EFI

THE MARK CONSISTS OF STANDARD CHARACTERS WITHOUT CLAIM TO ANY PARTICULAR FONT, STYLE, SIZE, OR COLOR.

OWNER OF U.S. REG. NOS. 1,133,503 AND 2,346,330.

NO CLAIM IS MADE TO THE EXCLUSIVE RIGHT TO USE "EFI", APART FROM THE MARK AS SHOWN.

CLASS 7—MACHINERY

FOR FUEL INJECTION SYSTEMS FOR AUTOMOBILES COMPRISING FUEL INJECTORS, THROTTLE BODIES, FUEL PUMPS, FUEL LINES, INTAKE MANIFOLDS, AND INSTRUCTIONAL MANUALS FOR USE THEREWITH SOLD AS A UNIT (U.S. CLS. 13, 19, 21, 23, 31, 34 AND 35).

CLASS 9—ELECTRICAL AND SCIENTIFIC APPARATUS

FOR ELECTRONIC FUEL INJECTION AND VEHICLE MANAGEMENT SYSTEM COMPONENTS FOR INTERNAL COMBUSTION ENGINES, NAMELY, ELECTRONIC CONTROL UNITS ("ECUS"), ELECTRONIC PRESSURE, POSITION, TEMPERATURE, VACUUM, AIR/FUEL RATIO, AND AIRFLOW GAUGES, ELECTRONIC SENSORS AND CONTROL DEVICES FOR MONITORING AND CONTROLLING PRESSURE, POSITION, TEMPERATURE, VACUUM, AIR/FUEL RATIO, AND AIRFLOW, ELECTRONIC TOUCH COMPUTER DISPLAY SCREENS, COMPUTER SOFTWARE FOR CONTROLLING ENGINE AND TRANSMISSION FUNCTIONS AND ELECTRIC WIRING HARNESSES THEREFOR, AND INSTRUCTIONAL MANUALS FOR USE THEREWITH SOLD AS A UNIT (U.S. CLS. 21, 23, 26, 36 AND 38).

CAROL SPILS, EXAMINING ATTORNEY

AMAZON PLANET

THE MARK CONSISTS OF STANDARD CHARACTERS WITHOUT CLAIM TO ANY PARTICULAR FONT, STYLE, SIZE, OR COLOR.

CLASS 25—CLOTHING

FOR CLOTHING, NAMELY, SHIRTS, PANTS, JACKETS, FOOTWEAR AND HEADWEAR (U.S. CLS. 22 AND 39).

CLASS 43—HOTEL AND RESTAURANT SERVICES

FOR HOTEL, RESTAURANT AND BAR SERVICES (U.S. CLS. 100 AND 101).
LINDA M. KING, EXAMINING ATTORNEY

SN 77-817,156. SUPERMEDIA LLC, DALLAS/FORT WORTH AIRPORT, TX. FILED 9-1-2009.

AUTOINDUSTRYINSIGHTS.COM

THE MARK CONSISTS OF STANDARD CHARACTERS WITHOUT CLAIM TO ANY PARTICULAR FONT, STYLE, SIZE, OR COLOR.

CLASS 35—ADVERTISING AND BUSINESS

FOR PROVIDING INFORMATION ON THE SELLING AND BUYING OF AUTOMOBILES; PROVIDING LINKS TO WEB SITES OF OTHERS FEATURING INFORMATION ABOUT THE BUYING AND SELLING OF AUTOMOBILES; PROVIDING LINKS TO AUTO INDUSTRY SOCIAL NETWORKING AND BLOGGING SITES OF OTHERS (U.S. CLS. 100, 101 AND 102).

FIRST USE 6-0-2009; IN COMMERCE 6-0-2009.

CLASS 41—EDUCATION AND ENTERTAINMENT

FOR ONLINE JOURNALS, NAMELY, BLOGS ON THE SUBJECTS OF AUTOMOBILES AND THE AUTO INDUSTRY (U.S. CLS. 100, 101 AND 107).

FIRST USE 6-0-2009; IN COMMERCE 6-0-2009.

KELLY CHOE, EXAMINING ATTORNEY

SN 77-817,815. TECHNOLOGY SOLUTION PARTNERS LLC, EASTON, CT. FILED 9-1-2009.

TRAKAID

THE MARK CONSISTS OF STANDARD CHARACTERS WITHOUT CLAIM TO ANY PARTICULAR FONT, STYLE, SIZE, OR COLOR.

CLASS 9—ELECTRICAL AND SCIENTIFIC APPARATUS

FOR RADIO-FREQUENCY IDENTIFICATION (RFID) ENABLED SMART TRACKING TAGS FOR ASSETS AND GOODS, AND RELATED OPERATING SOFTWARE AND DOWNLOADABLE DATABASE SOFTWARE APPLICATIONS FOR USE WITH SMART TRACKING TAGS (U.S. CLS. 21, 23, 26, 36 AND 38).

FIRST USE 3-0-2009; IN COMMERCE 6-0-2009.

SN 77-817,757. IMMS GMBH, ZUG, SWITZERLAND, FILED 9-1-2009.

CLASS 42—SCIENTIFIC AND COMPUTER SERVICES

FOR DESIGN AND DEVELOPMENT OF COMPUTER SOFTWARE, HARDWARE AND DEVICES FOR THE IDENTIFICATION, TRACKING, AND MANAGEMENT OF ASSETS AND GOODS BY INTEGRATING RADIO FREQUENCY IDENTIFICATION (RFID) TECHNOLOGIES; APPLICATION SERVICE PROVIDER (ASP) FEATURING SOFTWARE FOR THE IDENTIFICATION, TRACKING, AND MANAGEMENT OF ASSETS AND GOODS BY INTEGRATING RADIO FREQUENCY IDENTIFICATION (RFID) TECHNOLOGIES (U.S. CLS. 100 AND 101).

FIRST USE 3-0-2009; IN COMMERCE 6-0-2009.

WILLIAM ROSSMAN, EXAMINING ATTORNEY



NO CLAIM IS MADE TO THE EXCLUSIVE RIGHT TO USE "SPORTS GERMANY", APART FROM THE MARK AS SHOWN.

THE MARK CONSISTS OF THE WORDS "MY SPORTS GERMANY" DRAWN WITHIN A PARALLELOGRAM.

CLASS 38—COMMUNICATION

FOR BROADCASTING SERVICES, NAMELY, TELEVISION BROADCASTING THROUGH A SATELLITE TELEVISION CHANNEL FEATURING GERMAN-LANGUAGE SPORTS PROGRAMS (U.S. CLS. 100, 101 AND 104).

FIRST USE 8-6-2009; IN COMMERCE 8-6-2009.

CLASS 41—EDUCATION AND ENTERTAINMENT

FOR ENTERTAINMENT SERVICES IN THE NATURE OF ON-GOING GERMAN-LANGUAGE TELEVISION SPORTS PROGRAMS (U.S. CLS. 100, 101 AND 107).

FIRST USE 8-6-2009; IN COMMERCE 8-6-2009.

MELISSA VALLILLO, EXAMINING ATTORNEY

SN 77-818,332. TAIMED BIOLOGICS INC., TAIPEI, TAIWAN, FILED 9-2-2009.

TAIMED BIOLOGICS

THE MARK CONSISTS OF STANDARD CHARACTERS WITHOUT CLAIM TO ANY PARTICULAR FONT, STYLE, SIZE, OR COLOR.

NO CLAIM IS MADE TO THE EXCLUSIVE RIGHT TO USE "BIOLOGICS", APART FROM THE MARK AS SHOWN.

CLASS 5—PHARMACEUTICALS

FOR ANTI-INFECTIVE MEDICINES FOR HUMAN USE; NUTRITIONAL SUPPLEMENTS (U.S. CLS. 6, 18, 44, 46, 51 AND 52).

CLASS 35—ADVERTISING AND BUSINESS

FOR IMPORT AND EXPORT AGENCIES; PROVIDING BUSINESS INFORMATION ABOUT PRICE QUOTATIONS OF CONSUMER GOODS, TENDERING OF CONSUMER GOODS, AND SELLING OF CONSUMER GOODS TO DOMESTIC AND INTERNATIONAL MANUFACTURERS; COMMERCIAL INFORMATION AGENCIES; WHOLESALE AND RETAIL STORE SERVICES AND ON-LINE RETAIL AND WHOLESALE STORE SERVICES FEATURING MEDICINES FOR HUMANS; WHOLESALE AND RETAIL STORE SERVICES AND ON-LINE RETAIL AND WHOLESALE STORE SERVICES FEATURING WESTERN MEDICINES; WHOLESALE AND RETAIL STORE SERVICES AND ON-LINE RETAIL AND WHOLESALE STORE SERVICES FEATURING CHINESE MEDICINES; WHOLESALE AND RETAIL STORE SERVICES AND ON-LINE RETAIL AND WHOLESALE STORE SERVICES FEATURING NUTRITIONAL SUPPLEMENTS (U.S. CLS. 100, 101 AND 102).

CLASS 42—SCIENTIFIC AND COMPUTER SERVICES

FOR CHEMICAL RESEARCH; CHEMICAL ANALYSIS; BIOLOGICAL RESEARCH AND ANALYSIS; BACTERIOLOGICAL RESEARCH AND ANALYSIS; MEDICAL RESEARCH PERTAINING TO PHARMACOLOGICAL AGENTS; MEDICAL AND SCIENTIFIC RESEARCH, NAMELY, CONDUCTING CLINICAL TRIALS OF MEDICAL REAGENTS; MEDICAL RESEARCH PERTAINING TO MEDICINES AND BIOLOGICAL PREPARATIONS (U.S. CLS. 100 AND 101).

CAROL SPILS, EXAMINING ATTORNEY

SN 77-818,733. UNIPRES KABUSHIKI KAISHA, TA UNIPRES CORPORATION, YOKOHAMA-SHI, KANAGAWA, JAPAN, FILED 9-2-2009.



OWNER OF JAPAN REG. NO. 4295385, DATED 7-16-1999, EXPIRES 7-16-2019.

THE MARK CONSISTS OF THE WORD "UNIPRES" BENEATH A STYLIZED LETTER "U".

CLASS 7—MACHINERY

FOR PRESS DIES FOR METAL FORMING; MACHINES AND LINES COMPOSED THEREOF FOR THE PRODUCTION OF LAND VEHICLE PARTS; INDUSTRIAL ROBOTS AND PARTS THEREOF; ELECTRIC WELDING MACHINES AND PARTS THEREOF; INDUSTRIAL ROBOTS, NAMELY, WELDING ROBOTS AND PARTS THEREOF; JIGS BEING PARTS OF MACHINES USED IN THE PRODUCTION OF LAND VEHICLE PARTS (U.S. CLS. 13, 19, 21, 23, 31, 34 AND 35).

CLASS 12—VEHICLES

FOR STRUCTURAL PARTS OF LAND VEHICLE BODIES; STRUCTURAL PARTS FOR LAND VEHICLES; STRUCTURAL PARTS FOR TRANSMISSIONS OF LAND VEHICLES; STRUCTURAL PARTS FOR LAND VEHICLES MADE OF PLASTICS; LAND VEHICLE INTERIOR PARTS MADE OF PLASTICS, NAMELY, PROTECTIVE AND DECORATIVE TRIM AND PANELING; LAND VEHICLE EXTERIOR PARTS MADE OF PLASTICS, NAMELY, PROTECTIVE AND DECORATIVE TRIM AND PANELING (U.S. CLS. 19, 21, 23, 31, 35 AND 44).

VELYN BRADLEY, EXAMINING ATTORNEY

SN 77-820,247. PRINSCO, INC., WILLMAR, MN. FILED 9-4-2009.

INTEGRITY

THE MARK CONSISTS OF STANDARD CHARACTERS WITHOUT CLAIM TO ANY PARTICULAR FONT, STYLE, SIZE, OR COLOR.

OWNER OF U.S. REG. NO. 3,739,182.

CLASS 17—RUBBER GOODS

FOR NON-METAL PIPE, TUBING, COUPLERS, AND PIPE FITTINGS, NAMELY, TEES, WYES, REDUCING TEES, REDUCING WYES, CROSS TEES, RISER TEES AND THE LIKE FOR IN-GROUND WATER MANAGEMENT SOLUTIONS, IRRIGATION AND FLUID DISTRIBUTION APPLICATIONS (U.S. CLS. 1, 5, 12, 13, 35 AND 50).

CLASS 19—NON-METALLIC BUILDING MATERIALS

FOR RIGID NON-METAL PIPE AND NON-METAL CONDUIT FOR IN-GROUND WATER MANAGEMENT SOLUTIONS, IRRIGATION AND FLUID DISTRIBUTION APPLICATIONS (U.S. CLS. 1, 12, 33 AND 50).

LAKEISHA LEWIS, EXAMINING ATTORNEY

SN 77-820,364. GROUP O, MILAN, IL. FILED 9-4-2009.

Optimization Agency

THE MARK CONSISTS OF STANDARD CHARACTERS WITHOUT CLAIM TO ANY PARTICULAR FONT, STYLE, SIZE, OR COLOR.

CLASS 35—ADVERTISING AND BUSINESS

FOR ARRANGING AND CONDUCTING INCENTIVE REWARD PROGRAMS TO PROMOTE THE SALE OF GOODS AND SERVICES OF OTHERS; BUSINESS MANAGEMENT CONSULTING WITH RELATION TO STRATEGY, MARKETING, SALES, OPERATION, PRODUCT DESIGN PARTICULARLY SPECIALIZING IN THE USE OF ANALYTIC AND STATISTIC MODELS FOR THE UNDERSTANDING AND PREDICTING OF CONSUMERS, BUSINESSES, AND MARKET TRENDS AND ACTIONS; BUSINESS PROCESS OUTSOURCING SERVICES FOR OTHERS IN THE FIELD OF ROUTINE BUSINESS OPERATIONS; OPERATION OF TELEPHONE CALL CENTERS FOR OTHERS; PROVIDED INCENTIVE AWARD PROGRAMS FOR CUSTOMERS AND EMPLOYEES THROUGH THE DISTRIBUTION OF PREPAID STORED VALUE CARDS FOR THE PURPOSE OF PROMOTING AND REWARDING LOYALTY (U.S. CLS. 100, 101 AND 102).

CLASS 39—TRANSPORTATION AND STORAGE

FOR SUPPLY CHAIN, LOGISTICS AND REVERSE LOGISTICS SERVICES, NAMELY, STORAGE, TRANSPORTATION AND DELIVERY OF DOCUMENTS, PACKAGES, RAW MATERIALS, AND OTHER FREIGHT FOR OTHERS BY AIR, RAIL, SHIP OR TRUCK; WAREHOUSING SERVICES, NAMELY, STORAGE, DISTRIBUTION, PICK-UP, AND PACKING FOR SHIPMENT OF DOCUMENTS, PACKAGES, RAW MATERIALS, AND OTHER FREIGHT FOR OTHERS (U.S. CLS. 100 AND 105).

CHERYL CLAYTON, EXAMINING ATTORNEY

SN 77-820,828. KYOCERA SOLAR, INC., SCOTTSDALE, AZ. FILED 9-4-2009.

MYGEN SKYLINE

THE MARK CONSISTS OF STANDARD CHARACTERS WITHOUT CLAIM TO ANY PARTICULAR FONT, STYLE, SIZE, OR COLOR.

OWNER OF U.S. REG. NOS. 2,617,422 AND 3,588,966.

CLASS 7—MACHINERY

FOR SOLAR POWER GENERATORS (U.S. CLS. 13, 19, 21, 23, 31, 34 AND 35).

CLASS 9—ELECTRICAL AND SCIENTIFIC APPARATUS

FOR SOLAR CELLS (U.S. CLS. 21, 23, 26, 36 AND 38).

CLASS 11—ENVIRONMENTAL CONTROL APPARATUS

FOR SOLAR COLLECTORS (U.S. CLS. 13, 21, 23, 31 AND 34).

BERYL GARDNER, EXAMINING ATTORNEY

SN 77-820,650. LUVE, LLC, DELAFIELD, WI. FILED 9-4-2009.

BATH LUVE

THE MARK CONSISTS OF STANDARD CHARACTERS WITHOUT CLAIM TO ANY PARTICULAR FONT, STYLE, SIZE, OR COLOR.

NO CLAIM IS MADE TO THE EXCLUSIVE RIGHT TO USE "BATH", APART FROM THE MARK AS SHOWN.

CLASS 24—FABRICS

FOR HOODED TOWELS, TOWELS, WASH CLOTHS, BATH MITTS, BEDDING, NAMELY, CHILDREN'S BLANKETS, RECEIVING BLANKETS, CRIB BUMPERS AND CRIB SHEETS (U.S. CLS. 42 AND 50).

FIRST USE 6-1-2007; IN COMMERCE 1-17-2008.

CLASS 25—CLOTHING

FOR ROBES, SLIPPERS, CLOTHING, NAMELY, ONE-PIECE UNDERWEAR, CREEPERS, HATS, SHIRTS AND BABY BIBS NOT OF PAPER (U.S. CLS. 22 AND 39).

FIRST USE 6-1-2007; IN COMMERCE 1-17-2008.
KIMBERLY FRYE, EXAMINING ATTORNEY

SN 77-821,016. HI-Q FOOD PRODUCTS CO., LTD., SAMUT-PRAKARN, THAILAND, FILED 9-5-2009.



OWNER OF THAILAND REG. NO. KOR145849, DATED 6-1-1971, EXPIRES 5-31-2011.

OWNER OF THAILAND REG. NO. KOR291856, DATED 10-15-2007, EXPIRES 10-14-2017.

OWNER OF THAILAND REG. NO. KOR287447, DATED 2-1-2008, EXPIRES 1-31-2018.

OWNER OF THAILAND REG. NO. KOR121624, DATED 8-8-1980, EXPIRES 8-7-2010.

THE MARK CONSISTS OF THE WORD "ROZA" IN ITALICIZED LETTERS ON AN OVAL BACKGROUND, SURROUNDED BY A BORDER.

CLASS 29—MEATS AND PROCESSED FOODS

FOR (BASED ON KOR121624) CANNED FISH, NAMELY, SARDINES IN TOMATO SAUCE, SARDINES IN GREEN CURRY SAUCE, SARDINES IN TERIYAKI SAUCE, MACKEREL IN TOMATO SAUCE, MACKEREL IN GREEN CURRY SAUCE, MACKEREL IN TERIYAKI SAUCE, TUNA IN TOMATO SAUCE, TUNA IN GREEN CURRY SAUCE, AND TUNA IN TERIYAKI SAUCE; (BASED ON KOR291856) SOUPS, NAMELY, MUSHROOM CREAM SOUP, INSTANT CORN SOUP; (BASED ON INTENT TO USE) COCONUT SOUP WITH TOFU AND VEGETABLES (U.S. CL. 46).

CLASS 30—STAPLE FOODS

FOR (BASED ON KOR287447) PACKAGED MEALS CONSISTING PRIMARILY OF PASTA OR RICE; PACKAGED MEALS CONSISTING OF RICE IN A SEALED CONTAINER; PACKAGED MEALS CONSISTING OF INSTANT FROZEN RICE; PACKAGED MEALS CONSISTING OF STEAMED RICE AND GREEN CURRY WITH TOFU, STEAMED RICE AND GREEN CURRY WITH TOFU AND VEGETABLES, STEAMED RICE AND YELLOW CURRY WITH TOFU, STEAMED RICE AND YELLOW CURRY WITH TOFU AND VEGETABLES, STEAMED RICE AND RED CURRY WITH TOFU, STEAMED RICE AND RED CURRY WITH TOFU AND VEGETABLES, STEAMED RICE AND PANANG CURRY WITH TOFU, AND STEAMED RICE AND PANANG CURRY WITH TOFU AND VEGETABLES; PACKAGED MEALS, CONSISTING OF EGG NOODLES AND PANANG CURRY SOUP WITH TOFU AND VEGETABLES; (BASED ON KOR145849) SAUCES, NAMELY, CHILI SAUCE, THAI BARBEQUE SAUCE, SWEET CHILI SAUCE, AND BLACK PEPPER SAUCE; STIR FRY SAUCE, NAMELY, PEPPER GARLIC SAUCE; (BASED ON INTENT TO USE) TERIYAKI SAUCE, SOY SAUCE, THAI PEANUT SAUCE, AND OYSTER SAUCE; STIR FRY SAUCE, NAMELY, BASIL GARLIC SAUCE, AND SWEET AND SOUR SAUCE (U.S. CL. 46).

KARANENDRA S. CHHINA, EXAMINING ATTORNEY

SN 77-821,360. VISMO, LLC, LAS VEGAS, NV. FILED 9-8-2009.

tokyo.basement

THE MARK CONSISTS OF STANDARD CHARACTERS WITHOUT CLAIM TO ANY PARTICULAR FONT, STYLE, SIZE, OR COLOR.

CLASS 25—CLOTHING

FOR MEN'S AND WOMEN'S CLOTHING AND ACCESSORY ITEMS, NAMELY, SHIRTS, PANTS, SKIRTS, JACKETS, BELTS, HATS, AND FOOTWEAR (U.S. CLS. 22 AND 39).

CLASS 35—ADVERTISING AND BUSINESS

FOR RETAIL STORE SERVICES FEATURING CLOTHING AND ACCESSORIES IN THE NATURE OF SHIRTS, PANTS, SKIRTS, JACKETS, BELTS, HATS, AND FOOTWEAR (U.S. CLS. 100, 101 AND 102).

CHARISMA HAMPTON, EXAMINING ATTORNEY

SN 77-821,792. SYNCOMY LTD., BERKSHIRE, UNITED KINGDOM, FILED 9-8-2009.

ZOMF

THE MARK CONSISTS OF STANDARD CHARACTERS WITHOUT CLAIM TO ANY PARTICULAR FONT, STYLE, SIZE, OR COLOR.

CLASS 9—ELECTRICAL AND SCIENTIFIC APPARATUS

FOR COMPUTER SOFTWARE FOR COMPARING AND SYNCHRONIZING FILES BETWEEN ELECTRONIC DEVICES; TELECOMMUNICATIONS SOFTWARE FOR LINKING ELECTRONIC DEVICES OVER A NETWORK; COMPUTER SOFTWARE AND ELECTRONIC APPARATUS FOR SYNCHRONIZING DIGITAL FILES AMONG ELECTRONIC APPARATUS; TELECOMMUNICATIONS APPARATUS AND INSTRUMENTS, NAMELY, CELLULAR TELEPHONES; APPARATUS AND INSTRUMENTS FOR COMMUNICATING WITH AND IN COMPUTER NETWORKS, NAMELY, GATEWAY SERVERS AND PERSONAL COMPUTERS; COMPUTER SOFTWARE FOR COMMUNICATING WITH AND IN COMPUTER NETWORKS; ELECTRONIC APPARATUS AND INSTRUMENTS, NAMELY, PERSONAL COMPUTERS, CELLULAR TELEPHONES AND PORTABLE MEDIA PLAYERS; OPTICAL AND ELECTRO-OPTICAL APPARATUS FOR SENDING AND TRANSMITTING SOUND, PICTURES, IMAGES, OR DATA; OPTICAL AND ELECTRO-OPTICAL DIGITAL MEDIA RECEIVERS; ELECTRONIC APPARATUS AND INSTRUMENTS FOR THE RETRIEVAL, COLLECTION, PROCESSING, LOGGING, STORING, TRANSMITTING, RECEPTION, DISPLAY AND PRINTING OUT OF COMMUNICATION SIGNALS AND DATA, NAMELY, COMPUTER HARDWARE, VIDEO MONITORS, RADIO SIGNAL TRANSMITTERS AND RECEIVERS, PRINTERS, CELLULAR PHONES, AND PORTABLE MEDIA PLAYERS; COMPUTER HARDWARE; AUTOMATIC SPEED SYNCHRONIZING APPARATUS, NAMELY, A DEVICE THAT SYNCHRONIZES THE DATA FILES BETWEEN ONE DIGITAL STORAGE DEVICE AND ANOTHER; APPARATUS FOR RECORDING, TRANSMISSION OR REPRODUCTION OF SOUND OR IMAGES; DATA PROCESSING EQUIPMENT AND COMPUTERS; BLANK MAGNETIC DATA CARRIERS AND BLANK RECORDABLE MAGNETIC AND OPTICAL DISCS; DOWNLOADABLE ELECTRONIC PUBLICATIONS, NAMELY, BOOKS, MAGAZINES, AND NEWSLETTERS, IN THE FIELDS OF BUSINESS, MUSIC, ENTERTAINMENT, CURRENT AFFAIRS, AND NEWS; REPLACEMENT PARTS FOR ALL THE AFORESAID GOODS (U.S. CLS. 21, 23, 26, 36 AND 38).

CLASS 38—COMMUNICATION

FOR TELECOMMUNICATIONS SERVICES, NAMELY, TRANSMITTING ELECTRONIC SIGNALS FOR THE SYNCHRONIZATION OF DATA FILES AND MEDIA FILES; TELECOMMUNICATIONS SERVICES, NAMELY, TRANSMISSION AND DISTRIBUTION OF DATA FILES AND MEDIA FILES OVER COMPUTER NETWORKS, THE INTERNET, CELLULAR TELEPHONES, MOBILE DEVICES, AND WIRELESS DEVICES; TELECOMMUNICATIONS SERVICES, NAMELY, TRANSMITTING ELECTRONIC SIGNALS FOR THE SYNCHRONIZATION OF ELECTRONIC APPARATUS; TELECOMMUNICATIONS SERVICES FOR THE SYNCHRONIZATION OF DATA AND APPLICATIONS ON ELECTRONIC APPARATUS, NAMELY, ELECTRONIC TRANSMISSION OF DATA AND DOCUMENTS VIA COMPUTER TERMINALS; TRANSMISSION AND DELIVERY OF DIGITAL MUSIC, IMAGES, VOICE AND DATA BY ELECTRONIC TRANSMISSION; PROVIDING ACCESS TO TELECOMMUNICATION NETWORKS; PROVIDING ADVICE, INFORMATION, AND CONSULTANCY SERVICES RELATING TO THE AFOREMENTIONED SERVICES (U.S. CLS. 100, 101 AND 104).

CLASS 42—SCIENTIFIC AND COMPUTER SERVICES

FOR SCIENTIFIC RESEARCH; TECHNOLOGICAL DESIGN OF COMPUTER SOFTWARE; DESIGN AND DEVELOPMENT OF COMPUTER HARDWARE AND SOFTWARE; DESIGN AND DEVELOPMENT OF COMPUTER HARDWARE AND SOFTWARE FOR SYNCHRONIZING ELECTRONIC APPARATUS, AND DATA AND APPLICATIONS ON ELECTRONIC APPARATUS; OPERATION OF A DIGITALIZED MEDIA PLATFORM FOR THE EXCHANGE OF MESSAGES AND INFORMATION; COMPUTER SERVICES, NAMELY, COMPARING AND UPDATING DATA FILES AND MEDIA FILES AMONG ELECTRONIC APPARATUS; PROVIDING ADVICE, INFORMATION, AND CONSULTANCY SERVICES RELATING TO THE AFOREMENTIONED SERVICES (U.S. CLS. 100 AND 101).

JASON BLAIR, EXAMINING ATTORNEY

SN 77-822,504. SOLDELUZ S.A., 1101 MONTEVIDEO, URUGUAY, FILED 9-9-2009.



NO CLAIM IS MADE TO THE EXCLUSIVE RIGHT TO USE "AREQUITA", APART FROM THE MARK AS SHOWN. THE COLOR(S) BLUE, WHITE, GREEN, AND BLACK IS/ARE CLAIMED AS A FEATURE OF THE MARK.

THE MARK CONSISTS OF STYLIZED WHITE LETTERS WITH THE WORDS "VIRGEN DE LAS ANIMAS DEL AREQUITA" ON A BLUE BACKGROUND AND A SILHOUETTE OF A MERMAID WITH BLACK HAIR, A BLUE TORSO AND A GREEN TAIL.

THE ENGLISH TRANSLATION OF "VIRGEN DE LAS ANIMAS DEL AREQUITA" IN THE MARK IS VIRGIN SOULS OF AREQUITA.

SN 77-822,046. UMBRA DATA, INC., SAN JOSE, CA. FILED 9-8-2009.



THE MARK CONSISTS OF CAPITAL LETTERS "UD" WITH A STYLIZED EYE BETWEEN THE "U" AND THE "D", AND THE LETTERS "UMBRADATA".

CLASS 9—ELECTRICAL AND SCIENTIFIC APPARATUS

FOR ANTI-SPYWARE SOFTWARE; COMPUTER ANTI-VIRUS SOFTWARE; COMPUTER SOFTWARE AND HARDWARE FOR PROTECTING AGAINST BOTNETS AND THE ASSOCIATED CYBERCRIMINAL ACTIVITY; COMPUTER SOFTWARE FOR PROVIDING AN ONLINE DATABASE IN THE FIELD OF TRANSACTION PROCESSING TO UPLOAD TRANSACTIONAL DATA, PROVIDE STATISTICAL ANALYSIS, AND PRODUCE NOTIFICATIONS AND REPORTS; ENTERPRISE SOFTWARE IN THE NATURE OF A DATABASE FOR NON-TRANSACTIONAL DATA AND A SEARCH ENGINE FOR DATABASE CONTENT; SOFTWARE FOR MONITORING AND CONTROLLING COMMUNICATION BETWEEN COMPUTERS AND AUTOMATED MACHINE SYSTEMS (U.S. CLS. 21, 23, 26, 36 AND 38).

FIRST USE 10-25-2009; IN COMMERCE 11-16-2009.

CLASS 42—SCIENTIFIC AND COMPUTER SERVICES

FOR CLOUD COMPUTING FEATURING SOFTWARE FOR USE PROTECTING AGAINST BOTNETS AND THE ASSOCIATED CYBERCRIMINAL ACTIVITY; COMPUTER SERVICE, NAMELY, ACTING AS AN APPLICATION SERVICE PROVIDER IN THE FIELD OF KNOWLEDGE MANAGEMENT TO HOST COMPUTER APPLICATION SOFTWARE FOR SEARCHING AND RETRIEVING INFORMATION FROM DATABASES AND COMPUTER NETWORKS; DEVELOPMENT OF SOFTWARE FOR SECURE NETWORK OPERATIONS (U.S. CLS. 100 AND 101).

FIRST USE 10-25-2009; IN COMMERCE 11-16-2009.
SEAN CROWLEY, EXAMINING ATTORNEY

CLASS 32—LIGHT BEVERAGES

FOR MINERAL WATER; BEER (U.S. CLS. 45, 46 AND 48).

CLASS 33—WINES AND SPIRITS

FOR ALCOHOLIC BEVERAGES EXCEPT BEERS (U.S. CLS. 47 AND 49).

JOHN DALIER, EXAMINING ATTORNEY

SN 77-823,456. HIGHLANDS OVERRIDE, INC, PORTSMOUTH, NH. FILED 9-10-2009.

ÊTRE AU COURANT, ÇA RAPPORTE

THE MARK CONSISTS OF STANDARD CHARACTERS WITHOUT CLAIM TO ANY PARTICULAR FONT, STYLE, SIZE, OR COLOR.

THE ENGLISH TRANSLATION OF "ÊTRE AU COURANT, ÇA RAPPORTE" IN THE MARK IS TO BE IN THE KNOW PAYS OFF.

CLASS 35—ADVERTISING AND BUSINESS

FOR CUSTOMER LOYALTY SERVICES AND CUSTOMER CLUB SERVICES, FOR COMMERCIAL, PROMOTIONAL AND/OR ADVERTISING PURPOSES; PROVIDING INCENTIVE AWARD PROGRAMS FOR CUSTOMERS THROUGH THE ISSUANCE AND PROCESSING OF LOYALTY CARDS AND DISCOUNT CARDS FOR FREQUENT USE OF PARTICIPATING BUSINESSES; INCENTIVE AWARD PROGRAMS TO PROMOTE THE SALE OF PRODUCTS AND SERVICES OF OTHERS; CONSUMER LOYALTY SERVICES FOR COMMERCIAL, PROMOTIONAL, AND/OR ADVERTISING PURPOSES, NAMELY, ADMINISTRATION OF FREQUENT BUYER PROGRAM THAT ALLOWS MEMBERS TO REDEEM PURCHASE POINTS FOR DISCOUNTS OR AWARDS OFFERED BY THE LOYALTY PROGRAM; ADMINISTRATION OF A PROGRAM FOR ENABLING PARTICIPANTS TO OBTAIN DISCOUNTS ON GOODS AND RECEIVE IMPROVED SERVICES; SALES PROMOTION FOR OTHERS PROVIDED THROUGH THE DISTRIBUTION AND THE ADMINISTRATION OF PRIVILEGED USER CARDS; AND RETAIL STORE SERVICES IN THE FIELD OF CONVENIENCE STORE ITEMS AND FUEL FEATURING A BONUS INCENTIVE PROGRAM FOR CUSTOMERS (U.S. CLS. 100, 101 AND 102).

CLASS 37—CONSTRUCTION AND REPAIR

FOR GAS REFUELING SERVICE STATION SERVICES FOR VEHICLES; AND AUTOMOBILE SERVICE STATION SERVICES FEATURING A BONUS INCENTIVE PROGRAM FOR CUSTOMERS (U.S. CLS. 100, 103 AND 106).

SHAILA SETTLES, EXAMINING ATTORNEY

SN 77-823,578. HIGHLANDS OVERRIDE, INC, PORTSMOUTH, NH. FILED 9-10-2009.

ROLL IT BACK

THE MARK CONSISTS OF STANDARD CHARACTERS WITHOUT CLAIM TO ANY PARTICULAR FONT, STYLE, SIZE, OR COLOR.

CLASS 35—ADVERTISING AND BUSINESS

FOR ARRANGING AND CONDUCTING INCENTIVE REWARD PROGRAMS TO PROMOTE THE SALE OF MOTOR FUEL; ADMINISTRATION OF A DISCOUNT PROGRAM FOR ENABLING PARTICIPANTS TO OBTAIN DISCOUNTS ON FUEL PRODUCTS THROUGH USE OF A DISCOUNT MEMBERSHIP CARD (U.S. CLS. 100, 101 AND 102).

CLASS 37—CONSTRUCTION AND REPAIR

FOR GAS STATION SERVICES, NAMELY, VEHICLE REPAIR, REFUELING AND LUBRICATION SERVICES FEATURING A BONUS INCENTIVE PROGRAM FOR CUSTOMERS; AND AUTOMOBILE SERVICE STATION SERVICES FEATURING A BONUS INCENTIVE PROGRAM FOR CUSTOMERS (U.S. CLS. 100, 103 AND 106).

SHAILA SETTLES, EXAMINING ATTORNEY

SN 77-823,992. QUALCOMM INCORPORATED, SAN DIEGO, CA. FILED 9-10-2009.



NO CLAIM IS MADE TO THE EXCLUSIVE RIGHT TO USE "TV" OR "LIVE MOBILE TV", APART FROM THE MARK AS SHOWN.

THE MARK CONSISTS OF "FLO TV" INSIDE OF DESIGNS, AS WELL AS THE WORDING "LIVE MOBILE TV" BELOW THOSE DESIGNS. THE DESIGNS CONSIST OF A VAGUE QUADRILATERAL SHAPE THAT REPRESENTS A STYLIZED TELEVISION VIDEO SCREEN. THE QUADRILATERAL IS COMPOSED OF TWO "L"-SHAPED POLYGONS WITH SLIGHTLY CURVED SIDES THAT DO NOT QUITE CONNECT WITH EACH OTHER. THIS LEAVES AN OPEN SPACE IN THE MIDDLE OF THE QUADRILATERAL THAT IS ITSELF VAGUELY THE SHAPE OF A QUADRILATERAL. THE WORDING "FLO TV" APPEARS IN THE CENTER OF THIS OPEN SPACE.

CLASS 38—COMMUNICATION

FOR TELECOMMUNICATIONS SERVICES, NAMELY, ELECTRONIC TRANSMISSION AND RECEIVING OF DATA AND AUDIO-VISUAL DISPLAYS VIA COMPUTER TERMINALS AND WIRELESS COMMUNICATION DEVICES; SATELLITE COMMUNICATION SERVICES; TERRESTRIAL COMMUNICATION SERVICES, NAMELY, SATELLITE TRANSMISSION SERVICES; TEXT AND NUMERIC WIRELESS DIGITAL MESSAGING SERVICES; ONLINE DOCUMENT DELIVERY VIA A GLOBAL COMPUTER NETWORK (U.S. CLS. 100, 101 AND 104).

CLASS 41—EDUCATION AND ENTERTAINMENT

FOR AUDIO PRODUCTION SERVICES AND VISUAL EFFECTS PRODUCTION SERVICES FOR USE ON HAND-HELD DIGITAL ELECTRONIC DEVICES AND WIRELESS COMMUNICATION SYSTEMS (U.S. CLS. 100, 101 AND 107).

KEVON CHISOLM, EXAMINING ATTORNEY

SN 77-824,408. MANITOWOC FOODSERVICE COMPANIES, INC., SPARKS, NV. FILED 9-11-2009.

HARFORD

THE MARK CONSISTS OF STANDARD CHARACTERS WITHOUT CLAIM TO ANY PARTICULAR FONT, STYLE, SIZE, OR COLOR.

OWNER OF U.S. REG. NOS. 2,327,994 AND 2,423,754.
SEC. 2(F).

CLASS 11—ENVIRONMENTAL CONTROL APPARATUS

FOR WALK-IN COOLERS AND FREEZERS; AND CUSTOM-FABRICATED REFRIGERATION SYSTEMS COMPRISED OF MODULAR REFRIGERATION UNITS (U.S. CLS. 13, 21, 23, 31 AND 34).

FIRST USE 0-0-1968; IN COMMERCE 0-0-1968.

CLASS 42—SCIENTIFIC AND COMPUTER SERVICES

FOR CUSTOM DESIGN OF MODULAR STRUCTURES, NAMELY, MODULAR REFRIGERATION UNITS (U.S. CLS. 100 AND 101).

FIRST USE 0-0-1998; IN COMMERCE 0-0-1998.
EVELYN BRADLEY, EXAMINING ATTORNEY

CLASS 45—PERSONAL AND LEGAL SERVICES

FOR CONSULTATION RELATED TO THE LICENSING OF INTELLECTUAL PROPERTY, NAMELY, TRADEMARKS, PATENTS AND TRADE SECRETS; PROVIDING INFORMATION ABOUT TRADEMARKS, PATENTS AND TRADE SECRETS RELATING TO CERTAIN DRUGS, DRUG DELIVERY SYSTEMS, BIOTECHNOLOGY, ANIMAL HEALTH, AND MEDICAL DEVICES; PROVIDING AN ACCESSIBLE, INTERACTIVE WEB SITE OF INFORMATION AND RESOURCES RELATING TO TRADEMARKS, PATENTS, AND TRADE SECRETS (U.S. CLS. 100 AND 101).

FIRST USE 10-14-1998; IN COMMERCE 3-10-1999.
ESTHER BELENKER, EXAMINING ATTORNEY

SN 77-825,681. EXMAR NV, 2000 ANTWERPEN, BELGIUM, FILED 9-14-2009.

SN 77-825,587. UTEK EUROPE, LTD., YORK, YORKSHIRE, UNITED KINGDOM, FILED 9-14-2009.

PHARMALICENSING

THE MARK CONSISTS OF STANDARD CHARACTERS WITHOUT CLAIM TO ANY PARTICULAR FONT, STYLE, SIZE, OR COLOR.

OWNER OF U.S. REG. NO. 2,841,872.
SEC. 2(F).

CLASS 35—ADVERTISING AND BUSINESS

FOR PROMOTING THE GOODS AND SERVICES OF OTHERS BY PROVIDING MARKETING AND ADVERTISING MATERIALS RELATED TO PRODUCTS IN THE MEDICAL FIELD, NAMELY, DRUGS, DRUG DELIVERY SYSTEMS, BIOTECHNOLOGY, ANIMAL HEALTH, AND MEDICAL DEVICES VIA AN INTERACTIVE WEB SITE; PROVIDING AN ACCESSIBLE, SEARCHABLE DATABASE OF CONSUMER INFORMATION RELATED TO PRODUCTS IN THE MEDICAL FIELD, NAMELY, DRUGS, DRUG DELIVERY SYSTEMS, BIOTECHNOLOGY, ANIMAL HEALTH, AND MEDICAL DEVICES; PROVIDING TECHNICAL CONSUMER INFORMATION ON DRUGS, DRUG DELIVERY SYSTEMS, BIOTECHNOLOGY, ANIMAL HEALTH, AND MEDICAL DEVICES (U.S. CLS. 100, 101 AND 102).

FIRST USE 10-14-1998; IN COMMERCE 3-10-1999.

CLASS 44—MEDICAL, BEAUTY AND AGRICULTURAL SERVICES

FOR PROVIDING AN ACCESSIBLE, SEARCHABLE DATABASE OF MEDICAL INFORMATION RELATED TO PRODUCTS IN THE MEDICAL FIELD, NAMELY, DRUGS, DRUG DELIVERY SYSTEMS, BIOTECHNOLOGY, ANIMAL HEALTH, AND MEDICAL DEVICES; PROVIDING TECHNICAL MEDICAL INFORMATION ON DRUGS, DRUG DELIVERY SYSTEMS, BIOTECHNOLOGY, ANIMAL HEALTH, AND MEDICAL DEVICES (U.S. CLS. 100 AND 101).

FIRST USE 10-14-1998; IN COMMERCE 3-10-1999.

EXPORT

THE MARK CONSISTS OF STANDARD CHARACTERS WITHOUT CLAIM TO ANY PARTICULAR FONT, STYLE, SIZE, OR COLOR.

CLASS 6—METAL GOODS

FOR FLOATING OFFSHORE WORK PLATFORMS MADE PRIMARILY OF METAL FOR THE PRODUCTION AND/OR LIQUEFICATION OF NATURAL GAS (U.S. CLS. 2, 12, 13, 14, 23, 25 AND 50).

CLASS 19—NON-METALLIC BUILDING MATERIALS

FOR FLOATING OFFSHORE WORK PLATFORMS MADE PRIMARILY OF CONCRETE FOR THE PRODUCTION AND/OR LIQUEFICATION OF NATURAL GAS (U.S. CLS. 1, 12, 33 AND 50).

JILL PRATER, EXAMINING ATTORNEY

SN 77-825,703. TINNITUS OTOSOUND PRODUCTS, LLC, LOS ANGELES, CA. FILED 9-14-2009.



THE COLOR(S) GRAY, DARK BLUE AND LIGHT BLUE IS/ARE CLAIMED AS A FEATURE OF THE MARK.

THE MARK CONSISTS OF A CIRCLE TRANSECTED BY A SERIES OF THE LETTER "C" IN REVERSE ORIENTATION THEN FORWARD ORIENTATION. THE CIRCLE IS GRAY. THE "C" DESIGNS IN REVERSE ORIENTATION ARE DARK BLUE. THE "C" DESIGNS IN FORWARD ORIENTATION ARE IN LIGHT BLUE.

CLASS 10—MEDICAL APPARATUS

FOR MEDICAL DEVICES FOR USE IN TREATMENT OF HEARING AND NEUROLOGICAL DISORDERS WITH SOUND AND PARTS OF SUCH DEVICES (U.S. CLS. 26, 39 AND 44).

CLASS 44—MEDICAL, BEAUTY AND AGRICULTURAL SERVICES

FOR THERAPY OF HEARING AND NEUROLOGICAL DISORDERS WITH SOUND (U.S. CLS. 100 AND 101).
DANIEL CAPSHAW, EXAMINING ATTORNEY

SN 77-826,080. VISIBLEGAINS, INC., WALTHAM, MA.
FILED 9-14-2009.

VisibleGains

THE MARK CONSISTS OF STANDARD CHARACTERS WITHOUT CLAIM TO ANY PARTICULAR FONT, STYLE, SIZE, OR COLOR.

CLASS 35—ADVERTISING AND BUSINESS

FOR BUSINESS SERVICES, NAMELY, STRATEGY, DESIGN, AND MEASUREMENT OF ONLINE MARKETING AND SALES PROGRAMS (U.S. CLS. 100, 101 AND 102).

CLASS 42—SCIENTIFIC AND COMPUTER SERVICES

FOR SOFTWARE AS A SERVICE (SAAS) SERVICES FEATURING SOFTWARE FOR DESIGN, DELIVERY AND MEASUREMENT OF INTERACTIVE MARKETING AND SALES APPLICATIONS ENCOMPASSING TEXT, AUDIO, GRAPHICS, STILL IMAGES AND MOVING PICTURES (U.S. CLS. 100 AND 101).

MICHAEL ENGEL, EXAMINING ATTORNEY

SN 77-826,604. CHARITABLE LEADERSHIP FOUNDATION, COMPRISING RICHARD C. LIEBICH, A U.S. CITIZEN, CLIFTON PARK, NY. FILED 9-15-2009.



NO CLAIM IS MADE TO THE EXCLUSIVE RIGHT TO USE "SUSTAINING EDUCATIONAL ACHIEVEMENT IN LITERACY", APART FROM THE MARK AS SHOWN.

THE COLOR(S) RED, BLUE, GREEN AND IVORY IS/ARE CLAIMED AS A FEATURE OF THE MARK.

THE MARK CONSISTS OF A BLUE SEAL BALANCING ON ITS NOSE AN OPEN IVORY BOOK WITH THE WORDS "READ WRITE GROW" ON THE BOOK IN RED, BLUE AND GREEN, RESPECTIVELY, AND THE WORDS "SUSTAINING EDUCATIONAL" IN RED CONNECTING THE SEAL TO THE BOOK ON THE LEFT, AND THE WORDS "ACHIEVEMENT IN LITERACY" IN RED CONNECTING THE SEAL TO THE BOOK ON THE RIGHT.

CLASS 16—PAPER GOODS AND PRINTED MATTER

FOR PRINTED INSTRUCTIONAL, ASSESSMENT, EDUCATIONAL AND TEACHING MATERIALS IN THE FIELD OF LITERACY; PRINTED MATERIALS, NAMELY, EDUCATIONAL BOOKS, REPORTS, TEACHING MATERIALS, BOOKS, BROCHURES, NEWSLETTERS, TESTING AND ASSESSMENT MATERIALS, ALL FOR USE IN EDUCATIONAL INSTRUCTION, TESTING, ASSESSMENT, CURRICULUM DEVELOPMENT AND IMPLEMENTATION (U.S. CLS. 2, 5, 22, 23, 29, 37, 38 AND 50).

FIRST USE 6-1-2009; IN COMMERCE 6-1-2009.

CLASS 41—EDUCATION AND ENTERTAINMENT

FOR EDUCATIONAL SERVICES, NAMELY, CONDUCTING AND PROVIDING CLASSES, WORKSHOPS, INSTITUTES, COACHING AND TRAINING FOR TEACHERS, PRINCIPALS AND SCHOOL ADMINISTRATORS IN THE FIELDS OF LITERACY AND EDUCATION; ASSESSMENT OF EDUCATIONAL CURRICULUMS; DEVELOPING CURRICULUM AND INSTRUCTION STRATEGIES FOR TEACHERS AND STUDENTS; EDUCATIONAL RESEARCH SERVICES; DISTRIBUTION OF ONLINE OR PRINTED RESOURCE GUIDES FOR USE IN CONNECTION WITH ALL OF THE ABOVE (U.S. CLS. 100, 101 AND 107).

FIRST USE 6-1-2009; IN COMMERCE 6-1-2009.

JOHN WILKE, EXAMINING ATTORNEY

SN 77-826,634. PELICAN WIRE COMPANY, INC., NAPLES, FL. FILED 9-15-2009.

PELICAN WIRE

THE MARK CONSISTS OF STANDARD CHARACTERS WITHOUT CLAIM TO ANY PARTICULAR FONT, STYLE, SIZE, OR COLOR.

NO CLAIM IS MADE TO THE EXCLUSIVE RIGHT TO USE "WIRE", APART FROM THE MARK AS SHOWN.

CLASS 6—METAL GOODS

FOR WIRE; WIRE FOR USE OR APPLICATION IN THE DEFENSE/AEROSPACE, MEDICAL DEVICES, PLASTIC CUTTING MACHINES, SPECIAL HEATERS, DENTAL WORK, CERAMIC SHOPS INDUSTRIES (U.S. CLS. 2, 12, 13, 14, 23, 25 AND 50).

FIRST USE 12-31-1971; IN COMMERCE 12-31-1971.

CLASS 9—ELECTRICAL AND SCIENTIFIC APPARATUS

FOR WIRE, NAMELY, BARE RESISTANCE WIRES, FLOOR HEATING, NAMELY, ELECTRICAL RESISTANCE HEATING WIRES, INSULATED WIRES, NAMELY, INSULATED COPPER ELECTRICAL WIRE, AND THERMOCOUPLE WIRE (U.S. CLS. 21, 23, 26, 36 AND 38).

FIRST USE 12-31-1971; IN COMMERCE 12-31-1971.

MARLENE BELL, EXAMINING ATTORNEY

SN 77-826,768. THE REFINERY LIMITED, LONDON, UNITED KINGDOM, FILED 9-15-2009.

THE REFINERY

THE MARK CONSISTS OF STANDARD CHARACTERS WITHOUT CLAIM TO ANY PARTICULAR FONT, STYLE, SIZE, OR COLOR.

OWNER OF ERPN CMNTY TM OFC REG. NO. 001286426, DATED 8-14-2000, EXPIRES 8-18-2019.

CLASS 3—COSMETICS AND CLEANING PREPARATIONS

FOR TOILET PREPARATIONS, NAMELY, TOILET WATER; PERFUMERY; FRAGRANCES FOR PERSONAL USE; COLOGNES; TOILET WATERS; TALCUM POWDER; BATH ADDITIVES, NAMELY, BATH GELS, BATH OILS AND NONMEDICATED BATH SALTS; SHOWER GELS; HAND SOAPS, FACIAL SOAPS, BODY SOAPS, LAUNDRY SOAPS, MEDICATED SOAPS, SHAVING SOAPS; SHAMPOOS; PREPARATIONS FOR THE CARE OF THE HAIR; PREPARATIONS FOR CARE OF THE TEETH, NAMELY, TOOTHPASTE; ANTIPERSPIRANTS; DEODORANTS FOR PERSONAL USE; DEPILOTORIES; DEPILOTORY WAX; SHAVING PREPARATIONS; AFTER SHAVE PREPARATIONS; MASSAGE OILS, MASSAGE CREAMS; ESSENTIAL OILS FOR PERSONAL USE; COSMETIC PREPARATIONS FOR SKIN RENEWAL; SUN-TANNING PREPARATIONS; NON MEDICATED SKIN AND BODY CARE PREPARATIONS, NAMELY, CLEANSERS AND WASHES FOR THE FACE AND BODY, SHAVING OILS, GELS AND FOAMS, MOISTURIZING OILS, LOTIONS, NON-MEDICATED BALMS AND NON-MEDICATED SERUMS FOR THE FACE AND SKIN; COSMETIC PREPARATIONS FOR BODY CARE, SKIN CARE PREPARATIONS, NAMELY, BODY POLISH; SKIN LOTIONS, SKIN CREAMS, SKIN TONERS; SKIN MOISTURIZERS; SKIN CLEANSERS; NON MEDICATED ASTRINGENTS FOR COSMETIC PURPOSES; LIP BALM AND GLOSS; SUNSCREEN LOTIONS; SUNSCREEN GELS; SUNSCREEN OILS AND SUNSCREEN ROLL ON STICKS; BEAUTY MASKS, BEAUTY FACIAL PACKS, NAMELY, FACIAL MASKS, FACIAL SCRUBS; NAIL CARE PREPARATIONS; NAIL POLISH AND VARNISH; NAIL POLISH AND VARNISH REMOVER; EMERY BOARDS AND EMERY PAPER; COTTON WOOL FOR COSMETIC PURPOSES; COTTON WOOL STICKS, PADS AND BALLS FOR COSMETIC PURPOSES; POTPOURRI; GIFT PACKAGES COMPRISING COSMETICS AND SKIN CARE PRODUCTS, NAMELY, COSMETICS, NON-MEDICATED SKIN CARE PREPARATIONS (U.S. CLS. 1, 4, 6, 50, 51 AND 52).

CLASS 21—HOUSEWARES AND GLASS

FOR COMBS, BRUSHES, NAMELY, HAIR, NAIL AND TOOTH BRUSHES, SHAVING BRUSHES, SHAVING BRUSH STANDS, BASINS AND BOWLS, DECORATIVE GLASS; TABLEWARE IN THE FORM OF GLASSWARE, NAMELY, GLASS BEVERAGE WARE, DRINKING GLASSES, GLASS BOWLS, PORCELAIN AND EARTHENWARE, NAMELY, PLATES, MUGS, CUPS, BEAKERS, JUGS AND DECORATIVE HOUSEHOLD CONTAINERS; SOAP BOXES; BOTTLES, SOLD EMPTY; BOXES OF EARTHENWARE, PORCELAIN, GLASS; CLEANING CLOTHS; CLOTHES DRYING RACKS; CLOTHES PINS; TOILETRY CASES, NAMELY, COMPACTS SOLD EMPTY, DECANTERS, CONTAINERS FOR HOUSEHOLD GOODS, PERFUME CONTAINERS SOLD EMPTY, AND TOOTHBRUSH CASES; DISHWASHING BRUSHES; ELECTRIC TOOTH BRUSHES, BRUSHES FOR FOOTWEAR, CLEANING BRUSHES FOR HOUSEHOLD USE; SHOE BRUSHES, SHOE HORNS; SHOE TREES; SOAP DISPENSERS; SOAP HOLDERS; CLEANING SPONGES AND SPONGE HOLDERS; TOILET BRUSHES; DENTAL FLOSS (U.S. CLS. 2, 13, 23, 29, 30, 33, 40 AND 50).

CLASS 44—MEDICAL, BEAUTY AND AGRICULTURAL SERVICES

FOR HAIRDRESSING AND BEAUTY SALON SERVICES; HAIRDRESSING SALONS; BEAUTY SALON SERVICES; HEALTH SPA SERVICES FOR HEALTH AND WELLNESS OF BODY AND SPIRIT, NAMELY, PROVIDING FACIAL AND BODY TREATMENT SERVICES; BODY WAXING AND MANICURE SERVICES; MAKEUP CONSULTATION AND APPLICATION SERVICES; PEDICURE SERVICES; HEALTH AND BODY THERAPY, NAMELY, BODYWORK THERAPY, MASSAGE THERAPY SERVICES; TONING THERAPY, NAMELY, BODYWORK THERAPY, MASSAGE THERAPY SERVICES; MASSAGE SERVICES; COSMETIC CONSULTANCY SERVICES IN THE FIELD OF HEALTH AND BEAUTY CARE; INFORMATION AND CONSULTANCY SERVICES IN THE FIELDS OF HAIR, HAIRDRESSING, NAIL AND HEALTH CARE; PROVISION OF AROMA THERAPY SERVICES; TANNING SALONS (U.S. CLS. 100 AND 101).

ASMAT KHAN, EXAMINING ATTORNEY

SN 77-827,368. MDC ACQUISITION CO., TWINSBURG, OH. FILED 9-16-2009.

BODY SPORT

THE MARK CONSISTS OF STANDARD CHARACTERS WITHOUT CLAIM TO ANY PARTICULAR FONT, STYLE, SIZE, OR COLOR.

OWNER OF U.S. REG. NOS. 2,265,654 AND 3,186,476.

NO CLAIM IS MADE TO THE EXCLUSIVE RIGHT TO USE "SPORT", APART FROM THE MARK AS SHOWN.

CLASS 10—MEDICAL APPARATUS

FOR ELECTRIC VIBRATING THERAPEUTIC MASSAGER; ORTHOPEDIC SUPPORTS AND BRACES (U.S. CLS. 26, 39 AND 44).

FIRST USE 10-1-2005; IN COMMERCE 10-1-2005.

CLASS 20—FURNITURE AND ARTICLES NOT OTHERWISE CLASSIFIED

FOR CUSHIONS AND PILLOWS (U.S. CLS. 2, 13, 22, 25, 32 AND 50).

FIRST USE 5-20-2008; IN COMMERCE 5-20-2008.

CLASS 28—TOYS AND SPORTING GOODS

FOR FITNESS EQUIPMENT, NAMELY, BALLS, BALANCE DISCS, PULLEYS, RESISTANCE BANDS, TUBES, LOOPS, ROPES, ROLLERS, WEIGHTS AND WEIGHT BARS, ATHLETIC TAPE, PERSONAL EXERCISE MATS, PILATES RINGS; BALL STACKERS, NAMELY, RINGS FOR STORING BALLS (U.S. CLS. 22, 23, 38 AND 50).

FIRST USE 10-1-2005; IN COMMERCE 10-1-2005.

THEODORE MCBRIDE, EXAMINING ATTORNEY

SN 77-827,525. DELTECH CONTROLS, L.L.C., GEISMAR, LA. FILED 9-16-2009.

DELTECH

THE MARK CONSISTS OF STANDARD CHARACTERS WITHOUT CLAIM TO ANY PARTICULAR FONT, STYLE, SIZE, OR COLOR.

OWNER OF U.S. REG. NOS. 2,823,506 AND 2,877,350.

CLASS 6—METAL GOODS

FOR INDUSTRIAL VALVES NOT BEING PARTS OF MACHINES, NAMELY, METAL BALL VALVES, METAL BUTTERFLY VALVES, AND METAL MOUNTING HARDWARE THEREFOR (U.S. CLS. 2, 12, 13, 14, 23, 25 AND 50).

FIRST USE 9-26-2003; IN COMMERCE 9-26-2003.

CLASS 7—MACHINERY

FOR VALVE ACTUATORS, NAMELY, PNEUMATIC VALVE ACTUATORS, MOUNTING HARDWARE FOR PNEUMATIC VALVE ACTUATORS, AND REPLACEMENT PARTS THEREFOR; INDUSTRIAL VALVES BEING PARTS OF MACHINES, NAMELY, METAL BALL VALVES, METAL BUTTERFLY VALVES, AND MOUNTING HARDWARE THEREFOR (U.S. CLS. 13, 19, 21, 23, 31, 34 AND 35).

FIRST USE 9-26-2003; IN COMMERCE 9-26-2003.

CLASS 9—ELECTRICAL AND SCIENTIFIC APPARATUS

FOR VALVE ACTUATORS, NAMELY, ELECTRIC VALVE ACTUATORS, MOUNTING HARDWARE FOR ELECTRIC VALVE ACTUATORS, AND REPLACEMENT PARTS THEREFOR (U.S. CLS. 21, 23, 26, 36 AND 38).

FIRST USE 6-2-2009; IN COMMERCE 6-2-2009.

TINA BROWN, EXAMINING ATTORNEY

SN 77-829,096. THE CHRISTIAN SCIENCE BOARD OF DIRECTORS OF THE FIRST CHURCH OF CHRIST, SCIENTIST, BOSTON, MA. FILED 9-17-2009.

THE MARY BAKER EDDY LIBRARY

THE MARK CONSISTS OF STANDARD CHARACTERS WITHOUT CLAIM TO ANY PARTICULAR FONT, STYLE, SIZE, OR COLOR.

OWNER OF U.S. REG. NOS. 403,487, 3,090,971 AND OTHERS.

NO CLAIM IS MADE TO THE EXCLUSIVE RIGHT TO USE "LIBRARY", APART FROM THE MARK AS SHOWN.

THE NAME "MARY BAKER EDDY" DOES NOT IDENTIFY A LIVING INDIVIDUAL.

CLASS 16—PAPER GOODS AND PRINTED MATTER

FOR PRINTED MATTER, NAMELY, BOOKS, ARTICLES AND NEWSLETTERS IN THE FIELDS OF RELIGION, SPIRITUALITY, SOCIAL SCIENCE, CULTURE, HISTORY, SCIENCE, HEALTH AND WELLBEING (U.S. CLS. 2, 5, 22, 23, 29, 37, 38 AND 50).

FIRST USE 9-29-2002; IN COMMERCE 9-29-2002.

CLASS 41—EDUCATION AND ENTERTAINMENT

FOR EDUCATIONAL SERVICES, NAMELY, LIBRARY SERVICES IN PERSON OR ONLINE AND ARRANGING AND CONDUCTING PROGRAMS AND EVENTS IN THE NATURE OF PUBLIC TALKS, EXHIBITS AND MUSEUM TOURS IN THE FIELDS OF RELIGION, SPIRITUALITY, CULTURE AND HISTORY; COMPUTER SERVICES, NAMELY, PROVIDING AN ONLINE INTERACTIVE DATABASE VIA THE INTERNET AND AN INTRANET NETWORK, IN THE FIELDS OF CULTURE AND HISTORY (U.S. CLS. 100, 101 AND 107).

FIRST USE 9-29-2002; IN COMMERCE 9-29-2002.

CLASS 45—PERSONAL AND LEGAL SERVICES

FOR COMPUTER SERVICES, NAMELY, PROVIDING AN ONLINE INTERACTIVE DATABASE VIA THE INTERNET AND AN INTRANET NETWORK, IN THE FIELDS OF RELIGION AND SPIRITUALITY (U.S. CLS. 100 AND 101).

FIRST USE 9-29-2002; IN COMMERCE 9-29-2002.

KRISTINA MORRIS, EXAMINING ATTORNEY

SN 77-829,941. ASH INTERNATIONAL GROUP LIMITED, KOWLOON, HONG KONG, FILED 9-18-2009.



PRIORITY CLAIMED UNDER SEC. 44(D) ON HONG KONG APPLICATION NO. 301398619, FILED 8-4-2009, REG. NO. 301398619, DATED 8-4-2009, EXPIRES 8-4-2019.

OWNER OF U.S. REG. NOS. 3,373,484, 3,638,152 AND 3,659,877.

THE MARK CONSISTS OF THE WORD "ASH" IN STYLIZED FONT AND THE OUTLINE OF A STYLIZED SHIELD DESIGN.

CLASS 18—LEATHER GOODS

FOR GOODS MADE OF LEATHER, ANIMAL SKINS AND HIDES, AND IMITATION OF THE FOREGOING MATERIALS, NAMELY, CLUTCH BAGS, ATTACHE CASES, TRUNKS, LUGGAGE, TRAVEL BAGS, KNAPSACKS AND BACKPACKS, SATCHELS, HANDBAGS, WALLETS, PURSES, LEATHER KEY CASES; AND UMBRELLAS (U.S. CLS. 1, 2, 3, 22 AND 41).

CLASS 25—CLOTHING

FOR FOOTWEAR, NAMELY, SHOES, BOOTS, SANDALS, SLIPPERS, ATHLETIC SHOES; CLOTHING, NAMELY, SHIRTS, T-SHIRTS, SWEATSHIRTS, JACKETS, TROUSERS, SKIRTS, SUITS, DRESSES, JEANS, TANK-TOPS, UNDERVESTS, UNDERPANTS, SOCKS AND STOCKINGS, GLOVES, SCARVES, BELTS, KNITTED PULLOVERS, SHORTS, COATS, OVERCOATS, RAINCOATS; HEADGEAR, NAMELY, HATS AND CAPS (U.S. CLS. 22 AND 39).

CLASS 35—ADVERTISING AND BUSINESS

FOR WHOLESALE STORE, RETAIL STORE, DISTRIBUTORSHIP AND MAIL ORDER SERVICES, ALL THE AFORESAID SERVICES RELATING TO CLOTHING, FOOTWEAR, SHOE POLISH, SHOE POLISHERS, HEADGEAR, BELTS, KEY RINGS AND KEY HOLDERS, WALLETS, HANDBAGS, SPORT BAGS, ALL-PURPOSE BAGS AND CASES, TRUNKS, LUGGAGE ARTICLES, ORNAMENTS FOR PERSONAL USE, TIE PINS, BRACELETS, NECKLACES, FASHION ACCESSORIES, TIES, SCARVES, MUFFLERS, GLOVES, SOCKS, HOSIERY, LEGGINGS, UMBRELLAS; SALES PROMOTIONAL AND MARKETING SERVICES; IMPORT AND EXPORT AGENCY SERVICES; AND PROVISION OF BUSINESS INFORMATION (U.S. CLS. 100, 101 AND 102).

HAI-LY LAM, EXAMINING ATTORNEY

SN 77-830,110. JOHN MILLS LIMITED, LONDON NW5 3EG, UNITED KINGDOM, FILED 9-18-2009.

HALOWAVE

THE MARK CONSISTS OF STANDARD CHARACTERS WITHOUT CLAIM TO ANY PARTICULAR FONT, STYLE, SIZE, OR COLOR.

PRIORITY CLAIMED UNDER SEC. 44(D) ON UNITED KINGDOM APPLICATION NO. 2522189, FILED 7-28-2009, REG. NO. 2522189, DATED 11-6-2009, EXPIRES 7-28-2019.

CLASS 11—ENVIRONMENTAL CONTROL APPARATUS

FOR ELECTRIC APPARATUS FOR COOKING, NAMELY, OVENS AND ROASTERS, AND PARTS AND FITTINGS FOR THE AFOREMENTIONED GOODS (U.S. CLS. 13, 21, 23, 31 AND 34).

CLASS 16—PAPER GOODS AND PRINTED MATTER

FOR PRINTED MATTER, NAMELY, BOOKS, MAGAZINES, AND LEAFLETS FEATURING FOOD PREPARATION; PRINTED RECIPE CARDS (U.S. CLS. 2, 5, 22, 23, 29, 37, 38 AND 50).

WILLIAM P. SHANAHAN, EXAMINING ATTORNEY

SN 77-830,131. SONOSITE, INC., BOTHELL, WA. FILED 9-18-2009.

SONOSITE

THE MARK CONSISTS OF STANDARD CHARACTERS WITHOUT CLAIM TO ANY PARTICULAR FONT, STYLE, SIZE, OR COLOR.

OWNER OF U.S. REG. NOS. 2,414,562 AND 2,955,570.

CLASS 9—ELECTRICAL AND SCIENTIFIC APPARATUS

FOR COMPUTER HARDWARE; COMPUTER PERIPHERALS; COMPUTER SOFTWARE IN THE NATURE OF A CONTROL SYSTEM FOR THE MANAGEMENT AND OPERATION OF MEDICAL ULTRASOUND EQUIPMENT; COMPUTER SOFTWARE USED FOR MEDICAL DIAGNOSIS SOLD AS A COMPONENT OF MEDICAL ULTRASOUND APPARATUS; COMPUTER SOFTWARE USED TO ENHANCE ULTRASOUND IMAGES; COMPUTER SOFTWARE FOR USE IN OPERATING, ANALYZING RESULTS AND GENERATING PRINTED REPORTS FROM A MEDICAL ULTRASOUND DEVICE; COMPUTER SOFTWARE FOR USE IN MEDICAL SCREENING AND DIAGNOSTICS; SOFTWARE FOR WIRELESS CONTENT DELIVERY; COMPUTER APPLICATION SOFTWARE FOR MOBILE PHONES; SOFTWARE, NAMELY, MOBILE PHONE AND PDA APPLICATIONS AND DOWNLOADABLE APPLICATIONS FOR CREATING, DISPLAYING, ACCESSING, AND USING ARTICLES, TUTORIALS, NEWS, NEWSLETTERS, JOURNALS, MAGAZINES, GUIDES, PAMPHLETS, BROCHURES, PRODUCT INFORMATION, REVIEWS, ADVICE, AUDIO CONTENT, AND VIDEOS; EDUCATIONAL SOFTWARE FEATURING INSTRUCTION IN THE FIELDS OF MEDICINE, MEDICAL IMAGING, AND HEALTH CARE; DOWNLOADABLE AUDIO, VIDEO, MULTIMEDIA, AND TEXT FILES FEATURING ARTICLES, TUTORIALS, NEWS, NEWSLETTERS, JOURNALS, MAGAZINES, GUIDES, PAMPHLETS, BROCHURES, PRODUCT INFORMATION, REVIEWS, ADVICE, AUDIO CONTENT, AND VIDEOS, ON THE SUBJECTS OF MEDICINE, MEDICAL IMAGING, HEALTH CARE, AND A WIDE RANGE OF TOPICS OF GENERAL INTEREST; CHARGER FOR BATTERIES (U.S. CLS. 21, 23, 26, 36 AND 38).

CLASS 42—SCIENTIFIC AND COMPUTER SERVICES

FOR PROVIDING ONLINE, NON-DOWNLOADABLE SOFTWARE, NAMELY, MOBILE PHONE AND PDA APPLICATIONS FOR CREATING, DISPLAYING, ACCESSING, AND USING ARTICLES, TUTORIALS, NEWS, NEWSLETTERS, JOURNALS, MAGAZINES, GUIDES, PAMPHLETS, BROCHURES, PRODUCT INFORMATION, REVIEWS, ADVICE, AUDIO CONTENT, AND VIDEOS (U.S. CLS. 100 AND 101).

REBECCA EISINGER, EXAMINING ATTORNEY

SN 77-830,742. TODD SMITH INTERNATIONAL, LLLP, SARASOTA, FL. FILED 9-21-2009.

LITTLE THINGS MATTER

THE MARK CONSISTS OF STANDARD CHARACTERS WITHOUT CLAIM TO ANY PARTICULAR FONT, STYLE, SIZE, OR COLOR.

CLASS 9—ELECTRICAL AND SCIENTIFIC APPARATUS

FOR AUDIO AND VIDEO RECORDINGS AND DOWNLOADABLE PODCASTS IN THE FIELD OF PERSONAL AND PROFESSIONAL SUCCESS (U.S. CLS. 21, 23, 26, 36 AND 38).

CLASS 16—PAPER GOODS AND PRINTED MATTER

FOR EDUCATIONAL PUBLICATIONS, NAMELY, A SERIES OF BOOKS, ARTICLES AND MANUALS IN THE FIELD OF PERSONAL AND PROFESSIONAL SUCCESS (U.S. CLS. 2, 5, 22, 23, 29, 37, 38 AND 50).

CLASS 41—EDUCATION AND ENTERTAINMENT

FOR PROVIDING A WEBSITE FEATURING PERSONAL AND PROFESSIONAL COACHING IN THE FIELD OF PERSONAL AND PROFESSIONAL SUCCESS (U.S. CLS. 100, 101 AND 107).

ROBERT C. CLARK JR., EXAMINING ATTORNEY

SN 77-831,146. 15TH STREET DISTRIBUTORS, INC., DEERFIELD BEACH, FL. FILED 9-21-2009.



THE MARK CONSISTS OF THE STYLIZED WORD "WAP" IN LARGE FONT AND THE WORDING "WE ARE PLASTIC" UNDERNEATH IN SMALLER STYLIZED FONT.

CLASS 9—ELECTRICAL AND SCIENTIFIC APPARATUS

FOR EYEWEAR AND SUNGLASSES (U.S. CLS. 21, 23, 26, 36 AND 38).

CLASS 35—ADVERTISING AND BUSINESS

FOR RETAIL STORE SERVICES FEATURING EYEWEAR AND SUNGLASSES (U.S. CLS. 100, 101 AND 102).
TIMOTHY FINNEGAN, EXAMINING ATTORNEY

SN 77-832,881. CINERGY HEALTH, INC., AVENTURA, FL. FILED 9-23-2009.

CINERGY HEALTH

THE MARK CONSISTS OF STANDARD CHARACTERS WITHOUT CLAIM TO ANY PARTICULAR FONT, STYLE, SIZE, OR COLOR.

OWNER OF U.S. REG. NO. 3,228,996.

NO CLAIM IS MADE TO THE EXCLUSIVE RIGHT TO USE "HEALTH", APART FROM THE MARK AS SHOWN.

CLASS 35—ADVERTISING AND BUSINESS

FOR ADMINISTRATION OF A DISCOUNT PROGRAM FOR ENABLING PARTICIPANTS TO OBTAIN DISCOUNTS ON MEDICAL GOODS AND SERVICES THROUGH USE OF A DISCOUNT MEMBERSHIP CARD (U.S. CLS. 100, 101 AND 102).

FIRST USE 7-24-2006; IN COMMERCE 12-3-2007.

CLASS 36—INSURANCE AND FINANCIAL

FOR INSURANCE AGENCY SERVICES (U.S. CLS. 100, 101 AND 102).

FIRST USE 7-24-2006; IN COMMERCE 12-3-2007.

NELSON SNYDER, EXAMINING ATTORNEY

SN 77-833,266. NSE, INC., ALPHARETTA, GA. FILED 9-23-2009.

eSENSE

THE MARK CONSISTS OF STANDARD CHARACTERS WITHOUT CLAIM TO ANY PARTICULAR FONT, STYLE, SIZE, OR COLOR.

OWNER OF U.S. REG. NOS. 1,987,057, 2,524,380 AND 2,524,381.

CLASS 9—ELECTRICAL AND SCIENTIFIC APPARATUS

FOR DOWNLOADABLE SOFTWARE TO ENHANCE AND SIMPLIFY THE MANAGEMENT, DATA INTEGRATION AND APPLICATION DASHBOARD CAPABILITIES OF COLLABORATION TECHNOLOGIES (U.S. CLS. 21, 23, 26, 36 AND 38).

FIRST USE 3-1-2001; IN COMMERCE 3-1-2001.

CLASS 42—SCIENTIFIC AND COMPUTER SERVICES

FOR COMPUTER SERVICES, NAMELY, DESIGN AND DEVELOPMENT OF SOFTWARE TO ENHANCE AND SIMPLIFY THE MANAGEMENT, DATA INTEGRATION AND APPLICATION DASHBOARD CAPABILITIES OF COLLABORATION TECHNOLOGIES; SOFTWARE AS A SERVICE (SAAS) SERVICES, NAMELY, HOSTING SOFTWARE FOR USE BY OTHERS FOR USE IN THE MANAGEMENT, DATA INTEGRATION AND APPLICATION DASHBOARD CAPABILITIES OF COLLABORATION TECHNOLOGIES (U.S. CLS. 100 AND 101).

FIRST USE 3-1-2000; IN COMMERCE 3-1-2000.

JUSTINE D. PARKER, EXAMINING ATTORNEY

SN 77-833,749. SUAREZ CORPORATION INDUSTRIES, N. CANTON, OH. FILED 9-24-2009.

EMPOWERED CITIZENS NEWS NETWORK

THE MARK CONSISTS OF STANDARD CHARACTERS WITHOUT CLAIM TO ANY PARTICULAR FONT, STYLE, SIZE, OR COLOR.

NO CLAIM IS MADE TO THE EXCLUSIVE RIGHT TO USE "NEWS NETWORK", APART FROM THE MARK AS SHOWN.

CLASS 16—PAPER GOODS AND PRINTED MATTER

FOR BOOKLETS IN THE FIELD OF NEWS, HEALTH, FITNESS, SPORTS AND CELEBRITIES; BROCHURES ABOUT NEWS, HEALTH, FITNESS, SPORTS AND CELEBRITIES; MAGAZINES IN THE FIELD OF NEWS, HEALTH, FITNESS, SPORTS AND CELEBRITIES; NEWSLETTERS IN THE FIELD OF NEWS, HEALTH, FITNESS, SPORTS AND CELEBRITIES; PAMPHLETS IN THE FIELD OF NEWS, HEALTH, FITNESS, SPORTS AND CELEBRITIES; PUBLICATIONS, NAMELY, BOOKS IN THE FIELDS OF NEWS, HEALTH, FITNESS, SPORTS AND CELEBRITIES (U.S. CLS. 2, 5, 22, 23, 29, 37, 38 AND 50).

SN 77-834,259. AKITA, INC., WILMINGTON, DE. FILED 9-24-2009.

TRAVEL GUARD

THE MARK CONSISTS OF STANDARD CHARACTERS WITHOUT CLAIM TO ANY PARTICULAR FONT, STYLE, SIZE, OR COLOR.

OWNER OF U.S. REG. NO. 1,280,126.

NO CLAIM IS MADE TO THE EXCLUSIVE RIGHT TO USE "TRAVEL", APART FROM THE MARK AS SHOWN.

CLASS 35—ADVERTISING AND BUSINESS

FOR PRODUCTION AND DISTRIBUTION OF RADIO AND TELEVISION COMMERCIALS; PRODUCTION OF TELEVISION COMMERCIALS (U.S. CLS. 100, 101 AND 102).

CLASS 35—ADVERTISING AND BUSINESS

FOR TRAVEL MANAGEMENT (U.S. CLS. 100, 101 AND 102).

FIRST USE 7-0-1998; IN COMMERCE 7-0-1998.

CLASS 38—COMMUNICATION

FOR BROADCASTING OF TELEVISION PROGRAMMES; BROADCASTING PROGRAMS VIA A GLOBAL COMPUTER NETWORK; COMPUTER SERVICES, NAMELY, PROVIDING ON-LINE FACILITIES FOR REAL-TIME INTERACTION WITH OTHER COMPUTER USERS CONCERNING TOPICS OF GENERAL INTEREST; COMPUTER-AIDED TRANSMISSION OF MESSAGES; PROVIDING INTERNET CHATROOMS; PROVIDING ON-LINE CHAT ROOMS FOR TRANSMISSION OF MESSAGES AMONG COMPUTER USERS CONCERNING NEWS, HEALTH, FITNESS, SPORTS, CELEBRITIES AND GENERAL INTEREST; PROVIDING ON-LINE ELECTRONIC BULLETIN BOARDS FOR TRANSMISSION OF MESSAGES AMONG COMPUTER USERS CONCERNING NEWS, HEALTH, FITNESS, SPORTS, CELEBRITIES AND GENERAL INTEREST; PROVIDING ON-LINE FORUMS FOR TRANSMISSION OF MESSAGES AMONG COMPUTER USERS CONCERNING NEWS, HEALTH, FITNESS, SPORTS, CELEBRITIES AND GENERAL INTEREST; VIDEO TELEPHONE SERVICES; VIRTUAL CHATROOMS ESTABLISHED VIA TEXT MESSAGING; VOICE CHAT SERVICES; WEB CONFERENCING SERVICES (U.S. CLS. 100, 101 AND 104).

CLASS 39—TRANSPORTATION AND STORAGE

FOR TRAVEL ASSISTANCE SERVICES, NAMELY, ARRANGING FOR EMERGENCY MEDICAL TRANSPORTATION, TRAVEL INFORMATION, TRAVEL BOOKINGS, AND ARRANGING FOR REPLACEMENT OF LOST TICKETS AND TRAVEL DOCUMENTS (U.S. CLS. 100 AND 105).

FIRST USE 7-0-1998; IN COMMERCE 7-0-1998.

NAKIA HENRY, EXAMINING ATTORNEY

SN 77-834,791. O'BRYAN'S NINE IRISH BROTHERS, LLC, WEST LAFAYETTE, IN. FILED 9-25-2009.

**CLASS 41—EDUCATION AND ENTERTAINMENT**

FOR EDUCATIONAL AND ENTERTAINMENT SERVICES, NAMELY, A CONTINUING PROGRAM ABOUT NEWS, HEALTH, FITNESS, SPORTS, AND CELEBRITIES ACCESSIBLE BY RADIO, TELEVISION, SATELLITE, AUDIO, VIDEO AND COMPUTER NETWORKS; ENTERTAINMENT, NAMELY, A CONTINUING NEWS AND COMMENTARY SHOW BROADCAST OVER TELEVISION, SATELLITE, AUDIO, AND VIDEO MEDIA; ENTERTAINMENT, NAMELY, TELEVISION NEWS SHOWS; NEWS AGENCIES, NAMELY, GATHERING AND DISSEMINATION OF NEWS; NEWS REPORTER SERVICES IN THE NATURE OF NEWS ANALYSIS AND NEWS COMMENTARY; NEWS REPORTERS SERVICES; PROVIDING CURRENT EVENT NEWS AND INFORMATION VIA A GLOBAL COMPUTER NETWORK; TELEVISION SHOW PRODUCTION (U.S. CLS. 100, 101 AND 107).

CHARLOTTE CORWIN, EXAMINING ATTORNEY

THE COLOR(S) GOLD AND GREEN IS/ARE CLAIMED AS A FEATURE OF THE MARK.

THE MARK CONSISTS OF THE NUMERAL "9" IN GOLD ENCLOSED A SHAMROCK IN THE COLOR GREEN.

CLASS 21—HOUSEWARES AND GLASS

FOR BEVERAGE GLASSWARE (U.S. CLS. 2, 13, 23, 29, 30, 33, 40 AND 50).

CLASS 43—HOTEL AND RESTAURANT SERVICES

FOR RESTAURANT AND BAR SERVICES (U.S. CLS. 100 AND 101).

GINA HAYES, EXAMINING ATTORNEY

SN 77-835,040. CERES TERMINALS INCORPORATED, EAST BRUNSWICK, NJ. FILED 9-25-2009.

CERES

THE MARK CONSISTS OF STANDARD CHARACTERS WITHOUT CLAIM TO ANY PARTICULAR FONT, STYLE, SIZE, OR COLOR.

CLASS 35—ADVERTISING AND BUSINESS

FOR CONTAINER TERMINAL MANAGEMENT SERVICES FOR OTHERS (U.S. CLS. 100, 101 AND 102).
FIRST USE 0-0-2007; IN COMMERCE 0-0-2007.

CLASS 37—CONSTRUCTION AND REPAIR

FOR CLEANING CARGO AND SHIPPING CONTAINERS (U.S. CLS. 100, 103 AND 106).
FIRST USE 0-0-1995; IN COMMERCE 0-0-1995.

CLASS 39—TRANSPORTATION AND STORAGE

FOR STEVEDORING SERVICES; CARGO HANDLING, LOADING AND UNLOADING; STORING, STUFFING AND STRIPPING CARGO AND SHIPPING CONTAINERS; PROVIDING INFORMATION CONCERNING COLLECTION AND DELIVERY OF CARGO AND SHIPPING CONTAINERS IN TRANSIT; TERMINAL DRAYAGE SERVICES; CRUISE SHIP SERVICES, NAMELY, PASSENGER PROCESSING, BAGGAGE HANDLING AND GROUND TRANSPORT COORDINATION (U.S. CLS. 100 AND 105).

FIRST USE 0-0-1959; IN COMMERCE 0-0-1959.
KARANENDRA S. CHHINA, EXAMINING ATTORNEY

SN 77-835,190. CERES TERMINALS INCORPORATED, EAST BRUNSWICK, NJ. FILED 9-25-2009.



THE MARK CONSISTS OF THE WORD "CERES" TO THE RIGHT OF A SERIES OF HORIZONTAL LINES OF VARYING WIDTH.

CLASS 35—ADVERTISING AND BUSINESS

FOR CONTAINER TERMINAL MANAGEMENT SERVICES FOR OTHERS (U.S. CLS. 100, 101 AND 102).
FIRST USE 0-0-2007; IN COMMERCE 0-0-2007.

CLASS 37—CONSTRUCTION AND REPAIR

FOR CLEANING CARGO AND SHIPPING CONTAINERS (U.S. CLS. 100, 103 AND 106).
FIRST USE 0-0-1998; IN COMMERCE 0-0-1998.

CLASS 39—TRANSPORTATION AND STORAGE

FOR STEVEDORING SERVICES; CARGO HANDLING, LOADING AND UNLOADING; STORING, STUFFING AND STRIPPING CARGO AND SHIPPING CONTAINERS; PROVIDING INFORMATION CONCERNING COLLECTION AND DELIVERY OF CARGO AND SHIPPING CONTAINERS IN TRANSIT; TERMINAL DRAYAGE SERVICES; CRUISE SHIP SERVICES, NAMELY, PASSENGER PROCESSING, BAGGAGE HANDLING AND GROUND TRANSPORT COORDINATION (U.S. CLS. 100 AND 105).

FIRST USE 0-0-1998; IN COMMERCE 0-0-1998.
KARANENDRA S. CHHINA, EXAMINING ATTORNEY

SN 77-836,386. HUDSON STREET MEDIA LLC, NEW YORK, NY. FILED 9-28-2009.

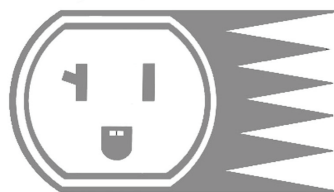

THE MARK CONSISTS OF A STYLIZED HEAD WITH A SIX-POINT CROWN-SHAPE EXTENDING FROM ITS RIGHT SIDE SUGGESTING THAT THE HEAD IS MOVING FROM RIGHT TO LEFT. THE STYLIZED HEAD ALSO RESEMBLES AN ELECTRIC PLUG.

CLASS 9—ELECTRICAL AND SCIENTIFIC APPARATUS

FOR COMPUTER SOFTWARE FOR GRAPHICAL APPLICATIONS, NAMELY, FOR THE DELIVERY, AND VIEWING OF DIGITAL MEDIA, NAMELY, VIDEO, SOUND, ANIMATION, GRAPHICS, TEXT, AND MUSIC (U.S. CLS. 21, 23, 26, 36 AND 38).

CLASS 35—ADVERTISING AND BUSINESS

FOR ADVERTISING SERVICES (U.S. CLS. 100, 101 AND 102).

CLASS 38—COMMUNICATION

FOR COMMUNICATION SERVICES, NAMELY, TRANSMISSION OF DIGITIZED AUDIO AND VIDEO SIGNALS OVER WIRED AND WIRELESS NETWORKS; PROVIDING ELECTRONIC TRANSMISSION OF CREDIT CARD TRANSACTION DATA AND ELECTRONIC PAYMENT DATA VIA A GLOBAL COMPUTER NETWORK (U.S. CLS. 100, 101 AND 104).

NANCY CLARKE, EXAMINING ATTORNEY

SN 77-836,642. FOTO FANTASY, INC., SALEM, NH. FILED 9-28-2009.

BLABABOOTH

THE MARK CONSISTS OF STANDARD CHARACTERS WITHOUT CLAIM TO ANY PARTICULAR FONT, STYLE, SIZE, OR COLOR.

CLASS 9—ELECTRICAL AND SCIENTIFIC APPARATUS

FOR INTERACTIVE SELF-SERVICE PHOTO AND VIDEO KIOSKS FOR TAKING, EDITING, ELECTRONICALLY DISTRIBUTING AND PRINTING PHOTOGRAPHS (U.S. CLS. 21, 23, 26, 36 AND 38).

FIRST USE 6-5-2009; IN COMMERCE 6-5-2009.

CLASS 42—SCIENTIFIC AND COMPUTER SERVICES

FOR PROVIDING A WEBSITE THAT GIVES INTERNET USERS THE ABILITY TO UPLOAD, EXCHANGE, PUBLISH, TAG AND SHARE MULTIMEDIA CONTENT, IMAGES, PHOTOS, VIDEOS, AND USER-GENERATED CONTENT; PROVIDING A WEBSITE FEATURING TEMPORARY USE OF NON-DOWNLOADABLE SOFTWARE ALLOWING WEB SITE USERS TO UPLOAD MULTIMEDIA CONTENT, IMAGES, PHOTOS, VIDEOS, TEXT MESSAGES, AND USER-GENERATED CONTENT FOR SHARING WITH OTHERS FOR ENTERTAINMENT PURPOSES; PROVIDING A WEBSITE FEATURING TEMPORARY USE OF NON-DOWNLOADABLE SOFTWARE FOR SHARING MULTIMEDIA CONTENT, IMAGES, PHOTOS, VIDEOS, TEXT MESSAGES, AND USER-GENERATED CONTENT; COMPUTER SERVICES, NAMELY, INTERACTIVE HOSTING SERVICES WHICH ALLOW THE USER TO PUBLISH AND SHARE THEIR OWN MULTIMEDIA CONTENT, IMAGES, PHOTOS, VIDEOS, TEXT MESSAGES, AND USER-GENERATED CONTENT ON-LINE VIA COMPUTER AND COMMUNICATIONS NETWORKS; CREATING AND MAINTAINING BLOGS FOR OTHERS (U.S. CLS. 100 AND 101).

FIRST USE 6-5-2009; IN COMMERCE 6-5-2009.
GINA FINK, EXAMINING ATTORNEY

SN 77-836,733. LOSTINE CATTLE COMPANY, LLC, AKA LOSTINE CATTLE COMPANY, WALLA WALLA, WA. FILED S.R. 9-28-2009; AM. P.R. 3-23-2010.

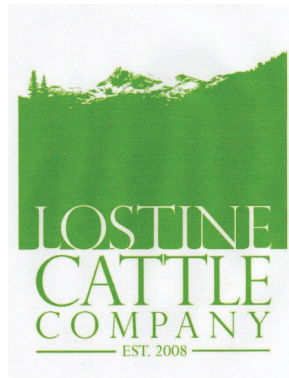

NO CLAIM IS MADE TO THE EXCLUSIVE RIGHT TO USE "CATTLE COMPANY EST. 2008", APART FROM THE MARK AS SHOWN.

THE COLOR(S) GREEN AND WHITE IS/ARE CLAIMED AS A FEATURE OF THE MARK.

THE MARK CONSISTS OF A PICTURE OF GREEN MOUNTAINS AND A MEADOW BELOW THE WORD "LOSTINE" IN WHITE AND "CATTLE COMPANY EST. 2008" IN GREEN BELOW THE MEADOW.

CLASS 18—LEATHER GOODS

FOR ANIMAL HIDES (U.S. CLS. 1, 2, 3, 22 AND 41).

CLASS 20—FURNITURE AND ARTICLES NOT OTHERWISE CLASSIFIED

FOR ANIMAL HORNS (U.S. CLS. 2, 13, 22, 25, 32 AND 50).

CLASS 29—MEATS AND PROCESSED FOODS

FOR BEEF; CHEESE; CHICKEN; DAIRY PRODUCTS EXCLUDING ICE CREAM, ICE MILK AND FROZEN YOGURT; DAIRY-BASED BEVERAGES; EGGS (U.S. CL. 46).

CLASS 31—NATURAL AGRICULTURAL PRODUCTS

FOR LIVE ANIMALS, NAMELY, CATTLE AND POULTRY; LIVESTOCK, NAMELY, CATTLE AND POULTRY (U.S. CLS. 1 AND 46).

KEVON CHISOLM, EXAMINING ATTORNEY

SN 77-836,858. NEW ENGLAND COGNITIVE CENTER, HARTFORD, CT. FILED 9-29-2009.

NEW ENGLAND COGNITIVE CENTER

THE MARK CONSISTS OF STANDARD CHARACTERS WITHOUT CLAIM TO ANY PARTICULAR FONT, STYLE, SIZE, OR COLOR.
SEC. 2(F).

CLASS 16—PAPER GOODS AND PRINTED MATTER

FOR EDUCATIONAL PUBLICATIONS, NAMELY, WORKBOOKS, ACTIVITY BOOKS AND PRINTED MATERIALS, TRAINING GUIDES, AND MANUALS IN THE FIELD OF COGNITIVE FITNESS (U.S. CLS. 2, 5, 22, 23, 29, 37, 38 AND 50).

FIRST USE 10-16-2001; IN COMMERCE 3-11-2002.

CLASS 41—EDUCATION AND ENTERTAINMENT

FOR EDUCATIONAL SERVICES, NAMELY, DEVELOPING AND CONDUCTING COGNITIVE FITNESS PROGRAMS (U.S. CLS. 100, 101 AND 107).

FIRST USE 10-16-2001; IN COMMERCE 3-11-2002.
JUSTINE D. PARKER, EXAMINING ATTORNEY

SN 77-837,202. PUBLISHING HOUSE OF THE EVANGELICAL LUTHERAN CHURCH IN AMERICA, MINNEAPOLIS, MN. FILED 9-29-2009.



OWNER OF U.S. REG. NOS. 3,197,620 AND 3,570,028.
THE MARK CONSISTS OF A LOGO HAVING FOUR GENERALLY RECTANGULAR SHAPES, THE OUTLINE OF WHICH FORMS A CROSS, THE LOGO BEING TO THE LEFT OF THE WORDS "AUGSBURG FORTRESS".

CLASS 9—ELECTRICAL AND SCIENTIFIC APPARATUS

FOR PRE-RECORDED CDS FEATURING MUSIC, PRE-RECORDED DVDS IN THE FIELD OF RELIGIOUS TOPICS, SPIRITUAL TOPICS, ETHICAL TOPICS AND EDUCATIONAL TOPICS FEATURING RELIGION, SPIRITUALITY AND ETHICS; DOWNLOADABLE ELECTRONIC PUBLICATIONS IN THE NATURE OF BOOKS FEATURING PRAYERS, HYMNS, LITURGY, AND MUSIC; DOWNLOADABLE ELECTRONIC PUBLICATIONS IN THE NATURE OF BIBLE STUDY BOOKS, WORKBOOKS, PAMPHLETS AND BOOKS IN FIELDS OF WORSHIP MATERIALS, RELIGIOUS TOPICS, SPIRITUAL TOPICS, ETHICAL TOPICS AND EDUCATIONAL TOPICS FEATURING RELIGION, SPIRITUALITY AND ETHICS (U.S. CLS. 21, 23, 26, 36 AND 38).

FIRST USE 1-0-2009; IN COMMERCE 1-0-2009.

CLASS 16—PAPER GOODS AND PRINTED MATTER

FOR PRINTED RELIGIOUS PUBLICATIONS, NAMELY, BOOKS FEATURING PRAYERS, HYMNS, LITURGY, AND MUSIC; PRINTED BIBLE STUDY BOOKS, WORKBOOKS AND PAMPHLETS CONTAINING WORSHIP MATERIALS; AND PRINTED BOOKS IN THE FIELD OF RELIGIOUS TOPICS, SPIRITUAL TOPICS, ETHICAL TOPICS AND EDUCATIONAL TOPICS FEATURING RELIGION, SPIRITUALITY AND ETHICS (U.S. CLS. 2, 5, 22, 23, 29, 37, 38 AND 50).

FIRST USE 11-0-2008; IN COMMERCE 11-0-2008.

CLASS 45—PERSONAL AND LEGAL SERVICES

FOR PROVIDING INFORMATION VIA THE INTERNET IN THE FIELDS OF RELIGION, SPIRITUALITY AND FAITH (U.S. CLS. 100 AND 101).

FIRST USE 1-0-2009; IN COMMERCE 1-0-2009.

PAULA MAHONEY, EXAMINING ATTORNEY

SN 77-838,385. BCC ENGINEERING, INC., MIAMI, FL. FILED 9-30-2009.



THE COLOR(S) BLACK IS/ARE CLAIMED AS A FEATURE OF THE MARK.

THE MARK CONSISTS OF FOUR CURVED LINES, EACH OF WHICH INTERSECTS TWO OTHER CURVED LINES NEAR THE MIDDLE OF EACH SUCH LINE SO AS TO RESEMBLE FOUR INTERSECTING CURVED HIGHWAYS.

CLASS 16—PAPER GOODS AND PRINTED MATTER

FOR PRESENTATION BOARDS; PRESENTATION FOLDERS (U.S. CLS. 2, 5, 22, 23, 29, 37, 38 AND 50).

FIRST USE 8-10-2009; IN COMMERCE 8-10-2009.

CLASS 25—CLOTHING

FOR WEARABLE GARMENTS AND CLOTHING, NAMELY, SHIRTS (U.S. CLS. 22 AND 39).

EDWARD FENNESSY, EXAMINING ATTORNEY

SN 77-838,770. CAREER PARTNERS INTERNATIONAL LLC, DBA POWERMYCAREER, CHAPEL HILL, NC. FILED 9-30-2009.

POWERMYCAREER

THE MARK CONSISTS OF STANDARD CHARACTERS WITHOUT CLAIM TO ANY PARTICULAR FONT, STYLE, SIZE, OR COLOR.

CLASS 35—ADVERTISING AND BUSINESS

FOR PROVIDING A JOB-READINESS, CAREER DEVELOPMENT AND PERSONAL BRANDING WEBSITE FEATURING CAREER INFORMATION AND INFORMATION IN THE FIELD OF RESUME PREPARATION; PROVIDING INFORMATION ON-LINE AND THROUGH DISTRIBUTION OF PRINTED MATERIALS IN THE FIELD OF CAREER INFORMATION AND RESUME PREPARATION FOR MANAGERS, PROFESSIONALS, EXECUTIVES, AND THOSE NEW TO THE WORK FORCE (U.S. CLS. 100, 101 AND 102).

FIRST USE 8-1-2009; IN COMMERCE 8-1-2009.

CLASS 41—EDUCATION AND ENTERTAINMENT

FOR PROVIDING A JOB-READINESS, CAREER DEVELOPMENT AND PERSONAL BRANDING WEBSITE FEATURING INFORMATION AND CONSULTATION IN THE FIELD OF CAREER COUNSELING; PROVIDING ON-LINE TRAINING COURSES AND PERSONAL AND PROFESSIONAL COACHING IN THE FIELD OF CAREER DEVELOPMENT (U.S. CLS. 100, 101 AND 107).

FIRST USE 8-1-2009; IN COMMERCE 8-1-2009.

CIMMERIAN COLEMAN, EXAMINING ATTORNEY

SN 77-839,255. APPALACHIAN SCHOOL OF LAW, GRUNDY, VA. FILED 10-1-2009.

Appalachian School of Law

THE MARK CONSISTS OF STANDARD CHARACTERS WITHOUT CLAIM TO ANY PARTICULAR FONT, STYLE, SIZE, OR COLOR.

OWNER OF U.S. REG. NO. 2,255,056.

NO CLAIM IS MADE TO THE EXCLUSIVE RIGHT TO USE "SCHOOL OF LAW", APART FROM THE MARK AS SHOWN.

SEC. 2(F) AS TO "APPALACHIAN".

CLASS 25—CLOTHING

FOR WEARABLE GARMENTS AND CLOTHING, NAMELY, SHIRTS (U.S. CLS. 22 AND 39).

FIRST USE 9-1-1996; IN COMMERCE 9-1-1996.

CLASS 41—EDUCATION AND ENTERTAINMENT

FOR EDUCATIONAL SERVICES, NAMELY, PROVIDING LEGAL EDUCATION AND COURSES OF INSTRUCTION IN THE FIELDS OF LAW AND LEGAL STUDIES (U.S. CLS. 100, 101 AND 107).

FIRST USE 9-1-1996; IN COMMERCE 9-1-1996.
INGA ERVIN, EXAMINING ATTORNEY

SN 77-840,078. COALTEC ENERGY USA INC., CARTERVILLE, IL. FILED 10-2-2009.

CHARgreen

THE COLOR(S) GREEN, BLACK, AND WHITE IS/ARE CLAIMED AS A FEATURE OF THE MARK.

THE MARK CONSISTS OF THE WORD "CHAR" WHICH IS FORMED OF SOLID BLACK LETTERS AND THE WORD "GREEN" WHICH IS FORMED OF LETTERS THAT ARE GREEN, WITH A WHITE OUTLINE AROUND THE BODY OF EACH GREEN LETTER, WHICH IS THEN SURROUNDED BY A GREEN OUTLINE AROUND EACH OF THE GREEN LETTERS THAT ARE OUTLINED IN WHITE.

CLASS 5—PHARMACEUTICALS

FOR ANIMAL FEED SUPPLEMENTS; DIETARY SUPPLEMENTS FOR ANIMALS; FEED SUPPLEMENTS FOR LIVESTOCK, PETS, BIRDS, OTHER ANIMALS (U.S. CLS. 6, 18, 44, 46, 51 AND 52).

CLASS 31—NATURAL AGRICULTURAL PRODUCTS

FOR ANIMAL LITTER; CAT LITTER AND LITTER FOR SMALL ANIMALS; NUTRITIONAL ADDITIVES FOR ANIMAL FOODSTUFFS, NOT FOR MEDICAL PURPOSES (U.S. CLS. 1 AND 46).

JASON TURNER, EXAMINING ATTORNEY

SN 77-842,046. RYUZO YAMAMOTO, SAKAI-SHI, OSAKA, JAPAN, FILED 10-6-2009.

KYK

THE MARK CONSISTS OF STANDARD CHARACTERS WITHOUT CLAIM TO ANY PARTICULAR FONT, STYLE, SIZE, OR COLOR.

THE WORDING "KYK" HAS NO MEANING IN A FOREIGN LANGUAGE.

CLASS 7—MACHINERY

FOR MACHINE PARTS, NAMELY, BEARINGS (U.S. CLS. 13, 19, 21, 23, 31, 34 AND 35).

FIRST USE 3-0-1952; IN COMMERCE 1-0-1974.

CLASS 12—VEHICLES

FOR BEARINGS FOR LAND VEHICLES (U.S. CLS. 19, 21, 23, 31, 35 AND 44).

FIRST USE 3-0-1952; IN COMMERCE 1-0-1974.
CAROLINE WOOD, EXAMINING ATTORNEY

SN 77-843,064. ELECTRO-OPTICAL SCIENCES, INC., IRVINGTON, NY. FILED 10-7-2009.

MELA SCIENCES

THE MARK CONSISTS OF STANDARD CHARACTERS WITHOUT CLAIM TO ANY PARTICULAR FONT, STYLE, SIZE, OR COLOR.

OWNER OF U.S. REG. NOS. 2,713,699 AND 3,659,168.

NO CLAIM IS MADE TO THE EXCLUSIVE RIGHT TO USE "SCIENCES", APART FROM THE MARK AS SHOWN.

CLASS 10—MEDICAL APPARATUS

FOR MEDICAL DEVICES, NAMELY, ELECTRO-OPTICAL DEVICES INCORPORATING BOTH HARDWARE AND SOFTWARE FOR OBTAINING IMAGES IN DIFFERENT SPECTRAL BANDS AND SOFTWARE FOR ANALYZING THE IMAGES FOR USE IN ANALYZING SKIN LESIONS AND DETERMINING THE EXISTENCE OF MELANOMA; INSTRUMENTATION COMPRISING COMPUTER-ASSISTED OPTICAL IMAGES AND IMAGE ANALYZERS FOR USE IN THE DETECTION OF CUTANEOUS MELANOMA AND OTHER PATHOLOGY OF SKIN AND TISSUES (U.S. CLS. 26, 39 AND 44).

CLASS 44—MEDICAL, BEAUTY AND AGRICULTURAL SERVICES

FOR MEDICAL SERVICES, NAMELY, DIAGNOSIS OF CUTANEOUS MELANOMA AND OTHER PATHOLOGY OF SKIN AND TISSUES (U.S. CLS. 100 AND 101).

MEGHAN REINHART, EXAMINING ATTORNEY

SN 77-843,356. COMPONENT HARDWARE GROUP, INC., LAKEWOOD, NJ. FILED 10-7-2009.

 **Flame Gard**

OWNER OF U.S. REG. NO. 3,539,930.

THE COLOR(S) RED, WHITE AND BLACK IS/ARE CLAIMED AS A FEATURE OF THE MARK.

THE MARK CONSISTS OF THE WORDS "FLAME GARD" WITH THE RED FLAME DESIGN SURROUNDING THE LETTER "F". THE LETTER "F" IS WHITE AND THE REMAINING LETTERS ARE IN BLACK. THE COLORS WHITE AND BLACK IN THE WORDS "FLAME GARD" ARE INTENDED AS BACKGROUND, OUTLINING, SHADING AND/OR TRANSPARENT AREAS AND ARE NOT PART OF THE MARK.

CLASS 6—METAL GOODS

FOR METAL ACCESS PANELS AND METAL ACCESS DOORS FOR DUCTS, NAMELY, GREASE DUCTS, COOKING HOOD DUCTS, HEATING DUCTS AND VENTILATING DUCTS (U.S. CLS. 2, 12, 13, 14, 23, 25 AND 50).

FIRST USE 12-31-1969; IN COMMERCE 12-31-1969.

CLASS 11—ENVIRONMENTAL CONTROL APPARATUS

FOR GREASE FILTERS FOR USE ON AND IN GREASE DUCTS, VENTILATING DUCTS AND VENT HOODS AT COOKING LOCATIONS; GREASE FILTERS FOR FILTERING GREASE FROM VENTILATING DUCT GASES; AND BAFFLES FOR INFLUENCING THE DIRECTION AND VELOCITY OF GASES CONDUCTED BY GREASE AND VENTILATING DUCTS (U.S. CLS. 13, 21, 23, 31 AND 34).

FIRST USE 12-31-1969; IN COMMERCE 12-31-1969.
ERNEST SHOSHO, EXAMINING ATTORNEY

SN 77-844,698. CITY-WIDE TAX ASSISTANCE PROGRAM, CHICAGO, IL. FILED 10-8-2009.

LADDER UP FINANCIAL LIBERATION

THE MARK CONSISTS OF STANDARD CHARACTERS WITHOUT CLAIM TO ANY PARTICULAR FONT, STYLE, SIZE, OR COLOR.

CLASS 35—ADVERTISING AND BUSINESS

FOR CHARITABLE SERVICES, NAMELY, ORGANIZING AND CONDUCTING VOLUNTEER PROGRAMS FOR PROVISION OF SERVICES TO INDIVIDUALS IN NEED OF ADVICE ON TAX PREPARATION AND FILING, PROCUREMENT OF FINANCIAL AID FOR EDUCATION, ON MANAGEMENT OF PERSONAL FINANCES AND ON PROCURING AND USING BANKING SERVICES; CHARITABLE SERVICES FOR INDIVIDUALS IN NEED, NAMELY, PROVIDING ADVICE ON TAX PREPARATION AND FILING (U.S. CLS. 100, 101 AND 102).

FIRST USE 12-0-2008; IN COMMERCE 12-0-2008.

CLASS 36—INSURANCE AND FINANCIAL

FOR CHARITABLE SERVICES FOR INDIVIDUALS IN NEED, NAMELY, PROVIDING ADVICE REGARDING PROCUREMENT OF FINANCIAL AID FOR EDUCATION, MANAGEMENT OF PERSONAL FINANCES, AND PROCURING AND USING BANKING SERVICES (U.S. CLS. 100, 101 AND 102).

FIRST USE 12-0-2008; IN COMMERCE 12-0-2008.
KIMBERLY FRYE, EXAMINING ATTORNEY

SN 77-845,321. JOSEPH MELNICK, WESTBROOK, ME.
FILED 10-9-2009.

JOSEPH MELNICK, PHD

THE MARK CONSISTS OF STANDARD CHARACTERS WITHOUT CLAIM TO ANY PARTICULAR FONT, STYLE, SIZE, OR COLOR.

NO CLAIM IS MADE TO THE EXCLUSIVE RIGHT TO USE "PHD", APART FROM THE MARK AS SHOWN.
THE NAME "JOSEPH MELNICK" IDENTIFIES A LIVING INDIVIDUAL WHOSE CONSENT IS OF RECORD.

CLASS 9—ELECTRICAL AND SCIENTIFIC APPARATUS

FOR PRERECORDED CDS AND DVDS FEATURING INFORMATION ON MARRIAGE AND RELATIONSHIPS (U.S. CLS. 21, 23, 26, 36 AND 38).

CLASS 41—EDUCATION AND ENTERTAINMENT

FOR CONDUCTING TRAINING IN THE FIELD OF MARITAL AND RELATIONSHIP COUNSELING (U.S. CLS. 100, 101 AND 107).

CLASS 45—PERSONAL AND LEGAL SERVICES

FOR MARITAL AND RELATIONSHIP COUNSELING; PROVIDING INFORMATION OVER A GLOBAL COMPUTER NETWORK IN THE FIELD OF MARRIAGE AND RELATIONSHIPS (U.S. CLS. 100 AND 101).

H. M. FISHER, EXAMINING ATTORNEY

SN 77-847,711. DURO TEXTILES, LLC, FALL RIVER, MA.
FILED 10-13-2009.

DUROSURANCE II

THE MARK CONSISTS OF STANDARD CHARACTERS WITHOUT CLAIM TO ANY PARTICULAR FONT, STYLE, SIZE, OR COLOR.

CLASS 9—ELECTRICAL AND SCIENTIFIC APPARATUS

FOR PROTECTIVE GARMENTS (U.S. CLS. 21, 23, 26, 36 AND 38).

CLASS 24—FABRICS

FOR TEXTILE FABRICS FOR THE MANUFACTURE OF CLOTHING AND TEXTILE MILITARY PRODUCTS IN THE NATURE OF CLOTHING, BACKPACKS, BAGS, CASES AND COVERS (U.S. CLS. 42 AND 50).

JOHN WILKE, EXAMINING ATTORNEY

SN 77-847,723. ALLIED BUILDING PRODUCTS CORPORATION, EAST RUTHERFORD, NJ. FILED 10-13-2009.

ONE SOURCE ONE SOLUTION

THE MARK CONSISTS OF STANDARD CHARACTERS WITHOUT CLAIM TO ANY PARTICULAR FONT, STYLE, SIZE, OR COLOR.
OWNER OF U.S. REG. NO. 3,528,374.

CLASS 35—ADVERTISING AND BUSINESS

FOR BUSINESS SERVICES, NAMELY, SCREENING, CREDENTIALING, AND ORGANIZING THIRD-PARTY VENDORS, SUPPLIERS, AND HOME REMODELING CONTRACTORS ON BEHALF OF OTHERS; REFERRALS FOR GENERAL BUILDING AND HOME REMODELING CONTRACTORS (U.S. CLS. 100, 101 AND 102).

CLASS 36—INSURANCE AND FINANCIAL

FOR FACILITATING AND ARRANGING FOR THE FINANCING OF HOME REMODELING (U.S. CLS. 100, 101 AND 102).

CLASS 37—CONSTRUCTION AND REPAIR

FOR INSTALLATION, REPAIR AND RENOVATION SERVICES FOR FLOORING, ROOFING AND HOME IMPROVEMENTS, CONSULTING SERVICES REGARDING HOME RENOVATION AND REPAIRS (U.S. CLS. 100, 103 AND 106).
JAY FLOWERS, EXAMINING ATTORNEY

SN 77-848,771. ASPEN HOLDINGS, INC., OMAHA, NV. FILED 10-14-2009.

EPI

THE MARK CONSISTS OF STANDARD CHARACTERS WITHOUT CLAIM TO ANY PARTICULAR FONT, STYLE, SIZE, OR COLOR.

CLASS 35—ADVERTISING AND BUSINESS

FOR ADMINISTRATION AND MANAGEMENT OF BUSINESS PAYROLL FOR OTHERS, PROVIDING ON-LINE PAYROLL PREPARATION, PROCESSING AND REPORTING SERVICES, PROVIDING HUMAN RESOURCES AND PAYROLL AND BENEFITS DATA AND REPORTS TO EMPLOYEES AND EMPLOYERS, NAMELY EMPLOYEE TIME AND ATTENDANCE INFORMATION, EMPLOYEE PROFILE, PAYROLL DEDUCTIONS, PAYROLL HISTORY, PROVIDING HUMAN RESOURCES CONSULTING, PROVIDING HUMAN RESOURCES INFORMATION IN THE NATURE OF EMPLOYEE HANDBOOKS, HUMAN RESOURCES FORMS, LETTERS, POLICIES AND JOB DESCRIPTIONS, PROCESSING PAYROLL TAX FILINGS, BUSINESS CONSULTING AND INFORMATION SERVICES (U.S. CLS. 100, 101 AND 102).
FIRST USE 5-13-2009; IN COMMERCE 5-13-2009.

CLASS 42—SCIENTIFIC AND COMPUTER SERVICES

FOR APPLICATION SERVICE PROVIDER (ASP) FEATURING SOFTWARE FOR PROCESSING PAYROLL, PAYROLL ADMINISTRATION, PROCESSING PAYROLL TAX FILINGS, PAYROLL AND HUMAN RESOURCES REPORTS (U.S. CLS. 100 AND 101).

FIRST USE 5-13-2009; IN COMMERCE 5-13-2009.
WILLIAM ROSSMAN, EXAMINING ATTORNEY

SN 77-850,057. DSM IP ASSETS B.V., HEERLEN, NETHERLANDS, FILED 10-15-2009.

COGNIVIDA

THE MARK CONSISTS OF STANDARD CHARACTERS WITHOUT CLAIM TO ANY PARTICULAR FONT, STYLE, SIZE, OR COLOR.

PRIORITY CLAIMED UNDER SEC. 44(D) ON BENELUX APPLICATION NO. 1189643, FILED 10-7-2009, REG. NO. 0870114, DATED 10-8-2009, EXPIRES 10-7-2019.

OWNER OF U.S. REG. NOS. 3,468,042, 3,682,669 AND 3,688,599.

CLASS 5—PHARMACEUTICALS

FOR DIETETIC SUBSTANCES, NAMELY, FOODS ADAPTED FOR MEDICAL USE; FOOD SUPPLEMENTS FOR MEDICAL USE; DIETETIC BEVERAGES ADAPTED FOR MEDICAL PURPOSES; VITAMINS; VITAMIN PREPARATIONS; NATURAL MEDICINES, NAMELY, NATURAL PHARMACEUTICAL PREPARATIONS FOR THE TREATMENT AND PREVENTION OF INFECTIOUS DISEASES, BLOOD DISORDERS, PAIN, INFLAMMATION, SEPSIS, ALOPECIA, OBESITY, NUTRITIONAL DISORDERS, HEALTH DISORDERS, EATING DISORDERS, SKIN DISORDERS AND COGNITIVE DISORDERS (U.S. CLS. 6, 18, 44, 46, 51 AND 52).

CLASS 29—MEATS AND PROCESSED FOODS

FOR DIETARY SUPPLEMENTS AND FOOD SUPPLEMENTS, NOT FOR MEDICAL USE, NOT INCLUDED IN OTHER CLASSES, NAMELY, DAIRY-BASED FOOD BEVERAGES, PROTEIN FOR USE AS A FOOD ADDITIVE, EDIBLE OILS AND FATS; PRESERVED, FROZEN, DRIED AND COOKED FRUITS AND VEGETABLES; JELLIES, JAMS, COMPOTES; EDIBLE OILS; SNACK FOODS, NAMELY, FRUIT-BASED SNACK FOODS, POTATO-BASED SNACK FOODS, SOY-BASED SNACK FOODS; MILK AND MILK PRODUCTS, EXCLUDING ICE CREAM, ICE MILK AND FROZEN YOGURT; YOGHURT (U.S. CL. 46).

CLASS 30—STAPLE FOODS

FOR DIETARY SUPPLEMENTS AND FOOD SUPPLEMENTS, NOT FOR MEDICAL USE, NOT INCLUDED IN OTHER CLASSES, NAMELY, FOOD FLAVORINGS, FOOD ADDITIVES FOR NON-NUTRITIONAL PURPOSES FOR USE AS A FLAVORING; FLOUR; PREPARATIONS MADE FROM CEREALS, NAMELY, BREAKFAST CEREALS, READY TO EAT CEREAL DERIVED FOOD BARS; BREAD, PASTRY; BISCUITS; COOKIES; TEA; TEA-BASED ADDITIVES, NAMELY, MIXES IN THE NATURE OF CONCENTRATES, SYRUPS OR POWDERS USED IN THE PREPARATION OF TEA BASED BEVERAGES, NOT FOR MEDICAL USE (U.S. CL. 46).

CLASS 32—LIGHT BEVERAGES

FOR SYRUPS FOR MAKING BEVERAGES; PREPARATIONS FOR MAKING BEVERAGES, NAMELY, FOR MAKING FRUIT FLAVORED BEVERAGES, FLAVORED WATER, ENERGY DRINKS, SPORTS DRINKS, BOTTLED WATER, FRUIT DRINKS, FRUIT JUICES, VEGETABLE JUICES, HERBAL JUICES, ISOTONIC BEVERAGES, MINERAL AND CARBONATED WATERS, NON-ALCOHOLIC BEVERAGES WITH TEA FLAVOR, SMOOTHIES AND SOFT DRINKS (U.S. CLS. 45, 46 AND 48).

MAYUR VAGHANI, EXAMINING ATTORNEY

CLASS 25—CLOTHING

FOR CLOTHING, NAMELY, PAJAMA TOPS AND PANTS HAVING CLOSABLE OPENINGS (U.S. CLS. 22 AND 39).

FIRST USE 9-4-2009; IN COMMERCE 10-2-2009.

CHARISMA HAMPTON, EXAMINING ATTORNEY

SN 77-850,168. MÖLNLYCKE HEALTH CARE AB, GOTHENBURG, SWEDEN, FILED 10-16-2009.

MEPILEX

THE MARK CONSISTS OF STANDARD CHARACTERS WITHOUT CLAIM TO ANY PARTICULAR FONT, STYLE, SIZE, OR COLOR.

OWNER OF U.S. REG. NO. 2,346,713.

THE WORD "MEPILEX" HAS NO MEANING IN A FOREIGN LANGUAGE.

CLASS 5—PHARMACEUTICALS

FOR SURGICAL DRESSINGS; WOUND DRESSINGS; MEDICAL PLASTERS; MEDICATED COMPRESSES (U.S. CLS. 6, 18, 44, 46, 51 AND 52).

FIRST USE 3-1-1999; IN COMMERCE 3-1-1999.

CLASS 10—MEDICAL APPARATUS

FOR NON-MEDICATED COMPRESSES (U.S. CLS. 26, 39 AND 44).

FIRST USE 3-1-1999; IN COMMERCE 3-1-1999.

DAVID YONTEF, EXAMINING ATTORNEY

SN 77-851,429. THOMPSON, SUSANNE, TULSA, OK. FILED 10-19-2009.

PRVY

THE MARK CONSISTS OF STANDARD CHARACTERS WITHOUT CLAIM TO ANY PARTICULAR FONT, STYLE, SIZE, OR COLOR.

THE ENGLISH TRANSLATION OF "PRVY" IN THE MARK IS PRIVY.

CLASS 10—MEDICAL APPARATUS

FOR MEDICAL TREATMENT APPAREL, NAMELY, TOPS AND PANTS HAVING CLOSABLE OPENINGS FOR USE IN MEDICAL EXAMINATION AND TREATMENT OF MEDICAL PATIENTS (U.S. CLS. 26, 39 AND 44).

FIRST USE 9-4-2009; IN COMMERCE 10-2-2009.

SN 77-851,544. RACINE BERKOW ASSOCIATES, INC. DBA RBA, INC, LONG ISLAND CITY, NY. FILED 10-19-2009.



NO CLAIM IS MADE TO THE EXCLUSIVE RIGHT TO USE "SECURE SHIPPING SOLUTIONS A DIVISION OF RBA, INC.", APART FROM THE MARK AS SHOWN.

THE COLOR(S) PURPLE, (PANTONE 2612C) IS/ARE CLAIMED AS A FEATURE OF THE MARK.

THE MARK CONSISTS OF THE WORDING "SECURE SHIPPING SOLUTIONS A DIVISION OF RBA, INC." DEPICTED IN PURPLE. TO THE RIGHT OF "INC." IS A DEPICTION OF A PURPLE SQUARE WITH TWO CUTOUTS IN THE SHAPE OF UPWARD POINTING ARROWS INSIDE THE BOX. TO THE RIGHT OF THE WORDING IS THE DESIGN OF A DIAMOND, INSIDE OF WHICH IS THE LETTERING "S", "S", "S".

CLASS 35—ADVERTISING AND BUSINESS

FOR ARRANGING FOR PICKUP, DELIVERY, STORAGE AND TRANSPORTATION OF DOCUMENTS, PACKAGES, FREIGHT AND PARCELS VIA GROUND AND AIR CARRIERS; TRANSPORTATION LOGISTICS SERVICES, NAMELY, ARRANGING THE TRANSPORTATION OF GOODS FOR OTHERS; TRANSPORTATION LOGISTICS SERVICES, NAMELY, PLANNING AND SCHEDULING SHIPMENTS FOR USERS OF TRANSPORTATION SERVICES; TRANSPORTATION MANAGEMENT SERVICES, NAMELY, PLANNING AND COORDINATING TRANSPORTATION OF PEOPLE FOR OTHERS (U.S. CLS. 100, 101 AND 102).

CLASS 39—TRANSPORTATION AND STORAGE

FOR AIR TRANSPORT AND STORAGE OF GOODS; AIR TRANSPORT SERVICES; AIR TRANSPORTATION; AIR TRANSPORTATION OF PASSENGERS AND FREIGHT; ARMORED CAR TRANSPORT; CARGO SHIP TRANSPORT; FREIGHT AND TRANSPORT BROKERAGE; FREIGHT SHIP TRANSPORT; FREIGHT TRANSPORTATION BROKERAGE; FREIGHT TRANSPORTATION CONSULTATION IN THE FIELD OF FREIGHT TRANSPORTATION BY TRUCK, RAIL, AIR AND OCEAN; GLOBAL TRANSPORTATION OF FREIGHT FOR OTHERS BY ALL AVAILABLE MEANS; GUARDED TRANSPORT OF VALUABLES; GUARDED TRANSPORTATION OF VALUABLES; GUARDED TRANSPORTATION OF VALUABLES AND MONEY BY TRUCK; GUARDED TRUCK TRANSPORT; MARINE TRANSPORT; PACKAGING ARTICLES FOR TRANSPORTATION; PACKING ARTICLES FOR TRANSPORTATION; PROVIDING OCEAN TRANSPORTATION, STORAGE AND DELIVERY SERVICES; SHIPPING AND DELIVERY SERVICES, NAMELY, PICKUP, TRANSPORTATION, AND DELIVERY OF PACKAGES AND LETTERS BY VARIOUS MODES OF TRANSPORTATION; SUPPLY CHAIN LOGISTICS AND REVERSE LOGISTICS SERVICES, NAMELY, STORAGE, TRANSPORTATION AND DELIVERY OF GOODS FOR OTHERS BY AIR, RAIL, SHIP OR TRUCK; SUPPLY CHAIN, LOGISTICS AND REVERSE LOGISTICS SERVICES, NAMELY, STORAGE, TRANSPORTATION AND DELIVERY OF DOCUMENTS, PACKAGES, RAW MATERIALS, AND OTHER FREIGHT FOR OTHERS BY AIR, RAIL, SHIP OR TRUCK; TRANSPORT AND DELIVERY OF GOODS; TRANSPORT AND STORAGE OF GOODS; TRANSPORT BROKERAGE; TRANSPORT OF GOODS; TRANSPORT OF MONEY AND VALUABLES; TRANSPORT OF VALUABLES; TRANSPORTATION AND DELIVERY SERVICES BY AIR, ROAD, RAIL AND SEA; TRANSPORTATION AND DELIVERY SERVICES, NAMELY, SAME DAY SHIPMENT SERVICES; TRANSPORTATION AND STORAGE OF GOODS; TRANSPORTATION CONSULTING; TRANSPORTATION OF GOODS; TRUCK TRANSPORT (U.S. CLS. 100 AND 105).
EMILY CARLSEN, EXAMINING ATTORNEY

CLASS 9—ELECTRICAL AND SCIENTIFIC APPARATUS

FOR COMPUTER HARDWARE; COMPUTER SOFTWARE FOR USE WITH SATELLITE AND FOR USE WITH SATELLITE AND/OR GPS NAVIGATION SYSTEMS FOR NAVIGATION, ROUTE AND TRIP PLANNING, AND ELECTRONIC MAPPING; COMPUTER SOFTWARE FOR TRAVEL INFORMATION SYSTEMS FOR THE PROVISION OR RENDERING OF TRAVEL ADVICE AND/OR INFORMATION CONCERNING SERVICE STATIONS, CAR PARKS, MULTI-STORY CAR PARKS, RESTAURANTS, CAR DEALERS AND OTHER INFORMATION REGARDING TRAVEL AND TRANSPORT; HARDWARE AND SOFTWARE FOR INFORMATION MANAGEMENT FOR THE TRANSPORT AND TRAFFIC INDUSTRIES; COMPUTER SOFTWARE TO BE USED FOR VIEWING AND DOWNLOADING ELECTRONIC MAPS; SOFTWARE FOR OPERATING ROUTE PLANNERS; ROUTE PLANNERS IN THE NATURE OF HAND-HELD PERSONAL COMPUTERS; SOFTWARE FOR OPERATING DIGITAL DICTIONARIES; ELECTRONIC DIGITAL DICTIONARIES; LOCATION, ORIENTATION, AND NAVIGATION SENSORS, TRANSMITTERS, ACTUATORS, CAMERAS AND GLOBAL POSITIONING SYSTEMS, NAMELY, GPS COMPRISING COMPUTERS, COMPUTER SOFTWARE, TRANSMITTERS, GPS AND SATELLITE RECEIVERS, NETWORK INTERFACE DEVICES, CONNECTING CABLES, AND PARTS AND FITTINGS THEREOF; HOLDERS FOR POCKET PERSONAL COMPUTERS, NAMELY, PROTECTIVE CARRYING CASES SPECIALLY ADAPTED FOR PERSONAL DIGITAL ASSISTANTS (PDA); SATELLITE AND RADIO TRANSMISSION PROCESSORS AND RECEIVERS; TELECOMMUNICATION INSTALLATIONS, NETWORKS AND APPARATUS, NAMELY, MOUNTING RACKS FOR TELECOMMUNICATIONS HARDWARE, TELECOMMUNICATIONS SWITCHES; COMPUTER TERMINALS TO BE USED WITH NAVIGATION SYSTEMS, ROUTE PLANNERS AND DIGITAL MAPS; BLANK MAGNETIC DATA CARRIERS AND BLANK RECORDING DISCS; AUDIO AND VIDEO APPARATUS, NAMELY, AUDIO AND VIDEO RECEIVERS AND PROCESSORS; HAND-HELD PERSONAL COMPUTERS; PERSONAL DIGITAL ASSISTANTS; ELECTRIC AND ELECTRONIC INSTRUMENTS FOR PROVIDING INFORMATION REGARDING MAPS, NAVIGATION, TRAFFIC, WEATHER AND INTERESTING LOCATIONS, ALARM APPARATUS AND INSTRUMENTS TO BE USED FOR TRACKING AND TRACING VEHICLES, NAMELY, VEHICLE LOCATING AND TRACKING SYSTEMS COMPRISED OF COMPUTERS, COMPUTER SOFTWARE, TRANSCEIVERS, TRANSPONDERS, GLOBAL POSITIONING SATELLITE RECEIVERS AND ANTENNAS (U.S. CLS. 21, 23, 26, 36 AND 38).

SN 77-852,472. TOMTOM INTERNATIONAL B.V., AMSTERDAM, NETHERLANDS, FILED 10-20-2009.

EQ ROUTES

THE MARK CONSISTS OF STANDARD CHARACTERS WITHOUT CLAIM TO ANY PARTICULAR FONT, STYLE, SIZE, OR COLOR.

NO CLAIM IS MADE TO THE EXCLUSIVE RIGHT TO USE "ROUTES", APART FROM THE MARK AS SHOWN.

CLASS 38—COMMUNICATION

FOR SECURED OR NOT SECURED TELECOMMUNICATION SERVICES, NAMELY, TRANSMISSION AND DELIVERY OF DIGITAL DATA, LIGHT FILES, SOUND FILES, DATA, INFORMATION AND IMAGE SIGNALS, BY MEANS OF COMPUTER, CABLE, RADIO AND SATELLITE NETWORKS, ALL IN PARTICULAR FOR NAVIGATION SYSTEMS, ROUTE PLANNERS AND THE USE OF ELECTRONIC MAPS; WIRELESS TRANSMISSION OF DATA BY MEANS OF VIDEOTEXT, THE INTERNET, GSM AND WAP; WIRELESS TRANSMISSION OF DIGITAL DATA; COMMUNICATION BY WAY OF COMPUTER TERMINALS; TELECOMMUNICATION SERVICES FOR THE COMMUNICATION WITH MEANS OF TRANSPORT, NAMELY, TRANSMISSION OF DIGITAL DATA, LIGHT FILES, SOUND FILES, DATA, INFORMATION AND IMAGE SIGNALS, BY MEANS OF WIRELESS AND SATELLITE NETWORKS; RENTAL OF TELECOMMUNICATION EQUIPMENT; TECHNICAL TELECOMMUNICATIONS CONSULTATION CONCERNING ALL SERVICES MENTIONED ABOVE (U.S. CLS. 100, 101 AND 104).

CLASS 39—TRANSPORTATION AND STORAGE

FOR NAVIGATIONAL SERVICES, NAMELY, PROVIDING NAVIGATIONAL INFORMATION FOR USE IN PILOTING LAND VEHICLES, PROVIDING GLOBAL POSITIONING AND NAVIGATION INFORMATION VIA MOBILE TELEPHONE, WIRELESS AND SATELLITE NETWORKS; INFORMATION SERVICES REGARDING TRAFFIC AND TRAFFIC CONGESTION; PROVISION OF INFORMATION REGARDING TRAVEL; PROVISION OF INFORMATION TO TRAVELLERS REGARDING FARES, TIME TABLES AND MEANS OF PUBLIC TRANSPORT; SERVICES OF A TRAVEL AGENCY, NAMELY, BOOKING OF RENTAL CARS, BOATS AND OTHER VEHICLES; ALL OF THE AFORESAID SERVICES ALSO PROVIDED VIA A COMMUNICATIONS NETWORK OR A MOBILE TELEPHONE OR A WIRELESS NAVIGATION DEVICE; SECURED AND UNSECURED TELECOMMUNICATIONS SERVICES, NAMELY, ELECTRONIC STORAGE OF DIGITAL DATA, SOUND, DATA, INFORMATION AND IMAGE SIGNALS ALL IN PARTICULAR FOR NAVIGATION SYSTEMS, ROUTE PLANNERS AND THE USE OF ELECTRONIC MAPS (U.S. CLS. 100 AND 105).

CLASS 42—SCIENTIFIC AND COMPUTER SERVICES

FOR DEVELOPMENT AND DESIGN OF NAVIGATION SYSTEMS, ROUTE PLANNERS, ELECTRONIC MAPS AND DIGITAL DICTIONARIES FOR OTHERS; COMPUTER SOFTWARE AND HARDWARE DESIGN; DEVELOPMENT AND DESIGN OF SOFTWARE FOR USE WITH NAVIGATION SYSTEMS, ROUTE PLANNERS, ELECTRONIC MAPS AND DIGITAL DICTIONARIES; DEVELOPMENT AND DESIGN OF TELECOMMUNICATION AND DATA COMMUNICATION NETWORKS; PROVIDING TEMPORARY USE OF NON-DOWNLOADABLE SOFTWARE FOR TRACKING AND TRACING GOODS AND VEHICLES VIA COMPUTER NETWORKS, INTRANETS AND THE INTERNET (U.S. CLS. 100 AND 101).

DEIRDRE ROBERTSON, EXAMINING ATTORNEY

SN 77-852,824. SILVERLINE CREATIVE, INC., NAPERVILLE, IL. FILED 10-20-2009.

SILVERLINE CREATIVE

THE MARK CONSISTS OF STANDARD CHARACTERS WITHOUT CLAIM TO ANY PARTICULAR FONT, STYLE, SIZE, OR COLOR.

NO CLAIM IS MADE TO THE EXCLUSIVE RIGHT TO USE "CREATIVE", APART FROM THE MARK AS SHOWN.

CLASS 35—ADVERTISING AND BUSINESS

FOR ADVERTISING AND PUBLICITY SERVICES, NAMELY, PROMOTING THE GOODS, SERVICES, BRAND IDENTITY AND COMMERCIAL INFORMATION AND NEWS OF THIRD PARTIES THROUGH PRINT, AUDIO, VIDEO, DIGITAL AND ON-LINE MEDIUM; ADVERTISING SERVICES, NAMELY, CREATING CORPORATE AND BRAND IDENTITY FOR OTHERS; ADVERTISING VIA ELECTRONIC MEDIA AND SPECIFICALLY THE INTERNET (U.S. CLS. 100, 101 AND 102).

FIRST USE 2-9-2005; IN COMMERCE 2-9-2005.

CLASS 42—SCIENTIFIC AND COMPUTER SERVICES

FOR WEBSITE DEVELOPMENT FOR OTHERS (U.S. CLS. 100 AND 101).

FIRST USE 2-9-2005; IN COMMERCE 2-9-2005.

WILLIAM P. SHANAHAN, EXAMINING ATTORNEY

SN 77-853,159. ALLIED BUILDING PRODUCTS CORPORATION, EAST RUTHERFORD, NJ. FILED 10-20-2009.

ONE source | ONE solution

OWNER OF U.S. REG. NO. 3,528,374.

THE COLOR(S) RED AND BLACK IS/ARE CLAIMED AS A FEATURE OF THE MARK.

THE MARK CONSISTS OF THE WORDS "SOURCE" AND "SOLUTION" APPEAR IN RED; THE WORDS "ONE" AND THE NUMERAL "1" APPEAR IN BLACK.

CLASS 35—ADVERTISING AND BUSINESS

FOR BUSINESS SERVICES, NAMELY, SCREENING, CREDENTIALING, AND ORGANIZING THIRD-PARTY VENDORS, SUPPLIERS, AND HOME REMODELING CONTRACTORS ON BEHALF OF OTHERS; REFERRALS FOR GENERAL BUILDING AND HOME REMODELING CONTRACTORS (U.S. CLS. 100, 101 AND 102).

CLASS 36—INSURANCE AND FINANCIAL

FOR FACILITATING AND ARRANGING FOR THE FINANCING OF HOME REMODELING (U.S. CLS. 100, 101 AND 102).

CLASS 37—CONSTRUCTION AND REPAIR

FOR INSTALLATION, REPAIR AND RENOVATION SERVICES FOR FLOORING, ROOFING AND HOME IMPROVEMENTS; CONSULTING SERVICES REGARDING HOME RENOVATION AND REPAIRS (U.S. CLS. 100, 103 AND 106).

JAY FLOWERS, EXAMINING ATTORNEY

SN 77-853,926. VERTRO, INC., FORT MYERS, FL. FILED 10-21-2009.

vertro

THE MARK CONSISTS OF THE STYLIZED WORD "VERTRO" IN LOWERCASE.

CLASS 9—ELECTRICAL AND SCIENTIFIC APPARATUS

FOR DOWNLOADABLE COMPUTER SOFTWARE FOR USE IN INCREASING PERSONAL PRODUCTIVITY AND ACCESSING INFORMATION FROM A GLOBAL COMPUTER NETWORK; COMPUTER SEARCH ENGINE SOFTWARE; COMPUTER SHAREWARE FOR USE WITH THE WORLD WIDE WEB, NAMELY, FOR USE IN INCREASING PERSONAL PRODUCTIVITY AND ACCESSING INFORMATION FROM A GLOBAL COMPUTER NETWORK; COMPUTER SOFTWARE PLATFORMS FOR NETWORK APPLICATIONS, NAMELY, FOR THE INTEGRATION, PROVISIONING, AND EFFICIENT ADMINISTRATION OF MULTIPLE COMPUTER SOFTWARE APPLICATIONS BEING WEB-BASED APPLICATIONS, SERVER-BASED APPLICATIONS AND THIRD PARTY HOSTED APPLICATIONS (U.S. CLS. 21, 23, 26, 36 AND 38).

FIRST USE 10-5-2009; IN COMMERCE 10-5-2009.

CLASS 35—ADVERTISING AND BUSINESS

FOR COMPUTERIZED ONLINE RETAIL STORE SERVICES FEATURING COMPUTER SOFTWARE (U.S. CLS. 100, 101 AND 102).

FIRST USE 10-5-2009; IN COMMERCE 10-5-2009.
SUSAN LESLIE DUBOIS, EXAMINING ATTORNEY

SN 77-856,375. STRATEGIC ANALYSIS, INC., ARLINGTON, VA. FILED 10-23-2009.

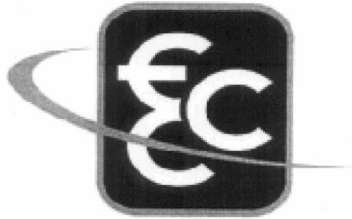

NO CLAIM IS MADE TO THE EXCLUSIVE RIGHT TO USE "ECC", APART FROM THE MARK AS SHOWN.

THE MARK CONSISTS OF THE LETTERS "E" AND "C" AND "C" IN A TRIANGULAR CONFIGURATION ENCLOSED WITHIN A RECTANGLE WITH A STYLIZED SWOOSH ACROSS THE CENTER.

CLASS 35—ADVERTISING AND BUSINESS

FOR ARRANGING OF MEETINGS, GATHERINGS, AND EXHIBITIONS FOR SMALL AND MEDIUM-SIZED GROUPS FOR BUSINESS PURPOSES, NAMELY, PROVIDING FACILITIES FOR BUSINESS MEETINGS AND TEMPORARY SECRETARIAL SERVICES (U.S. CLS. 100, 101 AND 102).

FIRST USE 1-1-2001; IN COMMERCE 1-1-2001.

CLASS 41—EDUCATION AND ENTERTAINMENT

FOR ARRANGING OF MEETINGS, GATHERINGS, AND EXHIBITIONS FOR SMALL AND MEDIUM-SIZED GROUPS FOR BUSINESS PURPOSES, NAMELY, RENTAL OF AUDIOVISUAL EQUIPMENT (U.S. CLS. 100, 101 AND 107).

FIRST USE 1-1-2001; IN COMMERCE 1-1-2001.
BRIAN PINO, EXAMINING ATTORNEY

SN 77-856,400. ALACER CORPORATION, FOOTHILL RANCH, CA. FILED 10-23-2009.

EMERGEN-C LITE

THE MARK CONSISTS OF STANDARD CHARACTERS WITHOUT CLAIM TO ANY PARTICULAR FONT, STYLE, SIZE, OR COLOR.

OWNER OF U.S. REG. NOS. 2,616,360, 3,669,688 AND OTHERS.

NO CLAIM IS MADE TO THE EXCLUSIVE RIGHT TO USE "LITE", APART FROM THE MARK AS SHOWN.

CLASS 30—STAPLE FOODS

FOR BREWED COFFEE, CAPPUCCINO, TEA LATTES AND COCOA BEVERAGE PRODUCTS DISPENSED AT VARIOUS RETAIL VENUES (U.S. CL. 46).

CLASS 32—LIGHT BEVERAGES

FOR FOUNTAIN BEVERAGES, NAMELY, SOFT DRINKS TO BE DISPENSED AT RETAIL VENUES (U.S. CLS. 45, 46 AND 48).

LAKEISHA LEWIS, EXAMINING ATTORNEY

SN 77-856,405. ALACER CORPORATION, FOOTHILL RANCH, CA. FILED 10-23-2009.

FEEL THE GOOD

THE MARK CONSISTS OF STANDARD CHARACTERS WITHOUT CLAIM TO ANY PARTICULAR FONT, STYLE, SIZE, OR COLOR.

OWNER OF U.S. REG. NOS. 3,483,518, 3,513,030 AND 3,521,887.

CLASS 30—STAPLE FOODS

FOR BREWED COFFEE, CAPPUCCINO, TEA LATTES AND COCOA BEVERAGE PRODUCTS DISPENSED AT VARIOUS RETAIL VENUES (U.S. CL. 46).

CLASS 32—LIGHT BEVERAGES

FOR FOUNTAIN BEVERAGES, NAMELY, SOFT DRINKS TO BE DISPENSED AT RETAIL VENUES (U.S. CLS. 45, 46 AND 48).

LAKEISHA LEWIS, EXAMINING ATTORNEY

SN 77-856,416. ALACER CORPORATION, FOOTHILL RANCH, CA. FILED 10-23-2009.

SN 77-857,101. ZHANG JIZHONG CULTURAL DEVELOPMENT, BEIJING, CHINA, FILED 10-26-2009.

EMERGEN-C

THE MARK CONSISTS OF STANDARD CHARACTERS WITHOUT CLAIM TO ANY PARTICULAR FONT, STYLE, SIZE, OR COLOR.

OWNER OF U.S. REG. NOS. 2,616,360, 3,669,388 AND OTHERS.

CLASS 30—STAPLE FOODS

FOR BREWED COFFEE, CAPPUCCINO, TEA LATTES AND COCOA BEVERAGE PRODUCTS DISPENSED AT VARIOUS RETAIL VENUES (U.S. CL. 46).

CLASS 32—LIGHT BEVERAGES

FOR FOUNTAIN BEVERAGES, NAMELY, SOFT DRINKS TO BE DISPENSED AT RETAIL VENUES (U.S. CLS. 45, 46 AND 48).

LAKEISHA LEWIS, EXAMINING ATTORNEY

SN 77-857,084. VINCENT MOTORS, USA, SAN DIEGO, CA. FILED 10-26-2009.

LEGENDARY PERFORMANCE

THE MARK CONSISTS OF STANDARD CHARACTERS WITHOUT CLAIM TO ANY PARTICULAR FONT, STYLE, SIZE, OR COLOR.

CLASS 12—VEHICLES

FOR MOTORCYCLES AND MOTORCYCLE STRUCTURAL PARTS; AUTOMOBILE AND MOTORCYCLE SUSPENSION SYSTEMS; MOTORCYCLE WHEELS, SEATS, AND REAR VIEW MIRRORS; MOTORCYCLE AERODYNAMIC PARTS AND ACCESSORIES, NAMELY, SKIRTS, WINGS, FLARES, SPOILERS, FENDERS, WINDSHIELDS, HAND SHIELDS, AND DRINK HOLDERS (U.S. CLS. 19, 21, 23, 31, 35 AND 44).

CLASS 25—CLOTHING

FOR MOTORCYCLE STYLE CLOTHING, NAMELY, JACKETS, HATS, PANTS, GLOVES, AND T-SHIRTS, ALL FOR PROMOTIONAL USE IN CONNECTION WITH MOTORCYCLES (U.S. CLS. 22 AND 39).

BARBARA GAYNOR, EXAMINING ATTORNEY



THE MARK CONSISTS OF A HIGHLY STYLIZED YIN-YANG DESIGN WHERE THE RIGHT HAND SIDE OF THE DESIGN IS NOT ENCLOSED.

CLASS 25—CLOTHING

FOR CLOTHING, NAMELY, TOPS, BOTTOMS, SWEATSHIRTS AND JACKETS; HEADWEAR; FOOTWEAR (U.S. CLS. 22 AND 39).

CLASS 41—EDUCATION AND ENTERTAINMENT

FOR ENTERTAINMENT SERVICES IN THE NATURE OF AMUSEMENT PARK RIDES; AMUSEMENT PARK AND THEME PARK SERVICES; AMUSEMENT ARCADES; PROVIDING A WEBSITE FEATURING INFORMATION RELATED TO ENTERTAINMENT SERVICES IN THE NATURE OF AMUSEMENT PARK AND THEME PARK SERVICES AND AMUSEMENT ARCADES (U.S. CLS. 100, 101 AND 107).

CLASS 43—HOTEL AND RESTAURANT SERVICES

FOR RESTAURANT SERVICES; TAKE OUT RESTAURANT SERVICES; CAFE SERVICES; FOOD STANDS AND CARTS IN THE NATURE OF MOBILE CAFE SERVICES FOR PROVIDING FOOD AND DRINK; PROVIDING A WEBSITE FEATURING RESTAURANT INFORMATION (U.S. CLS. 100 AND 101).

COLLEEN KEARNEY, EXAMINING ATTORNEY

SN 77-857,459. THE CARITAS PROJECT, INC., MIAMI, FL. FILED 10-26-2009.

A PLACE TO FLOURISH

THE MARK CONSISTS OF STANDARD CHARACTERS WITHOUT CLAIM TO ANY PARTICULAR FONT, STYLE, SIZE, OR COLOR.

CLASS 41—EDUCATION AND ENTERTAINMENT

FOR (BASED ON USE IN COMMERCE) EDUCATIONAL SERVICES, NAMELY, PROVIDING TRAINING AND INSTRUCTION IN THE FIELD OF HEALTHCARE, NAMELY, PROVIDING TRAINING AND INSTRUCTION IN THE AREA OF GENERATIVE SPACE TO CULTIVATE SUSTAINABLE IMPROVEMENTS IN THE HEALTHCARE FIELD; ENTERTAINMENT SERVICES, NAMELY, CONDUCTING CONTESTS AND PROVIDING RECOGNITION AND INCENTIVES BY THE WAY OF AWARDS TO DEMONSTRATE EXCELLENCE IN THE FIELD OF HEALTHCARE, NAMELY, SUSTAINABLE IMPROVEMENTS IN HEALTHCARE ACHIEVED THROUGH GENERATIVE SPACE (U.S. CLS. 100, 101 AND 107).

FIRST USE 9-13-2009; IN COMMERCE 9-13-2009.

CLASS 44—MEDICAL, BEAUTY AND AGRICULTURAL SERVICES

FOR (BASED ON INTENT TO USE) PROVIDING INFORMATION IN THE FIELD OF HEALTHCARE, NAMELY, SUSTAINABLE IMPROVEMENTS IN HEALTHCARE THAT CAN BE ACHIEVED THROUGH GENERATIVE SPACE (U.S. CLS. 100 AND 101).

LINDA M. KING, EXAMINING ATTORNEY

SN 77-857,550. U.S. RE COMPANIES, INC., PEARL RIVER, NY. FILED 10-26-2009.



THE COLOR(S) GRAY IS/ARE CLAIMED AS A FEATURE OF THE MARK.

THE MARK CONSISTS OF A GREY GLOBE HAVING THREE LATITUDE LINES AND THREE LONGITUDE LINES.

CLASS 35—ADVERTISING AND BUSINESS

FOR BUSINESS RISK MANAGEMENT; BUSINESS RISK MANAGEMENT CONSULTATION (U.S. CLS. 100, 101 AND 102).

FIRST USE 12-31-1988; IN COMMERCE 12-31-1988.

CLASS 36—INSURANCE AND FINANCIAL

FOR INVESTMENT BANKING SERVICES; INVESTMENT CONSULTATION SERVICES; REINSURANCE BROKER; REINSURANCE UNDERWRITING; REINSURANCE UNDERWRITING CONSULTATION; REINSURANCE BROKERAGE SERVICES; FINANCIAL RISK MANAGEMENT; FINANCIAL RISK MANAGEMENT CONSULTING; ALTERNATIVE RISK FINANCE; FINANCIAL ANALYSES, NAMELY, DYNAMIC ANALYSIS; FINANCIAL CATASTROPHE AND RISK MODELING (U.S. CLS. 100, 101 AND 102).

FIRST USE 12-31-2004; IN COMMERCE 12-31-2004.
HENRY S. ZAK, EXAMINING ATTORNEY

SN 77-858,775. DONSKY, ERIC, DBA CHATMETV, INC., LAGUNA BEACH, CA. FILED 10-27-2009.

ChatMeTV a socializing network

THE MARK CONSISTS OF STANDARD CHARACTERS WITHOUT CLAIM TO ANY PARTICULAR FONT, STYLE, SIZE, OR COLOR.

NO CLAIM IS MADE TO THE EXCLUSIVE RIGHT TO USE "A SOCIALIZING NETWORK", APART FROM THE MARK AS SHOWN.

CLASS 38—COMMUNICATION

FOR TELECOMMUNICATIONS SERVICES FOR PROVIDING MULTIPLE-USER ACCESS TO A GLOBAL COMPUTER NETWORK; CHAT ROOM SERVICES FOR SOCIAL NETWORKING (U.S. CLS. 100, 101 AND 104).

CLASS 45—PERSONAL AND LEGAL SERVICES

FOR INTERNET-BASED SOCIAL NETWORKING SERVICES (U.S. CLS. 100 AND 101).

GEOFFREY FOSDICK, EXAMINING ATTORNEY

SN 77-859,447. THE LDS CORPORATION, DENVER, CO. FILED 10-28-2009.

LOGIVIEW

THE MARK CONSISTS OF STANDARD CHARACTERS WITHOUT CLAIM TO ANY PARTICULAR FONT, STYLE, SIZE, OR COLOR.

CLASS 35—ADVERTISING AND BUSINESS

FOR PROVIDING ONLINE SUPPLY CHAIN MANAGEMENT INFORMATION CONCERNING WAREHOUSE LOGISTICS VIA A WORLDWIDE COMPUTER NETWORK (U.S. CLS. 100, 101 AND 102).

FIRST USE 1-1-2000; IN COMMERCE 1-1-2000.

CLASS 39—TRANSPORTATION AND STORAGE

FOR PROVIDING ONLINE INFORMATION VIA A WORLDWIDE COMPUTER NETWORK CONCERNING SUPPLY CHAIN WAREHOUSE LOGISTICS AND REVERSE WAREHOUSE LOGISTICS SERVICES, NAMELY, STORAGE, TRANSPORTATION AND DELIVERY OF GOODS FOR OTHERS BY AIR, RAIL, SHIP OR TRUCK (U.S. CLS. 100 AND 105).

FIRST USE 1-1-2000; IN COMMERCE 1-1-2000.
NATALIE POLZER, EXAMINING ATTORNEY

SN 77-860,039. JOS. SCHNEIDER OPTISCHE WERKE GMBH, BAD KREUZNACH, FED REP GERMANY, FILED 10-29-2009.

SWIRON

THE MARK CONSISTS OF STANDARD CHARACTERS WITHOUT CLAIM TO ANY PARTICULAR FONT, STYLE, SIZE, OR COLOR.

THE WORDING "SWIRON" HAS NO MEANING IN A FOREIGN LANGUAGE.

CLASS 9—ELECTRICAL AND SCIENTIFIC APPARATUS

FOR SCIENTIFIC, NAUTICAL, SURVEYING, ELECTRIC, ELECTRONIC, OPTO-ELECTRONIC, PHOTOGRAPHIC, CINEMATOGRAPHIC, OPTICAL, WEIGHING, MEASURING, SIGNALING, CHECKING AND SUPERVISION APPARATUS AND INSTRUMENTS, NAMELY, OPTICAL DETECTORS IN THE NATURE OF OPTICAL CHARACTER READERS AND OPTICAL SCANNERS, OPTICAL LENSES FOR SCANNING OR READING CHARACTERS IN A TELEFAXING OR COPYING APPARATUS; APPARATUS FOR RECORDING, TRANSMISSION OR REPRODUCTION OF IMAGES; BLANK MAGNETIC DATA CARRIERS; DATA PROCESSING EQUIPMENT, NAMELY, DATA PROCESSORS; COMPUTERS AND COMPUTER GRAPHIC SOFTWARE; PHOTOGRAPHIC AND CINEMATOGRAPHIC LENSES; PHOTOGRAPHIC AND CINEMATOGRAPHIC FILM AND DIGITAL PROJECTOR LENSES; OPTICAL GLASSES; OPTICAL FIBERS; OPTICAL FILTERS (U.S. CLS. 21, 23, 26, 36 AND 38).

CLASS 42—SCIENTIFIC AND COMPUTER SERVICES

FOR DESIGN OF CALCULATING LENSES; AND DESIGN OF OPTICAL RECORDING, TRANSMISSION OR REPRODUCTION SYSTEMS FOR USERS (U.S. CLS. 100 AND 101).

SAMUEL E. SHARPER JR., EXAMINING ATTORNEY

SN 77-860,685. RISC, LLC, PHOENIX, AZ. FILED 10-29-2009.

RISC

THE MARK CONSISTS OF STANDARD CHARACTERS WITHOUT CLAIM TO ANY PARTICULAR FONT, STYLE, SIZE, OR COLOR.

CLASS 35—ADVERTISING AND BUSINESS

FOR INVESTIGATION OF ASSETS, CREDIT REPORTS, FISCAL ASSESSMENTS, BUSINESS RECORDS, AND COLLECTION REPORTS, FOR BUSINESS TRANSACTIONS; BUSINESS SERVICES, NAMELY, BACKGROUND SCREENING FOR THE PURPOSES OF MERGERS, ACQUISITIONS, AND INVESTMENT TRANSACTIONS ON BEHALF OF OTHERS (U.S. CLS. 100, 101 AND 102).

CLASS 45—PERSONAL AND LEGAL SERVICES

FOR PRIVATE INVESTIGATION AND CONSULTATION SERVICES; PRE-EMPLOYMENT BACKGROUND SCREENING; ALTERNATIVE DISPUTE RESOLUTION AND LITIGATION SUPPORT; INVESTIGATION OF ASSETS, CREDIT REPORTS, FISCAL ASSESSMENTS, BUSINESS RECORDS, AND COLLECTION REPORTS FOR SECURITY OR AUTHENTICATION PURPOSES; AND EXPERT WITNESS SERVICES IN LEGAL MATTERS IN THE FIELD OF BUSINESS DUE DILIGENCE (U.S. CLS. 100 AND 101).

ODESSA BIBBINS, EXAMINING ATTORNEY

SN 77-861,499. TEC ENTERTAINMENT PRODUCTIONS, BEVERLY HILLS, CA. FILED 10-30-2009.

Drx. E

THE MARK CONSISTS OF STANDARD CHARACTERS WITHOUT CLAIM TO ANY PARTICULAR FONT, STYLE, SIZE, OR COLOR.

CLASS 3—COSMETICS AND CLEANING PREPARATIONS

FOR NON-MEDICATED ACNE TREATMENT PREPARATIONS; NON-MEDICATED SKIN BRIGHTENING PREPARATION; HAIR SHAMPOOS; HAIR CONDITIONING PREPARATIONS; HAIR GEL; NON-MEDICATED PRE-SHAMPOO HAIR TREATMENT PREPARATIONS; STYLING GELS; COSMETICS, NAMELY, MAKEUP, FOUNDATION, FACE POWDER, CONCEALER, BLUSH, EYESHADOW, EYELINER, MASCARA, LIP COLOUR; SKIN MOISTURIZER; BODY AND FACIAL SCRUB; LIQUID AND BAR SOAP FOR FACE AND BODY; COSMETICS; NON-MEDICATED TOILETRIES; LOTIONS FOR FACE CARE; FACE LOTIONS AND CREAMS; SKIN CLEANSING GELS; SKIN CLEANSING FOAMS; NON-MEDICATED FACIAL TREATMENTS, NAMELY, FACIAL LOTIONS, FACIAL EMULSIONS, SKIN MOISTURIZER; NON-MEDICATED ANTI-AGING SERUM; NON-MEDICATED FACIAL SERUM, NAMELY, AN ANTI-WRINKLE SKIN CARE PREPARATION; SUN SCREEN PREPARATIONS (U.S. CLS. 1, 4, 6, 50, 51 AND 52).

CLASS 5—PHARMACEUTICALS

FOR ACNE TREATMENT PREPARATION (U.S. CLS. 6, 18, 44, 46, 51 AND 52).

JEAN IM, EXAMINING ATTORNEY

SN 77-861,699. DA VINCI, S.A., SAN JOSE, COSTA RICA, FILED 10-30-2009.

GAMBLEVISION

THE MARK CONSISTS OF STANDARD CHARACTERS WITHOUT CLAIM TO ANY PARTICULAR FONT, STYLE, SIZE, OR COLOR.

CLASS 38—COMMUNICATION

FOR STREAMING OF AUDIO AND VIDEO MATERIAL ON THE INTERNET (U.S. CLS. 100, 101 AND 104).

CLASS 41—EDUCATION AND ENTERTAINMENT

FOR WAGERING SERVICES; CASINO SERVICES; SPORTS WAGERING SERVICES; ON-LINE POKER AND BINGO GAMES; GAMBLING SERVICES; PROVIDING INFORMATION IN THE FIELD OF CASINOS VIA THE INTERNET (U.S. CLS. 100, 101 AND 107).
VERNA BETH RIRIE, EXAMINING ATTORNEY

SN 77-863,061. TEC ENTERTAINMENT PRODUCTIONS, BEVERLY HILLS, CA. FILED 11-2-2009.

Drx. Evans

THE MARK CONSISTS OF STANDARD CHARACTERS WITHOUT CLAIM TO ANY PARTICULAR FONT, STYLE, SIZE, OR COLOR.

CLASS 3—COSMETICS AND CLEANING PREPARATIONS

FOR NON-MEDICATED ACNE TREATMENT PREPARATIONS; NON-MEDICATED SKIN BRIGHTENING PREPARATION; HAIR SHAMPOOS; HAIR CONDITIONING PREPARATIONS; HAIR GEL; NON-MEDICATED PRE-SHAMPOO HAIR TREATMENT PREPARATIONS; STYLING GELS; COSMETICS, NAMELY, MAKEUP, FOUNDATION, FACE POWDER, CONCEALER, BLUSH, EYESHADOW, EYELINER, MASCARA, LIPCOLOR; SKIN MOISTURIZER; BODY AND FACIAL SCRUB; LIQUID AND BAR SOAP FOR FACE AND BODY; COSMETICS; NON-MEDICATED TOILETRIES; LOTIONS FOR FACE CARE; FACE LOTIONS AND CREAMS; SKIN CLEANSING GELS; SKIN CLEANSING FOAMS; NON-MEDICATED FACIAL TREATMENTS, NAMELY, FACIAL LOTIONS; NON-MEDICATED ANTI-AGING SERUM; NON-MEDICATED FACIAL SERUM, NAMELY, AN ANTI-WRINKLE SKIN CARE PREPARATION; SUN SCREEN PREPARATIONS (U.S. CLS. 1, 4, 6, 50, 51 AND 52).

CLASS 5—PHARMACEUTICALS

FOR ACNE TREATMENT PREPARATION (U.S. CLS. 6, 18, 44, 46, 51 AND 52).
JEAN IM, EXAMINING ATTORNEY

SN 77-863,086. ALSTOM HYDRO FRANCE, LEVALLOIS-PERRET, FRANCE, FILED 11-2-2009.

Hydro PlantLife

OWNER OF FRANCE REG. NO. 083560211, DATED 2-27-2008, EXPIRES 2-27-2018.
NO CLAIM IS MADE TO THE EXCLUSIVE RIGHT TO USE "HYDRO", APART FROM THE MARK AS SHOWN.

THE MARK CONSISTS OF THE WORDS "HYDRO PLANTLIFE" IN STYLIZED FORMAT.

CLASS 7—MACHINERY

FOR ELECTRICITY GENERATORS, HYDRAULIC TURBINES (U.S. CLS. 13, 19, 21, 23, 31, 34 AND 35).

CLASS 9—ELECTRICAL AND SCIENTIFIC APPARATUS

FOR COMPUTER SOFTWARE FOR THE MONITORING, DIAGNOSIS, OPERATION AND CONTROL OF HYDRAULIC TURBINES, POWER PLANTS AND POWER GENERATION SYSTEMS (U.S. CLS. 21, 23, 26, 36 AND 38).

CLASS 11—ENVIRONMENTAL CONTROL APPARATUS

FOR POWER PLANTS (U.S. CLS. 13, 21, 23, 31 AND 34).

CLASS 37—CONSTRUCTION AND REPAIR

FOR CONSTRUCTION, INSTALLATION AND MAINTENANCE AND REPAIR OF POWER PLANTS, HYDRAULIC TURBINES AND ELECTRICITY GENERATORS (U.S. CLS. 100, 103 AND 106).

CLASS 41—EDUCATION AND ENTERTAINMENT

FOR TRAINING SERVICES IN THE FIELD OF CONSTRUCTION, INSTALLATION, MAINTENANCE, AND REPAIR OF POWER PLANTS, HYDRAULIC TURBINES AND ELECTRICITY GENERATORS (U.S. CLS. 100, 101 AND 107).

CLASS 42—SCIENTIFIC AND COMPUTER SERVICES

FOR ENGINEERING SERVICES IN THE FIELD OF POWER PLANTS, HYDRAULIC TURBINES AND ELECTRICITY GENERATORS; TECHNOLOGY CONSULTATION IN THE FIELD OF POWER PLANTS, HYDRAULIC TURBINES AND ELECTRICITY GENERATORS; QUALITY CONTROL FOR OTHERS IN THE FIELD OF CONSTRUCTION, INSTALLATION, MAINTENANCE AND REPAIR OF POWER PLANTS, HYDRAULIC TURBINES AND ELECTRICITY GENERATORS; MAINTENANCE ASSESSMENT OF THE PERFORMANCE AND RELIABILITY OF POWER PLANTS, HYDRAULIC TURBINES AND ELECTRICITY GENERATORS (U.S. CLS. 100 AND 101).

JENNIFER MARTIN, EXAMINING ATTORNEY

SN 77-863,099. ALSTOM HYDRO FRANCE, LEVALLOIS-PERRET, FRANCE, FILED 11-2-2009.

PlantLife

OWNER OF FRANCE REG. NO. 083560213, DATED 2-27-2008, EXPIRES 2-27-2018.
THE MARK CONSISTS OF THE WORD "PLANTLIFE" IN STYLIZED FORMAT.

CLASS 7—MACHINERY

FOR ELECTRICITY GENERATORS, HYDRAULIC TURBINES (U.S. CLS. 13, 19, 21, 23, 31, 34 AND 35).

CLASS 9—ELECTRICAL AND SCIENTIFIC APPARATUS

FOR COMPUTER SOFTWARE FOR THE MONITORING, DIAGNOSIS, OPERATION AND CONTROL OF HYDRAULIC TURBINES, POWER PLANTS AND POWER GENERATION SYSTEMS (U.S. CLS. 21, 23, 26, 36 AND 38).

CLASS 11—ENVIRONMENTAL CONTROL APPARATUS

FOR POWER PLANTS (U.S. CLS. 13, 21, 23, 31 AND 34).

CLASS 37—CONSTRUCTION AND REPAIR

FOR CONSTRUCTION, INSTALLATION AND MAINTENANCE AND REPAIR OF POWER PLANTS, HYDRAULIC TURBINES AND ELECTRICITY GENERATORS (U.S. CLS. 100, 103 AND 106).

CLASS 41—EDUCATION AND ENTERTAINMENT

FOR TRAINING SERVICES IN THE FIELD OF CONSTRUCTION, INSTALLATION, MAINTENANCE, AND REPAIR OF POWER PLANTS, HYDRAULIC TURBINES AND ELECTRICITY GENERATORS (U.S. CLS. 100, 101 AND 107).

CLASS 42—SCIENTIFIC AND COMPUTER SERVICES

FOR ENGINEERING SERVICES IN THE FIELD OF POWER PLANTS, HYDRAULIC TURBINES AND ELECTRICITY GENERATORS; TECHNOLOGY CONSULTATION IN THE FIELD OF POWER PLANTS, HYDRAULIC TURBINES AND ELECTRICITY GENERATORS; QUALITY CONTROL FOR OTHERS IN THE FIELD OF CONSTRUCTION, INSTALLATION, MAINTENANCE AND REPAIR OF POWER PLANTS, HYDRAULIC TURBINES AND ELECTRICITY GENERATORS; MAINTENANCE ASSESSMENT OF THE PERFORMANCE AND RELIABILITY OF POWER PLANTS, HYDRAULIC TURBINES AND ELECTRICITY GENERATORS (U.S. CLS. 100 AND 101).

JENNIFER MARTIN, EXAMINING ATTORNEY

SN 77-864,091. ALLIANT ENERGY CORPORATION, MADISON, WI. FILED 11-3-2009.

Growing kids Growing trees

THE MARK CONSISTS OF THE WORDS "GROWING KIDS GROWING TREES" IN STYLIZED LETTERS WITH A DRAWING OF A TREE WITH TWO BRANCHES RAISED UPWARD LIKE ARMS, LEAVES AT THE END OF THE BRANCHES LIKE HANDS AND A HEAD-LIKE FIGURE BETWEEN THE BRANCHES. THE TREE IS LOCATED BETWEEN THE WORDS "GROWING KIDS AND GROWING TREES".

CLASS 35—ADVERTISING AND BUSINESS

FOR PROMOTING ENERGY EFFICIENCY OF OTHERS THROUGH ENCOURAGING TREE PLANTING BY COMMERCIAL CUSTOMERS; ADVISORY AND CONSULTING SERVICES OFFERED TO COMMERCIAL CUSTOMERS IN THE FIELD OF ENERGY EFFICIENCY, NAMELY, PROMOTING THEIR PARTICIPATION IN TREE PLANTING PROGRAMS (U.S. CLS. 100, 101 AND 102).

CLASS 36—INSURANCE AND FINANCIAL

FOR PROVIDING GRANTS FOR SCHOOL TREE PLANTING PROJECTS (U.S. CLS. 100, 101 AND 102).
GINA FINK, EXAMINING ATTORNEY

SN 77-864,209. OCUSOFT, INC., ROSENBERG, TX. FILED 11-3-2009.



THE MARK CONSISTS OF A CRESCENT SHAPED RING.

CLASS 3—COSMETICS AND CLEANING PREPARATIONS

FOR COSMETICS, NAMELY, MASCARA, MAKEUP REMOVER, LID SCRUB AND FACIAL CLEANSERS; LID SCRUB PLUS FOAMING EYELID CLEANSERS; DISPOSABLE WIPES IMPREGNATED WITH CLEANSING COMPOUNDS FOR USE ON EYELIDS; FOAMS, CREAMS, GELS, LOTIONS AND BALMS FOR EYELID AND EYELASH CLEANSING; HAND SOAPS (U.S. CLS. 1, 4, 6, 50, 51 AND 52).

FIRST USE 6-1-2005; IN COMMERCE 6-1-2005.

CLASS 5—PHARMACEUTICALS

FOR PHARMACEUTICAL PREPARATIONS FOR THE DIAGNOSIS AND TREATMENT OF BLEPHARITIS, CHALAZION, DRY EYE SYNDROME, STYE AND CONJUNCTIVITIS; EYE DROPS; OPHTHALMIC LUBRICANTS IN THE FORM OF GELS, SOLUTIONS, DROPS, CREAMS AND OINTMENTS FOR THE EYES; MEDICATED LID SCRUB; MEDICATED LID SCRUB PLUS FOAMING EYELID CLEANSERS; MEDICATED EYE PRODUCTS, NAMELY, HYPERTONIC SOLUTIONS AND OINTMENTS FOR THE EYES; CONTACT LENS SOLUTION; EYELID TREATMENT PRODUCTS FOR MEDICAL PURPOSES, NAMELY, EYE PATCHES WITH SELF-WARMING ELEMENTS, WARM EYE COMPRESSES; THERAPEUTIC EYE CARE PADS; ORAL NUTRITIONAL SUPPLEMENTS FOR THE SUPPORT OF DRY EYES; MEDICATED PRE-MOISTENED WIPES; MEDICATED FOAMS, SOLUTIONS, CREAMS, GELS, LOTIONS AND OINTMENTS FOR EYELID CLEANSING AND REMOVAL OF ENCRUSTATION AND OTHER FOREIGN MATTER FROM THE EYELIDS, EYELASHES AND PARTICULAR AREA (U.S. CLS. 6, 18, 44, 46, 51 AND 52).

FIRST USE 6-1-2005; IN COMMERCE 6-1-2005.
AMY HELLA, EXAMINING ATTORNEY

SN 77-864,998. GREATER PHILADELPHIA URBAN AFFAIRS COALITION, PHILADELPHIA, PA. FILED 11-4-2009.

**DRIVING CHANGE FROM THE
GROUND UP**

THE MARK CONSISTS OF STANDARD CHARACTERS WITHOUT CLAIM TO ANY PARTICULAR FONT, STYLE, SIZE, OR COLOR.

CLASS 35—ADVERTISING AND BUSINESS

FOR PROMOTING THE INTERESTS OF CHARITABLE ORGANIZATIONS AND COMMUNITY ORGANIZATIONS BY OFFERING THE ORGANIZATIONS PROFESSIONAL SERVICES, NAMELY, ACCOUNTING SERVICES, MARKETING SERVICES IN THE FIELD OF PLANNED-GIVING FOR NON-PROFIT COMMUNITY AND CHARITABLE ORGANIZATIONS, ADMINISTRATION OF BUSINESS PAYROLL FOR OTHERS, AND PROVIDING BUSINESS NETWORKING SERVICES, NAMELY, MATCHING THE CHARITABLE AND COMMUNITY ORGANIZATIONS WITH THIRD PARTIES IN THE FIELDS OF EDUCATION AND TECHNICAL COMPUTER ASSISTANCE (U.S. CLS. 100, 101 AND 102).

CLASS 36—INSURANCE AND FINANCIAL

FOR CHARITABLE SERVICES, NAMELY, FINANCIAL SPONSORSHIP OF CHARITABLE AND COMMUNITY ORGANIZATIONS; LEASING OFFICE SPACE TO CHARITABLE AND COMMUNITY ORGANIZATIONS (U.S. CLS. 100, 101 AND 102).

CLASS 41—EDUCATION AND ENTERTAINMENT

FOR EDUCATIONAL SERVICES, NAMELY, ARRANGING PROFESSIONAL WORKSHOPS IN THE FIELDS OF WEALTH-BUILDING AND ENTREPRENEURSHIP FOR CHARITABLE AND COMMUNITY ORGANIZATIONS (U.S. CLS. 100, 101 AND 107).
BARBARA GAYNOR, EXAMINING ATTORNEY

SN 77-865,327. RM ACQUISITION, LLC, SKOKIE, IL. FILED 11-4-2009.

**MORE ROADS - BETTER
DIRECTIONS**

THE MARK CONSISTS OF STANDARD CHARACTERS WITHOUT CLAIM TO ANY PARTICULAR FONT, STYLE, SIZE, OR COLOR.

CLASS 16—PAPER GOODS AND PRINTED MATTER

FOR MAPS AND ATLASES (U.S. CLS. 2, 5, 22, 23, 29, 37, 38 AND 50).
FIRST USE 5-0-2008; IN COMMERCE 5-0-2008.

CLASS 39—TRANSPORTATION AND STORAGE

FOR ON-LINE TRAVEL ROUTING SERVICES (U.S. CLS. 100 AND 105).
FIRST USE 12-0-2008; IN COMMERCE 12-0-2008.

CLASS 42—SCIENTIFIC AND COMPUTER SERVICES

FOR ONLINE MAPPING SERVICES (U.S. CLS. 100 AND 101).
FIRST USE 12-0-2008; IN COMMERCE 12-0-2008.
MIDGE BUTLER, EXAMINING ATTORNEY

SN 77-865,738. VICTORIA JOHNSON, NEW YORK, NY. FILED 11-5-2009.

WaggleForce

THE MARK CONSISTS OF STANDARD CHARACTERS WITHOUT CLAIM TO ANY PARTICULAR FONT, STYLE, SIZE, OR COLOR.

CLASS 35—ADVERTISING AND BUSINESS

FOR CAREER PLACEMENT AND CAREER INFORMATION SERVICES FOR JOB SEEKERS PROVIDED BY MEANS OF A SERIES OF LOCAL AND COMMUNITY JOB CLUBS (U.S. CLS. 100, 101 AND 102).

CLASS 41—EDUCATION AND ENTERTAINMENT

FOR CAREER COUNSELING SERVICES (U.S. CLS. 100, 101 AND 107).
EDWARD FENNESSY, EXAMINING ATTORNEY

SN 77-865,757. HALIFAX FILM LTD., HALIFAX, NOVA SCOTIA, CANADA, FILED 11-5-2009.

ANIMAL MECHANICALS

THE MARK CONSISTS OF STANDARD CHARACTERS WITHOUT CLAIM TO ANY PARTICULAR FONT, STYLE, SIZE, OR COLOR.

CLASS 16—PAPER GOODS AND PRINTED MATTER

SN 77-867,372. MODERN MEMOIRS, AMHERST, MA. FILED 11-6-2009.

FOR PRINTED MATTER, NAMELY, COLORING AND CHILDREN'S ACTIVITY BOOKS, NOTE PAPER AND LOOSE LEAF PAPER, SERIES OF FICTION BOOKS, DECALS, TRADING CARDS, NOTE CARDS, POSTERS, FOLDERS, CALENDARS, STATIONERY WRITING PAPER AND ENVELOPES, ARTS AND CRAFT PAINT KITS; NOTEBOOKS; BLANK JOURNALS ADDRESS BOOKS; DIARIES; BOOKMARKS AND CARDBOARD CRAFT BOOKS; SCHOOL SUPPLIES, NAMELY, PENCIL, PENS, PEN AND PENCIL CASES AND HOLDERS, ERASERS, PENCIL SHARPENERS, HIGHLIGHTS MARKERS, MARKERS, AND DRAWING RULERS; GIFT WRAPPING PAPER; PAPER PARTY DECORATIONS; PARTY PAPER BAGS (U.S. CLS. 2, 5, 22, 23, 29, 37, 38 AND 50).

CLASS 18—LEATHER GOODS

FOR UMBRELLAS, LUGGAGE AND LUGGAGE TAGS, TRAVEL BAGS, BACKPACKS (U.S. CLS. 1, 2, 3, 22 AND 41).

CLASS 25—CLOTHING

FOR APPAREL AND ACCESSORIES, NAMELY, SHIRTS, T-SHIRTS, SWEATSHIRTS, SWEATERS, PANTS, JACKETS, SHORTS, SOCKS, UNDERWEAR, BELTS, BATHROBES, SCARVES, HEADWEAR, GLOVES, FOOTWEAR, NAMELY, BOOTS, SHOES AND SANDALS; HALLOWEEN COSTUMES, DRESSES, SKI WEAR, PAJAMAS, BEACHWEAR, EAR MUFFS, AND RAINWEAR (U.S. CLS. 22 AND 39).

JAMES GRIFFIN, EXAMINING ATTORNEY

SN 77-865,924. COMPOSITE TECHNOLOGIES CO. LLC, DAYTON, OH. FILED 11-5-2009.

X-PRO

THE MARK CONSISTS OF STANDARD CHARACTERS WITHOUT CLAIM TO ANY PARTICULAR FONT, STYLE, SIZE, OR COLOR.

CLASS 1—CHEMICALS

FOR SYNTHETIC RESINS FOR USE IN THE MANUFACTURE OF PLASTIC MOLDING COMPOUNDS OF FUNCTIONAL AND DECORATIVE PARTS BY INJECTION MOLDING, COMPRESSION MOLDING, EXTRUSION MOLDING AND BLOW MOLDING; PLASTIC MOLDING COMPOUNDS FOR USE IN THE MANUFACTURE OF MOLDED PLASTIC FUNCTIONAL AND DECORATIVE PARTS BY INJECTION MOLDING, COMPRESSION MOLDING, EXTRUSION MOLDING AND BLOW MOLDING (U.S. CLS. 1, 5, 6, 10, 26 AND 46).

CLASS 17—RUBBER GOODS

FOR SEMI-WORKED SYNTHETIC PLASTIC AND SYNTHETIC RESINS AS SEMI-FINISHED PRODUCTS IN THE FORM OF PELLETS, RODS, FOILS, FOAMS, FIBERS, FILMS AND SHEETS FOR MANUFACTURE OF FUNCTIONAL AND DECORATIVE PARTS BY INJECTION MOLDING, COMPRESSION MOLDING, EXTRUSION MOLDING AND BLOW MOLDING (U.S. CLS. 1, 5, 12, 13, 35 AND 50).

MICHAEL SOUDERS, EXAMINING ATTORNEY

WHITE POPPY PRESS

THE MARK CONSISTS OF STANDARD CHARACTERS WITHOUT CLAIM TO ANY PARTICULAR FONT, STYLE, SIZE, OR COLOR.

NO CLAIM IS MADE TO THE EXCLUSIVE RIGHT TO USE "PRESS", APART FROM THE MARK AS SHOWN.

CLASS 35—ADVERTISING AND BUSINESS

FOR CONSULTING SERVICES, NAMELY, CONSULTATION, INFORMATION AND ADVICE IN THE FIELD OF MARKETING AND SELLING OF BOOKS; ONLINE ORDERING SERVICES FEATURING BOOKS; DISTRIBUTORSHIP SERVICES IN THE FIELD OF BOOKS (U.S. CLS. 100, 101 AND 102).

CLASS 41—EDUCATION AND ENTERTAINMENT

FOR CONSULTING SERVICES, NAMELY, CONSULTATION, INFORMATION AND ADVICE IN THE FIELD OF SELF-PUBLISHING OF BOOKS; PUBLISHING OF BOOKS AND E-BOOKS; DESKTOP PUBLISHING FOR OTHERS; DIGITAL AUDIO AND MULTIMEDIA PUBLISHING SERVICES; ONLINE ELECTRONIC PUBLISHING OF BOOKS; LAYOUT SERVICES OTHER THAN FOR ADVERTISING PURPOSES; WRITTEN TEXT EDITING, PHOTOGRAPH EDITING, AUDIO AND VIDEO RECORDING SERVICES IN CONNECTION WITH BOOKS; WRITING OF TEXTS FOR BOOKS; CONSULTATION SERVICES IN THE FIELD OF WRITTEN TEXT EDITING (U.S. CLS. 100, 101 AND 107).

WENDY JUN, EXAMINING ATTORNEY

SN 77-867,933. CAROLINE LONG LIMITED, INC., JACKSONVILLE, FL. FILED 11-9-2009.



WWW.CAROLINELONG.COM

OWNER OF U.S. REG. NOS. 3,555,805, 3,585,987 AND 3,642,216.

THE NAME "CAROLINE LONG" IDENTIFIES A LIVING INDIVIDUAL WHOSE CONSENT IS OF RECORD.

THE MARK CONSISTS OF THE TERMS "WED BY CAROLINE LONG" INSIDE A CIRCLE WITH "WED" IN ALL CAPITAL LETTERS, BLOCK TEXT, AND "BY CAROLINE LONG" IN SCRIPT. THE TERM "BY" IS CENTERED UNDER "WED" AND "CAROLINE LONG" CENTERED UNDER "BY". A CELTIC STAR DESIGN IS CENTERED BELOW "CAROLINE LONG" AND IS ALSO INSIDE THE CIRCLE. THE COMPANY WEBSITE ADDRESS "WWW.CAROLINELONG.COM" IS CENTERED BELOW THE CIRCLE.

CLASS 16—PAPER GOODS AND PRINTED MATTER

FOR ORGANIZATIONAL KIT USED IN PLANNING THE DESIGN AND APPAREL FOR SPECIAL EVENTS CONTAINING COLOR SELECTION SAMPLE SHEETS, PLANNING FOLDERS AND FABRIC SWATCHES (U.S. CLS. 2, 5, 22, 23, 29, 37, 38 AND 50).
FIRST USE 10-6-2009; IN COMMERCE 10-6-2009.

CLASS 18—LEATHER GOODS

FOR HANDBAGS (U.S. CLS. 1, 2, 3, 22 AND 41).

CLASS 25—CLOTHING

FOR BATHING SUITS; BELTS; CAPRI PANTS; CUMMERBUNDS; DRESSES; MILLINERY, NAMELY, FASCINATORS; PANTS; SHAWLS; SHIRTS; SHORTS; SKIRTS; SWIMWEAR; TIES; TOPS; TUNICS; WRAPS (U.S. CLS. 22 AND 39).
FIRST USE 10-6-2009; IN COMMERCE 10-6-2009.
KIMBERLY FRYE, EXAMINING ATTORNEY

SN 77-870,582. SIERRA RETAIL PARTNERS, INC., CARNELIAN BAY, CA. FILED 11-11-2009.

MISE EN PLACE

THE MARK CONSISTS OF STANDARD CHARACTERS WITHOUT CLAIM TO ANY PARTICULAR FONT, STYLE, SIZE, OR COLOR.

THE ENGLISH TRANSLATION OF "MISE EN PLACE" IN THE MARK IS PUTTING IN PLACE.

CLASS 29—MEATS AND PROCESSED FOODS

FOR FROZEN VEGETABLES, MEATS, FRUITS (U.S. CL. 46).

CLASS 30—STAPLE FOODS

FOR FROZEN HERBS (U.S. CL. 46).
AMY C. KEAN, EXAMINING ATTORNEY

SN 77-870,878. LAND USE BY DESIGN, LLC, DBA LAND USE BY DESIGN, SILVER SPRING, MD. FILED 11-12-2009.

Land Use by Design

SN 77-869,041. ROMERO, MELCHOR, STATEN ISLAND, NY. FILED 11-10-2009.

The image shows the stylized text "D5W+" in a bold, black, serif font. The "D" is the largest, followed by "5", "W", and "+" which is slightly smaller than the "5".

THE MARK CONSISTS OF THE STYLIZED TEXT "D5W+".

CLASS 5—PHARMACEUTICALS

FOR VITAMIN ENRICHED WATER CONTAINING 5% DEXTROSE IN WATER (U.S. CLS. 6, 18, 44, 46, 51 AND 52).

CLASS 32—LIGHT BEVERAGES

FOR ENERGY DRINKS CONTAINING 5% DEXTROSE IN WATER (U.S. CLS. 45, 46 AND 48).
KEVON CHISOLM, EXAMINING ATTORNEY

THE MARK CONSISTS OF STANDARD CHARACTERS WITHOUT CLAIM TO ANY PARTICULAR FONT, STYLE, SIZE, OR COLOR.

NO CLAIM IS MADE TO THE EXCLUSIVE RIGHT TO USE "LAND USE", APART FROM THE MARK AS SHOWN.

CLASS 42—SCIENTIFIC AND COMPUTER SERVICES

FOR ARCHITECTURAL AND ENGINEERING SERVICES; LAND USE PLANNING SERVICES (U.S. CLS. 100 AND 101).

FIRST USE 8-1-2007, THE MARK WAS FIRST USED ANYWHERE IN A DIFFERENT FORM OTHER THAN THAT SOUGHT TO BE REGISTERED AT LEAST AS EARLY AS 08/01/2007.; IN COMMERCE 8-1-2007, THE MARK WAS FIRST USED IN COMMERCE IN A DIFFERENT FORM OTHER THAN THAT SOUGHT TO BE REGISTERED AT LEAST AS EARLY AS 08/01/2007..

CLASS 45—PERSONAL AND LEGAL SERVICES

FOR PERMITTING, NAMELY, OBTAINING ENVIRONMENTAL, DESIGN, ZONING AND OTHER GOVERNMENTAL PERMITS FOR DEVELOPMENT PROJECTS (U.S. CLS. 100 AND 101).

FIRST USE 8-1-2007, THE MARK WAS FIRST USED ANYWHERE IN A DIFFERENT FORM OTHER THAN THAT SOUGHT TO BE REGISTERED AT LEAST AS EARLY AS 08/01/2007.; IN COMMERCE 8-1-2007, THE MARK WAS FIRST USED IN COMMERCE IN A DIFFERENT FORM OTHER THAN THAT SOUGHT TO BE REGISTERED AT LEAST AS EARLY AS 08/01/2007.
ANNE E. GUSTASON, EXAMINING ATTORNEY

SN 77-870,921. ROAD & RAIL SERVICES, INC., LOUISVILLE, KY. FILED 11-12-2009.



THE MARK CONSISTS OF A WHEEL MADE UP OF TRIANGULAR ELEMENTS WITH THE LETTER "R" IN THE CENTER.

CLASS 35—ADVERTISING AND BUSINESS

FOR RAIL TERMINAL OPERATING SERVICES, NAMELY, OPERATION OF RAILWAY SWITCHING EQUIPMENT FOR OTHERS (U.S. CLS. 100, 101 AND 102).

FIRST USE 3-18-2008; IN COMMERCE 3-18-2008.

CLASS 37—CONSTRUCTION AND REPAIR

FOR REPAIR AND MAINTENANCE OF RAILCARS AND RAILCAR ASSEMBLIES; MECHANIC SERVICES FOR RAILCARS; MECHANIC SERVICES (U.S. CLS. 100, 103 AND 106).

FIRST USE 3-18-2008; IN COMMERCE 3-18-2008.
PAUL E. FAHRENKOPF, EXAMINING ATTORNEY

SN 77-871,305. ILC TRADEMARK CORP., TORTOLA, BR.VIRGIN ISLANDS, FILED 11-12-2009.

LIGHTNING BOLT

THE MARK CONSISTS OF STANDARD CHARACTERS WITHOUT CLAIM TO ANY PARTICULAR FONT, STYLE, SIZE, OR COLOR.

OWNER OF U.S. REG. NOS. 1,656,694, 2,988,079 AND OTHERS.

CLASS 9—ELECTRICAL AND SCIENTIFIC APPARATUS

FOR EYEGLASSES (U.S. CLS. 21, 23, 26, 36 AND 38).

CLASS 14—JEWELRY

FOR JEWELRY AND WATCHES (U.S. CLS. 2, 27, 28 AND 50).

CLASS 18—LEATHER GOODS

FOR WALLETS, BACKPACKS, HANDBAGS, DUFFLE BAGS, LUGGAGE BAGS OF NYLON AND IMITATION LEATHER (U.S. CLS. 1, 2, 3, 22 AND 41).

CLASS 24—FABRICS

FOR TOWELS (U.S. CLS. 42 AND 50).

CLASS 25—CLOTHING

FOR CLOTHING, NAMELY, SURF WEAR, TOPS, SHIRTS, T-SHIRTS, POLO SHIRTS, SWEATER, SWEATSHIRTS, JACKETS, JEANS, PANTS, SKIRTS, VESTS, UNDERWEAR, CAPS, HATS, SCARVES, GLOVES; SPORTSWEAR, NAMELY, SHORTS, SWIM WEAR, BATHING SUITS, WETSUITS; FOOTWEAR (U.S. CLS. 22 AND 39).

CLASS 28—TOYS AND SPORTING GOODS

FOR SURFBOARDS, SKATEBOARDS (U.S. CLS. 22, 23, 38 AND 50).
TIMOTHY FINNEGAN, EXAMINING ATTORNEY

SN 77-871,354. ILC TRADEMARK CORP., TORTOLA, BR.VIRGIN ISLANDS, FILED 11-12-2009.



OWNER OF U.S. REG. NOS. 1,656,694, 2,988,079 AND OTHERS.

THE MARK CONSISTS OF THE STYLIZED WORDING "LIGHTNING BOLT" WITH A LIGHTNING DESIGN WITHIN A CIRCLE SET BETWEEN THE WORDS "LIGHTNING" AND "BOLT".

CLASS 9—ELECTRICAL AND SCIENTIFIC APPARATUS

FOR EYEGLASSES (U.S. CLS. 21, 23, 26, 36 AND 38).

CLASS 14—JEWELRY

FOR JEWELRY AND WATCHES (U.S. CLS. 2, 27, 28 AND 50).

CLASS 18—LEATHER GOODS

FOR WALLETS, BACKPACKS, HANDBAGS, DUFFLE BAGS, LUGGAGE BAGS OF NYLON AND IMITATION LEATHER (U.S. CLS. 1, 2, 3, 22 AND 41).

CLASS 24—FABRICS

FOR TOWELS (U.S. CLS. 42 AND 50).

CLASS 25—CLOTHING

FOR CLOTHING, NAMELY, SURF WEAR, TOPS, SHIRTS, T-SHIRTS, POLO SHIRTS, SWEATER, SWEATSHIRTS, JACKETS, JEANS, PANTS, SKIRTS, VESTS, UNDERWEAR, CAPS, HATS, SCARVES, GLOVES; SPORTSWEAR, NAMELY, SHORTS, SWIM WEAR, BATHING SUITS, WETSUITS; FOOTWEAR (U.S. CLS. 22 AND 39).

CLASS 28—TOYS AND SPORTING GOODS

FOR SURFBOARDS, SKATEBOARDS (U.S. CLS. 22, 23, 38 AND 50).
TIMOTHY FINNEGAN, EXAMINING ATTORNEY

SN 77-871,382. MINTED PROSE, LLC, NEW YORK, NY.
FILED 11-12-2009.



THE MARK CONSISTS OF THREE STYLIZED LEAVES.

CLASS 16—PAPER GOODS AND PRINTED MATTER

FOR (BASED ON INTENT-TO-USE) NON-FICTION BOOKS ON A VARIETY OF TOPICS; (BASED ON USE IN COMMERCE) SERIES OF FICTION BOOKS (U.S. CLS. 2, 5, 22, 23, 29, 37, 38 AND 50).
FIRST USE 6-2-2009; IN COMMERCE 6-2-2009.

CLASS 41—EDUCATION AND ENTERTAINMENT

FOR BOOK PUBLISHING, BOOK AND REVIEW PUBLISHING; ENTERTAINMENT SERVICES, NAMELY, PROVIDING ON-LINE REVIEWS OF BOOKS, AUTHORS, AND EVENTS PERTAINING TO LITERATURE; PROVIDING A WEB SITE FEATURING INFORMATION ABOUT BOOKS, AUTHORS, AND EVENTS PERTAINING TO LITERATURE (U.S. CLS. 100, 101 AND 107).
FIRST USE 6-2-2009; IN COMMERCE 6-2-2009.
KATHERINE CONNOLLY, EXAMINING ATTORNEY

SN 77-871,472. SOZO GLOBAL, LLC, IRVING, TX. FILED 11-12-2009.



THE MARK CONSISTS OF AN ABSTRACT FIGURE OF A MAN HOLDING A BASKET CONTAINING THREE COFFEE BERRIES, WITH THE MAN ENCLOSED IN A DARK-TONED SHADED AND OUTLINED CIRCLE.

CLASS 5—PHARMACEUTICALS

FOR DIETARY AND NUTRITIONAL SUPPLEMENTS; DIETARY SUPPLEMENTAL DRINKS (U.S. CLS. 6, 18, 44, 46, 51 AND 52).
FIRST USE 6-1-2009; IN COMMERCE 6-1-2009.

CLASS 30—STAPLE FOODS

FOR COFFEE BASED BEVERAGES (U.S. CL. 46).
FIRST USE 6-1-2009; IN COMMERCE 6-1-2009.

CLASS 32—LIGHT BEVERAGES

FOR FRUIT BASED BEVERAGES; SPORTS DRINKS, NAMELY, ENERGY DRINKS; POWDERS USED IN THE PREPARATION OF SPORTS DRINKS AND ENERGY DRINKS (U.S. CLS. 45, 46 AND 48).
FIRST USE 6-1-2009; IN COMMERCE 6-1-2009.
EMILY CARLSEN, EXAMINING ATTORNEY

SN 77-871,835. UROLOGY CENTERS OF ALABAMA, P.C.,
HOMEWOOD, AL. FILED 11-13-2009.



NO CLAIM IS MADE TO THE EXCLUSIVE RIGHT TO USE "UROLOGY CENTERS" AND "P.C.", APART FROM THE MARK AS SHOWN.

THE MARK CONSISTS OF THE WORD "UROLOGY" TO THE LEFT OF A BLACK RECTANGLE WITH THE WORD "BIRMINGHAM" IN WHITE LETTERS APPEARING INSIDE THE RECTANGLE AND THE WORDS "CENTERS OF ALABAMA, P.C." ALL APPEARING BELOW THE WORDS "UROLOGY" AND "BIRMINGHAM".
SEC. 2(F).

CLASS 42—SCIENTIFIC AND COMPUTER SERVICES

FOR MEDICAL LABORATORY SERVICES (U.S. CLS. 100 AND 101).
FIRST USE 7-0-1998; IN COMMERCE 7-0-1998.

CLASS 44—MEDICAL, BEAUTY AND AGRICULTURAL SERVICES

FOR MEDICAL SERVICES, NAMELY, MEDICAL DIAGNOSIS AND TREATMENT OF UROLOGICAL DISORDERS AND THE PROVISION OF UROLOGICAL SERVICES; PROVIDING INFORMATION TO PATIENTS AND PHYSICIANS ABOUT CANCER AND UROLOGICAL DISEASES AND VARIOUS TREATMENT OPTIONS FOR SAME; PROVIDING WEBSITES FEATURING INFORMATION ON THE TREATMENT AND PREVENTION OF UROLOGICAL DISEASES; RADIATION ONCOLOGY SERVICES; MEDICAL INFORMATION, NAMELY, CONSUMER-AUTHORIZED CLINICAL LABORATORY TESTING SERVICES THAT REPORT RESULTS DIRECTLY TO THE PATIENT (U.S. CLS. 100 AND 101).
FIRST USE 7-0-1998; IN COMMERCE 7-0-1998.
HOWARD SMIGA, EXAMINING ATTORNEY

SN 77-871,839. ACADEMYHEALTH, WASHINGTON, DC.
FILED 11-13-2009.



OWNER OF U.S. REG. NOS. 2,783,995 AND 2,793,913.
THE MARK CONSISTS OF A TRIANGLE SHAPE, FOLDED DIAMOND SHAPE AND STAR SHAPE IN A SEMI CIRCULAR DESIGN ABOVE THE WORD "ACADEMY-HEALTH".

CLASS 35—ADVERTISING AND BUSINESS

FOR ASSOCIATION SERVICES, NAMELY, PROMOTING THE INTERESTS, GOALS AND OBJECTIVES OF HEALTH PRACTITIONERS, POLICY MAKERS, INDIVIDUALS AND ORGANIZATIONS WHICH CONDUCT RESEARCH IN THE FIELD OF HEALTH RESEARCH AND POLICY THROUGH PROGRAMS, PUBLICATIONS, COMMUNICATIONS AND ON-LINE BY MEANS OF A GLOBAL COMPUTER NETWORK; ECONOMIC FORECASTING AND ANALYSIS IN THE FIELD OF HEALTH RESEARCH AND HEALTH POLICY AND REGULATORY ISSUES; PROMOTING PUBLIC AWARENESS OF THE NEED FOR EFFICIENT, QUALITY AND ACCESSIBLE HEALTH SERVICES (U.S. CLS. 100, 101 AND 102).
FIRST USE 9-16-2002; IN COMMERCE 9-16-2002.

CLASS 41—EDUCATION AND ENTERTAINMENT

FOR EDUCATIONAL SERVICES, NAMELY, CONDUCTING PROGRAMS IN THE FIELD OF HEALTH RESEARCH AND HEALTH POLICY AND REGULATORY ISSUES AND DISTRIBUTING COURSE MATERIALS IN CONNECTION THEREWITH (U.S. CLS. 100, 101 AND 107).
FIRST USE 9-16-2002; IN COMMERCE 9-16-2002.
MEGHAN REINHART, EXAMINING ATTORNEY

SN 77-871,891. TEXAS A & I ALUMNI ASSOCIATION, FRANKLIN, TX. FILED 11-13-2009.

TEXAS A & I ALUMNI
ASSOCIATION

THE MARK CONSISTS OF STANDARD CHARACTERS WITHOUT CLAIM TO ANY PARTICULAR FONT, STYLE, SIZE, OR COLOR.
NO CLAIM IS MADE TO THE EXCLUSIVE RIGHT TO USE "A & I ALUMNI ASSOCIATION", APART FROM THE MARK AS SHOWN.
SEC. 2(F).

CLASS 16—PAPER GOODS AND PRINTED MATTER

FOR BROCHURES ABOUT ALUMNI ASSOCIATION MEMBERS, ALUMNI SERVICES PROVIDED, AND ALUMNI ASSOCIATION WEBSITE; COASTERS MADE OF PAPER; FLAGS AND PENNANTS OF PAPER; FLAGS OF PAPER; INFORMATIONAL FLYERS ABOUT ALUMNI ASSOCIATION MEMBERS, ALUMNI SERVICES PROVIDED, AND ALUMNI ASSOCIATION WEBSITE; INFORMATIONAL SHEETS ABOUT ALUMNI ASSOCIATION MEMBERS, ALUMNI SERVICES PROVIDED, AND ALUMNI ASSOCIATION WEBSITE; PAPER BADGES; PAPER BANNERS; PAPER LABELS; PAPER NAME BADGES; PAPER NOTE TABLETS; PAPER NOTEBOOKS; PAPER SIGN HOLDERS; PAPER TABLE CLOTHS; PENNANTS OF PAPER; PLACARDS OF PAPER OR CARDBOARD; PLACE MATS OF PAPER; POSTCARD PAPER; POSTERS MADE OF PAPER; PRINTED PAPER LABELS; PRINTED PAPER SIGNS (U.S. CLS. 2, 5, 22, 23, 29, 37, 38 AND 50).

FIRST USE 6-12-1998; IN COMMERCE 6-12-1998.

CLASS 24—FABRICS

FOR CLOTH FLAGS; CLOTH PENNANTS (U.S. CLS. 42 AND 50).

FIRST USE 6-12-1998; IN COMMERCE 6-12-1998.

CLASS 25—CLOTHING

FOR HEADBANDS FOR CLOTHING; JACKETS; JERSEYS; POCKET SQUARES; WEARABLE GARMENTS AND CLOTHING, NAMELY, SHIRTS (U.S. CLS. 22 AND 39).

FIRST USE 6-12-1998; IN COMMERCE 6-12-1998.
BARBARA A. GOLD, EXAMINING ATTORNEY

SN 77-872,476. TRACY BORKUM, SAN DIEGO, CA. FILED 11-13-2009.

Cucina Urbana

THE MARK CONSISTS OF STANDARD CHARACTERS WITHOUT CLAIM TO ANY PARTICULAR FONT, STYLE, SIZE, OR COLOR.

NO CLAIM IS MADE TO THE EXCLUSIVE RIGHT TO USE "CUCINA", APART FROM THE MARK AS SHOWN.

THE ENGLISH TRANSLATION OF "CUCINA URBANA" IN THE MARK IS URBAN KITCHEN.

CLASS 29—MEATS AND PROCESSED FOODS

FOR CHEESE SPREADS; DAIRY-BASED SPREADS; FRUIT-BASED SPREADS; MEAT-BASED SPREADS; VEGETABLE-BASED SPREADS; PREPARED AND PACKAGED MEALS CONSISTING PRIMARILY OF MEAT, FISH, POULTRY OR VEGETABLES (U.S. CL. 46).

CLASS 30—STAPLE FOODS

FOR READY-MADE SAUCES; SAUCES (U.S. CL. 46).

CLASS 43—HOTEL AND RESTAURANT SERVICES

FOR BAR AND RESTAURANT SERVICES; RESTAURANT (U.S. CLS. 100 AND 101).

FIRST USE 6-24-2009; IN COMMERCE 6-24-2009.
PRISCILLA MILTON, EXAMINING ATTORNEY

SN 77-873,891. ZAVIK, JEFFREY, FORT LAUDERDALE, FL.
FILED 11-16-2009.



NO CLAIM IS MADE TO THE EXCLUSIVE RIGHT TO USE "ALLERGY-FREE", APART FROM THE MARK AS SHOWN.

THE STIPPLING IS FOR SHADING PURPOSES ONLY. THE MARK CONSISTS OF A CIRCULAR DESIGN WITH AN ABSTRACT IMAGE AND THE TEXT "IMMUNO" AT THE CENTER, "A WORLD, ALLERGY-FREE" BELOW THE ABSTRACT IMAGE, AND "EAT WELL . FEEL WELL . LIVE WELL" AT THE TOP OF THE CIRCULAR DESIGN.

CLASS 5—PHARMACEUTICALS

FOR ALLERGY MEDICATIONS (U.S. CLS. 6, 18, 44, 46, 51 AND 52).

CLASS 44—MEDICAL, BEAUTY AND AGRICULTURAL SERVICES

FOR HEALTH CARE SERVICES, NAMELY, NATURAL ALLERGY DESENSITIZATION USING MUSCLE TESTING AND VIBRATIONAL FREQUENCY TREATMENT (U.S. CLS. 100 AND 101).

INGA ERVIN, EXAMINING ATTORNEY

SN 77-874,056. PACTIV CORPORATION, LAKE FOREST, IL.
FILED 11-17-2009.

CLEAR ADVANTAGE

THE MARK CONSISTS OF STANDARD CHARACTERS WITHOUT CLAIM TO ANY PARTICULAR FONT, STYLE, SIZE, OR COLOR.

CLASS 20—FURNITURE AND ARTICLES NOT OTHERWISE CLASSIFIED

FOR DISPOSABLE PLASTIC FOOD PACKAGING CONTAINERS FOR COMMERCIAL USE (U.S. CLS. 2, 13, 22, 25, 32 AND 50).

CLASS 21—HOUSEWARES AND GLASS

FOR DISPOSABLE PLASTIC HINGED LID FOOD CONTAINERS, DISPOSABLE PLASTIC BOWLS, DISPOSABLE PLASTIC CUPS (U.S. CLS. 2, 13, 23, 29, 30, 33, 40 AND 50).

HEATHER THOMPSON, EXAMINING ATTORNEY

SN 77-874,609. PURPLE CIRCLES SAFETY, INC., HEBRON, IN. FILED 11-17-2009.



NO CLAIM IS MADE TO THE EXCLUSIVE RIGHT TO USE "SAFETY INC.", APART FROM THE MARK AS SHOWN.

THE MARK CONSISTS OF HANDS GRASPING A CIRCLE WITHIN ANOTHER CIRCLE. THE WORDS "PURPLE CIRCLE SAFETY INC." BORDER THE OUTSIDE CIRCLE.

CLASS 16—PAPER GOODS AND PRINTED MATTER

FOR A TOOL FOR IMPLEMENTATION OF AN INTERPERSONAL INTERVENTIONAL COMMUNICATION SYSTEM FOR IMPROVING A WORKPLACE ENVIRONMENT CONSISTING OF PRINTED TRAINING MATERIALS IN THE FIELD OF WORKPLACE COMMUNICATIONS AND PRINTED IDENTIFICATION STICKERS (U.S. CLS. 2, 5, 22, 23, 29, 37, 38 AND 50).

CLASS 26—FANCY GOODS

FOR CLOTH PATCHES FOR ATTACHMENT TO ARTICLES OF CLOTHING (U.S. CLS. 37, 39, 40, 42 AND 50).

CLASS 41—EDUCATION AND ENTERTAINMENT

FOR PROVIDING CLASSES, SEMINARS, WORKSHOPS, AND TRAINING FOR WORKFORCE PERSONNEL AND OTHER INDIVIDUALS IN THE FIELDS OF OCCUPATIONAL SAFETY AND WORKPLACE INTERPERSONAL INTERPERSONAL COMMUNICATION TECHNIQUES FOR IMPROVING WORKPLACE ENVIRONMENT, AND IN THE USE OF A TOOL ADAPTED TO IMPLEMENT INTERPERSONAL COMMUNICATION TECHNIQUES FOR IMPROVING WORKPLACE ENVIRONMENT (U.S. CLS. 100, 101 AND 107).

STEVEN JACKSON, EXAMINING ATTORNEY

SN 77-874,638. PURPLE CIRCLES SAFETY, INC., HEBRON, IN. FILED 11-17-2009.

PURPLE CIRCLES

THE MARK CONSISTS OF STANDARD CHARACTERS WITHOUT CLAIM TO ANY PARTICULAR FONT, STYLE, SIZE, OR COLOR.

CLASS 16—PAPER GOODS AND PRINTED MATTER

FOR A TOOL FOR IMPLEMENTATION OF AN INTERPERSONAL INTERVENTIONAL COMMUNICATION SYSTEM FOR IMPROVING A WORKPLACE ENVIRONMENT CONSISTING OF PRINTED TRAINING MATERIALS IN THE FIELD OF WORKPLACE COMMUNICATIONS AND PRINTED IDENTIFICATION STICKERS (U.S. CLS. 2, 5, 22, 23, 29, 37, 38 AND 50).

CLASS 41—EDUCATION AND ENTERTAINMENT

FOR PROVIDING CLASSES, SEMINARS, WORKSHOPS, AND TRAINING FOR WORKFORCE PERSONNEL AND OTHER INDIVIDUALS IN THE FIELDS OF OCCUPATIONAL SAFETY AND WORKPLACE INTERVENTIONAL INTERPERSONAL COMMUNICATION TECHNIQUES FOR IMPROVING WORKPLACE ENVIRONMENT, AND IN THE USE OF A TOOL ADAPTED TO IMPLEMENT INTERPERSONAL COMMUNICATION TECHNIQUES FOR IMPROVING WORKPLACE ENVIRONMENT (U.S. CLS. 100, 101 AND 107).

STEVEN JACKSON, EXAMINING ATTORNEY

CLASS 42—SCIENTIFIC AND COMPUTER SERVICES

FOR PROVIDING TECHNOLOGY INFORMATION IN THE OIL AND GAS INDUSTRY; PERFORMING WELL DIAGNOSTICS; OIL-FIELD SURVEYS; OIL WELL TESTING; OIL PROSPECTING, NAMELY, WELL LOGGING AND TESTING; INSPECTION OF OIL FIELDS; OIL PROSPECTING; OIL FIELD SURVEYING; OIL FIELD EXPLORATION; EXPLORATION AND SEARCHING OF OIL AND GAS; COMPUTER SERVICES, NAMELY, ELECTRONICALLY GATHERING, ANALYZING AND FORMATTING DATA TO TRACK, LOCATE, MONITOR AND LOG OPERATIONS IN THE OIL INDUSTRY; ANALYSIS OF OIL FIELDS; PROFESSIONAL COMPUTER SERVICES, NAMELY, NETWORK ANALYSIS, LAN/WAN DESIGN, WIRELESS ENGINEERING, VIRTUALIZATION AND COMPUTER MANAGEMENT; CONSULTING IN THE FIELD OF IT PROJECT MANAGEMENT; COMPUTER PROJECT MANAGEMENT SERVICES IN THE FIELD OF TELECOMMUNICATIONS; COMPUTER PROJECT MANAGEMENT SERVICES; WRITING AND UPDATING COMPUTER SOFTWARE; SOFTWARE DESIGN AND DEVELOPMENT; COMPUTER SOFTWARE CONSULTING; COMPUTER SOFTWARE DEVELOPMENT (U.S. CLS. 100 AND 101).

FIRST USE 12-1-2002; IN COMMERCE 12-1-2002.
ALICIA COLLINS, EXAMINING ATTORNEY

SN 77-874,875. XM TEK LLC, KELLER, TX. FILED 11-17-2009.

SN 77-875,229. GENOVA DIAGNOSTICS, INC., ASHEVILLE, NC. FILED 11-18-2009.

XM Tek

THE MARK CONSISTS OF STANDARD CHARACTERS WITHOUT CLAIM TO ANY PARTICULAR FONT, STYLE, SIZE, OR COLOR.

NO CLAIM IS MADE TO THE EXCLUSIVE RIGHT TO USE "TECH", APART FROM THE MARK AS SHOWN.

CLASS 35—ADVERTISING AND BUSINESS

FOR MANAGING THE EXPLORATION, PRODUCTION AND OPERATIONS OF NATURAL GAS AND OIL PROPERTIES FOR OTHERS; MEDICAL BILLING OUTSOURCING SERVICES; MEDICAL BILLING SUPPORT SERVICES; PROVIDING ONLINE BUSINESS MANAGEMENT SERVICES INCLUDING ACCOUNTING, MARKETING, BUSINESS PROJECT MANAGEMENT, AND BUSINESS DEVELOPMENT; PROJECT MANAGEMENT SERVICES FOR OTHERS FOR BUSINESS PURPOSES IN THE FIELDS OF ARCHITECTURE, INTERIOR DESIGN, URBAN PLANNING DESIGN; BUSINESS MANAGEMENT CONSULTANCY AS WELL AS DEVELOPMENT OF PROCESSES FOR THE ANALYSIS AND THE IMPLEMENTATION OF STRATEGY PLANS AND MANAGEMENT PROJECTS (U.S. CLS. 100, 101 AND 102).

FIRST USE 12-1-2002; IN COMMERCE 12-1-2002.

CLASS 37—CONSTRUCTION AND REPAIR

FOR DRILLING AND PUMPING OF OIL; DRILLING FOR CRUDE; OIL AND GAS DRILLING; OIL PUMPING AND EXTRACTION; OIL WELL CASING, TUBING, AND DRILL PIPE INSTALLATION; OIL WELL DRILLING; PUMPING CRUDE OIL; WATER OR WELL BORING (U.S. CLS. 100, 103 AND 106).

FIRST USE 12-1-2002; IN COMMERCE 12-1-2002.



OPTIMAL NUTRITION EVALUATION

NO CLAIM IS MADE TO THE EXCLUSIVE RIGHT TO USE "NUTRITION EVALUATION", APART FROM THE MARK AS SHOWN.

THE COLOR(S) BLACK AND GREEN IS/ARE CLAIMED AS A FEATURE OF THE MARK.

THE MARK CONSISTS OF THE STYLIZED GREEN LETTERS "ONE" WITH A GREEN ARC EXTENDING FROM THE CENTER OF THE "E" TO BELOW THE "O"; SMALLER BLACK LETTERS "FMV" TO THE RIGHT OF AND ALIGNED WITH THE TOP OF THE "E"; THE WORDS "OPTIMAL NUTRITION EVALUATION" APPEAR IN BLACK AND ARE CENTERED BELOW THE ARC-"ONE"- "FMV" COMBINATION.

CLASS 42—SCIENTIFIC AND COMPUTER SERVICES

FOR MEDICAL LABORATORY SERVICES (U.S. CLS. 100 AND 101).

CLASS 44—MEDICAL, BEAUTY AND AGRICULTURAL SERVICES

FOR MEDICAL TESTING FOR DIAGNOSTIC OR TREATMENT PURPOSES (U.S. CLS. 100 AND 101).

HOWARD B. LEVINE, EXAMINING ATTORNEY

SN 77-875,601. ENGBRETSON, DONALD GEORGE, EX-
CELSIOR, MN. FILED 11-18-2009.

RENEGADE GARDENER

THE MARK CONSISTS OF STANDARD CHARACTERS WITHOUT CLAIM TO ANY PARTICULAR FONT, STYLE, SIZE, OR COLOR.

OWNER OF U.S. REG. NO. 2,297,125.

NO CLAIM IS MADE TO THE EXCLUSIVE RIGHT TO USE "GARDENER", APART FROM THE MARK AS SHOWN.

CLASS 41—EDUCATION AND ENTERTAINMENT

FOR EDUCATIONAL AND ENTERTAINMENT SERVICES, NAMELY, PROVIDING EDUCATIONAL SPEAKING SERVICES IN THE FIELD OF GARDENING AND LANDSCAPING (U.S. CLS. 100, 101 AND 107).

FIRST USE 12-31-2003; IN COMMERCE 12-31-2003.

CLASS 44—MEDICAL, BEAUTY AND AGRICULTURAL SERVICES

FOR PROVIDING A WEBSITE FEATURING INFORMATION IN THE FIELD OF GARDENING AND LANDSCAPING (U.S. CLS. 100 AND 101).

FIRST USE 6-15-1999; IN COMMERCE 6-15-1999.

SARA THOMAS, EXAMINING ATTORNEY

CLASS 39—TRANSPORTATION AND STORAGE

FOR ORGANIZATION OF EXCURSIONS, SIGHTSEEING TOURS, HOLIDAYS, TOURS AND TRAVEL; TOUR CONDUCTING; TRAVEL AGENCY SERVICES, NAMELY, MAKING RESERVATIONS AND BOOKINGS FOR TRANSPORTATION; TRAVEL INFORMATION SERVICES (U.S. CLS. 100 AND 105).

FIRST USE 4-6-2007; IN COMMERCE 4-6-2007.

CLASS 43—HOTEL AND RESTAURANT SERVICES

FOR TRAVEL AGENCY SERVICES, NAMELY, MAKING RESERVATIONS AND BOOKING FOR TEMPORARY LODGING (U.S. CLS. 100 AND 101).

FIRST USE 4-6-2007; IN COMMERCE 4-6-2007.

MARGERIE A. TIERNEY, EXAMINING ATTORNEY

SN 77-876,418. UNIVERSITY OF PITTSBURGH - OF THE COMMONWEALTH SYSTEM OF HIGHER EDUCATION, PITTSBURGH, PA. FILED 11-19-2009.

UPMC Resources for Life

SN 77-875,950. GUILIN CHINA INTERNATIONAL TRAVEL SERVICE CO., LTD., GUILIN, CHINA, FILED 11-18-2009.



NO CLAIM IS MADE TO THE EXCLUSIVE RIGHT TO USE "CHINA" AND "ZHONG HUA YOU", APART FROM THE MARK AS SHOWN.

THE COLOR(S) RED, BLACK AND WHITE IS/ARE CLAIMED AS A FEATURE OF THE MARK.

THE MARK CONSISTS OF A RED SQUIGGLED LINE FOLLOWED BY THE STYLIZED WORDS "CHINA HIGHLIGHTS" IN BLACK WITH THE STYLIZED WORD "CHINA" APPEARING OVER THE STYLIZED WORD "HIGHLIGHTS" FOLLOWED BY A RED CIRCLE SHAPED OBJECT. INSIDE THE RED CIRCLE SHAPED OBJECT APPEARS CHINESE LETTERING WHICH TRANSLATES IN ENGLISH TO "CHINA TRAVEL" IN WHITE.

THE ENGLISH TRANSLATION OF THE CHINESE WORDS IN THE MARK IS "CHINA TRAVEL".

THE NON-LATIN CHARACTERS IN THE MARK TRANSLITERATE TO "ZHONG HUA YOU" AND THIS MEANS "CHINA TRAVEL" IN ENGLISH.

THE MARK CONSISTS OF STANDARD CHARACTERS WITHOUT CLAIM TO ANY PARTICULAR FONT, STYLE, SIZE, OR COLOR.

OWNER OF U.S. REG. NO. 2,174,963.

CLASS 35—ADVERTISING AND BUSINESS

FOR PROVIDING REFERRALS TO HEALTH PLAN MEMBERS AND THEIR FAMILIES FOR SERVICES IN THE NATURE OF HOME HEALTH CARE, ELDER CARE, PET CARE, TRANSPORTATION, VACATION PLANNING, FINANCIAL AND LEGAL ASSISTANCE, TAX GUIDANCE, RETIREMENT PLANNING, AND IN-HOME SERVICES, NAMELY, HOME REPAIRS, HOME CLEANING AND PREPARING MEALS (U.S. CLS. 100, 101 AND 102).

FIRST USE 1-1-2009; IN COMMERCE 1-1-2009.

CLASS 45—PERSONAL AND LEGAL SERVICES

FOR HEALTH PLAN BENEFIT PROGRAM PROVIDING PERSONAL EMOTIONAL SUPPORT AND GRIEF COUNSELING TO ASSIST EMPLOYEES AND THEIR FAMILIES IN THE AREAS OF FAMILY OR EMOTIONAL ISSUES, INCLUDING STRESS, DEPRESSION, AND RECOVERING FROM THE LOSS OF A LOVED ONE (U.S. CLS. 100 AND 101).

FIRST USE 1-1-2009; IN COMMERCE 1-1-2009.

FRED CARL, EXAMINING ATTORNEY

SN 77-876,724. MARY HERRICK, AMHERST, OH. FILED 11-19-2009.

USCA

THE MARK CONSISTS OF STANDARD CHARACTERS WITHOUT CLAIM TO ANY PARTICULAR FONT, STYLE, SIZE, OR COLOR.

CLASS 18—LEATHER GOODS

FOR BACKPACKS, BEACH BAGS, TOTE BAGS, SPORTS BAGS, ALL-PURPOSE CARRYING BAGS AND CARRY-ALL BAGS (U.S. CLS. 1, 2, 3, 22 AND 41).

CLASS 25—CLOTHING

FOR T-SHIRTS, SHIRTS, BLOUSES, TOPS, TANK TOPS, PANTS, SLACKS, SHORTS, SKIRTS, SWEATSHIRTS, HOODED SWEATSHIRTS, SWEATPANTS, SWEATERS, TENNIS WEAR, JACKETS, COATS, SOCKS, HEAD BANDS, WRISTBANDS, CAPS, HATS, BASEBALL CAPS, BANDANAS, VISORS, FOOTWEAR, FLIP FLOPS (U.S. CLS. 22 AND 39).

CLASS 35—ADVERTISING AND BUSINESS

FOR ASSOCIATION SERVICES, NAMELY, PROMOTING THE INTERESTS OF SPORTS COACHES EXCLUDING SPORTS COACHES OF ALL BOATING SPORTS INCLUDING CANOEING AND KAYAKING; JOB PLACEMENT (U.S. CLS. 100, 101 AND 102).

CLASS 41—EDUCATION AND ENTERTAINMENT

FOR EDUCATIONAL SERVICES, NAMELY, PROVIDING, DEVELOPING AND CONDUCTING CLASSES, LECTURES, WORKSHOPS, COURSES, SEMINARS, CONFERENCES, TUTORING AND TRAINING IN THE FIELDS OF SOCCER, CROSS-COUNTRY, FOOTBALL, VOLLEYBALL, BASKETBALL, SWIMMING, WRESTLING, BASEBALL, TRACK AND FIELD, GOLF, TENNIS, SPORTS, SPORTS TEACHING TECHNIQUES, SPORTS TEACHING, SPORTS COACHING, SPORTS TECHNOLOGY, SPORTS EDUCATION, SPORTS MARKETING, ADMINISTRATION OF SPORTS EVENTS AND TOURNAMENTS, PREPARATION FOR SPORTS CERTIFICATION EXAMINATIONS, PREPARATION FOR SPORTS COACHING CERTIFICATION EXAMINATIONS, AND DISTRIBUTION OF COURSE MATERIALS AND TRAINING MATERIALS IN CONNECTION THEREWITH; ENTERTAINMENT, IN THE NATURE OF TENNIS TOURNAMENTS; SPORTS CAMPS (U.S. CLS. 100, 101 AND 107).

CAROL SPILS, EXAMINING ATTORNEY

SN 77-876,923. 974514 ALBERTA LTD., CALGARY, CANADA, FILED 11-19-2009.

EUROSTEAM GREEN

THE MARK CONSISTS OF STANDARD CHARACTERS WITHOUT CLAIM TO ANY PARTICULAR FONT, STYLE, SIZE, OR COLOR.

PRIORITY CLAIMED UNDER SEC. 44(D) ON CANADA APPLICATION NO. 1458061, FILED 11-5-2009.

OWNER OF U.S. REG. NO. 3,164,614.

NO CLAIM IS MADE TO THE EXCLUSIVE RIGHT TO USE "GREEN", APART FROM THE MARK AS SHOWN.

CLASS 7—MACHINERY

FOR (BASED ON 1(B) AND 44(D)) MULTI-PURPOSE STEAM CLEANERS; STEAM CLEANING MACHINES (U.S. CLS. 13, 19, 21, 23, 31, 34 AND 35).

CLASS 9—ELECTRICAL AND SCIENTIFIC APPARATUS

FOR (BASED ON 1(B) AND 44(D)) STEAM IRONS (U.S. CLS. 21, 23, 26, 36 AND 38).

CLASS 21—HOUSEWARES AND GLASS

FOR (BASED ON 1(B) AND 44(D)) CLEANING CLOTHS; CLEANING MITTS OF FABRIC (U.S. CLS. 2, 13, 23, 29, 30, 33, 40 AND 50).

CLASS 35—ADVERTISING AND BUSINESS

FOR (BASED ON 1(B) AND 44(D)) ARRANGING AND CONDUCTING TRADE SHOW EXHIBITIONS IN THE FIELD OF STEAM CLEANERS, STEAM IRONS, CLEANING MITTS OF FABRIC, CLEANING CLOTHS; COMPUTERIZED ON-LINE RETAIL STORE SERVICES IN THE FIELD OF STEAM CLEANERS, STEAM IRONS, CLEANING MITTS OF FABRIC, CLEANING CLOTHS; (BASED ON 1(B)) RETAIL OUTLETS FEATURING STEAM CLEANERS, STEAM IRONS, CLEANING MITTS OF FABRIC, CLEANING CLOTHS; RETAIL STORE AND ON-LINE RETAIL STORE SERVICES FEATURING STEAM CLEANERS, STEAM IRONS, CLEANING MITTS OF FABRIC, CLEANING CLOTHS (U.S. CLS. 100, 101 AND 102).

TRICIA SONNEBORN, EXAMINING ATTORNEY

SN 77-877,783. THE PEPSOM GROUP, INC., MIAMI, FL. FILED 11-20-2009.

DR. EPSOM

THE MARK CONSISTS OF STANDARD CHARACTERS WITHOUT CLAIM TO ANY PARTICULAR FONT, STYLE, SIZE, OR COLOR.

OWNER OF U.S. REG. NOS. 3,369,913 AND 3,463,108.

CLASS 3—COSMETICS AND CLEANING PREPARATIONS

FOR BATH CREAM; BATH GEL; BATH LOTION; BATH OIL; BATH SALTS; BATH SALTS; NON-MEDICATED BATH PREPARATIONS (U.S. CLS. 1, 4, 6, 50, 51 AND 52).

CLASS 5—PHARMACEUTICALS

FOR EPSOM SALTS; MEDICATED BATH SALTS (U.S. CLS. 6, 18, 44, 46, 51 AND 52).

ANNE E. GUSTASON, EXAMINING ATTORNEY

SN 77-877,895. DAVIS, MARCELLUS, PLATTE CITY, MO.
FILED 11-20-2009.

SN 77-878,768. ENERGY COST REDUCERS, LLC, MEMPHIS,
TN. FILED 11-23-2009.

DAVIS
COLLISION & TOW

NO CLAIM IS MADE TO THE EXCLUSIVE RIGHT TO USE "COLLISION & TOW", APART FROM THE MARK AS SHOWN.
SEC. 2(F).

CLASS 37—CONSTRUCTION AND REPAIR

FOR AUTOMOBILE BODY REPAIR AND FINISHING FOR OTHERS (U.S. CLS. 100, 103 AND 106).
FIRST USE 0-0-1998; IN COMMERCE 0-0-1998.

CLASS 39—TRANSPORTATION AND STORAGE

FOR VEHICLE TOWING (U.S. CLS. 100 AND 105).
FIRST USE 0-0-1998; IN COMMERCE 0-0-1998.
TAMARA FRAZIER, EXAMINING ATTORNEY

SN 77-878,154. ARMSTRONG, ELLEN C., DBA INFORMMOTION, SOMERVILLE, MA. FILED 11-21-2009.

informmotion

THE MARK CONSISTS OF STANDARD CHARACTERS WITHOUT CLAIM TO ANY PARTICULAR FONT, STYLE, SIZE, OR COLOR.

CLASS 9—ELECTRICAL AND SCIENTIFIC APPARATUS

FOR INTERACTIVE MULTIMEDIA COMPUTER PROGRAM FOR EDUCATION (U.S. CLS. 21, 23, 26, 36 AND 38).
FIRST USE 8-10-2001; IN COMMERCE 9-22-2001.

CLASS 42—SCIENTIFIC AND COMPUTER SERVICES

FOR ANIMATION AND SPECIAL-EFFECTS DESIGN FOR OTHERS (U.S. CLS. 100 AND 101).
FIRST USE 8-10-2001; IN COMMERCE 9-22-2001.
ARETHA SOMERVILLE, EXAMINING ATTORNEY

ENERGY COST REDUCERS, LLC

THE MARK CONSISTS OF STANDARD CHARACTERS WITHOUT CLAIM TO ANY PARTICULAR FONT, STYLE, SIZE, OR COLOR.

NO CLAIM IS MADE TO THE EXCLUSIVE RIGHT TO USE "ENERGY" AND "LLC", APART FROM THE MARK AS SHOWN.

CLASS 35—ADVERTISING AND BUSINESS

FOR BUSINESS CONSULTING AND ADVISORY SERVICES IN THE FIELD OF ENERGY EFFICIENCY; CONSULTATION IN THE FIELD OF ENERGY EFFICIENCY; ENERGY USAGE MANAGEMENT; ENERGY USAGE MANAGEMENT INFORMATION SERVICES; HOME ENERGY ASSESSMENT SERVICES FOR THE PURPOSE OF DETERMINING ENERGY EFFICIENCY OR USAGE MANAGEMENT; LOBBYING SERVICES, NAMELY, PROMOTING THE INTERESTS OF INTERNATIONAL, REAL ESTATE AND NONPROFIT COMPANIES IN THE FIELDS OF POLITICS, LEGISLATION, AND REGULATION (U.S. CLS. 100, 101 AND 102).
FIRST USE 8-27-2008; IN COMMERCE 8-27-2008.

CLASS 42—SCIENTIFIC AND COMPUTER SERVICES

FOR ENGINEERING SERVICES IN THE FIELD OF ENERGY EFFICIENCY; PROVIDING A WEB SITE FEATURING TECHNOLOGY THAT ENABLES USERS TO SHARE, BOOKMARK, INDEX, STORE, COLLECT AND SHOWCASE CONTENT, ARTICLES, IMAGES, CALENDARS, PRODUCTS, PROJECTS, AND OTHER INFORMATION RESOURCES IN ELECTRONIC FORM IN THE NATURE AND FIELD OF CLIMATE CHANGE AND GLOBAL WARMING AND ASSOCIATED RELATED FIELDS INCLUDING GREEN BUILDING, PLANNING, RENEWABLE ENERGY, SUSTAINABLE COMMUNITIES, CONSERVATION, AND OTHER HUMAN ACTIVITIES AFFECTING CARBON USE AND ITS IMPACTS ON THE WORLD AND THE ENVIRONMENT (U.S. CLS. 100 AND 101).

FIRST USE 8-27-2008; IN COMMERCE 8-27-2008.
SAMUEL E. SHARPER JR., EXAMINING ATTORNEY

SN 77-879,227. SUNPOWER CORPORATION, SAN JOSE, CA.
FILED 11-23-2009.

SUNPOWER

THE MARK CONSISTS OF STANDARD CHARACTERS WITHOUT CLAIM TO ANY PARTICULAR FONT, STYLE, SIZE, OR COLOR.

OWNER OF U.S. REG. NO. 2,257,938.

CLASS 35—ADVERTISING AND BUSINESS

FOR ENERGY USAGE MANAGEMENT; ENERGY USAGE MANAGEMENT INFORMATION SERVICES; HOME ENERGY ASSESSMENT SERVICES FOR THE PURPOSE OF DETERMINING ENERGY EFFICIENCY OR USAGE MANAGEMENT; INFORMATION IN THE FIELD OF ENERGY EFFICIENCY; BUSINESS CONSULTING AND ADVISORY SERVICES IN THE FIELD OF ENERGY EFFICIENCY; CONSULTATION IN THE FIELD OF ENERGY EFFICIENCY (U.S. CLS. 100, 101 AND 102).

CLASS 42—SCIENTIFIC AND COMPUTER SERVICES

FOR REMOTE MONITORING, METERING AND ANALYSIS OF ENERGY USAGE AND ENERGY MANAGEMENT SYSTEMS; ENERGY USAGE MONITORING (U.S. CLS. 100 AND 101).

TARAH HARDY, EXAMINING ATTORNEY

SN 77-879,321. PARAGON INDUSTRIES, INC., FRESNO, CA. FILED 11-23-2009.

AlysEdwards Tile & Stone

THE MARK CONSISTS OF STANDARD CHARACTERS WITHOUT CLAIM TO ANY PARTICULAR FONT, STYLE, SIZE, OR COLOR.

NO CLAIM IS MADE TO THE EXCLUSIVE RIGHT TO USE "TILE & STONE", APART FROM THE MARK AS SHOWN.

THE NAME(S), PORTRAIT(S), AND/OR SIGNATURE(S) SHOWN IN THE MARK DOES NOT IDENTIFY A PARTICULAR LIVING INDIVIDUAL.

CLASS 19—NON-METALLIC BUILDING MATERIALS

FOR ARTIFICIAL STONE; CERAMIC ENAMEL TILES; CERAMIC TILES; CERAMIC TILES FOR FLOORING AND FACING; CERAMIC TILES FOR FLOORING AND LINING; CERAMIC TILES FOR TILE FLOORS AND COVERINGS; FOOTING STONE; GRANITE; MARBLE; MOSAIC ART TILES MADE OF MARBLE; NATURAL STONE; NATURAL STONE SLABS AND TILES; NATURAL STONES THAT ARE INSCRIBED WITH A NAME, QUOTATION AND/OR PHRASE; NONSTRUCTURAL BUILDING MATERIALS, NAMELY, GRANITE USED IN DECORATIVE SURFACE APPLICATIONS FOR COUNTERTOPS AND VANITY TOPS (U.S. CLS. 1, 12, 33 AND 50).

FIRST USE 11-5-2007; IN COMMERCE 11-5-2007.

CLASS 35—ADVERTISING AND BUSINESS

FOR WHOLESALE AND RETAIL STORE SERVICES FEATURING TILE AND STONE (U.S. CLS. 100, 101 AND 102).

FIRST USE 11-5-2007; IN COMMERCE 11-5-2007.
JULIE GUTTADAURO, EXAMINING ATTORNEY

SN 77-879,755. EUROPEAN ASSOCIATION FOR THE STUDY OF THE LIVER, 8001 ZURICH, SWITZERLAND, FILED 11-24-2009.

 **EASL** | THE INTERNATIONAL LIVER CONGRESS

PRIORITY CLAIMED UNDER SEC. 44(D) ON SWITZERLAND APPLICATION NO. 590628, FILED 6-11-2009, REG. NO. 590628, DATED 8-25-2009, EXPIRES 6-11-2019.

NO CLAIM IS MADE TO THE EXCLUSIVE RIGHT TO USE "INTERNATIONAL LIVER CONGRESS", APART FROM THE MARK AS SHOWN.

THE MARK CONSISTS OF THE WORDS "EASL THE INTERNATIONAL LIVER CONGRESS" AND SEVEN HEXAGON DESIGNS.

CLASS 16—PAPER GOODS AND PRINTED MATTER

FOR PRINTED MATTER, NAMELY, NEWSLETTERS, CALENDARS, INFORMATION BROCHURES, JOURNALS AND BULLETINS IN THE FIELD OF HEALTH; PRINTED INSTRUCTIONAL AND TEACHING MATERIAL IN THE FIELD OF HEALTH (U.S. CLS. 2, 5, 22, 23, 29, 37, 38 AND 50).

CLASS 41—EDUCATION AND ENTERTAINMENT

FOR EDUCATIONAL ACTIVITIES, NAMELY, ARRANGING, CONDUCTING AND SPONSORING OF EDUCATIONAL COLLOQUIUMS, SYMPOSIUMS, SEMINARS, CONGRESSES AND CONFERENCES IN THE FIELD OF HEALTH; EDUCATION, NAMELY, TEACHING COURSES IN THE FIELD OF HEPATOLOGY; TRAINING AND EDUCATION CONSULTATION IN THE FIELD OF HEPATOLOGY (U.S. CLS. 100, 101 AND 107).

DEZMONA MIZELLE, EXAMINING ATTORNEY

SN 77-880,314. MANIATIS, FROSENE, ORINDA, CA. FILED S.R. 11-24-2009; AM. P.R. 3-2-2010.

FROSENE ON THE SCENE

THE MARK CONSISTS OF STANDARD CHARACTERS WITHOUT CLAIM TO ANY PARTICULAR FONT, STYLE, SIZE, OR COLOR.

CLASS 16—PAPER GOODS AND PRINTED MATTER

FOR COLUMNS FEATURING INFORMATION AND COMMENTARY ABOUT CULTURAL EVENTS (U.S. CLS. 2, 5, 22, 23, 29, 37, 38 AND 50).

FIRST USE 5-2-1997; IN COMMERCE 5-2-1997.

CLASS 41—EDUCATION AND ENTERTAINMENT

FOR CULTURAL AND ENTERTAINMENT SERVICES, NAMELY, PROVIDING ONLINE COLUMNS FEATURING INFORMATION AND COMMENTARY ABOUT CULTURAL EVENTS (U.S. CLS. 100, 101 AND 107).

FIRST USE 5-2-1997; IN COMMERCE 5-2-1997.
KARANENDRA S. CHHINA, EXAMINING ATTORNEY

SN 77-880,496. MEDICAL BILLING SPECIALISTS LIMITED OF FLORIDA, INC., DBA MEDICAL BILLING SPECIALISTS, LTD., PORT ORANGE, FL. FILED 11-25-2009.

Guiding your Anesthesia practice through uncertain times

THE MARK CONSISTS OF STANDARD CHARACTERS WITHOUT CLAIM TO ANY PARTICULAR FONT, STYLE, SIZE, OR COLOR.

CLASS 35—ADVERTISING AND BUSINESS

FOR MEDICAL, ANESTHESIA AND INTERVENTIONAL PAIN MEDICINE BILLING SERVICES; CONSULTING SERVICES IN THE FIELD OF MEDICAL AND ANESTHESIA PRACTICE MANAGEMENT; BUSINESS CONSULTATION SERVICES IN THE FIELD OF REGULATORY COMPLIANCE OF PROFESSIONALS IN MEDICAL AND ANESTHESIA PRACTICES; BUSINESS AUDITING SERVICES IN THE FIELD OF MEDICAL AND ANESTHESIA PRACTICES (U.S. CLS. 100, 101 AND 102).

FIRST USE 9-15-2009; IN COMMERCE 9-15-2009.

CLASS 45—PERSONAL AND LEGAL SERVICES

FOR REVIEWING STANDARDS AND PRACTICES TO ASSURE COMPLIANCE WITH THE HEALTH INSURANCE PORTABILITY AND ACCOUNTABILITY ACT (HIPAA) AND PHYSICIAN QUALITY REPORTING INITIATIVE (PQRI) IN MEDICAL AND ANESTHESIA PRACTICES; VERIFYING AND MONITORING THE CREDENTIALS OF MEDICAL PROFESSIONALS (U.S. CLS. 100 AND 101).

FIRST USE 9-15-2009; IN COMMERCE 9-15-2009.
MARC LEIPZIG, EXAMINING ATTORNEY

SN 77-880,494. MEDICAL BILLING SPECIALISTS LIMITED OF FLORIDA, INC., DBA MEDICAL BILLING SPECIALISTS, LTD., PORT ORANGE, FL. FILED 11-25-2009.



THE MARK CONSISTS OF A LIGHTHOUSE WITH WAVES AT THE BASE, WHICH HAS A BEAM OF LIGHT SHINING OUT FROM WITHIN THE TOP, AND A HALF CIRCLE ON THE LEFT SIDE, SIMULATING A SUN OR MOON.

CLASS 35—ADVERTISING AND BUSINESS

FOR MEDICAL, ANESTHESIA AND INTERVENTIONAL PAIN MEDICINE BILLING SERVICES; CONSULTING SERVICES IN THE FIELD OF MEDICAL AND ANESTHESIA PRACTICE MANAGEMENT; BUSINESS CONSULTATION SERVICES IN THE FIELD OF REGULATORY COMPLIANCE OF PROFESSIONALS IN MEDICAL AND ANESTHESIA PRACTICES; BUSINESS AUDITING SERVICES IN THE FIELD OF MEDICAL AND ANESTHESIA PRACTICES (U.S. CLS. 100, 101 AND 102).

FIRST USE 9-15-2009; IN COMMERCE 9-15-2009.

CLASS 45—PERSONAL AND LEGAL SERVICES

FOR REVIEWING STANDARDS AND PRACTICES TO ASSURE COMPLIANCE WITH THE HEALTH INSURANCE PORTABILITY AND ACCOUNTABILITY ACT (HIPAA) AND PHYSICIAN QUALITY REPORTING INITIATIVE (PQRI) IN MEDICAL AND ANESTHESIA PRACTICES; VERIFYING AND MONITORING THE CREDENTIALS OF MEDICAL PROFESSIONALS (U.S. CLS. 100 AND 101).

FIRST USE 9-15-2009; IN COMMERCE 9-15-2009.
MARC LEIPZIG, EXAMINING ATTORNEY

SN 77-880,743. MECHANICAL NATURE, LLC, COLUMBIA, SC. FILED 11-25-2009.

MECHANICAL NATURE

THE MARK CONSISTS OF STANDARD CHARACTERS WITHOUT CLAIM TO ANY PARTICULAR FONT, STYLE, SIZE, OR COLOR.

NO CLAIM IS MADE TO THE EXCLUSIVE RIGHT TO USE "MECHANICAL", APART FROM THE MARK AS SHOWN.

CLASS 14—JEWELRY

FOR JEWELRY (U.S. CLS. 2, 27, 28 AND 50).

CLASS 25—CLOTHING

FOR DRESSES; PANTS; SHIRTS (U.S. CLS. 22 AND 39).
MICHAEL GAAFAR, EXAMINING ATTORNEY

SN 77-881,485. PRESCRIPTION HEALTH NETWORK, ST. PETERSBURG, FL. FILED 11-27-2009.

SN 77-882,066. AIRCONOMY AVIATION INTELLIGENCE GMBH & CO. KG, FRANKFURT, FED REP GERMANY, FILED 11-30-2009.



THE MARK CONSISTS OF STYLIZED HUMAN SHAPE.

CLASS 35—ADVERTISING AND BUSINESS

FOR OFFERING BUSINESS MANAGEMENT ASSISTANCE IN THE ESTABLISHMENT AND/OR OPERATION OF MEDICALLY SUPERVISED WEIGHT LOSS PROGRAMS (U.S. CLS. 100, 101 AND 102).

CLASS 44—MEDICAL, BEAUTY AND AGRICULTURAL SERVICES

FOR MEDICALLY SUPERVISED WEIGHT LOSS PROGRAMS (U.S. CLS. 100 AND 101).
LINDA ORNDORFF, EXAMINING ATTORNEY

SN 77-881,947. LIFESTYLE BRANDS, LLC, ATLANTA, GA. FILED 11-30-2009.

Cool 2 Be American

THE MARK CONSISTS OF STANDARD CHARACTERS WITHOUT CLAIM TO ANY PARTICULAR FONT, STYLE, SIZE, OR COLOR.

CLASS 16—PAPER GOODS AND PRINTED MATTER

FOR BANNERS OF PAPER; BUMPER STICKERS; CALENDARS; DECALS; FLAGS AND PENNANTS OF PAPER; FLAGS OF PAPER; MONEY CLIPS; PAPER BANNERS; PAPER FLAGS; PAPER PENNANTS; POSTERS; POSTERS MADE OF PAPER; STICKERS; TEMPORARY TATTOOS (U.S. CLS. 2, 5, 22, 23, 29, 37, 38 AND 50).

CLASS 24—FABRICS

FOR BANNERS AND FLAGS OF TEXTILE; CLOTH BANNERS; CLOTH FLAGS; CLOTH PENNANTS; FABRIC FLAGS; NYLON FLAGS; TOWELS (U.S. CLS. 42 AND 50).
WILLIAM P. SHANAHAN, EXAMINING ATTORNEY



THE MARK CONSISTS OF THE WORD "AIRCONOMY" UNDER AN Y-SHAPED DEVICE THAT IS PARTLY UNDERLAPPED WITH A CIRCLE.

CLASS 35—ADVERTISING AND BUSINESS

FOR ACQUISITION AND MERGER CONSULTATION; ADVISORY SERVICES FOR PREPARING AND CARRYING OUT COMMERCIAL TRANSACTIONS; ADVISORY SERVICES RELATING TO BUSINESS MANAGEMENT AND BUSINESS OPERATIONS; ANALYSES AND APPRAISALS OF ENTERPRISES; ANALYSIS OF MARKET RESEARCH DATA AND STATISTICS; ASSISTANCE AND ADVICE REGARDING BUSINESS ORGANIZATION AND MANAGEMENT; ASSISTANCE IN MANAGEMENT OF BUSINESS ACTIVITIES; ASSISTANCE TO INDUSTRIAL OR COMMERCIAL ENTERPRISES IN THE RUNNING OF THEIR BUSINESS; ASSISTANCE WITH BUSINESS MANAGEMENT AND PLANNING; ASSISTANCE, ADVISORY SERVICES AND CONSULTANCY WITH REGARD TO BUSINESS PLANNING, BUSINESS ANALYSIS, BUSINESS MANAGEMENT, AND BUSINESS ORGANIZATION; BUSINESS ACQUISITION AND MERGER CONSULTATION; BUSINESS ADMINISTRATION AND MANAGEMENT; BUSINESS ADMINISTRATION AND OFFICE WORK; BUSINESS ADMINISTRATION CONSULTANCY; BUSINESS ADVICE AND ANALYSIS OF MARKETS; BUSINESS ADVICE AND INFORMATION; BUSINESS APPRAISAL CONSULTATION; BUSINESS APPRAISALS AND EVALUATIONS IN BUSINESS MATTERS; BUSINESS CONSULTATION SERVICES; BUSINESS DATA ANALYSIS; BUSINESS DEVELOPMENT CONSULTING SERVICES; BUSINESS EFFICIENCY ADVICE; BUSINESS INVESTIGATIONS; BUSINESS MANAGEMENT CONSULTANCY AND ADVISORY SERVICES; BUSINESS MARKETING CONSULTING SERVICES; BUSINESS OPERATION, BUSINESS ADMINISTRATION AND OFFICE FUNCTIONS; BUSINESS RELOCATION CONSULTING; COLLECTION OF MARKET RESEARCH INFORMATION; COMMERCIAL ASSISTANCE IN BUSINESS MANAGEMENT; COMMERCIAL BUSINESS MANAGEMENT; COMMERCIAL CONSULTANCY; COMPILING FINANCIAL, SECURITIES, STOCK EXCHANGE, TRADE AND QUOTE, INDEX VALUE AND OTHER FINANCIAL MARKET INFORMATION FOR BUSINESS PURPOSES; CONDUCTING BUSINESS AND MARKET RESEARCH SURVEYS; CONSULTANCY SERVICES REGARDING BUSINESS STRATEGIES; COST ANALYSES; COST PRICE ANALYSIS; ECONOMIC FORECASTING AND ANALYSIS; EVALUATIONS RELATING TO COMMERCIAL MATTERS; FINANCIAL STATEMENT PREPARATION AND ANALYSIS FOR BUSINESSES; HELP IN THE MANAGEMENT OF BUSINESS AFFAIRS OR COMMERCIAL FUNCTIONS OF AN INDUSTRIAL OR COMMERCIAL ENTERPRISE; INDUSTRIAL MANAGEMENT CONSULTATION INCLUDING COST/YIELD ANALYSES; INFORMATION AND DATA COMPILING AND ANALYZING RELATING TO BUSINESS MANAGEMENT; INFORMATION AND EXPERT OPINIONS RELATING TO COMPANIES AND BUSINESS; INFORMATION IN BUSINESS MATTERS; MARKET ANALYSIS AND RESEARCH SERVICES; PREPARING BUSINESS REPORTS; PROFESSIONAL BUSINESS CONSULTING; SERVICES COMPRISING THE RECORDING, TRANSCRIPTION, COMPOSITION, COMPILATION AND SYSTEMATIZATION OF WRITTEN COMMUNICA-

TIONS AND RECORDINGS, AS WELL AS THE COMPILATION OF MATHEMATICAL OR STATISTICAL DATA (U.S. CLS. 100, 101 AND 102).
FIRST USE 4-1-2007; IN COMMERCE 4-1-2007.

SN 77-882,764. VIERRA, DAVID A., CARMICHAEL, CA. FILED 11-30-2009.

CLASS 36—INSURANCE AND FINANCIAL

FOR FINANCIAL ADVICE AND CONSULTANCY SERVICES; FINANCIAL ANALYSIS AND CONSULTATION; INVESTMENT ADVISORY SERVICES (U.S. CLS. 100, 101 AND 102).
FIRST USE 4-1-2007; IN COMMERCE 4-1-2007.

CLASS 39—TRANSPORTATION AND STORAGE

FOR AIR CHARTER SERVICES; AIR TRANSPORT SERVICES; AIRLINE AND SHIPPING SERVICES; ARRANGING OF TOURS AND CRUISES; ARRANGING TRAVEL TOURS; CARGO HANDLING; CARGO UNLOADING; FREIGHT TRANSPORTATION BY AIR; ORGANISATION OF TRAVEL; ORGANIZATION OF TRIPS; PACKING ARTICLES FOR TRANSPORTATION; PASSENGER TRANSPORT; STORAGE OF GOODS; TOUR GUIDE SERVICES; TRAVEL AGENCY SERVICES, NAMELY, MAKING RESERVATIONS AND BOOKINGS FOR TRANSPORTATION (U.S. CLS. 100 AND 105).

CLASS 41—EDUCATION AND ENTERTAINMENT

FOR ARRANGING AND CONDUCTING BUSINESS SEMINARS IN THE FIELD OF BUSINESS MANAGEMENT AND CONSULTANCY; ARRANGING OF SEMINARS; ARRANGING PROFESSIONAL WORKSHOP AND TRAINING COURSES; PUBLICATION OF PRINTED MATTER; WRITING OF TEXTS OTHER THAN PUBLICITY TEXTS (U.S. CLS. 100, 101 AND 107).
FIRST USE 4-1-2007; IN COMMERCE 4-1-2007.
JOHN DALIER, EXAMINING ATTORNEY

SN 77-882,637. WAYNE MCDONALD LLC, DBA CHANGECAST, SAN FRANCISCO, CA. FILED 11-30-2009.

InChargeInChange

THE MARK CONSISTS OF STANDARD CHARACTERS WITHOUT CLAIM TO ANY PARTICULAR FONT, STYLE, SIZE, OR COLOR.

CLASS 16—PAPER GOODS AND PRINTED MATTER

FOR BOOKS AND RELATED MATERIALS, NAMELY, PRINTED TEACHING MATERIALS IN THE FIELD OF RECOGNIZING AND COPING WITH THE EFFECTS OF CHANGE ON INDIVIDUALS AND ORGANIZATIONS (U.S. CLS. 2, 5, 22, 23, 29, 37, 38 AND 50).

CLASS 41—EDUCATION AND ENTERTAINMENT

FOR PROFESSIONAL COACHING AND TRAINING SERVICES REGARDING THE EFFECTS OF CHANGE ON INDIVIDUALS AND ORGANIZATIONS (U.S. CLS. 100, 101 AND 107).
ELLEN PERKINS, EXAMINING ATTORNEY

KICKIN ASPHALT

THE MARK CONSISTS OF STANDARD CHARACTERS WITHOUT CLAIM TO ANY PARTICULAR FONT, STYLE, SIZE, OR COLOR.

CLASS 16—PAPER GOODS AND PRINTED MATTER

FOR PRINTED MATERIALS, NAMELY, BOOKS DOCUMENTING THE HISTORY, TRADITIONS AND ACTIVITIES RELATED TO TAILGATING, CALENDARS, POSTERS, BOOKMARKS AND STICKERS (U.S. CLS. 2, 5, 22, 23, 29, 37, 38 AND 50).

CLASS 41—EDUCATION AND ENTERTAINMENT

FOR ENTERTAINMENT SERVICES IN THE NATURE OF TELEVISION SERIES DOCUMENTING THE HISTORY, TRADITIONS, AND ACTIVITIES RELATED TO TAILGATING (U.S. CLS. 100, 101 AND 107).
JULIE VEPPUMTHARA, EXAMINING ATTORNEY

SN 77-882,768. PARAGON INDUSTRIES, INC., DBA BEDROSANS, FRESNO, CA. FILED 11-30-2009.

AlysEdwards

THE MARK CONSISTS OF STANDARD CHARACTERS WITHOUT CLAIM TO ANY PARTICULAR FONT, STYLE, SIZE, OR COLOR.

THE NAME(S), PORTRAIT(S), AND/OR SIGNATURE(S) SHOWN IN THE MARK DOES NOT IDENTIFY A PARTICULAR LIVING INDIVIDUAL.

CLASS 19—NON-METALLIC BUILDING MATERIALS

FOR ARTIFICIAL STONE; CERAMIC ENAMEL TILES; CERAMIC TILES; CERAMIC TILES FOR FLOORING AND FACING; CERAMIC TILES FOR FLOORING AND LINING; CERAMIC TILES FOR TILE FLOORS AND COVERINGS; GLASS TILES; GLAZED CERAMIC TILES; GRANITE; MARBLE; MOSAIC ART TILES MADE OF MARBLE; NATURAL STONE; NATURAL STONE SLABS AND TILES; TILES OF CERAMIC FOR WALL, FLOOR OR CEILING (U.S. CLS. 1, 12, 33 AND 50).
FIRST USE 11-5-2007; IN COMMERCE 11-5-2007.

CLASS 35—ADVERTISING AND BUSINESS

FOR RETAIL SHOPS FEATURING STONE, GRANITE, MARBLE, ARTIFICIAL STONE, VARIOUS TYPES OF TILE.; WHOLESALE AND RETAIL STORE SERVICES FEATURING STONE, GRANITE, MARBLE, ARTIFICIAL STONE, VARIOUS TYPES OF TILE (U.S. CLS. 100, 101 AND 102).
FIRST USE 11-5-2007; IN COMMERCE 11-5-2007.
JULIE GUTTADAURO, EXAMINING ATTORNEY

SN 77-882,833. SHINE-HO KNAPSACK & BAG MFG CO., LTD., TAIPEI CITY, TAIWAN, FILED 12-1-2009.



THE COLOR(S) BLACK AND ORANGE IS/ARE CLAIMED AS A FEATURE OF THE MARK.

THE MARK CONSISTS OF THREE LETTERS, "LTG". THE LETTERS "L", "T" AND THE BOTTOM HALF OF THE LETTER "G" ARE IN BLACK, WHILE THE TOP HALF OF THE LETTER "G" IS IN ORANGE.

CLASS 12—VEHICLES

FOR BICYCLE BAGS; BICYCLES AND STRUCTURAL PARTS THEREFOR; SEAT PILLAR QUICK RELEASE APPARATUS; QUICK RELEASE APPARATUS FOR LOCKING OR RELEASING A BASKET FROM A BICYCLE; BASKETS ADAPTED FOR BICYCLES; SPLASH GUARDS FOR BICYCLES; BICYCLE BELLS; BICYCLE SADDLES; BICYCLE SADDLE COVERS; BICYCLE PUMPS; BICYCLES; BICYCLE FRAMES; BICYCLE KICKSTANDS; BICYCLE BRAKES; BICYCLE CHAINS; MOTORIZED BICYCLES; BICYCLE SEAT POSTS; STEERING UNITS FOR BICYCLES; HANDLEBARS FOR BICYCLES; BICYCLE PEDALS; BICYCLE HANDLEBAR GRIPS; RIMS FOR BICYCLE WHEELS (U.S. CLS. 19, 21, 23, 31, 35 AND 44).

CLASS 18—LEATHER GOODS

FOR BACK PACKS; SCHOOL BAGS; WAIST BAGS; HANDBAGS; PET ACCESSORIES, NAMELY, SPECIALLY DESIGNED CANVAS, VINYL OR LEATHER BAGS ATTACHED TO ANIMAL LEASHES FOR HOLDING SMALL ITEMS SUCH AS KEYS, CREDIT CARDS, MONEY OR DISPOSABLE BAGS FOR DISPOSING OF PET WASTE; WHEELED SHOPPING BAGS; ATHLETIC BAGS; BAGS FOR SPORTS; CANVAS, LEATHER, MESH, REUSABLE, AND TEXTILE SHOPPING BAGS; TOOL BAGS OF LEATHER SOLD EMPTY; TRAVELING SETS, NAMELY, TRAVELING BAGS; ATTACHE CASES; RUCKSACKS FOR MOUNTAINEERS; BRIEFCASES; HUNTING BAGS; GENERAL PURPOSE BAGS FOR CARRYING YOGA EQUIPMENT; LEATHER PURSES; WALLETS; COSMETIC CASES SOLD EMPTY; LUGGAGE (U.S. CLS. 1, 2, 3, 22 AND 41).

NATALIE POLZER, EXAMINING ATTORNEY

SN 77-882,902. WILSON, REID M., COLUMBUS, OH. FILED 12-1-2009.

TWADEMARKS

THE MARK CONSISTS OF STANDARD CHARACTERS WITHOUT CLAIM TO ANY PARTICULAR FONT, STYLE, SIZE, OR COLOR.

CLASS 41—EDUCATION AND ENTERTAINMENT

FOR ON-LINE JOURNALS, NAMELY, BLOGS FEATURING CURRENT EVENTS, LEGAL DEVELOPMENTS AND OTHER GENERAL CONTENT (U.S. CLS. 100, 101 AND 107).

CLASS 45—PERSONAL AND LEGAL SERVICES

FOR LEGAL SERVICES; LEGAL SERVICES, NAMELY, PREPARATION OF APPLICATIONS FOR TRADEMARK REGISTRATION (U.S. CLS. 100 AND 101).

PAUL E. FAHRENKOPF, EXAMINING ATTORNEY

SN 77-883,040. DEAN INTELLECTUAL PROPERTY SERVICES, INC., DALLAS, TX. FILED 12-1-2009.

CINCO PUNTOS DE CONTROL DE PUREZA

THE MARK CONSISTS OF STANDARD CHARACTERS WITHOUT CLAIM TO ANY PARTICULAR FONT, STYLE, SIZE, OR COLOR.

THE ENGLISH TRANSLATION OF "CINCO PUNTOS DE CONTROL DE PUREZA" IN THE MARK IS FIVE POINT PURITY CHECKLIST.

CLASS 29—MEATS AND PROCESSED FOODS

FOR DAIRY PRODUCTS EXCLUDING ICE CREAM, ICE MILK AND FROZEN YOGURT (U.S. CL. 46).

CLASS 30—STAPLE FOODS

FOR ICE CREAM (U.S. CL. 46).
DARRYL SPRUILL, EXAMINING ATTORNEY

SN 77-883,057. JACKSON, JUNE-ELLA, S, HAYMARKET, VA. FILED 12-1-2009.

Mommies on the Mic

THE MARK CONSISTS OF STANDARD CHARACTERS WITHOUT CLAIM TO ANY PARTICULAR FONT, STYLE, SIZE, OR COLOR.

CLASS 41—EDUCATION AND ENTERTAINMENT

FOR ARRANGING, ORGANIZING, CONDUCTING, AND HOSTING SOCIAL ENTERTAINMENT EVENTS; ENTERTAINMENT IN THE NATURE OF LIVE STAGE PERFORMANCES IN THE NATURE OF POETRY AND MUSIC OR LECTURE FOR HIRE IN THE FIELD OF POETRY AND MUSIC BY AN INDIVIDUAL; ENTERTAINMENT SERVICES, NAMELY, MULTIMEDIA PRODUCTION SERVICES (U.S. CLS. 100, 101 AND 107).

CLASS 45—PERSONAL AND LEGAL SERVICES

FOR PROVIDING A SOCIAL NETWORKING WEBSITE FOR ENTERTAINMENT PURPOSES (U.S. CLS. 100 AND 101).

DARRYL SPRUILL, EXAMINING ATTORNEY

SN 77-883,361. ROHR, HELENE, MOAB, UT. FILED 12-1-2009.

I am a Homo sapiens

THE MARK CONSISTS OF STANDARD CHARACTERS WITHOUT CLAIM TO ANY PARTICULAR FONT, STYLE, SIZE, OR COLOR.

CLASS 14—JEWELRY

FOR JEWELRY (U.S. CLS. 2, 27, 28 AND 50).

CLASS 25—CLOTHING

FOR CLOTHING, NAMELY, DRESSES, SKIRTS, BLOUSES, JACKETS, COATS, FLEECE PULLOVERS, SWEATERS, JEANS, PANTS, OVERALLS, SWEAT PANTS, T-SHIRTS, POLO SHIRTS, SWEATSHIRTS, TANK TOPS, SHORTS, UNDERWEAR, BRIEFS, THERMAL UNDERWEAR, THONGS, PANTIES, SWIM SUITS, TRUNKS, YOGA PANTS, CAPRI PANTS, SPORTS BRAS, BANDANAS, SHOES, LEATHER BELTS, FABRIC BELTS, CAPS, HATS, BEANIES, VISORS (U.S. CLS. 22 AND 39).

CHARISMA HAMPTON, EXAMINING ATTORNEY

SN 77-883,527. YANYAN JI, SAN DIEGO, CA. FILED 12-1-2009.

SUVI AINOA

THE MARK CONSISTS OF STANDARD CHARACTERS WITHOUT CLAIM TO ANY PARTICULAR FONT, STYLE, SIZE, OR COLOR.

THE ENGLISH TRANSLATION OF "SUVI AINOA" IN THE MARK IS SUMMER, THE ONLY ONE.

CLASS 24—FABRICS

FOR TEXTILE AND TEXTILE GOODS, NAMELY, BED AND TABLE COVERS, COASTERS, NAPKINS, PLACE-MATS, TABLE RUNNERS, TEA TOWELS, QUILTS, CRIB LINING MATTRESS PADS, CRIB SHEET SETS, BEDDING SHEET SETS (U.S. CLS. 42 AND 50).

FIRST USE 12-1-2009; IN COMMERCE 12-1-2009.

CLASS 25—CLOTHING

FOR WOMEN'S, CHILDREN'S AND INFANTS SHIRTS, T-SHIRTS, BELTS, UNDERWEAR, SWEATERS, COATS, JEANS, SHORTS, HOSIERY, TANK TOPS, HALTER TOPS, NIGHTGOWNS, NIGHT SHIRTS, PAJAMAS, PANTS, SWEATSHIRTS, SWEATPANTS, LINGERIE, SWIMSUITS, SKIRTS, CHILDREN'S CLOTH EATING BIBS, CLOTH DIAPERS, BURP CLOTHS, BABY BIBS NOT OF PAPER, FOOTWEAR, HATS, APRONS (U.S. CLS. 22 AND 39).

FIRST USE 12-1-2009; IN COMMERCE 12-1-2009.

SUSAN LESLIE DUBOIS, EXAMINING ATTORNEY

SN 77-883,530. ELYSE C. BEC, INC., CHICAGO, IL. FILED 12-1-2009.

FEAR NO ART CHICAGO

THE MARK CONSISTS OF STANDARD CHARACTERS WITHOUT CLAIM TO ANY PARTICULAR FONT, STYLE, SIZE, OR COLOR.

NO CLAIM IS MADE TO THE EXCLUSIVE RIGHT TO USE "ART CHICAGO", APART FROM THE MARK AS SHOWN.

CLASS 25—CLOTHING

FOR T-SHIRTS (U.S. CLS. 22 AND 39).

CLASS 41—EDUCATION AND ENTERTAINMENT

FOR ENTERTAINMENT SERVICES, NAMELY, AN ON-GOING SERIES FEATURING ART PROVIDED THROUGH TV., RADIO (U.S. CLS. 100, 101 AND 107).

FIRST USE 1-1-2009; IN COMMERCE 1-11-2009.

SUSAN RICHARDS, EXAMINING ATTORNEY

SN 77-883,558. ALLISON TRANSMISSION, INC., INDIANAPOLIS, IN. FILED 12-1-2009.



OWNER OF U.S. REG. NOS. 2,686,798, 3,678,354 AND OTHERS.

NO CLAIM IS MADE TO THE EXCLUSIVE RIGHT TO USE "HYBRID", APART FROM THE MARK AS SHOWN.

THE MARK CONSISTS OF THE WORDS "ALLISON HYBRID" TO THE RIGHT OF THE LETTER "A" WITH A TRIANGLE ON EACH SIDE.

CLASS 12—VEHICLES

FOR DRIVETRAINS FOR MOTOR LAND VEHICLES (U.S. CLS. 19, 21, 23, 31, 35 AND 44).

CLASS 37—CONSTRUCTION AND REPAIR

FOR MAINTENANCE AND REPAIR OF DRIVE-TRAINS FOR LAND VEHICLES (U.S. CLS. 100, 103 AND 106).

MIDGE BUTLER, EXAMINING ATTORNEY

SN 77-883,581. ALLISON TRANSMISSION, INC., INDIANA-POLIS, IN. FILED 12-1-2009.

SN 77-883,880. CMB MEDIA LIMITED, DBA ALPHA FEMALE, LONDON, UNITED KINGDOM, FILED 12-2-2009.



OWNER OF U.S. REG. NOS. 2,686,798, 3,678,354 AND OTHERS.

NO CLAIM IS MADE TO THE EXCLUSIVE RIGHT TO USE "TRANSMISSION", APART FROM THE MARK AS SHOWN.

THE MARK CONSISTS OF THE WORDS "ALLISON TRANSMISSION OPTIMIZED" AND A SWIRL ENCOMPASSED BY AN OVAL.

CLASS 12—VEHICLES

FOR DRIVETRAINS FOR MOTOR LAND VEHICLES (U.S. CLS. 19, 21, 23, 31, 35 AND 44).

CLASS 37—CONSTRUCTION AND REPAIR

FOR MAINTENANCE AND REPAIR OF DRIVE-TRAINS FOR LAND VEHICLES (U.S. CLS. 100, 103 AND 106).

MIDGE BUTLER, EXAMINING ATTORNEY

SN 77-883,766. JUST KITE IT, BROOKLYN, NY. FILED 12-1-2009.



THE MARK CONSISTS OF THE WORDING "JUST KITE IT." AND THE STYLIZED KITE IN FORWARD MOTION FLIGHT WITH FOUR LINES ATTACHED TO THE LETTER "J" IN THE WORDING "JUST KITE IT."

CLASS 25—CLOTHING

FOR HATS; SHIRTS; SWEAT SHIRTS; T-SHIRTS (U.S. CLS. 22 AND 39).

CLASS 45—PERSONAL AND LEGAL SERVICES

FOR ON-LINE SOCIAL NETWORKING SERVICES (U.S. CLS. 100 AND 101).
JENNY PARK, EXAMINING ATTORNEY



PRIORITY CLAIMED UNDER SEC. 44(D) ON UNITED KINGDOM APPLICATION NO. REF200951485, FILED 10-19-2009.

THE COLOR(S) BLACK AND WHITE IS/ARE CLAIMED AS A FEATURE OF THE MARK.

THE MARK CONSISTS OF BLACK BACKGROUND WITH WHITE STYLISED "A'S AND THE WORDS "ALPHA FEMALE" IN BLOCK CAPS.

CLASS 35—ADVERTISING AND BUSINESS

FOR ADVERTISING AND BUSINESS SERVICES, NAMELY, PROVIDING AN ONLINE WEBSITE WHERE ADVERTISERS, MARKETERS, AND CONTENT PROVIDERS CAN INTERACT WITH USERS FOR ADVERTISING, BRANDING, AND PROMOTING KNOWLEDGE, PRODUCTS, AND SERVICES, AND TRADESHOWS, ON BEHALF OF THEMSELVES AND OTHERS, AND FOR EVALUATING AND RATING THE SAME, ALL THE FOREGOING RELEVANT TO HUMAN ACTIVITIES AFFECTING CLIMATE CHANGE AND RELATED FIELDS; ADVERTISING AND DIRECTORY SERVICES, NAMELY, PROMOTING THE SERVICES OF OTHERS BY PROVIDING A WEB PAGE FEATURING LINKS TO THE WEBSITES OF OTHERS; PROMOTION, ADVERTISING AND MARKETING OF ON-LINE WEBSITES; PROVIDING A SEARCHABLE ON-LINE ADVERTISING WEBSITE AND GUIDE FEATURING THE GOODS AND SERVICES OF OTHER VENDORS VIA THE INTERNET; PROVIDING A SEARCHABLE WEBSITE FEATURING THE GOODS AND SERVICES OF OTHER VENDORS; PROVIDING A WEBSITE FEATURING PRODUCTS AND SERVICES RATINGS OF OTHERS IN THE FIELD OF HOME CONTRACT SERVICES RECOMMENDED BY CONSUMERS; PROVIDING A WEBSITE FOR CONNECTING SELLERS WITH BUYERS; PROVIDING A WEBSITE WHERE OWNERS CAN POST ITEMS AND SERVICES AVAILABLE FOR RENT BY OTHERS; PROVIDING AN INTERNET WEBSITE PORTAL FEATURING LINKS TO MUSIC-RELATED MERCHANDISE FOR RETAIL PURPOSES; PROVISION OF SPACE ON WEBSITES FOR ADVERTISING GOODS AND SERVICES (U.S. CLS. 100, 101 AND 102).

CLASS 39—TRANSPORTATION AND STORAGE

FOR PROVIDING A WEBSITE FEATURING INFORMATION ON TRAVEL (U.S. CLS. 100 AND 105).

CLASS 42—SCIENTIFIC AND COMPUTER SERVICES

FOR HOSTING AN ONLINE WEBSITE FEATURING ARTICLES AND ADVICE FOR CAREER WOMEN, A DIRECTORY OF TOP SERVICE PROVIDERS, ABILITY TO NETWORK, ARTICLES/ PROPRIETORIAL CONTENT; PROVIDING A WEBSITE FEATURING INFORMATION IN THE FIELD OF INTERIOR DESIGN AND ARCHITECTURE FOR USE BY INTERIOR DESIGNERS AND ARCHITECTS; PROVIDING A WEBSITE THAT ENABLES USERS TO SUBSCRIBE TO COACHING, MENTORING, AND/OR EDUCATIONAL SERVICES AND TO ENABLE USERS TO AUTHOR AND PUBLISH INSTRUCTIONAL CONTENT FOR OTHERS; PROVIDING A WEBSITE THAT GIVES USERS THE ABILITY TO CREATE CUSTOMIZED WEB PAGES FEATURING USER-DEFINED INFORMATION; PROVIDING A WEBSITE THAT GIVES USERS THE ABILITY TO CREATE CUSTOMIZED WEB PAGES FEATURING USER-DEFINED PROFILES (U.S. CLS. 100 AND 101).

GIANCARLO CASTRO, EXAMINING ATTORNEY

SN 77-883,915. FAIRFIELD INDUSTRIES INCORPORATED, SUGAR LAND, TX. FILED 12-2-2009.

Z NODE

THE MARK CONSISTS OF STANDARD CHARACTERS WITHOUT CLAIM TO ANY PARTICULAR FONT, STYLE, SIZE, OR COLOR.

OWNER OF U.S. REG. NO. 3,545,186.

NO CLAIM IS MADE TO THE EXCLUSIVE RIGHT TO USE "NODE", APART FROM THE MARK AS SHOWN.

CLASS 9—ELECTRICAL AND SCIENTIFIC APPARATUS

FOR SEISMIC DETECTION AND SEISMIC DATA ACQUISITION INSTRUMENTS (U.S. CLS. 21, 23, 26, 36 AND 38).

CLASS 42—SCIENTIFIC AND COMPUTER SERVICES

FOR PROVIDING SERVICES IN THE FIELD OF EXPLORATION FOR OIL AND GAS, NAMELY, GEOPHYSICAL SURVEYS, DATA ACQUISITION AND ANALYSIS (U.S. CLS. 100 AND 101).

SAIMA MAKHDOOM, EXAMINING ATTORNEY

SN 77-883,922. FAIRFIELD INDUSTRIES INCORPORATED, SUGAR LAND, TX. FILED 12-2-2009.

Z NODE TECHNOLOGY

THE MARK CONSISTS OF STANDARD CHARACTERS WITHOUT CLAIM TO ANY PARTICULAR FONT, STYLE, SIZE, OR COLOR.

OWNER OF U.S. REG. NO. 3,545,186.

NO CLAIM IS MADE TO THE EXCLUSIVE RIGHT TO USE "NODE TECHNOLOGY", APART FROM THE MARK AS SHOWN.

CLASS 9—ELECTRICAL AND SCIENTIFIC APPARATUS

FOR SEISMIC DETECTION AND SEISMIC DATA ACQUISITION INSTRUMENTS (U.S. CLS. 21, 23, 26, 36 AND 38).

CLASS 42—SCIENTIFIC AND COMPUTER SERVICES

FOR PROVIDING SERVICES IN THE FIELD OF EXPLORATION FOR OIL AND GAS, NAMELY, GEOPHYSICAL SURVEYS, DATA ACQUISITION AND ANALYSIS (U.S. CLS. 100 AND 101).

SAIMA MAKHDOOM, EXAMINING ATTORNEY

SN 77-883,927. FAIRFIELD INDUSTRIES INCORPORATED, SUGAR LAND, TX. FILED 12-2-2009.

Z NODAL

THE MARK CONSISTS OF STANDARD CHARACTERS WITHOUT CLAIM TO ANY PARTICULAR FONT, STYLE, SIZE, OR COLOR.

OWNER OF U.S. REG. NO. 3,545,186.

NO CLAIM IS MADE TO THE EXCLUSIVE RIGHT TO USE "NODAL", APART FROM THE MARK AS SHOWN.

CLASS 9—ELECTRICAL AND SCIENTIFIC APPARATUS

FOR SEISMIC DETECTION AND SEISMIC DATA ACQUISITION INSTRUMENTS (U.S. CLS. 21, 23, 26, 36 AND 38).

CLASS 42—SCIENTIFIC AND COMPUTER SERVICES

FOR PROVIDING SERVICES IN THE FIELD OF EXPLORATION FOR OIL AND GAS, NAMELY, GEOPHYSICAL SURVEYS, DATA ACQUISITION AND ANALYSIS (U.S. CLS. 100 AND 101).

SAIMA MAKHDOOM, EXAMINING ATTORNEY

SN 77-884,069. RASQUIDES, RICARDO JOSE, MIRAMAR, FL. FILED 12-2-2009.

TECHNODNA

THE MARK CONSISTS OF STANDARD CHARACTERS WITHOUT CLAIM TO ANY PARTICULAR FONT, STYLE, SIZE, OR COLOR.

CLASS 9—ELECTRICAL AND SCIENTIFIC APPARATUS

FOR SUNGLASSES, EYEGLASSES, EYEGLASS FRAMES, CASES FOR EYEWEAR, EARPHONE CASES, PORTABLE PHONE CASES (U.S. CLS. 21, 23, 26, 36 AND 38).

CLASS 14—JEWELRY

FOR TIMEPIECES AND CHRONOMETRIC INSTRUMENTS, NAMELY, WATCHES, WRISTWATCHES, WATCH BANDS, WATCH CASES, CHRONOGRAPH FOR USE AS TIMEPIECES, CHRONOMETERS, BOXES FOR WATCHES, GOODS MADE OF PRECIOUS METALS, THEIR ALLOYS OR PLATED THEREWITH, NAMELY, JEWELRY, FASHION JEWELRY, KEY RINGS, CUFF LINKS, BRACELETS, CHARMS, NECKLACES, AND MEDALLIONS (U.S. CLS. 2, 27, 28 AND 50).
KATHERINE STOIDES, EXAMINING ATTORNEY

SN 77-884,254. PARABAL INCORPORATED, HIGHLAND, MD. FILED 12-2-2009.

PARABAL

THE MARK CONSISTS OF STANDARD CHARACTERS WITHOUT CLAIM TO ANY PARTICULAR FONT, STYLE, SIZE, OR COLOR.

THE WORDING "PARABAL" HAS NO MEANING IN A FOREIGN LANGUAGE.

CLASS 35—ADVERTISING AND BUSINESS

FOR VALUE-ADDED RESELLER SERVICES, NAMELY, DISTRIBUTORSHIP SERVICES FEATURING COMPUTER SOFTWARE THAT EXTRACTS, ORGANIZES, AND ANALYZES DATA IN FREE FORM TEXT DOCUMENTS, AND SOFTWARE THAT PROTECTS COMPUTER NETWORKS FROM WEB-BASED MALWARE AND OTHER SECURITY THREATS (U.S. CLS. 100, 101 AND 102).

FIRST USE 2-0-2009; IN COMMERCE 2-0-2009.

CLASS 42—SCIENTIFIC AND COMPUTER SERVICES

FOR COMPUTER SOFTWARE, HARDWARE, AND COMPUTER SYSTEM DESIGN SERVICES FOR EXTRACTING, ORGANIZING, AND ANALYZING DATA IN FREE FORM TEXT DOCUMENTS, AND FOR PROTECTING COMPUTER NETWORKS FROM WEB-BASED MALWARE AND OTHER SECURITY THREATS; SOFTWARE DEVELOPMENT SERVICES IN THE FIELDS OF EXTRACTING, ORGANIZING, AND ANALYZING DATA IN FREE FORM TEXT DOCUMENTS, AND PROTECTING COMPUTER NETWORKS FROM WEB-BASED MALWARE AND OTHER SECURITY THREATS; COMPUTER SOFTWARE AND INFORMATION TECHNOLOGY SYSTEMS CONSULTING SERVICES IN THE FIELDS OF EXTRACTING, ORGANIZING, AND ANALYZING DATA IN FREE FORM TEXT DOCUMENTS, AND PROTECTING COMPUTER NETWORKS FROM WEB-BASED MALWARE AND OTHER SECURITY THREATS; INFORMATION TECHNOLOGY CONSULTING SERVICES IN THE FIELD OF SOFTWARE AND SYSTEMS DESIGN RELATED TO EXTRACTING, ORGANIZING, AND ANALYZING DATA IN FREE FORM TEXT DOCUMENTS, AND PROTECTING COMPUTER NETWORKS FROM WEB-BASED MALWARE AND OTHER SECURITY THREATS (U.S. CLS. 100 AND 101).

FIRST USE 2-0-2009; IN COMMERCE 2-0-2009.
MARY ROSSMAN, EXAMINING ATTORNEY

SN 77-884,295. EAGLE MOUNTAIN INTERNATIONAL CHURCH, AKA KENNETH COPELAND MINISTRIES, FORT WORTH, TX. FILED 12-2-2009.



THE MARK CONSISTS OF A SHADED RECTANGLE WITH CURVED CORNERS CONTAINING GEOMETRIC FIGURES REPRESENTING A PERSON ENCLOSED IN A CIRCULAR DESIGN WITH THE WORDS, "LIFELINE PRACTICAL TOOLS FOR EVERYDAY NEEDS".

CLASS 9—ELECTRICAL AND SCIENTIFIC APPARATUS

FOR DIGITAL MEDIA, NAMELY, C.D.'S, DVD'S AND DOWNLOADABLE TEXT FILES FEATURING RELIGIOUS MATERIALS (U.S. CLS. 21, 23, 26, 36 AND 38).

FIRST USE 1-9-2009; IN COMMERCE 1-9-2009.

CLASS 16—PAPER GOODS AND PRINTED MATTER

FOR EDUCATIONAL PUBLICATIONS, NAMELY, BOOKS, WORKBOOKS, WORKSHEETS, JOURNALS AND SCRIPTURE CARDS IN THE FIELDS OF RELIGION AND CHRISTIAN LIVING (U.S. CLS. 2, 5, 22, 23, 29, 37, 38 AND 50).

FIRST USE 1-9-2009; IN COMMERCE 1-9-2009.

CLASS 35—ADVERTISING AND BUSINESS

FOR ADVERTISING, MARKETING AND PROMOTION SERVICES; DISSEMINATION OF ADVERTISING MATERIAL; ONLINE ADVERTISING VIA A COMPUTER COMMUNICATIONS NETWORK (U.S. CLS. 100, 101 AND 102).

FIRST USE 3-1-2009; IN COMMERCE 3-1-2009.

CLASS 41—EDUCATION AND ENTERTAINMENT

FOR EDUCATIONAL SERVICES, NAMELY, PROVIDING TEACHING IN THE FIELDS OF RELIGION AND CHRISTIAN LIVING AND DISTRIBUTION OF TRAINING MATERIALS IN CONNECTION THEREWITH (U.S. CLS. 100, 101 AND 107).

FIRST USE 1-9-2009; IN COMMERCE 1-9-2009.

WARREN L. OLANDRIA, EXAMINING ATTORNEY

SN 77-884,380. J.R. GRAHAM & ASSOCIATES, INC., MONARCH BAY, CA. FILED 12-2-2009.

THE MARK CONSISTS OF THE WORD "MONARCH" WITH THE "M" AND "H" IN CAPITAL LETTERS WITH A CROWN DESIGN ABOVE THE "N".

CLASS 8—HAND TOOLS

FOR SILVERWARE IN THE NATURE OF CUTLERY, NAMELY, FORKS, SPOONS, AND KNIVES SOLD EXCLUSIVELY IN RESTAURANT, HOTEL, AND INSTITUTIONAL CHANNELS OF TRADE; AND STAINLESS STEEL FLATWARE SOLD EXCLUSIVELY IN RESTAURANT, HOTEL, AND INSTITUTIONAL CHANNELS OF TRADE (U.S. CLS. 23, 28 AND 44).

FIRST USE 1-1-1989; IN COMMERCE 1-1-1989.

CLASS 21—HOUSEWARES AND GLASS

FOR PORCELAIN/CHINA TABLEWARE, NAMELY, PLATES, SAUCERS, AND CUPS SOLD EXCLUSIVELY IN RESTAURANT, HOTEL, AND INSTITUTIONAL CHANNELS OF TRADE; BEVERAGE GLASSWARE AND STEMWARE SOLD EXCLUSIVELY IN RESTAURANT, HOTEL, AND INSTITUTIONAL CHANNELS OF TRADE (U.S. CLS. 2, 13, 23, 29, 30, 33, 40 AND 50).

FIRST USE 4-1-2009; IN COMMERCE 4-1-2009.

JOHN DALIER, EXAMINING ATTORNEY

CLASS 5—PHARMACEUTICALS

FOR NUTRICEUTICALS FOR USE AS A DIETARY SUPPLEMENT, NUTRICEUTICALS IN CONCENTRATE FORM FOR USE AS A DIETARY SUPPLEMENT (U.S. CLS. 6, 18, 44, 46, 51 AND 52).

CLASS 32—LIGHT BEVERAGES

FOR ISOTONIC DRINKS, ISOTONIC DRINKS IN CONCENTRATE FORM, DRINKING WATER (U.S. CLS. 45, 46 AND 48).

MATTHEW PAPPAS, EXAMINING ATTORNEY

SN 77-884,556. JOSHUA LIEBLING, BELLMORE, NY. FILED 12-2-2009.

SN 77-884,478. ACTUANT CORPORATION, BUTLER, WI. FILED 12-2-2009.

UNI-LIFT

THE MARK CONSISTS OF STANDARD CHARACTERS WITHOUT CLAIM TO ANY PARTICULAR FONT, STYLE, SIZE, OR COLOR.

CLASS 7—MACHINERY

FOR POWER OPERATED JACKS (U.S. CLS. 13, 19, 21, 23, 31, 34 AND 35).

FIRST USE 12-23-1965; IN COMMERCE 12-23-1965.

CLASS 8—HAND TOOLS

FOR MANUALLY-OPERATED JACKS (U.S. CLS. 23, 28 AND 44).

FIRST USE 12-23-1965; IN COMMERCE 12-23-1965.

LAURIE KAUFMAN, EXAMINING ATTORNEY

SN 77-884,507. SKINNY NUTRITIONAL CORPORATION, BALA CYNWYD, PA. FILED 12-2-2009.

Skinny Water Zero

THE MARK CONSISTS OF STANDARD CHARACTERS WITHOUT CLAIM TO ANY PARTICULAR FONT, STYLE, SIZE, OR COLOR.

OWNER OF U.S. REG. NOS. 2,557,075, 2,650,352 AND 2,657,083.

NO CLAIM IS MADE TO THE EXCLUSIVE RIGHT TO USE "WATER", APART FROM THE MARK AS SHOWN.

LOVE AT FIRST LAUGH

THE MARK CONSISTS OF STANDARD CHARACTERS WITHOUT CLAIM TO ANY PARTICULAR FONT, STYLE, SIZE, OR COLOR.

CLASS 16—PAPER GOODS AND PRINTED MATTER

FOR GREETING CARDS, POSTERS, CALENDARS, STICKERS, NOTEPADS, PENS, PENCILS, COMIC BOOKS, PUZZLE BOOKS, NOTE CARDS, CHILDREN'S ACTIVITY BOOKS, PICTURE BOOKS; MOTIVATIONAL CARDS FEATURING ILLUSTRATIONS ALONG WITH QUOTES AND SAYINGS, WORDS OF WISDOM, IDIOMS, AND MOTIVATIONAL PHRASES; ILLUSTRATED BOOKS IN THE FIELD OF THE SCIENCE OF LAUGHTER, LOVE OF HUMOR, AND INTERPERSONAL RELATIONSHIPS; ACTIVITY BOOKS, NAMELY, WORKBOOKS IN THE FIELD OF THE SCIENCE OF LAUGHTER, LOVE OF HUMOR, AND INTERPERSONAL RELATIONSHIPS; CARTOONS, NAMELY, COMIC STRIPS (U.S. CLS. 2, 5, 22, 23, 29, 37, 38 AND 50).

CLASS 25—CLOTHING

FOR HATS, SHIRTS, PANTS, SWEATSHIRTS (U.S. CLS. 22 AND 39).

CLASS 41—EDUCATION AND ENTERTAINMENT

FOR ONLINE JOURNALS, NAMELY, BLOGS IN THE FIELD OF THE SCIENCE OF LAUGHTER, LOVE OF HUMOR, AND INTERPERSONAL RELATIONSHIPS; TELEVISION SHOW PRODUCTION; ENTERTAINMENT SERVICES, NAMELY, THE PROVISION OF CONTINUING PROGRAMS AND SEGMENTS FEATURING AN EXPLORATION OF CULTURE, INTERPERSONAL RELATIONSHIPS, LAUGHTER, AND HUMOR FROM DIFFERENT PERSPECTIVES DELIVERED BY TELEVISION, RADIO, AND THE INTERNET; PROVIDING VIDEO PODCASTS IN THE FIELD OF THE SCIENCE OF LAUGHTER, LOVE OF HUMOR, AND INTERPERSONAL RELATIONSHIPS (U.S. CLS. 100, 101 AND 107).

NICHOLAS COLEMAN, EXAMINING ATTORNEY

SN 77-884,694. THE ASSOCIATION OF BOARDING SCHOOLS, ASHEVILLE, NC. FILED 12-2-2009.

BEGIN THE ADVENTURE OF YOUR LIFE

THE MARK CONSISTS OF STANDARD CHARACTERS WITHOUT CLAIM TO ANY PARTICULAR FONT, STYLE, SIZE, OR COLOR.

OWNER OF U.S. REG. NOS. 3,016,897 AND 3,016,898.

CLASS 16—PAPER GOODS AND PRINTED MATTER

FOR EDUCATIONAL PUBLICATIONS, NAMELY, A DIRECTORY AND MAGAZINE ON THE SUBJECT OF COLLEGE PREPARATORY BOARDING SCHOOLS; NEWSLETTERS AND BROCHURES FEATURING ARTICLES AND INFORMATION ON THE SUBJECT OF COLLEGE PREPARATORY BOARDING SCHOOLS (U.S. CLS. 2, 5, 22, 23, 29, 37, 38 AND 50).

FIRST USE 10-20-2009; IN COMMERCE 10-20-2009.

CLASS 41—EDUCATION AND ENTERTAINMENT

FOR EDUCATIONAL SERVICES, NAMELY, PROVIDING AN INTERACTIVE WEB SITE FEATURING INFORMATION ON COLLEGE PREPARATORY BOARDING SCHOOLS; PROVIDING ELECTRONIC NEWSLETTERS FEATURING INFORMATION ON COLLEGE PREPARATORY BOARDING SCHOOLS; PROVIDING PROGRAMS ON THE SUBJECT OF COLLEGE PREPARATORY BOARDING SCHOOLS (U.S. CLS. 100, 101 AND 107).

FIRST USE 10-0-2009; IN COMMERCE 10-0-2009.
ARETHA SOMERVILLE, EXAMINING ATTORNEY

SN 77-884,761. IPG INTERNATIONAL PRODUCTS GROUP INC, DORAL, FL. FILED 12-2-2009.



NO CLAIM IS MADE TO THE EXCLUSIVE RIGHT TO USE "DESIGN", APART FROM THE MARK AS SHOWN.

THE COLOR(S) YELLOW, BLACK, ORANGE AND WHITE IS/ARE CLAIMED AS A FEATURE OF THE MARK.

THE MARK CONSISTS OF FOUR SQUARE BOXES; THE FIRST BOX CONTAINS A CAPITAL "N" IN BLACK AND THE REST OF THE BOX IS ORANGE. THE SECOND BOX CONTAINS A CAPITAL "Y" IN BLACK AND THE REST OF THE BOX IS YELLOW. THE THIRD BOX CONTAINS A CAPITAL "C" IN BLACK AND THE REST OF THE BOX IS ORANGE. THE FOURTH BOX CONTAINS A CAPITAL "K" IN BLACK AND THE REST OF THE BOX IS YELLOW. TO THE RIGHT OF THE FOURTH BOX IS AN IMAGE OF A KANGAROO. THE KANGAROO'S BODY IS ORANGE AND THE HEAD IS YELLOW. THE TAIL OF THE KANGAROO EXTENDS INTO THE FOURTH BOX. THERE IS A BABY KANGAROO HEAD WHOSE COLOR IS YELLOW THAT IS STICKING OUT OF THE KANGAROO'S POUCH. UNDERNEATH THE FOUR BOXES AND THE KANGAROO THERE IS A THICK ORANGE BAR THAT CONTAINS TEXT IN WHITE FONT STARTING AT THE BEGINNING OF THE FOURTH BOX AND ENDING AT THE KANGAROO THAT SAYS "INNOVATION DESIGN"

CLASS 9—ELECTRICAL AND SCIENTIFIC APPARATUS

FOR CARRYING CASES FOR MOBILE COMPUTERS; CD DRIVES FOR COMPUTERS; CD-ROM DRIVES; COMPUTER BAGS; COMPUTER DOCKING STATION; COMPUTER KEYBOARD CONTROLLERS; COMPUTER KEYBOARDS; COMPUTER KEYPADS; COMPUTER MONITORS; COMPUTER MOUSE; COMPUTER PRINTERS; EXTERNAL COMPUTER HARD DRIVES; FLOPPY DISCS DRIVES; HEADSETS FOR USE WITH COMPUTERS; KEYBOARDS; LAPTOP CARRYING CASES; LASER COLOR PRINTERS; LASER POINTERS; LOUD SPEAKERS; MOUSE PADS; MOUSEPADS; NEOPRENE LAPTOP COVERS; NOTEBOOK COMPUTER CARRYING CASES; NOTEBOOK COMPUTER COOLING PADS (U.S. CLS. 21, 23, 26, 36 AND 38).

CLASS 18—LEATHER GOODS

FOR ALL PURPOSE SPORT BAGS; ALL-PURPOSE ATHLETIC BAGS; ALL-PURPOSE CARRYING BAGS; BACKPACKS, BOOK BAGS, SPORTS BAGS, BUM BAGS, WALLETS AND HANDBAGS; CARRY-ALL BAGS; CARRY-ON BAGS; FASHION HANDBAGS; HANDBAGS; PURSES; SPORTS BAGS (U.S. CLS. 1, 2, 3, 22 AND 41).

CLASS 25—CLOTHING

FOR ATHLETIC SHOES; BEACH SHOES; CANVAS SHOES; HEELS; LEISURE SHOES; SHOES; SNEAKERS (U.S. CLS. 22 AND 39).

ERIN FALK, EXAMINING ATTORNEY

SN 77-884,924. STAPLES, NATHAN G, DBA NAUTI-DOG LLC, NEWTON, MA. FILED 12-2-2009.

NAUTI-DOG

THE MARK CONSISTS OF STANDARD CHARACTERS WITHOUT CLAIM TO ANY PARTICULAR FONT, STYLE, SIZE, OR COLOR.

OWNER OF U.S. REG. NO. 3,605,438.

CLASS 21—HOUSEWARES AND GLASS

FOR PET FEEDING AND DRINKING BOWLS (U.S. CLS. 2, 13, 23, 29, 30, 33, 40 AND 50).

FIRST USE 7-0-2007; IN COMMERCE 2-0-2008.

CLASS 28—TOYS AND SPORTING GOODS

FOR PET TOYS (U.S. CLS. 22, 23, 38 AND 50).

FIRST USE 7-0-2007; IN COMMERCE 3-0-2008.

CLASS 31—NATURAL AGRICULTURAL PRODUCTS

FOR PET TREATS (U.S. CLS. 1 AND 46).

FIRST USE 7-0-2007; IN COMMERCE 6-0-2008.

CLASS 44—MEDICAL, BEAUTY AND AGRICULTURAL SERVICES

FOR PET CARE SERVICES, NAMELY, DOG WALKING, DOG BATHING AND NON-MEDICATED PET GROOMING (U.S. CLS. 100 AND 101).

FIRST USE 7-0-2007; IN COMMERCE 1-0-2009.

ANNE FARRELL, EXAMINING ATTORNEY

SN 77-884,927. STRAWFEE LLC, FRASER, CO. FILED 12-2-2009.

SN 77-885,225. ANTEFLOW RECORDS, INC., HEISKELL, TN. FILED 12-3-2009.

Strawfee

THE MARK CONSISTS OF STANDARD CHARACTERS WITHOUT CLAIM TO ANY PARTICULAR FONT, STYLE, SIZE, OR COLOR.

CLASS 20—FURNITURE AND ARTICLES NOT OTHERWISE CLASSIFIED

FOR DRINKING STRAWS (U.S. CLS. 2, 13, 22, 25, 32 AND 50).

CLASS 21—HOUSEWARES AND GLASS

FOR COFFEE STIRRERS (U.S. CLS. 2, 13, 23, 29, 30, 33, 40 AND 50).
HEATHER BIDDULPH, EXAMINING ATTORNEY

SN 77-885,219. SATELLITE TRACKING OF PEOPLE, LLC, HOUSTON, TX. FILED 12-3-2009.

REMOVING THE ANONYMITY OF CRIME

THE MARK CONSISTS OF STANDARD CHARACTERS WITHOUT CLAIM TO ANY PARTICULAR FONT, STYLE, SIZE, OR COLOR.

CLASS 35—ADVERTISING AND BUSINESS

FOR SERVICES COMPRISING THE COMPILATION AND PROVISION OF STATISTICAL DATA TO ASSIST IN LAW ENFORCEMENT (U.S. CLS. 100, 101 AND 102).
FIRST USE 2-1-2002; IN COMMERCE 2-1-2002.

CLASS 45—PERSONAL AND LEGAL SERVICES

FOR ELECTRONIC MONITORING SERVICES FOR SECURITY PURPOSES IN THE FIELD OF CRIMINAL JUSTICE AND CRIME SCENE CORRELATION; COLLECTION, ACQUISITION AND PROVISION OF CRIMINAL AND CRIME SCENE INFORMATION, DATA, STATISTICS AND INDICES (U.S. CLS. 100 AND 101).
FIRST USE 2-1-2002; IN COMMERCE 2-2-2002.
JACQUELINE A. LAVINE, EXAMINING ATTORNEY

ANTEFLOW RECORDS

THE MARK CONSISTS OF STANDARD CHARACTERS WITHOUT CLAIM TO ANY PARTICULAR FONT, STYLE, SIZE, OR COLOR.

NO CLAIM IS MADE TO THE EXCLUSIVE RIGHT TO USE "RECORDS", APART FROM THE MARK AS SHOWN.

CLASS 9—ELECTRICAL AND SCIENTIFIC APPARATUS

FOR MUSICAL SOUND RECORDINGS, NAMELY, COMPACT DISCS FEATURING MUSIC, AND DOWNLOADABLE AND DIGITAL MUSICAL SOUND RECORDINGS (U.S. CLS. 21, 23, 26, 36 AND 38).

CLASS 41—EDUCATION AND ENTERTAINMENT

FOR ENTERTAINMENT SERVICES IN THE NATURE OF LIVE MUSICAL PERFORMANCES (U.S. CLS. 100, 101 AND 107).
JACQUELINE A. LAVINE, EXAMINING ATTORNEY

SN 77-885,269. METRO ELEVATOR CO., INC., INDIANAPOLIS, IN. FILED 12-3-2009.



NO CLAIM IS MADE TO THE EXCLUSIVE RIGHT TO USE "ELEVATOR CO., INC.", APART FROM THE MARK AS SHOWN.

THE MARK CONSISTS OF RACK AND PINION GEAR WITH THE WORDS "METRO ELEVATOR CO., INC."

CLASS 7—MACHINERY

FOR ELEVATORS; HOISTS (U.S. CLS. 13, 19, 21, 23, 31, 34 AND 35).
FIRST USE 1-1-1970; IN COMMERCE 1-1-1970.

CLASS 37—CONSTRUCTION AND REPAIR

FOR ELEVATOR INSTALLATION AND REPAIR; INSTALLATION SERVICES OF ELEVATORS AND LIFTS; REPAIR OR MAINTENANCE OF ELEVATORS (U.S. CLS. 100, 103 AND 106).
FIRST USE 1-1-1970; IN COMMERCE 1-1-1970.
JOHN WILKE, EXAMINING ATTORNEY

SN 77-885,274. BURGERS BAR LLC, CEDARHURST, NY.
FILED 12-3-2009.



NO CLAIM IS MADE TO THE EXCLUSIVE RIGHT TO USE "BURGERS BAR", APART FROM THE MARK AS SHOWN.

THE MARK CONSISTS OF THE STYLIZED DESIGN OF A HAMBURGER BELOW THE WORDING "BURGERS BAR THE PLACE TO MEAT" IN STYLIZED FONT.

CLASS 29—MEATS AND PROCESSED FOODS

FOR FRANKFURTERS; HAMBURGER; HOT DOGS; MEAT; MEAT, FROZEN; PREPARED MEAT (U.S. CL. 46).

CLASS 30—STAPLE FOODS

FOR MARINADE MIXES; MARINADES; READY-MADE SAUCES; SALAD DRESSINGS; SALAD SAUCES; SAUCES FOR BARBECUED MEAT; SPICE BLENDS (U.S. CL. 46).

JAMES MACFARLANE, EXAMINING ATTORNEY

SN 77-885,358. REACHBIO LLC, SEATTLE, WA. FILED 12-3-2009.

REACHBIO

THE MARK CONSISTS OF STANDARD CHARACTERS WITHOUT CLAIM TO ANY PARTICULAR FONT, STYLE, SIZE, OR COLOR.

CLASS 1—CHEMICALS

FOR CELLS FOR SCIENTIFIC, LABORATORY OR MEDICAL RESEARCH; REAGENTS FOR RESEARCH PURPOSES; REAGENTS FOR SCIENTIFIC OR MEDICAL RESEARCH USE; STEM CELLS FOR RESEARCH OR SCIENTIFIC PURPOSES; STEM CELLS FOR RESEARCH PURPOSES (U.S. CLS. 1, 5, 6, 10, 26 AND 46).

FIRST USE 4-7-2008; IN COMMERCE 4-7-2008.

CLASS 42—SCIENTIFIC AND COMPUTER SERVICES

FOR LABORATORY RESEARCH IN THE FIELD OF PRIMARY CELL BIOLOGY, STEM CELL BIOLOGY, TOXICOLOGY, DRUG DEVELOPMENT, RESEARCH REAGENTS, CELL CULTURE, AND THE DEVELOPMENT OF RESEARCH TOOLS FOR SAME; MEDICAL AND SCIENTIFIC RESEARCH INFORMATION IN THE FIELD OF PRIMARY CELL BIOLOGY, STEM CELL BIOLOGY, TOXICOLOGY, DRUG DEVELOPMENT, RESEARCH REAGENTS, CELLS, CELL CULTURE, AND THE DEVELOPMENT OF RESEARCH; RESEARCH AND DEVELOPMENT AND CONSULTATION RELATED THERETO IN THE FIELD OF PRIMARY CELL BIOLOGY, STEM CELL BIOLOGY, TOXICOLOGY, DRUG DEVELOPMENT, RESEARCH REAGENTS, CELLS, CELL CULTURE, AND THE DEVELOPMENT OF RESEARCH TOOLS FOR SAME (U.S. CLS. 100 AND 101).

FIRST USE 11-19-2007; IN COMMERCE 11-19-2007.
MELISSA VALLILLO, EXAMINING ATTORNEY

SN 77-885,388. THE SOAP AND DETERGENT ASSOCIATION, WASHINGTON, DC. FILED 12-3-2009.



THE MARK CONSISTS OF A BLOCK CONTAINING THREE INTERLOCKING CIRCLES AND ONE PARTIAL CIRCLE, AND THE LETTERS "aci" IN LOWER CASE DIRECTLY BELOW, WHEREIN THE "c" IS IN DARKER SHADING SLIGHTLY OVERLAPPING THE LETTER "a" AND THE DOT IN THE LETTER "i" IS BETWEEN THE LETTERS "c" AND "i".

CLASS 35—ADVERTISING AND BUSINESS

FOR ARRANGING AND CONDUCTING TRADE SHOWS IN THE FIELD OF THE CLEANING PRODUCTS AND OLEOCHEMICAL INDUSTRIES; ASSOCIATION SERVICES, NAMELY, PROMOTING THE INTERESTS OF MANUFACTURERS OF CLEANING PRODUCTS AND OLEOCHEMICALS; LOBBYING SERVICES, NAMELY, PROMOTING THE INTERESTS OF MANUFACTURERS OF CLEANING PRODUCTS AND OLEOCHEMICALS IN THE FIELDS OF LEGISLATION AND REGULATION; PUBLIC RELATIONS (U.S. CLS. 100, 101 AND 102).

CLASS 41—EDUCATION AND ENTERTAINMENT

FOR EDUCATION INFORMATION (U.S. CLS. 100, 101 AND 107).

CLASS 42—SCIENTIFIC AND COMPUTER SERVICES

FOR SCIENTIFIC RESEARCH (U.S. CLS. 100 AND 101).

REBECCA EISINGER, EXAMINING ATTORNEY

SN 77-885,393. PACKARD MEDIA GROUP LLC, WOODBRIDGE, VA. FILED 12-3-2009.

SN 77-885,504. COURTNEY WATKINS, LOS ANGELES, CA. FILED 12-3-2009.

The Washington Guardian

THE MARK CONSISTS OF STANDARD CHARACTERS WITHOUT CLAIM TO ANY PARTICULAR FONT, STYLE, SIZE, OR COLOR.

NO CLAIM IS MADE TO THE EXCLUSIVE RIGHT TO USE "WASHINGTON", APART FROM THE MARK AS SHOWN.

CLASS 16—PAPER GOODS AND PRINTED MATTER

FOR NEWSPAPERS (U.S. CLS. 2, 5, 22, 23, 29, 37, 38 AND 50).

CLASS 38—COMMUNICATION

FOR BROADCASTING OF RADIO AND TELEVISION PROGRAMMES; BROADCASTING OF VIDEO AND AUDIO PROGRAMMING OVER THE INTERNET; BROADCASTING SERVICES, NAMELY, TRANSMISSION OF ADVERTISING PROGRAMS AND MEDIA ADVERTISING COMMUNICATIONS VIA DIGITAL COMMUNICATIONS NETWORKS (U.S. CLS. 100, 101 AND 104).

LAKEISHA LEWIS, EXAMINING ATTORNEY

SN 77-885,493. SUPER DUPER INC., DBA SUPER DUPER PUBLICATIONS, GREENVILLE, SC. FILED 12-3-2009.

SAY AND DO

THE MARK CONSISTS OF STANDARD CHARACTERS WITHOUT CLAIM TO ANY PARTICULAR FONT, STYLE, SIZE, OR COLOR.

CLASS 16—PAPER GOODS AND PRINTED MATTER

FOR PRINTED TEACHING MATERIALS FOR PRESCHOOLERS PRIMARILY IN THE AREA OF LANGUAGE AND ARTICULATION, NAMELY, WORKBOOKS AND FLASH CARDS (U.S. CLS. 2, 5, 22, 23, 29, 37, 38 AND 50).

FIRST USE 0-0-1987; IN COMMERCE 0-0-1987.

CLASS 28—TOYS AND SPORTING GOODS

FOR EQUIPMENT SOLD AS A UNIT FOR PLAYING EDUCATIONAL GAMES, CONSISTING PRIMARILY OF BOARD GAMES, WORKBOOKS, AND FLASH CARDS (U.S. CLS. 22, 23, 38 AND 50).

FIRST USE 0-0-1987; IN COMMERCE 0-0-1987.

DAVID C. REIHNER, EXAMINING ATTORNEY

THE POSSIBILITY SHOP

THE MARK CONSISTS OF STANDARD CHARACTERS WITHOUT CLAIM TO ANY PARTICULAR FONT, STYLE, SIZE, OR COLOR.

NO CLAIM IS MADE TO THE EXCLUSIVE RIGHT TO USE "SHOP", APART FROM THE MARK AS SHOWN.

CLASS 16—PAPER GOODS AND PRINTED MATTER

FOR ART PAPER; ARTISTS' BRUSHES; ARTISTS' PASTELS; ARTISTS' PENCILS; ARTISTS' PENS; BOOK BINDING MATERIALS; BOOK-COVER PAPER; BOOK-BINDING MATERIALS FOR CREATING HARDCOVER BOOKS, NAMELY, BOOK COVERS, CRACK-AND-PEEL BINDING PAPER, REINFORCEMENT STRIPS, PEEL-AND-STICK LABELS, STAPLER AND STAPLES; CALLIGRAPHY PAPER; CHILDREN'S ARTS AND CRAFTS PAPER KITS; CONSTRUCTION PAPER; CRAFT PAPER; CREPE PAPER; DRAWING MATERIALS FOR BLACKBOARDS; MODELING MATERIALS AND COMPOUNDS FOR USE BY CHILDREN; MODELING MATERIALS FOR USE IN MAKING CAST PAPER SCULPTURED FLOWERS; MOLDS FOR MODELING CLAYS; MOULDS FOR MODELLING CLAYS; PACKAGED KITS COMPRISING PRINTED INSTRUCTIONAL, EDUCATIONAL, AND TEACHING MATERIALS FOR EDUCATIONAL ACTIVITIES IN THE FIELD OF EDUCATION; PAPER; PAPER AND CARDBOARD; PAPER STATIONERY; PUBLICATION PAPER; STATIONERY WRITING PAPER AND ENVELOPES (U.S. CLS. 2, 5, 22, 23, 29, 37, 38 AND 50).

CLASS 28—TOYS AND SPORTING GOODS

FOR CHILDREN'S MULTIPLE ACTIVITY TOYS SOLD AS A UNIT WITH PRINTED BOOKS; DRAWING TOYS; MANIPULATIVE GAMES; MEMORY GAMES; PLAYTHINGS, NAMELY, PUPPET THEATRES; SKETCHING TOYS (U.S. CLS. 22, 23, 38 AND 50).

CLASS 35—ADVERTISING AND BUSINESS

FOR ADVERTISEMENT AND PUBLICITY SERVICES BY TELEVISION, RADIO, MAIL; ADVERTISING AND ADVERTISEMENT SERVICES; ADVERTISING AND MARKETING; ADVERTISING AND PUBLICITY SERVICES (U.S. CLS. 100, 101 AND 102).

CLASS 41—EDUCATION AND ENTERTAINMENT

FOR EDUCATION AND ENTERTAINMENT SERVICES, NAMELY, PRODUCTION AND DISTRIBUTION OF ONGOING TELEVISION PROGRAMS IN THE FIELD OF FAMILY MANAGEMENT AND RELATIONSHIPS; EDUCATION INFORMATION; EDUCATION SERVICES IN THE NATURE OF EARLY CHILDHOOD INSTRUCTION; ENTERTAINMENT AND EDUCATION SERVICES IN THE NATURE OF LIVE DANCE AND MUSICAL PERFORMANCES (U.S. CLS. 100, 101 AND 107).

SAMUEL E. SHARPER JR., EXAMINING ATTORNEY

SN 77-885,615. IMAGO DEI INC, WEDDINGTON, NC. FILED 12-3-2009.

SN 77-885,704. NEWTEK BUSINESS SERVICES, INC., NEW YORK, NY. FILED 12-3-2009.

IMAGO DEI

THE MARK CONSISTS OF STANDARD CHARACTERS WITHOUT CLAIM TO ANY PARTICULAR FONT, STYLE, SIZE, OR COLOR.

THE ENGLISH TRANSLATION OF "IMAGO DEI" IS "IMAGE OF GOD".

CLASS 18—LEATHER GOODS

FOR ALL PURPOSE SPORT BAGS; ALL-PURPOSE CARRYING BAGS; COSMETIC BAGS SOLD EMPTY; GENERAL PURPOSE SPORT TROLLEY BAGS; POCKET-BOOKS; SHOULDER BAGS (U.S. CLS. 1, 2, 3, 22 AND 41).

CLASS 25—CLOTHING

FOR ATHLETIC APPAREL, NAMELY, SHIRTS, PANTS, JACKETS, FOOTWEAR, HATS AND CAPS, ATHLETIC UNIFORMS; BELTS FOR CLOTHING; BRAS; EVENING DRESSES; FOOTWEAR; GLOVES; PAJAMAS; PANTS; SHIRTS; SHOES; SKIRTS AND DRESSES; SOCKS AND STOCKINGS; TOPS; UNDERWEAR; WOMEN'S SHOES (U.S. CLS. 22 AND 39).

ANDREW LEASER, EXAMINING ATTORNEY

SN 77-885,626. BASF SE, LUDWIGSHAFEN AM RHEIN, FED REP GERMANY, FILED 12-3-2009.

CELLIONICS

THE MARK CONSISTS OF STANDARD CHARACTERS WITHOUT CLAIM TO ANY PARTICULAR FONT, STYLE, SIZE, OR COLOR.

CLASS 1—CHEMICALS

FOR CHEMICAL PRODUCTS FOR INDUSTRIAL PURPOSES, NAMELY, SOLUTIONS OF CELLULOSE IN IONIC LIQUIDS (U.S. CLS. 1, 5, 6, 10, 26 AND 46).

CLASS 42—SCIENTIFIC AND COMPUTER SERVICES

FOR PROVIDING TECHNICAL ADVICE ON THE USE OF SOLUTIONS OF CELLULOSE IN IONIC LIQUIDS (U.S. CLS. 100 AND 101).

SEAN CROWLEY, EXAMINING ATTORNEY

NEWTEK BUSINESS SOLUTIONS

THE MARK CONSISTS OF STANDARD CHARACTERS WITHOUT CLAIM TO ANY PARTICULAR FONT, STYLE, SIZE, OR COLOR.

OWNER OF U.S. REG. NOS. 3,318,058 AND 3,547,273.

NO CLAIM IS MADE TO THE EXCLUSIVE RIGHT TO USE "BUSINESS SOLUTIONS", APART FROM THE MARK AS SHOWN.

CLASS 9—ELECTRICAL AND SCIENTIFIC APPARATUS

FOR DOWNLOADABLE COMPUTER SOFTWARE FOR USE IN COLLECTING, MAINTAINING, TRACKING, AND SHARING FINANCIAL INFORMATION AND LOAN INFORMATION AND DATA (U.S. CLS. 21, 23, 26, 36 AND 38).

CLASS 42—SCIENTIFIC AND COMPUTER SERVICES

FOR PROVIDING TEMPORARY USE OF ON-LINE NON-DOWNLOADABLE SOFTWARE FOR USE IN COLLECTING, MAINTAINING, TRACKING, AND SHARING FINANCIAL INFORMATION AND LOAN INFORMATION AND DATA; PROVIDING TEMPORARY USE OF ON-LINE NON-DOWNLOADABLE SOFTWARE TO ALLOW CUSTOMERS TO ACCESS FINANCIAL AND LOAN INFORMATION AND DATA; ON-LINE NON-DOWNLOADABLE CLOUD COMPUTING FEATURING SOFTWARE FOR USE IN COLLECTING, MAINTAINING, TRACKING, AND SHARING FINANCIAL INFORMATION AND LOAN INFORMATION AND DATA (U.S. CLS. 100 AND 101).

SHAUNIA CARLYLE, EXAMINING ATTORNEY

SN 77-885,712. NEWTEK BUSINESS SERVICES, INC., NEW YORK, NY. FILED 12-3-2009.



OWNER OF U.S. REG. NOS. 3,318,058 AND 3,454,308.

THE MARK CONSISTS OF THE WORDING "NEWTEK" WITH THE WORDING REFLECTED BENEATH. A STYLIZED NEWT WEARING A T-SHIRT WITH THE TERM "NEWT" ON IT STANDS TO THE LEFT OF THE LETTER "N".

CLASS 9—ELECTRICAL AND SCIENTIFIC APPARATUS

FOR DOWNLOADABLE COMPUTER SOFTWARE FOR USE IN COLLECTING, MAINTAINING, TRACKING, AND SHARING FINANCIAL INFORMATION AND LOAN INFORMATION AND DATA (U.S. CLS. 21, 23, 26, 36 AND 38).

CLASS 42—SCIENTIFIC AND COMPUTER SERVICES

FOR PROVIDING TEMPORARY USE OF ON-LINE NON-DOWNLOADABLE SOFTWARE FOR USE IN COLLECTING, MAINTAINING, TRACKING, AND SHARING FINANCIAL INFORMATION AND LOAN INFORMATION AND DATA; PROVIDING TEMPORARY USE OF ON-LINE NON-DOWNLOADABLE SOFTWARE TO ALLOW CUSTOMERS TO ACCESS FINANCIAL AND LOAN INFORMATION AND DATA; ON-LINE NON-DOWNLOADABLE CLOUD COMPUTING FEATURING SOFTWARE FOR USE IN COLLECTING, MAINTAINING, TRACKING, AND SHARING FINANCIAL INFORMATION AND LOAN INFORMATION AND DATA (U.S. CLS. 100 AND 101).

SHAUNIA CARLYLE, EXAMINING ATTORNEY

SN 77-885,750. MICHAEL OWEN, BALTIMORE, MD. FILED 12-3-2009.



THE MARK CONSISTS OF SILHOUETTE OF HANDS AND WRISTS LOOSELY FORMING THE WORD LOVE.

CLASS 25—CLOTHING

FOR CLOTHING, NAMELY, SHIRTS AND T-SHIRTS (U.S. CLS. 22 AND 39).

FIRST USE 11-1-2007; IN COMMERCE 11-30-2007.

CLASS 41—EDUCATION AND ENTERTAINMENT

FOR PUBLIC ART EXHIBITIONS (U.S. CLS. 100, 101 AND 107).

FIRST USE 11-1-2007; IN COMMERCE 11-30-2007.

PAUL E. FAHRENKOPF, EXAMINING ATTORNEY

SN 77-885,794. SYNTHETIC TURF PRODUCTS, LAS VEGAS, NV. FILED 12-3-2009.



NO CLAIM IS MADE TO THE EXCLUSIVE RIGHT TO USE "GREEN" AND "SERVICES", APART FROM THE MARK AS SHOWN.

THE MARK CONSISTS OF A TRIANGULAR SHAPED ROOF OVER THE TOP OF THE MARK WITH A LINE OF GRASS ON THE BOTTOM BELOW AND THE STYLIZED TEXT "GREEN LIVING SERVICES".

CLASS 9—ELECTRICAL AND SCIENTIFIC APPARATUS

FOR SOLAR PANELS FOR PRODUCTION OF ELECTRICITY (U.S. CLS. 21, 23, 26, 36 AND 38).

CLASS 44—MEDICAL, BEAUTY AND AGRICULTURAL SERVICES

FOR LANDSCAPE DESIGN; LANDSCAPE GARDENING (U.S. CLS. 100 AND 101).

FIRST USE 4-1-2009; IN COMMERCE 4-1-2009.

AMY HELLA, EXAMINING ATTORNEY

SN 77-885,818. FEEVA TECHNOLOGY INC., SAN FRANCISCO, CA. FILED 12-3-2009.

MediaEnabler

THE MARK CONSISTS OF STANDARD CHARACTERS WITHOUT CLAIM TO ANY PARTICULAR FONT, STYLE, SIZE, OR COLOR.

CLASS 35—ADVERTISING AND BUSINESS

FOR ON-LINE ADVERTISING SERVICES FOR OTHERS (U.S. CLS. 100, 101 AND 102).

CLASS 38—COMMUNICATION

FOR STREAMING OF VIDEO MATERIAL ON THE INTERNET (U.S. CLS. 100, 101 AND 104).

JOHN DWYER, EXAMINING ATTORNEY

SN 77-885,835. HEIFER PROJECT INTERNATIONAL, LITTLE ROCK, AR. FILED 12-3-2009.

HEIFER HOPE

THE MARK CONSISTS OF STANDARD CHARACTERS WITHOUT CLAIM TO ANY PARTICULAR FONT, STYLE, SIZE, OR COLOR.

OWNER OF U.S. REG. NOS. 2,235,711, 2,831,229 AND 3,220,895.

NO CLAIM IS MADE TO THE EXCLUSIVE RIGHT TO USE "HEIFER", APART FROM THE MARK AS SHOWN.

CLASS 36—INSURANCE AND FINANCIAL

FOR CHARITABLE FUND RAISING SERVICES (U.S. CLS. 100, 101 AND 102).

CLASS 41—EDUCATION AND ENTERTAINMENT

FOR EDUCATIONAL SERVICES, NAMELY, CONDUCTING CLASSES, SEMINARS, AND INDIVIDUAL INSTRUCTION IN ENVIRONMENTAL TRAINING, NAMELY, SUSTAINABLE AGRICULTURE OR ANIMAL HUSBANDRY (U.S. CLS. 100, 101 AND 107).
STEVEN JACKSON, EXAMINING ATTORNEY

SN 77-885,859. SPICEWORKS, INC., AUSTIN, TX. FILED 12-3-2009.

It's Everything IT

THE MARK CONSISTS OF STANDARD CHARACTERS WITHOUT CLAIM TO ANY PARTICULAR FONT, STYLE, SIZE, OR COLOR.
NO CLAIM IS MADE TO THE EXCLUSIVE RIGHT TO USE "IT", APART FROM THE MARK AS SHOWN.

CLASS 9—ELECTRICAL AND SCIENTIFIC APPARATUS

FOR COMPUTER SOFTWARE FOR ADMINISTRATION OF COMPUTER NETWORKS; COMPUTER SOFTWARE FOR NETWORK MANAGEMENT, NAMELY, INVENTORYING, MONITORING AND REPORTING ON A NETWORK AND RUNNING AN INFORMATION TECHNOLOGY (IT) HELP DESK (U.S. CLS. 21, 23, 26, 36 AND 38).
FIRST USE 9-1-2009; IN COMMERCE 9-1-2009.

CLASS 38—COMMUNICATION

FOR PROVIDING ON-LINE FORUMS FOR TRANSMISSION OF MESSAGES AMONG COMPUTER USERS CONCERNING INFORMATION TECHNOLOGY (IT) (U.S. CLS. 100, 101 AND 104).
FIRST USE 9-1-2009; IN COMMERCE 9-1-2009.
ESTHER BELENKER, EXAMINING ATTORNEY

SN 77-885,923. BLASER, MELISSA, BOULDER, CO. AND DIDOMENICANTONIO, KIMBERLY, TORRANCE, CA. FILED 12-4-2009.

Healthy, Holistic and Hot

THE MARK CONSISTS OF STANDARD CHARACTERS WITHOUT CLAIM TO ANY PARTICULAR FONT, STYLE, SIZE, OR COLOR.

CLASS 16—PAPER GOODS AND PRINTED MATTER

FOR A SERIES OF BOOKS AND WRITTEN ARTICLES IN THE FIELD OF HOLISTIC HEALTH; PUBLICATIONS, NAMELY, BOOKS, ARTICLES IN THE FIELDS OF HOLISTIC HEALTH; SERIES OF NON-FICTION BOOKS IN THE FIELD OF HOLISTIC HEALTH BOOKS (U.S. CLS. 2, 5, 22, 23, 29, 37, 38 AND 50).

CLASS 41—EDUCATION AND ENTERTAINMENT

FOR (BASED ON USE IN COMMERCE) ON-LINE JOURNALS, NAMELY, BLOGS FEATURING HOLISTIC HEALTH(BASED ON INTENT TO USE) ENTERTAINMENT AND EDUCATIONAL SERVICES, NAMELY, THE PRESENTATION OF SEMINARS, LECTURES, WORKSHOPS AND PANEL DISCUSSIONS, AND ONGOING TELEVISION AND RADIO TALK SHOWS ALL IN THE FIELD OF PUBLIC INTEREST CONCERNING HOLISTIC HEALTH; ENTERTAINMENT IN THE NATURE OF ONGOING TELEVISION PROGRAMS IN THE FIELD OF HOLISTIC HEALTH; ENTERTAINMENT SERVICES IN THE NATURE OF AN ON-GOING REALITY BASED TELEVISION PROGRAM; ENTERTAINMENT SERVICES, NAMELY, AN ON-GOING SERIES FEATURING HOLISTIC HEALTH PROVIDED THROUGH TELEVISION AND WEBCASTS; ENTERTAINMENT, NAMELY, A CONTINUING HOLISTIC HEALTH SHOW BROADCAST OVER TELEVISION, SATELLITE, AUDIO, AND VIDEO MEDIA; ENTERTAINMENT, NAMELY, A CONTINUING HOLISTIC HEALTH SHOW BROADCAST OVER TELEVISION AND WEBCASTS; PUBLICATION OF BOOKS, OF MAGAZINES, OF JOURNALS, OF NEWSPAPERS, OF PERIODICALS, OF CATALOGS, OF BROCHURES; PUBLICATION OF HOLISTIC HEALTH BOOKS; PUBLISHING OF JOURNALS, BOOKS AND HANDBOOKS IN THE FIELD OF MEDICINE (U.S. CLS. 100, 101 AND 107).
FIRST USE 2-1-2009; IN COMMERCE 2-1-2009.

CLASS 44—MEDICAL, BEAUTY AND AGRICULTURAL SERVICES

FOR INFORMATION IN THE FIELD OF PARENTING CONCERNING THE HEALTH OF CHILDREN; PROVIDING A INTERACTIVE HOLISTIC WEB SITE FEATURING HEALTH INFORMATION AND PATIENT INITIATED, PATIENT AUTHORIZED, FEE-FOR-SERVICE, HOLISTIC APPROACH DISTANCE HEALING SESSIONS BASED ON THE PATIENT'S SPECIFIC SET OF SYMPTOMS, MEDICAL PROFILE AND MEDICAL RECORD ANALYSIS AND PATIENT BENEFIT INFORMATION CONCERNING ORGANIC AND HOLISTIC PRODUCTS AND SERVICES; PROVIDING A WEB SITE FEATURING INFORMATION IN THE FIELD OF MENTAL HEALTH AND PHYSICAL HEALTH, INCLUDING LIVING A HEALTHY AND DISEASE FREE LIFE; PROVIDING A WEB SITE FEATURING INFORMATION ON HEALTH AND NUTRITION; PROVIDING A WEBSITE FEATURING INFORMATION CONCERNING ALTERNATIVE HEALTH AND HEALING; PROVIDING HEALTH INFORMATION (U.S. CLS. 100 AND 101).
FIRST USE 2-1-2009; IN COMMERCE 2-1-2009.
KELLEY WELLS, EXAMINING ATTORNEY

SN 77-885,948. AGILITY SPORTS LLC, GRAND RAPIDS, MI. FILED 12-4-2009.

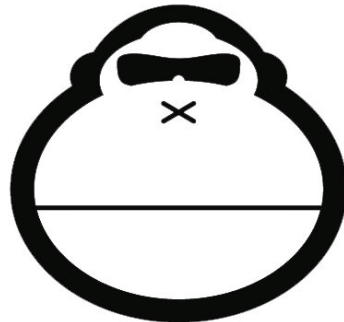

THE MARK CONSISTS OF A CARTOON DRAWING OF THE HEAD OF A MONKEY.

CLASS 3—COSMETICS AND CLEANING PREPARATIONS

FOR SUNSCREEN CREAM (U.S. CLS. 1, 4, 6, 50, 51 AND 52).

CLASS 16—PAPER GOODS AND PRINTED MATTER

FOR STICKERS (U.S. CLS. 2, 5, 22, 23, 29, 37, 38 AND 50).

CLASS 25—CLOTHING

FOR FOOTWEAR; HEADWEAR; SHORTS; SWEAT SHIRTS; T-SHIRTS (U.S. CLS. 22 AND 39).

CLASS 28—TOYS AND SPORTING GOODS

FOR TOY ANIMALS (U.S. CLS. 22, 23, 38 AND 50).
SANJEEV VOHRA, EXAMINING ATTORNEY

SN 77-885,955. AGILITY SPORTS LLC, GRAND RAPIDS, MI. FILED 12-4-2009.

SUN BUM

THE MARK CONSISTS OF STANDARD CHARACTERS WITHOUT CLAIM TO ANY PARTICULAR FONT, STYLE, SIZE, OR COLOR.

OWNER OF U.S. REG. NO. 3,572,365.

CLASS 16—PAPER GOODS AND PRINTED MATTER

FOR STICKERS (U.S. CLS. 2, 5, 22, 23, 29, 37, 38 AND 50).

CLASS 25—CLOTHING

FOR FOOTWEAR; HEADWEAR; SHORTS; SWEAT SHIRTS; T-SHIRTS (U.S. CLS. 22 AND 39).

CLASS 28—TOYS AND SPORTING GOODS

FOR TOY ANIMALS (U.S. CLS. 22, 23, 38 AND 50).
SANJEEV VOHRA, EXAMINING ATTORNEY

SN 77-885,953. AGILITY SPORTS LLC, GRAND RAPIDS, MI. FILED 12-4-2009.

TRUST THE BUM

THE MARK CONSISTS OF STANDARD CHARACTERS WITHOUT CLAIM TO ANY PARTICULAR FONT, STYLE, SIZE, OR COLOR.

OWNER OF U.S. REG. NO. 3,572,365.

CLASS 3—COSMETICS AND CLEANING PREPARATIONS

FOR SUNSCREEN CREAM (U.S. CLS. 1, 4, 6, 50, 51 AND 52).

CLASS 16—PAPER GOODS AND PRINTED MATTER

FOR STICKERS (U.S. CLS. 2, 5, 22, 23, 29, 37, 38 AND 50).

CLASS 25—CLOTHING

FOR FOOTWEAR; HEADWEAR; SHORTS; SWEAT SHIRTS; T-SHIRTS (U.S. CLS. 22 AND 39).

CLASS 28—TOYS AND SPORTING GOODS

FOR TOY ANIMALS (U.S. CLS. 22, 23, 38 AND 50).
SANJEEV VOHRA, EXAMINING ATTORNEY

SN 77-885,995. BYD COMPANY LIMITED, SHENZHEN, 518118, CHINA, FILED 12-4-2009.

BYD AUTO

THE MARK CONSISTS OF STANDARD CHARACTERS WITHOUT CLAIM TO ANY PARTICULAR FONT, STYLE, SIZE, OR COLOR.

OWNER OF U.S. REG. NOS. 3,340,327, 3,431,429 AND OTHERS.

NO CLAIM IS MADE TO THE EXCLUSIVE RIGHT TO USE "AUTO", APART FROM THE MARK AS SHOWN.

THE WORDING "BYD" HAS NO MEANING IN A FOREIGN LANGUAGE.

CLASS 12—VEHICLES

FOR LAND MOTOR VEHICLES, NAMELY, AUTOMOBILES AND THEIR STRUCTURAL PARTS (U.S. CLS. 19, 21, 23, 31, 35 AND 44).

CLASS 35—ADVERTISING AND BUSINESS

FOR AUTOMOBILE DEALERSHIPS (U.S. CLS. 100, 101 AND 102).

CLASS 37—CONSTRUCTION AND REPAIR

FOR AUTOMOTIVE MAINTENANCE AND REPAIR SERVICES (U.S. CLS. 100, 103 AND 106).

CLASS 39—TRANSPORTATION AND STORAGE

FOR AUTOMOBILE RENTAL SERVICES (U.S. CLS. 100 AND 105).
JESSICA A. POWERS, EXAMINING ATTORNEY

SN 77-886,134. LOWE'S FOOD STORES, INC., WINSTON-SALEM, NC. FILED 12-4-2009.

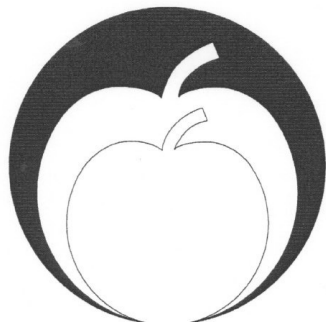

THE MARK CONSISTS OF THE REPRESENTATION OF A SMALL APPLE INSIDE OF A LARGER APPLE WITH BOTH APPLES WITHIN A CIRCLE.

CLASS 9—ELECTRICAL AND SCIENTIFIC APPARATUS

FOR MAGNETICALLY ENCODED PLASTIC LOYALTY REWARD CARDS (U.S. CLS. 21, 23, 26, 36 AND 38).

FIRST USE 10-7-2009; IN COMMERCE 10-7-2009.

CLASS 35—ADVERTISING AND BUSINESS

FOR RETAIL GROCERY STORE LOYALTY INCENTIVE REWARDS PROGRAM WHICH ENABLES A PURCHASER TO EARN REWARDS AND REDEEM THE REWARDS, TO PROMOTE THE SALE OF FOOD PRODUCTS, HOUSEHOLD ITEMS, HEALTH AND BEAUTY PRODUCTS, AND GENERAL MERCHANDISE (U.S. CLS. 100, 101 AND 102).

FIRST USE 10-7-2009; IN COMMERCE 10-7-2009.
HOWARD B. LEVINE, EXAMINING ATTORNEY

SN 77-886,220. WALTON FACILITIES MANAGEMENT, INC., CALABASAS, CA. FILED 12-4-2009.



THE COLOR(S) CHARTREUSE, LIGHT BLUE, WHITE AND DARK GRAY IS/ARE CLAIMED AS A FEATURE OF THE MARK.

THE MARK CONSISTS OF TWO TRIANGLES, ONE OF WHICH IS CHARTREUSE AND THE OTHER LIGHT BLUE, WITHIN A WHITE BOX-SHAPED BACKGROUND WITH SHAVED OFF EDGES, SURROUNDED BY DARK GRAY SHADOWING.

CLASS 44—MEDICAL, BEAUTY AND AGRICULTURAL SERVICES

FOR LANDSCAPE DESIGN; LANDSCAPE GARDENING (U.S. CLS. 100 AND 101).

CLASS 45—PERSONAL AND LEGAL SERVICES

FOR SECURITY GUARD SERVICES (U.S. CLS. 100 AND 101).

GEORGE LORENZO, EXAMINING ATTORNEY

SN 77-886,237. CONEXIA, S.A., BUENOS AIRES, ARGENTINA, FILED 12-4-2009.

CONEXIA

THE MARK CONSISTS OF STANDARD CHARACTERS WITHOUT CLAIM TO ANY PARTICULAR FONT, STYLE, SIZE, OR COLOR.

THE WORDING "CONEXIA" HAS NO MEANING IN A FOREIGN LANGUAGE.

CLASS 36—INSURANCE AND FINANCIAL

FOR ELECTRONIC PAYMENT, NAMELY, ELECTRONIC PROCESSING AND TRANSMISSION OF BILL PAYMENT DATA; AND ELECTRONIC PROCESSING OF INSURANCE CLAIMS AND PAYMENT DATA (U.S. CLS. 100, 101 AND 102).

CLASS 44—MEDICAL, BEAUTY AND AGRICULTURAL SERVICES

FOR ELECTRONICALLY MAINTAINING PERSONAL MEDICAL HISTORY RECORDS AND FILES FOR USE IN THE HEALTH CARE INDUSTRY (U.S. CLS. 100 AND 101).

AARON BRODSKY, EXAMINING ATTORNEY

SN 77-886,248. AUSTRALIAN THERAPEUTIC SUPPLIES PTY LTD, NORTH STRATHFIELD, NSW, AUSTRALIA, FILED 12-4-2009.

FOUR SEASONS

THE MARK CONSISTS OF STANDARD CHARACTERS WITHOUT CLAIM TO ANY PARTICULAR FONT, STYLE, SIZE, OR COLOR.

OWNER OF U.S. REG. NO. 2,915,110.

CLASS 3—COSMETICS AND CLEANING PREPARATIONS

FOR SUN TAN LOTION, SUN BLOCK, SUN BLOCK FOR LIPS, SUN SCREEN, SUN SCREEN FOR LIPS, NON-MEDICATED SKIN CARE PREPARATIONS, SKIN MOISTURIZER, LIP BALM, LIP CREAM, NON-MEDICATED LIP CARE PREPARATIONS, NON-MEDICATED LIP PROTECTORS, COSMETICS, NAMELY, LIP REPAIRERS (U.S. CLS. 1, 4, 6, 50, 51 AND 52).

CLASS 5—PHARMACEUTICALS

FOR MEDICATED LIP BALM, MEDICATED LIP CARE PREPARATIONS (U.S. CLS. 6, 18, 44, 46, 51 AND 52).
LAURA HAMMEL, EXAMINING ATTORNEY

SN 77-886,458. CAMPAIGNE, DANIEL P, OCEANSIDE, CA.
FILED 12-4-2009.

SN 77-886,291. TERRI ROGERS, LINCOLSHIRE, IL. FILED
12-4-2009.

NO OODLE

THE MARK CONSISTS OF STANDARD CHARACTERS WITHOUT CLAIM TO ANY PARTICULAR FONT, STYLE, SIZE, OR COLOR.

CLASS 5—PHARMACEUTICALS

FOR NOODLES FOR MEALS HAVING NO FAT AND LOW CALORIES IN A MEDICALLY RESTRICTED DIET (U.S. CLS. 6, 18, 44, 46, 51 AND 52).

CLASS 30—STAPLE FOODS

FOR NOODLES AND PREPARED MEALS CONSISTING PRIMARILY OF NOODLES HAVING LOW CALORIES AND NO FAT (U.S. CL. 46).

CLASS 35—ADVERTISING AND BUSINESS

FOR ADVERTISING IN THE FORM OF A WEB-SITE AND OTHER PROMOTIONAL MATERIAL FOR PROMOTING AND SELLING PACKAGED NOODLES, PREPARED MEALS, COOKBOOKS, MEAL PLANS, AND OTHER FOOD-RELATED ITEMS (U.S. CLS. 100, 101 AND 102).

REBECCA GILBERT, EXAMINING ATTORNEY

SN 77-886,367. SMITH MOUNTAIN INDUSTRIES, INC.,
FOREST, VA. FILED 12-4-2009.

WOODWICK METRO

THE MARK CONSISTS OF STANDARD CHARACTERS WITHOUT CLAIM TO ANY PARTICULAR FONT, STYLE, SIZE, OR COLOR.

OWNER OF U.S. REG. NOS. 3,255,835, 3,556,278 AND OTHERS.
SEC. 2(F) AS TO "WOODWICK".

CLASS 3—COSMETICS AND CLEANING PREPARATIONS

FOR NON-ELECTRIC ROOM SCENT DIFFUSERS COMPRISED OF REEDS AND OILS IN A CONTAINER (U.S. CLS. 1, 4, 6, 50, 51 AND 52).

CLASS 4—LUBRICANTS AND FUELS

FOR SCENTED CANDLES (U.S. CLS. 1, 6 AND 15).
JASON LOTT, EXAMINING ATTORNEY

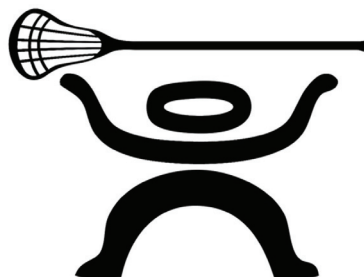

THE MARK CONSISTS OF AN ARTISTIC RENDITION OF A LACROSSE PLAYER IN THE FORM OF A FANCIFUL STICK FIGURE. THE STICK FIGURE IS HOLDING A LACROSSE STICK ABOVE ITS HEAD IN A HORIZONTAL POSITION.

CLASS 25—CLOTHING

FOR ATHLETIC APPAREL, NAMELY, SHIRTS, PANTS, JACKETS, FOOTWEAR, HATS AND CAPS, ATHLETIC UNIFORMS (U.S. CLS. 22 AND 39).

CLASS 41—EDUCATION AND ENTERTAINMENT

FOR ENCOURAGING AMATEUR SPORTS AND PHYSICAL EDUCATION BY ORGANIZING, SANCTIONING, CONDUCTING, REGULATING AND GOVERNING AMATEUR ATHLETIC PROGRAMS AND ACTIVITIES (U.S. CLS. 100, 101 AND 107).

RON FAIRBANKS, EXAMINING ATTORNEY

SN 77-886,498. BELLWORK ENTERPRISES, INC., BREA, CA.
FILED 12-4-2009.

BELLWORK

THE MARK CONSISTS OF STANDARD CHARACTERS WITHOUT CLAIM TO ANY PARTICULAR FONT, STYLE, SIZE, OR COLOR.

CLASS 9—ELECTRICAL AND SCIENTIFIC APPARATUS

FOR CHILDREN'S EDUCATIONAL SOFTWARE; COMPACT DISCS FEATURING EDUCATIONAL MATERIALS IN THE FIELD OF ARITHMETIC AND MATHEMATICS AND PRIMARY AND SECONDARY SCHOOL EDUCATION; DIGITAL MATERIALS, NAMELY, PRE-RECORDED CDS FEATURING EDUCATIONAL MATERIALS IN THE FIELDS OF PRIMARY AND SECONDARY SCHOOL ARITHMETIC AND MATHEMATICS; DIGITAL MEDIA, NAMELY, PRERECORDED CDS FEATURING EDUCATIONAL MATERIAL IN THE FIELD OF PRIMARY AND SECONDARY SCHOOL LEVEL ARITHMETIC AND MATHEMATICS; EDUCATIONAL SOFTWARE FEATURING INSTRUCTION IN ARITHMETIC, MATHEMATICS, PRIMARY AND SECONDARY SCHOOL LEVEL; MULTIMEDIA SOFTWARE RECORDED ON CD-ROM FEATURING EDUCATIONAL MATERIALS IN THE FIELD OF ARITHMETIC AND MATHEMATICS, PRIMARY AND SECONDARY SCHOOL; PRE-RECORDED CDS FEATURING EDUCATIONAL MATERIALS IN THE FIELD OF ARITHMETIC, MATHEMATICS AND PRIMARY AND SECONDARY SCHOOL LEVELS; PRE-RECORDED DIGITAL MEDIA FEATURING EDUCATIONAL MATERIALS IN THE FIELD OF ARITHMETIC, MATHEMATICS, PRIMARY AND SECONDARY SCHOOL LEVELS; PRE-RECORDED DIGITAL VIDEO DISCS FEATURING EDUCATIONAL MATERIALS IN THE FIELD OF ARITHMETIC AND MATHEMATICS, PRIMARY AND SECONDARY SCHOOL LEVELS; PRE-RECORDED ELECTRONIC AND DIGITAL MEDIA FEATURING EDUCATIONAL MATERIALS IN THE FIELD OF ARITHMETIC, MATHEMATICS, PRIMARY AND SECONDARY SCHOOL LEVELS; PRE-RECORDED ELECTRONIC MEDIA FEATURING EDUCATIONAL MATERIALS IN THE FIELDS OF ARITHMETIC, MATHEMATICS, PRIMARY AND SECONDARY SCHOOL LEVELS (U.S. CLS. 21, 26, 36 AND 38).

FIRST USE 1-16-2008; IN COMMERCE 1-16-2008.

CLASS 16—PAPER GOODS AND PRINTED MATTER

FOR A SERIES OF BOOKS, WRITTEN ARTICLES, HANDOUTS AND WORKSHEETS IN THE FIELD OF ARITHMETIC, MATHEMATICS, PRIMARY AND SECONDARY EDUCATION; BOOKS IN THE FIELD OF ARITHMETIC, MATHEMATICS, PRIMARY AND SECONDARY EDUCATION; CHILDREN'S ACTIVITY BOOKS; CHILDREN'S BOOKS; CHILDREN'S INTERACTIVE EDUCATIONAL BOOKS; EDUCATIONAL BOOKS FEATURING ARITHMETIC PROBLEMS, MATH PROBLEMS, TEACHER'S GUIDES AND TEACHER'S MANUALS; EDUCATIONAL PUBLICATIONS, NAMELY, BOOKS, WORKBOOKS, WORK SHEETS, TEXTBOOKS, BOOKLETS, TEACHER'S MANUALS, TEACHER'S GUIDES, IN THE FIELDS OF ARITHMETIC, MATHEMATICS, PRIMARY AND SECONDARY EDUCATION; MANUALS IN THE FIELD OF EDUCATION AND TEACHING OF ARITHMETIC, MATHEMATICS, PRIMARY AND SECONDARY EDUCATION; PUBLICATIONS, NAMELY, BOOKS, BOOKLETS, TEXTBOOKS, WORKBOOKS, WORK SHEETS, TEACHER'S MANUALS, TEACHER'S GUIDES IN THE FIELDS OF ARITHMETIC, MATHEMATICS, PRIMARY AND SECONDARY EDUCATION; TEXTBOOKS IN THE FIELD OF ARITHMETIC, MATHEMATICS, PRIMARY AND SECONDARY EDUCATION; WORKBOOKS DIRECTED TO ARITHMETIC, MATHEMATICS, PRIMARY AND SECONDARY EDUCATION (U.S. CLS. 2, 5, 22, 23, 29, 37, 38 AND 50).

FIRST USE 9-14-1982; IN COMMERCE 9-14-1982.
RUSS HERMAN, EXAMINING ATTORNEY

SN 77-886,528. PRODUCERS PEANUT COMPANY, INCORPORATED, SUFFOLK, VA. FILED 12-4-2009.

PEANUT KIDS

THE MARK CONSISTS OF STANDARD CHARACTERS WITHOUT CLAIM TO ANY PARTICULAR FONT, STYLE, SIZE, OR COLOR.

OWNER OF U.S. REG. NO. 517,170.

NO CLAIM IS MADE TO THE EXCLUSIVE RIGHT TO USE "PEANUT", APART FROM THE MARK AS SHOWN.

CLASS 29—MEATS AND PROCESSED FOODS

FOR SALTED PEANUTS; PROCESSED GROUND NUTS AND TREE NUTS; FLAVORED AND SPICED NUTS; NUT-BASED SNACK FOODS, NAMELY, NUT-BASED SNACK BARS IN A SQUARE SHAPE (U.S. CL. 46).

FIRST USE 0-0-1998; IN COMMERCE 0-0-1998.

CLASS 30—STAPLE FOODS

FOR CHOCOLATE COVERED PEANUT BRITTLE; CHOCOLATE COVERED NUTS (U.S. CL. 46).

FIRST USE 0-0-1998; IN COMMERCE 0-0-1998.

COLLEEN KEARNEY, EXAMINING ATTORNEY

SN 77-886,534. PRODUCERS PEANUT COMPANY, INCORPORATED, SUFFOLK, VA. FILED 12-4-2009.



OWNER OF U.S. REG. NO. 517,170.

NO CLAIM IS MADE TO THE EXCLUSIVE RIGHT TO USE "PEANUT", APART FROM THE MARK AS SHOWN.

THE MARK CONSISTS OF THE STYLIZED WORDS "PEANUT KIDS".

CLASS 29—MEATS AND PROCESSED FOODS

FOR SALTED PEANUTS; PROCESSED GROUND NUTS AND TREE NUTS; FLAVORED AND SPICED NUTS; NUT-BASED SNACK FOODS, NAMELY, NUT-BASED SNACK BARS IN A SQUARE SHAPE (U.S. CL. 46).

FIRST USE 0-0-1998; IN COMMERCE 0-0-1998.

CLASS 30—STAPLE FOODS

FOR CHOCOLATE COVERED PEANUT BRITTLE; CHOCOLATE COVERED NUTS (U.S. CL. 46).

FIRST USE 0-0-1998; IN COMMERCE 0-0-1998.

COLLEEN KEARNEY, EXAMINING ATTORNEY

SN 77-886,541. PUINSAI CLOTHING CO, LTD, SANTA MONICA, CA. FILED 12-4-2009.

SN 77-886,568. PRODUCERS PEANUT COMPANY, INCORPORATED, SUFFOLK, VA. FILED 12-4-2009.

RIDE SAFE

THE MARK CONSISTS OF STANDARD CHARACTERS WITHOUT CLAIM TO ANY PARTICULAR FONT, STYLE, SIZE, OR COLOR.

CLASS 10—MEDICAL APPARATUS

FOR CONDOMS (U.S. CLS. 26, 39 AND 44).

CLASS 25—CLOTHING

FOR ATHLETIC APPAREL, NAMELY, SHIRTS, PANTS, JACKETS, FOOTWEAR, HATS AND CAPS, ATHLETIC UNIFORMS; BOARD SHORTS; GOLF SHIRTS; GOLF SHORTS; HATS; HOODED SWEAT SHIRTS; MOISTURE-WICKING SPORTS SHIRTS; SHIRTS AND SHORT-SLEEVED SHIRTS; SHORT-SLEEVED OR LONG-SLEEVED T-SHIRTS; SHORTS; SOCKS; SPORTS SHIRTS; SWEAT SHIRTS (U.S. CLS. 22 AND 39).

KELLY CHOE, EXAMINING ATTORNEY

SN 77-886,563. PRODUCERS PEANUT COMPANY, INCORPORATED, SUFFOLK, VA. FILED 12-4-2009.

THE PEANUT KIDS

THE MARK CONSISTS OF STANDARD CHARACTERS WITHOUT CLAIM TO ANY PARTICULAR FONT, STYLE, SIZE, OR COLOR.

OWNER OF U.S. REG. NO. 517,170.

NO CLAIM IS MADE TO THE EXCLUSIVE RIGHT TO USE "PEANUT", APART FROM THE MARK AS SHOWN.

CLASS 29—MEATS AND PROCESSED FOODS

FOR PEANUT BUTTER; SNACK MIX CONSISTING PRIMARILY OF PROCESSED NUTS AND ALSO INCLUDING SESAME STICKS AND TOASTED CORN (U.S. CL. 46).

FIRST USE 4-1-1924; IN COMMERCE 4-1-1924.

CLASS 30—STAPLE FOODS

FOR CHOCOLATE COVERED NUTS; CHOCOLATE COVERED RAISINS (U.S. CL. 46).

FIRST USE 0-0-1998; IN COMMERCE 0-0-1998.

COLLEEN KEARNEY, EXAMINING ATTORNEY



THE MARK CONSISTS OF A BOY AND A GIRL, EACH WEARING A BASEBALL CAP WITH A PEANUT DEPICTED ON IT, RIDING A UNICYCLE WITH A PEANUT SEAT.

CLASS 29—MEATS AND PROCESSED FOODS

FOR PEANUT BUTTER; SALTED PEANUTS; HONEY ROASTED PEANUTS; PROCESSED GROUND NUTS AND TREE NUTS; FLAVORED AND SPICED NUTS; SEASONED NUTS; NUT-BASED SNACK FOODS, NAMELY, NUT-BASED SNACK BARS IN A SQUARE SHAPE; SNACK MIX CONSISTING PRIMARILY OF PROCESSED NUTS AND ALSO INCLUDING SESAME STICKS AND TOASTED CORN (U.S. CL. 46).

FIRST USE 0-0-1998; IN COMMERCE 0-0-1998.

CLASS 30—STAPLE FOODS

FOR CHOCOLATE COVERED NUTS; CHOCOLATE COVERED RAISINS (U.S. CL. 46).

FIRST USE 0-0-1998; IN COMMERCE 0-0-1998.

COLLEEN KEARNEY, EXAMINING ATTORNEY

SN 77-886,689. SMITH MOUNTAIN INDUSTRIES, INC., FOREST, VA. FILED 12-4-2009.

WOODWICK AMBIANCE

THE MARK CONSISTS OF STANDARD CHARACTERS WITHOUT CLAIM TO ANY PARTICULAR FONT, STYLE, SIZE, OR COLOR.

OWNER OF U.S. REG. NOS. 3,255,835, 3,556,278 AND OTHERS.

SEC. 2(F) AS TO "WOODWICK".

CLASS 3—COSMETICS AND CLEANING PREPARATIONS

FOR NON-ELECTRIC ROOM SCENT DIFFUSERS COMPRISED OF REEDS AND OILS IN A CONTAINER (U.S. CLS. 1, 4, 6, 50, 51 AND 52).

CLASS 4—LUBRICANTS AND FUELS

FOR SCENTED CANDLES (U.S. CLS. 1, 6 AND 15).

JASON LOTT, EXAMINING ATTORNEY

SN 77-886,692. THE LARYNGOSPASMS, LLC, ST. PAUL, MN. FILED 12-4-2009.

THE LARYNGOSPASMS

THE MARK CONSISTS OF STANDARD CHARACTERS WITHOUT CLAIM TO ANY PARTICULAR FONT, STYLE, SIZE, OR COLOR.

CLASS 9—ELECTRICAL AND SCIENTIFIC APPARATUS

FOR MUSICAL VIDEO RECORDINGS, NAMELY, VIDEO DISCS FEATURING MUSIC AND MUSICAL PERFORMANCES; MUSICAL AUDIO RECORDINGS, NAMELY, AUDIO DISCS FEATURING MUSIC AND MUSICAL PERFORMANCES; COMPACT DISCS FEATURING MUSIC AND MUSICAL PERFORMANCES; PRE-RECORDED CD'S AND LASER DISCS FEATURING MUSIC AND MUSICAL PERFORMANCES; MOUSE PADS (U.S. CLS. 21, 23, 26, 36 AND 38).

FIRST USE 8-0-1993; IN COMMERCE 8-0-1993.

CLASS 16—PAPER GOODS AND PRINTED MATTER

FOR PROMOTIONAL ITEMS, NAMELY, STICKERS; POSTERS; PHOTOS; SOUVENIR PROGRAMS FEATURING IMAGES, WORDS, AND DESIGNS OF A MUSICAL, RECORDING, AND PERFORMING GROUP; SHEET MUSIC (U.S. CLS. 2, 5, 22, 23, 29, 37, 38 AND 50).

FIRST USE 8-28-2009; IN COMMERCE 8-28-2009.

CLASS 25—CLOTHING

FOR PROMOTIONAL APPAREL, IN EACH CASE TO PROMOTE THE SERVICES OF A MUSICAL BAND, NAMELY, BASEBALL CAPS; HATS; SURGICAL TOPS, SURGICAL JACKETS; UNDERWEAR FEATURING IMAGES, WORDS, AND DESIGNS OF A MUSICAL, RECORDING, AND PERFORMING GROUP; PROMOTIONAL APPAREL, IN EACH CASE TO PROMOTE THE SERVICES OF A MUSICAL BAND, NAMELY, HOODED SWEAT SHIRTS, LONG-SLEEVED T-SHIRTS, SHORT-SLEEVED T-SHIRTS, AND A-SHIRTS, FEATURING IMAGES, WORDS, AND DESIGNS OF A MUSICAL, RECORDING, AND PERFORMING GROUP (U.S. CLS. 22 AND 39).

FIRST USE 8-28-2009; IN COMMERCE 8-28-2009.

CLASS 35—ADVERTISING AND BUSINESS

FOR ON-LINE RETAIL STORE SERVICES FEATURING DVDS, STICKERS, POSTERS, SOUVENIR PROGRAMS, CDS, ELECTRONIC AND DIGITAL FILES, NOVELTY ITEMS, AND CLOTHING OF AND ABOUT A PERFORMING AND RECORDING MUSICAL GROUP (U.S. CLS. 100, 101 AND 102).

FIRST USE 9-4-2009; IN COMMERCE 9-4-2009.

CLASS 41—EDUCATION AND ENTERTAINMENT

FOR ENTERTAINMENT SERVICES, NAMELY, MUSIC PUBLISHING SERVICES; ENTERTAINMENT SERVICES, NAMELY, LIVE PERFORMANCES BY A MUSICAL BAND; LIVE MUSIC CONCERTS; LIVE PERFORMANCES BY MUSICAL BANDS; LIVE PERFORMANCES BY ROCK GROUPS; PRESENTATION OF LIVE SHOW PERFORMANCES; AND PRESENTATION OF MUSICAL PERFORMANCE; ENTERTAINMENT SERVICES, NAMELY, A WEB SITE FEATURING MUSICAL PERFORMANCES, MUSICAL VIDEOS, RELATED VIDEO CLIPS, PHOTOGRAPHS, AND OTHER MULTIMEDIA MATERIALS FEATURING MUSICAL PERFORMANCES, AND PROVIDING INFORMATION CONCERNING A PERFORMING AND RECORDING MUSICAL GROUP VIA THE WORLD WIDE WEB; ENTERTAINMENT SERVICES, NAMELY, MUSIC COMPOSITION FOR OTHERS (U.S. CLS. 100, 101 AND 107).

FIRST USE 1-0-1991; IN COMMERCE 8-1-1991.

GEOFFREY FOSDICK, EXAMINING ATTORNEY

SN 77-886,717. BELLWORK ENTERPRISES, INC., BREA, CA. FILED 12-4-2009.



THE MARK CONSISTS OF AN OLD-FASHIONED SCHOOL BELL WITH A SMILING FACE.

CLASS 9—ELECTRICAL AND SCIENTIFIC APPARATUS

FOR CHILDREN'S EDUCATIONAL SOFTWARE; DIGITAL MATERIALS, NAMELY, PRERECORDED CDS FEATURING EDUCATIONAL MATERIALS IN THE FIELD OF ARITHMETIC, MATHEMATICS AND RELATED PRIMARY AND SECONDARY SCHOOL SUBJECTS; DIGITAL MEDIA, NAMELY, PRERECORDED CDS FEATURING EDUCATIONAL AND TEACHING MATERIALS IN THE FIELD OF ARITHMETIC, MATHEMATICS AND RELATED SUBJECTS; EDUCATIONAL SOFTWARE FEATURING INSTRUCTION IN ARITHMETIC, MATHEMATICS AND RELATED SUBJECTS; MULTIMEDIA SOFTWARE RECORDED ON CD-ROM FEATURING MATH AND ARITHMETIC PROBLEMS, ANSWERS AND RELATED INSTRUCTIONAL AND TEACHING MATERIALS; PRE-RECORDED CDS FEATURING INSTRUCTIONAL AND EDUCATIONAL MATERIALS IN THE FIELD OF ARITHMETIC AND MATHEMATICS (U.S. CLS. 21, 23, 26, 36 AND 38).

FIRST USE 1-16-2008; IN COMMERCE 1-16-2008.

CLASS 16—PAPER GOODS AND PRINTED MATTER

FOR A SERIES OF BOOKS, WRITTEN ARTICLES, HANDOUTS AND WORKSHEETS IN THE FIELD OF ARITHMETIC, MATHEMATICS AND PRIMARY AND SECONDARY EDUCATION; CHILDREN'S ACTIVITY BOOKS; CHILDREN'S BOOKS; CHILDREN'S INTERACTIVE EDUCATIONAL BOOKS; EDUCATIONAL BOOKS FEATURING ARITHMETIC AND MATH PROBLEMS, ANSWERS, TEACHER'S MANUALS, TEACHER'S GUIDES AND EDUCATIONAL MATERIALS RELATED TO MATH AND ARITHMETIC; EDUCATIONAL PUBLICATIONS, NAMELY, EDUCATIONAL LEARNING CARDS, FLASH CARDS, ACTIVITY CARDS, WORKBOOKS, TEXTBOOKS, ACTIVITY BOOKS, STORY BOOKS, PUZZLE BOOKS, PRINTED PUZZLES, TEACHER GUIDES, MANUALS, POSTERS AND EDUCATIONAL BOOKLETS IN THE FIELD OF PRIMARY AND SECONDARY SCHOOL ARITHMETIC AND MATHEMATICS; EDUCATIONAL PUBLICATIONS, NAMELY, TRAINING MANUALS IN THE FIELD OF PRIMARY AND SECONDARY SCHOOL INSTRUCTION IN ARITHMETIC, MATHEMATICS AND RELATED SUBJECTS; EDUCATIONAL PUBLICATIONS, NAMELY, WORKBOOKS, BOOKLETS, TEXTBOOKS, WORKSHEETS, HANDOUTS, BOOKS, TEACHER'S MANUALS, ANSWER GUIDES, TEACHER'S GUIDES IN THE FIELDS OF ARITHMETIC, MATHEMATICS PRIMARY AND RELATED SECONDARY SCHOOL EDUCATION; MANUALS IN THE FIELD OF ARITHMETIC, MATHEMATICS, PRIMARY AND SECONDARY SCHOOL TEACHING AND EDUCATION; NON-FICTION BOOKS ON A VARIETY OF TOPICS; PACKAGED KITS COMPRISING PRINTED INSTRUCTIONAL, EDUCATIONAL, AND TEACHING MATERIALS FOR EDUCATIONAL ACTIVITIES IN THE FIELD OF ARITHMETIC, MATHEMATICS AND RELATED SUBJECTS; PAPER TEACHING MATERIALS IN THE FIELD OF ARITHMETIC, MATHEMATICS AND RELATED SUBJECTS; PRINTED EDUCATIONAL MATERIALS IN THE FIELD OF ARITHMETIC, MATHEMATICS AND RELATED SUBJECTS; PRINTED INSTRUCTIONAL, EDUCATIONAL, AND TEACHING MATERIALS IN THE FIELD OF ARITHMETIC, MATHEMATICS, AND RELATED SUBJECTS; PRINTED MATERIALS, NAMELY, CURRICULA IN THE FIELD OF PRIMARY AND SECONDARY SCHOOL ARITHMETIC, MATHEMATICS AND RELATED SUBJECTS; PRINTED TEACHING ACTIVITY GUIDES IN THE FIELD OF PRIMARY AND SECONDARY SCHOOL ARITHMETIC, MATHEMATICS AND RELATED SUBJECTS; PRINTED TEACHING MATERIALS IN THE FIELD OF ARITHMETIC, MATHEMATICS AND RELATED SUBJECTS; PRINTED TRAINING MATERIALS IN THE FIELD OF PRIMARY AND SECONDARY SCHOOL ARITHMETIC, MATHEMATICS AND RELATED SUBJECTS FOR PRIMARY AND SECONDARY SCHOOL STUDENTS AND TEACHERS; PUBLICATIONS, NAMELY, BROCHURES, BOOKLETS, AND TEACHING MATERIALS IN THE FIELD OF ARITHMETIC, MATHEMATICS AND RELATED SUBJECTS; PUBLICATIONS, NAMELY, BOOKS, WORKBOOKS, HAND-OUTS, WORKSHEETS, TEACHER'S MANUALS, ANSWER KEYS, TEACHER GUIDES IN THE FIELDS OF ARITHMETIC, MATHEMATICS AND RELATED PRIMARY AND SECONDARY SCHOOL SUBJECTS; REFERENCE BOOKS IN THE FIELD OF TEACHING ARITHMETIC AND MATHEMATICS TO PRIMARY AND SECONDARY SCHOOL CHILDREN; SERIES OF NON-FICTION BOOKS IN THE FIELD OF ARITHMETIC AND MATHEMATICS FOR PRIMARY AND SECONDARY SCHOOL STUDENTS AND TEACHERS; TEXTBOOKS IN THE FIELD OF ARITHMETIC, MATHEMATICS AND RELATED PRIMARY AND SECONDARY SCHOOL EDUCATION; WORKBOOKS DIRECTED TO MATH AND ARITHMETIC PROBLEMS, TEACHING AND EDUCATION (U.S. CLS. 2, 5, 22, 23, 29, 37, 38 AND 50).

FIRST USE 9-14-1982; IN COMMERCE 9-14-1982.
RUSS HERMAN, EXAMINING ATTORNEY

SN 77-886,828. SOUTHWEST CENTER FOR HIV/AIDS, INC., PHOENIX, AZ. FILED 12-4-2009.

PIZZA AND THE BASICS

THE MARK CONSISTS OF STANDARD CHARACTERS WITHOUT CLAIM TO ANY PARTICULAR FONT, STYLE, SIZE, OR COLOR.

CLASS 16—PAPER GOODS AND PRINTED MATTER

FOR PRINTED INSTRUCTIONAL, EDUCATIONAL, AND TEACHING MATERIALS IN THE FIELD OF HIV AND AIDS (U.S. CLS. 2, 5, 22, 23, 29, 37, 38 AND 50).

FIRST USE 2-8-2003; IN COMMERCE 2-8-2003.

CLASS 41—EDUCATION AND ENTERTAINMENT

FOR CONDUCTING CLASSES, WORKSHOPS AND SEMINARS IN THE FIELD OF HIV AND AIDS (U.S. CLS. 100, 101 AND 107).

FIRST USE 2-8-2003; IN COMMERCE 2-8-2003.

KIM MONINGHOFF, EXAMINING ATTORNEY

SN 77-886,848. LAM, THAI C., ESCONDIDO, CA. FILED 12-4-2009.

DRAGONTA

THE MARK CONSISTS OF STANDARD CHARACTERS WITHOUT CLAIM TO ANY PARTICULAR FONT, STYLE, SIZE, OR COLOR.

CLASS 16—PAPER GOODS AND PRINTED MATTER

FOR ADDRESS BOOKS; APPLIQUES IN THE FORM OF DECALS; APPOINTMENT BOOKS; ART PRINTS; ARTS AND CRAFT PAINT KITS; BALL POINT PENS; BOOKENDS; BOOKMARKS; BOOKS IN THE FIELD OF STORIES, GAMES AND ACTIVITIES FOR CHILDREN; BUMPER STICKERS; CALENDARS; CHILDREN'S ACTIVITY BOOKS; COLOR PENCILS; COLORING BOOKS; COMIC BOOKS; DECALS; DECORATIVE PAPER CENTERPIECES; DIARIES; DRAWING RULERS; ERASERS; FELT PENS; GIFT WRAPPING PAPER; GREETING CARDS; MAGAZINES IN THE FIELD OF STORIES, GAMES AND ACTIVITIES FOR CHILDREN; MEMO PADS; MODELING CLAY; NOTE PAPER; NOTEBOOKS; PAINTINGS; PAPER CAKE DECORATIONS; PAPER NAPKINS; PAPER PARTY BAGS; PAPER PARTY DECORATIONS; PAPER PARTY FAVORS; PAPER TABLECLOTHS; PEN OR PENCIL HOLDERS; PENCIL SHARPENERS; PENCILS; PENS; PHOTOGRAPH ALBUMS; PICTORIAL PRINTS; PICTURE BOOKS; PORTRAITS; POSTERS; PRINTED CERTIFICATES; PRINTED INVITATIONS; PRINTED PERIODICALS IN THE FIELD OF STORIES, GAMES AND ACTIVITIES FOR CHILDREN; RUBBER STAMPS; STATIONERY; STICKERS; TEMPORARY TATTOOS; TRADING CARDS; WRITING IMPLEMENTS (U.S. CLS. 2, 5, 22, 23, 29, 37, 38 AND 50).

CLASS 28—TOYS AND SPORTING GOODS

FOR ACTION FIGURES AND ACCESSORIES THEREFOR; AMUSEMENT PRODUCTS, NAMELY, INFLATABLE BALLS; BALLOONS; BALLS FOR GAMES; BALLS FOR SPORTS; BATH TOYS; BEACH BALLS; BOARD GAMES; BUBBLE MAKING WAND AND SOLUTION SETS; CARD GAMES; CHRISTMAS STOCKINGS; CHRISTMAS TREE DECORATIONS; COLLECTABLE TOY FIGURES; DISC TOSS TOYS; DOLL ACCESSORIES; DOLL CLOTHING; DOLLS; EQUIPMENT SOLD AS A UNIT FOR PLAYING CARD GAMES; HAND HELD UNITS FOR PLAYING ELECTRONIC GAMES OTHER THAN THOSE ADAPTED FOR USE WITH AN EXTERNAL DISPLAY SCREEN OR MONITOR; JIGSAW PUZZLES; JUMP ROPES; KITES; MUSICAL TOYS; PARTY FAVORS IN THE NATURE OF SMALL TOYS; PLAYING CARDS; PLAYSETS FOR DOLLS; PLUSH TOYS; RUBBER BALLS; TOY ACTION FIGURES; TOY BANKS; TOY BUILDING BLOCKS; TOY FIGURES; TOY MODEL HOBBYCRAFT KITS; TOY SCOOTERS; TOY VEHICLES; TOY WATCHES; YO-YOS (U.S. CLS. 22, 23, 38 AND 50).
CHRISTINE COOPER, EXAMINING ATTORNEY

CLASS 41—EDUCATION AND ENTERTAINMENT

FOR (BASED ON USE IN COMMERCE) ENTERTAINMENT SERVICES, NAMELY, PROVIDING ONLINE CONTESTS; (BASED ON INTENT TO USE) ENTERTAINMENT SERVICES, NAMELY, PROVIDING ONLINE SWEEPSTAKES, GAMES AND QUIZZES; NON-DOWNLOADABLE ELECTRONIC PUBLICATIONS, NAMELY, ARTICLES FEATURING INFORMATION ABOUT DOGS (U.S. CLS. 100, 101 AND 107).
FIRST USE 11-23-2009; IN COMMERCE 11-23-2009.

CLASS 45—PERSONAL AND LEGAL SERVICES

FOR DOG ADOPTION SERVICES; PROVIDING AN ONLINE SEARCHABLE DATABASE FEATURING DOGS AVAILABLE FOR ADOPTION AND DOG ADOPTION ORGANIZATIONS; PROVIDING INFORMATION ABOUT DOG ADOPTION (U.S. CLS. 100 AND 101).
FIRST USE 6-18-2009; IN COMMERCE 6-18-2009.
JAMES LOVELACE, EXAMINING ATTORNEY

SN 77-886,877. DOGTIME MEDIA, INC., SAN FRANCISCO, CA. FILED 12-4-2009.



THE COLOR(S) ORANGE, RED, GRAY, BLACK, WHITE, BROWN AND PINK IS/ARE CLAIMED AS A FEATURE OF THE MARK.

THE MARK CONSISTS OF THE WORDS "SAVE A DOG" PLACED ABOVE THE WORDS "HELPING DOGS + HAVING FUN", ALL NEXT TO A DESIGN COMPRISING A DONUT-SHAPED LIFE PRESERVER WITH FOUR EQUALLY SPACED COLOR BANDS AND AN IMAGE OF A DOG'S HEAD (WITH PROTRUDING TONGUE) AND FRONT PAWS PROTRUDING THROUGH THE MIDDLE OF THE LIFE PRESERVER. THE WORD "SAVE" IS IN BOLD FONT LOWERCASE LETTERS HAVING AN ORANGE COLOR AT THE TOP OF THE LETTERING WHICH TRANSFORMS INTO A RED COLOR AT THE BOTTOM OF THE LETTERING. THE WORDS "A DOG" ARE IN STANDARD FONT LOWERCASE LETTERS AND GRAY IN COLOR. THE WORDS "HELPING DOGS + HAVING FUN" ARE IN STANDARD FONT LOWERCASE LETTERS AND BLACK IN COLOR. THE LIFE PRESERVER IS WHITE IN COLOR. THE FOUR COLOR BANDS ON THE LIFE PRESERVER ARE RED IN COLOR. THE DOG'S FUR IS BLACK, BROWN AND WHITE IN COLOR. THE DOG'S EYES ARE BROWN IN COLOR AND THE DOG'S TONGUE IS PINK IN COLOR.

CLASS 9—ELECTRICAL AND SCIENTIFIC APPARATUS

FOR DOWNLOADABLE ELECTRONIC PUBLICATIONS, NAMELY, ARTICLES FEATURING INFORMATION ABOUT DOGS (U.S. CLS. 21, 23, 26, 36 AND 38).

CLASS 35—ADVERTISING AND BUSINESS

FOR ONLINE RETAIL STORE SERVICES FEATURING NUTRITION AND HEALTH PRODUCTS FOR DOGS (U.S. CLS. 100, 101 AND 102).

CLASS 36—INSURANCE AND FINANCIAL

FOR CHARITABLE FUND RAISING SERVICES, NAMELY, MONETARY DONATIONS TO CHARITY BASED ON USER PARTICIPATION IN ONLINE ACTIVITIES (U.S. CLS. 100, 101 AND 102).
FIRST USE 6-18-2009; IN COMMERCE 6-18-2009.

SN 77-886,880. DOGTIME MEDIA, INC., SAN FRANCISCO, CA. FILED 12-4-2009.



THE COLOR(S) BLUE, GRAY, BLACK, WHITE AND YELLOW GREEN IS/ARE CLAIMED AS A FEATURE OF THE MARK.

THE MARK CONSISTS OF THE WORDS "SAVE A CAT" PLACED ABOVE THE WORDS "HELPING CATS + HAVING FUN", ALL NEXT TO A DESIGN COMPRISING A DONUT SHAPED LIFE PRESERVER WITH FOUR EQUALLY SPACED COLOR BANDS AND AN IMAGE OF A CAT'S HEAD, EARS AND FRONT PAWS PROTRUDING THROUGH THE MIDDLE OF THE LIFE PRESERVER. THE WORD "SAVE" IS IN BOLD FONT LOWERCASE LETTERS HAVING A BLUE COLOR WHICH FADES TO A LIGHTER SHADE AT THE TOP OF THE LETTERING. THE WORDS "A CAT" ARE IN STANDARD FONT LOWERCASE LETTERS AND GRAY IN COLOR. THE WORDS "HELPING CATS + HAVING FUN" ARE IN LOWERCASE LETTERS AND BLACK IN COLOR. THE LIFE PRESERVER IS WHITE IN COLOR WITH GRAY SHADING. THE FOUR COLOR BANDS ON THE LIFE PRESERVER ARE A SHADE OF BLUE IN COLOR. THERE IS ALSO A WHITE REFLECTION ABOUT THE MIDDLE PERIMETER OF THE LIFE PRESERVER. THE CAT'S FUR IS GRAY AND WHITE IN COLOR WITH BLACK STRIPES. THE CAT'S EYES ARE YELLOW GREEN IN COLOR WITH BLACK PUPILS HAVING WHITE REFLECTIONS.

CLASS 9—ELECTRICAL AND SCIENTIFIC APPARATUS

FOR DOWNLOADABLE ELECTRONIC PUBLICATIONS, NAMELY, ARTICLES FEATURING INFORMATION ABOUT CATS (U.S. CLS. 21, 23, 26, 36 AND 38).

CLASS 35—ADVERTISING AND BUSINESS

FOR ONLINE RETAIL STORE SERVICES FEATURING NUTRITION AND HEALTH PRODUCTS FOR CATS (U.S. CLS. 100, 101 AND 102).

CLASS 36—INSURANCE AND FINANCIAL

FOR CHARITABLE FUND RAISING SERVICES, NAMELY, MONETARY DONATIONS TO CHARITY BASED ON USER PARTICIPATION IN ONLINE ACTIVITIES (U.S. CLS. 100, 101 AND 102).
FIRST USE 10-1-2009; IN COMMERCE 10-1-2009.

SN 77-886,894. ACE INDUSTRIES INC., DBA ISIS NUTRACEUTICAL, GILBERT, AZ. FILED 12-4-2009.

CLASS 41—EDUCATION AND ENTERTAINMENT

FOR (BASED ON USE IN COMMERCE) ENTERTAINMENT SERVICES, NAMELY, PROVIDING ONLINE CONTESTS; (BASED ON INTENT TO USE) ENTERTAINMENT SERVICES, NAMELY, PROVIDING ONLINE SWEEPSTAKES, GAMES AND QUIZZES; NON-DOWNLOADABLE ELECTRONIC PUBLICATIONS, NAMELY, ARTICLES FEATURING INFORMATION ABOUT CATS (U.S. CLS. 100, 101 AND 107).
FIRST USE 11-23-2009; IN COMMERCE 11-23-2009.

Isis

THE MARK CONSISTS OF STANDARD CHARACTERS WITHOUT CLAIM TO ANY PARTICULAR FONT, STYLE, SIZE, OR COLOR.

CLASS 45—PERSONAL AND LEGAL SERVICES

FOR CAT ADOPTION SERVICES; PROVIDING AN ONLINE SEARCHABLE DATABASE FEATURING CATS AVAILABLE FOR ADOPTION AND CAT ADOPTION ORGANIZATIONS; PROVIDING INFORMATION ABOUT CAT ADOPTION (U.S. CLS. 100 AND 101).
FIRST USE 10-1-2009; IN COMMERCE 10-1-2009.
JAMES LOVELACE, EXAMINING ATTORNEY

CLASS 1—CHEMICALS

FOR ANTIOXIDANTS AND PROTEINS USED IN THE MANUFACTURE OF COSMETICS, BEVERAGES, FOOD PRODUCTS AND FOOD SUPPLEMENTS (U.S. CLS. 1, 5, 6, 10, 26 AND 46).

CLASS 5—PHARMACEUTICALS

FOR DIETARY SUPPLEMENTS FOR HUMAN CONSUMPTION; HEALTH FOOD SUPPLEMENTS; HERBAL SUPPLEMENTS; HOMEOPATHIC SUPPLEMENTS; LECITHIN FOR USE AS A DIETARY SUPPLEMENT; LIQUID NUTRITIONAL SUPPLEMENT; NATURAL HERBAL SUPPLEMENTS; NUTRACEUTICALS FOR USE AS A DIETARY SUPPLEMENT; NUTRITIONAL SUPPLEMENT FOR ELIMINATING TOXINS FROM THE BODY; NUTRITIONAL SUPPLEMENTS; PROTEIN SUPPLEMENTS; VITAMIN AND MINERAL SUPPLEMENTS; WEIGHT MANAGEMENT SUPPLEMENTS (U.S. CLS. 6, 18, 44, 46, 51 AND 52).
MICHAEL ENGEL, EXAMINING ATTORNEY

SN 77-886,886. DEMANDTEC, INC., SAN MATEO, CA. FILED 12-4-2009.

DemandBetter

SN 77-886,960. ARENDS, BRETT P., BOSTON, MA. FILED 12-5-2009.

THE MARK CONSISTS OF STANDARD CHARACTERS WITHOUT CLAIM TO ANY PARTICULAR FONT, STYLE, SIZE, OR COLOR.
OWNER OF U.S. REG. NO. 2,730,812.

CLASS 35—ADVERTISING AND BUSINESS

FOR ARRANGING AND CONDUCTING BUSINESS CONFERENCES (U.S. CLS. 100, 101 AND 102).
FIRST USE 11-8-2001; IN COMMERCE 11-8-2001.

The 2 Minute Money Manager

CLASS 41—EDUCATION AND ENTERTAINMENT

FOR EDUCATIONAL SERVICES, NAMELY, CONDUCTING CONFERENCES IN THE FIELD OF CONSUMER DEMAND MANAGEMENT (U.S. CLS. 100, 101 AND 107).
FIRST USE 11-8-2001; IN COMMERCE 11-8-2001.
JAMES LOVELACE, EXAMINING ATTORNEY

THE MARK CONSISTS OF STANDARD CHARACTERS WITHOUT CLAIM TO ANY PARTICULAR FONT, STYLE, SIZE, OR COLOR.
NO CLAIM IS MADE TO THE EXCLUSIVE RIGHT TO USE "MONEY MANAGER", APART FROM THE MARK AS SHOWN.

CLASS 16—PAPER GOODS AND PRINTED MATTER

FOR BOOKS AND PAMPHLETS IN THE FIELD OF FINANCIAL CLASSIFICATION OF COMPANIES AND SECURITIES; COLUMNS ON THE SUBJECT OF PERSONAL FINANCE, FINANCIAL PLANNING, INVESTMENT OR MONEY MANAGEMENT; NEWSLETTERS IN THE FIELD OF PERSONAL FINANCE, FINANCIAL PLANNING, INVESTMENT OR MONEY MANAGEMENT; NEWSLETTERS, BROCHURES, AND MAGAZINES IN THE FIELDS OF SECURITIES, OPTIONS, BONDS AND OTHER FINANCIAL INSTRUMENTS; NEWSPAPERS IN THE FIELD OF PERSONAL FINANCE, FINANCIAL PLANNING, INVESTMENT OR MONEY MANAGEMENT; PAMPHLETS IN THE FIELD OF PERSONAL FINANCE, FINANCIAL PLANNING, INVESTMENT OR MONEY MANAGEMENT; PRINTED MATTER, NAMELY, NEWSPAPERS, PHOTOGRAPHS, MAGAZINES, BOOKS, PRINTED PERIODICALS, NEWSLETTERS, AND BROCHURES ALL IN THE FIELDS OF SECURITIES, OPTIONS AND OTHER FINANCIAL INSTRUMENTS; PUBLICATIONS, NAMELY, BROCHURES, BOOKLETS, AND TEACHING MATERIALS IN THE FIELD OF PERSONAL FINANCE, FINANCIAL PLANNING, INVESTMENT OR MONEY MANAGEMENT; PUBLICATIONS, NAMELY, BOOKS, NEWSPAPERS, PAMPHLETS, OR ONLINE PUBLICATIONS INCLUDING NEWSLETTERS IN THE FIELDS OF PERSONAL FINANCE, FINANCIAL PLANNING, INVESTMENT OR MONEY MANAGEMENT; QUICK REFERENCE POCKET GUIDES IN THE FIELD OF PERSONAL FINANCE, FINANCIAL PLANNING, INVESTMENT OR MONEY MANAGEMENT; RESEARCH REPORTS FEATURING PERSONAL FINANCE, FINANCIAL PLANNING, INVESTMENT OR MONEY MANAGEMENT; SCHOLARLY BOOKS ON VARIOUS TOPICS, NAMELY, PERSONAL FINANCE, FINANCIAL PLANNING, INVESTMENT OR MONEY MANAGEMENT; SYNDICATED COLUMNS DEALING WITH PERSONAL FINANCE, FINANCIAL PLANNING, INVESTMENT OR MONEY MANAGEMENT; SYNDICATED NEWSPAPER COLUMNS DEALING WITH PERSONAL FINANCE, FINANCIAL PLANNING, INVESTMENT OR MONEY MANAGEMENT; TEXTBOOKS IN THE FIELD OF PERSONAL FINANCE, FINANCIAL PLANNING, INVESTMENT OR MONEY MANAGEMENT; TRADE JOURNALS IN THE FIELD OF PERSONAL FINANCE, FINANCIAL PLANNING, INVESTMENT OR MONEY MANAGEMENT; WORKBOOKS DIRECTED TO PERSONAL FINANCE, FINANCIAL PLANNING, INVESTMENT OR MONEY MANAGEMENT; YEARBOOKS IN THE FIELD OF PERSONAL FINANCE, FINANCIAL PLANNING, INVESTMENT OR MONEY MANAGEMENT (U.S. CLS. 2, 5, 22, 23, 29, 37, 38 AND 50).

CLASS 36—INSURANCE AND FINANCIAL

FOR ADVICE RELATING TO INVESTMENTS; ADVISORY SERVICES RELATING TO CREDIT AND DEBIT CONTROL, INVESTMENT, GRANTS AND FINANCING OF LOANS; ANNUITY SERVICES, NAMELY, ACCOUNT AND INVESTMENT ADMINISTRATION; ANNUITY SERVICES, NAMELY, ACCOUNT AND INVESTMENT ADMINISTRATION AND THE INVESTMENT AND DISTRIBUTION OF ANNUITY FUNDS; APPRAISAL AND EVALUATION OF REAL ESTATE; APPRAISAL OF REAL ESTATE; APPRAISALS FOR INSURANCE CLAIMS OF REAL ESTATE; ASSESSMENT AND MANAGEMENT OF REAL ESTATE; ASSUMING FINANCIAL RISK OF OTHERS BY ENTERING INTO OPTIONS AND SWAPS; BROKERAGE SERVICES FOR CAPITAL INVESTMENTS; BROKERAGE SERVICES IN THE FIELD OF SECURITIES AND COMMODITIES INVESTING; CAPITAL INVESTMENT CONSULTING; CAPITAL INVESTMENT SERVICES; CHARITABLE FOUNDATION SERVICES, NAMELY, PROVIDING FINANCIAL SUPPORT TO INDIVIDUALS WHO ARE SEEKING TO BE WITH FAMILY DURING THE HOLIDAYS BUT ARE UNABLE DUE TO FINANCIAL CONSTRAINTS; CHARITABLE FOUNDATION SERVICES, NAMELY, PROVIDING FUND RAISING ACTIVITIES AND INVESTMENT MANAGEMENT SERVICES TO SUPPORT MEDICAL EDUCATION AND RESEARCH AND PROCEDURES FOR THOSE IN NEED; CHARITABLE FOUNDATION SERVICES, NAMELY, PROVIDING FUND RAISING ACTIVITIES, SUPPLEMENTAL FUNDING, CAPITAL

IMPROVEMENT FUNDING, SCHOLARSHIPS AND FINANCIAL ASSISTANCE FOR PROGRAMS AND SERVICES OF OTHERS; CHARITABLE FUNDRAISING SERVICES USING PROCEEDS FROM CD'S, TO PROVIDE FOOD, BLANKETS, SHELTER, OTHER RELIEF MATERIALS, BLOOD, AND FINANCIAL ASSISTANCE TO VICTIMS OF DISEASES AND DISASTERS IN THE U.S.; CHARITABLE SERVICES, NAMELY, PROVIDING FINANCIAL ASSISTANCE TO MEET THE PHYSICAL, PSYCHOLOGICAL, SOCIAL AND OTHER SPECIAL NEEDS OF CHILDREN; CHARITABLE SERVICES, NAMELY, PROVIDING FINANCIAL SUPPORT TO DISADVANTAGED PATIENTS FOR THE PURPOSE OF FACILITATING GOOD HEALTH; CHARITABLE SERVICES, NAMELY, PROVIDING FINANCIAL SUPPORT TO PEOPLE FROM DISADVANTAGED COUNTRIES FOR THE PURPOSE OF FACILITATING EDUCATIONAL OPPORTUNITIES; CLASSIFIED REAL ESTATE LISTINGS OF APARTMENT RENTALS AND HOUSING RENTALS; COLLEGE CONSULTING SERVICES, NAMELY, ASSISTING STUDENTS IN APPLYING FOR SCHOLARSHIPS AND FINANCIAL AID; COLLEGE COUNSELING SERVICES, NAMELY, ASSISTING STUDENTS IN APPLYING FOR SCHOLARSHIPS AND FINANCIAL AID; COMMERCIAL AND RESIDENTIAL REAL ESTATE AGENCY SERVICES; COMMODITY INVESTMENT ADVICE; CONSULTATION IN ART AS AN INVESTMENT; CONSULTATION SERVICES IN THE FIELD OF FINANCIAL MANAGEMENT OF YACHT OPERATIONS; CREDIT AND FINANCIAL CONSULTATION; CURRENCY EXCHANGE AND ADVICE; ELECTRONIC FINANCIAL SERVICE FOR THE PURCHASE OF SAVINGS BONDS; ELECTRONIC FINANCIAL TRADING SERVICES; EQUITY CAPITAL INVESTMENT; ESTATE PLANNING; ESTATE TRUST MANAGEMENT; EVALUATION OF REAL PROPERTY; FIDUCIARY TAX PAYMENT PROCESSING SERVICES; FINANCIAL ADMINISTRATION OF RETIREMENT PLANS; FINANCIAL ADMINISTRATION OF STOCK EXCHANGE TRADING OF SHARES AND OTHER FINANCIAL SECURITIES IN FINANCIAL MARKETS; FINANCIAL ADVICE; FINANCIAL ADVICE AND CONSULTANCY SERVICES; FINANCIAL ADVISORY AND CONSULTANCY SERVICES; FINANCIAL ADVISORY AND CONSULTANCY SERVICES RELATING TO MICRO CREDITS, MICRO FINANCE AND ENERGY PRODUCTS; FINANCIAL AFFAIRS AND MONETARY AFFAIRS, NAMELY, FINANCIAL INFORMATION, MANAGEMENT AND ANALYSIS SERVICES; FINANCIAL ANALYSES; FINANCIAL ANALYSIS AND CONSULTATION; FINANCIAL ANALYSIS AND RESEARCH SERVICES; FINANCIAL AND INVESTMENT SERVICES, NAMELY, MANAGEMENT AND BROKERAGE IN THE FIELDS OF STOCKS, BONDS, OPTIONS, COMMODITIES, FUTURES AND OTHER SECURITIES, AND THE INVESTMENT OF FUNDS OF OTHERS; FINANCIAL ASSET MANAGEMENT; FINANCIAL CLEARING HOUSES; FINANCIAL CONSULTANCY; FINANCIAL CONSULTANCY AND INSURANCE CONSULTANCY; FINANCIAL CONSULTANCY SERVICES IN THE AREA OF HEALTHCARE; FINANCIAL CONSULTATION; FINANCIAL CONSULTATION IN THE FIELD OF FUELS, DIESEL FUEL, BIOFUEL AND BIODIESEL FUEL.; FINANCIAL CONSULTATION IN THE FIELD OF PERSONAL FINANCE, FINANCIAL PLANNING, INVESTMENT OR MONEY MANAGEMENT; FINANCIAL CONSULTING; FINANCIAL CONSULTING AND ADVISING IN THE FIELD OF MERGERS AND ACQUISITIONS; FINANCIAL CONSULTING IN THE FIELD OF REAL ESTATE NOTE BROKERAGE; FINANCIAL CONSULTING SERVICES IN THE FIELD OF PLANNED GIVING FOR NON-PROFIT AND CHARITABLE ORGANIZATIONS; FINANCIAL CONSULTING SERVICES, NAMELY, EXPERT ANALYSIS IN FINANCE; FINANCIAL COUNSELING SERVICES, NAMELY, HELPING OTHERS BUILD A BETTER WORKING RELATIONSHIP WITH THEIR MONEY; FINANCIAL DUE DILIGENCE; FINANCIAL DUE DILIGENCE SERVICES IN THE FIELD OF REAL ESTATE; FINANCIAL EVALUATION FOR INSURANCE PURPOSES; FINANCIAL EXCHANGE; FINANCIAL FORECASTING; FINANCIAL GUARANTEE AND SURETY; FINANCIAL GUARANTEES; FINANCIAL INFORMATION AND ADVISORY SERVICES; FINANCIAL INFORMATION AND EVALUATIONS; FINANCIAL INFORMATION IN THE NATURE OF RATES OF EXCHANGE; FINANCIAL INFORMATION PROCESSING; FINANCIAL INFORMATION PROVIDED BY ELECTRONIC MEANS; FINANCIAL INFORMATION SERVICES PROVIDED ON-LINE FROM A COMPUTER DATABASE

OR A GLOBAL COMPUTER NETWORK, NAMELY, PROVIDING INFORMATION IN THE FIELD OF FINANCIAL CLASSIFICATION OF COMPANIES AND SECURITIES; FINANCIAL INVESTMENT BROKERAGE; FINANCIAL INVESTMENT IN THE FIELD OF STOCKS, BONDS, COMMODITIES OR OTHER SECURITIES; FINANCIAL INVESTMENT SERVICES, NAMELY, ADMINISTERING THE ISSUANCE, UNDERWRITING AND DISTRIBUTION OF SECURITIES; FINANCIAL LOAN CONSULTATION; FINANCIAL MANAGEMENT; FINANCIAL MANAGEMENT OF YACHT OPERATIONS; FINANCIAL PLANNING; FINANCIAL PLANNING AND INVESTMENT ADVISORY SERVICES; FINANCIAL PLANNING CONSULTATION; FINANCIAL PLANNING FOR RETIREMENT; FINANCIAL PLANNING SERVICES, NAMELY, DEVELOPING AND MANAGING CHARITABLE GIVING PROGRAMS ON BEHALF OF WEALTHY INDIVIDUALS OR FAMILIES; FINANCIAL PLANNING, NAMELY, THE CREATION OF PERSONALIZED STRATEGIES TO ACHIEVE FINANCIAL INDEPENDENCE; FINANCIAL PORTFOLIO ANALYSIS SERVICES; FINANCIAL PORTFOLIO MANAGEMENT; FINANCIAL RESEARCH; FINANCIAL RESEARCH AND EQUITY RESEARCH BROKERAGE SERVICES; FINANCIAL RESEARCH AND INFORMATION SERVICES; FINANCIAL RESTRUCTURING SERVICES; FINANCIAL RISK MANAGEMENT; FINANCIAL RISK MANAGEMENT CONSULTATION; FINANCIAL SECURITIES EXCHANGE SERVICES; FINANCIAL SERVICES IN THE FIELD OF MONEY LENDING; FINANCIAL SERVICES IN THE NATURE OF AN INVESTMENT SECURITY; FINANCIAL SERVICES, NAMELY, A TOTAL PORTFOLIO OFFERING FOR HIGH NET WORTH CLIENTS CONSISTING OF BOTH SEPARATE ACCOUNTS AND MUTUAL FUNDS FOR EQUITY AND FIXED INCOME INVESTMENTS; FINANCIAL SERVICES, NAMELY, ADMINISTRATION OF TRANSACTIONS INVOLVING FUNDS DRAWN FROM SECURITIES, STOCKS, FUNDS, EQUITIES, BONDS, CASH, OR OTHER TYPES OF FINANCIAL INVESTMENTS IN RETIREMENT PLANS USING A CHECK OR NEGOTIABLE ORDER OF WITHDRAWAL OVER A GLOBAL DATA NETWORK; FINANCIAL SERVICES, NAMELY, ADMINISTRATION OF TRANSACTIONS INVOLVING FUNDS DRAWN FROM SECURITIES, STOCKS, FUNDS, EQUITIES, BONDS, CASH, OR OTHER TYPES OF FINANCIAL INVESTMENTS IN RETIREMENT PLANS USING A CREDIT OR DEBIT CARD OVER A GLOBAL DATA NETWORK; FINANCIAL SERVICES, NAMELY, ARRANGING OF MODIFIED LOAN TERMS DESIGNED TO PREVENT HOME FORECLOSURE; FINANCIAL SERVICES, NAMELY, ASSISTING OTHERS WITH THE COMPLETION OF FINANCIAL TRANSACTIONS FOR STOCKS, BONDS, SECURITIES AND EQUITIES; FINANCIAL SERVICES, NAMELY, BUSINESS FUND RAISING PROVIDED OVER A COMPUTER NETWORK SUCH AS THE INTERNET; FINANCIAL SERVICES, NAMELY, COMMODITY TRADING AND MANAGED FUTURES ADVISORY AND MANAGEMENT SERVICES; FINANCIAL SERVICES, NAMELY, CONDUCTING A SECURITIES AND DERIVATIVES EXCHANGE; FINANCIAL SERVICES, NAMELY, COORDINATION, WITHIN A SINGLE ACCOUNT, OF AN INVESTMENT PORTFOLIO'S MAINTENANCE, TRADING, REBALANCING, AND TAX MANAGEMENT NEEDS; FINANCIAL SERVICES, NAMELY, CREDIT REPAIR AND RESTORATION; FINANCIAL SERVICES, NAMELY, DEBT RESOLUTION SERVICES IN THE NATURE OF DEBT SETTLEMENT AND ELIMINATION; FINANCIAL SERVICES, NAMELY, DEBT SETTLEMENT; FINANCIAL SERVICES, NAMELY, ELECTRONIC REMOTE CHECK DEPOSIT SERVICES; FINANCIAL SERVICES, NAMELY, ESTATE SETTLEMENT SERVICES; FINANCIAL SERVICES, NAMELY, FUNDING ONLINE CASH ACCOUNTS FROM PREPAID CASH CARDS, BANK ACCOUNTS AND CREDIT CARD ACCOUNTS; FINANCIAL SERVICES, NAMELY, GOLD TRADING; FINANCIAL SERVICES, NAMELY, INVESTMENT ADVICE, INVESTMENT MANAGEMENT, INVESTMENT CONSULTATION AND INVESTMENT OF FUNDS FOR OTHERS, INCLUDING PRIVATE AND PUBLIC EQUITY AND DEBT INVESTMENT SERVICES; FINANCIAL SERVICES, NAMELY, INVESTMENT FUND TRANSFER AND TRANSACTION SERVICES; FINANCIAL SERVICES, NAMELY, ISSUANCE AND MANAGEMENT OF CERTIFICATES BACKED BY LOAN PORTFOLIOS WHICH ARE SUBSEQUENTLY MANAGED TO INSURE THE INTEGRITY OF THE CERTIFICATES; FINANCIAL SERVICES, NAMELY, LIFE INSURANCE SETTLEMENT

SERVICES; FINANCIAL SERVICES, NAMELY, LOAN DEFAULT MITIGATION SERVICES; FINANCIAL SERVICES, NAMELY, LOSS MITIGATION SERVICES FOR UNDER- OR NON-PERFORMING MORTGAGE LOANS; FINANCIAL SERVICES, NAMELY, MONEY LENDING; FINANCIAL SERVICES, NAMELY, MORTGAGE PLANNING; FINANCIAL SERVICES, NAMELY, MORTGAGE REFINANCING; FINANCIAL SERVICES, NAMELY, PROVIDING A VIRTUAL CURRENCY FOR USE BY MEMBERS OF AN ON-LINE COMMUNITY VIA A GLOBAL COMPUTER NETWORK; FINANCIAL SERVICES, NAMELY, PROVIDING AN INVESTMENT OPTION AVAILABLE FOR VARIABLE ANNUITY AND VARIABLE LIFE INSURANCE PRODUCTS; FINANCIAL SERVICES, NAMELY, PROVIDING FOR THE EXCHANGE OF FOREIGN CURRENCY, COMMODITIES, FINANCIAL DERIVATIVES, INTEREST RATE PRODUCTS, AND EQUITIES VIA THE INTERNET AND INTRANET SYSTEMS; FINANCIAL SERVICES, NAMELY, PROVIDING ON-LINE STORED VALUE ACCOUNTS IN AN ELECTRONIC ENVIRONMENT; FINANCIAL SERVICES, NAMELY, RAISING DEBT AND EQUITY CAPITAL FOR OTHERS; FINANCIAL SERVICES, NAMELY, RAISING MONEY FOR THE HEDGE FUNDS OF OTHERS; FINANCIAL SERVICES, NAMELY, REAL ESTATE NOTE BROKERAGE; FINANCIAL SERVICES, NAMELY, SAVINGS PROGRAMS FOR YOUTHS; FINANCIAL SERVICES, NAMELY, THE PURCHASE OF RESIDENTIAL MORTGAGES ON BEHALF OF OTHERS AND THE ISSUANCE OF MORTGAGE-BACKED SECURITIES; FINANCIAL SERVICES, NAMELY, THE TRADING OF FINANCIAL INSTRUMENTS, SECURITIES, SHARES, OPTIONS AND OTHER DERIVATIVE PRODUCTS; FINANCIAL TRANSACTION SERVICES, NAMELY, PROVIDING SECURE COMMERCIAL TRANSACTIONS AND PAYMENT OPTIONS USING A MOBILE DEVICE AT A POINT OF SALE; FINANCIAL TRUST OPERATIONS; FINANCIAL VALUATION OF PERSONAL PROPERTY AND REAL ESTATE; FINANCIAL VALUATIONS; FINANCIALLY-GUARANTEED FINANCING; FINANCING OF REAL ESTATE DEVELOPMENT PROJECTS; FUND INVESTMENT CONSULTATION; FUND INVESTMENT SERVICES FEATURING SECURITIES OFFERED ACCORDING TO PREVIOUSLY ESTABLISHED CRITERIA IN ORDER TO MAINTAIN A PREDETERMINED LEVEL OF PAYMENTS TO THE ACCOUNT HOLDER; FUND INVESTMENT SERVICES FEATURING THE TRADING OF AN ACCOUNT HOLDER'S SECURITIES ACCORDING TO PREVIOUSLY ESTABLISHED CRITERIA IN ORDER TO MAINTAIN A PREDETERMINED LEVEL OF PAYMENTS TO THE ACCOUNT HOLDER; FUNDS INVESTMENT; GLOBAL INVESTMENT RESEARCH SERVICES; HEDGE FUND INVESTMENT SERVICES; HOUSING SERVICES, NAMELY, REAL PROPERTY ACQUISITION AND CONSUMER FINANCING TO FACILITATE HOME OWNERSHIP; INSURANCE AND FINANCIAL INFORMATION AND CONSULTANCY SERVICES; INSURANCE CONSULTANCY SERVICES, NAMELY, PROVIDING ADVICE IN THE FIELD OF PROPERTY AND CASUALTY INSURANCE; INVESTMENT ADVICE; INVESTMENT ADVISORY SERVICES; INVESTMENT BANKING SERVICES; INVESTMENT BROKERAGE; INVESTMENT BY ELECTRONIC MEANS; INVESTMENT CLUBS; INVESTMENT CONSULTATION; INVESTMENT MANAGEMENT; INVESTMENT MANAGEMENT OF AND DISTRIBUTION OF ANNUITIES; INVESTMENT MANAGEMENT OF AND DISTRIBUTION OF VARIABLE ANNUITIES; INVESTMENT MANAGEMENT SERVICES IN THE FIELD OF ACQUIRING JOINT VENTURES; INVESTMENT OF FUNDS FOR OTHERS; INVESTMENT SERVICES, NAMELY, ASSET ACQUISITION, CONSULTATION, DEVELOPMENT AND MANAGEMENT SERVICES; LAND ACQUISITION, NAMELY, REAL ESTATE BROKERAGE; LEASE OF REAL ESTATE; LEASING OF REAL ESTATE; LEASING OF REAL PROPERTY; LEVERAGED BUY OUTS AND INVESTMENTS IN FINANCIALLY DISTRESSED OR UNDERPERFORMING COMPANIES; MAINTAINING ESCROW ACCOUNTS FOR INVESTMENTS; MANAGEMENT OF A CAPITAL INVESTMENT FUND; MANAGEMENT OF PORTFOLIOS COMPRISING SECURITIES; MANAGEMENT OF PORTFOLIOS OF TRANSFERABLE SECURITIES; MEMBERSHIP CLUB SERVICES, NAMELY, PROVIDING INFORMATION TO

MEMBERS IN THE FIELDS OF REAL ESTATE, MORTGAGES AND DEBT ELIMINATION; MERCHANT BANKING AND INVESTMENT BANKING SERVICES; MORTGAGE COMPLIANCE CONSULTING SERVICES CONCERNING FINANCIAL REQUIREMENTS FOR MORTGAGES FOR MORTGAGE LENDERS AND SERVICERS AND MORTGAGE BROKERS; MORTGAGE FORECLOSURE MITIGATION AND LOAN DEFAULT MITIGATION SERVICES, NAMELY, ACQUISITION AND LEASE-BACK OF REAL ESTATE; MUTUAL FUND INVESTMENT; MUTUAL FUNDS AND CAPITAL INVESTMENT; NEWS REPORTING SERVICES IN THE FIELD OF FINANCIAL NEWS; ON-LINE FINANCIAL PLANNING SERVICES; ON-LINE TRADING OF FINANCIAL INSTRUMENTS, SHARES, OPTIONS AND OTHER DERIVATIVE PRODUCTS; ORGANIZATION OF ON-LINE STOCK EXCHANGES FOR THE BENEFIT OF THE TRADE OF STOCKS AND OTHER FINANCIAL SECURITIES; ORGANIZATION OF STOCK EXCHANGES FOR THE BENEFIT OF THE TRADE OF STOCKS AND OTHER FINANCIAL VALUES; PAYROLL TAX DEBITING SERVICES; PRIVATE EQUITY FUND INVESTMENT SERVICES; PROVIDING A DATABASE OF INFORMATION ABOUT RESIDENTIAL REAL ESTATE LISTINGS IN DIFFERENT NEIGHBORHOODS AND COMMUNITIES; PROVIDING A DATABASE OF RESIDENTIAL REAL ESTATE LISTINGS WITHIN NEIGHBORHOODS AND COMMUNITIES SPECIFICALLY IDENTIFIED BY USERS; PROVIDING A WEB SITE FEATURING PERSONAL FINANCIAL INFORMATION AND FINANCIAL ADVICE; PROVIDING A WEB SITE THAT ASSISTS FINANCIAL PROFESSIONALS IN THE MANAGEMENT OF RETIREMENT ACCOUNTS; PROVIDING A WEB SITE WHERE USERS CAN POST RATINGS, REVIEWS AND RECOMMENDATIONS ON STOCKS, BONDS, MUTUAL FUNDS AND OTHER FINANCIAL INSTRUMENTS; PROVIDING A WEBSITE FEATURING NON-DOWNLOADABLE VIDEOS IN THE FIELD OF FINANCIAL PLANNING; PROVIDING FINANCIAL ASSESSMENTS OF DAMAGES AFTER A DISASTER; PROVIDING FINANCIAL INFORMATION; PROVIDING FINANCIAL RISK MANAGEMENT SERVICES FOR ELECTRONIC FUNDS TRANSFER, CREDIT AND DEBIT CARD AND ELECTRONIC CHECK TRANSACTIONS VIA A GLOBAL COMPUTER NETWORK; PROVIDING INFORMATION AND ADVICE IN THE FIELD OF FINANCE, FINANCIAL INVESTMENTS, FINANCIAL VALUATIONS, AND THE FINANCIAL ASPECTS OF RETIREMENT; PROVIDING INFORMATION AND RESEARCH IN THE FIELD OF FINANCE AND FINANCIAL INVESTMENTS; PROVIDING INFORMATION IN THE FIELD OF REAL ESTATE BY MEANS OF LINKING THE WEB SITE TO OTHER WEB SITES FEATURING REAL ESTATE INFORMATION; PROVIDING INFORMATION IN THE FIELD OF REAL ESTATE VIA THE INTERNET; PROVIDING INFORMATION ON GOVERNMENT FINANCIAL ASSISTANCE PROGRAMS; PROVIDING ON-LINE FINANCIAL CALCULATORS; PROVIDING ON-LINE INFORMATION IN THE FIELD OF CHARITABLE MONETARY GIVING THROUGH FINANCIAL AND ESTATE PLANNING; PROVIDING POST-COMPLIANCE FINANCIAL REVIEWS FOR THE MORTGAGE INDUSTRY; PROVIDING REAL ESTATE LISTINGS AND REAL ESTATE INFORMATION VIA THE INTERNET; PROVIDING REAL ESTATE LISTINGS VIA THE INTERNET; PROVISION OF A FINANCIAL EXCHANGE FOR THE TRADING OF SECURITIES, SHARES AND OPTIONS AND OTHER DERIVATIVE PRODUCTS; PROVISION OF FINANCIAL INFORMATION; PUBLIC EQUITY INVESTMENT MANAGEMENT; REAL ESTATE ACQUISITION SERVICES; REAL ESTATE AGENCIES; REAL ESTATE APPRAISAL; REAL ESTATE APPRAISAL AND VALUATION; REAL ESTATE BROKERAGE; REAL ESTATE BROKERAGE SERVICES SPECIALIZING IN RESTAURANTS AND OTHER FOOD SERVICE RELATED BUSINESSES; REAL ESTATE CONSULTANCY; REAL ESTATE CONSULTATION; REAL ESTATE EQUITY SHARING, NAMELY, MANAGING AND ARRANGING FOR CO-OWNERSHIP OF REAL ESTATE; REAL ESTATE ESCROW SERVICES; REAL ESTATE FINANCING SERVICES; REAL ESTATE INSURANCE UNDERWRITING SERVICES; REAL ESTATE INVESTMENT; REAL ESTATE INVESTMENT SERVICES IN THE NATURE OF PURCHASING AND SELLING OF REAL ESTATE FOR OTHERS; REAL ESTATE LENDING SERVICES; REAL ESTATE LISTING; REAL ESTATE LISTING SERVICES FOR HOUSING RENTALS AND APARTMENT RENTALS; REAL ESTATE MANAGEMENT CONSULTATION; REAL ESTATE MANAGE-

MENT OF VACATION HOMES; REAL ESTATE MANAGEMENT SERVICES; REAL ESTATE MULTIPLE LISTING SERVICES; REAL ESTATE PROCUREMENT FOR OTHERS; REAL ESTATE RENTAL SERVICES, NAMELY, RENTAL OF RESIDENTIAL HOUSING; REAL ESTATE SERVICE, NAMELY, RENTAL PROPERTY MANAGEMENT; REAL ESTATE SERVICES IN THE FORM OF PROVIDING PHYSICAL ACCESS TO AVAILABLE PROPERTIES VIA A REMOTE CALL-IN LOCKING DEVICE; REAL ESTATE SERVICES TO STOP FORECLOSURE, NAMELY, MORTGAGE DEBT MANAGEMENT; REAL ESTATE SERVICES, NAMELY, AD VALOREM APPRAISALS; REAL ESTATE SERVICES, NAMELY, CONDOMINIUM MANAGEMENT SERVICES; REAL ESTATE SERVICES, NAMELY, LEASING AND MANAGEMENT FOR OTHERS OF RESIDENTIAL CONDOMINIUMS LOCATED WITHIN HOTEL DEVELOPMENTS; REAL ESTATE SERVICES, NAMELY, MASS APPRAISALS; REAL ESTATE SERVICES, NAMELY, PROPERTY MANAGEMENT SERVICES FOR CONDOMINIUM ASSOCIATIONS, HOMEOWNER ASSOCIATIONS AND APARTMENT BUILDINGS; REAL ESTATE SERVICES, NAMELY, PROVIDING ONLINE QUESTIONS TO HELP USERS DETERMINE THE BEST NEIGHBORHOODS AND COMMUNITIES SUITED TO THEIR INDIVIDUAL NEEDS AND PREFERENCES; REAL ESTATE SERVICES, NAMELY, RENTAL OF SHORT-TERM FURNISHED APARTMENTS; REAL ESTATE SERVICES, NAMELY, RENTAL OF VACATION HOMES; REAL ESTATE SERVICES, NAMELY, RENTAL OF VACATION HOMES, CONDOMINIUMS, CABINS, AND VILLAS USING PAY PER CLICK ADVERTISING ON A GLOBAL COMPUTER NETWORK; REAL ESTATE SERVICES, NAMELY, RENTAL, BROKERAGE, LEASING AND MANAGEMENT OF COMMERCIAL PROPERTY, OFFICES AND OFFICE SPACE; REAL ESTATE SERVICES, NAMELY, TAX APPRAISALS; REAL ESTATE SERVICES, NAMELY, VACATION HOME RENTAL MANAGEMENT SERVICES; REAL ESTATE SYNDICATION; REAL ESTATE TIME-SHARING; REAL ESTATE TRUSTEE SERVICES; REAL ESTATE VALUATION SERVICES; REAL ESTATE VALUATIONS; REAL PROPERTY REAPPRAISAL SERVICES; REPAIR COST EVALUATION; SECURITIES TRADING AND INVESTING SERVICES FOR OTHERS VIA THE INTERNET; STRATEGIC CORPORATE FINANCIAL ADVISORY SERVICES; STRATEGIC FINANCIAL ADVISORY SERVICES; TAX PAYMENT PROCESSING SERVICES; TRANSFER AGENCY SERVICES RENDERED TO ISSUERS OF INVESTMENT SECURITIES; TRUST MANAGEMENT ACCOUNTS; TRUST SERVICES, NAMELY, INVESTMENT AND TRUST COMPANY SERVICES; VACATION REAL ESTATE TIME SHARE EXCHANGE SERVICES; VACATION REAL ESTATE TIME-SHARING; VACATION REAL ESTATE TIMESHARE SERVICES; VALUATIONS IN REAL ESTATE MATTERS; WEBSITE FOR CHILDREN WITH PARENTAL CONTROLS THAT PROMOTES AND FACILITATES FINANCIAL GOAL SETTING (U.S. CLS. 100, 101 AND 102).

DAWN FELDMAN, EXAMINING ATTORNEY

SN 77-887,035. GRIFFITH, STEWART M., DBA VERBAL STRATEGY, NEWBURY PARK, CA. FILED 12-5-2009.

Top Ten Power Tools of Persuasion

THE MARK CONSISTS OF STANDARD CHARACTERS WITHOUT CLAIM TO ANY PARTICULAR FONT, STYLE, SIZE, OR COLOR.

CLASS 9—ELECTRICAL AND SCIENTIFIC APPARATUS

FOR DIGITAL MEDIA, NAMELY, CDS, DVDS, AND DOWNLOADABLE AUDIO FILES FEATURING EDUCATIONAL MATERIALS FOR THE FIELDS OF SALES, MANAGEMENT, LAW, AND POLITICS (U.S. CLS. 21, 23, 26, 36 AND 38).

CLASS 16—PAPER GOODS AND PRINTED MATTER

FOR PRINTED EDUCATIONAL MATERIALS IN THE FIELD OF SALES, MANAGEMENT, LAW, AND POLITICS (U.S. CLS. 2, 5, 22, 23, 29, 37, 38 AND 50).
THOMAS MANOR, EXAMINING ATTORNEY

SN 77-887,189. BIGWEINER, LL:C, JESUP, IA. FILED 12-6-2009.

BigWeiner

THE MARK CONSISTS OF STANDARD CHARACTERS WITHOUT CLAIM TO ANY PARTICULAR FONT, STYLE, SIZE, OR COLOR.

CLASS 21—HOUSEWARES AND GLASS

FOR CUPS AND MUGS (U.S. CLS. 2, 13, 23, 29, 30, 33, 40 AND 50).
FIRST USE 9-1-2009; IN COMMERCE 9-1-2009.

CLASS 25—CLOTHING

FOR CLOTHING, NAMELY T-SHIRTS, SHIRTS, HATS, AND CAPS (U.S. CLS. 22 AND 39).
FIRST USE 9-1-2009; IN COMMERCE 9-1-2009.
JILL PRATER, EXAMINING ATTORNEY

SN 77-887,209. SHENZHEN XINGYAOHUA INDUSTRIAL CO., LTD., SHENZHEN, CHINA, FILED 12-7-2009.

THE MARK CONSISTS OF THE LETTERS "RTE" THAT ARE SHADED BY HORIZONTAL STRIPES.

CLASS 7—MACHINERY

FOR MACHINE PARTS, NAMELY, JOINTS AND JOINT PARTS FOR CONNECTING SLIDING STRIPS, PLATES AND GUIDES; PISTONS FOR CYLINDERS, DASHPOT; POWER TRANSMISSIONS AND GEARING FOR MACHINES; POWER-OPERATED LIFE-SAVING SAFETY MECHANISM, NAMELY, A CONTROLLED DESCENT DEVICE COMPRISED OF SEVERAL DESCENT SLOWING MECHANISMS ALLOWING FOR THE REGULATED DESCENT AT A FIXED AND SAFE SPEED, A HARNESS ATTACHED AT EITHER END OF A STEEL FIBER CABLE, AND AN ASSORTMENT OF ACCESSORIES ATTACHED THERETO; PUMPS AS PARTS OF MACHINES, MOTORS AND ENGINES; STARTERS FOR MOTORS AND ENGINES (U.S. CLS. 13, 19, 21, 23, 31, 34 AND 35).
FIRST USE 4-21-2007; IN COMMERCE 4-21-2007.

CLASS 28—TOYS AND SPORTING GOODS

FOR ELECTRIC ACTION TOYS; ELECTRONIC TOY VEHICLES; PROTECTIVE SUPPORTS FOR SHOULDERS AND ELBOWS; SCALE MODEL AIRPLANES; SCALE MODEL VEHICLES; SPRING BOARDS; TOY AIRPLANES; TOY CARS; WEIGHT LIFTING BELTS (U.S. CLS. 22, 23, 38 AND 50).
FIRST USE 5-17-2006; IN COMMERCE 5-17-2006.
MARILYN IZZI, EXAMINING ATTORNEY

SN 77-887,317. PIVOT POINT INTERNATIONAL, INC., EVANSTON, IL. FILED 12-7-2009.



THE MARK CONSISTS OF THE DESIGN OF THE LETTER "P" LAYING HORIZONTALLY AND COMPOSED OF A SHADED CIRCLE ON TOP OF THE LEFT PORTION OF A SHADED HORIZONTAL BAR.

CLASS 16—PAPER GOODS AND PRINTED MATTER

FOR BROCHURES, CATALOGS, PERIODICAL MAGAZINES, COURSE BOOKS, AND INSTRUCTIONAL MATERIALS, NAMELY, STUDENT AND TEACHER GUIDES, WORKBOOKS AND MANUALS, ALL IN THE AREA OF COSMETOLOGY, HAIRSTYLING AND HAIR DESIGN; PACKAGED HAIR COLOR AND PERMANENT WAVE TESTING KITS COMPRISING COLOR-TEST HAIR SWATCH BOOKS, CLIP BOARD, BINDER, COLOR TEST BOOKLET, PERMANENT TEST BOOKLET, PALLETTE AND CONTAINERS FOR HOLDING COLOR OR PERMANENT TESTING CHEMICALS FOR EDUCATIONAL ACTIVITIES IN THE FIELD OF HAIR COLOR (U.S. CLS. 2, 5, 22, 23, 29, 37, 38 AND 50).

CLASS 41—EDUCATION AND ENTERTAINMENT

FOR EDUCATIONAL SERVICES, NAMELY, TRAINING OF PERSONNEL AND COORDINATING AND CONDUCTING CLASSES, WORKSHOPS AND DEMONSTRATIONS IN THE FIELD OF COSMETOLOGY, HAIRSTYLING AND HAIR DESIGN AND DISTRIBUTION OF EDUCATIONAL MATERIALS IN THE FIELD OF COSMETOLOGY, HAIRSTYLING AND HAIR DESIGN IN CONNECTION THEREWITH; TRAINING OTHERS IN THE FIELD OF HAIR STYLING AND DESIGN (U.S. CLS. 100, 101 AND 107).
AMY KERTGATE, EXAMINING ATTORNEY

SN 77-887,348. RETAIL BRAND ALLIANCE, INC., ENFIELD, CT. FILED 12-7-2009.

MISS MADISON

THE MARK CONSISTS OF STANDARD CHARACTERS WITHOUT CLAIM TO ANY PARTICULAR FONT, STYLE, SIZE, OR COLOR.

OWNER OF U.S. REG. NO. 3,665,138.

CLASS 3—COSMETICS AND CLEANING PREPARATIONS

FOR BLUSHER; EYE MAKE-UP; BODY POWDER; CONCEALERS FOR SKIN; FACE AND BODY BEAUTY CREAMS; FACE POWDER; MAKE-UP FOR THE FACE AND BODY; LIPSTICK; LIP BALM; LIP GLOSS; LIP LINER; FOUNDATION MAKE-UP; MAKE-UP; MAKE-UP POWDER; NAIL POLISH; BODY SPRAYS; ROOM FRAGRANCES; SCENTED LINEN SPRAYS; INCENSE STICKS; FRAGRANCES FOR PERSONAL USE; OILS FOR TOILETRY PURPOSES; BATH BEADS; POTPOURRI; PERFUMING SACHETS; SACHET-LIKE EYE PILLOWS CONTAINING FRAGRANCES; SACHETS; SCENTED BODY LOTIONS AND CREAMS; SCENTED BODY SPRAY; SCENTED CERAMIC STONES; SCENTED FABRIC REFRESHER SPRAY; SCENTED OILS USED TO PRODUCE AROMAS WHEN HEATED; SCENTED ROOM SPRAYS; AROMATHERAPY OILS; BABY OIL; BATH OIL; BODY OIL; COSMETIC OILS; ESSENTIAL OILS; PERFUME OILS; TANNING OILS; EMERY BOARDS; COLOGNE; AFTER-SHAVE; AFTER-SHAVE BALMS; AFTER-SHAVE CREAMS; AFTER-SHAVE EMULSIONS; AFTER-SHAVE GEL; AFTER-SHAVE LOTIONS; AFTER-SUN LOTIONS; AROMATHERAPY LOTIONS; BATH LOTION; BATHING LOTIONS; BODY LOTION; COSMETIC SUNTAN LOTIONS; FACE AND BODY LOTIONS; HAIR WAVING LOTION; HAND LOTIONS; NON-MEDICATED SKIN CARE PREPARATIONS, NAMELY, CREAMS, LOTIONS, GELS, TONERS, CLEANSERS AND PEELS; STYLING LOTIONS; BEAUTY CREAMS; BODY CREAM; COSMETIC CREAMS; EXFOLIANT CREAMS; FACE AND BODY CREAMS; PRE-SHAVE CREAMS; SHAVING BALM; SHAVING CREAM; SHAVING GEL; SHAVING PREPARATIONS; SKIN CREAM; BATH SOAPS; DEODORANT SOAP; DEODORANT FOR PERSONAL USE; SHAMPOOS; BATH GEL; HAIR GEL; HAIR STYLING SPRAY; SHOWER AND BATH GEL; BEAUTY LOTIONS; EAU DE PERFUME; PERFUME; EAU DE TOILETTE; DEODORANTS FOR BODY CARE (U.S. CLS. 1, 4, 6, 50, 51 AND 52).

CLASS 4—LUBRICANTS AND FUELS

FOR CANDLES; PERFUMED CANDLES; FRAGRANT WAX FOR USE IN POTPOURRI BURNERS; SCENTED CANDLES (U.S. CLS. 1, 6 AND 15).

CYNTHIA TRIPI, EXAMINING ATTORNEY

SN 77-887,530. CARMICHAEL TRAINING SYSTEMS, INC., COLORADO SPRINGS, CO. FILED 12-7-2009.

THE TIME-CRUNCHED ATHLETE

THE MARK CONSISTS OF STANDARD CHARACTERS WITHOUT CLAIM TO ANY PARTICULAR FONT, STYLE, SIZE, OR COLOR.

NO CLAIM IS MADE TO THE EXCLUSIVE RIGHT TO USE "ATHLETE", APART FROM THE MARK AS SHOWN.

CLASS 9—ELECTRICAL AND SCIENTIFIC APPARATUS

FOR ELECTRONIC GOODS, NAMELY, PRE-RECORDED VIDEO CASSETTES, DIGITAL VIDEO DISCS AND CD'S FEATURING ENDURANCE AND AEROBIC TRAINING, PHYSICAL FITNESS AND NUTRITION INSTRUCTION; DOWNLOADABLE ELECTRONIC PUBLICATIONS, NAMELY, NEWSLETTERS FEATURING ARTICLES AND INFORMATION ABOUT ENDURANCE AND AEROBIC TRAINING, NUTRITION, PHYSICAL FITNESS, HEALTH AND WELLNESS (U.S. CLS. 21, 23, 26, 36 AND 38).

CLASS 16—PAPER GOODS AND PRINTED MATTER

FOR PRINTED MATERIALS, NAMELY, A SERIES OF BOOKS AND PAMPHLETS FEATURING INFORMATION ABOUT ENDURANCE AND AEROBIC TRAINING, NUTRITION, PHYSICAL FITNESS, HEALTH AND WELLNESS (U.S. CLS. 2, 5, 22, 23, 29, 37, 38 AND 50).

ALEXANDER L. POWERS, EXAMINING ATTORNEY

SN 77-887,599. CHANNING BETE COMPANY, INC., SOUTH DEERFIELD, MA. FILED 12-7-2009.

GUIDING GOOD CHOICES

THE MARK CONSISTS OF STANDARD CHARACTERS WITHOUT CLAIM TO ANY PARTICULAR FONT, STYLE, SIZE, OR COLOR.

OWNER OF U.S. REG. NO. 2,793,323.
SEC. 2(F).

CLASS 9—ELECTRICAL AND SCIENTIFIC APPARATUS

FOR PRE-RECORDED VIDEO CASSETTES, OPTICAL DISCS, COMPUTER DISCS, AND COMPUTER SOFTWARE RELATING TO PARENTING, CHILDREN'S EDUCATION, AND SOCIAL ISSUES THAT FACE CHILDREN AND TEENAGERS (U.S. CLS. 21, 23, 26, 36 AND 38).

FIRST USE 1-13-2003; IN COMMERCE 1-13-2003.

CLASS 16—PAPER GOODS AND PRINTED MATTER

FOR PRINTED WORKBOOKS, MANUALS, GUIDES, ACTIVITY BOOKS AND RELATED PRINTED MATERIALS RELATING TO PARENTING, CHILDREN'S EDUCATION, AND SOCIAL ISSUES THAT FACE CHILDREN AND TEENAGERS (U.S. CLS. 2, 5, 22, 23, 29, 37, 38 AND 50).

FIRST USE 1-13-2003; IN COMMERCE 1-13-2003.

CLASS 41—EDUCATION AND ENTERTAINMENT

FOR CONDUCTING EDUCATIONAL PROGRAMS, WORKSHOPS, SEMINARS AND CONFERENCES, AND PROVIDING TRAINING SERVICES RELATED THERE-TO ALL IN THE FIELD OF PARENTING, CHILDREN'S EDUCATION AND SOCIAL ISSUES THAT FACE CHILDREN AND TEENAGERS (U.S. CLS. 100, 101 AND 107).

FIRST USE 2-26-2003; IN COMMERCE 2-26-2003.
SHAILA SETTLES, EXAMINING ATTORNEY

SN 77-887,604. BLUMENS INC., DBA BLUMEN LIGHTS, SEATTLE, WA. FILED 12-7-2009.



THE MARK CONSISTS OF A DISK CONTAINING A STYLIZED "B" WITH THE DISK SURROUNDED BY AN OVAL OR CIRCLE.

CLASS 11—ENVIRONMENTAL CONTROL APPARATUS

FOR ELECTRIC LIGHTING FIXTURES; LED (LIGHT EMITTING DIODE) LIGHTING FIXTURES; LED (LIGHT EMITTING DIODES) LIGHTING FIXTURES FOR USE IN DISPLAY, COMMERCIAL, INDUSTRIAL, RESIDENTIAL, AND ARCHITECTURAL ACCENT LIGHTING APPLICATIONS (U.S. CLS. 13, 21, 23, 31 AND 34).
FIRST USE 11-1-2006; IN COMMERCE 8-18-2007.

CLASS 26—FANCY GOODS

FOR ARTIFICIAL FLOWER ARRANGEMENTS; ARTIFICIAL FLOWERS; ARTIFICIAL FLOWERS OF PLASTICS; ARTIFICIAL FLOWERS OF TEXTILE (U.S. CLS. 37, 39, 40, 42 AND 50).
FIRST USE 11-1-2006; IN COMMERCE 8-18-2007.

TRACY WHITTAKER-BROWN, EXAMINING ATTORNEY

SN 77-887,652. DANSKO, LLC, WEST GROVE, PA. FILED 12-7-2009.



THE MARK CONSISTS OF DOTS CREATING THE LETTER S SURROUNDED BY FLOWING LINES COMPRISED OF DOTS.

CLASS 18—LEATHER GOODS

FOR HANDBAGS; ALL PURPOSE SPORTS BAGS; ALL PURPOSE CARRYING BAGS; LUGGAGE; LEATHER GOODS AND IMITATION LEATHER GOODS, NAMELY, WALLETS, BRIEFCASES, AND PURSES (U.S. CLS. 1, 2, 3, 22 AND 41).

CLASS 25—CLOTHING

FOR CLOTHING, NAMELY, SHIRTS, PANTS, SHORTS, JACKETS, JERSEYS, SWEATERS, SWEATSHIRTS, SWEATPANTS, HATS, CAPS, UNDERWEAR, AND SOCKS; FOOTWEAR; LEATHER BELTS; TEXTILE BELTS (U.S. CLS. 22 AND 39).

CLASS 35—ADVERTISING AND BUSINESS

FOR RETAIL STORES FEATURING CLOTHING AND FOOTWEAR; ONLINE RETAIL STORES FEATURING CLOTHING AND FOOTWEAR (U.S. CLS. 100, 101 AND 102).

JENNIFER MARTIN, EXAMINING ATTORNEY

SN 77-887,658. ASSOCIATION OF COLLEGE AND UNIVERSITY TELECOMMUNICATIONS ADMINISTRATORS, INCORPORATED, LEXINGTON, KY. FILED 12-7-2009.

ACUTA

THE MARK CONSISTS OF STANDARD CHARACTERS WITHOUT CLAIM TO ANY PARTICULAR FONT, STYLE, SIZE, OR COLOR.

CLASS 16—PAPER GOODS AND PRINTED MATTER

FOR NEWSLETTERS, JOURNALS AND WHITE PAPERS IN THE FIELD OF INFORMATION COMMUNICATIONS TECHNOLOGY (U.S. CLS. 2, 5, 22, 23, 29, 37, 38 AND 50).
FIRST USE 4-0-1973; IN COMMERCE 4-0-1973.

CLASS 35—ADVERTISING AND BUSINESS

FOR ASSOCIATION SERVICES, NAMELY, PROMOTING THE INTERESTS OF HIGHER EDUCATION INFORMATION COMMUNICATIONS TECHNOLOGY PROFESSIONALS (U.S. CLS. 100, 101 AND 102).
FIRST USE 7-0-1972; IN COMMERCE 7-0-1972.

CLASS 41—EDUCATION AND ENTERTAINMENT

FOR EDUCATIONAL SERVICES, NAMELY, ARRANGING AND CONDUCTING CONFERENCES AND SEMINARS IN THE FIELD OF INFORMATION COMMUNICATIONS TECHNOLOGY; PROVIDING ONLINE NEWSLETTERS, JOURNALS AND WHITE PAPERS IN THE FIELD OF INFORMATION COMMUNICATIONS TECHNOLOGY (U.S. CLS. 100, 101 AND 107).
FIRST USE 7-0-1972; IN COMMERCE 7-0-1972.

COLLEEN DOMBROW, EXAMINING ATTORNEY

SN 77-887,663. THE V FOUNDATION FOR CANCER RESEARCH, CARY, NC. FILED 12-7-2009.

SN 77-887,723. ED HAKONSON, STOUFFVILLE, CANADA, FILED 12-7-2009.

PROUD TO FARM

ONE TEAM. ONE CAUSE.

THE MARK CONSISTS OF STANDARD CHARACTERS WITHOUT CLAIM TO ANY PARTICULAR FONT, STYLE, SIZE, OR COLOR.

THE MARK CONSISTS OF STANDARD CHARACTERS WITHOUT CLAIM TO ANY PARTICULAR FONT, STYLE, SIZE, OR COLOR.

CLASS 35—ADVERTISING AND BUSINESS

FOR PROMOTING PUBLIC AWARENESS OF THE NEED FOR FINDING A CURE FOR CANCER AND OF THE NEED FOR CANCER RESEARCH (U.S. CLS. 100, 101 AND 102).

FIRST USE 12-2-2009; IN COMMERCE 12-2-2009.

CLASS 36—INSURANCE AND FINANCIAL

FOR CHARITABLE FUND RAISING SERVICES (U.S. CLS. 100, 101 AND 102).

FIRST USE 12-2-2009; IN COMMERCE 12-2-2009.
EMILY CARLSEN, EXAMINING ATTORNEY

SN 77-887,722. ANNA SEATON HUNTINGTON, RAPID CITY, SD. FILED 12-7-2009.



THE MARK CONSISTS OF THE WORD "TOM", FOLLOWED BY A DEPICTION OF A GIRL HOLDING A SLINGSHOT, FOLLOWED BY THE WORD "MOM" WITH A FROG ON TOP OF THE LETTER "O" IN "MOM".

CLASS 18—LEATHER GOODS

FOR BACKPACKS, BOOK BAGS, SPORTS BAGS, BUM BAGS, WALLETS AND HANDBAGS (U.S. CLS. 1, 2, 3, 22 AND 41).

CLASS 25—CLOTHING

FOR CLOTHING AND APPAREL, NAMELY, SHIRTS, JACKETS, HATS, SWEATSHIRTS, PANTS, BANDANAS, HEADBANDS, VESTS, SOCKS, TANK TOPS, SHORTS, SKIRTS AND DRESSES (U.S. CLS. 22 AND 39).

KELLY BOULTON, EXAMINING ATTORNEY

CLASS 18—LEATHER GOODS

FOR LUGGAGE, NAMELY, SPORTS BAGS, DUFFLE BAGS, BACK PACKS AND FANNY PACKS; WALLETS; LEATHER KEY CHAINS (U.S. CLS. 1, 2, 3, 22 AND 41).

CLASS 21—HOUSEWARES AND GLASS

FOR CERAMIC, GLASS, STAINLESS STEEL AND ALUMINUM COFFEE MUGS; PORTABLE FOOD AND BEVERAGE COOLERS (U.S. CLS. 2, 13, 23, 29, 30, 33, 40 AND 50).

CLASS 25—CLOTHING

FOR CLOTHING AND ACCESSORIES, NAMELY, PANTS, SHORTS, BELTS; OUTERWEAR, NAMELY, COATS, OVERCOATS, WIND RESISTANT JACKETS, LIGHTWEIGHT JACKETS AND HEAVYWEIGHT JACKETS; SHIRTS, NAMELY, T-SHIRTS, CASUAL SHIRTS, POLO SHIRTS, JERSEYS, FLEECE SHIRTS, LONG AND SHORT SLEEVE SHIRTS; HEADWEAR, NAMELY, BASEBALL CAPS, TOQUES, HATS, TRAPPER HATS, COWBOY HATS, BALACLAVAS AND BEANIES; FOOTWEAR, NAMELY, CASUAL SHOES, ATHLETIC SHOES, WINTER BOOTS, PROTECTIVE STEEL TOE BOOTS AND HIKING BOOTS (U.S. CLS. 22 AND 39).

KAPIL BHANOT, EXAMINING ATTORNEY

SN 77-887,818. GENESIS PHYSICIANS GROUP, INC., DALLAS, TX. FILED 12-7-2009.

GENPro

THE MARK CONSISTS OF STANDARD CHARACTERS WITHOUT CLAIM TO ANY PARTICULAR FONT, STYLE, SIZE, OR COLOR.

CLASS 35—ADVERTISING AND BUSINESS

FOR CONSULTING SERVICES IN THE FIELD OF PHYSICIAN PRACTICE MANAGEMENT (U.S. CLS. 100, 101 AND 102).

FIRST USE 9-1-2009; IN COMMERCE 9-1-2009.

CLASS 42—SCIENTIFIC AND COMPUTER SERVICES

FOR SOFTWARE AS A SERVICE (SAAS) SERVICES, NAMELY, HOSTING SOFTWARE FOR USE BY PHYSICIANS FOR PRACTICE MANAGEMENT, REVENUE CYCLE MANAGEMENT, ELECTRONIC MEDICAL RECORD MANAGEMENT, AND MEDICAL PRACTICE ANALYTICS (U.S. CLS. 100 AND 101).

FIRST USE 9-1-2009; IN COMMERCE 9-1-2009.
TRACY CROSS, EXAMINING ATTORNEY

SN 77-887,933. WISECRACKER LLC, PETALUMA, CA.
FILED 12-7-2009.

WISECRACKER

THE MARK CONSISTS OF STANDARD CHARACTERS WITHOUT CLAIM TO ANY PARTICULAR FONT, STYLE, SIZE, OR COLOR.

CLASS 9—ELECTRICAL AND SCIENTIFIC APPARATUS

FOR LEATHER LAPTOP COMPUTER BAGS (U.S. CLS. 21, 23, 26, 36 AND 38).

CLASS 18—LEATHER GOODS

FOR LUGGAGE, LEATHER BRIEFCASES, AND WALLET (U.S. CLS. 1, 2, 3, 22 AND 41).

CLASS 25—CLOTHING

FOR CLOTHING, NAMELY, JACKETS, COATS AND VESTS (U.S. CLS. 22 AND 39).
JAMES MACFARLANE, EXAMINING ATTORNEY

SN 77-887,949. PRETTY UGLY LLC, EDISON, NJ. AND HORVATH, DAVID, EDISON, NJ. AND KIM, SUN-MIN, EDISON, NJ. FILED 12-7-2009.

UGLYVERSE

THE MARK CONSISTS OF STANDARD CHARACTERS WITHOUT CLAIM TO ANY PARTICULAR FONT, STYLE, SIZE, OR COLOR.

CLASS 16—PAPER GOODS AND PRINTED MATTER

FOR COLORING BOOKS AND COMIC BOOKS, STATIONERY, CHILDREN'S BOOKS, CHILDREN'S ACTIVITY BOOKS FEATURING GAMES, GREETING CARDS, POSTCARDS, POSTERS, NOTEBOOKS, THANK YOU CARDS, VALENTINE CARDS SOLD IN PACKS, INVITATIONS, CALENDARS, STICKERS, WRAPPING PAPER, PAPER GIFT BAGS, PAPER GIFT TAGS, PAPER AND METALLIC PAPER PARTY DECORATIONS, PAPER PARTY BAGS, PAPER PARTY FAVORS, BANK CHECKS, PAPER NAPKINS, TRADING CARDS, LUNCH BAGS, CHRISTMAS CARDS, LITHOGRAPHS, ART PRINTS, ART PICTURES, AND BOOK MARKS; ADDRESS BOOKS, BLANK JOURNALS, SCHOOL DAY PLANNERS, POSTCARDS (U.S. CLS. 2, 5, 22, 23, 29, 37, 38 AND 50).

CLASS 25—CLOTHING

FOR CLOTHING; NAMELY, SHIRTS, T-SHIRTS, SWEATSHIRTS, SWEATERS, VESTS, JACKETS, WARM-UP SUITS, ROBES, PANTS, SHORTS, CLOTHING BELTS, OVERALLS, INFANTWEAR, PLAYSUITS, CLOTH BABY BIBS, HEADWEAR, FOOTWEAR, BOOTS, SOCKS, TIGHTS, BEACHWEAR, SWIMSUITS, SWIMWEAR, BATHING CAPS, TENNIS WEAR, RAINWEAR, JACKETS, COATS, GLOVES, HATS, SUN VISORS, BANDANAS, SCARVES, PAJAMAS, NIGHTSHIRTS, NIGHTGOWNS, UNDERGARMENTS, MASQUERADE COSTUMES, AND MASQUERADE COSTUMES WITH MASKS SOLD IN CONNECTION THEREWITH (U.S. CLS. 22 AND 39).

CLASS 28—TOYS AND SPORTING GOODS

FOR TOYS AND SPORTING GOODS, NAMELY, PLAY FIGURES AND ACCESSORIES THEREFOR, ACTION FIGURES AND ACCESSORIES THEREFOR, TOY FIGURES, ELECTRIC ACTION TOYS, MECHANICAL ACTION TOYS, DOLLS AND ACCESSORIES THEREFOR, DOLL PLAYSETS, PLUSH TOYS, STUFFED TOYS, PUPPETS, WINDUP TOYS, BOARD GAMES, CARD GAMES, DOMINOES, JIGSAW PUZZLES, MANIPULATIVE GAMES, MARBLES, PADDLE BALL GAMES, YO-YO'S, BALLOONS, JUMP ROPES, KITES AND ACCESSORIES THEREFOR, NAMELY, KITE PARTS, KITE LINES AND KITE REELS, BUBBLE MAKING WANDS AND SOLUTION SETS, MAGIC TRICKS, BATH TOYS, PLAY SWIMMING POOLS, TOY VEHICLES AND ACCESSORIES THEREFOR, TOY MODEL HOBBY CRAFT KITS, TOY BANKS, TOY BOXES, TOY GUNS, TOY HOLSTERS, TOY ARCHERY BOWS AND ARROWS, TOY ROCKETS, TOY BUCKET AND SHOVEL SETS, CHILDREN'S PLAY COSMETICS, BABY RATTLES, BABY MULTIPLE ACTIVITY TOYS, TOY CONSTRUCTION BLOCKS, MUSICAL TOYS, TARGET GAMES, ACTION SKILL GAMES, SPORT BALLS, BASEBALLS, BASKETBALLS, FOOTBALLS, GOLF BALLS, TENNIS BALLS, PLAYGROUND BALLS, SOCCER BALLS, VOLLEYBALLS, RUBBER BALLS, FOAM BALLS, BASEBALL BATS, BASEBALL GLOVES, FLYING DISKS, DISC TYPE TOSS TOYS, BODY BOARDS, BADMINTON SETS, DART FLIGHTS, GOLF CLUB HEAD COVERS, ROLLER SKATES, SKATEBOARDS, TOY SCOOTERS, SWIM FINS, SWIM FLOATS FOR RECREATIONAL USE, FACE MASKS, PINBALL-TYPE GAMES, CHRISTMAS TREE DECORATIONS, EGG DECORATING KITS, HAND HELD UNITS FOR PLAYING ELECTRONIC GAMES, AND PLAYING CARDS AND PAPER PARTY HATS (U.S. CLS. 22, 23, 38 AND 50).

CLASS 41—EDUCATION AND ENTERTAINMENT

FOR ENTERTAINMENT SERVICES, NAMELY, PRODUCTION AND DISTRIBUTION OF MOTION PICTURES, FILMS, TELEVISION PROGRAMS, INTERACTIVE TELEVISION PROGRAMS, LIVE PERFORMANCES, AUDIO RECORDING AND PRODUCTION OF ANIMATED AND LIVE ACTION ENTERTAINMENT, FAN CLUB SERVICES (U.S. CLS. 100, 101 AND 107).
MARGERY A. TIERNEY, EXAMINING ATTORNEY

SN 77-887,964. AUGUSTA NATIONAL, INC., AUGUSTA, GA.
FILED 12-7-2009.

MASTERS

THE MARK CONSISTS OF STANDARD CHARACTERS WITHOUT CLAIM TO ANY PARTICULAR FONT, STYLE, SIZE, OR COLOR.

OWNER OF U.S. REG. NOS. 361,678, 1,219,958 AND OTHERS.

CLASS 29—MEATS AND PROCESSED FOODS

FOR SALTED PEANUTS; POTATO CHIPS AND FLAVORED POTATO CHIPS (U.S. CL. 46).
FIRST USE 4-7-2008; IN COMMERCE 4-7-2008.

CLASS 30—STAPLE FOODS

FOR CRACKERS AND SANDWICH CRACKERS WITH PEANUT BUTTER AND FLAVORED CREAM FILLINGS; CHOCOLATE COVERED MARSHMALLOW FILLED SANDWICH PIES (U.S. CL. 46).
FIRST USE 4-7-2008; IN COMMERCE 4-7-2008.
ANGELA M. MICHELI, EXAMINING ATTORNEY

SN 77-888,070. GUESTFOLIO COMMUNICATIONS INC., WHISTLER, BC, CANADA, FILED 12-7-2009.

GUESTFOLIO

THE MARK CONSISTS OF STANDARD CHARACTERS WITHOUT CLAIM TO ANY PARTICULAR FONT, STYLE, SIZE, OR COLOR.

OWNER OF CANADA REG. NO. TMA758810, DATED 2-4-2010, EXPIRES 2-4-2025.

CLASS 9—ELECTRICAL AND SCIENTIFIC APPARATUS

FOR COMPUTER SOFTWARE IN THE FIELD OF TRAVEL AND TOURISM, THE FUNCTION OF WHICH IS TO MANAGE AND TRACK TRAVELERS PREFERRED BOOKINGS, LEISURE ACTIVITIES, PROVIDE TRAVEL AND DESTINATION INFORMATION TO INDIVIDUALS TRAVELLING AS WELL AS PROPERTY OPERATORS AND PROVIDE COMPREHENSIVE INFORMATION REGARDING ALL ASPECTS OF THE DESIRED DESTINATION INCLUDING PROGRAM INTELLIGENCE WHICH AUTOMATICALLY ADJUSTS TO ANY ONE OF THE SPECIFICATIONS (U.S. CLS. 21, 23, 26, 36 AND 38).

CLASS 35—ADVERTISING AND BUSINESS

FOR PROVIDING A WEBSITE IN THE FIELD OF TRAVEL MANAGEMENT (U.S. CLS. 100, 101 AND 102).
DAVID MILLER, EXAMINING ATTORNEY

SN 77-888,131. LEWIS, JUSTIN, MC FARLAND, WI. FILED 12-7-2009.

**INSIGNIS MARKETING Needs
Inspired Solutions**

THE MARK CONSISTS OF STANDARD CHARACTERS WITHOUT CLAIM TO ANY PARTICULAR FONT, STYLE, SIZE, OR COLOR.

NO CLAIM IS MADE TO THE EXCLUSIVE RIGHT TO USE "MARKETING", APART FROM THE MARK AS SHOWN.

CLASS 35—ADVERTISING AND BUSINESS

FOR ADVERTISING, MARKETING AND PROMOTION SERVICES; COPYWRITING SERVICES (U.S. CLS. 100, 101 AND 102).

CLASS 42—SCIENTIFIC AND COMPUTER SERVICES

FOR GRAPHIC DESIGN SERVICES; WEB SITE DEVELOPMENT FOR OTHERS; WEB SITE DESIGN (U.S. CLS. 100 AND 101).

Laura KOVALSKY, EXAMINING ATTORNEY

SN 77-888,263. CLIFFSTAR CORPORATION, DUNKIRK, NY. FILED 12-8-2009.

eXact

THE MARK CONSISTS OF STANDARD CHARACTERS WITHOUT CLAIM TO ANY PARTICULAR FONT, STYLE, SIZE, OR COLOR.

CLASS 30—STAPLE FOODS

FOR COFFEE BASED BEVERAGES (U.S. CL. 46).

CLASS 32—LIGHT BEVERAGES

FOR SPORTS DRINKS, NAMELY, ENERGY DRINKS (U.S. CLS. 45, 46 AND 48).
EMILY CARLSEN, EXAMINING ATTORNEY

SN 77-888,337. KIEFFABER MEDIA INC, SOUTHLAKE, TX. FILED 12-8-2009.

**REPETITIONS BUILD
REPUTATIONS**

THE MARK CONSISTS OF STANDARD CHARACTERS WITHOUT CLAIM TO ANY PARTICULAR FONT, STYLE, SIZE, OR COLOR.

CLASS 28—TOYS AND SPORTING GOODS

FOR BASEBALL AND SOFTBALL TRAINING APPARATUS USED FOR A BATTER TO IMPROVE BAT SWINGING AND CONTACT PERFORMANCE (U.S. CLS. 22, 23, 38 AND 50).

CLASS 41—EDUCATION AND ENTERTAINMENT

FOR SPORTS TRAINING SERVICES (U.S. CLS. 100, 101 AND 107).
DAVID MURRAY, EXAMINING ATTORNEY

SN 77-888,340. DYNAMAXX INTERNATIONAL LTD, CLEBURNE, TX. FILED 12-8-2009.



THE COLOR(S) BLACK AND RED IS/ARE CLAIMED AS A FEATURE OF THE MARK.

THE MARK CONSISTS OF THE LITERAL ELEMENT "DYNA" APPEARS IN BLACK FOLLOWED BY THE LITERAL ELEMENT "MAXX" IN RED. THE LETTER "X" APPEARING AT THE END OF THE LITERAL ELEMENT "MAXX" IS IN THE SHAPE OF A MAN WITH THE LEFT ARM AND RIGHT LEG APPEARING TO CURVE SYMMETRICALLY TO FORM ONE CROSS OF THE "X" AND THE RIGHT ARM AND LEFT LEG APPEARING TO CURVE SYMMETRICALLY TO FORM THE SECOND CROSS OF THE "X". THERE IS A RED CIRCLE IN THE CENTER OF THE UPPER CROSS OF THE "X" TO REPRESENT THE HEAD OF THE MAN.

CLASS 3—COSMETICS AND CLEANING PREPARATIONS

FOR ANTI-WRINKLE CREAM; ANTI-WRINKLE CREAMS; WRINKLE REMOVING SKIN CARE PREPARATIONS; WRINKLE-MINIMIZING COSMETIC PREPARATIONS FOR TOPICAL FACIAL USE (U.S. CLS. 1, 4, 6, 50, 51 AND 52).

CLASS 5—PHARMACEUTICALS

FOR GELS FOR USE AS PERSONAL LUBRICANT; HERBAL DRINKS USED TO AID IN SLEEP AND RELAXATION; HERBAL MALE ENHANCEMENT CAPSULES; HERBAL SUPPLEMENTS; NATURAL HERBAL SUPPLEMENTS; NATURAL SUPPLEMENTS FOR TREATING ERECTILE DYSFUNCTION; SILICONE-BASED PERSONAL LUBRICANTS; WATER-BASED PERSONAL LUBRICANTS (U.S. CLS. 6, 18, 44, 46, 51 AND 52).

REGINA DRUMMOND, EXAMINING ATTORNEY

SN 77-888,344. DYNAMAXX INTERNATIONAL LTD, CLEBURNE, TX. FILED 12-8-2009.

LIVE LIFE TO THE MAXX

THE MARK CONSISTS OF STANDARD CHARACTERS WITHOUT CLAIM TO ANY PARTICULAR FONT, STYLE, SIZE, OR COLOR.

CLASS 3—COSMETICS AND CLEANING PREPARATIONS

FOR ANTI-WRINKLE CREAM; ANTI-WRINKLE CREAMS; WRINKLE REMOVING SKIN CARE PREPARATIONS; WRINKLE-MINIMIZING COSMETIC PREPARATIONS FOR TOPICAL FACIAL USE (U.S. CLS. 1, 4, 6, 50, 51 AND 52).

CLASS 5—PHARMACEUTICALS

FOR GELS FOR USE AS PERSONAL LUBRICANT; HERBAL DRINKS USED TO AID IN SLEEP AND RELAXATION; HERBAL MALE ENHANCEMENT CAPSULES; HERBAL SUPPLEMENTS; NATURAL HERBAL SUPPLEMENTS; NATURAL SUPPLEMENTS FOR TREATING ERECTILE DYSFUNCTION; SILICONE-BASED PERSONAL LUBRICANTS; WATER-BASED PERSONAL LUBRICANTS (U.S. CLS. 6, 18, 44, 46, 51 AND 52).

REGINA DRUMMOND, EXAMINING ATTORNEY

SN 77-888,349. DYNAMAXX INTERNATIONAL LTD, CLEBURNE, TX. FILED 12-8-2009.

DYNAMAXX

THE MARK CONSISTS OF STANDARD CHARACTERS WITHOUT CLAIM TO ANY PARTICULAR FONT, STYLE, SIZE, OR COLOR.

CLASS 3—COSMETICS AND CLEANING PREPARATIONS

FOR ANTI-WRINKLE CREAM; ANTI-WRINKLE CREAMS; WRINKLE REMOVING SKIN CARE PREPARATIONS; WRINKLE-MINIMIZING COSMETIC PREPARATIONS FOR TOPICAL FACIAL USE (U.S. CLS. 1, 4, 6, 50, 51 AND 52).

CLASS 5—PHARMACEUTICALS

FOR GELS FOR USE AS PERSONAL LUBRICANT; HERBAL DRINKS USED TO AID IN SLEEP AND RELAXATION; HERBAL MALE ENHANCEMENT CAPSULES; HERBAL SUPPLEMENTS; NATURAL HERBAL SUPPLEMENTS; NATURAL SUPPLEMENTS FOR TREATING ERECTILE DYSFUNCTION; SILICONE-BASED PERSONAL LUBRICANTS; WATER-BASED PERSONAL LUBRICANTS (U.S. CLS. 6, 18, 44, 46, 51 AND 52).

REGINA DRUMMOND, EXAMINING ATTORNEY

SN 77-888,519. SIFTEO, INC., SAN FRANCISCO, CA. FILED 12-8-2009.

SIFTABLES

THE MARK CONSISTS OF STANDARD CHARACTERS WITHOUT CLAIM TO ANY PARTICULAR FONT, STYLE, SIZE, OR COLOR.

CLASS 9—ELECTRICAL AND SCIENTIFIC APPARATUS

FOR MULTIPLE SMALL BATTERY POWERED COMPUTERS WHICH CAN ACT IN CONCERT TO FORM A SINGLE INTERFACE WHICH RESPONDS TO THE USER'S PHYSICAL MANIPULATION OF ONE OR MORE UNITS, WITH EACH UNIT FEATURING ONE OR MORE OF MOTION SENSING, ATTITUDE SENSING, NEIGHBOR DETECTION, GRAPHICAL DISPLAY AND WIRELESS COMMUNICATION (U.S. CLS. 21, 23, 26, 36 AND 38).

SN 77-888,549. UKONWA OJO, EDEN PRAIRIE, MN. FILED 12-8-2009.

BERRY SIMPLE

THE MARK CONSISTS OF STANDARD CHARACTERS WITHOUT CLAIM TO ANY PARTICULAR FONT, STYLE, SIZE, OR COLOR.

NO CLAIM IS MADE TO THE EXCLUSIVE RIGHT TO USE "BERRY", APART FROM THE MARK AS SHOWN.

CLASS 28—TOYS AND SPORTING GOODS

FOR APPARATUS FOR ELECTRONIC GAMES, OTHER THAN THOSE ADAPTED FOR USE WITH AN EXTERNAL DISPLAY SCREEN OR MONITOR, COMPRISED OF MULTIPLE SMALL BATTERY POWERED COMPUTERS CONFIGURED FOR ELECTRONIC GAMES WHICH CAN ACT IN CONCERT TO FORM A SINGLE INTERFACE WHICH RESPONDS TO THE USER'S PHYSICAL MANIPULATION OF ONE OR MORE UNITS, WITH EACH UNIT FEATURING ONE OR MORE OF MOTION SENSING, ATTITUDE SENSING, NEIGHBOR DETECTION, GRAPHICAL DISPLAY AND WIRELESS COMMUNICATION (U.S. CLS. 22, 23, 38 AND 50).

RUDY R. SINGLETON, EXAMINING ATTORNEY

CLASS 29—MEATS AND PROCESSED FOODS

FOR DEHYDRATED FRUIT SNACKS; DRIED FRUIT-BASED SNACKS; DRIED FRUITS; DRINKING YOGURTS; FROZEN FRUITS; FRUIT CHIPS; FRUIT SALADS; FRUIT-BASED ORGANIC FOOD BARS; FRUIT-BASED SNACK FOOD; FRUIT-BASED SPREADS; JELLIES AND JAMS; YOGURT DRINKS; YOGURT-BASED BEVERAGES; YOGURTS (U.S. CL. 46).

CLASS 32—LIGHT BEVERAGES

FOR FRUIT BEVERAGES; FRUIT JUICES AND FRUIT DRINKS; FRUIT-BASED BEVERAGES (U.S. CLS. 45, 46 AND 48).

SUE LAWRENCE, EXAMINING ATTORNEY

SN 77-888,548. PMAB, LLC, DBA MEDA/RX, CHARLOTTE, NC. FILED 12-8-2009.

SN 77-888,581. SENSIO INC., MONTREAL, CANADA, FILED 12-8-2009.

THE PRESCRIPTION FOR RESTORING FISCAL HEALTH

THE MARK CONSISTS OF STANDARD CHARACTERS WITHOUT CLAIM TO ANY PARTICULAR FONT, STYLE, SIZE, OR COLOR.

CLASS 35—ADVERTISING AND BUSINESS

FOR ACCOUNTS RECEIVABLE SERVICES, NAMELY, ADMINISTRATION, BILLING AND RECONCILIATION OF ACCOUNTS ON BEHALF OF OTHERS (U.S. CLS. 100, 101 AND 102).

FIRST USE 3-31-2008; IN COMMERCE 3-31-2008.

THE MARK CONSISTS OF STANDARD CHARACTERS WITHOUT CLAIM TO ANY PARTICULAR FONT, STYLE, SIZE, OR COLOR.

CLASS 7—MACHINERY

FOR POWER-OPERATED KITCHEN APPLIANCES, NAMELY, ELECTRIC FOOD BLENDERS AND ELECTRIC STAND MIXERS (U.S. CLS. 13, 19, 21, 23, 31, 34 AND 35).

CLASS 36—INSURANCE AND FINANCIAL

FOR FINANCIAL SERVICES, NAMELY, FINANCIAL CONSULTING; COLLECTION SERVICES, NAMELY, COLLECTION OF DEBTS IN THE MEDICAL, UTILITY, AND FINANCIAL INDUSTRIES (U.S. CLS. 100, 101 AND 102).

FIRST USE 3-31-2008; IN COMMERCE 3-31-2008.
SUE LAWRENCE, EXAMINING ATTORNEY

CLASS 11—ENVIRONMENTAL CONTROL APPARATUS

FOR SMALL ELECTRIC KITCHEN APPLIANCES, NAMELY, TOASTERS AND COFFEE MAKERS (U.S. CLS. 13, 21, 23, 31 AND 34).

CHERYL CLAYTON, EXAMINING ATTORNEY

CUISILUXE

SN 77-888,620. THE V FOUNDATION FOR CANCER RESEARCH, CARY, NC. FILED 12-8-2009.

SN 77-888,641. ROBERTS, DANIEL N., SANTA MONICA, CA. FILED 12-8-2009.



OWNER OF U.S. REG. NO. 3,084,344.
THE MARK CONSISTS OF A STYLIZED LETTER "V" ABOVE A LINE.

CLASS 35—ADVERTISING AND BUSINESS

FOR PROMOTING PUBLIC AWARENESS OF THE NEED FOR FINDING A CURE FOR CANCER AND OF THE NEED FOR CANCER RESEARCH (U.S. CLS. 100, 101 AND 102).
FIRST USE 9-1-1993; IN COMMERCE 9-1-1993.

CLASS 36—INSURANCE AND FINANCIAL

FOR CHARITABLE FUND RAISING SERVICES (U.S. CLS. 100, 101 AND 102).
FIRST USE 9-1-1993; IN COMMERCE 9-1-1993.
EMILY CARLSEN, EXAMINING ATTORNEY

SN 77-888,633. STEINHOFF, THOM N, DBA ZOBOT, SAN MARINO, CA. FILED 12-8-2009.

Zudo

THE MARK CONSISTS OF STANDARD CHARACTERS WITHOUT CLAIM TO ANY PARTICULAR FONT, STYLE, SIZE, OR COLOR.
THE WORDING "ZUDO" HAS NO MEANING IN A FOREIGN LANGUAGE.

CLASS 9—ELECTRICAL AND SCIENTIFIC APPARATUS

FOR COMPUTER GAME SOFTWARE; COMPUTER GAME SOFTWARE DOWNLOADABLE FROM A GLOBAL COMPUTER NETWORK; COMPUTER GAME SOFTWARE FOR GAMING MACHINES INCLUDING SLOT MACHINES OR VIDEO LOTTERY TERMINALS; COMPUTER GAME SOFTWARE FOR PERSONAL COMPUTERS AND HOME VIDEO GAME CONSOLES; ELECTRONIC GAME SOFTWARE FOR CELLULAR TELEPHONES; VIDEO GAME SOFTWARE (U.S. CLS. 21, 23, 26, 36 AND 38).

CLASS 16—PAPER GOODS AND PRINTED MATTER

FOR PEN AND PENCIL CASES; PENCIL OR PEN BOXES; PENCILS; PENS (U.S. CLS. 2, 5, 22, 23, 29, 37, 38 AND 50).

CLASS 28—TOYS AND SPORTING GOODS

FOR PUZZLES; PUZZLES (U.S. CLS. 22, 23, 38 AND 50).
FIRST USE 11-15-2009; IN COMMERCE 11-15-2009.
ELI HELLMAN, EXAMINING ATTORNEY

Snargle

THE MARK CONSISTS OF STANDARD CHARACTERS WITHOUT CLAIM TO ANY PARTICULAR FONT, STYLE, SIZE, OR COLOR.

CLASS 5—PHARMACEUTICALS

FOR DRY INGREDIENTS FOR MAKING A SALINE SOLUTION FOR SINUS AND NASAL IRRIGATION; NASAL RINSE; NASAL SPRAY PREPARATIONS; SALINE SOLUTION FOR MEDICAL PURPOSES; SALINE WASH FOR MEDICAL PURPOSES (U.S. CLS. 6, 18, 44, 46, 51 AND 52).

CLASS 10—MEDICAL APPARATUS

FOR NASAL IRRIGATION VESSEL; NASAL LAVAGE VESSEL; NETI POT (U.S. CLS. 26, 39 AND 44).
DOMINICK J. SALEMI, EXAMINING ATTORNEY

SN 77-888,759. HEALTHCOM, INC., DBA HEALTHCOM HEALTHCARE COMMUNICATIONS, SULLIVAN, IL. FILED 12-8-2009.

SmartPERS

THE MARK CONSISTS OF STANDARD CHARACTERS WITHOUT CLAIM TO ANY PARTICULAR FONT, STYLE, SIZE, OR COLOR.

CLASS 44—MEDICAL, BEAUTY AND AGRICULTURAL SERVICES

FOR PROVIDING HEALTH CARE INFORMATION BY TELEPHONE; PROVIDING HEALTH CARE INFORMATION BY TELEPHONE AND THE INTERNET; REMOTE MONITORING OF DATA INDICATIVE OF THE HEALTH OR CONDITION OF AN INDIVIDUAL OR GROUP OF INDIVIDUALS (U.S. CLS. 100 AND 101).
FIRST USE 11-3-2009; IN COMMERCE 11-3-2009.

CLASS 45—PERSONAL AND LEGAL SERVICES

FOR MONITORING ALARMS; MONITORING TELEPHONE CALLS FROM SUBSCRIBERS AND NOTIFYING EMERGENCY FACILITIES (U.S. CLS. 100 AND 101).
FIRST USE 11-3-2009; IN COMMERCE 11-3-2009.
CYNTHIA SLOAN, EXAMINING ATTORNEY

SN 77-888,998. HARTMANN & FORBES, INC., TUALATIN, OR. FILED 12-8-2009.

SN 77-889,099. BROOKSTONE PURCHASING, INC., MERRIMACK, NH. FILED 12-8-2009.

LINIEDGE

THE MARK CONSISTS OF STANDARD CHARACTERS WITHOUT CLAIM TO ANY PARTICULAR FONT, STYLE, SIZE, OR COLOR.

CLASS 19—NON-METALLIC BUILDING MATERIALS

FOR NON-METAL CORNICES (U.S. CLS. 1, 12, 33 AND 50).

CLASS 20—FURNITURE AND ARTICLES NOT OTHERWISE CLASSIFIED

FOR WINDOW SHADES, INTERIOR WINDOW BLINDS, FABRIC WINDOW BLINDS; WINDOW SHADES, NAMELY, ROMAN SHADES AND ROLLER-SHADES (U.S. CLS. 2, 13, 22, 25, 32 AND 50).

CLASS 24—FABRICS

FOR FABRIC WINDOW COVERINGS AND TREATMENTS, NAMELY, DRAPERIES AND VALANCES (U.S. CLS. 42 AND 50).

JORDAN BAKER, EXAMINING ATTORNEY

SN 77-889,039. LIFE INNOVATIONS, LLC, WELLINGTON, CO. FILED 12-8-2009.

Turtle

THE MARK CONSISTS OF STANDARD CHARACTERS WITHOUT CLAIM TO ANY PARTICULAR FONT, STYLE, SIZE, OR COLOR.

CLASS 10—MEDICAL APPARATUS

FOR A MEDICAL DEVICE, NAMELY, A FORM-FITTING INFANT BEANIE HAT TO AID IN THE PREVENTION OF DEFORMATIONAL OR POSITIONAL PLAGIOCEPHALY ARISING FROM CONSISTENT BACK-SLEEPING POSTURES (U.S. CLS. 26, 39 AND 44).

CLASS 25—CLOTHING

FOR CHILDREN'S AND INFANT'S APPAREL, NAMELY, JUMPERS, OVERALL SLEEPWEAR, PAJAMAS, ROMPERS AND ONE-PIECE GARMENTS (U.S. CLS. 22 AND 39).

ANTHONY RINKER, EXAMINING ATTORNEY

better than  Down

OWNER OF U.S. REG. NO. 3,455,021.

THE MARK CONSISTS OF A SILHOUETTE OF A DUCK BETWEEN THE WORDS "BETTER THAN" AND "DOWN" WHEREIN THE WORDS ARE PRINTED IN A STYLIZED FONT.

CLASS 20—FURNITURE AND ARTICLES NOT OTHERWISE CLASSIFIED

FOR PILLOWS (U.S. CLS. 2, 13, 22, 25, 32 AND 50).
FIRST USE 12-1-2009; IN COMMERCE 12-1-2009.

CLASS 24—FABRICS

FOR COMFORTERS (U.S. CLS. 42 AND 50).
FIRST USE 12-1-2009; IN COMMERCE 12-1-2009.
NELSON SNYDER, EXAMINING ATTORNEY

SN 77-889,127. SKALLI CORPORATION, RUTHERFORD, CA. FILED 12-8-2009.

DOLLARHIDE

THE MARK CONSISTS OF STANDARD CHARACTERS WITHOUT CLAIM TO ANY PARTICULAR FONT, STYLE, SIZE, OR COLOR.

OWNER OF U.S. REG. NO. 1,570,135.

CLASS 29—MEATS AND PROCESSED FOODS

FOR JELLIES; JAMS; FRUIT PRESERVES; OLIVE OIL (U.S. CL. 46).

CLASS 30—STAPLE FOODS

FOR HONEY (U.S. CL. 46).

CLASS 31—NATURAL AGRICULTURAL PRODUCTS

FOR FRESH FRUIT; FRESH GRAPES FOR WINE-MAKING; LIVING PLANTS (U.S. CLS. 1 AND 46).

CLASS 33—WINES AND SPIRITS

FOR ALCOHOLIC BEVERAGES EXCEPT BEERS (U.S. CLS. 47 AND 49).
MICHAEL SOUDERS, EXAMINING ATTORNEY

SN 77-889,146. CENTER FOR NETWORK CENTRIC PRODUCT SUPPORT RESEARCH, LLC, EAST HARTFORD, CT. FILED 12-9-2009.

SWIMLINK

THE MARK CONSISTS OF STANDARD CHARACTERS WITHOUT CLAIM TO ANY PARTICULAR FONT, STYLE, SIZE, OR COLOR.

CLASS 9—ELECTRICAL AND SCIENTIFIC APPARATUS

FOR COMPUTER SERVERS (U.S. CLS. 21, 23, 26, 36 AND 38).

CLASS 35—ADVERTISING AND BUSINESS

FOR SUBSCRIPTION TO A TELEMATICS, TELEPHONE OR COMPUTER SERVICE (U.S. CLS. 100, 101 AND 102).

CLASS 38—COMMUNICATION

FOR PEER-TO-PEER NETWORK COMPUTER SERVICES, NAMELY, ELECTRONIC TRANSMISSION OF AUDIO, VIDEO AND OTHER DATA AND DOCUMENTS AMONG COMPUTERS (U.S. CLS. 100, 101 AND 104).

CLASS 39—TRANSPORTATION AND STORAGE

FOR ON-LINE COMPUTER SERVICES FOR STORING CONTENT ITEMS SELECTED BY USERS FROM INTERNET WEB PAGES; PARKING DOMAIN NAMES FOR OTHERS, NAMELY, PROVIDING COMPUTER SERVERS FOR FACILITATION OF THE STORAGE OF DOMAIN NAME ADDRESSES (U.S. CLS. 100 AND 105).

CLASS 42—SCIENTIFIC AND COMPUTER SERVICES

FOR COMPUTER CO-LOCATION SERVICES, NAMELY, PROVIDING FACILITIES FOR THE LOCATION OF COMPUTER SERVERS WITH THE EQUIPMENT OF OTHERS; COMPUTER SERVICE, NAMELY, ACTING AS AN APPLICATION SERVICE PROVIDER IN THE FIELD OF INFORMATION MANAGEMENT TO HOST COMPUTER APPLICATION SOFTWARE FOR THE PURPOSE OF AIRCRAFT OPERATIONS AND AIRCRAFT OPERATIONS SUPPORT MANAGEMENT; COMPUTER SERVICE, NAMELY, ACTING AS AN APPLICATION SERVICE PROVIDER IN THE FIELD OF KNOWLEDGE MANAGEMENT TO HOST COMPUTER APPLICATION SOFTWARE FOR CREATING SEARCHABLE DATABASES OF INFORMATION AND DATA; COMPUTER SERVICE, NAMELY, ACTING AS AN APPLICATION SERVICE PROVIDER IN THE FIELD OF KNOWLEDGE MANAGEMENT TO HOST COMPUTER APPLICATION SOFTWARE FOR SEARCHING AND RETRIEVING INFORMATION FROM DATABASES AND COMPUTER NETWORKS; COMPUTER SERVICE, NAMELY, ACTING AS AN APPLICATION SERVICE PROVIDER IN THE FIELD OF KNOWLEDGE MANAGEMENT TO HOST COMPUTER APPLICATION SOFTWARE FOR THE COLLECTION, EDITING, ORGANIZING, MODIFYING, BOOK MARKING, TRANSMISSION, STORAGE AND SHARING OF DATA AND INFORMATION; COMPUTER SERVICES IN THE NATURE OF CUSTOMIZED WEB PAGES FEATURING USER-DEFINED INFORMATION, PERSONAL PROFILES AND INFORMATION; COMPUTER SERVICES, NAMELY, COMPUTER SYSTEM ADMINISTRATION FOR OTHERS; COMPUTER SERVICES, NAMELY, CONTINUAL MONITORING AND UPDATING OF A CUSTOMER'S ENGLISH WEBSITE FOR CHANGES AND

EDITING AND MAKING THESE CHANGES TO THE CUSTOMER'S MULTILINGUAL WEBSITE(S) WITHOUT INVOLVEMENT FROM THE CUSTOMER'S INTERNAL IT RESOURCES; COMPUTER SERVICES, NAMELY, CREATING AN ON-LINE COMMUNITY FOR REGISTERED USERS TO PARTICIPATE IN DISCUSSIONS, GET FEEDBACK FROM THEIR PEERS, FORM VIRTUAL COMMUNITIES, AND ENGAGE IN SOCIAL NETWORKING; COMPUTER SERVICES, NAMELY, CREATING AND MAINTAINING WEB SITES FOR OTHERS; COMPUTER SERVICES, NAMELY, CREATING INDEXES OF INFORMATION, SITES AND OTHER RESOURCES AVAILABLE ON COMPUTER NETWORKS; COMPUTER SERVICES, NAMELY, DESIGNING AND IMPLEMENTING NETWORK WEB PAGES FOR OTHERS; COMPUTER SERVICES, NAMELY, DESIGNING AND IMPLEMENTING ON DEMAND WEB SITES IN THE NATURE OF TURNKEY PACKAGES ALLOWING CUSTOMERS TO CREATE ECOMMERCE WEB SITES FOR THE PURPOSE OF UPLOADING PHOTOS AND CREATING GIFTS; COMPUTER SERVICES, NAMELY, DESIGNING AND IMPLEMENTING WEB SITES FOR OTHERS; COMPUTER SERVICES, NAMELY, HOSTING AN INTERACTIVE WEB SITE THAT ALLOWS USERS TO UPLOAD, STORE AND MAINTAIN AUTOMOTIVE REPAIR RECORDS, MANAGE ONLINE RECORDS OF SERVICES PERFORMED ON THEIR VEHICLES, AND RECEIVE AUTOMATED SERVICE REMINDERS, SAFETY ALERTS, RECALL ALERTS, AND SPECIAL DISCOUNT OFFERS; COMPUTER SERVICES, NAMELY, HOSTING AND MAINTAINING AN ON-LINE WEB SITE FOR OTHERS TO ENABLE A MOBILE VEHICLE, SUCH AS AN AIRCRAFT TO CONNECT AS A WEB HOME PAGE TO AN INTRANET OR INTERNET; COMPUTER SERVICES, NAMELY, HOSTING OF INSPECTION, TESTING, AND QUALITY CONTROL SERVICES' DIGITAL CONTENT OF OTHERS; COMPUTER SERVICES, NAMELY, HOSTING ON-LINE INTERACTIVE PUBLIC CALENDARS THAT ALLOW MULTIPLE PARTICIPANTS TO SHARE EVENT SCHEDULES, FACILITY RESERVATIONS, AND TRANSPORTATION REQUESTS; COMPUTER SERVICES, NAMELY, HOSTING ON-LINE WEB FACILITIES FOR OTHERS FOR ORGANIZING AND CONDUCTING ONLINE MEETINGS, GATHERINGS, AND INTERACTIVE DISCUSSIONS; COMPUTER SERVICES, NAMELY, INTERACTIVE HOSTING SERVICES WHICH ALLOW THE USER TO PUBLISH AND SHARE THEIR OWN CONTENT AND IMAGES ON-LINE; COMPUTER SERVICES, NAMELY, MANAGING ON-LINE WAITLISTS AND AUTOMATION OF THE WAITLIST PROCESS FOR OTHERS; COMPUTER SERVICES, NAMELY, MANAGING WEB SITES FOR OTHERS; COMPUTER SERVICES, NAMELY, MICROCONTROLLER PROGRAMMING; COMPUTER SERVICES, NAMELY, MONITORING THE WEB SITES OF OTHERS TO IMPROVE SCALABILITY AND PERFORMANCE OF WEB SITES OF OTHERS; COMPUTER SERVICES, NAMELY, MONITORING, TESTING, ANALYZING, AND REPORTING ON THE INTERNET TRAFFIC CONTROL AND CONTENT CONTROL OF THE WEB SITES OF OTHERS; COMPUTER SERVICES, NAMELY, PROVIDING A WEB-BASED SYSTEM AND ONLINE PORTAL FEATURING ON-LINE NON-DOWNLOADABLE SOFTWARE THAT ENABLES USERS TO ACCESS TRAINING, EDUCATION, TESTING AND CERTIFICATION MATERIALS IN THE FIELD OF AIRCRAFT OPERATIONS, MAINTENANCE, SUPPORT AND SECURITY; COMPUTER SERVICES, NAMELY, PROVIDING A WEB-BASED SYSTEM AND ONLINE PORTAL FOR CUSTOMERS TO REMOTELY MANAGE, ADMINISTER, MODIFY AND CONTROL THEIR END USER COMPUTER DEVICES, DATA AND SOFTWARE APPLICATIONS; COMPUTER SERVICES, NAMELY, PROVIDING AN INTERACTIVE WEB SITE THAT ALLOWS USERS TO COLLECT, STORE, MANAGE, DELIVER AND SHOWCASE ELECTRONIC AND PAPER-BASED CONTENT; COMPUTER SERVICES, NAMELY, PROVIDING AN INTERACTIVE WEB SITE THAT ALLOWS USERS TO CREATE THEIR OWN BOOKS; COMPUTER SERVICES, NAMELY, PROVIDING SEARCH ENGINES FOR OBTAINING DATA FROM JOURNALS AND OTHER PUBLICATIONS ON A GLOBAL COMPUTER NETWORK; COMPUTER SERVICES, NAMELY, PROVIDING SEARCH ENGINES FOR OBTAINING DATA ON A GLOBAL COMPUTER NETWORK; COMPUTER SERVICES, NAMELY, PROVIDING SEARCH PLATFORMS TO ALLOW USERS TO REQUEST CONTENT FROM AND RECEIVE CONTENT TO A MOBILE DEVICE; COMPUTER SERVICES, NAMELY,

REDIRECTING ELECTRONIC MAIL TO CHANGED PERSONAL ELECTRONIC ADDRESS; COMPUTER SERVICES, NAMELY, REMOTE AND ON-SITE MANAGEMENT OF ELECTRONIC MESSAGING SYSTEMS AND APPLICATIONS FOR OTHERS; COMPUTER SERVICES, NAMELY, REMOTE AND ON-SITE MANAGEMENT OF THE INFORMATION TECHNOLOGY (IT) SYSTEMS OF OTHERS; COMPUTER SERVICES, NAMELY, REMOTE MANAGEMENT OF COMPUTER APPLICATIONS FOR OTHERS; COMPUTER SERVICES, NAMELY, SEARCH ENGINE OPTIMIZATION; COMPUTER SERVICES, NAMELY, THE RE-DIRECTION AND FORWARDING OF MESSAGES; COMPUTER SERVICES, NAMELY, UP-LOADING MUSIC TO THE INTERNET FOR OTHERS; DISPLAYING THE WEB SITES AND IMAGES OF OTHERS ON A COMPUTER SERVER; HOSTING THE WEB SITES OF OTHERS ON A COMPUTER SERVER FOR A GLOBAL COMPUTER NETWORK; ON-LINE BATCH COMPUTER SERVICES; PROFESSIONAL COMPUTER SERVICES, NAMELY, NETWORK ANALYSIS, LAN/WAN DESIGN, WIRELESS ENGINEERING, VIRTUALIZATION AND COMPUTER PROJECT MANAGEMENT (U.S. CLS. 100 AND 101).

DAVID MURRAY, EXAMINING ATTORNEY

SN 77-889,350. JIMENEZURIBE, GLORIA, DOUGLSTON, NY. FILED 12-9-2009.



THE MARKS CONSISTS OF THE UNITARY TERM, "K9BLISS", IN STYLIZED FORM WITH THE NUMBER 9 AND THE WORD "BLISS" INTEGRATED WITH THE DESIGN OF THE LETTER K, AND THE DESIGN OF FOUR DOGS, A LABRADOR RETRIEVER, A BULLDOG, A BOSTON TERRIER, AND A YORKSHIRE TERRIER, INSIDE THE NUMBER 9.

SN 77-889,329. ARZU, INC., CHICAGO, IL. FILED 12-9-2009.



OWNER OF U.S. REG. NO. 3,056,936.
THE MARK CONSISTS OF THE WORDS "ARZU STUDIO HOPE" WITH A GEOMETRICAL DESIGN COMPRISING THE "O" IN THE WORD "HOPE".
THE ENGLISH TRANSLATION OF "ARZU" IN THE MARK IS "HOPE".

CLASS 27—FLOOR COVERINGS

FOR RUGS (U.S. CLS. 19, 20, 37, 42 AND 50).

CLASS 36—INSURANCE AND FINANCIAL

FOR CHARITABLE FUNDRAISING (U.S. CLS. 100, 101 AND 102).

WILLIAM VERHOSEK, EXAMINING ATTORNEY

CLASS 16—PAPER GOODS AND PRINTED MATTER

FOR BOOKMARKS; CALENDARS; GREETING CARDS; POSTCARDS (U.S. CLS. 2, 5, 22, 23, 29, 37, 38 AND 50).

CLASS 25—CLOTHING

FOR TEE SHIRTS (U.S. CLS. 22 AND 39).
BARBARA A. GOLD, EXAMINING ATTORNEY

SN 77-889,455. WADE ENTERPRISES LLC, CHICAGO, IL. FILED 12-9-2009.

WADE'S WORLD

THE MARK CONSISTS OF STANDARD CHARACTERS WITHOUT CLAIM TO ANY PARTICULAR FONT, STYLE, SIZE, OR COLOR.

CLASS 25—CLOTHING

FOR CLOTHING, NAMELY, SHOES, BASKETBALL JERSEYS, JERSEYS AND TOPS, SHORTS AND TRUNKS, WARM-UP SUITS, JACKETS, T-SHIRTS, LONG-SLEEVE T-SHIRTS, SWEAT SHIRTS AND SWEAT PANTS, SWEAT BANDS, HEADBANDS, SOCKS, HATS, AND CAPS (U.S. CLS. 22 AND 39).

CLASS 28—TOYS AND SPORTING GOODS

FOR TOYS AND SPORTING GOODS, NAMELY, BASKETBALLS, BASKETBALL GOALS AND HOOPS, BACKBOARDS, BASKETBALL NETS, ARCADE GAMES FEATURING BASKETBALL, ACTION FIGURES, DOLL FIGURES, BOBBLEHEAD ACTION FIGURES, ARCADE-TYPE ELECTRONIC VIDEO GAMES FEATURING BASKETBALL; HAND-HELD UNIT FOR PLAYING VIDEO GAMES FEATURING BASKETBALL, OTHER THAN THOSE ADAPTED FOR USE WITH AN EXTERNAL DISPLAY SCREEN OR MONITOR; COIN-OPERATED VIDEO GAMES FEATURING BASKETBALL; AND STAND ALONE VIDEO GAME MACHINES FEATURING BASKETBALL (U.S. CLS. 22, 23, 38 AND 50).

HANNO RITTNER, EXAMINING ATTORNEY

SN 77-889,693. RIVERO, JORGE F, ASHEBORO, NC. FILED 12-9-2009.

EL CLUB MEXICANO

THE MARK CONSISTS OF STANDARD CHARACTERS WITHOUT CLAIM TO ANY PARTICULAR FONT, STYLE, SIZE, OR COLOR.

NO CLAIM IS MADE TO THE EXCLUSIVE RIGHT TO USE "MEXICANO", APART FROM THE MARK AS SHOWN.

THE ENGLISH TRANSLATION OF "EL CLUB MEXICANO" IN THE MARK IS "THE MEXICAN CLUB".

CLASS 29—MEATS AND PROCESSED FOODS

FOR PROCESSED PEANUTS; FRUIT-BASED SNACK FOOD (U.S. CL. 46).

FIRST USE 4-15-2000; IN COMMERCE 4-15-2000.

CLASS 30—STAPLE FOODS

FOR CANDIES; SPICES; PROCESSED HERBS; DRIED CHILI PEPPERS FOR USE AS A SEASONING; CEREAL-BASED SNACK FOOD (U.S. CL. 46).

FIRST USE 4-15-2000; IN COMMERCE 4-15-2000.

DAVID YONTEF, EXAMINING ATTORNEY

SN 77-889,479. FIDELITY INDUSTRIES, INC., WAYNE, NJ. FILED 12-9-2009.

REVIVE

THE MARK CONSISTS OF STANDARD CHARACTERS WITHOUT CLAIM TO ANY PARTICULAR FONT, STYLE, SIZE, OR COLOR.

CLASS 16—PAPER GOODS AND PRINTED MATTER

FOR VINYL WALLCOVERINGS SAMPLE BOOKS, WALLPAPER SAMPLE BOOKS (U.S. CLS. 2, 5, 22, 23, 29, 37, 38 AND 50).

CLASS 27—FLOOR COVERINGS

FOR VINYL WALLCOVERINGS AND WALLPAPER (U.S. CLS. 19, 20, 37, 42 AND 50).

ODESSA BIBBINS, EXAMINING ATTORNEY

SN 77-889,747. NORVILL, KEITH A., VICTORIA, TX. FILED 12-9-2009.

SN 77-889,545. HL OPERATING CORPORATION, LEBANON, TN. FILED 12-9-2009.

HIGH ALTITUDE

THE MARK CONSISTS OF STANDARD CHARACTERS WITHOUT CLAIM TO ANY PARTICULAR FONT, STYLE, SIZE, OR COLOR.

CLASS 16—PAPER GOODS AND PRINTED MATTER

FOR AGENDAS; DOCUMENT AND STATIONERY-TYPE PORTFOLIOS (U.S. CLS. 2, 5, 22, 23, 29, 37, 38 AND 50).

CLASS 18—LEATHER GOODS

FOR LUGGAGE, GARMENT BAGS FOR TRAVEL, ATTACHE CASES, TOTE BAGS, AND BRIEFCASE-TYPE PORTFOLIOS WITH AND WITHOUT HANDLES (U.S. CLS. 1, 2, 3, 22 AND 41).

ANTHONY RINKER, EXAMINING ATTORNEY

SACRALIF

THE MARK CONSISTS OF STANDARD CHARACTERS WITHOUT CLAIM TO ANY PARTICULAR FONT, STYLE, SIZE, OR COLOR.

CLASS 10—MEDICAL APPARATUS

FOR MEDICAL APPARATUS, NAMELY, A SPINAL FUSION DEVICE (U.S. CLS. 26, 39 AND 44).

CLASS 44—MEDICAL, BEAUTY AND AGRICULTURAL SERVICES

FOR SURGICAL SERVICES, NAMELY, SPINAL THERAPIES (U.S. CLS. 100 AND 101).

PATRICIA EVANKO, EXAMINING ATTORNEY

SN 77-889,763. NORTHWIRE, INC., OSCEOLA, WI. FILED 12-9-2009.

COILMED

THE MARK CONSISTS OF STANDARD CHARACTERS WITHOUT CLAIM TO ANY PARTICULAR FONT, STYLE, SIZE, OR COLOR.

CLASS 9—ELECTRICAL AND SCIENTIFIC APPARATUS

FOR ELECTRICAL CABLE; ELECTRICAL CORDAGE (U.S. CLS. 21, 23, 26, 36 AND 38).

CLASS 40—MATERIAL TREATMENT

FOR CUSTOM MANUFACTURE OF ELECTRICAL CABLE (U.S. CLS. 100, 103 AND 106).
BARNEY CHARLON, EXAMINING ATTORNEY

SN 77-889,831. CRUISER CUSTOMIZING, INC., LIVERMORE, CA. FILED 12-9-2009.

MOTOTRIBE

THE MARK CONSISTS OF STANDARD CHARACTERS WITHOUT CLAIM TO ANY PARTICULAR FONT, STYLE, SIZE, OR COLOR.

CLASS 35—ADVERTISING AND BUSINESS

FOR ON-LINE RETAIL STORE SERVICES FEATURING MOTORCYCLE PARTS AND ACCESSORIES (U.S. CLS. 100, 101 AND 102).

CLASS 42—SCIENTIFIC AND COMPUTER SERVICES

FOR HOSTING AN ON-LINE COMMUNITY WEB SITE FEATURING TOPICS OF INTEREST TO MOTORCYCLE AFICIONADOS (U.S. CLS. 100 AND 101).
MARLENE BELL, EXAMINING ATTORNEY

SN 77-889,845. ONIRACOM, SANTA BARBARA, CA. FILED 12-9-2009.

Solutions for Dreamers

THE MARK CONSISTS OF STANDARD CHARACTERS WITHOUT CLAIM TO ANY PARTICULAR FONT, STYLE, SIZE, OR COLOR.

CLASS 9—ELECTRICAL AND SCIENTIFIC APPARATUS

FOR MUSICAL SOUND RECORDINGS (U.S. CLS. 21, 23, 26, 36 AND 38).
FIRST USE 6-10-2006; IN COMMERCE 6-10-2006.

CLASS 41—EDUCATION AND ENTERTAINMENT

FOR ENTERTAINMENT SERVICES IN THE NATURE OF LIVE MUSICAL PERFORMANCES (U.S. CLS. 100, 101 AND 107).
FIRST USE 12-1-2006; IN COMMERCE 1-11-2007.
MARLENE BELL, EXAMINING ATTORNEY

SN 77-889,848. PENNYDIAL, INC., BEAVERTON, OR. FILED 12-9-2009.



NO CLAIM IS MADE TO THE EXCLUSIVE RIGHT TO USE "TELECOMMUNICATIONS", APART FROM THE MARK AS SHOWN.

THE MARK CONSISTS OF THE VERTICALLY STACKED WORDS "PENNYDIAL TELECOMMUNICATIONS" WHICH ARE TO THE RIGHT OF A BOX THAT CONTAINS THE LETTERS "PDT" BELOW AND TO THE LEFT OF A PARTIAL GRID.

CLASS 16—PAPER GOODS AND PRINTED MATTER

FOR PRE-PAID TELEPHONE CALLING CARDS, NOT MAGNETICALLY ENCODED (U.S. CLS. 2, 5, 22, 23, 29, 37, 38 AND 50).
FIRST USE 8-5-2009; IN COMMERCE 8-5-2009.

CLASS 38—COMMUNICATION

FOR TELECOMMUNICATION SERVICES, NAMELY, PROVIDING PRE-PAID LONG DISTANCE TRANSMISSION OF VOICE, DATA, GRAPHICS AND VIDEO BY MEANS OF BROADBAND, COPPER AND OPTICAL OR WIRELESS NETWORKS; TELECOMMUNICATIONS RESELLER SERVICES, NAMELY, PROVIDING LONG DISTANCE TELECOMMUNICATION SERVICES (U.S. CLS. 100, 101 AND 104).
FIRST USE 5-21-2009; IN COMMERCE 10-8-2009.
SUSAN STIGLITZ, EXAMINING ATTORNEY

SN 77-889,862. TOUCHPOINT AUTISM SERVICES, INC., FORMERLY THE JUDEVINE CENTER FOR AUTISM, ST. LOUIS, MO. FILED 12-9-2009.

TouchPoint Autism Services

THE MARK CONSISTS OF STANDARD CHARACTERS WITHOUT CLAIM TO ANY PARTICULAR FONT, STYLE, SIZE, OR COLOR.

NO CLAIM IS MADE TO THE EXCLUSIVE RIGHT TO USE "AUTISM SERVICES", APART FROM THE MARK AS SHOWN.

CLASS 41—EDUCATION AND ENTERTAINMENT

FOR EDUCATION SERVICES, NAMELY, PRE-KINDERGARTEN THROUGH 12TH GRADE CLASSROOM INSTRUCTION, VOCATIONAL INSTRUCTION, MENTORING, TUTORING, CLASSES, SEMINARS AND WORKSHOPS FOR INDIVIDUALS WITH AUTISM AND OTHER DEVELOPMENTAL DISORDERS; PROVIDING CLASSES, SEMINARS, WORKSHOPS, AND TRAINING FOR PARENTS, INSTRUCTORS, AND OTHER INDIVIDUALS IN THE FIELD OF EDUCATION FOR INDIVIDUALS WITH AUTISM AND OTHER DEVELOPMENTAL DISORDERS (U.S. CLS. 100, 101 AND 107).

FIRST USE 8-18-2009; IN COMMERCE 9-11-2009.

CLASS 43—HOTEL AND RESTAURANT SERVICES

FOR PROVIDING TEMPORARY ACCOMMODATIONS, NAMELY, RESIDENTIAL HOMES AND HOUSING SERVICES FOR INDIVIDUALS WITH AUTISM AND OTHER DEVELOPMENTAL DISORDERS (U.S. CLS. 100 AND 101).

FIRST USE 8-18-2009; IN COMMERCE 9-11-2009.

CLASS 44—MEDICAL, BEAUTY AND AGRICULTURAL SERVICES

FOR MEDICAL SERVICES, NAMELY, EVALUATIONS, ASSESSMENTS, AND CLINICAL THERAPIES FOR INDIVIDUALS WITH AUTISM AND OTHER DEVELOPMENTAL DISORDERS (U.S. CLS. 100 AND 101).

FIRST USE 8-18-2009; IN COMMERCE 9-11-2009.

COLLEEN KEARNEY, EXAMINING ATTORNEY

SN 77-889,916. KEEPCOOL INTERNATIONAL GENERAL PARTNERSHIP, LAFAYETTE, CA. FILED 12-9-2009.

Keepcool

THE MARK CONSISTS OF STANDARD CHARACTERS WITHOUT CLAIM TO ANY PARTICULAR FONT, STYLE, SIZE, OR COLOR.

CLASS 16—PAPER GOODS AND PRINTED MATTER

FOR GROCERY BAGS; PLASTIC OR PAPER BAGS FOR HOUSEHOLD USE; PLASTIC SHOPPING BAGS; TEXTILE WINE GIFT BAGS (U.S. CLS. 2, 5, 22, 23, 29, 37, 38 AND 50).

CLASS 18—LEATHER GOODS

FOR (BASED ON USE IN COMMERCE) TEXTILE SHOPPING BAGS(BASED ON INTENT TO USE) TOTE BAGS; WINE BAGS WITH HANDLES FOR CARRYING OR HOLDING WINE (U.S. CLS. 1, 2, 3, 22 AND 41).

FIRST USE 10-1-1999; IN COMMERCE 7-1-2005.

CLASS 21—HOUSEWARES AND GLASS

FOR THERMAL INSULATED BAGS FOR FOOD OR BEVERAGES (U.S. CLS. 2, 13, 23, 29, 30, 33, 40 AND 50).

FIRST USE 10-1-1999; IN COMMERCE 2-1-2000.
KATHRYN COWARD, EXAMINING ATTORNEY

SN 77-889,948. AGILENT TECHNOLOGIES, INC., SANTA CLARA, CA. FILED 12-9-2009.

1260 INFINITY

THE MARK CONSISTS OF STANDARD CHARACTERS WITHOUT CLAIM TO ANY PARTICULAR FONT, STYLE, SIZE, OR COLOR.

OWNER OF U.S. REG. NOS. 2,812,902, 3,406,927 AND 3,726,065.

CLASS 1—CHEMICALS

FOR CHEMICAL REAGENTS FOR NON-MEDICAL PURPOSES; PACKING MATERIALS IN THE NATURE OF CHEMICALS USED IN CHROMATOGRAPHY (U.S. CLS. 1, 5, 6, 10, 26 AND 46).

CLASS 9—ELECTRICAL AND SCIENTIFIC APPARATUS

FOR ULTRA HIGH PRESSURE LIQUID CHROMATOGRAPHY (UHPLC) EQUIPMENT COMPRISING CHROMATOGRAPHIC COLUMNS, CARTRIDGES, PUMPS, SEPARATION DEVICES IN SINGLE AND MULTI-WELL FORMATS, DETECTORS, INJECTORS, FILTERS, AND AUTOSAMPLERS; LABORATORY OPERATING SYSTEMS COMPRISING OF COMPUTER HARDWARE AND COMPUTER SOFTWARE FOR USE IN CONNECTION WITH ULTRA HIGH PRESSURE LIQUID CHROMATOGRAPHY SYSTEMS (UHPLC) (U.S. CLS. 21, 23, 26, 36 AND 38).

MICHAEL SOUDERS, EXAMINING ATTORNEY

SN 77-889,954. AGILENT TECHNOLOGIES, INC., SANTA CLARA, CA. FILED 12-9-2009.

1220 INFINITY

THE MARK CONSISTS OF STANDARD CHARACTERS WITHOUT CLAIM TO ANY PARTICULAR FONT, STYLE, SIZE, OR COLOR.

OWNER OF U.S. REG. NOS. 2,812,902, 3,406,927 AND 3,726,065.

CLASS 1—CHEMICALS

FOR CHEMICAL REAGENTS FOR NON-MEDICAL PURPOSES; PACKING MATERIALS IN THE NATURE OF CHEMICALS USED IN CHROMATOGRAPHY (U.S. CLS. 1, 5, 6, 10, 26 AND 46).

CLASS 9—ELECTRICAL AND SCIENTIFIC APPARATUS

FOR ULTRA HIGH PRESSURE LIQUID CHROMATOGRAPHY (UHPLC) EQUIPMENT COMPRISING CHROMATOGRAPHIC COLUMNS, CARTRIDGES, PUMPS, SEPARATION DEVICES IN SINGLE AND MULTI-WELL FORMATS, DETECTORS, INJECTORS, FILTERS, AND AUTOSAMPLERS; LABORATORY OPERATING SYSTEMS COMPRISING OF COMPUTER HARDWARE AND COMPUTER SOFTWARE FOR USE IN CONNECTION WITH ULTRA HIGH PRESSURE LIQUID CHROMATOGRAPHY SYSTEMS (UHPLC) (U.S. CLS. 21, 23, 26, 36 AND 38).

MICHAEL SOUDERS, EXAMINING ATTORNEY

SN 77-889,956. AGILENT TECHNOLOGIES, INC., SANTA CLARA, CA. FILED 12-9-2009.

AGILENT 1260 INFINITY

THE MARK CONSISTS OF STANDARD CHARACTERS WITHOUT CLAIM TO ANY PARTICULAR FONT, STYLE, SIZE, OR COLOR.

OWNER OF U.S. REG. NOS. 2,461,406, 2,643,345 AND OTHERS.

CLASS 1—CHEMICALS

FOR CHEMICAL REAGENTS FOR NON-MEDICAL PURPOSES; PACKING MATERIALS IN THE NATURE OF CHEMICALS USED IN CHROMATOGRAPHY (U.S. CLS. 1, 5, 6, 10, 26 AND 46).

CLASS 9—ELECTRICAL AND SCIENTIFIC APPARATUS

FOR ULTRA HIGH PRESSURE LIQUID CHROMATOGRAPHY (UHPLC) EQUIPMENT COMPRISING CHROMATOGRAPHIC COLUMNS, CARTRIDGES, PUMPS, SEPARATION DEVICES IN SINGLE AND MULTI-WELL FORMATS, DETECTORS, INJECTORS, FILTERS, AND AUTOSAMPLERS; LABORATORY OPERATING SYSTEMS COMPRISING OF COMPUTER HARDWARE AND COMPUTER SOFTWARE FOR USE IN CONNECTION WITH ULTRA HIGH PRESSURE LIQUID CHROMATOGRAPHY SYSTEMS (UHPLC) (U.S. CLS. 21, 23, 26, 36 AND 38).

MICHAEL SOUDERS, EXAMINING ATTORNEY

SN 77-889,959. AGILENT TECHNOLOGIES, INC., SANTA CLARA, CA. FILED 12-9-2009.

AGILENT 1220 INFINITY

THE MARK CONSISTS OF STANDARD CHARACTERS WITHOUT CLAIM TO ANY PARTICULAR FONT, STYLE, SIZE, OR COLOR.

OWNER OF U.S. REG. NOS. 2,461,406, 2,643,345 AND OTHERS.

CLASS 1—CHEMICALS

FOR CHEMICAL REAGENTS FOR NON-MEDICAL PURPOSES; PACKING MATERIALS IN THE NATURE OF CHEMICALS USED IN CHROMATOGRAPHY (U.S. CLS. 1, 5, 6, 10, 26 AND 46).

CLASS 9—ELECTRICAL AND SCIENTIFIC APPARATUS

FOR ULTRA HIGH PRESSURE LIQUID CHROMATOGRAPHY (UHPLC) EQUIPMENT COMPRISING CHROMATOGRAPHIC COLUMNS, CARTRIDGES, PUMPS, SEPARATION DEVICES IN SINGLE AND MULTI-WELL FORMATS, DETECTORS, INJECTORS, FILTERS, AND AUTOSAMPLERS; LABORATORY OPERATING SYSTEMS COMPRISING OF COMPUTER HARDWARE AND COMPUTER SOFTWARE FOR USE IN CONNECTION WITH ULTRA HIGH PRESSURE LIQUID CHROMATOGRAPHY SYSTEMS (UHPLC) (U.S. CLS. 21, 23, 26, 36 AND 38).

MICHAEL SOUDERS, EXAMINING ATTORNEY

SN 77-889,986. THATCHER BY ALISSE THATCHER, LLC, CARSON, CA. FILED 12-9-2009.

Thatcher By Alisse Thatcher

THE MARK CONSISTS OF STANDARD CHARACTERS WITHOUT CLAIM TO ANY PARTICULAR FONT, STYLE, SIZE, OR COLOR.

THE NAME "ALISSE THATCHER" IDENTIFIES A LIVING INDIVIDUAL WHOSE CONSENT IS OF RECORD.

CLASS 18—LEATHER GOODS

FOR HANDBAGS (U.S. CLS. 1, 2, 3, 22 AND 41).

CLASS 25—CLOTHING

FOR BELTS; DRESSES; FOOTWEAR; JACKETS; LEGGINGS; LINGERIE; PANTS; SWEATERS; TOPS; UNDERWEAR (U.S. CLS. 22 AND 39).

YAT SYE, LEE, EXAMINING ATTORNEY

SN 77-890,031. THE WORLD DEEJAY LEAGUE, WILMINGTON, DE. FILED 12-9-2009.

Follow your passion

THE MARK CONSISTS OF STANDARD CHARACTERS WITHOUT CLAIM TO ANY PARTICULAR FONT, STYLE, SIZE, OR COLOR.

CLASS 41—EDUCATION AND ENTERTAINMENT

FOR ARRANGING, ORGANIZING, CONDUCTING, AND HOSTING SOCIAL ENTERTAINMENT EVENTS; ENTERTAINMENT IN THE NATURE OF VISUAL AND AUDIO PERFORMANCES, NAMELY, MUSICAL BAND, ROCK GROUP, GYMNASIUM, DANCE, AND BALLET PERFORMANCES; ENTERTAINMENT INFORMATION SERVICES, NAMELY, PROVIDING INFORMATION AND NEWS RELEASES ABOUT A MUSICAL ARTIST; ENTERTAINMENT SERVICES IN THE NATURE OF LIVE MUSICAL PERFORMANCES; ENTERTAINMENT SERVICES, NAMELY, ARRANGING AND CONDUCTING OF COMPETITIONS FOR DISC JOCKEYS (U.S. CLS. 100, 101 AND 107).

CLASS 42—SCIENTIFIC AND COMPUTER SERVICES

FOR COMPUTER SERVICES, NAMELY, CREATING AN ON-LINE COMMUNITY FOR REGISTERED USERS TO PARTICIPATE IN COMPETITIONS, SHOWCASE THEIR SKILLS, GET FEEDBACK FROM THEIR PEERS, FORM VIRTUAL COMMUNITIES, ENGAGE IN SOCIAL NETWORKING AND IMPROVE THEIR TALENT (U.S. CLS. 100 AND 101).

JUSTINE D. PARKER, EXAMINING ATTORNEY

SN 77-890,139. THE WORLD DEEJAY LEAGUE, WILMINGTON, DE. FILED 12-10-2009.

Music is our first language

THE MARK CONSISTS OF STANDARD CHARACTERS WITHOUT CLAIM TO ANY PARTICULAR FONT, STYLE, SIZE, OR COLOR.

CLASS 41—EDUCATION AND ENTERTAINMENT

FOR ARRANGING, ORGANIZING, CONDUCTING, AND HOSTING SOCIAL ENTERTAINMENT EVENTS; ENTERTAINMENT IN THE NATURE OF VISUAL AND AUDIO PERFORMANCES, NAMELY, MUSICAL BAND, ROCK GROUP, GYMNASTIC, DANCE, AND BALLET PERFORMANCES; ENTERTAINMENT INFORMATION SERVICES, NAMELY, PROVIDING INFORMATION AND NEWS RELEASES ABOUT A MUSICAL ARTIST; ENTERTAINMENT SERVICES IN THE NATURE OF LIVE MUSICAL PERFORMANCES; ENTERTAINMENT SERVICES, NAMELY, ARRANGING AND CONDUCTING OF COMPETITIONS FOR DISC JOCKEYS (U.S. CLS. 100, 101 AND 107).

CLASS 42—SCIENTIFIC AND COMPUTER SERVICES

FOR COMPUTER SERVICES, NAMELY, CREATING AN ON-LINE COMMUNITY FOR REGISTERED USERS TO PARTICIPATE IN COMPETITIONS, SHOWCASE THEIR SKILLS, GET FEEDBACK FROM THEIR PEERS, FORM VIRTUAL COMMUNITIES, ENGAGE IN SOCIAL NETWORKING AND IMPROVE THEIR TALENT (U.S. CLS. 100 AND 101).

JUSTINE D. PARKER, EXAMINING ATTORNEY

SN 77-890,224. TOUCHPOINT AUTISM SERVICES, INC., FORMERLY THE JUDEVINE CENTER FOR AUTISM, ST. LOUIS, MO. FILED 12-10-2009.

TouchPoint
AUTISM SERVICES

NO CLAIM IS MADE TO THE EXCLUSIVE RIGHT TO USE "AUTISM SERVICES", APART FROM THE MARK AS SHOWN.

THE COLOR(S) GREEN AND BLUE IS/ARE CLAIMED AS A FEATURE OF THE MARK.

THE MARK CONSISTS OF THE FOLLOWING: THE WORD "TOUCHPOINT" IN GREEN LETTERS WITH A CAPITAL "T" AND "P", AND A BLUE PUZZLE PIECE SUBSTITUTED FOR THE I AND THE WORDS "AUTISM SERVICES" IN BLUE LETTERS, APPEARING IN A SMALLER FONT.

CLASS 41—EDUCATION AND ENTERTAINMENT

FOR EDUCATION SERVICES, NAMELY, PRE-KINDERGARTEN THROUGH 12TH GRADE CLASSROOM INSTRUCTION, VOCATIONAL INSTRUCTION, MENTORING, TUTORING, CLASSES, SEMINARS AND WORKSHOPS FOR INDIVIDUALS WITH AUTISM AND OTHER DEVELOPMENTAL DISORDERS; PROVIDING CLASSES, SEMINARS, WORKSHOPS, AND TRAINING FOR PARENTS, INSTRUCTORS, AND OTHER INDIVIDUALS IN THE FIELD OF EDUCATION FOR INDIVIDUALS WITH AUTISM AND OTHER DEVELOPMENTAL DISORDERS (U.S. CLS. 100, 101 AND 107).

FIRST USE 9-11-2009; IN COMMERCE 9-11-2009.

CLASS 43—HOTEL AND RESTAURANT SERVICES

FOR PROVIDING TEMPORARY ACCOMMODATIONS, NAMELY, RESIDENTIAL HOMES AND HOUSING SERVICES FOR INDIVIDUALS WITH AUTISM AND OTHER DEVELOPMENTAL DISORDERS (U.S. CLS. 100 AND 101).

FIRST USE 9-11-2009; IN COMMERCE 9-11-2009.

CLASS 44—MEDICAL, BEAUTY AND AGRICULTURAL SERVICES

FOR MEDICAL SERVICES, NAMELY, EVALUATIONS, ASSESSMENTS, AND CLINICAL THERAPIES FOR INDIVIDUALS WITH AUTISM AND OTHER DEVELOPMENTAL DISORDERS (U.S. CLS. 100 AND 101).

FIRST USE 9-11-2009; IN COMMERCE 9-11-2009.

COLLEEN KEARNEY, EXAMINING ATTORNEY

SN 77-890,271. VANI U.S.A., INC., NEW YORK, NY. FILED 12-10-2009.

AG
ANAIS GVANI
NEW YORK

OWNER OF U.S. REG. NO. 3,694,079.
NO CLAIM IS MADE TO THE EXCLUSIVE RIGHT TO USE "NEW YORK", APART FROM THE MARK AS SHOWN.

THE NAME "ANAIS GVANI" DOES NOT IDENTIFY A LIVING INDIVIDUAL.

THE MARK CONSISTS OF TWO STYLIZED LETTERS "AG" AND THE WORDS "ANAIS GVANI NEW YORK" BENEATH THE STYLIZED LETTERS.

CLASS 18—LEATHER GOODS

FOR LEATHER ARTICLES AND IMITATIONS OF LEATHER ARTICLES, NAMELY, TRUNKS AND TRAVELING BAGS, BRIEF CASES, BACK PACKS, HAND BAGS, SHOPPING BAGS, WALLETS, PURSES, KEY CASES AND KEY CHAINS (U.S. CLS. 1, 2, 3, 22 AND 41).

CLASS 25—CLOTHING

FOR CLOTHING, NAMELY, HEADWEAR, FOOTWEAR, JACKETS, JEANS, DRESSES, SKIRTS, SUITS, SWEATERS, JERSEYS, SHIRTS, BLOUSES, VESTS, SINGLETS, TROUSERS, PANTS, SHORTS, DUNGAREES, SOCKS, LEGGINGS, SHAWLS AND GLOVES, LEATHER HATS AND IMITATION LEATHER HATS (U.S. CLS. 22 AND 39).

MICHAEL WIENER, EXAMINING ATTORNEY

SN 77-890,319. GUNTER, DANE, DBA ALTR SOCIETY, LAS VEGAS, NV. FILED 12-10-2009.



THE MARK CONSISTS OF 5-POINT STAR WITH OUTLINE BROKEN IN MULTIPLE PLACES; FROWNING FACE IN CENTER OF STAR OUTLINE; STAR POINTS ARE ROUNDED AT EACH OUTSIDE TIP, EDGES OF MOUTH (FROWN) ARE SAME SHAPE AS EACH EYE; NOSE IS OVAL AND DIFFERENT SHAPE THAN EYES AND EDGES OF MOUTH EYEBROWS ARE TIPPED DOWN IN CENTER.

CLASS 16—PAPER GOODS AND PRINTED MATTER

FOR ACID-RESISTANT PAPER; ADDRESS LABELS; ADHESIVE LABELS; ADHESIVE NOTE PAPER; ADHESIVE PLASTIC FILM USED FOR MOUNTING IMAGES; ADHESIVE-BACKED LETTERS AND NUMBERS FOR USE IN MAKING STICKERS AND SIGNS; ADVERTISING SIGNS OF PAPER OR CARDBOARD; ALBUMS FOR STICKERS; ALUMINUM FOIL LAMINATED PAPER FOR PRINTING PURPOSES; ART AND PHOTOGRAPH PORTFOLIO CASES; ART ETCHINGS; ART MOUNTS; ART PADS; ART PAPER; ART PICTURES; ART PRINTS; ART PRINTS ON CANVAS; ARTS AND CRAFT CLAY KITS; ARTS AND CRAFT PAINT KITS; AUTOMATIC PENCILS; BABIES' DIAPERS OF PAPER; BACK-UP BOARDS, BACK-UP SHEETS, BACK-UP PANELS, ENTRY BOARDS, ENTRY SHEETS, AND ENTRY PANELS MADE OUT OF PAPER FOR USE IN THE OPERATION OF DRILLING HOLES IN PRINTED CIRCUIT BOARDS; BANNERS OF PAPER; BAR CODE LABELS; BAR CODE RIBBONS; BIBS OF PAPER; BINDING MATERIALS FOR BOOKS AND PAPERS; BIODEGRADABLE PAPER PULP-BASED TO-GO CONTAINERS FOR FOOD; BLANK OR PARTIALLY PRINTED PAPER LABELS; BLANK PAPER COMPUTER TAPES; BLANK PAPER COMPUTER TAPES FOR RECORDING PROGRAMS; BLANK PAPER NOTEBOOKS; BLANK PAPER TAPES AND CARDS FOR THE RECORDING OF COMPUTER PROGRAMS; BLOTTING PAPER; BOND PAPER; BOOK-COVER PAPER; BOOK-BINDING MATERIALS FOR CREATING HARDCOVER BOOKS, NAMELY, BOOK COVERS, CRACK-AND-PEEL BINDING PAPER, REINFORCEMENT STRIPS, PEEL-AND-STICK LABELS, STAPLER AND STAPLES; BOTTLE WRAPPERS OF CARDBOARD OR PAPER; BOXES OF CARDBOARD OR PAPER; BOXES OF PAPER; BOXES OF PAPER OR CARDBOARD; BUMPER STICKERS; BURP PADS OF PAPER; BUSINESS CARD PAPER; CALENDAR-FINISHED PAPER; CALLIGRAPHY PAPER; CARBON PAPER; CARBON PAPER; CARBONLESS PAPER; CARDBOARD MADE FROM PAPER MULBERRY

(SENKASI); CARRYING CASES MADE OF PAPER; CELLOPHANE PAPER; CHILDREN'S WALL STICKERS AND MURALS; CHILDREN'S ARTS AND CRAFTS PAPER KITS; COASTERS MADE OF PAPER; COASTERS OF PAPER; COLLAPSIBLE BOXES OF PAPER; COLLECTIBLE PAPER MONEY; COLORED CRAFT AND ART SAND; COMPOSITE PANELS CONSISTING OF A SPECIALLY-FORMULATED PAPERBOARD CORE WITH DENSE PAPER FACES FOR USE IN FURTHER MANUFACTURING; COMPUTER PAPER; COMPUTER PRINTER INK RIBBONS; COMPUTER PRINTER RIBBONS; COMPUTER RIBBONS; CONSTRUCTION PAPER; CONTAINERS FOR ICE MADE OF PAPER OR CARDBOARD; CONTAINERS FOR STORAGE OR TRANSPORT MADE OF PAPER OR CARDBOARD; COPIER PAPER; COPY PAPER; COPYING PAPER; CORRUGATED BOARD AND PAPER CONTAINERS; CORRUGATED PAPER; CORRUGATED PAPER PANELS LAMINATED WITH BLEACHED WHITE PAPER PRIMARILY FOR APPLICATION OF PRINTED MEDIA FOR FURTHER USE IN SIGNAGE APPLICATIONS; CORRUGATED PAPER PANELS LAMINATED WITH KRAFT LINERBOARD PRIMARILY FOR LAMINATION WITH DECORATIVE OVERLAYS FOR FURTHER USE IN THE CONSTRUCTION OF WALL PARTITIONS, ROOM DIVIDERS, DESKTOPS AND TABLETOPS; COSMETIC REMOVING PAPER; COVERS OF PAPER FOR FLOWER POTS; CRAFT PAPER; CREPE PAPER; CREPE PAPER FOR MEDICAL, SANITARY OR DOMESTIC USE; CREPED WOOD PULP PAPER FILTER THAT IS ACID AND ALKALI RESISTANT FOR LABORATORY AND INDUSTRIAL PURPOSES; CUSHIONING OR PADDING MADE OF PAPER FOR PACKING PURPOSES; DECORATIVE PAPER BOWS FOR WRAPPING; DECORATIVE PAPER CENTERPIECES; DECORATIVE STICKERS FOR HELMETS; DIGITAL PRINTING PAPER; DIRECTORY PAPER; DISPOSABLE PAPER SHEETS FOR PERSONAL HYGIENIC USE IN THE NATURE OF DISPOSABLE HEADREST COVERS NOT FOR MEDICAL USE; DOT MATRIX PRINTER RIBBONS; DRAWING PAPER; DUPLICATING PAPER; DYE-SUBLIMATION PRINT PAPER; EDUCATIONAL PUBLICATIONS, NAMELY, EDUCATIONAL LEARNING CARDS, FLASH CARDS, ACTIVITY CARDS, WORKBOOKS, TEXTBOOKS, ACTIVITY BOOKS, STORY BOOKS, PUZZLE BOOKS, PRINTED PUZZLES, TEACHER GUIDES, MANUALS, POSTERS AND EDUCATIONAL BOOKLETS IN THE FIELD OF EDUCATION; EKG PAPER; ELECTRIC PAPER HOLE DRILLS BEING OFFICE REQUISITES AND PARTS THEREFOR, NAMELY, BORING BITS, PROTECTION PLATES, AND GRINDERS; ELECTRIC PAPER HOLE PERFORATORS BEING OFFICE REQUISITES AND PARTS THEREFOR, NAMELY, BORING BITS, PROTECTION PLATES, AND GRINDERS; ELECTRIC PAPER HOLE PUNCHES; ELECTRIC PAPER HOLE PUNCHES BEING OFFICE REQUISITES AND PARTS THEREFOR, NAMELY, BORING BITS, PROTECTION PLATES, AND GRINDERS; ELECTROCARDIOGRAPH PAPER; ELECTRONIC TYPEWRITERS; ELECTROSTATIC PAPER; EMBROIDERY DESIGN PATTERNS; ENVELOPE PAPER; ENVELOPE PAPERS; FACE TOWELS OF PAPER; FACSIMILE TRANSMISSION PAPER; FIBER PAPER; FILE DRAWER POCKET MADE OF VARIOUS FABRICS FOR HOLDING FILES AND PAPERS THAT SLIDES ONTO THE FRONT OF A CABINET OR DRAWER VIA AN INTEGRATED POCKET; FILING FOLDERS, PAPER LABELS AND PRINTED INSTRUCTIONAL MATERIALS FOR ORGANIZING PERSONAL FILES; FILLER PAPER; FILTER PAPER; FLAGS AND PENNANTS OF PAPER; FLAGS OF PAPER; FLUORESCENT PAPER; FLUTING PAPER; FRAMED ART ETCHINGS; FRAMED ART PICTURES; FRAMED ART PRINTS; FRAMED GRAPHIC ART REPRODUCTIONS; FREE-STANDING AND WALL-MOUNTED PAPER AND CARDBOARD BOXES FOR DEPOSITING A WRITTEN MESSAGE OR PRAYER WISHING A LOVED ONE WELL, FOR USE IN HOSPITALS, ELDER CARE RESIDENCES, SCHOOLS, AND INSTITUTIONS FOR CHILDREN WITH SPECIAL NEEDS; GARBAGE BAGS OF PAPER; GARBAGE BAGS OF PAPER; GEOGRAPHICAL MAPS; GIFT WRAP PAPER; GIFT WRAPPING PAPER; GIFT-WRAPPING PAPER; GLASSINE PAPER; GRAPH PAPER; GRAPHIC ART REPRODUCTIONS; GROCERY PAPER; GUMMED PAPER; GUNPOWDER WRAPPING PAPER; HALLOWEEN GOODIE BAGS OF PAPER OR PLASTIC; HAND TOWELS OF PAPER; HAND-HELD LABELING DEVICES; HANDKERCHIEFS OF PAPER; HANDPAINTED PAPER WINE BOTTLE LABELS; HAT BOXES OF PAPER; HEAT SENSITIVE PAPER; HEAT

TRANSFER PAPER; HONEYCOMB PAPER; HYGIENIC PAPER; ILLUSTRATION PAPER; IMITATION LEATHER PAPER; INDIA PAPER; INDUSTRIAL PACKAGING CONTAINERS OF PAPER; INK RIBBONS; INK SHEETS FOR USE IN REPRODUCING IMAGES IN THE PRINTING INDUSTRY; INKING RIBBONS; INSULATED SHIPPING CONTAINERS FOR TRANSPORTING FROZEN MATERIALS MADE OF PAPER OR CARDBOARD; JAPANESE CEREMONIAL PAPER STRINGS (MIZUHIKI); JAPANESE HANDICRAFT PAPER; JAPANESE PAPER; JAPANESE PAPER (TORINOKO-GAMI); KRAFT PAPER; LABEL PAPER; LABEL PRINTING MACHINE RIBBONS; LABEL PRINTING MACHINES; LAMINATED PAPER; LAMINATED PAPERS TO BE AFFIXED TO THE SURFACE OF FURNITURE; LASER PRINT PAPER; LASER PRINTING PAPER; LAW REPORTS; LETTER PAPER; LETTERHEAD PAPER; LINING PAPER; LITHOGRAPHIC WORKS OF ART; LOOSE LEAF PAPER; LUMINOUS PAPER; MAGAZINE PAPER; MAGNETIC PAPER; MANIFOLD PAPER; MAPS; MASKING PAPER; METALLIC GIFT WRAPPING PAPER; METALLIC PAPER PARTY DECORATIONS; MILDEWPROOF PAPER; MIMEOGRAPH PAPER; MODELING MATERIALS FOR USE IN MAKING CAST PAPER SCULPTURED FLOWERS; MOISTENERS IN THE NATURE OF HAND HELD DEVICES FOR WETTING STAMPS, ENVELOPES AND GUMMED PAPER SURFACES; MOISTUREPROOF CELLOPHANE PAPER; MOUNTED POSTERS; MULCH PAPER; NAPKIN PAPER; NAPKINS OF PAPER FOR REMOVING MAKE-UP; NEWSPRINT PAPER; NOTE PAPER; NOTE PAPERS; NOTEBOOK PAPER; OFFICE LABELING MACHINES; OFFICE MACHINE RIBBONS; OFFICE PAPER DRILL MACHINES; OFFICE PAPER STATIONERY; OFFSET PAPER; OFFSET PRINTING PAPER FOR PAMPHLETS; OILED PAPER FOR PAPER UMBRELLAS (KASA-GAMI); OILPROOF PAPER; ONION SKIN PAPER; OPAQUE PAPER; PACKAGING AND CONTAINERS COMPRISED OF STARCH-BASED MATERIALS IN THE NATURE OF A PAPER SUBSTITUTE FOR FOOD, BEVERAGES AND CONSUMER PRODUCTS; PACKAGING CONTAINERS OF PAPER; PACKAGING MATERIALS MADE FROM MINERAL-BASED PAPER SUBSTITUTES; PACKAGING MATERIALS MADE OF RECYCLED PAPER; PACKING PAPER; PAINT TRAY LINERS OF PAPER OR PLASTIC; PAPER; PAPER AND CARDBOARD; PAPER BABY BIBS; PAPER BADGES; PAPER BAGS; PAPER BAGS AND SACKS; PAPER BAGS FOR PACKAGING; PAPER BANNERS; PAPER BOARD; PAPER BOARDS; PAPER BOWS FOR GIFT WRAP; PAPER BOXES; PAPER BOXES FOR STORING GREETING CARDS; PAPER BUNTING; PAPER CAKE DECORATIONS; PAPER CARTON SEALING TAPE; PAPER CARTONS FOR DELIVERING GOODS; PAPER CLIP HOLDERS; PAPER CLIPS; PAPER CLOSURES FOR CONTAINERS; PAPER CLOSURES FOR SEALING CONTAINERS; PAPER CONTAINERS; PAPER CONTAINING MICA; PAPER COVERS FOR TELEPHONE RECEIVERS; PAPER CUTTERS; PAPER DECORATIVE GARLANDS FOR PARTIES; PAPER DIAPERS; PAPER DIE CUT SHAPES; PAPER DISPLAY BOXES; PAPER DOILIES; PAPER DROP CLOTHS; PAPER EGG CARTONS; PAPER EMBLEMS; PAPER EMBOSSERS; PAPER ENVELOPES FOR PACKAGING; PAPER EXPANDING FILES; PAPER FASTENERS; PAPER FILE JACKETS; PAPER FILTERS FOR COFFEE MAKERS; PAPER FLAGS; PAPER FLOOR MATS; PAPER FLOWER POT COVERS; PAPER FOLDERS; PAPER FOLDING MACHINES AS OFFICE REQUISITES; PAPER FOLDING MACHINES FOR OFFICE USE; PAPER FOOD WRAP; PAPER FOR BAGS AND SACKS; PAPER FOR JAPANESE INDOOR SLIDING PARTITIONS (FUSUMA-GAMI); PAPER FOR JAPANESE SLIDING SCREENS (SHOJI-GAMI); PAPER FOR PHOTOCOPIES; PAPER FOR PHOTOCOPYING; PAPER FOR PRINTING PHOTOGRAPHS; PAPER FOR RECORDING MACHINES; PAPER FOR USE AS MATERIAL OF STOCK CERTIFICATES (SHOKENSHI); PAPER FOR USE IN THE GRAPHIC ARTS INDUSTRY; PAPER FOR USE IN THE MANUFACTURE OF WALL PAPER; PAPER FOR USE IN THE MANUFACTURE OF SIGNS OR POSTERS; PAPER FOR WRAPPING AND PACKAGING; PAPER FUTON COVERS; PAPER GARBAGE BAGS; PAPER GIFT BAGS; PAPER GIFT BAGS FOR WINE; PAPER GIFT TAGS; PAPER GIFT WRAP; PAPER GIFT WRAP BOWS; PAPER GIFT WRAPPING RIBBONS; PAPER HAND-TOWELS; PAPER HANDKERCHIEFS; PAPER HANDTOWELS; PAPER HANG TAGS; PAPER HOLE PUNCHES; PAPER IDENTIFICATION TAGS; PAPER ILLUSTRATION BOARDS; PAPER KNIVES; PAPER LABELS; PAPER LACE; PAPER LET-

TERS AND NUMBER FOR USE IN MAKING STICKERS AND SIGNS; PAPER LINERS FOR DIAPERS; PAPER MACHE; PAPER MACHE FIGURINES; PAPER MADE FROM PAPER MULBERRY (KOHZO-GAMI); PAPER MADE FROM PAPER MULBERRY (TENGUJOSI); PAPER MAIL POUCHES; PAPER MATS; PAPER NAME BADGES; PAPER NAPKINS; PAPER NOTE TABLETS; PAPER NOTEBOOKS; PAPER PACKAGING AND CONTAINERS FOR FOOD AND BEVERAGES COMPRISED OF MATERIALS DESIGNED TO LESSEN ADVERSE EFFECTS ON THE ENVIRONMENT; PAPER PADDING; PAPER PADS FOR CHANGING DIAPERS; PAPER PARTY BAGS; PAPER PARTY DECORATIONS; PAPER PARTY FAVORS; PAPER PATCHES FOR CLOTHING; PAPER PENNANTS; PAPER PET CRATE MATS; PAPER PICTURE MOUNTS; PAPER PLACE MATS; PAPER POUCHES FOR PACKAGING; PAPER POUCHES SOLD EMPTY FOR HOLDING CONDIMENTS; PAPER PRODUCTS, NAMELY, PAPER TUBES; PAPER PRODUCTS, NAMELY, PAPER TUBES AND PAPER CORES; PAPER RACKS; PAPER REFUSE BAGS; PAPER REPORT COVERS; PAPER RIBBONS; PAPER ROLLS FOR CALCULATING MACHINES; PAPER SHEETS FOR NOTE TAKING; PAPER SHOPPING BAGS; PAPER SHREDDERS; PAPER SIGN HOLDERS; PAPER SIGNBOARDS; PAPER STAPLERS; PAPER STAPLES; PAPER STATIONERY; PAPER STATIONERY WITH INSPIRATIONAL MESSAGES IMPRINTED THEREON; PAPER STOCK; PAPER TABLE CLOTHS; PAPER TABLE LINENS; PAPER TABLECLOTHS; PAPER TAGS; PAPER TAKE-OUT CARTONS FOR FOOD; PAPER TAPE; PAPER TAPES; PAPER TAPES FOR CALCULATING MACHINES; PAPER TAPES FOR CALCULATORS; PAPER TISSUES; PAPER TISSUES FOR COSMETIC USE; PAPER TOILET BOWL LINERS; PAPER TOWELS; PAPER TRANSPARENCIES; PAPER TRAY COVERS; PAPER WASHCLOTHS; PAPER WEIGHTS; PAPER WINE GIFT BAGS; PAPER-FEEDING MACHINES FOR OFFICE USE; PAPERS FOR HOUSEHOLD AND INDUSTRIAL USE; PAPERS FOR USE IN THE GRAPHIC ARTS INDUSTRY; PARAFINED PAPER; PARCHMENT PAPER; PARTY GOODIE BAGS OF PAPER OR PLASTIC; PARTY ORNAMENTS OF PAPER; PENNANTS OF PAPER; PERSONALIZED PAPER PLACE MATS; PHOTOCOPY PAPERS; PHOTOGRAPHIC OR ART MOUNTS; PICTURE MOUNTS OF PAPER; PLACARDS OF PAPER OR CARDBOARD; PLACE MATS OF PAPER; PLASTIC COATED COPYING PAPER; PLASTIC OR PAPER BAGS FOR HOUSEHOLD USE; PLASTIC OR PAPER BAGS FOR MERCHANDISE PACKAGING; PLASTIC-COATED COPYING PAPER; PLOTTING PAPERS; POCLETTE ENVELOPES OF PAPER; POLYESTER FILM FOR USE AS A PAPER SUBSTITUTE FOR DRY TONER XEROGRAPHIC IMAGING, NAMELY, LASER PRINTING, COLOR COPIER PRINTING, DRY TONER PRINTING, SCREEN PRINTING, AND OFFSET PRINTING; POSTCARD PAPER; POSTER BOARD; POSTERS; POSTERS MADE OF PAPER; PRINTED ADVERTISING BOARDS OF PAPER OR CARDBOARD; PRINTED ART REPRODUCTIONS; PRINTED GREETING CARDS WITH ELECTRONIC INFORMATION STORED THEREIN; PRINTED NOVELTY WINE LABELS; PRINTED PAPER LABELS; PRINTED PAPER SIGNS; PRINTED PAPER SIGNS, NAMELY, TABLE TENTS; PRINTED PERIODICALS IN THE FIELD OF FIGURATIVE ARTS; PRINTED WINE AND BEER BOTTLE LABELS INCORPORATING A FEATURE THAT CHANGES COLOR IN RESPONSE TO FLUCTUATION IN TEMPERATURE OF THE CONTENTS OF THE BOTTLE TO WHICH THE LABEL IS AFFIXED; PRINTING PAPER; PRINTING PAPERS; PROOFING PAPER; PROTECTIVE COVERS FOR SHEETS OR PAPER AND PAGES OF BOOKS AND THE LIKE; PUBLICATION PAPER; RECYCLED BOND PAPER; RECYCLED PAPER; REEL PAPER FOR PRINTERS; REPORTERS' NOTEBOOKS; REPRODUCTION PAPER; RIBBONS AND BANDS MADE OF PAPER AND CARDBOARD FOR USE ON FLORAL CONTAINERS; RICE PAPER; ROAD MAPS; RUBBISH BAGS (MADE OF PAPER OR PLASTIC MATERIALS); RULED PAPER; SAFETY PAPER; SCENTED PAPER DRAWER LINERS; SCHOOL SUPPLY KITS CONTAINING VARIOUS COMBINATIONS OF SELECTED SCHOOL SUPPLIES, NAMELY, WRITING INSTRUMENTS, PENS, PENCILS, MECHANICAL PENCILS, ERASERS, MARKERS, CRAYONS, HIGHLIGHTER PENS, FOLDERS, NOTEBOOKS, PAPER, PROTRACTORS, PAPER CLIPS, PENCIL SHARPENERS, WRITING GRIPS, GLUE AND BOOK MARKS; SEMI-PROCESSED PAPER; SHELF PAPER; SHIPPING LABELS; SMALL ANIMAL BEDDING MADE OF RECYCLED PAPER;

SPECIALTY PAPERS, NAMELY, VEGETABLE PARCHMENT, FOR USE IN FOOD WRAPPING, PREPARATION, PROCESSING AND PACKAGING APPLICATIONS; STATIONERY WRITING PAPER AND ENVELOPES; STENCIL PAPER; STENCILS AND PATTERNS, BEING OF PAPER AND PLASTIC, FOR THE TRANSFERRING OF GRAPHIC DESIGNS TO PUMPKINS, MINI-PUMPKINS, GOURDS, AND OTHER FRUITS AND VEGETABLES; STENCILS USED IN THE PRODUCTION OF ELECTRONIC CIRCUIT BOARDS AND OTHER ELECTRONIC COMPONENTS; STICKER ALBUMS; STICKERS; STICKERS AND DECALCOMANIAS; STICKERS AND STICKER ALBUMS; STICKERS AND TRANSFERS; STORAGE CONTAINERS MADE OF PAPER; STRIPS OF FANCY PAPER (TANZAKU); SUPERCALANDERED PRINTING PAPER; SYNTHETIC BOND PAPER; SYNTHETIC PAPER; TABLE CLOTHS OF PAPER; TABLE LINENS OF PAPER; TABLE MATS OF PAPER; TABLE NAPKINS OF PAPER; TAPE CARTRIDGES AND TAPES FOR LABEL PRINTING MACHINES; THERMOSENSITIVE PAPER; THICK JAPANESE PAPER; TISSUE PAPER; TISSUE PAPER FOR USE AS MATERIAL OF STENCIL PAPER (GANPISHI); TYPEWRITER RIBBONS; UNMOUNTED POSTERS; VINYL LETTERS AND NUMBERS FOR USE IN MAKING STICKERS AND SIGNS; WORKS OF ART MADE FROM CUSTOM MANUFACTURED PAPER (U.S. CLS. 2, 5, 22, 23, 29, 37, 38 AND 50).

CLASS 25—CLOTHING

FOR A-SHIRTS; ADHESIVE BRAS; ADULT NOVELTY GAG CLOTHING ITEM, NAMELY, SOCKS; ANGLERS' SHOES; ANKLE SOCKS; ANKLETS; ANTI-PERSPIRANT SOCKS; APRES-SKI SHOES; ATHLETIC APPAREL, NAMELY, SHIRTS, PANTS, JACKETS, FOOTWEAR, HATS AND CAPS, ATHLETIC UNIFORMS; ATHLETIC SHOES; BALLET SHOES; BALLOON PANTS; BALLROOM DANCING SHOES; BANDANAS; BASEBALL SHOES; BEACH SHOES; BED JACKETS; BERMUDA SHORTS; BIB SHORTS; BICYCLE GLOVES; BICYCLING GLOVES; BOARD SHORTS; BODY SHIRTS; BOMBER JACKETS; BOWLING SHOES; BOXER SHORTS; BOXING SHOES; BOXING SHORTS; BRAS; BRIEFS; BUTTON-FRONT ALOHA SHIRTS; CAMOUFLAGE GLOVES; CAMOUFLAGE JACKETS; CAMOUFLAGE PANTS; CAMOUFLAGE SHIRTS; CAMP SHIRTS; CANVAS SHOES; CAPRI PANTS; CARGO PANTS; CHEF'S HATS; CLEATS FOR ATTACHMENT TO SPORTS SHOES; CLOTHING FOR ATHLETIC USE, NAMELY, PADDED PANTS; CLOTHING FOR ATHLETIC USE, NAMELY, PADDED SHIRTS; CLOTHING FOR ATHLETIC USE, NAMELY, PADDED SHORTS; CROSS-COUNTRY GLOVES; CYCLING SHOES; DANCE SHOES; DECK-SHOES; DENIM JACKETS; DENIMS; DISPOSABLE UNDERWEAR; DOWN JACKETS; DRESS SHIRTS; DRIVERS; EAR BANDS; EAR MUFFS; EAR WARMERS; FISHERMEN'S JACKETS; FISHING SHIRTS; FITTED SHOE OR BOOT COVERING TO PROTECT THE SHOES OR BOOT FROM WATER OR OTHER DAMAGE; FITTED SWIMMING COSTUMES WITH BRA CUPS; FLEECE SHORTS; FOOTBALL SHOES; FUR COATS AND JACKETS; FUR HATS; FUR JACKETS; FUR MUFFS; GLOVES; GLOVES AS CLOTHING; GLOVES FOR PERSONAL HAND CONDITIONING USE; GLOVES INCLUDING THOSE MADE OF SKIN, HIDE OR FUR; GOLF PANTS, SHIRTS AND SKIRTS; GOLF SHIRTS; GOLF SHOES; GOLF SHORTS; GYM SHORTS; GYMNASIAC SHOES; HANDBALL SHOES; HAT BANDS; HATS; HATS FOR INFANTS, BABIES, TODDLERS AND CHILDREN; HEAD SCARVES; HEAVY JACKETS; HEEL PIECES FOR SHOES; HOCKEY SHOES; HOODED SWEAT SHIRTS; HUNTING JACKETS; HUNTING PANTS; HUNTING SHIRTS; INFANTS' SHOES AND BOOTS; INSOLES; JACKET LINERS; JACKETS; JACKETS AND SOCKS; JAPANESE STYLE SOCKS (TABI COVERS); JAPANESE STYLE SOCKS (TABI); JOGGING PANTS; KNIT SHIRTS; KNITTED GLOVES; KNITTED UNDERWEAR; LADIES' UNDERWEAR; LEATHER JACKETS; LEATHER PANTS; LEATHER SHOES; LEG SHIELDING DEVICE, ATTACHABLE TO AND DETACHABLE FROM A PERSON'S PANTS, COMPRISED OF PADDING TO SHIELD THE LEGS FROM FLYING DEBRIS WHEN MOWING WITH A STRING TRIMMER; LEISURE SHOES; LIGHT-REFLECTING JACKETS; LINGERIE ACCESSORIES, NAMELY, REMOVABLE SILICONE BREAST ENHANCER PADS USED IN A BRA; LONG JACKETS; LONG UNDERWEAR; LONG-SLEEVED SHIRTS; LOUNGE

PANTS; MATERNITY BRAS; MEN'S AND WOMEN'S JACKETS, COATS, TROUSERS, VESTS; MEN'S DRESS SOCKS; MEN'S SOCKS; MEN'S UNDERWEAR; MOISTURE-WICKING SPORTS BRAS; MOISTURE-WICKING SPORTS PANTS; MOISTURE-WICKING SPORTS SHIRTS; MOTORCYCLE GLOVES; MOTORCYCLE JACKETS; MOUNTAINEERING SHOES; MUFFS; NON-DISPOSABLE CLOTH TRAINING PANTS; OUTDOOR GLOVES; OUTER JACKETS; PADDED JACKETS; PADDING JACKETS; PANTIES, SHORTS AND BRIEFS; PAPER HATS FOR USE AS CLOTHING ITEMS; PAPER SHOES USED WHEN GOING THROUGH METAL DETECTORS TO KEEP FEET AND SOCKS CLEAN; PARTS OF CLOTHING, NAMELY, GUSSETS FOR TIGHTS, GUSSETS FOR STOCKINGS, GUSSETS FOR BATHING SUITS, GUSSETS FOR UNDERWEAR, GUSSETS FOR LEOTARDS AND GUSSETS FOR FOOTLETS; PARTY HATS; PERSPIRATION ABSORBENT STRAP TO BE USED IN THE BILL OF A HAT; PERSPIRATION ABSORBENT UNDERWEAR CLOTHING; PLEATED SKIRTS FOR FORMAL KIMONOS (HAKAMA); PROTECTIVE METAL MEMBERS FOR SHOES AND BOOTS; RAIN HATS; RAIN JACKETS; RAINPROOF JACKETS; REVERSIBLE JACKETS; RIDING GLOVES; RIDING SHOES; RUBBER SHOES; RUGBY SHOES; RUGBY SHORTS; RUNNING SHOES; SANDALS AND BEACH SHOES; SCARFS; SCARVES; SCIENTIFIC AND TECHNOLOGICAL APPAREL, NAMELY, SHIRTS, PANTS, JACKETS, FOOTWEAR, HATS AND CAPS, UNIFORMS; SEDGE HATS (SUGE-GASA); SHELL JACKETS; SHIRTS AND SHORT-SLEEVED SHIRTS; SHOE DOWELS; SHOE INSERTS FOR PRIMARILY NON-ORTHOPEDIC PURPOSES; SHOE PEGS; SHOE SOLES; SHOE STRAPS; SHOES; SHOES SOLES FOR REPAIR; SHORT OVER-COAT FOR KIMONO (HAORI); SHORT PETTICOATS; SHORT SETS; SHORT TROUSERS; SHORT-SLEEVED OR LONG-SLEEVED T-SHIRTS; SHORT-SLEEVED SHIRTS; SHORTS; SHOULDER SCARVES; SILK SCARVES; SKI AND SNOWBOARD SHOES AND PARTS THEREOF; SKI GLOVES; SKI JACKETS; SKIING SHOES; SKIRT SUITS; SKIRTS; SKIRTS AND DRESSES; SLEEVED OR SLEEVELESS JACKETS; SLIDING SHORTS; SMALL HATS; SMOKING JACKETS; SNOWBOARD BOOTS; SNOWBOARD GLOVES; SNOWBOARD MITTENS; SNOWBOARD PANTS; SOCCER SHOES; SOCK SUSPENDERS; SOCKS; SOCKS AND STOCKINGS; SPORTS BRA; SPORTS BRAS; SPORTS JACKETS; SPORTS SHIRTS WITH SHORT SLEEVES; STRAPLESS BRAS; STRAPS FOR BRAS; STUFF JACKETS; SUEDE JACKETS; SWEAT JACKETS; SWEAT SHORTS; TAP SHOES; TENNIS SHOES; THERMAL SOCKS; THERMAL UNDERWEAR; THONGS; TOBOGGAN HATS, PANTS AND CAPS; TONGUE OR PULLSTRAP FOR SHOES AND BOOTS; TRACK AND FIELD SHOES; TRACK JACKETS; TRAINING SHOES; TRAVEL CLOTHING CONTAINED IN A PACKAGE COMPRISING REVERSIBLE JACKETS, PANTS, SKIRTS, TOPS AND A BELT OR SCARF; TRIATHLON CLOTHING, NAMELY, TRIATHLON TIGHTS, TRIATHLON SHORTS, TRIATHLON SINGLET, TRIATHLON SHIRTS, TRIATHLON SUITS; UNDERWEAR; UNDERWEAR, NAMELY, BOY SHORTS; VOLLEYBALL SHOES; WALKING SHORTS; WATER SOCKS; WATERPROOF JACKETS AND PANTS; WET SUIT GLOVES; WIND RESISTANT JACKETS; WIND-JACKETS; WOMEN'S HATS AND HOODS; WOMEN'S SHOES; WOMEN'S UNDERWEAR; WOODEN SHOES; WOOLLEN SOCKS; WOOLLY HATS; WORK SHOES AND BOOTS; WOVEN OR KNITTED UNDERWEAR (U.S. CLS. 22 AND 39).

MICHAEL WIENER, EXAMINING ATTORNEY

SN 77-890,391. ASHOURIAN, JAMSHID, SANTA MONICA, CA. FILED 12-10-2009.

GO FREE

THE MARK CONSISTS OF STANDARD CHARACTERS WITHOUT CLAIM TO ANY PARTICULAR FONT, STYLE, SIZE, OR COLOR.

CLASS 29—MEATS AND PROCESSED FOODS

FOR FRUIT-BASED SNACK FOODS; POTATO-BASED SNACK FOODS; VEGETABLE-BASED SNACK FOODS; CANNED COOKED MEAT; BOTTLED COOKED MEAT; FISH; POULTRY; GAME (U.S. CL. 46).

CLASS 30—STAPLE FOODS

FOR CEREAL-BASED SNACK FOODS; RICE-BASED SNACK FOODS; WHEAT-BASED SNACK FOODS (U.S. CL. 46).

COLLEEN KEARNEY, EXAMINING ATTORNEY

SN 77-890,470. MAUNA LOA MACADAMIA NUT CORPORATION, WHEAT RIDGE, CO. FILED 12-10-2009.

ISLAND CLASSICS

THE MARK CONSISTS OF STANDARD CHARACTERS WITHOUT CLAIM TO ANY PARTICULAR FONT, STYLE, SIZE, OR COLOR.

OWNER OF U.S. REG. NOS. 2,296,693, 3,432,430 AND OTHERS.

CLASS 29—MEATS AND PROCESSED FOODS

FOR PROCESSED NUTS (U.S. CL. 46).
FIRST USE 11-30-2007; IN COMMERCE 11-30-2007.

CLASS 30—STAPLE FOODS

FOR CHOCOLATE COVERED NUTS (U.S. CL. 46).
FIRST USE 11-30-2007; IN COMMERCE 11-30-2007.
VIVIAN MICZNIK FIRST, EXAMINING ATTORNEY

SN 77-890,720. COLUMBIA SPORTSWEAR NORTH AMERICA, INC., PORTLAND, OR. FILED 12-10-2009.

THE FUTURE OF WARMTH

THE MARK CONSISTS OF STANDARD CHARACTERS WITHOUT CLAIM TO ANY PARTICULAR FONT, STYLE, SIZE, OR COLOR.

CLASS 18—LEATHER GOODS

FOR BACK PACKS; FANNY PACKS; LUMBAR PACKS; SPORTS PACKS (U.S. CLS. 1, 2, 3, 22 AND 41).

CLASS 25—CLOTHING

FOR COATS; FOOTWEAR; GAITERS; GLOVES; HEADWEAR; JACKETS; MITTENS; PANTS; PARKAS; RAIN SUITS; SKI BIBS; SKI SUITS; VESTS (U.S. CLS. 22 AND 39).

LINDA MICKLEBURGH, EXAMINING ATTORNEY

SN 77-890,786. RICHARDSON, STEVEN, ELGIN, IL. FILED 12-10-2009.



THE MARK CONSISTS OF "HPB" IN FAT LETTERS WITH 9 STRANDS OF BARBED WIRE RUNNING THRU IT WITH "HALF PINT BRAWLERS" UNDER IT, AND "PSYCHO MIDGET WRESTLING" UNDER "HALF PINT BRAWLERS".

CLASS 25—CLOTHING

FOR CLOTHING, NAMELY, HATS, TEE SHIRTS (U.S. CLS. 22 AND 39).

FIRST USE 1-15-2005; IN COMMERCE 1-15-2005.

CLASS 41—EDUCATION AND ENTERTAINMENT

FOR ENTERTAINMENT SERVICES, NAMELY, LIVE WRESTLING AND COMEDY SHOWS PERFORMED BY MIDGETS AND DWARVES (U.S. CLS. 100, 101 AND 107).

FIRST USE 1-15-2005; IN COMMERCE 1-15-2005.

LINDA MICKLEBURGH, EXAMINING ATTORNEY

SN 77-890,794. DÍEZ, MERCEDES GARCÍA, ELCHE, SPAIN, FILED 12-10-2009.

MTNG

THE MARK CONSISTS OF STANDARD CHARACTERS WITHOUT CLAIM TO ANY PARTICULAR FONT, STYLE, SIZE, OR COLOR.

CLASS 18—LEATHER GOODS

FOR LEATHER AND IMITATION LEATHER; GOODS MADE OF LEATHER AND IMITATION LEATHER, NAMELY, HANDBAGS, WALLETS, AND BAGS IN THE NATURE OF ALL-PURPOSE CARRYING BAGS, ALL-PURPOSE SPORT BAGS, BELT BAGS, BAGS FOR UMBRELLAS, CLUTCH BAGS, DUFFEL BAGS, AND OVERNIGHT BAGS; ANIMALS SKINS AND HIDES; TRUNKS AND SUITCASES; UMBRELLAS, SUNSHADES IN THE NATURE OF PARASOLS AND SUN UMBRELLAS; WALKING STICKS, WHIPS, AND SADDLERY (U.S. CLS. 1, 2, 3, 22 AND 41).

CLASS 25—CLOTHING

FOR READY-MADE WEAR FOR WOMEN, MEN AND CHILDREN, NAMELY, BELTS, GLOVES, JACKETS, SWEATERS, MITTENS, OVERCOATS, SHIRTS, T-SHIRTS, PANTS, AND UNDERGARMENTS; FOOTWEAR, NAMELY, BOOTS, SHOES, AND SANDALS; HEADGEAR, NAMELY, HATS AND CAPS (U.S. CLS. 22 AND 39).

CLASS 35—ADVERTISING AND BUSINESS

FOR ADVERTISING AND BUSINESS MANAGEMENT; BUSINESS ADMINISTRATION; PROVIDING OFFICE FUNCTIONS (U.S. CLS. 100, 101 AND 102).
CAROL SPILS, EXAMINING ATTORNEY

SN 77-890,889. ONDINE INTERNATIONAL HOLDINGS, LTD., ST. MICHAEL, BARBADOS, FILED 12-10-2009.

SOLACIN

THE MARK CONSISTS OF STANDARD CHARACTERS WITHOUT CLAIM TO ANY PARTICULAR FONT, STYLE, SIZE, OR COLOR.

CLASS 5—PHARMACEUTICALS

FOR PHOTOSENSITIZING AGENTS FOR MEDICAL APPLICATIONS, NAMELY, PHARMACEUTICALS FOR THE TREATMENT OF INFECTIOUS DISEASES; LIGHT-ACTIVATED DISINFECTANT COMPOSITIONS FOR KILLING DISEASE-CAUSING MICRO-ORGANISMS; LIGHT-ACTIVATED THERAPEUTIC PREPARATIONS FOR KILLING BACTERIAL, FUNGAL AND VIRAL INFECTIONS; PHOTOSENSITIZERS FOR USE IN PHOTODYNAMIC THERAPY AND/OR PHOTODISINFECTION, NAMELY, PHARMACEUTICALS FOR THE TREATMENT OF INFECTIOUS DISEASES; PHARMACEUTICAL PREPARATIONS FOR THE TREATMENT OF STAPH INFECTIONS; PHARMACEUTICAL PREPARATIONS FOR THE TREATMENT OF METHICILLIN-RESISTANT STAPH INFECTIONS (U.S. CLS. 6, 18, 44, 46, 51 AND 52).

CLASS 10—MEDICAL APPARATUS

FOR MEDICAL EQUIPMENT, NAMELY, LASERS, LED, INCANDESCENT LIGHTS, FLUORESCENT LIGHTS, STERILIZABLE LIGHT WANDS, SENSORY LIGHT THERAPY UNIT FOR USE IN FIELD OF PHOTODYNAMIC THERAPY AND/OR PHOTODISINFECTION; A LIGHT DELIVERY DEVICE, NAMELY, LASERS, LED, INCANDESCENT LIGHTS, FLUORESCENT LIGHTS, STERILIZABLE LIGHT WANDS, SENSORY LIGHT THERAPY UNIT FOR USE IN TREATMENT OF STAPH INFECTION; A LIGHT DELIVERY DEVICE, NAMELY, LASERS, LED, INCANDESCENT LIGHTS, FLUORESCENT LIGHTS, STERILIZABLE LIGHT WANDS, SENSORY LIGHT THERAPY UNIT FOR USE IN TREATMENT OF METHICILLIN-RESISTANT STAPH INFECTION; OPTIC PROBE TIPS, MEDICAL SYRINGES AND AEROSOL DISPENSER FOR MEDICAL USE IN PHOTODYNAMIC THERAPY AND/OR PHOTODISINFECTION (U.S. CLS. 26, 39 AND 44).

RENEE MCCRAY, EXAMINING ATTORNEY

SN 77-890,930. ION TORRENT SYSTEMS, INC., SAN FRANCISCO, CA. FILED 12-10-2009.

ION TORRENT SYSTEMS

THE MARK CONSISTS OF STANDARD CHARACTERS WITHOUT CLAIM TO ANY PARTICULAR FONT, STYLE, SIZE, OR COLOR.

NO CLAIM IS MADE TO THE EXCLUSIVE RIGHT TO USE "SYSTEMS", APART FROM THE MARK AS SHOWN.

CLASS 1—CHEMICALS

FOR KITS COMPRISING PRIMARILY OF REAGENTS, ENZYMES AND/OR NUCLEOTIDES FOR GENETIC RESEARCH (U.S. CLS. 1, 5, 6, 10, 26 AND 46).

CLASS 9—ELECTRICAL AND SCIENTIFIC APPARATUS

FOR SCIENTIFIC EQUIPMENT AND INSTRUMENTS, NAMELY, SEMICONDUCTOR CHIPS WITH INTEGRATED SENSORS FOR NUCLEIC ACID SEQUENCING, SEMICONDUCTOR CHIP READERS AND RELATED COMPUTER SOFTWARE USED FOR NUCLEIC ACID SEQUENCING AND ANALYSIS; NUCLEIC ACID POLYMER PARTICLES FOR USE IN GENETIC SEQUENCING; GENOME ANALYZER MACHINES AND RELATED COMPUTER OPERATING SOFTWARE; COMPUTER SOFTWARE FOR MONITORING OF GENOME ANALYZER MACHINES FROM HANDHELD OR MOBILE WIRELESS COMMUNICATION DEVICES CAPABLE OF VOICE, DATA AND/OR IMAGE TRANSMISSION (U.S. CLS. 21, 23, 26, 36 AND 38).
LINDA E. BLOHM, EXAMINING ATTORNEY

SN 77-890,932. ION TORRENT SYSTEMS, INC., SAN FRANCISCO, CA. FILED 12-10-2009.

ION TORRENT

THE MARK CONSISTS OF STANDARD CHARACTERS WITHOUT CLAIM TO ANY PARTICULAR FONT, STYLE, SIZE, OR COLOR.

CLASS 1—CHEMICALS

FOR KITS COMPRISING PRIMARILY OF REAGENTS, ENZYMES AND/OR NUCLEOTIDES FOR GENETIC RESEARCH (U.S. CLS. 1, 5, 6, 10, 26 AND 46).

CLASS 9—ELECTRICAL AND SCIENTIFIC APPARATUS

FOR SCIENTIFIC EQUIPMENT AND INSTRUMENTS, NAMELY, SEMICONDUCTOR CHIPS WITH INTEGRATED SENSORS FOR NUCLEIC ACID SEQUENCING, SEMICONDUCTOR CHIP READERS AND RELATED COMPUTER SOFTWARE USED FOR NUCLEIC ACID SEQUENCING AND ANALYSIS; NUCLEIC ACID POLYMER PARTICLES FOR USE IN GENETIC SEQUENCING; GENOME ANALYZER MACHINES AND RELATED COMPUTER OPERATING SOFTWARE; COMPUTER SOFTWARE FOR MONITORING OF GENOME ANALYZER MACHINES FROM HANDHELD OR MOBILE WIRELESS COMMUNICATION DEVICES CAPABLE OF VOICE, DATA AND/OR IMAGE TRANSMISSION (U.S. CLS. 21, 23, 26, 36 AND 38).
LINDA E. BLOHM, EXAMINING ATTORNEY

SN 77-890,941. ION TORRENT SYSTEMS, INC., SAN FRANCISCO, CA. FILED 12-10-2009.

THE CHIP IS THE MACHINE

THE MARK CONSISTS OF STANDARD CHARACTERS WITHOUT CLAIM TO ANY PARTICULAR FONT, STYLE, SIZE, OR COLOR.

CLASS 1—CHEMICALS

FOR KITS COMPRISING PRIMARILY OF REAGENTS, ENZYMES AND/OR NUCLEOTIDES FOR GENETIC RESEARCH (U.S. CLS. 1, 5, 6, 10, 26 AND 46).

CLASS 9—ELECTRICAL AND SCIENTIFIC APPARATUS

FOR SCIENTIFIC EQUIPMENT AND INSTRUMENTS, NAMELY, SEMICONDUCTOR CHIPS WITH INTEGRATED SENSORS FOR NUCLEIC ACID SEQUENCING, SEMICONDUCTOR CHIP READERS AND RELATED COMPUTER SOFTWARE USED FOR NUCLEIC ACID SEQUENCING AND ANALYSIS; NUCLEIC ACID POLYMER PARTICLES FOR USE IN GENETIC SEQUENCING; GENOME ANALYZER MACHINES AND RELATED COMPUTER OPERATING SOFTWARE; COMPUTER SOFTWARE FOR MONITORING OF GENOME ANALYZER MACHINES FROM HANDHELD OR MOBILE WIRELESS COMMUNICATION DEVICES CAPABLE OF VOICE, DATA AND/OR IMAGE TRANSMISSION (U.S. CLS. 21, 23, 26, 36 AND 38).
LINDA E. BLOHM, EXAMINING ATTORNEY

SN 77-890,937. USERVOICE, INC., SAN FRANCISCO, CA. FILED 12-10-2009.

USERVOICE

THE MARK CONSISTS OF STANDARD CHARACTERS WITHOUT CLAIM TO ANY PARTICULAR FONT, STYLE, SIZE, OR COLOR.

CLASS 38—COMMUNICATION

FOR PROVIDING ON-LINE FORUMS THAT ALLOW PEOPLE AND ORGANIZATIONS TO ANALYZE, FACILITATE, AGGREGATE AND MODERATE SUGGESTIONS, FEEDBACK, VOTES AND COMMENTS; PROVIDING ON-LINE FORUMS THAT ALLOW PEOPLE TO MAKE SUGGESTIONS, PROVIDE FEEDBACK, VOTE ON IDEAS AND PROVIDE COMMENTS; PROVIDING ON-LINE FORUMS THAT ALLOW PEOPLE AND ORGANIZATIONS TO RESPOND TO POSTINGS BY OTHERS; PROVIDING ON-LINE FORUMS THAT ALLOW PEOPLE AND ORGANIZATIONS TO PROVIDE UPDATES TO OTHERS (U.S. CLS. 100, 101 AND 104).
FIRST USE 4-20-2008; IN COMMERCE 4-20-2008.

SN 77-890,953. ECO-IT SOLUTIONS, BROOKLYN, NY. FILED 12-10-2009.

CLASS 42—SCIENTIFIC AND COMPUTER SERVICES

FOR PROVIDING TEMPORARY USE OF NON-DOWNLOADABLE COMPUTER SOFTWARE THAT ALLOWS PEOPLE AND ORGANIZATIONS TO ANALYZE, FACILITATE, AGGREGATE AND MODERATE SUGGESTIONS, FEEDBACK, VOTES AND COMMENTS; PROVIDING TEMPORARY USE OF NON-DOWNLOADABLE COMPUTER SOFTWARE THAT ALLOWS PEOPLE AND ORGANIZATIONS TO EMBED WIDGETS ON WEBSITES IN ORDER TO ANALYZE, FACILITATE, AGGREGATE AND MODERATE SUGGESTIONS, FEEDBACK, VOTES AND COMMENTS; PROVIDING TEMPORARY USE OF NON-DOWNLOADABLE COMPUTER SOFTWARE THAT ALLOWS PEOPLE AND ORGANIZATIONS TO POST CONTENT AND RESPOND TO POSTINGS OF OTHERS; PROVIDING TEMPORARY USE OF NON-DOWNLOADABLE COMPUTER SOFTWARE THAT ALLOWS PEOPLE AND ORGANIZATIONS TO PROVIDE UPDATES TO OTHERS (U.S. CLS. 100 AND 101).
FIRST USE 4-20-2008; IN COMMERCE 4-20-2008.
MICHAEL WEBSTER, EXAMINING ATTORNEY



NO CLAIM IS MADE TO THE EXCLUSIVE RIGHT TO USE "IT", APART FROM THE MARK AS SHOWN.
THE STIPPLING IS FOR SHADING PURPOSES ONLY.
THE MARK CONSISTS OF AN ABSTRACT DESIGN WITHIN A GLOBE WITH THE STYLIZED TEXT "IT"

CLASS 37—CONSTRUCTION AND REPAIR

FOR COMPUTER INSTALLATION AND REPAIR (U.S. CLS. 100, 103 AND 106).
FIRST USE 9-1-2009; IN COMMERCE 9-1-2009.

CLASS 42—SCIENTIFIC AND COMPUTER SERVICES

FOR CONSULTING IN THE FIELD OF IT PROJECT MANAGEMENT; INFORMATION TECHNOLOGY CONSULTATION; INSTALLATION, MAINTENANCE AND REPAIR OF COMPUTER SOFTWARE (U.S. CLS. 100 AND 101).

FIRST USE 9-1-2009; IN COMMERCE 9-1-2009.
CARYN GLASSER, EXAMINING ATTORNEY

SN 77-891,015. EMAX ENTERPRISES LIMITED, KOWLOON, HONG KONG, FILED 12-10-2009.

CULINX

THE MARK CONSISTS OF STANDARD CHARACTERS WITHOUT CLAIM TO ANY PARTICULAR FONT, STYLE, SIZE, OR COLOR.

CLASS 8—HAND TOOLS

FOR CARVING KNIVES; CHEF KNIVES; FLATWARE, NAMELY, FORKS, KNIVES, AND SPOONS; HOUSEHOLD KNIVES; KNIVES, FORKS AND SPOONS; TABLEWARE, NAMELY, KNIVES, FORKS AND SPOONS (U.S. CLS. 23, 28 AND 44).

CLASS 21—HOUSEWARES AND GLASS

FOR COOKWARE, NAMELY, POTS AND PANS; HOUSEHOLD UTENSILS, NAMELY, GRATERS; HOUSEHOLD UTENSILS, NAMELY, KITCHEN TONGS; HOUSEHOLD UTENSILS, NAMELY, SIEVES; HOUSEHOLD UTENSILS, NAMELY, SKIMMERS; HOUSEHOLD UTENSILS, NAMELY, SPATULAS; HOUSEHOLD UTENSILS, NAMELY, STRAINERS; HOUSEHOLD UTENSILS, NAMELY, TURNERS (U.S. CLS. 2, 13, 23, 29, 30, 33, 40 AND 50).

JUDITH HELFMAN, EXAMINING ATTORNEY



THE MARK CONSISTS OF THE WORD "HUMANITY" INCORPORATED INTO A GRAPHIC. THE GRAPHIC INCORPORATES THE LETTER "A" WITH A GREEK LETTER OMEGA OVER IT. THERE IS A LINEAR GRAPHIC OF A ROD THROUGH BOTH THE "A" AND THE OMEGA, WITH HORIZONTAL SCROLLING ON EITHER SIDE.

CLASS 3—COSMETICS AND CLEANING PREPARATIONS

FOR PERFUME, COSMETICS, SOAPS FOR BODY CARE, HAND SOAPS, BODY SPRAYS, LOTIONS FOR COSMETIC PURPOSES, LOTIONS FOR FACE AND BODY CARE (U.S. CLS. 1, 4, 6, 50, 51 AND 52).

CLASS 9—ELECTRICAL AND SCIENTIFIC APPARATUS

FOR MOUSE PADS, SUNGLASSES, COMPUTER CARRYING CASE, CD CASE, CELL PHONE COVERS, DECORATIVE COVER FOR COMPUTERS (U.S. CLS. 21, 23, 26, 36 AND 38).

CLASS 14—JEWELRY

FOR JEWELRY, WATCHES, COSTUME JEWELRY (U.S. CLS. 2, 27, 28 AND 50).

CLASS 18—LEATHER GOODS

FOR PURSES, WALLETS, LEATHER BAGS, SUITCASES, TOILETRY CASES SOLD EMPTY, TOTE BAGS, BACKPACKS, LUGGAGE (U.S. CLS. 1, 2, 3, 22 AND 41).

CLASS 25—CLOTHING

FOR CLOTHING, NAMELY, DRESSES, T-SHIRTS, TANK TOPS, SWEATSHIRTS, JOGGING SUITS, SHORTS, JACKETS, PAJAMAS, PANTS, BATHROBES; FOOTWEAR; SCARVES; HEADGEAR, NAMELY, HATS, CAPS, BEANIES (U.S. CLS. 22 AND 39).
JUDITH HELFMAN, EXAMINING ATTORNEY

SN 77-891,036. AMANDA BROTMAN, NEW YORK, NY. FILED 12-10-2009.

P.S. WE THINK YOU'RE
FABULOUS!

THE MARK CONSISTS OF STANDARD CHARACTERS WITHOUT CLAIM TO ANY PARTICULAR FONT, STYLE, SIZE, OR COLOR.

CLASS 3—COSMETICS AND CLEANING PREPARATIONS

FOR COSMETICS AND MAKE-UP; LIPSTICKS AND LIP GLOSS; PERFUME OILS; HAND AND BODY LOTIONS AND CREMES, PERFUME OILS FOR THE MANUFACTURE OF COSMETIC PREPARATIONS; PERFUMES AND TOILET WATERS (U.S. CLS. 1, 4, 6, 50, 51 AND 52).

CLASS 9—ELECTRICAL AND SCIENTIFIC APPARATUS

FOR CASES FOR SPECTACLES AND SUNGLASSES; AND SUNGLASSES (U.S. CLS. 21, 23, 26, 36 AND 38).

CLASS 18—LEATHER GOODS

FOR EVENING HANDBAGS; HANDBAG FRAMES; HANDBAGS; LEATHER HANDBAGS; STRAPS FOR HANDBAGS; PURSES AND WALLETS (U.S. CLS. 1, 2, 3, 22 AND 41).

CLASS 25—CLOTHING

FOR HEAD SCARVES; SCARVES; SHOULDER SCARVES; SKIRTS; BLOUSES; PANTS; JACKETS; COATS; SHOES; HATS; GLOVES; WAIST BELTS; AND HOSIERY (U.S. CLS. 22 AND 39).

KAELIE KUNG, EXAMINING ATTORNEY

SN 77-891.080. BUTTERFLY CANYON PRODUCTIONS, INC., TOLUCA LAKE, CA. FILED 12-11-2009.



THE MARK CONSISTS OF THE SHAPE OF AN OPEN HAND. ACROSS THE PALM "HAND JOB!" IS SMALLER AT THE BEGINNING OF THE WORD AND BIGGER AT THE END. IT IS ALSO ARCHED. ACROSS THE WRIST IS "WWW.INEEDAHANDJOB.COM".

CLASS 8—HAND TOOLS

FOR MANUALLY OPERATED CONTAINER OPENER FOR HOUSEHOLD OR DOMESTIC USE (U.S. CLS. 23, 28 AND 44).

FIRST USE 12-9-2009; IN COMMERCE 12-9-2009.

CLASS 40—MATERIAL TREATMENT

FOR IMPRINTING MESSAGES ON WEARING APPAREL, ACCESSORIES AND MUGS (U.S. CLS. 100, 103 AND 106).

TINA L. SNAPP, EXAMINING ATTORNEY

SN 77-891.085. SHARISM AT WORK LTD., HONG KONG, HONG KONG, FILED 12-11-2009.

Sharism

THE MARK CONSISTS OF STANDARD CHARACTERS WITHOUT CLAIM TO ANY PARTICULAR FONT, STYLE, SIZE, OR COLOR.

CLASS 9—ELECTRICAL AND SCIENTIFIC APPARATUS

FOR CELLULAR PHONES; COMPUTER HARDWARE; COMPUTER PERIPHERALS; COMPUTERS; ELECTRONIC BOOK READER; HANDHELD COMPUTERS; MOBILE COMPUTERS; PORTABLE MEDIA PLAYERS (U.S. CLS. 21, 23, 26, 36 AND 38).

CLASS 40—MATERIAL TREATMENT

FOR RECYCLING (U.S. CLS. 100, 103 AND 106).
TINA L. SNAPP, EXAMINING ATTORNEY

SN 77-891.106. INTERNATIONAL PAPER COMPANY, MEMPHIS, TN. FILED 12-11-2009.

SPRING GROVE

THE MARK CONSISTS OF STANDARD CHARACTERS WITHOUT CLAIM TO ANY PARTICULAR FONT, STYLE, SIZE, OR COLOR.

CLASS 6—METAL GOODS

FOR ALUMINUM FOIL WRAP FOR USE WITH FOOD (U.S. CLS. 2, 12, 13, 14, 23, 25 AND 50).

FIRST USE 5-31-2008; IN COMMERCE 5-31-2008.

CLASS 16—PAPER GOODS AND PRINTED MATTER

FOR PAPER TOWELS, PAPER FACIAL TISSUE, PAPER TOILET TISSUE, PAPER NAPKINS (U.S. CLS. 2, 5, 22, 23, 29, 37, 38 AND 50).

FIRST USE 5-31-2008; IN COMMERCE 5-31-2008.

CLASS 17—RUBBER GOODS

FOR PLASTIC FILM WRAP FOR USE WITH FOOD FOR COMMERCIAL PURPOSES (U.S. CLS. 1, 5, 12, 13, 35 AND 50).

FIRST USE 5-31-2008; IN COMMERCE 5-31-2008.

CLASS 21—HOUSEWARES AND GLASS

FOR FIXED DISPENSERS MADE OF PLASTIC USED FOR PAPER TOWEL AND PAPER TOILET TISSUE (U.S. CLS. 2, 13, 23, 29, 30, 33, 40 AND 50).

FIRST USE 5-31-2008; IN COMMERCE 5-31-2008.

APRIL ROACH, EXAMINING ATTORNEY

SN 77-891.108. RICHARD LANZA, BRAINTREE, MA. FILED 12-11-2009.

OPEN DOORS

THE MARK CONSISTS OF STANDARD CHARACTERS WITHOUT CLAIM TO ANY PARTICULAR FONT, STYLE, SIZE, OR COLOR.

CLASS 41—EDUCATION AND ENTERTAINMENT

FOR PHYSICAL FITNESS CONDITIONING CLASSES; PHYSICAL FITNESS CONSULTATION; PHYSICAL FITNESS INSTRUCTION; PHYSICAL FITNESS TRAINING SERVICES; PROVIDING FITNESS AND EXERCISE FACILITIES; YOGA INSTRUCTION (U.S. CLS. 100, 101 AND 107).

FIRST USE 1-1-1999; IN COMMERCE 1-1-1999.

CLASS 45—PERSONAL AND LEGAL SERVICES

FOR ASTROLOGICAL FORECASTING; ASTROLOGY CONSULTATION; PSYCHIC READING SERVICES (U.S. CLS. 100 AND 101).

FIRST USE 1-1-1992; IN COMMERCE 1-1-1992.
STEVEN PEREZ, EXAMINING ATTORNEY

CLASS 11—ENVIRONMENTAL CONTROL APPARATUS

FOR ELECTRICAL OR BATTERY-OPERATED AIR FRESHENER UNITS (U.S. CLS. 13, 21, 23, 31 AND 34).

JOHN HWANG, EXAMINING ATTORNEY

SN 77-891,151. THE PROCTER & GAMBLE COMPANY, CINCINNATI, OH. FILED 12-11-2009.

SN 77-891,235. DR. MIRACLES, INC., NEW YORK, NY. FILED 12-11-2009.

INSTANTMATIC

THE MARK CONSISTS OF STANDARD CHARACTERS WITHOUT CLAIM TO ANY PARTICULAR FONT, STYLE, SIZE, OR COLOR.

CLASS 3—COSMETICS AND CLEANING PREPARATIONS

FOR ROOM FRAGRANCES (U.S. CLS. 1, 4, 6, 50, 51 AND 52).

CLASS 5—PHARMACEUTICALS

FOR AIR DEODORANTS AND DEODORIZERS, PREPARATIONS FOR NEUTRALIZING BAD ODORS (U.S. CLS. 6, 18, 44, 46, 51 AND 52).

CLASS 11—ENVIRONMENTAL CONTROL APPARATUS

FOR ELECTRICAL OR BATTERY-OPERATED AIR FRESHENER UNITS (U.S. CLS. 13, 21, 23, 31 AND 34).

JOHN HWANG, EXAMINING ATTORNEY

SN 77-891,169. THE PROCTER & GAMBLE COMPANY, CINCINNATI, OH. FILED 12-11-2009.

3VOLUTION

THE MARK CONSISTS OF STANDARD CHARACTERS WITHOUT CLAIM TO ANY PARTICULAR FONT, STYLE, SIZE, OR COLOR.

CLASS 3—COSMETICS AND CLEANING PREPARATIONS

FOR ROOM FRAGRANCES (U.S. CLS. 1, 4, 6, 50, 51 AND 52).

CLASS 5—PHARMACEUTICALS

FOR AIR DEODORANTS AND DEODORIZERS, PREPARATIONS FOR NEUTRALIZING BAD ODORS (U.S. CLS. 6, 18, 44, 46, 51 AND 52).

**DR. MIRACLE'S**

THE MARK CONSISTS OF A FIGURE OF A MAN WRITING ON A CLIP BOARD WITH THE WORDS "DR. MIRACLE'S" BELOW.

CLASS 3—COSMETICS AND CLEANING PREPARATIONS

FOR NON-MEDICATED ACNE TREATMENT PREPARATIONS (U.S. CLS. 1, 4, 6, 50, 51 AND 52).

FIRST USE 10-0-2008; IN COMMERCE 10-0-2008.

CLASS 5—PHARMACEUTICALS

FOR MEDICATED ACNE TREATMENT PREPARATIONS (U.S. CLS. 6, 18, 44, 46, 51 AND 52).

FIRST USE 10-0-2008; IN COMMERCE 10-0-2008.

AISHA CLARKE, EXAMINING ATTORNEY

SN 77-891,241. ION TORRENT SYSTEMS, INC., SAN FRANCISCO, CA. FILED 12-11-2009.

SEMICONDUCTOR SEQUENCING
FOR LIFE

THE MARK CONSISTS OF STANDARD CHARACTERS WITHOUT CLAIM TO ANY PARTICULAR FONT, STYLE, SIZE, OR COLOR.

CLASS 1—CHEMICALS

FOR KITS COMPRISING PRIMARILY OF REAGENTS, ENZYMES AND/OR NUCLEOTIDES FOR GENETIC RESEARCH (U.S. CLS. 1, 5, 6, 10, 26 AND 46).

CLASS 9—ELECTRICAL AND SCIENTIFIC APPARATUS

FOR SCIENTIFIC EQUIPMENT AND INSTRUMENTS, NAMELY, SEMICONDUCTOR CHIPS WITH INTEGRATED SENSORS FOR NUCLEIC ACID SEQUENCING, SEMICONDUCTOR CHIP READERS AND RELATED COMPUTER SOFTWARE USED FOR NUCLEIC ACID SEQUENCING AND ANALYSIS; NUCLEIC ACID POLYMER PARTICLES FOR USE IN GENETIC SEQUENCING; GENOME ANALYZER MACHINES AND RELATED COMPUTER OPERATING SOFTWARE; COMPUTER SOFTWARE FOR MONITORING OF GENOME ANALYZER MACHINES FROM HANDHELD OR MOBILE WIRELESS COMMUNICATION DEVICES CAPABLE OF VOICE, DATA AND/OR IMAGE TRANSMISSION (U.S. CLS. 21, 23, 26, 36 AND 38).

LINDA E. BLOHM, EXAMINING ATTORNEY

CLASS 20—FURNITURE AND ARTICLES NOT OTHERWISE CLASSIFIED

FOR FLAGPOLES AND PLASTIC FLAGS AND ACCESSORIES FOR FLAGS AND FLAGPOLES SOLD TOGETHER AS A UNIT, NAMELY, RODS, ROD SUPPORTS AND COUPLERS, CONNECTORS, PINS, BRACKETS, CLAMPS, FASTENERS, NUTS AND BOLTS, AND POLE SUPPORTS (U.S. CLS. 2, 13, 22, 25, 32 AND 50).

CLASS 24—FABRICS

FOR CLOTH FLAGS; FABRIC FLAGS; NYLON FLAGS (U.S. CLS. 42 AND 50).

CHARLOTTE CORWIN, EXAMINING ATTORNEY

SN 77-891,277. RESTORING LIVES INTERNATIONAL, INC., HOUSTON, TX. FILED 12-11-2009.

RESTORING LIVES INTERNATIONAL

THE MARK CONSISTS OF STANDARD CHARACTERS WITHOUT CLAIM TO ANY PARTICULAR FONT, STYLE, SIZE, OR COLOR.

NO CLAIM IS MADE TO THE EXCLUSIVE RIGHT TO USE "INTERNATIONAL", APART FROM THE MARK AS SHOWN.

CLASS 36—INSURANCE AND FINANCIAL

FOR ACCEPTING AND ADMINISTERING MONETARY CHARITABLE CONTRIBUTIONS; CHARITABLE FUND RAISING; CHARITABLE SERVICES, NAMELY, PROVIDING FINANCIAL SUPPORT TO PEOPLE FROM DISADVANTAGED COUNTRIES FOR THE PURPOSE OF FACILITATING EDUCATIONAL OPPORTUNITIES (U.S. CLS. 100, 101 AND 102).

FIRST USE 6-13-2002; IN COMMERCE 6-13-2002.

CLASS 45—PERSONAL AND LEGAL SERVICES

FOR CHARITABLE SERVICES, NAMELY, PROVIDING CLOTHING TO NEEDY PERSONS; CHARITABLE SERVICES, NAMELY, PROVIDING SHOES TO NEEDY CHILDREN; CHRISTIAN MINISTRY SERVICES (U.S. CLS. 100 AND 101).

FIRST USE 6-13-2002; IN COMMERCE 6-13-2002.

KAREN K. BUSH, EXAMINING ATTORNEY

SN 77-891,336. MAYWOOD GROUP LLC, GROSSE POINTE SHORES, MI. FILED 12-11-2009.

FLY TRUE

THE MARK CONSISTS OF STANDARD CHARACTERS WITHOUT CLAIM TO ANY PARTICULAR FONT, STYLE, SIZE, OR COLOR.

SN 77-891,639. HUSKY OIL OPERATIONS LIMITED, CALGARY, AB T2P3G7, CANADA, FILED 12-11-2009.



OWNER OF CANADA REG. NO. TMA641156, DATED 6-2-2005, EXPIRES 6-2-2020.

OWNER OF U.S. REG. NOS. 3,542,629, 3,703,990 AND OTHERS.

THE COLOR(S) BLUE, RED, AND WHITE IS/ARE CLAIMED AS A FEATURE OF THE MARK.

THE MARK CONSISTS OF "HUSKY" AND A HUSKY DOG HEAD DESIGN (COLOUR). THE COLOR(S) ARE BLUE, RED AND WHITE. THE SHADED AREA AROUND THE PERIMETER OF THE SQUARE IS BLUE. THE SPACE BEHIND THE DOG HEAD, INSIDE THE BLUE PERIMETER IS WHITE. THE SHADED AREA OF THE DOG HEAD IS RED AND THE BALANCE IS WHITE. THE WORD "HUSKY" IS WHITE. THE SPACE BEHIND THE WORD "HUSKY" INSIDE THE RECTANGLE IS BLUE.

CLASS 4—LUBRICANTS AND FUELS

FOR PETROLEUM PRODUCTS, NAMELY, GASOLINE, INDUSTRIAL LUBRICANTS, ENGINE LUBRICATING OILS, VEHICULAR LUBRICATING OILS, VEHICULAR GREASES, HEATING FUEL OILS, DIESEL FUEL OILS, INDUSTRIAL FUEL OILS, TREATING OILS; KEROSENE, JET FUEL, PROPANE FUEL, BUTANE FUEL, PETROLEUM COKE, BENZENE, PROPYLENE, BUTYLENE AND ETHANOL BASED FUEL (U.S. CLS. 1, 6 AND 15).

CLASS 19—NON-METALLIC BUILDING MATERIALS

FOR ASPHALT PRODUCTS, NAMELY, PAVING ASPHALT, INDUSTRIAL ASPHALT, MODIFIED ASPHALT, ROOFING ASPHALT (U.S. CLS. 1, 12, 33 AND 50).

ROBIN CHOSID, EXAMINING ATTORNEY

SN 77-891,712. SONY ENGINEERING CORPORATION, TOKYO 141-0031, JAPAN, FILED 12-11-2009.

SN 77-891,718. HUSKY OIL OPERATIONS LIMITED, CALGARY, AB T2P3G7, CANADA, FILED 12-11-2009.

Tenobo



OWNER OF U.S. REG. NOS. 3,542,629, 3,703,990 AND OTHERS.

THE COLOR(S) BLUE, RED, AND WHITE IS/ARE CLAIMED AS A FEATURE OF THE MARK.

THE MARK CONSISTS OF DOG HEAD DESIGN (COLOUR). THE COLOR(S) ARE BLUE, RED AND WHITE. THE SHADED AREA AROUND THE PERIMETER OF THE SQUARE IS BLUE. THE SPACE BEHIND THE DOG HEAD, INSIDE THE BLUE PERIMETER IS WHITE. THE SHADED AREA OF THE DOG HEAD IS RED, THE BALANCE IS WHITE.

THE MARK CONSISTS OF STANDARD CHARACTERS WITHOUT CLAIM TO ANY PARTICULAR FONT, STYLE, SIZE, OR COLOR.

THE WORDING "TENOBO" HAS NO MEANING IN A FOREIGN LANGUAGE.

CLASS 9—ELECTRICAL AND SCIENTIFIC APPARATUS

FOR COMPUTER INPUT DIGITIZER TABLETS WITH A NETWORKING FUNCTION AND COMPUTER INPUT LIGHT PENS; ELECTRONIC PUBLICATIONS, NAMELY, MAGAZINES, BOOKS, AND NEWSPAPERS RECORDED ON CD-ROMS OR DOWNLOADABLE FROM A COMPUTER NETWORK FEATURING EDUCATION, TEACHING, AND INSTRUCTION IN THE FIELD OF NATIONAL LANGUAGE, ARITHMETIC, SCIENCE, SOCIAL STUDIES, ENGLISH AND OTHER FOREIGN LANGUAGES, HEALTH, PHYSICAL EDUCATION, MUSIC, ART, COMPUTER LITERACY, COMPUTING AND COMPUTER SCIENCE, DOMESTIC SCIENCE, MATHEMATICS, CHEMISTRY, PHYSICS, BIOLOGY, ETHICS, MORALS, EARTH SCIENCE, JAPANESE HISTORY, WORLD HISTORY, GEOGRAPHY, POLITICS, ECONOMICS, LITERATURE, LAW, LIBERAL ARTS, BUSINESS, COMMERCE AND MANAGEMENT, ENGINEERING, MEDICINE, PHARMACY, DENTISTRY, AND AGRICULTURE FOR BABIES, INFANTS, CHILDREN, STUDENTS AND THOSE TEACHING BABIES, INFANTS, CHILDREN AND STUDENTS (U.S. CLS. 21, 23, 26, 36 AND 38).

CLASS 41—EDUCATION AND ENTERTAINMENT

FOR EDUCATIONAL SERVICES, NAMELY, PROVIDING INFORMATION AND DATA ON EDUCATION; EDUCATIONAL SERVICES, NAMELY, PROVIDING COURSES OF INSTRUCTION AT THE PRIMARY, SECONDARY AND COLLEGE LEVELS; EDUCATIONAL SERVICES IN THE NATURE OF CORRESPONDENCE SCHOOLS; EDUCATIONAL TESTING; EDUCATIONAL SERVICES, NAMELY, PROVIDING INSTRUCTION ON LANGUAGES AND EDUCATIONAL ASSESSMENT OF LINGUISTIC ABILITY AND SKILLS (U.S. CLS. 100, 101 AND 107).

TRACY CROSS, EXAMINING ATTORNEY

CLASS 4—LUBRICANTS AND FUELS

FOR PETROLEUM PRODUCTS, NAMELY, GASOLINE, INDUSTRIAL LUBRICANTS, ENGINE LUBRICATING OILS, VEHICULAR LUBRICATING OILS, VEHICULAR GREASES, HEATING FUEL OILS, DIESEL FUEL OILS, INDUSTRIAL FUEL OILS, TREATING OILS, KEROSENE, JET FUEL, PROPANE FUEL, BUTANE FUEL, PETROLEUM COKE, BENZENE, PROPYLENE, BUTYLENE AND ETHANOL BASED FUEL (U.S. CLS. 1, 6 AND 15).

CLASS 19—NON-METALLIC BUILDING MATERIALS

FOR ASPHALT PRODUCTS, NAMELY, PAVING ASPHALT, INDUSTRIAL ASPHALT, MODIFIED ASPHALT, ROOFING ASPHALT (U.S. CLS. 1, 12, 33 AND 50).

ROBIN CHOSID, EXAMINING ATTORNEY

SN 77-891,746. THORPE, LE ETTA, PLEASANT VIEW, UT. FILED 12-11-2009.

Due to the economy, the
light at the end of the
tunnel has been turned off
until further notice

THE MARK CONSISTS OF STANDARD CHARACTERS WITHOUT CLAIM TO ANY PARTICULAR FONT, STYLE, SIZE, OR COLOR.

CLASS 16—PAPER GOODS AND PRINTED MATTER

FOR BUMPER STICKERS; DECALS (U.S. CLS. 2, 5, 22, 23, 29, 37, 38 AND 50).

CLASS 21—HOUSEWARES AND GLASS

FOR COFFEE CUPS (U.S. CLS. 2, 13, 23, 29, 30, 33, 40 AND 50).

CLASS 25—CLOTHING

FOR T-SHIRTS (U.S. CLS. 22 AND 39).
MAUREEN DALL, EXAMINING ATTORNEY

SN 77-891,798. ARRAYIT CORPORATION, SUNNYVALE, CA. FILED 12-11-2009.

OvaDx

THE MARK CONSISTS OF STANDARD CHARACTERS WITHOUT CLAIM TO ANY PARTICULAR FONT, STYLE, SIZE, OR COLOR.

CLASS 1—CHEMICALS

FOR DIAGNOSTIC PREPARATIONS FOR SCIENTIFIC OR RESEARCH USE; DIAGNOSTIC PREPARATIONS FOR CLINICAL OR MEDICAL LABORATORY USE; DIAGNOSTIC PREPARATIONS FOR SCIENTIFIC USE; DIAGNOSTIC PREPARATIONS USED IN SCIENCE; DIAGNOSTIC REAGENTS FOR CLINICAL OR MEDICAL LABORATORY USE; DIAGNOSTIC REAGENTS FOR IN VITRO USE IN BIOCHEMISTRY, CLINICAL CHEMISTRY AND MICROBIOLOGY; LABORATORY CHEMICALS, NAMELY, AN ANTIBODY REAGENT USED FOR THE DETECTION OF ANTIGENS IN CELL AND TISSUE ANALYSIS FOR IN VITRO DIAGNOSTIC USE (U.S. CLS. 1, 5, 6, 10, 26 AND 46).

CLASS 5—PHARMACEUTICALS

FOR DIAGNOSTIC AGENTS, PREPARATIONS AND SUBSTANCES FOR MEDICAL PURPOSES; DIAGNOSTIC KITS CONSISTING PRIMARILY OF MONOCLONAL ANTIBODIES, BUFFERS, AND REAGENTS FOR USE IN DISEASE TESTING; DIAGNOSTIC PREPARATIONS FOR MEDICAL AND VETERINARY USE; DIAGNOSTIC PREPARATIONS FOR MEDICAL OR VETERINARY PURPOSES; DIAGNOSTIC PREPARATIONS FOR MEDICAL PURPOSES; DIAGNOSTIC PREPARATIONS FOR MEDICAL PURPOSES FOR DETECTING THE PRESENCE OF MALIGNANT, INFLAMMATORY AND AUTOIMMUNE DISORDERS AND CONDITIONS AND TISSUE TRAUMA IN HUMANS; MEDICAL DIAGNOSTIC REAGENTS AND ASSAYS FOR TESTING OF BODY FLUIDS (U.S. CLS. 6, 18, 44, 46, 51 AND 52).

JESSICA FATHY, EXAMINING ATTORNEY

SN 77-891,836. IFA EDUCATIONAL FOUNDATION, WASHINGTON, DC. FILED 12-11-2009.

IFA FRAN-GUARD

THE MARK CONSISTS OF STANDARD CHARACTERS WITHOUT CLAIM TO ANY PARTICULAR FONT, STYLE, SIZE, OR COLOR.

OWNER OF U.S. REG. NOS. 1,908,437, 2,186,317 AND OTHERS.

CLASS 16—PAPER GOODS AND PRINTED MATTER

FOR MAGAZINES, NEWSLETTERS, HANDBOOKS AND BOOKS IN THE FIELD OF FRANCHISING (U.S. CLS. 2, 5, 22, 23, 29, 37, 38 AND 50).

CLASS 35—ADVERTISING AND BUSINESS

FOR PROVIDING A WEBSITE ABOUT FRANCHISING OPPORTUNITIES; PROVIDING INFORMATION REGARDING FRANCHISING TO COMPANIES IN THE FRANCHISE INDUSTRY (U.S. CLS. 100, 101 AND 102).

CLASS 41—EDUCATION AND ENTERTAINMENT

FOR EDUCATIONAL SERVICES, NAMELY, CONDUCTING CONFERENCES, SEMINARS, WORKSHOPS AND ONLINE COURSES IN THE FIELD OF FRANCHISING; PROVIDING ONLINE MAGAZINES, NEWSLETTERS, HANDBOOKS AND BOOKS IN THE FIELD OF FRANCHISING (U.S. CLS. 100, 101 AND 107).

JESSICA FATHY, EXAMINING ATTORNEY

SN 77-891,848. SOUTHEASTERN FIREFIGHTERS' BURN FOUNDATION, INC., AUGUSTA, GA. FILED 12-11-2009.



THE COLOR(S) YELLOW, ORANGE, WHITE, AND BLUE IS/ARE CLAIMED AS A FEATURE OF THE MARK.

THE MARK CONSISTS OF THE SHAPE OF A HEART COMPRISED OF THE COLORS YELLOW, ORANGE, WHITE AND BLUE.

CLASS 36—INSURANCE AND FINANCIAL

FOR CHARITABLE FOUNDATION SERVICES, NAMELY, CONDUCTING FUND RAISING ACTIVITIES AND PROVIDING FINANCIAL SUPPORT TO BURN VICTIMS AND THEIR FAMILIES (U.S. CLS. 100, 101 AND 102).

FIRST USE 9-10-2009; IN COMMERCE 9-10-2009.

CLASS 43—HOTEL AND RESTAURANT SERVICES

FOR CHARITABLE SERVICES, NAMELY, PROVIDING MEALS AND TEMPORARY HOUSING TO FAMILIES OF HOSPITALIZED BURN VICTIMS (U.S. CLS. 100 AND 101).

FIRST USE 9-10-2009; IN COMMERCE 9-10-2009.
SUSAN STIGLITZ, EXAMINING ATTORNEY

SN 77-891,893. ASSOCIATION OF INDEPENDENT OIL DISTRIBUTORS INC, MONTROSE, CO. FILED 12-11-2009.

SN 77-891,928. NATIONAL COUNCIL OF STATE BOARDS OF NURSING, INC., CHICAGO, IL. FILED 12-11-2009.

PURUS

THE MARK CONSISTS OF STANDARD CHARACTERS WITHOUT CLAIM TO ANY PARTICULAR FONT, STYLE, SIZE, OR COLOR.

CLASS 1—CHEMICALS

FOR ANTIFREEZE; CHEMICAL ENGINE TREATMENTS AND ADDITIVES FOR ENGINE OILS, GASOLINE AND DIESEL FUELS, TRANSMISSION FLUIDS AND COOLING SYSTEMS (U.S. CLS. 1, 5, 6, 10, 26 AND 46).

FIRST USE 12-1-2009; IN COMMERCE 12-1-2009.

CLASS 4—LUBRICANTS AND FUELS

FOR INDUSTRIAL LUBRICANTS; LUBRICATION GREASE FOR VEHICLES; MOTOR OIL (U.S. CLS. 1, 6 AND 15).

FIRST USE 12-1-2009; IN COMMERCE 12-1-2009.
GILBERT SWIFT, EXAMINING ATTORNEY

SN 77-891,920. NATIONAL COUNCIL OF STATE BOARDS OF NURSING, INC., CHICAGO, IL. FILED 12-11-2009.

MACE

THE MARK CONSISTS OF STANDARD CHARACTERS WITHOUT CLAIM TO ANY PARTICULAR FONT, STYLE, SIZE, OR COLOR.

CLASS 16—PAPER GOODS AND PRINTED MATTER

FOR INSTRUCTION SHEETS, EDUCATIONAL BOOKLETS AND PRINTED TEST SHEETS RELATED TO MEDICATION AIDE/ASSISTANT CERTIFICATION AND MEDICATION AIDE/ASSISTANT TESTING (U.S. CLS. 2, 5, 22, 23, 29, 37, 38 AND 50).

FIRST USE 8-1-2009; IN COMMERCE 8-1-2009.

CLASS 41—EDUCATION AND ENTERTAINMENT

FOR EDUCATIONAL SERVICES, NAMELY, PROVIDING AND CONDUCTING WORKSHOPS RELATED TO MEDICATION AIDE/ASSISTANT CERTIFICATION AND MEDICATION AIDE/ASSISTANT TESTING; DEVELOPMENT AND DISSEMINATION OF EDUCATIONAL MATERIALS IN THE FIELD OF MEDICATION AIDE/ASSISTANT CERTIFICATION AND MEDICATION AIDE/ASSISTANT TESTING (U.S. CLS. 100, 101 AND 107).

FIRST USE 8-1-2009; IN COMMERCE 8-1-2009.
GISELLE AGOSTO, EXAMINING ATTORNEY

NNAAP

THE MARK CONSISTS OF STANDARD CHARACTERS WITHOUT CLAIM TO ANY PARTICULAR FONT, STYLE, SIZE, OR COLOR.

CLASS 16—PAPER GOODS AND PRINTED MATTER

FOR INSTRUCTION SHEETS, EDUCATIONAL BOOKLETS AND PRINTED TEST SHEETS RELATED TO NURSE AID CERTIFICATION AND TESTING (U.S. CLS. 2, 5, 22, 23, 29, 37, 38 AND 50).

FIRST USE 6-1-1998; IN COMMERCE 6-1-1998.

CLASS 41—EDUCATION AND ENTERTAINMENT

FOR EDUCATIONAL SERVICES, NAMELY, PROVIDING AND CONDUCTING WORKSHOPS RELATED TO NURSE AID CERTIFICATION AND TESTING; DEVELOPMENT AND DISSEMINATION OF EDUCATIONAL MATERIALS IN THE FIELD OF NURSE AID CERTIFICATION AND TESTING (U.S. CLS. 100, 101 AND 107).

FIRST USE 6-1-1998; IN COMMERCE 6-1-1998.
GISELLE AGOSTO, EXAMINING ATTORNEY

SN 77-891,946. BAR NONE MUSIC, INC., ENCINO, CA. FILED 12-11-2009.



THE MARK CONSISTS OF A SILHOUETTE OF A PERSON WITH WINGS EXTENDED SOARING IN FLIGHT, AND THE WORDS "THE FLYING BURRITO BROS" IN STYLIZED LETTERS.

CLASS 9—ELECTRICAL AND SCIENTIFIC APPARATUS

FOR AUDIO RECORDINGS FEATURING MUSIC; COMPACT DISCS FEATURING MUSIC (U.S. CLS. 21, 23, 26, 36 AND 38).

CLASS 25—CLOTHING

FOR T-SHIRTS (U.S. CLS. 22 AND 39).
DAVID COLLIER, EXAMINING ATTORNEY

SN 77-892,005. LIVING WITH LIONS LIMITED, NANYUKI, KENYA, FILED 12-11-2009.



THE MARK CONSISTS OF A SILHOUETTE OF THE BUST OF A LION AND PERSON WITH THEIR BACKS TO EACH OTHER AND A SPEAR IN THE CENTER BEHIND AN IMAGE OF A BULL.

CLASS 41—EDUCATION AND ENTERTAINMENT

FOR CHARITABLE SERVICES, NAMELY, PROVIDING TRAINING IN THE FIELD OF LION CONSERVATION; EDUCATION SERVICES, NAMELY, PROVIDING MENTORING, TUTORING, CLASSES, SEMINARS AND WORKSHOPS IN THE FIELD OF LION CONSERVATION; EDUCATIONAL SERVICES, NAMELY, CONDUCTING SEMINARS IN THE FIELD OF LION CONSERVATION AND DISTRIBUTION OF COURSE MATERIAL IN CONNECTION THEREWITH (U.S. CLS. 100, 101 AND 107).

FIRST USE 9-26-2005; IN COMMERCE 9-26-2005.

CLASS 42—SCIENTIFIC AND COMPUTER SERVICES

FOR BIOLOGICAL RESEARCH; RESEARCH IN THE FIELD OF ENVIRONMENTAL PROTECTION; SCIENTIFIC RESEARCH (U.S. CLS. 100 AND 101).

FIRST USE 9-26-2005; IN COMMERCE 9-26-2005.
LESLIE RICHARDS, EXAMINING ATTORNEY

CLASS 25—CLOTHING

FOR (BASED ON USE IN COMMERCE) SHORT-SLEEVED OR LONG-SLEEVED T-SHIRTS; (BASED ON INTENT TO USE) HATS; HOODED SWEAT SHIRTS; JACKETS; PANTS; SWEAT SHIRTS (U.S. CLS. 22 AND 39).

FIRST USE 10-1-2009; IN COMMERCE 10-1-2009.

CLASS 39—TRANSPORTATION AND STORAGE

FOR (BASED ON USE IN COMMERCE) DESIGNATED DRIVER SERVICES, NAMELY, PROVIDING DRIVERS FOR INDIVIDUALS WHOSE ABILITY TO DRIVE THEIR CARS IS IMPAIRED (U.S. CLS. 100 AND 105).

FIRST USE 10-1-2009; IN COMMERCE 10-1-2009.
MAUREEN DALL, EXAMINING ATTORNEY

SN 77-892,079. LARSEN, MARILYN C, MADISON, WI, FILED 12-12-2009.

Distracted Gadget Users Awareness Program (DGUAP)

THE MARK CONSISTS OF STANDARD CHARACTERS WITHOUT CLAIM TO ANY PARTICULAR FONT, STYLE, SIZE, OR COLOR.

CLASS 16—PAPER GOODS AND PRINTED MATTER

FOR BUMPER STICKERS (U.S. CLS. 2, 5, 22, 23, 29, 37, 38 AND 50).

CLASS 25—CLOTHING

FOR T-SHIRTS (U.S. CLS. 22 AND 39).
MARY CRAWFORD, EXAMINING ATTORNEY

SN 77-892,026. PEAR TRANSPORTATION COMPANY LLC, PITTSBURGH, PA. FILED 12-11-2009.



THE COLOR(S) GREEN AND BROWN IS/ARE CLAIMED AS A FEATURE OF THE MARK.

THE MARK CONSISTS OF THE DESIGN OF A PEAR WHO IS WINKING WHILE HOLDING A KEY IN ONE HAND AND POINTING WITH HIS OTHER HAND AT THE STYLIZED WORDING "THE PEAR CARES". THE COLOR BROWN APPEARS IN THE WORDING "THE PEAR CARES", IN THE KEY, IN THE PEAR'S STEM, AND IN THE PEAR'S EYES AND MOUTH. THE COLOR GREEN APPEARS IN THE PEAR'S BODY. THE WHITE IN THE DRAWING REPRESENTS BACKGROUND AREAS ONLY AND IS NOT PART OF THE MARK.

SN 77-892,129. OLIVERA, STEVE T., NORTH PORT, FL, FILED 12-12-2009.

BIKERSPOST

THE MARK CONSISTS OF STANDARD CHARACTERS WITHOUT CLAIM TO ANY PARTICULAR FONT, STYLE, SIZE, OR COLOR.

CLASS 16—PAPER GOODS AND PRINTED MATTER

FOR BUMPER STICKERS; MOTORCYCLE RIDING; MAGAZINES IN THE FIELD OF MOTORCYCLE RIDING; MANUALS IN THE FIELD OF MOTORCYCLE RIDING; MAPS; POSTERS; PRINTED PAPER SIGNS; ROAD MAPS (U.S. CLS. 2, 5, 22, 23, 29, 37, 38 AND 50).

FIRST USE 8-7-2009; IN COMMERCE 8-7-2009.

CLASS 25—CLOTHING

FOR BANDANAS; BASEBALL CAPS; HATS; HOODED SWEAT SHIRTS; JERSEYS; POLO SHIRTS; SHORT-SLEEVED OR LONG-SLEEVED T-SHIRTS; SWEAT SHIRTS; T-SHIRTS (U.S. CLS. 22 AND 39).

FIRST USE 8-7-2009; IN COMMERCE 8-7-2009.

KATHERINE STOIDES, EXAMINING ATTORNEY

SN 77-892,147. BOMBBEAT ENTERTAINMENT, LLC, MADISON, WI. FILED 12-12-2009.



BOMBBEAT

THE MARK CONSISTS OF A GRIMACING BOMB WITH HEADPHONES ON AND A LIT FUSE WITH THE WORDS "BOMBBEAT".

CLASS 9—ELECTRICAL AND SCIENTIFIC APPARATUS

FOR AUDIO RECORDINGS FEATURING MUSIC; COMPACT DISCS FEATURING MUSIC; DIGITAL MUSIC DOWNLOADABLE FROM THE INTERNET; DOWNLOADABLE MUSICAL SOUND RECORDINGS; DOWNLOADABLE MUSIC VIA THE INTERNET AND WIRELESS DEVICES; MUSICAL SOUND RECORDINGS; MUSICAL VIDEO RECORDINGS; SOUND RECORDINGS FEATURING MUSIC; VIDEO RECORDINGS FEATURING MUSIC (U.S. CLS. 21, 23, 26, 36 AND 38).

CLASS 41—EDUCATION AND ENTERTAINMENT

FOR COMPOSITION OF MUSIC FOR OTHERS; CONSULTATION AND ADVICE REGARDING MUSICAL SELECTIONS AND ARRANGEMENTS FOR SOUND RECORDINGS AND LIVE PERFORMANCES; ENTERTAINMENT AND EDUCATIONAL SERVICES, NAMELY, PROVIDING ADVICE AND INFORMATION FOR MUSIC, VIDEO AND FILM CONCEPT AND SCRIPT DEVELOPMENT; ENTERTAINMENT IN THE NATURE OF AN ON-GOING SPECIAL VARIETY, NEWS, MUSIC OR COMEDY SHOW FEATURING HIP HOP AND ELECTRONIC MUSIC BROADCAST OVER TELEVISION, SATELLITE, AUDIO, AND VIDEO MEDIA; ENTERTAINMENT IN THE NATURE OF LIVE MUSIC AND DJ PERFORMANCES; ENTERTAINMENT, NAMELY, LIVE MUSIC CONCERTS; ENTERTAINMENT, NAMELY, LIVE PERFORMANCES BY MUSICAL BANDS; MULTIMEDIA ENTERTAINMENT SERVICES IN THE NATURE OF RECORDING, PRODUCTION AND POST-PRODUCTION SERVICES IN THE FIELDS OF MUSIC, VIDEO, AND FILMS; MULTIMEDIA PUBLISHING OF BOOKS, MAGAZINES, JOURNALS, SOFTWARE, GAMES, MUSIC, AND ELECTRONIC PUBLICATIONS; MUSIC COMPOSITION FOR OTHERS; MUSIC PRODUCTION SERVICES; MUSIC PUBLISHING SERVICES; MUSIC SELECTION SERVICES FOR USE IN TELEVISION, FILM, RADIO AND VIDEO GAMES; MUSIC VIDEO PRODUCTION; PRESENTATION OF MUSICAL PERFORMANCE; PRODUCTION OF MUSICAL SOUND RECORDING; PRODUCTION OF SOUND AND MUSIC VIDEO RECORDINGS (U.S. CLS. 100, 101 AND 107).

FIRST USE 12-31-2001; IN COMMERCE 12-31-2008.

CHARLOTTE CORWIN, EXAMINING ATTORNEY

SN 77-892,159. ONE2CONSULT, INC., TINLEY PARK, IL. FILED 12-12-2009.

ONE2ABSORB

THE MARK CONSISTS OF STANDARD CHARACTERS WITHOUT CLAIM TO ANY PARTICULAR FONT, STYLE, SIZE, OR COLOR.

CLASS 1—CHEMICALS

FOR CHEMICAL COMPOSITION FOR SOLIDIFICATION OF FLUIDS AND FOR ABSORBING SPILLS; CHEMICALS FOR USE IN THE DECONTAMINATION OF POLLUTED SITES (U.S. CLS. 1, 5, 6, 10, 26 AND 46).

CLASS 17—RUBBER GOODS

FOR ABSORBENT PRODUCTS, NAMELY, PERFORATED PADS, FOR THE CONTAINMENT AND CLEAN-UP OF OIL BASED CHEMICALS, OILS AND LIQUIDS (U.S. CLS. 1, 5, 12, 13, 35 AND 50).

CLASS 40—MATERIAL TREATMENT

FOR CHEMICAL ENCAPSULATION AND DISPERSION OF HAZARDOUS CHEMICALS; ENVIRONMENTAL REMEDIATION SERVICES, NAMELY, SOIL TREATMENT SERVICES; INDUSTRIAL TOXIC WASTE DISPOSAL (U.S. CLS. 100, 103 AND 106).

RONALD DELGIZZI, EXAMINING ATTORNEY

SN 77-892,402. COASTAL TRAINING TECHNOLOGIES CORPORATION, VIRGINIA BEACH, VA. FILED 12-14-2009.

COASTAL

THE MARK CONSISTS OF STANDARD CHARACTERS WITHOUT CLAIM TO ANY PARTICULAR FONT, STYLE, SIZE, OR COLOR.

CLASS 9—ELECTRICAL AND SCIENTIFIC APPARATUS

FOR PRE-RECORDED VIDEOTAPES, DVDS AND CD-ROMS FEATURING INFORMATION IN THE FIELDS OF OCCUPATIONAL SAFETY TRAINING, RECREATIONAL SAFETY TRAINING, HEALTH CARE TRAINING, HUMAN RESOURCE TRAINING, ENVIRONMENTAL TRAINING, INDUSTRIAL SAFETY TRAINING, REGULATION COMPLIANCE TRAINING AND OCCUPATIONAL SKILLS TRAINING (U.S. CLS. 21, 23, 26, 36 AND 38).

FIRST USE 11-15-1990; IN COMMERCE 11-15-1990.

CLASS 16—PAPER GOODS AND PRINTED MATTER

FOR INSTRUCTIONAL HANDBOOKS, MANUALS, WORKBOOKS, AND POSTERS IN THE FIELDS OF OCCUPATIONAL SAFETY TRAINING, RECREATIONAL SAFETY TRAINING, HEALTH CARE TRAINING, HUMAN RESOURCE TRAINING, ENVIRONMENTAL TRAINING, INDUSTRIAL SAFETY TRAINING, REGULATION COMPLIANCE TRAINING AND OCCUPATIONAL SKILLS TRAINING (U.S. CLS. 2, 5, 22, 23, 29, 37, 38 AND 50).

FIRST USE 11-15-1990; IN COMMERCE 11-15-1990.

CLASS 41—EDUCATION AND ENTERTAINMENT

FOR EDUCATIONAL SERVICES, NAMELY, PROVIDING INTERACTIVE COURSES OF INSTRUCTION VIA A GLOBAL COMPUTER INFORMATION NETWORK IN THE FIELDS OF OCCUPATIONAL SAFETY TRAINING, RECREATIONAL SAFETY TRAINING, HEALTH CARE TRAINING, HUMAN RESOURCE TRAINING, ENVIRONMENTAL TRAINING, INDUSTRIAL SAFETY TRAINING, REGULATION COMPLIANCE TRAINING AND OCCUPATIONAL SKILLS TRAINING (U.S. CLS. 100, 101 AND 107).

FIRST USE 12-22-1997; IN COMMERCE 12-22-1997.

LINDA M. KING, EXAMINING ATTORNEY

SN 77-892,440. IMPEX OF DORAL, INC., MIAMI, FL. FILED 12-14-2009.

MINI STARS

THE MARK CONSISTS OF STANDARD CHARACTERS WITHOUT CLAIM TO ANY PARTICULAR FONT, STYLE, SIZE, OR COLOR.

CLASS 3—COSMETICS AND CLEANING PREPARATIONS

FOR BABY WIPES (U.S. CLS. 1, 4, 6, 50, 51 AND 52).

CLASS 16—PAPER GOODS AND PRINTED MATTER

FOR DISPOSABLE DIAPERS (U.S. CLS. 2, 5, 22, 23, 29, 37, 38 AND 50).

DAWN FELDMAN, EXAMINING ATTORNEY

SN 77-892,498. DEAN INTELLECTUAL PROPERTY SERVICES II, INC., DALLAS, TX. FILED 12-14-2009.

WWW.SAVEFIVEFORSCHOOLS.COM

THE MARK CONSISTS OF STANDARD CHARACTERS WITHOUT CLAIM TO ANY PARTICULAR FONT, STYLE, SIZE, OR COLOR.

CLASS 29—MEATS AND PROCESSED FOODS

FOR DAIRY PRODUCTS EXCLUDING ICE CREAM, ICE MILK AND FROZEN YOGURT (U.S. CL. 46).

FIRST USE 7-31-2004; IN COMMERCE 7-31-2004.

CLASS 32—LIGHT BEVERAGES

FOR ORANGE JUICE (U.S. CLS. 45, 46 AND 48).

FIRST USE 7-31-2004; IN COMMERCE 7-31-2004.

LYDIA BELZER, EXAMINING ATTORNEY

SN 77-892,596. CUNA MUTUAL INSURANCE SOCIETY, MADISON, WI. FILED 12-14-2009.

LENDER DEVELOPMENT PROGRAM

THE MARK CONSISTS OF STANDARD CHARACTERS WITHOUT CLAIM TO ANY PARTICULAR FONT, STYLE, SIZE, OR COLOR.

OWNER OF U.S. REG. NOS. 2,996,215 AND 2,996,216.

NO CLAIM IS MADE TO THE EXCLUSIVE RIGHT TO USE "PROGRAM", APART FROM THE MARK AS SHOWN. SEC. 2(F).

CLASS 35—ADVERTISING AND BUSINESS

FOR CONSULTING SERVICES, NAMELY, CONSULTING REGARDING BUSINESS MANAGEMENT SKILLS FOR FINANCIAL INSTITUTION MANAGERS, NAMELY, PROVIDING THEM WITH TOOLS TO ENHANCE BUSINESS MANAGEMENT SKILLS, INCLUDING GOAL SETTING, SALES ACTION PLANNING, STAFF COMMUNICATIONS, AND SKILLS FOR COACHING, MOTIVATING, TRACKING PERFORMANCE AND PROVIDING FEEDBACK TO LENDING STAFF (U.S. CLS. 100, 101 AND 102).

FIRST USE 1-15-2003; IN COMMERCE 1-15-2003.

CLASS 41—EDUCATION AND ENTERTAINMENT

FOR TRAINING, NAMELY, TRAINING OF FINANCIAL INSTITUTION MANAGERS TO PROVIDE THEM WITH TOOLS TO ENHANCE BUSINESS MANAGEMENT SKILLS, INCLUDING GOAL SETTING, SALES ACTION PLANNING, STAFF COMMUNICATIONS, AND SKILLS FOR COACHING, MOTIVATING, TRACKING PERFORMANCE AND PROVIDING FEEDBACK TO LENDING STAFF; PROVIDING TRAINING TO FINANCIAL INSTITUTION LENDING STAFF IN THE AREAS OF SELLING STRATEGIES, PERSONAL SELLING SKILLS AND TOOLS, KNOWLEDGE OF LENDING INSURANCE PRODUCTS AND SERVICES AND GOAL SETTING IN ORDER TO EFFECTIVELY UNCOVER CUSTOMER NEEDS, PRESENT AND DELIVER COMPLETE LOAN AND FINANCIAL PACKAGE SOLUTIONS THAT MEET THESE NEEDS, AND TO MAXIMIZE LENDING OPPORTUNITIES ACROSS MARKETING CHANNELS, SUCH AS FACE-TO-FACE, TELEPHONE CALL CENTERS AND WEB BASED MARKETING (U.S. CLS. 100, 101 AND 107).
FIRST USE 1-15-2003; IN COMMERCE 1-15-2003.
PAUL E. FAHRENKOPF, EXAMINING ATTORNEY

SN 77-892,648. GILBERTO DIAZ-MORENO, ADDISON, IL. FILED 12-14-2009.

ALIADOS DE LA SIERRA

THE MARK CONSISTS OF STANDARD CHARACTERS WITHOUT CLAIM TO ANY PARTICULAR FONT, STYLE, SIZE, OR COLOR.

THE ENGLISH TRANSLATION OF "ALIADOS DE LA SIERRA" IN THE MARK IS "THE SIERRA ALLIANCE".

CLASS 9—ELECTRICAL AND SCIENTIFIC APPARATUS

FOR PRE-RECORDED CDS FEATURING MUSICAL COMPILATIONS (U.S. CLS. 21, 23, 26, 36 AND 38).
FIRST USE 3-28-2007; IN COMMERCE 3-28-2007.

CLASS 41—EDUCATION AND ENTERTAINMENT

FOR ENTERTAINMENT IN THE NATURE OF LIVE PERFORMANCES BY A REGIONAL MEXICAN MUSICAL GROUP (U.S. CLS. 100, 101 AND 107).
FIRST USE 3-28-2007; IN COMMERCE 3-28-2007.
ALICE BENMAMAN, EXAMINING ATTORNEY

SN 77-892,652. NKPS MEDIA, LLC., SAN BERNARDINO, CA. FILED 12-14-2009.

NastyKinkPigs

THE MARK CONSISTS OF STANDARD CHARACTERS WITHOUT CLAIM TO ANY PARTICULAR FONT, STYLE, SIZE, OR COLOR.

CLASS 41—EDUCATION AND ENTERTAINMENT

FOR ENTERTAINMENT SERVICES, NAMELY, PROVIDING A WEB SITE FEATURING ADULT-THEMED PHOTOGRAPHS AND VIDEOS; FILM AND VIDEO FILM PRODUCTION (U.S. CLS. 100, 101 AND 107).
FIRST USE 12-1-2008; IN COMMERCE 12-1-2008.

CLASS 42—SCIENTIFIC AND COMPUTER SERVICES

FOR COMPUTER SERVICES, NAMELY, CREATING AN ON-LINE COMMUNITY FOR REGISTERED USERS TO PARTICIPATE IN DISCUSSIONS, GET FEEDBACK FROM THEIR PEERS, FORM VIRTUAL COMMUNITIES, AND ENGAGE IN SOCIAL NETWORKING (U.S. CLS. 100 AND 101).
FIRST USE 12-1-2008; IN COMMERCE 12-1-2008.
ALICE BENMAMAN, EXAMINING ATTORNEY

SN 77-892,716. SEEKING SERENITY LLC, NEW YORK, NY. FILED 12-14-2009.



CLASS 14—JEWELRY

FOR JEWELRY (U.S. CLS. 2, 27, 28 AND 50).

CLASS 25—CLOTHING

FOR INFANT AND TODDLER ONE PIECE CLOTHING; SWEAT SHIRTS; T-SHIRTS; TANK TOPS; UNDERWEAR (U.S. CLS. 22 AND 39).
EMILY CARLSEN, EXAMINING ATTORNEY

SN 77-892,823. SIFTEO, INC., SAN FRANCISCO, CA. FILED 12-14-2009.

SIFTEO

THE MARK CONSISTS OF STANDARD CHARACTERS WITHOUT CLAIM TO ANY PARTICULAR FONT, STYLE, SIZE, OR COLOR.

CLASS 9—ELECTRICAL AND SCIENTIFIC APPARATUS

FOR MULTIPLE SMALL BATTERY POWERED COMPUTERS WHICH CAN ACT IN CONCERT TO FORM A SINGLE INTERFACE WHICH RESPONDS TO THE USER'S PHYSICAL MANIPULATION OF ONE OR MORE UNITS, WITH EACH UNIT FEATURING ONE OR MORE OF MOTION SENSING, ATTITUDE SENSING, NEIGHBOR DETECTION, GRAPHICAL DISPLAY AND WIRELESS COMMUNICATION; SOFTWARE FOR CONTROL AND UTILIZATION OF SUCH UNITS (U.S. CLS. 21, 23, 26, 36 AND 38).

CLASS 28—TOYS AND SPORTING GOODS

FOR APPARATUS FOR ELECTRONIC GAMES, OTHER THAN THOSE ADAPTED FOR USE WITH AN EXTERNAL DISPLAY SCREEN OR MONITOR, COMPRISED OF MULTIPLE SMALL BATTERY POWERED COMPUTERS CONFIGURED FOR ELECTRONIC GAMES WHICH CAN ACT IN CONCERT TO FORM A SINGLE INTERFACE WHICH RESPONDS TO THE USER'S PHYSICAL MANIPULATION OF ONE OR MORE UNITS, WITH EACH UNIT FEATURING ONE OR MORE OF MOTION SENSING, ATTITUDE SENSING, NEIGHBOR DETECTION, GRAPHICAL DISPLAY AND WIRELESS COMMUNICATION (U.S. CLS. 22, 23, 38 AND 50).

RUDY R. SINGLETON, EXAMINING ATTORNEY

SN 77-892,888. AMERICAN FINANCIAL MARKETING, INC., ST. LOUIS PARK, MN. FILED 12-14-2009.

SURVIVOR ROADMAP

THE MARK CONSISTS OF STANDARD CHARACTERS WITHOUT CLAIM TO ANY PARTICULAR FONT, STYLE, SIZE, OR COLOR.

CLASS 16—PAPER GOODS AND PRINTED MATTER

FOR EDUCATIONAL PUBLICATIONS, NAMELY, WORKBOOKS IN THE FIELDS OF FINANCIAL AND ESTATE PLANNING; PRINTED GUIDES FOR COLLECTING OR DOCUMENTING FAMILY FINANCIAL AND ESTATE INFORMATION (U.S. CLS. 2, 5, 22, 23, 29, 37, 38 AND 50).

FIRST USE 11-20-2009; IN COMMERCE 11-20-2009.

CLASS 36—INSURANCE AND FINANCIAL

FOR ESTATE PLANNING; FINANCIAL PLANNING CONSULTATION; INSURANCE AND FINANCIAL INFORMATION AND CONSULTANCY SERVICES (U.S. CLS. 100, 101 AND 102).

FIRST USE 11-20-2009; IN COMMERCE 11-20-2009.

JACQUELINE A. LAVINE, EXAMINING ATTORNEY

SN 77-892,912. MICHAEL O'NEILL, INC., AKA MICHAEL O'NEILL PHOTOGRAPHY, BROOKLYN, NY. FILED 12-14-2009.

Zoobabies

THE MARK CONSISTS OF STANDARD CHARACTERS WITHOUT CLAIM TO ANY PARTICULAR FONT, STYLE, SIZE, OR COLOR.

CLASS 41—EDUCATION AND ENTERTAINMENT

FOR PHOTOGRAPHY; PHOTOGRAPHY SERVICES; PORTRAIT PHOTOGRAPHY; PROVIDING FACILITIES FOR PRODUCING VIDEO, CINEMA AND PHOTOGRAPHY PRODUCTIONS (U.S. CLS. 100, 101 AND 107).

CLASS 45—PERSONAL AND LEGAL SERVICES

FOR STOCK PHOTOGRAPHY SERVICES, NAMELY, LEASING REPRODUCTION RIGHTS OF PHOTOGRAPHS AND TRANSPARENCIES TO OTHERS (U.S. CLS. 100 AND 101).

TRACY FLETCHER, EXAMINING ATTORNEY

SN 77-892,948. BAZILE, MARIO, KENNER, LA. FILED 12-14-2009.

WHODATVILLE

THE MARK CONSISTS OF STANDARD CHARACTERS WITHOUT CLAIM TO ANY PARTICULAR FONT, STYLE, SIZE, OR COLOR.

CLASS 16—PAPER GOODS AND PRINTED MATTER

FOR CHILDREN'S BOOKS (U.S. CLS. 2, 5, 22, 23, 29, 37, 38 AND 50).

CLASS 18—LEATHER GOODS

FOR BACKPACKS, BOOK BAGS, SPORTS BAGS, BUM BAGS, WALLETS AND HANDBAGS (U.S. CLS. 1, 2, 3, 22 AND 41).

ALEX KEAM, EXAMINING ATTORNEY

SN 77-892,950. PUBLIC RELATIONS SOCIETY OF AMERICA, INC., NEW YORK, NY. FILED 12-14-2009.

COMPREHENSION

THE MARK CONSISTS OF STANDARD CHARACTERS WITHOUT CLAIM TO ANY PARTICULAR FONT, STYLE, SIZE, OR COLOR.

CLASS 38—COMMUNICATION

FOR PROVIDING ON-LINE ELECTRONIC BULLETIN BOARDS FOR TRANSMISSION OF MESSAGES AMONG USERS IN THE FIELD OF PUBLIC RELATIONS (U.S. CLS. 100, 101 AND 104).

FIRST USE 4-9-2008; IN COMMERCE 4-9-2008.

CLASS 41—EDUCATION AND ENTERTAINMENT

FOR ON-LINE JOURNALS, NAMELY, INTERACTIVE WEB BLOGS FEATURING INFORMATION IN THE FIELD OF PUBLIC RELATIONS (U.S. CLS. 100, 101 AND 107).

FIRST USE 4-9-2008; IN COMMERCE 4-9-2008.

DAVID YONTEF, EXAMINING ATTORNEY

SN 77-893,096. AMERICAN GEOPHYSICAL UNION, WASHINGTON, DC. FILED 12-14-2009.

SN 77-893,527. TANDBERG TELECOM AS, LYSAKER, NORWAY, FILED 12-15-2009.

GEOPRESS

THE MARK CONSISTS OF STANDARD CHARACTERS WITHOUT CLAIM TO ANY PARTICULAR FONT, STYLE, SIZE, OR COLOR.

CLASS 16—PAPER GOODS AND PRINTED MATTER

FOR PRINTED PUBLICATIONS, NAMELY, BOOKS IN THE FIELD OF THE GEOSCIENCES (U.S. CLS. 2, 5, 22, 23, 29, 37, 38 AND 50).

CLASS 41—EDUCATION AND ENTERTAINMENT

FOR PUBLICATION OF BOOKS (U.S. CLS. 100, 101 AND 107).
ARETHA SOMERVILLE, EXAMINING ATTORNEY

SN 77-893,306. WILEY, THEODORE A., PITTSBURGH, PA. FILED 12-14-2009.

Aquion Energy

THE MARK CONSISTS OF STANDARD CHARACTERS WITHOUT CLAIM TO ANY PARTICULAR FONT, STYLE, SIZE, OR COLOR.

NO CLAIM IS MADE TO THE EXCLUSIVE RIGHT TO USE "ENERGY", APART FROM THE MARK AS SHOWN.

THE WORDING "AQUION" HAS NO MEANING IN A FOREIGN LANGUAGE.

CLASS 1—CHEMICALS

FOR BATTERY ELECTROLYTES (U.S. CLS. 1, 5, 6, 10, 26 AND 46).

CLASS 4—LUBRICANTS AND FUELS

FOR ELECTRICAL ENERGY (U.S. CLS. 1, 6 AND 15).

CLASS 9—ELECTRICAL AND SCIENTIFIC APPARATUS

FOR BATTERIES; BATTERIES AND BATTERY CHARGERS; BATTERIES FOR VEHICLES; BATTERIES, ELECTRIC; BATTERIES, ELECTRIC, FOR VEHICLES; POWER INVERTERS (U.S. CLS. 21, 23, 26, 36 AND 38).
NICHOLAS COLEMAN, EXAMINING ATTORNEY

SOON IS TOO LATE

THE MARK CONSISTS OF STANDARD CHARACTERS WITHOUT CLAIM TO ANY PARTICULAR FONT, STYLE, SIZE, OR COLOR.

CLASS 9—ELECTRICAL AND SCIENTIFIC APPARATUS

FOR VIDEOCONFERENCING SYSTEMS COMPRISING VIDEO SCREENS, SOFTWARE AND DOWNLOADABLE WEB-BASED SOFTWARE APPLICATIONS FOR REAL-TIME MULTIMEDIA AND MULTIPARTY COMMUNICATIONS OVER COMPUTER NETWORKS; VIDEOCONFERENCING APPARATUS AND EQUIPMENT, NAMELY, VIDEO SCREENS, SOFTWARE AND DOWNLOADABLE WEB-BASED SOFTWARE APPLICATIONS FOR REAL-TIME MULTIMEDIA AND MULTIPARTY COMMUNICATIONS OVER COMPUTER NETWORKS; SOFTWARE AND DOWNLOADABLE WEB-BASED SOFTWARE APPLICATIONS FOR REAL-TIME, MULTIMEDIA AND MULTIPARTY COMMUNICATIONS OVER COMPUTER NETWORKS; APPARATUS FOR THE RECEPTION, STORAGE, REPRODUCTION, PLAYBACK, RECORDING AND TRANSMISSION OF SOUNDS AND IMAGES, NAMELY, CAMERAS, MICROPHONES, TELEVISION MONITORS, VIDEO MONITORS, COMPUTER MONITORS, DESKTOP VIDEO SYSTEMS COMPRISING VIDEO SCREENS, SOFTWARE AND DOWNLOADABLE WEB-BASED SOFTWARE APPLICATIONS FOR REAL-TIME MULTIMEDIA AND MULTIPARTY COMMUNICATIONS OVER COMPUTER NETWORKS, AMPLIFIERS, ECHO CANCELLERS, SOUND MIXERS, LOUDSPEAKERS, TELEVISION SETS, RADIO SETS, COMPACT AND VIDEO DISC PLAYERS, MEMORY-BASED MEDIA PLAYERS, TELEPHONES, VIDEO TELEPHONES, MOBILE TELEPHONES AND PORTABLE TELEPHONE TERMINALS, REMOTE CONTROL TRANSMITTERS FOR THE AFOREMENTIONED GOODS; SOFTWARE APPLICATIONS AND DOWNLOADABLE WEB-BASED SOFTWARE APPLICATIONS FOR COMMUNICATION, INTEGRATION OF TEXT, AUDIO, GRAPHICS, STILL IMAGES AND MOVING PICTURES INTO AN INTERACTIVE DELIVERY FOR MULTI-MEDIA APPLICATIONS, AND DATA SHARING; ANALOG TO DIGITAL AND DIGITAL TO ANALOG CONVERTERS; SYSTEMS COMPRISING SOFTWARE AND DOWNLOADABLE WEB-BASED SOFTWARE APPLICATIONS AND EQUIPMENT FOR DIGITAL BROADCASTING OF AUDIO, DATA AND VIDEO ACROSS CABLE, SATELLITE, TERRESTRIAL, INTERNET PROTOCOL AND TELECOMMUNICATIONS NETWORKS; SYSTEMS COMPRISING SOFTWARE AND DOWNLOADABLE WEB-BASED SOFTWARE APPLICATIONS AND EQUIPMENT FOR STREAMING OF AUDIO, DATA AND VIDEO ACROSS CABLE, SATELLITE, TERRESTRIAL, INTERNET PROTOCOL AND TELECOMMUNICATIONS NETWORKS; SYSTEMS COMPRISING SOFTWARE AND DOWNLOADABLE WEB-BASED SOFTWARE APPLICATIONS AND EQUIPMENT FOR COMMUNICATION INFRASTRUCTURE, NAMELY, COMMUNICATIONS SERVERS, DATA ARCHIVES, MULTIPOINT CONTROL UNITS, SWITCHES, MIXERS, GATEWAYS, GATEKEEPERS, FIREWALLS AND NETWORK MANAGEMENT SOFTWARE; SYSTEMS AND EQUIPMENT FOR SURVEILLANCE, SECURITY, ENCRYPTION AND AUTHENTICATION OF DATA COMPRISING ELECTRONIC ENCRYPTION UNITS AND COMPUTER SOFTWARE FOR AUTHENTICATION AND ENCRYPTION; COMPUTER HARDWARE AND SOFTWARE FOR MANAGEMENT OF TIME, APPOINTMENTS, SCHEDULES, ASSETS AND MEETING ROOM MANAGEMENT; DOWNLOADABLE ELECTRONIC PUBLICATIONS IN THE NATURE OF BOOKS, MANUALS AND BROCHURES IN THE FIELD OF VIDEOCONFERENCING; ELECTRONIC PUBLICATIONS,

NAMELY BOOKS, MANUALS, BROCHURES IN THE FIELD OF VIDEOCONFERENCING RECORDED ON COMPUTER MEDIA (U.S. CLS. 21, 23, 26, 36 AND 38).

CLASS 35—ADVERTISING AND BUSINESS

FOR ARRANGING AND CONDUCTING OF VIDEOCONFERENCES FOR BUSINESS PURPOSES IN THE FIELDS OF EDUCATION, BUSINESS, TELEMEDICINE, FIELD OPERATIONS, JUDICIARY AND HEALTHCARE (U.S. CLS. 100, 101 AND 102).

CLASS 38—COMMUNICATION

FOR TELECOMMUNICATIONS AND TELECOMMUNICATIONS SERVICES NAMELY, PROVIDING REAL-TIME, MULTIMEDIA AND MULTIPARTY COMMUNICATIONS OVER COMPUTER NETWORKS, TELECONFERENCING AND VIDEO CONFERENCING SERVICES; TRANSMISSION OF AUDIO, VIDEO, DATA AND GRAPHICS BY CABLE, SATELLITE, TERRESTRIAL, INTERNET PROTOCOL AND TELECOMMUNICATIONS NETWORKS; COLLABORATION SERVICES, NAMELY PROVIDING REAL-TIME, MULTIMEDIA AND MULTIPARTY COMMUNICATIONS OVER COMPUTER NETWORKS; TELECOMMUNICATIONS SERVICES FOR MEDIA AND DATA CREATION, MAINTENANCE EXCHANGE AND COLLABORATIVE SERVICES, NAMELY, INSTANT MESSAGING AND PROVIDING ON-LINE FACILITIES FOR REAL-TIME INTERACTION WITH OTHER COMPUTER USERS FOR APPLICATION AND FILE SHARING; COMMUNICATIONS SERVICES, NAMELY, PROVIDING REAL-TIME, MULTIMEDIA AND MULTIPARTY COMMUNICATIONS VIA INTRANETS, EXTRANETS, INTERNET AND OTHER ELECTRONIC AND OPTICAL MEANS; COMMUNICATIONS SERVICES, NAMELY, TRANSMITTING STREAMED SOUND AND AUDIO-VISUAL RECORDINGS VIA THE INTERNET; STREAMING OF AUDIO AND VIDEO MATERIAL VIA THE INTERNET; PROVIDING INFORMATION ABOUT COMMUNICATION AND BROADCASTING BY ELECTRONIC MEDIA (U.S. CLS. 100, 101 AND 104).

CLASS 41—EDUCATION AND ENTERTAINMENT

FOR EDUCATION IN THE FIELD OF VIDEOCONFERENCING AND BUSINESS RENDERED THROUGH VIDEO CONFERENCES, ON-LINE TUTORIALS AND COURSES; PROVIDING OF VIDEOCONFERENCING AND BUSINESS TRAINING; PROVIDING OF TRAINING, NAMELY, ON-LINE VIDEOCONFERENCING AND BUSINESS TRAINING; ARRANGING AND CONDUCTING OF VIDEOCONFERENCES NOT FOR BUSINESS PURPOSES IN THE FIELDS OF EDUCATION, BUSINESS, TELEMEDICINE, FIELD OPERATIONS, JUDICIARY AND HEALTHCARE; RENTAL OR LEASING OF VIDEOCONFERENCE APPARATUS AND EQUIPMENT, NAMELY, CAMERAS, MICROPHONES, TELEVISION MONITORS, VIDEO MONITORS, COMPUTER MONITORS, AMPLIFIERS, ECHO CANCELLERS, SOUND MIXERS, LOUDSPEAKERS, REMOTE CONTROL TRANSMITTERS, TELEVISION SETS, RADIO SETS, MEMORY-BASED MEDIA PLAYERS, TELEPHONES, VIDEO TELEPHONES, MOBILE TELEPHONES AND PORTABLE TELEPHONE TERMINALS (U.S. CLS. 100, 101 AND 107).

CLASS 42—SCIENTIFIC AND COMPUTER SERVICES

FOR RENTAL AND LEASING OF COMPUTER DATABASE AND COMPUTER SERVERS TO OTHERS; RENTAL OF MULTIMEDIA AND MULTIPARTY COMMUNICATIONS APPARATUS AND EQUIPMENT, NAMELY, COMPUTERS AND COMPUTER SOFTWARE; RENTAL OR LEASING OF DATA NETWORKS AND TELECOMMUNICATION EQUIPMENT, INFRASTRUCTURE, SOFTWARE AND EQUIPMENT, NAMELY, SYSTEMS COMPRISING SOFTWARE AND DOWNLOADABLE WEB-BASED SOFTWARE APPLICATIONS AND EQUIPMENT FOR COMMUNICATION INFRASTRUCTURE, NAMELY, COMMUNICATIONS SERVERS, DATA ARCHIVES, MULTIPOINT CONTROL UNITS, SWITCHES, MIXERS, GATEWAYS, GATEKEEPERS, FIREWALLS AND NETWORK MANAGEMENT SOFTWARE (U.S. CLS. 100 AND 101).
RON FAIRBANKS, EXAMINING ATTORNEY

SN 77-893,657. LDA ARCHITECTS, INC., SAN FRANCISCO, CA. FILED 12-15-2009.

LDA Architects, Inc.

THE MARK CONSISTS OF STANDARD CHARACTERS WITHOUT CLAIM TO ANY PARTICULAR FONT, STYLE, SIZE, OR COLOR.

NO CLAIM IS MADE TO THE EXCLUSIVE RIGHT TO USE "ARCHITECTS, INC.", APART FROM THE MARK AS SHOWN.

THE WORDING "LDA" HAS NO MEANING OTHER THAN TRADEMARK SIGNIFICANCE.

CLASS 16—PAPER GOODS AND PRINTED MATTER

FOR ARCHITECTURAL PLANS AND SPECIFICATIONS (U.S. CLS. 2, 5, 22, 23, 29, 37, 38 AND 50).
FIRST USE 3-21-1984; IN COMMERCE 3-21-1984.

CLASS 35—ADVERTISING AND BUSINESS

FOR ADVISORY SERVICES FOR OTHERS FOR BUSINESS PURPOSES IN THE FIELDS OF ARCHITECTURE, INTERIOR DESIGN AND URBAN PLANNING DESIGN; BUSINESS ADVISORY SERVICES IN THE FIELDS OF ARCHITECTURE, INTERIOR DESIGN AND URBAN PLANNING DESIGN; BUSINESS CONSULTATION SERVICES, NAMELY, BUSINESS PROCESS IMPROVEMENT AND ENTERPRISE ARCHITECTURE DESIGN; PROJECT MANAGEMENT SERVICES FOR OTHERS FOR BUSINESS PURPOSES IN THE FIELDS OF ARCHITECTURE, INTERIOR DESIGN, URBAN PLANNING DESIGN (U.S. CLS. 100, 101 AND 102).

FIRST USE 3-21-1984; IN COMMERCE 3-21-1984.

CLASS 42—SCIENTIFIC AND COMPUTER SERVICES

FOR ARCHITECTURAL AND ENGINEERING SERVICES; ARCHITECTURAL CONSULTANCY; ARCHITECTURAL CONSULTATION; ARCHITECTURAL DESIGN; CONSULTING IN THE FIELDS OF ENGINEERING AND ARCHITECTURE; CONSULTING SERVICES IN THE FIELD OF ARCHITECTURAL DESIGN (U.S. CLS. 100 AND 101).

FIRST USE 3-21-1984; IN COMMERCE 3-21-1984.
RONALD DELGIZZI, EXAMINING ATTORNEY

SN 77-893,781. HEIFER PROJECT INTERNATIONAL, LITTLE ROCK, AR. FILED 12-15-2009.

SN 77-893,898. BRIGHTPLANET CORPORATION II, INC., SIOUX FALLS, SD. FILED 12-15-2009.

Family Friend - Share Their Journey Out Of Poverty

THE MARK CONSISTS OF STANDARD CHARACTERS WITHOUT CLAIM TO ANY PARTICULAR FONT, STYLE, SIZE, OR COLOR.

NO CLAIM IS MADE TO THE EXCLUSIVE RIGHT TO USE "FAMILY", APART FROM THE MARK AS SHOWN.

CLASS 36—INSURANCE AND FINANCIAL

FOR CHARITABLE FUND RAISING SERVICES (U.S. CLS. 100, 101 AND 102).

CLASS 41—EDUCATION AND ENTERTAINMENT

FOR EDUCATIONAL SERVICES, NAMELY, CONDUCTING CLASSES, SEMINARS, AND INDIVIDUAL INSTRUCTION IN ENVIRONMENTAL TRAINING, NAMELY, SUSTAINABLE AGRICULTURE OR ANIMAL HUSBANDRY (U.S. CLS. 100, 101 AND 107).

STEVEN JACKSON, EXAMINING ATTORNEY

SN 77-893,792. HEIFER PROJECT INTERNATIONAL, LITTLE ROCK, AR. FILED 12-15-2009.

Family Friend

THE MARK CONSISTS OF STANDARD CHARACTERS WITHOUT CLAIM TO ANY PARTICULAR FONT, STYLE, SIZE, OR COLOR.

NO CLAIM IS MADE TO THE EXCLUSIVE RIGHT TO USE "FAMILY", APART FROM THE MARK AS SHOWN.

CLASS 36—INSURANCE AND FINANCIAL

FOR CHARITABLE FUND RAISING SERVICES (U.S. CLS. 100, 101 AND 102).

CLASS 41—EDUCATION AND ENTERTAINMENT

FOR EDUCATIONAL SERVICES, NAMELY, CONDUCTING CLASSES, SEMINARS, AND INDIVIDUAL INSTRUCTION IN ENVIRONMENTAL TRAINING, NAMELY, SUSTAINABLE AGRICULTURE OR ANIMAL HUSBANDRY (U.S. CLS. 100, 101 AND 107).

STEVEN JACKSON, EXAMINING ATTORNEY

DEEPHARVESTER

THE MARK CONSISTS OF STANDARD CHARACTERS WITHOUT CLAIM TO ANY PARTICULAR FONT, STYLE, SIZE, OR COLOR.

CLASS 9—ELECTRICAL AND SCIENTIFIC APPARATUS

FOR COMPUTER SOFTWARE FOR SEARCHING, TRACKING, AND RETRIEVING INFORMATION FROM A LOCAL AND/OR GLOBAL COMPUTER NETWORK; COMPUTER SEARCH ENGINE SOFTWARE (U.S. CLS. 21, 23, 26, 36 AND 38).

FIRST USE 12-14-2009; IN COMMERCE 12-14-2009.

CLASS 42—SCIENTIFIC AND COMPUTER SERVICES

FOR CONSULTING SERVICES IN THE FIELD OF DESIGN, SELECTION, IMPLEMENTATION AND USE OF COMPUTER HARDWARE, SOFTWARE, AND INFORMATION SYSTEMS FOR OTHERS; COMPUTER SERVICES, NAMELY, SEARCHING AND RETRIEVING INFORMATION, SITES, AND OTHER RESOURCES AVAILABLE ON COMPUTER NETWORKS FOR OTHERS; COMPUTER SERVICES, NAMELY, PROVIDING SEARCH ENGINES FOR OBTAINING DATA FROM A LOCAL AND/OR GLOBAL COMPUTER NETWORK (U.S. CLS. 100 AND 101).

FIRST USE 12-14-2009; IN COMMERCE 12-14-2009.

MICHELE SWAIN, EXAMINING ATTORNEY

SN 77-893,909. JOVIAL ORGANICS, INC., NORTH FRANKLIN, CT. FILED 12-15-2009.

JOVIAL

THE MARK CONSISTS OF STANDARD CHARACTERS WITHOUT CLAIM TO ANY PARTICULAR FONT, STYLE, SIZE, OR COLOR.

CLASS 29—MEATS AND PROCESSED FOODS

FOR CANNED, COOKED OR OTHERWISE PROCESSED TOMATOES; DRIED BEANS; FRUIT PRESERVES; FRUIT-BASED SPREADS; JELLIES, JAMS; OLIVE OIL; PEELED TOMATOES; PROCESSED BEANS; TOMATO PASTE; TOMATO PUREE; VEGETABLE OILS (U.S. CL. 46).

CLASS 30—STAPLE FOODS

FOR COOKIES AND CRACKERS; PACKAGED MEAL MIXES CONSISTING PRIMARILY OF PASTA OR RICE; PASTA AND NOODLES; RICE; TOMATO SAUCE; PREPARED OR PACKAGED MEALS CONSISTING PRIMARILY OF PASTA OR RICE (U.S. CL. 46).

COLLEEN KEARNEY, EXAMINING ATTORNEY

SN 77-893,954. CHILDREN'S HOSPITAL CENTRAL CALIFORNIA, MADERA, CA. FILED 12-15-2009.

THOMAS MANOR, EXAMINING ATTORNEY

Amazing People. Incredible Care.

THE MARK CONSISTS OF STANDARD CHARACTERS WITHOUT CLAIM TO ANY PARTICULAR FONT, STYLE, SIZE, OR COLOR.
SEC. 2(F).

CLASS 35—ADVERTISING AND BUSINESS

FOR RECRUITMENT OF HEALTHCARE EMPLOYEES AND PHYSICIANS (U.S. CLS. 100, 101 AND 102).
FIRST USE 9-11-2007; IN COMMERCE 9-11-2007.

CLASS 36—INSURANCE AND FINANCIAL

FOR CHARITABLE FUNDRAISING, NAMELY, PROVIDING FUNDRAISING ACTIVITIES TO SUPPORT THE PEDIATRIC HOSPITAL AND PATIENTS IN NEED OF CARE (U.S. CLS. 100, 101 AND 102).
FIRST USE 9-11-2007; IN COMMERCE 9-11-2007.

CLASS 44—MEDICAL, BEAUTY AND AGRICULTURAL SERVICES

FOR PEDIATRIC HEALTHCARE SERVICES (U.S. CLS. 100 AND 101).
FIRST USE 9-11-2007; IN COMMERCE 9-11-2007.
RICHARD WHITE, EXAMINING ATTORNEY

SN 77-894,055. SHEILA HANLEY, CHICAGO, IL. FILED 12-15-2009.

TEMPLNABOE

THE MARK CONSISTS OF STANDARD CHARACTERS WITHOUT CLAIM TO ANY PARTICULAR FONT, STYLE, SIZE, OR COLOR.

THE ENGLISH TRANSLATION OF "TEMPLNABOE" IN THE MARK IS "CHURCH OF THE COW".

CLASS 35—ADVERTISING AND BUSINESS

FOR ECONOMIC FEASIBILITY STUDIES; ECONOMIC FORECASTING AND ANALYSIS; PROVIDING INFORMATION AND ANALYSIS IN THE FIELDS OF ECONOMICS AND BUSINESS (U.S. CLS. 100, 101 AND 102).

CLASS 36—INSURANCE AND FINANCIAL

FOR FINANCIAL ASSET MANAGEMENT; INVESTMENT SERVICES, NAMELY, ASSET ACQUISITION, CONSULTATION, DEVELOPMENT AND MANAGEMENT SERVICES (U.S. CLS. 100, 101 AND 102).

CLASS 45—PERSONAL AND LEGAL SERVICES

FOR INVESTIGATION OF ASSETS, CREDIT REPORTS, FISCAL ASSESSMENTS, AND COLLECTION REPORTS FOR SECURITY OR AUTHENTICATION PURPOSES (U.S. CLS. 100 AND 101).

SN 77-894,061. VANDERWARKER, BRYAN, EVANSTON, IL. AND STACY KARZEN, EVANSTON, IL. FILED 12-15-2009.

Pistolero

THE MARK CONSISTS OF STANDARD CHARACTERS WITHOUT CLAIM TO ANY PARTICULAR FONT, STYLE, SIZE, OR COLOR.

CLASS 35—ADVERTISING AND BUSINESS

FOR BRAND IMAGERY CONSULTING SERVICES; BRANDING SERVICES, NAMELY, CONSULTING, DEVELOPMENT, MANAGEMENT AND MARKETING OF BRANDS FOR BUSINESSES (U.S. CLS. 100, 101 AND 102).

CLASS 42—SCIENTIFIC AND COMPUTER SERVICES

FOR GRAPHIC DESIGN SERVICES (U.S. CLS. 100 AND 101).
GILBERT SWIFT, EXAMINING ATTORNEY

SN 77-894,144. PERFORMANCE AUDIO, LLC, DBA PERFORMANCE AUDIO, SALT LAKE CITY, UT. FILED 12-15-2009.

PERFORMANCE AUDIO

THE MARK CONSISTS OF STANDARD CHARACTERS WITHOUT CLAIM TO ANY PARTICULAR FONT, STYLE, SIZE, OR COLOR.

NO CLAIM IS MADE TO THE EXCLUSIVE RIGHT TO USE "AUDIO", APART FROM THE MARK AS SHOWN.

CLASS 9—ELECTRICAL AND SCIENTIFIC APPARATUS

FOR ELECTRONIC PRODUCTS, NAMELY, AUDIO, VIDEO AND SPEAKER CABLES AND CONNECTORS, AND POWER DISTRIBUTION PRODUCTS, NAMELY, SURGE PROTECTORS (U.S. CLS. 21, 23, 26, 36 AND 38).
FIRST USE 12-31-1977; IN COMMERCE 12-31-1977.

CLASS 35—ADVERTISING AND BUSINESS

FOR RETAIL STORE SERVICES IN THE FIELD OF AUDIO AND VIDEO PRODUCTS (U.S. CLS. 100, 101 AND 102).

FIRST USE 12-31-1977; IN COMMERCE 12-31-1977.

CLASS 41—EDUCATION AND ENTERTAINMENT

FOR AUDIO AND VIDEO RECORDING SERVICES; AUDIO RECORDING AND PRODUCTION; RENTAL OF AUDIO EQUIPMENT; RENTAL SERVICES FOR AUDIO AND VIDEO EQUIPMENT (U.S. CLS. 100, 101 AND 107).

FIRST USE 12-31-1977; IN COMMERCE 12-31-1977.
DAVID MURRAY, EXAMINING ATTORNEY

SN 77-895,081. RIEHL, JOHNER, SAN DIEGO, CA. FILED 12-16-2009.



THE MARK CONSISTS OF THE OUTLINE OF FOUR CHARACTERS WITH A RAINBOW STARTING BEHIND THE FIRST CHARACTER AND ENDING BEHIND THE THIRD AND FOURTH CHARACTERS.

SN 77-894,461. DAVID B. CLAYTON, DBA PROGRESSIVE PRESS, ROANOKE, VA. FILED 12-16-2009.

**CLASS 41—EDUCATION AND ENTERTAINMENT**

FOR EDUCATIONAL SERVICES, NAMELY, CONDUCTING ON-LINE EXHIBITIONS AND DISPLAYS AND INTERACTIVE EXHIBITS IN THE FIELD OF VIDEO GAME CONTENT; PROVIDING A WEBSITE FEATURING INFORMATION, ADVICE, ANALYSIS, MONITORING, RATINGS AND REVIEWS IN THE FIELD OF VIDEO GAME CONTENT; PROVIDING INFORMATION IN THE FORM OF REVIEWS AND RATINGS OF VIDEO GAME CONTENT; PROVIDING ONLINE INFORMATION REGARDING VIDEO GAME CONTENT (U.S. CLS. 100, 101 AND 107).

CLASS 42—SCIENTIFIC AND COMPUTER SERVICES

FOR TESTING, ANALYSIS AND EVALUATION OF OTHER COMPANIES' COMPUTER AND VIDEO GAMES FOR THE PURPOSE OF CERTIFICATION (U.S. CLS. 100 AND 101).

SEAN CROWLEY, EXAMINING ATTORNEY

NO CLAIM IS MADE TO THE EXCLUSIVE RIGHT TO USE "BABY", APART FROM THE MARK AS SHOWN.

THE COLOR(S) BLACK, WHITE, RED, YELLOW AND GREEN IS/ARE CLAIMED AS A FEATURE OF THE MARK.

THE MARK CONSISTS OF A BLACK MORTAR BOARD CAP WITH YELLOW TASSEL, ATOP TWO BOOKS, ONE GREEN WITH WHITE AND BLACK LINES ON THE BINDING AND WHITE PAGES AND ONE RED WITH WHITE STRIPES ON THE BINDING AND WHITE PAGES, ON A WHITE CIRCULAR BACKGROUND WITH A BLACK BORDER; SURROUNDED BY RED FLAMES THAT HAVE A BLACK BORDER AND A YELLOW INTERIOR CIRCULAR LINE. IN THE LOWER BORDER OF THE FLAMES IS THE WORDING "LEARN BABY LEARN" IN WHITE.

CLASS 25—CLOTHING

FOR HATS; JACKETS; PANTS; SHIRTS (U.S. CLS. 22 AND 39).

FIRST USE 2-2-2009; IN COMMERCE 2-9-2009.

CLASS 35—ADVERTISING AND BUSINESS

FOR ONLINE RETAIL STORE SERVICES FEATURING CLOTHING (U.S. CLS. 100, 101 AND 102).

FIRST USE 2-2-2009; IN COMMERCE 2-9-2009.
SUSAN RICHARDS, EXAMINING ATTORNEY

SN 77-895,105. SHOE FABULOUS, LLC, EL SEGUNDO, CA. FILED 12-16-2009.



SHOEFABULOUS

THE MARK CONSISTS OF THE LETTER "S" INSIDE A STYLIZED "U" SHAPE WITH THE WORDS "SHOE FABULOUS" UNDERNEATH.

CLASS 25—CLOTHING

FOR SHOES, FOOTWEAR (U.S. CLS. 22 AND 39).

CLASS 35—ADVERTISING AND BUSINESS

FOR ONLINE RETAIL STORE SERVICES FEATURING SHOES AND FOOTWEAR; RETAIL STORE SERVICES FEATURING SHOES AND FOOTWEAR (U.S. CLS. 100, 101 AND 102).

LINDA M. KING, EXAMINING ATTORNEY

CLASS 32—LIGHT BEVERAGES

FOR FRUIT JUICES AND FRUIT DRINKS; NON-ALCOHOLIC BEVERAGES CONTAINING FRUIT JUICES (U.S. CLS. 45, 46 AND 48).

FIRST USE 11-1-2009; IN COMMERCE 11-1-2009.

KELLEY WELLS, EXAMINING ATTORNEY

SN 77-895,822. GORBATY, BEN, WESTON, CT. AND SATTEN, MICHAEL, I, GREAT NECK, NY. FILED 12-17-2009.

SN 77-896,015. C4 WATERMAN, INC., HONOLULU, HI. FILED 12-17-2009.

PLAYFACES

THE MARK CONSISTS OF STANDARD CHARACTERS WITHOUT CLAIM TO ANY PARTICULAR FONT, STYLE, SIZE, OR COLOR.

CLASS 20—FURNITURE AND ARTICLES NOT OTHERWISE CLASSIFIED

FOR PILLOWS (U.S. CLS. 2, 13, 22, 25, 32 AND 50).

CLASS 28—TOYS AND SPORTING GOODS

FOR STUFFED TOYS (U.S. CLS. 22, 23, 38 AND 50).
DAVID I, EXAMINING ATTORNEY

SN 77-895,882. LIFE BRANDS, LLC., BLAUVELT, NY. FILED 12-17-2009.

Sinfully Healthy

THE MARK CONSISTS OF STANDARD CHARACTERS WITHOUT CLAIM TO ANY PARTICULAR FONT, STYLE, SIZE, OR COLOR.

NO CLAIM IS MADE TO THE EXCLUSIVE RIGHT TO USE "HEALTHY", APART FROM THE MARK AS SHOWN.

CLASS 5—PHARMACEUTICALS

FOR DIETARY AND NUTRITIONAL SUPPLEMENTS; DIETARY FOOD SUPPLEMENTS; DIETARY SUPPLEMENTAL DRINKS (U.S. CLS. 6, 18, 44, 46, 51 AND 52).
FIRST USE 11-1-2009; IN COMMERCE 11-1-2009.

CLASS 30—STAPLE FOODS

FOR BEVERAGES MADE OF TEA; CANDY; CEREAL-BASED SNACK FOODS; CHOCOLATE AND CHOCOLATES; CHOCOLATE BARS; CHOCOLATE CANDIES; CHOCOLATE FOOD BEVERAGES NOT BEING DAIRY-BASED OR VEGETABLE BASED; CHOCOLATE FOR CONFECTIONERY AND BREAD; CHOCOLATES AND CHOCOLATE BASED READY TO EAT CANDIES AND SNACKS; COCOA-BASED BEVERAGES; HERBAL FOOD BEVERAGES; READY TO EAT, CEREAL DERIVED FOOD BARS; SALAD DRESSINGS; TEA-BASED BEVERAGES (U.S. CL. 46).

FIRST USE 11-1-2009; IN COMMERCE 11-9-2009.

iWATERMAN

THE MARK CONSISTS OF STANDARD CHARACTERS WITHOUT CLAIM TO ANY PARTICULAR FONT, STYLE, SIZE, OR COLOR.

OWNER OF U.S. REG. NO. 3,400,611.

CLASS 25—CLOTHING

FOR BASEBALL CAPS; HATS; SHORT-SLEEVED OR LONG-SLEEVED T-SHIRTS; SPORTS SHIRTS; T-SHIRTS (U.S. CLS. 22 AND 39).

CLASS 28—TOYS AND SPORTING GOODS

FOR PADDLE BOARDS; PADDLE SURFBOARDS; PADDLES FOR USE WITH SURFBOARDS; SURFBOARDS (U.S. CLS. 22, 23, 38 AND 50).

HENRY S. ZAK, EXAMINING ATTORNEY

SN 77-897,292. AGC IP, LLC, PROVO, UT. FILED 12-18-2009.



NO CLAIM IS MADE TO THE EXCLUSIVE RIGHT TO USE "VENTURES MEXICO", APART FROM THE MARK AS SHOWN.

THE COLOR(S) RED AND GRAY IS/ARE CLAIMED AS A FEATURE OF THE MARK.

THE MARK CONSISTS OF A STYLIZED MOUNTAIN PEAK WITH A GRAY PORTION AT THE TOP AND A RED PORTION BELOW AND WITH THE WORD "ALTA" BELOW IN RED AND THE WORDS "VENTURES MEXICO" BELOW THAT IN GRAY.

CLASS 35—ADVERTISING AND BUSINESS

FOR ASSISTANCE, ADVISORY SERVICES AND CONSULTANCY WITH REGARD TO BUSINESS PLANNING, BUSINESS ANALYSIS, BUSINESS MANAGEMENT, AND BUSINESS ORGANIZATION; BUSINESS ADMINISTRATION AND MANAGEMENT; BUSINESS INVESTIGATIONS, EVALUATIONS, EXPERT APPRAISALS, INFORMATION AND RESEARCH; BUSINESS MANAGEMENT; NEW BUSINESS VENTURE DEVELOPMENT AND FORMATION CONSULTING SERVICES (U.S. CLS. 100, 101 AND 102).

FIRST USE 12-3-2009, THE MARK WAS FIRST USED ANYWHERE IN A DIFFERENT FORM OTHER THAN THAT SOUGHT TO BE REGISTERED AT LEAST AS EARLY AS 10/12/2009.; IN COMMERCE 12-10-2009, THE MARK WAS FIRST USED IN COMMERCE IN A DIFFERENT FORM OTHER THAN THAT SOUGHT TO BE REGISTERED AT LEAST AS EARLY AS 10/12/2009..

CLASS 36—INSURANCE AND FINANCIAL

FOR CAPITAL INVESTMENT SERVICES; EQUITY CAPITAL INVESTMENT; MANAGEMENT OF A CAPITAL INVESTMENT FUND; MANAGEMENT OF PRIVATE EQUITY FUNDS; VENTURE CAPITAL ADVISORY SERVICES; VENTURE CAPITAL SERVICES, NAMELY, PROVIDING FINANCING TO EMERGING AND START-UP COMPANIES (U.S. CLS. 100, 101 AND 102).

FIRST USE 12-3-2009, THE MARK WAS FIRST USED ANYWHERE IN A DIFFERENT FORM OTHER THAN THAT SOUGHT TO BE REGISTERED AT LEAST AS EARLY AS 10/12/2009.; IN COMMERCE 12-10-2009, THE MARK WAS FIRST USED IN COMMERCE IN A DIFFERENT FORM OTHER THAN THAT SOUGHT TO BE REGISTERED AT LEAST AS EARLY AS 10/12/2009..

MATTHEW MCDOWELL, EXAMINING ATTORNEY

SN 77-897,953. ASSOCIATED OCEANS, LLC, MIAMI, FL. FILED 12-21-2009.



NO CLAIM IS MADE TO THE EXCLUSIVE RIGHT TO USE "EMERGENCY RESPONSE INFORMATION SYSTEM", APART FROM THE MARK AS SHOWN.

THE MARK CONSISTS OF A SQUARE SHAPED BOX WITH A STYLIZED IMAGE OF A CROSS LOCATED INSIDE THE BOX AND A STYLIZED RECTANGLE LINE INTERSECTING THE BOX FROM THE TOP LEFT TO THE BOTTOM RIGHT. THE STYLIZED TEXT "ERIS" IS WRITTEN INSIDE THE STYLIZED CROSS AND THE TEXT "EMERGENCY RESPONSE INFORMATION SYSTEM" IS WRITTEN TO THE RIGHT OF THE BOX.

CLASS 9—ELECTRICAL AND SCIENTIFIC APPARATUS

FOR DOWNLOADABLE COMPUTER SOFTWARE FOR THE DELIVERY OF MEDICAL AND INSURANCE INFORMATION FOR USE IN THE FIELD OF SCUBA DIVING (U.S. CLS. 21, 23, 26, 36 AND 38).

CLASS 42—SCIENTIFIC AND COMPUTER SERVICES

FOR PROVIDING TEMPORARY USE OF ON-LINE NON-DOWNLOADABLE COMPUTER SOFTWARE FOR THE DELIVERY OF MEDICAL AND INSURANCE INFORMATION FOR USE IN THE FIELD OF SCUBA DIVING (U.S. CLS. 100 AND 101).

TOBY BULLOFF, EXAMINING ATTORNEY

SN 77-897,969. ASSOCIATED OCEANS, LLC, MIAMI, FL. FILED 12-21-2009.

ERIS EMERGENCY RESPONSE INFORMATION SYSTEM

THE MARK CONSISTS OF STANDARD CHARACTERS WITHOUT CLAIM TO ANY PARTICULAR FONT, STYLE, SIZE, OR COLOR.

NO CLAIM IS MADE TO THE EXCLUSIVE RIGHT TO USE "EMERGENCY RESPONSE INFORMATION SYSTEM", APART FROM THE MARK AS SHOWN.

CLASS 9—ELECTRICAL AND SCIENTIFIC APPARATUS

FOR DOWNLOADABLE COMPUTER SOFTWARE FOR THE DELIVERY OF MEDICAL AND INSURANCE INFORMATION FOR USE IN THE FIELD OF SCUBA DIVING (U.S. CLS. 21, 23, 26, 36 AND 38).

CLASS 42—SCIENTIFIC AND COMPUTER SERVICES

FOR PROVIDING TEMPORARY USE OF ON-LINE NON-DOWNLOADABLE COMPUTER SOFTWARE FOR THE DELIVERY OF MEDICAL AND INSURANCE INFORMATION FOR USE IN THE FIELD OF SCUBA DIVING (U.S. CLS. 100 AND 101).

TOBY BULLOFF, EXAMINING ATTORNEY

SN 77-897,975. SERENIGY GLOBAL, INC., MIAMI, FL. FILED 12-21-2009.

SERENIGY GLOBAL

THE MARK CONSISTS OF STANDARD CHARACTERS WITHOUT CLAIM TO ANY PARTICULAR FONT, STYLE, SIZE, OR COLOR.

NO CLAIM IS MADE TO THE EXCLUSIVE RIGHT TO USE "GLOBAL", APART FROM THE MARK AS SHOWN.

CLASS 3—COSMETICS AND CLEANING PREPARATIONS

FOR COSMETICS, TOOTHPASTE, SOAP, AND SHAMPOO, ALL MIXED WITH NON-ORGANIC OR ORGANIC MUSHROOM OR MUSHROOM EXTRACT (U.S. CLS. 1, 4, 6, 50, 51 AND 52).

CLASS 5—PHARMACEUTICALS

FOR NUTRACEUTICALS USED AS A FOOD SUPPLEMENT MIXED WITH NON-ORGANIC OR ORGANIC MUSHROOMS (U.S. CLS. 6, 18, 44, 46, 51 AND 52).

CLASS 30—STAPLE FOODS

FOR ORGANIC AND NON-ORGANIC INSTANT COFFEE AND TEA, MIXED WITH ORGANIC AND NON-ORGANIC MUSHROOMS AND MUSHROOM EXTRACTS; POWDERED MIXES USED IN THE PREPARATION OF COFFEE, TEA, AND COCOA-BASED BEVERAGES (U.S. CL. 46).

SN 77-898,184. WILLIS N. BROWN, JR., DUBLIN, OH. FILED 12-21-2009.

Get informed, not sold

CLASS 32—LIGHT BEVERAGES

FOR ENERGY DRINKS WITH ORGANIC AND NON-ORGANIC MUSHROOM OR MUSHROOM EXTRACTS (U.S. CLS. 45, 46 AND 48).

KATHERINE STOIDES, EXAMINING ATTORNEY

THE MARK CONSISTS OF STANDARD CHARACTERS WITHOUT CLAIM TO ANY PARTICULAR FONT, STYLE, SIZE, OR COLOR.

CLASS 35—ADVERTISING AND BUSINESS

FOR RETAIL OPTICAL STORE AND ON-LINE RETAIL OPTICAL STORE SERVICES (U.S. CLS. 100, 101 AND 102).

SN 77-898,131. WYNDHAM TM CORP., LAS VEGAS, NV. FILED 12-21-2009.

**CLASS 44—MEDICAL, BEAUTY AND AGRICULTURAL SERVICES**

FOR OPTICIAN SERVICES (U.S. CLS. 100 AND 101).
RUSS HERMAN, EXAMINING ATTORNEY

OWNER OF U.S. REG. NOS. 2,859,133, 3,409,859 AND 3,415,106.

NO CLAIM IS MADE TO THE EXCLUSIVE RIGHT TO USE "EXCHANGE & RENTALS", APART FROM THE MARK AS SHOWN.

THE COLOR(S) BLUE IS/ARE CLAIMED AS A FEATURE OF THE MARK.

THE MARK CONSISTS OF THE WORD "WYNDHAM" IN THE COLOR BLUE ABOVE A BLUE SWOOSH UNDERNEATH WHICH ARE THE WORDS "EXCHANGE & RENTALS" ALSO IN THE COLOR BLUE.

SN 77-898,208. WILLIS N. BROWN, JR., DUBLIN, OH. FILED 12-21-2009.

Get educated, not sold

THE MARK CONSISTS OF STANDARD CHARACTERS WITHOUT CLAIM TO ANY PARTICULAR FONT, STYLE, SIZE, OR COLOR.

CLASS 35—ADVERTISING AND BUSINESS

FOR BUSINESS AND MARKETING CONSULTING SERVICES; ADVERTISING SERVICES, NAMELY, ADVERTISING REAL ESTATE PROPERTIES FOR RENTAL BY MEANS OF BROCHURES, CATALOGUES, AND OVER A GLOBAL TELECOMMUNICATIONS NETWORK; CONSULTING SERVICES FOR RESORT PROPERTIES, NAMELY, REAL ESTATE SALES MANAGEMENT (U.S. CLS. 100, 101 AND 102).

CLASS 35—ADVERTISING AND BUSINESS

FOR RETAIL OPTICAL STORE AND ON-LINE RETAIL OPTICAL STORE SERVICES (U.S. CLS. 100, 101 AND 102).

CLASS 36—INSURANCE AND FINANCIAL

FOR REAL ESTATE SERVICES, NAMELY, RENTAL OF VACATION HOMES, CONDOMINIUMS, CABINS, AND VILLAS; REAL ESTATE TIME-SHARE EXCHANGE SERVICES; REAL ESTATE MANAGEMENT; REAL ESTATE MANAGEMENT CONSULTATION; REAL ESTATE OWNERSHIP EXCHANGE SERVICES, NAMELY, VACATION REAL ESTATE TIME SHARING, REAL ESTATE MANAGEMENT AND LEASING SERVICES, AND CONSULTING SERVICES FOR RESORT PROPERTIES, NAMELY, LEASING AND MANAGEMENT OF RESORT PROPERTIES (U.S. CLS. 100, 101 AND 102).

CLASS 44—MEDICAL, BEAUTY AND AGRICULTURAL SERVICES

FOR OPTICIAN SERVICES (U.S. CLS. 100 AND 101).
RUSS HERMAN, EXAMINING ATTORNEY

CLASS 43—HOTEL AND RESTAURANT SERVICES

FOR ARRANGING TEMPORARY HOUSING ACCOMMODATIONS; BOOKING OF CAMPGROUND ACCOMMODATION; CONSULTING SERVICES IN THE FIELD OF HOSPITALITY; PROVIDING TRAVEL LODGING INFORMATION SERVICES AND TRAVEL LODGING BOOKING AGENCY SERVICES FOR TRAVELERS; TRAVEL AGENCY SERVICES, NAMELY, MAKING RESERVATIONS AND BOOKING FOR TEMPORARY LODGING (U.S. CLS. 100 AND 101).

SANJEEV VOHRA, EXAMINING ATTORNEY

SN 77-899,195. OROGRAIN BAKERIES PRODUCTS, INC., HORSHAM, PA. FILED 12-22-2009.

OROGRAIN BAKERIES

THE MARK CONSISTS OF STANDARD CHARACTERS WITHOUT CLAIM TO ANY PARTICULAR FONT, STYLE, SIZE, OR COLOR.

NO CLAIM IS MADE TO THE EXCLUSIVE RIGHT TO USE "BAKERIES", APART FROM THE MARK AS SHOWN.

CLASS 30—STAPLE FOODS

FOR BAKERY PRODUCTS (U.S. CL. 46).

CLASS 40—MATERIAL TREATMENT

FOR BAKERY SERVICES, NAMELY, THE MANUFACTURE OF BAKERY PRODUCTS TO ORDER AND/OR SPECIFICATION OF OTHERS; BAKERY SERVICES, NAMELY, THE CUSTOM MANUFACTURING OF BAKERY PRODUCTS FOR WHOLESALE AND RETAIL BY OTHERS (U.S. CLS. 100, 103 AND 106).

CHRISTOPHER BUONGIORNO, EXAMINING ATTORNEY

SN 77-900,039. HYDRO-GEAR LIMITED PARTNERSHIP, SULLIVAN, IL. FILED 12-23-2009.



OWNER OF U.S. REG. NOS. 2,119,507, 3,246,798 AND OTHERS.

THE MARK CONSISTS OF A DOUBLE-LINE BAND AND "S" SWIRL BESIDE AND ABOVE THE WORDS "HYDRO-GEAR".

CLASS 6—METAL GOODS

FOR METAL HOSE FITTINGS, METAL COUPLINGS FOR USE WITH HYDRAULIC HOSES, METAL COUPLINGS FOR USE WITH FILTERS FOR HYDRAULIC MACHINES, METAL COUPLINGS FOR USE WITH FILTERS FOR HYDRAULIC TRANSMISSIONS FOR MACHINES, METAL COUPLINGS FOR USE WITH FILTERS FOR HYDROSTATIC TRANSMISSIONS FOR MACHINES, METAL COUPLINGS FOR USE WITH FILTERS FOR HYDRAULIC TRANSAXLES FOR MACHINES, METAL COUPLINGS FOR USE WITH FILTERS FOR HYDROSTATIC TRANSAXLES FOR MACHINES, METAL COUPLINGS FOR USE WITH FILTERS FOR GEAR BOXES FOR MACHINES, METAL COUPLINGS FOR USE WITH FILTERS FOR HYDRAULIC PUMPS FOR MACHINES (U.S. CLS. 2, 12, 13, 14, 23, 25 AND 50).

FIRST USE 10-0-2008; IN COMMERCE 10-0-2008.

CLASS 7—MACHINERY

FOR MACHINE PARTS, NAMELY, HYDROSTATIC TRANSAXLES, HYDROSTATIC TRANSMISSIONS, HYDROSTATIC PUMPS AND GEAR DRIVES; HYDRAULIC PUMPS AND HYDRAULIC MOTORS FOR MACHINES, GEAR MOTORS FOR MACHINES, WHEEL MOTORS FOR MACHINES, HYDRAULIC TRANSMISSIONS FOR MACHINES, HYDROSTATIC TRANSMISSIONS FOR MACHINES, HYDRAULIC TRANSAXLES FOR MACHINES, HYDROSTATIC TRANSAXLES FOR MACHINES, GEAR BOXES FOR MACHINES, COUPLINGS FOR MACHINES, BRAKES FOR MACHINES, FILTERS FOR HYDRAULIC MACHINES, FILTERS FOR HYDRAULIC TRANSMISSIONS FOR MACHINES, FILTERS FOR HYDROSTATIC TRANSMISSIONS FOR MACHINES, FILTERS FOR HYDRAULIC TRANSAXLES FOR MACHINES, FILTERS FOR HYDROSTATIC TRANSAXLES FOR MACHINES, FILTERS FOR GEAR BOXES FOR MACHINES, FILTERS FOR HYDRAULIC PUMPS FOR MACHINES (U.S. CLS. 13, 19, 21, 23, 31, 34 AND 35).

FIRST USE 2-5-2009; IN COMMERCE 3-4-2009.

CLASS 12—VEHICLES

FOR LAND VEHICLE PARTS, NAMELY, HYDRAULIC MOTORS, GEAR MOTORS, WHEEL MOTORS, HYDRAULIC TRANSMISSIONS, HYDROSTATIC TRANSMISSIONS, HYDRAULIC TRANSAXLES, HYDROSTATIC TRANSAXLES AND GEAR BOXES (U.S. CLS. 19, 21, 23, 31, 35 AND 44).

FIRST USE 2-5-2009; IN COMMERCE 3-4-2009.

CLASS 17—RUBBER GOODS

FOR HYDRAULIC HOSES MADE OF RUBBER, NON-METAL COUPLINGS FOR USE WITH HYDRAULIC HOSES, NON-METAL TUBING AND TUBING COUPLINGS FOR JOINING AND TERMINATING PIPES (U.S. CLS. 1, 5, 12, 13, 35 AND 50).

FIRST USE 10-0-2008; IN COMMERCE 10-0-2008.

CLASS 20—FURNITURE AND ARTICLES NOT OTHERWISE CLASSIFIED

FOR NON-METAL HOSE FITTINGS, NON-METAL FLUID STORAGE TANKS, PLASTIC RESERVOIRS (U.S. CLS. 2, 13, 22, 25, 32 AND 50).

FIRST USE 12-16-2008; IN COMMERCE 12-16-2008.

CLASS 41—EDUCATION AND ENTERTAINMENT

FOR CONSULTING SERVICES IN THE FIELD OF TRAINING IN THE OPERATION OF PUMPS, TRANSMISSIONS, TRANSAXLES, GEAR BOXES AND MOTORS (U.S. CLS. 100, 101 AND 107).

FIRST USE 10-0-2007; IN COMMERCE 12-0-2008.

CLASS 42—SCIENTIFIC AND COMPUTER SERVICES

FOR CONSULTING SERVICES AND TECHNICAL CONSULTATION RELATING TO THE DESIGN AND MATERIALS TESTING IN THE FIELD OF PUMPS, TRANSMISSIONS, TRANSAXLES, GEAR BOXES AND MOTORS (U.S. CLS. 100 AND 101).

FIRST USE 10-0-2007; IN COMMERCE 12-0-2008.

SCOTT BIBB, EXAMINING ATTORNEY

SN 77-903,877. FUNZIO, INC., DBA FUNZIO, SAN FRANCISCO, CA. FILED 1-1-2010.

SPAVILLE

THE MARK CONSISTS OF STANDARD CHARACTERS WITHOUT CLAIM TO ANY PARTICULAR FONT, STYLE, SIZE, OR COLOR.

CLASS 9—ELECTRICAL AND SCIENTIFIC APPARATUS

FOR DOWNLOADABLE COMPUTER GAME PROGRAMS (U.S. CLS. 21, 23, 26, 36 AND 38).

CLASS 41—EDUCATION AND ENTERTAINMENT

FOR ENTERTAINMENT SERVICES, NAMELY, PROVIDING ON-LINE COMPUTER GAMES (U.S. CLS. 100, 101 AND 107).

ADA HAN, EXAMINING ATTORNEY

SN 77-904,120. FUNZIO, INC., DBA FUNZIO, SAN FRANCISCO, CA. FILED 1-4-2010.

HAPPY HOUSE

THE MARK CONSISTS OF STANDARD CHARACTERS WITHOUT CLAIM TO ANY PARTICULAR FONT, STYLE, SIZE, OR COLOR.

CLASS 9—ELECTRICAL AND SCIENTIFIC APPARATUS

FOR DOWNLOADABLE COMPUTER GAME PROGRAMS (U.S. CLS. 21, 23, 26, 36 AND 38).

CLASS 41—EDUCATION AND ENTERTAINMENT

FOR ENTERTAINMENT SERVICES, NAMELY, PROVIDING ON-LINE COMPUTER GAMES (U.S. CLS. 100, 101 AND 107).
ADA HAN, EXAMINING ATTORNEY

SN 77-905,477. KANGAROO BRANDS, INC., MILWAUKEE, WI. FILED 1-5-2010.

WE BAKE REALLY GOOD STUFF

THE MARK CONSISTS OF STANDARD CHARACTERS WITHOUT CLAIM TO ANY PARTICULAR FONT, STYLE, SIZE, OR COLOR.

CLASS 29—MEATS AND PROCESSED FOODS

FOR FROZEN ENTREE CONSISTING PRIMARILY OF MEAT, FISH, POULTRY, EGGS OR VEGETABLES, AND PITA BREAD SOLD THEREWITH AS A UNIT; HUMMUS (U.S. CL. 46).

CLASS 30—STAPLE FOODS

FOR PITA CHIPS; PITA BREAD; SOFT TACOS; PIZZA (U.S. CL. 46).
DAWN HAN, EXAMINING ATTORNEY

SN 77-906,540. JOSH SUHRE DESIGN, LLC, CINCINNATI, OH. FILED 1-6-2010.

OPERATIV

THE MARK CONSISTS OF STANDARD CHARACTERS WITHOUT CLAIM TO ANY PARTICULAR FONT, STYLE, SIZE, OR COLOR.

CLASS 18—LEATHER GOODS

FOR ALL PURPOSE SPORT BAGS; ATTACHE CASES; BACKPACKS; HANDBAGS; MESSENGER BAGS; SUIT-CASES; TRAVEL BAGS; WALLETS (U.S. CLS. 1, 2, 3, 22 AND 41).

CLASS 25—CLOTHING

FOR BANDANAS; BELTS; CAPS; GLOVES; HATS; JACKETS; PANTS; SHIRTS; SHOES; SHORTS; SOCKS; SWEAT SHIRTS (U.S. CLS. 22 AND 39).
MARY ROSSMAN, EXAMINING ATTORNEY

SN 77-907,226. RETAIL BRAND ALLIANCE, INC., ENFIELD, CT. FILED 1-7-2010.

BROOKS BROTHERS FLEECE

THE MARK CONSISTS OF STANDARD CHARACTERS WITHOUT CLAIM TO ANY PARTICULAR FONT, STYLE, SIZE, OR COLOR.

OWNER OF U.S. REG. NOS. 3,029,064, 3,258,230 AND OTHERS.

NO CLAIM IS MADE TO THE EXCLUSIVE RIGHT TO USE "FLEECE", APART FROM THE MARK AS SHOWN.

CLASS 25—CLOTHING

FOR CLOTHING, NAMELY, SHIRTS, TOPS, SWEATERS, JACKETS, PANTS, SUITS, BOTTOMS, SOCKS, HATS AND CAPS; SHOES; SHORTS, COATS, UNDERWEAR, VESTS, ROBES, HOSIERY, SKIRTS, DRESSES, LOUNGEWEAR, SCARVES, RAINWEAR, TROUSERS, TIES, POLO SHIRTS, PAJAMAS, GLOVES, BELTS, BOOTS, SLIPPERS, BEACH WEAR, SWIMWEAR (U.S. CLS. 22 AND 39).

CLASS 35—ADVERTISING AND BUSINESS

FOR RETAIL STORE SERVICES, ONLINE RETAIL STORE SERVICES AND MAIL ORDER CATALOG SERVICES FEATURING CLOTHING, SPORTING GOODS, EYEWEAR, FRAGRANCE, HOUSEWARES, PERSONAL ACCESSORIES AND LUGGAGE (U.S. CLS. 100, 101 AND 102).

CYNTHIA TRIPI, EXAMINING ATTORNEY

SN 77-911,185. UPRIGHT CITIZENS BRIGADE, NEW YORK, NY. FILED 1-13-2010.

Upright Citizens Brigade

THE MARK CONSISTS OF STANDARD CHARACTERS WITHOUT CLAIM TO ANY PARTICULAR FONT, STYLE, SIZE, OR COLOR.

CLASS 9—ELECTRICAL AND SCIENTIFIC APPARATUS

FOR DIGITAL MEDIA, NAMELY, DVDS FEATURING COMEDY SKETCHES (U.S. CLS. 21, 23, 26, 36 AND 38).
FIRST USE 0-0-2004; IN COMMERCE 0-0-2004.

CLASS 25—CLOTHING

FOR HATS; HOODED SWEAT SHIRTS; T-SHIRTS (U.S. CLS. 22 AND 39).
FIRST USE 0-0-1992; IN COMMERCE 0-0-1992.

CLASS 41—EDUCATION AND ENTERTAINMENT

FOR EDUCATION SERVICES, NAMELY, PROVIDING CLASSES, WORKSHOPS, SEMINARS, PROGRAMS, MEETINGS AND CONFERENCES IN THE FIELDS OF THEATRICAL SKILLS AND IMPROVISATIONAL COMEDY; ENTERTAINMENT IN THE NATURE OF LIVE STAND-UP COMEDY, IMPROVISATIONAL COMEDY AND GROUP SKETCH COMEDY (U.S. CLS. 100, 101 AND 107).

FIRST USE 8-0-1991; IN COMMERCE 8-0-1991.
JAMES MACFARLANE, EXAMINING ATTORNEY

SN 77-912,993. MANHEIM, INC., ATLANTA, GA. FILED 1-15-2010.



OWNER OF U.S. REG. NOS. 3,145,992, 3,415,408 AND OTHERS.

THE COLOR(S) GOLD, BROWN, BLUE AND WHITE IS/ARE CLAIMED AS A FEATURE OF THE MARK.

THE MARK CONSISTS OF A GOLD "M" OVER A BLUE CIRCULAR BACKGROUND AND WITHIN TWO GOLD OUTER RINGS. THE COLOR BROWN OUTLINES THE MARK. TO THE RIGHT OF THE "M" ARE THE WORDS "MANHEIM" AND "FRONTLINE" IN THE COLOR WHITE AND BETWEEN THE WORDS "MANHEIM" AND "FRONTLINE" IS A DESIGN OF AN ARROW IN THE COLOR GOLD ALL ON A BLUE BACKGROUND.

SN 77-912,009. HEALTH SOLUTIONS, LTD., SHEBOYGAN, WI. FILED 1-14-2010.

WELL NATION

THE MARK CONSISTS OF STANDARD CHARACTERS WITHOUT CLAIM TO ANY PARTICULAR FONT, STYLE, SIZE, OR COLOR.

CLASS 35—ADVERTISING AND BUSINESS

FOR ASSISTING EMPLOYERS IN MANAGING HEALTH CARE COSTS (U.S. CLS. 100, 101 AND 102).

CLASS 36—INSURANCE AND FINANCIAL

FOR HEALTH INSURANCE CONSULTING SERVICES (U.S. CLS. 100, 101 AND 102).

CLASS 41—EDUCATION AND ENTERTAINMENT

FOR PROVIDING TRAINING AND EDUCATION PROGRAMS IN THE FIELD OF HEALTH EDUCATION (U.S. CLS. 100, 101 AND 107).

CLASS 44—MEDICAL, BEAUTY AND AGRICULTURAL SERVICES

FOR HEALTHCARE SERVICES IN THE NATURE OF PROVIDING PATIENT POPULATION HEALTH MANAGEMENT SERVICES FOR EMPLOYERS, NAMELY WELLNESS MANAGEMENT, DISEASE PREVENTION MANAGEMENT AND DISEASE MANAGEMENT; PROVIDING HEALTH ASSESSMENT SERVICES TO EMPLOYERS AND EMPLOYEES IN THE NATURE OF BIOMETRIC TESTING, HEALTH RISK ASSESSMENTS AND HEALTH COACHING ASSESSMENTS (U.S. CLS. 100 AND 101).

KATHLEEN M. VANSTON, EXAMINING ATTORNEY

CLASS 37—CONSTRUCTION AND REPAIR

FOR AUTOMOTIVE DETAILING, RECONDITIONING, REPAIR, CONVERSION, NAMELY, INSTALLATION OF SPECIAL EQUIPMENT AND CUSTOMIZATION SERVICES (U.S. CLS. 100, 103 AND 106).

FIRST USE 11-1-2009; IN COMMERCE 11-1-2009.

CLASS 42—SCIENTIFIC AND COMPUTER SERVICES

FOR AUTOMOBILE INSPECTION SERVICES (U.S. CLS. 100 AND 101).

FIRST USE 11-1-2009; IN COMMERCE 11-1-2009.

WILLIAM ROSSMAN, EXAMINING ATTORNEY

SN 77-913,949. AWANA CLUBS INTERNATIONAL, STREAMWOOD, IL. FILED 1-18-2010.

Modern Day Joseph

THE MARK CONSISTS OF STANDARD CHARACTERS WITHOUT CLAIM TO ANY PARTICULAR FONT, STYLE, SIZE, OR COLOR.

CLASS 9—ELECTRICAL AND SCIENTIFIC APPARATUS

FOR DIGITAL MATERIALS, NAMELY, CDS AND DOWNLOADABLE MP3 FILES FEATURING RELIGIOUS CONTENT FOR USE IN CONNECTION WITH AN EDUCATIONAL MINISTRY WITHIN CHRISTIAN CHURCHES (U.S. CLS. 21, 23, 26, 36 AND 38).

FIRST USE 1-25-2008; IN COMMERCE 1-25-2008.

CLASS 16—PAPER GOODS AND PRINTED MATTER

FOR BOOKS, PUBLICATIONS, NAMELY, BROCHURES, BOOKLETS, AND TEACHING MATERIALS IN THE FIELD OF CHRISTIAN INSTRUCTION (U.S. CLS. 2, 5, 22, 23, 29, 37, 38 AND 50).

FIRST USE 1-25-2008; IN COMMERCE 1-25-2008.

CLASS 41—EDUCATION AND ENTERTAINMENT

FOR EDUCATIONAL SERVICES, NAMELY, DEVELOPMENT AND DISSEMINATION OF EDUCATIONAL CURRICULUM MATERIALS IN THE FIELD OF CHRISTIAN INSTRUCTION (U.S. CLS. 100, 101 AND 107).

FIRST USE 1-25-2008; IN COMMERCE 1-25-2008.
MICHELE SWAIN, EXAMINING ATTORNEY

SN 77-915,531. AMERICAN GEOPHYSICAL UNION, WASHINGTON, DC. FILED 1-20-2010.



THE MARK CONSISTS OF A GRAPHIC PORTION OF INTERLOCKING OVAL DESIGNS TO THE LEFT OF THE LITERAL PORTION, "AGU".

CLASS 35—ADVERTISING AND BUSINESS

FOR ASSOCIATION SERVICES, NAMELY, PROMOTING THE INTERESTS OF EARTH AND SPACE SCIENTISTS, THE FIELDS OF THE EARTH AND SPACE SCIENCES AND THE UNDERSTANDING OF EARTH AND SPACE FOR THE BENEFIT OF HUMANITY (U.S. CLS. 100, 101 AND 102).

FIRST USE 1-2-1979; IN COMMERCE 1-2-1979.

CLASS 41—EDUCATION AND ENTERTAINMENT

FOR EDUCATIONAL SERVICES, NAMELY, ARRANGING AND CONDUCTING CONFERENCES, SEMINARS, CLASSES, WORKSHOPS, LECTURES AND SYMPOSIA IN THE FIELD OF THE EARTH AND SPACE SCIENCES; PROVIDING RECOGNITION AND INCENTIVES BY THE WAY OF AWARDS TO DEMONSTRATE EXCELLENCE AND OUTSTANDING CONTRIBUTIONS IN THE FIELD OF THE GEOPHYSICAL SCIENCES; PROVIDING ONLINE PUBLICATIONS IN THE NATURE OF NEWSLETTERS, NEWSPAPERS, JOURNALS, MAGAZINES AND MONOGRAPHS IN THE FIELD OF THE EARTH AND SPACE SCIENCES (U.S. CLS. 100, 101 AND 107).

FIRST USE 1-2-1979; IN COMMERCE 1-2-1979.
ARETHA SOMERVILLE, EXAMINING ATTORNEY

SN 77-915,545. AMERICAN GEOPHYSICAL UNION, WASHINGTON, DC. FILED 1-20-2010.

AGU

THE MARK CONSISTS OF STANDARD CHARACTERS WITHOUT CLAIM TO ANY PARTICULAR FONT, STYLE, SIZE, OR COLOR.

CLASS 35—ADVERTISING AND BUSINESS

FOR ASSOCIATION SERVICES, NAMELY, PROMOTING THE INTERESTS OF EARTH AND SPACE SCIENTISTS, THE FIELDS OF THE EARTH AND SPACE SCIENCES AND THE UNDERSTANDING OF EARTH AND SPACE FOR THE BENEFIT OF HUMANITY (U.S. CLS. 100, 101 AND 102).

FIRST USE 0-0-1919; IN COMMERCE 0-0-1919.

CLASS 41—EDUCATION AND ENTERTAINMENT

FOR EDUCATIONAL SERVICES, NAMELY, ARRANGING AND CONDUCTING CONFERENCES, SEMINARS, CLASSES, WORKSHOPS, LECTURES AND SYMPOSIA IN THE FIELD OF THE EARTH AND SPACE SCIENCES; PROVIDING RECOGNITION AND INCENTIVES BY THE WAY OF AWARDS TO DEMONSTRATE EXCELLENCE AND OUTSTANDING CONTRIBUTIONS IN THE FIELD OF THE GEOPHYSICAL SCIENCES; PROVIDING ONLINE PUBLICATIONS IN THE NATURE OF NEWSLETTERS, NEWSPAPERS, JOURNALS, MAGAZINES AND MONOGRAPHS IN THE FIELD OF THE EARTH AND SPACE SCIENCES (U.S. CLS. 100, 101 AND 107).

FIRST USE 0-0-1919; IN COMMERCE 0-0-1919.
ARETHA SOMERVILLE, EXAMINING ATTORNEY

SN 77-919,017. APPTIS TECHNOLOGY SOLUTIONS, LLC, CHANTILLY, VA. FILED 1-25-2010.



NO CLAIM IS MADE TO THE EXCLUSIVE RIGHT TO USE "TECHNOLOGIES", APART FROM THE MARK AS SHOWN.

THE MARK CONSISTS OF THE WORDING "IRON BOW", WITH AN ARCHING LINE BETWEEN "IRON" AND "BOW", AND THE WORD "TECHNOLOGIES" UNDER THE "BOW".

CLASS 35—ADVERTISING AND BUSINESS

FOR BUSINESS CONSULTING AND INFORMATION SERVICES (U.S. CLS. 100, 101 AND 102).

CLASS 38—COMMUNICATION

FOR ELECTRONIC MAIL AND MESSAGING SERVICES; SATELLITE COMMUNICATION SERVICES; TELECOMMUNICATION CONSULTATION IN THE NATURE OF TECHNICAL CONSULTING IN THE FIELD OF AUDIO, TEXT AND VISUAL DATA TRANSMISSION AND COMMUNICATION; TELECOMMUNICATIONS CONSULTATION; TELEPHONY COMMUNICATION SERVICES; TRANSMISSION OF INFORMATION BY ELECTRONIC COMMUNICATIONS NETWORKS; VOICE OVER IP SERVICES; WIRELESS BROADBAND COMMUNICATION SERVICES (U.S. CLS. 100, 101 AND 104).

CLASS 42—SCIENTIFIC AND COMPUTER SERVICES

FOR BACK-UP SERVICES FOR COMPUTER HARD DRIVE DATA; BUSINESS TECHNOLOGY SOFTWARE CONSULTATION SERVICES; COMPUTER CONSULTATION; COMPUTER CONSULTATION IN THE FIELD OF COMPUTER SECURITY; COMPUTER DISASTER RECOVERY PLANNING; COMPUTER HARDWARE AND SOFTWARE DESIGN; COMPUTER NETWORK DESIGN FOR OTHERS; COMPUTER PROGRAMMING SERVICES; COMPUTER PROJECT MANAGEMENT SERVICES; COMPUTER SECURITY CONSULTANCY; COMPUTER SERVICE, NAMELY, ACTING AS AN APPLICATION SERVICE PROVIDER IN THE FIELD OF KNOWLEDGE MANAGEMENT TO HOST COMPUTER APPLICATION SOFTWARE FOR CREATING SEARCHABLE DATABASES OF INFORMATION AND DATA; COMPUTER SERVICES, NAMELY, COMPUTER SYSTEM ADMINISTRATION FOR OTHERS; COMPUTER SERVICES, NAMELY, DATA RECOVERY SERVICES; COMPUTER SERVICES, NAMELY, REMOTE AND ON-SITE MANAGEMENT OF THE INFORMATION TECHNOLOGY (IT) SYSTEMS OF OTHERS; COMPUTER SOFTWARE CONSULTING; COMPUTER SYSTEMS INTEGRATION SERVICES; CONSULTING IN THE FIELD OF CONFIGURATION MANAGEMENT FOR COMPUTER HARDWARE AND SOFTWARE; CONSULTING IN THE FIELD OF INFORMATION TECHNOLOGY; CONSULTING IN THE FIELD OF IT PROJECT MANAGEMENT; CONSULTING IN THE FIELD OF TELECOMMUNICATIONS TECHNOLOGY; CONSULTING IN THE FIELD OF VIRTUALIZATION TECHNOLOGIES FOR ENTERPRISES AND BUSINESSES; DATA CONVERSION OF ELECTRONIC INFORMATION; DATA MIGRATION SERVICES; DATA WAREHOUSING; DESIGN AND DEVELOPMENT OF NETWORKS; DESIGN AND DEVELOPMENT OF WIRELESS COMPUTER NETWORKS; DESIGN, DEPLOYMENT AND MANAGEMENT OF WIRELESS NETWORKS FOR OTHERS; DEVELOPMENT OF SECURITY SYSTEMS AND CONTINGENCY PLANNING FOR INFORMATION SYSTEMS; ENGINEERING; INFORMATION TECHNOLOGY CONSULTATION; INTEGRATION OF COMPUTER SYSTEMS AND NETWORKS; IT CONSULTING SERVICES; IT INTEGRATION SERVICES; MAINTENANCE OF COMPUTER SOFTWARE RELATING TO COMPUTER SECURITY AND PREVENTION OF COMPUTER RISKS; PLANNING AND DEVELOPMENT OF ELECTRONIC COMMUNICATIONS NETWORKS; PLANNING, DESIGN AND IMPLEMENTATION OF VIRTUALIZATION TECHNOLOGIES FOR ENTERPRISES AND BUSINESSES; PROFESSIONAL COMPUTER SERVICES, NAMELY, NETWORK ANALYSIS, LAN/WAN DESIGN, WIRELESS ENGINEERING, VIRTUALIZATION AND COMPUTER PROJECT MANAGEMENT; PROVIDING PLANNING AND ENGINEERING SERVICES IN THE FIELD OF INFORMATION AND COMMUNICATIONS NETWORKS; RECOVERY OF COMPUTER DATA; REMOTE COMPUTER BACKUP SERVICES; REMOTE COMPUTER NETWORK TECHNICAL MONITORING AND SOFTWARE MAINTENANCE SERVICES; SATELLITE TELECOMMUNICATIONS TECHNOLOGY SERVICE TO ALLOW EFFICIENCIES OF THE CARRIER BY CREATING EFFICIENT USE OF BANDWIDTH ON A SATELLITE TRANSPONDER; TECHNICAL CONSULTATION IN THE FIELD OF REAL-TIME RECONFIGURABLE WIRELESS COMMUNICATION HANDSETS AND NETWORK EQUIPMENT FOR USE IN WIDEBAND COMMUNICATIONS; TECHNICAL CONSULTING AND ASSISTANCE WITH COMPUTER-BASED INFORMATION SYSTEMS AND COMPONENTS; TECHNICAL SUPPORT SERVICES, NAMELY, TROUBLESHOOTING IN THE NATURE OF DIAGNOSING COMPUTER HARDWARE AND SOFTWARE PROBLEMS; TECHNICAL SUPPORT, NAMELY, MONITORING OF NETWORK SYSTEMS; TECHNICAL SUPPORT, NAMELY, PROVIDING BACK-UP COMPUTER PROGRAMS AND FACILITIES (U.S. CLS. 100 AND 101).

KHANH LE, EXAMINING ATTORNEY

SN 77-920,153. FTEN, INC., NEW YORK, NY. FILED 1-26-2010.

Know your client in real
time

THE MARK CONSISTS OF STANDARD CHARACTERS WITHOUT CLAIM TO ANY PARTICULAR FONT, STYLE, SIZE, OR COLOR.

CLASS 9—ELECTRICAL AND SCIENTIFIC APPARATUS

FOR SOFTWARE FOR USE IN HIGH SPEED, LOW LATENCY FINANCIAL SECURITIES TRADING (U.S. CLS. 21, 23, 26, 36 AND 38).

CLASS 35—ADVERTISING AND BUSINESS

FOR ANALYZING AND COMPILING DATA FOR MEASURING THE PERFORMANCE OF FINANCIAL MARKETS (U.S. CLS. 100, 101 AND 102).

EDWARD FENNESSY, EXAMINING ATTORNEY

SN 77-920,198. FTEN, INC., NEW YORK, NY. FILED 1-26-2010.

Know your client - Know
their Trades - in Real time

THE MARK CONSISTS OF STANDARD CHARACTERS WITHOUT CLAIM TO ANY PARTICULAR FONT, STYLE, SIZE, OR COLOR.

CLASS 9—ELECTRICAL AND SCIENTIFIC APPARATUS

FOR SOFTWARE FOR USE IN HIGH SPEED, LOW LATENCY FINANCIAL SECURITIES TRADING (U.S. CLS. 21, 23, 26, 36 AND 38).

CLASS 35—ADVERTISING AND BUSINESS

FOR ANALYZING AND COMPILING DATA FOR MEASURING THE PERFORMANCE OF FINANCIAL MARKETS (U.S. CLS. 100, 101 AND 102).

EDWARD FENNESSY, EXAMINING ATTORNEY

SN 77-921,085. CARGILL, INCORPORATED, WAYZATA, MN. FILED 1-27-2010.



OWNER OF U.S. REG. NOS. 2,947,686 AND 3,046,493.
THE MARK CONSISTS OF A CORN STALK WITHIN A SEMI-CIRCLE OVER THE WORD "INNOVASURE".

CLASS 30—STAPLE FOODS

FOR WHITE CORN MASA FLOUR, YELLOW CORN MASA FLOUR AND PROCESSED YELLOW CORN (U.S. CL. 46).
FIRST USE 6-1-2002; IN COMMERCE 6-1-2002.

CLASS 42—SCIENTIFIC AND COMPUTER SERVICES

FOR SETTING STANDARDS AND REVIEWING PRACTICES TO ASSURE COMPLIANCE IN THE PROVISION OF PRODUCTS OR INGREDIENTS USING A UNIQUE IDENTITY PRESERVATION PROTOCOL FOR THE SELECTION OF HYBRIDS THROUGH GROWING, HANDLING, PROCESSING AND DISTRIBUTION; TESTING AND CONSULTATION IN THE FIELD OF IDENTITY PRESERVED CORN; PRODUCT RESEARCH AND DEVELOPMENT IN THE FIELD OF IDENTITY PRESERVED CORN; AND TECHNICAL SUPERVISION AND INSPECTION IN THE FIELD OF IDENTITY PRESERVED CORN (U.S. CLS. 100 AND 101).
FIRST USE 9-13-2005; IN COMMERCE 9-13-2005.
KATHERINE STOIDES, EXAMINING ATTORNEY

SN 77-921,555. CARGILL, INCORPORATED, WAYZATA, MN. FILED 1-27-2010.

SCHOOL MATES

THE MARK CONSISTS OF STANDARD CHARACTERS WITHOUT CLAIM TO ANY PARTICULAR FONT, STYLE, SIZE, OR COLOR.

CLASS 5—PHARMACEUTICALS

FOR MEAL REPLACEMENT SNACKS (U.S. CLS. 6, 18, 44, 46, 51 AND 52).

CLASS 30—STAPLE FOODS

FOR PROCESSED CEREAL-BASED FOOD TO BE USED AS A BREAKFAST FOOD, SNACK FOOD OR INGREDIENT FOR MAKING OTHER FOODS; SNACK CAKES (U.S. CL. 46).

KATHERINE STOIDES, EXAMINING ATTORNEY

SN 77-921,578. JGCID, INC., AMAGANSET, NY. FILED 1-27-2010.

VERLAINE

THE MARK CONSISTS OF STANDARD CHARACTERS WITHOUT CLAIM TO ANY PARTICULAR FONT, STYLE, SIZE, OR COLOR.

CLASS 9—ELECTRICAL AND SCIENTIFIC APPARATUS

FOR EYEGLASSES; SUNGLASSES (U.S. CLS. 21, 23, 26, 36 AND 38).

CLASS 18—LEATHER GOODS

FOR ALL-PURPOSE CARRYING BAGS; LEATHER BAGS AND WALLETS; PURSES; TOTE BAGS; WALLETS (U.S. CLS. 1, 2, 3, 22 AND 41).

CLASS 25—CLOTHING

FOR BELTS; BLAZERS; BOTTOMS; COATS; GLOVES; HATS; JACKETS; JEANS; PANTS; RAINWEAR; ROBES; SCARVES; SHOES; SHORTS; SLACKS; SLEEPWEAR; SLIPPERS; SNEAKERS; SOCKS; SUITS; SWEAT PANTS; SWEAT SHIRTS; SWEATERS; T-SHIRTS; TIES; TOPS; UNDERWEAR; VESTS (U.S. CLS. 22 AND 39).
COLLEEN DOMBROW, EXAMINING ATTORNEY

SN 77-922,097. DSW SHOE WAREHOUSE, INC., COLUMBUS, OH. FILED 1-28-2010.

HAPPY THEM. HAPPY YOU.

THE MARK CONSISTS OF STANDARD CHARACTERS WITHOUT CLAIM TO ANY PARTICULAR FONT, STYLE, SIZE, OR COLOR.

CLASS 35—ADVERTISING AND BUSINESS

FOR RETAIL STORE SERVICES, IN THE FIELD OF FOOTWEAR, HOSIERY AND CLOTHING ACCESSORIES (U.S. CLS. 100, 101 AND 102).
FIRST USE 11-5-2009; IN COMMERCE 11-5-2009.

CLASS 36—INSURANCE AND FINANCIAL

FOR FINANCIALLY-RELATED CARD IMPLEMENTED SERVICES, NAMELY, ISSUING STORED VALUE CARDS THAT MAY BE REDEEMED FOR THE PURCHASE OF GOODS (U.S. CLS. 100, 101 AND 102).
FIRST USE 11-5-2009; IN COMMERCE 11-5-2009.
WILLIAM ROSSMAN, EXAMINING ATTORNEY

SN 77-923,318. WHITEWAVE SERVICES, INC., DALLAS, TX.
FILED 1-29-2010.

SILK

THE MARK CONSISTS OF STANDARD CHARACTERS WITHOUT CLAIM TO ANY PARTICULAR FONT, STYLE, SIZE, OR COLOR.

OWNER OF U.S. REG. NOS. 2,302,273, 3,287,098 AND OTHERS.

CLASS 29—MEATS AND PROCESSED FOODS

FOR NUT-BASED MILK (U.S. CL. 46).

CLASS 30—STAPLE FOODS

FOR GRAIN-BASED BEVERAGES (U.S. CL. 46).

CLASS 32—LIGHT BEVERAGES

FOR COCONUT MILK (U.S. CLS. 45, 46 AND 48).
CHERYL CLAYTON, EXAMINING ATTORNEY

SN 77-923,528. GREEN MOUNTAIN COFFEE ROASTERS,
INC., WATERBURY, VT. FILED 1-29-2010.



NO CLAIM IS MADE TO THE EXCLUSIVE RIGHT TO USE "BREW OVER ICE" AS TO INTERNATIONAL CLASS 030, APART FROM THE MARK AS SHOWN.

THE MARK CONSISTS OF A CIRCLE CONTAINING THE WORD ELEMENTS "BREW OVER ICE" ENCIRCLING A BEVERAGE GLASS CONTAINING A STYLIZED BEVERAGE AND THREE STYLIZED ICE CUBES AND A STRAW, ALL ENCLOSED WITHIN A SQUARE.

CLASS 5—PHARMACEUTICALS

FOR NUTRITIONALLY FORTIFIED WATER; VITAMIN ENRICHED WATER (U.S. CLS. 6, 18, 44, 46, 51 AND 52).

CLASS 29—MEATS AND PROCESSED FOODS

FOR DAIRY-BASED BEVERAGES; DAIRY-BASED FOOD BEVERAGES; FRUIT-BASED FOOD BEVERAGE; MILK-BASED BEVERAGE CONTAINING COFFEE (U.S. CL. 46).

CLASS 30—STAPLE FOODS

FOR BEVERAGES MADE OF COFFEE; BEVERAGES MADE OF TEA; CHAI TEA; COFFEE AND TEA; COFFEE BASED BEVERAGES; COFFEE BEVERAGES WITH MILK; FRUIT TEAS; GREEN TEA; ICED TEA; PREPARED COFFEE AND COFFEE-BASED BEVERAGES; TEA-BASED BEVERAGES; TEA-BASED BEVERAGES WITH FRUIT FLAVORING (U.S. CL. 46).

CLASS 32—LIGHT BEVERAGES

FOR BOTTLED WATER; CARBONATED WATERS; DRINKING WATER WITH VITAMINS; FLAVOURED MINERAL WATER; FLAVOURED WATERS; FRUIT BEVERAGES; FRUIT-BASED SOFT DRINKS FLAVORED WITH TEA (U.S. CLS. 45, 46 AND 48).
ASMAT KHAN, EXAMINING ATTORNEY

SN 77-924,594. SHOES FOR CREWS, LLC, WEST PALM BEACH, FL. FILED 2-1-2010.



OWNER OF U.S. REG. NOS. 1,834,116, 3,666,305 AND OTHERS.

THE COLOR(S) YELLOW, PURPLE AND BLACK IS/ARE CLAIMED AS A FEATURE OF THE MARK.

THE MARK CONSISTS OF THE WORDS "SHOES FOR CREWS" OUTLINED IN BLACK WITH BOLD YELLOW LETTERING SUPERIMPOSED ON A PURPLE CRESCENT DESIGN.

CLASS 25—CLOTHING

FOR SLIP RESISTANT FOOTWEAR (U.S. CLS. 22 AND 39).

FIRST USE 3-1-2002; IN COMMERCE 3-1-2002.

CLASS 35—ADVERTISING AND BUSINESS

FOR RETAIL ONLINE STORE SERVICES FEATURING FOOTWEAR (U.S. CLS. 100, 101 AND 102).

FIRST USE 3-1-2002; IN COMMERCE 3-1-2002.

JOHN DALIER, EXAMINING ATTORNEY

SN 77-925,691. IDEAL INDUSTRIES, INC., SYCAMORE, IL.
FILED 2-2-2010.

CABLECREATOR

THE MARK CONSISTS OF STANDARD CHARACTERS WITHOUT CLAIM TO ANY PARTICULAR FONT, STYLE, SIZE, OR COLOR.

CLASS 8—HAND TOOLS

FOR HAND TOOLS FOR APPLYING ELECTRICAL CONNECTORS TO WIRES, CABLES AND FIBER CABLE (U.S. CLS. 23, 28 AND 44).

CLASS 9—ELECTRICAL AND SCIENTIFIC APPARATUS

FOR COAXIAL CABLE, TWISTED PAIR CABLE, AND FIBER CABLE, AND CONNECTORS FOR EACH TYPE OF CABLE; KITS CONTAINING COAXIAL, TWISTED PAIR AND FIBER CABLE AND CONNECTORS FOR EACH TYPE OF CABLE; AND ELECTRONIC TEST AND MEASURING DEVICES FOR TESTING THE ELECTRICAL CONTINUITY AND PERFORMANCE OF NEW OR EXISTING VOICE, DATA AND VIDEO CABLING SYSTEMS (U.S. CLS. 21, 23, 26, 36 AND 38).

MORGAN WYNNE, EXAMINING ATTORNEY

SN 77-926,163. AMERICAN GEOPHYSICAL UNION, WASHINGTON, DC. FILED 2-2-2010.

EOS

THE MARK CONSISTS OF STANDARD CHARACTERS WITHOUT CLAIM TO ANY PARTICULAR FONT, STYLE, SIZE, OR COLOR.

CLASS 16—PAPER GOODS AND PRINTED MATTER

FOR PRINTED PUBLICATIONS, NAMELY, NEWSPAPERS AND NEWSLETTERS IN THE FIELD OF THE EARTH AND SPACE SCIENCES (U.S. CLS. 2, 5, 22, 23, 29, 37, 38 AND 50).

FIRST USE 1-2-1979; IN COMMERCE 1-2-1979.

CLASS 41—EDUCATION AND ENTERTAINMENT

FOR PROVIDING ONLINE PUBLICATIONS IN THE NATURE OF NEWSPAPERS AND NEWSLETTERS IN THE FIELD OF THE EARTH AND SPACE SCIENCES (U.S. CLS. 100, 101 AND 107).

FIRST USE 1-7-2003; IN COMMERCE 1-7-2003.
ARETHA SOMERVILLE, EXAMINING ATTORNEY

SN 77-927,199. RECKITT BENCKISER (SWITZERLAND) AG, WALLISELLEN-ZURICH, SWITZERLAND, FILED 2-3-2010.

AIROMIST

THE MARK CONSISTS OF STANDARD CHARACTERS WITHOUT CLAIM TO ANY PARTICULAR FONT, STYLE, SIZE, OR COLOR.

PRIORITY CLAIMED UNDER SEC. 44(D) ON ERPNCMNTY TM OFC APPLICATION NO. 008503864, FILED 8-21-2009, REG. NO. 008503864, DATED 1-27-2010, EXPIRES 8-21-2019.

CLASS 3—COSMETICS AND CLEANING PREPARATIONS

FOR PERFUMING PREPARATIONS FOR THE AIR, NAMELY, ROOM FRAGRANCES, ROOM PERFUME SPRAYS; PREPARATIONS FOR PERFUMING OR FRAGRANCING THE AIR, NAMELY, INCENSE, INCENSE CONES, INCENSE STICKS, INCENSE SACHETS, INCENSE SPRAYS, ESSENTIAL OILS, POTPOURRI AND ROOM PERFUME SPRAYS; ALL FOR CONSUMER OR HOUSEHOLD USE ONLY (U.S. CLS. 1, 4, 6, 50, 51 AND 52).

CLASS 5—PHARMACEUTICALS

FOR AIR FRESHENERS AND AIR FRESHENING PREPARATIONS; AIR PURIFYING PREPARATIONS IN THE NATURE OF AIR DEODORIZERS; PREPARATIONS FOR PERFUMING OR FRAGRANCING THE AIR, NAMELY, ROOM AIR FRESHENERS; HOUSEHOLD AND ROOM DEODORANTS; ODOR NEUTRALIZING PREPARATIONS FOR USE ON CARPETS, TEXTILES AND IN THE AIR; ALL FOR CONSUMER OR HOUSEHOLD USE ONLY (U.S. CLS. 6, 18, 44, 46, 51 AND 52).

CLASS 11—ENVIRONMENTAL CONTROL APPARATUS

FOR APPARATUS AND INSTRUMENTS, NAMELY, DISPENSING UNITS AND DIFFUSERS FOR ROOM FRAGRANCES, AIR FRESHENERS AND ROOM DEODORANTS, ALL FOR SCENTING, PURIFYING OR FRESHENING THE ATMOSPHERE; PARTS AND FITTINGS FOR ALL THE AFORESAID GOODS SOLD AS A UNIT THEREWITH; ALL FOR CONSUMER OR HOUSEHOLD USE ONLY (U.S. CLS. 13, 21, 23, 31 AND 34).

MATTHEW EINSTEIN, EXAMINING ATTORNEY

SN 77-928,781. TRAILERLOGIC, DBA MORTUARY RESPONSE SOLUTIONS, BELTON, SC. FILED 2-5-2010.

CHALKMAN

THE MARK CONSISTS OF STANDARD CHARACTERS WITHOUT CLAIM TO ANY PARTICULAR FONT, STYLE, SIZE, OR COLOR.

CLASS 21—HOUSEWARES AND GLASS

FOR CONTAINERS, NAMELY, CUPS; DRINKING GLASSES, AND MUGS (U.S. CLS. 2, 13, 23, 29, 30, 33, 40 AND 50).

CLASS 25—CLOTHING

FOR CLOTHING, NAMELY, T-SHIRTS AND CAPS (U.S. CLS. 22 AND 39).

CLASS 28—TOYS AND SPORTING GOODS

FOR TOYS, NAMELY, SKATEBOARDS AND MINIATURE SKATEBOARDS (U.S. CLS. 22, 23, 38 AND 50).

CLASS 39—TRANSPORTATION AND STORAGE

FOR DISASTER RESPONSE SERVICES, NAMELY, PROVIDING FACILITIES, STORAGE UNITS, AND COOLING TRAILERS, BAGS, PACKS, AND REFRIGERATORS FOR HOUSING FATALITIES (U.S. CLS. 100 AND 105).

MARY ROSSMAN, EXAMINING ATTORNEY

SN 77-929,117. 745 LLC, BOSTON, MA. FILED 2-5-2010.

THE GIG

THE MARK CONSISTS OF STANDARD CHARACTERS WITHOUT CLAIM TO ANY PARTICULAR FONT, STYLE, SIZE, OR COLOR.

CLASS 9—ELECTRICAL AND SCIENTIFIC APPARATUS

FOR COMPUTER GAME SOFTWARE, VIDEO GAME SOFTWARE, INTERACTIVE COMPUTER AND VIDEO GAME PROGRAMS, VIDEO GAME CONTROLLERS, GAME CONTROLLERS FOR COMPUTER GAMES, VIDEO GAME DISCS AND CARTRIDGES FOR USE BY ONE OR MORE PLAYERS ON VIDEO GAME CONSOLES, DOWNLOADABLE VIDEO GAME SOFTWARE, INTERACTIVE VIDEO GAME SOFTWARE RECORDED ON A CARTRIDGE OR DVD OR CD SOLD AS A UNIT WITH AN ELECTRONIC VIDEO GAME CONTROLLER, INTERACTIVE MULTIMEDIA VIDEO GAME PROGRAMS AND ACCOMPANYING INSTRUCTION AND STRATEGY MANUALS, PRE-RECORDED CD-ROMS AND DVDS FEATURING GAMES, FILMS, AND MUSIC, COMPUTER GAME SOFTWARE, VIDEO GAME SOFTWARE (U.S. CLS. 21, 23, 26, 36 AND 38).

CLASS 15—MUSICAL INSTRUMENTS

FOR MUSICAL INSTRUMENTS (U.S. CLS. 2, 21 AND 36).

SAMUEL E. SHARPER JR., EXAMINING ATTORNEY

SN 77-929,131. 745 LLC, BOSTON, MA. FILED 2-5-2010.

SIXXSTRING

THE MARK CONSISTS OF STANDARD CHARACTERS WITHOUT CLAIM TO ANY PARTICULAR FONT, STYLE, SIZE, OR COLOR.

CLASS 9—ELECTRICAL AND SCIENTIFIC APPARATUS

FOR COMPUTER GAME SOFTWARE, VIDEO GAME SOFTWARE, INTERACTIVE COMPUTER AND VIDEO GAME PROGRAMS, VIDEO GAME CONTROLLERS, GAME CONTROLLERS FOR COMPUTER GAMES, VIDEO GAME DISCS AND CARTRIDGES FOR USE BY ONE OR MORE PLAYERS ON VIDEO GAME CONSOLES, DOWNLOADABLE VIDEO GAME SOFTWARE, INTERACTIVE VIDEO GAME SOFTWARE RECORDED ON A CARTRIDGE OR DVD OR CD SOLD AS A UNIT WITH AN ELECTRONIC VIDEO GAME CONTROLLER, INTERACTIVE MULTIMEDIA VIDEO GAME PROGRAMS AND ACCOMPANYING INSTRUCTION AND STRATEGY MANUALS, PRE-RECORDED CD-ROMS AND DVDS FEATURING GAMES, FILMS, AND MUSIC, COMPUTER GAME SOFTWARE, VIDEO GAME SOFTWARE (U.S. CLS. 21, 23, 26, 36 AND 38).

CLASS 15—MUSICAL INSTRUMENTS

FOR MUSICAL INSTRUMENTS (U.S. CLS. 2, 21 AND 36).

SAMUEL E. SHARPER JR., EXAMINING ATTORNEY

SN 77-929,139. 745 LLC, BOSTON, MA. FILED 2-5-2010.

STORMER

THE MARK CONSISTS OF STANDARD CHARACTERS WITHOUT CLAIM TO ANY PARTICULAR FONT, STYLE, SIZE, OR COLOR.

CLASS 9—ELECTRICAL AND SCIENTIFIC APPARATUS

FOR COMPUTER GAME SOFTWARE, VIDEO GAME SOFTWARE, INTERACTIVE COMPUTER AND VIDEO GAME PROGRAMS, VIDEO GAME CONTROLLERS, GAME CONTROLLERS FOR COMPUTER GAMES, VIDEO GAME DISCS AND CARTRIDGES FOR USE BY ONE OR MORE PLAYERS ON VIDEO GAME CONSOLES, DOWNLOADABLE VIDEO GAME SOFTWARE, INTERACTIVE VIDEO GAME SOFTWARE RECORDED ON A CARTRIDGE OR DVD OR CD SOLD AS A UNIT WITH AN ELECTRONIC VIDEO GAME CONTROLLER, INTERACTIVE MULTIMEDIA VIDEO GAME PROGRAMS AND ACCOMPANYING INSTRUCTION AND STRATEGY MANUALS, PRE-RECORDED CD-ROMS AND DVDS FEATURING GAMES, FILMS, AND MUSIC, COMPUTER GAME SOFTWARE, VIDEO GAME SOFTWARE (U.S. CLS. 21, 23, 26, 36 AND 38).

CLASS 15—MUSICAL INSTRUMENTS

FOR MUSICAL INSTRUMENTS (U.S. CLS. 2, 21 AND 36).

SAMUEL E. SHARPER JR., EXAMINING ATTORNEY

SN 77-929,463. ZINUS INC., DBA ZINUS INC., PLEASANTON, CA. FILED 2-5-2010.

COMFORT FOAM

THE MARK CONSISTS OF STANDARD CHARACTERS WITHOUT CLAIM TO ANY PARTICULAR FONT, STYLE, SIZE, OR COLOR.

NO CLAIM IS MADE TO THE EXCLUSIVE RIGHT TO USE "FOAM", APART FROM THE MARK AS SHOWN.

CLASS 20—FURNITURE AND ARTICLES NOT OTHERWISE CLASSIFIED

FOR BATH PILLOWS; MATTRESS TOPPERS; MATTRESSES AND PILLOWS; SLEEP PRODUCTS, NAMELY, MATTRESSES, SPRING MATTRESSES, BOX SPRINGS AND MATTRESS FOUNDATIONS, ALL GOODS ARE MADE IN WHOLE OR IN PART OF FOAM (U.S. CLS. 2, 13, 22, 25, 32 AND 50).

CLASS 25—CLOTHING

SN 77-933,689. JKA, INC., HOPKINS, MN. FILED 2-11-2010.

FOR BATH SLIPPERS; SLIPPERS, ALL GOODS ARE MADE IN WHOLE OR IN PART OF FOAM (U.S. CLS. 22 AND 39).

CLASS 27—FLOOR COVERINGS

FOR BATH MATS MADE IN WHOLE OR IN PART OF FOAM (U.S. CLS. 19, 20, 37, 42 AND 50).
KEVON CHISOLM, EXAMINING ATTORNEY

GAS UP THE TRUCK

THE MARK CONSISTS OF STANDARD CHARACTERS WITHOUT CLAIM TO ANY PARTICULAR FONT, STYLE, SIZE, OR COLOR.

SN 77-931,342. FTEN, INC., NEW YORK, NY. FILED 2-9-2010.

CLASS 9—ELECTRICAL AND SCIENTIFIC APPARATUS

FOR DECORATIVE MAGNETS (U.S. CLS. 21, 23, 26, 36 AND 38).

QuantXpress

THE MARK CONSISTS OF STANDARD CHARACTERS WITHOUT CLAIM TO ANY PARTICULAR FONT, STYLE, SIZE, OR COLOR.

CLASS 16—PAPER GOODS AND PRINTED MATTER

FOR STICKERS (U.S. CLS. 2, 5, 22, 23, 29, 37, 38 AND 50).

CLASS 9—ELECTRICAL AND SCIENTIFIC APPARATUS

FOR SOFTWARE FOR USE IN HIGH SPEED, LOW LATENCY FINANCIAL SECURITIES TRADING (U.S. CLS. 21, 23, 26, 36 AND 38).

CLASS 24—FABRICS

FOR TEXTILE OR VINYL BANNERS (U.S. CLS. 42 AND 50).

CLASS 35—ADVERTISING AND BUSINESS

FOR ANALYZING AND COMPILING DATA FOR MEASURING THE PERFORMANCE OF FINANCIAL MARKETS (U.S. CLS. 100, 101 AND 102).
EDWARD FENNESSY, EXAMINING ATTORNEY

CLASS 25—CLOTHING

FOR TEE SHIRTS AND HATS (U.S. CLS. 22 AND 39).

CLASS 30—STAPLE FOODS

FOR BREATH MINTS FOR USE AS A BREATH FRESHENER (U.S. CL. 46).
SUSAN RICHARDS, EXAMINING ATTORNEY

SN 77-933,607. SABRA DIPPING COMPANY, LLC, ASTORIA, NY. FILED 2-11-2010.

SN 77-933,878. THE QUAKER OATS COMPANY, CHICAGO, IL. FILED 2-11-2010.

SABRA

THE PERFECT BREAKFAST

THE MARK CONSISTS OF STANDARD CHARACTERS WITHOUT CLAIM TO ANY PARTICULAR FONT, STYLE, SIZE, OR COLOR.

OWNER OF U.S. REG. NOS. 2,414,891 AND 2,982,651.
THE ENGLISH TRANSLATION OF "SABRA" IN THE MARK IS NATIVE BORN IN THE LANGUAGE HEBREW.

THE MARK CONSISTS OF STANDARD CHARACTERS WITHOUT CLAIM TO ANY PARTICULAR FONT, STYLE, SIZE, OR COLOR.

NO CLAIM IS MADE TO THE EXCLUSIVE RIGHT TO USE "BREAKFAST", APART FROM THE MARK AS SHOWN.

CLASS 29—MEATS AND PROCESSED FOODS

FOR VEGETABLE SALADS, GARDEN SALADS, VEGETABLE-BASED SPREADS, DAIRY-BASED SPREADS, LEGUME-BASED SPREADS, DAIRY-BASED DIPS, GUACAMOLE AND HUMMUS (U.S. CL. 46).

CLASS 30—STAPLE FOODS

FOR BREAKFAST CEREALS, NAMELY, READY TO EAT CEREALS AND HOT CEREALS; CEREAL BASED SNACK FOODS; GRAIN-BASED SNACK BARS; GRAIN-BASED RICE CAKES; OATMEAL (U.S. CL. 46).

CLASS 30—STAPLE FOODS

FOR SALSA (U.S. CL. 46).
ADA HAN, EXAMINING ATTORNEY

CLASS 32—LIGHT BEVERAGES

FOR FRUIT JUICE AND FRUIT JUICE DRINKS (U.S. CLS. 45, 46 AND 48).
SUSAN RICHARDS, EXAMINING ATTORNEY

SN 77-936.030. RETAIL BRAND ALLIANCE, INC., ENFIELD, CT. FILED 2-15-2010.

SN 77-940.026. THE QUAKER OATS COMPANY, CHICAGO, IL. FILED 2-19-2010.



OWNER OF U.S. REG. NOS. 3,029,205, 3,277,205 AND OTHERS.

THE MARK CONSISTS OF THE TERMS "BROOKS BROTHERS" IN A SCRIPT FONT AND A CREST DESIGN CONTAINING THE LETTERS "BB" WITH A DECORATIVE PARTITION BETWEEN THE TWO LETTERS AND A RIBBON CONTAINING THE TERMS "COUNTRY CLUB".

CLASS 3—COSMETICS AND CLEANING PREPARATIONS

FOR FRAGRANCES, AFTER SHAVE BALM, BODY CREAMS AND BODY WASH (U.S. CLS. 1, 4, 6, 50, 51 AND 52).

FIRST USE 3-31-2003; IN COMMERCE 3-31-2003.

CLASS 18—LEATHER GOODS

FOR HANDBAGS, TOTE BAGS, BACKPACKS, LUGGAGE, WALLETS, PURSES, DUFFLE BAGS, ALL-PURPOSE SPORT BAGS, BILLFOLDS, KEY CASES, TRAVEL BAGS, OVERNIGHT BAGS, UMBRELLAS (U.S. CLS. 1, 2, 3, 22 AND 41).

FIRST USE 3-31-2003; IN COMMERCE 3-31-2003.

CLASS 25—CLOTHING

FOR SHIRTS, TOPS, SWEATERS, JACKETS, PANTS, BOTTOMS, SOCKS, HATS AND CAPS, SHORTS, COATS, UNDERWEAR, VESTS, ROBES, HOSIERY, SKIRTS, DRESSES, LOUNGEWEAR, SCARVES, RAINWEAR, TROUSERS, TIES, PAJAMAS, ROBES, GLOVES, BELTS, BOOTS, BEACH WEAR, SWIMWEAR (U.S. CLS. 22 AND 39).

FIRST USE 3-31-2003; IN COMMERCE 3-31-2003.

CLASS 28—TOYS AND SPORTING GOODS

FOR GOLF ACCESSORIES AND GOLF EQUIPMENT, NAMELY, GOLF BALLS, GOLF BAGS, GOLF TEES, AND GOLF CLUB COVERS (U.S. CLS. 22, 23, 38 AND 50).

FIRST USE 3-31-2003; IN COMMERCE 3-31-2003.

CLASS 35—ADVERTISING AND BUSINESS

FOR RETAIL MAIL ORDER SERVICES AND RETAIL STORES SERVICES AND COMPUTERIZED ONLINE ORDERING AND ONLINE RETAIL STORE SERVICES VIA A COMPUTER NETWORK IN THE FIELD OF CONSUMER GOODS, NAMELY, CLOTHING, LUGGAGE, WALLETS, COSMETICS AND JEWELRY (U.S. CLS. 100, 101 AND 102).

FIRST USE 3-31-2003; IN COMMERCE 3-31-2003.
CYNTHIA TRIPI, EXAMINING ATTORNEY

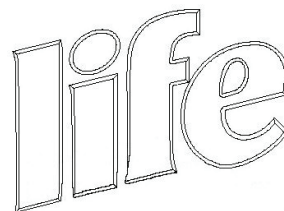

OWNER OF U.S. REG. NOS. 372,072, 1,758,570 AND OTHERS.

THE MARK CONSISTS OF THE WORD "LIFE" IN STYLIZED LETTERS, SLANTING UPWARD.

CLASS 29—MEATS AND PROCESSED FOODS

FOR NUT-BASED SNACK BARS (U.S. CL. 46).

CLASS 30—STAPLE FOODS

FOR BAKERY GOODS, BREADS, COOKIES AND FROZEN BREAKFAST FOODS, NAMELY, WAFFLES, PANCAKES, FRENCH TOAST, BAKERY GOODS, AND PASTRIES (U.S. CL. 46).

SUSAN RICHARDS, EXAMINING ATTORNEY

SN 77-940,331. 745 LLC, BOSTON, MA. FILED 2-19-2010.

POWERGIG

THE MARK CONSISTS OF STANDARD CHARACTERS WITHOUT CLAIM TO ANY PARTICULAR FONT, STYLE, SIZE, OR COLOR.

CLASS 9—ELECTRICAL AND SCIENTIFIC APPARATUS

FOR COMPUTER GAME SOFTWARE, VIDEO GAME SOFTWARE, INTERACTIVE COMPUTER AND VIDEO GAME PROGRAMS, VIDEO GAME CONTROLLERS, GAME CONTROLLERS FOR COMPUTER GAMES, VIDEO GAME DISCS AND CARTRIDGES FOR USE BY ONE OR MORE PLAYERS ON VIDEO GAME CONSOLES, DOWNLOADABLE VIDEO GAME SOFTWARE, INTERACTIVE VIDEO GAME SOFTWARE RECORDED ON A CARTRIDGE OR DVD OR CD SOLD AS A UNIT WITH AN ELECTRONIC VIDEO GAME CONTROLLER, INTERACTIVE MULTIMEDIA VIDEO GAME PROGRAMS AND ACCOMPANYING INSTRUCTION AND STRATEGY MANUALS, PRE-RECORDED CD-ROMS AND DVDS FEATURING GAMES, FILMS, AND MUSIC, COMPUTER GAME SOFTWARE, VIDEO GAME SOFTWARE (U.S. CLS. 21, 23, 26, 36 AND 38).

CLASS 15—MUSICAL INSTRUMENTS

FOR MUSICAL INSTRUMENTS (U.S. CLS. 2, 21 AND 36).

SAMUEL E. SHARPER JR., EXAMINING ATTORNEY

SN 77-940,502. FTEN, INC., NEW YORK, NY. FILED 2-19-2010.

AXcessExpress

THE MARK CONSISTS OF STANDARD CHARACTERS WITHOUT CLAIM TO ANY PARTICULAR FONT, STYLE, SIZE, OR COLOR.

CLASS 9—ELECTRICAL AND SCIENTIFIC APPARATUS

FOR SOFTWARE FOR USE IN HIGH SPEED, LOW LATENCY FINANCIAL SECURITIES TRADING (U.S. CLS. 21, 23, 26, 36 AND 38).

CLASS 35—ADVERTISING AND BUSINESS

FOR ANALYZING AND COMPILING DATA FOR MEASURING THE PERFORMANCE OF FINANCIAL MARKETS (U.S. CLS. 100, 101 AND 102).
EDWARD FENNESSY, EXAMINING ATTORNEY

SN 77-941,519. VINCENT T. WILLIAMS, CHESTERFIELD, VA. FILED 2-22-2010.

2T222

THE MARK CONSISTS OF STANDARD CHARACTERS WITHOUT CLAIM TO ANY PARTICULAR FONT, STYLE, SIZE, OR COLOR.

CLASS 14—JEWELRY

FOR BRACELETS; BROACHES; BROOCHES; CHARMS; CHARMS FOR COLLAR JEWELRY AND BRACELET; IDENTIFICATION BRACELETS; JEWELRY; JEWELRY AND IMITATION JEWELRY; JEWELRY BOXES; JEWELRY BOXES NOT OF METAL; JEWELRY BOXES OF PRECIOUS METAL; JEWELRY BROOCHES; JEWELRY CHAINS; JEWELRY FINDINGS; JEWELRY FOR THE HEAD; JEWELRY IN THE NATURE OF ARMBANDS; JEWELRY ORGANIZERS; JEWELRY PINS FOR USE ON HATS; JEWELRY WATCHES; JEWELRY, NAMELY, AMULETS; JEWELRY, NAMELY, ANKLETS; JEWELRY, NAMELY, ARM CUFFS; JEWELRY, NAMELY, CROSSES; JEWELRY, NAMELY, MAGNETIC NECKLACES; JEWELRY, NAMELY, MAGNETIC PENDANTS; JEWELRY, NAMELY, PRECIOUS METAL PLATED REAL LEAVES AND FLOWERS; JEWELRY, NAMELY, STONE PENDANTS; LAPEL PINS; PRECIOUS AND SEMI-PRECIOUS CRYSTAL STONES AND BEADS FOR USE IN JEWELRY; RINGS; RINGS BEING JEWELRY; RUBBER OR SILICON WRISTBANDS IN THE NATURE OF A BRACELET; STAINLESS STEEL JEWELRY BRACELETS; WATCHES AND JEWELRY; WATCHES, CLOCKS, JEWELRY AND IMITATION JEWELRY (U.S. CLS. 2, 27, 28 AND 50).

CLASS 18—LEATHER GOODS

FOR BACKPACKS; BACKPACKS, BOOK BAGS, SPORTS BAGS, BUM BAGS, WALLETS AND HANDBAGS; MILITARY DUFFLE BAGS, GARMENT BAGS FOR TRAVEL, TOTE BAGS, SHOULDER BAGS AND BACKPACKS; POUCHES AND BAGS SOLD EMPTY FOR ATTACHMENT TO BACKPACKS; SCHOOLCHILDREN'S BACKPACKS; SMALL BACKPACKS (U.S. CLS. 1, 2, 3, 22 AND 41).

CHRISTINE BLOMQUIST, EXAMINING ATTORNEY

SN 77-944,463. 745 LLC, BOSTON, MA. FILED 2-25-2010.

POWER GIG

THE MARK CONSISTS OF STANDARD CHARACTERS WITHOUT CLAIM TO ANY PARTICULAR FONT, STYLE, SIZE, OR COLOR.

CLASS 9—ELECTRICAL AND SCIENTIFIC APPARATUS

FOR COMPUTER GAME SOFTWARE, VIDEO GAME SOFTWARE, INTERACTIVE COMPUTER AND VIDEO GAME PROGRAMS, VIDEO GAME CONTROLLERS, GAME CONTROLLERS FOR COMPUTER GAMES, VIDEO GAME DISCS AND CARTRIDGES FOR USE BY ONE OR MORE PLAYERS ON VIDEO GAME CONSOLES, DOWNLOADABLE VIDEO GAME SOFTWARE, INTERACTIVE VIDEO GAME SOFTWARE RECORDED ON A CARTRIDGE OR DVD OR CD SOLD AS A UNIT WITH AN ELECTRONIC VIDEO GAME CONTROLLER, INTERACTIVE MULTIMEDIA VIDEO GAME PROGRAMS AND ACCOMPANYING INSTRUCTION AND STRATEGY MANUALS, PRE-RECORDED CD-ROMS AND DVDS FEATURING GAMES, FILMS, AND MUSIC, COMPUTER GAME SOFTWARE, VIDEO GAME SOFTWARE (U.S. CLS. 21, 23, 26, 36 AND 38).

CLASS 15—MUSICAL INSTRUMENTS

FOR MUSICAL INSTRUMENTS (U.S. CLS. 2, 21 AND 36).

SAMUEL E. SHARPER JR., EXAMINING ATTORNEY

SN 77-949,786. TAHARI, ELIE, MILLBURN, NJ. FILED 3-3-2010.

T TAHARI

THE MARK CONSISTS OF STANDARD CHARACTERS WITHOUT CLAIM TO ANY PARTICULAR FONT, STYLE, SIZE, OR COLOR.

OWNER OF U.S. REG. NOS. 3,350,460, 3,447,086 AND OTHERS.

CLASS 3—COSMETICS AND CLEANING PREPARATIONS

FOR FRAGRANCES, NAMELY, PERFUMES, COLOGNES AND EAU DE TOILETTE; COSMETICS, NAMELY, LIPSTICK, LIP BALM, LIP GLOSS, LIP CONTOUR PENCIL, EYE SHADOW, EYE LINER, EYE COLOR PENCIL, BROW COLOR PENCIL, MASCARA, BLUSHER, FACE AND BODY POWDER, FOUNDATION MAKEUP, NAIL POLISH, COSMETIC MASQUES AND MAKEUP REMOVER; SKIN CARE PRODUCTS, NAMELY, SKIN MOISTURIZERS, SKIN CONDITIONING CREAM, NIGHT CREAM, BODY CREAM, HAND CREAM, BODY POWDER, AND SKIN SOAP; HAIR CARE PRODUCTS, NAMELY, SHOWER GEL, HAIR SHAMPOO, HAIR CONDITIONER AND HAIR STYLING GEL; SUNSCREEN; AFTER SHAVE LOTIONS AND NON-MEDICATED AFTER SHAVE BALM (U.S. CLS. 1, 4, 6, 50, 51 AND 52).

CLASS 9—ELECTRICAL AND SCIENTIFIC APPARATUS

FOR SUNGLASSES, EYEGLASSES, NON-PRESCRIPTION READING GLASSES, EYEGASS CASES, EYEGASS CORDS, SUNGLASS CORDS (U.S. CLS. 21, 23, 26, 36 AND 38).

CLASS 14—JEWELRY

FOR JEWELRY, CLOCKS AND WATCHES (U.S. CLS. 2, 27, 28 AND 50).

CLASS 18—LEATHER GOODS

FOR HANDBAGS, LUGGAGE, TOTE BAGS, SCHOOL BAGS, SPORTS BAGS, BACKPACKS, MINI BACKPACKS, CARRY-ALL BAGS, WAIST BAGS, FANNY PACKS, KEY CASES, BRIEFCASES, DUFFLE BAGS, ALL-PURPOSE SPORT BAGS, BUSINESS CARD CASES, CREDIT CARD CASES, CHANGE PURSES, ATTACHE CASES AND BILLFOLDS (U.S. CLS. 1, 2, 3, 22 AND 41).

CLASS 20—FURNITURE AND ARTICLES NOT OTHERWISE CLASSIFIED

FOR FURNITURE, PILLOWS, CHAIR PADS, INTERIOR WINDOW BLINDS, WINDOW SHADES, CURTAIN RODS, CURTAIN RINGS, DECORATIVE CURTAIN HARDWARE, NAMELY, FINIALS AND CLOSET ORGANIZER KITS COMPRISED OF A SHELVES RACK, HOOKS AND BRACKETS (U.S. CLS. 2, 13, 22, 25, 32 AND 50).

CLASS 21—HOUSEWARES AND GLASS

FOR DINNERWARE, NAMELY, PLATES, CUPS, SAUCERS, BOWLS, SERVING PLATTERS, SERVING SPOONS AND FORKS, TABLEWARE, NAMELY, CAKE SERVERS, SALAD BOWLS, AND SALT AND PEPPER SHAKERS; VASES; CANDLESTICKS NOT OF PRECIOUS METAL; BEVERAGE GLASSWARE, NAMELY, STEAMWARE, TUMBLERS IN THE NATURE OF DRINKING GLASSES, ICED TEA GLASSES, WINE GLASSES, WATER GLASSES, HI-BALL GLASSES, GOBLETS, CHAMPAGNE GLASSES, LIQUEUR GLASSES, BRANDY GLASSES, CARAFES, ICE BUCKETS, DECANTERS, PERFUME BOTTLES AND ATOMIZERS SOLD EMPTY; VASES AND DECORATIVE PLATES NOT OF PRECIOUS METAL; WOODENWARE, PORCELAIN, AND CHINA, NAMELY, DISHES, CHARGER DISHES, BOWLS, PLATES, SERVING PLATTERS, CUPS, SAUCERS, CANDLESTICK HOLDERS, VASES AND PITCHERS (U.S. CLS. 2, 13, 23, 29, 30, 33, 40 AND 50).

CLASS 24—FABRICS

FOR HOME FURNISHINGS, NAMELY, BED SHEETS, PILLOW CASES, PILLOW SHAMS, DUVET COVERS, COMFORTERS, BED SPREADS, BED BLANKETS, BED LINENS, DUST RUFFLES, CURTAINS, DRAPES IN THE NATURE OF CURTAINS, TABLE CLOTHS NOT OF PAPER, FABRIC TABLE RUNNERS, TABLE LINENS, TEXTILE NAPKINS, TEXTILE PLACE MATS, TOWELS (U.S. CLS. 42 AND 50).

CLASS 25—CLOTHING

FOR APPAREL FOR WOMEN, NAMELY, OVERALLS, SWEATSHIRTS, SWEATPANTS, PLAYSUITS, ATHLETIC SUITS, BODYSUITS, TIGHTS AND BICYCLE SHORTS, HATS, CAPS, HEADBANDS, SOCKS AND HOSE, UNDERWEAR, ROBES, PAJAMA TOPS, PAJAMA BOTTOMS, NIGHTGOWNS, SLIPPERS, JUMPSUITS, TENNISWEAR, AND SKIWEAR, NAMELY, SKI JACKETS, SKI BODYSUITS AND SKI PANTS, SWIMWEAR, NAMELY, BATHING SUITS AND BEACH COVER UPS, KNIT HATS, KNIT GLOVES, HEAD WRAPS, COWL WRAPS AND EARMUFFS, WOMEN'S TIES, CUMMERBUNDS; APPAREL FOR GIRLS, NAMELY, SHIRTS, T-SHIRTS, TANK TOPS, HALTERS, BLOUSES, TOPS, JEANS, PANTS, SLACKS, OVERALLS, DRESSES, SKIRTS, SHORTS, JEAN JACKETS AND ANORAKS, SWEATERS, ATHLETIC TOPS AND BOTTOMS, BLAZERS, SUITS, SWEATSHIRTS, SWEATPANTS, PLAYSUITS, ATHLETIC AND JOGGING SUITS, BODYSUITS, TIGHTS AND BICYCLE SHORTS, HATS, CAPS, HEADBANDS, SCARVES, BELTS, SOCKS AND HOSE, UNDERWEAR AND LINGERIE, ROBES, PAJAMA TOPS, PAJAMA BOTTOMS, NIGHTGOWNS, SLIPPERS, JUMPSUITS, OUTERWEAR, KNITWEAR, AND TENNISWEAR, AND SKIWEAR, NAMELY, SKI JACKETS, SKI BODYSUITS AND SKI PANTS, SWIMWEAR, NAMELY, BATHING SUITS AND BEACH COVER UPS, CLOTH AND LEATHER COATS AND JACKETS, KNIT TOPS, KNIT BOTTOMS, KNIT HATS, KNIT GLOVES, HEAD WRAPS, COWL WRAPS AND EARMUFFS, WOMEN'S TIES, CUMMERBUNDS, NON-OUTERWEAR VESTS; FOOTWEAR FOR WOMEN AND GIRLS, NAMELY, BOOTS, SHOES, PUMPS, SNEAKERS, CLOGS, SLIPPERS, SANDALS AND THONGS; APPAREL FOR MEN AND BOYS, NAMELY, SHIRTS, T-SHIRTS, SUITS, VESTS, SWEATERS, TIES, BELTS, SPORTS JACKETS, BLAZERS, DINNER JACKETS, PANTS, JEANS, SOCKS, UNDERWEAR, ROBES, JEAN JACKETS, ATHLETIC AND JOGGING SUITS, BICYCLE SHORTS, OUTER COATS, RAINCOATS, TENNISWEAR, HATS, CAPS, HEADBANDS; FOOTWEAR FOR MEN AND BOYS, NAMELY, BOOTS, SHOES, SNEAKERS, CLOGS, SLIPPERS AND THONGS (U.S. CLS. 22 AND 39).

JENNIFER HETU, EXAMINING ATTORNEY

SN 77-951,511. TAHARI, ELIE, MILLBURN, NJ. FILED 3-5-2010.

TAHARI

THE MARK CONSISTS OF STANDARD CHARACTERS WITHOUT CLAIM TO ANY PARTICULAR FONT, STYLE, SIZE, OR COLOR.

OWNER OF U.S. REG. NOS. 1,489,405, 3,607,802 AND OTHERS.

CLASS 3—COSMETICS AND CLEANING PREPARATIONS

FOR FRAGRANCES, NAMELY, PERFUMES, COLOGNES AND EAU DE TOILETTE; COSMETICS, NAMELY, LIPSTICK, LIP BALM, LIP GLOSS, LIP CONTOUR PENCIL, EYE SHADOW, EYE LINER, EYE COLOR PENCIL, BROW COLOR PENCIL, MASCARA, BLUSHER, FACE AND BODY POWDER, FOUNDATION MAKEUP, NAIL POLISH, COSMETIC MASQUES AND MAKEUP REMOVER; SKIN CARE PRODUCTS, NAMELY, SKIN MOISTURIZERS, SKIN CONDITIONING CREAM, NIGHT CREAM, BODY CREAM, HAND CREAM, BODY POWDER, AND SKIN SOAP; HAIR CARE PRODUCTS, NAMELY, SHOWER GEL, HAIR SHAMPOO, HAIR CONDITIONER AND HAIR STYLING GEL; SUNSCREEN; AFTER SHAVE LOTIONS AND NON-MEDICATED AFTER SHAVE BALM (U.S. CLS. 1, 4, 6, 50, 51 AND 52).

CLASS 9—ELECTRICAL AND SCIENTIFIC APPARATUS

FOR SUNGLASSES, EYEGLASSES, NON-PRESCRIPTION READING GLASSES, EYEGLASS CASES, EYEGLASS CORDS, SUNGLASS CORDS (U.S. CLS. 21, 23, 26, 36 AND 38).

CLASS 14—JEWELRY

FOR JEWELRY, CLOCKS AND WATCHES (U.S. CLS. 2, 27, 28 AND 50).

CLASS 18—LEATHER GOODS

FOR UMBRELLAS, LUGGAGE, SCHOOL BAGS, SPORTS BAGS, BACKPACKS, MINI BACKPACKS, CARRY-ALL BAGS, WAIST BAGS, FANNY PACKS, KEY CASES, BRIEFCASES, DUFFLE BAGS, ALL-PURPOSE SPORT BAGS, BUSINESS CARD CASES, CREDIT CARD CASES, CHANGE PURSES, ATTACHÉ CASES AND BILLFOLDS (U.S. CLS. 1, 2, 3, 22 AND 41).

CLASS 25—CLOTHING

FOR CHILDREN'S CLOTHING, NAMELY, DRESSES, SKIRTS, BLOUSES, JACKETS, PANTS, SHIRTS, SUITS, BLAZERS, PULLOVERS, CARDIGANS, OVERALLS AND SOCKS (U.S. CLS. 22 AND 39).

JENNIFER HETU, EXAMINING ATTORNEY

SN 77-977,711. LIVE TO SURF, INC., TOFINO, CANADA, FILED 1-13-2009.



PRIORITY CLAIMED UNDER SEC. 44(D) ON CANADA APPLICATION NO. 1403125, FILED 7-14-2008.

OWNER OF CANADA REG. NO. TMA7612, DATED 10-20-2009, EXPIRES 10-20-2024.

NO CLAIM IS MADE TO THE EXCLUSIVE RIGHT TO USE "TOFINO", APART FROM THE MARK AS SHOWN.

THE MARK CONSISTS OF A CIRCLE WITH THE WORDS "LIVE TO SURF" ALONG AND WITHIN THE TOP PERIMETER OF THE CIRCLE AND THE WORD "TOFINO" ALONG AND WITHIN THE BOTTOM PERIMETER OF THE CIRCLE. A SUN DESIGN OVERLAPS A CIRCLE WITH ZIG-ZAG EDGES. AT THE CENTER OF THE SUN DESIGN IS A CIRCLE CONTAINING A SINGLE WAVE DESIGN WITH A SUN DESIGN IN THE UPPER RIGHT PORTION OF THE CIRCLE.

CLASS 3—COSMETICS AND CLEANING PREPARATIONS

FOR (BASED ON SECTIONS 1(B) AND 44(E)) LIP BALM; (BASED ON SECTION 1(B)) SUNSCREEN, SUN TANNING PREPARATIONS, NON-MEDICATED SKIN CARE PREPARATIONS, AFTER SUN LOTIONS (U.S. CLS. 1, 4, 6, 50, 51 AND 52).

CLASS 5—PHARMACEUTICALS

FOR (BASED ON SECTION 1(B)) MEDICATED SKIN CARE PREPARATIONS; AIR FRESHENERS (U.S. CLS. 6, 18, 44, 46, 51 AND 52).

CLASS 16—PAPER GOODS AND PRINTED MATTER

FOR (BASED ON SECTIONS 1(B) AND 44(E)) PRINTED MATTER, NAMELY, GIFT CARDS, POSTCARDS; (BASED ON SECTION 1(B)) PRINTED MATTER, NAMELY, PAPER BANNERS, CALENDARS, STATIONERY, STICKERS, DECALS, ADHESIVE TAPE FOR STATIONERY PURPOSES, POSTERS, SERIES OF BOOKS IN THE FIELD OF SPORTS AND LEISURE ACTIVITIES; PRINTED INSTRUCTIONAL AND EDUCATIONAL MATERIAL, ALL IN THE FIELD OF SURFING, SKATEBOARDING, AND SKIM BOARDING; READING MATERIAL, NAMELY, MAGAZINES AND BROCHURES, ALL IN THE FIELD OF SURFING, SKATEBOARDING, AND SKIMBOARDING; PAPER COASTERS, MONEY CLIPS, BALLPOINT PENS, PENCILS, DRIVERS LICENSE HOLDER, PLASTIC SHOPPING BAGS (U.S. CLS. 2, 5, 22, 23, 29, 37, 38 AND 50).

CLASS 18—LEATHER GOODS

FOR (BASED ON SECTION 1(B)) LUGGAGE AND LUGGAGE BAG TAGS, PURSES, WALLETS, CARD WALLETS, BACKPACKS, KEYCHAINS MADE OF LEATHER, UMBRELLAS, BEACH BAGS, TOTE BAGS, CREDIT CARD HOLDERS, WETSUIT BAGS (U.S. CLS. 1, 2, 3, 22 AND 41).

CLASS 20—FURNITURE AND ARTICLES NOT OTHERWISE CLASSIFIED

FOR (BASED ON SECTION 1(B)) PLASTIC BANNERS, INFLATABLE MATTRESS FOR USE WHEN CAMPING, PLASTIC KEYCHAINS (U.S. CLS. 2, 13, 22, 25, 32 AND 50).

CLASS 21—HOUSEWARES AND GLASS

FOR (BASED ON SECTION 1(B)) MUGS, DRINKING GLASSES, PLATES, CUPS, DISHES, GLASS BEVERAGEWARE AND STEMWARE, DINNERWARE, BOWLS, PITCHERS, GOBLETs, NAPKIN HOLDERS, STAINLESS STEEL BOTTLES SOLD EMPTY, WINE OPENERS, HOUSEWARES, NAMELY, TRIVETS, VASES, SALT AND PEPPER SHAKERS, COASTERS NOT OF PAPER AND NOT BEING TABLE LINEN; PORTABLE BEVERAGE COOLER, INSULATING FOAM DRINK HOLDERS, INSULATING NEOPRENE DRINK HOLDERS (U.S. CLS. 2, 13, 23, 29, 30, 33, 40 AND 50).

CLASS 24—FABRICS

FOR (BASED ON SECTION 1(B)) TEXTILE FABRICS, NAMELY, BLANKETS FOR OUTDOOR USE, TOWELS, BED SHEETS, PILLOW CASES, DUVET COVERS, BED BLANKETS, PLACE MATS NOT OF PAPER, CLOTH BANNERS, LINENS, NAMELY, BED LINEN AND BATH LINEN (U.S. CLS. 42 AND 50).

CLASS 28—TOYS AND SPORTING GOODS

FOR (BASED ON SECTIONS 1(B) AND 44(E)) SPORTING EQUIPMENT, NAMELY, SURFBOARDS; (BASED ON SECTION 1(B)) SPORTING EQUIPMENT, NAMELY, BODYBOARDS, SKIMBOARDS, SKATEBOARDS, PADDLE BOARDS, LEASHES FOR SURFBOARDS AND BODYBOARDS, BAGS ESPECIALLY DESIGNED FOR SURFBOARDS, BODYBOARDS, SKIMBOARDS AND SKATEBOARDS, SURFBOARD TRACTION PADS, SURF FINS, SWIM FINS, FINS FOR BODYBOARDS, AND SURF RELATED ACCESSORIES, NAMELY, SURF BOARD WAX, WAX COMBS, SURFBOARD STORAGE RACK, SURFBOARD CARRIERS WORN ON THE BODY, PADDLES FOR USE WITH SURFBOARDS, SLINGS WORN ON THE BODY FOR CARRYING SURFBOARDS AND LEASHES FOR SWIM FINS, FLYING DISCS, BALLOONS, BEACH BALLS, DART BOARDS, INFLATABLE MATTRESS FOR RECREATIONAL USE, PLAYING CARDS (U.S. CLS. 22, 23, 38 AND 50).

CLASS 35—ADVERTISING AND BUSINESS

FOR (BASED ON SECTIONS 1(B) AND 44(E)) RETAIL STORE SERVICES FEATURING SURF, SKATE AND SWIM EQUIPMENT; (BASED ON SECTION 1(B)) WHOLESALE STORE SERVICES FEATURING SURF, SKATE AND SWIM EQUIPMENT (U.S. CLS. 100, 101 AND 102).

CLASS 41—EDUCATION AND ENTERTAINMENT

FOR (BASED ON SECTIONS 1(B) AND 44(E)) RENTALS OF SURF, SKATE AND SWIM EQUIPMENT; PROVIDING SURF, SKATE AND SWIM LESSONS (U.S. CLS. 100, 101 AND 107).

LEIGH LOWRY, EXAMINING ATTORNEY

SN 77-978,774. TEAMLINE ATHLETICS LTD., BURNABY, B.C., CANADA, FILED 5-20-2009.

TEAMLINE

THE MARK CONSISTS OF STANDARD CHARACTERS WITHOUT CLAIM TO ANY PARTICULAR FONT, STYLE, SIZE, OR COLOR.

CLASS 9—ELECTRICAL AND SCIENTIFIC APPARATUS

FOR NET ANTENNAE (U.S. CLS. 21, 23, 26, 36 AND 38).
FIRST USE 0-0-1997; IN COMMERCE 6-17-2003.

CLASS 10—MEDICAL APPARATUS

FOR THERAPEUTIC HOT AND COLD PACKS (U.S. CLS. 26, 39 AND 44).
FIRST USE 0-0-1997; IN COMMERCE 10-1-2003.

CLASS 28—TOYS AND SPORTING GOODS

FOR SPORTING AND ATHLETIC GOODS AND EQUIPMENT, NAMELY, TABLE TENNIS BALLS, FOOTBALL KICKING TEES, FLAG FOOTBALL BELTS, FOOTBALLS, VOLLEYBALLS, BASKETBALL NETS, AND GYMNASTIC EQUIPMENT, NAMELY, RIBBONS (U.S. CLS. 22, 23, 38 AND 50).

FIRST USE 0-0-1991; IN COMMERCE 3-30-2004.
KOURTNEE HODGES, EXAMINING ATTORNEY

SN 77-979,044. SEAN COMBS, NEW YORK, NY. FILED 6-3-2009.

DIDDY-DIRTY MONEY

THE MARK CONSISTS OF STANDARD CHARACTERS WITHOUT CLAIM TO ANY PARTICULAR FONT, STYLE, SIZE, OR COLOR.

OWNER OF U.S. REG. NO. 3,109,611.

CLASS 9—ELECTRICAL AND SCIENTIFIC APPARATUS

FOR SERIES OF MUSICAL SOUND RECORDINGS; DOWNLOADABLE MUSICAL SOUND RECORDINGS; AUDIO-VISUAL RECORDINGS FEATURING MUSIC AND MUSICAL PERFORMANCES; DOWNLOADABLE AUDIO-VISUAL RECORDINGS FEATURING MUSIC AND MUSICAL PERFORMANCES; DOWNLOADABLE RINGTONES AND GRAPHICS VIA A GLOBAL COMPUTER NETWORK AND WIRELESS DEVICES (U.S. CLS. 21, 23, 26, 36 AND 38).

CLASS 16—PAPER GOODS AND PRINTED MATTER

FOR PRINTED MATERIALS, NAMELY, POSTERS, STICKERS, SONG BOOKS, SHEET MUSIC; TOUR PAMPHLETS FEATURING INFORMATION ON A MUSIC GROUP AND ITS PERFORMANCES; SCHOOL AND DESK SUPPLIES, NAMELY, WRITING INSTRUMENTS, FILE FOLDERS AND NOTEBOOKS (U.S. CLS. 2, 5, 22, 23, 29, 37, 38 AND 50).

CLASS 38—COMMUNICATION

FOR STREAMING OF AUDIO MATERIAL AND VIDEO MATERIAL ON THE INTERNET; PROVIDING ONLINE CHATROOMS AND ELECTRONIC BULLETIN BOARDS FOR TRANSMISSION OF MESSAGES AMONG USERS CONCERNING A BAND, ITS RECORDINGS AND OTHER ACTIVITIES (U.S. CLS. 100, 101 AND 104).

CLASS 41—EDUCATION AND ENTERTAINMENT

FOR ENTERTAINMENT SERVICES, NAMELY, LIVE AND TELEVISED APPEARANCES AND PERFORMANCES BY A MUSIC GROUP; INTERNET SERVICES, NAMELY, PROVIDING A WEBSITE AND ONLINE PROFILE PAGES FEATURING MUSIC, VIDEOS, AND ENTERTAINMENT INFORMATION ON A MUSICAL GROUP AND ITS TOURS, RECORDINGS, APPEARANCES, PHOTOGRAPHS, BIOGRAPHIES AND OTHER ENTERTAINMENT INFORMATION (U.S. CLS. 100, 101 AND 107).

JAMES A. RAUEN, EXAMINING ATTORNEY

SN 78-083,253. BRAINLAB AG, KIRCHHEIM/HEIMSTETTEN, FED REP GERMANY, FILED 9-9-2001.

VECTORVISION KOLIBRI

PRIORITY CLAIMED UNDER SEC. 44(D) ON FED REP GERMANY APPLICATION NO. 30123412.4, FILED 4-10-2001, REG. NO. 30123412, DATED 3-27-2002, EXPIRES 4-30-2011.

THE ENGLISH TRANSLATION OF THE WORD "KOLIBRI" IN THE MARK IS "HUMMINGBIRD".

CLASS 9—ELECTRICAL AND SCIENTIFIC APPARATUS

FOR COMPUTERS; PLANNING SOFTWARE AND PROGRAMS FOR USE IN CONDUCTING NEUROSURGICAL, ORTHOPEDIC, RADIOTHERAPEUTIC OR RADIOSURGICAL PROCEDURES; PLANNING SOFTWARE AND PROGRAMS FOR APPLICATION IN ROBOT-ASSISTED MEDICAL APPLICATIONS; PLANNING SOFTWARE AND PROGRAMS FOR APPLICATION IN EAR, NOSE AND THROAT (ENT) SURGERY; PLANNING SOFTWARE AND PROGRAMS FOR APPLICATION TO THREE-DIMENSIONAL REGISTRATION OR REFERENCING PATIENT DATA BY PRODUCING LIGHT MARKINGS; DATA CARRIERS FEATURING PLANNING SOFTWARE AND PROGRAMS FOR NEUROSURGICAL, ORTHOPEDIC, RADIOTHERAPEUTIC OR RADIOSURGICAL PURPOSES; DATA CARRIERS FEATURING PLANNING SOFTWARE AND PROGRAMS FOR APPLICATION IN EAR, NOSE, AND THROAT SURGERY PURPOSES; DATA CARRIERS FEATURING PLANNING SOFTWARE AND PROGRAMS FOR APPLICATION TO THREE-DIMENSIONAL REGISTRATION AND/OR REFERENCING PATIENT DATA BY PRODUCING LIGHT MARKINGS; LIGHT POINTERS, LASER LIGHT POINTERS AND INFRARED LIGHT POINTERS ALL FOR IMAGE REGISTRATION AND LOCALIZATION IN MEDICAL APPLICATIONS (U.S. CLS. 21, 23, 26, 36 AND 38).

CLASS 10—MEDICAL APPARATUS

FOR IMAGE PRESENTATION APPARATUS FOR DISPLAYING MEDICAL IMAGES FOR MEDICAL PURPOSES; IMAGE-GUIDED LOCALIZATION SYSTEMS FOR SURGICAL PURPOSES; MEDICAL AND SURGICAL ROBOTS AND ACCESSORIES, NAMELY, CONTROL BOXES, INSTRUMENT ADAPTORS, TOOL HOLDERS, ADAPTORS FOR ENDOSCOPES AND MICROSCOPES, AND CONNECTION CABLES; RADIOTHERAPEUTIC AND RADIOSURGICAL APPARATUS; DEVICES TO ACQUIRE AND ADJUST RADIATION POINTS FOR MEDICAL PURPOSES; SYSTEMS AND COMPONENTS TO PRECISELY POSITION PATIENTS FOR RADIOTHERAPEUTIC, RADIOSURGICAL OR NEUROSURGICAL PURPOSES, NAMELY, COLLIMATORS, INFRARED AND VIDEO CAMERAS AND ACCESSORIES, PATIENT MARKERS, DISPLAYS, ISOCENTER PHANTOMS, CALIBRATION PHANTOMS, PATIENT TRAYS AND ACCESSORIES, HEAD HOLDERS AND ADAPTORS, VACUUM PUMPS, VACUUM CUSHIONS, REFERENCING STARS, ULTRASOUND PHANTOMS, ULTRASOUND ADAPTORS, AND X-RAY REGISTRATION KITS; NUCLEAR SPIN TOMOGRAPHS; MAGNETIC RESONANCE TOMOGRAPHS. INTRA-OPERATIVE, IMAGE-GUIDED LOCALIZATION SYSTEMS AND COMPONENTS FOR NEUROSURGICAL, ORTHOPEDIC, STEREOTACTIC, RADIOTHERAPEUTICAL OR RADIOSURGICAL PURPOSES, AND FOR APPLICATION IN EAR, NOSE AND THROAT SURGERY, CONSISTING OF CAMERAS, DISPLAYS, IMAGE PRESENTATION APPARATUS, COMPUTERS, REFERENCE CLAMPS, POINTERS, SURGICAL INSTRUMENTS, REGISTRATION MARKERS AND MARKER SPHERES, BODY MARKERS, CANULLAE, LAPTOPS, DOCKING STATIONS, PANELS, PANEL PARTS, HEADSETS, HEADRINGS, REMOTE CONTROLS, PROBES, SENSORS, INSTRUMENT ADAPTORS, VIRTUAL KEYBOARDS, DENTAL REFERENCING DEVICES, LASER POINTERS, PHANTOM POINTERS, SYSTEMS AND COMPONENTS FOR SOFTWARE-CONTROLLED PRECISION TREATMENT IN NEUROSURGERY, ORTHOPEDICS, RADIOTHERAPY OR RADIOSURGERY AND IN

EAR, NOSE, AND THROAT SURGERY, NAMELY, LOCALIZERS, TORQUE WRENCH SETS, STEREOTACTIC OR NEUROSURGICAL ARCS, FIXATION ADAPTORS, INSTRUMENT CALIBRATION MATRIXES AND FIXATION RINGS, PLANNING STATIONS, COMPUTERS, COUCHMOUNTS, COLLIMATORS, TARGET POSITIONERS, FILM HOLDERS, COUCH STABILIZERS, COUCH ADAPTORS, RADIATION DEVICES, LINEAR ACCELERATORS, GANTRIES, MICROSCOPE ADAPTORS, FIXATION PINS, HEAD AND NECK IMMOBILIZATION DEVICES, INSTRUMENTS AND APPARATUS FOR THREE-DIMENSIONAL REGISTRATION OR REFERENCING OF PATIENTS; LIGHT POINTERS FOR MEDICAL USE (U.S. CLS. 26, 39 AND 44).

CLASS 42—SCIENTIFIC AND COMPUTER SERVICES

FOR COMPUTER PROGRAMMING SERVICES, NAMELY, DEVELOPING PROGRAMS FOR OTHERS FOR NEUROSURGICAL, ORTHOPEDIC, RADIOTHERAPEUTIC OR RADIOSURGICAL PURPOSES, FOR APPLICATION IN EAR, NOSE, AND THROAT SURGERY, FOR ROBOT-ASSISTED APPLICATIONS, AND FOR THREE-DIMENSIONAL REGISTRATION OR REFERENCING OF PATIENTS (U.S. CLS. 100 AND 101).
DEZMONA MIZELLE, EXAMINING ATTORNEY

SN 78-441,619. LUNA CHICA RECORDS, LLC, BOULDER, CO. FILED 6-25-2004.

LUNA CHICA RECORDS

THE MARK CONSISTS OF STANDARD CHARACTERS WITHOUT CLAIM TO ANY PARTICULAR FONT, STYLE, SIZE, OR COLOR.

NO CLAIM IS MADE TO THE EXCLUSIVE RIGHT TO USE "RECORDS", APART FROM THE MARK AS SHOWN.

THE ENGLISH TRANSLATION OF THE WORDING "LUNA CHICA" IN THE MARK IS "LITTLE MOON".

CLASS 9—ELECTRICAL AND SCIENTIFIC APPARATUS

FOR CDS, VINYL RECORDS, AUDIO TAPES, AUDIO CASSETTES, AND OTHER RECORDING MEDIA, NAMELY, DIGITAL AUDIO TAPES AND DVD'S, ALL FEATURING MUSIC. (U.S. CLS. 21, 23, 26, 36 AND 38).

CLASS 41—EDUCATION AND ENTERTAINMENT

FOR ENTERTAINMENT SERVICES, NAMELY, PRODUCING MUSICAL AUDIO AND VIDEO RECORDINGS, AND ORGANIZING CONCERTS FEATURING LIVE MUSICAL PERFORMANCES. (U.S. CLS. 100, 101 AND 107).

EVELYN BRADLEY, EXAMINING ATTORNEY

SN 78-491,352. DSM IP ASSETS B.V., HEERLEN, NETHERLANDS, FILED 9-29-2004.

OLIBRA

THE MARK CONSISTS OF STANDARD CHARACTERS WITHOUT CLAIM TO ANY PARTICULAR FONT, STYLE, SIZE, OR COLOR.

OWNER OF ERPN CMNTY TM OFC REG. NO. 000736041, DATED 12-10-1999, RENEWED AS REG. NO. 000736041, DATED 2-3-2008, EXPIRES 1-26-2018.

CLASS 5—PHARMACEUTICALS

FOR PHARMACEUTICAL PREPARATIONS FOR THE TREATMENT OF CARDIOVASCULAR DISEASE, OBESITY AND DIABETES; DIETETIC PREPARATIONS AND SUBSTANCES ADAPTED FOR MEDICAL USE, NAMELY, DIETARY SUPPLEMENTS, NUTRITIONAL SUPPLEMENTS, MEAL REPLACEMENT BARS, MEAL REPLACEMENT POWDERS, VITAMINS AND CALCIUM SUPPLEMENTS FOR THE TREATMENT OF OBESITY AND FOR THE PREVENTION AND TREATMENT OF CARDIOVASCULAR DISORDERS AND DIABETES; FOODS FOR BABIES; VITAMIN PREPARATIONS; NUTRITIONAL SUPPLEMENTS; FOOD SUPPLEMENTS (U.S. CLS. 6, 18, 44, 46, 51 AND 52).

CLASS 29—MEATS AND PROCESSED FOODS

FOR DAIRY PRODUCTS, NAMELY, MILK AND MILK PRODUCTS, NAMELY, MILK, CHOCOLATE MILK, CHEESE, COTTAGE CHEESE AND SOUR CREAM; MILK BEVERAGES WITH HIGH MILK CONTENT; YOGURT, KEPHIR, NAMELY, FERMENTED MILK BEVERAGE, SOUPS, EDIBLE OILS AND FATS, CURED MEATS (U.S. CL. 46).

TIMOTHY FINNEGAN, EXAMINING ATTORNEY

SN 78-630,024. SEARS, ROEBUCK AND CO., HOFFMAN ESTATES, IL. FILED 5-13-2005.

SENSES

THE MARK CONSISTS OF STANDARD CHARACTERS WITHOUT CLAIM TO ANY PARTICULAR FONT, STYLE, SIZE, OR COLOR.

CLASS 2—PAINTS

FOR PAINTS; COATINGS IN THE NATURE OF STAINS FOR EXTERIOR AND INTERIOR USE ON A VARIETY OF SUBSTRATES; LEATHER STAINS (U.S. CLS. 6, 11 AND 16).

CLASS 3—COSMETICS AND CLEANING PREPARATIONS

FOR ALL-PURPOSE CLEANING PREPARATIONS, HOUSEHOLD CLEANING PREPARATIONS, POTPOURRI (U.S. CLS. 1, 4, 6, 50, 51 AND 52).

CLASS 4—LUBRICANTS AND FUELS

FOR CANDLES (U.S. CLS. 1, 6 AND 15).

CLASS 5—PHARMACEUTICALS

FOR AEROSOL AND SPRAY ROOM FRESHENERS OR AIR FRESHENERS (U.S. CLS. 6, 18, 44, 46, 51 AND 52).

CLASS 6—METAL GOODS

FOR CABINET HARDWARE, NAMELY, DRAWER PULLS OF METAL; DOOR HARDWARE, NAMELY, KEYS AND KEY CYLINDERS; DOOR JAMBS OF METAL (U.S. CLS. 2, 12, 13, 14, 23, 25 AND 50).

CLASS 8—HAND TOOLS

FOR FLATWARE, CUTLERY (U.S. CLS. 23, 28 AND 44).

CLASS 9—ELECTRICAL AND SCIENTIFIC APPARATUS

FOR HARDWARE FIXTURING, NAMELY, AUDIO SPEAKERS; ELECTRICAL SUPPLIES, NAMELY, ELECTRICAL OUTLET PLATES, ELECTRICAL PLUGS, ELECTRICAL POWER EXTENSION CORDS; LIGHTING BALLASTS (U.S. CLS. 21, 23, 26, 36 AND 38).

CLASS 11—ENVIRONMENTAL CONTROL APPARATUS

FOR LIGHT BULBS, CEILING FANS, LIGHTING FIXTURES, LIGHTING TUBES, LIGHTING TRACKS, LAMP SHADES, GAS GRILLS, ELECTRIC GRILLS AND CHARCOAL GRILLS, GRILL ACCESSORIES, NAMELY, CERAMIC BRIQUETTES FOR USE IN BARBEQUE GRILLS, WARMING TRAYS, LAVA ROCK FOR USE IN BARBEQUE GRILLS AND LIGHTERS PRIMARILY FOR LIGHTING GRILLS, MICROWAVE OVENS, FAUCETS, PLUMBING SUPPLIES, NAMELY, SHOWER SPRAYER, SINK STRAINER, SINK SPRAYER AND SINK TRAPS (U.S. CLS. 13, 21, 23, 31 AND 34).

CLASS 14—JEWELRY

FOR CLOCKS (U.S. CLS. 2, 27, 28 AND 50).

CLASS 16—PAPER GOODS AND PRINTED MATTER

FOR FRAMED ART, COOKBOOKS (U.S. CLS. 2, 5, 22, 23, 29, 37, 38 AND 50).

CLASS 19—NON-METALLIC BUILDING MATERIALS

FOR NON-METAL DOOR FRAMES (U.S. CLS. 1, 12, 33 AND 50).

CLASS 20—FURNITURE AND ARTICLES NOT OTHERWISE CLASSIFIED

FOR BAR STOOLS, MIRRORS, OCCASIONAL FURNITURE, PICTURE FRAMES, PATIO FURNITURE, BATH CABINETS AND VANITIES, WINE STORAGE RACKS, STORAGE RACKS FOR APPAREL, HEADBOARDS, MATTRESSES, SHOWER CURTAIN RINGS AND SHOWER CURTAIN HOOKS, DECORATIVE PILLOWS, DRAPERY HARDWARE, NAMELY, TRAVERSE RODS, POLES, CURTAIN HOOKS, CURTAIN RODS AND FINIALS, METAL PLATE RACK, METAL DISH RACK, METAL WINE RACK (U.S. CLS. 2, 13, 22, 25, 32 AND 50).

CLASS 21—HOUSEWARES AND GLASS

FOR CANDLESTICKS OF GLASS, CANDLESTICKS NOT OF PRECIOUS METAL, BATH ACCESSORIES, NAMELY, LOTION/SOAP BOTTLE WITH PUMP SOLD EMPTY, SOAP DISH, TRAY, TOOTHBRUSH HOLDER, TUMBLER CUP, WASTEBASKET, TOILET BRUSH HOLDER, GLASS STORAGE JARS FOR STORING COTTON, DECORATIVE BATH ACCESSORIES, NAMELY, CUP HOLDERS, COOKWARE, NAMELY, POTS AND PANS, STEAMERS AND ROASTING PANS, BAKEWARE, DINNERWARE, BEVERAGE GLASSWARE, CLEANING CLOTHS, CLEANING PADS, CLEANING SPONGES, TOWEL BAR, TOWEL HOOK, TOILET PAPER HOLDER, TOWEL RING, CAMPING GRILLS, GRILL ACCESSORIES, NAMELY, GRILL COVERS FOR USE AS COOKING UTENSILS, HOUSEHOLD UTENSILS, NAMELY, SPATULAS, POT AND PAN SCRAPERS, ROLLING PINS, TURNERS, WHISKS, STRAINERS, CUTTING BOARDS, MEAL TRAYS, SERVING TRAYS NOT OF PRECIOUS METAL; WINE BOTTLE CRADLES FOR STORING WINE (U.S. CLS. 2, 13, 23, 29, 30, 33, 40 AND 50).

CLASS 22—CORDAGE AND FIBERS

FOR GARMENT BAGS FOR STORING APPAREL (U.S. CLS. 1, 2, 7, 19, 22, 42 AND 50).

CLASS 24—FABRICS

FOR BASIC AND FASHION BEDDING, NAMELY, BED BLANKETS, BED SHEETS, BED SKIRTS AND BED LINENS, TAKE-WITH NON-CUSTOM WINDOW DRAPES, BED LINEN, BATH LINENS, TOWELS AND TABLE LINENS, SHOWER CURTAINS AND SHOWER LINERS (U.S. CLS. 42 AND 50).

CLASS 26—FANCY GOODS

FOR FABRIC TISSUE BOX COVER, ARTIFICIAL FLOWER WREATHS (U.S. CLS. 37, 39, 40, 42 AND 50).

CLASS 27—FLOOR COVERINGS

FOR DECORATIVE RUGS, HARDSURFACE FLOORCOVERING, WALLCOVERINGS, AND BATH RUGS (U.S. CLS. 19, 20, 37, 42 AND 50).

CLASS 29—MEATS AND PROCESSED FOODS

FOR GOURMET FOODS, NAMELY, GOURMET CHEESES, GOURMET SOUP MIXES (U.S. CL. 46).

CLASS 30—STAPLE FOODS

FOR GOURMET FOODS, NAMELY, GOURMET BREADS, GOURMET CANDY, GOURMET CAKE MIX, GOURMET COCOA MIX, GOURMET PANCAKE MIX, GOURMET MIXES FOR BAKERY GOODS (U.S. CL. 46).

CLASS 31—NATURAL AGRICULTURAL PRODUCTS

FOR DRIED FLORAL WREATHS (U.S. CLS. 1 AND 46).

CLASS 32—LIGHT BEVERAGES

FOR GOURMET POWDERED DRINK MIXES USED IN THE PREPARATION OF FRUIT-BASED BEVERAGES, ISOTONIC SPORTS DRINKS AND SPORTS BEVERAGES AND SOFT DRINKS; GOURMET NON-ALCOHOLIC COCKTAIL MIXES (U.S. CLS. 45, 46 AND 48).

CLASS 33—WINES AND SPIRITS

FOR GOURMET ALCOHOLIC COCKTAIL MIXES (U.S. CLS. 47 AND 49).
ALICE BENMAMAN, EXAMINING ATTORNEY

SN 78-656,456, TOD'S S.P.A., ASCOLI PICENO, ITALY,
FILED 6-22-2005.



PRIORITY CLAIMED UNDER SEC. 44(D) ON ITALY APPLICATION NO. TO2005C00157, FILED 5-19-2005, REG. NO. 0001171487, DATED 2-23-2009, EXPIRES 5-19-2015.
OWNER OF U.S. REG. NOS. 1,958,523 AND 2,225,345.

CLASS 8—HAND TOOLS

FOR CUTLERY, NAMELY, KNIVES, FORKS, SPOONS, SCISSORS AND RAZORS (U.S. CLS. 23, 28 AND 44).

CLASS 14—JEWELRY

FOR PRECIOUS METALS AND THEIR ALLOYS; JEWELRY AND PERSONAL ORNAMENTS, NAMELY, EARRINGS, RINGS, NECKLACES, BRACELETS, ORNAMENTAL PINS MADE OF PRECIOUS METAL, SHOE ORNAMENTS OF PRECIOUS METAL; IMITATION JEWELRY; PRECIOUS STONES; WATCHES; CLOCKS; PENDULUM CLOCKS; CHRONOGRAPHS AND CHRONOMETERS (U.S. CLS. 2, 27, 28 AND 50).

CLASS 16—PAPER GOODS AND PRINTED MATTER

FOR PAPER, CARDBOARD AND GOODS MADE FROM THESE MATERIALS NOT INCLUDED IN OTHER CLASSES, NAMELY, NEWSPAPERS, JOURNALS, MAGAZINES, BOOKS, BROCHURES, AND CATALOGS IN THE FIELD OF FASHION; ALBUMS, NAMELY, PHOTOGRAPH ALBUMS, SCRAPBOOK ALBUMS; CALENDARS; MAPS; PICTURE POSTCARDS; STATIONER, WRITING MATERIALS, NAMELY, PENS AND NOTEBOOKS; PAPER COVERS FOR AGENDAS, ADDRESS BOOKS AND DOCUMENT HOLDERS (U.S. CLS. 2, 5, 22, 23, 29, 37, 38 AND 50).

CLASS 19—NON-METALLIC BUILDING MATERIALS

FOR NON-METALLIC BUILDING MATERIALS, NAMELY, NATURAL AND ARTIFICIAL STONE, CEMENT, LIME, MORTAR AND PLASTER; CERAMIC TILES FOR FLOORS (U.S. CLS. 1, 12, 33 AND 50).

CLASS 20—FURNITURE AND ARTICLES NOT OTHERWISE CLASSIFIED

FOR FURNITURE, PARTS OF FURNITURE, FIGURES OF CERAMIC, GLASS OR WOOD TO BE USED AS PARTS OF FURNITURE; MIRRORS, PICTURE FRAMES, GOODS NOT INCLUDED IN OTHER CLASSES OF WOOD, CORK, REED, CANE, WICKER, HORN, BONE, IVORY, WHALEBONE, SHELL, AMBER, MOTHER-OF-PEARL, MEERSCHAUM AND SUBSTITUTES FOR ALL THESE MATERIALS OR OF PLASTIC MATERIALS, NAMELY, TABLES, DESKS, BEDS, PILLOWS, DIVAN BEDS, CHAIRS, DIVANS, ARMCHAIRS, SOFAS, WARDROBES, SIDEBOARDS, BUREAUS; SMALL DECORATIVE OBJECTS IN WOOD OR OTHER MATERIALS NOT INCLUDED IN OTHER CLASSES, NAMELY, CASES, BOXES, ASHTRAYS, POTS, JARS, VASES, TRAYS, CANDY DISHES, PLATES, VASES, STATUETTES, CANDELABRAS, CANDLESTICKS, CANDLE HOLDERS, TRINKET ARTICLES, NOT OF PRECIOUS METAL; NON-METAL KEY HOLDERS, NAMELY, LEATHER KEY HOLDERS (U.S. CLS. 2, 13, 22, 25, 32 AND 50).

CLASS 21—HOUSEWARES AND GLASS

FOR HOUSEHOLD OR KITCHEN UTENSILS AND CONTAINERS NOT OF PRECIOUS METAL OR COATED THEREWITH, NAMELY, PLATES, DISHES, BEVERAGE GLASSES, BEER MUGS, CUPS, BOTTLE OPENERS, DINNERWARE, TABLE SERVICES BEING SETS OF PLATES AND GLASSES, BOWLS, BOXES, CANDELABRAS, CANDLESTICKS, CANDLE HOLDERS, COFFEE SERVERS, TEA SERVERS, SOAP DISPENSERS, CAKE SERVERS; UNWORKED OR SEMI-WORKED GLASS EXCEPT GLASS USED IN BUILDING, NAMELY, DECORATIVE GLASS NOT FOR BUILDING; GLASSWARE, CRYSTALWARE, PORCELAIN AND EARTHENWARE, NAMELY, FIGURINES; NON-ELECTRIC TOOTHBRUSHES, SPONGES FOR HOUSEHOLD PURPOSES, ABRASIVE SPONGES FOR HOUSEHOLD CLEANING, HAIR BRUSHES, HAIR COMBS, SHAVING BRUSHES, PLATES AND BEVERAGE GLASSWARE (U.S. CLS. 2, 13, 23, 29, 30, 33, 40 AND 50).

CLASS 24—FABRICS

FOR TEXTILES AND TEXTILE GOODS NOT INCLUDED IN OTHER CLASSES, NAMELY, HANDKERCHIEFS; CURTAINS, COVERINGS FOR UPHOLSTERED CHAIRS, DRAPERIES, LINEN, BEDLINEN, HOUSEHOLD-LINEN, TABLE-LINEN, BATH LINEN, TOWELS (U.S. CLS. 42 AND 50).
JACQUELINE A. LAVINE, EXAMINING ATTORNEY

SN 78-677,347. HANSSON, HENRIK, ERIKSBERG, SWEDEN, FILED 7-25-2005.

POLYFIX

THE MARK CONSISTS OF STANDARD CHARACTERS WITHOUT CLAIM TO ANY PARTICULAR FONT, STYLE, SIZE, OR COLOR.
OWNER OF ERPN CMNTY TM OFC REG. NO. 004258984, DATED 5-22-2006, EXPIRES 1-24-2015.

CLASS 10—MEDICAL APPARATUS

FOR PROSTHESES, NAMELY FOOT, KNEE, HIP, HAND AND FINGER PROSTHESES; SURGICAL IMPLANTS COMPRISING ARTIFICIAL MATERIALS; BONE IMPLANTS COMPRISING ARTIFICIAL MATERIALS; ORTHOPEDIC JOINT IMPLANTS; INTERNAL AND EXTERNAL FIXATION DEVICES FOR FIXATION OF FRACTURED BONES, NAMELY FOOT, KNEE, HIP, HANDS, WRIST AND FINGER FIXTURES; BONE SCREWS (U.S. CLS. 26, 39 AND 44).

CLASS 44—MEDICAL, BEAUTY AND AGRICULTURAL SERVICES

FOR MEDICAL AND VETERINARY SERVICES INCLUDING INTERNAL AND EXTERNAL FIXATION OF FRACTURED BONES (U.S. CLS. 100 AND 101).
BARNEY CHARLON, EXAMINING ATTORNEY

SN 78-693,138. ASTROLOGER, INC., THE, SAN FRANCISCO, CA. FILED 8-15-2005.

ASK THE ASTROLOGER

THE MARK CONSISTS OF STANDARD CHARACTERS WITHOUT CLAIM TO ANY PARTICULAR FONT, STYLE, SIZE, OR COLOR.
NO CLAIM IS MADE TO THE EXCLUSIVE RIGHT TO USE "ASTROLOGER", APART FROM THE MARK AS SHOWN.

CLASS 9—ELECTRICAL AND SCIENTIFIC APPARATUS

FOR COMPUTER PROGRAMS USED FOR INFORMATION DISTRIBUTION AND DATA EXCHANGES OVER NETWORKS; COMPUTER PROGRAMS FOR ACCESSING GLOBAL COMMUNICATION NETWORKS AND DISPLAYING CONTENT THERE FROM; AND COMPUTER PROGRAMS FOR USE WITH HAND-HELD COMPUTERS OR MOBILE DEVICES, NAMELY, UTILITY PROGRAMS; A FULL LINE OF BUSINESS APPLICATION PROGRAMS, NAMELY, COMPUTER SOFTWARE FOR REPORT GENERATION FROM DATABASE OR REMOTE PROGRAM EXECUTION, AND GLOBAL COMMUNICATIONS NETWORK BROWSING ON COMPUTERS AND ELECTRONIC FILES FOR USE WITH HAND-HELD DEVICES OR COMPUTERS (U.S. CLS. 21, 23, 26, 36 AND 38).

CLASS 38—COMMUNICATION

FOR ELECTRONIC TRANSMISSION OF ON-LINE TEXT, IMAGE, AUDIO AND VIDEO DATA; ELECTRONIC TRANSMISSION OF TEXT, IMAGE, AUDIO AND VIDEO DATA SUITABLE FOR PORTABLE APPLICATIONS (U.S. CLS. 100, 101 AND 104).

CLASS 45—PERSONAL AND LEGAL SERVICES

FOR COMPUTER SERVICES, NAMELY, PROVIDING INFORMATION REGARDING AND IN THE NATURE OF ON-LINE DATING AND INTRODUCTION SERVICES; PROVIDING A COMPUTER DATABASE IN THE FIELD OF COMPUTER DATING SERVICES THAT FEATURES DATA ABOUT INDIVIDUALS CONCERNING THE RELATIONSHIPS BETWEEN THE INDIVIDUALS, THEIR CONTACT INFORMATION, PERSONAL CHARACTERISTICS, NAMELY, SKILLS, HOBBIES, INTERESTS, EDUCATIONAL INFORMATION, CAREER INFORMATION, HEALTH INFORMATION, DATING INFORMATION, RESULTS OF SELF ASSESSMENT TESTS, AND OTHER PERSONAL INFORMATION; COMPUTER DATING SERVICES (U.S. CLS. 100 AND 101).

LINDA ORNDORFF, EXAMINING ATTORNEY

SN 78-933,838. DYSCO CAR & TRUCK RENTAL LTD., BURNABY, B.C., CANADA, FILED 7-20-2006.



PRIORITY CLAIMED UNDER SEC. 44(D) ON CANADA APPLICATION NO. 1297528, FILED 4-12-2006, REG. NO. TMA739328, DATED 5-1-2009, EXPIRES 5-1-2024.

CLASS 37—CONSTRUCTION AND REPAIR

FOR RENTAL OF HAND AND POWER TOOLS (U.S. CLS. 100, 103 AND 106).

CLASS 39—TRANSPORTATION AND STORAGE

FOR RENTAL OF VEHICLES, NAMELY, TRUCKS; MOVING VAN TRANSPORT; STORAGE OF VEHICLES; AND PROVIDING SELF STORAGE FACILITIES IN THE NATURE OF WAREHOUSE STORAGE (U.S. CLS. 100 AND 105).

ALEXANDER L. POWERS, EXAMINING ATTORNEY

SN 78-952,634. FRESHCHANGE FOODS GROUP LTD., TORONTO, CANADA, FILED 8-15-2006.



PRIORITY CLAIMED UNDER SEC. 44(D) ON CANADA APPLICATION NO. 1311415, FILED 8-1-2006, REG. NO. TMA757,814, DATED 1-26-2010, EXPIRES 1-26-2025.

CLASS 35—ADVERTISING AND BUSINESS

FOR OPERATING A BUSINESS OF OTHERS RELATING TO THE MANUFACTURE AND SALE, RETAIL AND/OR WHOLESALE, OF FOOD AND FOOD PRODUCTS, NAMELY, OPERATION OF BUSINESSES FOR OTHERS OF FOOD MANUFACTURING PLANTS AND FOOD RETAIL AND WHOLESALE RETAIL STORES; BUSINESS INFORMATION SERVICES, NAMELY, FOOD PRODUCT INFORMATION; BUSINESS MANAGEMENT SERVICES; CONSULTATION SERVICES, NAMELY, BUSINESS ACQUISITION AND MERGER SERVICES; BUSINESS ADMINISTRATION SERVICES; BUSINESS MANAGEMENT SERVICES; BUSINESS PLANNING SERVICES; BUSINESS RESEARCH SERVICES (U.S. CLS. 100, 101 AND 102).

CLASS 36—INSURANCE AND FINANCIAL

FOR EQUITY CAPITAL INVESTMENT SERVICES (U.S. CLS. 100, 101 AND 102).

CLASS 42—SCIENTIFIC AND COMPUTER SERVICES

FOR WEB SITE HOSTING SERVICES; RESEARCH SERVICES, NAMELY, FOOD AND FOOD PRODUCT RESEARCH (U.S. CLS. 100 AND 101).

ALEX KEAM, EXAMINING ATTORNEY

SN 78-955,601. SOLAR HYDROGEN ENERGY CORPORATION, SASKATOON, CANADA, FILED 8-18-2006.



PRIORITY CLAIMED UNDER SEC. 44(D) ON CANADA APPLICATION NO. 1311570, FILED 8-2-2006, REG. NO. TMA744,772, DATED 8-6-2009, EXPIRES 8-6-2024.

THE MARK CONSISTS OF THE WORD MARK "SHEC" ALONG WITH AN ARCH AND STAR LOGO.

CLASS 9—ELECTRICAL AND SCIENTIFIC APPARATUS

FOR RENEWABLE ENERGY AND ENERGY CONVERSION DEVICES, NAMELY, SOLAR REACTORS AND SOLAR ENERGY RECEIVERS (U.S. CLS. 21, 23, 26, 36 AND 38).

CLASS 11—ENVIRONMENTAL CONTROL APPARATUS

FOR ENERGY PRODUCTION COMPONENTS AND EQUIPMENT FOR USE IN THE PRODUCTION OF HYDROGEN GAS, BIOFUELS, HYDROGEN-BASED ENERGY AND SOLAR ENERGY, NAMELY, SOLAR REACTORS AND SOLAR ENERGY RECEIVERS (U.S. CLS. 13, 21, 23, 31 AND 34).

CLASS 40—MATERIAL TREATMENT

FOR PRODUCTION OF HYDROGEN GAS AND RENEWABLE ENERGY; CONTRACT MANUFACTURING FOR OTHERS IN THE FIELD OF ENERGY CONVERSION DEVICES (U.S. CLS. 100, 103 AND 106).

ELLEN BURNS, EXAMINING ATTORNEY

SN 78-955,613. SOLAR HYDROGEN ENERGY CORPORATION, SASKATOON, CANADA, FILED 8-18-2006.

SHEC

THE MARK CONSISTS OF STANDARD CHARACTERS WITHOUT CLAIM TO ANY PARTICULAR FONT, STYLE, SIZE, OR COLOR.

PRIORITY CLAIMED UNDER SEC. 44(D) ON CANADA APPLICATION NO. 1311563, FILED 8-2-2006, REG. NO. TMA738,077, DATED 4-15-2009, EXPIRES 4-15-2024.

CLASS 9—ELECTRICAL AND SCIENTIFIC APPARATUS

FOR RENEWABLE ENERGY AND ENERGY CONVERSION DEVICES, NAMELY, SOLAR REACTORS AND SOLAR ENERGY RECEIVERS (U.S. CLS. 21, 23, 26, 36 AND 38).

CLASS 11—ENVIRONMENTAL CONTROL APPARATUS

FOR ENERGY PRODUCTION COMPONENTS AND EQUIPMENT FOR USE IN THE PRODUCTION OF HYDROGEN GAS, BIOFUELS, HYDROGEN-BASED ENERGY AND SOLAR ENERGY, NAMELY, SOLAR REACTORS AND SOLAR ENERGY RECEIVERS (U.S. CLS. 13, 21, 23, 31 AND 34).

CLASS 40—MATERIAL TREATMENT

FOR PRODUCTION OF HYDROGEN GAS AND RENEWABLE ENERGY; CONTRACT MANUFACTURING FOR OTHERS IN THE FIELD OF ENERGY CONVERSION DEVICES (U.S. CLS. 100, 103 AND 106).
ELLEN BURNS, EXAMINING ATTORNEY

CLASS 35—ADVERTISING AND BUSINESS

FOR ADVERTISING AGENCIES; RETAIL STORE SERVICES IN SMALL SHOPS AND VIA GLOBAL COMPUTER NETWORKS FEATURING COMMON METALS AND THEIR ALLOYS, METAL BUILDING MATERIALS, TRANSPORTABLE METAL CONSTRUCTIONS, MATERIALS OF METAL FOR RAILWAY TRACKS, NON-ELECTRIC CABLES AND WIRES OF COMMON METAL, METAL PIPES AND TUBES, SAFES, MINERALS (U.S. CLS. 100, 101 AND 102).

CLASS 39—TRANSPORTATION AND STORAGE

FOR TRANSPORTATION AND DELIVERY OF GOODS AND PACKAGES BY GROUND VEHICLE, RAIL, AIR, AND BOAT; PACKAGING FOR TRANSPORTATION AND STORAGE SERVICES FOR COMMON METALS AND THEIR ALLOYS, METAL BUILDING MATERIALS, TRANSPORTABLE METAL CONSTRUCTIONS, MATERIALS OF METAL FOR RAILWAY TRACKS, NON-ELECTRIC CABLES AND WIRES OF COMMON METAL, IRONMONGERY AND SMALL ITEMS OF METAL HARDWARE, METAL PIPES AND TUBES, SAFES, GOODS OF COMMON METAL, MINERALS (U.S. CLS. 100 AND 105).

CLASS 40—MATERIAL TREATMENT

FOR TREATMENT OF MATERIALS, NAMELY, METAL TREATMENT (U.S. CLS. 100, 103 AND 106).

CLASS 42—SCIENTIFIC AND COMPUTER SERVICES

FOR INDUSTRIAL ANALYSIS AND EVALUATION SERVICES ALL IN THE FIELD OF METALS, NAMELY, UNWROUGHT AND SEMI-WROUGHT BASE METALS AND STEEL, BRASS, COPPER, ALUMINUM AND THEIR ALLOYS; DEVELOPMENT OF COMPUTER HARDWARE AND SOFTWARE FOR OTHERS; LEGAL SERVICES (U.S. CLS. 100 AND 101).

LEIGH LOWRY, EXAMINING ATTORNEY

SN 79-011,162. MARIA DEL ORO UGARTE ANDA, SPAIN, AND LEYRE TERESA UGARTE ANDA, E-01015 VITORIA (ALAVA), SPAIN, AND LEANDRO JESUS UGARTE ANDA, E-01015 VITORIA (ALAVA), SPAIN, FILED 11-19-2004.

AUSASTEEL

THE MARK CONSISTS OF STANDARD CHARACTERS WITHOUT CLAIM TO ANY PARTICULAR FONT, STYLE, SIZE, OR COLOR.

OWNER OF INTERNATIONAL REGISTRATION 0850381 DATED 11-19-2004, EXPIRES 11-19-2014.
OWNER OF U.S. REG. NO. 3,007,558.

CLASS 6—METAL GOODS

FOR UNWROUGHT AND SEMI-WROUGHT BASE METALS AND STEEL, BRASS, COPPER, ALUMINUM AND THEIR ALLOYS IN THE FORM OF BARS, ROLLS, COILS, INGOTS AND PIECES FOR FURTHER MANUFACTURE; ROLLED AND CAST METAL CONSTRUCTION MATERIALS, NAMELY, METAL MOLDS FOR FORMING CEMENT PRODUCTS; METAL SPRINGS; METALLIC RAILS FOR RAILWAY TRACKS AND STEEL, BRASS, COPPER AND ALUMINUM FOR RAILWAY TRACKS, EXCEPT FOR DRIVING CHAINS FOR VEHICLES; METALLIC TUBES, LARGE AND TRANSPORTABLE METAL SAFES (U.S. CLS. 2, 12, 13, 14, 23, 25 AND 50).

SN 79-029,374. TEA TOO PTY LTD, AUSTRALIA, FILED 4-10-2006.

T2

THE MARK CONSISTS OF STANDARD CHARACTERS WITHOUT CLAIM TO ANY PARTICULAR FONT, STYLE, SIZE, OR COLOR.

PRIORITY DATE OF 10-11-2005 IS CLAIMED.
OWNER OF INTERNATIONAL REGISTRATION 0899635 DATED 4-10-2006, EXPIRES 4-10-2016.

CLASS 24—FABRICS

FOR TEA TOWELS (U.S. CLS. 42 AND 50).

CLASS 30—STAPLE FOODS

FOR TEA; AROMATIC TEAS OTHER THAN FOR MEDICINAL USE; AROMATIC TEAS; FLAVORED TEAS USING NATURAL OR NATURAL IDENTICAL FLAVORING; ARTIFICIAL TEA OTHER THAN FOR MEDICINAL USE; FRUIT FLAVORED TEA OTHER THAN FOR MEDICINAL USE; FRUIT FLAVOURED INFUSIONS OTHER THAN FOR MEDICINAL USE; HERBAL TEA OTHER THAN FOR MEDICINAL USE; HERBAL INFUSIONS OTHER THAN FOR MEDICINAL USE; INSTANT TEA OTHER THAN FOR MEDICINAL USE; INSTANT FRUIT INFUSIONS OTHER THAN FOR MEDICINAL USE; PACKAGED TEA OTHER THAN FOR MEDICINAL USE; PACKAGED FRUIT AND HERBAL INFUSIONS OTHER THAN FOR MEDICINAL USE; TEA-BASED BEVERAGES; BEVERAGES MADE OF TEA; TEA CAKES; TEA BISCUITS; TEA CHOCOLATES; NON-MEDICATED TEA ESSENCE; NON-MEDICATED TEA PRODUCTS, NAMELY, TEA PODS; NON-MEDICATED TISANES MADE OF TEA; TEA, FRUIT, OR HERBAL BASED PREPARATIONS FOR MAKING BEVERAGES, NAMELY, INSTANT SUGAR BASED TEAS AND TEA POWDERS PACKAGED IN BULK FOR BREWING AND INFUSIONS (U.S. CL. 46).

CLASS 43—HOTEL AND RESTAURANT SERVICES

FOR TEAROOM SERVICES AND BAR SERVICES (U.S. CLS. 100 AND 101).
HEATHER BIDDULPH, EXAMINING ATTORNEY

SN 79-042,837. ROL INREDNING AB, SWEDEN, FILED 3-26-2007.

ROL

THE MARK CONSISTS OF STANDARD CHARACTERS WITHOUT CLAIM TO ANY PARTICULAR FONT, STYLE, SIZE, OR COLOR.

OWNER OF INTERNATIONAL REGISTRATION 0678656 DATED 5-23-1997, EXPIRES 5-23-2017.

CLASS 6—METAL GOODS

FOR METAL FITTINGS FOR SHELVING AND DISPLAY UNITS, NAMELY, BASKETS, SPIKES, HOOKS, HOOK ARMS, MERCHANDISING HOLDERS, PANELS, WALL RAILS, BRACKETS, STANDS, PILLARS, POSTS, CORNER SUPPORTS, PLINTHS, WALL ATTACHMENTS, WHEELS OF METAL FOR USE ON THE AFORESAID GOODS, METAL RAMP INTENDED FOR USE IN THE INTERIORS OF SHOPS, PETROL STATIONS, EXHIBITION STANDS, LIBRARIES AND BANKS (U.S. CLS. 2, 12, 13, 14, 23, 25 AND 50).

CLASS 20—FURNITURE AND ARTICLES NOT OTHERWISE CLASSIFIED

FOR FITTINGS NOT OF METAL FOR SHELVING AND DISPLAY UNITS, NAMELY, SHELF SYSTEMS, SHELF STANDS, STANDS FOR DISPLAY OF ARTICLES, GONDOLA SHELF DISPLAYS, SALES AND DISPLAY COUNTERS, TABLES AND CASES FOR THE DISPLAY OF MERCHANDISE INTENDED FOR USE IN THE INTERIORS OF SHOPS, PETROL STATIONS, EXHIBITION STANDS, LIBRARIES AND BANKS (U.S. CLS. 2, 13, 22, 25, 32 AND 50).

RONALD DELGIZZI, EXAMINING ATTORNEY

SN 79-050,062. MR LOUZON VICTOR, FRANCE, AND MR BETTANE BENJAMIN, FRANCE, FILED 12-18-2007.



wize and ope

PRIORITY DATE OF 6-20-2007 IS CLAIMED.
OWNER OF INTERNATIONAL REGISTRATION 0953732 DATED 12-18-2007, EXPIRES 12-18-2017.

THE NAME "WIZE AND OPE" IDENTIFIES A LIVING INDIVIDUAL WHOSE CONSENT IS OF RECORD.

THE MARK CONSISTS OF A TEDDY BEAR SITUATED ABOVE THE WORDING "WIZE" AND "OPE".

THE WORDING "WIZE" AND "OPE" HAS NO MEANING IN A FOREIGN LANGUAGE.

CLASS 9—ELECTRICAL AND SCIENTIFIC APPARATUS

FOR COMPUTER HARDWARE AND SOFTWARE FOR RECORDING, TRANSMITTING, REPRODUCING OR PROCESSING SOUND OR IMAGES; MAGNETIC RECORDING MEDIA, NAMELY, FILE SERVERS AND ELECTRONIC STORAGE SERVERS, BLANK ACOUSTIC AND BLANK OPTICAL DISKS; BLANK FLOPPY DISCS; COMPUTER HARDWARE AND SOFTWARE FOR DATA PROCESSING; SOFTWARE FOR COMPUTER GAMES; SOFTWARE FOR OPERATING A RETAIL WEB SITE; COMPUTER PERIPHERAL DEVICES; ELECTRIC BATTERIES; ELECTRIC WIRES; ELECTRIC RELAYS; SPECTACLES; SPECTACLE CASES; SOFTWARE, NAMELY, COMPUTER DIAGNOSTIC PROGRAMS; MEMORY OR MICROPROCESSOR CARDS (U.S. CLS. 21, 23, 26, 36 AND 38).

CLASS 14—JEWELRY

FOR JEWELRY; PRECIOUS STONES; HOROLOGICAL AND CHRONOMETRIC INSTRUMENTS; PRECIOUS METALS AND THEIR ALLOYS, NAMELY, GOLD AND SILVER; NON-MONETARY COINS; WORKS OF ART OF PRECIOUS METAL; JEWELRY CASES; PRECIOUS METAL BOXES; BRACELETS, JEWELRY CHAINS, WATCH SPRINGS, WATCH GLASSES; FANCY KEY RINGS OF PRECIOUS METAL; STATUES OR FIGURINES OF PRECIOUS METAL; CLOCK AND WATCH CASES; MEDALS (U.S. CLS. 2, 27, 28 AND 50).

CLASS 25—CLOTHING

FOR CLOTHING, NAMELY, SHIRTS, PANTS, JACKETS, COATS, DRESSES, SKIRTS, SWEATERS, SWEATSHIRTS; FOOTWEAR, HEADGEAR, NAMELY, HATS; BELTS; GLOVES; SCARVES; TIES; HOSIERY; SOCKS; SLIPPERS; BEACH WEAR, SKI BOOTS, SPORTS SHOES; TEXTILE NAPPIES; UNDERWEAR (U.S. CLS. 22 AND 39).

CLASS 28—TOYS AND SPORTING GOODS

FOR GAMES, NAMELY, APPARATUS FOR ELECTRONIC GAMES OTHER THAN THOSE ADAPTED FOR USE WITH AN EXTERNAL DISPLAY SCREEN MONITOR, ARCADE GAMES, ACTION TARGET GAME, PLUSH TOYS; DECORATIONS FOR CHRISTMAS TREES, EXCEPT LIGHTING ARTICLES; CHRISTMAS TREES OF SYNTHETIC MATERIAL; PHYSICAL TRAINING OR GYMNASIUMS APPARATUS, NAMELY, EXERCISE AND FITNESS MACHINES, AEROBIC EXERCISE EQUIPMENT, AND EXERCISE TREADMILLS; FISHING TACKLE; BALLS FOR GAMES AND PLAY BALLOONS; BILLIARD TABLES, CUES OR BALLS; CARD OR BOARD GAMES; ICE OR ROLLER SKATES; CHILDREN'S SCOOTERS, NAMELY, TOY SCOOTERS; SAIL OR SURF BOARDS; RACKETS FOR TENNIS AND SQUASH; SNOW-SHOES; SKIS; PROTECTIVE PADDINGS FOR PLAYING SOCCER, FOOTBALL, BASEBALL, LACROSSE, HOCKEY (U.S. CLS. 22, 23, 38 AND 50).

NAKIA HENRY, EXAMINING ATTORNEY

SN 79-053,708. COMPAGNIE GENERALE DE GEOPHYSIQUE -; VERITAS, PARIS, FRANCE, FILED 10-15-2007.



PRIORITY DATE OF 5-3-2007 IS CLAIMED.
OWNER OF INTERNATIONAL REGISTRATION 0963988 DATED 10-15-2007, EXPIRES 10-15-2017.

THE COLOR(S) BLUE, GREEN AND ORANGE IS/ARE CLAIMED AS A FEATURE OF THE MARK.

THE MARK CONSISTS OF THREE CURVED BANDS AND ARCS IN BLUE, GREEN AND ORANGE, RESPECTIVELY.

CLASS 9—ELECTRICAL AND SCIENTIFIC APPARATUS

FOR COMPUTER SOFTWARES FOR USE IN ACQUIRING, PROCESSING, INTERPRETING GEOPHYSICAL DATA WITH A VIEW TO UNDERGROUND EXPLORATION AND EXPLOITATION; SCIENTIFIC APPARATUS AND INSTRUMENTS FOR USE IN ACQUIRING, PROCESSING, INTERPRETING GEOPHYSICAL DATA WITH A VIEW TO UNDERGROUND EXPLORATION AND EXPLOITATION; MEASURING, SIGNALING, CHECKING APPARATUS AND INSTRUMENTS USED FOR ACQUIRING, PROCESSING, INTERPRETING GEOPHYSICAL DATA WITH A VIEW TO UNDERGROUND EXPLORATION AND EXPLOITATION; COMPUTER SOFTWARE FOR USE IN ACQUIRING, PROCESSING, INTERPRETING SEISMIC DATA WITH A VIEW TO SEARCHING OR EXPLOITING HYDROCARBON OR GAS DEPOSITS, SCIENTIFIC APPARATUS AND INSTRUMENTS FOR USE IN ACQUIRING, PROCESSING, INTERPRETING SEISMIC DATA WITH A VIEW TO SEARCHING OR EXPLOITING HYDROCARBON OR GAS DEPOSITS; MEASURING, SIGNALING, CHECKING APPARATUS AND INSTRUMENTS FOR ACQUIRING, PROCESSING, INTERPRETING SEISMIC DATA WITH A VIEW TO SEARCHING OR EXPLOITING HYDROCARBON OR GAS DEPOSITS (U.S. CLS. 21, 23, 26, 36 AND 38).

CLASS 35—ADVERTISING AND BUSINESS

FOR COMPUTERIZED AND CENTRAL FILE MANAGEMENT OF GEOPHYSICAL AND SEISMIC DATA; MANAGEMENT OF COMPUTER FILES IN THE GEOPHYSICS AND SEISMICS FIELD; DATABASE MANAGEMENT OF GEOPHYSICAL AND SEISMIC DATA (U.S. CLS. 100, 101 AND 102).

CLASS 37—CONSTRUCTION AND REPAIR

FOR INSTALLATION, CONSTRUCTION, UPKEEP, MAINTENANCE AND REPAIR OF SCIENTIFIC APPARATUS AND INSTRUMENTS, OF MEASURING, SIGNALLING, CHECKING SUPERVISION APPARATUS AND INSTRUMENTS FOR ACQUIRING, PROCESSING, INTERPRETING GEOPHYSICAL DATA WITH A VIEW TO UNDERGROUND EXPLORATION OR EXPLOITATION AND SCIENTIFIC APPARATUS AND INSTRUMENTS, MEASURING, SIGNALLING, CHECKING SUPERVISION APPARATUS AND INSTRUMENTS FOR ACQUIRING, PROCESSING, INTERPRETING SEISMIC DATA WITH A VIEW TO SEEKING OR EXPLOITING HYDROCARBON OR GAS DEPOSITS; WELL DRILLING, OVERSEEING OF CONSTRUCTION WORK WITH A VIEW TO UNDERGROUND EXPLORATION AND EXPLOITATION AND SEEKING OR EXPLOITATION OF HYDROCARBON OR GAS DEPOSITS; INSTALLATION AND UPKEEP OF OIL AND GAS PIPELINES; CONSTRUCTION, PLASTERING AND CEMENT WORK FOR INSTALLATIONS IN THE SEISMICS AND GEOPHYSICS FIELD (U.S. CLS. 100, 103 AND 106).

CLASS 42—SCIENTIFIC AND COMPUTER SERVICES

FOR SCIENTIFIC SERVICES, NAMELY, ACQUIRING, PROCESSING, INTERPRETING GEOPHYSICAL DATA FOR UNDERGROUND EXPLORATION AND EXPLOITATION; SCIENTIFIC SERVICES, NAMELY, ACQUIRING, PROCESSING, INTERPRETING SEISMIC DATA FOR SEARCHING OR EXPLOITATION OF HYDROCARBON OR GAS DEPOSITS; INSTALLING, UPDATING AND MAINTAINING SOFTWARE IN THE GEOPHYSICS AND SEISMIC FIELD (U.S. CLS. 100 AND 101).

BERNICE MIDDLETON, EXAMINING ATTORNEY

SN 79-056,120. METAIO GMBH, FED REP GERMANY, FILED 4-23-2008.

METAIO

THE MARK CONSISTS OF STANDARD CHARACTERS WITHOUT CLAIM TO ANY PARTICULAR FONT, STYLE, SIZE, OR COLOR.

OWNER OF INTERNATIONAL REGISTRATION 0970316 DATED 4-23-2008, EXPIRES 4-23-2018.

THE WORDING "METAIO" HAS NO MEANING IN A FOREIGN LANGUAGE.

CLASS 9—ELECTRICAL AND SCIENTIFIC APPARATUS

FOR COMPUTER SOFTWARE FOR PRODUCT VISUALIZATION FOR COMMERCIAL AND INDUSTRIAL USE; COMPUTER SOFTWARE FOR MAINTENANCE OF COMMERCIAL AND INDUSTRIAL PRODUCTS AND INSTALLATIONS; COMPUTER PROGRAMS, NAMELY, DATABASE PROGRAMS FOR USE IN INTEGRATING PRODUCT DATA AND SPECIFICATIONS FOR COMMERCIAL AND INDUSTRIAL USE; COMPUTER PROGRAMS, NAMELY, AUGMENTED REALITY PROGRAMS FOR COMMERCIAL AND INDUSTRIAL USE; COMPUTER PROGRAMS, NAMELY AUTHORIZING TOOLS FOR CREATING LOCATION BASED CONTENT; COMPUTER PROGRAMS, NAMELY GEOGRAPHICAL INFORMATION SERVICES FOR INTERNET AND MOBILE DEVICES; COMPUTER PROGRAMS, NAMELY, NAVIGATION SYSTEMS FOR VEHICLES FOR COMMERCIAL, INDUSTRIAL, AND MILITARY USE; COMPUTER PROGRAMS, NAMELY, SIMULATION SYSTEMS FOR TRAINING; COMPUTER PROGRAMS, NAMELY, COMPUTER GAMES; COMPUTER HARDWARE AND PARTS THEREOF (U.S. CLS. 21, 23, 26, 36 AND 38).

CLASS 38—COMMUNICATION

FOR TELECOMMUNICATION SERVICES, NAMELY, TRANSMISSION OF VOICE, DATA, AND GRAPHICS; TELECOMMUNICATION SERVICES, NAMELY, TRANSMISSION OF VOICE, DATA AND GRAPHICS RELATED TO LOCATION; PROVIDING AN INTERNET PLATFORM FOR ELECTRONIC COMMERCE, NAMELY, ELECTRONIC TRANSMISSION OF VIRTUAL DATA; SERVICES OF AN ONLINE PROVIDER, NAMELY TRANSMITTING INFORMATION, TEXTS, DRAWINGS AND PICTURES ON GOODS AND SERVICES, NAMELY, PHOTOS AND THREE DIMENSIONAL MODELS OF GOODS AND SERVICES; RECORDING, FORWARDING, PROCESSING AND AUTOMATIC ANSWERING OF TELEPHONE CALLS, TELEFAX MESSAGES, EMAILS AND MESSAGES LEFT ON AN INTERNET HOMEPAGE (U.S. CLS. 100, 101 AND 104).

CLASS 42—SCIENTIFIC AND COMPUTER SERVICES

FOR DESIGN AND DEVELOPMENT OF COMPUTERS AND COMPUTER PROGRAMS, NAMELY, FOR MOBILE COMPUTER-SUPPORTED INFORMATION SYSTEMS; DESIGN AND DEVELOPMENT OF COMPUTERS AND COMPUTER PROGRAMS, NAMELY, FOR AUGMENTED REALITY; DESIGN AND DEVELOPMENT OF COMPUTERS AND COMPUTER PROGRAMS, NAMELY, FOR MOBILE GAMES; DESIGN AND DEVELOPMENT OF COMPUTERS AND COMPUTER PROGRAMS, NAMELY, FOR NAVIGATION SYSTEMS; DESIGN AND DEVELOPMENT OF COMPUTERS AND COMPUTER PROGRAMS, NAMELY, FOR SIMULATION AND TRAINING SYSTEMS; TECHNICAL, INFORMATION, AND ADVISORY SUPPORT SERVICES CONCERNING THE PREPARATION OF DATA PROCESSING PROGRAMS, NAMELY, MATCHING OF DATA RELATING TO THE PRODUCTS OR SERVICES, CONCERNING, NAMELY, PREPARATION OF DATA PROCESSING PROGRAMS; UPDATING FOR COMPUTER PROGRAMS; DEVELOPMENT AND TECHNICAL ADVISORY SERVICES IN THE FIELD OF MECHANICAL ENGINEERING, AUTOMOTIVE TECHNOLOGY AND AVIATION; DEVELOPMENT AND TECHNICAL ADVISORY SERVICES IN THE FIELD OF SEARCH ENGINE TECHNOLOGY; DEVELOPMENT AND TECHNICAL ADVISORY SERVICES IN THE FIELD OF GEOGRAPHIC INFORMATION SYSTEMS; TECHNICAL ADVISORY SERVICES FOR USERS OF THE INTERNET, DATABASES AND OTHER NEWS MEDIA, NAMELY, MOBILE COMPUTER-SUPPORTED INFORMATION SYSTEMS, BY MEANS OF A HOTLINE (U.S. CLS. 100 AND 101).

CLASS 45—PERSONAL AND LEGAL SERVICES

FOR LICENSING OF COMPUTER PROGRAMS (U.S. CLS. 100 AND 101).
BERNICE MIDDLETON, EXAMINING ATTORNEY

SN 79-057,398. ECHO REIZEN BVBA, BELGIUM, FILED 10-3-2007.



PRIORITY DATE OF 4-19-2007 IS CLAIMED.
OWNER OF INTERNATIONAL REGISTRATION 0973443 DATED 10-3-2007, EXPIRES 10-3-2017.

THE COLOR(S) PINK, WHITE IS/ARE CLAIMED AS A FEATURE OF THE MARK.

THE MARK CONSISTS OF THE STYLIZED DESIGN OF A SUN BEHIND A PALM TREE TO THE LEFT OF THE TERM "ENJOY" ABOVE THE TERM "PARADISE"; THE COLOR PINK APPEARS IN THE STYLIZED DESIGN OF A SUN BEHIND A PALM, IN THE TERM "ENJOY" AND IN THE TERM "PARADISE"; THE COLOR WHITE APPEARS IN THE BACKGROUND OF THE MARK.

CLASS 16—PAPER GOODS AND PRINTED MATTER

FOR PRINTED MATTER, NAMELY, PRODUCT GUIDES IN THE FIELDS OF TRAVEL AND LEISURE ACTIVITIES, SPORTS AND SPORT WORK PLACEMENTS, PRINTING PAPER, LETTER HEAD PAPER, DOCUMENT COVERS, DOCUMENT HOLDERS, ENVELOPE PAPER, ENVELOPES FOR STATIONERY USE; MEMO BLOCKS, NOTE PADS, AND PAPER STATIONERY IN THE FIELD OF TRAVEL AND LEISURE ACTIVITIES, SPORTS AND SPORT WORK PLACEMENTS; MAGAZINES IN THE FIELD OF TRAVEL AND LEISURE ACTIVITIES, SPORTS AND SPORT WORK PLACEMENTS; LEAFLETS ABOUT TRAVEL AND LEISURE ACTIVITIES, SPORTS AND SPORT WORK PLACEMENTS; PAMPHLETS ABOUT TRAVEL AND LEISURE ACTIVITIES, SPORTS AND SPORT WORK PLACEMENTS; POSTERS; CARDS, NAMELY, BLANK CARDS, BUSINESS CARDS, FILING CARDS, GREETING CARDS; ATLASES; BOOKS IN THE FIELD OF TRAVEL AND LEISURE ACTIVITIES, SPORTS AND SPORT WORK PLACEMENTS; CALENDARS (U.S. CLS. 2, 5, 22, 23, 29, 37, 38 AND 50).

CLASS 39—TRANSPORTATION AND STORAGE

FOR TRANSPORT AND ESCORTING OF TRAVELLERS AND THEIR LUGGAGE; ARRANGING AND BOOKING OF TOURS, GUIDED TOURS, EXCURSIONS, CRUISES AND BOAT TRIPS, DAY TRIPS, SIGHT SEEING TOURS; BOOKING OF TRANSPORT; RESERVATION AND RENTAL OF ROWING AND MOTORBOATS, SAILING BOATS, CANOES, CARS AND HORSES FOR TRAVEL, LEISURE, SPORTS AND SPORTS WORK PLACEMENTS PURPOSES ALL FOR TRANSPORTATION PURPOSES; TRAVELLING INFORMATION AND ADVICE IN THE FIELD OF TRANSPORTATION; TRANSPORT RESERVATION; VEHICLE RENTAL; PARKING PLACE RENTAL; TOUR OPERATOR SERVICES; BOOKING OF SEATS FOR TRAVEL; PLEASURE BOAT TRANSPORT; REPATRIATION OF TRAVELLERS, NAMELY, TRANSPORTATION OF TRAVELLERS IN THE EVENT OF AN ACCIDENT OR INJURY OF A TRAVELLER, OR MORTAL REMAINS IN THE EVENT OF DEATH OF A TRAVELLER; BUS TRANSPORT; FREIGHTING, NAMELY, FREIGHT TRANSPORTATION BY TRUCK, TRAIN, AIR AND BOAT; CAR PARKING; PROVIDING TRAVEL INFORMATION REGARDING TARIFFS, FLIGHT TIMETABLES, FLIGHT SCHEDULES AND OTHER TRANSPORTATION MATTERS (U.S. CLS. 100 AND 105).

CLASS 41—EDUCATION AND ENTERTAINMENT

FOR EDUCATION AND TRAINING IN THE FIELD OF TOURISM, TRAVEL, GAMES AND SPORTS ACTIVITIES RENDERED VIA CLASSES, WORKSHOPS, SEMINARS, COURSES, CONGRESSES; ORGANIZATION OF SPORTS AND GAME COMPETITIONS; BOOKING OF SEATS FOR SPORTING AND CULTURAL EVENTS; ORGANIZATION OF VIDEO SHOWS, FAIRS, EXHIBITIONS FOR CULTURAL OR SPORTIVE PURPOSE; DISTRIBUTION OF FILMS; PUBLICATION OF PRINTED MATTER, BOOKS, MAGAZINES, PAMPHLETS, CATALOGUES IN CONNECTION WITH TRAVEL, CULTURE, TOURISM AND SPORTS; ARRANGING AND CONDUCTING OF SEMINARS, EDUCATIONAL CONGRESSES AND EDUCATIONAL CONFERENCES IN CONNECTION WITH TRAVEL, CULTURE, TOURISM AND SPORTS; PUBLICATION OF PRINTED MATTER WITH REGARD TO TRAVEL EXPERIENCES, TRAVEL TIPS, TRAVEL OBSERVATIONS AND TRAVEL REPORTS (U.S. CLS. 100, 101 AND 107).

CLASS 43—HOTEL AND RESTAURANT SERVICES

FOR HOTEL AND RESTAURANT RESERVATIONS; ACCOMMODATION BUREAUX, NAMELY, HOTELS AND BOARDING HOUSES; MOTELS; BOARDING HOUSE BOOKINGS; PROVIDING CAMPGROUND FACILITIES, TOURIST HOMES, HOLIDAY CAMP SERVICES FOR LODGING PURPOSES, NAMELY, RESORT LODGING SERVICES, HOLIDAY PARKS FOR LODGING PURPOSES, NAMELY, RESORT LODGING SERVICES; HOLIDAY CAMPS FOR LODGING PURPOSES, NAMELY, RESORT LODGING SERVICES AND CONSULTANCY IN THE FIELD OF RESORT LODGING (U.S. CLS. 100 AND 101).

MYRIAH HABEEB, EXAMINING ATTORNEY

SN 79-059,379. OJO DE AGUA - WEINKONTOR GMBH, SWITZERLAND, FILED 5-20-2008.

OJO DE AGUA

THE MARK CONSISTS OF STANDARD CHARACTERS WITHOUT CLAIM TO ANY PARTICULAR FONT, STYLE, SIZE, OR COLOR.

OWNER OF INTERNATIONAL REGISTRATION 0820651 DATED 3-4-2004, EXPIRES 3-4-2014.

THE ENGLISH TRANSLATION OF THE WORD "OJO DE AGUA" IN THE MARK IS "EYE OF WATER".

CLASS 29—MEATS AND PROCESSED FOODS

FOR MEAT, FISH, POULTRY AND GAME; MEAT EXTRACTS; PRESERVED, DRIED AND COOKED FRUIT AND VEGETABLES; JELLIES, JAMS, COMPOSTES; EGGS, MILK AND DAIRY PRODUCTS EXCLUDING ICE CREAM, ICE MILK AND FROZEN YOGURT; EDIBLE OILS AND FATS (U.S. CL. 46).

CLASS 30—STAPLE FOODS

FOR COFFEE, TEA, COCOA, SUGAR, RICE, TAPIOCA, SAGO, ARTIFICIAL COFFEE; PREPARATIONS MADE FROM CEREAL, NAMELY, OATMEAL, WHEAT FLAKES, CORN, RYE; EDIBLE ICE; HONEY, TREACLE; YEAST, BAKING POWDER; SALT, MUSTARD; VINEGAR, SAUCES; SPICES; ICE FOR REFRESHMENT (U.S. CL. 46).

CLASS 31—NATURAL AGRICULTURAL PRODUCTS

FOR AGRICULTURAL, HORTICULTURAL AND FORESTRY PRODUCTS, NAMELY, VEGETABLE SEEDS FOR PLANTING AND UNPROCESSED GRAINS, INCLUDED IN THIS CLASS; LIVE ANIMALS; FRESH FRUITS AND VEGETABLES; NATURAL SEEDS; PLANTS AND FLOWERS; ANIMAL FEED; MALT FOR BREWING AND DISTILLING (U.S. CLS. 1 AND 46).

CLASS 32—LIGHT BEVERAGES

FOR BEERS; MINERAL AND SPARKLING WATER AND OTHER NON-ALCOHOLIC BEVERAGES IN THE NATURE OF FRUIT JUICE BEVERAGES, SODA POP, SPARKLING WATER FRUIT DRINKS AND FRUIT JUICES; SYRUPS FOR MAKING BEVERAGES (U.S. CLS. 45, 46 AND 48).

CLASS 33—WINES AND SPIRITS

FOR ALCOHOLIC BEVERAGES, EXCLUDING BEERS (U.S. CLS. 47 AND 49).

CLASS 35—ADVERTISING AND BUSINESS

FOR RETAIL STORE SERVICES FEATURING WINE AND MEAT (U.S. CLS. 100, 101 AND 102).

LAURA HAMMEL, EXAMINING ATTORNEY

SN 79-059,513. WACKER NEUSON SE, FED REP GERMANY, FILED 5-28-2008.



PRIORITY DATE OF 11-28-2007 IS CLAIMED. OWNER OF INTERNATIONAL REGISTRATION 0978851 DATED 5-28-2008, EXPIRES 5-28-2018.

THE MARK CONSISTS OF THE LETTER "W" INSIDE A CIRCLE.

CLASS 7—MACHINERY

FOR WORK MACHINES FOR THE BUILDING INDUSTRY AND FOR THE BUILDING MATERIAL INDUSTRY, NAMELY, SKID STEER LOADERS, ARTICULATED FRONT END WHEEL LOADERS, ALL-WHEEL-STEERED FRONT END LOADERS, TELESCOPIC FRONT END WHEEL LOADERS, TELESCOPIC HANDLERS, ARTICULATED FOUR-WHEEL DUMPERS, TRACK DUMPERS, COMPACT EXCAVATORS, MOBILE EXCAVATORS, CRAWLER EXCAVATORS, AND PARTS THEREFOR, NAMELY, BUCKETS, BLADES, FRONT SHOVELS, LIFTING FORKS, BROOMS, GRIPPERS, ATTACHMENT COMPACTORS, ATTACHMENT BREAKERS, SPREADERS, SOIL AUGERS, PLANERS, ADAPTER PLATES, WORK PLATFORMS; VIBRATION AND OSCILLATION MACHINES FOR SOIL, GRAVEL AND ASPHALT COMPACTION, NAMELY, VIBRATORY RAMMERS, VIBRATORY PLATES, VIBRATORY ROLLERS; MACHINE VIBRATION AND OSCILLATION DEVICES FOR CONCRETE COMPACTION, NAMELY, CONCRETE INTERNAL VIBRATORS, EXTERNAL VIBRATORS FOR SHUTTERING AND MOLDS, MOTORIZED VIBRATION WET SCREEDS, TRUSS SCREEDS AND PARTS THEREFOR, NAMELY, MACHINE TOOLS FOR LEVELING CONCRETE SURFACES, SHAFT MOTORS, FLEXIBLE SHAFTS; WORK MACHINES FOR THE BUILDING INDUSTRY AND FOR THE BUILDING MATERIAL INDUSTRY, FOR CONCRETE FLATWORK, NAMELY, WALK BEHIND AND SIT-ON POWER TROWELS, AND PARTS THEREFOR, NAMELY, FLATTENING PANS; MOTOR DRIVEN HAMMERS, DRILLING MACHINES, AND HAMMER DRILLS; RAMMERS IN THE NATURE OF MACHINES; MACHINE PUMPS FOR CLEAN WATER AND DIRTY WATER FOR DEWATERING AND FOR TRASH WATER FOR DRAINING PITS AND TRENCHES, NAMELY, DIAPHRAGM PUMPS, CENTRIFUGAL DEWATERING PUMPS, CENTRIFUGAL TRASH PUMPS, SUBMERSIBLE ELECTRIC PUMPS, MODULAR SUBMERSIBLE PUMPS WITH FLEXIBLE SHAFTS; CUTTING DEVICES AND JOINT CUTTING DEVICES IN PARTICULAR CUTTING DEVICES FOR ASPHALT AND CONCRETE IN THE NATURE OF CUTTING MACHINES; MACHINE CONCRETE FLAT PANS, NAMELY, CONCRETE IMPELLER FLAT PANS, POWER TROWELS AND CONCRETE SURFACE FLATTENERS; ELECTRIC POWER GENERATORS; APPARATUS FOR CUTTING REINFORCING STEEL, NAMELY, MACHINES FOR CUTTING STEEL THAT IS USED FOR REINFORCING; APPARATUS FOR BENDING REINFORCING STEEL, NAMELY, MACHINES FOR BENDING STEEL THAT IS USED FOR REINFORCING (U.S. CLS. 13, 19, 21, 23, 31, 34 AND 35).

CLASS 9—ELECTRICAL AND SCIENTIFIC APPARATUS

FOR REMOTE CONTROLS, NAMELY, RADIO CONTROLS, INFRARED REMOTE CONTROLS AND COMBINATIONS THEREOF FOR REMOTE CONTROL OF EARTH MOVING MACHINES AND VIBRATION AND OSCILLATION MACHINES FOR SOIL, GRAVEL AND ASPHALT COMPACTION; ELECTRONIC CONTROLS FOR MOTORS; ELECTRIC SWITCHING DEVICES AND CONTROL UNITS, NAMELY, FREQUENCY AND VOLTAGE CONVERTERS AND COMPONENTS THEREFOR IN THE NATURE OF ELECTRIC CONTROLLERS FOR USE WITH FREQUENCY AND VOLTAGE CONVERTERS (U.S. CLS. 21, 23, 26, 36 AND 38).

CLASS 11—ENVIRONMENTAL CONTROL APPARATUS

FOR LIGHTING INSTALLATIONS FOR CONSTRUCTION SITES, NAMELY, PORTABLE LIGHT TOWERS, LIGHT BALLOONS IN THE NATURE OF BALLOON-SHAPED LIGHT BULBS ON TELESCOPIC TRIPODS; HEATING APPARATUS FOR CONSTRUCTION SITES, NAMELY, ELECTRIC SPACE HEATERS, PAVEMENT HEATERS, INDIRECT FIRED AIR HEATERS WITH OIL BURNERS, INDIRECT FIRED AIR HEATERS WITH PROPANE BURNERS, INDIRECT FIRED AIR HEATERS WITH NATURAL GAS BURNERS, DIRECT FIRED AIR HEATER WITH OIL BURNERS, DIRECT FIRED AIR HEATER WITH NATURAL GAS BURNERS, DEHUMIDIFIERS FOR ACCELERATED DRYING OF WET OR FLOODED BUILDINGS, SURFACE HEATERS WITH ENROLLED HOSES FOR DEFROSTING OF SOIL AND CURING OF CONCRETE, AND REPLACEMENT PARTS THEREFOR (U.S. CLS. 13, 21, 23, 31 AND 34).

CLASS 37—CONSTRUCTION AND REPAIR

FOR RENTAL OF CONSTRUCTION MACHINES (U.S. CLS. 100, 103 AND 106).
APRIL ROACH, EXAMINING ATTORNEY

SN 79-061,963, HAGER + ELSÄSSER HOLDING GMBH,
FED REP GERMANY, FILED 4-3-2008.

Ecolutia

THE MARK CONSISTS OF STANDARD CHARACTERS WITHOUT CLAIM TO ANY PARTICULAR FONT, STYLE, SIZE, OR COLOR.

PRIORITY DATE OF 10-15-2007 IS CLAIMED.
OWNER OF INTERNATIONAL REGISTRATION 0984634
DATED 4-3-2008, EXPIRES 4-3-2018.

THE WORDING "ECOLUTIA" HAS NO MEANING IN A FOREIGN LANGUAGE.

CLASS 4—LUBRICANTS AND FUELS

FOR DUST ABSORBING COMPOSITIONS FOR USE IN WATER TREATMENT APPLICATIONS, DUST WETTING COMPOSITIONS FOR USE IN WATER TREATMENT APPLICATIONS AND DUST BINDING COMPOSITIONS (U.S. CLS. 1, 6 AND 15).

CLASS 6—METAL GOODS

FOR PORTABLE BUILDINGS OF METAL, NAMELY, SILOS; GOODS MADE OF METAL, NAMELY, TRANSPORTABLE METAL CONSTRUCTIONS, PIPES AND TUBES OF METAL INCLUDING THOSE FROM ALLOY STEEL AND TITANIUM, METAL TUBING, METAL PIPES AND TUBES FOR INDUSTRIAL USE, METAL PIPES FOR LIQUID AND GAS TRANSFER, METAL PIPES AND FITTINGS THEREFORE, METAL PIPE COUPLINGS AND JOINTS (U.S. CLS. 2, 12, 13, 14, 23, 25 AND 50).

CLASS 7—MACHINERY

FOR MACHINES FOR THE TREATMENT OF SLUDGE OF ALL KINDS, NAMELY, FILTRATION SYSTEMS AND PUMPS; MACHINES FOR DRAINAGE AND SEPARATION OF SUBSTANCES OF ALL KINDS, NAMELY, AGITATORS, FILTRATION SYSTEMS AND PUMPS; MACHINES FOR RECYCLING FLUIDS, NAMELY, REVERSE OSMOSIS PUMPS; GRANULATING MACHINES; MACHINES FOR GENERATING ENERGY OF RENEWABLE PRIMARY PRODUCTS AND RENEWABLE ENERGY CARRIERS, NAMELY, BIOGAS APPLICATIONS TO CONVERT WASTE INTO ENERGY, NAMELY, BLOWING MACHINES FOR THE COMPRESSION, EXHAUSTION AND TRANSPORT OF GASES (U.S. CLS. 13, 19, 21, 23, 31, 34 AND 35).

CLASS 9—ELECTRICAL AND SCIENTIFIC APPARATUS

FOR SCIENTIFIC, OPTICAL, DOSAGE, WEIGHING, MEASURING, SIGNALING, REGULATING APPARATUS AND INSTRUMENTS FOR USE IN WATER TREATMENT APPLICATIONS, NAMELY, ELECTRICAL INTEGRATED CONTROL SYSTEMS, WATER FILTER CONTROLLERS, COMPUTER PROGRAMS FOR DETECTING AND MEASURING WATER QUALITY, WATER TESTING INSTRUMENTATION FOR MONITORING AND DETECTING CONTAMINATION, FLOW REGULATORS AND FLOW CONTROL REGULATORS FOR INDUSTRIAL COMMERCIAL, MUNICIPAL, PRIVATE AND AGRICULTURAL USE, ELECTRIC METERS, WATER METERS, WATER LEVEL INDICATORS, PRESSURE INDICATORS FOR VALVES, APPARATUS AND INSTRUMENTS FOR CONVEYING, DISTRIBUTING, TRANSFORMING, STORING, REGULATING OR CONTROLLING ELECTRIC CURRENT; APPARATUS FOR RECORDING, TRANSMITTING AND REPRODUCING SOUND AND IMAGES, BLANK MAGNETIC RECORDING CARRIERS, DATA PROCESSING APPARATUS AND COMPUTERS; ALL ABOVE-MENTIONED GOODS, NAMELY, AS APPARATUS OR DEVICES FOR INSTALLATIONS FOR THE TREATMENT OF WATER OF ALL KINDS, INSTALLATIONS FOR THE TREATMENT OF SEWAGE WATER OF ALL KINDS, INSTALLATIONS FOR THE TREATMENT OF SLUDGE OF ALL KINDS, INSTALLATIONS FOR THE DRAINAGE AND SEPARATION OF SUBSTANCES OF ALL KINDS, INSTALLATIONS FOR THE TREATMENT AND UTILIZATION OF GASES OF ALL KINDS, DEGASSING INSTALLATIONS, INSTALLATIONS FOR RECYCLING FLUIDS, INSTALLATIONS FOR THE FILTRATION, REVERSE OSMOSIS, HEATING, PASTEURIZATION, STERILIZATION, FERMENTATION, INSTALLATIONS FOR THE CLEANING IN PROCESS METHOD, NAMELY, METHOD FOR AUTOMATICALLY APPLYING STERILIZATION TO WATER TREATMENT MACHINES WHILE IN OPERATION, INSTALLATIONS FOR PROCESS AUTOMATION AND INDUSTRIAL AUTOMATION, INSTALLATIONS FOR GRANULATION, DRYING, AGGLOMERATION, MATRIX ENCAPSULATION AND COATING OF SUBSTANCES OF ALL KINDS, INSTALLATIONS FOR GENERATING ENERGY, NAMELY, ENERGY OF RENEWABLE PRIMARY PRODUCTS AND RENEWABLE ENERGY CARRIERS (U.S. CLS. 21, 23, 26, 36 AND 38).

CLASS 11—ENVIRONMENTAL CONTROL APPARATUS

FOR APPARATUS FOR HEATING, STEAM GENERATING, COOLING, BOILING, DRYING, VENTILATION AND WATER CONDUIT APPARATUS, NAMELY, HEAT AND STEAM ACCUMULATORS, AIR DRYERS, NAMELY, DRYERS USED FOR THE REMOVAL OF SOLID, LIQUID AND VAPOR CONTAMINANTS FROM COMPRESSED AIR AND GASES, AIR PURIFYING APPARATUS AND MACHINES, BOILER PIPES FOR HEATING INSTALLATIONS, BOILERS FOR HEATING INSTALLATIONS, FANS, NAMELY, VENTILATING EXHAUST FANS, GAS BOILERS, HEAT ACCUMULATORS, HEAT EXCHANGERS, INCLUDING SHELL AND TUBE HEAT EXCHANGERS, HEAT GENERATORS, HEATING BOILERS, WATER AND HOT WATER HEATING INSTALLATIONS, ALL FOR INSTALLATIONS FOR THE TREATMENT OF WATER OF ALL KINDS, INSTALLATIONS FOR THE TREATMENT OF SEWAGE WATER OF

ALL KINDS, INSTALLATIONS FOR THE TREATMENT OF SLUDGE OF ALL KINDS, INSTALLATIONS FOR DRAINAGE AND SEPARATION OF SUBSTANCES OF ALL KINDS, INSTALLATIONS FOR THE TREATMENT AND UTILIZATION OF GASES OF ALL KINDS, DEGASSING INSTALLATIONS, INSTALLATIONS FOR THE RECYCLING OF FLUIDS, INSTALLATIONS FOR FILTRATION, REVERSE OSMOSIS, HEATING, PASTEURIZATION, STERILIZATION, FERMENTATION, INSTALLATIONS FOR THE CLEANING IN PROCESS METHOD, NAMELY, METHOD FOR AUTOMATICALLY APPLYING STERILIZATION TO WATER TREATMENT MACHINES WHILE IN OPERATION; INSTALLATIONS FOR PROCESS AUTOMATION AND INDUSTRIAL AUTOMATION, INSTALLATIONS FOR GRANULATION, DRYING, AGGLOMERATION, MATRIX ENCAPSULATION AND COATING OF SUBSTANCES OF ALL KINDS, INSTALLATIONS FOR GENERATING ENERGY, NAMELY, ENERGY OF RENEWABLE PRIMARY PRODUCTS AND RENEWABLE ENERGY CARRIERS; MACHINES FOR THE TREATMENT OF WATER OF ALL KINDS, NAMELY, CARTRIDGE FILTRATION UNITS, CHEMICAL STERILIZATION UNITS, REVERSE OSMOSIS FILTRATION UNITS, DESALINATION UNITS, AND STERILIZATION UNITS; MACHINES FOR THE TREATMENT OF SEWAGE WATER OF ALL KINDS, NAMELY, THICKENING AND DEWATERING MACHINES FOR USE IN TREATMENT OF LIQUIDS INCLUDING WATER, INDUSTRIAL EFFLUENT AND SEWAGE; MACHINES FOR FILTRATION, REVERSE OSMOSIS, HEATING, PASTEURIZATION, STERILIZATION AND FERMENTATION, NAMELY, BIOREACTOR FOR USE IN THE TREATMENT OF WASTE, NAMELY, A DIGESTER FOR CONVERTING ORGANIC WASTE INTO USEFUL PRODUCTS, NAMELY, BIOGAS, ELECTRICITY GENERATED BY MEANS OF BIOGAS, USEFUL ORGANIC RESIDUES, THERMAL ENERGY, FERTILIZER, AND CARBON CREDITS (U.S. CLS. 13, 21, 23, 31 AND 34).

CLASS 19—NON-METALLIC BUILDING MATERIALS

FOR TRANSPORTABLE BUILDINGS, NOT OF METAL (U.S. CLS. 1, 12, 33 AND 50).

CLASS 36—INSURANCE AND FINANCIAL

FOR LEASE-PURCHASE FINANCING; FINANCIAL AFFAIRS, NAMELY, FINANCIAL AND ADVISORY CONSULTANCY SERVICES; RESEARCH, FINANCIAL AND ADVISORY CONSULTANCY SERVICES IN THE FIELD OF REAL ESTATE; FINANCIAL SERVICES RELATING TO BUILD-OWN-OPERATE AND BUILD-OWN-TRANSFER BUSINESS AND PROJECTS, NAMELY, RESEARCH, FINANCIAL AND ADVISORY CONSULTANCY SERVICES FOR THE COMPLETION OF FINANCIAL TRANSACTIONS AND LEASE-PURCHASE FINANCING (U.S. CLS. 100, 101 AND 102).

CLASS 37—CONSTRUCTION AND REPAIR

FOR CONSTRUCTION, INSTALLATION, MAINTENANCE AND REPAIR SERVICES FOR INSTALLATIONS FOR THE TREATMENT OF WATER OF ALL KINDS, INSTALLATIONS FOR THE TREATMENT OF SEWAGE WATER OF ALL KINDS, INSTALLATIONS FOR THE TREATMENT OF SLUDGE OF ALL KINDS, INSTALLATIONS FOR DRAINAGE AND SEPARATION OF SUBSTANCES OF ALL KINDS, INSTALLATIONS FOR THE TREATMENT AND UTILIZATION OF GASES OF ALL KINDS, DEGASSING INSTALLATIONS, INSTALLATIONS FOR THE RECYCLING OF FLUIDS, INSTALLATIONS FOR FILTRATION, REVERSE OSMOSIS, HEATING, PASTEURIZATION, STERILIZATION, FERMENTATION, INSTALLATIONS FOR THE CLEANING IN PROCESS METHOD, INSTALLATIONS FOR PROCESS AUTOMATION AND INDUSTRIAL AUTOMATION, INSTALLATIONS FOR GRANULATION, DRYING, AGGLOMERATION, MATRIX ENCAPSULATION AND COATING OF SUBSTANCES OF ALL KINDS, INSTALLATIONS FOR GENERATING ENERGY, NAMELY, ENERGY OF RENEWABLE PRIMARY PRODUCTS AND RENEWABLE ENERGY CARRIERS (U.S. CLS. 100, 103 AND 106).

CLASS 39—TRANSPORTATION AND STORAGE

FOR TRANSPORTATION OF GOODS; STORAGE OF GOODS, NAMELY, SUBSTANCES AND FLUIDS (U.S. CLS. 100 AND 105).

CLASS 40—MATERIAL TREATMENT

FOR MATERIAL PROCESSING, NAMELY, SEPARATING WATER FROM SOLID AND DISSOLVED COMPOSITIONS IN INSTALLATIONS FOR THE TREATMENT OF WATER OF ALL KINDS, INSTALLATIONS FOR THE TREATMENT OF SEWAGE WATER OF ALL KINDS, INSTALLATIONS FOR THE TREATMENT OF SLUDGE OF ALL KINDS, INSTALLATIONS FOR DRAINAGE AND SEPARATION OF SUBSTANCES OF ALL KINDS, INSTALLATIONS FOR THE TREATMENT AND UTILIZATION OF GASES OF ALL KINDS, DEGASSING INSTALLATIONS, INSTALLATIONS FOR THE RECYCLING OF FLUIDS, INSTALLATIONS FOR FILTRATION, REVERSE OSMOSIS, HEATING, PASTEURIZATION, STERILIZATION, FERMENTATION, INSTALLATIONS FOR THE CLEANING IN PROCESS METHOD, INSTALLATIONS FOR PROCESS AUTOMATION AND INDUSTRIAL AUTOMATION, INSTALLATIONS FOR GRANULATION, DRYING, AGGLOMERATION, MATRIX ENCAPSULATION AND COATING OF SUBSTANCES OF ALL KINDS, INSTALLATIONS FOR GENERATING ENERGY, NAMELY, ENERGY OF RENEWABLE PRIMARY PRODUCTS AND RENEWABLE ENERGY CARRIERS (U.S. CLS. 100, 103 AND 106).

CLASS 42—SCIENTIFIC AND COMPUTER SERVICES

FOR SERVICES OF AN ENGINEER, ENGINEERING TECHNICIAN, PHYSICIST, CHEMIST, BIOLOGIST, NAMELY, DESIGN, ENGINEERING, RESEARCH, DEVELOPMENT AND TESTING SERVICES, NAMELY, DESIGN AND TESTING OF NEW PRODUCTS FOR OTHERS; MATERIALS TESTING AND ANALYZING; RESEARCH AND DEVELOPMENT OF TECHNOLOGY IN THE FIELD OF SCIENCE AND TECHNOLOGY; SERVICES IN THE FIELD OF SCIENCE AND TECHNOLOGY AND RESEARCH AND DEVELOPMENT SERVICES RELATING THERETO, NAMELY, DESIGN, ENGINEERING, RESEARCH, DEVELOPMENT AND TESTING SERVICES, NAMELY, DESIGN AND TESTING OF NEW PRODUCTS FOR OTHERS; MATERIALS TESTING AND ANALYZING; RESEARCH AND DEVELOPMENT OF TECHNOLOGY IN THE FIELD OF SCIENCE AND TECHNOLOGY; INDUSTRIAL ANALYSES AND RESEARCH, IN THE FIELD OF INSTALLATIONS FOR THE TREATMENT OF WATER OF ALL KINDS, INSTALLATIONS FOR THE TREATMENT OF SEWAGE WATER OF ALL KINDS, INSTALLATIONS FOR THE TREATMENT OF SLUDGE OF ALL KINDS, INSTALLATIONS FOR DRAINAGE AND SEPARATION OF SUBSTANCES OF ALL KINDS, INSTALLATIONS FOR THE TREATMENT AND UTILIZATION OF GASES OF ALL KINDS, DEGASSING INSTALLATIONS, INSTALLATIONS FOR THE RECYCLING OF FLUIDS, INSTALLATIONS FOR FILTRATION, REVERSE OSMOSIS, HEATING, PASTEURIZATION, STERILIZATION, FERMENTATION, INSTALLATIONS FOR THE CLEANING IN PROCESS METHOD, INSTALLATIONS FOR PROCESS AUTOMATION AND INDUSTRIAL AUTOMATION, INSTALLATIONS FOR GRANULATION, DRYING, AGGLOMERATION, MATRIX ENCAPSULATION AND COATING OF SUBSTANCES OF ALL KINDS, INSTALLATIONS FOR GENERATING ENERGY, NAMELY, ENERGY OF RENEWABLE PRIMARY PRODUCTS AND RENEWABLE ENERGY CARRIERS (U.S. CLS. 100 AND 101).

SCOTT BIBB, EXAMINING ATTORNEY

SN 79-062,409. COPPERDIME LIMITED, UNITED KINGDOM, FILED 6-20-2008.

COPPERDIME

THE MARK CONSISTS OF STANDARD CHARACTERS WITHOUT CLAIM TO ANY PARTICULAR FONT, STYLE, SIZE, OR COLOR.

OWNER OF INTERNATIONAL REGISTRATION 0985708 DATED 6-20-2008, EXPIRES 6-20-2018.

CLASS 9—ELECTRICAL AND SCIENTIFIC APPARATUS

FOR COMPUTER PROGRAMS RELATING TO FINANCIAL MATTERS, NAMELY, FOR THE EXCHANGE OF DATA AND ELECTRONIC FINANCIAL INSTRUMENTS, NAMELY, A MULTI ASSET-TRADING PLATFORM; COMPUTER PROGRAMS RELATING TO FINANCIAL MATTERS, NAMELY, FOR THE CONDUCTING OF TRANSACTIONS IN SHARES, STOCKS, BONDS, SECURITIES, CURRENCY EXCHANGES, FUTURES, OPTIONS, AND DERIVATIVES; COMPUTER SOFTWARE FOR EXCHANGING ELECTRONIC DATA BETWEEN BANKS AND OTHER FINANCIAL INSTITUTIONS; COMPUTER SOFTWARE FOR COMPUTING, PROCESSING, MANAGING AND RECORDING ELECTRONIC DATA RELATING TO FINANCIAL OPERATIONS AND FINANCIAL TRANSACTIONS; COMPUTER SOFTWARE FOR DISPLAYING INFORMATION REGARDING FINANCIAL TRANSACTIONS; COMPUTER SOFTWARE FOR PROCESSING AND FACILITATING ELECTRONIC PAYMENTS; COMPUTER SOFTWARE FOR PROCESSING DATA RELATING TO DEALINGS IN SHARES, STOCKS, BONDS AND SECURITIES; COMPUTER PROGRAMS FOR COMPUTING, PROCESSING, MANAGING AND RECORDING STOCK EXCHANGE TRANSACTIONS; COMPUTER SOFTWARE FOR THE MANAGEMENT OF ELECTRONIC DATA OF ORGANIZATIONS ENGAGED IN STOCK EXCHANGE TRANSACTIONS; COMPUTERS; COMPUTER TERMINALS; DATA TRANSMITTING AND RECEIVING APPARATUS AND INSTRUMENTS, NAMELY, MODEMS FOR USE IN THE TRANSFER AND RECEIPT OF DATA FROM ONE COMPUTER TO ANOTHER, OR BY TELEPHONE LINES, RADIO WAVES, A GLOBAL COMPUTER NETWORK OR OTHER SUCH TELEPHONIC MEANS FOR USE IN FINANCIAL TRANSACTIONS; ENCODED MAGNETIC CARDS FOR USE IN RELATION TO THE ELECTRONIC TRANSFER AND RECORDAL OF FINANCIAL TRANSACTIONS; DOWNLOADABLE ELECTRONIC PUBLICATIONS IN THE FORM OF MANUALS FOR COMPUTER SOFTWARE FOR FINANCIAL OPERATIONS AND FINANCIAL TRANSACTIONS (U.S. CLS. 21, 23, 26, 36 AND 38).

CLASS 36—INSURANCE AND FINANCIAL

FOR FINANCIAL SERVICES, NAMELY, CONDUCTING OF TRANSACTIONS IN SHARES, STOCKS, BONDS, SECURITIES, CURRENCY EXCHANGES, FUTURES, OPTIONS, AND DERIVATIVES; CONDUCTING FINANCIAL TRANSACTIONS, NAMELY, MULTI-ASSET CLASS TRADING TRANSACTIONS; COMPUTERIZED FINANCIAL SERVICES, NAMELY, ELECTRONIC CASH TRANSACTIONS, ELECTRONIC CREDIT CARD TRANSACTIONS, ELECTRONIC FUNDS TRANSFERS; COMPUTERIZED INFORMATION SERVICES RELATING TO FINANCIAL INFORMATION; FINANCIAL MANAGEMENT SERVICES; FINANCIAL ADVICE, CONSULTANCY, RESEARCH AND INFORMATION SERVICES; TRANSMISSION OF ELECTRONIC FINANCIAL TRANSACTIONS, NAMELY, ELECTRONIC DEBIT AND CREDIT TRANSACTIONS, ELECTRONIC FUNDS TRANSFERS, STOCK AND BOND TRANSFERS, CURRENCY EXCHANGE TRANSFERS, AND FINANCIAL REPORTS AND FINANCIAL STATEMENTS TRANSMITTED ALONG WITH THE ELECTRONIC DEBIT, CREDIT, FUNDS, STOCK AND BOND TRANSFERS (U.S. CLS. 100, 101 AND 102).

CLASS 38—COMMUNICATION

FOR COMMUNICATIONS BY COMPUTER TERMINALS; COMMUNICATION SERVICES BETWEEN DATABASES, NAMELY, THE ELECTRONIC EXCHANGE OF DATA STORED IN DATABASES ACCESSIBLE VIA TELECOMMUNICATION NETWORKS, TRANSMISSION OF DATABASE INFORMATION VIA TELECOMMUNICATIONS NETWORKS; PROVISION OF TELECOMMUNICATION ACCESS AND GATEWAY LINKS TO COMPUTER DATABASES AND TO THE INTERNET; TRANSMISSION AND RECEPTION OF ELECTRONIC FINANCIAL TRANSACTIONS, NAMELY, ELECTRONIC DATA AND MESSAGE TRANSMISSION CONCERNING FINANCIAL TRANSACTIONS, DATA TRANSMISSION AND RECEPTION SERVICES VIA TELECOMMUNICATION MEANS RELATED TO FINANCIAL TRANSACTIONS; PROVIDING ACCESS TO THE INTERNET AND TO DATABASES; ELECTRONIC MAIL; ELECTRONIC MESSAGE SENDING; RENTAL OF TELECOMMUNICATION APPARATUS AND EQUIPMENT (U.S. CLS. 100, 101 AND 104).

CLASS 42—SCIENTIFIC AND COMPUTER SERVICES

FOR COMPUTER PROGRAMMING SERVICES; COMPUTER SOFTWARE ENGINEERING, COMPUTER SYSTEMS ANALYSIS, COMPUTERIZED ANALYSIS OF DATA, NAMELY, ANALYZING DATABASES OF OTHERS IN THE FIELD OF FINANCIAL TRANSACTIONS, AND DATA AUTOMATION AND COLLECTION SERVICE USING PROPRIETARY SOFTWARE TO EVALUATE, ANALYZE AND COLLECT SERVICE DATA; RECOVERY OF COMPUTER DATA; DESIGN, CUSTOMIZATION, MODIFICATION, RESEARCH, DEVELOPMENT, TESTING, INSTALLATION AND MAINTENANCE OF COMPUTER SOFTWARE AND COMPUTER DATABASES; DESIGN, CUSTOMIZATION, MODIFICATION AND DEVELOPMENT OF COMPUTER HARDWARE AND COMPUTER NETWORKING SYSTEMS; PROVISION OF TECHNICAL SUPPORT SERVICES FOR COMPUTER HARDWARE AND SOFTWARE, NAMELY, TROUBLESHOOTING IN THE NATURE OF DIAGNOSING COMPUTER HARDWARE AND SOFTWARE PROBLEMS; RENTAL OF COMPUTER SOFTWARE, COMPUTER HARDWARE, AND COMPUTER NETWORKING SYSTEMS; ALL OF THE ABOVE FOR BANKS AND OTHER FINANCIAL INSTITUTIONS AND ORGANIZATIONS ENGAGED IN STOCK EXCHANGE TRANSACTIONS, AND FOR DEALINGS IN SHARES, STOCKS, BONDS, SECURITIES, CURRENCY EXCHANGES, FUTURES, OPTIONS, AND DERIVATIVES; INFORMATION, ADVISORY AND CONSULTANCY SERVICES RELATING TO ALL THE AFORESAID SERVICES (U.S. CLS. 100 AND 101).

TINA BROWN, EXAMINING ATTORNEY

SN 79-062,637. MAN S.R.L., SAN MARINO, FILED 9-18-2008.



OWNER OF INTERNATIONAL REGISTRATION 0968569 DATED 1-2-2008, EXPIRES 1-2-2018.

OWNER OF U.S. REG. NO. 2,658,570. THE COLOR(S) BLACK AND YELLOW IS/ARE CLAIMED AS A FEATURE OF THE MARK.

THE MARK CONSISTS OF A YELLOW SHADED RECTANGLE WITH THE WORD "MANAS" SUPERIMPOSED IN BLACK.

CLASS 18—LEATHER GOODS

FOR LEATHER AND IMITATION LEATHER BAGS (U.S. CLS. 1, 2, 3, 22 AND 41).

CLASS 25—CLOTHING

FOR FOOTWEAR, NAMELY, BOOTS, BOOTIES, SANDALS, SHOES AND SLIPPERS (U.S. CLS. 22 AND 39).
JERI J. FICKES, EXAMINING ATTORNEY

SN 79-062,683. TOPCO, FRANCE, FILED 10-10-2008.

SMARTBOX

THE MARK CONSISTS OF STANDARD CHARACTERS WITHOUT CLAIM TO ANY PARTICULAR FONT, STYLE, SIZE, OR COLOR.

PRIORITY DATE OF 4-11-2008 IS CLAIMED.
OWNER OF INTERNATIONAL REGISTRATION 0986422 DATED 10-10-2008, EXPIRES 10-10-2018.

CLASS 9—ELECTRICAL AND SCIENTIFIC APPARATUS

FOR MAGNETICALLY ENCODED CREDIT CARDS (U.S. CLS. 21, 23, 26, 36 AND 38).

CLASS 16—PAPER GOODS AND PRINTED MATTER

FOR CARDBOARD BOXES FOR USE AS GIFT BOXES; BOOKS, PRINTED PERIODICALS, BOOKLETS, PAMPHLETS, CATALOGUES, NEWSPAPERS, MAGAZINES, AND MANUALS IN THE FIELDS OF LEISURE, ENTERTAINMENT, TRANSPORT, SPORT, GASTRONOMY, COOKERY, COACHING, BEAUTY CARE, RELAXATION, ART, FLORAL ART, INTERIOR DESIGN, OENOLOGY, PILOTING, SCUBA DIVING; SCRAPBOOKS; INFORMATION BULLETINS CONCERNING LEISURE, ENTERTAINMENT, TRANSPORT, SPORT, GASTRONOMY, COOKERY, COACHING, BEAUTY CARE, RELAXATION, ART, FLORAL ART, INTERIOR DESIGN, OENOLOGY, PILOTING, SCUBA DIVING; PRINTED PUBLICATIONS, NAMELY, PROSPECTUSES IN THE FIELDS OF LEISURE, ENTERTAINMENT, TRANSPORT, SPORT, GASTRONOMY, COOKERY, COACHING, BEAUTY CARE, RELAXATION, ART, FLORAL ART, INTERIOR DESIGN, OENOLOGY, PILOTING, SCUBA DIVING; POSTERS; STICKERS; PHOTOGRAPHS; POSTCARDS, ENVELOPES; NOTE PAPER; SIGNBOARDS OF PAPER AND CARDBOARD; TIME PLANNERS; NOTE-PADS; NON-MAGNETICALLY ENCODED CREDIT, DEBIT, PREPAID PURCHASE CARDS OF CARDBOARD AND PLASTIC; NON-MAGNETICALLY ENCODED LOYALTY CARDS, NAMELY, PREPAID PURCHASE CARDS FOR ALLOWING USERS TO TRANSFER FINANCIAL VALUE ON-LINE VIA RETAIL COMPUTER NETWORKS; PRINTED VOUCHERS FOR THE PURCHASE OF GOODS AND SERVICES; PRINTED VOUCHERS INTENDED TO BE EXCHANGED FOR GOODS AND SERVICES; PRINTED GIFT VOUCHERS FOR ADVERTISING AND COMMERCIAL PURPOSES (U.S. CLS. 2, 5, 22, 23, 29, 37, 38 AND 50).

CLASS 36—INSURANCE AND FINANCIAL

FOR ISSUE OF GIFT CERTIFICATES, OF TRAVELERS' CHEQUES, OF VOUCHERS INTENDED TO BE EXCHANGED FOR GOODS AND/OR SERVICES; ISSUE OF VOUCHERS FOR THE PURCHASE OF GOODS AND/OR SERVICES; ISSUE OF GIFT VOUCHERS FOR COMMERCIAL OR ADVERTISING PURPOSES (U.S. CLS. 100, 101 AND 102).

CHRISTINE BLOMQUIST, EXAMINING ATTORNEY

SN 79-062,776. ALECH FRANK, BELGIUM, FILED 9-15-2008.



OWNER OF INTERNATIONAL REGISTRATION 0986704 DATED 9-15-2008, EXPIRES 9-15-2018.

NO CLAIM IS MADE TO THE EXCLUSIVE RIGHT TO USE THE DESIGN OF THE HELICOPTER, APART FROM THE MARK AS SHOWN.

THE COLOR(S) YELLOW AND BLACK IS/ARE CLAIMED AS A FEATURE OF THE MARK.

THE MARK CONSISTS OF A ROAD SIGN SHAPED LIKE A DIAMOND ABOVE A RECTANGLE. THE ROAD SIGN IS SHADED IN YELLOW AND OUTLINED IN BLACK. IN THE DIAMOND-SHAPED PORTION, A DESIGN OF A HELICOPTER APPEARS IN BLACK. IN THE RECTANGLE-SHAPED PORTION, IN BLACK, APPEARS THE WORDING "HELISTUFF".

CLASS 6—METAL GOODS

FOR TRANSPORTABLE BUILDINGS OF METAL; GOODS OF COMMON METAL NOT INCLUDED IN OTHER CLASSES, NAMELY, ARCHITECTURAL METALWORK, BAR HANGERS AND PARTS AND FITTINGS THEREFOR MADE OF METAL FOR LIGHTING FIXTURES, BAR HANGERS AND PARTS AND FITTINGS THEREFOR MADE OF METAL FOR ELECTRICAL FIXTURES/HOUSING, METAL HOLDERS FOR SIGNBOARDS, METAL HOLDERS FOR SIGNS, DECORATIVE BOXES OF COMMON METAL; GENERAL PURPOSE METAL STORAGE UNITS, FITTINGS OF METAL FOR FURNITURE; MONUMENTS OF NON-PRECIOUS METAL; SIGNALING PANELS, NON-LUMINOUS AND NON-MECHANICAL, OF METAL; SIGNS, NON-LUMINOUS AND NON MECHANICAL OF METAL; WIND VANES OF METAL; WORKS OF ART OF COMMON METAL (U.S. CLS. 2, 12, 13, 14, 23, 25 AND 50).

CLASS 9—ELECTRICAL AND SCIENTIFIC APPARATUS

FOR BLANK MAGNETIC DATA CARRIERS AND RECORDING DISCS; BEACONS, LUMINOUS FOR HELICOPTER SAFETY AND LANDING PURPOSES; PROTECTIVE HELMETS; LUMINOUS AND MECHANICAL SIGNALING DISPLAY PANELS; ELECTRONIC NOTICE BOARDS; LUMINOUS AND MECHANICAL SIGNALS FOR AIDING HELICOPTERS IN TAKING OFF AND IN LANDING; LUMINOUS AND MECHANICAL SIGNS; SPECIAL PROTECTIVE PILOT OVERALLS; ANEMOMETERS; WIND SOCKS FOR INDICATING WIND DIRECTION; TRAINING FILMS FEATURING HELICOPTER SAFETY AND HELICOPTER PILOTING (U.S. CLS. 21, 23, 26, 36 AND 38).

CLASS 16—PAPER GOODS AND PRINTED MATTER

FOR PHOTOGRAPHS; PRINTED INSTRUCTIONAL AND TEACHING MATERIAL NOT INCLUDING APPARATUS IN THE FIELD OF HELICOPTER SAFETY AND HELICOPTER PILOTING; HANDBOOKS IN THE NATURE OF MANUALS IN THE FIELD OF HELICOPTER SAFETY AND HELICOPTER PILOTING; CALENDARS; PERIODICALS IN THE FIELD OF HELICOPTERS (U.S. CLS. 2, 5, 22, 23, 29, 37, 38 AND 50).

CLASS 18—LEATHER GOODS

FOR TRUNKS AND TRAVELING BAGS; UMBRELLAS; BRIEFCASES; HANDBAGS; RUCKSACKS (U.S. CLS. 1, 2, 3, 22 AND 41).

CLASS 25—CLOTHING

FOR CLOTHING, NAMELY, ASCOTS, BELTS IN THE NATURE OF CLOTHING, COATS, GLOVES, JACKETS, JERSEYS IN THE NATURE OF CLOTHING, JUMPERS, NECKTIES, OVERALLS, OVERCOATS, PARKAS, PULL-OVERS, SASHES, SHIRTS, SPORTS JERSEYS, SUITS, SWEATERS, TEE-SHIRTS, TOPCOATS, TROUSERS, UNIFORMS, VESTS, WAISTCOATS, HELICOPTER JACKETS, NOT PROTECTIVE CLOTHING; HELICOPTER GLOVES, NOT PROTECTIVE CLOTHING; FOOTWEAR; HEADGEAR, NAMELY, BERETS, CAPS CLOTHING, EAR MUFFS, HATS, HEADBANDS CLOTHING, HOODS CLOTHING, SKULL CAPS, SUN VISORS (U.S. CLS. 22 AND 39).

MARILYN IZZI, EXAMINING ATTORNEY

SN 79-062,846. PLUMINA INC., REPUBLIC OF KOREA, FILED 9-30-2008.



OWNER OF INTERNATIONAL REGISTRATION 0986878 DATED 9-30-2008, EXPIRES 9-30-2018.

THE COLOR(S) PINK, GREEN, ORANGE, BLUE, YELLOW, BLACK, PURPLE AND DEEP BLUE IS/ARE CLAIMED AS A FEATURE OF THE MARK.

THE MARK CONSISTS OF THE TERM "PLUMINA" WHEREIN THE DOT OVER THE LETTER "I" IS REPRESENTED BY THREE LINES AND THE WORDING IS UNDERLINED BY A RAINBOW-LIKE STRAIGHT, HORIZONTAL LINE COMPRISED OF SEVEN QUADRILATERALS; THE COLOR PINK APPEARS IN THE LETTER "P" AND IN THE LEFTMOST QUADRILATERAL IN THE UNDERLINE; THE COLOR GREEN APPEARS IN THE LETTER "L", IN THE MIDDLE LINE ABOVE THE LETTER "I" AND IN THE MIDDLE QUADRILATERAL IN THE UNDERLINE; THE COLOR ORANGE APPEARS IN THE LETTER "U", IN THE LEFT LINE ABOVE THE LETTER "I" AND IN THE SECOND QUADRILATERAL FROM THE LEFT IN THE UNDERLINE; THE COLOR BLUE APPEARS IN THE LETTER "M" AND IN THE THIRD QUADRILATERAL FROM THE RIGHT IN THE UNDERLINE; THE COLOR YELLOW APPEARS IN THE BOTTOM PORTION OF THE LETTER "I" AND IN THE THIRD QUADRILATERAL FROM THE LEFT IN THE UNDERLINE; THE COLOR BLACK APPEARS IN THE LETTER "N"; THE COLOR PURPLE APPEARS IN THE LETTER "A" AND IN THE RIGHTMOST QUADRILATERAL IN THE UNDERLINE; THE COLOR DEEP BLUE APPEARS IN THE RIGHT LINE ABOVE THE LETTER "I" AND IN THE SECOND QUADRILATERAL FROM THE RIGHT IN THE UNDERLINE.

THE WORDING "PLUMINA" HAS NO MEANING IN A FOREIGN LANGUAGE.

CLASS 7—MACHINERY

FOR ENGINE RADIATORS FOR AUTOMOBILES (U.S. CLS. 13, 19, 21, 23, 31, 34 AND 35).

SN 79-062,964. OD-OS GMBH, 14513 TELTOW, FED REP GERMANY, FILED 6-4-2008.

OD-OS

CLASS 9—ELECTRICAL AND SCIENTIFIC APPARATUS

FOR COOLING MODULES FOR COMPUTERS, NAMELY, CENTRAL PROCESSING UNIT (CPU) COOLERS (U.S. CLS. 21, 23, 26, 36 AND 38).

THE MARK CONSISTS OF STANDARD CHARACTERS WITHOUT CLAIM TO ANY PARTICULAR FONT, STYLE, SIZE, OR COLOR.

OWNER OF INTERNATIONAL REGISTRATION 0987124 DATED 6-4-2008, EXPIRES 6-4-2018.

CLASS 10—MEDICAL APPARATUS

FOR MEDICAL INSTRUMENTS AND APPARATUS FOR DIAGNOSES AND THERAPY IN THE FIELD OF OPHTHALMOLOGY (U.S. CLS. 26, 39 AND 44).

CLASS 11—ENVIRONMENTAL CONTROL APPARATUS

FOR STREET LAMPS; SAFETY LAMPS FOR UNDERGROUND USE; GERMICIDAL LAMPS FOR PURIFYING AIR NOT FOR MEDICAL USE; LAMPS FOR MINE WORKERS; NEON LAMPS; LANTERNS; DISCHARGE LAMPS AND THEIR FITTINGS; INCANDESCENT LAMPS AND THEIR FITTINGS; ULTRAVIOLET RAY LAMPS NOT FOR MEDICAL PURPOSES; GERMICIDAL LAMPS NOT FOR MEDICAL PURPOSES; CHANDELIERS; MINIATURE LAMPS; LIGHTING DEVICES FOR SHOWCASES; WATER SURFACE LAMPS; AQUARIUM LIGHTS; SPOTLIGHTS; CARBON FOR ARC LAMPS BEING FITTING FOR LAMPS; SAFETY LAMPS; LAMPS FOR OUTDOOR USE; PROJECTOR LAMPS; OVERHEAD LAMPS; DIVING LIGHTS; LAMPS FOR DECORATION; INFRARED ELECTRONIC LIGHT BULBS; ELECTRIC BULBS; ELECTRIC POCKET TORCHES FOR LIGHTING; ELECTRIC LIGHTING APPARATUS, NAMELY, LED LIGHT ASSEMBLIES FOR STREET LIGHTS, SIGNS, COMMERCIAL LIGHTING, AUTOMOBILES, BUILDINGS, AND OTHER ARCHITECTURAL USES; LIGHTING APPARATUS FOR AUTOMOBILES AND AUTOMOBILE HEADLIGHTS; BICYCLE LIGHTS; REFLECTORS FOR AUTOMOBILES; LAMPS FOR DIRECTIONAL SIGNALS OF AUTOMOBILES; LIGHT BULBS FOR DIRECTIONAL SIGNALS OF AUTOMOBILES AND VEHICLES; SOCKETS FOR ELECTRIC LIGHTS; LANTERNS FOR LIGHTING; LUMINOUS TUBES FOR LIGHTING; ELECTRIC DISCHARGE TUBES FOR LIGHTING; LIGHT DIFFUSERS; FISH GATHERING LAMPS; CEILING LIGHTS; ELECTRIC LIGHTS FOR CHRISTMAS TREES; TABLE LAMPS; HIGH INTENSITY SEARCH LIGHTS; ARTIFICIAL SOLAR LAMPS; FLOODLIGHTS; AIR CONDITIONERS FOR AUTOMOBILES; ENGINE RADIATORS FOR AUTOMOBILES; HVAC, NAMELY, HEATING, VENTILATING, AND AIR CONDITIONING UNITS; GAS REFRIGERATORS; LOCALLY INDUCED AIR-CONDITIONERS FOR INDUSTRIAL PURPOSES; WINDOW-MOUNTING AIR-CONDITIONERS FOR INDUSTRIAL PURPOSES; COOLERS, NAMELY, HEAT SINKS FOR USE IN HEATING, COOLING AND VENTILATING APPARATUS AND HEAT PIPES TO COOL HEAT PRODUCING COMPONENTS; COOLING DOMES; COOLING APPARATUS AND MACHINES, NAMELY, ELECTRIC SPACE COOLING APPARATUS FOR HOUSEHOLD PURPOSES, PELTIER COOLING AND HEATING APPARATUS, SOLAR ENERGY BASED COOLING APPARATUS; COOLING EVAPORATORS; REFRIGERATING CABINETS; WATER COOLING TOWERS; WATER COOLERS; AIR CONDITIONERS; AIR FILTERS FOR AIR CONDITIONING UNITS; AIR CONDITIONING APPARATUS AND INSTALLATIONS; EVAPORATIVE AIR COOLERS FOR FURNACES (U.S. CLS. 13, 21, 23, 31 AND 34).

MYRIAH HABEEB, EXAMINING ATTORNEY

CLASS 42—SCIENTIFIC AND COMPUTER SERVICES

FOR SCIENTIFIC AND TECHNOLOGICAL RESEARCH SERVICES; TECHNOLOGICAL MAINTENANCE SERVICES, NAMELY, REPAIR OF COMPUTER SOFTWARE; COMPUTER HARDWARE AND SOFTWARE DESIGN AND DEVELOPMENT SERVICES; ALL OF THE FOREGOING SERVICES ARE IN CONNECTION WITH MEDICAL CARE IN THE FIELD OF OPHTHALMOLOGY (U.S. CLS. 100 AND 101).

EMILY CARLSEN, EXAMINING ATTORNEY

SN 79-063,591. JSC "BANK OF GEORGIA", REP OF GEORGIA, FILED 9-16-2008.



PRIORITY DATE OF 8-6-2008 IS CLAIMED.
OWNER OF INTERNATIONAL REGISTRATION 0988561 DATED 9-16-2008, EXPIRES 9-16-2018.

THE COLOR(S) WHITE, GOLD AND GREY IS/ARE CLAIMED AS A FEATURE OF THE MARK.

THE MARK CONSISTS OF A STYLIZED GOLD AND WHITE LION WITH GOLD AND WHITE ARMOR COVERING ITS HEAD, NECK, AND FRONT LEGS APPEARING ON THE WHITE BACKGROUND AND ENCLOSED IN A GRAY SQUARE CARRIER.

CLASS 9—ELECTRICAL AND SCIENTIFIC APPARATUS

FOR MAGNETICALLY ENCODED CASH CARDS, MAGNETICALLY ENCODED BANK CARDS, MAGNETICALLY ENCODED CREDIT CARDS, MAGNETICALLY ENCODED DEBIT CARDS; DOWNLOADABLE COMPUTER SOFTWARE SUPPLIED ON-LINE FROM DATABASES OR FROM FACILITIES PROVIDED ON THE INTERNET INCLUDING WEB PAGES AND WEB SITES FOR DATABASE MANAGEMENT; COMPUTER SOFTWARE TO ENABLE SEARCHING OF DATA; REPLACEMENT PARTS FOR ALL OF THE AFORESAID GOODS; HAND-HELD DEVICES FOR PAYMENT AND VALUE EXCHANGE SERVICES AND FOR ENABLING PROCESSING OF OTHER PERSONAL INFORMATION SERVICES, NAMELY, MAGNETICALLY ENCODED BANK CARDS, CARD READERS FOR CREDIT CARDS AND DEBIT CARDS; MAGNETICALLY ENCODED ATM (AUTOMATED TELLER MACHINE) CARDS; ATM MACHINES; COMPUTER SOFTWARE FOR THE PROVISION OF BANKING SERVICES, FINANCIAL SERVICES, BANK ACCOUNT MANAGEMENT SERVICES, MONETARY TRANSFER SERVICES, PAYMENT SERVICES, FINANCIAL ANALYSIS AND FINANCIAL REPORTS, FINANCIAL MANAGEMENT SERVICES, AND INFORMATION SERVICES RELATING TO BANKING AND FINANCE; COMPUTER SOFTWARE TO ENABLE THE SEARCHING OF DATA RELATING TO THE FOREGOING (U.S. CLS. 21, 23, 26, 36 AND 38).

CLASS 35—ADVERTISING AND BUSINESS

FOR ADVERTISING, BUSINESS MANAGEMENT AND BUSINESS ADMINISTRATION SERVICES, INCLUDING ADVERTISING, BUSINESS MANAGEMENT AND BUSINESS ADMINISTRATION SERVICES FOR THE PROVISION, USE AND PROMOTION OF BANKING AND FINANCIAL SERVICES OF ALL KINDS; ADVERTISING, MARKETING AND PROMOTIONAL SERVICES; ADVERTISING SERVICES ASSOCIATED WITH THE PROVISION OF CORPORATE AND INSTITUTIONAL RETAIL SALES SERVICES, COMMERCIAL AND BUSINESS INFORMATION SERVICES; RADIO, TELEVISION AND ON-LINE ADVERTISING OF BANKING AND FINANCIAL SERVICES; PROMOTION OF GOODS AND SERVICES OF OTHERS (U.S. CLS. 100, 101 AND 102).

CLASS 36—INSURANCE AND FINANCIAL

FOR INSURANCE SERVICES, NAMELY, HEALTH, LIFE AND MARINE INSURANCE UNDERWRITING SERVICES; BANKING ACTIVITIES, CURRENCY EXCHANGE, FINANCIAL PORTFOLIO MANAGEMENT, PROVIDING LOANS AGAINST SECURITY, NAMELY, PROVIDING LOANS SECURED BY COMMERCIAL PAPER, DEBT RECOVERY SERVICES, ISSUING OF DEBIT AND CREDIT CARDS, ISSUING OF TRAVELER'S CHECKS, STOCK AND BONDS BROKERAGE; MANAGEMENT OF REAL ESTATE (U.S. CLS. 100, 101 AND 102).

DEBRA LEE, EXAMINING ATTORNEY

SN 79-064,080. GOGOYOKO EHF., IS-110 REYKJAVIK, ICELAND, FILED 8-13-2008.

GOGOYOKO

THE MARK CONSISTS OF STANDARD CHARACTERS WITHOUT CLAIM TO ANY PARTICULAR FONT, STYLE, SIZE, OR COLOR.

PRIORITY DATE OF 3-3-2008 IS CLAIMED.

OWNER OF INTERNATIONAL REGISTRATION 0989936 DATED 8-13-2008, EXPIRES 8-13-2018.

THE WORDING "GOGOYOKO" HAS NO MEANING IN A FOREIGN LANGUAGE.

CLASS 9—ELECTRICAL AND SCIENTIFIC APPARATUS

FOR SCIENTIFIC, NAUTICAL, SURVEYING, PHOTOGRAPHIC, CINEMATOGRAPHIC, OPTICAL, WEIGHING, MEASURING, SIGNALING, CHECKING AND SUPERVISION, LIFE-SAVING AND TEACHING APPARATUS AND INSTRUMENTS, NAMELY, MICROSCOPES, COMPASSES, PROTRACTORS, MAGNIFYING GLASSES, TELESCOPES, GRADUATED RULERS, EMERGENCY FLARES, OPTICAL LENSES, SCALES, SIGNALING BUOYS, LIFE-SAVING RAFTS; APPARATUS AND INSTRUMENTS FOR CONDUCTING, SWITCHING, TRANSFORMING, ACCUMULATING, REGULATING OR CONTROLLING ELECTRICITY, NAMELY, ELECTRIC ACCUMULATORS, ELECTRIC TRANSFORMERS, ELECTRIC CURRENT SWITCHES, ELECTRICAL CONDUCTORS, VOLTAGE REGULATORS, ARC FLASH MONITORS AND ARC FLASH PREVENTION DEVICES; APPARATUS FOR RECORDING, TRANSMISSION OR REPRODUCTION OF SOUND OR IMAGES; BLANK MAGNETIC DATA CARRIERS AND RECORDING DISCS; PRERECORDED MAGNETIC DATA CARRIERS AND RECORDING DISCS FEATURING MUSIC, SOUND EFFECTS, GAMES, AUDIO BOOKS FEATURING FICTIONAL AND NON-FICTIONAL TEXTS; AUTOMATIC VENDING MACHINES AND MECHANISMS FOR COIN-OPERATED APPARATUS; CASH REGISTERS, CALCULATING MACHINES (U.S. CLS. 21, 23, 26, 36 AND 38).

CLASS 35—ADVERTISING AND BUSINESS

FOR ADVERTISING; BUSINESS MANAGEMENT; BUSINESS ADMINISTRATION; OFFICE FUNCTIONS (U.S. CLS. 100, 101 AND 102).

CLASS 36—INSURANCE AND FINANCIAL

FOR INSURANCE SERVICES, NAMELY, ACCIDENT INSURANCE UNDERWRITING, INSURANCE ACTUARIAL SERVICES, INSURANCE ADMINISTRATION, INSURANCE AGENCY AND BROKERAGE, INSURANCE CLAIMS ADMINISTRATION, INSURANCE CLAIMS PROCESSING, INSURANCE CONSULTANCY, PROVIDING INSURANCE INFORMATION, INSURANCE SUBROGATION, INSURANCE UNDERWRITING CONSULTATION IN RELATION TO AUTOMOBILE INSURANCE, HEALTH INSURANCE, LIFE INSURANCE, ACCIDENT INSURANCE, MALPRACTICE INSURANCE, LIABILITY INSURANCE, INFRINGEMENT INSURANCE, PRIVATE MORTGAGE INSURANCE, SERVICE CONTRACT INSURANCE, FLIGHT INSURANCE, CREDIT INSURANCE, MORTGAGE INSURANCE AND SHORT-TERM MEDICAL INSURANCE, PROVIDING INDEPENDENT SCORING SERVICE RELATED TO EXISTING INSURANCE SERVICES IN A SPECIFIC GEOGRAPHIC REGION OR TYPE OF INSURANCE FOR INSURANCE EVALUATION PURPOSES, LOSS CONTROL MANAGEMENT FOR OTHERS, PROVIDING INFORMATION REGARDING POLICY RATES FOR ALL TYPES OF INSURANCE AND ELECTRONIC PROCESSING OF INSURANCE CLAIMS AND PAYMENT DATA OVER A WEB BASED COMPUTER NETWORK; FINANCIAL SERVICES, NAMELY, CHARITABLE FUNDRAISING SERVICES IN RELATION TO POVERTY, DISEASE, EDUCATION, CHILD ABUSE, SPOUSE ABUSE, ANIMAL ABUSE, HOMELESSNESS, DISCRIMINATION, GLOBAL WARMING, RELIGION AND HUMAN OPPRESSION, CONSULTATION SERVICES IN THE FIELD OF PERSONAL FINANCIAL MANAGEMENT, ELECTRONIC FINANCIAL SERVICE FOR THE PURCHASE OF DEBT-RELATED SECURITIES IN RELATION TO FINANCIAL INVESTMENTS, REAL ESTATE, BONDS, STOCKS, COMMODITIES, AND CURRENCY, FINANCIAL ADVICE AND CONSULTANCY SERVICES, FINANCIAL ANALYSIS AND RESEARCH SERVICES, SURETY SERVICES, FINANCIAL INFORMATION AND ADVISORY SERVICES, FINANCIAL PLANNING AND INVESTMENT ADVISORY SERVICES, FINANCIAL PLANNING SERVICES, NAMELY, DEVELOPING AND MANAGING CHARITABLE GIVING PROGRAMS ON BEHALF OF OTHERS, FINANCIAL RESEARCH AND INFORMATION SERVICES, MONEY LENDING, PROVIDING ON-LINE STORED VALUE ACCOUNTS IN AN ELECTRONIC ENVIRONMENT, ASSISTING OTHERS WITH THE COMPLETION OF FINANCIAL TRANSACTIONS FOR

STOCKS, BONDS, SECURITIES AND EQUITIES, SAVINGS PROGRAMS FOR YOUTHS, PROVIDING FOR THE EXCHANGE OF FOREIGN CURRENCY, COMMODITIES, FINANCIAL DERIVATIVES, INTEREST RATE PRODUCTS, AND EQUITIES VIA THE INTERNET AND INTRANET SYSTEMS, PROVIDING INFORMATION IN THE FIELDS OF FOREIGN CURRENCY, COMMODITIES, FINANCIAL DERIVATIVES, INTEREST RATE PRODUCTS, AND EQUITIES VIA THE INTERNET AND INTRANET SYSTEMS, PROVIDING A VIRTUAL CURRENCY FOR USE BY MEMBERS OF AN ON-LINE COMMUNITY VIA A GLOBAL COMPUTER NETWORK, CREDIT REPAIR AND RESTORATION, BUSINESS FUND RAISING PROVIDED OVER A COMPUTER NETWORK SUCH AS THE INTERNET, ELECTRONIC REMOTE CHECK DEPOSIT SERVICES, ADMINISTRATION OF TRANSACTIONS INVOLVING FUNDS DRAWN FROM SECURITIES, STOCKS, FUNDS, EQUITIES, BONDS, CASH OR OTHER TYPES OF FINANCIAL INVESTMENTS IN RETIREMENT PLANS USING A CREDIT OR DEBIT CARD OVER A GLOBAL DATA NETWORK, INVESTMENT ADVICE, INVESTMENT MANAGEMENT, INVESTMENT CONSULTATION AND INVESTMENT OF FUNDS FOR OTHERS, INCLUDING PRIVATE AND PUBLIC EQUITY AND DEBT INVESTMENT SERVICES, ADMINISTRATION OF TRANSACTIONS INVOLVING FUNDS DRAWN FROM SECURITIES, STOCKS, FUNDS, EQUITIES, BONDS, CASH OR OTHER TYPES OF FINANCIAL INVESTMENTS IN RETIREMENT PLANS USING A CHECK OR NEGOTIABLE ORDER OF WITHDRAWAL OVER A GLOBAL DATA NETWORK, FUNDING ON-LINE CASH ACCOUNTS FROM PREPAID CASH CARDS, BANK ACCOUNTS AND CREDIT CARD ACCOUNTS, FINANCIAL TRANSACTION SERVICES, NAMELY, PROVIDING SECURE COMMERCIAL TRANSACTIONS AND PAYMENT OPTIONS USING A MOBILE DEVICE AT A POINT OF SALE, ON-LINE FINANCIAL PLANNING SERVICES, PROVIDING FINANCIAL RISK MANAGEMENT SERVICES FOR ELECTRONIC FUNDS TRANSFER, CREDIT AND DEBIT CARD AND ELECTRONIC CHECK TRANSACTIONS VIA A GLOBAL COMPUTER NETWORK; MONETARY AFFAIRS, NAMELY, ACCEPTING AND ADMINISTERING MONETARY CHARITABLE CONTRIBUTIONS, ELEMOSYNARY SERVICES IN THE FIELD OF MONETARY DONATIONS, PHILANTHROPIC SERVICES CONCERNING MONETARY DONATIONS; REAL ESTATE AFFAIRS, NAMELY, COMMERCIAL AND RESIDENTIAL REAL ESTATE AGENCY SERVICES, FINANCIAL DUE DILIGENCE SERVICES IN THE FIELD OF REAL ESTATE, REAL ESTATE ACQUISITION SERVICES, REAL ESTATE ESCROW SERVICES, REAL ESTATE FINANCING SERVICES, REAL ESTATE INVESTMENT SERVICES IN THE NATURE OF PURCHASING AND SELLING OF REAL ESTATE FOR OTHERS, REAL ESTATE LISTING SERVICES FOR HOUSING RENTALS AND APARTMENT RENTALS, REAL ESTATE MANAGEMENT SERVICES, REAL ESTATE RESIDENTIAL RENTAL SERVICES, RENTAL PROPERTY MANAGEMENT SERVICES, RENTAL, BROKERAGE, LEASING AND MANAGEMENT OF COMMERCIAL PROPERTY, OFFICES AND OFFICE SPACE, REAL ESTATE TRUSTEE SERVICES, REAL ESTATE VALUATION SERVICES, VACATION REAL ESTATE TIME SHARE EXCHANGE SERVICES (U.S. CLS. 100, 101 AND 102).

CLASS 38—COMMUNICATION

FOR TELECOMMUNICATIONS SERVICES, NAMELY, TRANSMISSION OF VOICE, AUDIO, VISUAL IMAGES AND DATA BY TELECOMMUNICATIONS NETWORKS, WIRELESS COMMUNICATION NETWORKS, THE INTERNET, INFORMATION SERVICES NETWORKS AND DATA NETWORKS, COMMUNICATIONS VIA MULTINATIONAL TELECOMMUNICATION NETWORKS, DATA TRANSMISSION AND RECEPTION SERVICES VIA TELECOMMUNICATION MEANS, INFORMATION ABOUT TELECOMMUNICATION, INTERNET CAFE SERVICES, NAMELY, PROVIDING TELECOMMUNICATIONS CONNECTIONS TO THE INTERNET IN A CAFE ENVIRONMENT, PROVIDING ACCESS TO TELECOMMUNICATION NETWORKS, PROVIDING TELECOMMUNICATIONS CONNECTIONS TO A GLOBAL COMPUTER NETWORK, PROVIDING TELECOMMUNICATION CHANNELS FOR TEleshopping SERVICES, PROVIDING THIRD PARTY USERS WITH ACCESS TO TELECOMMUNICATION INFRASTRUCTURE, SIGNAL

TRANSMISSION FOR ELECTRONIC COMMERCE VIA TELECOMMUNICATION SYSTEMS AND DATA COMMUNICATION SYSTEMS, TELECOMMUNICATION ACCESS SERVICES, PROVIDING LONG DISTANCE SERVICE WITH AUDIO ADVERTISING FOR OTHERS AS A COMPONENT OF THE LONG DISTANCE SERVICE, TRANSMISSION OF PODCASTS, TRANSMISSION OF WEBCASTS, LOCAL AND LONG DISTANCE TRANSMISSION OF VOICE, DATA, GRAPHICS AND VIDEO BY MEANS OF BROADBAND OPTICAL OR WIRELESS NETWORKS, PROVIDING INTERNET ACCESS VIA BROADBAND OPTICAL OR WIRELESS NETWORKS, WIRELESS TELEPHONE SERVICES, PROVIDING TELEPHONE FEATURES, NAMELY, CALL WAITING, CALL IDENTIFICATION, CALL FORWARDING, AND MESSAGE WAITING, TRANSMISSION OF VOICE, DATA, GRAPHICS, IMAGES, AUDIO AND VIDEO BY MEANS OF TELECOMMUNICATIONS NETWORKS, WIRELESS COMMUNICATION NETWORKS, AND THE INTERNET, PERSONAL COMMUNICATION SERVICES, PROVIDING PREPAID MINUTES FOR USE ON CELL PHONES ABROAD, PROVIDING TOLL-FREE MNEMONIC TELEPHONE NUMBERS (U.S. CLS. 100, 101 AND 104).

CLASS 40—MATERIAL TREATMENT

FOR TREATMENT OF MATERIALS, NAMELY, MATERIAL TREATMENT SERVICES IN CONNECTION WITH RECYCLING, PAPER TREATMENT, CHEMICAL TREATMENT OF TEXTILES, SOIL TREATMENT SERVICES, FUEL TREATMENT SERVICES, METAL TREATMENT, PREPARATION AND TREATMENT OF FABRIC, SUSTAINABLE ON-SITE WATER RECYCLING AND WASTEWATER TREATMENT SERVICES, TREATMENT OF MATERIALS FOR THE MANUFACTURE OF CERAMIC GOODS, WATER TREATMENT AND PURIFICATION (U.S. CLS. 100, 103 AND 106).

CLASS 41—EDUCATION AND ENTERTAINMENT

FOR EDUCATIONAL SERVICES, NAMELY, PROVIDING CLASSES, SEMINARS, WORKSHOPS, AND INTERNET-BASED CLASSES AND SEMINARS, IN THE FIELDS OF MUSIC, INTERNET TECHNOLOGIES, WEBSITE DESIGN AND IMPLEMENTATION, COMPUTERS, DATA SECURITY, BUSINESS, PERSONAL FINANCIAL MANAGEMENT, RECYCLING, AND CHARITABLE SERVICES; INFORMATION RELATED TO EDUCATION IN THE FIELDS OF MUSIC, INTERNET TECHNOLOGIES, WEBSITE DESIGN AND IMPLEMENTATION, COMPUTERS, DATA SECURITY, BUSINESS, PERSONAL FINANCIAL MANAGEMENT, RECYCLING AND CHARITABLE SERVICES; CONSULTATION RELATED TO EDUCATIONAL SERVICES, NAMELY, CONSULTATION IN THE FIELD OF PRIMARY, SECONDARY AND POST-SECONDARY EDUCATIONAL SYSTEMS IN THE FIELD OF MUSIC, INTERNET TECHNOLOGIES, WEBSITE DESIGN AND IMPLEMENTATION, COMPUTERS, DATA SECURITY, BUSINESS, PERSONAL FINANCIAL MANAGEMENT, RECYCLING, AND CHARITABLE SERVICES; PROVIDING TRAINING IN THE FIELD OF MUSIC, INTERNET TECHNOLOGIES, WEBSITE DESIGN AND IMPLEMENTATION, COMPUTERS, DATA SECURITY, BUSINESS, PERSONAL FINANCIAL MANAGEMENT, RECYCLING, AND CHARITABLE SERVICES; ENTERTAINMENT IN THE NATURE OF LIVE MUSICAL PERFORMANCES, LIVE THEATRICAL PERFORMANCES, LIVE REAL-TIME ONLINE MUSICAL AND THEATRICAL PERFORMANCES, PROVIDING A WEB SITE FEATURING INFORMATION ON MUSIC AND MUSIC EVALUATION, SPORTING EVENTS IN THE NATURE OF SOCCER COMPETITIONS, AMERICAN FOOTBALL COMPETITIONS, BASEBALL AND SOFTBALL COMPETITIONS, GYMNASTIC COMPETITIONS, HOCKEY COMPETITIONS, VOLLEYBALL COMPETITIONS, SWIMMING COMPETITIONS, WATER POLO COMPETITIONS, TRACK AND FIELD COMPETITIONS, CAR RACING COMPETITIONS, AND LIVE CULTURAL READINGS; ORGANIZING ONLINE AND LIVE COMMUNITY SPORTING AND CULTURAL EVENTS (U.S. CLS. 100, 101 AND 107).

CLASS 42—SCIENTIFIC AND COMPUTER SERVICES

FOR SCIENTIFIC AND TECHNOLOGICAL SERVICES AND RESEARCH AND DESIGN RELATING THERETO, NAMELY, SCIENTIFIC RESEARCH, COMPUTER CONSULTATION IN THE FIELD OF WEB SITE DESIGN AND WEB SITE IMPLEMENTATION, PROVIDING A WEBSITE ALLOWING USERS TO UPLOAD AND DOWNLOAD MUSIC, DESIGN OF HOMEPAGES AND WEBSITES, DESIGN, CREATION, HOSTING, MAINTENANCE OF WEBSITES FOR OTHERS, HOSTING AN ONLINE COMMUNITY WEBSITE FEATURING SHARED COMMUNICATIONS BETWEEN COMMUNITY MEMBERS INTERESTED IN MUSIC, WEBSITE DEVELOPMENT FOR OTHERS, WEBSITE USABILITY TESTING SERVICES, PROVIDING A WEBSITE THAT GIVES USERS THE ABILITY TO PURCHASE DOWNLOADABLE MUSIC; SCIENTIFIC AND TECHNOLOGICAL SERVICES AND RESEARCH AND DESIGN RELATING THERETO, NAMELY, SCIENTIFIC RESEARCH, SCIENTIFIC ANALYSIS, AND COMPUTER CONSULTATION IN THE FIELD OF MUSIC AND ENTERTAINMENT DEMOGRAPHICS, TRENDS, PERSONALITIES AND PURCHASING; DESIGN AND DEVELOPMENT OF COMPUTER HARDWARE AND SOFTWARE (U.S. CLS. 100 AND 101).

CLASS 45—PERSONAL AND LEGAL SERVICES

FOR LEGAL SERVICES; SECURITY SERVICES FOR THE PROTECTION OF PROPERTY AND INDIVIDUALS, NAMELY, SECURITY GUARD SERVICES; PERSONAL AND SOCIAL SERVICES RENDERED BY OTHERS TO MEET THE NEEDS OF INDIVIDUALS, NAMELY, PERSONAL CARE ASSISTANCE WITH ACTIVITIES OF DAILY LIVING, SUCH AS BATHING, GROOMING AND PERSONAL MOBILITY FOR MENTALLY OR PHYSICALLY CHALLENGED PEOPLE; PROVIDING INFORMATION IN THE FIELD OF INTERPERSONAL COMMUNICATION (U.S. CLS. 100 AND 101).

KRISTINA MORRIS, EXAMINING ATTORNEY

SN 79-064,187. SINFONIA TECHNOLOGY CO., LTD., JAPAN, FILED 5-27-2008.

SINFONIA TECHNOLOGY

PRIORITY DATE OF 2-29-2008 IS CLAIMED.
OWNER OF INTERNATIONAL REGISTRATION 0990302 DATED 5-27-2008, EXPIRES 5-27-2018.

NO CLAIM IS MADE TO THE EXCLUSIVE RIGHT TO USE "TECHNOLOGY", APART FROM THE MARK AS SHOWN.

THE MARK CONSISTS OF THE WORDING "SINFONIA TECHNOLOGY" IN STYLIZED LETTERING.

CLASS 7—MACHINERY

FOR METALWORKING GRINDERS; CONSTRUCTION MACHINES AND APPARATUS, NAMELY, INTERFERENCE PREVENTION DEVICES FOR A HYDRAULIC EXCAVATOR TO RESTRICT MOVEMENT OF AN ARM OR BOOM OF THE EXCAVATOR AND SAFETY DEVICES THAT PREVENT THE OVERTURNING OF A HYDRAULIC EXCAVATOR; LOADING AND UNLOADING MACHINES, NAMELY, FORK LIFT TRUCKS, CONTAINER LIFT LOADERS, BELT LOADERS, MAIN DECK LOADERS; FOOD OR BEVERAGE PROCESSING MACHINES AND APPARATUS, NAMELY, VIBRATION SCREENS FOR SORTING FOODSTUFF; SEWING MACHINES; SEMICONDUCTOR WAFER TRANSFERRING MACHINES; SEMICONDUCTOR WAFER STORING MACHINES; SEMICONDUCTOR WAFER POSITIONING MACHINES; SEMICONDUCTOR SUBSTRATE TRANSFERRING MACHINES; SEMICONDUCTOR MANUFACTURING MACHINES; WATER MILLS; WIND MILLS; A/C GENERATORS, NAMELY, WIND POWER GENERATORS AND HYDRAULIC POWER GENERATORS; DISH WASHING MACHINE; VEHICLE WASHING INSTALLATIONS; STARTERS FOR MOTORS AND ENGINES; AC MOTORS AND DC MOTORS, NOT FOR LAND VEHICLES, AND STRUCTURAL PARTS THEREOF; AC GENERATORS; DC GENERATORS; POWER TRANSMISSIONS AND GEARINGS FOR MACHINES, NOT FOR LAND VEHICLES; BRAKES FOR MACHINES, NOT FOR LAND VEHICLES; SYNCHRONOUS GENERATORS EXCLUSIVELY FOR USE IN CONNECTION WITH RAILWAY ROLLING STOCK (U.S. CLS. 13, 19, 21, 23, 31, 34 AND 35).

CLASS 9—ELECTRICAL AND SCIENTIFIC APPARATUS

FOR CASH REGISTERS; COIN COUNTING OR SORTING MACHINES; ELECTRIC SIGN BOARDS, NAMELY, ELECTRONIC LED SIGNS, FOR DISPLAYING TARGET FIGURES, CURRENT OUTPUTS OR THE LIKE; PHOTOCOPYING MACHINES; TIME AND DATE STAMPING MACHINES; TIME CLOCKS, NAMELY, TIME RECORDING DEVICES; PUNCHED CARD OFFICE MACHINES, NAMELY, PUNCH CLOCKS; VOTING MACHINES; POSTAGE STAMP CHECKING APPARATUS, NAMELY, POSTAGE STAMP METERS; VENDING MACHINES; LUMINOUS OR MECHANICAL ROAD SIGNS; DYNAMOMETERS; SLIP AND SLIDE DETECTING DEVICES FOR RAILWAY CARS; INCLINOMETERS; ACCELEROMETERS; TACHOMETERS; TESTING EQUIPMENT FOR MOTORS, INVERTERS AND OTHER PARTS OF ELECTRIC CARS, HYBRID CARS AND OTHER TYPES OF CARS, NAMELY, TORQUE AND SPEED TESTING EQUIPMENT AND DYNAMOMETERS; MEASURING EQUIPMENT FOR MEASURING IMPACT LOAD, DAMAGES OF AN AUTOMOBILE FOR USE IN AUTOMOBILE COLLISION TESTING; GROUNDWATER LEVEL METERS; ELECTRIC SWITCHES AND BASES FOR MULTIPLE MOUNTED SWITCHES FOR CONTROL PANELS; ROTARY CONVERTERS; PHASE MODIFIERS; TELECOMMUNICATION NETWORK SYSTEMS FOR NOTIFICATION OF ADVANCE DETECTION OF SOIL AVALANCHE AND OTHER NATURAL CALAMITIES, COMPRISED OF A CONTROL STATION AND LOCAL STATION, THE MAJOR COMPONENTS OF WHICH ARE COMPUTER HARDWARE AND SOFTWARE, COMPUTER SERVERS, METERS AND GPS DEVICES; TELECOMMUNICATION MONITORING SYSTEMS FOR WATER AND SEWAGE EQUIPMENT, COMPRISED OF A CONTROL STATION AND LOCAL STATION, THE MAJOR COMPONENTS OF WHICH ARE COMPUTER HARDWARE AND SOFTWARE, COMPUTER SERVERS AND METERS; TELECOMMUNICATION DEVICES FOR MONITORING AND CONTROLLING ELECTRIC EQUIPMENT USED FOR DAMS, COMPRISED OF A CONTROL STATION AND LOCAL STATION, THE MAJOR COMPONENTS OF WHICH ARE COMPUTER HARDWARE AND SOFTWARE, COMPUTER SERVERS AND METERS; CRT (CATHODE RAY TUBE) CENTRAL MONITORING AND CONTROLLING DEVICES, NAMELY, ELECTRIC CONTROLLERS FOR CRT'S, COMPUTERS FOR MONITORING CRT'S; PRINTERS USED WITH COMPUTERS; DIGITAL PHOTO PRINTERS; THERMAL PRINTERS FOR CREATING PRINTING PLATES FOR A LARGE-SIZED PRINTING MACHINE; ROCKETS AS PART OF SPACE VEHICLES (U.S. CLS. 21, 23, 26, 36 AND 38).

CLASS 11—ENVIRONMENTAL CONTROL APPARATUS

FOR DRYING APPARATUS FOR CHEMICAL PROCESSING, NAMELY, INDUSTRIAL DRYERS FOR HEATING AND DEHUMIDIFYING; RECUPERATORS FOR CHEMICAL PROCESSING FOR FURNACES; STEAMERS FOR CHEMICAL PROCESSING; EVAPORATORS FOR CHEMICAL PROCESSING; DISTILLERS FOR CHEMICAL PROCESSING; HEAT EXCHANGERS FOR CHEMICAL PROCESSING; INDUSTRIAL FURNACES; NUCLEAR REACTORS; PIPE LINE COCKS; WASTE WATER TREATMENT TANKS FOR INDUSTRIAL PURPOSES; SEPTIC TANKS FOR INDUSTRIAL PURPOSES (U.S. CLS. 13, 21, 23, 31 AND 34).

CLASS 12—VEHICLES

FOR UNLOADING TIPLERS FOR TILTING RAILWAY FREIGHT CARS, NAMELY, RAILWAY BOGIES, TRUCKS, FORK LIFT TRUCKS; PUSH CARS FOR MINING; PULL CARS FOR MINING; TRACTION ENGINES, NAMELY, STEAM LOCOMOTIVES; RAILWAY ROLLING STOCK AND THEIR STRUCTURAL PARTS AND FITTINGS, NAMELY, ANTI-LOCK BRAKE SYSTEMS (ABS) EXCLUSIVELY FOR USE IN CONNECTION WITH RAILWAY ROLLING STOCK; AUTOMOBILES AND THEIR PARTS AND FITTINGS, NAMELY, CLUTCHES FOR VEHICLES, ANTI-LOCK BRAKE SYSTEMS (ABS) FOR LAND VEHICLES, BRAKES AND VIBRATION CONTROL SYSTEMS COMPRISING A VIBRATION DETECTING DEVICE AND A MOTOR FOR CONTROLLING THE VIBRATION OF THE VEHICLE; BRAKES FOR LAND VEHICLES (U.S. CLS. 19, 21, 23, 31, 35 AND 44).

CLASS 16—PAPER GOODS AND PRINTED MATTER

FOR ADDRESSING MACHINES; INK RIBBONS; AUTOMATIC STAMP AFFIXING MACHINES, NAMELY, FRANKING MACHINES; ELECTRIC STAPLERS FOR OFFICES; ENVELOPE SEALING MACHINES FOR OFFICES; STAMP OBLITERATING MACHINES FOR OFFICES; DRAWING INSTRUMENTS; TYPEWRITERS; OFFICE CHECK WRITING MACHINES; MIMEOGRAPHS; PAPER SHREDDERS FOR OFFICE USE; FRANKING MACHINES, NAMELY, STAMPING MACHINES; ROTARY DUPLICATING MACHINES (U.S. CLS. 2, 5, 22, 23, 29, 37, 38 AND 50).

CLASS 37—CONSTRUCTION AND REPAIR

FOR BUILDING CONSTRUCTION; INDUSTRIAL FURNACE INSTALLATION; REPAIR OR MAINTENANCE OF POWER DISTRIBUTION OR CONTROL MACHINES AND APPARATUS; REPAIR OR MAINTENANCE OF POWER GENERATORS; REPAIR OR MAINTENANCE OF ELECTRIC MOTORS; REPAIR OR MAINTENANCE OF INDUSTRIAL FURNACES; REPAIR OR MAINTENANCE OF VENDING MACHINES; REPAIR OR MAINTENANCE OF PRINTERS USED WITH COMPUTERS AND DIGITAL PHOTO PRINTERS (U.S. CLS. 100, 103 AND 106).

CLASS 42—SCIENTIFIC AND COMPUTER SERVICES

FOR COMPUTER SOFTWARE DESIGN, COMPUTER PROGRAMMING, AND MAINTENANCE OF COMPUTER SOFTWARE (U.S. CLS. 100 AND 101).
DEBRA LEE, EXAMINING ATTORNEY

SN 79-064,237. YARA INTERNATIONAL ASA, NORWAY, FILED 9-30-2008.

NOXCARE

THE MARK CONSISTS OF STANDARD CHARACTERS WITHOUT CLAIM TO ANY PARTICULAR FONT, STYLE, SIZE, OR COLOR.

OWNER OF INTERNATIONAL REGISTRATION 0838962 DATED 3-24-2004, EXPIRES 3-24-2014.

CLASS 1—CHEMICALS

FOR CHEMICAL PRODUCTS FOR NITROGEN OXIDE EMISSION REDUCTION (U.S. CLS. 1, 5, 6, 10, 26 AND 46).

CLASS 4—LUBRICANTS AND FUELS

FOR FUEL, LUBRICANTS AND NITROGEN OXIDE EMISSION REDUCING LIQUID OPERATIONAL AGENTS IN THE NATURE OF NON-CHEMICAL ADDITIVES TO MOTOR FUEL, FOR INTERNAL COMBUSTION ENGINES IN VEHICLES FOR LAND AND SEA (U.S. CLS. 1, 6 AND 15).

CLASS 6—METAL GOODS

FOR ACCESSORY PARTS OF METAL FOR PETROL STATIONS, IN PARTICULAR STORAGE TANKS AND PIPES FOR THE STORAGE, SALE AND TRANSPORTATION OF LIQUID FUELS AND SOLID, LIQUID, AND GASEOUS CHEMICAL LUBRICATING AND OPERATIONAL AGENTS (U.S. CLS. 2, 12, 13, 14, 23, 25 AND 50).

CLASS 20—FURNITURE AND ARTICLES NOT OTHERWISE CLASSIFIED

FOR ACCESSORY PARTS OF SYNTHETIC MATERIAL FOR PETROL STATIONS, IN PARTICULAR NON-METAL STORAGE TANKS FOR THE STORAGE, SALE AND TRANSPORTATION OF LIQUID FUELS AND SOLID, LIQUID, AND GASEOUS CHEMICAL LUBRICATING AND OPERATIONAL AGENTS (U.S. CLS. 2, 13, 22, 25, 32 AND 50).

JEAN IM, EXAMINING ATTORNEY

SN 79-064,484. OVIESSE S.P.A., ITALY, FILED 11-11-2008.



OWNER OF INTERNATIONAL REGISTRATION 0912285 DATED 10-9-2006, EXPIRES 10-9-2016.

NO CLAIM IS MADE TO THE EXCLUSIVE RIGHT TO USE "INDUSTRY", APART FROM THE MARK AS SHOWN. THE COLOR(S) ORANGE AND WHITE IS/ARE CLAIMED AS A FEATURE OF THE MARK.

THE TRADEMARK CONSISTS OF A SQUARE WITH ORANGE BACKGROUND AND ROUNDED RIGHT CORNERS. INSIDE THERE ARE THE LETTERS "O","V","S" IN SMALL WHITE CHARACTERS, WITH THE LETTER "V" SLIGHTLY RISING ABOVE AND THE LETTER "O" HAVING THE LEFT SIDE INCOMPLETE. BELOW SAID LETTERS THERE IS THE WORD "INDUSTRY" IN SMALL WHITE CHARACTERS, OF SMALLER DIMENSION.

SN 79-064,512. ALEXANDRE LEFORESTIER, FRANCE, FILED 3-4-2008.

CLASS 18—LEATHER GOODS

FOR LEATHER ARTICLES AND IMITATION THEREOF, NAMELY, HANDBAGS, SHOULDER BAGS, EVENING BAGS, DUFFEL BAGS, CLUTCH BAGS, SATCHELS, SHOPPING BAGS, TOTE BAGS, SCHOOL BAGS, BEACH BAGS, FLEXIBLE BAGS FOR GARMENTS, SPORT BAGS, OVERNIGHT BAGS, SHOE BAGS FOR TRAVELLING, BUSINESS CARD CASES, DOCUMENT CASES, BRIEFCASES, POUCHES, CREDIT CARD CASES, CHECK HOLDERS, PURSES, COIN PURSES, WALLETS, BRIEFCASE-TYPE PORTFOLIOS, LEATHER BOXES, LEATHER HAT BOXES, LEATHER CASES, BACKPACKS, HAVERSACKS, WAIST PACKS; KEY CASES; VANITY CASES SOLD EMPTY; TOILETRY BAGS SOLD EMPTY; LUGGAGE TAGS; ANIMAL SKINS AND HIDES; TRUNKS AND TRAVELLING BAGS; LUGGAGE AND LUGGAGE SETS; UMBRELLAS; WHIPS, HARNESS AND SADDLERY (U.S. CLS. 1, 2, 3, 22 AND 41).

THE MARK CONSISTS OF STANDARD CHARACTERS WITHOUT CLAIM TO ANY PARTICULAR FONT, STYLE, SIZE, OR COLOR.

OWNER OF INTERNATIONAL REGISTRATION 0991083 DATED 3-4-2008, EXPIRES 3-4-2018.

CLASS 9—ELECTRICAL AND SCIENTIFIC APPARATUS

FOR APPARATUS FOR RECORDING, TRANSMITTING AND REPRODUCING SOUNDS AND IMAGES, NAMELY, TAPE RECORDERS, TELEVISIONS, DVD AND CD READERS AND RECORDERS, VIDEO RECORDERS; BLANK MAGNETIC, COMPUTING, TELEMATIC RECORDING MEDIA, NAMELY, CD-ROMS, COMPUTER DISCS, COMPACT DISCS, AUDIO DISCS, COMPACT OPTICAL DISCS, BLANK AUDIO-VIDEO DISCS; PRE-RECORDED MAGNETIC, COMPUTING, TELEMATIC RECORDING MEDIA, NAMELY, CD-ROMS, COMPUTER DISCS, COMPACT DISCS, AUDIO DISCS, COMPACT OPTICAL DISCS, AUDIO-VIDEO DISCS, ALL FEATURING MUSIC; DOWNLOADABLE DIGITAL AUDIO RECORDINGS, VIDEO RECORDINGS, GRAPHIC ILLUSTRATIONS, DATA FILES, COMPUTER GAMES, COMPUTER PROGRAMS FOR DOWNLOADING AND UPLOADING MUSIC, AUDIO FILES, GRAPHIC FILES AND VIDEO FILES FROM THE INTERNET AND MULTIMEDIA ENTERTAINMENT CONTENT ALL IN THE FIELD OF MUSIC, AUDIO, GRAPHICS AND VIDEO PROVIDED ON THE INTERNET; DOWNLOADABLE DIGITAL AUDIO RECORDINGS FEATURING MUSIC, VIDEO RECORDINGS FEATURING MUSIC, GRAPHICS FOR MOBILE PHONES, COMPUTER GAMES PROVIDED ON THE INTERNET; PRE-RECORDED, CD-ROMS, DVDS, MINIDISCS, COMPUTER DISCS, AUDIO TAPES, AUDIO TAPE CASSETTES, AUDIO TAPE CARTRIDGES, SOUND CARDS ALL CONTAINING AUDIO RECORDINGS, VIDEO RECORDINGS, GRAPHIC ILLUSTRATIONS, TEXTS, DATA FILES, COMPUTER GAMES, COMPUTER PROGRAMS FOR DOWNLOADING AND UPLOADING MUSIC, AUDIO FILES, GRAPHIC FILES AND VIDEO FILES FROM THE INTERNET AND MULTIMEDIA ENTERTAINMENT CONTENT ALL IN THE FIELD OF MUSIC, AUDIO, GRAPHICS AND VIDEO; BLANK MAGNETIC AND OPTICAL RECORDING DISCS; PRE-RECORDED CD-ROMS, DVDS, MINIDISCS, COMPUTER DISCS, AUDIO TAPES, AUDIO TAPE CASSETTES, AUDIO TAPE CARTRIDGES, SOUND CARDS FEATURING AUDIO RECORDINGS, VIDEO RECORDINGS, GRAPHIC ILLUSTRATIONS, TEXTS, DATA FILES, COMPUTER GAMES; COMPUTER PROGRAMS FOR DOWNLOADING AND UPLOADING MUSIC, AUDIO FILES, GRAPHIC FILES, VIDEO FILES FROM THE INTERNET AND MULTIMEDIA ENTERTAINMENT CONTENT ALL IN THE FIELD OF MUSIC, AUDIO, GRAPHICS AND VIDEO (U.S. CLS. 21, 23, 26, 36 AND 38).

CLASS 24—FABRICS

FOR TEXTILES AND TEXTILE GOODS OF SILK, MUSLIN, HEMP, COTTON, CREPE, JERSEY, WOOL, LINEN AND CANVAS, NAMELY, TABLE CLOTHS, HAND TOWELS, BATH TOWELS, DISH TOWELS, WASHCLOTHS, DUSTERS IN THE NATURE OF DUST RUFFLES, CLOTH COASTERS, NAPKINS, PLACEMATS; LINENS, NAMELY, BED SHEETS, PILLOW-CASES, MATTRESS COVERS, BED BLANKET COVERS, COMFORTERS, BED BLANKETS, LAP BLANKETS, BEDSPREADS; CURTAINS (U.S. CLS. 42 AND 50).

CLASS 25—CLOTHING

FOR DRESSES, JACKETS, SPORT JACKETS AND WIND-RESISTANT JACKETS, BLAZERS, COATS, RAIN-COATS, CLOAKS, ANORAKS, SKIRTS, TROUSERS, SLACKS, JEANS, SHORTS, BERMUDA SHORTS, LEGGINGS, CARDIGANS, PULLOVERS, SWEATERS, SWEAT-SHIRTS, T-SHIRTS, SHIRTS, BLOUSES, TANK TOPS, TOPS, POLO SHIRTS, TIGHTS, SKI SUITS, SWEAT SUITS, JOGGING SUITS, KNITTED WEAR, NAMELY, SHIRTS, POLO SHIRTS AND DRESSES; BEACHWEAR, BATHING SUITS, BATHROBES; INFANT WEAR, CHILDREN WEAR, NAMELY, SHORTS, SHOES, SHIRTS, T-SHIRTS, DRESSES, SWEATERS, SKIRTS AND PANTS; UNDERWEAR; NIGHTWEAR, SOCKS, STOCKINGS, PANTYHOSE BELTS, MONEY BELTS, NECKTIES, BOW TIES, ASCOTS, GLOVES, MITTENS, FINGERLESS GLOVES, SCARVES, NECKERCHIEFS, SHAWLS, SHOULDER WRAPS, MANTILLAS, STOLAS, SASHES, SUSPENDERS, GARTERS; FOOTWEAR; HEADGEAR, NAMELY, HATS, BERETS, CAPS, HOODS, TURBANS AND BANDANAS (U.S. CLS. 22 AND 39).

CLASS 16—PAPER GOODS AND PRINTED MATTER

FOR PAPER AND CARDBOARD FOR STATIONERY AND PRINTING PURPOSES; PRINTED MATTER, NAMELY, REPORTS AND SCHEDULES IN THE FIELD OF MUSIC; PRINTED MATTER, NAMELY, CALENDARS AND GREETING CARDS; PRINTED PUBLICATIONS, NAMELY, BOOKS, MAGAZINES, CATALOGUES, PERIODICALS, NEWSPAPERS, AND REVIEWS, ALL IN THE FIELD OF MUSIC (U.S. CLS. 2, 5, 22, 23, 29, 37, 38 AND 50).

CLASS 35—ADVERTISING AND BUSINESS

FOR BUSINESS MANAGEMENT CONSULTING SERVICES FOR FRANCHISEES AND OTHERS IN THE FIELD OF RETAIL DEPARTMENT STORES (U.S. CLS. 100, 101 AND 102).

ASMAT KHAN, EXAMINING ATTORNEY

CLASS 35—ADVERTISING AND BUSINESS

FOR ELECTRONIC SERVICES FOR THE RETAIL PURCHASE OF AND SUBSCRIPTION TO DOWNLOADS, NAMELY, ONLINE RETAIL STORE SERVICES AND ARRANGING ONLINE SUBSCRIPTION FOR OTHERS, IN CONNECTION WITH AUDIO RECORDINGS, VIDEO RECORDINGS, COMPUTER GAMES, COMPUTER PROGRAMS AND MULTIMEDIA ENTERTAINMENT CONTENT (U.S. CLS. 100, 101 AND 102).

CLASS 38—COMMUNICATION

FOR TELECOMMUNICATIONS, NAMELY, AUDIO BROADCASTING; PROVIDING ACCESS TO DIGITAL MUSIC, GRAPHICS FILES AND AUDIO FILES WEBSITES ON THE INTERNET; STREAMING OF MUSIC VIA THE INTERNET (U.S. CLS. 100, 101 AND 104).

CLASS 39—TRANSPORTATION AND STORAGE

FOR ELECTRONIC STORAGE OF DATA MEDIA AND ELECTRONICALLY STORED DOCUMENTS; SERVICES OF ELECTRONIC STORAGE OF A DATABASE IN THE FIELD OF THE MUSIC (U.S. CLS. 100 AND 105).

CLASS 41—EDUCATION AND ENTERTAINMENT

FOR PROVIDING A WEBSITE FEATURING INFORMATION, GRAPHICS, TEXTS AND COMMENTS ABOUT CULTURAL ACTIVITIES AND MUSIC; ENTERTAINMENT, NAMELY, PROVIDING A WEBSITE FEATURING MUSIC, PRESENTATION OF LIVE MUSICAL CONCERTS; ARRANGING AND HOLDING CONFERENCES, COLLOQUIA, CONVENTIONS AND SEMINARS FOR CULTURAL PURPOSES, NAMELY, IN THE FIELD OF MUSIC; TICKET OFFICE SERVICES, NAMELY, ENTERTAINMENT TICKET AGENCY SERVICES, TICKET RESERVATION AND BOOKING SERVICES FOR ENTERTAINMENT, SPORTING, AND CULTURAL EVENTS (U.S. CLS. 100, 101 AND 107).

HOWARD B. LEVINE, EXAMINING ATTORNEY

CLASS 7—MACHINERY

FOR DRILL CROWNS BEING PARTS OF INDUSTRIAL DRILLING MACHINES, AND PARTS AND ACCESSORIES FOR DRILL CROWNS, INCLUDED IN THIS CLASS, NAMELY, DRILLING HEADS AND DRILL CROWN INSERTS IN THE NATURE OF DRILL TIPS; ACCESSORIES FOR ROAD CUTTING MACHINES, SOIL STABILIZERS, TREE STUMP CUTTERS FOR CUTTING TREE STUMPS, TRENCH CUTTING MACHINES, SHREDDING MACHINES, RECYCLING MACHINES, MULCHING EQUIPMENT, STONE CUTTING MACHINES AND SURFACE GRINDING MACHINES, INCLUDED IN THIS CLASS, NAMELY, MECHANICAL BIT HOLDER SYSTEMS COMPOSED OF MECHANICAL BIT HOLDER DEVICES IN THE NATURE OF BIT TOOL HOLDERS AND PARTS OF BIT HOLDER CHANGING DEVICES, NAMELY, POWER OPERATED CHISELS, CHISEL SUPPORTS IN THE NATURE OF CHISEL HOLDERS AND WELDING SUPPORTS IN THE NATURE OF WELDED TOOL HOLDERS AND BIT TOPS IN THE NATURE OF BIT INSERTS INCLUDED IN THIS CLASS; CHISELS BEING PARTS OF POWER-OPERATED MACHINES, NAMELY, ROUND SHAFTED CHISEL BITS, FLAT TEETH CHISEL BITS, AND MINING CHISEL BITS; DRILL BITS FOR POWER-OPERATED ROAD CUTTING OR MINING MACHINES, NAMELY, EARTH AUGERS, DRILLS FOR THE MINING INDUSTRY, PILOT DRILLS; ACCESSORIES FOR POWER-OPERATED DRILLS INCLUDED IN THIS CLASS, NAMELY, THREADED SLEEVES IN THE NATURE OF SLEEVES FOR BITS; ACCESSORIES FOR DRILLING EQUIPMENT INCLUDED IN THIS CLASS, NAMELY, BIT HOLDER CHANGING SYSTEMS COMPOSED OF BIT HOLDERS IN THE NATURE OF DRILL BIT TOOL HOLDERS, POWER DRILL BITS, SUPPORTS FOR CASING SHOES, NAMELY, CASING SHOE HOLDERS IN THE NATURE OF CASINGS FOR BORES, FLUSHING HEADS IN THE NATURE OF FLUSHING DRILL HEADS, PIPES BEING PARTS OF MACHINES, AND RODS MADE OF METAL BEING PARTS OF MACHINES; CARBIDE TIPPED TOOLS FOR POWER-OPERATED DRILLING EQUIPMENT, NAMELY, POWER OPERATED CHISELS AND POWER DRILL BITS (U.S. CLS. 13, 19, 21, 23, 31, 34 AND 35).

SN 79-064,544. BETEK BERGBAU- UND HARTMETALL-TECHNIK; KARL-HEINZ SIMON GMBH & CO. KG, 78733 AICHHALDEN, FED REP GERMANY, FILED 10-13-2008.

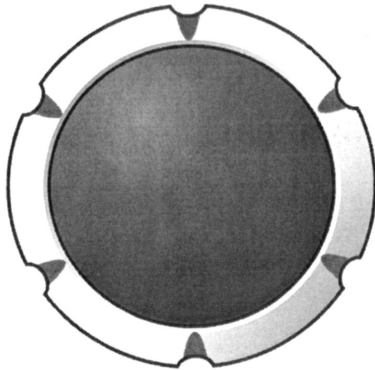

OWNER OF INTERNATIONAL REGISTRATION 0991223 DATED 10-13-2008, EXPIRES 10-13-2018.
THE MARK CONSISTS OF A STYLIZED REPRESENTATION OF A BIT WEAR PLATE.

CLASS 8—HAND TOOLS

FOR MANUALLY OPERATED TOOLS, NAMELY, EJECTOR DRIFTS, EXTRACTORS, AND HAMMERS FOR ASSEMBLING DRILL BITS OR CHISEL BITS AND DISSEMBLING DRILL BITS OR CHISEL BITS FROM BIT HOLDERS (U.S. CLS. 23, 28 AND 44).

CLASS 42—SCIENTIFIC AND COMPUTER SERVICES

FOR TECHNICAL CONSULTANCY REGARDING THE FIELD OF ROAD CUTTING TECHNOLOGY (U.S. CLS. 100 AND 101).

AMY ALFIERI, EXAMINING ATTORNEY

SN 79-064,545. BETEK BERGBAU- UND HARTMETALL-TECHNIK; KARL-HEINZ SIMON GMBH & CO. KG, FED REP GERMANY, FILED 10-13-2008.



OWNER OF INTERNATIONAL REGISTRATION 0991224 DATED 10-13-2008, EXPIRES 10-13-2018.

THE MARK CONSISTS OF A STYLIZED REPRESENTATION OF A BIT FOR A TOOL HOLDER SURROUNDED BY A STYLIZED REPRESENTATION OF A BIT WEAR PLATE.

CLASS 7—MACHINERY

FOR DRILL CROWNS BEING PARTS OF INDUSTRIAL DRILLING MACHINES, AND PARTS AND ACCESSORIES FOR DRILL CROWNS, INCLUDED IN THIS CLASS, NAMELY, DRILLING HEADS AND DRILL CROWN INSERTS IN THE NATURE OF DRILL TIPS; ACCESSORIES FOR ROAD CUTTING MACHINES, SOIL STABILIZERS, TREE STUMP CUTTERS FOR CUTTING TREE STUMPS, TRENCH CUTTING MACHINES, SHREDDING MACHINES, RECYCLING MACHINES, MULCHING EQUIPMENT, STONE CUTTING MACHINES AND SURFACE GRINDING MACHINES, INCLUDED IN THIS CLASS, NAMELY, MECHANICAL BIT HOLDER SYSTEMS COMPOSED OF MECHANICAL BIT HOLDER DEVICES IN THE NATURE OF BIT TOOL HOLDERS AND PARTS OF BIT HOLDER CHANGING DEVICES, NAMELY, POWER OPERATED CHISELS, CHISEL SUPPORTS IN THE NATURE OF CHISEL HOLDERS AND WELDING SUPPORTS IN THE NATURE OF WELDED TOOL HOLDERS AND BIT TOPS IN THE NATURE OF BIT INSERTS INCLUDED IN THIS CLASS; CHISELS BEING PARTS OF POWER-OPERATED MACHINES, NAMELY, ROUND SHAFTED CHISEL BITS, FLAT TEETH CHISEL BITS, AND MINING CHISEL BITS; DRILL BITS FOR POWER-OPERATED ROAD CUTTING OR MINING MACHINES, NAMELY, EARTH AUGERS, DRILLS FOR THE MINING INDUSTRY, PILOT DRILLS; ACCESSORIES FOR POWER-OPERATED DRILLS INCLUDED IN THIS CLASS, NAMELY, THREADED SLEEVES IN THE NATURE OF SLEEVES FOR BITS; ACCESSORIES FOR DRILLING EQUIPMENT INCLUDED IN THIS CLASS, NAMELY, BIT HOLDER CHANGING SYSTEMS COMPOSED OF BIT HOLDERS IN THE NATURE OF DRILL BIT TOOL HOLDERS, POWER DRILL BITS, SUPPORTS FOR CASING SHOES, NAMELY, CASING SHOE HOLDERS IN THE NATURE OF CASINGS FOR BORES, FLUSHING HEADS IN THE NATURE OF FLUSHING DRILL HEADS, PIPES BEING PARTS OF MACHINES, AND RODS MADE OF METAL BEING PARTS OF MACHINES; CARBIDE TIPPED TOOLS FOR POWER-OPERATED DRILLING EQUIPMENT, NAMELY, POWER OPERATED CHISELS AND POWER DRILL BITS (U.S. CLS. 13, 19, 21, 23, 31, 34 AND 35).

CLASS 8—HAND TOOLS

FOR MANUALLY OPERATED TOOLS, NAMELY, EJECTOR DRIFTS, EXTRACTORS, AND HAMMERS FOR ASSEMBLING DRILL BITS OR CHISEL BITS AND DISSEMBLING DRILL BITS OR CHISEL BITS FROM BIT HOLDERS (U.S. CLS. 23, 28 AND 44).

CLASS 42—SCIENTIFIC AND COMPUTER SERVICES

FOR TECHNICAL CONSULTANCY REGARDING THE FIELD OF ROAD CUTTING TECHNOLOGY (U.S. CLS. 100 AND 101).

AMY ALFIERI, EXAMINING ATTORNEY

SN 79-064,774. SAAROB SERVICES PTY LTD, MELBOURNE VIC, AUSTRALIA, FILED 12-5-2008.



PARTNERRUNNING

PRIORITY DATE OF 6-6-2008 IS CLAIMED.
OWNER OF INTERNATIONAL REGISTRATION 0991803 DATED 12-5-2008, EXPIRES 12-5-2018.

CLASS 9—ELECTRICAL AND SCIENTIFIC APPARATUS

FOR COMPUTER SOFTWARE FOR USE IN DATABASE MANAGEMENT, COACHING, MENTORING AND TRAINING IN THE FIELDS OF PROFESSIONAL DEVELOPMENT, PERSONAL DEVELOPMENT, HEALTH AND FITNESS, RELATIONSHIP, TEAMWORK, LEADERSHIP, SPORT AND EXERCISE; AUDIO-VISUAL RECORDINGS INCLUDING DVDS AND COMPACT DISCS FEATURING PROFESSIONAL DEVELOPMENT, PERSONAL DEVELOPMENT, HEALTH AND FITNESS, RELATIONSHIPS, TEAMWORK, LEADERSHIP, SPORT AND EXERCISE (U.S. CLS. 21, 23, 26, 36 AND 38).

CLASS 16—PAPER GOODS AND PRINTED MATTER

FOR PUBLICATIONS, NAMELY, BOOKS, MANUALS, JOURNALS, WORKBOOKS, HOW-TO GUIDES, PRINTED INSTRUCTIONAL MATERIALS FOR COACHING IN THE FIELDS OF PROFESSIONAL DEVELOPMENT, PERSONAL DEVELOPMENT, HEALTH AND FITNESS, RELATIONSHIPS, TEAMWORK, LEADERSHIP, SPORT AND EXERCISE; POSTERS; PHOTOGRAPHS; STATIONERY; PRINTED INSTRUCTIONAL AND TEACHING MATERIALS IN THE FIELDS OF PROFESSIONAL DEVELOPMENT, PERSONAL DEVELOPMENT, HEALTH AND FITNESS, RELATIONSHIPS, TEAMWORK, LEADERSHIP, SPORT AND EXERCISE (U.S. CLS. 2, 5, 22, 23, 29, 37, 38 AND 50).

CLASS 25—CLOTHING

FOR CLOTHING, NAMELY, T-SHIRTS, POLO SHIRTS, SHORTS, JACKETS, AND RUNNING SINGLET; FOOTWEAR, NAMELY, SOCKS; HEADGEAR, NAMELY, HATS AND CAPS (U.S. CLS. 22 AND 39).

CLASS 35—ADVERTISING AND BUSINESS

FOR BUSINESS CONSULTANCY; BUSINESS MANAGEMENT CONSULTANCY; PERSONNEL MANAGEMENT CONSULTANCY (U.S. CLS. 100, 101 AND 102).

CLASS 41—EDUCATION AND ENTERTAINMENT

FOR PROVIDING ON-LINE TRAINING, COACHING, AND MENTORING IN THE FIELDS OF PROFESSIONAL DEVELOPMENT, PERSONAL DEVELOPMENT, HEALTH AND FITNESS, RELATIONSHIPS, TEAMWORK, LEADERSHIP, SPORT AND EXERCISE; EDUCATIONAL SERVICES, NAMELY, ARRANGING, ORGANIZING, AND CONDUCTING SEMINARS, WORKSHOPS AND TRAINING IN THE FIELDS OF PROFESSIONAL DEVELOPMENT, PERSONAL DEVELOPMENT, HEALTH AND FITNESS, RELATIONSHIPS, TEAMWORK, LEADERSHIP, SPORT AND EXERCISE (U.S. CLS. 100, 101 AND 107).

TARAH HARDY, EXAMINING ATTORNEY

CLASS 41—EDUCATION AND ENTERTAINMENT

FOR EDUCATION SERVICES, NAMELY, PROVIDING CONTINUING PROFESSIONAL EDUCATIONAL COURSES IN THE FIELD OF BANKING, FINANCE, ECONOMICS, INVESTMENTS, AND MONEY MANAGEMENT; TRAINING SERVICES THE FIELD OF IN BANKING, FINANCE, ECONOMICS, INVESTMENTS, AND MONEY MANAGEMENT; ORGANIZATION OF SEMINARS, COLLOQUIUMS, SYMPOSIUMS AND CONGRESSES IN THE FIELD OF BANKING, FINANCE, ECONOMICS, INVESTMENTS, AND MONEY MANAGEMENT; PROVIDING NON-DOWNLOADABLE ELECTRONIC PUBLICATIONS IN THE FIELD OF BANKING, FINANCE, ECONOMICS, INVESTMENTS, AND MONEY MANAGEMENT; ORGANIZING COMMUNITY SPORTING AND CULTURAL EVENTS (U.S. CLS. 100, 101 AND 107).

LAKEISHA LEWIS, EXAMINING ATTORNEY

SN 79-064,834. CAJA DE AHORROS Y MONTE; DE PIEDAD DE NAVARRA, E-31002 PAMPLONA, SPAIN, FILED 12-4-2008.

CONCIBANK

THE MARK CONSISTS OF STANDARD CHARACTERS WITHOUT CLAIM TO ANY PARTICULAR FONT, STYLE, SIZE, OR COLOR.

PRIORITY DATE OF 8-14-2008 IS CLAIMED.
OWNER OF INTERNATIONAL REGISTRATION 0991945 DATED 12-4-2008, EXPIRES 12-4-2018.

CLASS 35—ADVERTISING AND BUSINESS

FOR ADVERTISING SERVICES; BUSINESS MANAGEMENT; BUSINESS MANAGEMENT AND ORGANISATION CONSULTANCY; BUSINESS ADMINISTRATION; PROVIDING OFFICE FUNCTIONS; MARKET RESEARCH AND STUDIES; PREPARATION OF STATISTICS IN THE FIELD OF BUSINESS AND INDUSTRY; IMPORT-EXPORT AGENCY SERVICES; ADVISORY AND CONSULTANCY SERVICES RELATING TO EXPORT, EXPORT SERVICES AND EXPORT PROMOTION INFORMATION SERVICES; COMPUTERIZED FILE MANAGEMENT AND DATABASE MANAGEMENT; ORGANIZATION OF EXHIBITIONS FOR COMMERCIAL OR ADVERTISING PURPOSES; RENTAL OF ADVERTISING SPACE (U.S. CLS. 100, 101 AND 102).

CLASS 36—INSURANCE AND FINANCIAL

FOR FINANCING SERVICES, CREDIT AND INVESTMENT SERVICES, NAMELY, CREDIT AND INVESTMENT CONSULTATION, CREDIT BUREAUS, ISSUING CREDIT CARDS, INVESTMENT ADVICE, INVESTMENT BROKERAGE, AND INVESTMENT MANAGEMENT, FINANCIAL INVESTMENTS IN THE FIELD OF SECURITIES, BONDS, DEBENTURES, MORTGAGE BOND HOLDINGS, NEGOTIABLE SECURITIES AND NEGOTIABLE SECURITIES THAT INCLUDE OPTIONS TO PURCHASE, TO SUBSCRIBE OR TO SELL THE UNDERLYING ASSETS, MAINTAINING INVESTMENT ESCROW ACCOUNTS AND MONEY DEPOSIT ACCOUNTS; REAL ESTATE SERVICES, NAMELY, REAL ESTATE ACQUISITION SERVICES, REAL ESTATE ESCROW SERVICES, REAL ESTATE INVESTMENT, AND REAL ESTATE MANAGEMENT; MORTGAGES, NAMELY, MORTGAGE LENDING, MORTGAGE BANKING AND MAINTAINING MORTGAGE ESCROW ACCOUNTS; LOANS, NAMELY, LOAN FINANCING, AND SAVINGS AND LOAN SERVICES; INSURANCE SERVICES, NAMELY, INSURANCE AGENCIES, INSURANCE CONSULTATION, INSURANCE BROKERAGE, AND INSURANCE ADMINISTRATION (U.S. CLS. 100, 101 AND 102).

SN 79-065,147. HUECK RHEINISCHE GMBH & CO. KG, FED REP GERMANY, FILED 9-16-2008.

Heliochrome

THE MARK CONSISTS OF STANDARD CHARACTERS WITHOUT CLAIM TO ANY PARTICULAR FONT, STYLE, SIZE, OR COLOR.

PRIORITY DATE OF 3-27-2008 IS CLAIMED.
OWNER OF INTERNATIONAL REGISTRATION 0992812 DATED 9-16-2008, EXPIRES 9-16-2018.

THE NAME(S), PORTRAIT(S), AND/OR SIGNATURE(S) SHOWN IN THE MARK DOES NOT IDENTIFY A PARTICULAR LIVING INDIVIDUAL.

CLASS 7—MACHINERY

FOR MACHINE PARTS, NAMELY, PRESS PLATES AND ENDLESS BANDS IN THE NATURE OF PRESSURE EQUALISING CUSHIONS, OF A FABRIC CONTAINING CHEMICAL FIBRES FOR MECHANICAL PRESSES, PRESSED SHEETS AND ENDLESS BANDS FOR MANUFACTURING SMOOTH AND STRUCTURED SURFACES USING ONE-DAYLIGHT PRESSES OR PLATEN PRESSES, SHORT-CYCLE PRESSES FOR LOW-PRESSURE COATING OF HIGH-PRESSURE LAMINATE MANUFACTURING (U.S. CLS. 13, 19, 21, 23, 31, 34 AND 35).

CLASS 37—CONSTRUCTION AND REPAIR

FOR REPAIR OF DAMAGE TO USED PRESS PLATES AND ENDLESS BANDS, FOR OTHERS, NAMELY, REMOVAL OF DAMAGE AND REFURBISHMENT OF USED PRESS ON BEHALF OF OTHERS, POLISHING OF PRESSING PLATES (U.S. CLS. 100, 103 AND 106).

CLASS 40—MATERIAL TREATMENT

FOR MANUFACTURE OF PRESS PLATES AND ENDLESS BANDS, NAMELY, MECHANICAL PRETREATMENT, ETCHING, ENGRAVING, METALISING, COATING, ELECTROPLATING, CHROMIUM PLATING TO ORDER AND/OR SPECIFICATION OF OTHERS (U.S. CLS. 100, 103 AND 106).

CLASS 42—SCIENTIFIC AND COMPUTER SERVICES

FOR SCIENTIFIC AND TECHNOLOGICAL SERVICES AND RESEARCH AND DEVELOPMENT IN THE FIELD OF PRODUCT RESEARCH, PRODUCT DEVELOPMENT, STATISTIC EVALUATION OF PRODUCT QUALITY, SURVEY OF PRODUCTION CHARGES, COMPUTER PROGRAMMING FOR PRODUCTION AND DEVELOPMENT PROCESSES, SCIENTIFIC RESEARCH, NAMELY, MATERIAL RESEARCH, RECYCLING RESEARCH AND PROCESS PLANNING; INDUSTRIAL ANALYSIS, DESIGN AND RESEARCH IN THE FIELD OF DEVELOPMENT OF RESISTANT SURFACE MATERIALS STAMPING TECHNOLOGY FOR PRESSING PLATES (U.S. CLS. 100 AND 101).

SCOTT BIBB, EXAMINING ATTORNEY

SN 79-065,527. GEORG FISCHER WAGA N.V., NL-8161 PA EPE, NETHERLANDS, FILED 9-10-2008.

MULTI/JOINT

THE MARK CONSISTS OF STANDARD CHARACTERS WITHOUT CLAIM TO ANY PARTICULAR FONT, STYLE, SIZE, OR COLOR.

OWNER OF INTERNATIONAL REGISTRATION 0544581 DATED 10-4-1989, EXPIRES 10-4-2019. SEC. 2(F).

CLASS 6—METAL GOODS

FOR PIPES OF METAL AND METAL COUPLINGS FOR PIPES; METAL BOLTS AND METAL COLLARS FOR PIPES AND METAL SERVICE CLAMPS (U.S. CLS. 2, 12, 13, 14, 23, 25 AND 50).

CLASS 17—RUBBER GOODS

FOR COUPLINGS FOR PIPES NOT OF METAL; CAULKING MATERIALS OF RUBBER FOR TUBES; FLEXIBLE NON-METALLIC PIPES (U.S. CLS. 1, 5, 12, 13, 35 AND 50).

CLASS 20—FURNITURE AND ARTICLES NOT OTHERWISE CLASSIFIED

FOR FASTENING COLLARS NOT OF METAL FOR PIPES AND NON-METAL SERVICE CLAMPS (U.S. CLS. 2, 13, 22, 25, 32 AND 50).

ERNEST SHOSHO, EXAMINING ATTORNEY

SN 79-065,222. UNISENSE FERTILITECH A/S, DENMARK, FILED 1-14-2009.

EmbryoSafe

THE MARK CONSISTS OF STANDARD CHARACTERS WITHOUT CLAIM TO ANY PARTICULAR FONT, STYLE, SIZE, OR COLOR.

PRIORITY DATE OF 7-14-2008 IS CLAIMED. OWNER OF INTERNATIONAL REGISTRATION 0993068 DATED 1-14-2009, EXPIRES 1-14-2019.

CLASS 9—ELECTRICAL AND SCIENTIFIC APPARATUS

FOR SCIENTIFIC, NAUTICAL, SURVEYING, PHOTOGRAPHIC, CINEMATOGRAPHIC, OPTICAL, WEIGHING AND MEASURING APPARATUS AND INSTRUMENTS, NAMELY APPARATUS FOR RECORDING, TRANSMISSION OR REPRODUCTION OF SOUND OR IMAGES; MICROSCOPES; LABORATORY EQUIPMENT AND SUPPLIES, NAMELY, INCUBATORS; COMPUTER SOFTWARE FOR ANALYSIS OF IMAGES; COMPUTER HARDWARE; COMPUTER SOFTWARE AND COMPUTER HARDWARE FOR ELECTRONIC TRANSMISSION OF IMAGES AND DATA; DIAGNOSTIC APPARATUS FOR MONITORING CELLS AND CELLULAR COMMUNITIES, NOT FOR MEDICAL PURPOSES; LABORATORY EQUIPMENT, NAMELY, INSTRUMENTS, CONTAINERS, TRAYS, DISHES FOR MEDICAL USE AND FOR MONITORING CELL CULTURE AND CELL ANALYSIS (U.S. CLS. 21, 23, 26, 36 AND 38).

CLASS 10—MEDICAL APPARATUS

FOR SURGICAL, MEDICAL, DENTAL AND VETERINARY APPARATUS AND INSTRUMENTS FOR MEDICAL ANALYSIS OF IMAGES; MEDICAL APPARATUS AND INSTRUMENTS FOR ANALYSIS OF EMBRYO IMAGES, ENDOSCOPES FOR MEDICAL USE, MEDICAL SENSOR EQUIPMENT FOR MICRO- OR NANORESPIRATION MEASUREMENTS, RESPIROMETERS (U.S. CLS. 26, 39 AND 44).

KEVON CHISOLM, EXAMINING ATTORNEY

SN 79-065,824. PAOLO BIGGIO, FED REP GERMANY, FILED 12-9-2008.

AIUS

THE MARK CONSISTS OF STANDARD CHARACTERS WITHOUT CLAIM TO ANY PARTICULAR FONT, STYLE, SIZE, OR COLOR.

PRIORITY DATE OF 6-9-2008 IS CLAIMED. OWNER OF INTERNATIONAL REGISTRATION 0994754 DATED 12-9-2008, EXPIRES 12-9-2018.

THE WORDING "AIUS" HAS NO MEANING IN A FOREIGN LANGUAGE.

CLASS 9—ELECTRICAL AND SCIENTIFIC APPARATUS

FOR PRERECORDED MAGNETIC DATA CARRIERS FEATURING COMPUTER AND ROLE PLAYING GAME SOFTWARE AND INSTRUCTIONAL MANUALS SOLD AS A UNIT THEREWITH; PRERECORDED CDS AND DVDS FEATURING COMPUTER AND ROLE PLAYING GAME SOFTWARE AND INSTRUCTIONAL MANUALS SOLD AS A UNIT THEREWITH; COMPUTER AND ROLE PLAYING GAME SOFTWARE (U.S. CLS. 21, 23, 26 AND 38).

CLASS 28—TOYS AND SPORTING GOODS

FOR GAMES AND PLAYTHINGS, NAMELY, BOARD GAMES AND ROLE PLAYING GAMES; THREE-DIMENSIONAL POSITIONABLE TOY FIGURES OF COMMON METAL SOLD AS A UNIT WITH BOARD GAMES OR ROLE PLAYING GAMES; DICE (U.S. CLS. 22, 23, 38 AND 50).

CLASS 41—EDUCATION AND ENTERTAINMENT

FOR ENTERTAINMENT SERVICES, NAMELY, PROVIDING ONLINE COMPUTER AND ROLE PLAYING GAMES; PROVIDING INFORMATION ONLINE RELATING TO COMPUTER AND ROLE PLAYING GAMES AND COMPUTER ENHANCEMENTS FOR GAMES; ONLINE PUBLICATION OF ELECTRONIC MANUALS AND MAGAZINES IN THE FIELD OF COMPUTER GAMES; ENTERTAINMENT SERVICES, NAMELY, CONSULTING SERVICES RELATING TO THE CONCEPT DEVELOPMENT OF ROLE PLAYING GAMES; ENTERTAINMENT SERVICES, NAMELY, CONDUCTING COMPETITIONS IN THE FIELD OF COMPUTER AND ROLE PLAYING GAMES; THE FOREGOING COMPETITIONS ALSO CONDUCTED VIA THE INTERNET; ARRANGING AND CONDUCTING ROLE PLAYING GAMES; THE FOREGOING GAMES ALSO CONDUCTED VIA THE INTERNET (U.S. CLS. 100, 101 AND 107).

CLASS 42—SCIENTIFIC AND COMPUTER SERVICES

FOR DESIGN AND DEVELOPMENT OF COMPUTER SOFTWARE; DESIGN OF COMPUTER GAME SOFTWARE (U.S. CLS. 100 AND 101).
ELI HELLMAN, EXAMINING ATTORNEY

CLASS 5—PHARMACEUTICALS

FOR PHARMACEUTICAL PREPARATIONS FOR THE DIAGNOSIS AND THERAPY OF SKIN DISORDERS, EYE DISORDERS, CANCER DIABETES, CNS DISORDERS (CNS = CENTRAL NERVOUS SYSTEM), STOMACH AND INTESTINE DISORDERS, ORTHOPAEDIC DISORDERS, LIVER DISORDERS, KIDNEY DISORDERS, SPLEEN DISORDERS, MUSCULAR SKELETAL DISORDERS, AUTOIMMUNE DISORDERS, INFLAMMATORY DISORDERS, PULMONARY DISORDERS, CARDIOVASCULAR DISORDERS; PRODUCTS FOR MEDICAL PURPOSES, NAMELY, DRUG DELIVERY AGENTS IN THE FORM OF CAPSULES THAT FACILITATE THE DELIVERY OF A WIDE RANGE OF PHARMACEUTICALS; ANTIMICROBIAL COATINGS TO TREAT THE GROWTH OF MOULD, MILDEW, BACTERIA AND FUNGUS ON MEDICAL EQUIPMENT; CONTRAST AGENTS FOR USE WITH MEDICAL IMAGING EQUIPMENT, NAMELY, ANGIOGRAPHIC CONTRAST APPLICATIONS, MAGNETIC RESONANCE TOMOGRAPHY APPLICATIONS (MRT), X-RAY APPLICATIONS, POSITRON EMISSION TOMOGRAPHY (PET), OPTICAL COHERENCE TOMOGRAPHY (OCT); SANITARY PREPARATIONS FOR MEDICAL PURPOSES, NAMELY, FOR STERILIZING SURFACES; MEDICAL PLASTERS; SURGICAL PLASTERS, SURGICAL THREAD; MATERIALS FOR DRESSING IN THE NATURE OF GAUZE, MEDICAL PATCHES, MEDICAL ADHESIVE TAPE; ALL PURPOSE DISINFECTANTS AND DISINFECTANTS FOR MEDICAL PURPOSES, SANITARY PURPOSES AND LABORATORY PURPOSES; PREPARATIONS FOR DESTROYING VERMIN, FUNGICIDES, HERBICIDES; ALL THE AFORESAID GOODS INCLUDING GOODS MADE FROM NANO-PARTICLES AND NANO-STRUCTURES (U.S. CLS. 6, 18, 44, 46, 51 AND 52).
TASNEEM HUSSAIN, EXAMINING ATTORNEY

SN 79-066,408. IMAC CO., LTD, JAPAN, FILED 2-13-2009.

KKIMAC

THE MARK CONSISTS OF STANDARD CHARACTERS WITHOUT CLAIM TO ANY PARTICULAR FONT, STYLE, SIZE, OR COLOR.

PRIORITY DATE OF 8-26-2008 IS CLAIMED.
OWNER OF INTERNATIONAL REGISTRATION 0996488 DATED 2-13-2009, EXPIRES 2-13-2019.

SN 79-065,859. CENTRUM FÜR ANGEWANDTE, NANO-TECHNOLOGIE (CAN) GMBH, FED REP GERMANY, FILED 1-6-2009.

CANdot

THE MARK CONSISTS OF STANDARD CHARACTERS WITHOUT CLAIM TO ANY PARTICULAR FONT, STYLE, SIZE, OR COLOR.

PRIORITY DATE OF 9-24-2008 IS CLAIMED.
OWNER OF INTERNATIONAL REGISTRATION 0994857 DATED 1-6-2009, EXPIRES 1-6-2019.

CLASS 9—ELECTRICAL AND SCIENTIFIC APPARATUS

FOR CAMERAS; OPTICAL CONDENSERS; IMAGE PROCESSORS, NOT FOR MEDICAL PURPOSES; OPTICAL LENSES; LIGHT DIMMERS, ELECTRIC; LIGHTING BALLASTS; APPARATUS FOR REGULATING ELECTRIC POWER SUPPLY FOR LIGHTING; ELECTRONIC APPARATUS FOR THE REMOTE CONTROL OF INDUSTRIAL OPERATIONS; COMPUTER PERIPHERAL DEVICES; COMPUTER OPERATING PROGRAMS (U.S. CLS. 21, 23, 26, 36 AND 38).

CLASS 10—MEDICAL APPARATUS

FOR LED LAMPS, FOR MEDICAL DIAGNOSIS AND OPERATION; MEDICAL IMAGE PROCESSORS; ORTHOPAEDIC FOOTWEAR; RADIOTHERAPY APPARATUS (U.S. CLS. 26, 39 AND 44).

CLASS 11—ENVIRONMENTAL CONTROL APPARATUS

FOR ELECTRIC LAMPS; FLARES; LED LAMPS, NOT FOR MEDICAL PURPOSES; ULTRAVIOLET RAY LAMPS, NOT FOR MEDICAL PURPOSES (U.S. CLS. 13, 21, 23, 31 AND 34).

SHAILA SETTLES, EXAMINING ATTORNEY

CLASS 1—CHEMICALS

FOR CHEMICALS USED IN INDUSTRY AND SCIENCE; UNPROCESSED ARTIFICIAL RESINS, UNPROCESSED PLASTICS; ALL THE AFORESAID GOODS INCLUDING GOODS MADE FROM NANO-PARTICLES AND NANO-STRUCTURES (U.S. CLS. 1, 5, 6, 10, 26 AND 46).

SN 79-066,444. WINADREAM INTERACTIVE LIMITED, FL-9490 VADUZ, LIECHTENSTEIN, FILED 2-17-2009.

winadream

THE MARK CONSISTS OF STANDARD CHARACTERS WITHOUT CLAIM TO ANY PARTICULAR FONT, STYLE, SIZE, OR COLOR.

PRIORITY DATE OF 9-29-2008 IS CLAIMED.
OWNER OF INTERNATIONAL REGISTRATION 0996550 DATED 2-17-2009, EXPIRES 2-17-2019.

CLASS 9—ELECTRICAL AND SCIENTIFIC APPARATUS

FOR COMPUTER SOFTWARE FOR USE IN SERVING AND MAINTENANCE OF INTERNET GAME PLATFORMS; COMPUTER HARDWARE COMPONENTS FOR SET-UP, OPERATION, AND HOSTING, AS WELL AS FOR SERVICING AND MAINTENANCE OF INTERNET GAME PLATFORMS (U.S. CLS. 21, 23, 26, 36 AND 38).

CLASS 41—EDUCATION AND ENTERTAINMENT

FOR ENTERTAINMENT SERVICES, NAMELY, PROVIDING RECREATION INFORMATION AND RECREATION FACILITIES, PROVIDING AMUSEMENT ARCADE SERVICES, OPERATING AMUSEMENT PARKS, OPERATING LOTTERIES, PROVIDING CASINO, GAMING, AND GAMBLING FACILITIES; PROVIDING ONLINE GAMING SERVICES, IN PARTICULAR, PROVIDING ONLINE BETTING SERVICES VIA THE INTERNET, VIA CALL CENTERS, MOBILE PLATFORMS, OR INTERACTIVE MEDIA (U.S. CLS. 100, 101 AND 107).

CLASS 42—SCIENTIFIC AND COMPUTER SERVICES

FOR HOSTING OF AN ONLINE WEBSITE FEATURING GAME PLATFORMS FOR REMOTE GAMING VIA THE INTERNET, VIA CALL CENTERS, MOBILE PLATFORMS, OR INTERACTIVE MEDIA; COMPUTER SYSTEM ADMINISTRATION FOR OTHERS FEATURING GAME PLATFORMS FOR REMOTE GAMING VIA THE INTERNET, VIA CALL CENTERS, MOBILE PLATFORMS, OR INTERACTIVE MEDIA; TECHNICAL SUPPORT, NAMELY, TROUBLESHOOTING OF COMPUTER SOFTWARE PROBLEMS OF GAME PLATFORMS FOR REMOTE GAMING VIA THE INTERNET, VIA CALL CENTERS, MOBILE PLATFORMS, OR INTERACTIVE MEDIA; MAINTENANCE, LEASING, DEVELOPMENT AND SET-UP OF COMPUTER SOFTWARE FEATURING GAME PLATFORMS FOR REMOTE GAMING VIA INTERNET, VIA CALL CENTERS, MOBILE PLATFORMS, OR INTERACTIVE MEDIA; OPERATION, NAMELY, MANAGING WEBSITES OF OTHERS, REMOTE MANAGEMENT OF COMPUTER APPLICATIONS OF OTHERS FEATURING GAME PLATFORMS FOR REMOTE GAMING VIA THE INTERNET, VIA CALL CENTERS, MOBILE PLATFORMS, OR INTERACTIVE MEDIA (U.S. CLS. 100 AND 101).

LEIGH LOWRY, EXAMINING ATTORNEY

SN 79-066,790. ELLERGER ANTRIEBSTECHNIK GMBH, AUSTRIA, FILED 11-27-2008.

GEISLINGER

THE MARK CONSISTS OF STANDARD CHARACTERS WITHOUT CLAIM TO ANY PARTICULAR FONT, STYLE, SIZE, OR COLOR.

PRIORITY DATE OF 5-29-2008 IS CLAIMED.
OWNER OF INTERNATIONAL REGISTRATION 0997462 DATED 11-27-2008, EXPIRES 11-27-2018.
OWNER OF U.S. REG. NO. 2,102,911.
THE WORDING "GEISLINGER" HAS NO MEANING IN A FOREIGN LANGUAGE.
SEC. 2(F).

CLASS 7—MACHINERY

FOR SHAFT CLUTCHES FOR MACHINES, MARINE VEHICLES AND AIRCRAFT; TORSIONAL VIBRATION DAMPERS FOR MACHINES, MARINE VEHICLES AND AIRCRAFT; MACHINE COUPLINGS AND TRANSMISSION COMPONENTS FOR MACHINES, MARINE VEHICLES AND AIRCRAFT, AS WELL AS THEIR PARTS, NAMELY, TRANSMISSION SHAFT COUPLINGS AND TORSIONAL VIBRATION DAMPERS; PARTS OF MACHINES AND MACHINE TOOLS, NAMELY, TRANSMISSION SHAFT COUPLINGS AND TORSIONAL VIBRATION DAMPERS NOT FOR LAND VEHICLES (U.S. CLS. 13, 19, 21, 23, 31, 34 AND 35).

CLASS 9—ELECTRICAL AND SCIENTIFIC APPARATUS

FOR ELECTRONIC SURVEILLANCE APPARATUS AND INSTRUMENTS, ESPECIALLY FOR THE SURVEILLANCE OF TORSIONAL VIBRATIONS, NAMELY, COMPUTER AND COMPUTER HARDWARE, VIBRATION SENSORS, INDUCTIVE SENSORS, ANGULAR ENCODERS, VIBRATION METERS (U.S. CLS. 21, 23, 26, 36 AND 38).

CLASS 12—VEHICLES

FOR PARTS OF VEHICLES AND APPARATUS FOR LOCOMOTION BY LAND, AIR OR WATER, NAMELY, TORSIONAL VIBRATION DAMPERS AND SHAFT CLUTCHES AS WELL AS THEIR REPLACEMENT PARTS, FOR VEHICLES AND APPARATUS FOR LOCOMOTION BY LAND, AIR OR WATER (U.S. CLS. 19, 21, 23, 31, 35 AND 44).

DEBRA LEE, EXAMINING ATTORNEY

SN 79-067,105. LABORATOIRE MERGENS SA, SWITZERLAND, FILED 1-9-2009.

Blue-Up!

THE MARK CONSISTS OF STANDARD CHARACTERS WITHOUT CLAIM TO ANY PARTICULAR FONT, STYLE, SIZE, OR COLOR.

PRIORITY DATE OF 8-11-2008 IS CLAIMED.
OWNER OF INTERNATIONAL REGISTRATION 0998319 DATED 1-9-2009, EXPIRES 1-9-2019.

CLASS 5—PHARMACEUTICALS

FOR SANITARY PRODUCTS FOR MEDICAL PURPOSES; DIETETIC SUBSTANCES ADAPTED FOR MEDICAL USE, NAMELY, DIETETIC FOODS ADAPTED FOR MEDICAL USE, FOOD FOR BABIES; MATERIALS FOR DRESSINGS, NAMELY, BANDAGES FOR DRESSINGS; MATERIAL FOR STOPPING TEETH, DENTAL WAX (U.S. CLS. 6, 18, 44, 46, 51 AND 52).

CLASS 32—LIGHT BEVERAGES

FOR BEERS, MINERAL AND AERATED WATERS AND OTHER NON-ALCOHOLIC BEVERAGES, NAMELY, SOFT DRINKS; FRUIT DRINKS AND FRUIT JUICES; SYRUPS AND OTHER PREPARATIONS FOR MAKING BEVERAGES, NAMELY, CONCENTRATIONS AND POWDERS USED IN THE PREPARATION OF SOFT DRINKS (U.S. CLS. 45, 46 AND 48).

MATTHEW EINSTEIN, EXAMINING ATTORNEY

CLASS 9—ELECTRICAL AND SCIENTIFIC APPARATUS

FOR SCIENTIFIC APPARATUS AND INSTRUMENTS, NAMELY, BAROMETERS, AMMETERS, PHOTOGRAPHIC APPARATUS AND INSTRUMENTS, NAMELY, PHOTOGRAPHIC CAMERAS, PHOTOGRAPHIC FLASHBULBS, PHOTOGRAPHIC VIEWFINDERS, CINEMATOGRAPHIC APPARATUS AND INSTRUMENTS, NAMELY, REMOTE CONTROL DEVICES FOR RADIOS, TELEVISIONS, HEADPHONES, AUDIO SPEAKERS, OPTICAL APPARATUS AND INSTRUMENTS, NAMELY, EYEGLASSES, SUNGLASSES, CONTACT LENSES AND THEIR CONTAINERS, WEIGHING APPARATUS AND INSTRUMENTS, NAMELY, SCALES AND BALANCES, MEASURING APPARATUS AND INSTRUMENTS, NAMELY, THERMOMETERS, VOLTMETERS, MICROSCOPES, SIGNALING APPARATUS AND INSTRUMENTS, NAMELY, REFLECTORS FOR TRAFFIC SIGNALS, LUMINOUS OR MECHANICAL ROAD SIGNS, TESTING AND CHECKING APPARATUS AND INSTRUMENTS, NAMELY, RADAR, SONAR, NIGHT VISION GOGGLES, LIFESAVING AND TEACHING APPARATUS AND INSTRUMENTS, NAMELY, LIFE JACKETS, LIFE NETS, LIFE PRESERVERS, LIFE-BUOYS; APPARATUS AND INSTRUMENTS FOR CONDUCTING, SWITCHING, TRANSFORMING, ACCUMULATING, REGULATING OR CONTROLLING ELECTRICITY, NAMELY, BATTERIES, DISTRIBUTION TRANSFORMERS, ELECTRIC SWITCHES; APPARATUS FOR RECORDING, TRANSMISSION OR REPRODUCTION OF SOUND OR IMAGES; BLANK MAGNETIC DATA CARRIERS; BLANK RECORDING DISCS; AUTOMATIC VENDING MACHINES AND MECHANISMS FOR COIN-OPERATED APPARATUS; CASH REGISTERS, CALCULATING MACHINES, DATA PROCESSING EQUIPMENT AND COMPUTERS; FIRE-EXTINGUISHING APPARATUS (U.S. CLS. 21, 23, 26, 36 AND 38).

SN 79-067,188. IHLAS EV ALETLERI IMALAT; SANAYI VE TICARET ANONIM SIRKETI, TURKEY, FILED 2-12-2009.



OWNER OF INTERNATIONAL REGISTRATION 0998550 DATED 2-12-2009, EXPIRES 2-12-2019.

THE WORDING "CEBILON" HAS NO MEANING IN A FOREIGN LANGUAGE.

CLASS 7—MACHINERY

FOR MACHINES AND MACHINE TOOLS, NAMELY, DISHWASHER MACHINES, CLOTHES WASHING MACHINES, ELECTRIC CLOTHES DRYING MACHINES, FLOOR POLISHING MACHINES, CARPET CLEANING MACHINES; MOTORS AND ENGINES EXCEPT FOR LAND VEHICLES; MACHINE COUPLING AND TRANSMISSION COMPONENTS EXCEPT FOR LAND VEHICLES; AGRICULTURAL IMPLEMENTS OTHER THAN HAND-OPERATED, NAMELY, TILLER MACHINES, HARVESTER MACHINES, TRACTOR TOWED PLOWS; INCUBATORS FOR EGGS (U.S. CLS. 13, 19, 21, 23, 31, 34 AND 35).

CLASS 11—ENVIRONMENTAL CONTROL APPARATUS

FOR APPARATUS FOR LIGHTING, NAMELY, LAMPS, BULBS, PROJECTOR LAMPS, APPARATUS FOR HEATING AND VAPOR PRODUCING, NAMELY, GAS BOILERS, BURNERS, HEATERS, NAMELY, GAS PATIO HEATERS, GAS WATER HEATERS, HEATERS FOR HOUSEHOLD BATHS, ELECTRIC WATER BOILERS, APPARATUS FOR COOKING, NAMELY, ELECTRIC TOASTERS, ELECTRIC BREAD TOASTERS, ELECTRIC DEEP FRYERS, GRIDIRONS, NAMELY, ELECTRIC GRIDDLES, GRILLS, NAMELY, GAS GRILLS, ELECTRIC GRILLS, OVENS, NAMELY, CONVECTION OVENS, COFFEE ROASTING OVENS, STOVES, NAMELY, ELECTRIC STOVES, CERAMIC STOVES, ELECTRIC CORN-POPPERS, ELECTRIC AUTOCLAVES, ELECTRIC COFFEE AND TEA MACHINES, ELECTRIC KETTLES AND THEIR STRUCTURAL PARTS, APPARATUS FOR DRYING, NAMELY, ELECTRIC HAIR-DRYERS, HAND DRYING APPARATUS FOR WASHROOMS, APPARATUS FOR REFRIGERATING, NAMELY, REFRIGERATING CABINETS, REFRIGERATING MACHINES, REFRIGERATORS, DEEP FREEZERS, ICE BOXES, NAMELY, REFRIGERATORS, ICE CHESTS, ICE MACHINES AND DEVICES, NAMELY, ICE MAKING MACHINES, ICE CHESTS, APPARATUS FOR VENTILATING, NAMELY, ACCLIMATIZERS, ELECTRIC AIR BLOWING FANS, VENTILATORS FOR STOVETOPS, OVENS, APPARATUS FOR WATER SUPPLY AND SANITARY PURPOSES, NAMELY, WATER PURIFYING APPARATUS AND MACHINES, WATER PURIFICATION INSTALLATIONS, INCINERATORS, WATER PURIFIERS (U.S. CLS. 13, 21, 23, 31 AND 34).

ALLISON SCHRODY, EXAMINING ATTORNEY

SN 79-067,330. HANKYU HANSHIN HOLDINGS, INC.,
OSAKA 563-0056, JAPAN, FILED 2-10-2009.

Hankyu Hanshin

PRIORITY DATE OF 9-29-2008 IS CLAIMED.
OWNER OF INTERNATIONAL REGISTRATION 0998900
DATED 2-10-2009, EXPIRES 2-10-2019.

OWNER OF U.S. REG. NOS. 3,247,787 AND 3,253,957.
"HANKYU HANSHIN" DOES NOT IDENTIFY A LIVING
INDIVIDUAL.

THE MARK CONSISTS OF THE WORDING "HANKYU
HANSHIN".

THE WORDING "HANKYU HANSHIN" HAS NO MEAN-
ING IN A FOREIGN LANGUAGE.

CLASS 35—ADVERTISING AND BUSINESS

FOR ADVERTISING SERVICES; RENTAL OF ADVER-
TISING SPACE; ON-LINE ADVERTISING SERVICES ON
A COMPUTER NETWORK; PRESENTATION OF GOODS
ON COMMUNICATION MEDIA, FOR RETAIL PUR-
POSES; ISSUANCE OF TRADING STAMPS, NAMELY,
PROVIDING COUPONS, REBATES AND VOUCHERS
FOR RETAIL STORE SERVICES OR WHOLESALE
STORE SERVICES; BUSINESS MANAGEMENT OF
SHOPPING MALL; COMMERCIAL INFORMATION
AGENCIES; BUSINESS MANAGEMENT OF HOTELS;
IMPORT-EXPORT AGENCIES INCLUDING CUSTOMS
CLEARANCE SERVICES; RETAIL STORE SERVICES OR
WHOLESALE STORE SERVICES FOR FOODS AND
BEVERAGES (U.S. CLS. 100, 101 AND 102).

CLASS 39—TRANSPORTATION AND STO- RAGE

FOR RAILWAY TRANSPORT; BUS TRANSPORT; CAR
TRANSPORT; VEHICLE-DRIVING SERVICES; BOAT
TRANSPORT; AIR TRANSPORT; FREIGHT TRANSPOR-
TATION BY TRUCK, TRAIN, AIR AND BOAT; PACKA-
GING OF GOODS FOR TRANSPORTATION; FREIGHT
BROKERAGE; COURIER SERVICES OF MESSAGES OR
MERCHANDISE; FREIGHTING COMPRISING CAR
TRANSPORT, AIR TRANSPORT, RAILWAY TRANS-
PORT AND BOAT TRANSPORT; REMOVAL SERVICES,
NAMELY, TRANSPORT MOVING AND PHYSICAL RE-
LOCATION OF HOUSEHOLD PROPERTY OF OTHERS;
SHIP BROKERAGE, NAMELY, BROKERAGE FOR REN-
TAL, SELLING, PURCHASING OR CHARTERING OF
VESSELS; ARRANGING OF TOURS; TRAVEL RESER-
VATION; BOOKING OF SEATS FOR TRAVEL; ESCORT-
ING OF TRAVELERS; ORGANIZING AND
CONDUCTING OF SIGHTSEEING TOURS; STORAGE
OF GOODS; RENTAL OF WAREHOUSES; CAR PARK-
ING; PROVISION OF CAR PARKING; CAR RENTAL;
BOAT RENTAL; BICYCLE RENTAL (U.S. CLS. 100 AND
105).

DOMINIC FATHY, EXAMINING ATTORNEY

SN 79-067,408. SUEZ ENVIRONNEMENT, F-75008 PARIS,
FRANCE, FILED 3-6-2009.

ALLIANCE EAU ET DEVELOPPEMENT

OWNER OF INTERNATIONAL REGISTRATION 0999100
DATED 3-6-2009, EXPIRES 3-6-2019.

NO CLAIM IS MADE TO THE EXCLUSIVE RIGHT TO
USE "EAU", APART FROM THE MARK AS SHOWN.

THE ENGLISH TRANSLATION OF THE FOREIGN
WORD(S) IN THE MARK IS: "WATER AND DEVELOP-
MENT ALLIANCE".

CLASS 35—ADVERTISING AND BUSINESS

FOR ADVERTISING SERVICES; BUSINESS MANAGE-
MENT; BUSINESS ADMINISTRATION; OFFICE FUNC-
TIONS; DISSEMINATION OF ADVERTISING
MATERIAL IN THE FORM OF LEAFLETS, PROSPEC-
TUSES, PRINTED MATTER, SAMPLES; ARRANGING
NEWSPAPERS SUBSCRIPTIONS (FOR OTHERS); BUSI-
NESS ORGANISATION AND MANAGEMENT CON-
SULTING; ACCOUNTING; DOCUMENT
REPRODUCTION; EMPLOYMENT AGENCIES; COMPU-
TERISED FILE MANAGEMENT; ORGANISATION OF
EXHIBITIONS FOR COMMERCIAL OR ADVERTISING
PURPOSES; ONLINE ADVERTISING ON A COMPUTER
NETWORK; RENTAL OF ADVERTISING TIME ON ALL
MEANS OF COMMUNICATION; PUBLISHING OF AD-
VERTISING TEXTS; RENTAL OF ADVERTISING
SPACE; DISSEMINATION OF ADVERTISING MATTER;
PUBLIC RELATIONS (U.S. CLS. 100, 101 AND 102).

CLASS 37—CONSTRUCTION AND REPAIR

FOR REPAIR OF WATER TREATMENT AND WATER
DISTRIBUTION APPARATUS AND INSTALLATIONS,
AND PROVIDING INFORMATION RELATING THERE-
TO (U.S. CLS. 100, 103 AND 106).

CLASS 39—TRANSPORTATION AND STO- RAGE

FOR WATER DISTRIBUTION, AND INFORMATION
RELATING THERETO (U.S. CLS. 100 AND 105).

CLASS 40—MATERIAL TREATMENT

FOR TREATMENT OF WATER, AND INFORMATION
RELATING THERETO (U.S. CLS. 100, 103 AND 106).

CLASS 42—SCIENTIFIC AND COMPUTER SERVICES

FOR SCIENTIFIC AND TECHNICAL RESEARCH
SERVICES WITH RELATION TO WATER; ADVICE ON
THE ENVIRONMENT, NAMELY, PROVIDING ADVI-
SORY SERVICES IN THE FIELD OF ENVIRONMENTAL
SCIENCE, AND INFORMATION RELATING THERETO
(U.S. CLS. 100 AND 101).

SUZANNE BLANE, EXAMINING ATTORNEY

SN 79-067,759. DR. MONIKA JUNGBLUT, FED REP GER-
MANY, FILED 2-20-2009.

SIPARI

THE MARK CONSISTS OF STANDARD CHARACTERS
WITHOUT CLAIM TO ANY PARTICULAR FONT, STYLE,
SIZE, OR COLOR.

OWNER OF INTERNATIONAL REGISTRATION 1000061
DATED 2-20-2009, EXPIRES 2-20-2019.

THE WORDING "SIPARI" HAS NO MEANING IN A
FOREIGN LANGUAGE.

CLASS 9—ELECTRICAL AND SCIENTIFIC APPARATUS

FOR APPARATUS FOR RECORDING, TRANSMIS-
SION AND REPRODUCTION OF SOUND AND IMAGES;
PRE-RECORDED MAGNETIC DATA CARRIERS FEAT-
URING MUSIC AS TEACHING MATERIAL; PRE-RE-
CORDED RECORDING DISCS FEATURING MUSIC AS
TEACHING MATERIAL; PRE-RECORDED COMPACT
DISCS FEATURING MUSIC AS TEACHING MATERIAL;
PRE-RECORDED DVDS FEATURING MUSIC AS
TEACHING MATERIAL (U.S. CLS. 21, 23, 26, 36 AND 38).

CLASS 41—EDUCATION AND ENTERTAINMENT

FOR EDUCATION IN THE NATURE OF INDIVIDUALIZED PERSONAL INSTRUCTIONS, WORKSHOPS, SEMINARS IN THE FIELD OF SPEECH AND MUSIC THERAPY; PROVIDING OF TRAINING SERVICES IN THE FIELD OF SPEECH AND MUSIC THERAPY (U.S. CLS. 100, 101 AND 107).

CLASS 44—MEDICAL, BEAUTY AND AGRICULTURAL SERVICES

FOR MUSIC THERAPY SERVICES; SERVICES OF A PSYCHOTHERAPIST; SERVICES OF A SPEECH THERAPIST; MEDICAL SERVICES; HEALTH CARE FOR HUMAN BEINGS (U.S. CLS. 100 AND 101).

MICHAEL WIENER, EXAMINING ATTORNEY

CLASS 45—PERSONAL AND LEGAL SERVICES

FOR LEGAL SERVICES; SECURITY SERVICES, NAMELY, THE PROTECTION OF PROPERTY AND INDIVIDUALS IN THE NATURE OF SECURITY GUARD SERVICES, SECURITY CONTROL OF PERSONNEL AND LUGGAGE AT AIRPORTS, MONITORING OF ALARMS AND COMPUTER SYSTEMS FOR SECURITY PURPOSES; PERSONAL CONCIERGE SERVICES FOR OTHERS COMPRISING MAKING REQUESTED PERSONAL ARRANGEMENTS AND RESERVATIONS, RUNNING ERRANDS AND PROVIDING CUSTOMER SPECIFIC INFORMATION TO MEET INDIVIDUAL NEEDS, ALL RENDERED IN BUSINESS ESTABLISHMENTS, OFFICE BUILDINGS, HOTELS, RESIDENTIAL COMPLEXES, HOMES AND AMUSEMENT-TYPE PARKS, LEISURE PARKS, RECREATION PARKS AND THEME PARKS (U.S. CLS. 100 AND 101).

HENRY S. ZAK, EXAMINING ATTORNEY

SN 79-067,986. TROPICAL ISLAND MANAGEMENT GMBH, 15910 KRAUSNICK, FED REP GERMANY, FILED 1-13-2009.

Tropical Island

THE MARK CONSISTS OF STANDARD CHARACTERS WITHOUT CLAIM TO ANY PARTICULAR FONT, STYLE, SIZE, OR COLOR.

OWNER OF INTERNATIONAL REGISTRATION 1000562 DATED 1-13-2009, EXPIRES 1-13-2019.

CLASS 35—ADVERTISING AND BUSINESS

FOR ADVERTISING; BUSINESS MANAGEMENT; BUSINESS ADMINISTRATION; PROVIDING OFFICE FUNCTIONS (U.S. CLS. 100, 101 AND 102).

CLASS 39—TRANSPORTATION AND STORAGE

FOR TRANSPORT BY AIR, RAIL, BOAT AND MOTOR VEHICLE; PACKAGING AND STORAGE OF GOODS; TRAVEL ARRANGEMENT (U.S. CLS. 100 AND 105).

CLASS 41—EDUCATION AND ENTERTAINMENT

FOR EDUCATION AND ENTERTAINMENT IN THE NATURE OF AMUSEMENT-TYPE PARK, LEISURE PARK, RECREATION PARK AND THEME PARK SERVICES; SPORTING AND CULTURAL ACTIVITIES RENDERED IN AMUSEMENT-TYPE PARKS, LEISURE PARKS, RECREATION PARKS AND THEME PARKS (U.S. CLS. 100, 101 AND 107).

CLASS 43—HOTEL AND RESTAURANT SERVICES

FOR SERVICES FOR PROVIDING FOOD AND DRINK; TEMPORARY ACCOMMODATION (U.S. CLS. 100 AND 101).

CLASS 44—MEDICAL, BEAUTY AND AGRICULTURAL SERVICES

FOR MEDICAL SERVICES; HYGIENIC AND BEAUTY CARE FOR HUMAN BEINGS OR ANIMALS (U.S. CLS. 100 AND 101).

SN 79-068,205. VTU HOLDING GMBH, A-8074 GRAMBACH, AUSTRIA, FILED 3-13-2009.

COOLOX

THE MARK CONSISTS OF STANDARD CHARACTERS WITHOUT CLAIM TO ANY PARTICULAR FONT, STYLE, SIZE, OR COLOR.

PRIORITY DATE OF 9-30-2008 IS CLAIMED.

OWNER OF INTERNATIONAL REGISTRATION 1001149 DATED 3-13-2009, EXPIRES 3-13-2019.

CLASS 37—CONSTRUCTION AND REPAIR

FOR BUILDING CONSTRUCTION; CONSTRUCTION OF PROCESS ENGINEERING INSTALLATIONS IN THE NATURE OF BUILDING, CONSTRUCTION SUPERVISION AND MAINTENANCE OF PROCESS ENGINEERING INSTALLATIONS; REPAIR OF PROCESS ENGINEERING INSTALLATIONS; INSTALLATION SERVICES OF PROCESS ENGINEERING INSTALLATIONS (U.S. CLS. 100, 103 AND 106).

CLASS 42—SCIENTIFIC AND COMPUTER SERVICES

FOR SURVEYING; TECHNICAL AND CHEMICAL RESEARCH IN THE FIELD OF PROCESS ENGINEERING INSTALLATIONS; CONSTRUCTION DRAFTING; TECHNICAL CONSULTANCY IN THE FIELDS OF PROCESS TECHNOLOGY AND INSTALLATION CONSTRUCTION, IN PARTICULAR IN THE FIELD OF ENVIRONMENTAL TECHNOLOGY; DESIGN OF PROCESS TECHNOLOGY INSTALLATIONS; TECHNICAL ASSEMBLY MONITORING OF PROCESS ENGINEERING INSTALLATIONS, NAMELY, QUALITY ASSESSMENT, TESTING OR INSPECTION OF PROCESSING ENGINEERING INSTALLATIONS; TECHNICAL COMMISSIONING MONITORING OF PROCESS ENGINEERING INSTALLATIONS, NAMELY, QUALITY ASSESSMENT, TESTING OR INSPECTION OF PROCESS ENGINEERING INSTALLATIONS (U.S. CLS. 100 AND 101).

JENNY PARK, EXAMINING ATTORNEY

SN 79-068,303. BANZAI S.P.A., ITALY, FILED 10-24-2008.

SN 79-068,506. TIMEPARTNER HOLDING GMBH, FED REP GERMANY, FILED 11-21-2008.

BANZAI

THE MARK CONSISTS OF STANDARD CHARACTERS WITHOUT CLAIM TO ANY PARTICULAR FONT, STYLE, SIZE, OR COLOR.

PRIORITY DATE OF 5-8-2008 IS CLAIMED.

OWNER OF INTERNATIONAL REGISTRATION 1001403 DATED 10-24-2008, EXPIRES 10-24-2018.

CLASS 35—ADVERTISING AND BUSINESS

FOR ADVERTISING; RENTAL OF ADVERTISING SPACE, NAMELY, RENTAL OF ADVERTISING SPACE FOR THIRD PARTIES; BUSINESS INVESTIGATION OF DATA AND INFORMATION; RECORDS MANAGEMENT SERVICES, NAMELY, DOCUMENT INDEXING OF INFORMATIVE MATERIAL, FOR OTHERS; RETAIL STORE SERVICES FEATURING SOFTWARE (U.S. CLS. 100, 101 AND 102).

CLASS 36—INSURANCE AND FINANCIAL

FOR FINANCIAL AFFAIRS, NAMELY, ON-LINE BUSINESS FUND RAISING SERVICES FOR COMPANIES OF THE GROUP; REAL ESTATE AFFAIRS, NAMELY, PROVISION OF LEASING AND SUBLEASING OFFICE SPACE FOR THE COMPANIES OF THE GROUP; FINANCIAL CONSULTING; ACQUISITION OF HOLDINGS IN VENTURE CAPITAL COMPANIES AS A FEATURE OF VENTURE CAPITAL FUNDING SERVICES TO EMERGING AND START-UP COMPANIES (U.S. CLS. 100, 101 AND 102).

CLASS 38—COMMUNICATION

FOR TRANSFER OF INFORMATION AND DATA THROUGH COMPUTER NETWORKS AND INTERNET; PROVISION ON-LINE ELECTRONIC BULLETIN BOARDS FOR TRANSMISSION OF MESSAGES AMONG COMPUTER USERS CONCERNING SCHOOL, EDUCATION, HIGH TECH, FOOD AND ENTERTAINMENT AND PROVIDING ON-LINE FORUMS FOR TRANSMISSION OF MESSAGES AMONG COMPUTER USERS CONCERNING ADVERTISING, MARKETING, E-COMMERCE; PROVISION OF ACCESS TO ELECTRONIC COMMUNICATION NETWORKS IN THE NATURE OF TELECOMMUNICATION NETWORKS, GLOBAL COMPUTER NETWORKS FOR THE PURPOSE OF COMMERCIAL TRANSACTIONS; PROVISION OF ACCESS TO ELECTRONIC COMMUNICATION NETWORKS IN THE NATURE OF TELECOMMUNICATION NETWORK, GLOBAL COMPUTER NETWORK AND THE INTERNET; ELECTRONIC DATA TRANSMISSION OF INFORMATIVE MATERIAL (U.S. CLS. 100, 101 AND 104).

CLASS 42—SCIENTIFIC AND COMPUTER SERVICES

FOR DEVELOPMENT OF SOFTWARE AND OPERATING SYSTEM HARDWARE AND NETWORK APPLICATION FOR WEB SERVICES; WEBSITE DEVELOPMENT FOR OTHERS; WEBSITE DESIGN AND CREATION FOR OTHERS; WEB SITES SERVICES, NAMELY, WEB HOSTING, USER GENERATED CONTENT WEB PUBLISHING, WEB DIRECT ADVERTISING AND EMAIL MARKETING (U.S. CLS. 100 AND 101).

Laura Hammel, Examining Attorney

TimePartner

THE MARK CONSISTS OF STANDARD CHARACTERS WITHOUT CLAIM TO ANY PARTICULAR FONT, STYLE, SIZE, OR COLOR.

PRIORITY DATE OF 5-23-2008 IS CLAIMED.

OWNER OF INTERNATIONAL REGISTRATION 1001899 DATED 11-21-2008, EXPIRES 11-21-2018.

CLASS 35—ADVERTISING AND BUSINESS

FOR ADVERTISING, ADVERTISING STRATEGY PLANNING, NAMELY, PERFORMING CONSUMER INSIGHT AND BRAND STRATEGY OF COMPANY LOGOS; BUSINESS MANAGEMENT CONSULTANCY, BUSINESS MANAGEMENT CONSULTANCY PLANNING, BUSINESS ADMINISTRATION; BUSINESS MANAGEMENT ASSISTANCE, PROFESSIONAL BUSINESS CONSULTANCY, BUSINESS PROCESS MANAGEMENT AND OPTIMIZATION IN THE FIELDS OF BUSINESS ORGANIZATION, CONCEPT AND BRAND DEVELOPMENT SERVICES FOR CORPORATE CLIENTS, BUSINESS PROCESS TECHNOLOGY; BUSINESS ORGANIZATIONAL DEVELOPMENT PLANNING AND MONITORING OF BUSINESS DEVELOPMENT AND ORGANIZATION, NAMELY, BUSINESS ADMINISTRATION AND MANAGEMENT, BUSINESS DEVELOPMENT CONSULTING SERVICES; OFFICE FUNCTIONS; EMPLOYMENT AGENCIES FEATURING PLACEMENT OF PERSONNEL IN THE FRAME OF THE EMPLOYEE'S RULE; EMPLOYMENT AGENCIES, NAMELY, PROCUREMENT AND NEGOTIATION OF EMPLOYMENT CONTRACTS BETWEEN EMPLOYEES AND TEMPORARY STAFF; HUMAN RESOURCES CONSULTING, EMPLOYMENT AGENCIES; PERSONNEL MANAGEMENT CONSULTANCY; PERSONNEL RECRUITMENT; TEMPORARY EMPLOYMENT AGENCY SERVICES; TEMPORARY STAFF EMPLOYMENT AGENCIES; OUTSOURCING SERVICES, ON-SITE BUSINESS MANAGEMENT, NONE OF THE FOREGOING BEING RELATED TO FINANCIAL OR INVESTMENT CONSULTANCY, FINANCIAL OR INVESTMENT MANAGEMENT, OR RELATED FINANCIAL OR INVESTMENT SERVICES (U.S. CLS. 100, 101 AND 102).

CLASS 38—COMMUNICATION

FOR TELECOMMUNICATION SERVICES, NAMELY, PROVIDING USER ACCESS TO A GLOBAL COMPUTER NETWORK, PROVIDING TELECOMMUNICATIONS CONNECTIONS TO A GLOBAL COMPUTER NETWORK, COMMUNICATIONS BY FIBER OPTICAL NETWORKS, COMMUNICATIONS BY COMPUTER TERMINALS, PROVIDING VOICE COMMUNICATION SERVICES VIA THE INTERNET, COMMUNICATIONS BY TELEPHONE AND MOBILE TELEPHONES, COMMUNICATIONS BY TELEGRAPH, TELEPRINT AND BY FACSIMILE, COMMUNICATIONS BY SATELLITE, AND TELECOMMUNICATION ROUTING AND JUNCTION SERVICES, TELECOMMUNICATION LINKING SERVICES, NAMELY, PROVIDING ON-LINE COMMUNICATIONS LINKS WHICH TRANSFER THE WEB SITE USER TO OTHER LOCAL AND GLOBAL WEB PAGES, TRANSMISSION OF INFORMATION ON OPTICAL TELECOMMUNICATION NETWORKS, OF NEWS, OF MESSAGES, VOICE OVER INTERNET PROTOCOL (VOIP) SERVICES, NAMELY, COMMUNICATIONS BY LOCAL AND LONG DISTANCE TRANSMISSION OF VOICE, DATA, GRAPHICS, BY MEANS OF THE AFOREMENTIONED, AND TELECOMMUNICATIONS CONSULTATION IN THE NATURE OF TECHNICAL CONSULTING IN THE FIELD OF AUDIO, TEXT AND VISUAL DATA TRANSMISSION AND COMMUNICATION, CALL CENTER TELEPHONE SERVICES, NAMELY, CALL FORWARDING SERVICES, INTERCEPTING AND PREVENTING UNSOLICITED CALLS FROM TELEMARKETERS, TELEPHONE CALL COMPLETION SERVICES FOR DIRECTORY ASSISTANCE CUSTOMERS (U.S. CLS. 100, 101 AND 104).

Charisma Hampton, Examining Attorney

SN 79-068,726. ARES SRL, I-20044 BERNAREGGIO (MI), ITALY, FILED 4-30-2009.

SN 79-069,204. PETER MORRISSEY PTY LTD AS TRUSTEE FOR PETER MORRISSEY TRUST, AUSTRALIA, FILED 12-17-2008.

ares

OWNER OF INTERNATIONAL REGISTRATION 1002542 DATED 4-30-2009, EXPIRES 4-30-2019.

CLASS 9—ELECTRICAL AND SCIENTIFIC APPARATUS

FOR LUMINOUS SAFETY BEACONS; LUMINOUS SIGNS IN THE NATURE OF SIGNALING PANELS; LIGHT DIODES (U.S. CLS. 21, 23, 26, 36 AND 38).

CLASS 11—ENVIRONMENTAL CONTROL APPARATUS

FOR LIGHTING INSTALLATIONS, NAMELY, LIGHTING FIXTURES; CHANDELIERS; LAMPS; LAMP REFLECTORS; LIGHT BULBS AND ELECTRIC BULBS; DECORATIVE LIGHTING, NAMELY, SCONCE LIGHTING FIXTURES, FLOOR LAMPS, FREE STANDING LUMINARIES, PORTABLE LUMINARIES, CEILING LIGHTING, WALL LAMPS; OUTDOOR LAMPS, LANTERNS, STREET LAMPS, LIGHTING FIXTURES, NAMELY, LIGHT FITTINGS, LIGHT BOLLARDS, RECESSED LIGHT FITTINGS, ARCHITECTURAL LIGHTING; PROJECTOR LAMPS (U.S. CLS. 13, 21, 23, 31 AND 34).

AISHA SALEM, EXAMINING ATTORNEY

SN 79-069,135. ESAB AB, SWEDEN, FILED 5-5-2009.

Suprarex

THE MARK CONSISTS OF STANDARD CHARACTERS WITHOUT CLAIM TO ANY PARTICULAR FONT, STYLE, SIZE, OR COLOR.

PRIORITY DATE OF 11-26-2008 IS CLAIMED.

OWNER OF INTERNATIONAL REGISTRATION 1003520 DATED 5-5-2009, EXPIRES 5-5-2019.

THE WORDING "SUPRAREX" HAS NO MEANING IN A FOREIGN LANGUAGE.

CLASS 7—MACHINERY

FOR CUTTING MACHINES AND ACCESSORIES AND PARTS FOR CUTTING MACHINES, NAMELY, TORCHES FOR PLASMA CUTTING, OXYFUEL CUTTING, MARKING, LABELING AND PREPARING OF WELDS (U.S. CLS. 13, 19, 21, 23, 31, 34 AND 35).

CLASS 9—ELECTRICAL AND SCIENTIFIC APPARATUS

FOR APPARATUS FOR CONTROLLING CUTTING PROCESSES AND ACCESSORIES AND PARTS THEREOF, NAMELY, MICRO-PROCESSOR BASED HARDWARE AND SOFTWARE USED TO MONITOR THE STATUS OF THE CUTTING MACHINES (U.S. CLS. 21, 23, 26, 36 AND 38).

MYRIAH HABEEB, EXAMINING ATTORNEY

Peter Morrissey

THE MARK CONSISTS OF STANDARD CHARACTERS WITHOUT CLAIM TO ANY PARTICULAR FONT, STYLE, SIZE, OR COLOR.

PRIORITY DATE OF 6-18-2008 IS CLAIMED.

OWNER OF INTERNATIONAL REGISTRATION 1003727 DATED 12-17-2008, EXPIRES 12-17-2018.

THE NAME(S), PORTRAIT(S), AND/OR SIGNATURE(S) SHOWN IN THE MARK IDENTIFIES "PETER MORRISSEY", WHOSE CONSENT(S) TO REGISTER IS MADE OF RECORD.

CLASS 3—COSMETICS AND CLEANING PREPARATIONS

FOR BEAUTY PRODUCTS, NAMELY, BEAUTY CREAMS, LOTIONS, MASKS, PERFUMES AND COLOGNES; COSMETICS, NAMELY, LIPSTICKS, LIP PENCILS, EYE MAKEUP, EYE SHADOW, EYE PENCILS, EYE LINER, MASCARA; NON-MEDICATED HAIR PRODUCTS, NAMELY, SHAMPOOS AND CONDITIONERS; SKIN PRODUCTS, NAMELY, COSMETIC CREAMS FOR SKIN CARE, EXFOLIANTS; SOAPS, ANTIPERSPIRANTS, NON-MEDICATED BATH PRODUCTS, NAMELY, BAR SOAP, LIQUID BATH SOAPS, PERFUMED SOAPS, BUBBLE BATH; NON-MEDICATED FACIAL CARE PRODUCTS, NAMELY, FACIAL CLEANSERS, TONERS, MOISTURIZERS, MASKS, EXFOLIANTS; NON-MEDICATED SKIN MOISTURIZERS; NON-MEDICATED NAIL PREPARATIONS, NAMELY, CUTICLE CONDITIONERS, CUTICLE CREAMS, HAND CREAM, FOOT CREAM; OILS FOR COSMETIC USE, SUN SKIN CARE PRODUCTS, NAMELY, SUN BLOCK AND SUN CARE LOTIONS; SHAVING PRODUCTS, NAMELY, SHAVING CREAM, SHAVING GEL, SHAVING FOAM, SHAVING LOTIONS, AFTERSHAVES (U.S. CLS. 1, 4, 6, 50, 51 AND 52).

CLASS 8—HAND TOOLS

FOR TABLEWARE, NAMELY, KNIVES, FORKS, SPOONS; CUTLERY (U.S. CLS. 23, 28 AND 44).

CLASS 11—ENVIRONMENTAL CONTROL APPARATUS

FOR LAMPS; CEILING LIGHTS; WALL LIGHTS; SPOT LIGHTS; ELECTRIC LIGHTS, NAMELY, ELECTRIC LIGHT BULBS; LIGHTS FOR FESTIVE DECORATION, NAMELY, ELECTRIC LIGHTS FOR CHRISTMAS TREES, LIGHTED PARTY - THEMED DECORATIONS, ELECTRIC LIGHT DECORATIVE STRINGS; NIGHT LIGHTS; WALL LIGHTS (U.S. CLS. 13, 21, 23, 31 AND 34).

CLASS 19—NON-METALLIC BUILDING MATERIALS

FOR FLOORING MADE OF WOOD, PARQUET FLOORING, FLOORING MADE OF CORK, FLOORING MADE OF PLASTIC, FLOORING MADE OF CERAMIC TILES, GLASS TILES, PAVING TILES, PLASTIC TILES; NON-METALLIC FLOORING (U.S. CLS. 1, 12, 33 AND 50).

CLASS 20—FURNITURE AND ARTICLES NOT OTHERWISE CLASSIFIED

FOR FURNITURE; MIRRORS; BEDS; WARDROBES; CHAIRS; SOFAS; LOUNGES, NAMELY, LOUNGE CHAIRS, COUCHES, SOFA BEDS, FURNITURE, NAMELY, STORAGE BOXES MADE OF WOOD AND MADE OF PLASTIC; DESKS, DRAWERS, BOXES MADE OF WOOD, BOXES MADE OF PLASTIC, TABLES, SIDE TABLES, STOOLS (U.S. CLS. 2, 13, 22, 25, 32 AND 50).

CLASS 21—HOUSEWARES AND GLASS

FOR BARWARE, NAMELY, COCKTAIL SHAKERS, ICE BUCKETS, CORKSCREWS, DECANTERS; TABLEWARE OF BONE CHINA, PORCELAIN, STONEWARE, NAMELY, CASSEROLE DISHES, RAMEKINS, CAKE PANS, BAKING DISHES, PLATES, MUGS, BOWLS; CROCKERY, NAMELY, PLATES, BOWLS, MUGS, TEACUPS, SAUCERS; BEVERAGE GLASSWARE; ORNAMENTS OF CHINA, GLASS, CRYSTAL, CERAMIC, TERRACOTTA; FLATWARE, NAMELY, PLATES, SERVING PLATTERS, SAUCERS; HAND-OPERATED BOTTLE OPENERS; TABLE ACCESSORIES, NAMELY, CUTLERY HOLDERS IN THE NATURE OF HOLDERS FOR CUTLERY MADE OF WOOD, STAINLESS STEEL AND PLASTIC, CUTLERY TRAYS, CANDLE HOLDERS, CONDIMENT DISHES AND DISPENSERS SOLD EMPTY, CENTERPIECES NOT IN OTHER CLASSES, NAMELY, CERAMIC SCULPTURES AND VASES (U.S. CLS. 2, 13, 23, 29, 30, 33, 40 AND 50).

CLASS 27—FLOOR COVERINGS

FOR FLOOR COVERINGS; RUGS; CARPETS; BATH MATS; MATS, NAMELY, DOOR MATS, FLOOR MATS, RUBBER MATS, TEXTILE FLOOR MATS FOR USE IN THE HOME; NON-TEXTILE WALL COVERINGS (U.S. CLS. 19, 20, 37, 42 AND 50).

CLASS 33—WINES AND SPIRITS

FOR ALCOHOL FOR DRINKING, NAMELY, BRANDY, CREAM LIQUORS, GIN, SCOTCH, RUM, TEQUILA, WHISKEY; ALCOHOLIC BEVERAGES, NAMELY, WINES, SPARKLING WINES, FORTIFIED WINES, CHAMPAGNE, SPIRITS, PORT; ALCOHOLIC PREPARATIONS FOR MAKING BEVERAGES, NAMELY, ALCOHOLIC COCKTAIL MIXES, LIQUEURS, PRE-MIXED ALCOHOLIC DRINKS, NAMELY, PREPARED WINE COCKTAILS, ALCOHOLIC FRUIT COCKTAIL DRINKS (U.S. CLS. 47 AND 49).

JAMES STEIN, EXAMINING ATTORNEY

CLASS 9—ELECTRICAL AND SCIENTIFIC APPARATUS

FOR SCIENTIFIC APPARATUS AND INSTRUMENTS, NAMELY, SENSOR CHIPS, CONDUCTIVITY METERS; ELECTRIC APPARATUS AND INSTRUMENTS, NAMELY, SWITCHES, TIME SWITCHES, CIRCUIT BREAKERS, MASTER SWITCHES, GANG SWITCHES, ACCUMULATORS, CONDUCTORS, CABLES, COILS; WEIGHING APPARATUS AND INSTRUMENTS; SIGNALING APPARATUS AND INSTRUMENTS, NAMELY, SIGNAL PROCESSORS, ROTATING LIGHTS; CHECKING APPARATUS AND INSTRUMENTS, NAMELY, ELECTRONIC SYSTEMS FOR MONITORING THE STATUS OF DOORS AND WINDOWS WHETHER OPEN, CLOSED, SECURED; APPARATUS FOR RECORDING, TRANSMISSION OR REPRODUCTION OF SOUND AND IMAGES; PRE-RECORDED MAGNETIC DATA CARRIERS FEATURING DATA CONCERNING FACILITIES OPERATION, NAMELY, THERMAL CONDITIONS, AIR CIRCULATION SPEED AND VOLUMES, GENERAL BUILDING MAINTENANCE DATA, PRESENCE OR ABSENCE OF RESIDENTS IN THEIR FLATS, PRESENCE OR ABSENCE OF CARS IN GARAGE PLACES, FIRE-EXTINGUISHING APPARATUS, PRE-RECORDED DIGITAL RECORDING DISCS FEATURING MUSIC; AUTOMATIC VENDING MACHINES AND MECHANISMS FOR COIN-OPERATED APPARATUS; CASH REGISTERS, CALCULATING MACHINES, DATA PROCESSING EQUIPMENT AND COMPUTERS; APPARATUS AND INSTRUMENTS FOR SCIENTIFIC RESEARCH IN LABORATORIES, NAMELY, FURNITURE, GLASSWARE, FILTERS, THERMOMETERS, STORAGE TUBES, ELECTRIC BATH HEATERS; APPARATUS TO CONVERT ELECTRONIC RADIATIONS INTO ELECTRIC ENERGY, NAMELY, PHOTOVOLTAIC SOLAR MODULES; COMPUTERS HARDWARE AND SOFTWARE FOR FACILITIES MANAGEMENT, NAMELY, CONTROLLING BUILDING ENVIRONMENT, ACCESS AND SECURITY SYSTEMS (U.S. CLS. 21, 23, 26, 36 AND 38).

CLASS 11—ENVIRONMENTAL CONTROL APPARATUS

FOR APPARATUS FOR LIGHTING, NAMELY, LIGHTING FIXTURES; HEATING INSTALLATIONS; HEAT EXCHANGERS; STEAM GENERATORS; APPARATUS FOR COOKING, NAMELY, COOKING RANGES, ELECTRIC COOKING OVENS; APPARATUS FOR REFRIGERATING, NAMELY, REFRIGERATORS, REFRIGERATING MACHINES, REFRIGERATING APPLIANCES AND INSTALLATIONS; APPARATUS FOR DRYING, NAMELY, CLOTHES DRYERS, INDUSTRIAL DRYERS FOR HEATING AND DEHUMIDIFYING, ELECTRIC HAND DRYING APPARATUS FOR WASHROOMS; VENTILATING APPARATUS, NAMELY, OVEN VENTILATOR HOODS, VENTILATING EXHAUST FANS, VENTILATION FANS FOR COMMERCIAL AND INDUSTRIAL USE; APPARATUS FOR WATER SUPPLY AND SANITARY PURPOSES, NAMELY, WATER FILTERS, WATER PURIFICATION INSTALLATIONS AND WATER PURIFICATION TANKS, WATER CONDITIONING UNITS, WATER STERILIZERS (U.S. CLS. 13, 21, 23, 31 AND 34).

CLASS 19—NON-METALLIC BUILDING MATERIALS

FOR NON-METAL BUILDING MATERIALS, NAMELY, SHINGLES, CLADDING, SIDING; NON-METAL REFRACTORY BLOCKS AND BRICKS; NON-METAL ROOFING TILES; NON-METAL FIRED REFRACTORY MATERIALS; ENGRAVED AND CUT STONE PLAQUES; STONES; NON-METAL FLOOR PANELS; NON-METAL FLOOR TILES AND OTHER THAN CARPET TILES; PLASTIC CONDUITS FOR DRAINAGE AND IRRIGATION (U.S. CLS. 1, 12, 33 AND 50).

SN 79-069,319. CAEBIT S.R.L., I-00196 ROMA, ITALY, FILED 11-4-2008.



PRIORITY DATE OF 10-21-2008 IS CLAIMED.
OWNER OF INTERNATIONAL REGISTRATION 1003878
DATED 11-4-2008, EXPIRES 11-4-2018.

NO CLAIM IS MADE TO THE EXCLUSIVE RIGHT TO USE "CLEAN ALTERNATIVE ENERGY" AND "BUILDING" AND "TECHNOLOGY", APART FROM THE MARK AS SHOWN.

THE MARK CONSISTS OF THE TERM "CAEBIT" IN LARGER STYLIZED FONT, ABOVE THE TERMS "CLEAN ALTERNATIVE ENERGY & BUILDING INNOVATION TECHNOLOGY" IN SMALLER BLOCK FONT, ALL BE- NEATH THREE CURVED BANDS.

CLASS 36—INSURANCE AND FINANCIAL

FOR REAL ESTATE SERVICES, NAMELY, FINANCING SERVICES FOR REAL ESTATE DEVELOPMENT; FINANCING SERVICES RELATING TO PURCHASE, SALE, ADMINISTRATION, MANAGEMENT, LEASING AND BROKERAGE OF APARTMENTS, HOUSES, CONDOMINIUMS, JOINTLY-OWNED PROPERTY AND REAL ESTATE OF ANY KIND; MANAGEMENT OF REAL ESTATE; FINANCING AND LOAN SERVICES FOR HOME LOANS; REAL ESTATE AGENCIES; REAL ESTATE SERVICES, NAMELY, TAX APPRAISALS; MANAGEMENT OF REAL ESTATE INVESTMENTS; REAL ESTATE ADMINISTRATION SERVICES, NAMELY, LEASING, BROKERAGE, INVESTMENT SERVICES; REAL ESTATE INSURANCE SERVICES, NAMELY, APPRAISALS AND UNDERWRITING; REAL ESTATE MANAGEMENT, NAMELY, MANAGEMENT OF CONDOMINIUMS, BLOCKS OF FLATS, DEPARTMENT STORES, AND RESIDENTIAL AND COMMERCIAL PROPERTIES (U.S. CLS. 100, 101 AND 102).

CLASS 37—CONSTRUCTION AND REPAIR

FOR BUILDING REPAIR AND RESTORATION WORK; TECHNICAL CONSULTANCY REGARDING BUILDING CONSTRUCTION; CONSTRUCTION OF BUILDINGS AND CONSULTANCY SERVICES RELATING THERETO; REPAIR AND INSTALLATION SERVICES, NAMELY, REPAIR AND INSTALLATION OF ELECTRICITY, HEATING, AIR-CONDITIONING, AND ENERGY SAVING AND ENERGY RECOVERY BUILDING INSTALLATIONS; FURNITURE MAINTENANCE AND RESTORATION; SUPERVISION OF BUILDING CONSTRUCTION WORK; MAINTENANCE OF BUILDING INSTALLATIONS FOR THE BUILDING INDUSTRY, NAMELY, HEATING, COOLING, AND ENERGY INSTALLATIONS (U.S. CLS. 100, 103 AND 106).

CLASS 40—MATERIAL TREATMENT

FOR PROCESSING OF INORGANIC OR ORGANIC SUBSTANCES, NAMELY, RECYCLING OF WASTE AND TRASH; PRODUCTION OF ENERGY (U.S. CLS. 100, 103 AND 106).

CLASS 42—SCIENTIFIC AND COMPUTER SERVICES

FOR SCIENTIFIC RESEARCH AND DEVELOPMENT SERVICES; INDUSTRIAL RESEARCH IN THE FIELD OF BUILDING TECHNOLOGY AND URBAN DEVELOPMENT; SPECIALIZED COMPUTER SOFTWARE DESIGN; COMPUTER PROGRAMMING; ENGINEERING AND DESIGN SERVICES IN THE FIELD OF HEATING AND AIR-CONDITIONING INSTALLATIONS; TECHNICAL CONSULTATION IN THE FIELD OF ENGINEERING SERVICES, DESIGN FOR OTHERS IN THE FIELD OF ENERGY ENGINEERING, DESIGNING AND TESTING OF ENERGY PRODUCTS FOR OTHERS; REAL ESTATE DESIGN, NAMELY, ARCHITECTURAL SERVICES; RESIDENTIAL BUILDING DESIGN; DESIGN OF INDUSTRIAL BUILDINGS (U.S. CLS. 100 AND 101).

HELENE LIWINSKI, EXAMINING ATTORNEY

SN 79-069,414, EVOCATAL GMBH, FED REP GERMANY, FILED 4-9-2009.

Evocatal

THE MARK CONSISTS OF STANDARD CHARACTERS WITHOUT CLAIM TO ANY PARTICULAR FONT, STYLE, SIZE, OR COLOR.

OWNER OF INTERNATIONAL REGISTRATION 1004162 DATED 4-9-2009, EXPIRES 4-9-2019.

CLASS 1—CHEMICALS

FOR CHEMICALS USED IN INDUSTRY, SCIENCE AND PHOTOGRAPHY, AS WELL AS IN AGRICULTURE, HORTICULTURE AND FORESTRY, NONE OF THE AFOREMENTIONED BEING FUNGICIDES, HERBICIDES, INSECTICIDES OR PARASITICIDES; UNPROCESSED ARTIFICIAL RESINS, UNPROCESSED PLASTICS; MANURES; FIRE EXTINGUISHING COMPOSITIONS; TEMPERING AND SOLDERING PREPARATIONS, NAMELY, CHEMICALS; CHEMICAL SUBSTANCES FOR PRESERVING FOODSTUFFS; TANNING SUBSTANCES, NAMELY, AGENTS FOR USE IN LEATHER; ADHESIVES USED IN INDUSTRY (U.S. CLS. 1, 5, 6, 10, 26 AND 46).

CLASS 5—PHARMACEUTICALS

FOR PHARMACEUTICAL AND VETERINARY PREPARATIONS FOR TREATING BACTERIAL AND FUNGAL INFECTIONS OR CANCER; PREPARATIONS FOR HEALTH CARE, NAMELY, NUTRITIONAL FOOD ADDITIVES FOR MEDICAL PURPOSES FOR HUMAN CONSUMPTION, ENZYME PREPARATIONS, NAMELY, ENZYME FOOD SUPPLEMENTS; PREPARATIONS FOR HEALTH CARE, NAMELY, SKIN CARE PRODUCTS; BIO-ENGINEERING PRODUCTS AND PREPARATIONS FOR MEDICAL AND VETERINARY PURPOSES, NAMELY, BONE MORPHOGENETIC PROTEIN FOR USE AS A BONE GROWTH MEDIA, BIO-ENGINEERING PRODUCTS AND PREPARATIONS, NAMELY, ENZYMES FOR MEDICAL PURPOSES, NAMELY, ENZYME FOOD SUPPLEMENTS; BIO-ENGINEERING PRODUCTS AND PREPARATIONS, NAMELY, BACTERIAL PREPARATIONS IN THE NATURE OF PRODUCTION STRAINS FOR MEDICAL AND VETERINARY MEDICAL PURPOSES; HERBAL DISINFECTANTS IN THE NATURE OF DISINFECTANTS COMPRISED OF HERBS FOR HYGIENIC AND SANITARY PURPOSES; PREPARATIONS FOR DESTROYING VERMIN; FUNGICIDES, HERBICIDES (U.S. CLS. 6, 18, 44, 46, 51 AND 52).

CLASS 42—SCIENTIFIC AND COMPUTER SERVICES

FOR SCIENTIFIC AND TECHNOLOGICAL SERVICES AND RESEARCH SERVICES, NAMELY, SCIENTIFIC RESEARCH IN THE FIELD OF INFORMATION TECHNOLOGY; COMPUTER SOFTWARE DESIGN FOR OTHERS; INDUSTRIAL ANALYSIS AND RESEARCH SERVICES, NAMELY, INDUSTRIAL RESEARCH IN THE FIELD OF BIOTECHNOLOGY; DESIGN AND PRODUCT DEVELOPMENT SERVICES IN THE FIELD OF COMPUTER HARDWARE AND SOFTWARE; SERVICES OF A CHEMICAL, PHARMACEUTICAL, BIO-ENGINEERING AND/OR GENETIC ENGINEERING LABORATORY, NAMELY, CHEMICAL LABORATORY SERVICES AND GENETIC TESTING OF LABORATORY ANIMALS FOR RESEARCH PURPOSES; TECHNICAL AND SCIENTIFIC ADVICE AND SUPPORT IN THE NATURE OF CONSULTING SERVICES IN THE FIELDS OF CHEMISTRY, PHARMACY, BIO-ENGINEERING OR GENETIC ENGINEERING, PERFORMED BOTH AT CUSTOMER SITE AND VIA COMMUNICATIONS MEDIA SUCH AS THE INTERNET; TECHNICAL CONSULTATION IN THE FIELD OF DESIGNING THEME GRAPHICS AND MULTIMEDIA SHOWS FOR THE LAUNCHING OF CHEMICAL, PHARMACEUTICAL, BIO-ENGINEERING AND GENETIC ENGINEERING PRODUCTS AND PREPARATIONS (U.S. CLS. 100 AND 101).

CLASS 44—MEDICAL, BEAUTY AND AGRICULTURAL SERVICES

FOR MEDICAL SERVICES; VETERINARY SERVICES; HYGIENIC AND BEAUTY CARE FOR HUMAN BEINGS OR ANIMALS (U.S. CLS. 100 AND 101).

TRACY WHITTAKER-BROWN, EXAMINING ATTORNEY

SN 79-069,445. AIRPAR.; SOCIÉTÉ ANONYME, BELGIUM, FILED 2-19-2009.

SN 79-069,688. PHEBRA PTY LTD, AUSTRALIA, FILED 4-21-2009.

EXTREME PLANET

OWNER OF INTERNATIONAL REGISTRATION 0723180 DATED 10-21-1999, EXPIRES 10-21-2019.

CLASS 18—LEATHER GOODS

FOR LEATHER AND IMITATION LEATHER; LEATHER UNWORKED OR SEMI-WORKED; ANIMAL SKINS AND HIDES; ARTIFICIAL FUR; BARREL BAGS, FLIGHT BAGS, GENERAL PURPOSE TROLLEY BAGS, DUFFEL BAGS, SHOULDER BAGS; TOILET BAGS, SOLD EMPTY; EXPEDITION, TREKKING AND HIKING BAGS, BACKPACKS, MOUNTAINEERING BAGS; DRY BAGS, CHALK BAGS; ALL-PURPOSE SPORT BAGS; ALL-PURPOSE CARRY BAGS; BACKPACKS; BELT BAGS AND HIP BAGS; CARRYING CASES; DRAW-STRING POUCHES; HANDBAGS; LEATHER AND IMITATION LEATHER BAGS; LEATHER BAGS, SUITCASES AND WALLETS; LUGGAGE AND TRUNKS; SHOE BAGS FOR TRAVEL; TRAVEL BAGS; TRAVEL CASES; WHEELED BAGS; TOOL BAGS, SOLD EMPTY; HARNESSES; HIKING POLES; HIKING STICKS; UMBRELLAS, PARASOLS AND WALKING STICKS; WHIPS, HARNESSES AND SADDLERY (U.S. CLS. 1, 2, 3, 22 AND 41).

CLASS 20—FURNITURE AND ARTICLES NOT OTHERWISE CLASSIFIED

FOR FURNITURE; FURNITURE, NAMELY, AIR MATTRESSES FOR USE WHEN CAMPING, INFLATABLE MATTRESSES FOR USE WHEN CAMPING; BACK SUPPORT CUSHIONS NOT FOR MEDICAL PURPOSES, PILLOWS, SLEEPING BAGS AND SLEEPING MATS; MIRRORS AND PICTURE FRAMES (U.S. CLS. 2, 13, 22, 25, 32 AND 50).

CLASS 22—CORDAGE AND FIBERS

FOR ROPES AND SYNTHETIC ROPES; CORDAGE; FEATHERS AND DOWN; SYNTHETIC FIBERS; SEMI-SYNTHETIC FIBERS FOR TEXTILE USE; RAW FIBROUS TEXTILE MATERIALS; RAW COTTON; RAW SILK; RAW WOOL; TENTS FOR MOUNTAINEERING OR CAMPING; PADDING AND STUFFING MATERIALS NOT OF RUBBER, PAPER OR PLASTIC (U.S. CLS. 1, 2, 7, 19, 22, 42 AND 50).

CLASS 25—CLOTHING

FOR BELTS FOR CLOTHING; BLOUSES; COATS; JACKETS; JEANS; KNIT FACE MASKS; HANDWARMERS; LEG WARMERS; NECKERCHIEVES; OVERALLS; PANTS; BASELAYER BOTTOMS; BASELAYER TOPS; PARKAS; RAINWEAR; SHAWLS; T-SHIRTS; SHIRTS; PULLOVERS; SWEATERS; SOCKS; VESTS; UNDERWEAR; SKIWEAR; EYESHADES CLOTHING; EAR WARMERS; GLOVES; MITTENS; MUFFLERS; SCARVES; HEADWEAR; FOOTWEAR; PERSPIRATION ABSORBENT STRAP TO BE USED IN THE BILL OF A HAT; WRISTBANDS CONTAINING A COOLING SUBSTANCE TO COOL THE WEARER (U.S. CLS. 22 AND 39).
DORITT L. CARROLL, EXAMINING ATTORNEY



PRIORITY DATE OF 10-21-2008 IS CLAIMED.
OWNER OF INTERNATIONAL REGISTRATION 1004802 DATED 4-21-2009, EXPIRES 4-21-2019.

THE MARK CONSISTS OF A BEAR HOLDING A BOTTLE; THE BOTTLE HAS A LABEL ON IT WITH A GREEK SYMBOL PHI, THE SYMBOL BEING PARTIALLY HIDDEN BY THE BEAR.

CLASS 5—PHARMACEUTICALS

FOR PEDIATRIC PHARMACEUTICAL PREPARATIONS FOR HUMAN PURPOSES, NAMELY, ANTIBIOTICS, ANTI-VIRALS, ANTI-FUNGALS, ANTIDOTES FOR POISONING AND DRUG DEPENDENCE, GASTRO-INTESTINAL DRUGS, RADIOLOGICAL AGENTS, ELECTROLYTES, ANTIDIARRHOEAL AGENTS, ANTI-PSYCHOTIC AGENTS, LAXATIVES, STEROIDS, NON-STEROIDAL ANTI-INFLAMMATORY AGENTS, NEUROLOGICALS, HYPOLIPIDAEMIC AGENTS, CARDIOVASCULAR AGENTS, ANTIDEPRESSANTS, ANTI-SPASMODICS, DRUGS FOR PAIN AND NAUSEA AND VOMITING CONTROL, ANTIPIRETTICS, HYPOGLYCEMIC AND HYPERGLYCEMIC AGENTS, VITAMINS, MINERAL SUPPLEMENTS AND DIETARY SUPPLEMENTS, ANTI-CANCER AGENTS, CHROMODIAGNOSTICS, AGENTS FOR AFFECTING CALCIUM AND BONE METABOLISM, HORMONES, CYSTIC FIBROSIS TREATMENT AGENTS, AGENTS FOR GOUT AND HYPERURICAEMIA, VACCINES, EXPECTORANTS, ANTITUSSIVES, MUCOLYTICS AND DECONGESTANTS, BRONCHODILATORS, OCULAR PREPARATIONS, DERMATOLOGICAL AGENTS INCLUDING THOSE FOR PSORIASIS AND SEBORRHEA, MEDICATED SKIN CREAMS AND LOTIONS, MEDICATED FACE CLEANSERS FOR THE TREATMENT OF ACNE, LOCAL AND GENERAL ANESTHETICS, ANTISEPTICS, AND FOOD FOR ENTERAL AND PARENTERAL FEEDING (U.S. CLS. 6, 18, 44, 46, 51 AND 52).

CLASS 10—MEDICAL APPARATUS

FOR SURGICAL AND MEDICAL APPARATUS FOR ADMINISTRATION OF PEDIATRIC PHARMACEUTICALS, NAMELY, DEVICES FOR DELIVERY BY INFUSION, INHALATION, AND INJECTION (U.S. CLS. 26, 39 AND 44).

MEGHAN REINHART, EXAMINING ATTORNEY

SN 79-069,700. MR. IVAR JOSAFATSSON, ICELAND, FILED 9-10-2008.

SOCCERITA

THE MARK CONSISTS OF STANDARD CHARACTERS WITHOUT CLAIM TO ANY PARTICULAR FONT, STYLE, SIZE, OR COLOR.

OWNER OF INTERNATIONAL REGISTRATION 1004848 DATED 9-10-2008, EXPIRES 9-10-2018.

THE WORDING "SOCCERITA" HAS NO MEANING IN A FOREIGN LANGUAGE.

SN 79-069,859. DASSAULT SYSTEMES, FRANCE, FILED 1-19-2009.

CLASS 32—LIGHT BEVERAGES

FOR BEERS, MINERAL AND AERATED WATERS, NON-ALCOHOLIC BEVERAGES, NAMELY, CARBONATED BEVERAGES; FRUIT DRINKS AND FRUIT JUICES; SYRUPS AND OTHER PREPARATIONS FOR MAKING BEVERAGES (U.S. CLS. 45, 46 AND 48).

CLASS 33—WINES AND SPIRITS

FOR ALCOHOLIC BEVERAGES EXCEPT BEERS (U.S. CLS. 47 AND 49).

JACQUELINE A. LAVINE, EXAMINING ATTORNEY



SN 79-069,766. BURGBAD AG, FED REP GERMANY, FILED 6-16-2009.

burgbad

THE MARK CONSISTS OF STANDARD CHARACTERS WITHOUT CLAIM TO ANY PARTICULAR FONT, STYLE, SIZE, OR COLOR.

OWNER OF INTERNATIONAL REGISTRATION 0990509 DATED 11-26-2008, EXPIRES 11-26-2018.

CLASS 11—ENVIRONMENTAL CONTROL APPARATUS

FOR SANITARY WARE, NAMELY, WASH-HAND BASINS, AND SUPPORTS THEREFORE, BIDETS, TOILET TANKS, URINALS; BATH TUBS; SHOWER TUBS, TOILET SEATS, SHOWERS, REGULATING ACCESSORIES FOR WATER SUPPLY, NAMELY, METERED VALVES, SINK TRAPS (U.S. CLS. 13, 21, 23, 31 AND 34).

CLASS 16—PAPER GOODS AND PRINTED MATTER

FOR PRINTED MATTER, NAMELY, BOOKS, NEWSLETTERS, BROCHURES ON THE SUBJECT OF BATHROOM FURNITURE (U.S. CLS. 2, 5, 22, 23, 29, 37, 38 AND 50).

CLASS 20—FURNITURE AND ARTICLES NOT OTHERWISE CLASSIFIED

FOR FURNITURE, NAMELY, BATHROOM FURNITURE, SHELVES, MIRRORS (U.S. CLS. 2, 13, 22, 25, 32 AND 50).

CLASS 21—HOUSEWARES AND GLASS

FOR SOAP DISHES, SOAP BOXES, TOILET-BRUSH SETS COMPRISED OF TOILET BRUSHES AND TOILET BRUSH HOLDERS; TOWEL RINGS, TOWEL RACKS, TOWEL HOOKS NOT OF METAL, BATH TOWEL RACKS, ALL AFOREMENTIONED GOODS NOT MADE OF PRECIOUS METALS (U.S. CLS. 2, 13, 23, 29, 30, 33, 40 AND 50).

GINA HAYES, EXAMINING ATTORNEY

PRIORITY DATE OF 7-24-2008 IS CLAIMED.

OWNER OF INTERNATIONAL REGISTRATION 1005163 DATED 1-19-2009, EXPIRES 1-19-2019.

NO CLAIM IS MADE TO THE EXCLUSIVE RIGHT TO USE "IPLM", APART FROM THE MARK AS SHOWN.

THE COLOR(S) ORANGE, DARK BLUE AND LIGHT BLUE IS/ARE CLAIMED AS A FEATURE OF THE MARK.

THE MARK CONSISTS OF THE TERMS "IPLM" WITH THE LETTER "I" APPEARING IN ORANGE WITH AN ORANGE REFLECTION UNDERNEATH, AND THE LETTERS "PLM" ALL APPEARING IN DARK BLUE WITH LIGHT BLUE REFLECTIONS UNDERNEATH.

CLASS 9—ELECTRICAL AND SCIENTIFIC APPARATUS

FOR COMPUTER SOFTWARE FOR GRAPHIC VISUALIZATION IN TWO OR THREE DIMENSIONS, PARTICULARLY FOR COMPUTER-AIDED DESIGN, ANIMATION, SIMULATION, PUBLICATION, DOCUMENT SEARCHES, DEFEATURING AND REMOTE MONITORING AND SURVEILLANCE; MAINTENANCE SOFTWARE FOR GRAPHIC VISUALIZATION IN TWO OR THREE DIMENSIONS; SOFTWARE FOR PRESENTATION OF DATA CONCERNING INDUSTRIAL PRODUCTS, THEIR MANUFACTURE, USE, MAINTENANCE AND DOCUMENTATION; COMPUTER GAME SOFTWARE; COMPUTER SOFTWARE FOR THE STORAGE AND EXCHANGE OF DATA; EDUCATIONAL SOFTWARE FEATURING INSTRUCTION IN GRAPHIC VISUALIZATION OF PRODUCTS IN TWO OR THREE DIMENSIONS; TRAINING SOFTWARE FEATURING INSTRUCTION IN GRAPHIC VISUALIZATION OF PRODUCTS IN TWO OR THREE DIMENSIONS; TEACHING SOFTWARE FEATURING INSTRUCTION IN GRAPHIC VISUALIZATION OF PRODUCTS IN TWO OR THREE DIMENSIONS; PRERECORDED CDS, DVDS, MINIDISCS AND FLOPPY DISKS FEATURING GRAPHIC VISUALIZATIONS OF PRODUCTS IN TWO OR THREE DIMENSIONS (U.S. CLS. 21, 23, 26, 36 AND 38).

CLASS 42—SCIENTIFIC AND COMPUTER SERVICES

FOR COMPUTER PROGRAMMING SERVICES; RENTAL OF COMPUTERS, COMPUTER PROGRAMS AND PERIPHERAL EQUIPMENT FOR COMPUTERS; ENGINEERING AND TECHNICAL CONSULTING SERVICES IN CONNECTION WITH THE DESIGN OF GOODS AND MEANS OF PRODUCTION AND WITH THE OPERATION OF INDUSTRIAL PROCESSES; SOFTWARE DESIGN, UPDATING AND MAINTENANCE SERVICES; TECHNICAL ASSISTANCE SERVICES TO PERSONALIZE SOFTWARE TO ADAPT THE SAID SOFTWARE TO THE SPECIFIC REQUIREMENTS ARISING OUT OF A CUSTOMER'S AREA OF ACTIVITY AND WORKING METHODS; CONSULTING SERVICES IN THE FIELD OF COMPUTER HARDWARE AND SOFTWARE (U.S. CLS. 100 AND 101).

KATHLEEN M. VANSTON, EXAMINING ATTORNEY

SN 79-069,935. IPMA INTERNATIONAL PROJECT; MANAGEMENT ASSOCIATION, CH-8001 ZÜRICH, SWITZERLAND, FILED 2-14-2009.

IPMA 

PRIORITY DATE OF 10-26-2008 IS CLAIMED.
OWNER OF INTERNATIONAL REGISTRATION 1005389 DATED 2-14-2009, EXPIRES 2-14-2019.
OWNER OF U.S. REG. NOS. 3,561,203, 3,576,296 AND OTHERS.

THE COLOR(S) RED AND BLACK IS/ARE CLAIMED AS A FEATURE OF THE MARK.

THE MARK CONSISTS OF THE LETTERS "IPMA" APPEARING IN BLACK TO THE LEFT OF A DESIGN OF TWO GREATER-THAN SIGNS APPEARING IN RED.

CLASS 35—ADVERTISING AND BUSINESS

FOR BUSINESS ADMINISTRATION AND MANAGEMENT, NAMELY, ORGANIZING, COORDINATING, MANAGING PROJECTS, MANAGING PROGRAMS AND MANAGING PROJECT PORTFOLIOS AT ALL LEVELS OF ACCOUNTABILITY; BUSINESS MANAGEMENT ASSISTANCE, NAMELY, DEFINING AND IMPLEMENTING PROCESSES TO MANAGE COMPANIES; PROFESSIONAL BUSINESS CONSULTING, NAMELY, DEFINING AND IMPLEMENTING ADMINISTRATIVE PROCESSES FOR REACHING PLANNED BUSINESS OBJECTIVES; PROFESSIONAL BUSINESS CONSULTING, NAMELY, DEFINING AND IMPLEMENTING MANAGEMENT CONDITIONS AT ALL PROJECT LEVELS TO REACH PRE-ESTABLISHED BUSINESS OBJECTIVES (U.S. CLS. 100, 101 AND 102).

CLASS 42—SCIENTIFIC AND COMPUTER SERVICES

FOR TESTING, ANALYSIS AND EVALUATION OF THE SERVICES OF OTHERS FOR THE PURPOSE OF CERTIFICATION IN THE FIELDS OF BUSINESS MANAGEMENT, PROJECT MANAGEMENT, PROGRAM MANAGEMENT, MANAGEMENT OF PROJECT PORTFOLIOS, IT SOFTWARE DESIGN AND DEVELOPMENT, AND ADMINISTRATIVE PROCESSES FOR REACHING PLANNED BUSINESS OBJECTIVES (U.S. CLS. 100 AND 101).

ARETHA SOMERVILLE, EXAMINING ATTORNEY

SN 79-069,941. CONTINENTAL ENGINEERING SERVICES GMBH, FED REP GERMANY, FILED 2-2-2009.

CESSAR

THE MARK CONSISTS OF STANDARD CHARACTERS WITHOUT CLAIM TO ANY PARTICULAR FONT, STYLE, SIZE, OR COLOR.

OWNER OF INTERNATIONAL REGISTRATION 1005397 DATED 2-2-2009, EXPIRES 2-2-2019.

THE ENGLISH TRANSLATION OF THE PORTUGUESE WORD "CESSAR" IN THE MARK IS "CEASE" OR "END".

CLASS 9—ELECTRICAL AND SCIENTIFIC APPARATUS

FOR SOFTWARE FOR OPERATING AND CONTROLLING ELECTRONIC DEVICES FOR USE IN LAND VEHICLES; SOFTWARE FOR THE CREATION AND CONFIGURATION OF SOFTWARE (U.S. CLS. 21, 23, 26, 36 AND 38).

CLASS 41—EDUCATION AND ENTERTAINMENT

FOR EDUCATION SERVICES, NAMELY, PROVIDING CLASSES, SEMINARS, WORKSHOPS, TUTORING, AND MENTORING IN THE FIELD OF AUTOMOTIVE ELECTRONICS, TRAINING IN THE FIELD OF AUTOMOTIVE ELECTRONICS (U.S. CLS. 100, 101 AND 107).

CLASS 42—SCIENTIFIC AND COMPUTER SERVICES

FOR SCIENTIFIC RESEARCH SERVICES; TECHNOLOGICAL CONSULTATION IN THE TECHNOLOGY FIELD OF AUTOMOTIVE ELECTRONICS; DESIGN SERVICES IN THE FIELD OF AUTOMOTIVE ELECTRONICS; INDUSTRIAL ANALYSIS AND RESEARCH SERVICES IN THE FIELD OF AUTOMOTIVE ELECTRONICS; DESIGN AND DEVELOPMENT OF COMPUTER HARDWARE AND SOFTWARE; INTEGRATION, CONFIGURATION AND TEST SUPPORT OF COMPUTER SOFTWARE, CUSTOMIZATION OF COMPUTER HARDWARE AND SOFTWARE (U.S. CLS. 100 AND 101).

JERI J. FICKES, EXAMINING ATTORNEY

SN 79-070,300. JOAN DEN EXTER, BELGIUM, AND TRUDIE WIJNEN, NETHERLANDS, FILED 8-1-2008.

MUY  **MALO**

OWNER OF INTERNATIONAL REGISTRATION 0852209 DATED 4-11-2005, EXPIRES 4-11-2015.

THE MARK CONSISTS OF THE WORDS "MUY MALO" WITH A HEART WITH HORNS AT THE TOP BETWEEN THE WORDS.

THE ENGLISH TRANSLATION OF "MUY MALO" IN THE MARK IS "VERY MISCHIEVOUS".

CLASS 16—PAPER GOODS AND PRINTED MATTER

FOR PAPER, CARDBOARD, GOODS MADE OF PAPER AND CARDBOARD, NAMELY, NOTEBOOKS, SCRAP PAPER, DIARIES; PRINTED CHILDREN'S ACTIVITY SHEETS; LEAFLETS PROVIDING INFORMATION RELATED TO CHILDREN AND ACTIVITIES FOR CHILDREN; CHILDREN'S BOOKS; COLORING BOOKS; CHILDREN'S ACTIVITY BOOKS; CHILDREN'S INTERACTIVE EDUCATIONAL BOOKS; OFFICE REQUISITES, NAMELY, STAPLERS, PUNCHES, PENS, PENCILS, PEN OR PENCIL HOLDERS, RUBBER ERASERS, SCISSORS; PLASTIC BAGS FOR PACKAGING; PLASTIC BAGS FOR MERCHANDISE PACKAGING; THE AFORESAID GOODS IN CONNECTION ONLY WITH CHILDREN (U.S. CLS. 2, 5, 22, 23, 29, 37, 38 AND 50).

CLASS 18—LEATHER GOODS

FOR LEATHER AND IMITATION LEATHER, LEATHER AND IMITATION LEATHER GOODS, NAMELY, BAGS, CASES, DUFFLE BAGS, ATTACHE CASES, PURSES; SMALL LEATHER GOODS, NAMELY, WALLETS, COIN PURSES, KEY CASES, BUSINESS CARD CASES, NAME CARD CASES, CREDIT CARD CASES, CALLING CARD CASES, FANNY PACKS; ANIMAL SKINS AND HIDES; TRUNKS AND SUITCASES, UMBRELLAS, PARASOLS AND WALKING STICKS; THE AFORESAID GOODS IN CONNECTION ONLY WITH CHILDREN (U.S. CLS. 1, 2, 3, 22 AND 41).

CLASS 25—CLOTHING

FOR CLOTHING, NAMELY, SHIRTS, SWEATERS, BLOUSES, JEANS, SKIRTS, DRESSES, CAPS, PULL-OVERS, JACKETS, BLAZERS, OUTDOOR JACKETS, UNDERWEAR, SHORTS, BEACHWEAR, PANTS, PONCHO'S, WAISTCOATS, SOCKS, HATS; FOOTWEAR; HEADWEAR; THE AFORESAID GOODS IN CONNECTION ONLY WITH CHILDREN (U.S. CLS. 22 AND 39).

CLASS 35—ADVERTISING AND BUSINESS

FOR ADVERTISING SERVICES AND PROMOTIONAL SERVICES; DISSEMINATION OF ADVERTISING MATERIAL; EMPLOYMENT AGENCIES AND CONSULTING THEREFORE; COMPILATION OF STATISTICS FOR BUSINESS PURPOSES; ACCOUNTING; AUCTIONEERING; COMMERCIAL INFORMATION AGENCIES; MARKET STUDY, MARKET RESEARCH AND ANALYSIS OF MARKET STUDIES; PUBLIC OPINION POLLING; SHOP-WINDOW DISPLAY ARRANGEMENT SERVICES; ADVISORY SERVICES REGARDING BUSINESS ORGANIZATION AND MANAGEMENT OF BUSINESS; RENTAL OF OFFICE MACHINES; DOCUMENT REPRODUCTION; BUSINESS MANAGEMENT; BUSINESS ADMINISTRATION; PROVIDING OFFICE FUNCTIONS; MEDIATION OF AGREEMENTS REGARDING THE PURCHASE, SALE AND IMPORTING OF GOODS; MEDIATION OF CONTRACTS FOR PURCHASE, SALE AND IMPORTING OF PRODUCTS (U.S. CLS. 100, 101 AND 102).

CHRISIE B. KING, EXAMINING ATTORNEY

SN 79-070,360. CRISPLANT A/S, DENMARK, FILED 5-1-2009.

RAMPMATE

THE MARK CONSISTS OF STANDARD CHARACTERS WITHOUT CLAIM TO ANY PARTICULAR FONT, STYLE, SIZE, OR COLOR.

PRIORITY DATE OF 11-6-2008 IS CLAIMED.

OWNER OF INTERNATIONAL REGISTRATION 1006371 DATED 5-1-2009, EXPIRES 5-1-2019.

CLASS 7—MACHINERY

FOR MACHINES AND INSTALLATIONS FOR PHYSICAL AS WELL AS FULLY OR PARTIALLY AUTOMATED TRANSPORT, SORTING, STORAGE AND OTHER HANDLING OF BAGGAGE, NAMELY, TRANSPORTATION, SORTING, STORAGE AND HANDLING OF FLIGHT BAGGAGE, CARGO, MAIL, PACKAGES AND PRODUCTS AND MATERIALS FOR INDUSTRIAL OR COMMERCIAL USE; INSTALLATIONS AND SYSTEMS FOR DISTRIBUTION AND SORTING IN PARTICULAR FOR HANDLING OF BAGGAGE IN AIRPORTS CONSISTING OF FULLY AUTOMATIC SYSTEMS COMPRISED OF CARTS, LOADING AND UNLOADING UNITS FOR LOADING AND UNLOADING BAGGAGE, THE SYSTEMS INCLUDE INTERNAL INTERMEDIATE STORAGE AND TRANSPORTATION INSTALLATIONS AS WELL AS INTERNAL CONTROL SYSTEMS; PARTS AND ACCESSORIES, NOT INCLUDED IN OTHER CLASSES, FOR THE BEFORE-MENTIONED MACHINES, INSTALLATIONS AND SYSTEMS, NAMELY, CAROUSELS, CHUTES, BUFFER AND CONVEYOR BELTS, LADDERS, SPIRALS, CAGES, LIFTS AND SORTING SYSTEMS AS WELL AS MACHINE PARTS AND ACCESSORIES FOR CAROUSELS, CHUTES, BUFFER AND CONVEYOR BELTS, LADDERS, SPIRALS, CAGES, LIFTS AND SORTING SYSTEMS (U.S. CLS. 13, 19, 21, 23, 31, 34 AND 35).

CLASS 9—ELECTRICAL AND SCIENTIFIC APPARATUS

FOR ELECTRONIC AND ELECTRIC APPARATUS AND INSTRUMENTS FOR WEIGHING, MEASURING, SIGNALLING AND CONTROL FOR USE WITH MACHINES, INSTALLATIONS AND SYSTEMS FOR DISTRIBUTION AND HANDLING OF BAGGAGE, CARGO AND PRODUCTS, SPECIALLY FOR SORTING, TRANSPORTATION AND STORAGE OF BAGGAGE, CARGO AND PRODUCTS, NAMELY, POWER PANELS, SCALES, HEIGHT AND WIDTH MEASUREMENTS, RFID READER, PROGRAMMABLE LOGIC CONTROLLER, DIGITAL INPUT/OUTPUT MODULES, SAFETY STOP COMPONENTS AND OPERATION PANELS WITH LAMPS AND PUSH BOTTOMS; COMPUTER HARDWARE AND SOFTWARE, NAMELY, FOR ACQUISITION OF DATA AND MANAGEMENT OF COMMUNICATION WITH OTHER COMPUTERS, FOR CONTROL OF THE OPERATION AND OF THE MONITORING THE RELIABILITY OF MACHINES, INSTALLATIONS, SYSTEMS AND ROLLING STOCK FOR DISTRIBUTION AND HANDLING OF BAGGAGE, CARGO AND PRODUCTS AND FOR IDENTIFICATION OF BAGGAGE, CARGO AND PRODUCTS (U.S. CLS. 21, 23, 26, 36 AND 38).

CLASS 12—VEHICLES

FOR ROLLING STOCK USED FOR TRANSPORTATION OF BAGGAGE, CARGO AND PRODUCTS; PORTABLE CARTS, NAMELY, CARTS FOR LOADING, STORAGE AND UNLOADING OF BAGGAGE, CARGO AND PRODUCTS (U.S. CLS. 19, 21, 23, 31, 35 AND 44).

CLASS 37—CONSTRUCTION AND REPAIR

FOR INSTALLATION, MAINTENANCE AND REPAIR OF MACHINES AND INSTALLATIONS FOR DISTRIBUTION AND HANDLING OF BAGGAGE, CARGO AND PRODUCTS (U.S. CLS. 100, 103 AND 106).

CLASS 42—SCIENTIFIC AND COMPUTER SERVICES

FOR TECHNICAL CONSULTANCY SERVICES RELATING TO DISTRIBUTION AND HANDLING SYSTEMS, NAMELY, PREPARATION OF TECHNICAL REQUIREMENT ANALYSIS; TECHNOLOGICAL DEVELOPMENT AND RESEARCH IN RELATION TO DISTRIBUTION AND HANDLING SYSTEMS FOR BAGGAGE, CARGO, PRODUCTS, BOOKS, PACKAGES AND INDUSTRIAL PRODUCTS; TECHNICAL ASSISTANCE WITH SOFTWARE IMPLEMENTATION FOR SOFTWARE TO BE USED WITH DISTRIBUTION AND HANDLING SYSTEMS FOR BAGGAGE, CARGO, PRODUCTS, BOOKS, PACKAGES AND INDUSTRIAL PRODUCTS (U.S. CLS. 100 AND 101).

KATINA MISTER, EXAMINING ATTORNEY

SN 79-070,421. OSIRIS CONSEIL, FRANCE, FILED 10-28-2008.

CCTI - Cailloux-Cauvin Type Indicator

THE MARK CONSISTS OF STANDARD CHARACTERS WITHOUT CLAIM TO ANY PARTICULAR FONT, STYLE, SIZE, OR COLOR.

PRIORITY DATE OF 4-29-2008 IS CLAIMED.

OWNER OF INTERNATIONAL REGISTRATION 1006508 DATED 10-28-2008, EXPIRES 10-28-2018.

NO CLAIM IS MADE TO THE EXCLUSIVE RIGHT TO USE "TYPE INDICATOR", APART FROM THE MARK AS SHOWN.

THE WORDING "CAILLOUX-CAUVIN" HAS NO MEANING IN A FOREIGN LANGUAGE.

CLASS 35—ADVERTISING AND BUSINESS

FOR CONSULTING IN CONNECTION WITH NEGOTIATING WITH PERSONNEL; PROVIDING ASSISTANCE TO COMPANIES IN IMPLEMENTING PERSONNEL COACHING STRATEGIES IN THE FIELD OF PERSONNEL MANAGEMENT COUNSELING SERVICES IN CONFLICT MANAGEMENT, DECISION MAKING, INTERPERSONAL RELATIONS, PERSONAL DEVELOPMENT, PROBLEM RESOLUTION, TEAM COHESIVENESS; PSYCHOLOGICAL TESTING; ASSESSMENT OF THE SKILLS OF THE INDIVIDUAL; DESIGNING AND CONDUCTING PSYCHOLOGICAL TESTS FOR RECRUITMENT PURPOSES USING PERSONALITY QUESTIONNAIRES; CAREER MANAGEMENT; RECRUITMENT TESTS USING QUESTIONNAIRES DESIGNED TO DETERMINE PERSONALITY TYPES AND PROFILES (U.S. CLS. 100, 101 AND 102).

CLASS 41—EDUCATION AND ENTERTAINMENT

FOR ARRANGING AND CONDUCTING TRAINING WORKSHOPS IN THE FIELD OF OCCUPATIONAL GUIDANCE (U.S. CLS. 100, 101 AND 107).

CLASS 44—MEDICAL, BEAUTY AND AGRICULTURAL SERVICES

FOR SERVICES OF A PSYCHOLOGIST FOR PERSONNEL DEVELOPMENT AND EVALUATING THE SKILLS OF THE INDIVIDUAL; PSYCHOLOGICAL TESTING SERVICES; PREPARING, MANAGING, SCORING AND INTERPRETING PSYCHOLOGICAL TESTS (U.S. CLS. 100 AND 101).

SUZANNE BLANE, EXAMINING ATTORNEY

CLASS 7—MACHINERY

FOR MACHINES, NAMELY, DRILLING MACHINES, GRINDING MACHINES, THERMIC LANCES, LATHES, MILLING MACHINES, SMOOTHING ROTARY PRESSES, CALENDERS, MACHINES FOR PLASTICS PROCESSING, NAMELY, INJECTION MOLDING MACHINES, PRESSURE CASTING MACHINES, SWAGING MACHINES, BLOW MOLDING MACHINES, MACHINES FOR METALWORKING, NAMELY, NUMERICALLY CONTROLLED LATHES, DRILLING MACHINES, MILLING MACHINES, PLANING MACHINES, SHAPING MACHINES, LASER CUTTING MACHINES, WATERJET CUTTING MACHINES, MACHINES FOR THE TEXTILE INDUSTRY, NAMELY, WEAVING MACHINES, SEWING MACHINES, KNITTING MACHINES, CROCHET MACHINES, SEALING MACHINES, PRESSES, NAMELY, HYDRAULIC PRESSES FOR INDUSTRIAL USE, CRANK PRESSES FOR INDUSTRIAL USE, HYDROPNEUMATIC PRESSES FOR INDUSTRIAL USE, INDUSTRIAL ROBOTS, SAWS, NAMELY, CIRCULAR SAWS, BACK SAWS, BAND SAWS, CUTTERS, NAMELY, ELECTRIC WELDING MACHINES AND GAS WELDING MACHINES, SPINNING FRAMES, KNITTING MACHINES, DEEP-DRAWING PRESSES, ROLLING MILLS, WEAVING LOOMS, CENTRIFUGAL GRINDING MACHINES, SHREDDERS FOR INDUSTRIAL USE; MACHINE PARTS, NAMELY, ELECTRICAL COMPONENTS IN THE NATURE OF PRESSURE SWITCHES AND SENSORS FOR MONITORING, CONTROLLING, AND SWITCHING HYDRAULIC OR PNEUMATIC SYSTEMS BEING SOLD AS A UNIT WITH MANUFACTURING MACHINES, ELECTROMECHANICAL COMPONENTS IN THE NATURE OF ELECTRIC MOTORS FOR MACHINES AND ELECTRIC MOTORS FOR POWER TOOLS, MECHANICAL COMPONENTS IN THE NATURE OF AXLES FOR MACHINES, HYDRAULIC COMPONENTS IN THE NATURE OF HYDRAULIC PUMPS AND LUBRICATING PUMPS, AND ELECTRONIC COMPONENTS IN THE NATURE OF PRINTED CIRCUIT BOARDS SOLD AS PART OF DRILLING MACHINES, GRINDING MACHINES, THERMIC LANCES, LATHES, MILLING MACHINES, SMOOTHING PRESSES, CALENDERS, MACHINES FOR PLASTICS PROCESSING, MACHINES FOR METALWORKING, MACHINES FOR THE TEXTILE INDUSTRY, PRESSES, ROBOTS, SAWS, CUTTERS, WELDING MACHINES, SPINNING FRAMES, KNITTING MACHINES, DEEP-DRAWING PRESSES, ROLLING MILLS, WEAVING LOOMS, CENTRIFUGAL MACHINES, AND SHREDDERS FOR INDUSTRIAL USE (U.S. CLS. 13, 19, 21, 23, 31, 34 AND 35).

CLASS 37—CONSTRUCTION AND REPAIR

FOR INSTALLATION, MAINTENANCE, AND REPAIR OF MACHINES FOR METAL WORKING, MACHINERY FOR TEXTILE PROCESSING, MACHINERY FOR PLASTICS PROCESSING, MACHINERY FOR STONE WORKING AND MACHINE PARTS; INSTALLATION, REPAIR, AND MAINTENANCE OF DATA-PROCESSING SYSTEMS IN THE NATURE OF HARDWARE, IN PARTICULAR OF DATA-PROCESSING SYSTEMS FOR MACHINES (U.S. CLS. 100, 103 AND 106).

CLASS 42—SCIENTIFIC AND COMPUTER SERVICES

FOR SERVICES OF ENGINEERS; INSTALLATION AND MAINTENANCE OF SOFTWARE, IN PARTICULAR SOFTWARE FOR MACHINES (U.S. CLS. 100 AND 101).

MARILYN IZZI, EXAMINING ATTORNEY

SN 79-070,443. MÜLLER WEINGARTEN AG, 88250 WEINGARTEN, FED REP GERMANY, FILED 4-14-2009.

BCN Technical Services

THE MARK CONSISTS OF STANDARD CHARACTERS WITHOUT CLAIM TO ANY PARTICULAR FONT, STYLE, SIZE, OR COLOR.

PRIORITY DATE OF 11-4-2008 IS CLAIMED.

OWNER OF INTERNATIONAL REGISTRATION 1006574 DATED 4-14-2009, EXPIRES 4-14-2019.

NO CLAIM IS MADE TO THE EXCLUSIVE RIGHT TO USE "TECHNICAL SERVICES", APART FROM THE MARK AS SHOWN.

SN 79-070,456. COMPAGNIE INDUSTRIELLE ET FINANCIERE D'INGENIERIE-INGENICO, FRANCE, FILED 9-12-2008.

INGENICO BEYOND PAYMENT

PRIORITY DATE OF 4-10-2008 IS CLAIMED.

OWNER OF INTERNATIONAL REGISTRATION 1006594 DATED 9-12-2008, EXPIRES 9-12-2018.

OWNER OF U.S. REG. NOS. 3,480,766 AND 3,508,764.
NO CLAIM IS MADE TO THE EXCLUSIVE RIGHT TO
USE "PAYMENT", APART FROM THE MARK AS SHOWN.

CLASS 9—ELECTRICAL AND SCIENTIFIC APPARATUS

FOR APPARATUS FOR RECORDING, TRANSMITTING AND REPRODUCING SOUND, IMAGES AND SIGNALS; BLANK MAGNETIC VIDEO AND LASER CASSETTES; BLANK RECORDING DISCS; BLANK VIDEOTAPES; BLANK COMPUTER DISKETTES; BLANK VIDEO DISCS; BLANK MAGNETIC DISCS; BLANK OPTICAL DISCS; BLANK COMPACT OPTICAL DISCS; INTERACTIVE COMPACT DISCS FEATURING INFORMATION ABOUT CONDUCTING PAYMENT TRANSACTIONS AND ABOUT PAYMENT SOLUTIONS; SOUND AND IMAGE TRANSMITTING APPARATUS; COMPUTER SERVERS; TELECOMMUNICATION APPARATUS, NAMELY, DIGITAL CELLULAR PHONES; MICROCOMPUTERS, PRINTED CIRCUITS, CENTRAL PROCESSING UNITS, COMPUTER PERIPHERAL DEVICES; COMPUTER GAME SOFTWARE; BLANK CD-ROMS; COMPUTER SOFTWARE FOR DATA BASE MANAGEMENT; INTERACTIVE VIDEO GAME SOFTWARE; CALCULATING MACHINES; DESKTOP COMPUTERS AND LAPTOP COMPUTERS; ELECTRONIC AGENDAS; SATELLITE DISHES FOR SATELLITE TRANSMISSION; BLANK ELECTRONIC CARDS, BLANK MAGNETIC CARDS, BLANK MAGNETIC IDENTITY CARDS, MACHINE-READABLE MAGNETIC ENCODED CARDS OR CARDS WHICH CAN BE ENCODED FOR AUTHORIZATION AND AUTHENTICATION OF NETWORK USERS AND DATA; ENCODED SMART CARDS FOR OBTAINING AND STORING INFORMATION, FOR SECURE PROCESSING AND TRANSFERRING OVER NETWORKS, FOR AUTHORIZATION AND AUTHENTICATION OF NETWORK USERS, AND DATA AND FOR PAYMENT OR PREPAYMENT CARDS; MAGNETICALLY ENCODED CARDS, NAMELY, MAGNETIC CARDS, MAGNETIC CREDIT CARDS, MAGNETIC DEBIT CARDS; ELECTRONIC PURSES, NAMELY, BLANK SMART CARDS; MAGNETIC RECHARGEABLE CARDS; MEMORY CARDS OR CHIP CARDS IN THE NATURE OF BLANK SMART CARDS; RANDOM ACCESS MEMORY CARDS; MAGNETIC PENS, MAGNETO-OPTICAL PENS; ELECTRONIC PENS; SECURE TERMINALS FOR ELECTRONIC TRANSACTIONS AND RECORDED SOFTWARE FOR PAYMENT AND FUNDS TRANSFER SYSTEM, INCLUDING THOSE USING MEMORY AND MICROPROCESSOR CARDS; TERMINALS ACCEPTING MICROCHIP CARDS FOR READING OR WRITING WHICH CAN BE CONNECTED TO A LOCAL OR REMOTE COMPUTER OR TO ANOTHER MACHINE ACCESSING A NETWORK WITH APPLICATIONS USED FOR ELECTRONIC TRANSACTIONS ON OPEN NETWORKS AND FOR PAYMENT TRANSACTIONS; SECURE ELECTRONIC COMPUTER TERMINALS FOR FINANCIAL AND PAYMENT TRANSACTIONS; ELECTRONIC PAYMENT TERMINALS FOR PAYMENT BY MAGNETICALLY ENCODED CARDS, NAMELY, CREDIT, DEBIT AND STORE CARDS AT SHOP SALES COUNTERS (U.S. CLS. 21, 23, 26, 36 AND 38).

CLASS 36—INSURANCE AND FINANCIAL

FOR PAYMENT AND FUND TRANSFER SERVICES BY MEANS OF ELECTRONIC CREDIT AND DEBIT CARDS AND ELECTRONIC PAY TERMINALS; ELECTRONIC FUNDS TRANSFER; ISSUANCE OF CREDIT CARDS AND DEBITS CARDS; SERVICES OF FUND INVESTMENT, FINANCIAL AND SECURITIES TRANSACTIONS AND PLACING ORDERS ON FINANCIAL MARKETS BY ANY MEDIUM AND IN PARTICULAR BY MEANS OF ELECTRONIC DEBIT OR CREDIT CARDS, NAMELY, THOSE USING A PAY TERMINAL (U.S. CLS. 100, 101 AND 102).

CLASS 38—COMMUNICATION

FOR TELECOMMUNICATIONS ACCESS SERVICES; NEWS AND PRESS AGENCIES, NAMELY, THE TRANSMISSION OF NEWS ITEMS TO NEWS REPORTING ORGANIZATIONS; COMMUNICATIONS VIA COMPUTER TERMINALS AND VIA PAYMENT TERMINALS, IN THE NATURE OF ELECTRONIC AND COMPUTER SYSTEMS PROVIDING AND SECURING FINANCIAL TRANSACTIONS AND PAYMENT OF GOODS OR SERVICES; COMMUNICATION VIA RADIO, TELEGRAPH, COMPUTERS AND TELEPHONES TRANSMISSIONS AND VIA ALL MEANS OF REMOTE DATA PROCESSING; COMMUNICATIONS VIA FIBER-OPTIC NETWORKS; TELECOMMUNICATIONS SERVICES, NAMELY, MAILING AND TRANSMISSION OF DISPATCHES; TRANSMISSION AND DISTRIBUTION OF MULTIMEDIA PROGRAMS, NAMELY, COMPUTER EDITING OF TEXTS OR FIXED OR ANIMATED IMAGES AND MUSICAL OR OTHER SOUNDS OR NOT, FOR INTERACTIVE OR OTHER USE; ELECTRONIC MAIL SERVICES; COMPUTER TRANSMISSION OF INFORMATION AND DATA; FACSIMILE TRANSMISSION; COMMUNICATION VIA CABLE, SATELLITE AND TELEVISION TRANSMISSION; COMPUTER-ASSISTED TRANSMISSION OF MESSAGES AND IMAGES ESPECIALLY ON A NETWORK FORMED FROM INDIVIDUAL COMPUTERS, SERVER CENTERS AND ON THE INTERNET; RENTAL OF TELECOMMUNICATION APPARATUS; RENTAL OF COMPUTER AND ELECTRONIC DATA TRANSMISSION APPARATUS FOR TRANSMISSION OF TEXT, SOUND AND/OR IMAGES; PROVIDING CONNECTION BY TELECOMMUNICATIONS TO A GLOBAL COMPUTER NETWORK; TELECOMMUNICATIONS SERVICES, NAMELY, COMMUNICATION AND FINANCIAL AND PAYMENT TRANSMISSION SERVICES REGARDLESS OF THE MEDIUM; COMMUNICATIONS BY COMPUTER TERMINALS; LEASING ACCESS TIME TO A DATABASE SERVER CENTER, NAMELY, PROVIDING ACCESS TO DATABASES (U.S. CLS. 100, 101 AND 104).

CLASS 42—SCIENTIFIC AND COMPUTER SERVICES

FOR SCIENTIFIC AND TECHNOLOGICAL ENGINEERING SERVICES; SCIENTIFIC AND TECHNOLOGICAL ENGINEERING RESEARCH AND DESIGN; COMPUTER SYSTEMS ANALYSIS SERVICES, NAMELY, RESEARCH AND DEVELOPMENT OF NEW PRODUCTS IN THE NATURE OF COMPUTER SYSTEMS ANALYSIS TOOLS; ENGINEERING SERVICES, NAMELY, SCIENTIFIC ANALYSIS AND RESEARCH; INDUSTRIAL RESEARCH SERVICES, NAMELY, RESEARCH AND DEVELOPMENT OF NEW PRODUCTS; GEOLOGICAL RESEARCH; DESIGN AND DEVELOPMENT OF COMPUTERS AND SOFTWARE; COMPUTER PROGRAMMING; DESIGN, DEVELOPMENT, UPDATING AND MAINTENANCE OF SOFTWARE FOR COMPUTERS AND COMPUTER SYSTEMS; COMPUTER SUPPORT AND ADVICE, NAMELY, TROUBLESHOOTING IN THE NATURE OF DIAGNOSING COMPUTER HARDWARE AND SOFTWARE PROBLEMS; COMPUTER PROJECT MANAGEMENT SERVICES; QUALITY SURVEY AND QUALITY CONTROL FOR OTHERS; HOSTING COMPUTER SITES ONLINE, HOSTING DATA SERVER SITES (U.S. CLS. 100 AND 101).

CLASS 45—PERSONAL AND LEGAL SERVICES

FOR LEGAL SERVICES; COPYRIGHT MANAGEMENT; LICENSING OF INTELLECTUAL PROPERTY (U.S. CLS. 100 AND 101).

SUZANNE BLANE, EXAMINING ATTORNEY

SN 79-070,473. RAHAPAJA OY, FI-01740 VANTAA, FINLAND, FILED 6-15-2009.

SN 79-070,528. STEFANEL S.P.A., ITALY, FILED 1-29-2009.



MINT of FINLAND LTD

PRIORITY DATE OF 12-15-2008 IS CLAIMED.
OWNER OF INTERNATIONAL REGISTRATION 1006640 DATED 6-15-2009, EXPIRES 6-15-2019.

NO CLAIM IS MADE TO THE EXCLUSIVE RIGHT TO USE "MINT OF FINLAND LTD", APART FROM THE MARK AS SHOWN.

THE MARK CONSISTS OF THE WORDING "MINT OF FINLAND LTD" UNDERNEATH A DESIGN OF AN ARROW-SHAPED SYMBOL WITH HORIZONTAL LINES OVER FOUR FLAT CIRCLES REPRESENTING COINS.

CLASS 14—JEWELRY

FOR COINS, NAMELY, COLLECTIBLE COINS, PRECIOUS METALS AND THEIR ALLOYS, JEWELLERY AND PRECIOUS STONES IN PRECIOUS METALS OR COATED THEREWITH; HOROLOGICAL AND CHRONOMETRIC INSTRUMENTS (U.S. CLS. 2, 27, 28 AND 50).

CLASS 16—PAPER GOODS AND PRINTED MATTER

FOR PRINTED MATTER, NAMELY, BROCHURES IN THE FIELD OF COLLECTIBLE COINS; PAPER, CARDBOARD AND GOODS MADE FROM THESE MATERIALS, NAMELY, CARDBOARD TUBES AND BOXES FOR COLLECTIBLE COINS; PHOTOGRAPHS; PRINTERS' TYPE; PRINTING BLOCKS (U.S. CLS. 2, 5, 22, 23, 29, 37, 38 AND 50).

CLASS 35—ADVERTISING AND BUSINESS

FOR ADVERTISING; DRAFTING, PREPARATION AND DISTRIBUTION OF ADVERTISING MATERIALS; PUBLICATION OF ADVERTISING MATERIALS, NAMELY, ADVERTISING TEXTS; MARKETING, NAMELY, BUSINESS MARKETING OF COINS, PRECIOUS METALS, MEDALS, PRECIOUS STONES, HOROLOGICAL AND CHRONOMETRIC INSTRUMENTS, PRINTED MATTER AND PHOTOGRAPHS; RETAIL STORES, ON-LINE RETAIL STORES, AND DISTRIBUTORSHIPS IN THE FIELD OF COINS, PRECIOUS METALS, MEDALS, PRECIOUS STONES, HOROLOGICAL AND CHRONOMETRIC INSTRUMENTS, PRINTED MATTER AND PHOTOGRAPHS (U.S. CLS. 100, 101 AND 102).

CLASS 36—INSURANCE AND FINANCIAL

FOR TRADING IN COINS, NAMELY, COIN APPRAISAL; NUMISMATIC VALUATIONS, NAMELY, NUMISMATIC APPRAISAL (U.S. CLS. 100, 101 AND 102).
JAMES STEIN, EXAMINING ATTORNEY



STEFANEL

PRIORITY DATE OF 10-27-2008 IS CLAIMED.
OWNER OF INTERNATIONAL REGISTRATION 1006757 DATED 1-29-2009, EXPIRES 1-29-2019.
OWNER OF U.S. REG. NOS. 1,279,935, 1,559,483 AND OTHERS.

THE MARK CONSISTS OF THE STYLIZED LETTER "S" REPRESENTED BY A SERIES OF UNDULATING BANDS OF DIFFERENT SIZE UNDER WHICH THERE IS THE WORDING "STEFANEL", OF A SMALLER SIZE.

"STEFANEL" HAS NO MEANING IN ANY FOREIGN LANGUAGE.

CLASS 18—LEATHER GOODS

FOR KNAPSACKS, RUCKSACKS, RUCKSACKS FOR LEISURE, BRIEFCASES, SCHOOL BAGS, PURSES, WALLETS, HANDBAGS, LUGGAGE, SHOULDER BAGS, BEACH BAGS, CLUTCH BAGS, ALL PURPOSE SPORTS BAGS, ATTACHE CASES, TOTE BAGS, TRAVELING BAGS, CARD CASES, BEING NOTE CASES, NAMELY, NAME CARD CASES, BUSINESS CARD CASES, CASES, OF LEATHER OR LEATHERBOARD, COSMETIC CASES SOLD EMPTY, KEY CASES MADE OF LEATHER OR LEATHERBOARD, TRAVELING TRUNKS; TRAVELING SETS IN THE NATURE OF A COMBINATION OF SUITCASES, UNFITTED VANITY CASES, TRAVELING BAGS, WHEELED SUITCASES AND WHEELED TRAVELING BAGS; SUITCASES; UMBRELLAS, PARASOLS, WALKING STICKS (U.S. CLS. 1, 2, 3, 22 AND 41).

CLASS 25—CLOTHING

FOR BRASSIERES; CORSETS, BEING CLOTHING; SINGLET, PETTICOATS, NIGHTGOWNS, PAJAMAS, DRESSING GOWNS, PULLOVERS, BATH ROBES, BATHING SUITS, BATHING CAPS; GLOVES AND MUFFS, BEING CLOTHING; CARDIGANS; JERSEYS, BEING CLOTHING; NECKTIES, NECKERCHIEFS, SCARVES, SWEATERS, SOCKS, STOCKINGS, SWEAT-ABSORBENT STOCKINGS, TIGHTS, TROUSERS, LEGGINGS, SKIRTS, JACKETS, JERKINS, SHIRTS, POLO SHIRTS, VESTS, WAISTCOATS, JUMPERS, TRACK SUITS, BLOUSES, JEANS, PANTIES, UNDERPANTS, PANTS, BERMUDA SHORTS, SHORTS, T-SHIRTS, SWEAT-SHIRTS, SUITS AND DRESSES, OVERCOATS, ANORAKS, COATS, RAINCOATS, KIMONOS, OVERALLS, SHAWLS, WIND-CHEATERS, MITTENS; FOULARDS, BEING CLOTHING; GARTERS; PANTYHOSE; HOSIERY; DANCE COSTUMES, MASQUERADE COSTUMES, SASHES FOR WEAR; BELTS, BEING CLOTHING; WAISTBANDS, BRACES, SUSPENDERS, SUSPENDER BELTS; LOUNGEWEAR, UNDERWEAR, BEACHWEAR, SLEEPWEAR, HEADWEAR, FOOTWEAR; NON-SLIPPING DEVICES FOR BOOTS AND SHOES, NAMELY, CLEATS FOR ATTACHMENT TO SPORTS SHOES, HEELPIECES FOR BOOTS AND SHOES, WELTS FOR BOOTS AND SHOES BEING STRUCTURAL PARTS OF BOOTS AND SHOES, HEELS, TIPS FOR FOOTWEAR, SOLES FOR FOOTWEAR, FOOTWEAR UPPERS, NAMELY, UPPERS FOR JAPANESE STYLE SANDALS, UPPERS OF WOVEN RATTAN FOR JAPANESE STYLE SANDALS, INNER SOLES (U.S. CLS. 22 AND 39).

CLASS 35—ADVERTISING AND BUSINESS

FOR FRANCHISING, NAMELY, SERVICES RENDERED BY A FRANCHISOR, NAMELY, TRANSFER OF BUSINESS AND ORGANIZATIONAL KNOW-HOW AND ASSISTANCE IN THE DEVELOPMENT AND MANAGEMENT OF A COMMERCIAL ENTERPRISE IN THE FIELD OF RETAIL STORES FEATURING KNAPSACKS, RUCKSACKS, RUCKSACKS FOR LEISURE, BRIEFCASES, SCHOOL BAGS, PURSES, WALLETS, HANDBAGS, LUGGAGE, SHOULDER BAGS, BEACH BAGS, CLUTCH BAGS, ALL PURPOSE SPORTS BAGS, ATTACHE CASES, TOTE BAGS, TRAVELING BAGS, CARD CASES, BEING NOTE CASES, CASES, OF LEATHER OR LEATHERBOARD, COSMETIC CASES SOLD EMPTY, KEY CASES MADE OF LEATHER OR LEATHERBOARD, TRAVELING TRUNKS, SUITCASES, TRAVELING SETS IN THE NATURE OF A COMBINATION OF SUITCASES, VANITY CASES, TRAVELING BAGS, WHEELED SUITCASES AND WHEELED TRAVELING BAGS AND ALL OTHER GOODS MADE OF LEATHER AND LEATHER IMITATIONS, UMBRELLAS, PARASOLS, WALKING STICKS, CLOTHING ARTICLES IN GENERAL, LOUNGEWEAR, UNDERWEAR, BEACHWEAR, SLEEPWEAR, HEADWEAR, FOOTWEAR AND THEIR PARTS; ON-LINE AND NON ON-LINE WHOLESALE AND RETAIL STORE SERVICES FEATURING KNAPSACKS, RUCKSACKS, RUCKSACKS FOR LEISURE, BRIEFCASES, SCHOOL BAGS, PURSES, WALLETS, HANDBAGS, LUGGAGE, SHOULDER BAGS, BEACH BAGS, CLUTCH BAGS, ALL PURPOSE SPORTS BAGS, ATTACHE CASES, TOTE BAGS, TRAVELING BAGS, CARD CASES, BEING NOTE CASES, CASES, OF LEATHER OR LEATHERBOARD, COSMETIC CASES SOLD EMPTY, KEY CASES MADE OF LEATHER OR LEATHERBOARD, TRAVELING TRUNKS, SUITCASES, TRAVELING SETS IN THE NATURE OF A COMBINATION OF SUITCASES, VANITY CASES, TRAVELING BAGS, WHEELED SUITCASES AND WHEELED TRAVELING BAGS AND ALL OTHER GOODS MADE OF LEATHER AND LEATHER IMITATION, UMBRELLAS, PARASOLS, WALKING STICKS, CLOTHING ARTICLES IN GENERAL, LOUNGEWEAR, UNDERWEAR, BEACHWEAR, SLEEPWEAR, HEADWEAR, FOOTWEAR AND THEIR PARTS; THE BRINGING TOGETHER, FOR THE BENEFIT OF OTHERS, OF A VARIETY OF GOODS, EXCLUDING THE TRANSPORT THEREOF, ENABLING CUSTOMERS TO CONVENIENTLY VIEW AND PURCHASE THOSE GOODS IN THE FIELD OF KNAPSACKS, RUCKSACKS, RUCKSACKS FOR LEISURE, BRIEFCASES, SCHOOL BAGS, PURSES, WALLETS, HANDBAGS, LUGGAGE, SHOULDER BAGS, CLUTCH BAGS, ALL PURPOSE SPORTS BAGS, ATTACHE CASES, TOTE BAGS, TRAVELING BAGS, CARD CASES, BEING NOTE CASES, CASES, OF LEATHER OR LEATHERBOARD, COSMETIC CASES SOLD EMPTY, KEY CASES MADE OF LEATHER OR LEATHERBOARD, TRAVELING TRUNKS, SUITCASES, TRAVELING SETS IN THE NATURE OF A COMBINATION OF SUITCASES, VANITY CASES, TRAVELING BAGS, WHEELED SUITCASES AND WHEELED TRAVELING BAGS AND ALL OTHER GOODS MADE OF LEATHER AND LEATHER IMITATION, UMBRELLAS, PARASOLS, WALKING STICKS, CLOTHING ARTICLES IN GENERAL, LOUNGEWEAR, UNDERWEAR, BEACHWEAR, SLEEPWEAR, HEADWEAR, FOOTWEAR AND THEIR PARTS; ADVERTISING AND PROMOTIONAL SERVICES; ADVERTISING CONSULTATION; PUBLICATION OF PUBLICITY TEXTS; DISSEMINATION OF ADVERTISING MATTER; DEMONSTRATION OF PRODUCTS; SHOP WINDOW DISPLAY ARRANGEMENT SERVICES; ON-LINE ADVERTISING ON COMPUTER COMMUNICATION NETWORKS; DISTRIBUTION OF SAMPLES FOR PUBLICITY PURPOSES; PUBLIC RELATIONS; COMMERCIAL AND INDUSTRIAL MANAGEMENT ASSISTANCE; BUSINESS APPRAISALS; MARKETING RESEARCH, NAMELY, CONSUMER MARKETING RESEARCH AND CONDUCTING CONSUMER TRACKING BEHAVIOR RESEARCH AND CONSUMER TREND ANALYSIS; PLANNING AND CONDUCTING OF TRADE FAIRS, EXHIBITIONS AND PRESENTATIONS FOR ECONOMIC OR ADVERTISING PURPOSES; PROVIDING STATISTICAL INFORMATION FOR BUSINESS OR COMMERCIAL PURPOSES; IMPORT-EXPORT AGENCIES; AUCTIONEERING; SALES PROMOTION FOR OTHERS; PREPARING ADVERTISEMENTS FOR OTHERS; PROMOTING THE GOODS AND SERVICES OF OTHERS THROUGH SAMPLE DISTRIBUTION AND THE DISTRIBUTION OF RADIO AND

TELEVISION COMMERCIALS; DATA PROCESSING SERVICES; BUSINESS MANAGEMENT SERVICES; COMPUTERIZED DATABASE MANAGEMENT (U.S. CLS. 100, 101 AND 102).

MYRIAH HABEEB, EXAMINING ATTORNEY

SN 79-070,579. MERIC VITRIN MANKENLERI IMALAT; SANAYI VE TICARET LIMITED SIRKETI, TURKEY, FILED 5-15-2009.



THE MARK CONSISTS OF STANDARD CHARACTERS WITHOUT CLAIM TO ANY PARTICULAR FONT, STYLE, SIZE, OR COLOR.

OWNER OF INTERNATIONAL REGISTRATION 1006882 DATED 5-15-2009, EXPIRES 5-15-2019.

CLASS 20—FURNITURE AND ARTICLES NOT OTHERWISE CLASSIFIED

FOR BUSTS OF MANNEQUINS; MANNEQUINS (U.S. CLS. 2, 13, 22, 25, 32 AND 50).

CLASS 35—ADVERTISING AND BUSINESS

FOR BRINGING TOGETHER A WIDE VARIETY OF GOODS ENABLING CUSTOMERS TO VIEW AND PURCHASE THOSE GOODS IN THE FIELD OF MANNEQUINS (U.S. CLS. 100, 101 AND 102).

DEBRA LEE, EXAMINING ATTORNEY

SN 79-070,584. LIFE EDUCATION AUSTRALIA, SYDNEY, AUSTRALIA, FILED 6-16-2009.



THE MARK CONSISTS OF STANDARD CHARACTERS WITHOUT CLAIM TO ANY PARTICULAR FONT, STYLE, SIZE, OR COLOR.

OWNER OF INTERNATIONAL REGISTRATION 1006894 DATED 6-16-2009, EXPIRES 6-16-2019.

THE WORDING "OCISOBER" HAS NO MEANING IN A FOREIGN LANGUAGE.

CLASS 36—INSURANCE AND FINANCIAL

FOR CHARITABLE FUNDRAISING SERVICES; CHARITABLE FUNDRAISING SERVICES PROVIDED ONLINE VIA THE INTERNET (U.S. CLS. 100, 101 AND 102).

CLASS 41—EDUCATION AND ENTERTAINMENT

FOR EDUCATIONAL SERVICES IN THE NATURE OF SEMINARS, WORKSHOPS AND TRAINING TO PROMOTE HEALTH AWARENESS, PREVENT HEALTH PROBLEMS AND TO PROMOTE AWARENESS OF DRUG AND ALCOHOL-RELATED HEALTH ISSUES; INFORMATION ON EDUCATION (U.S. CLS. 100, 101 AND 107).

LAURA KOVALSKY, EXAMINING ATTORNEY

SN 79-070,590. CUBIS LIMITED, NICOSIA, CYPRUS, FILED 6-18-2009.

CUBIS

THE MARK CONSISTS OF STANDARD CHARACTERS WITHOUT CLAIM TO ANY PARTICULAR FONT, STYLE, SIZE, OR COLOR.

OWNER OF INTERNATIONAL REGISTRATION 1006912 DATED 6-18-2009, EXPIRES 6-18-2019.

OWNER OF U.S. REG. NO. 3,307,496. THE WORDING "CUBIS" HAS NO MEANING IN A FOREIGN LANGUAGE.

CLASS 16—PAPER GOODS AND PRINTED MATTER

FOR CREAM CONTAINERS OF PAPER; CONTAINERS OF PAPER FOR FOOD BUT NOT FOR HOUSEHOLD PURPOSES (U.S. CLS. 2, 5, 22, 23, 29, 37, 38 AND 50).

CLASS 21—HOUSEWARES AND GLASS

FOR BOTTLES, SOLD EMPTY; DRINKING VESSELS (U.S. CLS. 2, 13, 23, 29, 30, 33, 40 AND 50).
RUDY R. SINGLETON, EXAMINING ATTORNEY

SN 79-070,797. DSM IP ASSETS B.V., NETHERLANDS, FILED 2-17-2009.

TILAMAR

THE MARK CONSISTS OF STANDARD CHARACTERS WITHOUT CLAIM TO ANY PARTICULAR FONT, STYLE, SIZE, OR COLOR.

PRIORITY DATE OF 8-20-2008 IS CLAIMED. OWNER OF INTERNATIONAL REGISTRATION 1007386 DATED 2-17-2009, EXPIRES 2-17-2019.

THE WORDING "TILAMAR" HAS NO MEANING IN A FOREIGN LANGUAGE.

CLASS 1—CHEMICALS

FOR CHEMICAL PRODUCTS USED IN INDUSTRY AND SCIENCE (U.S. CLS. 1, 5, 6, 10, 26 AND 46).

CLASS 3—COSMETICS AND CLEANING PREPARATIONS

FOR COSMETICS, HAIR LOTIONS (U.S. CLS. 1, 4, 6, 50, 51 AND 52).

CLASS 5—PHARMACEUTICALS

FOR PHARMACEUTICAL PREPARATIONS, NAMELY, FOR THE SCALP AND HAIR, PREPARATIONS FOR CLEANING, CARE, PROTECTION AND TREATMENT OF THE SCALP AND HAIR, AND PREPARATIONS FOR HAIR STRENGTHENING AND PREPARATIONS FOR TREATMENT AGAINST DANDRUFF, HAIR LOSS AND PROTECTION FROM DAMAGE BY THE SUN (U.S. CLS. 6, 18, 44, 46, 51 AND 52).
RONALD DELGIZZI, EXAMINING ATTORNEY

SN 79-070,798. BAUMER HOLDING AG, SWITZERLAND, FILED 3-19-2009.

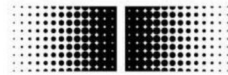

Baumer

PRIORITY DATE OF 10-1-2008 IS CLAIMED. OWNER OF INTERNATIONAL REGISTRATION 1007390 DATED 3-19-2009, EXPIRES 3-19-2019.

THE MARK CONSISTS OF TWO FACING RECTANGLES CONTAINING A FADING DOTTED DESIGN EMANATING FROM THE CENTER OUT WITH THE WORD "BAUMER" APPEARING TO THE RIGHT OF THE DESIGN.

CLASS 9—ELECTRICAL AND SCIENTIFIC APPARATUS

FOR SCIENTIFIC, SURVEYING, PHOTOGRAPHIC, CINEMATOGRAPHIC, OPTICAL, WEIGHING, MEASURING, SIGNALLING, CHECKING, LIFE-SAVING AND TEACHING APPARATUS AND INSTRUMENTS, NAMELY, ANALOG AND DIGITAL SENSORS AND SENSORY SYSTEMS, NAMELY, INDUCTIVE SENSORS, PHOTOELECTRIC SENSORS, ULTRASONIC SENSORS, CAPACITIVE SENSORS, MAGNETIC SENSORS, CYLINDER SENSORS, PRECISION SWITCHES, VISION SENSORS, ABSOLUTE ENCODERS, INCREMENTAL ENCODERS, ENCODERS WITHOUT BEARING, TACHOGENERATORS, RESOLVERS, SPEED SWITCHES, FORMAT ALIGNMENT, ACCELERATION SENSORS, INCLINATION SENSORS, COUNTERS, TACHOMETERS, PRESSURE SENSORS, FORCE AND STRAIN SENSORS, TEMPERATURE SENSORS, LEVEL MEASUREMENT SENSORS, PROCESS ANALYSIS SENSORS, SYSTEM COMPONENTS, INDUSTRIAL CAMERAS, NETWORK COMPONENTS, CAMERA ACCESSORIES, OEM CUSTOM DESIGN, COLD GLUE GUNS, COLD GLUE PUMPS, HOT MELT MELTING UNITS, HOT MELT GUNS, ADHESIVE APPLICATION CONTROLLERS, QUALITY ASSURANCE SYSTEM AND SENSORS, AS WELL AS A COMBINATION OF ALL THEM; MEASURING APPARATUS AND INSTRUMENTS USING THE WEAK-CURRENT ENGINEERING TECHNIQUE, NAMELY THE COMMUNICATIONS, HIGH-FREQUENCY AND REGULATION TECHNIQUES IN THE NATURE OF ANALOGUE AND DIGITAL CONTROL UNITS FOR AND INCLUDED IN SENSORS AND MACHINES; ELECTRIC APPARATUS AND INSTRUMENTS FOR SENSOR TECHNOLOGY, MEASUREMENT TECHNIQUES AND AUTOMATION TECHNOLOGY NAMELY, PRESSURE MEASURING, TEMPERATURE MEASURING, LEVEL MEASUREMENT, PROCESS ANALYSIS, MEASUREMENT, TEST AND CALIBRATION MEASURING, FLOW MEASUREMENT, TRANSVERSE MEASURING, STRAIN MEASURING DEVICES, ANGULAR AND LINEAR DISPLACEMENT MEASURING, ELECTRICAL POSITIONING DRIVERS, LINEAR ACTUATORS FOR CHANGING THE ADJUSTMENTS OF MACHINES, COUNTERS, IMAGE CAPTURING, IMAGE DATA PROCESSING, PHYSICAL DATA CAPTURING AND PROCESSING, PHOTOELECTRICAL MEASURING; COMPUTERS; ANGULAR AND LINEAR ENCODERS; POSITIONING AND CONTROL ENCODERS COMPRISED OF A CONTROL APPARATUS FOR CHECKING, CONTROL AND REGULATION OF DRIVES, AND METERING UNITS; APPARATUS AND INSTRUMENTS AND SYSTEMS COMPOSED PRIMARILY OF ANGULAR AND LINEAR ENCODERS FOR AXIAL MANAGEMENT; TACHOMETERS; INSTRUMENTS AND MACHINES FOR MATERIALS CONTROL MADE UP OF ELECTRONICALLY CONTROLLED HIGH-PERFORMANCE APPARATUS FOR THE INSPECTION AND CLASSIFICATION OF OBJECTS; APPARATUS AND INSTRUMENTS CONSISTING PRIMARILY OF COMPUTER HARDWARE, OPERATING SOFTWARE, SOFTWARE FOR RECORDING AND PROCESSING MEASURED DATA AND THE SUBSEQUENT PROVISION TO A CONTROL MODULE IN THE FIELD OF CONTROL ENGINEERING, MEASURING TECHNIQUE, TELECOMMUNICATIONS, DRIVERS, IN PARTICULAR FOR SENSORS AND ACTUATORS, CONTROLLING SOFTWARE FOR MACHINES AND ROBOTS IN THE FIELD OF CONTROL ENGINEERING, MEASURING TECHNIQUE, DRIVERS, IN PARTICULAR FOR SENSOR AND ACTUATORS, SOFTWARE FOR TRANSMISSION OF ELECTRICAL

SIGNALS, OPERATING SYSTEMS PROGRAMS FOR MACHINES, COMPUTER SOFTWARE FOR RECORDING AND PROCESSING MEASURED DATA AND CONTROL MODULE IN THE FILED OF CONTROL ENGINEERING, CONTROLLING SOFTWARE FOR MACHINES AND ROBOTS IN THE FILED OF CONTROL ENGINEERING, ANALOG AND DIGITAL ELECTRONICS AND MECHANICAL AND OPTICAL COMPONENTS FOR PROCESS CONTROL AND PROCESS ENGINEERING; PRESSURE SENSORS, FLOW SENSORS; MEASURING APPARATUS AND MEASUREMENT INSTRUMENTS COMPOSED OF PRESSURE SENSORS, DIFFERENTIAL PRESSURE TRANSMITTERS, PRESSURE TRANSMITTERS, SUBMERSIBLE PRESSURE TRANSMITTERS, MECHANICAL AND ELECTRONIC PRESSURE SWITCHES, PRESSURE GAUGES, CONTROL VALVES FOR REGULATING THE FLOW OF GASES AND LIQUIDS, THERMOMETERS, TEMPERATURE SENSORS, TEMPERATURE TRANSMITTERS, MECHANICAL AND ELECTRONIC TEMPERATURE SWITCHES, LEVEL SENSORS, LEVEL SWITCHES, LEVEL INDICATORS, LEAKAGE SENSORS, CONDUCTIVITY SENSORS, CONDUCTIVITY SWITCHES, HUMIDITY SENSORS, GAS ANALYSIS SENSORS, PH-ANALYSIS SENSORS, MECHANICAL AND ELECTRONIC CALIBRATION DEVICES, FLOW SENSORS, FLOW TRANSMITTERS, FLOW SWITCHES, STRAIN GAUGES, ANGULAR AND LINEAR ENCODERS, ELECTRICAL AND MECHANICAL COUNTERS FOR COUNTING ROTATIONS OF AXLES, DRIVES, MOTORS, AND MANUFACTURING MACHINES, TACHOMETERS, ELECTRIC CONTROLLERS FOR GLUING SYSTEMS, DIGITAL CAMERAS, DATA PROCESSORS, PCI INTERFACE BOARDS, DRIVERS, IN PARTICULAR FOR SENSORS AND ACTUATORS AND INTEGRATED AND RELATED SOFTWARE FOR ANALYZING PHYSICAL DATA; MEASURING APPARATUS AND MEASURING INSTRUMENTS ALONG WITH MEASURING SYSTEMS COMPOSED OF SUCH APPARATUS AND INSTRUMENTS FOR ENTERING, NAMELY CAPTURING, AND EVALUATING PHYSICAL MEASUREMENTS, LEVEL MEASUREMENTS, AND PROCESS ANALYSIS UNITS; TEST AND CALIBRATION SYSTEMS COMPOSED PRIMARILY OF MECHANICAL AND ELECTRONIC CALIBRATION AND TEST DEVICES, ANALOG AND DIGITAL SENSORS, COMPUTERS AND RELATED SOFTWARE, LED AND LCD DISPLAYS, SIGNAL PROCESSING UNITS; ELECTRONICALLY CONTROLLED INSTRUMENTS FOR THE ELECTRONIC CONTROL OF SIZING, GLUING AND FOLDING MECHANICAL SYSTEMS; ELECTRONICALLY CONTROLLED INSTRUMENTS AND APPARATUS AND THEIR COMPONENT INSTRUMENTS PARTS FOR MONITORING AND CONTROLLING SIZING AND GLUING SYSTEMS WITH INTEGRATED ELECTRONICS FOR INDUSTRIAL PROCESSES; PROGRAMMERS IN THE NATURE OF COMPUTER HARDWARE AND ELECTRONIC INTERFACES, ASICS WITH INTEGRATED SOFTWARE; DETECTION SYSTEMS, CONSISTING PRIMARILY OF ELECTRONIC AND MECHANICAL HARDWARE, OPERATING AND CONTROL SOFTWARE, ELECTRICAL AND ELECTRONIC SENSORS, OPTICAL SENSORS AND ACTUATORS, SIGNAL PROCESSING UNITS AND SOFTWARE; APPARATUS AND INSTRUMENTS AND THEIR COMPONENT SYSTEMS AND THEIR INTEGRATED ELECTRONICS AND ACCESSORIES FOR VARIOUS APPLICATIONS IN THE FIELD OF QUALITY CONTROL AND FOR SIZING TECHNIQUES; DIGITAL CAMERAS; DIGITAL SENSORS; DATA PROCESSING EQUIPMENT; IMAGE PROCESSING COMPONENTS, NAMELY, IDENTIFICATION DEVICES FOR RECORDING CHARACTERS AND IMAGES, PROCESSING UNITS FOR PROCESSING IMAGES, SIGNAL PROCESSING UNITS, CONTROL UNITS, ELECTRONIC AND SOFTWARE; COMPUTERS; PCI INTERFACE CARDS AND BOARDS; COMPUTER SOFTWARE FOR VISUALIZING AND FURTHER PROCESSING OF DATA CAPTURED AND MEASURED BY SENSORS; ANALOGUE AND DIGITAL SENSORS, NAMELY, PRESSURE SENSORS FORCE SENSORS, STRAIN SENSORS, STRAIN TRANSFORMERS, EXTENSOMETRIC SENSORS, SENSORS FOR DRIVE TECHNOLOGY, SURFACE STRAIN SENSORS, PIEZOELECTRIC SENSORS, PIEZORESISTIVE SENSORS, ACTUATORS, ELECTRIC INTERPOLATION SYSTEMS, NAMELY, FOR SENSORS AND ACTUATOR DRIVES, INDUCTIVE SENSORS, MAGNETIC FIELD SENSORS, HALL SENSORS, HIGH TEMPERATURE SENSORS, DISPLACEMENT SENSORS, DISTANCE SENSORS, CAPACITIVE LEVEL SENSORS, CAPACITIVE

HIGH TEMPERATURE SENSORS, OPTICAL SENSORS, LASER SENSORS, COLOR SENSORS, LINE SENSORS, ANGLE SENSORS, MAGNETIC SENSORS, PHOTOELECTRIC SENSORS, NAMELY, ANALOG AND DIGITAL SENSORS IN PARTICULARS, LIGHT ARRAY BARRIERS, DIFFUSE SENSORS, DIFFUSE SENSORS ARRAY, RETROREFLECTIVE SENSORS, RETROREFLECTIVE SENSORS ARRAY FIBER OPTIC SENSORS, LEVEL MONITORING AND LEAK DETECTION SENSORS, DISTANCE MEASURING SENSORS, COLOR DETECTION SENSORS, COLOR MEASURING SENSORS, COLOR MARK SENSORS, LASER SENSORS, LINE SENSORS, VISION SENSORS, SMART VISION SENSORS, LUMINESCENCE SENSORS, LIGHT GAUGING SENSORS, INFRARED LIGHT SENSORS, RADAR SENSORS, ULTRASONIC SENSORS, ULTRASONIC DISTANCE MEASURING SENSORS, SEPARATION SENSORS, CAPACITIVE SENSORS, CAPACITIVE HIGH TEMPERATURE SENSORS, COLOR SENSORS, LINE SENSORS, ELECTRIC STRAIN TRANSFORMERS, PRESSURE TRANSDUCERS, PRESSURE TRANSMITTERS, ELECTRIC PRESSURE AND TEMPERATURE SWITCHES SENSORS, EXTENSOMETERS, ELECTRIC PROXIMITY SWITCHES, INDUCTIVE CODE READERS, DISPLACEMENT TRANSDUCERS, DISPLACEMENT TRANSMITTERS, INDUCTIVE DISPLACEMENT TRANSDUCERS, CAPACITIVE PROXIMITY SWITCHES, DISTANCE MEASURING SCANNERS, PHOTOELECTRIC AREA SCANNER, ULTRASONIC SCANNERS, THOUGHT BEAM LIGHT BARRIERS OR FORKED LIGHT BARRIERS USED TO DETECT AND PREVENT DISRUPTION FROM EXTRANEIOUS LIGHT SOURCES, LIGHT GUIDE APPARATUS, FIBER-OPTIC LIGHT GUIDES, PLASTIC FIBERS LIGHT GUIDES, MEASURING LIGHT GUIDES USED FOR SAFETY AND WARNING PURPOSES, LASER COPY COUNTERS, ROTARY ENCODERS, MAGNETIC ROTARY ENCODERS, MULTI-TURN ROTARY ENCODERS, ABSOLUTE ROTARY ENCODERS, HALLOW SHAFT ROTARY ENCODERS, SHAFT ROTARY ENCODERS, LINEAR DISPLACEMENT TRANSDUCERS, PRECISION SWITCHES, PRECISION SCANNERS, IDENTIFICATION SENSORS FOR RECORDING THE LOCATION, POSITION, MOVEMENT OR SIZE OF PERSONS OR OBJECTS, IDENTIFICATION SENSORS FOR RECORDING ENCODED DATA AND INFORMATION, IDENTIFICATION DEVICES FOR RECORDING CHARACTERS AND IMAGES, NAMELY, PHOTOELECTRIC BARCODE READERS, PHOTOELECTRIC 2D CODE READERS, INDUCTIVE, MICROWAVE CODE READERS, MAGNETIC CODE READERS, MICROWAVE AND INDUCTIVE TAGS COMPUTERS, ANGULAR AND LINEAR ENCODERS, ELECTRICAL POSITIONING DRIVERS, COUNTERS, TACHOMETERS, GLUING SYSTEMS NOT ELECTRIC GLUING GUNS, DIGITAL CAMERAS, DATA PROCESSORS; ELECTRONIC PRESSURE TRANSDUCERS; ELECTRONIC PRESSURE TRANSMITTERS; TRANSVERSE MEASURING DEVICES; PRESSURE SWITCHES; EXTENSOMETERS; PIEZOELECTRIC SENSORS; BRIDGE AMPLIFIERS; INDUCTIVE SENSORS; PROXIMITY SWITCHES; MAGNETIC FIELD SENSORS; CORRIDOR SENSORS; INDUCTIVE CODE READERS; HIGH TEMPERATURE SENSORS; DISPLACEMENT SENSORS; TRANSDUCERS, DISPLACEMENT RECORDERS; SEPARATION SENSORS; CAPACITIVE SENSORS; CAPACITIVE PROXIMITY SWITCHES; CAPACITIVE LEVEL FILLING SENSORS; CAPACITIVE HIGH TEMPERATURE SENSORS; MANOMETERS, DIAPHRAGM SEALS BEING LABORATORY EQUIPMENT; OPTICAL SENSORS, PROBES, MOBILE REFLECTION LIGHT SPOT DETECTORS, LASER SENSORS, SEPARATION SENSORS, REFLECTION LIGHT BARRIERS, ONE-WAY LIGHT BARRIERS, FORKED LIGHT BARRIERS, LIGHT GUIDE APPARATUS, FIBRE-OPTIC LIGHT GUIDES, SYNTHETIC OPTICAL GUIDES, MEASURING LIGHT GUIDES, LASER COPY COUNTERS, COLOUR SENSORS, AND LINE SENSORS; ELECTRONIC SHAPE CONVERTERS; ENCODERS, MAGNETIC ROTARY ENCODERS, AND MULTI-TURN ROTARY ENCODERS; MAGNETIC SENSORS, ABSOLUTE COMPARATORS, ANGLE SENSORS, HOLLOW SHAFT ROTARY ENCODERS, SHAFT ROTARY ENCODERS, AND CABLE STRESS SENSORS; INTERPOLATION ELECTRONICS SYSTEMS CONSISTING PRIMARILY OF SENSORS AND ACTUATOR DRIVERS; METERING EQUIPMENT, NAMELY, COUNTING SENSORS, COUNTERS, ELECTRONIC COUNTERS, COUNTER SYSTEMS WITH INTEGRATED ELECTRONICS AND SIGNAL PROCESSING CONTROLLERS, PROCESS CONTROLLERS, PRECISION

SWITCHES, AND PRECISION SCANNERS; IDENTIFICATION INSTRUMENTS AND APPARATUS AND SYSTEMS COMPOSED PRIMARILY OF INTEGRATED ELECTRONICS FOR RECORDING THE LOCATION, POSITION, MOVEMENT OR SIZE OF PERSONS, AND OBJECTS; APPARATUS AND INSTRUMENTS FOR IDENTIFICATION AND SYSTEMS COMPOSED PRIMARILY OF INTEGRATED ELECTRONICS FOR RECORDING DATA, INFORMATION AND CODED SIGNALS; INSTRUMENTS AND APPARATUS FOR IDENTIFICATION AND RELATED SYSTEMS COMPOSED PRIMARILY OF THE INTEGRATED ELECTRONICS BEING COMPUTER HARDWARE AND COMPUTER OPERATING SOFTWARE FOR RECORDING CHARACTERS AND IMAGES; ALL THESE GOODS BEING FOR USE IN THE FIELD OF HANDLING AND ROBOTICS, THE BUILDING OF GRAPHIC MACHINERY, IN PARTICULAR GRAPHIC MACHINERY, MACHINERY FOR THE PLASTIC INDUSTRY, INDUSTRIAL MACHINERY FOR MACHINE TOOLS, IN PARTICULAR FOR TOOLS, MANUFACTURE OF MEDICAL APPARATUS, THE SEMICONDUCTOR INDUSTRY, THE CONSTRUCTION OF TEXTILE MACHINES, THE TRANSPORT SECTOR, WATER AND POWER SUPPLY, MINING, WAREHOUSING AND LOGISTICS, TIMBER PROCESSING, PACKAGING INDUSTRY, PROCESS ENGINEERING AND ECOLOGICAL TECHNOLOGIES, DRINKS AND FOOD INDUSTRIES, PHARMACEUTICAL AND BIOTECHNOLOGY INDUSTRIES, THE CHEMICAL INDUSTRY, PETROCHEMISTRY, HEATING, VENTILATION AND AIR CONDITIONING, SANITATION, TECHNICAL, POWER INDUSTRY AND LABORATORY INDUSTRIES (U.S. CLS. 21, 23, 26, 36 AND 38).

CLASS 42—SCIENTIFIC AND COMPUTER SERVICES

FOR SCIENTIFIC AND INDUSTRIAL RESEARCH AND DEVELOPMENT IN THE FIELD OF SENSOR TECHNOLOGY AND OPTICAL INFORMATION RECORDING AND PROCESSING; COMPUTER PROGRAMMING, NAMELY RECORDING DIGITAL INFORMATION FROM SENSORS AND ACTUATOR ACTIVATION; TECHNICAL CONSULTATION SERVICES IN THE FIELD OF CHEMICAL INDUSTRY, DRIVE ENGINEERING, ENERGY, FOOD AND BEVERAGE INDUSTRY, GRAPHIC MACHINERY, HANDLING AND ROBOTICS, HEATING, VENTILATING AND AIR CONDITIONING, LAB AUTOMATION, MEDICAL ENGINEERING, PACKAGING INDUSTRY, PETROCHEMICAL INDUSTRY, SEMICONDUCTOR INDUSTRY, TEXTILE MACHINERY, TRANSPORT AND LOGISTICS, WATER AND WASTEWATER, WIND POWER PLANTS, RENEWABLE ENERGY, PLASTIC INDUSTRY, TOOLS MACHINERY, TIMBER PROCESSING, PHARMACEUTICAL INDUSTRY (U.S. CLS. 100 AND 101).

JACLYN KIDWELL WALKER, EXAMINING ATTORNEY

CLASS 9—ELECTRICAL AND SCIENTIFIC APPARATUS

FOR SCIENTIFIC, SURVEYING, PHOTOGRAPHIC, CINEMATOGRAPHIC, OPTICAL, WEIGHING, MEASURING, SIGNALLING, CHECKING, LIFE-SAVING AND TEACHING APPARATUS AND INSTRUMENTS, NAMELY, ANALOG AND DIGITAL SENSORS AND SENSOR SYSTEMS, NAMELY, INDUCTIVE SENSORS, PHOTOELECTRIC SENSORS, ULTRASONIC SENSORS, CAPACITIVE SENSORS, MAGNETIC SENSORS, CYLINDER SENSORS, PRECISION SWITCHES, VISION SENSORS, ABSOLUTE ENCODERS, INCREMENTAL ENCODERS, ENCODERS WITHOUT BEARING, TACHOGENERATORS, RESOLVERS, SPEED SWITCHES, FORMAT ALIGNMENT, ACCELERATION SENSORS, INCLINATION SENSORS, COUNTERS, TACHOMETERS, PRESSURE SENSORS, FORCE AND STRAIN SENSORS, TEMPERATURE SENSORS, LEVEL MEASUREMENT SENSORS, PROCESS ANALYSIS SENSORS, SYSTEM COMPONENTS, INDUSTRIAL CAMERAS, NETWORK COMPONENTS, CAMERA ACCESSORIES, OEM CUSTOM DESIGN, COLD GLUE GUNS, COLD GLUE PUMPS, HOT MELT MELTING UNITS, HOT MELT GUNS, ADHESIVE APPLICATION CONTROLLERS, QUALITY ASSURANCE SYSTEM AND SENSORS, AS WELL AS A COMBINATION OF ALL THEM; MEASURING APPARATUS AND INSTRUMENTS USING THE WEAK-CURRENT ENGINEERING TECHNIQUE, NAMELY THE COMMUNICATIONS, HIGH-FREQUENCY AND REGULATION TECHNIQUES IN THE NATURE OF ANALOGUE AND DIGITAL CONTROL UNITS FOR AND INCLUDED IN SENSORS AND MACHINES; ELECTRIC APPARATUS AND INSTRUMENTS FOR SENSOR TECHNOLOGY, MEASUREMENT TECHNIQUES AND AUTOMATION TECHNOLOGY NAMELY, PRESSURE MEASURING, TEMPERATURE MEASURING, LEVEL MEASUREMENT, PROCESS ANALYSIS, MEASURE, TEST AND CALIBRATION MEASURING, FLOW MEASUREMENT, TRANSVERSE MEASURING, STRAIN MEASURING DEVICES, ANGULAR AND LINEAR DISPLACEMENT MEASURING, ELECTRICAL POSITIONING DRIVERS, LINEAR ACTUATORS FOR CHANGING THE ADJUSTMENTS OF MACHINES, COUNTERS, IMAGE CAPTURING, IMAGE DATA PROCESSING, PHYSICAL DATA CAPTURING AND PROCESSING, PHOTOELECTRICAL MEASURING; COMPUTERS; ANGULAR AND LINEAR ENCODERS; POSITIONING AND CONTROL ENCODERS COMPRISED OF A CONTROL APPARATUS FOR CHECKING, CONTROL AND REGULATION OF DRIVES, AND METERING UNITS; APPARATUS AND INSTRUMENTS AND SYSTEMS COMPOSED PRIMARILY OF ANGULAR AND LINEAR ENCODERS FOR AXIAL MANAGEMENT; TACHOMETERS; INSTRUMENTS AND MACHINES FOR MATERIALS CONTROL MADE UP OF ELECTRONICALLY CONTROLLED HIGH-PERFORMANCE APPARATUS FOR THE INSPECTION AND CLASSIFICATION OF OBJECTS; APPARATUS AND INSTRUMENTS CONSISTING PRIMARILY OF COMPUTER HARDWARE, OPERATING SOFTWARE, SOFTWARE FOR RECORDING AND PROCESSING MEASURED DATA AND THE SUBSEQUENT PROVISION TO A CONTROL MODULE IN THE FIELD OF CONTROL ENGINEERING, MEASURING TECHNIQUE, TELECOMMUNICATIONS, DRIVERS, IN PARTICULAR FOR SENSORS AND ACTUATORS, CONTROLLING SOFTWARE FOR MACHINES AND ROBOTS IN THE FIELD OF CONTROL ENGINEERING, MEASURING TECHNIQUE, DRIVERS, IN PARTICULAR FOR SENSOR AND ACTUATORS, SOFTWARE FOR TRANSMISSION OF ELECTRICAL SIGNALS, OPERATING SYSTEMS PROGRAMS FOR MACHINES, COMPUTER SOFTWARE FOR RECORDING AND PROCESSING MEASURED DATA AND CONTROL MODULE IN THE FIELD OF CONTROL ENGINEERING, CONTROLLING SOFTWARE FOR MACHINES AND ROBOTS IN THE FIELD OF CONTROL ENGINEERING, ANALOG AND DIGITAL ELECTRONICS AND MECHANICAL AND OPTICAL COMPONENTS FOR PROCESS CONTROL AND PROCESS ENGINEERING; PRESSURE SENSORS, FLOW SENSORS; MEASURING APPARATUS AND MEASUREMENT INSTRUMENTS COMPOSED OF PRESSURE SENSORS, DIFFERENTIAL PRESSURE TRANSMITTERS, PRESSURE TRANSMITTERS, SUBMERSIBLE PRESSURE TRANSMITTERS, MECHANICAL AND ELECTRONIC PRESSURE SWITCHES, PRESSURE GAUGES, CONTROL VALVES FOR REGULATING THE FLOW OF GASES AND LIQUIDS, THERMOMETERS,

SN 79-070,799, BAUMER HOLDING AG, SWITZERLAND, FILED 3-19-2009.



PRIORITY DATE OF 10-1-2008 IS CLAIMED.
OWNER OF INTERNATIONAL REGISTRATION 1007391 DATED 3-19-2009, EXPIRES 3-19-2019.
THE MARK CONSISTS OF TWO FACING RECTANGLES CONTAINING A FADING DOTTED DESIGN EMANATING THE CENTER OUT.

TEMPERATURE SENSORS, TEMPERATURE TRANSMITTERS, MECHANICAL AND ELECTRONIC TEMPERATURE SWITCHES, LEVEL SENSORS, LEVEL SWITCHES, LEVEL INDICATORS, LEAKAGE SENSORS, CONDUCTIVITY SENSORS, CONDUCTIVITY SWITCHES, HUMIDITY SENSORS, GAS ANALYSIS SENSORS, PH-ANALYSIS SENSORS, MECHANICAL AND ELECTRONIC CALIBRATION DEVICES, FLOW SENSORS, FLOW TRANSMITTERS, FLOW SWITCHES, STRAIN GAUGES, ANGULAR AND LINEAR ENCODERS, ELECTRICAL AND MECHANICAL COUNTERS FOR COUNTING ROTATIONS OF AXLES, DRIVES, MOTORS, AND MANUFACTURING MACHINES, TACHOMETERS, ELECTRIC CONTROLLERS FOR GLUING SYSTEMS, DIGITAL CAMERAS, DATA PROCESSORS, PCI INTERFACE BOARDS, DRIVERS, IN PARTICULAR FOR SENSORS AND ACTUATORS AND INTEGRATED AND RELATED SOFTWARE FOR ANALYZING PHYSICAL DATA; MEASURING APPARATUS AND MEASURING INSTRUMENTS ALONG WITH MEASURING SYSTEMS COMPOSED OF SUCH APPARATUS AND INSTRUMENTS FOR ENTERING, NAMELY CAPTURING, AND EVALUATING PHYSICAL MEASUREMENTS, LEVEL MEASUREMENTS, AND PROCESS ANALYSIS UNITS; TEST AND CALIBRATION SYSTEMS COMPOSED PRIMARILY OF MECHANICAL AND ELECTRONIC CALIBRATION AND TEST DEVICES, ANALOG AND DIGITAL SENSORS, COMPUTERS AND RELATED SOFTWARE, LED AND LCD DISPLAYS, SIGNAL PROCESSING UNITS; ELECTRONICALLY CONTROLLED INSTRUMENTS FOR THE ELECTRONIC CONTROL OF SIZING, GLUING AND FOLDING MECHANICAL SYSTEMS; ELECTRONICALLY CONTROLLED INSTRUMENTS AND APPARATUS AND THEIR COMPONENT INSTRUMENTS PARTS FOR MONITORING AND CONTROLLING SIZING AND GLUING SYSTEMS WITH INTEGRATED ELECTRONICS FOR INDUSTRIAL PROCESSES; PROGRAMMERS IN THE NATURE OF COMPUTER HARDWARE AND ELECTRONIC INTERFACES, ASICS WITH INTEGRATED SOFTWARE; DETECTION SYSTEMS, CONSISTING PRIMARILY OF ELECTRONIC AND MECHANICAL HARDWARE, OPERATING AND CONTROL SOFTWARE, ELECTRICAL AND ELECTRONIC SENSORS, OPTICAL SENSORS AND ACTUATORS, SIGNAL PROCESSING UNITS AND SOFTWARE; APPARATUS AND INSTRUMENTS AND THEIR COMPONENT SYSTEMS AND THEIR INTEGRATED ELECTRONICS AND ACCESSORIES FOR VARIOUS APPLICATIONS IN THE FIELD OF QUALITY CONTROL AND FOR SIZING TECHNIQUES; DIGITAL CAMERAS; DIGITAL SENSORS; DATA PROCESSING EQUIPMENT; IMAGE PROCESSING COMPONENTS, NAMELY, IDENTIFICATION DEVICES FOR RECORDING CHARACTERS AND IMAGES, PROCESSING UNITS FOR PROCESSING IMAGES, SIGNAL PROCESSING UNITS, CONTROL UNITS, ELECTRONIC AND SOFTWARE; COMPUTERS; PCI INTERFACE CARDS AND BOARDS; COMPUTER SOFTWARE FOR VISUALIZING AND FURTHER PROCESSING OF DATA CAPTURED AND MEASURED BY SENSORS; ANALOGUE AND DIGITAL SENSORS, NAMELY, PRESSURE SENSORS FORCE SENSORS, STRAIN SENSORS, STRAIN TRANSFORMERS, EXTENSOMETRIC SENSORS, SENSORS FOR DRIVE TECHNOLOGY, SURFACE STRAIN SENSORS, PIEZOELECTRIC SENSORS, PIEZORESISTIVE SENSORS, ACTUATORS, ELECTRIC INTERPOLATION SYSTEMS, NAMELY, FOR SENSORS AND ACTUATOR DRIVES, INDUCTIVE SENSORS, MAGNETIC FIELD SENSORS, HALL SENSORS, HIGH TEMPERATURE SENSORS, DISPLACEMENT SENSORS, DISTANCE SENSORS, CAPACITIVE LEVEL SENSORS, CAPACITIVE HIGH TEMPERATURE SENSORS, OPTICAL SENSORS, LASER SENSORS, COLOR SENSORS, LINE SENSORS, ANGLE SENSORS, MAGNETIC SENSORS, PHOTOELECTRIC SENSORS, NAMELY, ANALOG AND DIGITAL SENSORS IN PARTICULARS, LIGHT ARRAY BARRIERS, DIFFUSE SENSORS, DIFFUSE SENSORS ARRAY, RETROREFLECTIVE SENSORS, RETROREFLECTIVE SENSORS ARRAY FIBER OPTIC SENSORS, LEVEL MONITORING AND LEAK DETECTION SENSORS, DISTANCE MEASURING SENSORS, COLOR DETECTION SENSORS, COLOR MEASURING SENSORS, COLOR MARK SENSORS, LASER SENSORS, LINE SENSORS, VISION SENSORS, SMART VISION SENSORS, LUMINESCENCE SENSORS, LIGHT GAUGING SENSORS, INFRARED LIGHT SENSORS, RADAR SENSORS, ULTRASONIC SENSORS, ULTRASONIC DISTANCE MEASURING SENSORS, SEPARATION SENSORS, CAPACITIVE SENSORS, CAPACITIVE HIGH

TEMPERATURE SENSORS, COLOR SENSORS, LINE SENSORS, ELECTRIC STRAIN TRANSFORMERS, PRESSURE TRANSDUCERS, PRESSURE TRANSMITTERS, ELECTRIC PRESSURE AND TEMPERATURE SWITCHES SENSORS, EXTENSIMETERS, ELECTRIC PROXIMITY SWITCHES, INDUCTIVE CODE READERS, DISPLACEMENT TRANSDUCERS, DISPLACEMENT TRANSMITTERS, INDUCTIVE DISPLACEMENT TRANSDUCERS, CAPACITIVE PROXIMITY SWITCHES, DISTANCE MEASURING SCANNERS, PHOTOELECTRIC AREA SCANNER, ULTRASONIC SCANNERS, THOUGHT BEAM LIGHT BARRIERS OR FORKED LIGHT BARRIERS USED TO DETECT AND PREVENT DISRUPTION FROM EXTRANEIOUS LIGHT SOURCES, LIGHT GUIDE APPARATUS, FIBER-OPTIC LIGHT GUIDES, PLASTIC FIBERS LIGHT GUIDES, MEASURING LIGHT GUIDES USED FOR SAFETY AND WARNING PURPOSES, LASER COPY COUNTERS, ROTARY ENCODERS, MAGNETIC ROTARY ENCODERS, MULTI-TURN ROTARY ENCODERS, ABSOLUTE ROTARY ENCODERS, HOLLOW SHAFT ROTARY ENCODERS, SHAFT ROTARY ENCODERS, LINEAR DISPLACEMENT TRANSDUCERS, PRECISION SWITCHES, PRECISION SCANNERS, IDENTIFICATION SENSORS FOR RECORDING THE LOCATION, POSITION, MOVEMENT OR SIZE OF PERSONS OR OBJECTS, IDENTIFICATION SENSORS FOR RECORDING ENCODED DATA AND INFORMATION, IDENTIFICATION DEVICES FOR RECORDING CHARACTERS AND IMAGES, NAMELY, PHOTOELECTRIC BARCODE READERS, PHOTOELECTRIC 2D CODE READERS, INDUCTIVE, MICROWAVE CODE READERS, MAGNETIC CODE READERS, MICROWAVE AND INDUCTIVE TAGS COMPUTERS, ANGULAR AND LINEAR ENCODERS, ELECTRICAL POSITIONING DRIVERS, COUNTERS, TACHOMETERS, GLUING SYSTEMS NOT ELECTRIC GLUING GUNS, DIGITAL CAMERAS, DATA PROCESSORS; ELECTRONIC PRESSURE TRANSDUCERS; ELECTRONIC PRESSURE TRANSMITTERS; TRANSVERSE MEASURING DEVICES; PRESSURE SWITCHES; EXTENSOMETERS; PIEZOELECTRIC SENSORS; BRIDGE AMPLIFIERS; INDUCTIVE SENSORS; PROXIMITY SWITCHES; MAGNETIC FIELD SENSORS; CORRIDOR SENSORS; INDUCTIVE CODE READERS; HIGH TEMPERATURE SENSORS; DISPLACEMENT SENSORS; TRANSDUCERS, DISPLACEMENT RECORDERS; SEPARATION SENSORS; CAPACITIVE SENSORS; CAPACITIVE PROXIMITY SWITCHES; CAPACITIVE LEVEL FILLING SENSORS; CAPACITIVE HIGH TEMPERATURE SENSORS; MANOMETERS, DIAPHRAGM SEALS BEING LABORATORY EQUIPMENT; OPTICAL SENSORS, PROBES, MOBILE REFLECTION LIGHT SPOT DETECTORS, LASER SENSORS, SEPARATION SENSORS, REFLECTION LIGHT BARRIERS, ONE-WAY LIGHT BARRIERS, FORKED LIGHT BARRIERS, LIGHT GUIDE APPARATUS, FIBRE-OPTIC LIGHT GUIDES, SYNTHETIC OPTICAL GUIDES, MEASURING LIGHT GUIDES, LASER COPY COUNTERS, COLOUR SENSORS, AND LINE SENSORS; ELECTRONIC SHAPE CONVERTERS; ENCODERS, MAGNETIC ROTARY ENCODERS, AND MULTI-TURN ROTARY ENCODERS; MAGNETIC SENSORS, ABSOLUTE COMPARATORS, ANGLE SENSORS, HOLLOW SHAFT ROTARY ENCODERS, SHAFT ROTARY ENCODERS, AND CABLE STRESS SENSORS; INTERPOLATION ELECTRONICS SYSTEMS CONSISTING PRIMARILY OF SENSORS AND ACTUATOR DRIVERS; METERING EQUIPMENT, NAMELY, COUNTING SENSORS, COUNTERS, ELECTRONIC COUNTERS, COUNTER SYSTEMS WITH INTEGRATED ELECTRONICS AND SIGNAL PROCESSING CONTROLLERS, PROCESS CONTROLLERS, PRECISION SWITCHES, AND PRECISION SCANNERS; IDENTIFICATION INSTRUMENTS AND APPARATUS AND SYSTEMS COMPOSED PRIMARILY OF INTEGRATED ELECTRONICS FOR RECORDING THE LOCATION, POSITION, MOVEMENT OR SIZE OF PERSONS, AND OBJECTS; APPARATUS AND INSTRUMENTS FOR IDENTIFICATION AND SYSTEMS COMPOSED PRIMARILY OF INTEGRATED ELECTRONICS FOR RECORDING DATA, INFORMATION AND CODED SIGNALS; INSTRUMENTS AND APPARATUS FOR IDENTIFICATION AND RELATED SYSTEMS COMPOSED PRIMARILY OF THE INTEGRATED ELECTRONICS BEING COMPUTER HARDWARE AND COMPUTER OPERATING SOFTWARE FOR RECORDING CHARACTERS AND IMAGES; ALL THESE GOODS BEING FOR USE IN THE FIELD OF HANDLING AND ROBOTICS, THE BUILDING OF GRAPHIC MACHINERY, IN PARTICULAR GRAPHIC MACHINERY, MA-

CHINERY FOR THE PLASTIC INDUSTRY, INDUSTRIAL MACHINERY FOR MACHINE TOOLS, IN PARTICULAR FOR TOOLS, MANUFACTURE OF MEDICAL APPARATUSES, THE SEMICONDUCTOR INDUSTRY, THE CONSTRUCTION OF TEXTILE MACHINES, THE TRANSPORT SECTOR, WATER AND POWER SUPPLY, MINING, WAREHOUSING AND LOGISTICS, TIMBER PROCESSING, PACKAGING INDUSTRY, PROCESS ENGINEERING AND ECOLOGICAL TECHNOLOGIES, DRINKS AND FOOD INDUSTRIES, PHARMACEUTICAL AND BIOTECHNOLOGY INDUSTRIES, THE CHEMICAL INDUSTRY, PETROCHEMISTRY, HEATING, VENTILATION AND AIR CONDITIONING, SANITATION, TECHNICAL, POWER INDUSTRY AND LABORATORY INDUSTRIES (U.S. CLS. 21, 23, 26, 36 AND 38).

CLASS 42—SCIENTIFIC AND COMPUTER SERVICES

FOR SCIENTIFIC AND INDUSTRIAL RESEARCH AND DEVELOPMENT IN THE FIELD OF SENSOR TECHNOLOGY AND OPTICAL INFORMATION RECORDING AND PROCESSING; COMPUTER PROGRAMMING, NAMELY RECORDING DIGITAL INFORMATION FROM SENSORS AND ACTUATOR ACTIVATION; TECHNICAL CONSULTATION SERVICES IN THE FIELD OF CHEMICAL INDUSTRY, DRIVE ENGINEERING, ENERGY, FOOD AND BEVERAGE INDUSTRY, GRAPHIC MACHINERY, HANDLING AND ROBOTICS, HEATING, VENTILATING AND AIR-CONDITIONING, LAB AUTOMATION, MEDICAL ENGINEERING, PACKAGING INDUSTRY, PETROCHEMICAL INDUSTRY, SEMICONDUCTOR INDUSTRY, TEXTILE MACHINERY, TRANSPORT AND LOGISTICS, WATER AND WASTEWATER, WIND POWER PLANTS, RENEWABLE ENERGY, PLASTIC INDUSTRY, TOOLS MACHINERY, TIMBER PROCESSING, PHARMACEUTICAL INDUSTRY (U.S. CLS. 100 AND 101).

JACLYN KIDWELL WALKER, EXAMINING ATTORNEY

CLASS 9—ELECTRICAL AND SCIENTIFIC APPARATUS

FOR ELECTRONIC CIRCUITS, MAGNETIC DISKS, OPTICAL DISKS, MAGNETIC OPTICAL DISKS, CD-ROM, DVD-ROM AND OTHER RECORDING MEDIA RECORDED WITH GAME PROGRAMS FOR ARCADE GAME MACHINES FOR USE WITH AN EXTERNAL DISPLAY SCREEN OR MONITOR; DOWNLOADABLE GAME PROGRAMS FOR ARCADE GAME MACHINES FOR USE WITH AN EXTERNAL DISPLAY SCREEN OR MONITOR; ARCADE GAME MACHINES FOR USE WITH AN EXTERNAL DISPLAY SCREEN OR MONITOR; STRAPS AND NECKLACES FOR MOBILE PHONES; OTHER TELECOMMUNICATION DEVICES AND APPARATUS, NAMELY, TELEPHONES, MOBILE PHONES, RADIOS, TELEVISION RECEIVERS; NAVIGATION APPARATUS FOR VEHICLES; COMPACT DISC PLAYERS, RECORD PLAYERS, DIGITAL CAMERAS, VIDEO CAMERAS, VIDEODISC PLAYERS, VIDEOTAPE RECORDERS, DVD PLAYERS, DVD RECORDERS, APPARATUS FOR RECORDING, TRANSMISSION OR REPRODUCTION OF SOUND OR IMAGES; ELECTRONIC CIRCUITS, MAGNETIC DISKS, OPTICAL DISKS, MAGNETIC OPTICAL DISKS, CD-ROM, DVD-ROM AND OTHER RECORDING MEDIA RECORDED WITH GAME PROGRAMS FOR MOBILE PHONES; DOWNLOADABLE GAME PROGRAMS FOR MOBILE PHONES; ELECTRONIC CIRCUITS, MAGNETIC DISKS, OPTICAL DISKS, MAGNETIC OPTICAL DISKS, CD-ROM, DVD-ROM AND OTHER RECORDING MEDIA RECORDED WITH GAME PROGRAMS FOR PERSONAL DIGITAL ASSISTANTS; DOWNLOADABLE GAME PROGRAMS FOR PERSONAL DIGITAL ASSISTANTS; ELECTRONIC CIRCUITS, MAGNETIC DISKS, OPTICAL DISKS, MAGNETIC OPTICAL DISKS, CD-ROM, DVD-ROM AND OTHER RECORDING MEDIA RECORDED WITH GAME PROGRAMS FOR COMPUTERS; DOWNLOADABLE COMPUTER GAME PROGRAMS; ELECTRONIC CIRCUITS, MAGNETIC DISKS, OPTICAL DISKS, MAGNETIC OPTICAL DISKS, CD-ROM, DVD-ROM AND OTHER RECORDING MEDIA RECORDED WITH PROGRAMS FOR COMPUTER GRAPHICS; OTHER ELECTRONIC MACHINES, APPARATUS AND THEIR PARTS, NAMELY, COMPUTER HARDWARE AND COMPUTER PERIPHERALS; ELECTRONIC CIRCUITS, MAGNETIC DISKS, OPTICAL DISKS, MAGNETIC OPTICAL DISKS, CD-ROM, DVD-ROM AND OTHER RECORDING MEDIA RECORDED WITH GAME PROGRAMS FOR CONSUMER GAME MACHINES FOR USE WITH AN EXTERNAL DISPLAY SCREEN OR MONITOR; DOWNLOADABLE GAME PROGRAMS FOR CONSUMER GAME MACHINES FOR USE WITH AN EXTERNAL DISPLAY SCREEN OR MONITOR; ELECTRONIC CIRCUITS, MAGNETIC DISKS, OPTICAL DISKS, MAGNETIC OPTICAL DISKS, CD-ROM, DVD-ROM AND OTHER RECORDING MEDIA RECORDED WITH GAME PROGRAMS FOR HAND-HELD GAMES WITH LIQUID CRYSTAL DISPLAYS; DOWNLOADABLE GAME PROGRAMS FOR HAND-HELD GAMES WITH LIQUID CRYSTAL DISPLAYS; CONSUMER GAME MACHINES FOR USE WITH AN EXTERNAL DISPLAY SCREEN OR MONITOR; RECORDED COMPACT DISCS FEATURING SOUNDS, MUSIC, ANIMATION, IMAGES, VIDEO IMAGES, MOVIES, TELEVISION PROGRAMS AND INTERNET TELEVISION PROGRAMS; OTHER PHONOGRAPH RECORDS FEATURING MUSIC; ELECTRONIC CIRCUITS AND CD-ROM RECORDED WITH AUTOMATIC PERFORMANCE PROGRAMS FOR ELECTRONIC MUSICAL INSTRUMENTS; DOWNLOADABLE MUSIC FILES; EXPOSED CINEMATOGRAPHIC FILMS FOR ANIMATION; OTHER EXPOSED CINEMATOGRAPHIC FILMS; EXPOSED SLIDE FILMS; DOWNLOADABLE MOVIES AND VIDEOS FEATURING DRAMA, ANIMATION, SPORTS, MUSIC AND COMEDY; DOWNLOADABLE IMAGE FILES FEATURING CINEMATOGRAPHY, NAMELY, FILES CONTAINING ARTWORK, TEXT, DIAGRAMS, PHOTOGRAPHS, GRAPHICS, VIDEO AND GAMES; RECORDED CD-ROM, DVD, VIDEO DISCS AND VIDEO TAPES FEATURING CINEMATOGRAPHY FEATURING SOUNDS, MUSIC, ANIMATION, IMAGES, VIDEO IMAGES, MOVIES, TELEVISION PROGRAMS AND INTERNET TELEVISION PROGRAMS; DOWNLOADABLE ELECTRONIC PUBLICATIONS IN THE NATURE OF BOOKS, MAGAZINES, NEWSLETTERS AND COMICS FEATURING CINEMATOGRAPHY FEATURING MUSIC, IMAGES, VIDEO IMAGES, SOUNDS, TEXT, ANIMATION AND INFORMATION RELATING TO SUBJECTS OF GENERAL

SN 79-070,805. LUCENT PICTURES ENTERTAINMENT, INC., JAPAN, FILED 3-27-2009.

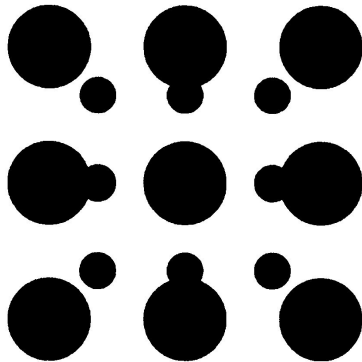

PRIORITY DATE OF 3-23-2009 IS CLAIMED.
OWNER OF INTERNATIONAL REGISTRATION 1007400
DATED 3-27-2009, EXPIRES 3-27-2019.

THE MARK CONSISTS OF NINE LARGE DOTS INTERSECTED BY A BACKGROUND DESIGN OF EIGHT SMALLER DOTS.

INTEREST; OTHER ELECTRONIC PUBLICATIONS RECORDED ON COMPUTER MEDIA IN THE NATURE OF BOOKS, MAGAZINES, NEWSLETTERS AND COMICS FEATURING CINEMATOGRAPHY FEATURING MUSIC, IMAGES, VIDEO IMAGES, SOUNDS, TEXT, ANIMATION AND INFORMATION RELATING TO SUBJECTS OF GENERAL INTEREST (U.S. CLS. 21, 23, 26, 36 AND 38).

CLASS 16—PAPER GOODS AND PRINTED MATTER

FOR PAPER AND CARDBOARD; STATIONERY; TRADING CARDS; PICTURE POSTCARDS; SHEET MUSIC; SONG BOOKS; CATALOGUES FEATURING ADVERTISEMENTS, COMICS, NOVELS, PRODUCTS AND INFORMATION RELATING TO SUBJECTS OF GENERAL INTEREST; POSTERS; CALENDARS; PUBLICATIONS IN THE NATURE OF BOOKS, MAGAZINES, NEWSLETTERS AND COMICS FEATURING CINEMATOGRAPHY FEATURING MUSIC, IMAGES, VIDEO IMAGES, SOUNDS, TEXT, ANIMATION AND INFORMATION RELATING TO SUBJECTS OF GENERAL INTEREST; MAGAZINES FEATURING CINEMATOGRAPHY; COMIC BOOKS; PHOTO BOOKS BEING PHOTO ALBUMS; OTHER PRINTED MATTER, NAMELY, NOTEPADS, ADDRESS BOOKS, AGENDAS, APPOINTMENT BOOKS, BLANK JOURNALS, DAY PLANNERS; CELLULOID PICTURES; PHOTOGRAPHS; PHOTOGRAPH STANDS (U.S. CLS. 2, 5, 22, 23, 29, 37, 38 AND 50).

CLASS 28—TOYS AND SPORTING GOODS

FOR TRADING CARD GAMES; HAND-HELD GAMES WITH LIQUID CRYSTAL DISPLAYS; OTHER TOYS, NAMELY, BABY MULTIPLE ACTIVITY TOYS, BATH TOYS, BATTERY OPERATED ACTION TOYS, BENDABLE TOYS, CLOCKWORK TOYS OF PLASTIC, COLLECTABLE TOY FIGURES, DOG TOYS, DRAWING TOYS, EDUCATIONAL TOYS FOR PURPOSES OF THE DEMONSTRATION OF ALTERNATIVE ENERGY SOURCES, ELECTRIC ACTION TOYS, FANTASY CHARACTER TOYS, GIFT BASKETS CONTAINING PLUSH TOYS, INFANT TOYS, MUSICAL TOYS, PET TOYS, PLASTIC CHARACTER TOYS, PLUSH TOYS, POP UP TOYS, POSITIONABLE TOY FIGURES, PRINTING TOYS, PULL TOYS, PUSH TOYS, REMOTE CONTROL TOYS, NAMELY, CARS, STUFFED ANIMAL TOYS, AND GIRL'S DOLLS WITH CLOTHING; DOLLS; CONJURING APPARATUS, NAMELY, MAGIC TRICKS; PLAYING CARDS; SLOT MACHINES, NAMELY, AMUSEMENT GAME MACHINES; BILLIARD EQUIPMENT; SPORTS EQUIPMENT, NAMELY, RACKETS, BADMINTON RACKETS, TABLE TENNIS RACKETS, GOLF BAGS, GOLF CLUBS, GOLF BALLS, GOLF BALL MARKERS, GOLF GLOVES, GOLF CLUB COVERS, SKIS, SKI CASES, SWIM FINS, SKATEBOARDS, SNOWBOARDS, SNOWBOARD CASES, SURFBOARDS, AND SURFBOARDS CASES (U.S. CLS. 22, 23, 38 AND 50).

CLASS 41—EDUCATION AND ENTERTAINMENT

FOR PROVIDING OF ELECTRONIC PUBLICATIONS, NAMELY, PUBLISHING OF ELECTRONIC PUBLICATIONS; SERVICES OF REFERENCE LIBRARIES FOR LITERATURE AND DOCUMENTARY RECORDS; PUBLICATION OF BOOKS AND ELECTRONIC PUBLICATIONS, AND PROVIDING INFORMATION THEREON; WRITING SCRIPTS FOR ANIMATED FILMS; WRITING SCRIPTS FOR OTHER FILMS; SUBTITLING; EDITING MOVIE FILMS; PRODUCTION OF VIDEO TAPE FILMS AND VIDEO DISK FILMS; PRODUCTION OF COMPUTER GRAPHICS FILMS; ANIMATED MOVIE FILM PRODUCTION, ANIMATED MOVIE SHOWING OR ANIMATED MOVIE FILM DISTRIBUTION, AND PROVIDING INFORMATION THEREON; MOVIE SHOWING, MOVIE FILM PRODUCTION OR MOVIE FILM DISTRIBUTION, AND PROVIDING INFORMATION THEREON; CONSULTANCY RELATING TO ANIMATED MOVIE FILM PRODUCTION, ANIMATED MOVIE SHOWING AND ANIMATED MOVIE FILM DISTRIBUTION; CONSULTANCY RELATING TO OTHER MOVIE SHOWING, MOVIE FILM PRODUCTION OR MOVIE FILM DISTRIBUTION; PROVIDING FILMS VIA INTERNET OR COM-

PUTER NETWORKS, AND PROVIDING INFORMATION THEREON; WRITING SCRIPTS FOR ANIMATED TV PROGRAMS; WRITING SCRIPTS FOR OTHER BROADCAST PROGRAMS; PLANNING AND PRODUCTION OF ANIMATED TV PROGRAMS; PRODUCTION OF ANIMATION VIDEOS FOR BROADCAST PROGRAMS; PLANNING AND PRODUCTION OF OTHER BROADCAST PROGRAMS; PROVIDING MOVIE THEATRE FACILITIES AND PROVIDING INFORMATION THEREON; PROVIDING GAMES VIA INTERNET OR COMPUTER NETWORK, AND PROVIDING INFORMATION THEREON; PROVIDING OTHER AMUSEMENT FACILITIES, NAMELY, AMUSEMENT PARKS AND PROVIDING INFORMATION THEREON; RENTAL OF RECORDS OR SOUND-RECORDED MAGNETIC TAPES; RENTAL OF IMAGE-RECORDED MAGNETIC TAPES, DVD AND OTHER IMAGE-RECORDED RECORDING MEDIA; PROVIDING INFORMATION ON RENTAL OF IMAGE-RECORDED MAGNETIC TAPES, DVD AND OTHER IMAGE-RECORDED RECORDING MEDIA (U.S. CLS. 100, 101 AND 107).

JACLYN KIDWELL WALKER, EXAMINING ATTORNEY

SN 79-070,842. SICHUAN SHENG WEI JU TE SHI PIN YOU; XIAN GONG SI, CHINA, FILED 1-12-2009.



OWNER OF INTERNATIONAL REGISTRATION 1007498 DATED 1-12-2009, EXPIRES 1-12-2019.

NO CLAIM IS MADE TO THE EXCLUSIVE RIGHT TO USE "VEGETABLE", APART FROM THE MARK AS SHOWN.

THE NON-LATIN CHARACTERS IN THE MARK TRANSLITERATE TO "WEI JU TE" AND THIS MEANS "SAFOR", "GATHER", AND "SPECIAL", RESPECTIVELY, IN ENGLISH. THE COMBINATION OF NON-LATIN CHARACTERS IN THE MARK HAS NO MEANING IN ENGLISH.

CLASS 29—MEATS AND PROCESSED FOODS

FOR PICKLES; SAUERKRAUT; BRINED VEGETABLE; PRESERVED SZECHUAN PICKLE; PRESERVED VEGETABLE; PROCESSED KOHLRABI; PRESERVED VEGETABLE IN SOY; PRESERVED BEANCURD; PROCESSED EDIBLE SEAWEED; POTATO FLAKES; EDIBLE OILS (U.S. CL. 46).

CLASS 30—STAPLE FOODS

FOR VINEGAR; SOYA SAUCE; SEASONINGS; SEASONING FOR INSTANT-BOILED MUTTON; BEAN VERMICELLI; LOBSTER SAUCE; CHILLI OIL; FIVE SPICES POWDER; MONOSODIUM GLUTAMATE BEING SEASONING FOR FOOD; FARINACEOUS FOODS, NAMELY, PASTA, FLOUR (U.S. CL. 46).

LIEF MARTIN, EXAMINING ATTORNEY

SN 79-070,857. IPETRONIK GMBH & CO. KG, FED REP GERMANY, FILED 4-7-2009.

IPEmotion

THE MARK CONSISTS OF STANDARD CHARACTERS WITHOUT CLAIM TO ANY PARTICULAR FONT, STYLE, SIZE, OR COLOR.

PRIORITY DATE OF 10-17-2008 IS CLAIMED.
OWNER OF INTERNATIONAL REGISTRATION 1007546 DATED 4-7-2009, EXPIRES 4-7-2019.

CLASS 7—MACHINERY

FOR MACHINES AND MACHINE REPLACEMENT PARTS THEREFORE FOR METAL AND PLASTICS PROCESSING AND FOR USE IN THE ELECTRICAL INDUSTRY FOR ELECTRIC WELDING PURPOSES; MOTORS OTHER THAN FOR LAND VEHICLES; COUPLINGS AND DEVICES FOR POWER TRANSMISSION OTHER THAN THOSE FOR LAND VEHICLES (U.S. CLS. 13, 19, 21, 23, 31, 34 AND 35).

CLASS 9—ELECTRICAL AND SCIENTIFIC APPARATUS

FOR SCIENTIFIC, SURVEYING, MEASURING, SIGNALING AND CHECKING INSTRUMENTS AND APPARATUS NAMELY, AUTOMOTIVE MEASURING INSTRUMENTS, NAMELY, WATER TEMPERATURE GAUGES, AIR/FUEL RATIO GAUGES, BOOST GAUGES, VACUUM GAUGES AND EXHAUST GAS TEMPERATURE GAUGES; AUTOMOTIVE TESTING EQUIPMENT, NAMELY, TRANSMISSION TESTING AND BRAKE TESTING EQUIPMENT; CONTROL SYSTEM FOR THE REMOTE OBSERVATION, MANAGEMENT AND OPERATION OF VEHICLES, COMPRISING COMPUTERS, SOFTWARE, ELECTROMECHANICAL CONTROLS, AND VIDEO DISPLAY SCREENS; ELECTRONIC APPARATUS, NAMELY, MOTION DETECTORS; ELECTRONIC CONTROLS FOR MOTORS; ELECTRONIC DEVICES FOR VEHICLE LOCATING AND TRACKING PROGRAMMED TO USE GLOBAL POSITIONING SYSTEMS (GPS) AND CELLULAR COMMUNICATIONS; MEASURING APPARATUS FOR TEMPERATURE AND HUMIDITY LEVELS IN GASES AND SOLID SUBSTANCES; SENSORS FOR THE DETERMINATION OF TEMPERATURES, POSITIONS AND DISTANCES; SIGNAL PROCESSORS; SIGNAL CONDITIONING AND COMMUNICATION DEVICES FOR INDUSTRIAL PROCESS CONTROL; TEMPERATURE METERS, NOT FOR MEDICAL USE; VEHICLE DETECTION EQUIPMENT, NAMELY, DISPLAY MONITORS, COMPUTERS, IMAGE SENSORS, VIDEO CAMERAS, AND OPERATING SYSTEM AND APPLICATION SOFTWARE TO DETECT LOCATION; VEHICLE ENGINE PARTS, NAMELY, THERMOSTATS; ELECTRIC INSTALLATIONS IN THE NATURE OF COMPUTER HARDWARE AND SOFTWARE FOR THE ACQUISITION, CONTROL AND CHECKING OF INDUSTRIAL WORKING OPERATIONS; DATA PROCESSING EQUIPMENT DEVICES AND COMPUTERS (U.S. CLS. 21, 23, 26, 36 AND 38).

CLASS 12—VEHICLES

FOR LAND VEHICLES AND STRUCTURAL PARTS THEREFOR; APPARATUS FOR LOCOMOTION BY LAND, AIR, AND WATER, NAMELY, AUTOMOBILES, MOTORCYCLES, AIRPLANES, HELICOPTERS, MOTORBOATS, BICYCLES, HOVERCRAFT, LORRIES, VANS, TRUCKS, BUSES (U.S. CLS. 19, 21, 23, 31, 35 AND 44).

CLASS 37—CONSTRUCTION AND REPAIR

FOR INSTALLATION, REPAIR AND MAINTENANCE OF MEASURING STATIONS, NAMELY, OF NETWORKING HARDWARE, OF TESTING MACHINES, TESTING INSTRUMENTS AND, TESTING APPARATUS FOR VEHICLES FOR LOCOMOTION BY AIR, LAND AND WATER (U.S. CLS. 100, 103 AND 106).

CLASS 38—COMMUNICATION

FOR PROVIDING USER ACCESS TO GLOBAL COMPUTER DATA NETWORKS; PROVIDING MULTIPLE USER ACCESS TO A GLOBAL COMPUTER NETWORK; PROVIDING TELECOMMUNICATION CONNECTIONS TO A GLOBAL COMPUTER NETWORK; PROVIDING ACCESS TO COMPUTER PROGRAM DATABASES IN DATA NETWORKS; PROVIDING INTERNET ACCESS TO INFORMATION ON THE INTERNET (U.S. CLS. 100, 101 AND 104).

CLASS 42—SCIENTIFIC AND COMPUTER SERVICES

FOR SCIENTIFIC AND TECHNOLOGICAL SERVICES AND RESEARCH WORK AND RELATED DESIGNER SERVICES, NAMELY, CALIBRATION MEASURING; COMBUSTION ENGINE SYSTEMS DESIGN SERVICES; DESIGN AND DEVELOPMENT OF SOFTWARE AND HARDWARE FOR PRODUCING, RECORDING AND PROCESSING DIGITAL AND ANALOGUE SIGNALS, FOR SIGNAL TRANSMISSION AND AMPLIFICATION; DESIGN AND IMPLEMENTATION OF SOFTWARE AND TECHNOLOGY SOLUTIONS FOR THE PURPOSE OF MEASURING PHYSICAL PARAMETERS WITH SENSORS AND THE ACQUIRING AND PROCESSING OF THE MEASURED DATA; MOTOR VEHICLE PARTS DESIGN SERVICES; INDUSTRIAL ANALYSIS AND RESEARCH SERVICES IN THE FIELD OF AUTOMOBILE TRANSMISSION DIAGNOSTIC SERVICES, TESTING, ANALYSIS AND EVALUATION OF AUTOMOTIVE DEVICES; MATERIALS TESTING AND EVALUATION; MEASUREMENT EVALUATIONS IN THE FIELD OF LOCOMOTION OF AUTOMOTIVE VEHICLES; PROVIDING AN ONLINE NETWORK SERVICE THAT ENABLES USERS TO SHARE DATA IN THE FIELD OF DATA ACQUISITION OF AUTOMOTIVE DEVICES; RECORDING DATA FOR OTHERS ON OPTICAL, DIGITAL AND MAGNETIC MEDIA FOR ELECTRONIC STORAGE; RESEARCH, DEVELOPMENT, ENGINEERING AND TESTING SERVICES IN THE FIELDS OF DATA ACQUISITION ON AUTOMOTIVE DEVICES DESIGN, DEVELOPMENT, TESTING AND RESEARCH ON MACHINES, APPARATUS AND INSTRUMENTS IN PARTICULAR IN THE FIELD OF AUTOMOTIVE TECHNIQUE; DESIGN AND DEVELOPMENT OF COMPUTER HARDWARE AND SOFTWARE, IN PARTICULAR IN THE FIELD OF AUTOMOTIVE TECHNIQUE; SERVICES OF AN ENGINEER; RENTAL OF MEASURING STATIONS APPARATUS INCLUDED IN THIS CLASS, IN PARTICULAR FOR DEVELOPMENT AND PILOT PRODUCTION IN THE FIELD OF AUTOMOTIVE TECHNIQUE (U.S. CLS. 100 AND 101).

JACLYN KIDWELL WALKER, EXAMINING ATTORNEY

SN 79-070,861. PAUL LATHROPE, UNITED KINGDOM, FILED 5-21-2009.



Quotemyjob

PRIORITY DATE OF 5-7-2009 IS CLAIMED.
OWNER OF INTERNATIONAL REGISTRATION 1007558 DATED 5-21-2009, EXPIRES 5-21-2019.

THE MARK CONSISTS OF THE LETTER "Q" IN A CIRCLE FOLLOWED BY THE WORD "QUOTEMYJOB".

CLASS 9—ELECTRICAL AND SCIENTIFIC APPARATUS

FOR COMPUTER SOFTWARE DEVELOPMENT TOOLS AND APPLICATION PROGRAM INTERFACES TO THIRD PARTY APPLICATIONS (API) FOR ENABLING THE UPLOADING, POSTING, DISPLAYING, TAGGING, SHARING OR OTHERWISE PROVIDING OTHER ELECTRONIC MEDIA OR INFORMATION AS A PLATFORM FOR EXCHANGING OF INFORMATION, TRACKING OF PROGRESS OF A PROJECT OR SERVICE, AND COMPLETING A TRANSACTION FOR PAYMENT OVER THE INTERNET OR OTHER COMMUNICATIONS NETWORKS IN THE FIELD OF THE CONSUMER SERVICE INDUSTRY (U.S. CLS. 21, 23, 26, 36 AND 38).

CLASS 35—ADVERTISING AND BUSINESS

FOR PRICING AND ADVERTISING SERVICES OPERATING AS AN ONLINE MARKETPLACE FOR BUYERS AND SELLERS, DELIVERED VIA THE INTERNET, OF SERVICES TO A VARIETY OF COMMERCIAL AND CONSUMER REQUIREMENTS BY; PROVIDING STRUCTURED REQUEST FOR PRICING OF GOODS AND SERVICES; PROVIDING A SEARCHABLE DATABASE OF PROVIDERS OF GOODS AND SERVICES; PROVIDING ADVICE ON PLANNING EVENTS, PROJECTS, AND SERVICE; PROVIDING ACCESS TO CROWD SOURCED INFORMATION AND EVALUATION OF QUALITY OF GOODS AND SERVICES; PROVIDING LINKAGE TO SOCIAL NETWORKS FOR THE PURPOSE OF ENABLING A MORE COMPREHENSIVE PROFILE OF THE BUYERS AND SELLERS OF GOODS AND SERVICES; PROVIDING ACCESS TO A HOST OF BUSINESS SERVICES INCLUDING WEBSITE HOSTING, MICRO-SITE, E-BANKING, BID AND PROPOSAL MANAGEMENT, ADVERTISING AND SEARCH ENGINE OPTIMIZATION (U.S. CLS. 100, 101 AND 102).

CLASS 38—COMMUNICATION

FOR TELECOMMUNICATION SERVICES, NAMELY, PROVIDING ELECTRONIC ACCESS TO A HOST OF COMMUNICATION SERVICES AND PLATFORMS; PROVIDING ONLINE FORUMS, CHAT ROOMS AND ELECTRONIC MESSAGE BOARDS FOR REGISTERED USERS FOR TRANSMISSION OF MESSAGES IN TEXT, AUDIO, PICTURES AND VIDEO FORMATS CONCERNING SERVICES RENDERED, PROJECTS COMPLETED, AND GENERAL SHARING OF IDEAS AND ADVICE OF A HOST OF SERVICES AND NEEDS (U.S. CLS. 100, 101 AND 104).

CLASS 42—SCIENTIFIC AND COMPUTER SERVICES

FOR DESIGN AND DEVELOPMENT OF INTERNET WEBSITES; COMPUTER PROGRAMMING (U.S. CLS. 100 AND 101).
SUZANNE BLANE, EXAMINING ATTORNEY

SN 79-070,910. CHINA NATIONAL HEAVY DUTY TRUCK GROUP CO., LTD., CHINA, FILED 2-16-2009.

CLASS 7—MACHINERY

FOR GASOLINE-POWERED MACHINES OTHER THAN FOR LAND VEHICLES, NAMELY, ELECTRICITY GENERATORS; DIESEL-OPERATED MACHINES OTHER THAN FOR LAND VEHICLES, NAMELY, DIESEL-OPERATED WATER PUMPS FOR USE IN MOTORS AND ENGINES; GLOW PLUGS; CARBURETORS; IGNITING DEVICES, NAMELY, SPARK PLUGS FOR INTERNAL COMBUSTION ENGINES; FUEL ECONOMIZERS FOR INTERNAL-COMBUSTION ENGINES; DYNAMOS; PISTONS FOR ENGINES, NAMELY, FOR INDUSTRIAL ENGINES; EXHAUST GAS REFINING DEVICE, NAMELY, A CATALYTIC CONVERTER FOR INTERNAL-COMBUSTION ENGINE; OIL FILTERS, NAMELY, DIESEL OIL FILTERS FOR MOTORS AND ENGINES (U.S. CLS. 13, 19, 21, 23, 31, 34 AND 35).

CLASS 12—VEHICLES

FOR BUSES; TILTING CARTS; MOTOR LAND VEHICLES, NAMELY, AUTOMOBILES, MOTOR COACHES, TRUCKS, VANS, SPORTS CARS; TIRES FOR VEHICLE WHEELS; FORK LIFT TRUCKS; TRAILERS FOR VEHICLES; AUTOMOBILE CHASSIS; BODIES FOR VEHICLES; UPHOLSTERY FOR VEHICLES; FUNICULARS; LOCOMOTIVES; VEHICLE WHEELS (U.S. CLS. 19, 21, 23, 31, 35 AND 44).

CLASS 37—CONSTRUCTION AND REPAIR

FOR MOTOR VEHICLE MAINTENANCE AND REPAIR; VEHICLE CLEANING; VEHICLE SERVICES STATION SERVICES FEATURING REFUELING AND MAINTENANCE SERVICES; CONSTRUCTION, NAMELY, BUILDING CONSTRUCTION SERVICES; BUILDING CONSTRUCTION SUPERVISION; UPHOLSTERING; RETREADING OF TIRES; DISINFECTING SERVICES, NAMELY, HEAT BASED DISINFECTING SERVICES, NAMELY, KILLING OF ORGANISMS AND REMOVAL OF TOXINS IN ENCLOSED ENVIRONMENTS, DRYING, DISINFECTION, REDUCTION OF ASTHMA TRIGGERS, BAKING OUT ODORS, DESTROYING VIRUSES AND BACTERIA (U.S. CLS. 100, 103 AND 106).

RONALD DELGIZZI, EXAMINING ATTORNEY

SN 79-070,954. FRANCES PRENNA JONES (DR), UNITED KINGDOM, FILED 1-23-2009.

DR FRANCES PRENNA JONES

HOWO

THE MARK CONSISTS OF STANDARD CHARACTERS WITHOUT CLAIM TO ANY PARTICULAR FONT, STYLE, SIZE, OR COLOR.

OWNER OF INTERNATIONAL REGISTRATION 1007692 DATED 2-16-2009, EXPIRES 2-16-2019.

THE WORDING "HOWO" HAS NO MEANING IN A FOREIGN LANGUAGE.

THE MARK CONSISTS OF STANDARD CHARACTERS WITHOUT CLAIM TO ANY PARTICULAR FONT, STYLE, SIZE, OR COLOR.

OWNER OF INTERNATIONAL REGISTRATION 1007825 DATED 1-23-2009, EXPIRES 1-23-2019.

THE NAME(S), PORTRAIT(S), AND/OR SIGNATURE(S) SHOWN IN THE MARK IDENTIFIES "DR. FRANCES PRENNA JONES", WHOSE CONSENT(S) TO REGISTER IS MADE OF RECORD.

CLASS 3—COSMETICS AND CLEANING PREPARATIONS

FOR COSMETICS; NON-MEDICATED TOILETRIES; NON-MEDICATED SKIN CARE PREPARATIONS; SKIN CARE PRODUCTS, NAMELY, SKIN CLEANSERS, SKIN EXFOLIATORS, SKIN MOISTURIZER, SUNSCREEN FOR THE SKIN; PREPARATIONS FOR THE EYES, FACE, NECK, HANDS AND BODY, NAMELY, EYE CREAM, FACE CREAM, NECK CREAM, BODY CREAM AND HAND CREAM; SKIN EMOLLIENTS; SKIN CREAMS; NON-MEDICATED SKIN SERUMS; COSMETIC MILKS; SKIN LOTIONS; SKIN TONERS; SKIN TONIC LOTIONS; SKIN MASKS; GEL, NAMELY, HAIR GELS, EYE GELS AND BATH GELS; OILS, NAMELY, COSMETIC OILS, AROMATHERAPY OILS AND BATH OILS; SOAPS; BODY AND FACE WASHES; BODY AND FACE SCRUBS; ASTRINGENTS FOR COSMETIC PURPOSES; SKIN CLARIFIERS; NON-MEDICATED COLLAGEN SKIN CARE PREPARATIONS FOR COSMETIC PURPOSES; NON-MEDICATED SKIN CARE PREPARATIONS AND APPLICATIONS FOR COSMETIC APPLICATION; NON-MEDICATED ANTI-WRINKLE AND ANTI-AGING SKINCARE PRODUCTS, PREPARATIONS AND APPLICATIONS FOR THE EYES, FACE, NECK, HANDS AND BODY, NAMELY, ANTI-AGING CREAMS, ANTI-AGING CLEANSERS AND ANTI-AGING MOISTURIZERS; NON-MEDICATED ANTI-WRINKLE AND ANTI-AGING SKIN EMOLLIENTS, CREAMS, SERUMS, MILKS, LOTIONS, TONERS, TONIC LOTIONS, MASKS, GELS, OILS, SOAPS, WASHES, SCRUBS, ASTRINGENTS AND CLARIFIERS; NON-MEDICATED WASHING, RINSING, CLEANSING, BLEACHING, POLISHING, SCRUBBING, ABRASIVE, EXFOLIATING AND MOISTURIZING PRODUCTS, PREPARATIONS AND APPLICATIONS FOR THE SKIN IN THE FORM OF CREAMS, SERUMS, MILKS, LOTIONS, TONERS, TONIC LOTIONS, EMOLLIENTS, MASKS, GELS, OILS, SOAPS, WASHES, SCRUBS, ASTRINGENTS AND CLARIFIERS; SKIN LIGHTENERS; PROTECTIVE LIP CARE PREPARATIONS FOR COSMETIC PURPOSES; LIPSTICK; LIP BALM; LIP GLOSS; LIP CREAM; LIP LOTION; LIP EMOLLIENT; MAKE-UP PREPARATIONS; MAKE-UP REMOVING MILKS, CREAMS, GELS AND LOTIONS; MAKE-UP REMOVING WASHES, RINSES, SCRUBS, EXFOLIATORS AND ASTRINGENTS; SUN BLOCK AND SUN SCREEN; SUN-TANNING, SELF-TANNING AND AFTER-SUN PRODUCTS AND PREPARATIONS IN THE FORM OF SERUMS, MILKS, LOTIONS, GELS, SPRAYS AND OILS; NAIL POLISH; NAIL POLISH REMOVER; SHOWER AND BATH PREPARATIONS, NAMELY, SHOWER AND BATH SOAP, SHOWER AND BATH GEL, BATH SALT AND BATH OIL; COSMETIC PREPARATIONS FOR THE HAIR; SHAVING AND AFTER SHAVE PREPARATIONS; PERFUMES; COLOGNES; TOILET WATERS; EAUX DE COLOGNE; DEODORANTS AND ANTI-PERSPIRANTS FOR PERSONAL USE; ESSENTIAL OILS; AROMATHERAPY BODY AND FACE CARE PRODUCTS, NAMELY, CREAMS, LOTIONS, TONERS, SERUMS, OILS, GELS, SHAMPOOS AND CONDITIONERS; DENTIFRICES (U.S. CLS. 1, 4, 6, 50, 51 AND 52).

CLASS 5—PHARMACEUTICALS

FOR PHARMACEUTICAL, MEDICATED AND DERMATOLOGICAL SKINCARE PRODUCTS, PREPARATIONS, APPLICATIONS AND TREATMENTS FOR THE EYES, FACE, NECK, HANDS AND BODY, NAMELY, PHARMACEUTICAL PREPARATIONS FOR THE TREATMENT OF EYE DISEASES AND CONDITIONS, PHARMACEUTICAL SKIN CREAMS AND LOTIONS, DERMATOLOGICAL SKIN CREAMS AND LOTIONS, AND MEDICATED SERUMS FOR TREATMENT OF SKIN; MEDICATED PRODUCTS, PREPARATIONS, APPLICATIONS AND TREATMENTS FOR TREATING CONDITIONS OF THE SKIN, NAMELY, MOISTURIZERS, CREAMS, LOTIONS, GELS, TONERS, CLEANSERS, SERUMS, MASKS AND PEELS; MEDICATED PRODUCTS, PREPARATIONS, APPLICATIONS AND TREATMENTS FOR USE IN MICRODERMABRASION, GLYCOLIC ACID PEELS AND CHEMICAL PEELS; MEDICATED PRODUCTS, PREPARATIONS, APPLICATIONS AND TREATMENTS CONTAINING COLLAGEN, NAMELY, GELS, CREAMS, LOTIONS, SERUMS, TONERS AND SOLUTIONS FOR DERMATOLOGICAL USE; PRODUCTS, PREPARATIONS, APPLICATIONS AND TREATMENTS FOR THE TREATMENT OF ACNE, ALL

FOR MEDICAL PURPOSES, NAMELY, ACNE MEDICATIONS AND ACNE TREATMENT PREPARATIONS; DERMATOLOGICAL AND DERMA-COSMETIC PHARMACEUTICAL PRODUCTS; DERMATOLOGICAL AND DERMA-COSMETIC PHARMACEUTICAL PRODUCTS, ALL FOR THE PREVENTION OF AGING OF THE SKIN; DERMATOLOGICAL AND DERMA-COSMETIC PHARMACEUTICAL PRODUCTS, ALL FOR THE TREATMENT OF THE SKIN; MEDICATED SKIN CARE PREPARATIONS, NAMELY, WASHING, RINSING, BLEACHING, POLISHING, CLEANSING, MOISTURIZING, SCRUBBING, ABRASIVE AND EXFOLIATING ANTI-AGING AND ANTI-WRINKLE SKINCARE PRODUCTS, PREPARATIONS, APPLICATIONS AND TREATMENTS FOR THE EYES, FACE, NECK, HANDS AND BODY IN THE FORM OF CREAMS, SERUMS, MILKS, LOTIONS, TONERS, TONIC LOTIONS, MASKS, SPRAYS, GELS, OILS, WASHES, EXFOLIATORS, SCRUBS, EMOLLIENTS, ASTRINGENTS AND CLARIFIERS; MEDICATED SKIN CARE PREPARATIONS, NAMELY, SELF-TANNING ANTI-AGING AND ANTI-WRINKLE PRODUCTS, PREPARATIONS, APPLICATIONS AND TREATMENTS IN THE FORM OF CREAMS, MILKS, LOTIONS, SPRAYS AND GELS; MEDICATED SKIN CARE PREPARATIONS, NAMELY, FACE MASKS, EYE MASKS, GEL-BASED FACE MASKS, GEL-BASED EYE MASKS; MEDICATED PROTECTIVE LIP CARE PREPARATIONS, NAMELY, LIP BALM, LIP SERUM; MEDICATED LIPSTICKS, LIP BALMS, LIP GLOSSES, LIP CREAMS, LIP LOTIONS AND LIP EMOLLIENTS; VITAMIN PREPARATIONS; HERBAL REMEDIES, NAMELY, MEDICINAL HERBS AND HERBAL SUPPLEMENTS; HOMEOPATHIC MEDICINES FOR USE IN THE TREATMENT OF SKIN DISEASES AND SKIN CONDITIONS; MINERAL FOOD SUPPLEMENTS; DIETETIC FOODS AND BEVERAGES ADAPTED FOR MEDICAL USE; NUTRITIONAL ADDITIVES FOR MEDICAL PURPOSES FOR USE IN FOODS AND DIETARY SUPPLEMENTS FOR HUMAN CONSUMPTION (U.S. CLS. 6, 18, 44, 46, 51 AND 52).

CLASS 44—MEDICAL, BEAUTY AND AGRICULTURAL SERVICES

FOR BEAUTY TREATMENT SERVICES, NAMELY, BEAUTY SPA SERVICES IN THE FIELD OF COSMETIC BODY CARE; BEAUTY SALON SERVICES; MEDICAL SERVICES; MEDICAL DERMATOLOGICAL SERVICES, INCLUDING APPLICATIONS AND TREATMENTS FOR TREATING CONDITIONS OF THE SKIN; COSMETIC ELECTROLYSIS; DEPILATORY HAIR REMOVAL SERVICES; HEALTH SPA SERVICES, NAMELY, COSMETIC BODY CARE SERVICES; MASSAGE SERVICES; PROVISION OF INFORMATION, CONSULTANCY AND ADVISORY SERVICES RELATING TO BEAUTY TREATMENT SERVICES, BEAUTY SALON SERVICES, MEDICAL SERVICES, DERMATOLOGICAL SERVICES, ELECTROLYSIS, DEPILATORY SERVICES, HEALTH SPA SERVICES AND MASSAGE SERVICES (U.S. CLS. 100 AND 101).

KRISTIN CARLSON, EXAMINING ATTORNEY

SN 79-070,955. FRANCES PRENNA JONES (DR), UNITED KINGDOM, FILED 1-23-2009.

DR FPJ

THE MARK CONSISTS OF STANDARD CHARACTERS WITHOUT CLAIM TO ANY PARTICULAR FONT, STYLE, SIZE, OR COLOR.

PRIORITY DATE OF 7-25-2008 IS CLAIMED.

OWNER OF INTERNATIONAL REGISTRATION 1007826 DATED 1-23-2009, EXPIRES 1-23-2019.

THE NAME(S), PORTRAIT(S), AND/OR SIGNATURE(S) SHOWN IN THE MARK IDENTIFIES "DR. FRANCES PRENNA JONES", WHOSE CONSENT(S) TO REGISTER IS MADE OF RECORD.

CLASS 3—COSMETICS AND CLEANING PREPARATIONS

FOR COSMETICS; NON-MEDICATED TOILETRIES; NON-MEDICATED SKIN CARE PREPARATIONS; SKIN CARE PRODUCTS, NAMELY, SKIN CLEANSERS, SKIN EXFOLIATORS, SKIN MOISTURIZER, SUNSCREEN FOR THE SKIN; PREPARATIONS FOR THE EYES, FACE, NECK, HANDS AND BODY, NAMELY, EYE CREAM, FACE CREAM, NECK CREAM, BODY CREAM AND HAND CREAM; SKIN EMOLLIENTS; SKIN CREAMS; NON-MEDICATED SKIN SERUMS; COSMETIC MILKS; SKIN LOTIONS; SKIN TONERS; SKIN TONIC LOTIONS; SKIN MASKS; GEL, NAMELY, HAIR GELS, EYE GELS AND BATH GELS; OILS, NAMELY, COSMETIC OILS, AROMATHERAPY OILS AND BATH OILS; SOAPS; BODY AND FACE WASHES; BODY AND FACE SCRUBS; ASTRINGENTS FOR COSMETIC PURPOSES; SKIN CLARIFIERS; NON-MEDICATED COLLAGEN SKIN CARE PREPARATIONS FOR COSMETIC PURPOSES; NON-MEDICATED SKIN CARE PREPARATIONS AND APPLICATIONS FOR COSMETIC APPLICATION; NON-MEDICATED ANTI-WRINKLE AND ANTI-AGING SKINCARE PRODUCTS, PREPARATIONS AND APPLICATIONS FOR THE EYES, FACE, NECK, HANDS AND BODY, NAMELY, ANTI-AGING CREAMS, ANTI-AGING CLEANSERS AND ANTI-AGING MOISTURIZERS; NON-MEDICATED ANTI-WRINKLE AND ANTI-AGING SKIN EMOLLIENTS, CREAMS, SERUMS, MILKS, LOTIONS, TONERS, TONIC LOTIONS, MASKS, GELS, OILS, SOAPS, WASHES, SCRUBS, ASTRINGENTS AND CLARIFIERS; NON-MEDICATED WASHING, RINSING, CLEANSING, BLEACHING, POLISHING, SCRUBBING, ABRASIVE, EXFOLIATING AND MOISTURIZING PRODUCTS, PREPARATIONS AND APPLICATIONS FOR THE SKIN IN THE FORM OF CREAMS, SERUMS, MILKS, LOTIONS, TONERS, TONIC LOTIONS, EMOLLIENTS, MASKS, GELS, OILS, SOAPS, WASHES, SCRUBS, ASTRINGENTS AND CLARIFIERS; SKIN LIGHTENERS; PROTECTIVE LIP CARE PREPARATIONS FOR COSMETIC PURPOSES; LIPSTICK; LIP BALM; LIP GLOSS; LIP CREAM; LIP LOTION; LIP EMOLLIENT; MAKE-UP PREPARATIONS; MAKE-UP REMOVING MILKS, CREAMS, GELS AND LOTIONS; MAKE-UP REMOVING WASHES, RINSES, SCRUBS, EXFOLIATORS AND ASTRINGENTS; SUN BLOCK AND SUN SCREEN; SUN-TANNING, SELF-TANNING AND AFTER-SUN PRODUCTS AND PREPARATIONS IN THE FORM OF SERUMS, MILKS, LOTIONS, GELS, SPRAYS AND OILS; NAIL POLISH; NAIL POLISH REMOVER; SHOWER AND BATH PREPARATIONS, NAMELY, SHOWER AND BATH SOAP, SHOWER AND BATH GEL, BATH SALT AND BATH OIL; COSMETIC PREPARATIONS FOR THE HAIR; SHAVING AND AFTER SHAVE PREPARATIONS; PERFUMES; COLOGNES; TOILET WATERS; EAUX DE COLOGNE; DEODORANTS AND ANTI-PERSPIRANTS FOR PERSONAL USE; ESSENTIAL OILS; AROMATHERAPY BODY AND FACE CARE PRODUCTS, NAMELY, CREAMS, LOTIONS, TONERS, SERUMS, OILS, GELS, SHAMPOOS AND CONDITIONERS; DENTIFRICES (U.S. CLS. 1, 4, 6, 50, 51 AND 52).

CLASS 5—PHARMACEUTICALS

FOR PHARMACEUTICAL, MEDICATED AND DERMATOLOGICAL SKINCARE PRODUCTS, PREPARATIONS, APPLICATIONS AND TREATMENTS FOR THE EYES, FACE, NECK, HANDS AND BODY, NAMELY, PHARMACEUTICAL PREPARATIONS FOR THE TREATMENT OF EYE DISEASES AND CONDITIONS, PHARMACEUTICAL SKIN CREAMS AND LOTIONS, DERMATOLOGICAL SKIN CREAMS AND LOTIONS, AND MEDICATED SERUMS FOR TREATMENT OF SKIN; MEDICATED PRODUCTS, PREPARATIONS, APPLICATIONS AND TREATMENTS FOR TREATING CONDITIONS OF THE SKIN, NAMELY, MOISTURIZERS, CREAMS, LOTIONS, GELS, TONERS, CLEANSERS, SERUMS, MASKS AND PEELS; MEDICATED PRODUCTS, PREPARATIONS, APPLICATIONS AND TREATMENTS FOR USE IN MICRODERMABRASION, GLYCOLIC ACID PEELS AND CHEMICAL PEELS; MEDICATED PRODUCTS, PREPARATIONS, APPLICATIONS AND TREATMENTS CONTAINING COLLAGEN, NAMELY, GELS, CREAMS, LOTIONS, SERUMS, TONERS AND SOLUTIONS FOR DERMATOLOGICAL USE; PRODUCTS, PREPARATIONS, APPLICATIONS AND TREATMENTS FOR THE TREATMENT OF ACNE, ALL

FOR MEDICAL PURPOSES, NAMELY, ACNE MEDICATIONS AND ACNE TREATMENT PREPARATIONS; DERMATOLOGICAL AND DERMA-COSMETIC PHARMACEUTICAL PRODUCTS; DERMATOLOGICAL AND DERMA-COSMETIC PHARMACEUTICAL PRODUCTS, ALL FOR THE PREVENTION OF AGING OF THE SKIN; DERMATOLOGICAL AND DERMA-COSMETIC PHARMACEUTICAL PRODUCTS, ALL FOR THE TREATMENT OF THE SKIN; MEDICATED SKIN CARE PREPARATIONS, NAMELY, WASHING, RINSING, BLEACHING, POLISHING, CLEANSING, MOISTURIZING, SCRUBBING, ABRASIVE AND EXFOLIATING ANTI-AGING AND ANTI-WRINKLE SKINCARE PRODUCTS, PREPARATIONS, APPLICATIONS AND TREATMENTS FOR THE EYES, FACE, NECK, HANDS AND BODY IN THE FORM OF CREAMS, SERUMS, MILKS, LOTIONS, TONERS, TONIC LOTIONS, MASKS, SPRAYS, GELS, OILS, WASHES, EXFOLIATORS, SCRUBS, EMOLLIENTS, ASTRINGENTS AND CLARIFIERS; MEDICATED SKIN CARE PREPARATIONS, NAMELY, SELF-TANNING ANTI-AGING AND ANTI-WRINKLE PRODUCTS, PREPARATIONS, APPLICATIONS AND TREATMENTS IN THE FORM OF CREAMS, MILKS, LOTIONS, SPRAYS AND GELS; MEDICATED SKIN CARE PREPARATIONS, NAMELY, FACE MASKS, EYE MASKS, GEL-BASED FACE MASKS, GEL-BASED EYE MASKS; MEDICATED PROTECTIVE LIP CARE PREPARATIONS, NAMELY, LIP BALM, LIP SERUM; MEDICATED LIPSTICKS, LIP BALMS, LIP GLOSSES, LIP CREAMS, LIP LOTIONS AND LIP EMOLLIENTS; VITAMIN PREPARATIONS; HERBAL REMEDIES, NAMELY, MEDICINAL HERBS AND HERBAL SUPPLEMENTS; HOMEOPATHIC MEDICINES FOR USE IN THE TREATMENT OF SKIN DISEASES AND SKIN CONDITIONS; MINERAL FOOD SUPPLEMENTS; DIETETIC FOODS AND BEVERAGES ADAPTED FOR MEDICAL USE; NUTRITIONAL ADDITIVES FOR MEDICAL PURPOSES FOR USE IN FOODS AND DIETARY SUPPLEMENTS FOR HUMAN CONSUMPTION (U.S. CLS. 6, 18, 44, 46, 51 AND 52).

CLASS 44—MEDICAL, BEAUTY AND AGRICULTURAL SERVICES

FOR BEAUTY TREATMENT SERVICES, NAMELY, BEAUTY SPA SERVICES IN THE FIELD OF COSMETIC BODY CARE; BEAUTY SALON SERVICES; MEDICAL SERVICES; MEDICAL DERMATOLOGICAL SERVICES, INCLUDING APPLICATIONS AND TREATMENTS FOR TREATING CONDITIONS OF THE SKIN; COSMETIC ELECTROLYSIS; DEPILATORY HAIR REMOVAL SERVICES; HEALTH SPA SERVICES, NAMELY, COSMETIC BODY CARE SERVICES; MASSAGE SERVICES; PROVISION OF INFORMATION, CONSULTANCY AND ADVISORY SERVICES RELATING TO BEAUTY TREATMENT SERVICES, BEAUTY SALON SERVICES, MEDICAL SERVICES, DERMATOLOGICAL SERVICES, ELECTROLYSIS, DEPILATORY SERVICES, HEALTH SPA SERVICES AND MASSAGE SERVICES (U.S. CLS. 100 AND 101).

KRISTIN CARLSON, EXAMINING ATTORNEY

SN 79-070,956. DECATHLON, FRANCE, FILED 3-5-2009.

OXYLANE

THE MARK CONSISTS OF STANDARD CHARACTERS WITHOUT CLAIM TO ANY PARTICULAR FONT, STYLE, SIZE, OR COLOR.

PRIORITY DATE OF 9-15-2008 IS CLAIMED.
OWNER OF INTERNATIONAL REGISTRATION 1007831 DATED 3-5-2009, EXPIRES 3-5-2019.

THE WORDING "OXYLANE" HAS NO MEANING IN A FOREIGN LANGUAGE.

CLASS 37—CONSTRUCTION AND REPAIR

FOR REPAIR, MAINTENANCE AND CLEANING OF SPORTS EQUIPMENT; LEATHER CLEANING AND REPAIR (U.S. CLS. 100, 103 AND 106).

CLASS 39—TRANSPORTATION AND STORAGE

FOR ARRANGING FOR TRANSPORT AND WAREHOUSING OF GOODS FOR OTHERS; RENTAL SERVICES, NAMELY, RENTAL OF WAREHOUSE SPACE; TRANSPORT OF GOODS; PACKAGING AND STORAGE OF GOODS, NAMELY, WAREHOUSE STORAGE; STORAGE AND DELIVERY OF GOODS; WRAPPING SERVICES FOR BAGGAGE PROTECTION DURING TRAVEL; PACKAGING OF GOODS FOR TRANSPORTATION; WRAPPING OF GOODS FOR OTHERS FOR BAGGAGE PROTECTION DURING TRAVEL (U.S. CLS. 100 AND 105).

RONALD DELGIZZI, EXAMINING ATTORNEY

SN 79-070,978. BUSHIDO GROUP LTD., BR.VIRGIN ISLANDS, FILED 5-20-2009.



OWNER OF INTERNATIONAL REGISTRATION 1007874 DATED 5-20-2009, EXPIRES 5-20-2019.

THE MARK CONSISTS OF THE STYLIZED DESIGN OF A SAMURAI WARRIOR.

CLASS 30—STAPLE FOODS

FOR COFFEE, TEA, COCOA, SUGAR, RICE, TAPIOCA, SAGO, ARTIFICIAL COFFEE; FLOUR AND PREPARATIONS MADE FROM CEREALS, NAMELY, CEREAL-BASED BARS, CEREAL-BASED SNACK FOOD, BREAKFAST CEREALS, PROCESSED CEREALS, UNPROCESSED CEREALS; BREAD, PASTRY AND CONFECTIONERY, NAMELY CONFECTIONERY CHIPS FOR BAKING, ALMOND PASTE, CHOCOLATE FOR CONFECTIONERY, FROZEN CONFECTIONERY, GUM SWEETS, PEANUT BUTTER CONFECTIONERY CHIPS, CONFECTIONERY MADE OF SUGAR; ICES; HONEY, TREACLE; YEAST, BAKING-POWDER; SALT, MUSTARD; VINEGAR; CONDIMENTS, NAMELY, SAUCES; SPICES; ICE (U.S. CL. 46).

CLASS 32—LIGHT BEVERAGES

FOR BEERS; MINERAL AND AERATED WATERS AND OTHER NON-ALCOHOLIC DRINKS, NAMELY, BOTTLED WATER, MINERAL WATER, LEMONADES, SOFT DRINK, NON-ALCOHOLIC HONEY-BASED BEVERAGES, WHEY BEVERAGES, NON-ALCOHOLIC FRUIT JUICE BEVERAGES, MILK OF ALMONDS FOR BEVERAGE, FRUIT NECTARS, SYRUPS FOR LEMONADE, VEGETABLE JUICES; FRUIT DRINKS AND FRUIT JUICES; SYRUPS FOR MAKING BEVERAGES; SYRUPS FOR MAKING FLAVORED MINERAL WATER, FRUIT JUICE CONCENTRATES, FRUIT JUICE BASES, VEGETABLE JUICE CONCENTRATES, VEGETABLE JUICE BASES (U.S. CLS. 45, 46 AND 48).

CLASS 35—ADVERTISING AND BUSINESS

FOR ADVERTISING; BUSINESS MANAGEMENT; BUSINESS ADMINISTRATION; OFFICE FUNCTIONS (U.S. CLS. 100, 101 AND 102).

CAROLYN CATALDO, EXAMINING ATTORNEY

SN 79-071,014. AMBRA EUROPE S.A., LUXEMBOURG, FILED 5-21-2009.

OWNER OF INTERNATIONAL REGISTRATION 0883100 DATED 12-20-2005, EXPIRES 12-20-2015.

THE NAME(S), PORTRAIT(S), AND/OR SIGNATURE(S) SHOWN IN THE MARK DOES NOT IDENTIFY A PARTICULAR LIVING INDIVIDUAL.

CLASS 3—COSMETICS AND CLEANING PREPARATIONS

FOR SOAPS, PERFUMERY, FACE AND BODY BEAUTY CREAMS, BATH SALTS, SKIN LOTION, BODY LOTION, HAIR LOTION, BATH POWDER, BODY POWDER, TALCUM POWDER, LIPSTICKS, EYE SHADOW, NAIL VARNISH, HAIR SPRAY, SHAMPOOS, BATH AND SHOWERS CREAMS AND GELS, MOISTURISERS AND BUTTERS FOR THE SKIN, MOISTURISERS AND BUTTERS FOR THE BODY; NON-MEDICATED HAND WASH, SOAPS FOR PERSONAL USE, HAND CREAM, CUTICLE CREAM, TANNING SUBSTANCES, NAMELY, TANNING CREAMS AND SELF-TANNING MOISTURIZERS, GRADUAL TAN, NAMELY, SELF-TANNING PREPARATIONS, EXFOLIATING SCRUB AND BODY SCRUBS, SHIMMERING BODY BALM, SUBSTANCES AND PREPARATIONS FOR PEDICURES AND MANICURES, NAMELY, HAND AND NAIL CREAM, ESSENTIAL OILS (U.S. CLS. 1, 4, 6, 50, 51 AND 52).

CLASS 10—MEDICAL APPARATUS

FOR MEDICAL EQUIPMENT FOR THE BEAUTY AND THE WELLNESS OF THE HUMAN BODY, NAMELY, EQUIPMENT FOR DIETARY, SLIMMING AND WEIGHT REDUCTION PURPOSES IN THE NATURE OF PHYSICAL EXERCISE APPARATUS FOR MEDICAL PURPOSES; MASSAGE APPARATUS FOR MEDICAL PURPOSES; MEDICAL APPARATUS AND INSTRUMENTS FOR MONITORING VITAL SIGNS, BLOOD PROPERTIES, AND RESPIRATORY EVENTS; ELECTRICAL WEIGHT LOSS BODY BELTS; APPARATUS FOR CELLULITE TREATMENT, REDUCTION, AND ELIMINATION; AND THERAPEUTIC SAUNAS (U.S. CLS. 26, 39 AND 44).

CLASS 44—MEDICAL, BEAUTY AND AGRICULTURAL SERVICES

FOR BEAUTY SALONS; MEDICAL SERVICES OFFERED IN A HEALTH AND BEAUTY SPA FACILITY; MEDICAL ASSISTANCE; HYGIENE AND BEAUTY CARE FOR HUMAN BEINGS; MASSAGE SERVICES; BEAUTY PARLORS; SAUNA SERVICES; SUN LOUNGES, NAMELY, SKIN TANNING SERVICES FOR COSMETIC PURPOSES; HEALTHCARE SERVICES OFFERED AT A PHYSICAL FITNESS FACILITY; INFORMATION IN THE FIELDS OF HEALTH AND BEAUTY, COSMETIC, HYGIENE AND BODY CARE SERVICES (U.S. CLS. 100 AND 101).

APRIL HESIK, EXAMINING ATTORNEY

SN 79-071,094. VESTAS WIND SYSTEMS A/S, RANDERS SV, DENMARK, FILED 6-15-2009.

COOLER TOP

THE MARK CONSISTS OF STANDARD CHARACTERS WITHOUT CLAIM TO ANY PARTICULAR FONT, STYLE, SIZE, OR COLOR.

PRIORITY DATE OF 12-17-2008 IS CLAIMED.

OWNER OF INTERNATIONAL REGISTRATION 1008184 DATED 6-15-2009, EXPIRES 6-15-2019.

CLASS 7—MACHINERY

FOR WIND MILLS, OFFSHORE WINDMILLS, WIND POWER PLANTS, NAMELY, WIND POWERED ELECTRIC GENERATORS AND OFFSHORE WIND POWERED GENERATORS, WIND TURBINES, AND STRUCTURAL PARTS AND ACCESSORIES FOR THE AFORESAID GOODS, NAMELY, MILL TOWERS AND MASTS, BLADES, BLADE HUBS, MILL HOUSINGS, MACHINE BEDS, ROTATION DEVICES, YAW RINGS AND GEARS, DEVICES FOR SETTING THE PITCH OF THE WINGS, BRAKES AND BRAKE DEVICES, MAIN SHAFTS, UNIVERSAL JOINTS, TRANSMISSION CASES, CLUTCHES AND ELECTRIC GENERATORS AND RESERVE POWER SUPPLY PLANTS AND STRUCTURAL PARTS THEREFOR (U.S. CLS. 13, 19, 21, 23, 31, 34 AND 35).

CLASS 9—ELECTRICAL AND SCIENTIFIC APPARATUS

FOR ELECTRICAL AND ELECTRONIC EQUIPMENT FOR WIND MILLS, WIND POWER PLANTS AND WIND TURBINES, NAMELY, APPARATUS AND INSTRUMENTS FOR SUPERVISORY CONTROL OF AND DATA ACQUISITION FROM WIND MILLS, WIND POWER PLANTS AND WIND POWERED ELECTRICITY GENERATORS AS WELL AS CONVERTERS AND CONVERTER SYSTEMS; COMPUTERS AND COMPUTER HARDWARE FOR WIND MILLS, WIND POWER PLANTS AND WIND TURBINES; COMPUTER SOFTWARE FOR CONTROL AND MONITORING WIND MILLS, WIND TURBINES, WIND GENERATORS, WIND TURBINE GENERATORS, OFFSHORE WIND TURBINES, OFFSHORE WIND GENERATORS AND OFFSHORE WIND TURBINE GENERATORS FOR USE WITH WIND MILLS, WIND POWER PLANTS AND WIND TURBINES; ELECTRONIC CONTROL SYSTEMS FOR MACHINES, NAMELY, ELECTRONIC CONTROL AND MONITORING SYSTEMS FOR AUTOMATICALLY TURNING ON OR OFF THE GENERATORS AND FOR AUTOMATIC STARTING GENERATORS AFTER PUBLIC POWER LINE BREAKDOWNS; APPARATUS FOR OVER-VOLTAGE PROTECTION AGAINST STROKES OF LIGHTNING, NAMELY, VOLTAGE SURGE PROTECTORS; MICROPROCESSORS USED FOR CONTROLLING AND MONITORING CONSTANT VOLTAGE, FREQUENCY, PHASE CONDITIONS, ROTOR SPEED, EFFICIENCY AND THICKNESS OF BREAK PADS, TEMPERATURE, WIND DIRECTION AND WIND SPEED; ELECTRONIC OR ELECTRONIC SENSORS FOR VIBRATION, NAMELY, VIBRATION SENSORS FOR INSTALLATION IN MILL HOUSINGS; ELECTRIC METERS, NAMELY, WATT-HOUR METERS; STRUCTURAL PARTS FOR ALL THE AFORESAID GOODS (U.S. CLS. 21, 23, 26, 36 AND 38).

CLASS 37—CONSTRUCTION AND REPAIR

FOR ERECTION, CONSTRUCTION, INSTALLATION, SERVICE, MAINTENANCE AND REPAIR OF WIND MILLS, WIND POWER PLANTS, WIND TURBINES AND OTHER WIND-OPERATED MACHINES; ADVISORY, CONSULTANCY AND INFORMATION SERVICES RELATING TO ALL THE AFORESAID GOODS AND SERVICES (U.S. CLS. 100, 103 AND 106).

CLASS 42—SCIENTIFIC AND COMPUTER SERVICES

FOR TECHNICAL CONSULTING SERVICES IN THE AREA OF WIND MILL AND WIND POWER PROJECTS; DEVELOPMENT AND TESTING OF WIND MILLS, WIND POWER PLANTS, WIND TURBINES, WIND-OPERATED MACHINES, AND COMPONENTS THEREFOR; RESEARCH IN THE FIELD OF WIND MILLS, WIND POWER PLANTS, WIND TURBINES AND OTHER WIND-OPERATED MACHINES; ADVISORY AND CONSULTATION SERVICES IN THE FIELD OF WIND MILLS, WIND POWER PLANTS, WIND TURBINES AND OTHER WIND-OPERATED MACHINES (U.S. CLS. 100 AND 101).

DAWN FELDMAN, EXAMINING ATTORNEY

SN 79-071,151. SULAKE CORPORATION OY, FINLAND, FILED 1-27-2009.

BOBBA

THE MARK CONSISTS OF STANDARD CHARACTERS WITHOUT CLAIM TO ANY PARTICULAR FONT, STYLE, SIZE, OR COLOR.

PRIORITY DATE OF 1-22-2009 IS CLAIMED.

OWNER OF INTERNATIONAL REGISTRATION 1008328 DATED 1-27-2009, EXPIRES 1-27-2019.

THE WORDING "BOBBA" HAS NO MEANING IN A FOREIGN LANGUAGE.

CLASS 35—ADVERTISING AND BUSINESS

FOR ADVERTISING AND INFORMATION DISTRIBUTION SERVICES, NAMELY, PROVIDING CLASSIFIED ADVERTISING SPACE VIA THE GLOBAL COMPUTER NETWORK; PROMOTING THE GOODS AND SERVICES OF OTHERS OVER THE INTERNET; PROVIDING ON-LINE COMPUTER DATABASES AND ON-LINE SEARCHABLE DATABASES FEATURING CLASSIFIED LISTINGS AND ADS (U.S. CLS. 100, 101 AND 102).

CLASS 38—COMMUNICATION

FOR PROVIDING ON-LINE CHAT ROOMS AND ELECTRONIC BULLETIN BOARDS FOR TRANSMISSION OF MESSAGES AMONG USERS IN THE FIELD OF GENERAL INTEREST; PROVIDING EMAIL AND INSTANT MESSAGING SERVICES (U.S. CLS. 100, 101 AND 104).

CLASS 41—EDUCATION AND ENTERTAINMENT

FOR ENTERTAINMENT SERVICES, NAMELY, PROVIDING ON-LINE COMPUTER GAMES, PROVIDING A WEB SITE FEATURING MUSICAL VIDEOS, RELATED FILM CLIPS, PHOTOGRAPHS, AND OTHER ENTERTAINMENT-BASED MULTIMEDIA MATERIALS AND INFORMATION FEATURING NEWS RELEASES AND INFORMATION ABOUT MUSICAL ARTISTS, PROVIDING INFORMATION ON-LINE RELATING TO COMPUTER GAMES AND COMPUTER ENHANCEMENTS FOR GAMES; MOBILE MEDIA AND ENTERTAINMENT SERVICES IN THE NATURE OF ELECTRONIC TRANSMISSION OF ENTERTAINMENT MEDIA CONTENT; MOBILE MEDIA AND ENTERTAINMENT SERVICES IN THE NATURE OF CONTENT PREPARATION; MULTIMEDIA ENTERTAINMENT SOFTWARE PRODUCTION SERVICES; ENTERTAINMENT IN THE NATURE OF TELEVISION SERIES IN THE FIELD OF CARTOONS, COMEDY AND MUSIC; PRODUCTION OF TELEVISION PROGRAMMES; PRODUCTION OF TELEVISION AND RADIO PROGRAMMES; PROVIDING OF ENTERTAINMENT ADVICE, CONSULTANCY AND INFORMATION REGARDING ALL OF THE AFORESAID SERVICES (U.S. CLS. 100, 101 AND 107).

MARY CRAWFORD, EXAMINING ATTORNEY

SN 79-071,220. TREND NEW-CONCEPT AND DEVELOPMENT GMBH, FED REP GERMANY, FILED 6-9-2009.

Duflex

THE MARK CONSISTS OF STANDARD CHARACTERS WITHOUT CLAIM TO ANY PARTICULAR FONT, STYLE, SIZE, OR COLOR.

PRIORITY DATE OF 2-9-2009 IS CLAIMED.
OWNER OF INTERNATIONAL REGISTRATION 1008542 DATED 6-9-2009, EXPIRES 6-9-2019.

CLASS 10—MEDICAL APPARATUS

FOR ORTHOPAEDIC ARTICLES, IN PARTICULAR ORTHOPAEDIC SOLES; MEDICAL TREATMENT AND DIAGNOSTIC EQUIPMENT, IN PARTICULAR HEART RHYTHM AND HEART RATE METERS AND BLOOD PRESSURE METERS (U.S. CLS. 26, 39 AND 44).

CLASS 17—RUBBER GOODS

FOR RUBBER, GUTTA-PERCHA, GUM, MICA AND GOODS MADE FROM THESE MATERIALS, NAMELY, RAW MATERIALS AND PARTS FOR USE IN MANUFACTURE OF FOOTWEAR, INNER SOLES, SHOES SOLES; PLASTICS IN EXTRUDED FORM, NAMELY, FOAM FOR USE IN MANUFACTURE OF FOOTWEAR, INNER SOLES, SHOES SOLES; PACKING AND INSULATING MATERIALS, NOT FOR USE IN BUILDING CONSTRUCTION; FLEXIBLE PIPES, NOT OF METAL (U.S. CLS. 1, 5, 12, 13, 35 AND 50).

CLASS 25—CLOTHING

FOR FOOTWEAR; HEADWEAR; INNER SOLES; SHOE SOLES (U.S. CLS. 22 AND 39).
WENDY JUN, EXAMINING ATTORNEY

SN 79-071,187. LIPOTEC, S.A., GAVA (BARCELONA), SPAIN, FILED 6-19-2009.

ARGIRELOX

THE MARK CONSISTS OF STANDARD CHARACTERS WITHOUT CLAIM TO ANY PARTICULAR FONT, STYLE, SIZE, OR COLOR.

OWNER OF INTERNATIONAL REGISTRATION 1008446 DATED 6-19-2009, EXPIRES 6-19-2019.
OWNER OF U.S. REG. NO. 3,105,853.

CLASS 1—CHEMICALS

FOR CHEMICAL PREPARATIONS FOR USE IN THE MANUFACTURE OF PHARMACEUTICALS, COSMETICS AND TEXTILES (U.S. CLS. 1, 5, 6, 10, 26 AND 46).

CLASS 3—COSMETICS AND CLEANING PREPARATIONS

FOR SKIN SOAP, SOAP BARS, BATH SOAPS, COSMETIC SOAPS, HAND SOAPS, DISINFECTANT SOAPS, PERFUMERY, ESSENTIAL OILS, COSMETICS, HAIR LOTIONS, DENTIFRICES (U.S. CLS. 1, 4, 6, 50, 51 AND 52).

CLASS 5—PHARMACEUTICALS

FOR PHARMACEUTICAL PREPARATIONS FOR THE TREATMENT OF NEUROLOGICAL AND NEURODEGENERATIVE DISEASES (U.S. CLS. 6, 18, 44, 46, 51 AND 52).

CHRISTOPHER BUONGIORNO, EXAMINING ATTORNEY

SN 79-071,231. LOSAN PHARMA GMBH, FED REP GERMANY, FILED 2-12-2009.

LOSAN

P H A R M A

PRIORITY DATE OF 8-12-2008 IS CLAIMED.
OWNER OF INTERNATIONAL REGISTRATION 1008572 DATED 2-12-2009, EXPIRES 2-12-2019.

NO CLAIM IS MADE TO THE EXCLUSIVE RIGHT TO USE "PHARMA", APART FROM THE MARK AS SHOWN.
THE MARK CONSISTS OF THE WORDING "LOSAN PHARMA", WITH THE "O" REPRESENTED BY A CIRCLE WITH WAVY BANDS IN IT.

CLASS 5—PHARMACEUTICALS

FOR PHARMACEUTICAL PREPARATIONS FOR THE TREATMENT OF COLDS, COUGH, PAIN, INFLUENZA, OSTEOPOROSIS, HEARTBURN; PHARMACEUTICAL SUBSTANCES, NAMELY, CREAMS FOR THE TREATMENT OF SKIN CONDITIONS AND PAIN; PHARMACEUTICAL SUBSTANCES, NAMELY, PILLS, TABLETS, CAPSULES, AND SUPPOSITORIES FOR THE TREATMENT OF COLDS, COUGH, PAIN, INFLUENZA, OSTEOPOROSIS, HEARTBURN (U.S. CLS. 6, 18, 44, 46, 51 AND 52).

CLASS 35—ADVERTISING AND BUSINESS

FOR ADMINISTERING THE APPLICATION PROCESS BETWEEN PHARMACEUTICAL COMPANIES AND GOVERNMENTAL AGENCIES FOR DRUG APPROVAL (U.S. CLS. 100, 101 AND 102).

CLASS 42—SCIENTIFIC AND COMPUTER SERVICES

FOR CONSULTING SERVICES IN THE FIELD OF PHARMACEUTICAL SCIENCES; MEDICAL AND PHARMACEUTICAL RESEARCH, DESIGN AND DEVELOPMENT SERVICES; PHARMACEUTICAL DRUG DEVELOPMENT SERVICES FOR THIRD PARTIES; PHARMACEUTICAL SERVICES, NAMELY, CONDUCTING CLINICAL TRIALS, MONITORING CLINICAL TRIALS AND DRUG DEVELOPMENT TO ENSURE THAT CERTIFICATION REQUIREMENTS ARE MET; TESTING SERVICES IN THE FIELD OF DRUG COMPATIBILITY; CONSULTANCY SERVICES IN THE FIELD OF MEDICAL AND PHARMACEUTICAL RESEARCH (U.S. CLS. 100 AND 101).

CLASS 44—MEDICAL, BEAUTY AND AGRICULTURAL SERVICES

FOR CONSULTANCY SERVICES IN THE FIELD OF MEDICAL TREATMENT AND PHARMACY ADVICE (U.S. CLS. 100 AND 101).

FRED CARL, EXAMINING ATTORNEY

CLASS 35—ADVERTISING AND BUSINESS

FOR ADMINISTRATIVE SERVICES RELATING TO CALL FOR TENDER, NAMELY, AUCTIONEERING IN THE FORM OF ORGANIZATION OF AUCTIONS ON THE INTERNET, INCLUDING IN THE FORM OF DUTCH AUCTIONS AND REVERSE AUCTIONS; PRESENTATION OF GOODS AND SERVICES, NAMELY, PRESENTATION OF GOODS AND SERVICES FOR THIRD PARTIES VIA THE INTERNET AT AN ONLINE AUCTION SITE OR AN ELECTRONIC MARKETPLACE; ARRANGING OF CONTRACTS, FOR OTHERS, FOR THE PROVIDING OF SERVICES; ARRANGING OF TRADING AND ECONOMICAL CONTACTS, ALSO OVER THE INTERNET; COMPARISON SERVICES CONCERNING PRICES; ADVERTISING ON THE INTERNET FOR OTHERS; SERVICES OF A COMMERCIAL INFORMATION AGENCY THAT PROVIDES INFORMATION AND ADVICE TO CONSUMERS, NAMELY GATHERING AND PROVIDING INFORMATION IN THE NATURE OF EDITORIAL CONTENT, TEXT REPORTS, CLASSIFIEDS, ADVERTISEMENTS, AND CONTRACT TENDERS VIA THE INTERNET, EMAIL NEWSLETTERS AND MOBILE COMMUNICATIONS MESSAGES; COMMERCIAL INFORMATION AND DIRECTORY AGENCIES, NAMELY, GATHERING AND PROVIDING PRODUCT DIRECTORIES, ADDRESS DIRECTORIES AND CLASSIFIED DIRECTORIES (U.S. CLS. 100, 101 AND 102).

CLASS 38—COMMUNICATION

FOR TRANSMISSION OF MESSAGES VIA COMPUTER NETWORKS, IN PARTICULAR VIA THE INTERNET; TRANSMISSION OF, NAMELY COLLECTION AND DELIVERY OF, ELECTRONIC MESSAGES; TRANSMISSION VIA THE INTERNET, OF ELECTRONIC MESSAGES CONTAINING NEWSLETTERS OVER A COMPUTER NETWORK, AND OF MOBILE TELEPHONE COMMUNICATIONS MESSAGES, THE INFORMATION BEING EDITORIAL CONTENT, TEST REPORTS, COMMERCIAL INFORMATION, CLASSIFIEDS, ADVERTISEMENTS, AND CONTRACT TENDERS; ELECTRONIC TRANSMISSION OF DATA, IMAGES AND DOCUMENTS VIA COMPUTERS, COMPUTER- OR TELECOMMUNICATIONS NETWORK OR MOBILE TELEPHONE COMMUNICATIONS EQUIPMENT; TELECOMMUNICATION GATEWAY SERVICES, NAMELY PROVIDING PORTALS ON THE INTERNET; TRANSMISSION OF DATA, NAMELY, PRODUCT, ADDRESS AND CLASSIFIED DIRECTORIES AND INFORMATION CONTAINED THEREIN VIA THE INTERNET (U.S. CLS. 100, 101 AND 104).

CLASS 41—EDUCATION AND ENTERTAINMENT

FOR PUBLICATION OF ELECTRONIC PUBLICATIONS, NAMELY, INFORMATION COMPRISING EDITORIAL CONTENT, INCLUDING TEST REPORTS, AND COMMERCIAL INFORMATION, INCLUDING CLASSIFIEDS, ADVERTISEMENTS, CONTRACT TENDERS, USING ELECTRONIC COMMUNICATIONS MEDIA, IN PARTICULAR VIA INTERNET PLATFORMS, EMAIL NEWSLETTERS OR MOBILE COMMUNICATIONS MESSAGES; PUBLICATION OF ELECTRONIC PUBLICATIONS NAMELY, PRODUCT, ADDRESS AND CLASSIFIED DIRECTORIES AND INFORMATION CONTAINED THEREIN; ALL AFOREMENTIONED SERVICES IN CONNECTION WITH THE ARRANGEMENT OF SERVICES, NAMELY CONTRACTS WITH CRAFTSMEN, REPAIRS, CLEANING OF BUILDINGS, HOUSEHOLD RELATED SERVICES, CARETAKER SERVICES, PLANNING AND CONSULTANCY, BROKERAGE SERVICES, EDP SUPPORT, MINOR ARTS AND ARTISTIC SERVICES, TREATMENT, THERAPY, EDUCATIONAL SERVICES, TRANSPORT SERVICES, COACHING, CARE AND CHILDCARE, TRANSLATIONS, SERVICES CONCERNING COMMODITIES, DESIGN RELATED SERVICES AND SERVICES OF ADVERTISING AGENCIES (U.S. CLS. 100, 101 AND 107).

MARILYN IZZI, EXAMINING ATTORNEY

SN 79-071,328. MY-HAMMER AG, FED REP GERMANY,
FILED 11-10-2008.

MyHammer

THE MARK CONSISTS OF STANDARD CHARACTERS WITHOUT CLAIM TO ANY PARTICULAR FONT, STYLE, SIZE, OR COLOR.

PRIORITY DATE OF 6-25-2008 IS CLAIMED.
OWNER OF INTERNATIONAL REGISTRATION 1008809
DATED 11-10-2008, EXPIRES 11-10-2018.

SN 79-071,355. SIEMENS AKTIENGESSELLSCHAFT, FED REP GERMANY, FILED 5-14-2009.

SN 79-071,474. MERKUR STAHLWAREN GMBH & CO. KG, FED REP GERMANY, FILED 2-18-2009.

TubeGuard

THE MARK CONSISTS OF STANDARD CHARACTERS WITHOUT CLAIM TO ANY PARTICULAR FONT, STYLE, SIZE, OR COLOR.

OWNER OF INTERNATIONAL REGISTRATION 1008916 DATED 5-14-2009, EXPIRES 5-14-2019.

CLASS 9—ELECTRICAL AND SCIENTIFIC APPARATUS

FOR COMPUTER SOFTWARE FOR USE IN CALCULATING THE OPTIMAL TIME TO REPLACE PARTS OF MEDICAL IMAGING APPARATUS; COMPUTER SOFTWARE FOR RETRIEVING, RECORDING AND PROCESSING DATA FROM ELECTRONIC SENSORS USED IN MONITORING THE FUNCTIONING OF PARTS OF MEDICAL IMAGING APPARATUS (U.S. CLS. 21, 23, 26, 36 AND 38).

CLASS 37—CONSTRUCTION AND REPAIR

FOR MAINTENANCE OF MEDICAL IMAGING APPARATUS, NAMELY, INSTALLING REPLACEMENT PARTS (U.S. CLS. 100, 103 AND 106).

KEVIN CORWIN, EXAMINING ATTORNEY

SN 79-071,367. SARA HOCHULI / PLASTIKHAAR, SWITZERLAND, FILED 3-26-2009.

Ukiyo5

THE MARK CONSISTS OF STANDARD CHARACTERS WITHOUT CLAIM TO ANY PARTICULAR FONT, STYLE, SIZE, OR COLOR.

PRIORITY DATE OF 3-25-2009 IS CLAIMED.
OWNER OF INTERNATIONAL REGISTRATION 1008943 DATED 3-26-2009, EXPIRES 3-26-2019.

CLASS 18—LEATHER GOODS

FOR LEATHER BELTS, BAGS AND WALLETS (U.S. CLS. 1, 2, 3, 22 AND 41).

CLASS 24—FABRICS

FOR TEXTILE NAPKINS, TEXTILE NECKTIES, TEXTILE WOVEN LABELS, BED AND PILLOW COVERS, TEXTILE FABRICS FOR USE IN THE MANUFACTURE OF BAGS AND WALLETS (U.S. CLS. 42 AND 50).

CLASS 25—CLOTHING

FOR T-SHIRTS, SHIRTS, PANTS, JACKETS, BABY CLOTHING, NAMELY, SLEEPWEAR, BODYSUITS, SCARVES, HATS, SOCKS, AND CAPS (U.S. CLS. 22 AND 39).

KATINA MISTER, EXAMINING ATTORNEY

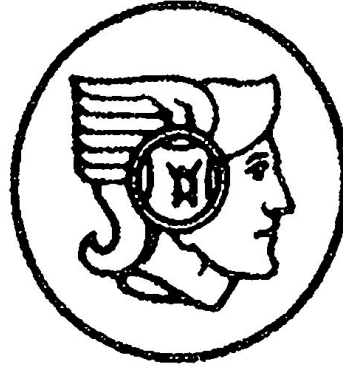

PRIORITY DATE OF 8-19-2008 IS CLAIMED.
OWNER OF INTERNATIONAL REGISTRATION 1009202 DATED 2-18-2009, EXPIRES 2-18-2019.

THE MARK CONSISTS OF A STYLIZED HEAD OF THE WINGED GOD MERCURY ON A CIRCULAR FIELD.

CLASS 8—HAND TOOLS

FOR CUTLERY; RAZOR BLADES; STRAIGHT RAZORS; RAZORS; SHAVING ACCESSORIES, NAMELY, SHAVING RAZOR CASES, LEATHER STROPS FOR RAZORS, ADAPTORS FOR RAZOR BLADES, OPEN TOOTH COMBS BEING PARTS OF RAZORS; CALLUS SHAVER BLADES; CALLUS SHAVERS (U.S. CLS. 23, 28 AND 44).

CLASS 21—HOUSEWARES AND GLASS

FOR SHAVING BRUSHES; SHAVING BRUSH HOLDERS INCORPORATING SOAP DISHES (U.S. CLS. 2, 13, 23, 29, 30, 33, 40 AND 50).

HANNO RITTNER, EXAMINING ATTORNEY

SN 79-071,551. LUDMILA DMITRIEVNA BUTEYKO, RU-111141 MOSCOW, RUSSIAN FED., FILED 5-19-2009.

BUTEYKO

THE MARK CONSISTS OF STANDARD CHARACTERS WITHOUT CLAIM TO ANY PARTICULAR FONT, STYLE, SIZE, OR COLOR.

PRIORITY DATE OF 12-29-2008 IS CLAIMED.
OWNER OF INTERNATIONAL REGISTRATION 1009432 DATED 5-19-2009, EXPIRES 5-19-2019.

THE WORDING "BUTEYKO" HAS NO MEANING IN A FOREIGN LANGUAGE.

CLASS 41—EDUCATION AND ENTERTAINMENT

FOR PUBLICATION OF BOOKS; HEALTH CLUB SERVICES, NAMELY, PROVIDING INSTRUCTIONS AND EQUIPMENT IN THE FIELD OF PHYSICAL EXERCISE, BREATHING EXERCISES, WEIGHT LOSS, SPORTS PERFORMANCE, HEALTH, FITNESS, AND WELLNESS; PROVIDING ONLINE ELECTRONIC PUBLICATIONS IN THE NATURE OF MAGAZINES, JOURNALS, PAMPHLETS IN THE FIELD OF WEIGHT LOSS, BREATHING EXERCISES, SPORTS PERFORMANCE, HEALTH, FITNESS, AND WELLNESS; PROVIDING TRAINING IN THE FIELD OF PHYSICAL EXERCISE, BREATHING EXERCISES, WEIGHT LOSS, SPORTS PERFORMANCE, HEALTH, FITNESS, AND WELLNESS; EDUCATION IN THE FIELD OF PHYSICAL EXERCISE, BREATHING EXERCISES, WEIGHT LOSS, SPORTS PERFORMANCE, HEALTH, FITNESS, AND WELLNESS RENDERED THROUGH CORRESPONDENCE COURSES; PRACTICAL TRAINING SERVICES IN THE FIELD OF PHYSICAL EXERCISE, BREATHING EXERCISES, WEIGHT LOSS, SPORTS PERFORMANCE, HEALTH, FITNESS, AND WELLNESS RENDERED THROUGH DEMONSTRATION; ARRANGING AND CONDUCTING OF EDUCATIONAL CONGRESSES IN THE FIELD OF HEALTH, FITNESS, AND WELLNESS; ARRANGING AND CONDUCTING OF EDUCATIONAL CONFERENCES IN THE FIELD OF HEALTH, FITNESS, AND WELLNESS; ARRANGING AND CONDUCTING OF EDUCATIONAL TRAINING WORKSHOPS IN THE FIELD OF HEALTH, FITNESS, AND WELLNESS; ARRANGING AND CONDUCTING OF EDUCATIONAL SEMINARS IN THE FIELD OF HEALTH, FITNESS, AND WELLNESS; ARRANGING AND CONDUCTING OF EDUCATIONAL SYMPOSIUMS IN THE FIELD OF HEALTH, FITNESS, AND WELLNESS; VOCATIONAL GUIDANCE; EDUCATIONAL EXAMINATION; ELECTRONIC DESKTOP PUBLISHING FOR OTHERS; PUBLICATION OF ELECTRONIC BOOKS AND JOURNALS ONLINE; PUBLICATION OF TEXTS, OTHER THAN PUBLICITY TEXTS; EDUCATIONAL SERVICES, NAMELY, PROVIDING CLASSES, SEMINARS, WORKSHOPS IN THE FIELD OF PHYSICAL EXERCISE, BREATHING EXERCISES, WEIGHT LOSS, SPORTS PERFORMANCE, HEALTH, FITNESS, AND WELLNESS; EDUCATIONAL SERVICES, NAMELY, INSTRUCTION IN THE FIELDS OF IN THE FIELD OF BREATHING EXERCISES, WEIGHT LOSS, SPORTS PERFORMANCE, HEALTH, FITNESS, AND WELLNESS; TEACHING IN THE FIELD OF BREATHING EXERCISES AIMED AT THE TREATMENT OF DISEASES CAUSED BY CARBON DIOXIDE SHORTAGE IN THE LUNGS AND IN THE ARTERIAL BLOOD AND TREATMENT OF DISEASES WHICH ARE CHARACTERIZED BY CARBON DIOXIDE SHORTAGE; WRITING OF TEXTS, OTHER THAN PUBLICITY TEXTS (U.S. CLS. 100, 101 AND 107).

CLASS 44—MEDICAL, BEAUTY AND AGRICULTURAL SERVICES

FOR MEDICAL SERVICES; VETERINARY SERVICES; HYGIENIC AND BEAUTY CARE FOR HUMAN BEINGS OR ANIMALS; CONVALESCENT HOMES; REST HOMES; NURSING HOMES; HOSPITALS; MEDICAL ASSISTANCE; SANATORIUMS; PHYSICAL THERAPY; PHYSIOTHERAPY; TELEMEDICINE SERVICES (U.S. CLS. 100 AND 101).

LAURA HAMMEL, EXAMINING ATTORNEY

SN 79-071,560. MAVIG GMBH, FED REP GERMANY, FILED 12-18-2008.

MAVIG

THE MARK CONSISTS OF STANDARD CHARACTERS WITHOUT CLAIM TO ANY PARTICULAR FONT, STYLE, SIZE, OR COLOR.

PRIORITY DATE OF 9-1-2008 IS CLAIMED.
OWNER OF INTERNATIONAL REGISTRATION 1009455
DATED 12-18-2008, EXPIRES 12-18-2018.
OWNER OF U.S. REG. NO. 1,133,573.

CLASS 9—ELECTRICAL AND SCIENTIFIC APPARATUS

FOR PROTECTION DEVICES AGAINST X-RAYS, NAMELY, MOBILE RADIATION PROTECTION SHIELDS, RADIATION PROTECTION CURTAINS, TABLE COLUMNS; GOGGLES FOR PROTECTION AGAINST X-RAYS; PROTECTIVE CLOTHING FOR PROTECTION AGAINST X-RAYS; GLOVES FOR PROTECTION AGAINST X-RAYS; RADIOLOGY SCREENS, NAMELY, PROTECTIVE FACE SCREENS AND EYEWEAR AGAINST RADIATION; SCATTER RADIATION COVERS, NAMELY, COVERS SPECIALLY ADAPTED TO CURVED SURFACES FOR USE IN AIDING RADIATION IMAGE CONTRAST OTHER THAN FOR MEDICAL USES; COMPENSATING FILTERS FOR RADIOLOGICAL PURPOSES, NAMELY, FILTERS FOR USE IN AIDING RADIATION CONTRAST OTHER THAN FOR MEDICAL USES AND FOR THE REDUCTION OF RADIATION FOR THE EXAMINER AND THE EXAMINED PERSON; HOLDER FOR RADIOLOGY CASSETTES OTHER THAN FOR MEDICAL USES; SCATTER RADIATION GRIDS FOR RADIOLOGICAL PURPOSES IN THE NATURE OF A CALIBRATING INSERT FOR RADIOLOGY CASSETTES OTHER THAN FOR MEDICAL USES; RADIATION PROTECTION SHIELDS, NAMELY, RADIATION SHIELDS FOR ELECTRONIC PRODUCTS (U.S. CLS. 21, 23, 26, 36 AND 38).

CLASS 10—MEDICAL APPARATUS

FOR PROTECTION DEVICES AGAINST X-RAYS, NAMELY, MOBILE RADIATION PROTECTION SHIELDS, RADIATION PROTECTION CURTAINS, TABLE COLUMNS; RADIOLOGY SCREENS SPECIALLY ADAPTED TO PROTECT MEDICAL EQUIPMENT FROM DELIVERING NON-THERAPEUTIC RADIATION DOSES TO PATIENTS, FIXED PROTECTION WALLS SPECIALLY ADAPTED TO PROTECT MEDICAL EQUIPMENT FROM DELIVERING NON-THERAPEUTIC RADIATION DOSES TO PATIENTS AND MEDICAL PERSONNEL; PROTECTIVE GLOVES FOR MEDICAL USE, NAMELY, GLOVES FOR PROTECTION AGAINST X-RAYS; PROTECTIVE GOGGLES FOR MEDICAL USE, NAMELY, GOGGLES FOR PROTECTION AGAINST X-RAYS; PROTECTIVE CLOTHING FOR MEDICAL USE, NAMELY, PROTECTIVE CLOTHING FOR PROTECTION AGAINST X-RAYS; SCATTER RADIATION COVERS, NAMELY, COVERS SPECIALLY ADAPTED TO HUMAN ANATOMY FOR USE IN AIDING RADIATION CONTRAST FOR MEDICAL USES; COMPENSATING FILTERS FOR RADIOLOGICAL PURPOSES, NAMELY, FILTERS FOR USE IN AIDING RADIATION IMAGE CONTRAST FOR MEDICAL USES; SCATTER RADIATION GRIDS FOR RADIOLOGICAL PURPOSES IN THE NATURE OF FILTERS FOR AIDING CONTRAST OF PATIENT RADIOLOGICAL IMAGES; COMPRESSION ELEMENTS FOR RADIOLOGICAL PURPOSES, NAMELY, UROLOGICAL BALLOONS FOR PATIENT TREATMENT AND DIAGNOSIS; PALPARIUM SPOONS FOR TREATMENT OF PATIENTS; RADIATION PROTECTION SHIELDS FOR MEDICAL EXAMINERS AND MEDICAL PERSONNEL DURING DIAGNOSTIC RADIOLOGICAL PROCEDURES AND THERAPEUTIC PROCEDURES; MEDICAL EXAMINATION LAMPS AND SURGICAL LAMPS; CEILING BEAMS, CEILING TRACKS, SUPPORT COLUMNS, AND SUPPORT ARMS, ALL SPECIALLY ADAPTED FOR X-RAY APPARATUS, INCLUDING, INJECTORS, MONITORS, RADIATION PROTECTION SHIELDS AND COLUMNS, TABLES, STRIPS AS WELL AS FOR CAMERAS, MEDICAL LAMPS, MICROSCOPES, DEFIBRILLATORS, SAFETY COLLARS, HIGH-FREQUENCY SURGICAL DEVICES, LASERS; PROTECTION DEVICES AGAINST X-RAYS, NAMELY, PROTECTIVE SHIELDS FOR X-RAY APPARATUS FOR MEDICAL USES; ROENTGEN APPARATUS FOR MEDICAL USE; REPLACEMENT PARTS OF THE AFORESAID GOODS FOR MEDICAL USES (U.S. CLS. 26, 39 AND 44).

CLASS 20—FURNITURE AND ARTICLES NOT OTHERWISE CLASSIFIED

FOR STORAGE SYSTEMS FOR CLOTHING FOR PROTECTION AGAINST X-RAYS, NAMELY, MOBILE RACKS FOR PROTECTIVE CLOTHING; NON-METALLIC WALL RACKS FOR PROTECTIVE CLOTHING AND PROTECTIVE GLOVES, AND NON-METALLIC HOOKS FOR CLOTHING FOR PROTECTION AGAINST X-RAYS; SPECIAL HANGERS FOR CLOTHING FOR PROTECTION AGAINST X-RAYS (U.S. CLS. 2, 13, 22, 25, 32 AND 50).

HANNO RITTNER, EXAMINING ATTORNEY

SN 79-071,573. ROTREXMA HOLDING B.V., NETHERLANDS, FILED 5-28-2009.



PRIORITY DATE OF 5-27-2009 IS CLAIMED.
OWNER OF INTERNATIONAL REGISTRATION 1009502 DATED 5-28-2009, EXPIRES 5-28-2019.

THE MARK CONSISTS OF AN OVAL DESIGN CONTAINING THE WORD "ROTRA".

THE WORDING "ROTRA" HAS NO MEANING IN A FOREIGN LANGUAGE.

CLASS 35—ADVERTISING AND BUSINESS

FOR SERVICES OF IMPORT AND EXPORT AGENCIES; FINANCIAL RECORDS MANAGEMENT, NAMELY, MANAGING THE FINANCIAL RECORDS OF SHIPMENTS BY AIR, SEA, OR LAND AS A MEANS OF SURVEILLANCE AND SUPERVISION OF CARGO; BUSINESS MANAGEMENT IN THE FIELD OF CARGO; BUSINESS ADMINISTRATION IN THE FIELD OF SUPERVISING CARGO (U.S. CLS. 100, 101 AND 102).

CLASS 36—INSURANCE AND FINANCIAL

FOR INSURANCES UNDERWRITING IN THE FIELD OF TRANSPORTATION ACCIDENT INSURANCE; CUSTOMS AGENCY SERVICES, NAMELY, CUSTOMS BROKERAGE (U.S. CLS. 100, 101 AND 102).

CLASS 39—TRANSPORTATION AND STORAGE

FOR TRANSPORT OF GOODS; LOGISTIC SERVICES IN THE FIELD OF TRANSPORT, NAMELY, STORAGE, TRANSPORTATION AND DELIVERY OF GOODS FOR OTHERS BY AIR, RAIL, SHIP OR TRUCK; MAIL DELIVERY; CARGO DELIVERY AND COURIERS SERVICES; ADVISING IN THE FIELD TRANSPORT (U.S. CLS. 100 AND 105).

LAURA HAMMEL, EXAMINING ATTORNEY

SN 79-071,639. CHEMISCHE WERKE KLUTHE GMBH, FED REP GERMANY, FILED 6-16-2009.

ADDI-LUB

THE MARK CONSISTS OF STANDARD CHARACTERS WITHOUT CLAIM TO ANY PARTICULAR FONT, STYLE, SIZE, OR COLOR.

PRIORITY DATE OF 1-28-2009 IS CLAIMED.

OWNER OF INTERNATIONAL REGISTRATION 1009644 DATED 6-16-2009, EXPIRES 6-16-2019.

CLASS 1—CHEMICALS

FOR CHEMICALS USED IN INDUSTRY, CHEMICALS FOR THE MANUFACTURE OF SOLVENTS, THINNER PAINTS, PRIMERS, AND LACQUERS; CHEMICALS FOR THE MANUFACTURE OF INDUSTRIAL CLEANING AND SCOURING PREPARATIONS; CHEMICAL PRESERVATIVES IN THE NATURE OF PRESERVATIVES COATINGS FOR METALS FOR USE AS CORROSION INHIBITORS; METAL ANNEALING PREPARATIONS, NAMELY, METAL TEMPERING PREPARATIONS; CHEMICAL ADDITIVES FOR OIL; OIL PURIFYING AGENTS IN THE NATURE OF CHEMICAL ADDITIVES FOR OIL, NAMELY, COAGULANTS, RELEASE AGENTS, NEUTRALIZERS, DEFROTHING AGENTS, FLOCCULANTS; METAL ETCHING MORDANTS; WATER PURIFYING CHEMICALS FOR INDUSTRIAL USE, WASTE WATER TREATMENT PREPARATIONS, NAMELY, WASTE WATER TREATMENT CHEMICALS FOR INDUSTRIAL USE (U.S. CLS. 1, 5, 6, 10, 26 AND 46).

CLASS 3—COSMETICS AND CLEANING PREPARATIONS

FOR DEGREASING PREPARATIONS WITH A SOLVENT BASE, NAMELY, FOR CLEANING METAL SURFACES, DEGREASING PREPARATIONS FOR CLEANING INDUSTRIAL MACHINES; INDUSTRIAL CLEANING PREPARATIONS AND SCOURING PREPARATIONS WITH AN EMULSION BASE, NAMELY, FOR CLEANING METAL SURFACES, FOR CLEANING OF INDUSTRIAL MACHINES; PAINT AND LACQUER REMOVING PREPARATIONS, BLEACHING PREPARATIONS FOR LAUNDRY USE, POLISHING HOUSEHOLD GOODS, SCOURING AND ABRASIVE PREPARATIONS, OILS FOR CLEANING PREPARATIONS; RUST REMOVING PREPARATIONS (U.S. CLS. 1, 4, 6, 50, 51 AND 52).

CLASS 4—LUBRICANTS AND FUELS

FOR COOLING LUBRICANTS FOR INDUSTRIAL USE, NAMELY, FOR METAL WORKING, COOLING LUBRICANT CONCENTRATES CONSISTING PRIMARILY OF LUBRICANTS FOR INDUSTRIAL USE, NAMELY, FOR METAL WORKING, ALL-PURPOSE LUBRICANTS OILS; CUTTING OILS; OILS FOR PAINTS AND OTHER COATINGS; CUTTING OIL FOR INDUSTRIAL METAL WORKING; INDUSTRIAL GREASES, GASOLINE; LUBRICATES FOR INDUSTRIAL MACHINERY AND LUBRICANTS IN THE NATURE OF LUBRICATING OILS (U.S. CLS. 1, 6 AND 15).

GINA HAYES, EXAMINING ATTORNEY

SN 79-071,640. WIGGLE LTD, UNITED KINGDOM, FILED 5-7-2009.

LIFELINE

THE MARK CONSISTS OF STANDARD CHARACTERS WITHOUT CLAIM TO ANY PARTICULAR FONT, STYLE, SIZE, OR COLOR.

PRIORITY DATE OF 11-10-2008 IS CLAIMED.
OWNER OF INTERNATIONAL REGISTRATION 1009645
DATED 5-7-2009, EXPIRES 5-7-2019.

SN 79-071,717. PREGLEM SA, SWITZERLAND, FILED 4-17-2009.

CLASS 3—COSMETICS AND CLEANING PREPARATIONS

FOR CLEANING PREPARATIONS, CLEANING FLUIDS AND DEGREASING PREPARATIONS FOR USE WITH BICYCLES (U.S. CLS. 1, 4, 6, 50, 51 AND 52).

CLASS 4—LUBRICANTS AND FUELS

FOR GREASES, LUBRICANTS AND OILS FOR USE WITH BICYCLES (U.S. CLS. 1, 6 AND 15).

CLASS 6—METAL GOODS

FOR METAL BOLTS AND CLIPS FOR USE WITH BICYCLES; METAL WORK STANDS FOR BICYCLES USED FOR HOLDING BICYCLES IN PLACE FOR EASE OF MAINTENANCE AND REPAIR; METAL WALL RACKS FOR BICYCLES, NAMELY, BICYCLE STORAGE RACKS OF METAL; LOCKS OF METAL FOR BICYCLES (U.S. CLS. 2, 12, 13, 14, 23, 25 AND 50).

CLASS 8—HAND TOOLS

FOR HAND TOOLS AND IMPLEMENTS FOR USE WITH BICYCLES, NAMELY, CHAIN WHIPS, BOTTOM BRACKET WRENCHES, CARTRIDGE BOTTOM BRACKET TOOLS, COTTERLESS CRANK TOOLS, CONE SPANNERS, FREEWHEEL REMOVERS, SCREWDRIVERS, BITS FOR HAND DRILLS, NAMELY, STAR BITS, TIRE IRONS, HEX KEY WRENCHES, CABLE CUTTERS, LOCKRING REMOVAL TOOLS, RIVET EXTRACTORS, CHAIN RIVET EXTRACTORS, CHAIN RING NUT TOOLS, CRANK REMOVAL TOOLS, SPOKE WRENCHES, PEDAL WRENCHES, CRANK EXTRACTORS, CABLE PULLERS; MULTI-FUNCTION HAND TOOLS FOR USE WITH BICYCLES COMPRISED OF SCREWDRIVERS, HEX KEY WRENCHES, CHAIN TOOLS, AND SPOKE TOOLS; TOOL KITS FOR BICYCLES (U.S. CLS. 23, 28 AND 44).

CLASS 11—ENVIRONMENTAL CONTROL APPARATUS

FOR BICYCLE LAMPS, LIGHTS AND REFLECTORS (U.S. CLS. 13, 21, 23, 31 AND 34).

CLASS 12—VEHICLES

FOR BICYCLES; BICYCLE ACCESSORIES ALL INCLUDED IN THIS CLASS, NAMELY, FRONT AND REAR BICYCLE RACK PACKS; BAG CARRIERS FOR BICYCLES, NAMELY, FRAMES, FOR LUGGAGE CARRIERS, FOR BICYCLES; BAGS SPECIFICALLY ADAPTED FOR CARRYING AND TRANSPORTING BICYCLES AND FOLDING BICYCLES; CARRYING RACKS FOR BICYCLES, NAMELY, BICYCLE RACKS FOR VEHICLES; PUNCTURE REPAIR KITS COMPRISED OF SANDPAPER, PATCHES, AND TIRE IRONS; PUNCTURE REPAIR KITS COMPRISED OF PATCHES, VULCANIZING SOLUTION, VALVE TUBES AND EMERY PAPER; PANNIER BAGS FOR BICYCLES; BICYCLE PUMPS, MINI PUMPS, FLOOR PUMPS; BICYCLE BELLS, CHAINS, BRAKES, DERAILLEURS, HANDLEBARS, STABILIZERS, MUDGUARDS, SADDLES, SPOKES, STANDS, TIRES, RIMS, WHEELS, PEDALS, CHAINS, FRAMES, HUBS, RACKS, MIRRORS (U.S. CLS. 19, 21, 23, 31, 35 AND 44).

CLASS 21—HOUSEWARES AND GLASS

FOR BRUSHES FOR CLEANING BICYCLES (U.S. CLS. 2, 13, 23, 29, 30, 33, 40 AND 50).
SCOTT BIBB, EXAMINING ATTORNEY

PREGLEM

THE MARK CONSISTS OF STANDARD CHARACTERS WITHOUT CLAIM TO ANY PARTICULAR FONT, STYLE, SIZE, OR COLOR.

OWNER OF INTERNATIONAL REGISTRATION 1009875
DATED 4-17-2009, EXPIRES 4-17-2019.

CLASS 5—PHARMACEUTICALS

FOR MEDICINAL PREPARATIONS FOR THE PREVENTION AND TREATMENT OF REPRODUCTIVE DISEASES AND DISORDERS; PHARMACEUTICAL PREPARATIONS FOR THE PREVENTION AND TREATMENT OF REPRODUCTIVE DISEASES AND DISORDERS; VETERINARY PREPARATIONS FOR SMALL AND LARGE ANIMALS AND POULTRY FOR THE PREVENTION AND TREATMENT OF REPRODUCTIVE DISEASES AND DISORDERS; AND SANITARY PREPARATIONS FOR MEDICAL USE; PHARMACEUTICAL AND BIOLOGICAL PREPARATIONS FOR DIAGNOSTIC PURPOSES, TREATMENT AND PREVENTION OF CONDITIONS IN HUMAN AND VETERINARY MEDICINE, NAMELY, FOR THE PREVENTION AND TREATMENT OF REPRODUCTIVE DISEASES AND DISORDERS; DIAGNOSTIC PREPARATIONS FOR MEDICAL PURPOSES OR VETERINARY PURPOSES (U.S. CLS. 6, 18, 44, 46, 51 AND 52).

CLASS 35—ADVERTISING AND BUSINESS

FOR ADVERTISING SERVICES; BUSINESS MANAGEMENT; BUSINESS ADMINISTRATION; PROVIDING OFFICE FUNCTIONS; ADVERTISING AND PROMOTION SERVICES FEATURING PHARMACEUTICAL AND BIOLOGICAL PREPARATIONS FOR DIAGNOSTIC PURPOSES, TREATMENT AND PREVENTION OF CONDITIONS IN HUMAN AND VETERINARY MEDICINE; ASSISTANCE TO CLIENTS IN MARKETING NEW PRODUCTS (U.S. CLS. 100, 101 AND 102).

CLASS 42—SCIENTIFIC AND COMPUTER SERVICES

FOR SCIENTIFIC AND TECHNOLOGICAL SERVICES AND RESEARCH AND ASSOCIATED DESIGN IN THE FIELD OF REPRODUCTIVE MEDICINE; INDUSTRIAL ANALYSES AND RESEARCH IN THE FIELD OF REPRODUCTIVE MEDICINE; RESEARCH, DEVELOPMENT, CONSULTING, INFORMATION, ASSISTANCE, ANALYSES, MEDICAL AND SCIENTIFIC RESEARCH, NAMELY, CONDUCTING CLINICAL TRIALS ALL IN THE FIELD OF FORMULATION AND PRODUCT DEVELOPMENT OF PHARMACEUTICAL AND BIOLOGICAL PREPARATIONS FOR DIAGNOSTICS, TREATMENT AND PREVENTION OF CONDITIONS IN HUMAN AND VETERINARY MEDICINE (U.S. CLS. 100 AND 101).

CLASS 45—PERSONAL AND LEGAL SERVICES

FOR LICENSING OF INTELLECTUAL PROPERTY, NAMELY, ACQUISITION AND GRANTING OF INTELLECTUAL PROPERTY RIGHTS ON THE GOODS LISTED IN CLASS 5, NAMELY, MEDICINAL PREPARATIONS FOR THE PREVENTION AND TREATMENT OF REPRODUCTIVE DISEASES AND DISORDERS, PHARMACEUTICAL PREPARATIONS FOR THE PREVENTION AND TREATMENT OF REPRODUCTIVE DISEASES AND DISORDERS, VETERINARY PREPARATIONS FOR SMALL AND LARGE ANIMALS AND POULTRY FOR THE PREVENTION AND TREATMENT OF REPRODUCTIVE DISEASES AND DISORDERS, AND SANITARY PREPARATIONS FOR MEDICAL USE, PHARMACEUTICAL AND BIOLOGICAL PREPARATIONS FOR DIAGNOSTIC PURPOSES, TREATMENT AND PREVENTION OF CONDITIONS IN HUMAN

AND VETERINARY MEDICINE, NAMELY, FOR THE PREVENTION AND TREATMENT OF REPRODUCTIVE DISEASES AND DISORDERS, AND DIAGNOSTIC PREPARATIONS FOR MEDICAL PURPOSES OR VETERINARY PURPOSES; INTELLECTUAL PROPERTY CONSULTATION, NAMELY, CONSULTING ON SERVICES PERFORMED FOR THIRD PARTIES, NAMELY, PROCEDURES IN RELATION TO COMPULSORY REGISTRATIONS AND LEGAL LICENSING FOR MARKETING OF PHARMACEUTICAL AND BIOLOGICAL PRODUCTS FOR DIAGNOSTICS, TREATMENT AND PREVENTION OF CONDITIONS IN HUMAN AND VETERINARY MEDICINE ON THE PART OF THE AUTHORITIES AND PUBLIC ADMINISTRATION, IN PARTICULAR FOR LICENSING OF MEDICAL DRUGS (U.S. CLS. 100 AND 101).

SCOTT BIBB, EXAMINING ATTORNEY

SN 79-071,754. GREGOIRE PRAT, FRANCE, FILED 4-17-2009.



PRIORITY DATE OF 10-28-2008 IS CLAIMED.
OWNER OF INTERNATIONAL REGISTRATION 1010019
DATED 4-17-2009, EXPIRES 4-17-2019.

THE COLOR(S) DARK BLUE, LIGHT BLUE AND WHITE IS/ARE CLAIMED AS A FEATURE OF THE MARK.

THE MARK CONSISTS OF THE REPRESENTATION OF A POSTAL STAMP WITH THE SYMBOL "@" IN THE MIDDLE; THE TEETH OF THE POSTAL STAMP AND THE SYMBOL "@" ARE IN WHITE; THE INNER BORDERS OF THE RECTANGLE REPRESENTING THE STAMP ARE IN DARK BLUE GRADATING TO LIGHT BLUE IN THE MIDDLE OF THE RECTANGLE; AND THE GRAY SURROUNDING THE RECTANGLE REPRESENTING THE POSTAL STAMP DESIGN AND THE SYMBOL "@" IS INTENDED AS SHADING AND IS NOT PART OF THE MARK.

CLASS 9—ELECTRICAL AND SCIENTIFIC APPARATUS

FOR DOWNLOADABLE ELECTRONIC PUBLICATIONS, NAMELY, BOOKS, MAGAZINES, NEWSLETTERS IN THE FIELD OF FUNDRAISING; OPTICAL, MAGNETIC AND ELECTRONIC DATA MEDIA, NAMELY, BLANK OPTICAL DATA CARRIERS, BLANK MAGNETIC DATA CARRIERS, BLANK ELECTRONIC STORAGE MEDIA; EXPOSED FILMS, NAMELY, EXPOSED CAMERA FILM, EXPOSED SLIDE FILMS, EXPOSED X-RAY FILM; SOFTWARE FOR TRACKING AND RECORDING ELECTRONIC MESSAGE SENDING (U.S. CLS. 21, 23, 26, 36 AND 38).

CLASS 36—INSURANCE AND FINANCIAL

FOR CHARITABLE FUNDRAISING TO RAISE FUNDS FOR RESEARCH IN THE FIELDS OF SCIENCE, MEDICINE, HUMANITARIANISM, ENVIRONMENTAL PROTECTION, SUSTAINABLE DEVELOPMENT; FINANCING SERVICES; FINANCIAL SPONSORSHIP FOR FUNDRAISING EVENTS IN THE NATURE OF ORGANIZING AND CONDUCTING SPECIAL EVENTS FOR CHARITABLE FUNDRAISING PURPOSES; CREATION, INVESTMENT AND MANAGEMENT OF CAPITAL INVESTMENT FUNDS AND PRIVATE EQUITY FUNDS, ELECTRONIC FUNDS TRANSFER; CAPITAL INVESTMENT; FINANCIAL GUARANTEES (U.S. CLS. 100, 101 AND 102).

CLASS 41—EDUCATION AND ENTERTAINMENT

FOR BOOK AND MAGAZINE PUBLISHING; ELECTRONIC PUBLISHING OF BOOKS AND PERIODICALS OF OTHERS ON ALL COMMUNICATION MEDIA, NAMELY, CDS, DVDS AND ONLINE FEATURING CHARITABLE FUNDRAISING; ORGANIZING LIVE AND ONLINE EXHIBITIONS, CONFERENCES, COLLOQUIUMS FOR TRAINING OTHERS IN CHARITABLE FUNDRAISING FOR CULTURAL AND EDUCATIONAL PURPOSES; ENTERTAINMENT SERVICES, NAMELY, PRODUCTION AND DISTRIBUTION OF TELEVISION SHOWS, MOTION PICTURES, MOVIES, AND PROGRAMS; PRODUCTION AND DISTRIBUTION OF ONLINE INFORMATION REPORTS IN THE FIELD OF ENTERTAINMENT AND EDUCATION, NAMELY, PROVIDING INFORMATION ABOUT ORGANIZING EVENTS PROMOTING CHARITABLE FUNDRAISING (U.S. CLS. 100, 101 AND 107).

SCOTT BIBB, EXAMINING ATTORNEY

SN 79-071,766. VITSOE LIMITED, UNITED KINGDOM, FILED 4-23-2009.

VITSOE

THE MARK CONSISTS OF STANDARD CHARACTERS WITHOUT CLAIM TO ANY PARTICULAR FONT, STYLE, SIZE, OR COLOR.

PRIORITY DATE OF 11-10-2008 IS CLAIMED.
OWNER OF INTERNATIONAL REGISTRATION 1010063
DATED 4-23-2009, EXPIRES 4-23-2019.

CLASS 6—METAL GOODS

FOR METAL SHELF BRACKETS (U.S. CLS. 2, 12, 13, 14, 23, 25 AND 50).

CLASS 20—FURNITURE AND ARTICLES NOT OTHERWISE CLASSIFIED

FOR FURNITURE; SHELVES AND SHELVING, CUPBOARDS, SETS OF DRAWERS, CHAIRS; PARTS AND FITTINGS, ALL RELATING TO THE AFORESAID GOODS; METAL SHELVING; SHELVING AND COMPONENT PARTS THEREOF, NAMELY, SHELVES AND BRACKETS SOLD AS A UNIT (U.S. CLS. 2, 13, 22, 25, 32 AND 50).

CLASS 42—SCIENTIFIC AND COMPUTER SERVICES

FOR DESIGN SERVICES FOR FURNITURE; INTERIOR DESIGN AND PLANNING SERVICES; INFORMATION, ADVISORY AND CONSULTANCY SERVICES, ALL RELATING TO THE AFORESAID SERVICES (U.S. CLS. 100 AND 101).

SCOTT BIBB, EXAMINING ATTORNEY

SN 79-071,895. INTUMEX GMBH, AUSTRIA, FILED 6-12-2009.

INTUMEX

THE MARK CONSISTS OF STANDARD CHARACTERS WITHOUT CLAIM TO ANY PARTICULAR FONT, STYLE, SIZE, OR COLOR.

OWNER OF INTERNATIONAL REGISTRATION 1010346 DATED 6-12-2009, EXPIRES 6-12-2019.

OWNER OF U.S. REG. NO. 1,724,830.

CLASS 1—CHEMICALS

FOR FLAME INHIBITORS, NAMELY, FLAME RETARDING COMPOSITIONS; FIREPROOFING PREPARATIONS (U.S. CLS. 1, 5, 6, 10, 26 AND 46).

CLASS 17—RUBBER GOODS

FOR INSULANTS AGAINST FIRE, BURNING, HEAT AND SMOKE, NAMELY, FIRE-RESISTANT COMPOSITE PANELS MADE OF ARAMID, GLASS, CARBON OR CERAMIC FIBERS (U.S. CLS. 1, 5, 12, 13, 35 AND 50).
SUZANNE BLANE, EXAMINING ATTORNEY

SN 79-071,976. CASA DEL BALSAMICO MODENESE S.R.L., ITALY, FILED 6-24-2009.

BALSAMOSO

THE MARK CONSISTS OF STANDARD CHARACTERS WITHOUT CLAIM TO ANY PARTICULAR FONT, STYLE, SIZE, OR COLOR.

OWNER OF INTERNATIONAL REGISTRATION 1010633 DATED 6-24-2009, EXPIRES 6-24-2019.

CLASS 29—MEATS AND PROCESSED FOODS

FOR FRUIT JELLIES; FRUIT PRESERVED; UNFLAVORED AND UNSWEETENED GELATIN FOR FOOD; JAMS; MARMALADES (U.S. CL. 46).

CLASS 30—STAPLE FOODS

FOR VINEGAR; SAUCES; DRESSINGS FOR SALAD AND FLAVORED AND SWEETENED GELATINS FOR FOOD (U.S. CL. 46).

DAVID HOFFMAN, EXAMINING ATTORNEY

SN 79-071,998. VILAIN MARCEL ET FILS SPRL, BELGIUM, FILED 7-16-2009.

WIPIC

THE MARK CONSISTS OF STANDARD CHARACTERS WITHOUT CLAIM TO ANY PARTICULAR FONT, STYLE, SIZE, OR COLOR.

PRIORITY DATE OF 1-19-2009 IS CLAIMED.

OWNER OF INTERNATIONAL REGISTRATION 1010720 DATED 7-16-2009, EXPIRES 7-16-2019.

CLASS 8—HAND TOOLS

FOR MANICURE AND PEDICURE SETS; ELECTRIC MANICURE AND PEDICURE SETS (U.S. CLS. 23, 28 AND 44).

CLASS 16—PAPER GOODS AND PRINTED MATTER

FOR PAMPHLETS AND BROCHURES RELATING TO PAINTING AND PAINT BRUSHES; PAINT BRUSHES; ELECTRIC PAINT BRUSHES; POWERED PAINT BRUSHES; VIBRATING PAINT BRUSHES; PAINT BRUSH HANDLES; PAINT BRUSH HEADS; PAINT BRUSH CONTAINERS (U.S. CLS. 2, 5, 22, 23, 29, 37, 38 AND 50).

CLASS 21—HOUSEWARES AND GLASS

FOR CONTAINERS FOR HOUSEHOLD OR KITCHEN USE; CLEANING BRUSHES FOR HOUSEHOLD USE; ELECTRIC CLEANING BRUSHES FOR HOUSEHOLD USE; POWERED CLEANING BRUSHES FOR HOUSEHOLD USE; POWER-OPERATED BRUSHES USED TO CLEAN AND EXFOLIATE THE SKIN; VIBRATING BRUSHES FOR HOUSEHOLD USE; NAIL BRUSHES; CONTAINERS FOR BRUSHES FOR HOUSEHOLD OR KITCHEN USE (U.S. CLS. 2, 13, 23, 29, 30, 33, 40 AND 50).
ANGELA M. MICHELI, EXAMINING ATTORNEY

SN 79-072,242. SMS SIEMAG AKTIENGESELLSCHAFT, FED REP GERMANY, FILED 6-18-2009.



PRIORITY DATE OF 12-22-2008 IS CLAIMED.
OWNER OF INTERNATIONAL REGISTRATION 1011380 DATED 6-18-2009, EXPIRES 6-18-2019.

THE COLOR(S) DARK GRAY, LIGHT GRAY AND RED IS/ARE CLAIMED AS A FEATURE OF THE MARK.

THE MARK CONSISTS OF THE FOLLOWING: TWO VERTICAL CURVED BARS, ONE LIGHT GREY AND ONE RED TO THE RIGHT OF THE WORD "SURCON", WHICH IS IN DARK GREY.

THE WORD "SURCON" HAS NO MEANING IN A FOREIGN LANGUAGE.

CLASS 7—MACHINERY

FOR MACHINES FOR THE METALLURGICAL INDUSTRY AND THE STEEL MILL INDUSTRY, NAMELY, CASTING MACHINES, CONTINUOUS CASTING MACHINES, ROLLING MACHINES FOR THE ROLLING OF METALS, MACHINERY FOR PROCESSING HOT AND COLD METAL STRIPS AND SLABS, FORGING MACHINES, PRESSES FOR METALS; REPLACEMENT PARTS FOR THE AFORESAID GOODS (U.S. CLS. 13, 19, 21, 23, 31, 34 AND 35).

CLASS 9—ELECTRICAL AND SCIENTIFIC APPARATUS

FOR SURVEYING, PHOTOGRAPHIC, CINEMATOGRAPHIC, OPTICAL, WEIGHING, MEASURING, SIGNALING, AND MONITORING APPARATUS AND INSTRUMENTS FOR THE METALLURGICAL INDUSTRY AND THE STEEL MILL INDUSTRY, NAMELY, 3D INSPECTION SYSTEMS FOR INSPECTING AND MEASURING STEEL SLABS COMPRISING LASER PROFILE SENSORS, HIGH RESOLUTION OPTICAL MICROMETERS, AND HIGH RESOLUTION COMPLEMENTARY METAL OXIDE SEMICONDUCTOR (CMOS) CAMERAS OR CHARGE COUPLED DEVICE CAMERAS (CCD) CAMERAS, 2D INSPECTION SYSTEMS FOR INSPECTING AND MEASURING STEEL SLABS, AND FOR CARRYING OUT ROLLED STRIP INSPECTIONS AND HOT AND COLD ROLLED STRIP INSPECTIONS COMPRISING LASER PROFILE SENSORS, HIGH RESOLUTION OPTICAL MICROMETERS, AND HIGH RESOLUTION COMPLEMENTARY METAL OXIDE SEMICONDUCTOR (CMOS) CAMERAS OR CHARGE COUPLED DEVICE CAMERAS (CCD); COMPUTER PROGRAMS FOR CONTROLLING SLAB INSPECTION SYSTEMS AS WELL AS FOR CONTROLLING HOT STRIP AND COLD STRIP INSPECTION SYSTEMS (U.S. CLS. 21, 23, 26, 36 AND 38).

SUZANNE BLANE, EXAMINING ATTORNEY

SN 79-073,104. MITSUI CHEMICALS, INC., JAPAN, FILED 8-12-2009.



OWNER OF INTERNATIONAL REGISTRATION 1013801 DATED 8-12-2009, EXPIRES 8-12-2019.

NO CLAIM IS MADE TO THE EXCLUSIVE RIGHT TO USE "DESIGNED BY" AND "CHEMICALS", APART FROM THE MARK AS SHOWN.

CLASS 1—CHEMICALS

FOR INDUSTRIAL CHEMICALS; UNPROCESSED PLASTICS; MONOMER USED IN THE MANUFACTURE OF PLASTIC LENSES (U.S. CLS. 1, 5, 6, 10, 26 AND 46).

CLASS 9—ELECTRICAL AND SCIENTIFIC APPARATUS

FOR SPECTACLES; SPECTACLE GLASSES; SPECTACLE LENSES; SUNGLASSES; SUNGLASS LENSES; OPTICAL LENSES (U.S. CLS. 21, 23, 26, 36 AND 38).
KATINA MISTER, EXAMINING ATTORNEY

SN 79-072,292. MIND CREATE JAPAN, INC., JAPAN, FILED 7-17-2009.



OWNER OF INTERNATIONAL REGISTRATION 1011539 DATED 7-17-2009, EXPIRES 7-17-2019.

NO CLAIM IS MADE TO THE EXCLUSIVE RIGHT TO USE "INFLATABLE MANNEQUIN", APART FROM THE MARK AS SHOWN.

THE COLOR(S) BLUE, GRAY IS/ARE CLAIMED AS A FEATURE OF THE MARK.

THE MARK CONSISTS OF THE WORDING "AIRQUIN INFLATABLE MANNEQUIN" APPEARING IN GRAY TO THE RIGHT OF A BLUE "O"-SHAPED DESIGN WHICH ITSELF IS ABOVE A BLUE SHADOW.

CLASS 20—FURNITURE AND ARTICLES NOT OTHERWISE CLASSIFIED

FOR MANNEQUINS (U.S. CLS. 2, 13, 22, 25, 32 AND 50).

CLASS 35—ADVERTISING AND BUSINESS

FOR PROVIDING INFORMATION ABOUT AND MAKING REFERRALS IN THE FILED OF MANNEQUINS; RENTAL OF ADVERTISING AND MARKETING PRODUCTS IN THE NATURE OF MANNEQUINS (U.S. CLS. 100, 101 AND 102).

MARC LEIPZIG, EXAMINING ATTORNEY

SN 79-073,577. TITANX ENGINE COOLING HOLDING AB, SWEDEN, FILED 8-4-2009.



PRIORITY DATE OF 2-5-2009 IS CLAIMED.

OWNER OF INTERNATIONAL REGISTRATION 1015179 DATED 8-4-2009, EXPIRES 8-4-2019.

CLASS 7—MACHINERY

FOR MOTORS OTHER THAN FOR LAND VEHICLES; ENGINES OTHER THAN FOR LAND VEHICLES; MACHINE COUPLING AND TRANSMISSIONS EXCEPT FOR LAND VEHICLES; FANS FOR MOTORS AND ENGINES; HEAT EXCHANGERS BEING PARTS OF MACHINES; RADIATORS FOR MOTORS AND ENGINES; HYDRAULIC CONTROLS FOR APPARATUS FOR HEATING, REFRIGERATING, AERATING, VENTILATING, AIR-CONDITIONING, DEMISTING OF VEHICLES; PNEUMATIC CONTROLS FOR APPARATUS FOR HEATING, REFRIGERATING, AERATING, VENTILATING, AIR-CONDITIONING, DEMISTING OF VEHICLES (U.S. CLS. 13, 19, 21, 23, 31, 34 AND 35).

CLASS 11—ENVIRONMENTAL CONTROL APPARATUS

FOR REFRIGERATORS; VENTILATING EXHAUST FANS; AIR CONDITIONING APPARATUS; AIR CONDITIONERS FOR VEHICLES; HEAT EXCHANGERS NOT BEING PART OF MACHINES; HEAT EXCHANGERS; ELECTRIC FANS; HEAT ACCUMULATORS; HEATING APPARATUS FOR DEFROSTING WINDOWS OF VEHICLES (U.S. CLS. 13, 21, 23, 31 AND 34).

MICHAEL SOUDERS, EXAMINING ATTORNEY

SN 79-073,578. TITANX ENGINE COOLING HOLDING AB, SWEDEN, FILED 8-4-2009.

The logo consists of the letters 'CAC' in a bold, black, serif font, followed by a plus sign '+'.

THE MARK CONSISTS OF STANDARD CHARACTERS WITHOUT CLAIM TO ANY PARTICULAR FONT, STYLE, SIZE, OR COLOR.

PRIORITY DATE OF 2-5-2009 IS CLAIMED.

OWNER OF INTERNATIONAL REGISTRATION 1015180 DATED 8-4-2009, EXPIRES 8-4-2019.

CLASS 7—MACHINERY

FOR MOTORS OTHER THAN FOR LAND VEHICLES; ENGINES OTHER THAN FOR LAND VEHICLES; MACHINE COUPLING AND TRANSMISSIONS EXCEPT FOR LAND VEHICLES; FANS FOR MOTORS AND ENGINES; HEAT EXCHANGERS BEING PARTS OF MACHINES; RADIATORS FOR MOTORS AND ENGINES; HYDRAULIC CONTROLS FOR APPARATUS FOR HEATING, REFRIGERATING, AERATING, VENTILATING, AIR-CONDITIONING, DEMISTING OF VEHICLES; PNEUMATIC CONTROLS FOR APPARATUS FOR HEATING, REFRIGERATING, AERATING, VENTILATING, AIR-CONDITIONING, DEMISTING OF VEHICLES (U.S. CLS. 13, 19, 21, 23, 31, 34 AND 35).

CLASS 11—ENVIRONMENTAL CONTROL APPARATUS

FOR REFRIGERATORS; VENTILATING EXHAUST FANS; AIR CONDITIONING APPARATUS; AIR CONDITIONERS FOR VEHICLES; HEAT EXCHANGERS NOT BEING PART OF MACHINES; HEAT EXCHANGERS; ELECTRIC FANS; HEAT ACCUMULATORS; HEATING APPARATUS FOR DEFROSTING WINDOWS OF VEHICLES (U.S. CLS. 13, 21, 23, 31 AND 34).

MICHAEL SOUDERS, EXAMINING ATTORNEY

SN 79-073,771. SIENA BLACK LIMITED, UNITED KINGDOM, FILED 8-11-2009.

The logo features a stylized butterfly design on the left, with the word 'Butterfly twists' written in a cursive script font to its right.

OWNER OF INTERNATIONAL REGISTRATION 1015664 DATED 8-11-2009, EXPIRES 8-11-2019.

THE MARK CONSISTS OF DESIGNS OF A BUTTERFLY AND THE WORDING "BUTTERFLY TWISTS" IN STYLIZED SCRIPT. THE "B" IN THE WORDING FORMS THE WING OF THE BUTTERFLY DESIGN.

CLASS 3—COSMETICS AND CLEANING PREPARATIONS

FOR SOAPS; PERFUMERY; ESSENTIAL OILS; COSMETICS; HAIR LOTIONS (U.S. CLS. 1, 4, 6, 50, 51 AND 52).

CLASS 18—LEATHER GOODS

FOR LEATHER AND IMITATION LEATHER; GOODS MADE OF LEATHER AND IMITATION LEATHER, NAMELY, BRIEFCASES, SUITCASES, HANDBAGS, DOG LEADS, BILLFOLDS, PURSES, AND WALLETS; ANIMAL SKINS AND HIDES; TRUNKS; TRAVEL BAGS (U.S. CLS. 1, 2, 3, 22 AND 41).

CLASS 25—CLOTHING

FOR CLOTHING, NAMELY, SHIRTS, T-SHIRTS, SWEATERS, TROUSERS, DRESSES, AND SOCKS; FOOTWEAR; HEADWEAR (U.S. CLS. 22 AND 39).

CORY BOONE, EXAMINING ATTORNEY

SN 79-073,904. TASK GEOMODELLING LIMITED, UNITED KINGDOM, FILED 3-9-2009.



OWNER OF INTERNATIONAL REGISTRATION 1016024 DATED 3-9-2009, EXPIRES 3-9-2019.

THE COLOR(S) CYAN, MAGENTA, ORANGE, RED, BLACK AND WHITE IS/ARE CLAIMED AS A FEATURE OF THE MARK.

THE MARK CONSISTS OF A BLACK CIRCLE WITH THE LETTER "A" IN THE CENTER. THE "A" IS IN ORANGE WITH VARIOUS LINES IN CYAN, MAGENTA, ORANGE, RED WITH A WHITE CIRCULAR GLARE IN THE TOP RIGHT CORNER. THE WORD "ATTITUDE" IS IN WHITE BENEATH THE "A".

CLASS 9—ELECTRICAL AND SCIENTIFIC APPARATUS

FOR COMPUTER OPERATING SOFTWARE FOR USE IN THE FIELD OF GEOLOGY, NAMELY, FOR ANALYSIS OF OIL-FIELD EXPLOITATION, GEOLOGICAL PROSPECTING RESEARCH AND SURVEYS (U.S. CLS. 21, 23, 26, 36 AND 38).

CLASS 42—SCIENTIFIC AND COMPUTER SERVICES

FOR TECHNICAL RESEARCH PROJECTS AND STUDIES IN THE FIELD OF GEOLOGY, NAMELY, FOR ANALYSIS OF OIL-FIELD EXPLOITATION, GEOLOGICAL PROSPECTING RESEARCH AND SURVEYS (U.S. CLS. 100 AND 101).

MORGAN WYNNE, EXAMINING ATTORNEY

SN 79-074,008. IMPACT COATINGS AB, LINKÖPING, SWEDEN, FILED 7-24-2009.

MAXPHASE

THE MARK CONSISTS OF STANDARD CHARACTERS WITHOUT CLAIM TO ANY PARTICULAR FONT, STYLE, SIZE, OR COLOR.

PRIORITY DATE OF 3-3-2009 IS CLAIMED.
OWNER OF INTERNATIONAL REGISTRATION 1016334 DATED 7-24-2009, EXPIRES 7-24-2019.
OWNER OF U.S. REG. NO. 3,708,799.

CLASS 1—CHEMICALS

FOR CHEMICALS USED IN INDUSTRY, SCIENCE AND PHOTOGRAPHY; CERAMICS AND NON-METALLIC COATINGS AND COVERINGS, NAMELY, CHEMICAL AGENTS FOR THE COATING OF ELECTRICAL CONTACTS (U.S. CLS. 1, 5, 6, 10, 26 AND 46).

CLASS 6—METAL GOODS

FOR COMMON METALS AND THEIR ALLOYS; COMMON METALS, UNWROUGHT OR SEMI-WROUGHT; METAL COATINGS AND COVERINGS, NAMELY, METAL COVERINGS FOR APPLICATION ON ELECTRICAL CONTACTS INCLUDED IN THIS CLASS AND PLATING COMPOSITIONS COMPOSED OF METAL FOR CORROSION AND ABRASION PROTECTION FOR ELECTRICAL CONTACTS (U.S. CLS. 2, 12, 13, 14, 23, 25 AND 50).

CLASS 40—MATERIAL TREATMENT

FOR TREATMENT OF MATERIALS RELATING TO COATINGS AND COVERINGS, NAMELY, APPLICATION OF COATINGS AND COVERINGS ON ELECTRICAL CONTACTS (U.S. CLS. 100, 103 AND 106).
MARK PILARO, EXAMINING ATTORNEY

SN 79-074,041. DR. MED. MATTHIAS RATH, SOUTH AFRICA, FILED 6-26-2009.



PRIORITY DATE OF 4-1-2009 IS CLAIMED.
OWNER OF INTERNATIONAL REGISTRATION 1016439 DATED 6-26-2009, EXPIRES 6-26-2019.

THE COLOR(S) BLUE, ORANGE, GREEN, WHITE AND GREY IS/ARE CLAIMED AS A FEATURE OF THE MARK. THE MARK CONSISTS OF AN INCOMPLETE BLUE CIRCLE WRAPPED IN THE MIDDLE BY AN ORANGE AND GREEN CURVE, ALL WITHIN A WHITE RECTANGLE WITH GREY-SHADED EDGES.

CLASS 16—PAPER GOODS AND PRINTED MATTER

FOR BOOKS, JOURNALS, NEWSPAPERS, PRINTED TEACHING AND EDUCATIONAL MATERIAL, NEWSLETTERS, PAMPHLETS, MAGAZINES, PRINTED PERIODICALS AND INFORMATIONAL FLIERS, ALL IN THE FIELD OF HEALTHCARE, PREVENTIVE HEALTH CARE AND NUTRITION (U.S. CLS. 2, 5, 22, 23, 29, 37, 38 AND 50).

CLASS 38—COMMUNICATION

FOR PROVIDING MULTIPLE USER ACCESS TO INFORMATION ON THE INTERNET; PROVIDING MULTIPLE USER ACCESS TO AN INTERNET PLATFORM; PROVIDING ACCESS TO INTERNET CHATROOMS AMONG COMPUTER USERS IN THE FIELDS OF HEALTHCARE, PREVENTIVE HEALTH CARE AND NUTRITION; PROVIDING ACCESS TO CHATLINES, UTILIZING THE INTERNET AND ONLINE ELECTRONIC BULLETIN BOARD SERVICES AND CHATROOMS FOR TRANSMISSION OF MESSAGES AMONG USERS CONCERNING HEALTHCARE, PREVENTIVE HEALTH CARE AND NUTRITION; TELECOMMUNICATION SERVICES, NAMELY, TRANSMISSION OF WEBCASTS, PODCASTS AND INFORMATION IN THE FIELDS OF HEALTHCARE, PREVENTIVE HEALTH CARE AND NUTRITION BY MEANS OF PLATFORMS AND INTERNET PORTALS; ELECTRONIC TRANSMISSION OF DATA, DOCUMENTS AND INFORMATION AMONG COMPUTER USERS VIA THE INTERNET AND OTHER DATABASES; WEB MESSAGING (U.S. CLS. 100, 101 AND 104).

CLASS 41—EDUCATION AND ENTERTAINMENT

FOR ORGANIZATION OF TRAINING LECTURES IN THE FIELDS OF HEALTHCARE, PREVENTIVE HEALTH CARE AND NUTRITION, ARRANGING AND CONDUCTING OF SEMINARS IN THE FIELDS OF HEALTHCARE, PREVENTIVE HEALTH CARE AND NUTRITION; PLANNING AND ORGANIZATION OF CHARITY EVENTS, NAMELY, PUBLIC LECTURES FOR HEALTH POLICY PURPOSES; EDUCATION AND PROVIDING OF TRAINING IN THE FIELD OF HEALTHCARE, PREVENTIVE HEALTH CARE AND NUTRITION; PUBLICATION AND EDITING OF BOOKS, NEWSPAPERS AND JOURNALS; INTERNET AND COMPUTER SERVICES, NAMELY, PROVIDING ONLINE NON-DOWNLOADABLE ELECTRONIC PUBLICATIONS IN THE NATURE OF MAGAZINES, JOURNALS AND NEWSLETTERS, AND PUBLICATION OF PRINTED MATTER IN THE FIELD OF HEALTHCARE, PREVENTIVE HEALTH CARE AND NUTRITION, IN PARTICULAR VIA THE INTERNET; PUBLICATION OF ELECTRONIC BOOKS AND JOURNALS ONLINE; PUBLICATION OF PRINTED MATTER, INCLUDING ELECTRONICALLY, OTHER THAN PUBLICITY TEXTS; PUBLICATION OF JOURNALS AND BOOKS ELECTRONICALLY, ALSO VIA THE INTERNET (U.S. CLS. 100, 101 AND 107).

CLASS 44—MEDICAL, BEAUTY AND AGRICULTURAL SERVICES

FOR MEDICAL ASSISTANCE; CONSULTANCY IN THE FIELD OF PREVENTIVE HEALTH CARE, HEALTH CARE AND NUTRITION (U.S. CLS. 100 AND 101).
VIVIAN MICZNIK FIRST, EXAMINING ATTORNEY

SN 79-074,305. TITTER BV, NETHERLANDS, FILED 9-15-2009.

Titter

THE MARK CONSISTS OF STANDARD CHARACTERS WITHOUT CLAIM TO ANY PARTICULAR FONT, STYLE, SIZE, OR COLOR.

PRIORITY DATE OF 6-26-2009 IS CLAIMED.
OWNER OF INTERNATIONAL REGISTRATION 1017068
DATED 9-15-2009, EXPIRES 9-15-2019.

CLASS 28—TOYS AND SPORTING GOODS

FOR GAMES, NAMELY, ACTION SKILL GAMES; PLAYTHINGS, NAMELY, ACTION FIGURES, PUPPETS, DOLLS (U.S. CLS. 22, 23, 38 AND 50).

CLASS 35—ADVERTISING AND BUSINESS

FOR ADVERTISING; BUSINESS MANAGEMENT (U.S. CLS. 100, 101 AND 102).

CLASS 41—EDUCATION AND ENTERTAINMENT

FOR ENTERTAINMENT SERVICES, NAMELY, PROVIDING ON-LINE COMPUTER GAMES (U.S. CLS. 100, 101 AND 107).

CHARLOTTE CORWIN, EXAMINING ATTORNEY

SN 79-074,475. KABUSHIKI KAISHA DAIDOH LIMITED, TOKYO 101-8619, JAPAN, FILED 7-2-2009.

gredecana

THE MARK CONSISTS OF STANDARD CHARACTERS WITHOUT CLAIM TO ANY PARTICULAR FONT, STYLE, SIZE, OR COLOR.

PRIORITY DATE OF 4-30-2009 IS CLAIMED.
OWNER OF INTERNATIONAL REGISTRATION 1017536
DATED 7-2-2009, EXPIRES 7-2-2019.
THE WORDING "GREDECANA" HAS NO MEANING IN A FOREIGN LANGUAGE.

CLASS 14—JEWELRY

FOR HOROLOGICAL AND CHRONOMETRIC INSTRUMENTS AND PARTS THEREOF; CASES FOR WATCHES AND CLOCKS; JEWELRY CASES; ORNAMENTS OF PRECIOUS METAL; JEWELRY AND COSTUME JEWELRY, EXCEPT PRECIOUS STONES, NAMELY, BRACELETS, NECKLACES, RINGS, TRINKETS, EARRING, PENDANTS, BROOCHES; CUFFLINKS, TIE PINS, TIE CLIPS, ORNAMENTAL PINS; KEY RINGS OF PRECIOUS METAL; KEY HOLDERS OF PRECIOUS METAL (U.S. CLS. 2, 27, 28 AND 50).

CLASS 18—LEATHER GOODS

FOR BAGS, NAMELY, ALL-PURPOSES SPORT BAGS, ALL-PURPOSES CARRYING BAGS, BELT BAGS, BOSTON BAGS, TOTE BAGS, HAND BAGS, SHOULDER BAGS, MAKE-UP BAGS SOLD EMPTY; SUITCASES; BRIEFCASES; RUCKSACKS; BACKPACKS; LEATHER POUCHES, FELT POUCHES, DRAWSTRING POUCHES, POUCHES FOR HOLDING KEYS, WEARABLE STRAPON POUCHES, JAPANESE UTILITY POUCHES; PURSES; WALLETS; UNFITTED VANITY CASES; BUSINESS CARD CASES; KEY CASES MADE OF LEATHER; UMBRELLAS; UMBRELLA COVERS; CLOTHING FOR PETS (U.S. CLS. 1, 2, 3, 22 AND 41).

CLASS 24—FABRICS

FOR FABRICS FOR TEXTILE USE; HOUSEHOLD LINEN, EXCEPT TOILET SEAT COVERS OF TEXTILE; TABLE LINEN OF TEXTILE; HANDKERCHIEFS OF TEXTILE; TOWELS OF TEXTILE; DISH CLOTHS; BATH LINEN, EXCEPT CLOTHING; BED LINEN; BED COVERS; PILLOWCASES; BED SHEETS; BED BLANKETS, CHILDREN'S BLANKETS, LAP BLANKETS, PET BLANKETS, SILK BLANKETS; CURTAINS (U.S. CLS. 42 AND 50).

CLASS 25—CLOTHING

FOR CLOTHING, NAMELY, SHIRTS, T-SHIRTS, PANTS, JEANS, JACKETS, COATS, DRESSES, SKIRTS, SOCKS, TIGHTS, STOCKINGS, GLOVES, VESTS, UNDERWEAR, RAINWEAR, WIND RESISTANT JACKETS, SWEATSHIRTS, TANK TOPS, PULLOVERS, BLOUSES, SWEATERS, KNIT SHIRTS, CARDIGANS, BELTS, PARKAS, MUFLERS, SUITS, SCARVES, SHAWLS, TIES AND FLEECE PULLOVERS; HEADGEAR, NAMELY, HATS AND CAPS; FOOTWEAR; SANDALS AND BEACH SHOES; SLIPPERS; SPORTSWEAR IN THE NATURE OF SWEAT SUITS, TRAINING SUITS, GYM SUITS, ATHLETIC UNIFORMS, BATHING SUITS; READY-MADE LININGS, NAMELY, FINISHED TEXTILE LININGS FOR GARMENTS (U.S. CLS. 22 AND 39).

AARON BRODSKY, EXAMINING ATTORNEY

SN 79-074,496. ALFA LAVAL CORPORATE AB, SWEDEN, FILED 7-2-2009.

OWNER OF INTERNATIONAL REGISTRATION 1017592
DATED 7-2-2009, EXPIRES 7-2-2019.

CLASS 11—ENVIRONMENTAL CONTROL APPARATUS

FOR APPARATUS FOR HEATING, HEAT RECOVERING, COOLING, REFRIGERATION, VENTILATION, BOILING, COOKING, STEAM GENERATION, CONCENTRATION, DRYING, PASTEURIZATION, DISTILLATION, STERILIZATION, DISINFECTION AND DESALINATION, NAMELY, HEAT EXCHANGERS NOT BEING PARTS OF MACHINES, PLATE HEAT EXCHANGERS, SPIRAL HEAT EXCHANGERS, SHELL AND TUBE HEAT EXCHANGERS, AIR COOLING HEAT EXCHANGERS; FILTERS AND MEMBRANE FILTERS FOR HEAT EXCHANGERS, NOT BEING PARTS OF MACHINES; PLATES AND GASKETS SOLD AS COMPONENTS OF HEAT EXCHANGERS NOT BEING PARTS OF MACHINES (U.S. CLS. 13, 21, 23, 31 AND 34).

CLASS 37—CONSTRUCTION AND REPAIR

FOR INSTALLATION, MAINTENANCE AND REPAIR SERVICES FOR APPARATUSES FOR HEATING, HEAT RECOVERING, COOLING, REFRIGERATION, VENTILATION, BOILING, COOKING, STEAM GENERATION, CONCENTRATION, DRYING, PASTEURIZATION, DISTILLATION, STERILIZATION, DISINFECTION AND DESALINATION, PLATE HEAT EXCHANGERS, SPIRAL HEAT EXCHANGERS, SHELL AND TUBE HEAT EXCHANGERS, AIR COOLING HEAT EXCHANGERS AS WELL AS OTHER TYPES OF HEAT EXCHANGERS AND FILTERS INCLUDING MEMBRANE FILTERS (U.S. CLS. 100, 103 AND 106).

ELI HELLMAN, EXAMINING ATTORNEY

CLASS 36—INSURANCE AND FINANCIAL

FOR PROVIDING ONLINE PAYMENT PROCESSING SERVICES, NAMELY, PERFORMING ELECTRONIC VERIFICATION OF BANK ACCOUNTS, ELECTRONIC PAYMENT ACCOUNTS, PHONE SUBSCRIBER ACCOUNTS, CREDIT CARDS, DEBIT CARDS, PREPAID PAYMENT CARDS AND GIFT CARDS, AND PROCESSING OF ELECTRONIC PAYMENT DATA, CASH ON DELIVERY DATA AND CREDIT RATING, SOLVENCY AND CREDIT RISK DATA IN RELATION TO PAYMENT SERVICES, ALL VIA A GLOBAL COMPUTER NETWORK; CHECKING OF CREDIT RATING, SOLVENCY AND CREDIT RISKS, PROVIDING FINANCIAL INFORMATION; FINANCIAL CONSULTING FEATURING INVESTIGATIONS AND RESEARCH IN DATABASES AND ON THE INTERNET FOR INFORMATION REGARDING FINANCIAL AFFAIRS AND MONETARY AFFAIRS; PROVIDING FINANCIAL INFORMATION AND FINANCIAL CONSULTANCY WITH REGARD TO ALL THE AFORESAID SERVICES (U.S. CLS. 100, 101 AND 102).

SN 79-074,516. PAY.ON AG, FED REP GERMANY, FILED 7-14-2009.

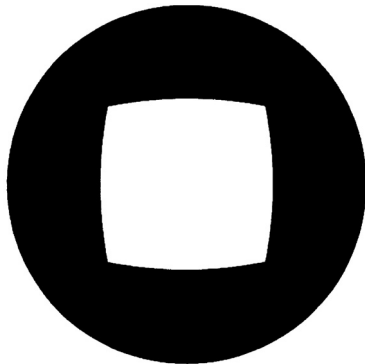

PRIORITY DATE OF 1-15-2009 IS CLAIMED.
OWNER OF INTERNATIONAL REGISTRATION 1017652
DATED 7-14-2009, EXPIRES 7-14-2019.
THE MARK CONSISTS OF A SHADED CIRCLE ENCOMPASSING A SQUARE WITH CURVED SIDES.

CLASS 35—ADVERTISING AND BUSINESS

FOR BUSINESS ADMINISTRATION; BUSINESS ORGANIZATION, MANAGEMENT AND ADMINISTRATION CONSULTANCY; PROVIDING PROFESSIONAL BUSINESS CONSULTING; PROVIDING OFFICE FUNCTIONS; PAYROLL PREPARATION; PAYROLL PROCESSING SERVICES; BILLING TRANSACTIONS FOR THE PURCHASE OF GOODS AND/OR THE USE OF SERVICES; INVOICE MANAGEMENT; DATABASE MANAGEMENT, NAMELY, COLLECTING, ORDERING, ADMINISTRATION, MAINTENANCE AND SYSTEMATIZATION OF DATA IN COMPUTER DATABASES; BUSINESS INVESTIGATION AND RESEARCH IN DATABASES AND ON THE INTERNET FOR OFFERS OF GOODS AND SERVICES; PROVIDING BUSINESS INFORMATION AND BUSINESS CONSULTANCY WITH REGARD TO ALL THE AFORESAID SERVICES (U.S. CLS. 100, 101 AND 102).

CLASS 38—COMMUNICATION

FOR TELECOMMUNICATIONS, NAMELY, PROVIDING ELECTRONIC TRANSMISSION OF ELECTRONIC DATA FOR VERIFICATION OF BANK ACCOUNTS, ELECTRONIC PAYMENT ACCOUNTS, PHONE SUBSCRIBER ACCOUNTS, CREDIT CARDS, DEBIT CARDS, PREPAID PAYMENT CARDS AND GIFT CARDS, AND PROVIDING OF ELECTRONIC TRANSMISSION OF ELECTRONIC PAYMENT DATA, CASH ON DELIVERY DATA AND CREDIT RATING DATA, ALL VIA A GLOBAL COMPUTER NETWORK; PROVIDING ACCESS TO COMPUTER DATABASES; PROVIDING ACCESS TO DATA, INFORMATION AND COMPUTER SOFTWARE STORED ELECTRONICALLY IN COMPUTER NETWORKS FOR REMOTE CONSULTATION; TRANSMISSION OF DATA, INFORMATION AND COMPUTER SOFTWARE VIA COMPUTER NETWORKS; TRANSMISSION OF ELECTRONIC DATA FOR THE CHECKING OF BANK ACCOUNTS, ELECTRONIC PAYMENT ACCOUNTS, TELEPHONE SUBSCRIBER ACCOUNTS, CREDIT CARDS, DEBIT CARDS, PREPAID CREDIT CARDS AND GIFT CARDS; TRANSMISSION OF ELECTRONIC PAYMENT DATA, PAYMENT-ON-DELIVERY DATA AND DATA ON CREDIT WORTHINESS, FINANCIAL SOLVENCY AND CREDIT RISKS; PROVIDING TELECOMMUNICATIONS INFORMATION AND TELECOMMUNICATIONS CONSULTANCY WITH REGARD TO ALL THE AFORESAID SERVICES (U.S. CLS. 100, 101 AND 104).

CLASS 42—SCIENTIFIC AND COMPUTER SERVICES

FOR DESIGN, DEVELOPMENT, CREATION, MAINTENANCE AND RENTAL OF COMPUTER SOFTWARE FOR BUSINESS ADMINISTRATION, OFFICE FUNCTIONS, ACCOUNTING, PAYROLL SERVICES AND BILLING OF TRANSACTIONS FOR THE BUYING OF GOODS AND/OR THE USE OF SERVICES AND INVOICE MANAGEMENT; DESIGN, DEVELOPMENT, CREATION, MAINTENANCE AND RENTAL OF COMPUTER SOFTWARE FOR FINANCIAL AFFAIRS, MONETARY AFFAIRS AND MONEY PAYMENT SERVICES; DESIGN, DEVELOPMENT, CREATION, MAINTENANCE AND RENTAL OF COMPUTER SOFTWARE FOR THE ENCRYPTION, DECRYPTION AND AUTHENTICATION OF DATA, INFORMATION AND MESSAGES; DESIGN, DEVELOPMENT, CREATION, MAINTENANCE, CUSTOMIZATION, LAYOUT AND UPKEEP OF WEB SITES FOR THIRD PARTIES; ENCRYPTION, DECRYPTION AND AUTHENTICATION OF DATA, INFORMATION AND MESSAGES FOR SECURITY PURPOSES; SCIENTIFIC INVESTIGATIONS AND RESEARCH IN COMPU-

TER DATABASES AND ON THE INTERNET FOR SCIENTIFIC RESEARCH PURPOSES; PROVIDING INFORMATION AND TECHNICAL CONSULTANCY WITH REGARD TO ALL THE AFORESAID SERVICES, NAMELY, PROVIDING COMPUTER SOFTWARE CONSULTING, CONSULTING IN THE FIELD OF IT PROJECT MANAGEMENT, AND CONSULTING IN THE FIELD OF INFORMATION TECHNOLOGY; STORING OF DATA IN COMPUTER DATABASES; ELECTRONIC STORAGE OF DATA; COMPUTER SERVICES, NAMELY, COMPUTER SERVER ADMINISTRATION FOR OTHERS (U.S. CLS. 100 AND 101).

ELI HELLMAN, EXAMINING ATTORNEY

SN 79-075,026. VISUAL COMPONENTS OY, FINLAND, FILED 10-5-2009.

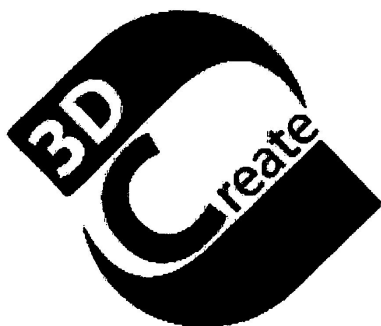

PRIORITY DATE OF 9-23-2009 IS CLAIMED.
OWNER OF INTERNATIONAL REGISTRATION 1019000
DATED 10-5-2009, EXPIRES 10-5-2019.
NO CLAIM IS MADE TO THE EXCLUSIVE RIGHT TO USE "3D CREATE", APART FROM THE MARK AS SHOWN.

CLASS 9—ELECTRICAL AND SCIENTIFIC APPARATUS

FOR COMPUTER SOFTWARE USED TO GENERATE AND PUBLISH LIBRARIES OF RE-USEABLE DIGITAL DATA COMPONENTS, WHICH CAN THEN BE USED FOR 3D SIMULATION PURPOSES (U.S. CLS. 21, 23, 26, 36 AND 38).

CLASS 42—SCIENTIFIC AND COMPUTER SERVICES

FOR DESIGN AND DEVELOPMENT OF COMPUTER HARDWARE AND SOFTWARE, UPDATING OF COMPUTER SOFTWARE (U.S. CLS. 100 AND 101).
KATHERINE CONNOLLY, EXAMINING ATTORNEY

SN 79-075,677. STADLER FORM AKTIENGESELLSCHAFT, SWITZERLAND, FILED 8-17-2009.

STADLER FORM

THE MARK CONSISTS OF STANDARD CHARACTERS WITHOUT CLAIM TO ANY PARTICULAR FONT, STYLE, SIZE, OR COLOR.

PRIORITY DATE OF 2-25-2009 IS CLAIMED.
OWNER OF INTERNATIONAL REGISTRATION 1020396
DATED 8-17-2009, EXPIRES 8-17-2019.
OWNER OF U.S. REG. NO. 2,759,156.

CLASS 11—ENVIRONMENTAL CONTROL APPARATUS

FOR APPARATUS FOR LIGHTING, HEATING, STEAM GENERATING, COOKING, REFRIGERATING, DRYING, VENTILATING, WATER SUPPLY AND SANITARY PURPOSES, NAMELY, HUMIDIFIERS, AIR PURIFIERS, ELECTRIC FANS, ELECTRIC HEATING FANS, GRILLS, NAMELY, ELECTRIC GRILLS AND GAS GRILLS, ELECTRIC KETTLES, ELECTRIC TOASTERS, ELECTRIC COFFEE MAKER, DEHUMIDIFIERS, EVAPORATIVE AIR COOLERS, AIR CONDITIONERS, ELECTRIC DISPENSERS FOR AIR FRESHENER AND ELECTRIC TOASTER OVENS (U.S. CLS. 13, 21, 23, 31 AND 34).

CLASS 21—HOUSEWARES AND GLASS

FOR HOUSEHOLD UTENSILS NOT MADE OF PRECIOUS METALS, NAMELY, NON-ELECTRIC FOOD BLENDERS, NON-ELECTRIC KETTLES, NON-ELECTRIC COFFEE MAKERS; HOUSEHOLD UTENSILS MADE OF PRECIOUS METALS, NAMELY, NON-ELECTRIC FOOD BLENDERS, NON-ELECTRIC STICK BLENDERS, NON-ELECTRIC KETTLES, NON-ELECTRIC COFFEE MAKERS (U.S. CLS. 2, 13, 23, 29, 30, 33, 40 AND 50).

LIEF MARTIN, EXAMINING ATTORNEY

SN 79-075,735. SWIX SPORT AS, NORWAY, FILED 9-28-2009.

SWIX Triac

THE MARK CONSISTS OF STANDARD CHARACTERS WITHOUT CLAIM TO ANY PARTICULAR FONT, STYLE, SIZE, OR COLOR.

PRIORITY DATE OF 9-8-2009 IS CLAIMED.
OWNER OF INTERNATIONAL REGISTRATION 1020578
DATED 9-28-2009, EXPIRES 9-28-2019.
OWNER OF U.S. REG. NOS. 2,969,219 AND 3,256,104.

CLASS 18—LEATHER GOODS

FOR SPORTS BAGS (U.S. CLS. 1, 2, 3, 22 AND 41).

CLASS 25—CLOTHING

FOR CLOTHING, NAMELY, T-SHIRTS, TURTLE-NECKS; SPORTS SHIRTS, SPORTS JERSEYS, PULL-OVERS, SWEAT SHIRTS, SKI SUITS, BODY SUITS, JACKETS, VESTS, PANTS, SHORTS, BOXER SHORTS, TIGHTS, HEADBANDS, HEADBANDS AGAINST SWEATING, SWEAT BANDS, BASEBALL CAPS, SOCKS, HATS, GLOVES, UNDERWEAR (U.S. CLS. 22 AND 39).

CLASS 28—TOYS AND SPORTING GOODS

FOR SKIS, SKI POLES, SKI BINDINGS, WAX FOR SKIS, SCRAPERS FOR SKIS, GOLF CLUBS, SNOWBOARDS, WAX FOR SNOWBOARDS, BAGS AND CASES SPECIALLY ADAPTED FOR SPORTS EQUIPMENT (U.S. CLS. 22, 23, 38 AND 50).

TINA L. SNAPP, EXAMINING ATTORNEY

SN 79-075,899. IMPREG GMBH, FED REP GERMANY,
FILED 10-7-2009.

SN 79-076,046. BASF SE, FED REP GERMANY, FILED 9-30-
2009.

IMPREG

E-por

THE MARK CONSISTS OF STANDARD CHARACTERS
WITHOUT CLAIM TO ANY PARTICULAR FONT, STYLE,
SIZE, OR COLOR.

OWNER OF INTERNATIONAL REGISTRATION 1020977
DATED 10-7-2009, EXPIRES 10-7-2019.

CLASS 17—RUBBER GOODS

FOR SEMI-FINISHED PRODUCTS MADE OF PLAS-
TIC, NAMELY, HOSE AND PIPE LINERS; FLEXIBLE
TUBES MADE OF PLASTIC (U.S. CLS. 1, 5, 12, 13, 35
AND 50).

CLASS 19—NON-METALLIC BUILDING MA- TERIALS

FOR BUILDING MATERIALS NOT OF METAL,
NAMELY, RIGID PIPES NOT MADE OF METAL OR
WOOD (U.S. CLS. 1, 12, 33 AND 50).
DAVID I, EXAMINING ATTORNEY

SN 79-075,929. SPUTNIK ENGINEERING AG, SWITZER-
LAND, FILED 6-19-2009.

SOLARMAX

THE MARK CONSISTS OF STANDARD CHARACTERS
WITHOUT CLAIM TO ANY PARTICULAR FONT, STYLE,
SIZE, OR COLOR.

PRIORITY DATE OF 12-19-2008 IS CLAIMED.
OWNER OF INTERNATIONAL REGISTRATION 1021083
DATED 6-19-2009, EXPIRES 6-19-2019.
OWNER OF U.S. REG. NO. 3,267,002.

CLASS 9—ELECTRICAL AND SCIENTIFIC APPARATUS

FOR INVERTERS; APPARATUS AND INSTRUMENTS
FOR PRODUCING, CONDUCTING, SWITCHING,
TRANSFORMING, ACCUMULATING, REGULATING
OR CONTROLLING ELECTRICITY; SOFTWARE FOR
INVERTERS FOR SOLAR GRID-CONNECTION; ELE-
MENTS OF SOLAR TECHNOLOGY, NAMELY, PHOTO-
VOLTAIC SOLAR MODULES, SOLAR PANELS FOR
PRODUCTION OF ELECTRICITY, AND INVERTERS
FOR PHOTOVOLTAIC SOLAR MODULES (U.S. CLS. 21,
23, 26, 36 AND 38).

CLASS 42—SCIENTIFIC AND COMPUTER SERVICES

FOR DESIGN AND DEVELOPMENT OF COMPUTERS
AND SOFTWARE IN THE FIELD OF SOLAR TECHNOL-
OGY; SERVICES OF AN ENGINEER; TECHNOLOGICAL
RESEARCH SERVICES IN THE FIELD OF SOLAR
TECHNOLOGY (U.S. CLS. 100 AND 101).
SUZANNE BLANE, EXAMINING ATTORNEY

THE MARK CONSISTS OF STANDARD CHARACTERS
WITHOUT CLAIM TO ANY PARTICULAR FONT, STYLE,
SIZE, OR COLOR.

PRIORITY DATE OF 4-2-2009 IS CLAIMED.

OWNER OF INTERNATIONAL REGISTRATION 1021413
DATED 9-30-2009, EXPIRES 9-30-2019.

THE WORDING "E-POR" HAS NO MEANING IN A
FOREIGN LANGUAGE.

CLASS 1—CHEMICALS

FOR RAW MATERIALS AND AUXILIARY AGENTS
FOR THE PLASTICS MANUFACTURING AND PROCES-
SING INDUSTRIES, NAMELY, CHEMICALS FOR USE
IN INDUSTRY, UNPROCESSED PLASTICS IN THE
FORM OF POWDERS, GRANULES, PASTES, AND LI-
QUIDS (U.S. CLS. 1, 5, 6, 10, 26 AND 46).

CLASS 17—RUBBER GOODS

FOR SEMI-FINISHED PRODUCTS, NAMELY, INSU-
LATING MATERIALS OF PLASTIC IN THE FORM OF
SLABS, RODS, BLOCKS, SHAPED PARTS, AND PIPES;
SLABS, SHAPED PARTS AND FILLINGS MADE OF
PLASTICS AS INSULATING MATERIAL FOR USE IN
THE CONSTRUCTION INDUSTRY (U.S. CLS. 1, 5, 12, 13,
35 AND 50).

SEAN CROWLEY, EXAMINING ATTORNEY

SN 79-076,419. A. KUSTER SIROCCO-KAFFEE AG, SWIT-
ZERLAND, FILED 7-15-2009.



PRIORITY DATE OF 4-28-2009 IS CLAIMED.
OWNER OF INTERNATIONAL REGISTRATION 1022348
DATED 7-15-2009, EXPIRES 7-15-2019.

THE MARK CONSISTS OF A SILHOUETTE OF A CHILD
CARRYING A CUP.

CLASS 30—STAPLE FOODS

FOR COFFEE, TEA, COCOA, SUGAR, RICE, TAPIOCA, SAGO, ARTIFICIAL COFFEE; COFFEE BLENDS, NAMELY, READY-TO-USE AND POWDERED COFFEE; FLOUR; PREPARATIONS MADE FROM CEREALS, NAMELY, CEREAL-BASED SNACK FOODS AND ENERGY BARS, BREAKFAST CEREALS, READY-TO-EAT CEREALS, PROCESSED CEREALS; BREAD, PASTRY AND CONFECTIONERY, NAMELY, FROZEN CONFECTIONS, CHOCOLATES, CANDIES; EDIBLE ICES; HONEY, TREACLE; YEAST, BAKING POWDER; SALT, MUSTARD; VINEGAR, SAUCES IN THE NATURE OF CONDIMENTS; SPICES; ICE FOR REFRESHMENT (U.S. CL. 46).

CLASS 32—LIGHT BEVERAGES

FOR BEERS; MINERAL AND SPARKLING WATER AND OTHER NON-ALCOHOLIC BEVERAGES, NAMELY, SOFT DRINKS, ENERGY DRINKS, HERBAL JUICES, VEGETABLE JUICES; FRUIT DRINKS AND FRUIT JUICES; SYRUPS FOR MAKING BEVERAGES AND OTHER PREPARATIONS FOR MAKING BEVERAGES, NAMELY, POWDERS USED IN THE PREPARATION OF ISOTONIC DRINKS AND SPORTS BEVERAGES AND FRUIT-BASED BEVERAGES, NON-ALCOHOLIC COCKTAIL-MIXES, CONCENTRATES FOR JUICES AND FRUIT DRINKS (U.S. CLS. 45, 46 AND 48).
APRIL ROACH, EXAMINING ATTORNEY

SN 79-076,664. MULTIPHARMA GMBH, FED REP GERMANY, FILED 8-12-2009.



PRIORITY DATE OF 2-24-2009 IS CLAIMED.
OWNER OF INTERNATIONAL REGISTRATION 1023017 DATED 8-12-2009, EXPIRES 8-12-2019.

THE COLOR(S) RED, BLUE, AND WHITE IS/ARE CLAIMED AS A FEATURE OF THE MARK.

THE MARK CONSISTS OF THE LETTERS "MULT" IN THE COLOR BLUE, A BLUE AND RED CAPSULE WITH WHITE HIGHLIGHTS REPRESENTING THE LETTER "I", WITH RED CURVED LINES EMANATING FROM IT, AND THE TERM "PHARMA" IN THE COLOR RED.

CLASS 5—PHARMACEUTICALS

FOR PHARMACEUTICAL AND VETERINARY PREPARATIONS FOR TREATING HEART DISEASE, DIABETES, GASTROINTESTINAL DISORDERS; SANITARY PREPARATIONS FOR MEDICAL PURPOSES; DIETETIC SUBSTANCES ADAPTED FOR MEDICAL USE, NAMELY, DIETARY AND NUTRITIONALLY FORTIFIED FOOD PRODUCTS ADAPTED FOR MEDICAL USE; FOOD FOR BABIES; MEDICAL PLASTERS; MATERIALS FOR DRESSINGS, IN THE NATURE OF MEDICAL DRESSINGS, WOUND DRESSINGS, BURN DRESSINGS; MATERIALS FOR STOPPING TEETH AND DENTAL WAX; DISINFECTANTS FOR SANITARY PURPOSES, FOR HYGIENE PURPOSES, FOR MEDICAL INSTRUMENTS, FOR ALL PURPOSE USE; PREPARATIONS FOR DESTROYING VERMIN; FUNGICIDES, HERBICIDES (U.S. CLS. 6, 18, 44, 46, 51 AND 52).

CLASS 35—ADVERTISING AND BUSINESS

FOR ADVERTISING; BUSINESS MANAGEMENT; BUSINESS ADMINISTRATION; OFFICE FUNCTIONS; IMPORT-EXPORT AGENCIES; BUSINESS MANAGEMENT FOR OTHERS; COMMERCIAL ADMINISTRATION OF THE LICENSING OF THE GOODS AND SERVICES OF OTHERS; RETAIL AND WHOLESALE STORE SERVICES FEATURING MEDICINES, MEDICAL, ORTHOPEDIC AND COSMETIC PRODUCTS, AS WELL AS OTHER GOODS IN THE HEALTH SECTOR, HOUSEHOLD GOODS, BOOKS AND OTHER PRINTED MATTER, FOOD AND BEVERAGES; ARRANGING COMMERCIAL CONTRACTS FOR THE BUYING AND SELLING OF GOODS, FOR OTHERS, AND FOR THE PROVIDING OF SERVICES, FOR OTHERS; PROMOTING THE GOODS OF OTHERS BY MEANS OF ON-LINE REAL TIME PRESENTATION FOR INSPECTION, VIEWING OR SHOWING OF MEDICINES, MEDICAL, ORTHOPEDIC AND COSMETIC PRODUCTS, AS WELL AS OTHER GOODS IN THE HEALTH SECTOR, HOUSEHOLD GOODS, BOOKS AND OTHER PRINTED MATTER, FOOD AND BEVERAGES; SERVICES WITH REGARD TO PRODUCT AND SERVICE PRESENTATION TO THE PUBLIC; ADVERTISING ON THE INTERNET, FOR OTHERS; BUSINESS CONSULTANCY AND ADVICE; PROFESSIONAL BUSINESS RESEARCH CONSULTANCY (U.S. CLS. 100, 101 AND 102).

CLASS 42—SCIENTIFIC AND COMPUTER SERVICES

FOR SCIENTIFIC SERVICES, NAMELY, SCIENTIFIC INVESTIGATIONS FOR MEDICAL PURPOSES; TECHNOLOGICAL SERVICES, NAMELY, PROVIDING TECHNOLOGICAL CONSULTATION SERVICES IN THE FIELD OF MANUFACTURING PHARMACEUTICALS; RESEARCH SERVICES, NAMELY, MEDICAL RESEARCH; SCIENTIFIC RESEARCH IN THE FIELD OF MEDICINE; SCIENTIFIC RESEARCH CONSULTING SERVICES IN THE FIELD OF MEDICINE AND PHARMACOLOGY (U.S. CLS. 100 AND 101).
JEAN IM, EXAMINING ATTORNEY

SN 79-076,710. TAIZHOU HONGMENG; INDUSTRIAL CO., LTD, CHINA, FILED 10-20-2009.

Go-touch

OWNER OF INTERNATIONAL REGISTRATION 1023157 DATED 10-20-2009, EXPIRES 10-20-2019.

CLASS 3—COSMETICS AND CLEANING PREPARATIONS

FOR LAUNDRY PREPARATIONS, NAMELY, BLEACH, SOAP, DETERGENT, FABRIC SOFTENER; ALL PURPOSE CLEANING PREPARATIONS; TOILET DETERGENT; CLEANING, POLISHING AND SCOURING PREPARATIONS; PERFUMERY; COSMETICS; DENTIFRICES; INCENSE; COSMETICS FOR ANIMALS (U.S. CLS. 1, 4, 6, 50, 51 AND 52).

CLASS 5—PHARMACEUTICALS

FOR ANTIALLERGIC MEDICINES; STERILISING PREPARATIONS; DIETETIC FOODS ADAPTED FOR MEDICAL USE; AIR FRESHENING PREPARATIONS; REFRIGERATOR DEODORIZER; TOILET DEODORIZER; MEDICATED ANIMAL WASHES; PESTICIDES; ANTISEPTIC WIPES; DENTAL LACQUER (U.S. CLS. 6, 18, 44, 46, 51 AND 52).

CLASS 21—HOUSEWARES AND GLASS

FOR PORCELAIN, ENAMEL, AND PLASTIC KITCHEN UTENSILS, NAMELY, GRATERS, SPATULAS, STRAINERS, TURNERS, PLATES, BOWLS AND CUPS; DRINKING VESSELS; WATERING CANS; BRUSH GOODS, NAMELY, WASHING BRUSHES, HAIR BRUSHES, FLOOR BRUSHES, DUSTING BRUSHES; COSMETIC UTENSILS, NAMELY, COSMETIC BRUSHES, EYEBROW BRUSHES, COSMETIC SPATULAS FOR USE WITH DEPILATORY PREPARATIONS; HEAT-INSULATED VESSELS; HAND OPERATED CLEANING INSTRUMENTS, NAMELY, CLOTHS, BRUSHES, RAGS, SPONGES, MOPS, BROOMS, FEATHER DUSTERS; TOOTHBRUSHES; TOOTHPICKS; INSECT TRAPS (U.S. CLS. 2, 13, 23, 29, 30, 33, 40 AND 50).

JEFFERY COWARD, EXAMINING ATTORNEY

CLASS 42—SCIENTIFIC AND COMPUTER SERVICES

FOR PROVIDING INFORMATION RELATING TO NEW PRODUCT DESIGN OF NAVIGATIONAL EQUIPMENT AND SOFTWARE IN THE FIELD OF SPORT AND RECREATION (U.S. CLS. 100 AND 101).

LYDIA BELZER, EXAMINING ATTORNEY

SN 79-076,979, SVP MANAGEMENT & PARTICIPATIONS, FRANCE, FILED 9-22-2009.

SN 79-076,728, NAVIONICS S.P.A., ITALY, FILED 10-21-2009.

NAVIPEDIA

THE MARK CONSISTS OF STANDARD CHARACTERS WITHOUT CLAIM TO ANY PARTICULAR FONT, STYLE, SIZE, OR COLOR.

PRIORITY DATE OF 8-18-2009 IS CLAIMED.

OWNER OF INTERNATIONAL REGISTRATION 1023197 DATED 10-21-2009, EXPIRES 10-21-2019.

DECISIONS BECOME EASY

THE MARK CONSISTS OF STANDARD CHARACTERS WITHOUT CLAIM TO ANY PARTICULAR FONT, STYLE, SIZE, OR COLOR.

PRIORITY DATE OF 3-24-2009 IS CLAIMED.

OWNER OF INTERNATIONAL REGISTRATION 1023975 DATED 9-22-2009, EXPIRES 9-22-2019.

CLASS 9—ELECTRICAL AND SCIENTIFIC APPARATUS

FOR ELECTRONIC DATABASES STORED ON ELECTRONIC STORAGE MEDIA AND DOWNLOADABLE ELECTRONIC DATABASES FEATURING DIGITALLY ENCODED DATA REPRESENTING MAPS AND OTHER GEOGRAPHIC INFORMATION, ELECTRONIC CHARTS FOR MARINE, MOUNTAIN, ROAD AND OUTDOOR NAVIGATION RECORDED ON ELECTRONIC STORAGE MEDIA, AND INSTRUMENTS FOR MARINE, MOUNTAIN, ROAD AND OUTDOOR NAVIGATION IN THE NATURE OF ELECTRONIC NAVIGATIONAL AND POSITIONING APPARATUS AND INSTRUMENTS (U.S. CLS. 21, 23, 26, 36 AND 38).

CLASS 35—ADVERTISING AND BUSINESS

FOR PROVIDING COMMERCIAL INFORMATION IN THE FIELD OF SPORT, RECREATION AND LEISURE ACTIVITIES, NAMELY, RELATING TO HIKING AND TREKKING TRAILS, SKI RUNS AND FACILITIES, RECREATIONAL PARKS AND AREAS, TRACKS FOR SNOWMOBILES AND TV (ALL TERRAIN VEHICLES) (U.S. CLS. 100, 101 AND 102).

CLASS 41—EDUCATION AND ENTERTAINMENT

FOR PROVIDING ON-LINE INFORMATION IN THE FIELD OF SPORT, RECREATION AND LEISURE ACTIVITIES; INFORMATION IN THE FIELD OF SPORT, RECREATION AND LEISURE ACTIVITIES, SPECIFICALLY RELATING TO HIKING AND TREKKING TRAILS, SKI RUNS AND FACILITIES, RECREATIONAL PARKS AND AREAS, TRACKS FOR SNOWMOBILES AND TV (ALL TERRAIN VEHICLES); EDUCATION SERVICES IN THE FIELD OF SPORT, RECREATION AND LEISURE ACTIVITIES, NAMELY, SEMINARS AND WORKSHOPS IN THE FIELDS OF LOCATING AND NAVIGATING HIKING AND TREKKING TRAILS, SELECTING SKI RUNS AND FACILITIES, AWARENESS OF RECREATIONAL PARKS AND AREAS, AND FINDING TRACKS FOR SNOWMOBILES AND TV (ALL TERRAIN VEHICLES) (U.S. CLS. 100, 101 AND 107).

CLASS 35—ADVERTISING AND BUSINESS

FOR BUSINESS INVESTIGATIONS IN THE FIELD OF COMMERCIAL AND INDUSTRIAL INVESTIGATION SERVICES; MARKET RESEARCH STUDIES; MARKETING RESEARCH SERVICES; PROVIDING BUSINESS INTELLIGENCE SERVICES; DATA SEARCH IN COMPUTER FILES FOR OTHERS, NAMELY, MARKET RESEARCH BY MEANS OF A COMPUTER DATABASE; COLLECTION, COMPILATION, ANALYSIS, SYSTEMATIZATION AND RETRIEVAL OF DATA AND INFORMATION FROM A COMPUTER DATABASE; BUSINESS ASSISTANCE, MANAGEMENT AND INFORMATION SERVICES ON BEHALF OF OTHERS RELATING TO FIELDS OF TAXATION, THE LAW, REGULATIONS, BUSINESS, SOCIAL AFFAIRS, HUMAN RESOURCES, THE ECONOMY, FINANCE; BUSINESS MANAGEMENT ASSISTANCE, BUSINESS ORGANIZATION AND MANAGEMENT CONSULTING, BUSINESS INFORMATION IN THE FIELD OF TAXATION, THE LAW, REGULATIONS, BUSINESS, SOCIAL AFFAIRS, HUMAN RESOURCES, THE ECONOMY, FINANCE; ACCOUNTING SERVICES, TAX PREPARATION (U.S. CLS. 100, 101 AND 102).

CLASS 36—INSURANCE AND FINANCIAL

FOR FINANCIAL ANALYSES; CONSULTING IN THE FIELDS OF FINANCE AND INSURANCE; CAPITAL INVESTMENTS SERVICES; FISCAL VALUATIONS AND ASSESSMENTS; PROVIDING RESEARCH AND INFORMATION IN THE FIELDS OF FINANCE, TAXATION AND INSURANCE (U.S. CLS. 100, 101 AND 102).

CLASS 45—PERSONAL AND LEGAL SERVICES

FOR LEGAL SERVICES, LEGAL RESEARCH, CONSULTING SERVICES RELATING TO INDUSTRIAL PROPERTY; SERVICES OF RESEARCH OF TRADEMARKS, PATENTS AND OTHER INTELLECTUAL PROPERTY RIGHTS; RESEARCH AND INFORMATION SERVICES IN THE FIELD OF LAW AND REGULATION (U.S. CLS. 100 AND 101).

MARK SHINER, EXAMINING ATTORNEY

SN 79-077,232. UNIVERSAL CAN CORPORATION, JAPAN,
FILED 12-7-2009.

SN 79-077,574. LCS INTERNATIONAL B.V., NETHER-
LANDS, FILED 11-10-2009.

UNILES

OWNER OF INTERNATIONAL REGISTRATION 1024674
DATED 12-7-2009, EXPIRES 12-7-2019.
THE WORDING "UNILES" HAS NO MEANING IN A
FOREIGN LANGUAGE.

CLASS 7—MACHINERY

FOR PRINTING PLATES; PRINTING CYLINDERS;
PRINTING ROLLERS FOR MACHINES (U.S. CLS. 13,
19, 21, 23, 31, 34 AND 35).

CLASS 40—MATERIAL TREATMENT

FOR OFFSET PRINTING; PHOTOGRAVURE PRINT-
ING; SCREEN PRINTING; LITHOGRAPHIC PRINTING;
LETTERPRESS PRINTING; PRINTING (U.S. CLS. 100,
103 AND 106).
MARY CRAWFORD, EXAMINING ATTORNEY

SN 79-077,387. DANISCO A/S, DENMARK, FILED 11-12-2009.

VIVAGRAPE

THE MARK CONSISTS OF STANDARD CHARACTERS
WITHOUT CLAIM TO ANY PARTICULAR FONT, STYLE,
SIZE, OR COLOR.

PRIORITY DATE OF 6-3-2009 IS CLAIMED.
OWNER OF INTERNATIONAL REGISTRATION 1025099
DATED 11-12-2009, EXPIRES 11-12-2019.

CLASS 1—CHEMICALS

FOR CHEMICAL PRODUCTS FOR INDUSTRIAL USE,
NAMESLY, GRAPE POLYPHENOLS (U.S. CLS. 1, 5, 6, 10,
26 AND 46).

CLASS 32—LIGHT BEVERAGES

FOR NON-ALCOHOLIC FRUIT EXTRACTS, NAMESLY,
GRAPE EXTRACTS FOR USE IN THE PREPARATION
OF BEVERAGES (U.S. CLS. 45, 46 AND 48).
PATRICIA EVANKO, EXAMINING ATTORNEY



PRIORITY DATE OF 8-26-2009 IS CLAIMED.
OWNER OF INTERNATIONAL REGISTRATION 1025605
DATED 11-10-2009, EXPIRES 11-10-2019.
OWNER OF U.S. REG. NOS. 1,189,988, 1,193,695 AND
OTHERS.

THE MARK CONSISTS OF THE STYLIZED WORDING
"LE COQ SPORTIF" AND A SILHOUETTE OF A ROOSTER.
THE ENGLISH TRANSLATION OF "LE COQ SPORTIF"
IN THE MARK IS "THE SPORTING COCK".

CLASS 18—LEATHER GOODS

FOR LEATHER AND IMITATION LEATHER, UM-
BRELLAS, PARASOLS, SPORTS BAGS, TRAVEL BAGS,
BACKPACKS, HANDBAGS, SCHOOL SACHELS,
BEACH BAGS, SUITCASES, UNFITTED VANITY CASES,
KEY CASES, GARMENT BAGS FOR TRAVEL, WAL-
LETS, COIN HOLDERS; ATTACHE CASES (U.S. CLS. 1,
2, 3, 22 AND 41).

CLASS 25—CLOTHING

FOR CLOTHING, NAMESLY, SHIRTS, KNIT SHIRTS,
JERSEYS, TANK TOPS, T-SHIRTS, SINGLETs, DRESSES,
SKIRTS, UNDERWEAR, SWIMWEAR, SHORTS, PANTS,
SWEATERS, TOPS AND BOTTOMS; SHOES AND FOOT-
WEAR, EXCEPT ORTHOPAEDIC SHOES; GLOVES;
SASHES FOR WEAR; SCARVES; HEADGEAR, NAMESLY,
HEADWEAR, HATS AND CAPS; SUSPENDERS; BELTS
(U.S. CLS. 22 AND 39).

ROBERT STRUCK, EXAMINING ATTORNEY

SN 79-077,575. WASABRÖD AKTIEBOLAG, SWEDEN,
FILED 10-9-2009.

WASA CRISP'N CACAO

THE MARK CONSISTS OF STANDARD CHARACTERS
WITHOUT CLAIM TO ANY PARTICULAR FONT, STYLE,
SIZE, OR COLOR.

PRIORITY DATE OF 10-7-2009 IS CLAIMED.
OWNER OF INTERNATIONAL REGISTRATION 1025606
DATED 10-9-2009, EXPIRES 10-9-2019.

CLASS 29—MEATS AND PROCESSED FOODS

FOR MEAT, FISH, POULTRY AND GAME; MEAT
EXTRACTS; PRESERVED, FROZEN, DRIED AND
COOKED FRUITS AND VEGETABLES; JELLIES, JAMS,
COMPOTES; EGGS, MILK AND MILK PRODUCTS
EXCLUDING ICE CREAM, ICE MILK AND FROZEN
YOGHURT; EDIBLE OILS AND FATS (U.S. CL. 46).

CLASS 30—STAPLE FOODS

FOR COFFEE, TEA, COCOA, SUGAR, RICE, TAPIOCA, SAGO, ARTIFICIAL COFFEE; FLOUR AND PREPARATIONS MADE FROM CEREALS, NAMELY, READY-TO-EAT CEREAL-DERIVED FOOD BARS, BREAKFAST CEREALS AND COOKIES; BREAD, ROLLS, BUNS, CRISP BREAD, CRACKERS, TARTS, PROCESSED CEREAL, SANDWICHES, PASTRIES, CAKES, RICE CAKES, RUSKS, BREAKFAST CEREAL, MUESLI, OAT FLAKES, OAT-BASED FOOD IN THE NATURE OF OATMEAL, PROCESSED CRUSHED OATS AND HUSKED OATS, UNLEAVENED BREAD, BREAD SUBSTITUTES IN THE NATURE OF BREAD STICKS, CRACKERS, RUSKS AND TOASTING BREAD; BREAD PRODUCTS, NAMELY, LOAVES OF BREAD, BREAD ROLLS, SAVORY BUNS, SWEET BUNS, PULLMAN LOAF, DINNER ROLLS, SANDWICH ROLLS, RUSTIC ROLLS AND BREADS, BAGUETTES, FLOURLESS BREAD, BUNS, BAGELS, TORTILLAS AND SANDWICH WRAPS AND SOURDOUGH BREAD; SNACKS MADE FROM CEREALS; BISCUITS; PASTRY, PASTRY GOODS AND CONFECTIONERY, NAMELY, CANDY AND CHOCOLATE; CHOCOLATE AND CHOCOLATE-BASED PRODUCTS CONTAINING CHOCOLATE, NAMELY, CHOCOLATE SYRUP, CHOCOLATE-BASED READY TO EAT FOOD BARS; BAKERY PRODUCTS; SNACKS, NAMELY, CEREAL-DERIVED FRUIT BARS, GRAIN-BASED FOOD BARS ALSO CONTAINING FRUIT, FRUIT-BASED ORGANIC FOOD BARS AND SWEET SNACKS, NAMELY, CAKES, COOKIES AND BISCUITS, VIENNESE PASTRIES, PARTICULARLY CROISSANTS, BRIOCHES, RAISIN BREADS AND PAINS AU CHOCOLATE; PREPARATIONS FOR MAKING CAKES, NAMELY, CAKE MIX; PIZZAS AND PREPARATIONS FOR PIZZAS IN THE NATURE OF PIZZA SAUCE, PIZZA CRUST MIXES, PREPARED AND FROZEN PIZZA CRUST; EDIBLE ICES; HONEY, TREACLE; YEAST, BAKING-POWDER; SALT, MUSTARD; VINEGAR, SAUCES BEING CONDIMENTS; SPICES; ICE (U.S. CL. 46).

MICHAEL WIENER, EXAMINING ATTORNEY

SN 79-078,591. SOLARFORCE, FRANCE, FILED 12-4-2009.

SOLARFORCE

THE MARK CONSISTS OF STANDARD CHARACTERS WITHOUT CLAIM TO ANY PARTICULAR FONT, STYLE, SIZE, OR COLOR.

PRIORITY DATE OF 6-4-2009 IS CLAIMED.
OWNER OF INTERNATIONAL REGISTRATION 1027991 DATED 12-4-2009, EXPIRES 12-4-2019.

CLASS 7—MACHINERY

FOR MACHINES AND MACHINE TOOLS FOR MAKING PHOTOVOLTAIC PANELS AND THEIR COMPONENT PARTS; MACHINES AND MACHINE TOOLS FOR MAKING SILICON WAFERS AND PHOTOVOLTAIC CELLS (U.S. CLS. 13, 19, 21, 23, 31, 34 AND 35).

CLASS 9—ELECTRICAL AND SCIENTIFIC APPARATUS

FOR SILICON WAFERS FOR PHOTOVOLTAIC CELLS, PHOTOVOLTAIC CELLS, PHOTOVOLTAIC PANELS; SOLAR COLLECTORS (U.S. CLS. 21, 23, 26, 36 AND 38).

CLASS 37—CONSTRUCTION AND REPAIR

FOR INSTALLATION, LAYING, REPAIR AND MAINTENANCE OF PHOTOVOLTAIC PANELS; INSTALLATION, LAYING, REPAIR AND MAINTENANCE SOLAR SENSORS AND COLLECTORS (U.S. CLS. 100, 103 AND 106).

KATHERINE M. DUBRAY, EXAMINING ATTORNEY

SN 79-078,717. RANDALL COMMUNICATIONS PTY LTD, AUSTRALIA, FILED 12-8-2009.

blahband

THE MARK CONSISTS OF STANDARD CHARACTERS WITHOUT CLAIM TO ANY PARTICULAR FONT, STYLE, SIZE, OR COLOR.

PRIORITY DATE OF 12-4-2009 IS CLAIMED.
OWNER OF INTERNATIONAL REGISTRATION 1028288 DATED 12-8-2009, EXPIRES 12-8-2019.

CLASS 9—ELECTRICAL AND SCIENTIFIC APPARATUS

FOR ELECTRONICALLY ENCODED IDENTITY WRISTBANDS (U.S. CLS. 21, 23, 26, 36 AND 38).

CLASS 16—PAPER GOODS AND PRINTED MATTER

FOR WRISTBANDS FOR THE RETENTION OF WRITING INSTRUMENTS (U.S. CLS. 2, 5, 22, 23, 29, 37, 38 AND 50).

CLASS 25—CLOTHING

FOR WRISTBANDS (U.S. CLS. 22 AND 39).
JAMES GRIFFIN, EXAMINING ATTORNEY

* * * * *

SECTION 2.— INTERNATIONAL CLASSIFICATION

The short titles associated below with the international class numbers are terms designed merely for quick identification and are not an official part of the international classification. The full names of international classes are given in section 6.1 of the trademark rules of practice.

The designation "U.S. Cl." appearing in this section refers to the U.S. class in effect prior to Sep. 1, 1973 rather than the international class which applies to applications filed on or after that date. For adoption of international classification see notice in the OFFICIAL GAZETTE of Jun. 26, 1973 (911 O.G. TM 210).

Application in one class

CLASS 1—CHEMICALS

SN 76-689,967. COLLINS, HUGH F., ENGLAND, UNITED KINGDOM, FILED 5-23-2008.

CLASS 1—(Continued).

SN 77-481,204. HYDROGARDEN WHOLESALE SUPPLIES LIMITED, COVENTRY, UNITED KINGDOM, FILED 5-22-2008.

CATACLEAN

THE MARK CONSISTS OF STANDARD CHARACTERS WITHOUT CLAIM TO ANY PARTICULAR FONT, STYLE, SIZE, OR COLOR.

OWNER OF UNITED KINGDOM REG. NO. 2281660, DATED 3-1-2002, EXPIRES 9-27-2011.

FOR CHEMICAL PREPARATIONS FOR USE IN THE SERVICING OF MOTOR VEHICLES, NAMELY, A CHEMICAL FUEL ADDITIVE FOR FUEL TREATMENT AND CHEMICAL ADDITIVES FOR CLEANING FUEL INJECTORS AND CATALYTIC CONVERTERS; CHEMICAL PREPARATIONS FOR USE IN CONNECTION WITH ENGINES AND PARTS AND FITTINGS THEREFORE, INCLUDING CATALYTIC CONVERTERS, NAMELY, CHEMICAL ADDITIVES FOR USE WITH INTERNAL COMBUSTION ENGINE FUELS AND CHEMICAL ENGINE TREATMENTS AND ADDITIVES FOR DIESEL FUELS; CHEMICAL ADDITIVES FOR THE TREATMENT OF CATALYTIC CONVERTERS AND FUEL INJECTION SYSTEMS; CHEMICAL ADDITIVES TO FUEL, NAMELY, ADDITIVES FOR FUEL TO CLEAN AND REJUVENATE FUEL INJECTORS AND CATALYTIC CONVERTERS; CHEMICAL PREPARATIONS FOR USE IN THE CLEANING OF CATALYSTS IN OR FOR CATALYTIC CONVERTERS, NAMELY, CHEMICAL ADDITIVES FOR GASOLINE AND CHEMICAL ADDITIVES FOR DIESEL FUEL (U.S. CLS. 1, 5, 6, 10, 26 AND 46).

SAIMA MAKHDOOM, EXAMINING ATTORNEY

VITALINK

THE MARK CONSISTS OF STANDARD CHARACTERS WITHOUT CLAIM TO ANY PARTICULAR FONT, STYLE, SIZE, OR COLOR.

OWNER OF ERPN CMNTY TM OFC REG. NO. 006921621, DATED 6-23-2009, EXPIRES 5-19-2018.

FOR CHEMICALS FOR USE IN AGRICULTURE; HORTICULTURE CHEMICALS, EXCEPT FUNGICIDES, HERBICIDES, INSECTICIDES AND PARASITICIDES; FERTILIZERS; SUBSTANCES FOR REGULATING PLANT GROWTH; AND GROWING MEDIA FOR PLANTS (U.S. CLS. 1, 5, 6, 10, 26 AND 46).

KATHERINE STOIDES, EXAMINING ATTORNEY

SN 77-522,932. GREENSTAR PLANT PRODUCTS INC., LANGLEY, BC, CANADA, FILED 7-15-2008.

VITABURST

THE MARK CONSISTS OF STANDARD CHARACTERS WITHOUT CLAIM TO ANY PARTICULAR FONT, STYLE, SIZE, OR COLOR.

PRIORITY CLAIMED UNDER SEC. 44(D) ON CANADA APPLICATION NO. 1401695, FILED 7-2-2008, REG. NO. TMA749897, DATED 10-9-2009, EXPIRES 10-9-2024.

FOR FERTILIZERS (U.S. CLS. 1, 5, 6, 10, 26 AND 46).
SUSAN STIGLITZ, EXAMINING ATTORNEY

CLASS 1—(Continued).

SN 77-545,185. PIERCE, KEVIN J., GRAND FORKS, ND. AND PIERCE, MICHAEL J., GRAND FORKS, ND. AND DUFAULT, RANDY, EAST GRAND FORKS, MN. FILED 8-12-2008.



DAKOTALIZER

THE COLOR(S) ARE GREEN AND BLACK IS/ARE CLAIMED AS A FEATURE OF THE MARK.

THE MARK CONSISTS OF THE WORD "DAKOTALIZER" REPRESENTED IN STYLIZED FONT IN THE COLOR "BLACK" AND PRESENTED IN A VERTICAL MANNER WHICH SHOULD BE READ FROM BOTTOM TO TOP WITH TWO GREEN RECTANGLE BLOCKS ON EACH SIDE OF THE WORD.

FOR PEAT PRODUCTS, NAMELY, PEAT FERTILIZER (U.S. CLS. 1, 5, 6, 10, 26 AND 46).

WARREN L. OLANDRIA, EXAMINING ATTORNEY

SN 77-594,206. GETINGE USA, INC., ROCHESTER, NY. FILED 10-16-2008.

CHEMISIX

THE MARK CONSISTS OF STANDARD CHARACTERS WITHOUT CLAIM TO ANY PARTICULAR FONT, STYLE, SIZE, OR COLOR.

FOR STERILIZATION INDICATORS, NAMELY, NON-MEDICAL CHEMICALLY TREATED INDICATOR STRIPS FOR INDICATING AN ITEM IS STERILIZED (U.S. CLS. 1, 5, 6, 10, 26 AND 46).

SHAILA SETTLES, EXAMINING ATTORNEY

CLASS 1—(Continued).

SN 77-631,377. SYMRISE GMBH & CO. KG, GENERAL PARTNER, SYMRISE VERWALTUNGS GMBH, HOLZ-MINDEN, FED REP GERMANY, FILED 12-11-2008.

SYMPEPTIDE

THE MARK CONSISTS OF STANDARD CHARACTERS WITHOUT CLAIM TO ANY PARTICULAR FONT, STYLE, SIZE, OR COLOR.

FOR CHEMICALS AND PLANT EXTRACTS USED IN MAKING COSMETICS (U.S. CLS. 1, 5, 6, 10, 26 AND 46).
LESLIE RICHARDS, EXAMINING ATTORNEY

SN 77-663,470. POLYSTAR, LLC, DALTON, GA. FILED 2-4-2009.



POLYSTAR

THE MARK CONSISTS OF A STAR SURROUNDED BY A PARTIAL CIRCLE FOLLOWED BY THE WORDS "POLY-STAR".

FOR CHEMICALS FOR USE IN INDUSTRY, NAMELY, THERMOSET RESINS, EPOXY RESINS, EPOXY CURING AGENTS, EPOXY MODIFIERS, URETHANES, URETHANE PREPOLYMERS, URETHANE MODIFIERS, AMINE RESINS, POLYOLS, AND ISOCYANATES (U.S. CLS. 1, 5, 6, 10, 26 AND 46).

FIRST USE 5-31-2006; IN COMMERCE 5-31-2006.
ALICIA COLLINS, EXAMINING ATTORNEY

SN 77-739,637. PAULSON OIL COMPANY, CHESTERTON, IN. FILED 5-18-2009.



FPS
FUEL PERFORMANCE SOLUTIONS

NO CLAIM IS MADE TO THE EXCLUSIVE RIGHT TO USE "FUEL PERFORMANCE SOLUTIONS", APART FROM THE MARK AS SHOWN.

THE MARK CONSISTS OF AN OVAL DESIGN WITH THE WORDS "FPS FUEL PERFORMANCE SOLUTIONS" PLACED INSIDE, WITH THREE LINES TO THE LEFT AND RIGHT OF THE LETTERS "FPS".

FOR CHEMICAL ADDITIVES FOR DIESEL FUEL (U.S. CLS. 1, 5, 6, 10, 26 AND 46).

FIRST USE 9-26-2006; IN COMMERCE 9-26-2006.
ALICE BENMAMAN, EXAMINING ATTORNEY

CLASS 1—(Continued).

SN 77-758,427. BONDPLEX L.L.C., HUDSON, WI. FILED 6-12-2009.

BONDPREP

THE MARK CONSISTS OF STANDARD CHARACTERS WITHOUT CLAIM TO ANY PARTICULAR FONT, STYLE, SIZE, OR COLOR.

OWNER OF U.S. REG. NOS. 2,697,949 AND 2,841,869. SEC. 2(F).

FOR CHEMICAL PREPARATIONS FOR PRE-TREATING LOW ENERGY SURFACES TO PROMOTE ADHESIVE QUALITY OF SUBSEQUENT ADHESIVE APPLICATION (U.S. CLS. 1, 5, 6, 10, 26 AND 46).

FIRST USE 1-1-2002; IN COMMERCE 1-1-2002.
BARBARA A. GOLD, EXAMINING ATTORNEY

SN 77-764,159. TESSENDERLO CHEMIE N.V./S.A., TESSENDERLO, BELGIUM, FILED 6-19-2009.

ECOFERRIC

THE MARK CONSISTS OF STANDARD CHARACTERS WITHOUT CLAIM TO ANY PARTICULAR FONT, STYLE, SIZE, OR COLOR.

PRIORITY CLAIMED UNDER SEC. 44(D) ON ERPNCMNTY TM OFC APPLICATION NO. 008199564, FILED 4-3-2009, REG. NO. 008199564, DATED 12-9-2009, EXPIRES 4-3-2019.

FOR CHEMICAL PREPARATIONS FOR USE AS A COAGULANT IN WATER TREATMENT; CHEMICAL PREPARATIONS FOR USE AS A CHEMICAL ETCHING AGENT FOR METALS AND AS RAW MATERIALS IN THE FERRITES, PIGMENT AND COAGULENT MARKETS (U.S. CLS. 1, 5, 6, 10, 26 AND 46).

HEATHER THOMPSON, EXAMINING ATTORNEY

SN 77-764,178. PLANET GREEN BOTTLE CORPORATION, TORONTO, CANADA, FILED 6-19-2009.

PLANET BOTTLE

THE MARK CONSISTS OF STANDARD CHARACTERS WITHOUT CLAIM TO ANY PARTICULAR FONT, STYLE, SIZE, OR COLOR.

NO CLAIM IS MADE TO THE EXCLUSIVE RIGHT TO USE "BOTTLE", APART FROM THE MARK AS SHOWN.

FOR CHEMICALS FOR PLASTICS PROCESSING AND ENGINEERING; PLASTICS ADDITIVES; CHEMICAL ADDITIVES FOR USE IN THE MANUFACTURE OF PLASTIC PRODUCTS (U.S. CLS. 1, 5, 6, 10, 26 AND 46).

CAROLYN CATALDO, EXAMINING ATTORNEY

CLASS 1—(Continued).

SN 77-782,776. TYRATECH, INC., MELBOURNE, FL. FILED 7-16-2009.

TYRATECH

THE MARK CONSISTS OF STANDARD CHARACTERS WITHOUT CLAIM TO ANY PARTICULAR FONT, STYLE, SIZE, OR COLOR.

FOR NATURAL BOTANICAL EXTRACTS FOR USE IN MAKING PESTICIDES, INSECTICIDES, MEDICINAL PRODUCTS AND PHARMACEUTICAL PRODUCTS (U.S. CLS. 1, 5, 6, 10, 26 AND 46).

HELENE LIWINSKI, EXAMINING ATTORNEY

SN 77-822,885. KIOR INC., PASADENA, TX. FILED 9-9-2009.

BCC

THE MARK CONSISTS OF STANDARD CHARACTERS WITHOUT CLAIM TO ANY PARTICULAR FONT, STYLE, SIZE, OR COLOR.

FOR CHEMICALS USED IN INDUSTRY, NAMELY, AROMATIC HYDROCARBONS, AROMATIC SOLVENTS FOR INDUSTRIAL AND COMMERCIAL USE, CHEMICAL ADDITIVES FOR FUEL TREATMENT; CHEMICAL GASOLINE ADDITIVES; SOIL ADDITIVES, NAMELY, SOIL IMPROVING AGENTS (U.S. CLS. 1, 5, 6, 10, 26 AND 46).

STEVEN R. FINE, EXAMINING ATTORNEY

SN 77-858,717. MP BIOMEDICALS, LLC, SANTA ANA, CA. FILED 10-27-2009.

GENECLEAN

THE MARK CONSISTS OF STANDARD CHARACTERS WITHOUT CLAIM TO ANY PARTICULAR FONT, STYLE, SIZE, OR COLOR.

FOR PROCESS KIT USED IN SCIENTIFIC RESEARCH LABORATORIES TO PURIFY NUCLEIC ACIDS, THE KIT CONSISTING PRIMARILY OF A SOLUTION OF SODIUM IODIDE, SODIUM CHLORIDE, AND A SUSPENSION OF SILICA IN WATER; PROCESS KIT USED IN MEDICAL LABORATORIES TO PURIFY NUCLEIC ACIDS, THE KIT CONSISTING PRIMARILY OF A SOLUTION OF SODIUM IODIDE, SODIUM CHLORIDE, AND A SUSPENSION OF SILICA IN WATER (U.S. CLS. 1, 5, 6, 10, 26 AND 46).

FIRST USE 4-1-1986; IN COMMERCE 8-1-1986.

KATHLEEN M. VANSTON, EXAMINING ATTORNEY

CLASS 1—(Continued).

SN 77-869,086. DART SEASONAL PRODUCTS, INC., WOODMERE, NY. FILED 11-10-2009.

Blue Fire Snow and Ice Melter

THE MARK CONSISTS OF STANDARD CHARACTERS WITHOUT CLAIM TO ANY PARTICULAR FONT, STYLE, SIZE, OR COLOR.

NO CLAIM IS MADE TO THE EXCLUSIVE RIGHT TO USE "SNOW AND ICE MELTER", APART FROM THE MARK AS SHOWN.

FOR CHEMICAL PREPARATIONS FOR MELTING SNOW AND ICE (U.S. CLS. 1, 5, 6, 10, 26 AND 46).

RUSS HERMAN, EXAMINING ATTORNEY

SN 77-876,893. ZYMOGENETICS, INC., SEATTLE, WA. FILED 11-19-2009.

ZYMOGENETICS

THE MARK CONSISTS OF STANDARD CHARACTERS WITHOUT CLAIM TO ANY PARTICULAR FONT, STYLE, SIZE, OR COLOR.

OWNER OF U.S. REG. NOS. 1,685,713, 3,424,808 AND OTHERS.

SEC. 2(F).

FOR REAGENTS FOR SCIENTIFIC, LABORATORY, AND MEDICAL RESEARCH; BIOCHEMICALS FOR SCIENTIFIC, LABORATORY, AND MEDICAL RESEARCH, NAMELY, ENZYMES, CATALYSTS, BUFFERS, ANTIBODIES, POLYPEPTIDES, PROTEINS, NUCLEIC ACIDS, POLYNUCLEOTIDES, DETERGENTS, FLUORESCENT PROBES FOR DETECTING AND ANALYZING MOLECULES IN VITRO AND IN VIVO, STAINS, ISOTOPES, AND MAGNETIC MATRICES; ORGANIC AND INORGANIC REAGENTS FOR GENETIC ENGINEERING RESEARCH (U.S. CLS. 1, 5, 6, 10, 26 AND 46).

KELLY CHOE, EXAMINING ATTORNEY

SN 77-882,278. FALCON TECHNOLOGIES INC., BRIDGETOWN, BARBADOS, FILED 11-30-2009.

COLOURFAL

THE MARK CONSISTS OF STANDARD CHARACTERS WITHOUT CLAIM TO ANY PARTICULAR FONT, STYLE, SIZE, OR COLOR.

FOR POLYMERS AND POLYMERIC ADDITIVES FOR USE IN THE MANUFACTURE OF COATINGS (U.S. CLS. 1, 5, 6, 10, 26 AND 46).

FIRST USE 1-0-2009; IN COMMERCE 1-0-2009.

DAWN HAN, EXAMINING ATTORNEY

CLASS 1—(Continued).

SN 77-882,310. FALCON TECHNOLOGIES INC., BRIDGETOWN, BARBADOS, FILED 11-30-2009.

FALGEL

THE MARK CONSISTS OF STANDARD CHARACTERS WITHOUT CLAIM TO ANY PARTICULAR FONT, STYLE, SIZE, OR COLOR.

FOR POLYMERS AND POLYMERIC ADDITIVES FOR USE IN THE MANUFACTURE OF COATINGS (U.S. CLS. 1, 5, 6, 10, 26 AND 46).

FIRST USE 1-0-2008; IN COMMERCE 1-0-2008.

DAWN HAN, EXAMINING ATTORNEY

SN 77-882,324. FALCON TECHNOLOGIES INC., BRIDGETOWN, BARBADOS, FILED 11-30-2009.

KAOFAL

THE MARK CONSISTS OF STANDARD CHARACTERS WITHOUT CLAIM TO ANY PARTICULAR FONT, STYLE, SIZE, OR COLOR.

FOR POLYMERS AND POLYMERIC ADDITIVES FOR USE IN THE MANUFACTURE OF COATINGS (U.S. CLS. 1, 5, 6, 10, 26 AND 46).

FIRST USE 1-0-2004; IN COMMERCE 1-0-2004.

DAWN HAN, EXAMINING ATTORNEY

SN 77-882,832. CARDINAL ASSOCIATES, DBA BERGSTROM NUTRITION, VANCOUVER, WA. FILED 12-1-2009.

DYSTILYTE

THE MARK CONSISTS OF STANDARD CHARACTERS WITHOUT CLAIM TO ANY PARTICULAR FONT, STYLE, SIZE, OR COLOR.

FOR CHEMICAL ADDITIVES FOR USE IN THE MANUFACTURE OF COSMETICS AND LOTIONS (U.S. CLS. 1, 5, 6, 10, 26 AND 46).

DAVID TOOLEY, EXAMINING ATTORNEY

CLASS 1—(Continued).

SN 77-883,070. ARR-MAZ PRODUCTS, L.P., MULBERRY, FL. FILED 12-1-2009.

GALOGREEN

THE MARK CONSISTS OF STANDARD CHARACTERS WITHOUT CLAIM TO ANY PARTICULAR FONT, STYLE, SIZE, OR COLOR.

FOR DUST SUPPRESSING CHEMICALS FOR USE ON FERTILIZERS TO PREVENT DUSTING (U.S. CLS. 1, 5, 6, 10, 26 AND 46).

MORGAN WYNNE, EXAMINING ATTORNEY

SN 77-883,303. TGX SOLUTIONS LLC, OXFORD, MI. FILED 12-1-2009.

TgX

THE MARK CONSISTS OF STANDARD CHARACTERS WITHOUT CLAIM TO ANY PARTICULAR FONT, STYLE, SIZE, OR COLOR.

FOR CHEMICAL ADDITIVES FOR REFRIGERANTS IN AIR CONDITIONING AND REFRIGERATING COOLING SYSTEMS (U.S. CLS. 1, 5, 6, 10, 26 AND 46).

FIRST USE 10-20-2009; IN COMMERCE 10-20-2009.

FONG HSU, EXAMINING ATTORNEY

SN 77-884,484. A.V.W. INC., DBA MAX PROFESSIONAL, FT LAUDERDALE, FL. FILED 12-2-2009.

Pro Stik

THE MARK CONSISTS OF STANDARD CHARACTERS WITHOUT CLAIM TO ANY PARTICULAR FONT, STYLE, SIZE, OR COLOR.

NO CLAIM IS MADE TO THE EXCLUSIVE RIGHT TO USE "STICK", APART FROM THE MARK AS SHOWN.

FOR ADHESIVES AND GLUES FOR INDUSTRIAL PURPOSES (U.S. CLS. 1, 5, 6, 10, 26 AND 46).

FIRST USE 10-15-2008; IN COMMERCE 10-30-2008.

CHARISMA HAMPTON, EXAMINING ATTORNEY

CLASS 1—(Continued).

SN 77-884,858. KOLLMAN, JOHN, BERKELEY, IL. FILED 12-2-2009.

MINERAL POINT LIQUID DEICER

THE MARK CONSISTS OF STANDARD CHARACTERS WITHOUT CLAIM TO ANY PARTICULAR FONT, STYLE, SIZE, OR COLOR.

NO CLAIM IS MADE TO THE EXCLUSIVE RIGHT TO USE "MINERAL" AND "LIQUID DEICER", APART FROM THE MARK AS SHOWN.

FOR ANTI-FREEZING AND DE-ICING PREPARATIONS; CHEMICAL PREPARATIONS FOR MELTING SNOW AND ICE; ROCK SALT (U.S. CLS. 1, 5, 6, 10, 26 AND 46).

FIRST USE 10-1-2007; IN COMMERCE 10-1-2007.

DEBRA LEE, EXAMINING ATTORNEY

SN 77-885,495. SYNCO TURF, LLC, CHICKAMAUGA, GA. FILED 12-3-2009.

TEXTRAW

THE MARK CONSISTS OF STANDARD CHARACTERS WITHOUT CLAIM TO ANY PARTICULAR FONT, STYLE, SIZE, OR COLOR.

FOR CHEMICAL PREPARATIONS FOR USE IN LANDSCAPING AND HORTICULTURE, NAMELY, CHEMICAL PREPARATIONS FOR STABILIZING SOIL (U.S. CLS. 1, 5, 6, 10, 26 AND 46).

FIRST USE 4-1-2009; IN COMMERCE 4-1-2009.

SAMUEL E. SHARPER JR., EXAMINING ATTORNEY

SN 77-885,499. SYNCO TURF, LLC, CHICKAMAUGA, GA. FILED 12-3-2009.

STAY-PUT

THE MARK CONSISTS OF STANDARD CHARACTERS WITHOUT CLAIM TO ANY PARTICULAR FONT, STYLE, SIZE, OR COLOR.

FOR CHEMICAL PREPARATION FOR USE WITH SYNTHETIC MULCH FOR STABILIZING SOIL (U.S. CLS. 1, 5, 6, 10, 26 AND 46).

FIRST USE 4-1-2009; IN COMMERCE 4-1-2009.

SAMUEL E. SHARPER JR., EXAMINING ATTORNEY

CLASS 1—(Continued).

SN 77-885,579. VP RACING FUELS, INC., SAN ANTONIO, TX. FILED 12-3-2009.

QUALITY FUELS FOR MOTORSPORTS

THE MARK CONSISTS OF STANDARD CHARACTERS WITHOUT CLAIM TO ANY PARTICULAR FONT, STYLE, SIZE, OR COLOR.

NO CLAIM IS MADE TO THE EXCLUSIVE RIGHT TO USE "FUELS", APART FROM THE MARK AS SHOWN.

SEC. 2(F).

FOR CHEMICAL ADDITIVES FOR MOTOR OIL; DETERGENT ADDITIVES FOR USE WITH MOTOR OIL; CHEMICAL ADDITIVES FOR FUEL TREATMENT, NAMELY OCTANE BOOSTER, CHEMICAL FUEL ADDITIVES (U.S. CLS. 1, 5, 6, 10, 26 AND 46).

FIRST USE 12-31-1974; IN COMMERCE 12-31-1974.

HANNO RITTNER, EXAMINING ATTORNEY

SN 77-885,972. CARGILL, INCORPORATED, WAYZATA, MN. FILED 12-4-2009.

DYN-O MELT

THE MARK CONSISTS OF STANDARD CHARACTERS WITHOUT CLAIM TO ANY PARTICULAR FONT, STYLE, SIZE, OR COLOR.

OWNER OF U.S. REG. NOS. 1,085,820, 1,933,738 AND OTHERS.

FOR DEICING PREPARATIONS FOR MELTING ICE AND SNOW ON PAVEMENT (U.S. CLS. 1, 5, 6, 10, 26 AND 46).

FIRST USE 10-6-1989; IN COMMERCE 10-6-1989.

KATHERINE STOIDES, EXAMINING ATTORNEY

SN 77-886,043. MICROBIOLOGICS, INC., ST. CLOUD, MN. FILED 12-4-2009.

EZ-ACCU SHOT

THE MARK CONSISTS OF STANDARD CHARACTERS WITHOUT CLAIM TO ANY PARTICULAR FONT, STYLE, SIZE, OR COLOR.

FOR DIAGNOSTIC REAGENTS AND KITS FOR IN VITRO USE CONSISTING PRIMARILY OF LYOPHILIZED MICROORGANISMS, NOT FOR MEDICAL OR VETERINARY USE (U.S. CLS. 1, 5, 6, 10, 26 AND 46).

ERNEST SHOSHO, EXAMINING ATTORNEY

CLASS 1—(Continued).

SN 77-887,056. PERIODIC PRODUCTS, LLC, TAMPA, FL. FILED 12-5-2009.

CuLator

THE MARK CONSISTS OF STANDARD CHARACTERS WITHOUT CLAIM TO ANY PARTICULAR FONT, STYLE, SIZE, OR COLOR.

FOR CHEMICAL POLYMER USED IN POOLS AND SPAS TO REMOVE METAL STAINS FROM CEMENT AND GROUT SURFACES (U.S. CLS. 1, 5, 6, 10, 26 AND 46).

CARRIE GENOVESE, EXAMINING ATTORNEY

SN 77-887,695. HELENA LABORATORIES CORPORATION, BEAUMONT, TX. FILED 12-7-2009.

SPIFE

THE MARK CONSISTS OF STANDARD CHARACTERS WITHOUT CLAIM TO ANY PARTICULAR FONT, STYLE, SIZE, OR COLOR.

OWNER OF U.S. REG. NO. 2,298,710.

FOR DIAGNOSTIC REAGENTS FOR CLINICAL OR MEDICAL LABORATORY USE (U.S. CLS. 1, 5, 6, 10, 26 AND 46).

FIRST USE 8-31-1996; IN COMMERCE 5-26-1998.

FRED CARL, EXAMINING ATTORNEY

SN 77-887,700. THE OCEAN COUNTY UTILITIES AUTHORITY, BAYVILLE, NJ. FILED 12-7-2009.

OCEANGRO

THE MARK CONSISTS OF STANDARD CHARACTERS WITHOUT CLAIM TO ANY PARTICULAR FONT, STYLE, SIZE, OR COLOR.

FOR FERTILIZER PRODUCT DERIVED FROM SEWAGE SLUDGE AND SOLD EXCLUSIVELY IN LARGE BAGS AND BULK TO MUNICIPALITIES, FARMS AND GARDEN CENTERS FOR USE IN LARGE SCALE APPLICATIONS ON GOLF COURSES, PARKS, ATHLETIC COMPLEXES, LAWNS, TREES, SHRUBS AND OUTDOOR FLOWERS (U.S. CLS. 1, 5, 6, 10, 26 AND 46).

FIRST USE 8-12-1998; IN COMMERCE 8-12-1998.

FRED CARL, EXAMINING ATTORNEY

CLASS 1—(Continued).

SN 77-888,257. LVD ACQUISITION, LLC, COLUMBUS, OH. FILED 12-8-2009.

STERILON

THE MARK CONSISTS OF STANDARD CHARACTERS WITHOUT CLAIM TO ANY PARTICULAR FONT, STYLE, SIZE, OR COLOR.

FOR CHEMICAL ADDITIVES FOR USE IN THE MANUFACTURE OF PRESSURE COOLERS, DRINKING FOUNTAINS, BOTTLED WATER COOLERS, POINT OF USE COOLERS AND BOTTLE FILTERS (U.S. CLS. 1, 5, 6, 10, 26 AND 46).

JUDITH HELFMAN, EXAMINING ATTORNEY

SN 77-888,958. EZ CARE GROWING TECHNOLOGIES, L.L.C., SAUGUS, MA. FILED 12-8-2009.

Watergrip

THE MARK CONSISTS OF STANDARD CHARACTERS WITHOUT CLAIM TO ANY PARTICULAR FONT, STYLE, SIZE, OR COLOR.

FOR GROWING MEDIA FOR PLANTS; HORTICULTURAL PRODUCTS, NAMELY, SOIL AMENDMENTS THAT ARE INCORPORATED INTO OR ONTO A TURF, LAWN OR SOIL PROFILE FOR CREATING A HEALTH MEDIUM FOR INCREASED ROOT GROWTH AND/OR A SMOOTHER TURF OR LAWN SURFACE CUT OR APPEARANCE; PLANT GROWTH REGULATING PREPARATIONS; SUBSTANCES FOR REGULATING PLANT GROWTH (U.S. CLS. 1, 5, 6, 10, 26 AND 46).

MICHAEL SOUDERS, EXAMINING ATTORNEY

SN 77-889,505. HERNON MANUFACTURING, INC., SANFORD, FL. FILED 12-9-2009.

NUTS N' BOLTS

THE MARK CONSISTS OF STANDARD CHARACTERS WITHOUT CLAIM TO ANY PARTICULAR FONT, STYLE, SIZE, OR COLOR.

OWNER OF U.S. REG. NO. 2,339,376. SEC. 2(F).

FOR INSTANT BONDING ADHESIVES FOR JOINING SIMILAR OR DISSIMILAR MATERIALS IN VARIOUS MANUFACTURING PROCESSES (U.S. CLS. 1, 5, 6, 10, 26 AND 46).

FIRST USE 0-0-1981; IN COMMERCE 0-0-1981.

REBECCA POVARCHUK, EXAMINING ATTORNEY

CLASS 1—(Continued).

SN 77-890,797. UNIVERSAL DISPLAY CORPORATION, EWING, NJ. FILED 12-10-2009.

UniversalP2OLED

THE MARK CONSISTS OF STANDARD CHARACTERS WITHOUT CLAIM TO ANY PARTICULAR FONT, STYLE, SIZE, OR COLOR.

FOR CHEMICALS FOR USE IN THE MANUFACTURE OF ORGANIC LIGHT EMITTING DEVICES AND OTHER ORGANIC ELECTRONIC DEVICES (U.S. CLS. 1, 5, 6, 10, 26 AND 46).

FIRST USE 5-27-2009; IN COMMERCE 5-27-2009.

ASMAT KHAN, EXAMINING ATTORNEY

SN 77-894,898. OMEGACHEM INC., ST-ROMUALD, QUEBEC, CANADA, FILED 12-16-2009.

XtalFluor-E

THE MARK CONSISTS OF STANDARD CHARACTERS WITHOUT CLAIM TO ANY PARTICULAR FONT, STYLE, SIZE, OR COLOR.

FOR REAGENT USED TO FLUORINATE OTHER CHEMICAL COMPOUNDS, FOR MANUFACTURING OTHER PRODUCTS (U.S. CLS. 1, 5, 6, 10, 26 AND 46).

FIRST USE 11-5-2009; IN COMMERCE 12-11-2009.

JULIE WATSON, EXAMINING ATTORNEY

SN 77-894,946. OMEGACHEM INC., ST-ROMUALD, QUEBEC, CANADA, FILED 12-16-2009.

XtalFluor-M

THE MARK CONSISTS OF STANDARD CHARACTERS WITHOUT CLAIM TO ANY PARTICULAR FONT, STYLE, SIZE, OR COLOR.

FOR REAGENT USED TO FLUORINATE OTHER CHEMICAL COMPOUNDS, FOR MANUFACTURING OTHER PRODUCTS (U.S. CLS. 1, 5, 6, 10, 26 AND 46).

FIRST USE 11-5-2009; IN COMMERCE 12-14-2009.

JULIE WATSON, EXAMINING ATTORNEY

CLASS 1—(Continued).

SN 77-897,335. ION TORRENT SYSTEMS, INC., SAN FRANCISCO, CA. FILED 12-18-2009.

ION SPHERE

THE MARK CONSISTS OF STANDARD CHARACTERS WITHOUT CLAIM TO ANY PARTICULAR FONT, STYLE, SIZE, OR COLOR.

NO CLAIM IS MADE TO THE EXCLUSIVE RIGHT TO USE "SPHERE", APART FROM THE MARK AS SHOWN.

FOR MICROSPHERES MADE PREDOMINANTLY OF GEL-LIKE MATERIAL FOR HOLDING NUCLEIC ACIDS FOR USE IN GENETIC ANALYSIS (U.S. CLS. 1, 5, 6, 10, 26 AND 46).

LINDA E. BLOHM, EXAMINING ATTORNEY

CLASS 1—(Continued).

SN 78-699,296. PQ SILICAS UK LIMITED, BARNESLEY, SOUTH YORKSHIRE, UNITED KINGDOM, FILED 8-24-2005.

CHILL-GARDE

THE MARK CONSISTS OF STANDARD CHARACTERS WITHOUT CLAIM TO ANY PARTICULAR FONT, STYLE, SIZE, OR COLOR.

FOR SILICAS, SILICATES AND ZEOLITES FOR USE IN THE MANUFACTURE OF FOOD AND DRINKS; STABILIZING AGENTS FOR BEER (U.S. CLS. 1, 5, 6, 10, 26 AND 46).

FIRST USE 5-31-1973; IN COMMERCE 5-31-1973.
SHAUNIA CARLYLE, EXAMINING ATTORNEY

SN 77-910,246. BAKER HUGHES INCORPORATED, HOUSTON, TX. FILED 1-12-2010.

OHR

THE MARK CONSISTS OF STANDARD CHARACTERS WITHOUT CLAIM TO ANY PARTICULAR FONT, STYLE, SIZE, OR COLOR.

FOR CHEMICALS, NAMELY, CORROSION CONTROL ADDITIVES, FOR USE IN HIGH DEFINITION WELL-BORE REMEDIATION SYSTEM (U.S. CLS. 1, 5, 6, 10, 26 AND 46).

FIRST USE 3-25-2008; IN COMMERCE 3-25-2008.
HEATHER THOMPSON, EXAMINING ATTORNEY

SN 79-071,068. BASF SE, LUDWIGSHAFEN AM RHEIN, FED REP GERMANY, FILED 5-14-2009.

CAPROMER

THE MARK CONSISTS OF STANDARD CHARACTERS WITHOUT CLAIM TO ANY PARTICULAR FONT, STYLE, SIZE, OR COLOR.

OWNER OF INTERNATIONAL REGISTRATION 1008121 DATED 5-14-2009, EXPIRES 5-14-2019.

THE WORDING "CAPROMER" HAS NO MEANING IN A FOREIGN LANGUAGE.

FOR UNPROCESSED PLASTICS IN THE FORM OF POWDERS, LIQUIDS, PASTES, GRANULES OR SHAVINGS; CHEMICALS USED FOR THE MANUFACTURE OF ADHESIVES, LACQUERS AND POLYURETHANE; INDUSTRIAL CHEMICALS USED IN THE ADHESIVES, LACQUERS AND POLYURETHANE INDUSTRIES (U.S. CLS. 1, 5, 6, 10, 26 AND 46).

LAURA HAMMEL, EXAMINING ATTORNEY

SN 77-911,815. BAKER HUGHES INCORPORATED, HOUSTON, TX. FILED 1-14-2010.

XERIC

THE MARK CONSISTS OF STANDARD CHARACTERS WITHOUT CLAIM TO ANY PARTICULAR FONT, STYLE, SIZE, OR COLOR.

FOR CHEMICAL DEMULSIFIER FOR BREAKING AN EMULSION COMPRISING HEAVY OIL AND WATER (U.S. CLS. 1, 5, 6, 10, 26 AND 46).

FIRST USE 11-1-2009; IN COMMERCE 11-1-2009.
HEATHER THOMPSON, EXAMINING ATTORNEY

SN 79-072,322. AKZO NOBEL CHEMICALS B.V., NETHERLANDS, FILED 5-28-2009.

STARQUAT

THE MARK CONSISTS OF STANDARD CHARACTERS WITHOUT CLAIM TO ANY PARTICULAR FONT, STYLE, SIZE, OR COLOR.

PRIORITY DATE OF 2-2-2009 IS CLAIMED.

OWNER OF INTERNATIONAL REGISTRATION 1011634 DATED 5-28-2009, EXPIRES 5-28-2019.

FOR CATIONIC STARCH FOR USE IN THE MANUFACTURE OF SHAMPOOS (U.S. CLS. 1, 5, 6, 10, 26 AND 46).

ADA HAN, EXAMINING ATTORNEY

CLASS 2—PAINTS

SN 76-700,724. FLEXABAR CORPORATION, LAKEWOOD, NJ. FILED 12-7-2009.

FLEXGARD

FOR PRESERVATIVE COATINGS TO PROTECT AGAINST FUNGUS AND FOULING FOR MARINE USE (U.S. CLS. 6, 11 AND 16).
FIRST USE 11-1-1978; IN COMMERCE 11-1-1978.
AMY HELLA, EXAMINING ATTORNEY

SN 77-595,969. GARLAND FLOORING, INC., CLEVELAND, OH. FILED 10-20-2008.

CHEM-SCREEN

THE MARK CONSISTS OF STANDARD CHARACTERS WITHOUT CLAIM TO ANY PARTICULAR FONT, STYLE, SIZE, OR COLOR.
FOR FLUID APPLIED SEAMLESS FLOORING SYSTEM PRIMARILY COMPRISED OF EPOXY COATINGS FOR USE ON HARD SURFACE FLOORS THAT IS HIGHLY RESISTANT TO HEAVY TRAFFIC AND CERTAIN TYPES OF LIQUIDS (U.S. CLS. 6, 11 AND 16).
LAURIE KAUFMAN, EXAMINING ATTORNEY

SN 77-595,978. GARLAND FLOORING, INC., CLEVELAND, OH. FILED 10-20-2008.

TREAD-SHIELD

THE MARK CONSISTS OF STANDARD CHARACTERS WITHOUT CLAIM TO ANY PARTICULAR FONT, STYLE, SIZE, OR COLOR.
FOR AN ANTI-STATIC FLUID APPLIED SEAMLESS FLOORING SYSTEM PRIMARILY COMPRISED OF EPOXY COATINGS FOR USE ON HARD SURFACE FLOORS THAT IS HIGHLY RESISTANT TO HEAVY TRAFFIC AND CERTAIN TYPES OF LIQUIDS (U.S. CLS. 6, 11 AND 16).
LAURIE KAUFMAN, EXAMINING ATTORNEY

CLASS 2—(Continued).

SN 77-595,984. GARLAND FLOORING, INC., CLEVELAND, OH. FILED 10-20-2008.

SHOCK GUARD

THE MARK CONSISTS OF STANDARD CHARACTERS WITHOUT CLAIM TO ANY PARTICULAR FONT, STYLE, SIZE, OR COLOR.
NO CLAIM IS MADE TO THE EXCLUSIVE RIGHT TO USE "SHOCK", APART FROM THE MARK AS SHOWN.
FOR AN ANTI-STATIC FLUID APPLIED SEAMLESS FLOORING SYSTEM PRIMARILY COMPRISED OF EPOXY COATINGS FOR USE ON HARD SURFACE FLOORS THAT IS HIGHLY RESISTANT TO HEAVY TRAFFIC AND CERTAIN TYPES OF LIQUIDS (U.S. CLS. 6, 11 AND 16).
LAURIE KAUFMAN, EXAMINING ATTORNEY

SN 77-683,532. JET-LUBE, INC., HOUSTON, TX. FILED 3-4-2009.

KOPR-SHIELD

THE MARK CONSISTS OF STANDARD CHARACTERS WITHOUT CLAIM TO ANY PARTICULAR FONT, STYLE, SIZE, OR COLOR.
FOR ANTI-CORROSION AND ANTI-SEIZE COATING PREPARATION USED ON STAINLESS STEEL FITTINGS AND ELECTRICAL CONNECTIONS (U.S. CLS. 6, 11 AND 16).
FIRST USE 2-1-1969; IN COMMERCE 2-1-1969.
MARGERY A. TIERNEY, EXAMINING ATTORNEY

SN 77-722,744. GENERAL COATINGS TECHNOLOGIES, INC., QUEENS, NY. FILED 4-27-2009.

NATURAL SELECTION

THE MARK CONSISTS OF STANDARD CHARACTERS WITHOUT CLAIM TO ANY PARTICULAR FONT, STYLE, SIZE, OR COLOR.
NO CLAIM IS MADE TO THE EXCLUSIVE RIGHT TO USE "NATURAL", APART FROM THE MARK AS SHOWN.
FOR PAINTS, AND COATINGS, NAMELY, CLEAR AND PIGMENTED ANTI-CORROSIVE COATINGS FOR SEALING AND DECORATING INTERIOR AND EXTERIOR SUBSTRATES (U.S. CLS. 6, 11 AND 16).
JEFF DEFORD, EXAMINING ATTORNEY

CLASS 2—(Continued).

SN 77-736,095. APPLIED TECHNOLOGY LABORATORIES, LLC, VANCOUVER, WA. FILED 5-13-2009.



THE MARK CONSISTS OF A FANCIFUL REPRESENTATION OF THE LETTERS "F" AND "A" INSIDE A SHIELD DESIGN.

FOR COATING MATERIALS FOR APPLYING TO AND FUSING WITH METAL SURFACES TO FORM AN OVERLYING VITREOUS CLADDING MATERIAL PROVIDING IMPROVED IMPACT AND CORROSION RESISTANCE AND ENHANCED THERMAL, ELECTRICAL, AND OTHER PERFORMANCE RELATED PROPERTIES THEREOF (U.S. CLS. 6, 11 AND 16).

CHARLOTTE CORWIN, EXAMINING ATTORNEY

SN 77-736,256. APPLIED TECHNOLOGY LABORATORIES, LLC, VANCOUVER, WA. FILED 5-13-2009.

STRONGER THAN STEEL

THE MARK CONSISTS OF STANDARD CHARACTERS WITHOUT CLAIM TO ANY PARTICULAR FONT, STYLE, SIZE, OR COLOR.

FOR COATING MATERIALS FOR APPLYING TO AND FUSING WITH METAL SURFACES TO FORM AN OVERLYING VITREOUS CLADDING MATERIAL PROVIDING IMPROVED IMPACT AND CORROSION RESISTANCE AND ENHANCED THERMAL, ELECTRICAL, AND OTHER PERFORMANCE RELATED PROPERTIES THEREOF (U.S. CLS. 6, 11 AND 16).

CHARLOTTE CORWIN, EXAMINING ATTORNEY

CLASS 2—(Continued).

SN 77-772,507. CRAYOLA PROPERTIES, INC., EASTON, PA. FILED 7-1-2009.



OWNER OF U.S. REG. NOS. 3,633,574, 3,633,575 AND 3,639,584.

NO CLAIM IS MADE TO THE EXCLUSIVE RIGHT TO USE "MESS FREE" AND "COLOR", APART FROM THE MARK AS SHOWN.

THE MARK CONSISTS OF THE PHRASE "MESS FREE" HORIZONTALLY POSITIONED DIRECTLY ABOVE THE OUTLINED, VERTICALLY-ARRANGED WORDS "COLOR WONDER".

FOR PAINTS (U.S. CLS. 6, 11 AND 16).
JESSICA FATHY, EXAMINING ATTORNEY

SN 77-772,556. CRAYOLA PROPERTIES, INC., EASTON, PA. FILED 7-1-2009.



OWNER OF U.S. REG. NOS. 3,633,574, 3,633,575 AND 3,639,584.

NO CLAIM IS MADE TO THE EXCLUSIVE RIGHT TO USE "MESS FREE" AND "COLOR", APART FROM THE MARK AS SHOWN.

THE MARK CONSISTS OF THE PHRASE "MESS FREE" HORIZONTALLY POSITIONED DIRECTLY ABOVE THE OUTLINED, VERTICALLY-ARRANGED WORDS "COLOR WONDER" WITH THE PHRASE "THE MAGIC OF COLOR WITHOUT THE MESS!" HORIZONTALLY POSITIONED DIRECTLY BELOW.

FOR PAINTS (U.S. CLS. 6, 11 AND 16).
JESSICA FATHY, EXAMINING ATTORNEY

CLASS 2—(Continued).

SN 77-822,132. MERCHANT IMPORT GLOBAL LLC, CANOGA PARK, CA. FILED 9-8-2009.

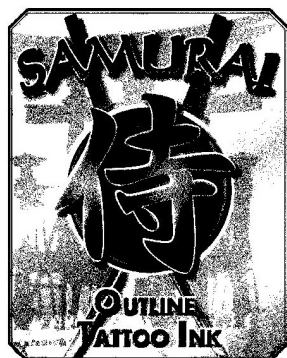

NO CLAIM IS MADE TO THE EXCLUSIVE RIGHT TO USE "OUTLINE TATTOO INK", APART FROM THE MARK AS SHOWN.

THE STIPPLING IS FOR SHADING PURPOSES ONLY.

THE MARK CONSISTS OF CONSISTS OF AN IMAGE OF A FOREIGN CHARACTER IN THE CENTER OF A SUN WITH TWO SWORDS CROSSING IN THE BACKGROUND WITH THE STYLIZED WORD "SAMURAI" ABOVE. THERE IS A STYLIZED PAGODA DESIGN IN THE BACKGROUND. THE STYLIZED WORDS "OUTLINE TATTOO INK" ARE BELOW. THE ENTIRE MARK IS ENCLOSED WITHIN A RECTANGULAR BORDER.

THE ENGLISH TRANSLATION OF THE FOREIGN CHARACTER IN THE MARK IS "SAMURAI".

FOR TATTOO COLORS; TATTOO DYES; TATTOO INKS (U.S. CLS. 6, 11 AND 16).

FIRST USE 8-1-2009; IN COMMERCE 8-1-2009.

TOBY BULLOFF, EXAMINING ATTORNEY

CLASS 2—(Continued).

SN 77-853,007. C & C VENTURES, LLC, DBA RANDOLPH PRODUCTS, CHICOPEE, MA. FILED 10-20-2009.

HERCUGRIP

THE MARK CONSISTS OF STANDARD CHARACTERS WITHOUT CLAIM TO ANY PARTICULAR FONT, STYLE, SIZE, OR COLOR.

FOR ANTI-SLIP COATINGS, PRIMERS, PAINT SEALERS, PAINT TOPCOATS (U.S. CLS. 6, 11 AND 16).

FIRST USE 12-0-2006; IN COMMERCE 12-0-2006.

KAREN K. BUSH, EXAMINING ATTORNEY

SN 77-878,691. ALCO INDUSTRIES, INC., NORRISTOWN, PA. FILED 11-23-2009.



SN 77-828,495. TRANSFER SUPPLIES, LLC, SALT LAKE CITY, UT. FILED 9-17-2009.

VISI-SUB

THE MARK CONSISTS OF STANDARD CHARACTERS WITHOUT CLAIM TO ANY PARTICULAR FONT, STYLE, SIZE, OR COLOR.

FOR PRINTING INKS (U.S. CLS. 6, 11 AND 16).

TINA L. SNAPP, EXAMINING ATTORNEY

OWNER OF U.S. REG. NO. 2,923,030.

NO CLAIM IS MADE TO THE EXCLUSIVE RIGHT TO USE "TRUCK BED LINER", APART FROM THE MARK AS SHOWN.

THE MARK CONSISTS OF THE WORDING "DEFENDER TRUCK BED LINER" IN A STYLIZED FONT APPEARING UNDER A DESIGN OF A MEDIEVAL HELMET WITH A PLUME.

FOR EPOXY COATING FOR USE ON VEHICLES, NAMELY, TRUCK BEDS (U.S. CLS. 6, 11 AND 16).

FIRST USE 11-5-2009; IN COMMERCE 11-5-2009.

RENEE MCCRAY, EXAMINING ATTORNEY

CLASS 2—(Continued).

SN 77-886,566. R & D COATINGS, INC., MCKEES ROCKS, PA. FILED 12-4-2009.



OWNER OF U.S. REG. NO. 3,695,538.
THE COLOR(S) DARK BLUE AND WHITE IS/ARE CLAIMED AS A FEATURE OF THE MARK.
THE MARK CONSISTS OF A SERIES OF OPPOSED CONCENTRIC DARK BLUE AND WHITE ARCS.
FOR INDUSTRIAL COATINGS, NAMELY, PAINTS, LACQUERS, STAINS, VARNISHES, COLORANTS AND DYES FOR WOOD, METAL AND PLASTICS (U.S. CLS. 6, 11 AND 16).
FIRST USE 5-0-1988; IN COMMERCE 5-0-1988.
NAPOLEON SHARMA, EXAMINING ATTORNEY

SN 77-905,525. MASTER COATING TECHNOLOGIES, LLC, EAGAN, MN. FILED 1-5-2010.

LIQUAPEARL

THE MARK CONSISTS OF STANDARD CHARACTERS WITHOUT CLAIM TO ANY PARTICULAR FONT, STYLE, SIZE, OR COLOR.
FOR COMMERCIAL INTERIOR PAINT AND COATINGS IN THE NATURE OF PAINT FINISHES THAT CREATE A PEARLESCENT PAINT FINISH OVER INTERIOR SURFACES (U.S. CLS. 6, 11 AND 16).
FIRST USE 12-31-2001; IN COMMERCE 12-31-2001.
TARA PATE, EXAMINING ATTORNEY

SN 78-750,839. GUPTA, LAXMI C., LOS ALAMITOS, CA. FILED 11-9-2005.

FIREWALL

THE MARK CONSISTS OF STANDARD CHARACTERS WITHOUT CLAIM TO ANY PARTICULAR FONT, STYLE, SIZE, OR COLOR.
FOR POLYMER COATINGS FOR WATERPROOFING CONSTRUCTION MATERIALS PRIOR TO OR DURING THE CONSTRUCTION PROCESS, NAMELY, WOOD, CONCRETE AND STEEL SUBSTRATES (U.S. CLS. 6, 11 AND 16).
DAVID MURRAY, EXAMINING ATTORNEY

CLASS 2—(Continued).

SN 79-070,384. PRINTON CO., LTD., REPUBLIC OF KOREA, FILED 5-28-2009.



OWNER OF INTERNATIONAL REGISTRATION 1006404 DATED 5-28-2009, EXPIRES 5-28-2019.
THE COLOR(S) GREEN, WHITE, RED, ORANGE, YELLOW, LIGHT BLUE, DARK BLUE, PURPLE AND BLACK IS/ARE CLAIMED AS A FEATURE OF THE MARK.
THE MARK CONSISTS OF A BLACK-OUTLINED GREEN CHAMELEON WITH A WHITE EYE, BLACK PUPIL AND RED, ORANGE, YELLOW, GREEN, LIGHT BLUE, DARK BLUE AND PURPLE STRIPES.
FOR FILLED INK CARTRIDGES FOR PRINTERS AND PHOTOCOPIERS; FILLED TONER CARTRIDGES FOR PRINTERS AND PHOTOCOPIERS; PRINTING INK; PRINTING TONERS; PROTECTIVE PREPARATIONS FOR METALS, NAMELY, ANTI-TARNISHING PREPARATIONS FOR COATING METALS; ANTI-CORROSIIVE PREPARATIONS, NAMELY, COATINGS; CHEMICAL PROOF PAINTS; BACTERICIDAL PAINTS; SYNTHETIC RESIN PAINTS; FLUORESCENT PAINTS (U.S. CLS. 6, 11 AND 16).
JULIE VEPPUMTHARA, EXAMINING ATTORNEY

SN 79-071,364. ANADOLU KIMYA SAN VE TIC.LTD.STI., TURKEY, FILED 2-12-2009.



OWNER OF INTERNATIONAL REGISTRATION 1008936 DATED 2-12-2009, EXPIRES 2-12-2019.
THE COLOR(S) BLUE, RED, YELLOW, AND BLACK IS/ARE CLAIMED AS A FEATURE OF THE MARK.
THE MARK CONSISTS OF THE WORD "ANTEX" IN BLUE FOLLOWED BY A SERIES OF BRUSH DIAGONAL LINES SIMULATING BRUSH STROKES. THE TOP LINE IS BLUE, THE NEXT LINE IS RED, THE NEXT LINE IS YELLOW, AND THE BOTTOM LINE IS BLACK.
THE WORDING "ANTEX" HAS NO MEANING IN A FOREIGN LANGUAGE.
FOR NATURAL AND SYNTHETIC DYES, NAMELY, SHOE DYES AND TEXTILE DYES; TEXTILE PRINTING INKS; METALS IN FOIL AND POWDER FORM FOR PAINTERS; BINDERS FOR TEXTILE PRINTING INK AND PASTE (U.S. CLS. 6, 11 AND 16).
MARK SHINER, EXAMINING ATTORNEY

CLASS 3—COSMETICS AND CLEANING PREPARATIONS

SN 76-701,128. SOCIETE PARISIENNE DE PARFUMS ET COSMETIQUES, PARIS, FRANCE, FILED 1-8-2010.

ONLY ME PASSION

THE MARK CONSISTS OF STANDARD CHARACTERS WITHOUT CLAIM TO ANY PARTICULAR FONT, STYLE, SIZE, OR COLOR.

OWNER OF U.S. REG. NO. 3,322,272.
FOR PERFUMES AND COLOGNES (U.S. CLS. 1, 4, 6, 50, 51 AND 52).

FIRST USE 9-0-2007; IN COMMERCE 10-0-2007.
JAMES STEIN, EXAMINING ATTORNEY

SN 77-193,403. CONAIR CORPORATION, STAMFORD, CT. FILED 5-30-2007.

AGE RENEW

THE MARK CONSISTS OF STANDARD CHARACTERS WITHOUT CLAIM TO ANY PARTICULAR FONT, STYLE, SIZE, OR COLOR.

FOR HAIR CARE PREPARATIONS; HAIR CONDITIONERS; HAIR SHAMPOO; HAIR STYLING PREPARATIONS (U.S. CLS. 1, 4, 6, 50, 51 AND 52).

PAUL CROWLEY, EXAMINING ATTORNEY

SN 77-326,501. PURE & TRUE, LLC, KAILUA, HI. FILED 11-9-2007.

pure & true

NO CLAIM IS MADE TO THE EXCLUSIVE RIGHT TO USE "PURE", APART FROM THE MARK AS SHOWN.

THE MARK CONSISTS OF STYLIZED SCRIPT OF THE PHRASE "PURE & TRUE".

FOR COSMETICS; COSMETICS AND MAKE-UP; BEAUTY LOTIONS; BEAUTY MASKS; BODY AND BEAUTY CARE COSMETICS; COLOGNES, PERFUMES AND COSMETICS; CONCEALERS; COSMETIC CREAMS; COSMETIC CREAMS FOR SKIN CARE; ADHESIVES FOR COSMETIC USE; AFTER-SUN GELS; AFTER-SUN MILKS; AFTER-SUN OILS; ALOE VERA GEL FOR COSMETIC PURPOSES; ASTRINGENTS FOR COSMETIC PURPOSES; BATH OILS FOR COSMETIC PURPOSES; BEAUTY CREAMS; BEAUTY CREAMS FOR BODY CARE; BEAUTY GELS; CLEANSING CREAMS; COSMETIC SOAPS; COSMETICS AND COSMETIC PREPARATIONS; COSMETICS IN GENERAL, INCLUDING PERFUMES; FACE AND BODY BEAUTY CREAMS; FACE CREAMS FOR COSMETIC USE; FACIAL BEAUTY MASKS; LOTIONS FOR COSMETIC PURPOSES; SKIN AND BODY TOPICAL LOTIONS, CREAMS AND OILS FOR COSMETIC USE; SOAPS (U.S. CLS. 1, 4, 6, 50, 51 AND 52).

KAREN SEVERSON, EXAMINING ATTORNEY

CLASS 3—(Continued).

SN 77-388,520. ENVIRONMENTAL BIOTECH INTERNATIONAL, LLC, BRADENTON, FL. FILED 2-5-2008.



THE COLOR(S) GREEN, BLUE AND WHITE IS/ARE CLAIMED AS A FEATURE OF THE MARK.

THE MARK CONSISTS OF THE SHAPE OF A DROP IN GREEN, THE LETTER "B" IN WHITE, A GREEN AND WHITE GLOBE AND BLUE AIR BUBBLES.

FOR ALL PURPOSE CLEANING AND DEGREASING PREPARATIONS; LIQUID FORMULATION FOR THE CLEANING OF DRAINS, DRAIN FIELDS, PUMPS, TRAPS, LIFT STATIONS AND PLUMBING; CLEANING PRODUCTS, NAMELY, CARPET ODOR ELIMINATORS; CLEANING PRODUCTS, NAMELY, AEROSOL MISTING AND FRAGRANCE PRODUCTS IN THE NATURE OF AEROSOL SPRAY FOR CLEANING CONDENSER COILS OF AIR FILTERS FOR AIR CONDITIONING, HEATING AND AIR FILTRATION UNITS; CLEANING PRODUCTS NAMELY, AEROSOL MISTING AND FRAGRANCE PRODUCTS, NAMELY, AROMATHERAPY SPRAYS, BODY SPRAYS, SCENTED FABRIC FRESHENER SPRAY, SCENTED ROOM SPRAYS, SCENTED LINEN SPRAYS, BODY SPRAY USED AS PERSONAL DEODORANT AND AS FRAGRANCE; GLASS CLEANERS; AC PAN AND DRAIN CLEANERS; AND AUTO CLEANERS; BABY WIPES; DISPOSABLE WIPES IMPREGNATED WITH CLEANSING CHEMICALS OR COMPOUNDS FOR INDUSTRIAL AND COMMERCIAL USE; DISPOSABLE WIPES IMPREGNATED WITH CLEANSING COMPOUNDS FOR USE ON INANIMATE SURFACES; DISPOSABLE WIPES IMPREGNATED WITH CLEANSING CHEMICALS OR COMPOUNDS FOR HOUSEHOLD USE; CLEANING PRODUCTS, NAMELY, CLEANING PREPARATIONS (U.S. CLS. 1, 4, 6, 50, 51 AND 52).

ERIN FALK, EXAMINING ATTORNEY

CLASS 3—(Continued).

SN 77-388,526. ENVIRONMENTAL BIOTECH INTERNATIONAL, LLC, BRADENTON, FL. FILED 2-5-2008.

B ENVIRONMENTAL

THE MARK CONSISTS OF STANDARD CHARACTERS WITHOUT CLAIM TO ANY PARTICULAR FONT, STYLE, SIZE, OR COLOR.

OWNER OF U.S. REG. NOS. 1,840,125, 2,164,965 AND 2,447,926.

NO CLAIM IS MADE TO THE EXCLUSIVE RIGHT TO USE "ENVIRONMENTAL", APART FROM THE MARK AS SHOWN.

FOR ALL PURPOSE CLEANING AND DEGREASING PREPARATIONS; LIQUID FORMULATION FOR THE CLEANING OF DRAINS DRAIN FIELDS, PUMPS, TRAPS, LIFT STATIONS AND PLUMBING; CLEANING PRODUCTS, NAMELY, CARPET ODOR ELIMINATORS; CLEANING PRODUCTS, NAMELY, AEROSOL MISTING AND FRAGRANCE PRODUCTS IN THE NATURE OF AEROSOL SPRAY FOR CLEANING CONDENSER COILS OF AIR FILTERS FOR AIR CONDITIONING, HEATING AND AIR FILTRATION UNITS; CLEANING PRODUCTS, NAMELY, AEROSOL MISTING AND FRAGRANCE PRODUCTS, NAMELY, AROMATHERAPY SPRAYS, BODY SPRAYS, SCENTED FABRIC FRESHENER SPRAY, SCENTED ROOM SPRAYS, SCENTED LINEN SPRAYS, BODY SPRAY USED AS PERSONAL DEODORANT AND AS FRAGRANCE; GLASS CLEANERS; AC PAN AND DRAIN CLEANERS; AND AUTO CLEANERS; BABY WIPES; DISPOSABLE WIPES IMPREGNATED WITH CLEANSING CHEMICALS OR COMPOUNDS FOR INDUSTRIAL AND COMMERCIAL USE; DISPOSABLE WIPES IMPREGNATED WITH CLEANSING COMPOUNDS FOR USE ON INANIMATE SURFACES; DISPOSABLE WIPES IMPREGNATED WITH CLEANSING CHEMICALS OR COMPOUNDS FOR HOUSEHOLD USE; CLEANING PRODUCTS, NAMELY, CLEANING PREPARATIONS (U.S. CLS. 1, 4, 6, 50, 51 AND 52).

ERIN FALK, EXAMINING ATTORNEY

SN 77-428,458. GOLDEN PRODUCTS LLC., HOWARD BEACH, NY. FILED 3-21-2008.



NO CLAIM IS MADE TO THE EXCLUSIVE RIGHT TO USE "PRODUCTS", APART FROM THE MARK AS SHOWN. THE COLOR(S) BLACK, ORANGE, AND YELLOW IS/ARE CLAIMED AS A FEATURE OF THE MARK.

THE MARK CONSISTS OF THE WORDS "GOLDEN PRODUCTS" IN BLACK. BEHIND THE WORDS IS A CIRCLE FORMED BY TWO SEMI CIRCLES, ONE IN ORANGE AND ONE IN YELLOW.

FOR ORAL HYGIENE PRODUCTS, NAMELY, TOOTHPASTE AND MOUTHWASH (U.S. CLS. 1, 4, 6, 50, 51 AND 52).

EUGENIA MARTIN, EXAMINING ATTORNEY

CLASS 3—(Continued).

SN 77-515,818. COTY US LLC, NEW YORK, NY. FILED 7-7-2008.



THE STIPPLING IS A FEATURE OF THE MARK AND DOES NOT INDICATE COLOR.

THE MARK CONSISTS OF STYLIZED FORM OF THE WORD "ICI".

THE FOREIGN WORDING IN THE MARK TRANSLATES INTO ENGLISH AS "HERE".

FOR PERFUMERY, EAÛ DE TOILETTE, COLOGNE, DEODORANT FOR PERSONAL USE, ANTI-PERSPIRANT, AFTER-SHAVE, SCENTED SOAPS, BEAUTY CARE PREPARATIONS, NAMELY, SKIN AND BODY CREAMS, SKIN LOTIONS, SKIN CLEANSERS, SKIN TONERS AND SKIN MOISTURIZERS, BODY WASH, SHOWER GEL, BUBBLE BATH, ESSENTIAL OILS AND COSMETICS (U.S. CLS. 1, 4, 6, 50, 51 AND 52).

FIRST USE 9-1-1995; IN COMMERCE 9-1-1995.

PAULA MAHONEY, EXAMINING ATTORNEY

SN 77-594,140. TODD CHRISTOPHER INTERNATIONAL INC., DBA VOGUE INTERNATIONAL, OLDSMAR, FL. FILED 10-16-2008.

THE MARK CONSISTS OF THE WORD "ORGANIX" WHERE ONE LINE OF THE LETTER "X" HAS AN EXTENDED AND CURVING ARM GOING FROM LOWER LEFT TO UPPER RIGHT.

SEC. 2(F).

FOR ORGANIC HAIR CARE PRODUCTS, NAMELY, HAIR SHAMPOOS, HAIR CONDITIONERS, HAIR GELS, HAIR MOUSSES, HAIR SPRAYS, HAIR CARE PREPARATIONS, HAIR CARE LOTIONS, HAIR CREAMS, HAIR WAIVING LOTIONS, NON-MEDICATED HAIR SERUMS, HAIR DRESSINGS, HAIR EMOLLIENTS, HAIR NOURISHERS, HAIR OILS, HAIR RELAXERS, NON-MEDICATED HAIR REPAIR TREATMENTS, NON-MEDICATED HAIR CARE TREATMENTS (U.S. CLS. 1, 4, 6, 50, 51 AND 52).

FIRST USE 12-22-2006; IN COMMERCE 12-22-2006.

KHANH LE, EXAMINING ATTORNEY

CLASS 3—(Continued).

SN 77-618,440. LANCOME PARFUMS ET BEAUTE & CIE, PARIS, FRANCE, FILED 11-20-2008.

TENDRE VOYAGE

THE MARK CONSISTS OF STANDARD CHARACTERS WITHOUT CLAIM TO ANY PARTICULAR FONT, STYLE, SIZE, OR COLOR.

PRIORITY CLAIMED UNDER SEC. 44(D) ON FRANCE APPLICATION NO. 083611034, FILED 11-13-2008, REG. NO. 083611034, DATED 11-13-2008, EXPIRES 11-13-2018.

THE ENGLISH TRANSLATION OF "TENDRE" IN THE MARK IS "TENDER".

FOR PERFUME, TOILET WATER; GELS AND SALTS FOR THE BATH AND THE SHOWER NOT FOR MEDICAL PURPOSE; TOILET SOAPS, BODY DEODORANTS; COSMETICS, NAMELY, CREAMS, MILKS, LOTIONS, GELS AND POWDERS FOR THE FACE, THE BODY AND THE HANDS; NON-MEDICATED SUN CARE PREPARATIONS; MAKEUP PREPARATIONS; SHAMPOOS; HAIR CARE AND HAIR STYLING PREPARATIONS, NAMELY, GELS, SPRAYS, MOUSSES, AND BALMS; HAIR LACQUERS; HAIR COLOURING AND HAIR DECOLORANT PREPARATIONS; PERMANENT WAVING AND CURLING PREPARATIONS; ESSENTIAL OILS FOR PERSONAL USE (U.S. CLS. 1, 4, 6, 50, 51 AND 52).
JIM RINGLE, EXAMINING ATTORNEY

SN 77-634,310. BEAUMONT PRODUCTS, INC., KENNESAW, GA. FILED 12-16-2008.

ESSENTIALS

THE MARK CONSISTS OF STANDARD CHARACTERS WITHOUT CLAIM TO ANY PARTICULAR FONT, STYLE, SIZE, OR COLOR.

FOR BATH SOAPS; HAND SOAPS (U.S. CLS. 1, 4, 6, 50, 51 AND 52).

RAUL CORDOVA, EXAMINING ATTORNEY

CLASS 3—(Continued).

SN 77-647,053. AMOREPACIFIC CORPORATION, SEOUL, REPUBLIC OF KOREA, FILED 1-9-2009.

潤潔 윤결에센스 Revitalizing Serum

NO CLAIM IS MADE TO THE EXCLUSIVE RIGHT TO USE "REVITALIZING SERUM" AND THE NON-LATIN CHARACTERS THAT MEAN "ESSENCE", APART FROM THE MARK AS SHOWN.

THE NAME(S), PORTRAIT(S), AND/OR SIGNATURE(S) SHOWN IN THE MARK DOES NOT IDENTIFY A PARTICULAR LIVING INDIVIDUAL.

THE MARK CONSISTS OF CHINESE CHARACTERS "YOON" AND "GYUL" FOLLOWED BY KOREAN CHARACTERS FOR "YOON" "GYUL" "ESSENCE" WITH THE ENGLISH WORDS "REVITALIZING SERUM".

THE NON-LATIN CHARACTER(S) IN THE MARK TRANSLITERATE INTO "YOON" "GYU" AND "YOON GYUL ESSENCE", AND THIS MEANS "YOON GYUL ESSENCE" IN ENGLISH.

FOR COSMETICS; BODY AND BEAUTY CARE COSMETICS; NON-MEDICATED COSMETIC PREPARATIONS FOR BODY CARE AND SKIN RENEWAL; COSMETICS FOR LIPS; COSMETIC OILS; COSMETIC CREAMS; COSMETIC SUN-TANNING PREPARATIONS; COSMETIC PREPARATIONS FOR THE CARE OF MOUTH AND TEETH; HAIR LOTIONS, HAIR LACQUERS, HAIR CONDITIONERS, HAIR GELS; COSMETIC MILKS; ASTRINGENTS FOR COSMETIC PURPOSES; BLEACHING PREPARATIONS FOR COSMETIC PURPOSES; COLORING PREPARATIONS FOR COSMETIC PURPOSES; COSMETIC PENCILS; COSMETIC PREPARATIONS AGAINST SUNBURN; COSMETIC PREPARATIONS FOR EYE LASHES; SKIN LOTIONS; MAKE-UP AND NAIL POLISH REMOVERS; FACIAL AND SKIN MASKS; BODY GELS; MASSAGE OILS AND NON-MEDICATED MASSAGE SKIN CREAMS; NAIL ENAMELS; FALSE NAILS; NON-MEDICATED BATH PREPARATIONS; BABY POWDERS; TALCUM POWDERS; NON-MEDICATED FRAGRANCE, NAMELY, FRAGRANCES FOR PERSONAL USE AND ROOM FRAGRANCES; POTPOURRI AND INCENSE; SHAVING CREAMS; DEODORANTS FOR PERSONAL USE; MUSTACHE AND DEPILATORY WAX; ADHESIVES FOR COSMETIC USE; COSMETIC SOAPS; SOAPS AND DETERGENTS; CLEANING PREPARATIONS FOR HOUSEHOLD PURPOSES; CLEANING PREPARATIONS FOR CLEANING WASTE PIPES; SKIN POLISHING RICE BRAN; NON-MEDICATED DOUCHES; FABRIC SOFTENERS FOR LAUNDRY USE; WINDSHIELD WASHING FLUID; MOUTHWASH AND NON-MEDICATED DENTAL RINSE; TOOTH AND DENTURE CLEANING AND WHITENING PREPARATIONS; NON-MEDICATED LIP CARE PREPARATIONS; MAKE-UP FOR THE FACE AND BODY; MASCARA; FACE POWDERS; SKIN CLEANSING CREAMS; SKIN CLEANSING MILK; FOUNDATIONS; CREAMY FOUNDATION; AFTER-SHAVE LOTIONS; LIPSTICKS; EYE LINER; BLUSHER; SUN BLOCK LOTIONS; NON-MEDICATED SUN CARE PREPARATIONS; SUN SCREEN PREPARATIONS; SKIN MILKS; PERFUMES; LAVENDER OILS; COTTON WOOL FOR COSMETIC PURPOSES; TOILET SOAPS; SHAMPOO; TOOTH PASTES; NON-MEDICATED NOURISHING CREAMS FOR SKIN (U.S. CLS. 1, 4, 6, 50, 51 AND 52).

MARY BOAGNI, EXAMINING ATTORNEY

CLASS 3—(Continued).

SN 77-702,527. UNILEVER SUPPLY CHAIN, INC., CLINTON, CT. FILED 3-30-2009.

SHEER SILK

THE MARK CONSISTS OF STANDARD CHARACTERS WITHOUT CLAIM TO ANY PARTICULAR FONT, STYLE, SIZE, OR COLOR.

NO CLAIM IS MADE TO THE EXCLUSIVE RIGHT TO USE "SILK", APART FROM THE MARK AS SHOWN.

FOR DEODORANTS AND ANTI-PERSPIRANTS (U.S. CLS. 1, 4, 6, 50, 51 AND 52).

ANDREW RHIM, EXAMINING ATTORNEY



SN 77-710,383. HENKEL AG & CO. KGAA, DUESSELDORF, FED REP GERMANY, FILED 4-9-2009.

PUREX PERFUME PEARLS

THE MARK CONSISTS OF STANDARD CHARACTERS WITHOUT CLAIM TO ANY PARTICULAR FONT, STYLE, SIZE, OR COLOR.

NO CLAIM IS MADE TO THE EXCLUSIVE RIGHT TO USE "PERFUME", APART FROM THE MARK AS SHOWN.

FOR FRAGRANCE DELIVERY SYSTEM COMPRISED PRIMARILY OF FRAGRANCES CONTAINED IN MICRO-CAPSULES THAT RELEASE THEIR CONTENTS OVER A PROLONGED PERIOD AND ARE SOLD AS AN INTEGRAL COMPONENT OF LAUNDRY DETERGENTS AND FABRIC SOFTENERS (U.S. CLS. 1, 4, 6, 50, 51 AND 52).

SEAN CROWLEY, EXAMINING ATTORNEY

CLASS 3—(Continued).

SN 77-713,975. ZIJA INTERNATIONAL, INC., LINDON, UT. FILED 4-14-2009.



THE MARK CONSISTS OF THREE ROUGHLY TEAR DROP SHAPES INSCRIBED IN A CIRCLE.

FOR COSMETICS AND PERSONAL CARE ITEMS, NAMELY, FACIAL CLEANSER, FACIAL MOISTURIZER, SPF FACIAL MOISTURIZER, FACIAL TONER, NON-MEDICATED ANTI-AGING FACIAL SKIN CLEANSER AND MOISTURIZER, NON-MEDICATED ANTI-AGING EYE SERUM, NON-MEDICATED ANTI-AGING EYE OIL, FACIAL BEAUTY MASK (U.S. CLS. 1, 4, 6, 50, 51 AND 52).

FIRST USE 10-24-2009; IN COMMERCE 10-24-2009.

MICHAEL SOUDERS, EXAMINING ATTORNEY



SN 77-713,977. ZIJA INTERNATIONAL, INC., LINDON, UT. FILED 4-14-2009.

INNER HEALTH OUTER BEAUTY

THE MARK CONSISTS OF STANDARD CHARACTERS WITHOUT CLAIM TO ANY PARTICULAR FONT, STYLE, SIZE, OR COLOR.

FOR COSMETICS AND PERSONAL CARE ITEMS, NAMELY, FACIAL CLEANSER, FACIAL MOISTURIZER, SPF FACIAL MOISTURIZER, FACIAL TONER, NON-MEDICATED ANTI-AGING FACIAL SKIN CLEANSER AND MOISTURIZER, NON-MEDICATED ANTI-AGING EYE SERUM, NON-MEDICATED ANTI-AGING EYE OIL, FACIAL BEAUTY MASK (U.S. CLS. 1, 4, 6, 50, 51 AND 52).

FIRST USE 10-24-2009; IN COMMERCE 10-24-2009.

MICHAEL SOUDERS, EXAMINING ATTORNEY

CLASS 3—(Continued).

SN 77-719,705. SANS SOLIEL LLC, BEVERLY HILLS, CA.
FILED 4-22-2009.

CLASS 3—(Continued).

SN 77-728,201. LANCOME PARFUMS ET BEAUTE & CIE,
PARIS, FRANCE, FILED 5-4-2009.

Glow on the go

THE MARK CONSISTS OF STANDARD CHARACTERS WITHOUT CLAIM TO ANY PARTICULAR FONT, STYLE, SIZE, OR COLOR.

FOR SKIN CARE PRODUCTS FOR TANNING, NAMELY, PRE-TANNING, TANNING AND POST-TANNING SUNLESS SPRAYS, MOISTURIZERS, BODY WASHES, EXFOLIATING BODY SCRUBS, BRONZERS, SUNLESS SELF-TANNING LOTIONS, AFTER-SUN COOLING LOTIONS, SUN TAN LOTIONS, SUN TAN GELS, SUN TAN LOTIONS, SUN TAN GELS, SUN TAN CREAMS AND SUNSCREEN CREAMS; UV-FREE INDOOR SUN-LESS TANNING PREPARATIONS (U.S. CLS. 1, 4, 6, 50, 51 AND 52).

FIRST USE 12-31-2006; IN COMMERCE 12-31-2006.
LAKEISHA LEWIS, EXAMINING ATTORNEY

FRENCH TOUCH

SN 77-727,024. AAVEN PRODUCT INC., DBA DOUCCE,
FRESH MEADOWS, NY. FILED 5-1-2009.



THE MARK CONSISTS OF "DOUCCE" IN A STYLIZED FONT.

THE WORDING "DOUCCE" HAS NO MEANING IN A FOREIGN LANGUAGE.

FOR CLEANSING CREAMS; COLOGNES, PERFUMES AND COSMETICS; CONCEALERS; COSMETIC CREAMS; COSMETIC CREAMS FOR SKIN CARE; COSMETIC PENCILS; COSMETIC ROUGES; COSMETIC SUNTAN LOTIONS; COSMETICS; COSMETICS AND MAKE-UP; COSMETICS IN GENERAL, INCLUDING PERFUMES; COSMETICS, NAMELY, COMPACTS; COSMETICS, NAMELY, LIP PRIMER; COSMETICS, NAMELY, LIP REPAIRERS; EYEBROW COSMETICS; FACE CREAMS FOR COSMETIC USE; LOTIONS FOR COSMETIC PURPOSES; PENCILS FOR COSMETIC PURPOSES; PRIVATE LABEL COSMETICS; SOLID POWDER FOR COMPACTS; TANNING OILS; WRINKLE-MINIMIZING COSMETIC PREPARATIONS FOR TOPICAL FACIAL USE (U.S. CLS. 1, 4, 6, 50, 51 AND 52).

FIRST USE 1-5-2009; IN COMMERCE 5-1-2009.
LESLIE RICHARDS, EXAMINING ATTORNEY

THE MARK CONSISTS OF STANDARD CHARACTERS WITHOUT CLAIM TO ANY PARTICULAR FONT, STYLE, SIZE, OR COLOR.

PRIORITY CLAIMED UNDER SEC. 44(D) ON ERP N CMNTY TM OFC APPLICATION NO. 7414378, FILED 11-24-2008, REG. NO. 7414378, DATED 5-27-2009, EXPIRES 11-24-2018.

NO CLAIM IS MADE TO THE EXCLUSIVE RIGHT TO USE "FRENCH", APART FROM THE MARK AS SHOWN.

FOR PERFUME, EAU DE TOILETTE; GELS AND SALTS FOR THE BATH AND THE SHOWER NOT FOR MEDICAL PURPOSE; TOILET SOAPS, BODY DEODORANTS; COSMETICS, NAMELY, CREAMS, MILKS, LOTIONS, GELS AND POWDERS FOR THE FACE, THE BODY AND THE HANDS; NON-MEDICATED SUN CARE PREPARATIONS; MAKEUP PREPARATIONS; SHAMPOOS; GELS, SPRAYS, MOUSSES AND BALMS FOR THE HAIR STYLING AND HAIR CARE; HAIR LACQUERS; HAIR COLOURING AND HAIR DECOLORANT PREPARATIONS; PERMANENT WAVING AND CURLING PREPARATIONS; ESSENTIAL OILS FOR PERSONAL USE (U.S. CLS. 1, 4, 6, 50, 51 AND 52).

MARY BOAGNI, EXAMINING ATTORNEY

CLASS 3—(Continued).

SN 77-733,016. MARY C. BROCKERT, PASADENA, CA. AND ALIA R. BROCKERT, PASADENA, CA. FILED 5-8-2009.

LADY TEE

THE MARK CONSISTS OF STANDARD CHARACTERS WITHOUT CLAIM TO ANY PARTICULAR FONT, STYLE, SIZE, OR COLOR.

THE NAME(S), PORTRAIT(S), AND/OR SIGNATURE(S) SHOWN IN THE MARK IDENTIFIES "MARY C. BROCKERT", WHOSE CONSENT(S) TO REGISTER IS MADE OF RECORD.

FOR BATH BEADS; BATH CREAM; BATH CRYSTALS; BATH FIZZIES; BATH FLAKES; BATH FOAMS; BATH GELS; BATH LOTION; BATH MILKS; BATH OILS; BATH PEARLS; BATH POWDER; BATH SALTS; BATH SOAPS IN LIQUID, SOLID OR GEL FORM; BATHING LOTIONS; BODY AND BEAUTY CARE COSMETICS; BODY BUTTER; BODY CREAMS; BODY DEODORANTS; BODY LOTIONS; BODY MASKS; BODY MILKS; BODY OILS; BODY POWDER; BODY SPLASH; BODY SPRAY USED AS A PERSONAL DEODORANT AND AS FRAGRANCE; BODY WASHES; BUBBLE BATH; COLOGNES, PERFUMES AND COSMETICS; COSMETIC CREAMS; COSMETIC CREAMS FOR SKIN CARE; COSMETIC MILKS; COSMETIC OILS; COSMETIC PREPARATIONS; COSMETIC PREPARATIONS FOR BODY CARE; COSMETICS AND MAKE-UP; COSMETICS IN GENERAL, INCLUDING PERFUMES; DEODORANTS FOR BODY CARE; EAU DE COLOGNES; EAU DE PERFUME; EAU DE TOILETTE; FACE AND BODY CREAMS; FOAM BATH; FRAGRANCES AND PERFUMERY; LIQUID BATH SOAPS; LIQUID PERFUMES; MAKE-UP FOR THE FACE AND BODY; OILS FOR PERFUMES AND SCENTS; PERFUME; PERFUME OILS; PERFUMED CREAMS; PERFUMED POWDERS; PERFUMED SOAPS; PERFUMED TALCUM POWDER; PERFUMES AND COLOGNES; PERFUMES AND TOILET WATERS; PERFUMES, EAU DE COLOGNES AND AFTERSHAVES; SCENTED BODY LOTIONS AND CREAMS; SCENTED BODY SPRAY; SCENTED OILS; SHOWER AND BATH FOAM; SHOWER AND BATH GEL; SKIN AND BODY TOPICAL LOTIONS, CREAMS AND OILS FOR COSMETIC USE; SOAPS FOR BODY CARE (U.S. CLS. 1, 4, 6, 50, 51 AND 52).

JAMES GRIFFIN, EXAMINING ATTORNEY

SN 77-733,039. INTERNATIONAL TEST SOLUTIONS, INC., RENO, NV. FILED 5-8-2009.

TCC

THE MARK CONSISTS OF STANDARD CHARACTERS WITHOUT CLAIM TO ANY PARTICULAR FONT, STYLE, SIZE, OR COLOR.

FOR CLEANING PREPARATIONS FOR COLLECTING AND/OR REMOVING DEBRIS GENERATED DURING TESTING OF INTEGRATED CIRCUITS FOR USE BY INDIVIDUAL DEVICE MANUFACTURERS SUCH AS CONSTRUCTORS, FABRICATORS OR ASSEMBLERS OF END-PRODUCT ELECTRONIC DEVICES IN ORDER TO PREPARE FOR THE TESTING OF THE PERFORMANCE OF THE COMPONENT INTEGRATED CIRCUITS FOR THEIR PRODUCTS (U.S. CLS. 1, 4, 6, 50, 51 AND 52).

FIRST USE 1-31-2009; IN COMMERCE 1-31-2009.
AARON BRODSKY, EXAMINING ATTORNEY

CLASS 3—(Continued).

SN 77-740,398. THE PROCTER & GAMBLE COMPANY, CINCINNATI, OH. FILED 5-19-2009.

LIQUICOLOR PERMANENTE

THE MARK CONSISTS OF STANDARD CHARACTERS WITHOUT CLAIM TO ANY PARTICULAR FONT, STYLE, SIZE, OR COLOR.

NO CLAIM IS MADE TO THE EXCLUSIVE RIGHT TO USE "PERMANENTE", APART FROM THE MARK AS SHOWN.

THE ENGLISH TRANSLATION OF "PERMANENTE" IN THE MARK IS "PERMANENT".

FOR HAIR COLORING PREPARATIONS (U.S. CLS. 1, 4, 6, 50, 51 AND 52).

BERYL GARDNER, EXAMINING ATTORNEY

SN 77-744,639. COLOMER ITALY, S.P.A., BOLOGNA, ITALY, FILED 5-26-2009.

OROFLUIDO

PRIORITY CLAIMED UNDER SEC. 44(D) ON ERPNCMNTY TM OFC APPLICATION NO. 8319378, FILED 5-25-2009, REG. NO. 8319378, DATED 11-22-2009, EXPIRES 5-25-2019.

THE MARK CONSISTS OF THE WORDING "OROFLUIDO", WITH A DOT IN THE FIRST "O" AND A CURVING, STYLIZED LETTER "I".

THE ENGLISH TRANSLATION OF "OROFLUIDO" IN THE MARK IS "FLUID GOLD".

FOR HAIR LOTIONS; HAIR CARE PREPARATIONS; HAIR OILS; HAIR GELS; SHAMPOOS; HAIR CONDITIONERS; HAIR MASKS; AND HAIR SPRAYS (U.S. CLS. 1, 4, 6, 50, 51 AND 52).

AMY KERTGATE, EXAMINING ATTORNEY

SN 77-749,836. I-SLICES INNOVATIONS (PTY) LTD, GLEN AUSTIN, MIDRAND, SOUTH AFRICA, FILED 6-2-2009.

EYE SLICES

THE MARK CONSISTS OF STANDARD CHARACTERS WITHOUT CLAIM TO ANY PARTICULAR FONT, STYLE, SIZE, OR COLOR.

OWNER OF SOUTH AFRICA REG. NO. 2005/12251, DATED 2-3-2009, EXPIRES 2-3-2019.

NO CLAIM IS MADE TO THE EXCLUSIVE RIGHT TO USE "EYE", APART FROM THE MARK AS SHOWN.

FOR HAND SOAPS; SKIN SOAPS; PERFUMERY; ESSENTIAL OILS; COSMETICS; ANTI-AGING EYE AND SKIN LOTIONS, ANTI-AGING EYE AND SKIN NON-MEDICATED BALM, CREAMS, AND OILS; ALOE VERA GEL FOR COSMETIC PURPOSES; COSMETIC PADS, NAMELY, PADS AND HYDROGEL PADS FOR THE TREATMENT OF EYELIDS AND EYES (U.S. CLS. 1, 4, 6, 50, 51 AND 52).

LAKEISHA LEWIS, EXAMINING ATTORNEY

CLASS 3—(Continued).

SN 77-754,755. BARE ESCENTUALS BEAUTY, INC., SAN FRANCISCO, CA. FILED 6-8-2009.

A BRIGHTER DAY

THE MARK CONSISTS OF STANDARD CHARACTERS WITHOUT CLAIM TO ANY PARTICULAR FONT, STYLE, SIZE, OR COLOR.

FOR COSMETICS; COSMETIC KITS COMPRISING POWDERS FOR THE FACE, POWDERS FOR THE EYES, EYELINER, LIP GLOSS, COSMETIC BRUSHES AND SKIN CARE PREPARATIONS (U.S. CLS. 1, 4, 6, 50, 51 AND 52).

JILL PRATER, EXAMINING ATTORNEY

SN 77-754,762. BARE ESCENTUALS BEAUTY, INC., SAN FRANCISCO, CA. FILED 6-8-2009.

THE GORGEOUS TAN

THE MARK CONSISTS OF STANDARD CHARACTERS WITHOUT CLAIM TO ANY PARTICULAR FONT, STYLE, SIZE, OR COLOR.

FOR COSMETICS; COSMETIC KITS COMPRISING LIP GLOSS, COSMETIC SELF-TANNING PREPARATION AND COSMETIC BRUSHES (U.S. CLS. 1, 4, 6, 50, 51 AND 52).

JILL PRATER, EXAMINING ATTORNEY

SN 77-756,414. BEAUTYBANK INC., NEW YORK, NY. FILED 6-10-2009.

PURPLE BLOSSOM

THE MARK CONSISTS OF STANDARD CHARACTERS WITHOUT CLAIM TO ANY PARTICULAR FONT, STYLE, SIZE, OR COLOR.

FOR BODY LOTION; COSMETICS; FRAGRANCES; SHOWER AND BATH GEL (U.S. CLS. 1, 4, 6, 50, 51 AND 52).

DAVID I, EXAMINING ATTORNEY

CLASS 3—(Continued).

SN 77-757,110. LIN QUAN ENTERPRISE CO., LTD., TAIPEI CITY 104, TAIWAN, FILED 6-11-2009.

SHILLS

THE MARK CONSISTS OF STANDARD CHARACTERS WITHOUT CLAIM TO ANY PARTICULAR FONT, STYLE, SIZE, OR COLOR.

OWNER OF TAIWAN REG. NO. 01264074, DATED 6-1-2007, EXPIRES 5-31-2017.

FOR SKIN TONER, SKIN LOTION, SKIN EXFOLIATOR, BEAUTY SKIN SERUM (U.S. CLS. 1, 4, 6, 50, 51 AND 52).

LEIGH LOWRY, EXAMINING ATTORNEY

SN 77-758,563. JEFF FREEDMAN, NEW YORK, NM. AND BILL KITCHEN, HOLDEN, MA. AND DEBRA BACON, HOLDEN, MA. FILED 6-12-2009.

GLOW LIKE A GIRL

THE MARK CONSISTS OF STANDARD CHARACTERS WITHOUT CLAIM TO ANY PARTICULAR FONT, STYLE, SIZE, OR COLOR.

FOR COSMETICS; PERFUMERY, NAMELY, AFTER SHAVE GELS AND BALMS, COLOGNE, EAU DE PARFUM, EAU DE TOILETTE, ESSENTIAL OILS FOR PERSONAL USE, FRAGRANCED BODY CREAMS, GELS AND LOTIONS AND PERFUME; ROOM FRAGRANCE SPRAYS; SKIN CARE PREPARATIONS, NAMELY, ANTI-PERSPIRANT AND DEODORANTS, BATH GRAINS, BATH OILS, BATH POWDERS, BATH SALTS, BODY CLEANSERS, BODY CREAMS, BODY EXFOLIATING PREPARATIONS, BODY LOTIONS, BODY OILS, BODY POWDERS, BODY SCRUBS, BODY TONERS, BODY WASHES, CLEANSING LOTIONS, CLEANSING CREAMS, CLEANSING GELS, EYE CREAMS, EYE GELS, EYE MAKEUP REMOVERS, FACE CREAMS, FACE GELS, FACE LOTIONS, FACIAL MASKS, FACIAL CLEANSERS, FACIAL EMULSIONS, FACIAL EXFOLIATING PREPARATIONS, FACIAL MAKEUP REMOVERS, FACIAL MOISTURIZERS, FACIAL SOAPS, FACIAL TONERS, HAIR CONDITIONERS, HAIR REVITALIZING TREATMENTS, HAIR SHampoos, HAIR MOUSSES, HAIR GEL, HAIR GLITTER, HAND CREAMS, NON-MEDICATED ANTI-WRINKLE CREAMS, LOTIONS AND GELS, NON-MEDICATED FACIAL SKIN OIL CONTROLLERS, NON-MEDICATED SKIN BLEMISH PREPARATIONS, NON-MEDICATED SKIN RENEWAL CREAMS, NON-MEDICATED SKIN REPAIR CREAMS, LOTIONS AND GELS, PERSONAL SOAPS, SALT SCRUBS FOR THE SKIN, SHAVING FOAMS, CREAMS, LOTIONS AND GELS, SKIN BALANCING LOTION, SKIN FIRMING PREPARATIONS, SKIN BRIGHTENERS, SKIN LIGHTENERS, SKIN REFRESHERS, SUNSCREENS FOR THE BODY, SUNSCREENS FOR THE FACE AND AFTER-SUN SOOTHING AND MOISTURIZING PREPARATIONS; POTPOURRI; FACIAL MAKEUP, NAMELY, EYE SHADOW, EYE LINER, MASCARA, BLUSH, LIP STICK, LIP GLOSS, LIP LINER, BODY GLITTER, BODY MAKEUP, NAIL POLISH, NAIL ACCESSORIES, NAMELY, NAIL TIPS, EMERY BOARDS AND NAIL STENCILS (U.S. CLS. 1, 4, 6, 50, 51 AND 52).

BRENDAN MCCAULEY, EXAMINING ATTORNEY

CLASS 3—(Continued).

SN 77-761,326. FUNCIK, THOMAS J., ISLE OF PALMS, SC. FILED 6-16-2009.

HIPPO BLOCK

THE MARK CONSISTS OF STANDARD CHARACTERS WITHOUT CLAIM TO ANY PARTICULAR FONT, STYLE, SIZE, OR COLOR.

NO CLAIM IS MADE TO THE EXCLUSIVE RIGHT TO USE "BLOCK", APART FROM THE MARK AS SHOWN.

FOR SUN SCREEN PREPARATIONS, SUN CARE LOTIONS, SUN TAN GELS, SUN TAN LOTIONS, SUN TAN OILS, AND AFTER SUN LOTIONS (U.S. CLS. 1, 4, 6, 50, 51 AND 52).

SOPHIA S. KIM, EXAMINING ATTORNEY

CLASS 3—(Continued).

SN 77-767,223. ALBERTO CULVER USA, INC., MELROSE PARK, IL. FILED 6-24-2009.



THE MARK CONSISTS OF A SHADED CIRCLE CONTAINING A SCRIPT LETTER "M". THE WHITE BACKGROUND IS NOT PART OF THE MARK.

FOR HAIR CARE PREPARATIONS (U.S. CLS. 1, 4, 6, 50, 51 AND 52).

NAKIA HENRY, EXAMINING ATTORNEY

SN 77-761,480. BELINDA NOAH PRODUCTIONS, INC., TAMPA, FL. FILED 6-17-2009.

AGELESS SECRETS

THE MARK CONSISTS OF STANDARD CHARACTERS WITHOUT CLAIM TO ANY PARTICULAR FONT, STYLE, SIZE, OR COLOR.

FOR BEAUTY BEVERAGES, NAMELY, FRUIT JUICES AND ENERGY DRINK CONTAINING NUTRITIONAL SUPPLEMENTS, VITAMIN AND MINERAL SUPPLEMENTS, NUTRITIONAL ADDITIVES FOR USE IN FOODS AND DIETARY SUPPLEMENTS FOR HUMAN CONSUMPTION, PLANT AND HERB EXTRACTS FOR COSMETIC PURPOSES AND MADE AVAILABLE THROUGH HEALTH CARE AND BEAUTY PRODUCT CATEGORIES (U.S. CLS. 1, 4, 6, 50, 51 AND 52).

FIRST USE 1-1-2006; IN COMMERCE 1-1-2006.
MARK PILARO, EXAMINING ATTORNEY

SN 77-767,304. DELTA PERFUME HOUSE, INC., BROOKLYN, NY. FILED 6-24-2009.

MUAGE

THE MARK CONSISTS OF STANDARD CHARACTERS WITHOUT CLAIM TO ANY PARTICULAR FONT, STYLE, SIZE, OR COLOR.

FOR PERFUME (U.S. CLS. 1, 4, 6, 50, 51 AND 52).
SANJEEV VOHRA, EXAMINING ATTORNEY

SN 77-762,251. BARE ESCENTUALS BEAUTY, INC., SAN FRANCISCO, CA. FILED 6-17-2009.

EXOTIC DESTINATIONS

THE MARK CONSISTS OF STANDARD CHARACTERS WITHOUT CLAIM TO ANY PARTICULAR FONT, STYLE, SIZE, OR COLOR.

FOR COSMETICS; COSMETIC KITS COMPRISING POWDERS FOR THE EYES (U.S. CLS. 1, 4, 6, 50, 51 AND 52).

FIRST USE 4-0-2009; IN COMMERCE 4-0-2009.
JILL PRATER, EXAMINING ATTORNEY

SN 77-767,329. DELTA PERFUME HOUSE, INC., BROOKLYN, NY. FILED 6-24-2009.

ADDRESS

THE MARK CONSISTS OF STANDARD CHARACTERS WITHOUT CLAIM TO ANY PARTICULAR FONT, STYLE, SIZE, OR COLOR.

FOR PERFUME (U.S. CLS. 1, 4, 6, 50, 51 AND 52).
SANJEEV VOHRA, EXAMINING ATTORNEY

CLASS 3—(Continued).

SN 77-767,676. TREECE, MARTA R, DAYTON, OH. FILED 6-24-2009.

MEDI-FACIAL

THE MARK CONSISTS OF STANDARD CHARACTERS WITHOUT CLAIM TO ANY PARTICULAR FONT, STYLE, SIZE, OR COLOR.

FOR NON-MEDICATED SKIN CARE PREPARATIONS; NON-MEDICATED SKIN CARE PREPARATIONS, NAMELY, CREAMS, LOTIONS, GELS, TONERS, CLEANSERS AND PEELS; SKIN ABRASIVE PREPARATIONS; SKIN AND BODY TOPICAL LOTIONS, CREAMS AND OILS FOR COSMETIC USE; SKIN CARE PREPARATIONS, NAMELY, CHEMICAL PEELS FOR SKIN; SKIN CARE PREPARATIONS, NAMELY, FRUIT ACID PEELS FOR SKIN; SKIN CARE PREPARATIONS, NAMELY, SKIN PEELS; SKIN CLARIFIERS; SKIN CLEANSERS; SKIN CLEANSING CREAM; SKIN CLEANSING LOTION; SKIN CONDITIONERS; SKIN CREAM; SKIN EMOLLIENTS; SKIN FRESHENERS; SKIN LOTIONS; SKIN MASKS; SKIN MOISTURIZER; SKIN MOISTURIZER MASKS; WRINKLE REMOVING SKIN CARE PREPARATIONS (U.S. CLS. 1, 4, 6, 50, 51 AND 52).

FIRST USE 0-0-2008; IN COMMERCE 6-1-2008.

DOMINICK J. SALEMI, EXAMINING ATTORNEY

CLASS 3—(Continued).

SN 77-771,301. DISNEY ENTERPRISES, INC., BURBANK, CA. FILED 6-30-2009.

WALT DISNEY SIGNATURE

THE MARK CONSISTS OF STANDARD CHARACTERS WITHOUT CLAIM TO ANY PARTICULAR FONT, STYLE, SIZE, OR COLOR.

OWNER OF U.S. REG. NOS. 3,584,878, 3,610,525 AND OTHERS.

"WALT DISNEY" DOES NOT IDENTIFY A LIVING INDIVIDUAL.

FOR COSMETICS; DENTIFRICES; NON-MEDICATED TOILETRIES; FRAGRANCES FOR PERSONAL USE; ROOM FRAGRANCES (U.S. CLS. 1, 4, 6, 50, 51 AND 52).

MEGHAN REINHART, EXAMINING ATTORNEY

SN 77-773,737. JH DIRECT, LLC, VISTA, CA. FILED 7-2-2009.

SN 77-770,534. RAÚL ARTURO TORRESDEY JIMÉNEZ, MONTERREY, N.L., MEXICO, FILED 6-29-2009.

RYT

THE MARK CONSISTS OF STANDARD CHARACTERS WITHOUT CLAIM TO ANY PARTICULAR FONT, STYLE, SIZE, OR COLOR.

FOR HAIR CARE CREAMS; HAIR CARE PREPARATIONS; HAIR LOTIONS; HAIR SHAMPOOS AND CONDITIONERS (U.S. CLS. 1, 4, 6, 50, 51 AND 52).

FIRST USE 4-1-2009; IN COMMERCE 4-1-2009.

JUDITH HELFMAN, EXAMINING ATTORNEY

ONE BEAUTY

THE MARK CONSISTS OF STANDARD CHARACTERS WITHOUT CLAIM TO ANY PARTICULAR FONT, STYLE, SIZE, OR COLOR.

NO CLAIM IS MADE TO THE EXCLUSIVE RIGHT TO USE "BEAUTY", APART FROM THE MARK AS SHOWN.

FOR COSMETICS; NON-MEDICATED SKIN CARE PREPARATIONS; COSMETIC PREPARATIONS FOR THE HAIR AND SCALP; NAIL CARE PREPARATIONS; SKIN LOTIONS; BEAUTY CREAMS; COSMETIC CREAMS; BODY WASHES; FACIAL WASHES; NON-MEDICATED ACNE TREATMENT PREPARATIONS; LIQUIDS, CREAMS AND LOTIONS FOR SKIN ANTI-AGING, SKIN WHITENING AND CELLULITE TREATMENT (U.S. CLS. 1, 4, 6, 50, 51 AND 52).

JOHN DWYER, EXAMINING ATTORNEY

CLASS 3—(Continued).

SN 77-773,903. BOWMAN, PAMELLA J, FORT WORTH, TX. FILED 7-2-2009.

TAMAR

THE MARK CONSISTS OF STANDARD CHARACTERS WITHOUT CLAIM TO ANY PARTICULAR FONT, STYLE, SIZE, OR COLOR.

THE NAME(S), PORTRAIT(S), AND/OR SIGNATURE(S) SHOWN IN THE MARK DOES NOT IDENTIFY A PARTICULAR LIVING INDIVIDUAL.

FOR PERFUME, COLOGNE, TOILET WATER, MEN'S COLOGNE, MEN'S AFTER SHAVE LOTION, MEN'S AFTER SHAVE BALM, BODY POWDER, BODY CREAM, BODY LOTION, HAND CREAM, SOAP, BATH GEL, BATH CRYSTALS, NON-MEDICATED SKIN CARE FOR FACE AND BODY, FACE SCRUB, FACE MASK, BODY SCRUB, FACIAL CLEANSING CREAM, FACE MOISTURIZING CREAM, EYE CREAM, NIGHT CREAM, EYE SHADOW, MASCARA, FOUNDATION, EYEBROW PENCIL, LIPSTICKS, BLUSH, BODY POWDERED GLISTENER FOR SPARKLE, SPRAY GLITTER FOR HAIR, NAIL POLISH, SUNSCREEN LOTION, HAIR GEL, SUNSCREEN CREAM, SUNTAN LOTION, DEODORANT, SHAVING GEL, DEPILATORY WAX, HAIR CONDITIONER, SHAMPOO (U.S. CLS. 1, 4, 6, 50, 51 AND 52).

SKYE YOUNG, EXAMINING ATTORNEY

SN 77-776,399. DELTA PERFUME HOUSE, INC., BROOKLYN, NY. FILED 7-8-2009.

FORT

THE MARK CONSISTS OF STANDARD CHARACTERS WITHOUT CLAIM TO ANY PARTICULAR FONT, STYLE, SIZE, OR COLOR.

FOR PERFUME (U.S. CLS. 1, 4, 6, 50, 51 AND 52).
SANJEEV VOHRA, EXAMINING ATTORNEY

SN 77-776,406. DELTA PERFUME HOUSE, INC., BROOKLYN, NY. FILED 7-8-2009.

DIGIC

THE MARK CONSISTS OF STANDARD CHARACTERS WITHOUT CLAIM TO ANY PARTICULAR FONT, STYLE, SIZE, OR COLOR.

FOR PERFUME (U.S. CLS. 1, 4, 6, 50, 51 AND 52).
SANJEEV VOHRA, EXAMINING ATTORNEY

CLASS 3—(Continued).

SN 77-777,062. ROOTS OF MYTON INC, FORT LAUDERDALE, FL. FILED 7-8-2009.



THE STIPLING IS FOR SHADING PURPOSES ONLY.
THE MARK CONSISTS OF THE DESIGN OF A BACKGROUND OF A SUNSET WITH A WOMAN STANDING IN THE GRASS ON ROOTS WITH HER HANDS IN THE AIR WITHIN A CIRCULAR DESIGN. THE WORDING "ROOTS OF MYTON" APPEARS WITHIN THE EXTERIOR OF THE CIRCLE WITH THE DESIGN OF GRASS OR WHEAT GRAIN. THE WORDING "MAKE YOUR ROOTS COME ALIVE" APPEARS BENEATH THE CIRCULAR DESIGN.

FOR ALL-NATURAL SKIN LOTIONS, SHAMPOOS, HAIR CONDITIONERS AND HAIR OILS (U.S. CLS. 1, 4, 6, 50, 51 AND 52).
KAREN BRACEY, EXAMINING ATTORNEY

SN 77-778,916. DERMAL SOLUTIONS INC., DBA FLOCKED, VALENCIA, CA. FILED 7-10-2009.

FLOCKED

THE MARK CONSISTS OF STANDARD CHARACTERS WITHOUT CLAIM TO ANY PARTICULAR FONT, STYLE, SIZE, OR COLOR.

FOR COSMETICS AND MAKE-UP; TOPICAL SKIN SPRAYS FOR COSMETIC PURPOSES (U.S. CLS. 1, 4, 6, 50, 51 AND 52).
FIRST USE 9-1-2007; IN COMMERCE 6-8-2008.
GINA HAYES, EXAMINING ATTORNEY

SN 77-781,373. NEUTROGENA CORPORATION, LOS ANGELES, CA. FILED 7-15-2009.

FINE FAIRNESS

THE MARK CONSISTS OF STANDARD CHARACTERS WITHOUT CLAIM TO ANY PARTICULAR FONT, STYLE, SIZE, OR COLOR.

FOR NON-MEDICATED SKIN CARE PREPARATIONS (U.S. CLS. 1, 4, 6, 50, 51 AND 52).
SHAILA SETTLES, EXAMINING ATTORNEY

CLASS 3—(Continued).

SN 77-812,686. AMOREPACIFIC CORPORATION, SEOUL, REPUBLIC OF KOREA, FILED 8-25-2009.

DESIGNING EYES LINER

THE MARK CONSISTS OF STANDARD CHARACTERS WITHOUT CLAIM TO ANY PARTICULAR FONT, STYLE, SIZE, OR COLOR.

NO CLAIM IS MADE TO THE EXCLUSIVE RIGHT TO USE "EYES LINER", APART FROM THE MARK AS SHOWN.

FOR MASCARA; EYE LINER; EYE MAKE-UP REMOVER; EYE SHADOWS; EYE CREAM; FALSE EYELASHES (U.S. CLS. 1, 4, 6, 50, 51 AND 52).

ELLEN BURNS, EXAMINING ATTORNEY

SN 77-817,338. GREEN BULLION FINANCIAL SERVICES, LLC, POMPANO BEACH, FL. FILED 9-1-2009.

HAIRMAJESTY

THE MARK CONSISTS OF STANDARD CHARACTERS WITHOUT CLAIM TO ANY PARTICULAR FONT, STYLE, SIZE, OR COLOR.

FOR HAIR BLEACHES; HAIR BLEACHING PREPARATIONS; HAIR CARE CREAMS; HAIR CARE LOTIONS; HAIR CARE PREPARATIONS; HAIR CLEANING PREPARATIONS; HAIR CONDITIONERS; HAIR CREAMS; HAIR CURLING PREPARATIONS; HAIR GELS; HAIR GLAZE; HAIR LOTIONS; HAIR MOUSSES; HAIR NOURISHERS; HAIR POMADES; HAIR RELAXERS; HAIR RELAXING PREPARATIONS; HAIR REMOVING CREAM; HAIR RINSES; HAIR SHAMPOOS AND CONDITIONERS; HAIR SPRAYS AND HAIR GELS; HAIR STRAIGHTENING PREPARATIONS; HAIR STYLING FIXATIVE IN THE NATURE OF HAIR WAX; HAIR STYLING GEL; HAIR STYLING PREPARATIONS; HAIR STYLING SPRAY; HAIR TONICS; HAIR WAVING LOTION; HAIR WAVING PREPARATIONS; HAIR WAX (U.S. CLS. 1, 4, 6, 50, 51 AND 52).

MARK SPARACINO, EXAMINING ATTORNEY

CLASS 3—(Continued).

SN 77-827,860. JOHN JOSEPH MANZIONE, BAY SHORE, NY. FILED 9-16-2009.

NADECO

THE MARK CONSISTS OF STANDARD CHARACTERS WITHOUT CLAIM TO ANY PARTICULAR FONT, STYLE, SIZE, OR COLOR.

THE WORDING "NADECO" HAS NO MEANING IN A FOREIGN LANGUAGE.

FOR GLUE REMOVER FOR USE WITH ARTIFICIAL FINGERNAILS; GLUE FOR USE WITH ARTIFICIAL FINGERNAILS; COSMETICS; FINGERNAIL ART, NAMELY, STICKER DESIGN, GLITTER, RHINESTONES, CHARMS, DANGLES, PAINT OR POLISH, OR ANY PRINTED MATTER THAT CAN BE ADHERED TO THE NAIL TO BEAUTIFY THE NATURAL OR ARTIFICIAL NAIL; DECALS FOR USE IN DECORATING FINGERNAILS; NAIL ART, NAMELY, WATER DECALS, STICKER DESIGN, GLITTER, RHINESTONES, CHARMS, DANGLES, PAINT OR POLISH, CUTICLE REMOVING PREPARATIONS AND FINGERNAIL CHARMS, DRIED FLOWERS USED TO DECORATE FINGERNAILS, DRIED SEA SHELLS USED TO DECORATE FINGERNAILS; ARTIFICIAL FULL COVER FINGERNAILS, ARTIFICIAL FINGERNAIL TIPS, AIRBRUSHED AND/OR PREDECORATED FULL COVER ARTIFICIAL FINGERNAILS, AIRBRUSHED AND/OR PREDECORATED ARTIFICIAL FINGERNAIL TIPS, PRECOLORED ARTIFICIAL FULL COVER FINGERNAILS AND ARTIFICIAL FINGERNAIL TIPS (U.S. CLS. 1, 4, 6, 50, 51 AND 52).

MELISSA VALLILLO, EXAMINING ATTORNEY

SN 77-835,917. JAMIL PRODUCTS CORP., DBA ORIGINAL PRODUCTS, BRONX, NY. FILED 9-27-2009.



NO CLAIM IS MADE TO THE EXCLUSIVE RIGHT TO USE "ORIGINAL PRODUCTS", APART FROM THE MARK AS SHOWN.

THE MARK CONSISTS OF THE DESIGN OF A HAND GRASPING A DOLLAR BILL AND MAKING A PEACE SIGN FEATURED ABOVE THE DESIGN OF A BANNER ENCASING THE WORDING "ORIGINAL PRODUCTS".

FOR BATH AND SHOWER GELS AND SALTS NOT FOR MEDICAL PURPOSES; BATH OILS AND BATH SALTS; INCENSE; INCENSE STICKS; PERFUME OILS; PERFUMED POWDERS; PERFUMED SOAP; PERFUMED TALCUM POWDER; PERFUMES AND COLOGNES (U.S. CLS. 1, 4, 6, 50, 51 AND 52).

FIRST USE 4-1-2009; IN COMMERCE 4-1-2009.

CHARISMA HAMPTON, EXAMINING ATTORNEY

CLASS 3—(Continued).

SN 77-843,151. MANUEL ANTONIO MARTÍNEZ CARBALLO, MEXICO, DF, MEXICO, FILED 10-7-2009.



OWNER OF U.S. REG. NO. 2,690,392.
THE MARK CONSISTS OF THE LETTERS "CRE" FOLLOWED BY A DASH AND A LETTER "C"; ALL IN SPECIAL ROUNDED STYLE.
THE WORDING "CRE·C" HAS NO MEANING IN A FOREIGN LANGUAGE.
FOR HAIR SHAMPOO (U.S. CLS. 1, 4, 6, 50, 51 AND 52).
FIRST USE 8-31-2001; IN COMMERCE 8-31-2001.
JASON BLAIR, EXAMINING ATTORNEY

SN 77-844,502. BELLISSIMA INTERNATIONAL INCORPORATED, SANTA CRUZ, CA. FILED 10-8-2009.



THE MARK CONSISTS OF STANDARD CHARACTERS WITHOUT CLAIM TO ANY PARTICULAR FONT, STYLE, SIZE, OR COLOR.
THE ENGLISH TRANSLATION OF "BELLA FORMA" IN THE MARK IS "BEAUTIFUL SHAPE".
FOR ADHESIVES FOR ARTIFICIAL NAILS (U.S. CLS. 1, 4, 6, 50, 51 AND 52).
FIRST USE 9-10-2009; IN COMMERCE 9-21-2009.
SUZANNE BLANE, EXAMINING ATTORNEY

SN 77-849,770. KAO KABUSHIKI KAISHA A/T/A KAO CORPORATION, CHUO-KU, TOKYO, JAPAN, FILED 10-15-2009.



THE MARK CONSISTS OF STANDARD CHARACTERS WITHOUT CLAIM TO ANY PARTICULAR FONT, STYLE, SIZE, OR COLOR.
OWNER OF U.S. REG. NO. 3,521,553.
NO CLAIM IS MADE TO THE EXCLUSIVE RIGHT TO USE "PERFECTING", APART FROM THE MARK AS SHOWN.
FOR NON-MEDICATED SKIN CARE PREPARATIONS (U.S. CLS. 1, 4, 6, 50, 51 AND 52).
FIRST USE 10-13-2009; IN COMMERCE 10-13-2009.
RAUL CORDOVA, EXAMINING ATTORNEY

CLASS 3—(Continued).

SN 77-850,672. HICKS, RUTH, DBA RUTH HICKS, CHARLOTTE, NC. FILED 10-16-2009.



THE MARK CONSISTS OF STANDARD CHARACTERS WITHOUT CLAIM TO ANY PARTICULAR FONT, STYLE, SIZE, OR COLOR.
FOR HAIR GEL; HAIR CARE KITS COMPRISING NON-MEDICATED HAIR CARE PREPARATIONS, NAMELY, SHAMPOO, CONDITIONER (U.S. CLS. 1, 4, 6, 50, 51 AND 52).
FIRST USE 1-1-2009; IN COMMERCE 1-1-2009.
JAMES A. RAUEN, EXAMINING ATTORNEY

SN 77-852,366. CASEY ENGINEERED MAINTENANCE INC., FOXBORO, MA. FILED 10-20-2009.



NO CLAIM IS MADE TO THE EXCLUSIVE RIGHT TO USE "BRAND", APART FROM THE MARK AS SHOWN.
THE MARK CONSISTS OF STYLIZED LETTERS "WAVELENGTH," WITH THE LETTERS "W" AND "L" CAPITALIZED, THE LETTERS "WAVE" SLIGHTLY HIGHER THAN THE LETTERS "LENGTH," THE LOWER END OF THE "L" EXTENDING UNDER THE "ENGT" AND ENDING WITH THE WORD "BRAND" IN SMALLER LETTERS, AND UNDER THE LETTERS "WAVE," SIX STACKS OF HORIZONTAL BARS OF VARYING HEIGHTS.
FOR SOAPS AND DETERGENTS FOR BUILDING CLEANING (U.S. CLS. 1, 4, 6, 50, 51 AND 52).
FIRST USE 1-1-2003; IN COMMERCE 1-1-2003.
GINA HAYES, EXAMINING ATTORNEY

SN 77-854,447. DOUGLAS BENDER, BROOKLYN, NY. FILED 10-21-2009.



THE MARK CONSISTS OF STANDARD CHARACTERS WITHOUT CLAIM TO ANY PARTICULAR FONT, STYLE, SIZE, OR COLOR.
FOR PERFUME, COLOGNE, FRAGRANCES, NON-MEDICATED SKIN CARE PREPARATIONS, AND SOAPS, NAMELY, LIQUID SOAPS, PERFUMED SOAPS (U.S. CLS. 1, 4, 6, 50, 51 AND 52).
MARLENE BELL, EXAMINING ATTORNEY

CLASS 3—(Continued).

SN 77-856,292. AROMALEIGH INC., HILTON HEAD ISLAND, SC. FILED 10-23-2009.

aromaleigh

THE MARK CONSISTS OF THE WORDING "AROMALEIGH" IN STYLIZED FORM.

FOR AROMATHERAPY BODY CARE PRODUCTS, NAMELY, BODY LOTION, SHOWER GEL, CUTICLE CREAM, SHAMPOO, CONDITIONER, NON-MEDICATED LIP BALM, SOAP, BODY POLISH, BODY AND FOOT SCRUB AND NON-MEDICATED FOOT CREAM; AROMATHERAPY OILS; COSMETIC CREAMS; COSMETIC CREAMS FOR SKIN CARE; COSMETIC OILS; COSMETIC PENCILS; COSMETIC ROUGES; COSMETICS; COSMETICS AND COSMETIC PREPARATIONS; COSMETICS AND MAKE-UP; FRAGRANCES FOR PERSONAL USE; PERFUMES (U.S. CLS. 1, 4, 6, 50, 51 AND 52).

FIRST USE 12-14-1988, THE MARK WAS FIRST USED ANYWHERE IN A DIFFERENT FORM OTHER THAN THAT SOUGHT TO BE REGISTERED AT LEAST AS EARLY AS 12/14/1998; IN COMMERCE 12-14-1988, THE MARK WAS FIRST USED IN COMMERCE IN A DIFFERENT FORM OTHER THAN THAT SOUGHT TO BE REGISTERED AT LEAST AS EARLY AS 12/14/1998.

LINDA POWELL, EXAMINING ATTORNEY

SN 77-859,436. RODNEY JENNINGS, DALLAS, TX. FILED 10-28-2009.

THE HAIR ARCHITECT

THE MARK CONSISTS OF STANDARD CHARACTERS WITHOUT CLAIM TO ANY PARTICULAR FONT, STYLE, SIZE, OR COLOR.

NO CLAIM IS MADE TO THE EXCLUSIVE RIGHT TO USE "HAIR", APART FROM THE MARK AS SHOWN.

FOR HAIR CARE PREPARATIONS, NAMELY, HAIR SHAMPOO, HAIR CONDITIONER, NON-MEDICATED HAIR SERUM AND HAIR SHINE SPRAY (U.S. CLS. 1, 4, 6, 50, 51 AND 52).

FIRST USE 9-9-2009; IN COMMERCE 10-1-2009.
LAKEISHA LEWIS, EXAMINING ATTORNEY

CLASS 3—(Continued).

SN 77-860,599. SIMONIZ USA, INC., BOLTON, CT. FILED 10-29-2009.

NITRO SHINE

THE MARK CONSISTS OF STANDARD CHARACTERS WITHOUT CLAIM TO ANY PARTICULAR FONT, STYLE, SIZE, OR COLOR.

NO CLAIM IS MADE TO THE EXCLUSIVE RIGHT TO USE "SHINE", APART FROM THE MARK AS SHOWN.
FOR AUTOMOBILE WAX (U.S. CLS. 1, 4, 6, 50, 51 AND 52).

FIRST USE 9-25-2009; IN COMMERCE 9-25-2009.
RONALD MCMORROW, EXAMINING ATTORNEY

SN 77-864,233. MIX BRANDS LLC, WILTON, CT. FILED 11-3-2009.

KILLER FILLER

THE MARK CONSISTS OF STANDARD CHARACTERS WITHOUT CLAIM TO ANY PARTICULAR FONT, STYLE, SIZE, OR COLOR.

FOR NON-MEDICATED SKIN CARE PREPARATIONS; COSMETIC CREAMS FOR SKIN CARE (U.S. CLS. 1, 4, 6, 50, 51 AND 52).

MARTHA FROMM, EXAMINING ATTORNEY

SN 77-866,444. CAPTAIN'S CHOICE SUNCARE INCORPORATED, PALM COAST, FL. FILED 11-5-2009.



NO CLAIM IS MADE TO THE EXCLUSIVE RIGHT TO USE "SUNCARE, INC.", APART FROM THE MARK AS SHOWN.

THE MARK CONSISTS OF THE UNDERLINED WORDING, "CAPTAIN'S CHOICE", WHEREIN THE "C" IN "CAPTAIN'S" IS DEPICTED AS A PARTIAL SHIP'S WHEEL, FOLLOWED BY THE WORDING, "SUNCARE, INC." FEATURED INSIDE A CIRCLE

FOR SUNSCREEN; SUNSCREEN CONTAINING INSECT REPELLENT (U.S. CLS. 1, 4, 6, 50, 51 AND 52).

FIRST USE 1-1-2008; IN COMMERCE 1-1-2008.
KELLY CHOE, EXAMINING ATTORNEY

CLASS 3—(Continued).

SN 77-870,170. SEAQUARIUS, LLC, ORLANDO, FL. FILED 11-11-2009.

DISCOVER THE DEPTHS OF
BEAUTY

THE MARK CONSISTS OF STANDARD CHARACTERS WITHOUT CLAIM TO ANY PARTICULAR FONT, STYLE, SIZE, OR COLOR.

FOR NON-MEDICATED SKINCARE PRODUCTS, NAMELY, MOISTURIZING AND EXFOLIATING WASH; SKIN CLARIFYING AND TONING WASH; SKIN MOISTURIZING AND EMOLLIENT WASH; SKIN CLEANSERS; LIQUID SOAP FOR HANDS, FACE AND BODY; FACIAL WASH (U.S. CLS. 1, 4, 6, 50, 51 AND 52).

FIRST USE 8-31-2009; IN COMMERCE 9-15-2009.
MELISSA VALLILLO, EXAMINING ATTORNEY

SN 77-870,180. SEAQUARIUS, LLC, ORLANDO, FL. FILED 11-11-2009.

EXOTICEUTICALS

THE MARK CONSISTS OF STANDARD CHARACTERS WITHOUT CLAIM TO ANY PARTICULAR FONT, STYLE, SIZE, OR COLOR.

FOR NON-MEDICATED SKINCARE PRODUCTS, NAMELY, MOISTURIZERS; SKIN MOISTURIZING SERUMS; SKIN CLARIFYING, CLEANSING AND TONING PRODUCTS, NAMELY, SKIN CLARIFYING LOTIONS, SKIN CLEANSERS AND SKIN TONERS; SKIN MOISTURIZERS AND EMOLLIENTS; FACIAL MOISTURIZER (U.S. CLS. 1, 4, 6, 50, 51 AND 52).

FIRST USE 10-14-2008; IN COMMERCE 10-3-2009.
MELISSA VALLILLO, EXAMINING ATTORNEY

CLASS 3—(Continued).

SN 77-875,775. LILI BEAUTY INC, DBA LILI, GLENDALE, CA. FILED 11-18-2009.



THE MARK CONSISTS OF THE STYLIZED WORD "LILI" WITH A RIBBON DESIGN CONTAINING TWO OVAL DOTS ON EITHER SIDE OF THE RIBBON.

FOR NAIL CARE PREPARATIONS; NAIL CARE PREPARATIONS, NAMELY, NAIL SOFTENERS; NAIL CREAM; NAIL ENAMEL; NAIL ENAMEL REMOVERS; NAIL ENAMELS; NAIL GLITTER; NAIL GROOMING PRODUCTS, NAMELY, TIPS, GLUE, LACQUER AND GLITTER; NAIL HARDENERS; NAIL POLISH; NAIL POLISH BASE COAT; NAIL POLISH REMOVER; NAIL POLISH REMOVERS; NAIL POLISH TOP COAT; NAIL REPAIR PRODUCTS, NAMELY, LINEN NAIL WRAPS; NAIL REPAIR PRODUCTS, NAMELY, NAIL WRAPS; NAIL REPAIR PRODUCTS, NAMELY, SILK NAIL WRAPS; NAIL STENCILS; NAIL STRENGTHENERS; NAIL TIPS; NAIL-POLISH REMOVERS (U.S. CLS. 1, 4, 6, 50, 51 AND 52).

FIRST USE 11-10-2008; IN COMMERCE 10-10-2009.
KELLY BOULTON, EXAMINING ATTORNEY

SN 77-876,357. RENEW LABS CORPORATION, MIAMI, FL. FILED 11-19-2009.

Nature's
Solutions

NO CLAIM IS MADE TO THE EXCLUSIVE RIGHT TO USE "SOLUTIONS", APART FROM THE MARK AS SHOWN.

FOR LOTIONS FOR FACE AND BODY CARE (U.S. CLS. 1, 4, 6, 50, 51 AND 52).

SIMON TENG, EXAMINING ATTORNEY

CLASS 3—(Continued).

SN 77-876,367. DISCUS DENTAL, LLC, CULVER CITY, CA. FILED 11-19-2009.

VOILÁ

THE MARK CONSISTS OF STANDARD CHARACTERS WITHOUT CLAIM TO ANY PARTICULAR FONT, STYLE, SIZE, OR COLOR.

THE ENGLISH TRANSLATION OF "VOILÁ" IN THE MARK IS "THIS IS".

FOR DENTIFRICES, TOOTHPASTE, COSMETIC TOOTH WHITENER, TOOTH BLEACHING PREPARATIONS AND TOOTH WHITENING KITS FOR COSMETIC PURPOSES (U.S. CLS. 1, 4, 6, 50, 51 AND 52).

SIMON TENG, EXAMINING ATTORNEY

SN 77-877,349. AMKEY, INC., IRWINDALE, CA. FILED 11-20-2009.

菟贝

THE MARK CONSISTS OF CHINESE CHARACTERS WHOSE TRANSLATION INTO ENGLISH IS L'BE AND TRANSLITERATION IS "LA BEI".

FOR SKINCARE PRODUCTS, NAMELY, EYE CREAMS, FACIAL CLEANERS, COSMETIC SOAPS, FACIAL CREAMS, FACIAL LOTIONS, COSMETIC SERUMS, ESSENTIAL OILS, MOISTURIZING LOTION, AND UV PROTECTING LOTION (U.S. CLS. 1, 4, 6, 50, 51 AND 52).

PAUL E. FAHRENKOPF, EXAMINING ATTORNEY

SN 77-878,452. UNIVERSAL COMPANIES INC., ABINGDON, VA. FILED 11-23-2009.

PURESSAGE

THE MARK CONSISTS OF STANDARD CHARACTERS WITHOUT CLAIM TO ANY PARTICULAR FONT, STYLE, SIZE, OR COLOR.

FOR MASSAGE CREAMS, MASSAGE LOTIONS, MASSAGE OILS AND ESSENTIAL OILS (U.S. CLS. 1, 4, 6, 50, 51 AND 52).

ANDREA BUTLER, EXAMINING ATTORNEY

CLASS 3—(Continued).

SN 77-878,655. LEVEL ORAL CARE, LLC, JACKSONVILLE, FL. FILED 11-23-2009.



NO CLAIM IS MADE TO THE EXCLUSIVE RIGHT TO USE "XYLITOL NATURAL ENAMEL PROTECTION", APART FROM THE MARK AS SHOWN.

THE MARK CONSISTS OF THE STYLIZED WORDS "XYLITOL NATURAL ENAMEL PROTECTION". A LEAF THAT IS COMBINED WITH THE WORD "XYLITOL". THE STEM ON THE LEAF COMPLETES THE LETTER "Y" IN THE WORD "XYLITOL".

FOR TOOTHPASTE AND MOUTHWASHES (U.S. CLS. 1, 4, 6, 50, 51 AND 52).

REBECCA SMITH, EXAMINING ATTORNEY

SN 77-879,384. LYONS, DEVON, BROOKLYN, NY. FILED 11-24-2009.

JUSTIN DULGE

THE MARK CONSISTS OF STANDARD CHARACTERS WITHOUT CLAIM TO ANY PARTICULAR FONT, STYLE, SIZE, OR COLOR.

THE NAME SHOWN IN THE MARK DOES NOT IDENTIFY A PARTICULAR LIVING INDIVIDUAL.

FOR BATH GEL; BATH LOTION; BEAUTY LOTIONS; BODY LOTIONS; COSMETIC PREPARATIONS, NAMELY, FIRING LOTIONS; FACE AND BODY LOTIONS; LIP BALM; SHOWER AND BATH GEL; SKIN TONERS (U.S. CLS. 1, 4, 6, 50, 51 AND 52).

KHANH LE, EXAMINING ATTORNEY

CLASS 3—(Continued).

SN 77-880,687. GLORIEUX, LEIGH MICHELLE, ATLANTA, GA. FILED 11-25-2009.

Refreshingly Pure Skincare

THE MARK CONSISTS OF STANDARD CHARACTERS WITHOUT CLAIM TO ANY PARTICULAR FONT, STYLE, SIZE, OR COLOR.

NO CLAIM IS MADE TO THE EXCLUSIVE RIGHT TO USE "PURE SKINCARE", APART FROM THE MARK AS SHOWN.

FOR AFTER SUN CREAMS; AFTER-SHAVE CREAMS; AFTER-SUN OILS; AGE SPOT REDUCING CREAMS; ALMOND SOAPS; ANTI-AGING CLEANSER; ANTI-AGING CREAM; ANTI-AGING CREAMS; ANTI-AGING MOISTURIZER; ANTI-AGING TONER; ANTI-WRINKLE CREAM; ANTI-WRINKLE CREAMS; ANTIBACTERIAL SKIN SOAPS; ANTIBACTERIAL SOAP; AROMATHERAPY BODY CARE PRODUCTS, NAMELY, BODY LOTION, SHOWER GEL, CUTICLE CREAM, SHAMPOO, CONDITIONER, NON-MEDICATED LIP BALM, SOAP, BODY POLISH, BODY AND FOOT SCRUB AND NON-MEDICATED FOOT CREAM; AROMATHERAPY CREAMS; AROMATHERAPY OIL; AROMATHERAPY OILS; BABY LOTION; BABY OIL; BABY OILS; BABY POWDER; BABY POWDERS; BABY SHAMPOO; BABY WIPES; BAR SOAP; BATH AND SHOWER GELS AND SALTS NOT FOR MEDICAL PURPOSES; BATH CREAM; BATH CRYSTALS; BATH FIZZIES; BATH HERBS; BATH LOTION; BATH MILKS; BATH OIL; BATH OILS; BATH OILS AND BATH SALTS; BATH OILS FOR COSMETIC PURPOSES; BATH POWDER; BATH SALTS; BATH SALTS; BATH SOAPS; BATH SOAPS IN LIQUID, SOLID OR GEL FORM; BATHING LOTIONS; BEAUTY CREAMS; BEAUTY CREAMS FOR BODY CARE; BODY AND BEAUTY CARE COSMETICS; BODY BUTTER; BODY CREAM; BODY CREAM SOAP; BODY CREAMS; BODY DEODORANTS; BODY LOTION; BODY LOTIONS; BODY MASK CREAM; BODY MASK LOTION; BODY MASK POWDER; BODY MASKS; BODY MILK; BODY MILKS; BODY OIL; BODY OILS; BODY POWDER; BODY SCRUB; BODY SPLASH; BODY SPRAY USED AS A PERSONAL DEODORANT AND AS FRAGRANCE; BODY SPRAYS; BODY SPRAYS, NAMELY, WATER IN ATOMIZED CONTAINERS USED TO PRODUCE A COOLING EFFECT; CLEANSING CREAMS; CLOTHS OR TISSUES IMPREGNATED WITH A SKIN CLEANSER; COLD CREAM; COLD CREAMS; COSMETIC CREAMS; COSMETIC CREAMS FOR SKIN CARE; COSMETIC OILS; COSMETIC OLIVE OIL FOR THE FACE AND BODY; COSMETIC PREPARATIONS, NAMELY, FIRING CREAMS; COSMETIC SOAPS; CREAM SOAPS; CREAMS FOR CELLULITE REDUCTION; CUTICLE CREAM; DEODORANT FOR PERSONAL USE; DEODORANT SOAP; DEODORANTS FOR BODY CARE; DEODORANTS FOR PERSONAL USE; DISINFECTANT SOAPS; DISINFECTING PERFUMED SOAPS; ESSENTIAL OILS; EXFOLIANT CREAMS; EYE CREAM; FACE AND BODY BEAUTY CREAMS; FACE AND BODY CREAMS; FACE AND BODY LOTIONS; FACE AND BODY MILK; FACE CREAMS; FACE CREAMS AND CLEANSERS CONTAINING BENZYL PEROXIDE FOR COSMETIC PURPOSES; FACE CREAMS FOR COSMETIC USE; FACIAL CLEANSERS; FACIAL CLEANSING GRAINS; FACIAL CLEANSING MILK; FACIAL CREAM; FACIAL CREAMS; FACIAL EMULSIONS; FACIAL LOTION; FACIAL MASKS; FACIAL SCRUBS; FACIAL WASHES; FAIR COMPLEXION CREAM; FOOT DEODORANT SPRAY; FOOT SCRUBS; GRANULATED SOAPS; GRAPE SEED OIL FOR COSMETIC USE; HAIR CARE CREAMS; HAIR CARE PREPARATIONS CONSISTING OF ORGANIC COCONUT VIRGIN OIL AND COCONUT VIRGIN OIL; HAIR CREAMS; HAIR OILS; HAIR PRODUCTS, NAMELY, THICKENING CONTROL CREAMS; HAIR REMOVING CREAM; HAND CREAM; HAND CREAMS; HAND LOTIONS; HAND SCRUBS; HAND SOAPS; JASMINE OIL FOR PERSONAL USE; LAVENDER OIL; LIP BALM; LIP BALM; LIP CREAM; LIP GLOSS; LIQUID BATH SOAPS; LIQUID SOAP;

CLASS 3—(Continued).

LIQUID SOAP USED IN FOOT BATH; LIQUID SOAPS; LIQUID SOAPS FOR HANDS AND FACE; LIQUID SOAPS FOR HANDS, FACE AND BODY; MAKE-UP REMOVING MILK, GEL, LOTIONS AND CREAMS; MASSAGE CREAMS; MASSAGE OIL; MASSAGE OILS; MINERAL SALT IN THE NATURE OF BATH SALTS NOT FOR MEDICAL PURPOSES; MOISTURIZING CREAMS; MOISTURIZING MILKS; NAIL CREAM; NATURAL COCOA BUTTER BASED PERSONAL CARE PRODUCTS, NAMELY, BODY LOTION, SHOWER GEL, SOAP, BODY POLISH, BODY AND FOOT SCRUB AND NON-MEDICATED SKIN CREAMS; NATURAL ESSENTIAL OILS; NIGHT CREAM; NON-MEDICATED BATH PREPARATIONS; NON-MEDICATED BATH SALTS; NON-MEDICATED BODY SOAKS; NON-MEDICATED COSMETIC SKIN CARE PREPARATIONS CONSISTING OF ORGANIC COCONUT VIRGIN OIL AND COCONUT VIRGIN OIL; NON-MEDICATED DIAPER RASH OINTMENTS AND LOTIONS; NON-MEDICATED FOOT CREAM; NON-MEDICATED LIP CARE PREPARATIONS; NON-MEDICATED LIP PROTECTORS; NON-MEDICATED SCALP TREATMENT CREAM; NON-MEDICATED SKIN CARE PREPARATION, NAMELY, BODY MIST; NON-MEDICATED SKIN CARE PREPARATIONS, NAMELY, CREAMS, LOTIONS, GELS, TONERS, CLEANERS AND PEELS; NON-MEDICATED SKIN CREAM FOR GENERAL SKIN RASH AND IRRITATION RESULTING FROM SKIN SHINGLES; NON-MEDICATED SKIN CREAMS; NUTRITIONAL OILS FOR COSMETIC PURPOSES; OIL BATHS FOR HAIR CARE; OILS FOR COSMETIC PURPOSES; OILS FOR HAIR CONDITIONING; OILS FOR PERFUMES AND SCENTS; OILS FOR TOILETRY PURPOSES; PERFUME OILS; PERFUME OILS FOR THE MANUFACTURE OF COSMETIC PREPARATIONS; PERFUMED CREAMS; PERFUMED SOAP; PERFUMED SOAPS; PET CARE KITS COMPRISING SHAMPOO, CONDITIONER, BODY SPRAY; PRE-SHAVE CREAMS; ROSE OIL FOR COSMETIC PURPOSES; SCENTED BODY LOTIONS AND CREAMS; SCENTED BODY SPRAY; SHAMPOOS FOR BABIES; SHAVING BALM; SHAVING CREAM; SHAVING CREAMS; SHAVING SOAP; SHAVING SOAPS; SHAVING SPRITZ IN THE NATURE OF A MOISTURIZING SOLUTION FOR SHAVING; SHOWER CREAMS; SKIN AND BODY TOPICAL LOTIONS, CREAMS AND OILS FOR COSMETIC USE; SKIN CARE PREPARATION, NAMELY, BODY POLISH; SKIN CARE PREPARATIONS, NAMELY, BODY BALM; SKIN CLEANSERS; SKIN CLEANSING CREAM; SKIN CONDITIONING CREAMS FOR COSMETIC PURPOSES; SKIN CREAM; SKIN CREAMS; SKIN CREAMS IN LIQUID AND IN SOLID FORM; SKIN CREAMS IN LIQUID AND SOLID; SKIN CREAMS IN LIQUID AND SOLID FORM; SKIN LIGHTENING CREAMS; SKIN MOISTURIZER; SKIN MOISTURIZER MASKS; SKIN SOAP; SKIN TONERS; SKIN WHITENING CREAMS; SOAP IN THE FORM OF BATH TOYS; SOAPS FOR BODY CARE; SOAPS FOR PERSONAL USE; TOPICAL SKIN SPRAYS FOR COSMETIC PURPOSES; WAX FOR REMOVING BODY HAIR (U.S. CLS. 1, 4, 6, 50, 51 AND 52).

DAVID COLLIER, EXAMINING ATTORNEY

CLASS 3—(Continued).

SN 77-881,250. CINQUE SCIENCE LABS, LLC, NEWPORT BEACH, CA. FILED 11-25-2009.

CINQUE SCIENCE

THE MARK CONSISTS OF STANDARD CHARACTERS WITHOUT CLAIM TO ANY PARTICULAR FONT, STYLE, SIZE, OR COLOR.

THE ENGLISH TRANSLATION OF "CINQUE" IN THE MARK IS "FIVE".

FOR HAIR CARE PREPARATIONS; SHAMPOOS, CONDITIONERS, HAIR RECONSTRUCTORS, VOLUMIZING PRODUCTS, NAMELY, HAIR VOLUMINIZING SPRAY, HAIR VOLUMINIZING GELS, HYDRATING PRODUCTS, NAMELY, HAIR CARE PREPARATIONS FOR HYDRATING THE HAIR; STYLING AIDS, NAMELY, STYLING MOUSSE FOR HAIR, STYLING GELS, STYLING FOAM FOR HAIR, HAIR STYLING PREPARATIONS; HAIR SPRAY, HAIR COLORING PREPARATIONS (U.S. CLS. 1, 4, 6, 50, 51 AND 52).

JANICE KIM, EXAMINING ATTORNEY

CLASS 3—(Continued).

SN 77-882,456. SMITH MOUNTAIN INDUSTRIES, INC., FOREST, VA. FILED 11-30-2009.

WOODWICK FUSION

THE MARK CONSISTS OF STANDARD CHARACTERS WITHOUT CLAIM TO ANY PARTICULAR FONT, STYLE, SIZE, OR COLOR.

OWNER OF U.S. REG. NOS. 3,255,835, 3,556,278 AND OTHERS.

FOR SCENTED OILS USED TO PRODUCE AROMAS; SCENTED OILS USED TO PRODUCE AROMAS AND REEDS USED TO DIFFUSE THE OIL AROMAS SOLD AS A COMBINATION; NON-ELECTRIC ROOM SCENT DIFFUSERS COMPRISED OF REEDS AND OILS IN A CONTAINER (U.S. CLS. 1, 4, 6, 50, 51 AND 52).

JASON LOTT, EXAMINING ATTORNEY

SN 77-883,241. FORZLEY, PATRICIA, DAVIE, FL. FILED 12-1-2009.

Precious Drops

THE MARK CONSISTS OF STANDARD CHARACTERS WITHOUT CLAIM TO ANY PARTICULAR FONT, STYLE, SIZE, OR COLOR.

NO CLAIM IS MADE TO THE EXCLUSIVE RIGHT TO USE "DROPS", APART FROM THE MARK AS SHOWN.

FOR SKIN CARE PRODUCTS, NAMELY, NON-MEDICATED SKIN SERUM (U.S. CLS. 1, 4, 6, 50, 51 AND 52). FIRST USE 12-1-2003; IN COMMERCE 12-1-2003.

PRISCILLA MILTON, EXAMINING ATTORNEY

SN 77-882,453. SMITH MOUNTAIN INDUSTRIES, INC., FOREST, VA. FILED 11-30-2009.

WOODWICK GREEN

THE MARK CONSISTS OF STANDARD CHARACTERS WITHOUT CLAIM TO ANY PARTICULAR FONT, STYLE, SIZE, OR COLOR.

OWNER OF U.S. REG. NOS. 3,255,835, 3,556,278 AND OTHERS.

NO CLAIM IS MADE TO THE EXCLUSIVE RIGHT TO USE "GREEN", APART FROM THE MARK AS SHOWN.

FOR ENVIRONMENTALLY FRIENDLY SCENTED OILS USED TO PRODUCE AROMAS; ENVIRONMENTALLY FRIENDLY SCENTED OILS USED TO PRODUCE AROMAS AND REEDS USED TO DIFFUSE THE OIL AROMAS SOLD AS A COMBINATION; ENVIRONMENTALLY FRIENDLY NON-ELECTRIC ROOM SCENT DIFFUSERS COMPRISED OF REEDS AND OILS IN A CONTAINER (U.S. CLS. 1, 4, 6, 50, 51 AND 52).

JASON LOTT, EXAMINING ATTORNEY

SN 77-883,437. BISSELL HOMECARE, INC., GRAND RAPIDS, MI. FILED 12-1-2009.

OXY TOTAL

THE MARK CONSISTS OF STANDARD CHARACTERS WITHOUT CLAIM TO ANY PARTICULAR FONT, STYLE, SIZE, OR COLOR.

OWNER OF U.S. REG. NOS. 3,002,895, 3,303,886 AND OTHERS.

FOR CARPET AND UPHOLSTERY STAIN REMOVER (U.S. CLS. 1, 4, 6, 50, 51 AND 52).

ELISSA GARBER KON, EXAMINING ATTORNEY

CLASS 3—(Continued).

SN 77-884,553. SOAPSMART LLC, WINNETKA, CA. FILED 12-2-2009.



NO CLAIM IS MADE TO THE EXCLUSIVE RIGHT TO USE ".COM", APART FROM THE MARK AS SHOWN.

THE COLOR(S) BLUE, PURPLE IS/ARE CLAIMED AS A FEATURE OF THE MARK.

THE MARK CONSISTS OF THE WORDS "SOAPSMART.COM" WITH 8 BUBBLES ON EACH SIDE OF THE WORDS. THE COLORS ARE BLUE AND PURPLE.

FOR HANDMADE BODY, FACE, AND HAND SOAP (U.S. CLS. 1, 4, 6, 50, 51 AND 52).

ZACHARY BELLO, EXAMINING ATTORNEY

SN 77-884,666. STC.UNM, ALBUQUERQUE, NM. FILED 12-2-2009.

MPF

THE MARK CONSISTS OF STANDARD CHARACTERS WITHOUT CLAIM TO ANY PARTICULAR FONT, STYLE, SIZE, OR COLOR.

FOR COSMETIC SUN-PROTECTING PREPARATIONS; COSMETIC SUN-TANNING PREPARATIONS; INDOOR SUN TANNING PREPARATIONS; NON-MEDICATED SUN CARE PREPARATIONS; SUN BLOCK; SUN BLOCK PREPARATIONS; SUN CARE LOTIONS; SUN CREAMS; SUN SCREEN; SUN SCREEN PREPARATIONS; SUN TAN GEL; SUN TAN LOTION; SUN TAN OIL; SUN-BLOCK LOTIONS; SUN-TANNING OILS; SUN-TANNING OILS AND LOTIONS; SUN-TANNING PREPARATIONS (U.S. CLS. 1, 4, 6, 50, 51 AND 52).

BENJAMIN OKEKE, EXAMINING ATTORNEY

SN 77-885,408. HI-TEC LABORATORIES, INC., FREEPORT, FL. FILED 12-3-2009.

FLUSH OUT

THE MARK CONSISTS OF STANDARD CHARACTERS WITHOUT CLAIM TO ANY PARTICULAR FONT, STYLE, SIZE, OR COLOR.

FOR DRAIN OPENERS (U.S. CLS. 1, 4, 6, 50, 51 AND 52).

REBECCA EISINGER, EXAMINING ATTORNEY

CLASS 3—(Continued).

SN 77-885,467. 100MC, LLC, LARKSPUR, CA. FILED 12-3-2009.

EAU1.0

THE MARK CONSISTS OF STANDARD CHARACTERS WITHOUT CLAIM TO ANY PARTICULAR FONT, STYLE, SIZE, OR COLOR.

THE ENGLISH TRANSLATION OF "EAU" IN THE MARK IS "WATER."

FOR FRAGRANCES; BODY AND BEAUTY CARE COSMETICS; FACE AND BODY LOTIONS (U.S. CLS. 1, 4, 6, 50, 51 AND 52).

LINDA M. KING, EXAMINING ATTORNEY

SN 77-886,906. IDEAL MARKETING CONCEPTS, RANCHO MIRAGE, CA. FILED 12-4-2009.

Amilean

THE MARK CONSISTS OF STANDARD CHARACTERS WITHOUT CLAIM TO ANY PARTICULAR FONT, STYLE, SIZE, OR COLOR.

FOR CREAMS FOR CELLULITE REDUCTION; LOTIONS FOR CELLULITE REDUCTION (U.S. CLS. 1, 4, 6, 50, 51 AND 52).

FIRST USE 7-0-2009; IN COMMERCE 10-0-2009.

MEGHAN REINHART, EXAMINING ATTORNEY

CLASS 3—(Continued).

SN 77-887,030. RAMIREZ, NINA ANDREA, DBA ECHO FRANCE, SONORA, CA. AND HOUPIN, MARC RAYMOND, DBA ECHO FRANCE, SONORA, CA. FILED 12-5-2009.

L'epi de Provence

THE MARK CONSISTS OF STANDARD CHARACTERS WITHOUT CLAIM TO ANY PARTICULAR FONT, STYLE, SIZE, OR COLOR.

THE ENGLISH TRANSLATION OF "L'ÉPI DE PROVENCE" IS "THE FLOWER CLUSTER FROM PROVINCE" IN FRENCH.

FOR AROMATHERAPY BODY CARE PRODUCTS, NAMELY, BODY LOTION, SHOWER GEL, CUTICLE CREAM, SHAMPOO, CONDITIONER, NON-MEDICATED LIP BALM, SOAP, BODY POLISH, BODY AND FOOT SCRUB AND NON-MEDICATED FOOT CREAM; BAR SOAP; BATH AND SHOWER GELS AND SALTS NOT FOR MEDICAL PURPOSES; BATH BEADS; BATH CREAM; BATH CRYSTALS; BATH FIZZIES; BATH FLAKES; BATH FOAM; BATH FOAMS; BATH GEL; BATH GELS; BATH HERBS; BATH LOTION; BATH MILKS; BATH OIL; BATH OILS; BATH SALTS; BATH SOAPS; BATH SOAPS IN LIQUID, SOLID OR GEL FORM; BATHING LOTIONS; BODY CREAM SOAP; BUBBLE BATH; CAKES OF TOILET SOAP; COSMETICS IN GENERAL, INCLUDING PERFUMES; CREAM SOAPS; EAU DE PERFUME; FOAM BATH; HAND SOAPS; LIQUID BATH SOAPS; LIQUID PERFUMES; LIQUID SOAP; LIQUID SOAP USED IN FOOT BATH; LIQUID SOAPS; LIQUID SOAPS FOR HANDS AND FACE; LIQUID SOAPS FOR HANDS, FACE AND BODY; OIL BATHS FOR HAIR CARE; PERFUME; PERFUME OILS; PERFUMED SOAPS; PERFUMES; PERFUMES AND COLOGNES; PERFUMES AND TOILET WATERS; PERFUMES IN SOLID FORM; SHOWER AND BATH FOAM; SHOWER AND BATH GEL; SKIN SOAP; SOAPS FOR BODY CARE; SOAPS FOR PERSONAL USE; TOILET SOAP; TOILET SOAPS (U.S. CLS. 1, 4, 6, 50, 51 AND 52).

FIRST USE 6-2-1998; IN COMMERCE 8-17-1998.
THOMAS MANOR, EXAMINING ATTORNEY

SN 77-887,095. PALETTE BY NATURE, MAPLE GROVE, MN. FILED 12-6-2009.

Palette by Nature

THE MARK CONSISTS OF STANDARD CHARACTERS WITHOUT CLAIM TO ANY PARTICULAR FONT, STYLE, SIZE, OR COLOR.

NO CLAIM IS MADE TO THE EXCLUSIVE RIGHT TO USE "PALETTE", APART FROM THE MARK AS SHOWN.

FOR HAIR COLOR; HAIR COLORANTS; HAIR COLORING PREPARATIONS; HAIR COLOURANTS; HAIR COLOURING; HAIR COLOURING AND DYES; HAIR COLOURING PREPARATIONS; HAIR CONDITIONER; HAIR CONDITIONERS; HAIR DYE; HAIR DYES; HAIR FIXERS; HAIR GEL; HAIR GELS; HAIR SHAMPOO; HAIR SHAMPOOS AND CONDITIONERS; HAIR STYLING GEL; HAIR STYLING SPRAY (U.S. CLS. 1, 4, 6, 50, 51 AND 52).

FIRST USE 7-0-2009; IN COMMERCE 7-0-2009.
BILL DAWE, EXAMINING ATTORNEY

CLASS 3—(Continued).

SN 77-887,319. ROBINSON, JAMES, CINCINNATI, OH. FILED 12-7-2009.

OLD SCHOOL

THE MARK CONSISTS OF STANDARD CHARACTERS WITHOUT CLAIM TO ANY PARTICULAR FONT, STYLE, SIZE, OR COLOR.

FOR AUTOMOBILE TIRE CLEANING AND POLISHING PREPARATIONS, NAMELY, TIRE SHINE; LEATHER CLEANING PREPARATIONS AND LEATHER POLISHES; CAR POLISH; CARPET AND UPHOLSTERY CLEANERS; FRAGRANCES FOR AUTOMOBILES; AND FURNITURE POLISH (U.S. CLS. 1, 4, 6, 50, 51 AND 52).

FIRST USE 8-21-2008; IN COMMERCE 8-21-2008.
AMY KERTGATE, EXAMINING ATTORNEY

SN 77-888,027. ÉMINENCE ORGANIC SKIN CARE INC., VANCOUVER, B.C., CANADA, FILED 12-7-2009.

DERMAFOLIANT

THE MARK CONSISTS OF STANDARD CHARACTERS WITHOUT CLAIM TO ANY PARTICULAR FONT, STYLE, SIZE, OR COLOR.

FOR BATH SALTS; BEAUTY MASKS; CLEANSING CREAMS; CLEANSING MILK FOR TOILET PURPOSES; COSMETIC CREAMS; COSMETIC CREAMS FOR SKIN CARE; COSMETIC OILS; COSMETIC OILS FOR THE EPIDERMIS; COSMETIC PADS; COSMETIC PREPARATIONS; COSMETIC PREPARATIONS FOR SLIMMING PURPOSES; COSMETIC SOAPS; COSMETIC SUNTAN LOTIONS; COSMETICS; DENTIFRICES; ESSENTIAL OILS; ESSENTIAL OILS FOR PERSONAL USE; EXFOLIANT CREAMS; EXFOLIANTS FOR FACIAL AND BODY MASKS; EYE CREAM; EYE GELS; EYE MAKE-UP; EYE MAKE-UP REMOVER; FACE CREAMS; FACIAL CLEANSERS; FACIAL CREAMS; FACIAL EMULSIONS; FACIAL MAKE-UP; FACIAL MASKS; FACIAL SCRUBS; FOAMS CONTAINING COSMETICS AND SUNSCREENS; HAIR LOTIONS; LOTIONS FOR COSMETIC PURPOSES; LOTIONS FOR SKIN, FACE AND BODY; MAKE-UP; NON-MEDICATED BATH PREPARATIONS; NON-MEDICATED SKIN CARE PREPARATIONS, NAMELY, CREAMS, LOTIONS, GELS, TONERS, CLEANERS AND PEELS; NON-MEDICATED SKIN CREAMS; OILS FOR COSMETIC PURPOSES; SKIN CLARIFIERS; SKIN CLEANSERS; SKIN CLEANSING CREAM; SKIN CLEANSING LOTION; SKIN CONDITIONERS; SKIN CREAMS; SKIN MASKS; SKIN MOISTURIZER; SKIN MOISTURIZER MASKS; SKIN SOAP; SKIN TONERS; SUN-TANNING PREPARATIONS; SUNSCREEN CREAMS; TISSUES IMPREGNATED WITH COSMETIC LOTIONS (U.S. CLS. 1, 4, 6, 50, 51 AND 52).

WILLIAM VERHOSEK, EXAMINING ATTORNEY

CLASS 3—(Continued).

SN 77-888,028. WORLD SKIN, LLC, HEALDSBURG, CA.
FILED 12-7-2009.

STANLEY JACOBS MD

THE MARK CONSISTS OF STANDARD CHARACTERS WITHOUT CLAIM TO ANY PARTICULAR FONT, STYLE, SIZE, OR COLOR.

NO CLAIM IS MADE TO THE EXCLUSIVE RIGHT TO USE "MD", APART FROM THE MARK AS SHOWN.

THE NAME(S), PORTRAIT(S), AND/OR SIGNATURE(S) SHOWN IN THE MARK IDENTIFIES "STANLEY JACOBS", WHOSE CONSENT(S) TO REGISTER IS MADE OF RECORD.

FOR NON-MEDICATED SKIN CARE PREPARATIONS (U.S. CLS. 1, 4, 6, 50, 51 AND 52).

FIRST USE 11-24-2009; IN COMMERCE 11-24-2009.
KIMBERLY PERRY, EXAMINING ATTORNEY

SN 77-888,116. MARTHA'S CLOSET, NEW YORK, NY.
FILED 12-7-2009.

BARE

THE MARK CONSISTS OF STANDARD CHARACTERS WITHOUT CLAIM TO ANY PARTICULAR FONT, STYLE, SIZE, OR COLOR.

FOR NON-MEDICATED BODY AND BEAUTY CARE PRODUCTS, NAMELY, COSMETICS, CLEANSERS, CREAMS, LOTIONS, PERFUMES, SOAPS, BODY OILS, HAIR TREATMENTS, FACIAL TREATMENTS, NAMELY, FACIAL BEAUTY MASKS, AND LIP BALM (U.S. CLS. 1, 4, 6, 50, 51 AND 52).

FIRST USE 9-12-2009; IN COMMERCE 9-12-2009.
TASNEEM HUSSAIN, EXAMINING ATTORNEY

SN 77-888,183. FORTO CORPORATION, SEATTLE, WA.
FILED 12-8-2009.

PIXO

THE MARK CONSISTS OF STANDARD CHARACTERS WITHOUT CLAIM TO ANY PARTICULAR FONT, STYLE, SIZE, OR COLOR.

THE WORDING "PIXO" HAS NO MEANING IN A FOREIGN LANGUAGE.

FOR HAIR CARE CREAMS; HAIR CARE LOTIONS; HAIR CARE PREPARATIONS; HAIR CONDITIONERS; HAIR CREAMS; HAIR GELS; HAIR MOUSSE; HAIR NOURISHERS; HAIR OILS; HAIR POMADES; HAIR RINSES; HAIR SHAMPOO; HAIR SPRAY; HAIR TONIC; HAIR WAVING LOTION (U.S. CLS. 1, 4, 6, 50, 51 AND 52).

BRENDAN MCCAULEY, EXAMINING ATTORNEY

CLASS 3—(Continued).

SN 77-888,252. QUALITY PENCILS, INC., OCEANSIDE, NY.
FILED 12-8-2009.

GRAFF*ETCH

THE MARK CONSISTS OF STANDARD CHARACTERS WITHOUT CLAIM TO ANY PARTICULAR FONT, STYLE, SIZE, OR COLOR.

FOR COSMETIC PENCILS (U.S. CLS. 1, 4, 6, 50, 51 AND 52).

FIRST USE 3-3-2010; IN COMMERCE 3-3-2010.
MARCIE MILONE, EXAMINING ATTORNEY

SN 77-888,438. KLARYS, INC., MIAMI BEACH, FL. FILED 12-8-2009.

ALOE ACQUA

THE MARK CONSISTS OF STANDARD CHARACTERS WITHOUT CLAIM TO ANY PARTICULAR FONT, STYLE, SIZE, OR COLOR.

NO CLAIM IS MADE TO THE EXCLUSIVE RIGHT TO USE "ALOE", APART FROM THE MARK AS SHOWN.

THE ENGLISH TRANSLATION OF "ACQUA" IN THE MARK IS "WATER".

FOR BODY SPRAYS (U.S. CLS. 1, 4, 6, 50, 51 AND 52).
FIRST USE 11-15-2009; IN COMMERCE 11-15-2009.

KARANENDRA S. CHHINA, EXAMINING ATTORNEY

SN 77-888,472. JESSICA ICLISOY, BEVERLY HILLS, CA.
FILED 12-8-2009.

**Calendula Nature's
First-Aid**

THE MARK CONSISTS OF STANDARD CHARACTERS WITHOUT CLAIM TO ANY PARTICULAR FONT, STYLE, SIZE, OR COLOR.

NO CLAIM IS MADE TO THE EXCLUSIVE RIGHT TO USE "CALENDULA", APART FROM THE MARK AS SHOWN.

FOR AFTER-SUN LOTIONS; AROMATHERAPY CREAMS; AROMATHERAPY LOTIONS; AROMATHERAPY OILS; BABY HAIR CONDITIONER; BABY LOTION; BABY OIL; BABY OILS; BABY POWDER; BABY POWDERS; BABY SHAMPOO; BABY WIPES; BATH FOAM; BATH FOAMS; BATH GEL; BATH GELS; BATH OIL; BATH OILS; BATH SOAPS IN LIQUID, SOLID OR GEL FORM; BATHING LOTIONS; BEAUTY CREAMS; BEAUTY CREAMS FOR BODY CARE; BEAUTY GELS; BEAUTY LOTIONS; BODY AND BEAUTY CARE COSMETICS; BODY CREAMS; BODY LOTIONS; BODY OIL; BODY OILS; BODY POWDER; BODY SPRAY USED AS A PERSONAL DEODORANT AND AS FRAGRANCE; BODY SPRAYS; BODY SPRAYS, NAMELY, WATER IN ATOMIZED CONTAINERS USED TO PRODUCE A COOLING EFFECT; BUBBLE BATH; COLOGNE; CO-

CLASS 3—(Continued).

LOGNE WATER; CONDITIONERS; COSMETIC CREAMS; COSMETIC CREAMS FOR SKIN CARE; COSMETIC OILS; COSMETIC OILS FOR THE EPIDERMIS; COSMETIC PREPARATIONS AGAINST SUNBURN; COSMETIC PREPARATIONS FOR BODY CARE; COSMETIC SUN-PROTECTING PREPARATIONS; COSMETIC SUN-TANNING PREPARATIONS; COSMETIC SUNTAN LOTIONS; COSMETICS; DISPOSABLE WIPES IMPREGNATED WITH CLEANSING CHEMICALS OR COMPOUNDS FOR PERSONAL HYGIENE AND HOUSEHOLD USE; DUSTING POWDER; EAU DE COLOGNE ; EAU DE PARFUM; EAU DE PERFUME; EAU DE TOILETTE; EAU-DE-TOILETTE; EAUX DE TOILETTE; ESSENTIAL OILS; ESSENTIAL OILS FOR HOUSEHOLD USE; ESSENTIAL OILS FOR PERSONAL USE; ESSENTIAL OILS FOR USE IN MANUFACTURING OF SKIN CARE AND BATH CARE PRODUCTS; ESSENTIAL OILS FOR USE IN THE MANUFACTURE OF SCENTED PRODUCTS; FACE AND BODY BEAUTY CREAMS; FACE AND BODY CREAMS; FACE AND BODY LOTIONS; FACE CREAMS; FACE MILK AND LOTIONS; FACIAL CREAM; FACIAL CREAMS; FACIAL EMULSIONS; FACIAL LOTION; FACIAL WASHES; FOAM BATH; FRAGRANCES FOR PERSONAL USE; GEL FOR HAIR; HAIR CARE CREAMS; HAIR CARE LOTIONS; HAIR CARE PREPARATIONS; HAIR CLEANING PREPARATIONS; HAIR CONDITIONER; HAIR CONDITIONERS; HAIR CONDITIONERS FOR BABIES; HAIR CREAMS; HAIR EMOLLIENTS; HAIR FIXERS; HAIR GEL; HAIR GELS; HAIR LOTIONS; HAIR MOUSSES; HAIR NOURISHERS; HAIR OILS; HAIR POMADES; HAIR RINSES; HAIR SHAMPOO; HAIR SPRAY; HAIR STYLING GEL; HAIR STYLING PREPARATIONS; HAIR STYLING SPRAY; HAND CLEANERS ; HAND CLEANING PREPARATIONS; HAND CREAM; HAND CREAMS; HAND LOTIONS; HAND SOAPS; LIQUID BATH SOAPS; LIQUID PERFUMES; LIQUID SOAP; LIQUID SOAPS; LIQUID SOAPS FOR HANDS AND FACE; LIQUID SOAPS FOR HANDS, FACE AND BODY; LOTIONS FOR FACE AND BODY CARE; MASSAGE OIL; MASSAGE OILS; NON-MEDICATED BATH PREPARATIONS; NON-MEDICATED DIAPER RASH OINTMENTS AND LOTIONS; NON-MEDICATED OINTMENTS FOR THE PREVENTION AND TREATMENT OF SUNBURN; NON-MEDICATED SKIN CARE PREPARATIONS; NON-MEDICATED SKIN CREAMS; NON-MEDICATED SUN CARE PREPARATIONS; NON-MEDICATED TOILETRIES; NUTRITIONAL OILS FOR COSMETIC PURPOSES; OILS FOR TOILETRY PURPOSES; PERFUME; PERFUME OILS; PERFUME OILS FOR THE MANUFACTURE OF COSMETIC PREPARATIONS; PERFUMED CREAMS; PERFUMED POWDER; PERFUMED POWDERS; PERFUMED SOAP; PERFUMED SOAPS; PERFUMERY; PERFUMES; PET SHAMPOO; POMADES; POMADES FOR HAIR; ROOM FRAGRANCES; SCENTED BODY SPRAY; SCENTED FABRIC REFRESHER SPRAY; SCENTED LINEN SPRAYS; SCENTED LINEN WATER; SCENTED OILS USED TO PRODUCE AROMAS WHEN HEATED; SCENTED ROOM SPRAYS; SCULPTING GEL; SHAMPOO-CONDITIONERS; SHAMPOOS; SHAMPOOS FOR BABIES; SHOWER AND BATH FOAM; SHOWER AND BATH GEL; SHOWER GEL; SHOWER GELS; SKIN CLEANSERS; SKIN CONDITIONERS; SKIN CREAM; SKIN CREAMS; SKIN CREAMS IN LIQUID AND IN SOLID FORM; SKIN EMOLLIENTS; SKIN LOTION; SKIN LOTIONS; SKIN MOISTURIZER; SOAPS FOR BODY CARE; SOAPS FOR PERSONAL USE; STYLING GELS; STYLING LOTIONS; STYLING MOUSSE; SUN BLOCK; SUN BLOCK PREPARATIONS; SUN CARE LOTIONS; SUN CREAMS; SUN SCREEN; SUN SCREEN PREPARATIONS; SUN-BLOCK LOTIONS; SUNSCREEN CREAM; SUNSCREEN CREAMS; SUNTAN CREAMS; WATERLESS SOAP; ALL OF THE FOREGOING GOODS CONTAINING CALENDULA (U.S. CLS. 1, 4, 6, 50, 51 AND 52).

FIRST USE 4-1-1995; IN COMMERCE 4-1-1995.
ESTHER BELENKER, EXAMINING ATTORNEY

CLASS 3—(Continued).

SN 77-888,486. THE NAPPERS COMPANY 114, LLC, NEW YORK, NY. FILED 12-8-2009.

JUST JOEY

THE MARK CONSISTS OF STANDARD CHARACTERS WITHOUT CLAIM TO ANY PARTICULAR FONT, STYLE, SIZE, OR COLOR.

FOR AFTERSHAVE COLOGNE; COLOGNE; COLOGNE WATER; COLOGNES, PERFUMES AND COSMETICS; EAU DE COLOGNE; EAU DE COLOGNES; EAU DE PERFUME; EAU DE TOILETTE AND EAU DE COLOGNE; EAU-DE-COLOGNE; EAUX DE COLOGNE; PERFUME; PERFUMED POWDER; PERFUMED SOAP; PERFUMED TALCUM POWDER; PERFUMES AND COLOGNES; PERFUMES AND TOILET WATERS; PERFUMES IN SOLID FORM; PERFUMES, AFTERSHAVES AND COLOGNES; PERFUMES, EAU DE COLOGNES AND AFTERSHAVES; PERFUMES, EAUX DE COLOGNE AND AFTERSHAVES (U.S. CLS. 1, 4, 6, 50, 51 AND 52).

TRACY CROSS, EXAMINING ATTORNEY

SN 77-888,584. ONLINETECHSTORES.COM, INC., RENO, NV. FILED 12-8-2009.

BATTERYEDGE.COM

THE MARK CONSISTS OF STANDARD CHARACTERS WITHOUT CLAIM TO ANY PARTICULAR FONT, STYLE, SIZE, OR COLOR.

FOR LAPTOP COMPUTER BATTERIES, NOTEBOOK COMPUTER BATTERIES, LAPTOP COMPUTER AC ADAPTERS, NOTEBOOK COMPUTER AC ADAPTERS, LAPTOP COMPUTER CHARGERS, NOTEBOOK COMPUTER CHARGERS (U.S. CLS. 1, 4, 6, 50, 51 AND 52).

FIRST USE 1-15-2009; IN COMMERCE 4-1-2009.

LOURDES AYALA, EXAMINING ATTORNEY

SN 77-888,637. PLUSH NATURALS, LAS VEGAS, NV. FILED 12-8-2009.

Plush Naturals

THE MARK CONSISTS OF STANDARD CHARACTERS WITHOUT CLAIM TO ANY PARTICULAR FONT, STYLE, SIZE, OR COLOR.

NO CLAIM IS MADE TO THE EXCLUSIVE RIGHT TO USE "NATURALS", APART FROM THE MARK AS SHOWN. FOR BAR SOAP; BATH SOAPS; BATH SOAPS IN LIQUID, SOLID OR GEL FORM; DETERGENT SOAP (U.S. CLS. 1, 4, 6, 50, 51 AND 52).

FIRST USE 3-24-2009; IN COMMERCE 3-24-2009.

HEATHER BIDDULPH, EXAMINING ATTORNEY

CLASS 3—(Continued).

SN 77-888,698. BEBA PRODUCT CONCEPTS, INC., UNION CITY, NJ. FILED 12-8-2009.

Touch Up & Go

THE MARK CONSISTS OF STANDARD CHARACTERS WITHOUT CLAIM TO ANY PARTICULAR FONT, STYLE, SIZE, OR COLOR.

NO CLAIM IS MADE TO THE EXCLUSIVE RIGHT TO USE "TOUCH UP", APART FROM THE MARK AS SHOWN. FOR HAIR COMB WITH HOLLOW HANDLE PRE-FILLED WITH HAIR DYE TO DELIVER COLOR, BY TWISTING THE APPLICATION MECHANISM, TO THE HAIR ROOTS, WHILE COMBING AND STYLING HAIR, FOR TEMPORARY ROOT COVERAGE (U.S. CLS. 1, 4, 6, 50, 51 AND 52).

FIRST USE 6-24-2007; IN COMMERCE 8-31-2009.
KATHERINE STOIDES, EXAMINING ATTORNEY

CLASS 3—(Continued).

SN 77-889,204. HOLLANDER CORPORATION, CALHOUN, GA. FILED 12-9-2009.



THE MARK CONSISTS OF THE LETTERS, "UV2", THREE RECTANGULAR STRIPES, AND A YIN-YANG SYMBOL.

FOR AUTOMOBILE AND CAR WAX PREPARATIONS; AUTOMOBILE CARPET AND UPHOLSTERY CLEANING PREPARATIONS; AUTOMOBILE CLEANERS; AUTOMOBILE POLISHES; AUTOMOBILE TIRE CLEANING AND POLISHING PREPARATIONS (U.S. CLS. 1, 4, 6, 50, 51 AND 52).

FIRST USE 1-1-1987; IN COMMERCE 1-1-1987.
ESTHER BELENKER, EXAMINING ATTORNEY

SN 77-889,026. THE ESTHETICIANS GARDEN, DBA TERRA DOLCE SOAP, BISCAYNE PARK, FL. FILED 12-8-2009.

Be Clean Smelly Dog

THE MARK CONSISTS OF STANDARD CHARACTERS WITHOUT CLAIM TO ANY PARTICULAR FONT, STYLE, SIZE, OR COLOR.

FOR BAR SOAP; DISINFECTANT SOAPS (U.S. CLS. 1, 4, 6, 50, 51 AND 52).

FIRST USE 8-1-2009; IN COMMERCE 8-1-2009.
MARK SPARACINO, EXAMINING ATTORNEY

SN 77-889,401. CRANHAM, SARA, RESEDA, CA. AND BONELLI, JOYCE, RESEDA, CA. FILED 12-9-2009.

Behind the Scenes

THE MARK CONSISTS OF STANDARD CHARACTERS WITHOUT CLAIM TO ANY PARTICULAR FONT, STYLE, SIZE, OR COLOR.

FOR COSMETICS (U.S. CLS. 1, 4, 6, 50, 51 AND 52).
EDWARD FENNESSY, EXAMINING ATTORNEY

SN 77-889,154. ROCK AND ROYALTY LLC, SAN DIEGO, CA. FILED 12-9-2009.

ROCK & ROYALTY

THE MARK CONSISTS OF STANDARD CHARACTERS WITHOUT CLAIM TO ANY PARTICULAR FONT, STYLE, SIZE, OR COLOR.

FOR EAU DE PARFUM; EAU DE TOILETTE AND EAU DE COLOGNE; FRAGRANCES; PERFUMES (U.S. CLS. 1, 4, 6, 50, 51 AND 52).

FIRST USE 3-17-2006; IN COMMERCE 3-17-2006.
ANDREA BUTLER, EXAMINING ATTORNEY

SN 77-889,553. HEALING HORIZONS LTD., ANDOVER, MA. FILED 12-9-2009.

HEALING HORIZONS

THE MARK CONSISTS OF STANDARD CHARACTERS WITHOUT CLAIM TO ANY PARTICULAR FONT, STYLE, SIZE, OR COLOR.

FOR ESSENTIAL OIL PRODUCTS FOR PERSONAL USE (U.S. CLS. 1, 4, 6, 50, 51 AND 52).

FIRST USE 7-24-2009; IN COMMERCE 8-27-2009.
ANTHONY RINKER, EXAMINING ATTORNEY

CLASS 3—(Continued).

SN 77-889,565. DERMADOCTOR, INC., KANSAS CITY, MO. FILED 12-9-2009.

GORILLA WARFARE

THE MARK CONSISTS OF STANDARD CHARACTERS WITHOUT CLAIM TO ANY PARTICULAR FONT, STYLE, SIZE, OR COLOR.

FOR COSMETIC HAIR REGROWTH INHIBITING PREPARATIONS, NAMELY, LOTIONS, CREAMS, GELS, OINTMENTS, SOAPS, ANTIPERSPIRANTS, SUNSCREENS, SKIN BRONZERS, SELF-TANNING CREAMS AND WAXES (U.S. CLS. 1, 4, 6, 50, 51 AND 52).

MARY ROSSMAN, EXAMINING ATTORNEY

SN 77-889,819. LEO CHUPRON, DBA AMERICAN BROTHERS IN ARMS LLC, SOUTHINGTON, CT. FILED 12-9-2009.

JARHEAD

THE MARK CONSISTS OF STANDARD CHARACTERS WITHOUT CLAIM TO ANY PARTICULAR FONT, STYLE, SIZE, OR COLOR.

FOR AFTERSHAVE COLOGNE; COLOGNE; FRAGRANCES; FRAGRANCES FOR PERSONAL USE (U.S. CLS. 1, 4, 6, 50, 51 AND 52).

ZHALEH DELANEY, EXAMINING ATTORNEY

SN 77-889,870. PREMIER CHEMICALS, LLC, WEST CONSHOHOCKEN, PA. FILED 12-9-2009.

WHITE MOUNTAIN

THE MARK CONSISTS OF STANDARD CHARACTERS WITHOUT CLAIM TO ANY PARTICULAR FONT, STYLE, SIZE, OR COLOR.

FOR BATH CRYSTALS; BATH SALTS; MINERAL SALT IN THE NATURE OF BATH SALTS NOT FOR MEDICAL PURPOSES; NON-MEDICATED BODY SOAKS; NON-MEDICATED FOOT SOAKS (U.S. CLS. 1, 4, 6, 50, 51 AND 52).

FIRST USE 12-31-1987; IN COMMERCE 12-31-1987.

HENRY S. ZAK, EXAMINING ATTORNEY

CLASS 3—(Continued).

SN 77-889,922. MOTHERS POLISHES WAXES CLEANERS, HUNTINGTON BEACH, CA. FILED 12-9-2009.

POWERPLASTIC 4LIGHTS

THE MARK CONSISTS OF STANDARD CHARACTERS WITHOUT CLAIM TO ANY PARTICULAR FONT, STYLE, SIZE, OR COLOR.

OWNER OF U.S. REG. NOS. 3,028,180, 3,487,737 AND OTHERS.

NO CLAIM IS MADE TO THE EXCLUSIVE RIGHT TO USE "FOR LIGHTS", APART FROM THE MARK AS SHOWN.

FOR PREPARATIONS FOR CLEANING, POLISHING AND PROTECTING VEHICLE PLASTIC SURFACES AND VEHICLE HEADLIGHTS (U.S. CLS. 1, 4, 6, 50, 51 AND 52).

EVELYN BRADLEY, EXAMINING ATTORNEY

SN 77-890,150. LEXNOVA/TM21 LLC, HARVEYS LAKE, PA. FILED 12-10-2009.

Magic Marker

THE MARK CONSISTS OF STANDARD CHARACTERS WITHOUT CLAIM TO ANY PARTICULAR FONT, STYLE, SIZE, OR COLOR.

NO CLAIM IS MADE TO THE EXCLUSIVE RIGHT TO USE "MARKER", APART FROM THE MARK AS SHOWN.

FOR COSMETICS USED TO REDUCE THE APPEARANCE OF BLEMISHES ON THE SKIN (U.S. CLS. 1, 4, 6, 50, 51 AND 52).

JENNIFER VASQUEZ, EXAMINING ATTORNEY

SN 77-890,668. STAR G.S. DISTRIBUTORS, INC., NORTH MIAMI BEACH, FL. FILED 12-10-2009.

BRONZETTA

THE MARK CONSISTS OF STANDARD CHARACTERS WITHOUT CLAIM TO ANY PARTICULAR FONT, STYLE, SIZE, OR COLOR.

FOR BLUSH; EYE SHADOW; EYE SHADOWS; EYESHADOW; EYESHADOWS (U.S. CLS. 1, 4, 6, 50, 51 AND 52).

FIRST USE 12-31-1990; IN COMMERCE 12-31-1990.

JUSTINE D. PARKER, EXAMINING ATTORNEY

CLASS 3—(Continued).

SN 77-890,846. SUSANA DE LA PARRA, SANTA ANA, CA.
FILED 12-10-2009.

MYTHICA

THE MARK CONSISTS OF STANDARD CHARACTERS WITHOUT CLAIM TO ANY PARTICULAR FONT, STYLE, SIZE, OR COLOR.

FOR BLUSH; COLOGNE; COSMETIC PENCILS; EYE LINER; EYE SHADOW; FACE POWDER; FACIAL CONCEALER; LIP BALM; LIP GLOSS; LIP LINER; LIPSTICK; MAKE UP FOUNDATIONS; MAKE-UP KITS COMPRISED OF LIPSTICK, LIP GLOSS, LIP LINER, LIP BALM, BLUSH, FOUNDATION, EYE SHADOW, EYE LINER, MASCARA, CONCEALER, COSMETIC PENCILS, AND FACIAL POWDER; MASCARA; PERFUME (U.S. CLS. 1, 4, 6, 50, 51 AND 52).

FIRST USE 1-1-2003; IN COMMERCE 1-1-2003.

JENNIFER MARTIN, EXAMINING ATTORNEY

SN 77-890,976. COAST PRODUCTS INC., HONOLULU, HI.
FILED 12-10-2009.

ORANGE MUSCLE

NO CLAIM IS MADE TO THE EXCLUSIVE RIGHT TO USE "ORANGE", APART FROM THE MARK AS SHOWN.

THE MARK CONSISTS OF THE TEXT "ORANGE MUSCLE" ABOVE AND "PLUS" BELOW, RIGHT WITH A TRAIL OF BUBBLES TO THE LEFT OF IT.

FOR ALL PURPOSE CLEANING PREPARATIONS (U.S. CLS. 1, 4, 6, 50, 51 AND 52).

DAVID COLLIER, EXAMINING ATTORNEY

SN 77-891,541. HANKY PANKY, LTD., NEW YORK, NY.
FILED 12-11-2009.

HANKY PANKY

THE MARK CONSISTS OF STANDARD CHARACTERS WITHOUT CLAIM TO ANY PARTICULAR FONT, STYLE, SIZE, OR COLOR.

OWNER OF U.S. REG. NOS. 2,847,981, 3,196,011 AND 3,405,101.

FOR PERFUME, COLOGNE, MAKEUP, NON-MEDICATED SKIN CARE PREPARATIONS, SUN SCREEN PREPARATIONS, HAIR CARE PREPARATIONS, SOAPS, AND BATH OILS AND BATH POWDERS (U.S. CLS. 1, 4, 6, 50, 51 AND 52).

ANGELA DUONG, EXAMINING ATTORNEY

CLASS 3—(Continued).

SN 77-891,566. MIRAGE COSMETICS, INC., BELTSVILLE, MD. FILED 12-11-2009.

Anti-Bite

THE MARK CONSISTS OF STANDARD CHARACTERS WITHOUT CLAIM TO ANY PARTICULAR FONT, STYLE, SIZE, OR COLOR.

FOR NAIL POLISH; NAIL POLISH TOP COAT; NAIL POLISH BASE COAT; NAIL CARE PREPARATIONS (U.S. CLS. 1, 4, 6, 50, 51 AND 52).

JILL PRATER, EXAMINING ATTORNEY

SN 77-891,604. 6569048 CANADA INC., LAVAL, QUEBEC, CANADA, FILED 12-11-2009.

ALCÔVE

THE MARK CONSISTS OF STANDARD CHARACTERS WITHOUT CLAIM TO ANY PARTICULAR FONT, STYLE, SIZE, OR COLOR.

FOR HAIR CARE PREPARATIONS, NAMELY, PERMANENT HAIR COLORS, HAIR COLOR DEVELOPERS, HAIR LOTIONS, HAIR TREATMENTS AND HAIR CLEANERS (U.S. CLS. 1, 4, 6, 50, 51 AND 52).

NORA BUCHANAN WILL, EXAMINING ATTORNEY

SN 77-892,199. DOALL COMPANY, WHEELING, IL. FILED 12-13-2009.



OWNER OF U.S. REG. NOS. 390,078, 679,957 AND OTHERS.

THE COLOR(S) GREEN, WHITE AND BLACK IS/ARE CLAIMED AS A FEATURE OF THE MARK.

THE MARK CONSISTS OF THE WORD "DOALL" IN GREEN COLOR OUTLINED IN BLACK SUPERIMPOSED OVER A GREEN AND WHITE GLOBE DESIGN.

FOR CHEMICAL CLEANERS AND REMOVERS FOR USE WITH SAWING, CUTTING AND GRINDING MACHINES AND BLADES (U.S. CLS. 1, 4, 6, 50, 51 AND 52).

FIRST USE 11-15-2009; IN COMMERCE 11-15-2009.

MARGERY A. TIERNEY, EXAMINING ATTORNEY

CLASS 3—(Continued).

SN 77-892,249. BRAND VISIONARIES LLC, BARRINGTON, RI. FILED 12-13-2009.

TRIPLE TAKE

THE MARK CONSISTS OF STANDARD CHARACTERS WITHOUT CLAIM TO ANY PARTICULAR FONT, STYLE, SIZE, OR COLOR.

FOR COLOGNES, PERFUMES AND COSMETICS (U.S. CLS. 1, 4, 6, 50, 51 AND 52).
MORGAN WYNNE, EXAMINING ATTORNEY

SN 77-892,380. VILLARREAL, JOSE ROMAN GARCIA, CANCUN, QUINTANA ROO, MEXICO, FILED 12-14-2009.

SEA JEWELS

THE MARK CONSISTS OF STANDARD CHARACTERS WITHOUT CLAIM TO ANY PARTICULAR FONT, STYLE, SIZE, OR COLOR.

FOR BATH OILS FOR COSMETIC PURPOSES; COLOGNES, PERFUMES AND COSMETICS; COSMETICS AND COSMETIC PREPARATIONS; SCENTED OILS USED TO PRODUCE AROMAS WHEN HEATED (U.S. CLS. 1, 4, 6, 50, 51 AND 52).

FIRST USE 11-22-2000; IN COMMERCE 11-22-2000.
LAKEISHA LEWIS, EXAMINING ATTORNEY

SN 77-892,431. IMPEX OF DORAL, INC., MIAMI, FL. FILED 12-14-2009.

ORANJO

THE MARK CONSISTS OF STANDARD CHARACTERS WITHOUT CLAIM TO ANY PARTICULAR FONT, STYLE, SIZE, OR COLOR.

FOR LAUNDRY DETERGENT AND FABRIC SOFTENERS (U.S. CLS. 1, 4, 6, 50, 51 AND 52).
DAWN FELDMAN, EXAMINING ATTORNEY

CLASS 3—(Continued).

SN 77-894,335. THE PROCTER & GAMBLE COMPANY, CINCINNATI, OH. FILED 12-16-2009.

 The logo for Pantene Pro-V, featuring the word "PANTENE" in a vertical, bold, black sans-serif font. Above the letter "V" is a small gold square containing the letters "PRO-V" in white.

OWNER OF U.S. REG. NOS. 2,447,036, 3,131,092 AND OTHERS.

THE COLOR(S) BLACK AND GOLD IS/ARE CLAIMED AS A FEATURE OF THE MARK.

THE MARK CONSISTS OF THE WORD "PANTENE" IN BLACK LETTERS IS VERTICALLY PLACED BENEATH A GOLD SQUARE BOX CONTAINING THE PARTIAL OUTLINE OF A VITAMIN SHAPE IN WHICH THE WORDS "PRO-V" ARE WRITTEN IN WHITE.

FOR HAIR CARE PREPARATIONS (U.S. CLS. 1, 4, 6, 50, 51 AND 52).

JOHN HWANG, EXAMINING ATTORNEY

SN 77-894,646. SYNTONICS INTERNATIONAL, LTD., MELROSE PARK, IL. FILED 12-16-2009.

GROTHENTIC

THE MARK CONSISTS OF STANDARD CHARACTERS WITHOUT CLAIM TO ANY PARTICULAR FONT, STYLE, SIZE, OR COLOR.

FOR HAIR CARE PRODUCTS, NAMELY, SCALP TREATMENTS, SHAMPOOS, CONDITIONERS, AND STYLING PRODUCTS, NAMELY, FOAMS, MOUSES, GELS, CREAMS AND SPRAYS (U.S. CLS. 1, 4, 6, 50, 51 AND 52).

CAROLYN CATALDO, EXAMINING ATTORNEY

CLASS 3—(Continued).

SN 77-895,554. LEO CHUPRON, DBA AMERICAN BROTHERS IN ARMS LLC, SOUTHLINGTON, CT. FILED 12-17-2009.

NIGHTSTICK

THE MARK CONSISTS OF STANDARD CHARACTERS WITHOUT CLAIM TO ANY PARTICULAR FONT, STYLE, SIZE, OR COLOR.

FOR AFTERSHAVE COLOGNE; COLOGNE; FRAGRANCES; FRAGRANCES FOR PERSONAL USE (U.S. CLS. 1, 4, 6, 50, 51 AND 52).

ZHALEH DELANEY, EXAMINING ATTORNEY

CLASS 3—(Continued).

SN 77-898,861. VICTORIA'S SECRET STORES BRAND MANAGEMENT, INC., REYNOLDSBURG, OH. FILED 12-22-2009.

NOIR DARLING

THE MARK CONSISTS OF STANDARD CHARACTERS WITHOUT CLAIM TO ANY PARTICULAR FONT, STYLE, SIZE, OR COLOR.

FOR BODY CREAMS; BODY LOTIONS; BODY POWDER; EAU DE PARFUM; LIP GLOSS; PERFUME; PERFUMES IN SOLID FORM (U.S. CLS. 1, 4, 6, 50, 51 AND 52).

COLLEEN DOMBROW, EXAMINING ATTORNEY

SN 77-895,576. LEO CHUPRON, DBA AMERICAN BROTHERS IN ARMS LLC, SOUTHLINGTON, CT. FILED 12-17-2009.

BACKDRAFT

THE MARK CONSISTS OF STANDARD CHARACTERS WITHOUT CLAIM TO ANY PARTICULAR FONT, STYLE, SIZE, OR COLOR.

FOR AFTERSHAVE COLOGNE; COLOGNE; FRAGRANCES; FRAGRANCES FOR PERSONAL USE (U.S. CLS. 1, 4, 6, 50, 51 AND 52).

ZHALEH DELANEY, EXAMINING ATTORNEY

SN 77-898,916. ZOTOS INTERNATIONAL, INC., DARIEN, CT. FILED 12-22-2009.

PURE ELEMENTS

THE MARK CONSISTS OF STANDARD CHARACTERS WITHOUT CLAIM TO ANY PARTICULAR FONT, STYLE, SIZE, OR COLOR.

FOR HAIR CARE PREPARATIONS (U.S. CLS. 1, 4, 6, 50, 51 AND 52).

TRACY CROSS, EXAMINING ATTORNEY

SN 77-895,665. PERIO, INC., DUBLIN, OH. FILED 12-17-2009.

MOUNTAIN BLAST

THE MARK CONSISTS OF STANDARD CHARACTERS WITHOUT CLAIM TO ANY PARTICULAR FONT, STYLE, SIZE, OR COLOR.

FOR AFTERSHAVE; BODY WASH; DEODORANT FOR PERSONAL USE; SHAVING PREPARATIONS (U.S. CLS. 1, 4, 6, 50, 51 AND 52).

JESSICA FATHY, EXAMINING ATTORNEY

SN 77-904,042. LEO CHUPRON, DBA AMERICAN BROTHERS IN ARMS LLC, SOUTHLINGTON, CT. FILED 1-3-2010.

SEMPER FIERCE

THE MARK CONSISTS OF STANDARD CHARACTERS WITHOUT CLAIM TO ANY PARTICULAR FONT, STYLE, SIZE, OR COLOR.

THE ENGLISH TRANSLATION OF THE WORD "SEMPER" IN THE MARK IS "ALWAYS".

FOR AFTERSHAVE COLOGNE; COLOGNE; FRAGRANCES; FRAGRANCES FOR PERSONAL USE (U.S. CLS. 1, 4, 6, 50, 51 AND 52).

ZHALEH DELANEY, EXAMINING ATTORNEY

CLASS 3—(Continued).

SN 77-904,047. LEO CHUPRON, DBA AMERICAN BROTHERS IN ARMS LLC, SOUTHLINGTON, CT. FILED 1-3-2010.

WARRIOR

THE MARK CONSISTS OF STANDARD CHARACTERS WITHOUT CLAIM TO ANY PARTICULAR FONT, STYLE, SIZE, OR COLOR.

FOR AFTERSHAVE COLOGNE; COLOGNE; FRAGRANCES; FRAGRANCES FOR PERSONAL USE (U.S. CLS. 1, 4, 6, 50, 51 AND 52).

ZHALEH DELANEY, EXAMINING ATTORNEY

SN 77-904,619. PURE & NATURAL COMPANY, SCOTTSDALE, AZ. FILED 1-4-2010.

COLOR SEAL

THE MARK CONSISTS OF STANDARD CHARACTERS WITHOUT CLAIM TO ANY PARTICULAR FONT, STYLE, SIZE, OR COLOR.

NO CLAIM IS MADE TO THE EXCLUSIVE RIGHT TO USE "COLOR", APART FROM THE MARK AS SHOWN.

FOR LAUNDRY BLEACH (U.S. CLS. 1, 4, 6, 50, 51 AND 52).

FIRST USE 4-13-1994; IN COMMERCE 4-13-1994.
ALICIA COLLINS, EXAMINING ATTORNEY

SN 77-906,733. FD MANAGEMENT, INC., STAMFORD, CT. FILED 1-7-2010.

ELIZABETH ARDEN PRETTY HOT

THE MARK CONSISTS OF STANDARD CHARACTERS WITHOUT CLAIM TO ANY PARTICULAR FONT, STYLE, SIZE, OR COLOR.

OWNER OF U.S. REG. NOS. 545,592, 3,652,083 AND OTHERS.

THE NAME "ELIZABETH ARDEN" DOES NOT IDENTIFY A LIVING INDIVIDUAL.

FOR FRAGRANCE PRODUCTS FOR PERSONAL USE, NAMELY, PERFUME, EAU DE PARFUM, EAU DE TOILETTE, SCENTED BODY LOTIONS, CREAMS, OILS AND GELS (U.S. CLS. 1, 4, 6, 50, 51 AND 52).

ANNE FARRELL, EXAMINING ATTORNEY

CLASS 3—(Continued).

SN 77-915,023. OLAN LABORATORIES, INC., HAUPPAUGE, NY. FILED 1-19-2010.

HAIR CRACK

THE MARK CONSISTS OF STANDARD CHARACTERS WITHOUT CLAIM TO ANY PARTICULAR FONT, STYLE, SIZE, OR COLOR.

NO CLAIM IS MADE TO THE EXCLUSIVE RIGHT TO USE "HAIR", APART FROM THE MARK AS SHOWN.

FOR HAIR CARE PREPARATIONS (U.S. CLS. 1, 4, 6, 50, 51 AND 52).

SANJEEV VOHRA, EXAMINING ATTORNEY

SN 77-916,042. OLAN LABORATORIES, INC., HAUPPAUGE, NY. FILED 1-20-2010.

CRACK

THE MARK CONSISTS OF STANDARD CHARACTERS WITHOUT CLAIM TO ANY PARTICULAR FONT, STYLE, SIZE, OR COLOR.

FOR HAIR CARE PREPARATIONS (U.S. CLS. 1, 4, 6, 50, 51 AND 52).

SANJEEV VOHRA, EXAMINING ATTORNEY

SN 77-917,670. PURE & NATURAL COMPANY, SCOTTSDALE, AZ. FILED 1-22-2010.

HOLLY BERRIES

THE MARK CONSISTS OF STANDARD CHARACTERS WITHOUT CLAIM TO ANY PARTICULAR FONT, STYLE, SIZE, OR COLOR.

NO CLAIM IS MADE TO THE EXCLUSIVE RIGHT TO USE "BERRIES", APART FROM THE MARK AS SHOWN.

FOR ANTIBACTERIAL SOAP; HAND SOAPS; LIQUID SOAPS; SOAPS FOR PERSONAL USE (U.S. CLS. 1, 4, 6, 50, 51 AND 52).

ALICIA COLLINS, EXAMINING ATTORNEY

CLASS 3—(Continued).

SN 77-917,912. TUPPERWARE PRODUCTS S.A., FRIBOURG, SWITZERLAND, FILED 1-22-2010.

BEAUTY FEMME FLOWERS

THE MARK CONSISTS OF STANDARD CHARACTERS WITHOUT CLAIM TO ANY PARTICULAR FONT, STYLE, SIZE, OR COLOR.

OWNER OF U.S. REG. NO. 3,690,285.

NO CLAIM IS MADE TO THE EXCLUSIVE RIGHT TO USE "BEAUTY", APART FROM THE MARK AS SHOWN, FOR DEODORANTS AND ANTIPERSPIRANTS FOR PERSONAL USE, NON-MEDICATED SKIN CARE PREPARATIONS (U.S. CLS. 1, 4, 6, 50, 51 AND 52).

LESLEY LAMOTHE, EXAMINING ATTORNEY

SN 77-927,712. ZOTOS INTERNATIONAL, INC., DARIEN, CT. FILED 2-4-2010.

Pur Elements

THE MARK CONSISTS OF STANDARD CHARACTERS WITHOUT CLAIM TO ANY PARTICULAR FONT, STYLE, SIZE, OR COLOR.

THE ENGLISH TRANSLATION OF "PUR" IN THE MARK IS PURE.

FOR HAIR CARE PREPARATIONS (U.S. CLS. 1, 4, 6, 50, 51 AND 52).

TRACY CROSS, EXAMINING ATTORNEY

SN 78-854,673. DOBBS, CHERIE, WINTER SPRINGS, FL. FILED 4-5-2006.

PRANAYAMA SPACEUTICALS

THE MARK CONSISTS OF STANDARD CHARACTERS WITHOUT CLAIM TO ANY PARTICULAR FONT, STYLE, SIZE, OR COLOR.

FOR NON-MEDICATED SKIN CARE PREPARATIONS. (U.S. CLS. 1, 4, 6, 50, 51 AND 52).

TRACY WHITTAKER-BROWN, EXAMINING ATTORNEY

CLASS 3—(Continued).

SN 78-858,626. PATHFINDER MANAGEMENT, INC., NASHVILLE, TN. FILED 4-11-2006.

DERMASCRIPT

THE MARK CONSISTS OF STANDARD CHARACTERS WITHOUT CLAIM TO ANY PARTICULAR FONT, STYLE, SIZE, OR COLOR.

FOR PREPARATIONS FOR CLEANING, PROTECTING AND PRESERVING VEHICLE SURFACES (U.S. CLS. 1, 4, 6, 50, 51 AND 52).

MYRIAH HABEEB, EXAMINING ATTORNEY

SN 79-070,508. CHARLOTTE ROBERT, SWITZERLAND, FILED 5-29-2009.

**MOUNTAIN
BLOSSOM**

by
*fleur
de
café*

PRIORITY DATE OF 1-20-2009 IS CLAIMED.
OWNER OF INTERNATIONAL REGISTRATION 1006737 DATED 5-29-2009, EXPIRES 5-29-2019.

THE ENGLISH TRANSLATION OF "FLEUR DE CAFÉ" IN THE MARK IS "COFFEE FLOWER."

FOR SOAPS, PERFUMERY, ESSENTIAL OILS, COSMETICS, HAIR LOTIONS; DENTIFRICES (U.S. CLS. 1, 4, 6, 50, 51 AND 52).

DAWN HAN, EXAMINING ATTORNEY

CLASS 3—(Continued).

SN 79-070,830. ZULIANI DARIO, ITALY, FILED 4-21-2009.

ACQUA FIORENTINA

THE MARK CONSISTS OF STANDARD CHARACTERS WITHOUT CLAIM TO ANY PARTICULAR FONT, STYLE, SIZE, OR COLOR.

PRIORITY DATE OF 11-6-2008 IS CLAIMED.
OWNER OF INTERNATIONAL REGISTRATION 1007480 DATED 4-21-2009, EXPIRES 4-21-2019.

NO CLAIM IS MADE TO THE EXCLUSIVE RIGHT TO USE "FIORENTINA", APART FROM THE MARK AS SHOWN.

THE ENGLISH TRANSLATION OF THE FOREIGN WORD(S) IN THE MARK IS FLORENTINE WATER.

FOR BLEACHING PREPARATIONS AND OTHER SUBSTANCES FOR LAUNDRY USE, NAMELY, LAUNDRY SOAPS, LAUNDRY PRE-SOAK, LAUNDRY STARCH, FABRIC SOFTENERS AND ESSENTIAL OILS AS PERFUME FOR LAUNDRY USE; CLEANING, POLISHING, SCOURING AND ABRASIVE PREPARATIONS; SOAPS; PERFUMERY, ESSENTIAL OILS, COSMETICS, HAIR LOTIONS; DENTIFRICES (U.S. CLS. 1, 4, 6, 50, 51 AND 52).

EVELYN BRADLEY, EXAMINING ATTORNEY

SN 79-071,412. LABORATOIRE NUXE, FRANCE, FILED 3-6-2009.

Bio-Végétal de Nuxe

THE MARK CONSISTS OF STANDARD CHARACTERS WITHOUT CLAIM TO ANY PARTICULAR FONT, STYLE, SIZE, OR COLOR.

OWNER OF INTERNATIONAL REGISTRATION 1009063 DATED 3-6-2009, EXPIRES 3-6-2019.

OWNER OF U.S. REG. NOS. 2,447,296, 3,537,366 AND OTHERS.

NO CLAIM IS MADE TO THE EXCLUSIVE RIGHT TO USE "BIO-VÉGÉTAL", APART FROM THE MARK AS SHOWN.

THE TERM "BIO" IS A SHORT FORM OF THE WORD "BIOLOGICAL". THE ENGLISH TRANSLATION OF "VÉGÉTAL" IS "VEGETABLE". THE WORDING "DE NUXE" HAS NO MEANING IN A FOREIGN LANGUAGE.

FOR COSMETICS, NAMELY, PERFUMES, TOILET WATER, DEODORANTS FOR PERSONAL USE; ESSENTIAL OILS FOR PERSONAL USE; COSMETICS CONTAINING PLANT EXTRACTS; SOAPS, NOT FOR MEDICAL USE, FOR SKIN CARE, COSMETIC CREAMS FOR THE SKIN, COSMETIC GELS FOR THE SKIN, MILKS FOR COSMETIC USE FOR THE SKIN, LOTIONS FOR COSMETIC USE FOR THE SKIN, BEAUTY MASKS FOR COSMETIC USE FOR THE SKIN, POMADES FOR COSMETIC USE FOR THE SKIN, POWDERS FOR THE FACE AND BODY AND COSMETIC PREPARATIONS FOR SKIN CARE, NOT FOR MEDICAL USE; COSMETIC ANTI-WRINKLE PREPARATIONS, NOT FOR MEDICAL USE, IN THE FORM OF CREAMS, IN THE FORM OF GELS, IN THE FORM OF MILKS, IN THE FORM OF SERUMS, AND IN THE FORM OF ADHESIVE PATCHES FOR THE SKIN; COSMETIC PREPARATIONS FOR LIP CARE IN THE FORM OF CREAMS, IN THE FORM OF BALMS, IN THE FORM OF STICKS AND IN THE FORM OF POMADES; COSMETIC SUNSCREEN PREPARATIONS IN THE FORM OF CREAMS, IN THE FORM OF GELS, IN THE FORM OF MILKS AND IN THE FORM OF OILS; COSMETIC SUN-TANNING PREPARATIONS IN THE FORM OF CREAMS, IN THE FORM OF GELS,

CLASS 3—(Continued).

IN THE FORM OF MILK AND IN THE FORM OF OILS; COSMETIC AFTERSUN PREPARATIONS IN THE FORM OF MILKS, IN THE FORM OF CREAMS, IN THE FORM OF GELS, IN THE FORM OF OILS AND IN THE FORM OF BALMS; COSMETIC PREPARATIONS FOR SLIMMING PURPOSES, NOT FOR MEDICAL USE; PREPARATIONS FOR THE HAIR, NAMELY, SHAMPOOS, LOTIONS, FOAMS, SERUMS, NOT FOR MEDICAL USE, AND HAIR SPRAYS; COSMETIC PREPARATIONS FOR BATHS, NOT FOR MEDICAL USE, IN THE FORM OF CREAMS, IN THE FORM OF GELS, IN THE FORM OF MILKS, IN THE FORM OF OILS, IN THE FORM OF PEARLS AND IN THE FORM OF SALTS; MAKE-UP PREPARATIONS FOR THE FACE AND BODY; MAKE-UP REMOVING PREPARATIONS IN THE FORM OF FOAMS, IN THE FORM OF GELS, IN THE FORM OF MILKS, IN THE FORM OF OILS AND IN THE FORM OF LOTIONS; ALL THE FOREGOING GOODS BEING OF BIOLOGICAL OR NATURAL ORIGIN AND CONTAINING VEGETABLE OR PLANT MATTER (U.S. CLS. 1, 4, 6, 50, 51 AND 52).

ESTHER BELENKER, EXAMINING ATTORNEY

SN 79-072,108. MOMOTANI JUNTENKAN LTD., JAPAN, FILED 6-30-2009.

OWNER OF INTERNATIONAL REGISTRATION 1011000 DATED 6-30-2009, EXPIRES 6-30-2019.

THE NON-LATIN CHARACTERS IN THE MARK TRANSLITERATE TO "MEISHOKU" AND THIS MEANS BRIGHT COLOR IN ENGLISH.

FOR SOAPS AND DETERGENTS; DENTIFRICES; COSMETICS; HAIR CARE PREPARATIONS; PERFUMES; PERFUMERY; INCENSES AND FRAGRANCES (U.S. CLS. 1, 4, 6, 50, 51 AND 52).

MATTHEW MCDOWELL, EXAMINING ATTORNEY

SN 79-074,560. YING GUANG HUI, HUANGYAN DISTRICT-TAIZHOU; ZHEJIANG, CHINA, FILED 9-1-2009.

OWNER OF INTERNATIONAL REGISTRATION 1017863 DATED 9-1-2009, EXPIRES 9-1-2019.

THE FIRST NON-LATIN CHARACTER IN THE MARK TRANSLITERATES TO "YI" AND THIS MEANS "IDEA, HOPE" IN ENGLISH. THE SECOND NON-LATIN CHARACTER IN THE MARK TRANSLITERATES TO "XIN" AND THIS MEANS "FLOURISHING, PROSPERITY, THRIVING" IN ENGLISH. THE LAST NON-LATIN CHARACTER IN THE MARK TRANSLITERATES TO "TANG" AND THIS MEANS "HALL, A HALL FOR A SPECIFIC PUBLIC USE" IN ENGLISH.

FOR COSMETICS; LAUNDRY DETERGENTS; DISH DETERGENTS; DETERGENTS FOR HOUSEHOLD USE; HAIR SHAMPOO; DENTIFRICES; PERFUMERY; POLISH FOR FURNITURE AND FLOORING; PERFUMES; INCENSE; BATH LOTION; FACIAL CLEANSERS (U.S. CLS. 1, 4, 6, 50, 51 AND 52).

GISELLE AGOSTO, EXAMINING ATTORNEY

CLASS 3—(Continued).

SN 79-074,800. BAWANG (GUANGZHOU) CO., LTD., CHINA, FILED 10-20-2009.



OWNER OF INTERNATIONAL REGISTRATION 1018438 DATED 10-20-2009, EXPIRES 10-20-2019.

THE MARK CONSISTS OF "ROYAL WIND" IN CAPITAL LETTERS TO THE LEFT OF THE CHINESE CHARACTERS THAT TRANSLITERATE TO BA WANG AND ZHUI FENG. UNDERNEATH THIS APPEARS A WRITTEN FORM OF CHINESE CHARACTERS.

THE ENGLISH TRANSLATION OF THE FOREIGN WORD(S) IN THE MARK IS: CATCH, WIND, WHICH MEANS CATCH THE WIND AS A WHOLE; DOMINATION, KING WHICH MEANS OVERLORD AS A WHOLE.

THE TRANSLITERATION OF THE NON-LATIN CHARACTERS IN THE MARK IS: BA WANG, ZHUI FENG.

FOR HAIR LOTIONS; LAUNDRY PREPARATIONS, NAMELY, LAUNDRY BLEACH, LAUNDRY DETERGENTS; HAIR CONDITIONERS; ESSENTIAL OILS; COSMETICS; DENTIFRICES; COSMETICS FOR ANIMALS; MOUTHWASHES, NOT FOR MEDICAL PURPOSES; BATH LOTIONS (U.S. CLS. 1, 4, 6, 50, 51 AND 52).

ANDREA BUTLER, EXAMINING ATTORNEY

SN 79-075,930. CARTIER INTERNATIONAL N.V.; A HOLDING AND TRADING COMPANY; ORGANIZED AND EXISTING UNDER THE LAWS OF THE NETHERLANDS ANTILLES, NETHERLD ANTILLES, FILED 9-17-2009.

LA TREIZIEME HEURE

PRIORITY DATE OF 4-20-2009 IS CLAIMED.

OWNER OF INTERNATIONAL REGISTRATION 1021085 DATED 9-17-2009, EXPIRES 9-17-2019.

THE ENGLISH TRANSLATION OF THE FOREIGN WORD(S) IN THE MARK IS: THE THIRTEENTH HOUR.

FOR SOAPS, PERFUMERY, ESSENTIAL OILS, COSMETICS, HAIR LOTIONS (U.S. CLS. 1, 4, 6, 50, 51 AND 52).

APRIL ROACH, EXAMINING ATTORNEY

CLASS 3—(Continued).

SN 79-075,932. CARTIER INTERNATIONAL N.V.; A HOLDING AND TRADING COMPANY ORGANIZED; AND EXISTING UNDER THE LAWS OF THE; NETHERLANDS ANTILLES, NETHERLD ANTILLES, FILED 9-17-2009.

L'HEURE FOLLE

PRIORITY DATE OF 3-26-2009 IS CLAIMED.

OWNER OF INTERNATIONAL REGISTRATION 1021087 DATED 9-17-2009, EXPIRES 9-17-2019.

THE ENGLISH TRANSLATION OF THE FOREIGN WORD(S) IN THE MARK IS: THE CRAZY HOUR.

FOR SOAPS, PERFUMERY, ESSENTIAL OILS, COSMETICS, HAIR LOTIONS (U.S. CLS. 1, 4, 6, 50, 51 AND 52).

APRIL ROACH, EXAMINING ATTORNEY

SN 79-075,933. CARTIER INTERNATIONAL N.V.; A HOLDING AND TRADING COMPANY ORGANIZED; AND EXISTING UNDER THE LAWS OF THE; NETHERLANDS ANTILLES, NETHERLD ANTILLES, FILED 9-17-2009.

L'HEURE PROMISE

PRIORITY DATE OF 3-26-2009 IS CLAIMED.

OWNER OF INTERNATIONAL REGISTRATION 1021088 DATED 9-17-2009, EXPIRES 9-17-2019.

THE ENGLISH TRANSLATION OF THE FOREIGN WORD(S) IN THE MARK IS: THE PROMISED HOUR.

FOR SOAPS, PERFUMERY, ESSENTIAL OILS, COSMETICS, HAIR LOTIONS (U.S. CLS. 1, 4, 6, 50, 51 AND 52).

APRIL ROACH, EXAMINING ATTORNEY

SN 79-077,063. LABORATOIRE BIODERMA, FRANCE, FILED 7-29-2009.

MATRICIANE

THE MARK CONSISTS OF STANDARD CHARACTERS WITHOUT CLAIM TO ANY PARTICULAR FONT, STYLE, SIZE, OR COLOR.

OWNER OF INTERNATIONAL REGISTRATION 1024204 DATED 7-29-2009, EXPIRES 7-29-2019.

THE WORDING "MATRICIANE" HAS NO MEANING IN A FOREIGN LANGUAGE.

FOR SOAPS, PERFUMERY, ESSENTIAL OILS, COSMETICS, HAIR LOTIONS; DENTIFRICES; FOOD SUPPLEMENTS FOR COSMETIC USE (U.S. CLS. 1, 4, 6, 50, 51 AND 52).

CHARISMA HAMPTON, EXAMINING ATTORNEY

SN 79-077,862. DR. ROLAND ZETTEL, SWITZERLAND, FILED 12-10-2009.

DENTALSNOW

THE MARK CONSISTS OF STANDARD CHARACTERS WITHOUT CLAIM TO ANY PARTICULAR FONT, STYLE, SIZE, OR COLOR.

PRIORITY DATE OF 7-20-2009 IS CLAIMED.

OWNER OF INTERNATIONAL REGISTRATION 1026304 DATED 12-10-2009, EXPIRES 12-10-2019.

FOR DENTIFRICES (U.S. CLS. 1, 4, 6, 50, 51 AND 52).

JAMES STEIN, EXAMINING ATTORNEY

CLASS 3—(Continued).

SN 79-078,030. COTY DEUTSCHLAND GMBH, FED REP GERMANY, FILED 12-8-2009.

MATCH PERFECTION

THE MARK CONSISTS OF STANDARD CHARACTERS WITHOUT CLAIM TO ANY PARTICULAR FONT, STYLE, SIZE, OR COLOR.

PRIORITY DATE OF 6-15-2009 IS CLAIMED.

OWNER OF INTERNATIONAL REGISTRATION 1026653 DATED 12-8-2009, EXPIRES 12-8-2019.

FOR SOAPS, PERFUMERY; ESSENTIAL OILS; COSMETICS; COSMETIC HAIR LOTIONS (U.S. CLS. 1, 4, 6, 50, 51 AND 52).

JESSICA A. POWERS, EXAMINING ATTORNEY

SN 79-079,229. PROCTER & GAMBLE; INTERNATIONAL OPERATIONS S.A., SWITZERLAND, FILED 11-19-2009.

ANIMAGICAL

THE MARK CONSISTS OF STANDARD CHARACTERS WITHOUT CLAIM TO ANY PARTICULAR FONT, STYLE, SIZE, OR COLOR.

PRIORITY DATE OF 5-19-2009 IS CLAIMED.

OWNER OF INTERNATIONAL REGISTRATION 1029732 DATED 11-19-2009, EXPIRES 11-19-2019.

FOR PERFUMES, BATH GELS, SHOWER GELS, BATH FOAMS AND DEODORANTS FOR PERSONAL USE, TOILET SOAP (U.S. CLS. 1, 4, 6, 50, 51 AND 52).

KRISTIN CARLSON, EXAMINING ATTORNEY

CLASS 4—LUBRICANTS AND FUELS

SN 76-697,087. BIERWICKS, INC., HANOVER, PA. FILED 4-27-2009.



NO CLAIM IS MADE TO THE EXCLUSIVE RIGHT TO USE "WICKS" AND "INC", APART FROM THE MARK AS SHOWN.

THE MARK CONSISTS OF THE WORDS "BIER WICKS, INC.", IN STYLIZED TEXT. THERE IS A FLAME OVER THE "I" IN "WICKS".

FOR CANDLES (U.S. CLS. 1, 6 AND 15).

LAKEISHA LEWIS, EXAMINING ATTORNEY

CLASS 4—(Continued).

SN 76-700,703. ORION INDUSTRIAL, LLC, OKEMOS, MI. FILED 12-7-2009.



THE MARK CONSISTS OF THE WORD "ORION" TO THE RIGHT OF A SPINNING PINWHEEL.

FOR ENGINE LUBRICANTS THAT REDUCE FRICTION WHILE ALSO PROVIDING CLEANING ELEMENTS TO THE ENGINE RESULTING IN IMPROVED ENGINE PERFORMANCE (U.S. CLS. 1, 6 AND 15).

FIRST USE 10-8-2009; IN COMMERCE 10-8-2009.

LINDA LAVACHE, EXAMINING ATTORNEY

SN 77-822,895. KIOR INC., PASADENA, TX. FILED 9-9-2009.



THE MARK CONSISTS OF STANDARD CHARACTERS WITHOUT CLAIM TO ANY PARTICULAR FONT, STYLE, SIZE, OR COLOR.

FOR HYDROCARBON FUELS, NAMELY, BIOFUELS, FUEL FOR MOTOR VEHICLES, BIODIESEL MADE FROM AGRICULTURAL AND WASTE PRODUCTS, RENEWABLE FUELS, FUEL FOR AIRCRAFT/SHIPS; AVIATION FUEL, BIODIESEL FUEL, DIESEL FUEL, GASOLINE, FOSSIL FUEL SUBSTITUTES, NAMELY, BIOFUELS; FUEL GAS; FUEL OIL; HEATING OIL; HEAVY OILS; INDUSTRIAL OILS; KEROSENE; LIGHT OILS; NON-CHEMICAL ADDITIVES FOR OILS AND FUELS; NON-CHEMICAL GASOLINE ADDITIVES; BIOFUELS, NAMELY, BIOGAS (U.S. CLS. 1, 6 AND 15).

STEVEN R. FINE, EXAMINING ATTORNEY

SN 77-861,785. NYE LUBRICANTS, INC., FAIRHAVEN, MA. FILED 10-30-2009.



THE MARK CONSISTS OF STANDARD CHARACTERS WITHOUT CLAIM TO ANY PARTICULAR FONT, STYLE, SIZE, OR COLOR.

OWNER OF U.S. REG. NOS. 1,239,918, 2,153,017 AND 2,398,447.

FOR SYNTHETIC LUBRICANTS FOR LUBRICATING EQUIPMENT IN CLEAN ROOMS AND IN LOW VACUUM CHAMBERS (U.S. CLS. 1, 6 AND 15).

NANCY CLARKE, EXAMINING ATTORNEY

CLASS 4—(Continued).

SN 77-861,798. NYE LUBRICANTS, INC., FAIRHAVEN, MA.
FILED 10-30-2009.

NyeVac

THE MARK CONSISTS OF STANDARD CHARACTERS WITHOUT CLAIM TO ANY PARTICULAR FONT, STYLE, SIZE, OR COLOR.

OWNER OF U.S. REG. NOS. 1,239,918, 2,153,017 AND 2,398,447.

FOR SYNTHETIC LUBRICANTS FOR VACUUM PUMPS (U.S. CLS. 1, 6 AND 15).

NANCY CLARKE, EXAMINING ATTORNEY

SN 77-883,586. NIEMERG, PHILIP, DBA CANDLEART CANDLE COMPANY, DIETERICH, IL. FILED 12-1-2009.

BARN WICK

THE MARK CONSISTS OF STANDARD CHARACTERS WITHOUT CLAIM TO ANY PARTICULAR FONT, STYLE, SIZE, OR COLOR.

NO CLAIM IS MADE TO THE EXCLUSIVE RIGHT TO USE "WICK", APART FROM THE MARK AS SHOWN.

FOR CANDLES; MELT TARTS, NAMELY, SCENTED WAX TO BE MELTED SLOWLY WITH A WARMER; PERFUMED CANDLES; SCENTED CANDLES; SCENTED WAX FOR USE IN CANDLE WARMERS; WICKS FOR CANDLES; WICKS FOR CANDLES FOR LIGHTING (U.S. CLS. 1, 6 AND 15).

FIRST USE 4-3-2008; IN COMMERCE 8-21-2008.

SUSAN RICHARDS, EXAMINING ATTORNEY

SN 77-887,061. BORCHERS, MARY E, HIGH SPRINGS, FL.
FILED 12-5-2009.

GOD SENDS LOVE

THE MARK CONSISTS OF STANDARD CHARACTERS WITHOUT CLAIM TO ANY PARTICULAR FONT, STYLE, SIZE, OR COLOR.

FOR SCENTED CANDLES (U.S. CLS. 1, 6 AND 15).

LINDA MICKLEBURGH, EXAMINING ATTORNEY

CLASS 4—(Continued).

SN 77-887,392. PENNZOIL-QUAKER STATE COMPANY, HOUSTON, TX. FILED 12-7-2009.



OWNER OF U.S. REG. NOS. 1,897,106, 3,240,337 AND OTHERS.

NO CLAIM IS MADE TO THE EXCLUSIVE RIGHT TO USE "DURABLE PROTECTION", APART FROM THE MARK AS SHOWN.

THE COLOR(S) YELLOW, WHITE, BLACK, TAN AND GOLD IS/ARE CLAIMED AS A FEATURE OF THE MARK.

THE MARK CONSISTS OF THE LITERAL ELEMENTS "QUAKER STATE DURABLE PROTECTION" IN STYLIZED LETTERING. THE LARGE INCOMPLETE LETTER "Q" IS DISPLAYED IN VARYING SHADES OF YELLOW, WHITE, TAN AND GOLD AND IS OUTLINED IN BLACK, CREATING A RAISED AND SHADOWING EFFECT. THE WORDS "QUAKER STATE" ARE LOCATED NEAR THE CENTER OF THE MARK, APPEARING IN WHITE ON A BLACK BACKGROUND, WITH GOLD SHADING APPEARING BELOW, BETWEEN AND ON THE SIDES OF THE LETTERS, ALSO TO CREATE A RAISED EFFECT. THE WORDS "DURABLE PROTECTION" ARE LOCATED DIRECTLY UNDER THE SLASH OF THE LARGE LETTER "Q", AND APPEAR IN YELLOW WITH BLACK BORDERING.

FOR MOTOR OIL (U.S. CLS. 1, 6 AND 15).

JUDITH HELFMAN, EXAMINING ATTORNEY

SN 77-889,059. SANTA BARBARA, INC., MCALLEN, TX.
FILED 12-8-2009.



THE MARK CONSISTS OF A DRAWING OF FLAMES ABOVE THE WORDS "CARBOMEX LA CHISPA DEL FUEGO" IN STYLIZED LETTERS.

THE ENGLISH TRANSLATION OF "LA CHISPA DEL FUEGO" IN THE MARK IS THE FIRE SPARK. THE WORDING "CARBOMEX" HAS NO MEANING IN A FOREIGN LANGUAGE.

FOR CHARCOAL BRIQUETTES (U.S. CLS. 1, 6 AND 15).

KIMBERLY FRYE, EXAMINING ATTORNEY

CLASS 4—(Continued).

SN 77-891,642. KOETTER & SMITH INC, BORDEN, IN.
FILED 12-11-2009.

SUPREME COMFORT

THE MARK CONSISTS OF STANDARD CHARACTERS
WITHOUT CLAIM TO ANY PARTICULAR FONT, STYLE,
SIZE, OR COLOR.

FOR FUEL PELLETS (U.S. CLS. 1, 6 AND 15).
KAELE KUNG, EXAMINING ATTORNEY

SN 77-891,822. KOETTER & SMITH INC, BORDEN, IN.
FILED 12-11-2009.

SMITH CREEK

THE MARK CONSISTS OF STANDARD CHARACTERS
WITHOUT CLAIM TO ANY PARTICULAR FONT, STYLE,
SIZE, OR COLOR.

FOR FUEL PELLETS (U.S. CLS. 1, 6 AND 15).
KAELE KUNG, EXAMINING ATTORNEY

SN 77-891,968. CREATIVE FUELS, LLC, ARLINGTON, VA.
FILED 12-11-2009.

CREATIVE FUELS

THE MARK CONSISTS OF STANDARD CHARACTERS
WITHOUT CLAIM TO ANY PARTICULAR FONT, STYLE,
SIZE, OR COLOR.

NO CLAIM IS MADE TO THE EXCLUSIVE RIGHT TO
USE "FUELS", APART FROM THE MARK AS SHOWN.
FOR BIOFUELS (U.S. CLS. 1, 6 AND 15).
JESSICA FATHY, EXAMINING ATTORNEY

CLASS 4—(Continued).

SN 77-892,194. DOALL COMPANY, WHEELING, IL. FILED
12-13-2009.

KLEEN-KOOL ULTRA

THE MARK CONSISTS OF STANDARD CHARACTERS
WITHOUT CLAIM TO ANY PARTICULAR FONT, STYLE,
SIZE, OR COLOR.

OWNER OF U.S. REG. NO. 2,955,089.

NO CLAIM IS MADE TO THE EXCLUSIVE RIGHT TO
USE "ULTRA", APART FROM THE MARK AS SHOWN.

FOR MULTI-PURPOSE LIQUID FOR USE PRIMARILY
AS A LUBRICANT WITH SAWING, CUTTING AND
GRINDING MACHINES AND BLADES AND ALSO
USED AS A COOLANT (U.S. CLS. 1, 6 AND 15).

FIRST USE 11-15-2009; IN COMMERCE 11-15-2009.

MARGERY A. TIERNEY, EXAMINING ATTORNEY

SN 77-892,195. DOALL COMPANY, WHEELING, IL. FILED
12-13-2009.

KOOL-ALL ULTRA

THE MARK CONSISTS OF STANDARD CHARACTERS
WITHOUT CLAIM TO ANY PARTICULAR FONT, STYLE,
SIZE, OR COLOR.

OWNER OF U.S. REG. NO. 2,030,954.

NO CLAIM IS MADE TO THE EXCLUSIVE RIGHT TO
USE "ULTRA", APART FROM THE MARK AS SHOWN.

FOR MULTI-PURPOSE LIQUID FOR USE PRIMARILY
AS A LUBRICANT WITH SAWING, CUTTING AND
GRINDING MACHINES AND BLADES AND ALSO
USED AS A COOLANT (U.S. CLS. 1, 6 AND 15).

FIRST USE 11-15-2009; IN COMMERCE 11-15-2009.

MARGERY A. TIERNEY, EXAMINING ATTORNEY

SN 77-892,196. DOALL COMPANY, WHEELING, IL. FILED
12-13-2009.

POWER-CUT ULTRA

THE MARK CONSISTS OF STANDARD CHARACTERS
WITHOUT CLAIM TO ANY PARTICULAR FONT, STYLE,
SIZE, OR COLOR.

OWNER OF U.S. REG. NO. 3,044,825.

NO CLAIM IS MADE TO THE EXCLUSIVE RIGHT TO
USE "ULTRA", APART FROM THE MARK AS SHOWN.

FOR MULTI-PURPOSE LIQUID FOR USE PRIMARILY
AS A LUBRICANT WITH SAWING, CUTTING AND
GRINDING MACHINES AND BLADES AND ALSO
USED AS A COOLANT (U.S. CLS. 1, 6 AND 15).

FIRST USE 11-15-2009; IN COMMERCE 11-15-2009.

MARGERY A. TIERNEY, EXAMINING ATTORNEY

CLASS 4—(Continued).

SN 77-892,197. DOALL COMPANY, WHEELING, IL. FILED 12-13-2009.



OWNER OF U.S. REG. NOS. 390,078, 679,957 AND OTHERS.

THE COLOR(S) GREEN, WHITE AND BLACK IS/ARE CLAIMED AS A FEATURE OF THE MARK.

THE MARK CONSISTS OF THE WORD "DOALL" IN GREEN COLOR OUTLINED IN BLACK SUPERIMPOSED OVER A GREEN AND WHITE GLOBE DESIGN.

FOR MULTI-PURPOSE LIQUID FOR USE PRIMARILY AS A LUBRICANT WITH SAWING, CUTTING AND GRINDING MACHINES AND BLADES AND ALSO USED AS A COOLANT (U.S. CLS. 1, 6 AND 15).

FIRST USE 11-15-2009; IN COMMERCE 11-15-2009.
MARGERY A. TIERNEY, EXAMINING ATTORNEY

SN 77-915,595. VP RACING FUELS, INC., SAN ANTONIO, TX. FILED 1-20-2010.



OWNER OF U.S. REG. NOS. 2,093,123, 2,608,893 AND OTHERS.

NO CLAIM IS MADE TO THE EXCLUSIVE RIGHT TO USE "100", APART FROM THE MARK AS SHOWN.

THE MARK CONSISTS OF "VP 100" SUPERIMPOSED IN PART UPON AN OVAL.

FOR GASOLINE AND FUELS (U.S. CLS. 1, 6 AND 15).
HANNO RITTNER, EXAMINING ATTORNEY

SN 77-928,297. PENNZOIL-QUAKER STATE COMPANY, HOUSTON, TX. FILED 2-4-2010.

ECOBX

THE MARK CONSISTS OF STANDARD CHARACTERS WITHOUT CLAIM TO ANY PARTICULAR FONT, STYLE, SIZE, OR COLOR.

FOR FUEL OIL, TRANSMISSION OIL, VEHICULAR LUBRICANTS AND GASOLINE (U.S. CLS. 1, 6 AND 15).
JUDITH HELFMAN, EXAMINING ATTORNEY

CLASS 5—PHARMACEUTICALS

SN 76-697,778. KIBO GROUP INTERNATIONAL INCORPORATED, GREENWOOD, AR. FILED 6-8-2009.



NO CLAIM IS MADE TO THE EXCLUSIVE RIGHT TO USE "MOTHER ADMINISTERED NUTRITIVE AID", APART FROM THE MARK AS SHOWN.

THE MARK CONSISTS OF THE DESIGN OF A WOMAN HOLDING A BABY APPEARING WITHIN A CIRCLE. TO THE RIGHT OF THE CIRCLE IS THE STYLIZED WORD "MANA" APPEARING ABOVE THE SMALLER, STYLIZED WORDING, "MOTHER ADMINISTERED NUTRITIVE AID".

FOR DIETARY AND NUTRITIONALLY FORTIFIED FOOD PRODUCTS ADAPTED FOR MEDICAL USE, NAMELY, READY TO USE THERAPEUTICALLY ENRICHED PEANUT AND SOY BASED FOOD FOR PEDIATRIC MALNUTRITION (U.S. CLS. 6, 18, 44, 46, 51 AND 52).

AMY KERTGATE, EXAMINING ATTORNEY

SN 76-697,880. KIBO GROUP INTERNATIONAL INCORPORATED, GREENWOOD, AR. FILED 6-12-2009.

MANA

THE MARK CONSISTS OF STANDARD CHARACTERS WITHOUT CLAIM TO ANY PARTICULAR FONT, STYLE, SIZE, OR COLOR.

FOR DIETARY AND NUTRITIONALLY FORTIFIED FOOD PRODUCTS ADAPTED FOR MEDICAL USE, NAMELY, READY TO USE THERAPEUTICALLY ENRICHED PEANUT AND SOY BASED FOOD FOR PEDIATRIC MALNUTRITION (U.S. CLS. 6, 18, 44, 46, 51 AND 52).

AMY KERTGATE, EXAMINING ATTORNEY

CLASS 5—(Continued).

SN 76-700,751. JAMES JOSEPH KIERMAN JR., SALT SPRINGS, FL. FILED 12-9-2009.



NO CLAIM IS MADE TO THE EXCLUSIVE RIGHT TO USE "GNAT", APART FROM THE MARK AS SHOWN.

THE COLOR(S) RED, BLACK, WHITE, AND YELLOW IS/ ARE CLAIMED AS A FEATURE OF THE MARK.

THE RECTANGLE IS YELLOW AND OUTLINED IN BLACK, INSIDE THE RECTANGLE IS THE WORDING "GNAT B GON", THE TERMS "GNAT" AND "GON" ARE BLACK, THE LETTER "B" IS RED AND OUTLINED IN BLACK, INSIDE THE LOWER PORTION OF THE LETTER "B" IS A DESIGN OF A BLACK INSECT WITH BLACK AND WHITE WINGS.

FOR INSECT REPELLENTS (U.S. CLS. 6, 18, 44, 46, 51 AND 52).

FIRST USE 6-15-2009; IN COMMERCE 10-18-2009.

ALICIA COLLINS, EXAMINING ATTORNEY

SN 76-700,817. CONTROL SOLUTIONS, INC., PASADENA, TX. FILED 12-11-2009.

CYZMIC

THE MARK CONSISTS OF STANDARD CHARACTERS WITHOUT CLAIM TO ANY PARTICULAR FONT, STYLE, SIZE, OR COLOR.

FOR INSECTICIDES (U.S. CLS. 6, 18, 44, 46, 51 AND 52).

AMY KERTGATE, EXAMINING ATTORNEY

SN 76-701,508. CONTROL SOLUTIONS, INC., PASADENA, TX. FILED 2-12-2010.

PYSTOL

THE MARK CONSISTS OF STANDARD CHARACTERS WITHOUT CLAIM TO ANY PARTICULAR FONT, STYLE, SIZE, OR COLOR.

FOR INSECTICIDES (U.S. CLS. 6, 18, 44, 46, 51 AND 52).

AMY KERTGATE, EXAMINING ATTORNEY

CLASS 5—(Continued).

SN 77-047,776. APPLIED NUTRICEUTICALS, CHARLOTTE, NC. FILED 11-20-2006.

Osteobolin-C

THE MARK CONSISTS OF STANDARD CHARACTERS WITHOUT CLAIM TO ANY PARTICULAR FONT, STYLE, SIZE, OR COLOR.

FOR DIETARY AND NUTRITIONAL SUPPLEMENTS; DIETARY FOOD SUPPLEMENTS; DIETARY SUPPLEMENTS; DIETARY SUPPLEMENTS FOR HUMAN CONSUMPTION; HERBAL SUPPLEMENTS; NUTRACEUTICALS FOR USE AS A DIETARY SUPPLEMENT (U.S. CLS. 6, 18, 44, 46, 51 AND 52).

FIRST USE 11-1-2006; IN COMMERCE 11-20-2006.

KIMBERLY FRYE, EXAMINING ATTORNEY

SN 77-440,328. NORGENIX PHARMACEUTICALS, LLC, SPARTANBURG, SC. FILED 4-4-2008.

CAROGENIX PHARMACEUTICALS

THE MARK CONSISTS OF STANDARD CHARACTERS WITHOUT CLAIM TO ANY PARTICULAR FONT, STYLE, SIZE, OR COLOR.

NO CLAIM IS MADE TO THE EXCLUSIVE RIGHT TO USE "PHARMACEUTICALS", APART FROM THE MARK AS SHOWN.

FOR PHARMACEUTICAL PREPARATIONS FOR THE PREVENTION AND TREATMENT OF DISORDERS OF THE NERVOUS SYSTEM, THE IMMUNE SYSTEM, THE CARDIO-VASCULAR SYSTEM, THE METABOLIC SYSTEM, THE RESPIRATORY SYSTEM, THE MUSCULO-SKELETAL SYSTEM, THE GENITOURINARY SYSTEM; FOR THE TREATMENT OF INFLAMMATORY DISORDERS; FOR USE IN DERMATOLOGY, ONCOLOGY, HEMATOLOGY AND IN TISSUE AND ORGAN TRANSPLANTATION, IN OPHTHALMOLOGY AND FOR GASTROENTEROLOGICAL DISORDERS, OCULAR DISORDERS OR DISEASES, FOR THE TREATMENT OF BACTERIA-BASED DISEASES, AND FOR THE TREATMENT OF DIABETES, AND ANTI-INFECTIVE PREPARATIONS, ANTIVIRAL PREPARATIONS, ANTI-BIOTICS, ANTIFUNGAL PREPARATIONS AND VACCINES (U.S. CLS. 6, 18, 44, 46, 51 AND 52).

DOMINIC FATHY, EXAMINING ATTORNEY

CLASS 5—(Continued).

SN 77-485,026. JUSTACIP, INC., DBA NUKEPILLS.COM, MOORESVILLE, NC. FILED 5-28-2008.

Nukepills

THE MARK CONSISTS OF STANDARD CHARACTERS WITHOUT CLAIM TO ANY PARTICULAR FONT, STYLE, SIZE, OR COLOR.

FOR PHARMACEUTICAL PREPARATIONS FOR THE PREVENTION OF THYROID CANCER (U.S. CLS. 6, 18, 44, 46, 51 AND 52).

FIRST USE 11-17-2001; IN COMMERCE 12-19-2001.
JAY FLOWERS, EXAMINING ATTORNEY

SN 77-487,965. WARD CASSANDRA G, LOGANVILLE, GA. FILED 5-31-2008.

Flushables A new feminine
product that is really
disposable!
A new day going a new way

THE MARK CONSISTS OF STANDARD CHARACTERS WITHOUT CLAIM TO ANY PARTICULAR FONT, STYLE, SIZE, OR COLOR.

NO CLAIM IS MADE TO THE EXCLUSIVE RIGHT TO USE "FLUSHABLES A NEW FEMININE PRODUCT THAT IS REALLY DISPOSABLE!", APART FROM THE MARK AS SHOWN.

FOR FEMININE HYGIENE PADS; SANITARY NAPKINS (U.S. CLS. 6, 18, 44, 46, 51 AND 52).
SANI KHOURI, EXAMINING ATTORNEY

SN 77-559,911. ARDELYX, INC., FREMONT, CA. FILED 9-2-2008.

ARDELYX

THE MARK CONSISTS OF STANDARD CHARACTERS WITHOUT CLAIM TO ANY PARTICULAR FONT, STYLE, SIZE, OR COLOR.

FOR PHARMACEUTICAL PREPARATIONS FOR THE TREATMENT OF RENAL, CARDIOVASCULAR, GASTROINTESTINAL, ENDOCRINE, HEPATIC, INFLAMMATORY, METABOLIC, INFECTIOUS, PULMONARY, AND RESPIRATORY CONDITIONS, DISEASES, DISORDERS, AILMENTS AND ILLNESSES; PHARMACEUTICAL PREPARATIONS FOR THE TREATMENT OF RARE GENETIC DISEASES, PAIN, DIABETES, OBESITY, AND BONE AND JOINT DISORDERS; AND, PHARMACEUTICAL PREPARATIONS FOR DIAGNOSING AND TREATING CANCER (U.S. CLS. 6, 18, 44, 46, 51 AND 52).

ANDREA K. NADELMAN, EXAMINING ATTORNEY

CLASS 5—(Continued).

SN 77-568,166. NATURAL PRECEPTS, LLC, WINNSBORO, LA. FILED 9-11-2008.

TRUCKERS LUV IT

THE MARK CONSISTS OF STANDARD CHARACTERS WITHOUT CLAIM TO ANY PARTICULAR FONT, STYLE, SIZE, OR COLOR.

OWNER OF U.S. REG. NOS. 2,792,414 AND 2,833,257.
NO CLAIM IS MADE TO THE EXCLUSIVE RIGHT TO USE "TRUCKERS", APART FROM THE MARK AS SHOWN. FOR HERBAL SUPPLEMENTS (U.S. CLS. 6, 18, 44, 46, 51 AND 52).

FIRST USE 3-4-2004; IN COMMERCE 3-4-2004.
MEGHAN REINHART, EXAMINING ATTORNEY

SN 77-571,258. ARCHER PHARMACEUTICALS, INC., SARASOTA, FL. FILED 9-16-2008.



NO CLAIM IS MADE TO THE EXCLUSIVE RIGHT TO USE "PHARMACEUTICALS" AND "TARGETED DRUG DISCOVERY", APART FROM THE MARK AS SHOWN.

THE MARK CONSISTS OF TWO CONCENTRIC CIRCLES WITH ARCHERY BOW AND ARROW IN THE CENTER AND THE WORDS "ARCHER PHARMACEUTICALS TARGETED DRUG DISCOVERY" IN THE OUTER CIRCLE.

FOR PHARMACEUTICALS FOR THE TREATMENT OF ALZHEIMER'S DISEASE AND RELATED DISORDERS (U.S. CLS. 6, 18, 44, 46, 51 AND 52).

INGA ERVIN, EXAMINING ATTORNEY

CLASS 5—(Continued).

SN 77-592,218. GR INTELLECTUAL RESERVE, LLC, HAVRE DE GRACE, MD. FILED 10-14-2008.

SOLEIL DEW

THE MARK CONSISTS OF STANDARD CHARACTERS WITHOUT CLAIM TO ANY PARTICULAR FONT, STYLE, SIZE, OR COLOR.

THE ENGLISH TRANSLATION OF "SOLEIL" IN THE MARK IS SUN.

FOR PHARMACEUTICAL PREPARATIONS FOR THE RELIEF OF COLDS AND FLU SYMPTOMS AND ENHANCEMENT OF THE IMMUNE SYSTEM (U.S. CLS. 6, 18, 44, 46, 51 AND 52).

TINA BROWN, EXAMINING ATTORNEY

SN 77-614,012. ACTIVE RESEARCH LABS, LLC, FREMONT, OH. FILED 11-13-2008.

Controltabs
PCT) Portion Control Technology

NO CLAIM IS MADE TO THE EXCLUSIVE RIGHT TO USE "CONTROL TABS" AND "TECHNOLOGY", APART FROM THE MARK AS SHOWN.

THE COLOR(S) BLACK, YELLOW, AND GRAY IS/ARE CLAIMED AS A FEATURE OF THE MARK.

THE MARK CONSISTS OF THE WORD "CONTROL" IN THE COLOR BLACK; THE WORD "TABS" IS IN THE COLOR YELLOW; AND THE WORDS "PCT) PORTION CONTROL TECHNOLOGY" ARE IN THE COLOR GRAY.

FOR DIETARY SUPPLEMENTS FOR APPETITE CONTROL (U.S. CLS. 6, 18, 44, 46, 51 AND 52).

COLLEEN DOMBROW, EXAMINING ATTORNEY

SN 77-654,150. SANOFI-AVENTIS, 75635 PARIS CEDEX 13, FRANCE, FILED 1-22-2009.

PICOVIR

THE MARK CONSISTS OF STANDARD CHARACTERS WITHOUT CLAIM TO ANY PARTICULAR FONT, STYLE, SIZE, OR COLOR.

FOR ANTIVIRAL PHARMACEUTICAL PREPARATIONS (U.S. CLS. 6, 18, 44, 46, 51 AND 52).

ODESSA BIBBINS, EXAMINING ATTORNEY

CLASS 5—(Continued).

SN 77-708,968. HIROOKA, RYUJI, SCOTTSDALE, AZ. FILED 4-7-2009.



NO CLAIM IS MADE TO THE EXCLUSIVE RIGHT TO USE "AMERICAN INSTITUTE OF EASTERN MEDICINE" AND THE NON-LATIN CHARACTERS THAT MEAN "PHILANTHROPY" AND "AMERICAN INSTITUTE OF EASTERN MEDICINE", APART FROM THE MARK AS SHOWN.

THE COLOR(S) RED, WHITE AND GOLD IS/ARE CLAIMED AS A FEATURE OF THE MARK.

THE MARK CONSISTS OF LATIN CHARACTERS FORMING THE WORDS "AMERICAN INSTITUTE OF EASTERN MEDICINE" IN WHITE SET BENEATH NON-LATIN CHARACTERS IN WHITE WHICH, ROUGHLY TRANSLATED, MEAN "PHILANTHROPY" ACCORDING TO THE CHINESE LANGUAGE. THE LATIN AND NON-LATIN CHARACTERS ARE SEPARATED BY A SMALL OVAL CONTAINING ADDITIONAL THE LATIN CHARACTERS "WXI" WHICH ARE WRITTEN IN RED AND SET WITHIN A GOLD BACKGROUND. THE LATIN AND NON-LATIN CHARACTERS, TOGETHER WITH THE OVAL SEPARATOR, ARE SET WITHIN A RED RECTANGULAR BACKGROUND. THE RED RECTANGULAR BACKGROUND IS SURROUNDED BY A SOLID GOLD BORDER WHICH IS SLIGHTLY SET APART FROM THE RED BACKGROUND AND BROKEN ON EITHER SIDE SO AS NOT TO OVERLAP THE TWO INWARD-FACING DRAGONS OF THE SAME SHADE AND COLOR PLACED ON THE EASTERN AND WESTERN BORDER THEREOF. APPEARING BELOW THE SOUTHERN SOLID GOLD BORDER ARE EIGHT NON-LATIN CHARACTERS DRAWN IN RED WHICH MEAN "AMERICAN INSTITUTE OF EASTERN MEDICINE" ACCORDING TO THE CHINESE LANGUAGE.

THE NON-LATIN CHARACTERS IN THE MARK TRANSLITERATE TO "AI BO" AND "MEI GUO DONG FANG YI XUE XIE HUI" AND THIS MEANS "PHILANTHROPY" AND "AMERICAN INSTITUTE OF EASTERN MEDICINE" IN ENGLISH.

FOR DIETARY SUPPLEMENTS; NUTRITIONAL SUPPLEMENTS (U.S. CLS. 6, 18, 44, 46, 51 AND 52).

FIRST USE 2-1-2007; IN COMMERCE 2-1-2007.

SKYE YOUNG, EXAMINING ATTORNEY

CLASS 5—(Continued).

SN 77-712,193. COMMOTION FRESH FOODS, LLC, BOULDER, CO. FILED 4-12-2009.

CLASS 5—(Continued).

SN 77-737,497. FATE THERAPEUTICS, INC., LA JOLLA, CA. FILED 5-14-2009.

SmartBaby

FATE THERAPEUTICS

THE MARK CONSISTS OF STANDARD CHARACTERS WITHOUT CLAIM TO ANY PARTICULAR FONT, STYLE, SIZE, OR COLOR.

FOR BABY FOOD, NAMELY, REFRIGERATED, FROZEN, AND SHELF STABLE FOOD FOR INFANTS AND TODDLERS; BABY BEVERAGES, NAMELY, INFANT FORMULA AND NUTRITIONALLY FORTIFIED BEVERAGES (U.S. CLS. 6, 18, 44, 46, 51 AND 52).
ANGELA DUONG, EXAMINING ATTORNEY

THE MARK CONSISTS OF STANDARD CHARACTERS WITHOUT CLAIM TO ANY PARTICULAR FONT, STYLE, SIZE, OR COLOR.

NO CLAIM IS MADE TO THE EXCLUSIVE RIGHT TO USE "THERAPEUTICS", APART FROM THE MARK AS SHOWN.

FOR A FULL LINE OF PHARMACEUTICAL PREPARATIONS AND THERAPEUTIC AGENTS; PHARMACEUTICAL PREPARATIONS AND THERAPEUTIC AGENTS TO MODULATE CELL FATE; REAGENTS FOR RESEARCH, DRUG DISCOVERY AND DEVELOPMENT, CLINICAL, AND MEDICAL USE; AND PHARMACEUTICAL PREPARATIONS AND THERAPEUTIC AGENTS FOR THE TREATMENT OF CANCER (U.S. CLS. 6, 18, 44, 46, 51 AND 52).
KEVON CHISOLM, EXAMINING ATTORNEY

SN 77-717,567. SANTAL SOLUTIONS LLC, APPLETON, WI. FILED 4-20-2009.

THE PERFECT BALANCE OF NATURE AND SCIENCE

THE MARK CONSISTS OF STANDARD CHARACTERS WITHOUT CLAIM TO ANY PARTICULAR FONT, STYLE, SIZE, OR COLOR.

FOR DIETARY AND NUTRITIONAL SUPPLEMENTS (U.S. CLS. 6, 18, 44, 46, 51 AND 52).
MICHAEL SOUDERS, EXAMINING ATTORNEY

SN 77-740,571. DOX SOLUTIONS LLC, PLAYA VISTA, CA. FILED 5-19-2009.

Dox Cardio Water

SN 77-731,844. UPLIFT NUTRITION, INC., SANDY, UT. FILED 5-7-2009.

EPIGAIA

THE MARK CONSISTS OF STANDARD CHARACTERS WITHOUT CLAIM TO ANY PARTICULAR FONT, STYLE, SIZE, OR COLOR.

OWNER OF U.S. REG. NO. 3,551,632.
NO CLAIM IS MADE TO THE EXCLUSIVE RIGHT TO USE "CARDIO WATER", APART FROM THE MARK AS SHOWN.

THE MARK CONSISTS OF STANDARD CHARACTERS WITHOUT CLAIM TO ANY PARTICULAR FONT, STYLE, SIZE, OR COLOR.

FOR EPIGENETIC NUTRITIONAL SUPPLEMENTS NOT CONTAINING EPIGAEA (U.S. CLS. 6, 18, 44, 46, 51 AND 52).
TRACY WHITTAKER-BROWN, EXAMINING ATTORNEY

FOR NUTRITIONALLY FORTIFIED WATER (U.S. CLS. 6, 18, 44, 46, 51 AND 52).
FIRST USE 1-7-2008; IN COMMERCE 1-7-2008.
JAMES LOVELACE, EXAMINING ATTORNEY

CLASS 5—(Continued).

SN 77-755,375. BAYER AKTIENGESELLSCHAFT, 51373 LEVERKUSEN, FED REP GERMANY, FILED 6-9-2009.

VALINDRA

THE MARK CONSISTS OF STANDARD CHARACTERS WITHOUT CLAIM TO ANY PARTICULAR FONT, STYLE, SIZE, OR COLOR.

PRIORITY CLAIMED UNDER SEC. 44(D) ON FED REP GERMANY APPLICATION NO. 302008078510, FILED 12-15-2008, REG. NO. 302008078510, DATED 2-23-2009, EXPIRES 12-31-2018.

THE WORDING "VALINDRA" HAS NO MEANING IN A FOREIGN LANGUAGE.

FOR PHARMACEUTICAL PREPARATIONS AND SUBSTANCES FOR THE TREATMENT OF PULMONARY HYPERTENSION, CARDIOVASCULAR DISORDERS AND DISEASES; NONE OF THE AFORESAID BEING IN TOPICAL FORM (U.S. CLS. 6, 18, 44, 46, 51 AND 52).
AISHA SALEM, EXAMINING ATTORNEY

SN 77-757,026. CROWN LABORATORIES, INC., JOHNSON CITY, TN, FILED 6-11-2009.

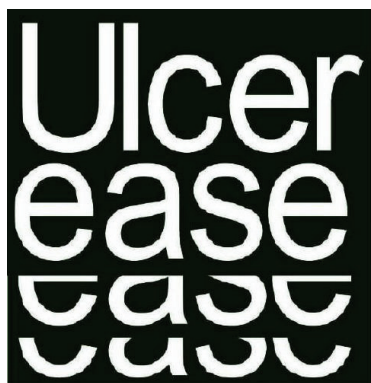

OWNER OF U.S. REG. NO. 1,106,969.
NO CLAIM IS MADE TO THE EXCLUSIVE RIGHT TO USE "ULCER EASE", APART FROM THE MARK AS SHOWN.

THE MARK CONSISTS OF "ULCER" APPEARING IN A SQUARE ABOVE THE WORD "EASE", AND BELOW THE WORD "EASE", SUCCESSIVELY OVER EACH OTHER ARE THE BOTTOM HALF OF THE LETTERS OF THE WORD "EASE" AND LOWER PORTIONS OF THE LETTERS OF THE WORD "EASE".

FOR ANESTHETIC MOUTH RINSE (U.S. CLS. 6, 18, 44, 46, 51 AND 52).
FIRST USE 2-9-1977; IN COMMERCE 3-1-1977.
MARGARET POWER, EXAMINING ATTORNEY

CLASS 5—(Continued).

SN 77-757,578. LEARNING CURVE BRANDS, INC., SOUTH BEND, IN, FILED 6-11-2009.

BEE RELIEVED

THE MARK CONSISTS OF STANDARD CHARACTERS WITHOUT CLAIM TO ANY PARTICULAR FONT, STYLE, SIZE, OR COLOR.

FOR NON-MEDICATED SPRAY FOR PERINEAL SOOTHING (U.S. CLS. 6, 18, 44, 46, 51 AND 52).

FIRST USE 5-18-2009; IN COMMERCE 5-18-2009.
JASON TURNER, EXAMINING ATTORNEY

SN 77-758,889. HEALTHY PETS, INC., UNION CITY, CA, FILED 6-12-2009.

CANIOX

THE MARK CONSISTS OF STANDARD CHARACTERS WITHOUT CLAIM TO ANY PARTICULAR FONT, STYLE, SIZE, OR COLOR.

FOR NUTRITIONAL SUPPLEMENTS FOR PETS (U.S. CLS. 6, 18, 44, 46, 51 AND 52).

FIRST USE 11-10-2008; IN COMMERCE 11-10-2008.
JULIE GUTTADAURÓ, EXAMINING ATTORNEY

SN 77-763,092. UNI-CHARM CORPORATION, EHIME-KEN, JAPAN, FILED 6-18-2009.

Lifree

THE MARK CONSISTS OF STANDARD CHARACTERS WITHOUT CLAIM TO ANY PARTICULAR FONT, STYLE, SIZE, OR COLOR.

OWNER OF JAPAN REG. NO. 4275807, DATED 5-21-1999, EXPIRES 5-21-2019.

FOR INCONTINENCE PANTS/LINERS/DIAPERS ABSORBENT PADS FOR INCONTINENCE (U.S. CLS. 6, 18, 44, 46, 51 AND 52).

HENRY S. ZAK, EXAMINING ATTORNEY

CLASS 5—(Continued).

SN 77-763,363. UNI-CHARM CORPORATION, EHIME-KEN, JAPAN, FILED 6-18-2009.

Rehabili Pants

THE MARK CONSISTS OF STANDARD CHARACTERS WITHOUT CLAIM TO ANY PARTICULAR FONT, STYLE, SIZE, OR COLOR.

NO CLAIM IS MADE TO THE EXCLUSIVE RIGHT TO USE "PANTS", APART FROM THE MARK AS SHOWN.

FOR INCONTINENCE PANTS/LINERS/DIAPERS ABSORBENT PADS FOR INCONTINENCE (U.S. CLS. 6, 18, 44, 46, 51 AND 52).

HENRY S. ZAK, EXAMINING ATTORNEY

SN 77-773,241. ELI LILLY AND COMPANY, INDIANAPOLIS, IN. FILED 7-2-2009.

RELZUR

THE MARK CONSISTS OF STANDARD CHARACTERS WITHOUT CLAIM TO ANY PARTICULAR FONT, STYLE, SIZE, OR COLOR.

FOR PHARMACEUTICAL PREPARATIONS, NAMELY, PHARMACEUTICAL PREPARATIONS FOR THE TREATMENT OF ALCOHOL USE DISORDERS, ANXIETY, BONE AND SKELETAL DISEASES AND DISORDERS, BLOOD DISORDERS, CANCER, CARDIOVASCULAR DISEASES, CENTRAL NERVOUS SYSTEM DISEASES AND DISORDERS, DIABETES, ENDOCRINE DISEASES AND DISORDERS, GASTROINTESTINAL DISEASES AND DISORDERS, HORMONAL DISEASES AND DISORDERS, INFLAMMATION AND INFLAMMATORY DISEASES AND DISORDERS, LIVER DISEASES AND DISORDERS, KIDNEY DISEASES AND DISORDERS, NEURODEGENERATIVE DISEASES AND DISORDERS, NEUROLOGICAL DISORDERS, OBESITY, PAIN, REPRODUCTIVE SYSTEM DISEASES AND DISORDERS, UROLOGICAL DISORDERS, DYSLIPIDEMIA, SLEEP DISORDERS, MIGRAINES, METABOLIC DISEASES AND DISORDERS; ANTIPSYCHOTICS; ANTIDEPRESSANTS (U.S. CLS. 6, 18, 44, 46, 51 AND 52).

JENNIFER VASQUEZ, EXAMINING ATTORNEY

CLASS 5—(Continued).

SN 77-781,747. BRISTOL-MYERS SQUIBB COMPANY, NEW YORK, NY. FILED 7-15-2009.

WIMBLIS

THE MARK CONSISTS OF STANDARD CHARACTERS WITHOUT CLAIM TO ANY PARTICULAR FONT, STYLE, SIZE, OR COLOR.

THE WORDING "WIMBLIS" HAS NO MEANING IN A FOREIGN LANGUAGE.

FOR PHARMACEUTICAL PREPARATIONS FOR HUMAN USE FOR THE TREATMENT AND PREVENTION OF OBESITY, DIABETES, INCONTINENCE, CARDIOVASCULAR DISEASES, CENTRAL NERVOUS SYSTEM DISEASES AND DISORDERS, METABOLIC DISORDERS, STROKE, CANCER, INFLAMMATION AND INFLAMMATORY DISEASES, RESPIRATORY AND INFECTIOUS DISEASES, AUTO-IMMUNE DISEASES, SOLID ORGAN TRANSPLANT REJECTION; PHARMACEUTICAL PREPARATIONS FOR HUMAN USE, NAMELY, ANTIBIOTICS, ANTI-FUNGALS, ANTI-VIRALS, IMMUNOSUPPRESSANTS AND PHARMACEUTICAL ANTIBODIES (U.S. CLS. 6, 18, 44, 46, 51 AND 52).

ZHALEH DELANEY, EXAMINING ATTORNEY

SN 77-787,189. AMERICAN NUTRACEUTICALS, INC., SEDRO WOOLLEY, WA. FILED 7-22-2009.

VARIMUNE

THE MARK CONSISTS OF STANDARD CHARACTERS WITHOUT CLAIM TO ANY PARTICULAR FONT, STYLE, SIZE, OR COLOR.

FOR DIETARY SUPPLEMENTS (U.S. CLS. 6, 18, 44, 46, 51 AND 52).

FIRST USE 11-1-2001; IN COMMERCE 11-1-2001.

MARLENE BELL, EXAMINING ATTORNEY

CLASS 5—(Continued).

SN 77-789,899. BRISTOL-MYERS SQUIBB COMPANY, NEW YORK, NY. FILED 7-27-2009.

KEXGARD

THE MARK CONSISTS OF STANDARD CHARACTERS WITHOUT CLAIM TO ANY PARTICULAR FONT, STYLE, SIZE, OR COLOR.

THE WORDING "KEXGARD" HAS NO MEANING IN A FOREIGN LANGUAGE.

FOR PHARMACEUTICAL PREPARATIONS FOR HUMAN USE FOR THE TREATMENT AND PREVENTION OF OBESITY, DIABETES, INCONTINENCE, CARDIOVASCULAR DISEASES, CENTRAL NERVOUS SYSTEM DISEASES AND DISORDERS, METABOLIC DISORDERS, STROKE, CANCER, INFLAMMATION AND INFLAMMATORY DISEASES, RESPIRATORY AND INFECTIOUS DISEASES, AUTO-IMMUNE DISEASES, SOLID ORGAN TRANSPLANT REJECTION; PHARMACEUTICAL PREPARATIONS FOR HUMAN USE, NAMELY, ANTIBIOTICS, ANTI-FUNGALS, ANTI-VIRALS, IMMUNOSUPPRESSANTS AND PHARMACEUTICAL ANTIBODIES (U.S. CLS. 6, 18, 44, 46, 51 AND 52).
ZHALEH DELANEY, EXAMINING ATTORNEY

SN 77-789,903. BRISTOL-MYERS SQUIBB COMPANY, NEW YORK, NY. FILED 7-27-2009.

INSUQUEST

THE MARK CONSISTS OF STANDARD CHARACTERS WITHOUT CLAIM TO ANY PARTICULAR FONT, STYLE, SIZE, OR COLOR.

THE WORDING "INSUQUEST" HAS NO MEANING IN A FOREIGN LANGUAGE.

FOR PHARMACEUTICAL PREPARATIONS FOR HUMAN USE FOR THE TREATMENT AND PREVENTION OF OBESITY, DIABETES, INCONTINENCE, CARDIOVASCULAR DISEASES, CENTRAL NERVOUS SYSTEM DISEASES AND DISORDERS, METABOLIC DISORDERS, STROKE, CANCER, INFLAMMATION AND INFLAMMATORY DISEASES, RESPIRATORY AND INFECTIOUS DISEASES, AUTO-IMMUNE DISEASES, SOLID ORGAN TRANSPLANT REJECTION; PHARMACEUTICAL PREPARATIONS FOR HUMAN USE, NAMELY, ANTIBIOTICS, ANTI-FUNGALS, ANTI-VIRALS, IMMUNOSUPPRESSANTS AND PHARMACEUTICAL ANTIBODIES (U.S. CLS. 6, 18, 44, 46, 51 AND 52).
ZHALEH DELANEY, EXAMINING ATTORNEY

CLASS 5—(Continued).

SN 77-796,979. GRUPO CAROSI SOCIEDAD ANONIMA, AVENTURA, FL. FILED 8-4-2009.

LA FUENTE DE LA SALUD

THE MARK CONSISTS OF STANDARD CHARACTERS WITHOUT CLAIM TO ANY PARTICULAR FONT, STYLE, SIZE, OR COLOR.

THE ENGLISH TRANSLATION OF "LA FUENTE DE LA SALUD" IN THE MARK IS THE FOUNTAIN OF HEALTH. FOR VITAMINS, MINERALS, DIETARY AND NUTRITIONAL SUPPLEMENTS (U.S. CLS. 6, 18, 44, 46, 51 AND 52).

CIMMERIAN COLEMAN, EXAMINING ATTORNEY

SN 77-805,526. CORPORACION INFARMASA S.A., MIRAFLORES, LIMA, PERU, FILED 8-16-2009.

ASEPTIL ROJO

THE MARK CONSISTS OF STANDARD CHARACTERS WITHOUT CLAIM TO ANY PARTICULAR FONT, STYLE, SIZE, OR COLOR.

NO CLAIM IS MADE TO THE EXCLUSIVE RIGHT TO USE "ROJO", APART FROM THE MARK AS SHOWN.

THE ENGLISH TRANSLATION OF "ROJO" IN THE MARK IS RED. THE WORDING "ASEPTIL" HAS NO MEANING IN A FOREIGN LANGUAGE.

FOR ANTI-INFLAMMATORY PREPARATIONS FOR TREATING THE THROAT; THROAT LOZENGES; MEDICATED THROAT SPRAYS (U.S. CLS. 6, 18, 44, 46, 51 AND 52).

SUSAN RICHARDS, EXAMINING ATTORNEY

SN 77-815,598. CUSTOM HBC CORPORATION, WACONIA, MN. FILED 8-28-2009.

Pocket Sprayer

THE MARK CONSISTS OF STANDARD CHARACTERS WITHOUT CLAIM TO ANY PARTICULAR FONT, STYLE, SIZE, OR COLOR.

NO CLAIM IS MADE TO THE EXCLUSIVE RIGHT TO USE "SPRAYER", APART FROM THE MARK AS SHOWN. SEC. 2(F).

FOR ANTIBACTERIAL ALCOHOL SKIN SANITIZER GEL; HAND-SANITIZING PREPARATIONS (U.S. CLS. 6, 18, 44, 46, 51 AND 52).

FIRST USE 12-31-2004; IN COMMERCE 1-2-2005.

MEGHAN REINHART, EXAMINING ATTORNEY

CLASS 5—(Continued).

SN 77-821,038. PHYTOPEDE LLC, SARASOTA, FL. FILED 9-5-2009.

"Green Heals"

THE MARK CONSISTS OF STANDARD CHARACTERS WITHOUT CLAIM TO ANY PARTICULAR FONT, STYLE, SIZE, OR COLOR.

NO CLAIM IS MADE TO THE EXCLUSIVE RIGHT TO USE "GREEN", APART FROM THE MARK AS SHOWN.

FOR ENVIRONMENTALLY FRIENDLY GREEN-COLORED ALCOHOL FOR TOPICAL USE; ENVIRONMENTALLY FRIENDLY GREEN-COLORED HERBAL TOPICAL CREAMS, GELS, SALVES, SPRAYS, POWDER, BALMS, LINIMENT AND OINTMENTS FOR THE RELIEF OF ACHEs AND PAIN; ENVIRONMENTALLY FRIENDLY GREEN-COLORED TOPICAL ANALGESICS; ENVIRONMENTALLY FRIENDLY GREEN-COLORED TOPICAL ANESTHETICS (U.S. CLS. 6, 18, 44, 46, 51 AND 52).

FIRST USE 6-1-2009; IN COMMERCE 7-1-2009.
NAKIA HENRY, EXAMINING ATTORNEY

SN 77-821,576. BIOBANK CO., LTD., OKAYAMA-SHI, OKAYAMA, JAPAN, FILED 9-8-2009.

BIOBANK

THE MARK CONSISTS OF STANDARD CHARACTERS WITHOUT CLAIM TO ANY PARTICULAR FONT, STYLE, SIZE, OR COLOR.

FOR NUTRITIONAL ADDITIVES FOR MEDICAL PURPOSES AND HEALTH MAINTENANCE FOR USE IN FOOD AND DIETARY SUPPLEMENTS FOR HUMAN CONSUMPTION; DIETARY SUPPLEMENTS (U.S. CLS. 6, 18, 44, 46, 51 AND 52).

CHARLOTTE CORWIN, EXAMINING ATTORNEY

SN 77-833,035. DRUGTECH CORPORATION, WILMINGTON, DE. FILED 9-23-2009.

DILITAZ

THE MARK CONSISTS OF STANDARD CHARACTERS WITHOUT CLAIM TO ANY PARTICULAR FONT, STYLE, SIZE, OR COLOR.

FOR PHARMACEUTICAL PRODUCTS AND PREPARATIONS, NAMELY, PREPARATIONS FOR THE TREATMENT OF HIGH BLOOD PRESSURE, HYPERTENSION, ANGINA, AND RELATED DISORDERS (U.S. CLS. 6, 18, 44, 46, 51 AND 52).

JANET LEE, EXAMINING ATTORNEY

CLASS 5—(Continued).

SN 77-833,038. DRUGTECH CORPORATION, WILMINGTON, DE. FILED 9-23-2009.

TIZEM

THE MARK CONSISTS OF STANDARD CHARACTERS WITHOUT CLAIM TO ANY PARTICULAR FONT, STYLE, SIZE, OR COLOR.

FOR PHARMACEUTICAL PRODUCTS AND PREPARATIONS, NAMELY, PREPARATIONS FOR THE TREATMENT OF HIGH BLOOD PRESSURE, HYPERTENSION, ANGINA, AND RELATED DISORDERS (U.S. CLS. 6, 18, 44, 46, 51 AND 52).

JANET LEE, EXAMINING ATTORNEY

SN 77-837,865. NOVAN, INC., DURHAM, NC. FILED 9-30-2009.

NITRISORB

THE MARK CONSISTS OF STANDARD CHARACTERS WITHOUT CLAIM TO ANY PARTICULAR FONT, STYLE, SIZE, OR COLOR.

FOR MEDICATED TOPICAL CREAMS, GELS, SALVES, SPRAYS, POWDERS, BALMS, LINIMENTS AND OINTMENTS ALL FOR MANAGING MOISTURE MICROBIAL GROWTH ON HUMAN SKIN (U.S. CLS. 6, 18, 44, 46, 51 AND 52).

Laurie Kaufman, EXAMINING ATTORNEY

SN 77-837,868. NOVAN, INC., DURHAM, NC. FILED 9-30-2009.

NITRICLEAR

THE MARK CONSISTS OF STANDARD CHARACTERS WITHOUT CLAIM TO ANY PARTICULAR FONT, STYLE, SIZE, OR COLOR.

FOR MEDICATED TOPICAL CREAMS, GELS, SALVES, SPRAYS, POWDERS, BALMS, LINIMENTS AND OINTMENTS ALL FOR PREVENTING MICROBIAL GROWTH ON HUMAN SKIN (U.S. CLS. 6, 18, 44, 46, 51 AND 52).

Laurie Kaufman, EXAMINING ATTORNEY

CLASS 5—(Continued).

SN 77-838,847. DAXLEY USA L.L.C., ORLANDO, FL. FILED 10-1-2009.



THE COLOR(S) BURGUNDY AND GRAY IS/ARE CLAIMED AS A FEATURE OF THE MARK.

THE MARK CONSISTS OF A STYLIZED LETTER "D" WITH THE RIGHT SIDE OF THE "D" APPEARING IN BURGUNDY AND THE LEFT SIDE OF THE "D" APPEARING IN GRAY AND THE WORD "DAXLEY" APPEARING IN BURGUNDY DIRECTLY TO THE RIGHT SIDE OF THE STYLIZED LETTER "D".

FOR PHARMACEUTICAL PREPARATIONS FOR THE TREATMENT OF INFERTILITY, NEUROLOGY, CANCER, HEMATOLOGY; PHARMACEUTICAL PREPARATIONS, NAMELY, A DRUG DELIVERY SYSTEM COMPRISING POLYMER-BASED ORAL TABLETS FOR THE CONTINUOUS RELEASE OF A WIDE VARIETY OF THERAPEUTIC AGENTS; PHARMACEUTICAL PRODUCTS FOR THE PREVENTION AND TREATMENT OF CANCER; PHARMACEUTICAL SOLUTIONS USED IN DIALYSIS; PHARMACEUTICALS, NAMELY, ANTI-INFECTIVES; PHARMACEUTICALS, NAMELY, PSYCHOTROPICS; VITAMIN AND MINERAL PREPARATIONS FOR USE AS INGREDIENTS IN THE FOOD AND PHARMACEUTICAL INDUSTRY (U.S. CLS. 6, 18, 44, 46, 51 AND 52).

ASMAT KHAN, EXAMINING ATTORNEY

SN 77-848,657. JUAREZ ORLANDO, DBA OXYMASS, SAN DIEGO, CA. FILED 10-14-2009.



THE COLOR(S) RED IS/ARE CLAIMED AS A FEATURE OF THE MARK.

THE MARK CONSISTS OF RED COLOR LETTERS, "T-KITO" ON TOP AND "KILOS" RIGHT BELOW "KITO". CAPITAL LETTERS.

FOR DIETARY FOOD SUPPLEMENTS (U.S. CLS. 6, 18, 44, 46, 51 AND 52).

JENNIFER VASQUEZ, EXAMINING ATTORNEY

CLASS 5—(Continued).

SN 77-849,910. SELOMITH RAMIREZ MORELES, IRAPUATO, MEXICO, FILED 10-15-2009.



THE MARK CONSISTS OF A STYLIZED RENDERING OF THE TEXT "VID-AZ FORTE".

THE WORDING "VID-AZ" HAS NO MEANING IN A FOREIGN LANGUAGE.

FOR DIETARY AND NUTRITIONAL SUPPLEMENTS (U.S. CLS. 6, 18, 44, 46, 51 AND 52).

ALICE BENMAMAN, EXAMINING ATTORNEY

SN 77-850,590. MIDDLEBROOK PHARMACEUTICALS, INC., GERMANTOWN, MD. FILED 10-16-2009.



OWNER OF U.S. REG. NOS. 3,627,404 AND 3,706,773.

THE MARK CONSISTS OF A STYLIZED DESIGN OF INCLUDING THE WORDS "MOXPAK" WITH A NUMBER "1" IN THE "M".

FOR ANTIBIOTICS (U.S. CLS. 6, 18, 44, 46, 51 AND 52).

ANN E. SAPPENFIELD, EXAMINING ATTORNEY

SN 77-853,534. ARES TRADING S.A., AUBONNE CH-1170, SWITZERLAND, FILED 10-21-2009.



THE MARK CONSISTS OF STANDARD CHARACTERS WITHOUT CLAIM TO ANY PARTICULAR FONT, STYLE, SIZE, OR COLOR.

FOR PHARMACEUTICAL PREPARATIONS FOR HUMAN USE, NAMELY, PREPARATIONS FOR THE TREATMENT OF IMMUNOLOGICAL DISEASES AND DISORDERS, INFLAMMATORY DISEASES AND DISORDERS, ENDOCRINOLOGICAL DISEASES AND DISORDERS, ONCOLOGICAL DISEASES AND DISORDERS, NEUROLOGICAL DISEASES AND DISORDERS, METABOLIC DISEASES AND DISORDERS, RHEUMATOLOGICAL DISEASES AND DISORDERS (U.S. CLS. 6, 18, 44, 46, 51 AND 52).

TRACY CROSS, EXAMINING ATTORNEY

CLASS 5—(Continued).

SN 77-855,981. ACTELION PHARMACEUTICALS LTD., ALLSCHWIL, SWITZERLAND, FILED 10-23-2009.

PIVLAZ

THE MARK CONSISTS OF STANDARD CHARACTERS WITHOUT CLAIM TO ANY PARTICULAR FONT, STYLE, SIZE, OR COLOR.

OWNER OF U.S. REG. NO. 3,302,805.

FOR PHARMACEUTICAL PREPARATIONS FOR CEREBROVASCULAR, CARDIOVASCULAR, PULMONARY, INFLAMMATORY INDICATIONS AS WELL AS FOR THE TREATMENT OF CANCER (U.S. CLS. 6, 18, 44, 46, 51 AND 52).

SEAN CROWLEY, EXAMINING ATTORNEY

SN 77-856,312. MARUHACHI MURAMATSU, INC, SHIZUOKA, JAPAN, FILED 10-23-2009.

HY-FISH

THE MARK CONSISTS OF STANDARD CHARACTERS WITHOUT CLAIM TO ANY PARTICULAR FONT, STYLE, SIZE, OR COLOR.

FOR FISH MEAT EXTRACT FOR BACTERIOLOGICAL CULTURES, FISH STOCK EXTRACT FOR BACTERIOLOGICAL CULTURES, FISH MEAT EXTRACT FOR CELL CULTURES, FISH STOCK EXTRACT FOR CELL CULTURES, MEDIA FOR BACTERIOLOGICAL CULTURES, MEDIA FOR CELL CULTURES, FISH MEAT EXTRACT TO BE ADDED TO THE MEDIA FOR BACTERIOLOGICAL CULTURES, FISH STOCK EXTRACT TO BE ADDED TO THE MEDIA FOR BACTERIOLOGICAL CULTURES, FISH MEAT EXTRACT TO BE ADDED TO THE MEDIA FOR CELL CULTURES, FISH STOCK EXTRACT TO BE ADDED TO THE MEDIA FOR CELL CULTURES (U.S. CLS. 6, 18, 44, 46, 51 AND 52).

FIRST USE 12-7-1998; IN COMMERCE 2-28-2000.
MICHAEL WEBSTER, EXAMINING ATTORNEY

SN 77-857,110. ARROYO FERRER, FERNANDO, MAYAGUEZ, PUERTO RICO, FILED 10-26-2009.

Abadisin

THE MARK CONSISTS OF STANDARD CHARACTERS WITHOUT CLAIM TO ANY PARTICULAR FONT, STYLE, SIZE, OR COLOR.

THE MARK HAS NO MEANING IN A FOREIGN LANGUAGE.

FOR ALL PURPOSE DISINFECTING AND DEODORIZING PREPARATIONS (U.S. CLS. 6, 18, 44, 46, 51 AND 52).

FIRST USE 11-3-2005; IN COMMERCE 11-3-2005.
EVELYN BRADLEY, EXAMINING ATTORNEY

CLASS 5—(Continued).

SN 77-857,149. ARROYO FERRER, FERNANDO, MAYAGUEZ, PUERTO RICO, FILED 10-26-2009.

Neudisin

THE MARK CONSISTS OF STANDARD CHARACTERS WITHOUT CLAIM TO ANY PARTICULAR FONT, STYLE, SIZE, OR COLOR.

THE MARK HAS NO MEANING IN A FOREIGN LANGUAGE.

FOR ALL PURPOSE DISINFECTING AND DEODORIZING PREPARATIONS (U.S. CLS. 6, 18, 44, 46, 51 AND 52).

FIRST USE 11-3-2005; IN COMMERCE 11-3-2005.
EVELYN BRADLEY, EXAMINING ATTORNEY

SN 77-857,165. ARROYO FERRER, FERNANDO, MAYAGUEZ, PUERTO RICO, FILED 10-26-2009.

Suhodisin

THE MARK CONSISTS OF STANDARD CHARACTERS WITHOUT CLAIM TO ANY PARTICULAR FONT, STYLE, SIZE, OR COLOR.

THE MARK HAS NO MEANING IN A FOREIGN LANGUAGE.

FOR ALL PURPOSE DISINFECTING AND DEODORIZING PREPARATIONS (U.S. CLS. 6, 18, 44, 46, 51 AND 52).

FIRST USE 11-3-2005; IN COMMERCE 11-3-2005.
EVELYN BRADLEY, EXAMINING ATTORNEY

SN 77-857,972. DAIICHI SANKYO, INC., PARSIPPANY, NJ, FILED 10-27-2009.



OWNER OF U.S. REG. NOS. 2,493,507, 3,473,865 AND OTHERS.

NO CLAIM IS MADE TO THE EXCLUSIVE RIGHT TO USE "COLESEVELAM HCl" AND "FOR ORAL SUSPENSION", APART FROM THE MARK AS SHOWN.

THE COLOR(S) BLUE, GREEN, YELLOW AND BLACK IS/ARE CLAIMED AS A FEATURE OF THE MARK.

THE MARK CONSISTS OF TWO ARROWS WHICH APPEAR TO LEFT OF THE WORD "WELCHOL". THE LARGER, OUTER ARROW APPEARS IN THE COLORS BLUE AND GREEN AND THE ARROW CONNECTS TO THE RIGHT-HAND PORTION OF THE LETTER "W" IN THE WORD "WELCHOL", WHICH IS IN THE COLOR GREEN. THE SMALLER, INNER ARROW APPEARS IN THE COLORS YELLOW AND GREEN AND CONNECTS TO THE LEFT-HAND PORTION OF THE LETTER "W" IN

CLASS 5—(Continued).

"WELCHOL". BOTH ARROWS CONVERGE TO THE LEFT OF THE WORD "WELCHOL", SHARING THE SAME GREEN ARROWHEAD. THE LETTER "W" IN "WELCHOL" IS CAPITALIZED. THE WORDS "COLESEVELAM HCl", ENCLOSED IN PARENTHESES, APPEAR IN SMALL, BLACK LETTERS, IMMEDIATELY BENEATH THE "LCHOL" PORTION OF THE WORD "WELCHOL". THE PARENTHESES ARE ALSO BLACK. THE WORDS "FOR ORAL SUSPENSION" APPEAR IMMEDIATELY BENEATH "(COLESEVELAM HCl)" IN THE COLOR GREEN.

FOR PHARMACEUTICAL PREPARATIONS FOR THE REDUCTION OF ELEVATED CHOLESTEROL IN PATIENTS HAVING PRIMARY HYPERCHOLESTEROLEMIA; PHARMACEUTICAL PREPARATIONS FOR THE TREATMENT OF DIABETES (U.S. CLS. 6, 18, 44, 46, 51 AND 52).

TRICIA SONNEBORN, EXAMINING ATTORNEY

CLASS 5—(Continued).

SN 77-867,613. LUNADA BIOMEDICAL, LOS ANGELES, CA. FILED 11-6-2009.

NAS Natural Activation System

THE MARK CONSISTS OF STANDARD CHARACTERS WITHOUT CLAIM TO ANY PARTICULAR FONT, STYLE, SIZE, OR COLOR.

NO CLAIM IS MADE TO THE EXCLUSIVE RIGHT TO USE "NATURAL ACTIVATION SYSTEM", APART FROM THE MARK AS SHOWN.

FOR DIETARY AND NUTRITIONAL SUPPLEMENTS; NUTRACEUTICALS FOR USE AS A DIETARY SUPPLEMENT; NUTRITIONAL SUPPLEMENT FOR ELIMINATING TOXINS FROM THE BODY (U.S. CLS. 6, 18, 44, 46, 51 AND 52).

LINDA ESTRADA, EXAMINING ATTORNEY

SN 77-857,975. DAIICHI SANKYO, INC., PARSIPPANY, NJ. FILED 10-27-2009.



SN 77-883,171. GULF SOUTH MEDICAL SUPPLY, INC., JACKSONVILLE, FL. FILED 12-1-2009.

OWNER OF U.S. REG. NOS. 2,493,507, 3,122,563 AND 3,473,865.

NO CLAIM IS MADE TO THE EXCLUSIVE RIGHT TO USE "COLESEVELAM HCl" AND "FOR ORAL SUSPENSION", APART FROM THE MARK AS SHOWN.

THE MARK CONSISTS OF TWO ARROWS WHICH APPEAR TO THE LEFT OF THE WORD "WELCHOL". THE LARGER, OUTER ARROW CONNECTS TO THE RIGHT-HAND PORTION OF THE LETTER "W" IN THE WORD "WELCHOL". THE SMALLER, INNER ARROW CONNECTS TO THE LEFT-HAND PORTION OF THE LETTER "W" IN "WELCHOL". BOTH ARROWS CONVERGE TO THE LEFT OF THE WORD "WELCHOL", SHARING THE SAME ARROWHEAD. THE LETTER "W" IN "WELCHOL" IS CAPITALIZED. THE WORDS "COLESEVELAM HCl" ARE ENCLOSED IN PARENTHESES AND APPEAR IMMEDIATELY BENEATH THE "LCHOL" PORTION OF THE WORD "WELCHOL". THE WORDS "FOR ORAL SUSPENSION" APPEAR IMMEDIATELY BENEATH "(COLESEVELAM HCl)".

FOR PHARMACEUTICAL PREPARATIONS FOR THE REDUCTION OF ELEVATED CHOLESTEROL IN PATIENTS HAVING PRIMARY HYPERCHOLESTEROLEMIA; PHARMACEUTICAL PREPARATIONS FOR THE TREATMENT OF DIABETES (U.S. CLS. 6, 18, 44, 46, 51 AND 52).

TRICIA SONNEBORN, EXAMINING ATTORNEY

NIGHTINGALE COOL COMFORT

THE MARK CONSISTS OF STANDARD CHARACTERS WITHOUT CLAIM TO ANY PARTICULAR FONT, STYLE, SIZE, OR COLOR.

OWNER OF U.S. REG. NOS. 2,849,333 AND 3,632,649. FOR ADULT INCONTINENCE GARMENTS, ADULT INCONTINENCE DISPOSABLE DIAPERS AND BRIEFS, FOR SALE INTO THE LONG TERM CARE, PHYSICIAN CARE, AND HOME HEALTHCARE MARKETS (U.S. CLS. 6, 18, 44, 46, 51 AND 52).

SHAUNIA CARLYLE, EXAMINING ATTORNEY

CLASS 5—(Continued).

SN 77-884,192. BENEFICIAL BLENDS, LLC, TAMPA, FL. FILED 12-2-2009.

Beneficial Blends, LLC

THE MARK CONSISTS OF STANDARD CHARACTERS WITHOUT CLAIM TO ANY PARTICULAR FONT, STYLE, SIZE, OR COLOR.

NO CLAIM IS MADE TO THE EXCLUSIVE RIGHT TO USE "BLENDS, LLC", APART FROM THE MARK AS SHOWN.

FOR DIETARY AND NUTRITIONAL SUPPLEMENTS; DIETARY BEVERAGE SUPPLEMENTS FOR HUMAN CONSUMPTION IN LIQUID AND DRY MIX FORM FOR THERAPEUTIC PURPOSES; DIETARY FOOD SUPPLEMENTS; DIETARY SUPPLEMENTAL DRINKS; DIETARY SUPPLEMENTAL DRINKS IN THE NATURE OF VITAMIN AND MINERAL BEVERAGES; DIETARY SUPPLEMENTS; DIETARY SUPPLEMENTS FOR HUMAN CONSUMPTION; FOOD SUPPLEMENTS, NAMELY, ANTI-OXIDANTS; HEALTH FOOD SUPPLEMENTS; HERBAL SUPPLEMENTS; LIQUID NUTRITIONAL SUPPLEMENT; NATURAL HERBAL SUPPLEMENTS; NUTRITIONAL SUPPLEMENTS; NUTRITIONAL SUPPLEMENTS IN LOTION FORM SOLD AS A COMPONENT OF NUTRITIONAL SKIN CARE PRODUCTS; VITAMIN AND MINERAL SUPPLEMENTS; VITAMIN SUPPLEMENT IN TABLET FORM FOR USE IN MAKING AN EFFERVESCENT BEVERAGE WHEN ADDED TO WATER; VITAMIN SUPPLEMENTS; WEIGHT MANAGEMENT SUPPLEMENTS (U.S. CLS. 6, 18, 44, 46, 51 AND 52).

NANCY CLARKE, EXAMINING ATTORNEY

SN 77-884,375. NEW NATURE HEALTH INC., ARCADIA, CA. FILED 12-2-2009.



THE COLOR(S) RED AND BLACK IS/ARE CLAIMED AS A FEATURE OF THE MARK.

THE MARK CONSISTS OF THE WORDS "DOUBLE FOREST" NEXT TO A HIGHLY STYLIZED YIN YANG SYMBOL. THE COLOR RED APPEARS IN THE WORD "DOUBLE" AND IN ONE HALF OF THE YIN YANG SYMBOL. THE COLOR BLACK APPEARS IN THE WORD "FOREST" AND IN THE OTHER HALF OF THE YIN YANG SYMBOL.

FOR DIETARY SUPPLEMENTS; NUTRITIONAL SUPPLEMENTS; CALCIUM SUPPLEMENTS; FOOD SUPPLEMENTS; MINERAL SUPPLEMENTS; HOMEOPATHIC SUPPLEMENTS; PROTEIN SUPPLEMENTS; FOOD FOR DIABETICS; HERBAL TOPICAL CREAMS, GELS, SALVES, SPRAYS, POWDER, BALMS, LINIMENT AND OINTMENTS FOR THE RELIEF OF ACHE AND PAIN; MEDICATED FOOT POWDER (U.S. CLS. 6, 18, 44, 46, 51 AND 52).

JOHN DALIER, EXAMINING ATTORNEY

CLASS 5—(Continued).

SN 77-884,547. GRO-POWER, INC., CHINO, CA. FILED 12-2-2009.

SNAIL & SLUG AWAY

THE MARK CONSISTS OF STANDARD CHARACTERS WITHOUT CLAIM TO ANY PARTICULAR FONT, STYLE, SIZE, OR COLOR.

NO CLAIM IS MADE TO THE EXCLUSIVE RIGHT TO USE "SNAIL & SLUG", APART FROM THE MARK AS SHOWN.

FOR GASTROPOD REPELLANT (U.S. CLS. 6, 18, 44, 46, 51 AND 52).

FIRST USE 11-17-2009; IN COMMERCE 11-17-2009.

ZACHARY BELLO, EXAMINING ATTORNEY

SN 77-885,128. NATUREBOY ENTERPRISES, LAUDERDALE BY THE SEA, FL. FILED 12-3-2009.

NATUREBOY

THE MARK CONSISTS OF STANDARD CHARACTERS WITHOUT CLAIM TO ANY PARTICULAR FONT, STYLE, SIZE, OR COLOR.

FOR DIETARY AND NUTRITIONAL SUPPLEMENTS FOR HUMAN CONSUMPTION; DIETARY BEVERAGE SUPPLEMENTS FOR HUMAN CONSUMPTION IN LIQUID AND DRY MIX FORM FOR THERAPEUTIC PURPOSES; DIETARY FOOD SUPPLEMENTS; DIETARY SUPPLEMENTS; DIETARY SUPPLEMENTS FOR HUMAN CONSUMPTION; FOOD SUPPLEMENTS, NAMELY, ANTI-OXIDANTS; HERBAL SUPPLEMENTS; LIQUID NUTRITIONAL SUPPLEMENT; MEAL REPLACEMENT AND DIETARY SUPPLEMENT DRINK MIXES; MINERAL FOOD SUPPLEMENTS; MINERAL NUTRITIONAL SUPPLEMENTS; NATURAL HERBAL SUPPLEMENTS; NUTRITIONAL SUPPLEMENTS; VITAMIN AND MINERAL SUPPLEMENTS (U.S. CLS. 6, 18, 44, 46, 51 AND 52).

SOPHIA S. KIM, EXAMINING ATTORNEY

SN 77-885,809. DRUGTECH CORPORATION, WILMINGTON, DE. FILED 12-3-2009.

PREMESISRX

THE MARK CONSISTS OF STANDARD CHARACTERS WITHOUT CLAIM TO ANY PARTICULAR FONT, STYLE, SIZE, OR COLOR.

FOR ANTI-NAUSEA PHARMACEUTICAL PREPARATIONS; NUTRITIONAL SUPPLEMENTS FOR TREATING NAUSEA; AND NUTRITIONAL SUPPLEMENT AND VITAMINS (U.S. CLS. 6, 18, 44, 46, 51 AND 52).

SUSAN STIGLITZ, EXAMINING ATTORNEY

CLASS 5—(Continued).

SN 77-885,849. NCS WHOLESALE, INC., MANTECA, CA. FILED 12-3-2009.

HECKA GOOD

THE MARK CONSISTS OF STANDARD CHARACTERS WITHOUT CLAIM TO ANY PARTICULAR FONT, STYLE, SIZE, OR COLOR.

FOR FOOD FOR BABIES (U.S. CLS. 6, 18, 44, 46, 51 AND 52).

JAMES MACFARLANE, EXAMINING ATTORNEY

SN 77-885,895. CALIFORNIA SCENTS, IRVINE, CA. FILED 12-3-2009.

Xtreme

THE MARK CONSISTS OF STANDARD CHARACTERS WITHOUT CLAIM TO ANY PARTICULAR FONT, STYLE, SIZE, OR COLOR.

FOR AIR FRESHENERS (U.S. CLS. 6, 18, 44, 46, 51 AND 52).

FIRST USE 12-1-2009; IN COMMERCE 12-1-2009.

JAMES STEIN, EXAMINING ATTORNEY

SN 77-885,899. YEN, RICHARD, ANAHEIM, CA. FILED 12-3-2009.

EASYPLATE

THE MARK CONSISTS OF STANDARD CHARACTERS WITHOUT CLAIM TO ANY PARTICULAR FONT, STYLE, SIZE, OR COLOR.

FOR BIOLOGICAL PREPARATIONS FOR MEDICAL PURPOSES (U.S. CLS. 6, 18, 44, 46, 51 AND 52).

FIRST USE 1-1-2009; IN COMMERCE 1-1-2009.

PAULA MAHONEY, EXAMINING ATTORNEY

CLASS 5—(Continued).

SN 77-886,061. EISAI R&D MANAGEMENT CO., LTD., BUNKYO-KU, TOKYO, JAPAN, FILED 12-4-2009.

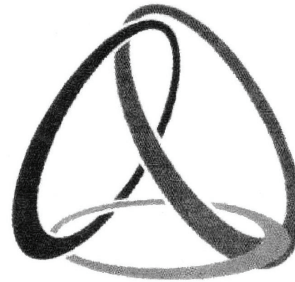

THE MARK CONSISTS OF THREE INTERLOCKING CIRCLES.

FOR PHARMACEUTICAL PREPARATIONS FOR THE TREATMENT OF ONCOLOGICAL DISEASES (U.S. CLS. 6, 18, 44, 46, 51 AND 52).

ANNE FARRELL, EXAMINING ATTORNEY

SN 77-886,094. SEROYAL USA, INC., WOOD DALE, IL. FILED 12-4-2009.

COMPLETE FOCUS

THE MARK CONSISTS OF STANDARD CHARACTERS WITHOUT CLAIM TO ANY PARTICULAR FONT, STYLE, SIZE, OR COLOR.

FOR DIETARY SUPPLEMENTS (U.S. CLS. 6, 18, 44, 46, 51 AND 52).

WILLIAM BRECKENFELD, EXAMINING ATTORNEY

SN 77-886,223. AGNEW, MICHELE, BELLEVUE, WA. FILED 12-4-2009.

WORKOUT COOKIE

THE MARK CONSISTS OF STANDARD CHARACTERS WITHOUT CLAIM TO ANY PARTICULAR FONT, STYLE, SIZE, OR COLOR.

NO CLAIM IS MADE TO THE EXCLUSIVE RIGHT TO USE "COOKIE", APART FROM THE MARK AS SHOWN.

FOR A NUTRITIONAL MEAL REPLACEMENT COOKIE (U.S. CLS. 6, 18, 44, 46, 51 AND 52).

ELIZABETH HUGHITT, EXAMINING ATTORNEY

CLASS 5—(Continued).

SN 77-886,425. SUNSET HEALTH PRODUCTS, INC., SHERMAN OAKS, CA. FILED 12-4-2009.

DAILY DOUBLE

THE MARK CONSISTS OF STANDARD CHARACTERS WITHOUT CLAIM TO ANY PARTICULAR FONT, STYLE, SIZE, OR COLOR.
FOR VITAMIN SUPPLEMENTS (U.S. CLS. 6, 18, 44, 46, 51 AND 52).
CHRISTINE COOPER, EXAMINING ATTORNEY

SN 77-887,298. GOOD HEALTH NATURALLY INC., LAS VEGAS, NV. FILED 12-7-2009.

RELAXWELL

THE MARK CONSISTS OF STANDARD CHARACTERS WITHOUT CLAIM TO ANY PARTICULAR FONT, STYLE, SIZE, OR COLOR.
FOR DIETARY SUPPLEMENTS; FOOD SUPPLEMENTS; MINERAL SUPPLEMENTS; NUTRITIONAL SUPPLEMENTS; VITAMIN SUPPLEMENTS (U.S. CLS. 6, 18, 44, 46, 51 AND 52).
CHRIS WELLS, EXAMINING ATTORNEY

SN 77-887,346. PADDOCK LABORATORIES, INC., MINNEAPOLIS, MN. FILED 12-7-2009.

MIN-LYTE

THE MARK CONSISTS OF STANDARD CHARACTERS WITHOUT CLAIM TO ANY PARTICULAR FONT, STYLE, SIZE, OR COLOR.
FOR GASTROINTESTINAL ORAL LAVAGE SOLUTION FOR USE IN HUMANS (U.S. CLS. 6, 18, 44, 46, 51 AND 52).
JOHN E. MICHOS, EXAMINING ATTORNEY

CLASS 5—(Continued).

SN 77-887,355. PADDOCK LABORATORIES, INC., MINNEAPOLIS, MN. FILED 12-7-2009.

LAX-LYTE

THE MARK CONSISTS OF STANDARD CHARACTERS WITHOUT CLAIM TO ANY PARTICULAR FONT, STYLE, SIZE, OR COLOR.
FOR GASTROINTESTINAL ORAL LAVAGE SOLUTION FOR USE IN HUMANS (U.S. CLS. 6, 18, 44, 46, 51 AND 52).
JOHN E. MICHOS, EXAMINING ATTORNEY

SN 77-887,369. SALIBA, MARWAN NICHOLAS, KNOXVILLE, TN. FILED 12-7-2009.



NO CLAIM IS MADE TO THE EXCLUSIVE RIGHT TO USE "SUPPLEMENTS" AND ".COM", APART FROM THE MARK AS SHOWN.
THE COLOR(S) RED, BLUE, WHITE, GREY AND DARK GREY IS/ARE CLAIMED AS A FEATURE OF THE MARK.
THE MARK CONSISTS OF THE TERM "A1" IN RED, CONTAINED IN A GREY AND WHITE SQUARE THAT IS OUTLINED IN DARK GREY, TO THE LEFT OF "SUPPLEMENTS" IN BLUE, ALL OVER A CURVED LINE FOLLOWED ".COM" IN RED.
FOR ONLINE RETAIL STORE SERVICES FEATURING DIETARY SUPPLEMENTS (U.S. CLS. 6, 18, 44, 46, 51 AND 52).
FIRST USE 9-1-1999; IN COMMERCE 9-1-1999.
TRACY WHITTAKER-BROWN, EXAMINING ATTORNEY

SN 77-887,399. CUREMARK, LLC, RYE, NY. FILED 12-7-2009.

JZYME

THE MARK CONSISTS OF STANDARD CHARACTERS WITHOUT CLAIM TO ANY PARTICULAR FONT, STYLE, SIZE, OR COLOR.
FOR PHARMACEUTICAL PREPARATIONS FOR THE TREATMENT OF PERSISTENT DEVELOPMENTAL DISORDERS, DYSAUTONOMIA, AND NEUROLOGICAL DISORDERS (U.S. CLS. 6, 18, 44, 46, 51 AND 52).
JUDITH HELFMAN, EXAMINING ATTORNEY

CLASS 5—(Continued).

SN 77-887,427. PEREZ, LUIS, NEWPORT NEWS, VA. FILED 12-7-2009.

CLASS 5—(Continued).

SN 77-887,710. STEVIA GERMANY GMBH UND CO. KG, 45131 ESSEN, FED REP GERMANY, FILED 12-7-2009.

Metaphytes

THE MARK CONSISTS OF STANDARD CHARACTERS WITHOUT CLAIM TO ANY PARTICULAR FONT, STYLE, SIZE, OR COLOR.

FOR VITAMINS (U.S. CLS. 6, 18, 44, 46, 51 AND 52).
DEBRA LEE, EXAMINING ATTORNEY

STESWEET

THE MARK CONSISTS OF STANDARD CHARACTERS WITHOUT CLAIM TO ANY PARTICULAR FONT, STYLE, SIZE, OR COLOR.

FOR ANIMAL FEED SUPPLEMENTS; AROMATIZED BEVERAGES BASED ON FRUIT, PROTEIN, CORDIAL, SUGAR AND OTHER FLUID NUTRIENTS, NAMELY, WEIGHT MANAGEMENT POWDERS FOR USE AS A FOOD FILLERS; DIETARY AND NUTRITIONAL SUPPLEMENTS; DIETARY BEVERAGE SUPPLEMENTS FOR HUMAN CONSUMPTION IN LIQUID AND DRY MIX FORM FOR THERAPEUTIC PURPOSES; DIETARY FOOD SUPPLEMENTS; DIETARY SUPPLEMENTAL DRINKS; DIETARY SUPPLEMENTAL DRINKS IN THE NATURE OF VITAMIN AND MINERAL BEVERAGES; DIETARY SUPPLEMENTS; DIETARY SUPPLEMENTS FOR CONTROLLING CHOLESTEROL; DIETARY SUPPLEMENTS FOR HUMAN CONSUMPTION; DIETETIC SUGAR FOR MEDICAL USE; ENERGY BOOSTING BARS FOR USE AS A MEAL SUBSTITUTE; HEALTH FOOD SUPPLEMENTS; HERBAL SUPPLEMENTS; HERBAL TEAS FOR MEDICINAL PURPOSES; HOMEOPATHIC SUPPLEMENTS; LIQUID NUTRITIONAL SUPPLEMENT; MEAL REPLACEMENT AND DIETARY SUPPLEMENT DRINK MIXES; NATURAL HERBAL SUPPLEMENTS; NATURAL SUPPLEMENTS FOR TREATING CANDIDA; NUTRACEUTICALS FOR THE TREATMENT OF OBESITY; NUTRACEUTICALS FOR USE AS A DIETARY SUPPLEMENT; NUTRITIONAL ADDITIVES FOR MEDICAL PURPOSES USED IN FOODS AND DIETARY SUPPLEMENTS FOR HUMAN CONSUMPTION; NUTRITIONAL ENERGY BARS FOR USE AS A MEAL SUBSTITUTE; NUTRITIONAL SHAKES FOR USE AS A MEAL SUBSTITUTE; NUTRITIONAL SUPPLEMENTS; POWDERED FRUIT-FLAVORED DIETARY SUPPLEMENT DRINK MIX; POWDERED NUTRITIONAL SUPPLEMENT DRINK MIX; SUGAR REPLACEMENT FOR MEDICINAL OR THERAPEUTIC PURPOSES; WEIGHT MANAGEMENT SUPPLEMENTS (U.S. CLS. 6, 18, 44, 46, 51 AND 52).

FIRST USE 11-27-2009; IN COMMERCE 11-27-2009.
KELLY BOULTON, EXAMINING ATTORNEY

SN 77-887,680. 4 YOUR LIFE, LLC, AGOURA HILLS, CA. FILED 12-7-2009.

NATURE'S GLOVE HAND SANITIZER

THE MARK CONSISTS OF STANDARD CHARACTERS WITHOUT CLAIM TO ANY PARTICULAR FONT, STYLE, SIZE, OR COLOR.

NO CLAIM IS MADE TO THE EXCLUSIVE RIGHT TO USE "HAND SANITIZER", APART FROM THE MARK AS SHOWN.

FOR HAND-SANITIZING PREPARATIONS; ANTI-BACTERIAL HAND SANITIZER WITH CATECHIN; ANTI-BACTERIAL SKIN SANITIZER GEL (U.S. CLS. 6, 18, 44, 46, 51 AND 52).

BRIAN NEVILLE, EXAMINING ATTORNEY

CLASS 5—(Continued).

SN 77-888,114. ROSENFELD, ADAM, LOS ANGELES, CA. FILED 12-7-2009.



THE MARK CONSISTS OF THE GREEK LETTER PHI. FOR DIETARY SUPPLEMENTAL DRINKS IN THE NATURE OF VITAMIN AND MINERAL BEVERAGES (U.S. CLS. 6, 18, 44, 46, 51 AND 52). ANNE E. GUSTASON, EXAMINING ATTORNEY

CLASS 5—(Continued).

SN 77-888,282. KAMADA LTD., REHOVOT, ISRAEL, FILED 12-8-2009.

RESPIKAM

THE MARK CONSISTS OF STANDARD CHARACTERS WITHOUT CLAIM TO ANY PARTICULAR FONT, STYLE, SIZE, OR COLOR. FOR PHARMACEUTICAL PREPARATIONS COMPRISING ALPHA-1 PROTEINASE INHIBITOR (U.S. CLS. 6, 18, 44, 46, 51 AND 52). EMILY CARLSEN, EXAMINING ATTORNEY

SN 77-888,429. WHITE, CAROL GALLMAN, WHITTIER, NC. FILED 12-8-2009.

Floph

THE MARK CONSISTS OF STANDARD CHARACTERS WITHOUT CLAIM TO ANY PARTICULAR FONT, STYLE, SIZE, OR COLOR. FOR INSECT REPELLENTS (U.S. CLS. 6, 18, 44, 46, 51 AND 52). FIRST USE 7-5-2002; IN COMMERCE 7-5-2002. JENNIFER HETU, EXAMINING ATTORNEY

SN 77-888,215. THE PROCTER & GAMBLE COMPANY, CINCINNATI, OH. FILED 12-8-2009.



SN 77-888,592. HU, FANG, PALO ALTO, CA. AND ZHANG, JIE, PALO ALTO, CA. FILED 12-8-2009.

CaliforniaBaby

OWNER OF U.S. REG. NOS. 3,094,217, 3,136,775 AND 3,517,675.

THE MARK CONSISTS OF AN OVAL TURNED ON ITS SIDE WITH THE WORDS "METAMUCIL" ACROSS THE MIDDLE. THERE IS GRAIN COMING OFF THE "T" IN "METAMUCIL" AND BRANCHING OUT OVER THE WORD. FOR DIETARY SUPPLEMENTS (U.S. CLS. 6, 18, 44, 46, 51 AND 52). JOHN HWANG, EXAMINING ATTORNEY

THE MARK CONSISTS OF STANDARD CHARACTERS WITHOUT CLAIM TO ANY PARTICULAR FONT, STYLE, SIZE, OR COLOR. FOR BABY FOOD (U.S. CLS. 6, 18, 44, 46, 51 AND 52). DAVID ELTON, EXAMINING ATTORNEY

CLASS 5—(Continued).

SN 77-888,616. BUSTOUT POKER, LLC, CHAPIN, SC. FILED 12-8-2009.

ROUNDERS EDGE

THE MARK CONSISTS OF STANDARD CHARACTERS WITHOUT CLAIM TO ANY PARTICULAR FONT, STYLE, SIZE, OR COLOR.
FOR DIETARY AND NUTRITIONAL SUPPLEMENTS (U.S. CLS. 6, 18, 44, 46, 51 AND 52).
HOWARD SMIGA, EXAMINING ATTORNEY

SN 77-888,942. DRSS, LLC, SOUTHLAKE, TX. FILED 12-8-2009.

Nouristrat

THE MARK CONSISTS OF STANDARD CHARACTERS WITHOUT CLAIM TO ANY PARTICULAR FONT, STYLE, SIZE, OR COLOR.
FOR ANTIMICROBIALS FOR DERMATOLOGIC USE; DERMATOLOGICAL PHARMACEUTICAL PRODUCTS; GELS, CREAMS AND SOLUTIONS FOR DERMATOLOGICAL USE; PARAPHARMACEUTICAL PRODUCTS FOR USE IN DERMATOLOGY (U.S. CLS. 6, 18, 44, 46, 51 AND 52).
FIRST USE 8-1-2009; IN COMMERCE 8-1-2009.
SHANNON TWOHIG, EXAMINING ATTORNEY

SN 77-889,042. TRIBRAVUS ENTERPRISES, ESCONDIDO, CA. FILED 12-8-2009.

PROTODROL

THE MARK CONSISTS OF STANDARD CHARACTERS WITHOUT CLAIM TO ANY PARTICULAR FONT, STYLE, SIZE, OR COLOR.
FOR DIETARY SUPPLEMENTS (U.S. CLS. 6, 18, 44, 46, 51 AND 52).
ANTHONY RINKER, EXAMINING ATTORNEY

CLASS 5—(Continued).

SN 77-889,134. GHC ND LICENSING, LTD., CASTRIES, ST.LUCIA, FILED 12-8-2009.

DETOXADINE

THE MARK CONSISTS OF STANDARD CHARACTERS WITHOUT CLAIM TO ANY PARTICULAR FONT, STYLE, SIZE, OR COLOR.
FOR DIETARY AND NUTRITIONAL SUPPLEMENTS; IODINE (U.S. CLS. 6, 18, 44, 46, 51 AND 52).
FIRST USE 11-30-2009; IN COMMERCE 11-30-2009.
NANCY CLARKE, EXAMINING ATTORNEY

SN 77-889,151. JIAN HUA LUO, HACIENDA HEIGHTS, CA. FILED 12-9-2009.

MIRACLENATURAL

THE MARK CONSISTS OF STANDARD CHARACTERS WITHOUT CLAIM TO ANY PARTICULAR FONT, STYLE, SIZE, OR COLOR.
FOR HERBAL SUPPLEMENTS; NATURAL HERBAL SUPPLEMENTS (U.S. CLS. 6, 18, 44, 46, 51 AND 52).
ANDREA BUTLER, EXAMINING ATTORNEY

SN 77-889,214. LIVEDO USA, INC., WILSON, NC. FILED 12-9-2009.

LiveDo

THE MARK CONSISTS OF STANDARD CHARACTERS WITHOUT CLAIM TO ANY PARTICULAR FONT, STYLE, SIZE, OR COLOR.
FOR INCONTINENCE DIAPERS FOR ADULTS; AND INCONTINENCE PADS FOR ADULTS (U.S. CLS. 6, 18, 44, 46, 51 AND 52).
TRACY CROSS, EXAMINING ATTORNEY

CLASS 5—(Continued).

SN 77-889,297. HU, FANG, PALO ALTO, CA. AND ZHANG, JIE, PALO ALTO, CA. FILED 12-9-2009.

Calibaby

THE MARK CONSISTS OF STANDARD CHARACTERS WITHOUT CLAIM TO ANY PARTICULAR FONT, STYLE, SIZE, OR COLOR.

FOR BABY FOODS (U.S. CLS. 6, 18, 44, 46, 51 AND 52).
DAVID ELTON, EXAMINING ATTORNEY

SN 77-889,469. KAIRE INTERNATIONAL (CANADA) LTD., LANGLEY, CANADA, FILED 12-9-2009.

Kaire

THE MARK CONSISTS OF STANDARD CHARACTERS WITHOUT CLAIM TO ANY PARTICULAR FONT, STYLE, SIZE, OR COLOR.

FOR DIETARY SUPPLEMENTS; DIETARY SUPPLEMENTS FOR HUMAN CONSUMPTION; FOOD SUPPLEMENTS (U.S. CLS. 6, 18, 44, 46, 51 AND 52).
ELI HELLMAN, EXAMINING ATTORNEY

SN 77-889,689. AFFYMAX, INC., PALO ALTO, CA. FILED 12-9-2009.

INNOTIDE

THE MARK CONSISTS OF STANDARD CHARACTERS WITHOUT CLAIM TO ANY PARTICULAR FONT, STYLE, SIZE, OR COLOR.

FOR PHARMACEUTICAL PREPARATIONS FOR THE PREVENTION AND TREATMENT OF NEURODEGENERATIVE DISEASES, RENAL FAILURE AND MYOCARDIAL INFARCTION (U.S. CLS. 6, 18, 44, 46, 51 AND 52).
ARETHA SOMERVILLE, EXAMINING ATTORNEY

CLASS 5—(Continued).

SN 77-889,775. COLLAMATRIX, TAIPEI, TAIWAN, FILED 12-9-2009.

CollaDental

THE MARK CONSISTS OF STANDARD CHARACTERS WITHOUT CLAIM TO ANY PARTICULAR FONT, STYLE, SIZE, OR COLOR.

OWNER OF U.S. REG. NO. 3,725,310.
FOR DENTAL COMPOSITE MATERIALS; DENTAL COMPOUNDS USED IN ENDODONTIC PROCEDURES; MATERIALS FOR DENTAL FILLINGS AND FOR SEALING PURPOSES (U.S. CLS. 6, 18, 44, 46, 51 AND 52).
REBECCA POVARCHUK, EXAMINING ATTORNEY

SN 77-889,839. PREMIER CHEMICALS, LLC, WEST CONSHOHOCKEN, PA. FILED 12-9-2009.

WHITE MOUNTAIN

THE MARK CONSISTS OF STANDARD CHARACTERS WITHOUT CLAIM TO ANY PARTICULAR FONT, STYLE, SIZE, OR COLOR.

FOR EPSOM SALTS; MAGNESIUM SULFATE FOR MEDICAL AND THERAPEUTIC PURPOSES; MUSCLE SOAKS; LAXATIVES; MINERAL SALTS FOR MEDICAL AND THERAPEUTIC PURPOSES (U.S. CLS. 6, 18, 44, 46, 51 AND 52).

FIRST USE 12-31-1987; IN COMMERCE 12-31-1987.
HENRY S. ZAK, EXAMINING ATTORNEY

SN 77-889,852. CEPABLON, INC., FRAZER, PA. FILED 12-9-2009.

SALISTRA

THE MARK CONSISTS OF STANDARD CHARACTERS WITHOUT CLAIM TO ANY PARTICULAR FONT, STYLE, SIZE, OR COLOR.

FOR PHARMACEUTICAL PREPARATIONS FOR THE TREATMENT OF CANCER (U.S. CLS. 6, 18, 44, 46, 51 AND 52).

MORGAN WYNNE, EXAMINING ATTORNEY

CLASS 5—(Continued).

SN 77-889,953. RIEDER, RETO, MURRIETA, CA. FILED 12-9-2009.

Resforte

THE MARK CONSISTS OF STANDARD CHARACTERS WITHOUT CLAIM TO ANY PARTICULAR FONT, STYLE, SIZE, OR COLOR.

FOR DIETARY SUPPLEMENTS (U.S. CLS. 6, 18, 44, 46, 51 AND 52).

FRED MANDIR, EXAMINING ATTORNEY

CLASS 5—(Continued).

SN 77-891,057. GLUTENUS MINIMUS, LLC, BELMONT, MA. FILED 12-10-2009.

GLUTENUS MINIMUS

THE MARK CONSISTS OF STANDARD CHARACTERS WITHOUT CLAIM TO ANY PARTICULAR FONT, STYLE, SIZE, OR COLOR.

FOR BISCUITS, BREAD, BREAD ROLLS, CAKES, CEREAL PRODUCTS, CONFECTIONERY, CRACKERS, NOODLES, FISH SAUCE, RELISH, SAUCES, CEREAL-BASED SNACK-FOODS AND PREPARED DIETARY ITEMS ALL OF WHICH ARE GLUTEN -FREE TO ACCOMMODATE SPECIAL MEDICAL AND HEALTH CONDITIONS (U.S. CLS. 6, 18, 44, 46, 51 AND 52).

FIRST USE 6-14-2008; IN COMMERCE 8-8-2008.

TINA L. SNAPP, EXAMINING ATTORNEY

SN 77-890,511. WILLIAMS, ANTHONY, K. DBA TIGER TAIL.COM, WESTMINSTER, CO. FILED 12-10-2009.

MEOWSTARD

THE MARK CONSISTS OF STANDARD CHARACTERS WITHOUT CLAIM TO ANY PARTICULAR FONT, STYLE, SIZE, OR COLOR.

FOR ANIMAL FEED SUPPLEMENTS (U.S. CLS. 6, 18, 44, 46, 51 AND 52).

GEORGE LORENZO, EXAMINING ATTORNEY

SN 77-891,207. UNICO INDUSTRIES, INC., NAPERVILLE, IL. FILED 12-11-2009.

NTIMA

THE MARK CONSISTS OF STANDARD CHARACTERS WITHOUT CLAIM TO ANY PARTICULAR FONT, STYLE, SIZE, OR COLOR.

THE WORDING "NTIMA" HAS NO MEANING IN A FOREIGN LANGUAGE.

FOR HERBAL MALE ENHANCEMENT CAPSULES (U.S. CLS. 6, 18, 44, 46, 51 AND 52).

NAAKWAMA ANKRAH, EXAMINING ATTORNEY

SN 77-890,824. ALOE CARE INTERNATIONAL, LLC, EDEN PRAIRIE, MN. FILED 12-10-2009.

SAFE CHOICE

THE MARK CONSISTS OF STANDARD CHARACTERS WITHOUT CLAIM TO ANY PARTICULAR FONT, STYLE, SIZE, OR COLOR.

FOR HAND SANITIZER (U.S. CLS. 6, 18, 44, 46, 51 AND 52).

TOBY BULLOFF, EXAMINING ATTORNEY

SN 77-891,221. UNICO INDUSTRIES, INC., NAPERVILLE, IL. FILED 12-11-2009.

NUMIA

THE MARK CONSISTS OF STANDARD CHARACTERS WITHOUT CLAIM TO ANY PARTICULAR FONT, STYLE, SIZE, OR COLOR.

THE WORDING "NUMIA" HAS NO MEANING IN A FOREIGN LANGUAGE.

FOR WEIGHT MANAGEMENT SUPPLEMENTS (U.S. CLS. 6, 18, 44, 46, 51 AND 52).

NAAKWAMA ANKRAH, EXAMINING ATTORNEY

CLASS 5—(Continued).

SN 77-891,269. ACAIOPTIMUM, LLC, PALM BEACH GARDENS, FL. FILED 12-11-2009.

AN AMAZING NEW YOU

THE MARK CONSISTS OF STANDARD CHARACTERS WITHOUT CLAIM TO ANY PARTICULAR FONT, STYLE, SIZE, OR COLOR.

FOR DIETARY AND NUTRITIONAL SUPPLEMENTS; WEIGHT LOSS SUPPLEMENTS; WEIGHT MANAGEMENT SUPPLEMENTS (U.S. CLS. 6, 18, 44, 46, 51 AND 52).

FIRST USE 12-7-2009; IN COMMERCE 12-7-2009. LINDA POWELL, EXAMINING ATTORNEY

SN 77-891,337. BIONEURIX CORPORATION, COSTA MESA, CA. FILED 12-11-2009.

PHARMATREE

THE MARK CONSISTS OF STANDARD CHARACTERS WITHOUT CLAIM TO ANY PARTICULAR FONT, STYLE, SIZE, OR COLOR.

FOR NUTRACEUTICALS FOR USE AS A DIETARY SUPPLEMENT (U.S. CLS. 6, 18, 44, 46, 51 AND 52). CHARLOTTE CORWIN, EXAMINING ATTORNEY

SN 77-891,465. CENTRIX PHARMACEUTICAL, INC., BIRMINGHAM, AL. FILED 12-11-2009.

PLURATUSS

THE MARK CONSISTS OF STANDARD CHARACTERS WITHOUT CLAIM TO ANY PARTICULAR FONT, STYLE, SIZE, OR COLOR.

FOR COUGH EXPECTORANTS; COUGH TREATMENT PREPARATIONS; PHARMACEUTICAL ANTI-TUSSIVE-COLD PREPARATIONS; PREPARATIONS FOR TREATING COLDS (U.S. CLS. 6, 18, 44, 46, 51 AND 52).

CIMMERIAN COLEMAN, EXAMINING ATTORNEY

CLASS 5—(Continued).

SN 77-891,494. DR. REDDY'S LABORATORIES, INC., BRIDGEWATER, NJ. FILED 12-11-2009.

L24HR

THE MARK CONSISTS OF STANDARD CHARACTERS WITHOUT CLAIM TO ANY PARTICULAR FONT, STYLE, SIZE, OR COLOR.

FOR PHARMACEUTICAL PREPARATIONS AND SUBSTANCES FOR THE TREATMENT OF GASTRO-INTESTINAL DISEASES (U.S. CLS. 6, 18, 44, 46, 51 AND 52).

GEORGE LORENZO, EXAMINING ATTORNEY

SN 77-891,518. ARGENTUM MEDICAL LLC, CHICAGO, IL. FILED 12-11-2009.

SILVER YOU CAN SEE

THE MARK CONSISTS OF STANDARD CHARACTERS WITHOUT CLAIM TO ANY PARTICULAR FONT, STYLE, SIZE, OR COLOR.

NO CLAIM IS MADE TO THE EXCLUSIVE RIGHT TO USE "SILVER", APART FROM THE MARK AS SHOWN.

FOR WOUND DRESSINGS; BANDAGES, NAMELY, BANDAGES FOR WOUND DRESSINGS, BANDAGES FOR SKIN WOUNDS, BANDAGES FOR BURNS, BANDAGES FOR RASHES, BANDAGES FOR BLISTERS, BANDAGES FOR BITES; SINGLE AND MULTI-LAYER WOUND DRESSINGS FOR SKIN WOUNDS; WOUND DRESSINGS FOR BURNS, RASHES, BITES AND BLISTERS; SURGICAL BANDAGES; MEDICATED COMPRESSES, NAMELY, ANTIMICROBIAL AND ANALGESIC COMPRESSES; WOUND PACKING MATERIALS, NAMELY, ANTIMICROBIAL FABRIC FOR DRESSING WOUNDS, AND WOUND DRESSINGS; ALL OF THE AFOREMENTIONED GOODS CONTAINING SILVER (U.S. CLS. 6, 18, 44, 46, 51 AND 52).

ESTHER BELENKER, EXAMINING ATTORNEY

SN 77-891,571. TRIARCO INDUSTRIES, INC., WAYNE, NJ. FILED 12-11-2009.

REFUSE TO LOSE

THE MARK CONSISTS OF STANDARD CHARACTERS WITHOUT CLAIM TO ANY PARTICULAR FONT, STYLE, SIZE, OR COLOR.

FOR VITAMINS, MINERAL SUPPLEMENTS, NUTRITIONAL AND DIETARY SUPPLEMENTS (U.S. CLS. 6, 18, 44, 46, 51 AND 52).

JERI J. FICKES, EXAMINING ATTORNEY

CLASS 5—(Continued).

SN 77-891,627. Merial, 69007 LYON, FRANCE, FILED 12-11-2009.

TOP SPOT

THE MARK CONSISTS OF STANDARD CHARACTERS WITHOUT CLAIM TO ANY PARTICULAR FONT, STYLE, SIZE, OR COLOR.

FOR TOPICAL LIQUID APPLICATION FOR USE ON ANIMALS FOR THE PREVENTION AND/OR TREATMENT OF FLEA AND TICK INFESTATION (U.S. CLS. 6, 18, 44, 46, 51 AND 52).

FIRST USE 9-18-1996; IN COMMERCE 9-18-1996.
SAIMA MAKHDOOM, EXAMINING ATTORNEY

SN 77-891,648. Merial, 69007 LYON, FRANCE, FILED 12-11-2009.

FRONTLINE TOP SPOT

THE MARK CONSISTS OF STANDARD CHARACTERS WITHOUT CLAIM TO ANY PARTICULAR FONT, STYLE, SIZE, OR COLOR.

FOR TOPICAL LIQUID APPLICATION FOR USE ON ANIMALS FOR THE PREVENTION AND/OR TREATMENT OF FLEA AND TICK INFESTATION (U.S. CLS. 6, 18, 44, 46, 51 AND 52).

FIRST USE 9-0-1996; IN COMMERCE 9-0-1996.
SAIMA MAKHDOOM, EXAMINING ATTORNEY

SN 77-892,156. GROOVE NUTRITION LIMITED, VICTORIA, BC, CANADA, FILED 12-12-2009.

VOYA

THE MARK CONSISTS OF STANDARD CHARACTERS WITHOUT CLAIM TO ANY PARTICULAR FONT, STYLE, SIZE, OR COLOR.

THE WORDING "VOYA" HAS NO MEANING IN A FOREIGN LANGUAGE.

FOR MEAL REPLACEMENT BEVERAGES; NUTRITIONAL DRINKS USED FOR MEAL REPLACEMENT (U.S. CLS. 6, 18, 44, 46, 51 AND 52).

SANDRA BUJA, EXAMINING ATTORNEY

CLASS 5—(Continued).

SN 77-892,192. BARTELS, JENNIFER, HAMMOND, LA, FILED 12-13-2009.

tushi roll

THE MARK CONSISTS OF STANDARD CHARACTERS WITHOUT CLAIM TO ANY PARTICULAR FONT, STYLE, SIZE, OR COLOR.

FOR BANDAGES FOR DRESSINGS; BANDAGES FOR SKIN WOUNDS; BURN DRESSINGS; DRESSINGS FOR INCONTINENCE WOUNDS AND BEDSORES; GAUZE FOR DRESSINGS; MEDICAL AND SURGICAL DRESSINGS; MEDICAL DRESSINGS; MEDICATED PRE-MOISTENED WIPES; MEDICATED SKIN PREPARATION FOR USE IN TREATING RASHES INCONTINENCE AND BEDSORES; PHARMACEUTICAL PREPARATIONS FOR TREATING SKIN DISORDERS; PRE-MOISTENED MEDICATED WIPES; WOUND DRESSINGS; WOUND DRESSINGS, NAMELY, PLEDGETS (U.S. CLS. 6, 18, 44, 46, 51 AND 52).

JACQUELINE A. LAVINE, EXAMINING ATTORNEY

SN 77-892,491. K & D VITAMINS AND SUPPLEMENTS, LLC., MIAMI, FL. FILED 12-14-2009.

2UR

THE MARK CONSISTS OF STANDARD CHARACTERS WITHOUT CLAIM TO ANY PARTICULAR FONT, STYLE, SIZE, OR COLOR.

FOR VITAMIN AND MINERAL SUPPLEMENTS; VITAMIN B PREPARATIONS; VITAMIN C PREPARATIONS; VITAMIN D PREPARATIONS; VITAMIN OILS FOR HUMAN CONSUMPTION; VITAMIN PREPARATIONS; VITAMIN SUPPLEMENTS; VITAMIN TABLETS; VITAMINS; VITAMINS AND VITAMIN PREPARATIONS (U.S. CLS. 6, 18, 44, 46, 51 AND 52).

MARK T. MULLEN, EXAMINING ATTORNEY

SN 77-892,617. HEALTH SCIENCE NUTRITION, PLEASANT GROVE, UT, FILED 12-14-2009.

TestoRipped

THE MARK CONSISTS OF STANDARD CHARACTERS WITHOUT CLAIM TO ANY PARTICULAR FONT, STYLE, SIZE, OR COLOR.

FOR DIETARY SUPPLEMENT FOR WEIGHT LOSS (U.S. CLS. 6, 18, 44, 46, 51 AND 52).

FIRST USE 1-1-2007; IN COMMERCE 2-1-2007.

SALLY SHIH, EXAMINING ATTORNEY

CLASS 5—(Continued).

SN 77-892,764. BRISTOL-MYERS SQUIBB COMPANY, NEW YORK, NY. FILED 12-14-2009.

VIGNITI

THE MARK CONSISTS OF STANDARD CHARACTERS WITHOUT CLAIM TO ANY PARTICULAR FONT, STYLE, SIZE, OR COLOR.

FOR PHARMACEUTICAL PREPARATIONS FOR HUMAN USE FOR THE TREATMENT OR PREVENTION OF METABOLIC DISORDERS (U.S. CLS. 6, 18, 44, 46, 51 AND 52).

WENDY GOODMAN, EXAMINING ATTORNEY

CLASS 5—(Continued).

SN 77-893,677. LIFE BRANDS, LLC., BLAUVELT, NY. FILED 12-15-2009.

SkinGuard

THE MARK CONSISTS OF STANDARD CHARACTERS WITHOUT CLAIM TO ANY PARTICULAR FONT, STYLE, SIZE, OR COLOR.

FOR DIETARY AND NUTRITIONAL SUPPLEMENTS; DIETARY FOOD SUPPLEMENTS; DIETARY SUPPLEMENTAL DRINKS (U.S. CLS. 6, 18, 44, 46, 51 AND 52).

FIRST USE 11-1-2009; IN COMMERCE 11-1-2009.
KELLEY WELLS, EXAMINING ATTORNEY

SN 77-892,820. NATURE'S RELIEF LLC, MACON, GA. FILED 12-14-2009.

DBRELIEF

THE MARK CONSISTS OF STANDARD CHARACTERS WITHOUT CLAIM TO ANY PARTICULAR FONT, STYLE, SIZE, OR COLOR.

FOR DIETARY AND NUTRITIONAL SUPPLEMENTS; FOOD SUPPLEMENTS; VITAMIN AND MINERAL SUPPLEMENTS (U.S. CLS. 6, 18, 44, 46, 51 AND 52).

KAPIL BHANOT, EXAMINING ATTORNEY

SN 77-893,690. LIFE BRANDS, LLC., BLAUVELT, NY. FILED 12-15-2009.

SunGuard

THE MARK CONSISTS OF STANDARD CHARACTERS WITHOUT CLAIM TO ANY PARTICULAR FONT, STYLE, SIZE, OR COLOR.

FOR DIETARY AND NUTRITIONAL SUPPLEMENTS; DIETARY FOOD SUPPLEMENTS; DIETARY SUPPLEMENTAL DRINKS (U.S. CLS. 6, 18, 44, 46, 51 AND 52).

FIRST USE 11-1-2009; IN COMMERCE 11-1-2009.
KELLEY WELLS, EXAMINING ATTORNEY

SN 77-893,348. GROOVE NUTRITION LIMITED, VICTORIA, BC, CANADA. FILED 12-15-2009.

GROW

THE MARK CONSISTS OF STANDARD CHARACTERS WITHOUT CLAIM TO ANY PARTICULAR FONT, STYLE, SIZE, OR COLOR.

FOR MEAL REPLACEMENT BEVERAGES; NUTRITIONAL DRINKS USED FOR MEAL REPLACEMENT (U.S. CLS. 6, 18, 44, 46, 51 AND 52).

SANDRA BUJA, EXAMINING ATTORNEY

SN 77-893,754. DR. REDDY'S LABORATORIES, INC., BRIDGEWATER, NJ. FILED 12-15-2009.

OMP20

THE MARK CONSISTS OF STANDARD CHARACTERS WITHOUT CLAIM TO ANY PARTICULAR FONT, STYLE, SIZE, OR COLOR.

FOR PHARMACEUTICAL PREPARATIONS AND SUBSTANCES FOR THE TREATMENT OF GASTRO-INTESTINAL DISEASES (U.S. CLS. 6, 18, 44, 46, 51 AND 52).

GEORGE LORENZO, EXAMINING ATTORNEY

CLASS 5—(Continued).

SN 77-893,766. FLUTRENDS INTERNATIONAL, LLC, DBA FLUTRENDS INTERNATIONAL, LLC, DENVER, CO. FILED 12-15-2009.

FLUNADA

THE MARK CONSISTS OF STANDARD CHARACTERS WITHOUT CLAIM TO ANY PARTICULAR FONT, STYLE, SIZE, OR COLOR.

FOR ANTI-VIRAL NOSE AND THROAT SPRAY (U.S. CLS. 6, 18, 44, 46, 51 AND 52).
RICHARD WHITE, EXAMINING ATTORNEY

SN 77-893,910. SCION CARDIO-VASCULAR, INC., MIAMI, FL. FILED 12-15-2009.

PEDIA-GUARD

THE MARK CONSISTS OF STANDARD CHARACTERS WITHOUT CLAIM TO ANY PARTICULAR FONT, STYLE, SIZE, OR COLOR.

FOR ANTI-MICROBIAL WOUND DRESSINGS; HEMOSTATIC WOUND DRESSINGS (U.S. CLS. 6, 18, 44, 46, 51 AND 52).

DAVID MILLER, EXAMINING ATTORNEY

SN 77-893,934. PURAPHARM INTERNATIONAL (H.K.) LIMITED, CENTRAL, HONG KONG, FILED 12-15-2009.

ONCO-Z

THE MARK CONSISTS OF STANDARD CHARACTERS WITHOUT CLAIM TO ANY PARTICULAR FONT, STYLE, SIZE, OR COLOR.

PRIORITY CLAIMED UNDER SEC. 44(D) ON HONG KONG APPLICATION NO. 301398178, FILED 8-3-2009, REG. NO. 301398178, DATED 8-3-2009, EXPIRES 8-3-2019.

OWNER OF U.S. REG. NO. 3,058,266.

FOR HERBAL SUPPLEMENTS CONTAINING YUNZHI ALSO KNOWN AS CORIOULUS VERSICOLOR IN THE FORM OF CAPSULES, GRANULES, PILLS AND TABLETS FOR THE TREATMENT OF TUMOR AND FOR ENHANCING THE IMMUNE SYSTEM (U.S. CLS. 6, 18, 44, 46, 51 AND 52).

ZACHARY BELLO, EXAMINING ATTORNEY

CLASS 5—(Continued).

SN 77-894,032. LIN, SUSAN, HILLSBOROUGH, CA. FILED 12-15-2009.

Life is Short. Make your lashes Long!

THE MARK CONSISTS OF STANDARD CHARACTERS WITHOUT CLAIM TO ANY PARTICULAR FONT, STYLE, SIZE, OR COLOR.

FOR HAIR GROWTH STIMULANTS (U.S. CLS. 6, 18, 44, 46, 51 AND 52).
CHARLOTTE CORWIN, EXAMINING ATTORNEY

SN 77-894,137. GRANDALL DISTRIBUTING CO., INC., GLENDALE, CA. FILED 12-15-2009.

OFTALMISAN

THE MARK CONSISTS OF STANDARD CHARACTERS WITHOUT CLAIM TO ANY PARTICULAR FONT, STYLE, SIZE, OR COLOR.

FOR OPHTHALMIC PREPARATION, NAMELY, EYE DROPS (U.S. CLS. 6, 18, 44, 46, 51 AND 52).
DAVID I, EXAMINING ATTORNEY

SN 77-894,141. GRANDALL DISTRIBUTING CO., INC., GLENDALE, CA. FILED 12-15-2009.

ANGIDOL

THE MARK CONSISTS OF STANDARD CHARACTERS WITHOUT CLAIM TO ANY PARTICULAR FONT, STYLE, SIZE, OR COLOR.

FOR OVER THE COUNTER ORAL ANESTHETIC (U.S. CLS. 6, 18, 44, 46, 51 AND 52).

DAVID I, EXAMINING ATTORNEY

CLASS 5—(Continued).

SN 77-894,451. BAYER AKTIENGESELLSCHAFT, 51373 LEVERKUSEN, FED REP GERMANY, FILED 12-16-2009.

ATLANTIS

THE MARK CONSISTS OF STANDARD CHARACTERS WITHOUT CLAIM TO ANY PARTICULAR FONT, STYLE, SIZE, OR COLOR.

FOR PREPARATIONS FOR KILLING WEEDS AND DESTROYING VERMIN, INSECTICIDES, HERBICIDES, FUNGICIDES (U.S. CLS. 6, 18, 44, 46, 51 AND 52).
ELLEN BURNS, EXAMINING ATTORNEY

SN 77-895,413. NOVARTIS AG, BASEL, SWITZERLAND, FILED 12-17-2009.

ABEONAC

THE MARK CONSISTS OF STANDARD CHARACTERS WITHOUT CLAIM TO ANY PARTICULAR FONT, STYLE, SIZE, OR COLOR.

OWNER OF U.S. REG. NO. 2,874,326.
FOR PHARMACEUTICAL PREPARATIONS FOR THE PREVENTION AND TREATMENT OF DISORDERS OF THE NERVOUS SYSTEM, THE IMMUNE SYSTEM, THE CARDIO-VASCULAR SYSTEM, THE METABOLIC SYSTEM, THE RESPIRATORY SYSTEM, THE MUSCULO-SKELETAL SYSTEM, THE GENITOURINARY SYSTEM; PHARMACEUTICAL PREPARATIONS FOR THE TREATMENT OF INFLAMMATORY DISORDERS; PHARMACEUTICAL PREPARATIONS FOR USE IN DERMATOLOGY, ONCOLOGY, AND HEMATOLOGY; PHARMACEUTICAL PREPARATIONS FOR USE IN TISSUE AND ORGAN TRANSPLANTATION; PHARMACEUTICAL PREPARATIONS FOR USE IN OPHTHALMOLOGY AND FOR GASTROENTEROLOGICAL DISORDERS (U.S. CLS. 6, 18, 44, 46, 51 AND 52).
JULIE VEPPUMTHARA, EXAMINING ATTORNEY

CLASS 5—(Continued).

SN 77-895,781. NOVARTIS AG, BASEL, SWITZERLAND, FILED 12-17-2009.



OWNER OF U.S. REG. NO. 3,225,177.
THE COLOR GRAY IS INTENDED TO SHOW SHADING OR CONTRAST ONLY.

THE MARK CONSISTS OF THE WORD "GILENIA" PRECEDED BY A STAR AND A GRADUALLY WIDENING ARCH.

FOR PHARMACEUTICAL PREPARATIONS FOR THE PREVENTION OF DISORDERS OF THE NERVOUS SYSTEM AND IMMUNE SYSTEM AND FOR THE PREVENTION OF INFLAMMATORY DISORDERS; PHARMACEUTICAL PREPARATIONS FOR THE TREATMENT OF DISORDERS OF THE NERVOUS SYSTEM AND IMMUNE SYSTEM AND FOR THE TREATMENT OF INFLAMMATORY DISORDERS (U.S. CLS. 6, 18, 44, 46, 51 AND 52).
JULIE VEPPUMTHARA, EXAMINING ATTORNEY

SN 77-896,658. NOVARTIS AG, BASEL, SWITZERLAND, FILED 12-18-2009.

ALMENAR

THE MARK CONSISTS OF STANDARD CHARACTERS WITHOUT CLAIM TO ANY PARTICULAR FONT, STYLE, SIZE, OR COLOR.

PRIORITY CLAIMED UNDER SEC. 44(D) ON SWITZERLAND APPLICATION NO. 62572/2009, FILED 11-11-2009, REG. NO. 593665, DATED 11-24-2009, EXPIRES 11-11-2019.

THE ENGLISH TRANSLATION OF "ALMENAR" IN THE MARK IS TORCHHOLDER.

FOR VACCINES FOR HUMAN USE (U.S. CLS. 6, 18, 44, 46, 51 AND 52).
JULIE VEPPUMTHARA, EXAMINING ATTORNEY

SN 77-896,927. NOVARTIS AG, BASEL, SWITZERLAND, FILED 12-18-2009.

BEXSERO

THE MARK CONSISTS OF STANDARD CHARACTERS WITHOUT CLAIM TO ANY PARTICULAR FONT, STYLE, SIZE, OR COLOR.

PRIORITY CLAIMED UNDER SEC. 44(D) ON SWITZERLAND APPLICATION NO. 62548/2009, FILED 11-11-2009, REG. NO. 593547, DATED 11-19-2009, EXPIRES 11-11-2019.

FOR VACCINES FOR HUMAN USE (U.S. CLS. 6, 18, 44, 46, 51 AND 52).
MAYUR VAGHANI, EXAMINING ATTORNEY

CLASS 5—(Continued).

SN 77-896,955. NOVARTIS AG, BASEL, SWITZERLAND,
FILED 12-18-2009.

BEVAMON

THE MARK CONSISTS OF STANDARD CHARACTERS
WITHOUT CLAIM TO ANY PARTICULAR FONT, STYLE,
SIZE, OR COLOR.

PRIORITY CLAIMED UNDER SEC. 44(D) ON SWITZER-
LAND APPLICATION NO. 62559/2009, FILED 11-11-2009,
REG. NO. 593557, DATED 11-19-2009, EXPIRES 11-11-2019.
FOR VACCINES FOR HUMAN USE (U.S. CLS. 6, 18, 44,
46, 51 AND 52).

MAYUR VAGHANI, EXAMINING ATTORNEY

CLASS 5—(Continued).

SN 77-897,209. NOVARTIS AG, BASEL, SWITZERLAND,
FILED 12-18-2009.

IDANTI

THE MARK CONSISTS OF STANDARD CHARACTERS
WITHOUT CLAIM TO ANY PARTICULAR FONT, STYLE,
SIZE, OR COLOR.

PRIORITY CLAIMED UNDER SEC. 44(D) ON SWITZER-
LAND APPLICATION NO. 62567/2009, FILED 11-11-2009,
REG. NO. 593563, DATED 11-19-2009, EXPIRES 11-11-2019.
FOR VACCINES FOR HUMAN USE (U.S. CLS. 6, 18, 44,
46, 51 AND 52).

MICHAEL WIENER, EXAMINING ATTORNEY

SN 77-897,114. NOVARTIS AG, BASEL, SWITZERLAND,
FILED 12-18-2009.

BEMOND

THE MARK CONSISTS OF STANDARD CHARACTERS
WITHOUT CLAIM TO ANY PARTICULAR FONT, STYLE,
SIZE, OR COLOR.

PRIORITY CLAIMED UNDER SEC. 44(D) ON SWITZER-
LAND APPLICATION NO. 62556/2009, FILED 11-11-2009,
REG. NO. 593555, DATED 11-19-2009, EXPIRES 11-11-2019.
THE ENGLISH TRANSLATION OF THE WORD "BE-
MOND" IN THE MARK IS TO GO OR TO CALL.

FOR VACCINES FOR HUMAN USE (U.S. CLS. 6, 18, 44,
46, 51 AND 52).

MAYUR VAGHANI, EXAMINING ATTORNEY

SN 77-897,230. EISAI R&D MANAGEMENT CO., LTD.,
TOKYO, JAPAN, FILED 12-18-2009.

ARICEPT XL

THE MARK CONSISTS OF STANDARD CHARACTERS
WITHOUT CLAIM TO ANY PARTICULAR FONT, STYLE,
SIZE, OR COLOR.

OWNER OF U.S. REG. NOS. 2,065,647, 3,093,734 AND
OTHERS.

NO CLAIM IS MADE TO THE EXCLUSIVE RIGHT TO
USE "XL", APART FROM THE MARK AS SHOWN.

FOR PHARMACEUTICAL PREPARATIONS FOR THE
TREATMENT OF CEREBRAL AND NEUROLOGIC DIS-
ORDERS, DISEASES AND CONDITIONS; PHARMACEU-
TICAL PREPARATIONS FOR THE TREATMENT OF
THE SYMPTOMS OF ALZHEIMER'S DISEASE (U.S.
CLS. 6, 18, 44, 46, 51 AND 52).

ANNE FARRELL, EXAMINING ATTORNEY

SN 77-897,150. NOVARTIS AG, BASEL, SWITZERLAND,
FILED 12-18-2009.

DOMENI

THE MARK CONSISTS OF STANDARD CHARACTERS
WITHOUT CLAIM TO ANY PARTICULAR FONT, STYLE,
SIZE, OR COLOR.

PRIORITY CLAIMED UNDER SEC. 44(D) ON SWITZER-
LAND APPLICATION NO. 62566/2009, FILED 11-11-2009,
REG. NO. 593562, DATED 11-19-2009, EXPIRES 11-11-2019.

FOR VACCINES FOR HUMAN USE (U.S. CLS. 6, 18, 44,
46, 51 AND 52).

MAYUR VAGHANI, EXAMINING ATTORNEY

SN 77-897,264. NOVARTIS AG, BASEL, SWITZERLAND,
FILED 12-18-2009.

DIZANTI

THE MARK CONSISTS OF STANDARD CHARACTERS
WITHOUT CLAIM TO ANY PARTICULAR FONT, STYLE,
SIZE, OR COLOR.

PRIORITY CLAIMED UNDER SEC. 44(D) ON SWITZER-
LAND APPLICATION NO. 62565/2009, FILED 11-11-2009,
REG. NO. 593561, DATED 11-19-2009, EXPIRES 11-11-2019.

FOR VACCINES FOR HUMAN USE (U.S. CLS. 6, 18, 44,
46, 51 AND 52).

MICHAEL WIENER, EXAMINING ATTORNEY

CLASS 5—(Continued).

SN 77-902,982. BLUEBONNET NUTRITION CORP., SUGAR LAND, TX. FILED 12-30-2009.

MUSHROOM ACTIVE

THE MARK CONSISTS OF STANDARD CHARACTERS WITHOUT CLAIM TO ANY PARTICULAR FONT, STYLE, SIZE, OR COLOR.

OWNER OF U.S. REG. NOS. 3,393,012 AND 3,454,361. NO CLAIM IS MADE TO THE EXCLUSIVE RIGHT TO USE "MUSHROOM", APART FROM THE MARK AS SHOWN.

FOR NUTRITIONAL SUPPLEMENTS (U.S. CLS. 6, 18, 44, 46, 51 AND 52).
JOHN WILKE, EXAMINING ATTORNEY

CLASS 5—(Continued).

SN 77-909,813. SYNGENTA PARTICIPATIONS AG, BASEL, SWITZERLAND, FILED 1-12-2010.

Micora

THE MARK CONSISTS OF STANDARD CHARACTERS WITHOUT CLAIM TO ANY PARTICULAR FONT, STYLE, SIZE, OR COLOR.

FOR FUNGICIDES FOR TURF AND ORNAMENTAL USE (U.S. CLS. 6, 18, 44, 46, 51 AND 52).
JENNIFER MARTIN, EXAMINING ATTORNEY

SN 77-914,120. SYNGENTA PARTICIPATIONS AG, BASEL, SWITZERLAND, FILED 1-18-2010.

Alibi

THE MARK CONSISTS OF STANDARD CHARACTERS WITHOUT CLAIM TO ANY PARTICULAR FONT, STYLE, SIZE, OR COLOR.

FOR PREPARATIONS FOR DESTROYING VERMIN; FUNGICIDES, HERBICIDES, INSECTICIDES (U.S. CLS. 6, 18, 44, 46, 51 AND 52).

JENNIFER MARTIN, EXAMINING ATTORNEY

SN 77-914,143. ORAHEALTH CORPORATION, BELLEVUE, WA. FILED 1-18-2010.

RESMELTS

THE MARK CONSISTS OF STANDARD CHARACTERS WITHOUT CLAIM TO ANY PARTICULAR FONT, STYLE, SIZE, OR COLOR.

FOR DIETARY SUPPLEMENTS FOR HUMAN CONSUMPTION (U.S. CLS. 6, 18, 44, 46, 51 AND 52).
JOHN DWYER, EXAMINING ATTORNEY

SN 77-905,008. CARGILL, INCORPORATED, WAYZATA, MN. FILED 1-5-2010.

CHITASURE

THE MARK CONSISTS OF STANDARD CHARACTERS WITHOUT CLAIM TO ANY PARTICULAR FONT, STYLE, SIZE, OR COLOR.

FOR DIETARY SUPPLEMENTS (U.S. CLS. 6, 18, 44, 46, 51 AND 52).
KATHERINE STOIDES, EXAMINING ATTORNEY

SN 77-905,819. SYNGENTA PARTICIPATIONS AG, BASEL, SWITZERLAND, FILED 1-6-2010.

Dorado

THE MARK CONSISTS OF STANDARD CHARACTERS WITHOUT CLAIM TO ANY PARTICULAR FONT, STYLE, SIZE, OR COLOR.

FOR FUNGICIDES (U.S. CLS. 6, 18, 44, 46, 51 AND 52).
FIRST USE 3-8-2007; IN COMMERCE 3-8-2007.
JENNIFER MARTIN, EXAMINING ATTORNEY

CLASS 5—(Continued).

SN 77-914,602. BIO-ENGINEERED SUPPLEMENTS & NUTRITION, INC., BOCA RATON, FL. FILED 1-19-2010.

ENDO BURN

THE MARK CONSISTS OF STANDARD CHARACTERS WITHOUT CLAIM TO ANY PARTICULAR FONT, STYLE, SIZE, OR COLOR.

FOR DIETARY SUPPLEMENT PRODUCTS SOLD OVER THE COUNTER ONLY, WITHOUT THE NEED FOR A PHYSICIAN'S PRESCRIPTION (U.S. CLS. 6, 18, 44, 46, 51 AND 52).

PAULA MAHONEY, EXAMINING ATTORNEY

CLASS 5—(Continued).

SN 77-925,761. KAMADA LTD., NESS ZIONA, ISRAEL, FILED 2-2-2010.

GLASSIA

THE MARK CONSISTS OF STANDARD CHARACTERS WITHOUT CLAIM TO ANY PARTICULAR FONT, STYLE, SIZE, OR COLOR.

FOR PHARMACEUTICAL PREPARATIONS, NAMELY, ALPHA-1 PROTEINASE INHIBITOR (U.S. CLS. 6, 18, 44, 46, 51 AND 52).

EMILY CARLSEN, EXAMINING ATTORNEY

SN 77-919,661. CCA INDUSTRIES, INC., EAST RUTHERFORD, NJ. FILED 1-25-2010.

CAL-X

THE MARK CONSISTS OF STANDARD CHARACTERS WITHOUT CLAIM TO ANY PARTICULAR FONT, STYLE, SIZE, OR COLOR.

FOR WEIGHT LOSS PRODUCTS IN THE NATURE OF DIETARY AND NUTRITIONAL SUPPLEMENTS (U.S. CLS. 6, 18, 44, 46, 51 AND 52).

RUSS HERMAN, EXAMINING ATTORNEY

SN 77-925,867. DSM IP ASSETS B.V., HEERLEN, NETHERLANDS, FILED 2-2-2010.

i-resLive

THE MARK CONSISTS OF "I-RESLIVE" IN STYLIZED FONT.

FOR NUTRITIONAL AND DIETARY FOOD SUPPLEMENTS (U.S. CLS. 6, 18, 44, 46, 51 AND 52).

PAULA MAHONEY, EXAMINING ATTORNEY

SN 77-921,206. ISS RESEARCH, LLC, CHARLOTTE, NC. FILED 1-27-2010.

MPR

THE MARK CONSISTS OF STANDARD CHARACTERS WITHOUT CLAIM TO ANY PARTICULAR FONT, STYLE, SIZE, OR COLOR.

FOR NUTRITIONAL SUPPLEMENTS FOR BODY BUILDING AND ATHLETIC TRAINING (U.S. CLS. 6, 18, 44, 46, 51 AND 52).

SEAN CROWLEY, EXAMINING ATTORNEY

SN 77-925,884. DSM IP ASSETS B.V., HEERLEN, NETHERLANDS, FILED 2-2-2010.

i-Live

THE MARK CONSISTS OF "I-LIVE" IN STYLIZED FONT. FOR NUTRITIONAL AND DIETARY FOOD SUPPLEMENTS (U.S. CLS. 6, 18, 44, 46, 51 AND 52).

PAULA MAHONEY, EXAMINING ATTORNEY

CLASS 5—(Continued).

SN 77-928,101. NYCOMED US INC., MELVILLE, NY. FILED 2-4-2010.

Think Outside The Tube

THE MARK CONSISTS OF STANDARD CHARACTERS WITHOUT CLAIM TO ANY PARTICULAR FONT, STYLE, SIZE, OR COLOR.

FOR PHARMACEUTICAL PREPARATIONS AND SUBSTANCES FOR PREVENTION, TREATMENT AND/OR ALLEVIATION OF DERMATOLOGICAL DISORDERS (U.S. CLS. 6, 18, 44, 46, 51 AND 52).

KATHERINE CHANG, EXAMINING ATTORNEY

SN 78-821,499. FOODSCIENCE CORPORATION, ESSEX JUNCTION, VT. FILED 2-23-2006.

BEAUTY & BRAINS

THE MARK CONSISTS OF STANDARD CHARACTERS WITHOUT CLAIM TO ANY PARTICULAR FONT, STYLE, SIZE, OR COLOR.

FOR VITAMIN AND MINERAL SUPPLEMENTS, HERBAL SUPPLEMENTS AND DIETARY SUPPLEMENTS (U.S. CLS. 6, 18, 44, 46, 51 AND 52).

PRISCILLA MILTON, EXAMINING ATTORNEY

SN 78-849,450. S.A.N CORPORATION, OXNARD, CA. FILED 3-29-2006.

Fierce

THE MARK CONSISTS OF STANDARD CHARACTERS WITHOUT CLAIM TO ANY PARTICULAR FONT, STYLE, SIZE, OR COLOR.

FOR DIETARY SUPPLEMENTS AND VITAMINS (U.S. CLS. 6, 18, 44, 46, 51 AND 52).

FIRST USE 3-1-2006; IN COMMERCE 3-29-2006.
LINDA ORNDORFF, EXAMINING ATTORNEY

CLASS 5—(Continued).

SN 79-063,067. MEDEVICE S.P.A., ITALY, FILED 10-6-2008.

CONDROTIDE

THE MARK CONSISTS OF STANDARD CHARACTERS WITHOUT CLAIM TO ANY PARTICULAR FONT, STYLE, SIZE, OR COLOR.

PRIORITY DATE OF 6-27-2008 IS CLAIMED.

OWNER OF INTERNATIONAL REGISTRATION 0987421 DATED 10-6-2008, EXPIRES 10-6-2018.

FOR PHARMACEUTICAL PREPARATIONS, NAMELY, INTRA-MUSCULAR, ORAL OR TOPICAL PREPARATIONS, FOR TREATING JOINTS AND FOR TREATING PAINS CAUSED BY JOINT LESIONS; VETERINARY PREPARATIONS, NAMELY, INTRA-MUSCULAR, ORAL OR TOPICAL PREPARATIONS, FOR TREATING JOINTS AND FOR TREATING PAINS CAUSED BY JOINT LESIONS IN DOGS, CATS AND HORSES (U.S. CLS. 6, 18, 44, 46, 51 AND 52).

HAI-LY LAM, EXAMINING ATTORNEY

SN 79-069,215. BASF SE, LUDWIGSHAFEN, FED REP GERMANY, FILED 5-18-2009.

ARAMO

OWNER OF INTERNATIONAL REGISTRATION 0519099 DATED 1-16-1988, EXPIRES 1-16-2018.

FOR PREPARATIONS FOR WEED KILLING; INOCULATION AGENTS FOR SEEDS, NAMELY, PREPARATIONS FOR PREVENTING DISEASE IN FIELD CROPS (U.S. CLS. 6, 18, 44, 46, 51 AND 52).

HAI-LY LAM, EXAMINING ATTORNEY

SN 79-071,443. PHARMACOSMOS HOLDING A/S, HOLBÆK, DENMARK, FILED 6-16-2009.

M O N O F E R

THE MARK CONSISTS OF STANDARD CHARACTERS WITHOUT CLAIM TO ANY PARTICULAR FONT, STYLE, SIZE, OR COLOR.

OWNER OF INTERNATIONAL REGISTRATION 0780653 DATED 5-3-2002, EXPIRES 5-3-2012.

FOR IRON PREPARATIONS FOR PHARMACEUTICAL AND VETERINARY USE AND IRON PREPARATIONS AS FOOD SUPPLEMENTS (U.S. CLS. 6, 18, 44, 46, 51 AND 52).

GINA HAYES, EXAMINING ATTORNEY

CLASS 5—(Continued).

SN 79-071,815. PROBIOTICAL SPA, ITALY, FILED 6-4-2009.

LADYFLOR

THE MARK CONSISTS OF STANDARD CHARACTERS WITHOUT CLAIM TO ANY PARTICULAR FONT, STYLE, SIZE, OR COLOR.

PRIORITY DATE OF 12-19-2008 IS CLAIMED.

OWNER OF INTERNATIONAL REGISTRATION 1010194 DATED 6-4-2009, EXPIRES 6-4-2019.

FOR PHARMACEUTICAL PRODUCTS FOR THE TREATMENT OF PATHOLOGIES INVOLVING THE VAGINAL APPARATUS, NAMELY, FOR THE PREVENTIVE OR CURATIVE TREATMENT OF INFECTIONS INVOLVING THE VAGINAL APPARATUS, SAID INFECTIONS BEING CAUSED BY FUNGI, CANDIDA ALBICANS, PATHOGENS AND PARASITES; PHARMACEUTICAL PREPARATIONS BASED ON LACTIC BACTERIA FOR THE TREATMENT OF CANDIDOSIS, VAGINITIS, VULVOVAGINITIS CAUSED BY CANDIDA, VAGINOSIS AND OF THE TRUSH OR CANDIDIASIS; PHARMACEUTICAL PRODUCTS BASED ON LACTIC BACTERIA FOR THE TREATMENT OF VAGINAL MUCOUS AND FOR THE RE-ESTABLISHMENT OF THE BACTERIAL VAGINAL FLORA; PHARMACEUTICAL PREPARATIONS BASED ON LACTIC BACTERIA FOR PERSONAL HYGIENE FOR MEDICAL USE, NAMELY, FOR THE PREVENTIVE OR CURATIVE TREATMENT OF INFECTIONS INVOLVING THE VAGINAL APPARATUS (U.S. CLS. 6, 18, 44, 46, 51 AND 52).
JESSICA FATHY, EXAMINING ATTORNEY

SN 79-072,054. GP PHARM, S.A., SPAIN, FILED 6-23-2009.

GEPRAL

THE MARK CONSISTS OF STANDARD CHARACTERS WITHOUT CLAIM TO ANY PARTICULAR FONT, STYLE, SIZE, OR COLOR.

PRIORITY DATE OF 12-23-2008 IS CLAIMED.

OWNER OF INTERNATIONAL REGISTRATION 1010832 DATED 6-23-2009, EXPIRES 6-23-2019.

THE WORDING "GEPRAL" HAS NO MEANING IN A FOREIGN LANGUAGE.

FOR PHARMACEUTICAL PREPARATIONS FOR HUMAN PURPOSES FOR USE IN UROLOGY; PHARMACEUTICAL PREPARATIONS FOR HUMAN PURPOSES FOR THE PREVENTION AND TREATMENT OF DISORDERS OF THE NERVOUS SYSTEM; PHARMACEUTICAL PREPARATIONS FOR HUMAN PURPOSES FOR THE TREATMENT OF INFLAMMATORY DISORDERS; PHARMACEUTICAL PREPARATIONS FOR HUMAN PURPOSES FOR USE IN ONCOLOGY AND IN TISSUE AND ORGAN TRANSPLANTATION; PHARMACEUTICAL PREPARATIONS FOR HUMAN PURPOSES FOR THE TREATMENT OF VIRAL, CARDIOVASCULAR AND PSYCHIATRIC RELATED DISEASES AND DISORDERS; PHARMACEUTICAL PREPARATIONS FOR HUMAN PURPOSES FOR THE PREVENTION AND TREATMENT OF AUTOIMMUNE DISEASES OR DISORDERS; PEPTIDES FOR USE IN UROLOGY, ONCOLOGY AND FOR THE TREATMENT OF VIRAL, INFLAMMATORY, NERVOUS SYSTEM, CARDIOVASCULAR, PSYCHIATRIC AND AUTOIMMUNE DISEASES OR DISORDERS (U.S. CLS. 6, 18, 44, 46, 51 AND 52).
CHRISTINA SOBRAL, EXAMINING ATTORNEY

CLASS 5—(Continued).

SN 79-073,007. MILLIE & MORE PTY LTD, AUSTRALIA, FILED 6-26-2009.



OWNER OF INTERNATIONAL REGISTRATION 0942752 DATED 10-3-2007, EXPIRES 10-3-2017.

THE MARK CONSISTS OF THE DESIGN OF A BOW.

FOR ARTICLES FOR FEMININE HYGIENE, NAMELY, DIGITAL TAMPONS AND APPLICATOR TAMPONS, SANITARY NAPKINS, MENSTRUATION SANITARY PADS, MENSTRUAL PANTY LINERS, NON-MENSTRUAL PANTY LINERS (U.S. CLS. 6, 18, 44, 46, 51 AND 52).
JESSICA FATHY, EXAMINING ATTORNEY

SN 79-073,329. BIOPLEX LIMITED, UNITED KINGDOM, FILED 8-7-2009.

AFTAMED

THE MARK CONSISTS OF STANDARD CHARACTERS WITHOUT CLAIM TO ANY PARTICULAR FONT, STYLE, SIZE, OR COLOR.

OWNER OF INTERNATIONAL REGISTRATION 1014512 DATED 8-7-2009, EXPIRES 8-7-2019.

FOR MEDICATED MOUTH CARE AND TREATMENT PREPARATIONS; MEDICATED MOUTH WASH, MEDICINAL PREPARATIONS FOR THE MOUTH AND AS SPRAYS; MEDICINAL PREPARATIONS FOR THE MOUTH TO BE APPLIED IN THE FORM OF DROPS, CAPSULES, TABLETS AND COMPRESSED TABLETS; MOUTH CAVITY CLEANERS; ANTICAVITY MOUTH RINSES; MEDICATED BRUSH ON ORAL CARE GELS (U.S. CLS. 6, 18, 44, 46, 51 AND 52).
MARCIE MILONE, EXAMINING ATTORNEY

CLASS 5—(Continued).

SN 79-074,685. SOLVAY PHARMACEUTICALS B.V., NL-1381 CP WEESP, NETHERLANDS, FILED 10-13-2009.

FILIANCE

THE MARK CONSISTS OF STANDARD CHARACTERS WITHOUT CLAIM TO ANY PARTICULAR FONT, STYLE, SIZE, OR COLOR.

PRIORITY DATE OF 7-8-2009 IS CLAIMED.

OWNER OF INTERNATIONAL REGISTRATION 1018124 DATED 10-13-2009, EXPIRES 10-13-2019.

OWNER OF U.S. REG. NOS. 2,763,915, 2,763,916 AND 3,055,734.

THE WORDING "FILIANCE" HAS NO MEANING IN A FOREIGN LANGUAGE.

FOR PHARMACEUTICAL PREPARATIONS AND SUBSTANCES FOR THE TREATMENT OF DISEASES OF THE CENTRAL NERVOUS SYSTEM, GASTRO-INTESTINAL DISEASES, GYNAECOLOGICAL DISEASES AND CARDIOVASCULAR DISEASES (U.S. CLS. 6, 18, 44, 46, 51 AND 52).

CHARISMA HAMPTON, EXAMINING ATTORNEY

SN 79-074,886. SOLVAY PHARMACEUTICALS B.V., NL-1381 CP WEESP, NETHERLANDS, FILED 9-18-2009.

PULZIUM

THE MARK CONSISTS OF STANDARD CHARACTERS WITHOUT CLAIM TO ANY PARTICULAR FONT, STYLE, SIZE, OR COLOR.

PRIORITY DATE OF 4-1-2009 IS CLAIMED.

OWNER OF INTERNATIONAL REGISTRATION 1018649 DATED 9-18-2009, EXPIRES 9-18-2019.

OWNER OF U.S. REG. NO. 2,763,912.

THE WORDING "PULZIUM" HAS NO MEANING IN A FOREIGN LANGUAGE.

FOR PHARMACEUTICAL PREPARATIONS AND SUBSTANCES FOR THE PREVENTION AND TREATMENT OF CARDIOVASCULAR AND RELATED DISEASES, INCLUDING CARDIOVASCULAR TREATMENT PREPARATIONS (U.S. CLS. 6, 18, 44, 46, 51 AND 52).

CHARISMA HAMPTON, EXAMINING ATTORNEY

SN 79-075,073. CID LINES NV, BELGIUM, FILED 6-23-2009.

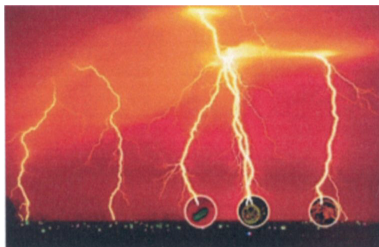

OWNER OF INTERNATIONAL REGISTRATION 1019124 DATED 6-23-2009, EXPIRES 6-23-2019.

THE COLOR(S) RED, ORANGE, YELLOW, WHITE, BLACK, BROWN, GREEN AND BLUE IS/ARE CLAIMED AS A FEATURE OF THE MARK.

THE MARK CONSISTS OF A RED, ORANGE AND YELLOW SKY APPEARING ABOVE THE DESIGN OF A BLACK LANDSCAPE WITH WHITE, GREEN AND BLUE LIGHTS. SEVERAL YELLOW OR WHITE LIGHTNING

CLASS 5—(Continued).

STRIKES EXTEND FROM THE SKY TO THE GROUND WITH THREE OF THE LIGHTNING STRIKES EXTENDING TO THREE ENCIRCLED IMAGES HAVING WHITE BORDERS. THE FIRST ENCIRCLED IMAGE CONSISTS OF A GREEN BACTERIA APPEARING IN A RED BACKGROUND. THE SECOND ENCIRCLED IMAGE CONSISTS OF A GREEN AND BROWN VIRUS APPEARING ON A BLACK BACKGROUND. THE THIRD ENCIRCLED IMAGE CONSISTS OF AN ORANGE FUNGUS APPEARING ON A BLACK BACKGROUND.

FOR PHARMACEUTICAL PREPARATIONS FOR THE TREATMENT OF INFECTIOUS DISEASES; PHARMACEUTICAL PREPARATIONS FOR ANIMAL SKINCARE; VETERINARY PHARMACEUTICAL COMPOUNDS FOR USE ON LIVESTOCK AND POULTRY TO TREAT CONDITIONS OF THE LEG, HOOF, EAR, NOSE AND THROAT; VETERINARY PREPARATIONS FOR TREATMENT OF INTESTINAL BACTERIA; ALL PURPOSE DISINFECTANTS; DISINFECTANTS FOR HYGIENIC PURPOSES; DISINFECTANTS FOR SANITARY PURPOSES; DISINFECTING HAND WASH; SANITIZING PREPARATIONS FOR HOUSEHOLD USE; SANITIZING PREPARATIONS FOR USE IN INSTITUTIONAL AND INDUSTRIAL AREAS; SANITARY PREPARATIONS FOR MEDICAL PURPOSES; PREPARATIONS FOR DESTROYING VERMIN; FUNGICIDES; HERBICIDES; BIOCIDES; GERMICIDES; PARASITICIDES; PESTICIDES; PREPARATIONS FOR DESTROYING VIRUSES (U.S. CLS. 6, 18, 44, 46, 51 AND 52).

DEBRA LEE, EXAMINING ATTORNEY

SN 79-078,093. PURE ANIMAL WELLBEING PTY LIMITED, AUSTRALIA, FILED 12-8-2009.

NutriDerm

THE MARK CONSISTS OF STANDARD CHARACTERS WITHOUT CLAIM TO ANY PARTICULAR FONT, STYLE, SIZE, OR COLOR.

PRIORITY DATE OF 7-1-2009 IS CLAIMED.

OWNER OF INTERNATIONAL REGISTRATION 1026818 DATED 12-8-2009, EXPIRES 12-8-2019.

FOR VETERINARY PREPARATIONS FOR TOPICAL APPLICATION, NAMELY, PHARMACEUTICAL PRODUCTS FOR ANIMAL SKINCARE (U.S. CLS. 6, 18, 44, 46, 51 AND 52).

PAUL F. GAST, EXAMINING ATTORNEY

CLASS 5—(Continued).

SN 79-078,148. BOEHRINGER INGELHEIM INTERNATIONAL GMBH, FED REP GERMANY, FILED 12-14-2009.

ESGLITEO

THE MARK CONSISTS OF STANDARD CHARACTERS WITHOUT CLAIM TO ANY PARTICULAR FONT, STYLE, SIZE, OR COLOR.

PRIORITY DATE OF 7-10-2009 IS CLAIMED.
OWNER OF INTERNATIONAL REGISTRATION 1026955 DATED 12-14-2009, EXPIRES 12-14-2019.

FOR PHARMACEUTICAL PREPARATIONS, NAMELY, PHARMACEUTICAL PREPARATIONS FOR THE TREATMENT OF DISEASES AND DISORDERS OF THE ALIMENTARY TRACT AND METABOLISM, AND BLOOD AND BLOOD FORMING ORGANS; PHARMACEUTICAL PREPARATIONS FOR THE TREATMENT OF DISEASES AND DISORDERS OF THE CARDIOVASCULAR SYSTEM, MUSCULOSKELETAL SYSTEM, CENTRAL NERVOUS SYSTEM, PERIPHERAL NERVOUS SYSTEM, GENITOURINARY SYSTEM AND RESPIRATORY SYSTEM; PHARMACEUTICAL PREPARATIONS FOR THE TREATMENT OF DERMATOLOGICAL, HORMONAL, INFECTIOUS, VIRAL AND ONCOLOGICAL DISEASES AND DISORDERS (U.S. CLS. 6, 18, 44, 46, 51 AND 52).

JAMES GRIFFIN, EXAMINING ATTORNEY

CLASS 5—(Continued).

SN 79-078,150. BOEHRINGER INGELHEIM INTERNATIONAL GMBH, FED REP GERMANY, FILED 12-14-2009.

ESGLINIO

THE MARK CONSISTS OF STANDARD CHARACTERS WITHOUT CLAIM TO ANY PARTICULAR FONT, STYLE, SIZE, OR COLOR.

PRIORITY DATE OF 7-10-2009 IS CLAIMED.
OWNER OF INTERNATIONAL REGISTRATION 1026957 DATED 12-14-2009, EXPIRES 12-14-2019.

FOR PHARMACEUTICAL PREPARATIONS, NAMELY, PHARMACEUTICAL PREPARATIONS FOR THE TREATMENT OF DISEASES AND DISORDERS OF THE ALIMENTARY TRACT AND METABOLISM, AND BLOOD AND BLOOD FORMING ORGANS; PHARMACEUTICAL PREPARATIONS FOR THE TREATMENT OF DISEASES AND DISORDERS OF THE CARDIOVASCULAR SYSTEM, MUSCULOSKELETAL SYSTEM, CENTRAL NERVOUS SYSTEM, PERIPHERAL NERVOUS SYSTEM, GENITOURINARY SYSTEM AND RESPIRATORY SYSTEM; PHARMACEUTICAL PREPARATIONS FOR THE TREATMENT OF DERMATOLOGICAL, HORMONAL, INFECTIOUS, VIRAL AND ONCOLOGICAL DISEASES AND DISORDERS (U.S. CLS. 6, 18, 44, 46, 51 AND 52).

JAMES GRIFFIN, EXAMINING ATTORNEY

SN 79-078,149. BOEHRINGER INGELHEIM INTERNATIONAL GMBH, FED REP GERMANY, FILED 12-14-2009.

GLYXUDRA

THE MARK CONSISTS OF STANDARD CHARACTERS WITHOUT CLAIM TO ANY PARTICULAR FONT, STYLE, SIZE, OR COLOR.

PRIORITY DATE OF 7-10-2009 IS CLAIMED.
OWNER OF INTERNATIONAL REGISTRATION 1026956 DATED 12-14-2009, EXPIRES 12-14-2019.

FOR PHARMACEUTICAL PREPARATIONS, NAMELY, PHARMACEUTICAL PREPARATIONS FOR THE TREATMENT OF DISEASES AND DISORDERS OF THE ALIMENTARY TRACT AND METABOLISM, AND BLOOD AND BLOOD FORMING ORGANS; PHARMACEUTICAL PREPARATIONS FOR THE TREATMENT OF DISEASES AND DISORDERS OF THE CARDIOVASCULAR SYSTEM, MUSCULOSKELETAL SYSTEM, CENTRAL NERVOUS SYSTEM, PERIPHERAL NERVOUS SYSTEM, GENITOURINARY SYSTEM AND RESPIRATORY SYSTEM; PHARMACEUTICAL PREPARATIONS FOR THE TREATMENT OF DERMATOLOGICAL, HORMONAL, INFECTIOUS, VIRAL AND ONCOLOGICAL DISEASES AND DISORDERS (U.S. CLS. 6, 18, 44, 46, 51 AND 52).

JAMES GRIFFIN, EXAMINING ATTORNEY

SN 79-078,152. BOEHRINGER INGELHEIM INTERNATIONAL GMBH, FED REP GERMANY, FILED 12-8-2009.

RONJOLI

THE MARK CONSISTS OF STANDARD CHARACTERS WITHOUT CLAIM TO ANY PARTICULAR FONT, STYLE, SIZE, OR COLOR.

PRIORITY DATE OF 7-10-2009 IS CLAIMED.
OWNER OF INTERNATIONAL REGISTRATION 1026960 DATED 12-8-2009, EXPIRES 12-8-2019.

FOR PHARMACEUTICAL PREPARATIONS, NAMELY, PHARMACEUTICAL PREPARATIONS FOR THE TREATMENT OF DISEASES AND DISORDERS OF THE ALIMENTARY TRACT AND METABOLISM, AND BLOOD AND BLOOD FORMING ORGANS; PHARMACEUTICAL PREPARATIONS FOR THE TREATMENT OF DISEASES AND DISORDERS OF THE CARDIOVASCULAR SYSTEM, MUSCULOSKELETAL SYSTEM, CENTRAL NERVOUS SYSTEM, PERIPHERAL NERVOUS SYSTEM, GENITOURINARY SYSTEM AND RESPIRATORY SYSTEM; PHARMACEUTICAL PREPARATIONS FOR THE TREATMENT OF DERMATOLOGICAL, HORMONAL, INFECTIOUS, VIRAL AND ONCOLOGICAL DISEASES AND DISORDERS (U.S. CLS. 6, 18, 44, 46, 51 AND 52).

JAMES GRIFFIN, EXAMINING ATTORNEY

CLASS 5—(Continued).

SN 79-078,421. MEDY-TOX INC., REPUBLIC OF KOREA, FILED 12-8-2009.

CUNOX

THE MARK CONSISTS OF STANDARD CHARACTERS WITHOUT CLAIM TO ANY PARTICULAR FONT, STYLE, SIZE, OR COLOR.

PRIORITY DATE OF 7-10-2009 IS CLAIMED.

OWNER OF INTERNATIONAL REGISTRATION 1027558 DATED 12-8-2009, EXPIRES 12-8-2019.

FOR BOTULINUM TOXIN FOR THE TREATMENT OF MUSCLE SPASMS; PHARMACEUTICAL PREPARATIONS FOR THE TREATMENT OF FROWN LINES, GLABELLAR LINES AND OTHER FACIAL WRINKLES; PHARMACEUTICAL PREPARATIONS FOR USE IN COSMETIC SURGERY; PHARMACEUTICAL PREPARATIONS FOR SKIN CARE; PHARMACEUTICAL PREPARATIONS FOR THE TREATMENT OF PAIN; PHARMACEUTICAL PREPARATIONS FOR THE TREATMENT OF HEMI FACIAL SPASM AND/OR BLEPHAROSPASM; PHARMACEUTICAL PREPARATIONS FOR THE TREATMENT OF DYSTONIA; PHARMACEUTICAL PREPARATIONS FOR THE TREATMENT OF TORTICOLLIS; PHARMACEUTICAL PREPARATIONS FOR THE TREATMENT OF CEREBRAL PALSY; PHARMACEUTICAL PREPARATIONS FOR THE TREATMENT OF ARTICULAR PATHOLOGIES; PHARMACEUTICAL PREPARATIONS FOR THE TREATMENT OF ACNE; PHARMACEUTICAL PREPARATIONS FOR THE TREATMENT OF HEADACHE; PHARMACEUTICAL PREPARATIONS FOR THE TREATMENT OF MIGRAINE; PHARMACEUTICAL PREPARATIONS FOR THE TREATMENT OF HYPERHYDROSIS; PHARMACEUTICAL PREPARATIONS FOR THE TREATMENT OF MYOFASCIAL PAIN; PHARMACEUTICAL PREPARATIONS FOR THE TREATMENT OF MUSCULAR DISORDERS; PHARMACEUTICAL PREPARATIONS FOR THE TREATMENT OF NEUROLOGICAL DISORDERS; PHARMACEUTICAL PREPARATIONS FOR THE TREATMENT OF ORTHOPEDIC DISORDERS; PHARMACEUTICAL PREPARATIONS FOR THE TREATMENT OF DISORDER RELATING TO AGE; PHARMACEUTICAL PREPARATIONS FOR THE TREATMENT OF OPHTHALMOLOGICAL DISORDERS (U.S. CLS. 6, 18, 44, 46, 51 AND 52).

JAMES GRIFFIN, EXAMINING ATTORNEY

CLASS 6—METAL GOODS

SN 77-562,849. FATIGUE TECHNOLOGY, INC., SEATTLE, WA. FILED 9-4-2008.

FORCELOC

THE MARK CONSISTS OF STANDARD CHARACTERS WITHOUT CLAIM TO ANY PARTICULAR FONT, STYLE, SIZE, OR COLOR.

FOR METAL FASTENERS COMPRISING A NUT PLATE FOR RECEIVING ANOTHER COMPONENT; EXPANDABLE METAL FASTENERS COMPRISING A NUT; METAL MULTI-PIECE FASTENERS COMPRISED OF A NUT, AN EXPANDABLE COLLAR, AND A BUSHING; FASTENER ASSEMBLIES COMPRISED OF BLIND NUTS AND METAL THREADED INSERTS; ELECTRICAL GROUNDING/BONDING POINT FASTENERS COMPRISING A NUT; METAL STAND-OFFS FOR MOUNTING SYSTEMS COMPRISING A NUT; METAL THREADED FASTENERS (U.S. CLS. 2, 12, 13, 14, 23, 25 AND 50).

RONALD AIKENS, EXAMINING ATTORNEY

SN 77-635,113. JEKYLL ISLAND STATE PARK AUTHORITY, JEKYLL ISLAND, GA. FILED 12-17-2008.

THE GEORGIA SEATURTLE CENTER



SN 79-078,989. PELGAR INTERNATIONAL LIMITED, UNITED KINGDOM, FILED 12-10-2009.

BRIGAND

THE MARK CONSISTS OF STANDARD CHARACTERS WITHOUT CLAIM TO ANY PARTICULAR FONT, STYLE, SIZE, OR COLOR.

OWNER OF INTERNATIONAL REGISTRATION 1028957 DATED 12-10-2009, EXPIRES 12-10-2019.

FOR PREPARATIONS FOR DESTROYING VERMIN (U.S. CLS. 6, 18, 44, 46, 51 AND 52).

TRACY FLETCHER, EXAMINING ATTORNEY

NO CLAIM IS MADE TO THE EXCLUSIVE RIGHT TO USE "GEORGIA" AND "CENTER", APART FROM THE MARK AS SHOWN.

THE MARK CONSISTS OF A DESIGN ELEMENT CONSISTING OF A TURTLE-SHAPED FIGURE LOCATED BELOW THE LITERAL ELEMENT CONSISTING OF THE WORDS "THE GEORGIA SEA TURTLE CENTER" WHERE THE WORDS "THE" AND "CENTER" APPEAR SMALLER THAN THE WORDS "GEORGIA SEA TURTLE".

FOR METAL KEY CHAINS; METAL LICENSE PLATES; SOUVENIR LICENSE PLATES OF METAL (U.S. CLS. 2, 12, 13, 14, 23, 25 AND 50).

FIRST USE 6-16-2007; IN COMMERCE 6-16-2007.

RONALD DELGIZZI, EXAMINING ATTORNEY

CLASS 6—(Continued).

SN 77-658,994. STA-RITE INDUSTRIES, LLC, DELAVAN, WI.
FILED 1-29-2009.



NO CLAIM IS MADE TO THE EXCLUSIVE RIGHT TO USE "PRESSURE TANK", APART FROM THE MARK AS SHOWN.

THE MARK CONSISTS OF THE WORDING "PRO-" IN A STYLIZED FONT IMMEDIATELY ABOVE THE WORD "SOURCE" IN A STYLIZED FONT. A HORIZONTAL LINE IS UNDERNEATH THE LETTERS "OURCE". THE DESIGN OF A PLUS SIGN APPEARS TO THE RIGHT OF THE WORDING IN THE MARK WITH THE WORD "PLUS" IN A STYLIZED FONT APPEARING INSIDE THE HORIZONTAL PORTION OF THE PLUS SIGN DESIGN. THE "P" IN THE WORD "PLUS" IS CONNECTED TO THE HORIZONTAL LINE UNDERNEATH THE LETTERS "OURCE". THE WORDING "PRESSURE TANK" APPEARS IN A STYLIZED FONT IMMEDIATELY BELOW THE HORIZONTAL LINE.

FOR METAL FLUID STORAGE TANKS, NAMELY, PUMP TANKS FOR HOLDING AND PRESSURIZING WATER WITHIN WATER SYSTEMS (U.S. CLS. 2, 12, 13, 14, 23, 25 AND 50).

FIRST USE 12-0-1999; IN COMMERCE 12-0-1999.
WILLIAM ROSSMAN, EXAMINING ATTORNEY

SN 77-677,527. WOLVERINE TUBE (CANADA) INC., LONDON, CANADA, FILED 2-24-2009.

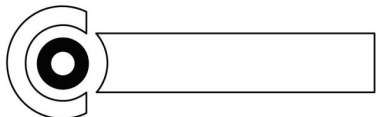

THE MARK CONSISTS OF A CURVED LINE FORMING A C SHAPE WITH SMOOTH EDGES AND A CIRCLE WITH A HOLLOW CENTER IN THE CENTER OF THE C SHAPE AS WELL AS A RECTANGULAR SHAPE TO THE LEFT WITH ONE CURVED SIDE.

FOR COPPER TUBING AND BRASS FLANGES (U.S. CLS. 2, 12, 13, 14, 23, 25 AND 50).

FIRST USE 12-31-2003; IN COMMERCE 12-31-2003.
LINDA ESTRADA, EXAMINING ATTORNEY

CLASS 6—(Continued).

SN 77-709,488. RESTEK CORPORATION, BELLEFONTE, PA.
FILED 4-8-2009.

SilcoSmooth

THE MARK CONSISTS OF STANDARD CHARACTERS WITHOUT CLAIM TO ANY PARTICULAR FONT, STYLE, SIZE, OR COLOR.

FOR AMORPHOUS SILICON LINED STAINLESS STEEL TUBING FOR USE WITH LABORATORY INSTRUMENTS AND EQUIPMENT (U.S. CLS. 2, 12, 13, 14, 23, 25 AND 50).

FIRST USE 1-1-1996; IN COMMERCE 1-1-1996.
SUNG IN, EXAMINING ATTORNEY

SN 77-717,229. MODULAR SPACE CORPORATION, BERWYN, PA. FILED 4-20-2009.



ModSafe

OWNER OF U.S. REG. NOS. 1,123,065, 3,133,642 AND 3,151,456.

THE MARK CONSISTS OF THE STYLIZED WORDING "MODSAFE" BELOW AN OVAL DESIGN CONTAINING THREE PARTIALLY SHADED SHAPES IN VARIOUS SIZES.

FOR PORTABLE METAL BUILDINGS (U.S. CLS. 2, 12, 13, 14, 23, 25 AND 50).

TIMOTHY FINNEGAN, EXAMINING ATTORNEY

SN 77-727,409. WASSON, JOHN, DBA I.B.B.I., FRUITA, CO. AND WASSON, NINNIAN, DBA I.B.B.I., FRUITA, CO. FILED 5-1-2009.

ShurLok

THE MARK CONSISTS OF STANDARD CHARACTERS WITHOUT CLAIM TO ANY PARTICULAR FONT, STYLE, SIZE, OR COLOR.

FOR METAL LOCK BOXES AND METAL KEY SAFES (U.S. CLS. 2, 12, 13, 14, 23, 25 AND 50).

FIRST USE 6-1-1997; IN COMMERCE 6-1-1997.
AMEEN IMAM, EXAMINING ATTORNEY

CLASS 6—(Continued).

SN 77-754,872. NIGHTBIRD PRODUCTIONS, INC., WEST HOLLYWOOD, CA. FILED 6-8-2009.

NIGHTBIRD

THE MARK CONSISTS OF STANDARD CHARACTERS WITHOUT CLAIM TO ANY PARTICULAR FONT, STYLE, SIZE, OR COLOR.

FOR METAL KEY CHAINS (U.S. CLS. 2, 12, 13, 14, 23, 25 AND 50).

TINA BROWN, EXAMINING ATTORNEY

SN 77-770,164. J.W. GOSS COMPANY, WARREN, OH. FILED 6-29-2009.

MIRRACO

THE MARK CONSISTS OF STANDARD CHARACTERS WITHOUT CLAIM TO ANY PARTICULAR FONT, STYLE, SIZE, OR COLOR.

FOR METAL MIRROR HANGERS; METAL MIRROR CLIPS (U.S. CLS. 2, 12, 13, 14, 23, 25 AND 50).

FIRST USE 6-26-2009; IN COMMERCE 6-26-2009.
ANNE FARRELL, EXAMINING ATTORNEY

SN 77-797,857. PECK & HALE, L.L.C., WEST SAYVILLE, NY. FILED 8-5-2009.

UCLS - Universal Container Locking System

THE MARK CONSISTS OF STANDARD CHARACTERS WITHOUT CLAIM TO ANY PARTICULAR FONT, STYLE, SIZE, OR COLOR.

NO CLAIM IS MADE TO THE EXCLUSIVE RIGHT TO USE "UNIVERSAL CONTAINER LOCKING SYSTEM", APART FROM THE MARK AS SHOWN.

FOR CONTAINERS OF METAL FOR TRANSPORT (U.S. CLS. 2, 12, 13, 14, 23, 25 AND 50).

MARY CRAWFORD, EXAMINING ATTORNEY

CLASS 6—(Continued).

SN 77-805,222. VECTOR INTERNATIONAL AS, DRAMMEN, NORWAY, FILED 8-14-2009.

SPO

THE MARK CONSISTS OF STANDARD CHARACTERS WITHOUT CLAIM TO ANY PARTICULAR FONT, STYLE, SIZE, OR COLOR.

PRIORITY CLAIMED UNDER SEC. 44(D) ON NORWAY APPLICATION NO. 200903074, FILED 3-24-2009, REG. NO. 251959, DATED 8-12-2009, EXPIRES 8-12-2019.

FOR METAL PIPES AND TUBES; METAL COUPLINGS FOR USE WITH PIPES, TUBES AND PRESSURE VESSELS; METAL PIPE, TUBE AND PRESSURE VESSEL JOINTS AND FITTINGS; METALLIC SEAL RINGS AND FLANGES FOR PIPES AND TUBES; METAL ALLOYS; METAL CLAMPS; METAL CLAMP CONNECTORS FOR PIPES AND TUBES; PARTS AND FITTINGS FOR THE AFORESAID GOODS (U.S. CLS. 2, 12, 13, 14, 23, 25 AND 50).

DAVID TAYLOR, EXAMINING ATTORNEY

SN 77-817,014. CREATIVELY YOURS OF SOUTH FLORIDA, INC., DBA CREATIVELY YOURS, LONG BEACH, CA. FILED 8-31-2009.



NO CLAIM IS MADE TO THE EXCLUSIVE RIGHT TO USE "INC", APART FROM THE MARK AS SHOWN.

THE COLOR(S) BLUE AND WHITE IS/ARE CLAIMED AS A FEATURE OF THE MARK.

THE MARK CONSISTS OF AN OUTLINE OF A LIGHT BULB IN THE CENTER OF A CIRCLE WITH 16 LINES RADIATING FROM THE BULB HEAD. THE LIGHT BULB IS SURROUNDED BY A CIRCLE. ABOVE THE UPPER ARC OF THE CIRCLE IS THE WORD "CREATIVELY" IN CAPITAL LETTERS. BELOW THE LOWER ARC OF THE CIRCLE IS THE WORDING "YOURS INC." THESE TWO WORDS ARE SEPARATED BY DOTS. THERE IS A FINAL CIRCLE ON THE PERIMETER OF THE MARK. THE COLOR BLUE APPEARS IN THE BACKGROUND AND THE COLOR WHITE APPEARS AS THE LETTERING, CIRCLES, DOTS, LIGHT BULB, AND LINES.

FOR KEY FOBS OF COMMON METAL; METAL KEY CHAINS; METAL KEY RINGS; PEWTER FIGURINES (U.S. CLS. 2, 12, 13, 14, 23, 25 AND 50).

FIRST USE 12-16-1993; IN COMMERCE 12-16-1993.

CARYN GLASSER, EXAMINING ATTORNEY

CLASS 6—(Continued).

SN 77-821,028. KING SLIDE WORKS CO., LTD., KAOHSIUNG HSIEN, TAIWAN, FILED 9-5-2009.

King Slide

OWNER OF U.S. REG. NO. 1,757,980.

NO CLAIM IS MADE TO THE EXCLUSIVE RIGHT TO USE "SLIDE", APART FROM THE MARK AS SHOWN.

THE MARK CONSISTS OF THE STYLIZED WORDS "KING SLIDE".

FOR METAL CASH DEPOSIT BOXES; MONEY BOXES OF METAL; STEEL FRAMES FOR BUILDINGS; METAL BRACKETS FOR USE IN THE CONSTRUCTION AND ASSEMBLY OF DECKING; METAL FRAMEWORKS FOR BUILDING; BUILDING MATERIALS, NAMELY, COMPOSITE PANELS COMPOSED PRIMARILY OF METAL; METAL WALL-MOUNTED PANEL UNITS FOR EXHIBITIONS, DISPLAYS AND PARTITIONING; NAILS; METAL PLUGS; SCREWS OF METAL; METAL NUTS; BOLTS OF METAL; METAL RIVETS; DOOR STOPS OF METAL; METAL CABINET STOPS; METAL PLUGS; BUCKLES OF COMMON METAL; METAL HOOKS; METAL CLAMPS; PIPES OF METAL; METAL JUNCTIONS FOR PIPES; METAL HINGES; METAL RAILS; METAL RUNNERS FOR SLIDING DOORS; METAL SLIDES FOR DRAWERS; CONTAINERS OF METAL FOR TRANSPORT; TOOL BOXES OF METAL; INDUSTRIAL PACKAGING CONTAINERS OF METAL; BASKETS OF COMMON METALS; METAL CHESTS; DOORS AND WINDOWS OF METAL; DOOR FITTINGS OF METAL; METAL LOCKS; METAL LOCKS FOR DRAWERS; METAL CASTERS; METAL PULLEYS, SPRINGS AND VALVES; METAL FLOORS; METAL TILES; ROAD SIGNS OF METAL; METAL HOLDERS FOR SIGNBOARDS; HOLIDAY ORNAMENTS OF COMMON METAL (U.S. CLS. 2, 12, 13, 14, 23, 25 AND 50).

FIRST USE 1-29-1992; IN COMMERCE 2-17-1992.

DEBRA LEE, EXAMINING ATTORNEY

SN 77-830,709. CRS HOLDINGS, INC., WILMINGTON, DE. FILED 9-21-2009.

INLAC

THE MARK CONSISTS OF STANDARD CHARACTERS WITHOUT CLAIM TO ANY PARTICULAR FONT, STYLE, SIZE, OR COLOR.

FOR COATED METAL STRIP FOR FURTHER MANUFACTURE BY OTHERS (U.S. CLS. 2, 12, 13, 14, 23, 25 AND 50).

LEIGH CAROLINE CASE, EXAMINING ATTORNEY

CLASS 6—(Continued).

SN 77-833,575. CLEVELAND ELECTRIC LABORATORIES, TWINSBURG, OH. FILED 9-23-2009.



THE FASTENER WITH A BRAIN

NO CLAIM IS MADE TO THE EXCLUSIVE RIGHT TO USE "BOLT" AND "FASTENER", APART FROM THE MARK AS SHOWN.

THE STIPPLING IS FOR SHADING PURPOSES ONLY.

THE MARK CONSISTS OF THE WORDING "THE FASTENER WITH A BRAIN" UNDER A BOLT DESIGN WITH THE WORDING "BRAINY BOLT" THEREIN. THE LETTER "O" OF THE WORD "BOLT" IS THE DESIGN OF A BRAIN.

FOR METAL FASTENERS, NAMELY, BOLTS CONTAINING A FIBER OPTIC INSERT THAT CAN MEASURE THE STRAIN AND ELONGATION PLACED UPON THE BOLT AS IT CLAMPS ARTICLES TOGETHER (U.S. CLS. 2, 12, 13, 14, 23, 25 AND 50).

FIRST USE 3-1-2009; IN COMMERCE 4-1-2009.

DAWN HAN, EXAMINING ATTORNEY

SN 77-853,124. TRANSNUCLEAR, INC., COLUMBIA, MD. FILED 10-20-2009.

NUSTOR

THE MARK CONSISTS OF STANDARD CHARACTERS WITHOUT CLAIM TO ANY PARTICULAR FONT, STYLE, SIZE, OR COLOR.

FOR STORAGE RACKS FOR METAL NUCLEAR FUEL CONTAINERS (U.S. CLS. 2, 12, 13, 14, 23, 25 AND 50).

NAKWAMA ANKRAH, EXAMINING ATTORNEY

SN 77-854,598. KELLER, WILLIAM R., SR., EPHRATA, PA. FILED 10-22-2009.

PRO-FOOTER

THE MARK CONSISTS OF STANDARD CHARACTERS WITHOUT CLAIM TO ANY PARTICULAR FONT, STYLE, SIZE, OR COLOR.

FOR METAL ANCHORING DEVICES FOR SECURING CONCRETE FOOTERS TO IN-GROUND POSTS (U.S. CLS. 2, 12, 13, 14, 23, 25 AND 50).

RONALD MCMORROW, EXAMINING ATTORNEY

CLASS 6—(Continued).

SN 77-858,796. WORLD MERCHANDISE INCORPORATED,
DBA WM CASTER, VERNON, CA. FILED 10-27-2009.

WMI

THE MARK CONSISTS OF STANDARD CHARACTERS WITHOUT CLAIM TO ANY PARTICULAR FONT, STYLE, SIZE, OR COLOR.

FOR HARDWARE MOUNTING SYSTEM COMPRISED OF METAL BRACKETS FOR BATH ACCESSORIES AND DECORATIVE HOOKS; METAL CASTERS; METAL COMPONENTS FOR METAL PROTECTIVE AND SECURITY WINDOW SHUTTERS, NAMELY, SLATS, SHUTTERBOXES, SIDE FRAMES, END CAPS, CRANK HANDLES, PULL STRAPS, SIDE TRACKS, BALL BEARINGS AND INSTALLATION HARDWARE, NAMELY, ROLLERS, RAILS, CABLES, CARRIERS, PINS, LOCKS, CLIPS, BRACKETS AND SCREWS (U.S. CLS. 2, 12, 13, 14, 23, 25 AND 50).

FIRST USE 9-1-2005; IN COMMERCE 9-1-2005.
LEIGH LOWRY, EXAMINING ATTORNEY

CLASS 6—(Continued).

SN 77-877,364. G HANDLE, INC., CHICAGO, IL. FILED 11-20-2009.



THE COLOR(S) BLACK, ORANGE, GRAY, AND WHITE IS/ARE CLAIMED AS A FEATURE OF THE MARK.

THE MARK CONSISTS OF A BLACK RECTANGLE. THE INSIDE OF THE RECTANGLE IS ORANGE. ON THE ORANGE BACKGROUND IS THE LETTER "G" IN GRAY. A HAND IN BLACK IS GRASPING THE BOTTOM OF THE LETTER. THE HAND HAS SHADING IN WHITE AND GRAY.

FOR PERSONALIZABLE METAL CLIPS THAT CLIP AND ATTACH TO A BAG, BELT, LOOP, OR STRAP FOR HOLDING AND CARRYING PERSONAL ITEMS (U.S. CLS. 2, 12, 13, 14, 23, 25 AND 50).

CIMMERIAN COLEMAN, EXAMINING ATTORNEY

SN 77-865,525. VOESTALPINE BWG GMBH & CO. KG,
BUTZBACH, FED REP GERMANY, FILED 11-5-2009.

KGO

THE MARK CONSISTS OF STANDARD CHARACTERS WITHOUT CLAIM TO ANY PARTICULAR FONT, STYLE, SIZE, OR COLOR.

OWNER OF FED REP GERMANY REG. NO. 30137965.3, DATED 8-28-2001, EXPIRES 6-30-2011.

FOR TRACK SUPERSTRUCTURE PARTS OF METAL, NAMELY, RAILS, POINTS, CROSSINGS, SLIDE CHAIRS, POINT CLAMPS, TONGUE ROLLERS, FROG TIPS, AND EXPANSION JOINTS, ALL OF THE AFOREMENTIONED GOODS BEING MADE OF METAL (U.S. CLS. 2, 12, 13, 14, 23, 25 AND 50).

DEZMONA MIZELLE, EXAMINING ATTORNEY

SN 77-883,413. WELDON, JENNIFER C., PEMBROKE, MA.
FILED 12-1-2009.



NO CLAIM IS MADE TO THE EXCLUSIVE RIGHT TO USE "CLIP", APART FROM THE MARK AS SHOWN.

THE MARK CONSISTS OF THE WORDS "JENNY CLIP", WITH WORD "JENNY" WRITTEN IN SCRIPT, WITH THE "Y" BEING A RIBBON WITH A CHAIN LINK ATTACHED TO THE BOTTOM OF THE RIBBON AND WITH A HEART DANGLING FROM THE CHAIN LINK; ABOVE THE WORD "CLIP", WHEREIN THE WORD "CLIP" POSSESSES INTERNAL SHADING AND THE "I" IN "CLIP" POSSESSING AN ENCIRCLED HEART TO DOT THE "I".

FOR DECORATIVE METAL CLIPS UTILIZED TO RETAIN THE BOTTOM OF PANTS BY GATHERING THE FABRIC LOCATED ON THE REAR OF THE PANT LEG (U.S. CLS. 2, 12, 13, 14, 23, 25 AND 50).

AARON BRODSKY, EXAMINING ATTORNEY

CLASS 6—(Continued).

SN 77-884,291. CORBIN RUSSWIN, INC., BERLIN, CT. FILED 12-2-2009.

ACCESS 3

THE MARK CONSISTS OF STANDARD CHARACTERS WITHOUT CLAIM TO ANY PARTICULAR FONT, STYLE, SIZE, OR COLOR.

OWNER OF U.S. REG. NOS. 3,149,501 AND 3,628,160.
NO CLAIM IS MADE TO THE EXCLUSIVE RIGHT TO USE "ACCESS", APART FROM THE MARK AS SHOWN.
FOR MECHANICAL HIGH SECURITY LOCK CYLINDERS (U.S. CLS. 2, 12, 13, 14, 23, 25 AND 50).
JERI J. FICKES, EXAMINING ATTORNEY

SN 77-884,938. HORIZON CABLE SERVICE INC., OKLAHOMA CITY, OK. FILED 12-2-2009.

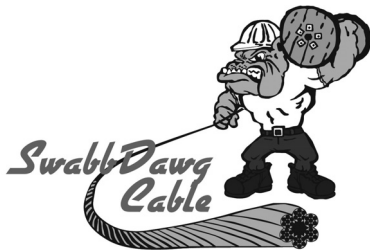

NO CLAIM IS MADE TO THE EXCLUSIVE RIGHT TO USE "CABLE", APART FROM THE MARK AS SHOWN.

THE MARK CONSISTS OF THE IMAGE OF A DOG WITH HUMAN-LIKE ATTRIBUTES, REELING IN A STEEL CABLE, WITH THE WORDING "SWABDAWG CABLE".

FOR STEEL WIRE ROPE; WIRE ROPES (U.S. CLS. 2, 12, 13, 14, 23, 25 AND 50).

HEATHER BIDDULPH, EXAMINING ATTORNEY

SN 77-886,002. THERMAGREEN STEEL STRUCTURES, LLC, ATLANTA, GA. FILED 12-4-2009.

TGSS

THE MARK CONSISTS OF STANDARD CHARACTERS WITHOUT CLAIM TO ANY PARTICULAR FONT, STYLE, SIZE, OR COLOR.

FOR WALL PANELS OF METAL (U.S. CLS. 2, 12, 13, 14, 23, 25 AND 50).

FIRST USE 3-17-2008; IN COMMERCE 3-17-2008.

SOPHIA S. KIM, EXAMINING ATTORNEY

CLASS 6—(Continued).

SN 77-887,721. HUNTER BUILDINGS & MANUFACTURING, LP, SHERMAN, TX. FILED 12-7-2009.



protected from the outside in.

NO CLAIM IS MADE TO THE EXCLUSIVE RIGHT TO USE "BUILDINGS", APART FROM THE MARK AS SHOWN. THE COLOR(S) GREEN, TAN, ORANGE IS/ARE CLAIMED AS A FEATURE OF THE MARK.

THE MARK CONSISTS OF AN INTERLOCKING "H" AND "B" LETTERS, WITH THE LEFT PORTION IN GREEN AND THE RIGHT PORTION IN TAN. THE WORD "HUNTER" IN GREEN WITH THE WORD "BUILDINGS" IN TAN. THE PHRASE "PROTECTED FROM THE OUTSIDE IN" IN LIGHT ORANGE.

FOR MODULAR METALLIC BUILDINGS; PREFABRICATED METAL BUILDINGS (U.S. CLS. 2, 12, 13, 14, 23, 25 AND 50).

FIRST USE 1-1-2008; IN COMMERCE 1-1-2008.

KELLY BOULTON, EXAMINING ATTORNEY

SN 77-887,878. STONEXPRESS, INC., KENNESAW, GA. FILED 12-7-2009.

METALSKIN

THE MARK CONSISTS OF STANDARD CHARACTERS WITHOUT CLAIM TO ANY PARTICULAR FONT, STYLE, SIZE, OR COLOR.

FOR METAL BUILDING MATERIAL, NAMELY, FACIA; METAL BUILDING MATERIALS, NAMELY, SOFFITS; METAL CEILING PANELS; METAL CLADDING FOR CONSTRUCTION AND BUILDING; METAL DOOR PANELS; METAL DOORS; METAL FLOORS; METAL ROOFING; METAL SIDING; METAL TRIM FOR BUILDINGS; METAL WINDOWS (U.S. CLS. 2, 12, 13, 14, 23, 25 AND 50).

PAUL E. FAHRENKOPF, EXAMINING ATTORNEY

SN 77-888,889. STEELRITE SYSTEMS, INC., TORONTO, ONTARIO, CANADA. FILED 12-8-2009.

LOADWAL

THE MARK CONSISTS OF STANDARD CHARACTERS WITHOUT CLAIM TO ANY PARTICULAR FONT, STYLE, SIZE, OR COLOR.

FOR BUILDING MATERIALS, NAMELY, COMPOSITE PANELS, FRAMES, DECKING MADE PRIMARILY OF METAL (U.S. CLS. 2, 12, 13, 14, 23, 25 AND 50).

ARETHA SOMERVILLE, EXAMINING ATTORNEY

CLASS 6—(Continued).

SN 77-888,904. STEELRITE SYSTEMS, INC., TORONTO, ONTARIO, CANADA, FILED 12-8-2009.

THINROOF

THE MARK CONSISTS OF STANDARD CHARACTERS WITHOUT CLAIM TO ANY PARTICULAR FONT, STYLE, SIZE, OR COLOR.

FOR BUILDING MATERIALS, NAMELY, COMPOSITE PANELS, FRAMES, DECKING MADE PRIMARILY OF METAL (U.S. CLS. 2, 12, 13, 14, 23, 25 AND 50).

ARETHA SOMERVILLE, EXAMINING ATTORNEY

CLASS 6—(Continued).

SN 77-890,206. FASTENER ADVANCE PRODUCTS, MANCHESTER, MI. FILED 12-10-2009.

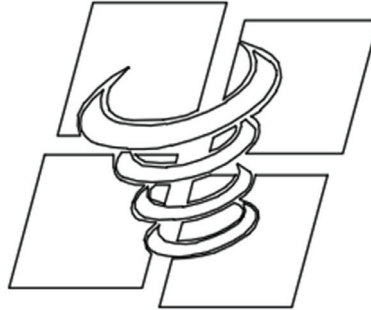

THE MARK CONSISTS OF FOUR SLANTED SQUARES AND ON TOP OF THE SQUARES ARE FOUR HALF CIRCLE MARKS, REPRESENTING THREADS OF A SCREW.

FOR METAL FASTENERS, NAMELY, SELF-PIERCING NUTS AND FASTENERS (U.S. CLS. 2, 12, 13, 14, 23, 25 AND 50).

FIRST USE 2-28-2009; IN COMMERCE 2-28-2009.

EMILY CARLSEN, EXAMINING ATTORNEY

SN 77-888,927. STEELRITE SYSTEMS, INC., TORONTO, ONTARIO, CANADA, FILED 12-8-2009.

THINFLOR

THE MARK CONSISTS OF STANDARD CHARACTERS WITHOUT CLAIM TO ANY PARTICULAR FONT, STYLE, SIZE, OR COLOR.

FOR BUILDING MATERIALS, NAMELY, COMPOSITE PANELS, FRAMES, DECKING MADE PRIMARILY OF METAL (U.S. CLS. 2, 12, 13, 14, 23, 25 AND 50).

ARETHA SOMERVILLE, EXAMINING ATTORNEY

SN 77-890,461. LOCKER, ROBERT A, LAFAYETTE, CA. FILED 12-10-2009.

Lockering

SN 77-889,680. LUVATA FRANKLIN, INC., FRANKLIN, KY. FILED 12-9-2009.

UNILITE

THE MARK CONSISTS OF STANDARD CHARACTERS WITHOUT CLAIM TO ANY PARTICULAR FONT, STYLE, SIZE, OR COLOR.

OWNER OF U.S. REG. NO. 2,540,465.

FOR METAL TUBES (U.S. CLS. 2, 12, 13, 14, 23, 25 AND 50).

SEAN CROWLEY, EXAMINING ATTORNEY

THE MARK CONSISTS OF STANDARD CHARACTERS WITHOUT CLAIM TO ANY PARTICULAR FONT, STYLE, SIZE, OR COLOR.

FOR METAL KEY RINGS; METAL RINGS AND CHAINS FOR KEYS; RING-SHAPED FITTINGS OF METAL; RINGS OF METAL FOR KEYS (U.S. CLS. 2, 12, 13, 14, 23, 25 AND 50).

GRETCHEN ULRICH, EXAMINING ATTORNEY

CLASS 6—(Continued).

SN 77-890,508. UNIVERSITY OF NORTHWESTERN OHIO, LIMA, OH. FILED 12-10-2009.



THE COLOR(S) RED, BLACK AND WHITE IS/ARE CLAIMED AS A FEATURE OF THE MARK.

THE MARK CONSISTS OF A RED LARGE "U" OUTLINED IN BLACK AND WHITE WITH THE STYLIZED WORDING "MOTORSPORTS" ARCHED ACROSS MIDDLE IN WHITE LETTERS WITH RED, BLACK, AND WHITE OUTLINING AND THE STYLIZED WORDING "UNOH" IN BLACK AND RED OUTLINED IN WHITE ACROSS THE BOTTOM OF THE "U".

FOR METAL KEY RINGS; ORNAMENTAL NON-LUMINOUS AND NON-MECHANICAL METAL SIGNS (U.S. CLS. 2, 12, 13, 14, 23, 25 AND 50).

LIEF MARTIN, EXAMINING ATTORNEY

SN 77-890,573. NATIONAL ROOFING PRODUCTS, LLC, FORT LAUDERDALE, FL. FILED 12-10-2009.

Solar Tuff Rail

THE MARK CONSISTS OF STANDARD CHARACTERS WITHOUT CLAIM TO ANY PARTICULAR FONT, STYLE, SIZE, OR COLOR.

NO CLAIM IS MADE TO THE EXCLUSIVE RIGHT TO USE "SOLAR" OR "RAIL", APART FROM THE MARK AS SHOWN.

FOR METAL STRUCTURES FOR MOUNTING SOLAR PANELS; SOLAR PANEL MOUNTS MADE OF METAL; SUBSTRATES PRIMARILY OF METAL FOR SUPPORTING SOLAR CELLS, PHOTOVOLTAIC CELLS AND SOLAR COLLECTORS (U.S. CLS. 2, 12, 13, 14, 23, 25 AND 50).

ELLEN B. AWRICH, EXAMINING ATTORNEY

CLASS 6—(Continued).

SN 77-890,612. REVERE COPPER PRODUCTS, INC., ROME, NY. FILED 12-10-2009.

ContinentalBronze

THE MARK CONSISTS OF STANDARD CHARACTERS WITHOUT CLAIM TO ANY PARTICULAR FONT, STYLE, SIZE, OR COLOR.

FOR OXIDIZED ARCHITECTURAL COPPER IN SHEET, COIL, AND ROLLS (U.S. CLS. 2, 12, 13, 14, 23, 25 AND 50).

ELISSA GARBER KON, EXAMINING ATTORNEY

SN 77-890,621. NATIONAL SOLAR PRODUCTS, LLC, FORT LAUDERDALE, FL. FILED 12-10-2009.

SUMO GRIP

THE MARK CONSISTS OF STANDARD CHARACTERS WITHOUT CLAIM TO ANY PARTICULAR FONT, STYLE, SIZE, OR COLOR.

FOR METAL STRUCTURES FOR MOUNTING SOLAR PANELS; SOLAR PANEL MOUNTS MADE OF METAL; SUBSTRATES PRIMARILY OF METAL FOR SUPPORTING SOLAR CELLS, PHOTOVOLTAIC CELLS AND SOLAR COLLECTORS (U.S. CLS. 2, 12, 13, 14, 23, 25 AND 50).

DAVID MILLER, EXAMINING ATTORNEY

SN 77-891,060. XITEL PTY. LIMITED, SOUTH BRISBANE, QLD, AUSTRALIA, FILED 12-10-2009.

MYSAFE

THE MARK CONSISTS OF STANDARD CHARACTERS WITHOUT CLAIM TO ANY PARTICULAR FONT, STYLE, SIZE, OR COLOR.

FOR METAL SAFES (U.S. CLS. 2, 12, 13, 14, 23, 25 AND 50).

LINDA M. KING, EXAMINING ATTORNEY

CLASS 6—(Continued).

SN 77-892,496. CALDWELL MANUFACTURING COMPANY, ROCHESTER, NY. FILED 12-14-2009.

EZ-LIFT

THE MARK CONSISTS OF STANDARD CHARACTERS WITHOUT CLAIM TO ANY PARTICULAR FONT, STYLE, SIZE, OR COLOR.

OWNER OF U.S. REG. NO. 1,968,441.

FOR METAL SPRING COUNTERBALANCES SOLD TO WINDOW MANUFACTURERS WHO MANUFACTURE AND ASSEMBLE THE SASH AND THE COUNTERBALANCES IN A WINDOW (U.S. CLS. 2, 12, 13, 14, 23, 25 AND 50).

FIRST USE 8-25-2006; IN COMMERCE 8-25-2006.

CORY BOONE, EXAMINING ATTORNEY

SN 77-894,249. APOLLO INDUSTRIES LIMITED, HANG-ZHOU, HONG KONG, FILED 12-16-2009.

MOTOCENTRIC

THE MARK CONSISTS OF STANDARD CHARACTERS WITHOUT CLAIM TO ANY PARTICULAR FONT, STYLE, SIZE, OR COLOR.

FOR METAL MOTORCYCLE STAND THAT MAY BE RAISED AND LOWERED BY NON-POWERED MEANS; METAL RAMPS (U.S. CLS. 2, 12, 13, 14, 23, 25 AND 50).

WILLIAM BRECKENFELD, EXAMINING ATTORNEY

SN 77-895,521. THE CEILING STORE, LLC, ST. LOUIS, MO. FILED 12-17-2009.



THE MARK CONSISTS OF THE WORD "PROSQUARE" AND A DESIGN COMPRISED OF CONNECTING RECTANGLES EMANATING FROM THE LETTER "P".

FOR METAL CEILING SUPPORTS AND METAL CEILING TILES (U.S. CLS. 2, 12, 13, 14, 23, 25 AND 50).

KATHERINE STOIDES, EXAMINING ATTORNEY

CLASS 6—(Continued).

SN 77-920,161. UNITED STATES GYPSUM COMPANY, CHICAGO, IL. FILED 1-26-2010.

SHEETROCK

THE MARK CONSISTS OF STANDARD CHARACTERS WITHOUT CLAIM TO ANY PARTICULAR FONT, STYLE, SIZE, OR COLOR.

OWNER OF U.S. REG. NOS. 153,038, 1,925,240 AND OTHERS.

FOR METAL CORNER BEAD FOR USE IN BUILDING CONSTRUCTION (U.S. CLS. 2, 12, 13, 14, 23, 25 AND 50).

FIRST USE 9-30-1995; IN COMMERCE 9-30-1995.

CIMMERIAN COLEMAN, EXAMINING ATTORNEY

SN 77-922,397. SHIN NIPPON SEITETSU KABUSHIKI KAISHA, DBA NIPPON STEEL CORPORATION, TOKYO, JAPAN, FILED 1-28-2010.

CAN-EXWEL

THE MARK CONSISTS OF STANDARD CHARACTERS WITHOUT CLAIM TO ANY PARTICULAR FONT, STYLE, SIZE, OR COLOR.

FOR GRANULAR TIN AND CHROME PLATED STEEL SHEET; STEEL SHEET IN COIL; STEEL SHEET (U.S. CLS. 2, 12, 13, 14, 23, 25 AND 50).

TRACY CROSS, EXAMINING ATTORNEY

CLASS 6—(Continued).

SN 79-070,833. SILVERY DRAGON; PC STEEL PRODUCTS GROUP CO., LTD.; TIANJIN, CHINA, FILED 5-27-2009.



OWNER OF INTERNATIONAL REGISTRATION 1007484 DATED 5-27-2009, EXPIRES 5-27-2019.

THE MARK CONSISTS OF A SOLID CIRCLE ATOP A LARGER CIRCLE; IN THE GAP BETWEEN THE INNER AND OUTER CIRCLES APPEARS THE WORDING "SILVERY DRAGON"; ATOP THE BOTTOM HALF OF THE CIRCLE DESIGNS APPEARS A LARGE LETTER "Y" EMBLAZONED WITH TWO CHINESE CHARACTERS.

THE ENGLISH TRANSLATION OF TWO CHINESE CHARACTERS IN THE MARK IS "SILVERY DRAGON".

THE NON-LATIN CHARACTERS IN THE MARK TRANSLITERATE TO "YIN LONG" AND THIS MEANS THE TWO CHINESE CHARACTERS IN THE MARK ARE CORRESPONDING WITH ITS ENGLISH CHARACTERS "SILVERY DRAGON", AND THEY ARE THE FIRST TWO WORDS OF THE APPLICANT'S COMPANY NAME IN ENGLISH.

FOR STEEL WIRE; WIRE OF COMMON METAL; POLES OF METAL; PILINGS OF METAL; PLATFORMS, PREFABRICATED, OF METAL (U.S. CLS. 2, 12, 13, 14, 23, 25 AND 50).

KEVIN CORWIN, EXAMINING ATTORNEY

SN 79-072,932. POLDI TRADE A.S., CZECH REPUBLIC, FILED 8-4-2009.

POLDI STEEL

THE MARK CONSISTS OF STANDARD CHARACTERS WITHOUT CLAIM TO ANY PARTICULAR FONT, STYLE, SIZE, OR COLOR.

PRIORITY DATE OF 2-4-2009 IS CLAIMED.

OWNER OF INTERNATIONAL REGISTRATION 1013353 DATED 8-4-2009, EXPIRES 8-4-2019.

NO CLAIM IS MADE TO THE EXCLUSIVE RIGHT TO USE "STEEL", APART FROM THE MARK AS SHOWN.

FOR STEEL AND STEEL ALLOYS, UNWROUGHT OR SEMI-WROUGHT (U.S. CLS. 2, 12, 13, 14, 23, 25 AND 50). ALLISON HOLTZ, EXAMINING ATTORNEY

CLASS 6—(Continued).

SN 79-077,378. HÖGANÄS AB, SWEDEN, FILED 12-3-2009.

CLEANIT

THE MARK CONSISTS OF STANDARD CHARACTERS WITHOUT CLAIM TO ANY PARTICULAR FONT, STYLE, SIZE, OR COLOR.

PRIORITY DATE OF 6-4-2009 IS CLAIMED.

OWNER OF INTERNATIONAL REGISTRATION 1025075 DATED 12-3-2009, EXPIRES 12-3-2019.

FOR COMMON METALS AND THEIR ALLOYS; METAL IN POWDER FORM (U.S. CLS. 2, 12, 13, 14, 23, 25 AND 50).

MARK PILARO, EXAMINING ATTORNEY

CLASS 7—MACHINERY

SN 76-692,819. ROYAL PURPLE, INC., PORTER, TX. FILED 9-12-2008.

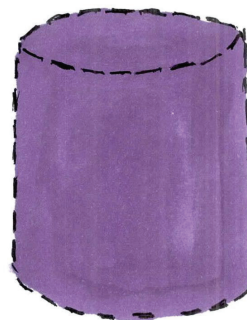

OWNER OF U.S. REG. NOS. 2,691,774, 3,203,213 AND OTHERS.

THE COLOR(S) PURPLE IS/ARE CLAIMED AS A FEATURE OF THE MARK.

THE MARK CONSISTS OF THE COLOR PURPLE AS APPLIED TO THE ENTIRE OUTER SURFACE OF OIL FILTERS, WITH THE EXCEPTION OF THE BOTTOM WHICH ATTACHES TO THE AUTOMOBILE OR MOTOR CYCLE ENGINE. THE DOTTED LINES INDICATE THE PLACEMENT OF THE MARK ON THE GOODS AND ARE NOT A PART OF THE MARK.

SEC. 2(F).

FOR OIL FILTERS FOR AUTOMOTIVE AND MOTOR-CYCLE ENGINES (U.S. CLS. 13, 19, 21, 23, 31, 34 AND 35).

FIRST USE 11-20-2008; IN COMMERCE 11-20-2008.

VERNA BETH RIRIE, EXAMINING ATTORNEY

CLASS 7—(Continued).

SN 76-700,754. ZIPPER'S CYCLE, INC., ELKRIDGE, MD. FILED 12-9-2009.



THE MARK CONSISTS OF THE STYLIZED TERM "TMAX".
FOR ENGINE PARTS, NAMELY, ELECTRONIC FUEL INJECTION MODULE FOR MOTORCYCLES (U.S. CLS. 13, 19, 21, 23, 31, 34 AND 35).
FIRST USE 1-1-2004; IN COMMERCE 1-1-2004.
ANDREW RHIM, EXAMINING ATTORNEY

CLASS 7—(Continued).

SN 77-599,798. PATTERSON-UTI ENERGY, INC., HOUSTON, TX. FILED 10-24-2008.

APEX DRILLING RIG

THE MARK CONSISTS OF STANDARD CHARACTERS WITHOUT CLAIM TO ANY PARTICULAR FONT, STYLE, SIZE, OR COLOR.
NO CLAIM IS MADE TO THE EXCLUSIVE RIGHT TO USE "DRILLING RIG", APART FROM THE MARK AS SHOWN.
FOR MOVABLE DRILLING RIGS USED FOR DRILLING FOR OIL AND GAS (U.S. CLS. 13, 19, 21, 23, 31, 34 AND 35).
HEATHER BIDDULPH, EXAMINING ATTORNEY

SN 77-599,705. PATTERSON-UTI ENERGY, INC., HOUSTON, TX. FILED 10-24-2008.

APEX

THE MARK CONSISTS OF STANDARD CHARACTERS WITHOUT CLAIM TO ANY PARTICULAR FONT, STYLE, SIZE, OR COLOR.
FOR MOVABLE DRILLING RIGS USED FOR DRILLING FOR OIL AND GAS (U.S. CLS. 13, 19, 21, 23, 31, 34 AND 35).
HEATHER BIDDULPH, EXAMINING ATTORNEY

SN 77-599,803. PATTERSON-UTI ENERGY, INC., HOUSTON, TX. FILED 10-24-2008.

APEX SERIES

THE MARK CONSISTS OF STANDARD CHARACTERS WITHOUT CLAIM TO ANY PARTICULAR FONT, STYLE, SIZE, OR COLOR.
NO CLAIM IS MADE TO THE EXCLUSIVE RIGHT TO USE "SERIES", APART FROM THE MARK AS SHOWN.
FOR MOVABLE DRILLING RIGS USED FOR DRILLING FOR OIL AND GAS (U.S. CLS. 13, 19, 21, 23, 31, 34 AND 35).
HEATHER BIDDULPH, EXAMINING ATTORNEY

SN 77-599,788. PATTERSON-UTI ENERGY, INC., HOUSTON, TX. FILED 10-24-2008.

APEX RIG

THE MARK CONSISTS OF STANDARD CHARACTERS WITHOUT CLAIM TO ANY PARTICULAR FONT, STYLE, SIZE, OR COLOR.
NO CLAIM IS MADE TO THE EXCLUSIVE RIGHT TO USE "RIG", APART FROM THE MARK AS SHOWN.
FOR MOVABLE DRILLING RIGS USED FOR DRILLING FOR OIL AND GAS (U.S. CLS. 13, 19, 21, 23, 31, 34 AND 35).
HEATHER BIDDULPH, EXAMINING ATTORNEY

SN 77-599,809. PATTERSON-UTI ENERGY, INC., HOUSTON, TX. FILED 10-24-2008.

APEX 1000

THE MARK CONSISTS OF STANDARD CHARACTERS WITHOUT CLAIM TO ANY PARTICULAR FONT, STYLE, SIZE, OR COLOR.
NO CLAIM IS MADE TO THE EXCLUSIVE RIGHT TO USE "1000", APART FROM THE MARK AS SHOWN.
FOR MOVABLE DRILLING RIGS USED FOR DRILLING FOR OIL AND GAS (U.S. CLS. 13, 19, 21, 23, 31, 34 AND 35).
HEATHER BIDDULPH, EXAMINING ATTORNEY

CLASS 7—(Continued).

SN 77-599,814. PATTERSON-UTI ENERGY, INC., HOUSTON, TX. FILED 10-24-2008.

APEX 1500

THE MARK CONSISTS OF STANDARD CHARACTERS WITHOUT CLAIM TO ANY PARTICULAR FONT, STYLE, SIZE, OR COLOR.

NO CLAIM IS MADE TO THE EXCLUSIVE RIGHT TO USE "1500", APART FROM THE MARK AS SHOWN.

FOR MOVABLE DRILLING RIGS USED FOR DRILLING FOR OIL AND GAS (U.S. CLS. 13, 19, 21, 23, 31, 34 AND 35).

HEATHER BIDDULPH, EXAMINING ATTORNEY

CLASS 7—(Continued).

SN 77-657,504. GOSS INTERNATIONAL AMERICAS, INC., DOVER, NH. FILED 1-27-2009.

AUTOPLATE

THE MARK CONSISTS OF STANDARD CHARACTERS WITHOUT CLAIM TO ANY PARTICULAR FONT, STYLE, SIZE, OR COLOR.

FOR PRINTING PRESSES AND PARTS THEREFOR; PRINTING PRESS COMPONENTS, NAMELY, PLATE LOADING APPARATUS, AND PARTS AND TECHNOLOGY THEREFOR, NAMELY, MECHANICAL DEVICES FOR LOADING PRINTING PLATES ON PRESSES (U.S. CLS. 13, 19, 21, 23, 31, 34 AND 35).

FIRST USE 5-0-1995; IN COMMERCE 1-0-1997.

FRANK LATTUCA, EXAMINING ATTORNEY

SN 77-599,818. PATTERSON-UTI ENERGY, INC., HOUSTON, TX. FILED 10-24-2008.

APEX WALKING

THE MARK CONSISTS OF STANDARD CHARACTERS WITHOUT CLAIM TO ANY PARTICULAR FONT, STYLE, SIZE, OR COLOR.

NO CLAIM IS MADE TO THE EXCLUSIVE RIGHT TO USE "WALKING", APART FROM THE MARK AS SHOWN.

FOR MOVABLE DRILLING RIGS USED FOR DRILLING FOR OIL AND GAS (U.S. CLS. 13, 19, 21, 23, 31, 34 AND 35).

HEATHER BIDDULPH, EXAMINING ATTORNEY

SN 77-718,413. RIVERVIEW, LLP, MORRIS, MN. FILED 4-21-2009.

Easy Rake

THE MARK CONSISTS OF STANDARD CHARACTERS WITHOUT CLAIM TO ANY PARTICULAR FONT, STYLE, SIZE, OR COLOR.

NO CLAIM IS MADE TO THE EXCLUSIVE RIGHT TO USE "RAKE", APART FROM THE MARK AS SHOWN.

FOR AGRICULTURAL IMPLEMENTS, NAMELY, SILAGE PILE DEFACERS (U.S. CLS. 13, 19, 21, 23, 31, 34 AND 35).

AMY KERTGATE, EXAMINING ATTORNEY

SN 77-634,998. NEW EDGE INNOVATIONS, LLC, SORRENTO, FL. FILED 12-17-2008.

TALON BLADE

THE MARK CONSISTS OF STANDARD CHARACTERS WITHOUT CLAIM TO ANY PARTICULAR FONT, STYLE, SIZE, OR COLOR.

NO CLAIM IS MADE TO THE EXCLUSIVE RIGHT TO USE "BLADE", APART FROM THE MARK AS SHOWN.

FOR LAWNMOWER BLADES AND LAWNMOWER BLADE RETAINERS (U.S. CLS. 13, 19, 21, 23, 31, 34 AND 35).

CYNTHIA TRIPI, EXAMINING ATTORNEY

SN 77-744,931. BELANGER, INC., NORTHVILLE, MI. FILED 5-26-2009.

BLACK ICE STEEL

THE MARK CONSISTS OF STANDARD CHARACTERS WITHOUT CLAIM TO ANY PARTICULAR FONT, STYLE, SIZE, OR COLOR.

NO CLAIM IS MADE TO THE EXCLUSIVE RIGHT TO USE "STEEL", APART FROM THE MARK AS SHOWN.

FOR A PROPRIETARY TYPE OF STEEL SOLD AS AN INTEGRAL COMPONENT OF ROLLER CONVEYORS FOR USE IN CONNECTION WITH VEHICLE WASH ASSEMBLIES (U.S. CLS. 13, 19, 21, 23, 31, 34 AND 35).

FIRST USE 3-24-2009; IN COMMERCE 3-24-2009.

JAMES LOVELACE, EXAMINING ATTORNEY

CLASS 7—(Continued).

SN 77-752,037. MARINE FILTRATION SERVICES, INC.,
DUXBURY, MA. FILED 6-4-2009.



NO CLAIM IS MADE TO THE EXCLUSIVE RIGHT TO USE "MARINE PERFORMANCE LINE", APART FROM THE MARK AS SHOWN.

THE MARK CONSISTS OF A TRAPEZOID WITH TWO STRIPES AT THE TOP ABOVE THE WORDING "MPL", WHICH IS ABOVE THE WORDING "MARINE PERFORMANCE LINE".

FOR FILTRATION PRODUCTS FOR MARINE VESSELS, NAMELY, AIR FILTERS FOR MARINE VESSEL MOTORS AND ENGINES, OIL FILTERS FOR MARINE VESSEL MOTORS AND ENGINES, AND GAS AND DIESEL FILTERS FOR MARINE VESSEL MOTORS AND ENGINES (U.S. CLS. 13, 19, 21, 23, 31, 34 AND 35).
FIRST USE 11-22-2007; IN COMMERCE 11-22-2007.

MARIAM MAHMOUDI, EXAMINING ATTORNEY

SN 77-759,310. SOHRE TURBOMACHINERY INC., MONSON, MA. FILED 6-15-2009.

SOHRE TURBOMACHINERY

THE MARK CONSISTS OF STANDARD CHARACTERS WITHOUT CLAIM TO ANY PARTICULAR FONT, STYLE, SIZE, OR COLOR.

OWNER OF U.S. REG. NO. 2,192,061.

NO CLAIM IS MADE TO THE EXCLUSIVE RIGHT TO USE "TURBOMACHINERY", APART FROM THE MARK AS SHOWN.

SEC. 2(F).

FOR BRUSHES BEING PARTS OF OR FOR USE WITH COMPRESSORS, PUMPS, MOTORS, ELECTRIC MOTORS, ELECTRIC MOTORS FOR MACHINES, WIND TURBINES, ELECTRIC GENERATORS, STEAM TURBINES, GAS TURBINES, HYDRO TURBINES, JET ENGINES, GEARSETS, BEARINGS, SHIP PROPULSION SYSTEMS, FANS, BLOWERS, AND PARTS THEREOF (U.S. CLS. 13, 19, 21, 23, 31, 34 AND 35).

FIRST USE 0-0-1984; IN COMMERCE 0-0-1984.

JULIE WATSON, EXAMINING ATTORNEY

CLASS 7—(Continued).

SN 77-766,122. GLOBAL SPECIALTY SOLUTIONS INC.,
SOUTH BELOIT, IL. FILED 6-23-2009.



OWNER OF U.S. REG. NOS. 3,557,116 AND 3,678,825.
NO CLAIM IS MADE TO THE EXCLUSIVE RIGHT TO USE "NORTH AMERICAN TOOL", APART FROM THE MARK AS SHOWN.

THE MARK CONSISTS OF THE UNDERLINED WORDS "NORTH AMERICAN TOOL" WITH A WORLD/GLOBE IMAGE SET BEHIND AND TO THE LEFT OF THE WORDS.

FOR POWER TOOLS, NAMELY, TAPS (U.S. CLS. 13, 19, 21, 23, 31, 34 AND 35).

FIRST USE 6-1-2007; IN COMMERCE 6-1-2007.

ALICIA COLLINS, EXAMINING ATTORNEY

SN 77-770,774. ARIEL CORPORATION, MOUNT VERNON, OH. FILED 6-30-2009.

ARIEL

THE MARK CONSISTS OF STANDARD CHARACTERS WITHOUT CLAIM TO ANY PARTICULAR FONT, STYLE, SIZE, OR COLOR.

OWNER OF U.S. REG. NO. 1,342,049.

FOR GAS COMPRESSORS (U.S. CLS. 13, 19, 21, 23, 31, 34 AND 35).

FIRST USE 10-31-1972; IN COMMERCE 10-31-1972.

THOMAS MANOR, EXAMINING ATTORNEY

SN 77-770,791. ARIEL CORPORATION, MOUNT VERNON, OH. FILED 6-30-2009.

ARIEL = COMPRESSION

THE MARK CONSISTS OF STANDARD CHARACTERS WITHOUT CLAIM TO ANY PARTICULAR FONT, STYLE, SIZE, OR COLOR.

OWNER OF U.S. REG. NO. 1,342,049.

NO CLAIM IS MADE TO THE EXCLUSIVE RIGHT TO USE "COMPRESSION", APART FROM THE MARK AS SHOWN.

FOR GAS COMPRESSORS (U.S. CLS. 13, 19, 21, 23, 31, 34 AND 35).

FIRST USE 1-31-2003; IN COMMERCE 1-31-2003.

THOMAS MANOR, EXAMINING ATTORNEY

CLASS 7—(Continued).

SN 77-808,344. FOREST CONCEPTS, LLC, AUBURN, WA. FILED 8-19-2009.

r²S₄

THE MARK CONSISTS OF A LOWER CASE LETTER "R" WITH A SUPERSCRIPT NUMERAL "2" FOLLOWED BY AN UPPER CASE LETTER "S" WITH A SUBSCRIPT NUMERAL "4".

FOR FORESTRY, AGRICULTURAL, AND INDUSTRIAL MACHINERY, NAMELY, BIOMASS BALERS (U.S. CLS. 13, 19, 21, 23, 31, 34 AND 35).
ELI HELLMAN, EXAMINING ATTORNEY

CLASS 7—(Continued).

SN 77-844,157. DURA-MILL, INC., MALTA, NY. FILED 10-8-2009.



THE MARK CONSISTS OF THE STYLIZED WORDING "DURA SHIELD" WITH "DURA" IN BOLD. THE WORDING IS WITHIN A SHIELD DESIGN WHICH IS DIVIDED INTO THREE IRREGULAR SEGMENTS AND BEHIND THE SHIELD ARE TWO CROSSED END MILL CUTTERS.

FOR CEMENTED CARBIDE CUTTING TOOLS (U.S. CLS. 13, 19, 21, 23, 31, 34 AND 35).
TIMOTHY FINNEGAN, EXAMINING ATTORNEY

SN 77-833,262. VAN STONE CONVEYOR INC., SAN DIMAS, CA. FILED 9-23-2009.

VAN STONE CONVEYOR INC.

THE MARK CONSISTS OF STANDARD CHARACTERS WITHOUT CLAIM TO ANY PARTICULAR FONT, STYLE, SIZE, OR COLOR.

NO CLAIM IS MADE TO THE EXCLUSIVE RIGHT TO USE "CONVEYOR INC.", APART FROM THE MARK AS SHOWN.

THE NAME(S), PORTRAIT(S), AND/OR SIGNATURE(S) SHOWN IN THE MARK DOES NOT IDENTIFY A PARTICULAR LIVING INDIVIDUAL.

FOR CONVEYORS (U.S. CLS. 13, 19, 21, 23, 31, 34 AND 35).

FIRST USE 7-31-1979; IN COMMERCE 7-31-1979.
DEZMONA MIZELLE, EXAMINING ATTORNEY

SN 77-861,469. INDEXATOR AB, VINDELN S-92221, SWEDEN, FILED 10-30-2009.

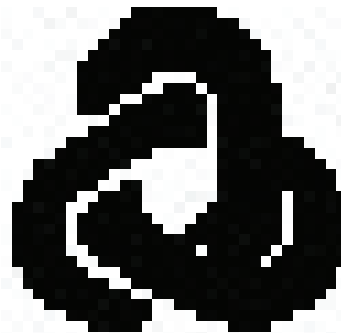

THE MARK CONSISTS OF A STYLIZED ROUNDED CORNER TRIANGLE.

FOR ATTACHMENTS FOR TILT ROTATORS USED IN CONNECTION WITH HYDRAULIC CRANES, BOOMS AND ARMS, NAMELY, BUCKETS, FORKS, AND ASPHALT CUTTERS (U.S. CLS. 13, 19, 21, 23, 31, 34 AND 35).

DOUGLAS LEE, EXAMINING ATTORNEY

CLASS 7—(Continued).

SN 77-867,943. WEATHERFORD/LAMB, INC., HOUSTON, TX. FILED 11-9-2009.

WellPilot

THE MARK CONSISTS OF STANDARD CHARACTERS WITHOUT CLAIM TO ANY PARTICULAR FONT, STYLE, SIZE, OR COLOR.

FOR VARIABLE SPEED DRIVES FOR ROD-PUMPED WELLS TO OPTIMIZE WELL PRODUCTION (U.S. CLS. 13, 19, 21, 23, 31, 34 AND 35).

FIRST USE 10-1-2008; IN COMMERCE 10-1-2008.
REBECCA EISINGER, EXAMINING ATTORNEY

CLASS 7—(Continued).

SN 77-874,545. BECKER, WILLIAM S., PARK FOREST, IL. FILED 11-17-2009.



Aeroturbine

THE MARK CONSISTS OF AN ABSTRACT DESIGN WITH THE STYLIZED TEXT "AEROTURBINE".
FOR WIND TURBINES (U.S. CLS. 13, 19, 21, 23, 31, 34 AND 35).

AARON BRODSKY, EXAMINING ATTORNEY

SN 77-869,855. E-Z GROUT CORPORATION, WATERFORD, OH. FILED 11-11-2009.

BAR HOG

THE MARK CONSISTS OF STANDARD CHARACTERS WITHOUT CLAIM TO ANY PARTICULAR FONT, STYLE, SIZE, OR COLOR.

OWNER OF U.S. REG. NOS. 2,874,810, 2,989,672 AND OTHERS.

NO CLAIM IS MADE TO THE EXCLUSIVE RIGHT TO USE "BAR", APART FROM THE MARK AS SHOWN.

FOR POWER OPERATED TOOLS, NAMELY, PORTABLE REBAR BENDING AND CUTTING TOOLS (U.S. CLS. 13, 19, 21, 23, 31, 34 AND 35).

DANIEL CAPSHAW, EXAMINING ATTORNEY

SN 77-879,620. PREGIS INNOVATIVE PACKAGING, INC., DEERFIELD, IL. FILED 11-24-2009.

DENSINATOR

THE MARK CONSISTS OF STANDARD CHARACTERS WITHOUT CLAIM TO ANY PARTICULAR FONT, STYLE, SIZE, OR COLOR.

FOR WASTE COMPACTING MACHINES, NAMELY, COMPACTORS FOR FOAM PLANKS (U.S. CLS. 13, 19, 21, 23, 31, 34 AND 35).

FIRST USE 9-1-2009; IN COMMERCE 9-1-2009.

AMY HELLA, EXAMINING ATTORNEY

SN 77-874,373. SEALED AIR CORPORATION (US), ELMWOOD PARK, NJ. FILED 11-17-2009.

TRACTOR MOLD

THE MARK CONSISTS OF STANDARD CHARACTERS WITHOUT CLAIM TO ANY PARTICULAR FONT, STYLE, SIZE, OR COLOR.

NO CLAIM IS MADE TO THE EXCLUSIVE RIGHT TO USE "MOLD", APART FROM THE MARK AS SHOWN.

FOR PACKAGING MACHINES, NAMELY, MACHINES FOR FORMING POLYURETHANE FOAM PACKAGING CUSHIONS (U.S. CLS. 13, 19, 21, 23, 31, 34 AND 35).

JULIE WATSON, EXAMINING ATTORNEY

SN 77-883,192. ENGINE PARTS GROUP, INC., WHEAT RIDGE, CO. FILED 12-1-2009.

NITRO BLACK

THE MARK CONSISTS OF STANDARD CHARACTERS WITHOUT CLAIM TO ANY PARTICULAR FONT, STYLE, SIZE, OR COLOR.

NO CLAIM IS MADE TO THE EXCLUSIVE RIGHT TO USE "BLACK", APART FROM THE MARK AS SHOWN.

FOR VALVES BEING ENGINE PARTS FOR INTRODUCING FUEL-AIR MIXTURES INTO THE COMBUSTION CHAMBERS OF INTERNAL COMBUSTION ENGINES (U.S. CLS. 13, 19, 21, 23, 31, 34 AND 35).

LYDIA BELZER, EXAMINING ATTORNEY

CLASS 7—(Continued).

SN 77-886,540. PRIMESOURCE BUILDING PRODUCTS, INC., IRVING, TX. FILED 12-4-2009.

PRIMEGUARD PLUS

THE MARK CONSISTS OF STANDARD CHARACTERS WITHOUT CLAIM TO ANY PARTICULAR FONT, STYLE, SIZE, OR COLOR.

OWNER OF U.S. REG. NOS. 3,095,108, 3,528,727 AND OTHERS.

FOR BITS FOR POWER TOOLS, NAMELY, HAMMER DRIVERS (U.S. CLS. 13, 19, 21, 23, 31, 34 AND 35).

FIRST USE 6-0-2004; IN COMMERCE 6-0-2004.

JEFFERY COWARD, EXAMINING ATTORNEY

SN 77-886,547. PRIMESOURCE BUILDING PRODUCTS, INC., IRVING, TX. FILED 12-4-2009.



OWNER OF U.S. REG. NOS. 2,940,702, 3,693,533 AND OTHERS.

THE MARK CONSISTS OF THE WORDS "GRIP RITE" IN A SHADED PARALLELOGRAM ABOVE AND TO THE LEFT OF THE WORDS "PRIMEGUARD PLUS" IN A PARALLELOGRAM ALONG WITH THE PICTORIAL REPRESENTATION OF A NAIL AND SCREW.

FOR BITS FOR POWER TOOLS, NAMELY, HAMMER DRIVERS (U.S. CLS. 13, 19, 21, 23, 31, 34 AND 35).

FIRST USE 6-0-2004; IN COMMERCE 6-0-2004.

JEFFERY COWARD, EXAMINING ATTORNEY

CLASS 7—(Continued).

SN 77-887,439. HANGZHOU UNI-HOSEN ELECTROMECHANICAL TOOLS CO., LTD., HANGZHOU, ZHEJIANG, CHINA. FILED 12-7-2009.

THE MARK CONSISTS OF THE WORD "GUDCRAFT", STYLIZED.

FOR LAWNMOWERS; CUTTING MACHINES; ELECTRIC DRILLS; DYNAMOS; HYDRAULIC PUMPS; COMPRESSED AIR MACHINES; GASOLINE ENGINES NOT FOR LAND VEHICLES; ELECTRIC HAMMERS; ELECTRONICALLY AND POWER OPERATED TOOLS, NAMELY, SPANNERS; ELECTRIC SCREWDRIVERS; PAINTING MACHINES; ELECTRIC WELDING MACHINES; ELECTRIC WAX-POLISHING MACHINES FOR INDUSTRIAL PURPOSES; ENGRAVING MACHINES; WINCHES; WATER PUMPS FOR BATHS; WATER PUMPS FOR LAND VEHICLES (U.S. CLS. 13, 19, 21, 23, 31, 34 AND 35).

FIRST USE 2-28-2004; IN COMMERCE 2-28-2009.

TAMARA FRAZIER, EXAMINING ATTORNEY

SN 77-887,998. CPHID, LLC, DRAPER, UT. FILED 12-7-2009.

UGLY BOX

THE MARK CONSISTS OF STANDARD CHARACTERS WITHOUT CLAIM TO ANY PARTICULAR FONT, STYLE, SIZE, OR COLOR.

FOR SNOW PLOWS AND BOX PLOWS, INCLUDING SNOW PUSHES, SNOW PUSHERS AND PUSH BOXES (U.S. CLS. 13, 19, 21, 23, 31, 34 AND 35).

FIRST USE 10-5-2009; IN COMMERCE 10-16-2009.

SUSAN RICHARDS, EXAMINING ATTORNEY

SN 77-888,126. GORDON, EURAL, BAKERSFIELD, CA. FILED 12-7-2009.

Weed Devil

THE MARK CONSISTS OF STANDARD CHARACTERS WITHOUT CLAIM TO ANY PARTICULAR FONT, STYLE, SIZE, OR COLOR.

NO CLAIM IS MADE TO THE EXCLUSIVE RIGHT TO USE "WEED", APART FROM THE MARK AS SHOWN.

FOR POWER TOOL DRILL BITS FOR USE IN AERATING SOIL, MULCHING WEED AND ROOTS AND TILLING THE SOIL (U.S. CLS. 13, 19, 21, 23, 31, 34 AND 35).

LAURA KOVALSKY, EXAMINING ATTORNEY

CLASS 7—(Continued).

SN 77-888,138. BEIJING PETROLEUM MACHINERY CO.,
BEIJING, CHINA, FILED 12-7-2009.



THE MARK CONSISTS OF TWO CHINESE CHARACTERS AND A DRAWING CONSISTING OF A SQUARE WITH S-SHAPED CURVE LINE IN THE MIDDLE.

THE NON-LATIN CHARACTERS IN THE MARK TRANSLITERATE TO "BEI SHI" AND THIS HAS NO MEANING IN A FOREIGN LANGUAGE.

FOR DISSOLVING MACHINES; DRILLING MACHINES; EARTH DRILLING MACHINES; EXTRACTING MACHINES; INDUSTRIAL CHEMICAL REACTORS; MINE BORERS; OIL CENTRIFUGES; OIL DRAIN PUMPS; OIL FIELD EQUIPMENT, NAMELY, DRILLING RIG MECHANICAL HANDLING MACHINES AND DEVICES; OIL FIELD EQUIPMENT, NAMELY, DRILLING RIG MECHANIZATION MACHINES AND DEVICES; OIL-WELL PUMPING MACHINES; PARTS OF OILFIELD WELLHEAD MACHINES, NAMELY, GATE VALVES, BALL VALVES, CHECK VALVES, PLUG VALVES, GLOBE VALVES, CHOKE AND MANIFOLD INDUSTRIAL PUMPS, PUMP AND VALVE PARTS, PIPE FITTINGS AND FLANGES; ROCK DRILLS; SEPARATING MACHINES; VARIABLE FREQUENCY DRIVES FOR LARGE POWER APPLICATIONS IN THE OIL AND GAS, METAL, MARINE AND OTHER INDUSTRIES; WELL DRILLING MACHINES (U.S. CLS. 13, 19, 21, 23, 31, 34 AND 35).

GISELLE AGOSTO, EXAMINING ATTORNEY

SN 77-888,151. BEIJING PETROLEUM MACHINERY CO.,
BEIJING, CHINA, FILED 12-7-2009.



THE MARK CONSISTS OF THREE ENGLISH LETTER "BPM" AND A DRAWING CONSISTING OF A SQUARE WITH A S-SHAPED CURVE IN THE MIDDLE.

FOR DISSOLVING MACHINES; DRILLING MACHINES; EARTH DRILLING MACHINES; EXTRACTING MACHINES; INDUSTRIAL CHEMICAL REACTORS; MINE BORERS; OIL CENTRIFUGES; OIL DRAIN PUMPS; OIL FIELD EQUIPMENT, NAMELY, DRILLING RIG MECHANICAL HANDLING MACHINES AND DEVICES; OIL FIELD EQUIPMENT, NAMELY, DRILLING RIG MECHANIZATION MACHINES AND DEVICES; OIL-WELL PUMPING MACHINES; PARTS OF OILFIELD WELLHEAD MACHINES, NAMELY, GATE VALVES, BALL VALVES, CHECK VALVES, PLUG VALVES, GLOBE VALVES, CHOKE AND MANIFOLD INDUSTRIAL PUMPS, PUMP AND VALVE PARTS, PIPE FITTINGS AND FLANGES; ROCK DRILLS; SEPARATING MACHINES; VARIABLE FREQUENCY DRIVES FOR LARGE POWER APPLICATIONS IN THE OIL AND GAS, METAL, MARINE AND OTHER INDUSTRIES; WELL DRILLING MACHINES (U.S. CLS. 13, 19, 21, 23, 31, 34 AND 35).

GISELLE AGOSTO, EXAMINING ATTORNEY

CLASS 7—(Continued).

SN 77-888,242. E. MISHAN & SONS, INC., NEW YORK, NY.
FILED 12-8-2009.

TORPEDO

THE MARK CONSISTS OF STANDARD CHARACTERS WITHOUT CLAIM TO ANY PARTICULAR FONT, STYLE, SIZE, OR COLOR.

FOR ELECTRIC BLENDERS FOR BLENDING FOOD AND BEVERAGES (U.S. CLS. 13, 19, 21, 23, 31, 34 AND 35).

MARCIE MILONE, EXAMINING ATTORNEY

SN 77-888,562. VAT-ENERGIES LLC, FISHERS, IN. FILED
12-8-2009.

VAT

THE MARK CONSISTS OF STANDARD CHARACTERS WITHOUT CLAIM TO ANY PARTICULAR FONT, STYLE, SIZE, OR COLOR.

FOR WIND-POWERED ELECTRICITY GENERATORS (U.S. CLS. 13, 19, 21, 23, 31, 34 AND 35).

CHERYL CLAYTON, EXAMINING ATTORNEY

SN 77-888,815. ENTRUST TOOL & DESIGN CO., INC.,
MENOMONEE FALLS, WI. FILED 12-8-2009.

UNISIG

THE MARK CONSISTS OF STANDARD CHARACTERS WITHOUT CLAIM TO ANY PARTICULAR FONT, STYLE, SIZE, OR COLOR.

FOR DEEP-HOLE DRILLING MACHINES (U.S. CLS. 13, 19, 21, 23, 31, 34 AND 35).

FIRST USE 12-0-1984; IN COMMERCE 12-0-1984.

REBECCA POVARCHUK, EXAMINING ATTORNEY

CLASS 7—(Continued).

SN 77-888,829. ENTRUST TOOL & DESIGN CO., INC., MENOMONEE FALLS, WI. FILED 12-8-2009.



THE MARK CONSISTS OF CROSSHAIRS WITHIN AN INNER CIRCLE OF FOUR ARROWS IN CLOCKWISE ROTATION AND AN OUTER CIRCLE OF FOUR ARROWS IN COUNTER-CLOCKWISE ROTATION, WITH THE LEFT CROSSHAIR EXTENDING OUT OF THE CIRCLES AND BISECTING THE LITERAL ELEMENT "UNISIG".

FOR DEEP-HOLE DRILLING MACHINES (U.S. CLS. 13, 19, 21, 23, 31, 34 AND 35).

FIRST USE 5-0-1993, THE MARK WAS FIRST USED ANYWHERE IN A DIFFERENT FORM OTHER THAN THAT SOUGHT TO BE REGISTERED AT LEAST AS EARLY AS 12/00/1984; IN COMMERCE 5-0-1993, THE MARK WAS FIRST USED IN COMMERCE IN A DIFFERENT FORM OTHER THAN THAT SOUGHT TO BE REGISTERED AT LEAST AS EARLY AS 12/00/1984.

REBECCA POVARCHUK, EXAMINING ATTORNEY

SN 77-889,156. SKYQUEST INC., DBA ROTARY-WORKS, S. EL MONTE, CA. FILED 12-9-2009.



THE COLOR(S) BLUE IS/ARE CLAIMED AS A FEATURE OF THE MARK.

THE MARK CONSISTS OF THE COLOR LIGHT BLUE APPEARING IN THE WORDING "ROTARY-WORKS" WHICH IS ABOVE A ROUNDED AND UPSIDE-DOWN TRIANGLE COMPRISED OF SHADES OF BLUE, CONTAINING A CIRCLE OF DARK BLUE FADING TO LIGHT BLUE AND THE LETTERS "R","W" IN DARK BLUE IN THE CENTER.

FOR AIR FILTERS FOR VEHICLE MOTORS AND ENGINES; ALTERNATORS FOR LAND VEHICLES; AUTOMOTIVE PARTS, NAMELY TURBOCHARGER SYSTEMS; AUTOMOTIVE PARTS, NAMELY, ENGINE SEALS; BALL VALVES BEING PARTS OF MACHINES; BEARINGS FOR TRANSMISSION SHAFTS, BEING PARTS OF MACHINES; BRUSHES BEING PARTS OF MOTORS, GENERATORS AND DYNAMOS; CAM-SHAFTS FOR VEHICLE ENGINES; DISTRIBUTORS FOR VEHICLES; ELECTRONIC IGNITIONS FOR VEHICLES; ENGINE CYLINDERS FOR LAND VEHICLES; ENGINE CYLINDERS FOR VEHICLES; ENGINE PARTS, NAMELY, CONTACT POINTS; ENGINE PARTS, NAMELY, ELECTRONIC FUEL INJECTION MODULES; ENGINE PARTS, NAMELY, OIL DIPSTICKS; EXHAUST PIPES FOR LAND VEHICLES; FUEL INJECTOR PARTS FOR LAND AND WATER VEHICLE ENGINES; FUEL PUMPS FOR LAND VEHICLES; GENERATORS FOR LAND VEHICLES; HEADERS AS PART OF VEHICLE EXHAUST SYSTEM; HEAT EXCHANGERS BEING

CLASS 7—(Continued).

PARTS OF MACHINES; IGNITION DEVICES FOR MOTORS OF LAND VEHICLES; IGNITION PARTS FOR INTERNAL COMBUSTION ENGINES, NAMELY, CONDENSERS; IGNITION WIRES FOR MOTOR VEHICLES; IGNITIONS PARTS FOR INTERNAL COMBUSTION ENGINES, NAMELY, POINTS; INTERNAL COMBUSTION ENGINE PARTS, NAMELY, HEADS; INTERNAL COMBUSTION ENGINE PARTS, NAMELY, PISTON RINGS; INTERNAL COMBUSTION ENGINE PARTS, NAMELY, PISTONS; INTERNAL COMBUSTION ENGINES FOR MACHINE OPERATION AND REPLACEMENT PARTS THEREFOR; INTERNAL COMBUSTION ENGINES LAND VEHICLE PARTS, NAMELY, COILS; INTERNAL COMBUSTION ENGINES LAND VEHICLE PARTS, NAMELY, DISTRIBUTOR CAPS; INTERNAL COMBUSTION ENGINES LAND VEHICLE PARTS, NAMELY, DISTRIBUTOR ROTORS; INTERNAL COMBUSTION LAND VEHICLE ENGINE PARTS, NAMELY, CONNECTING RODS; METAL ENGINE GASKETS FOR VEHICLES; OIL PUMPS FOR LAND VEHICLES; PULL-EYS BEING PARTS OF MACHINES; PUMPS AS PARTS OF MACHINES, MOTORS AND ENGINES; RADIATORS FOR VEHICLES; REGULATORS BEING PARTS OF MACHINES; SILENCERS AS PART OF VEHICLE EXHAUST SYSTEMS; TIMING BELTS FOR ENGINES FOR LAND VEHICLES; VALVES BEING ENGINE PARTS FOR INTRODUCING FUEL-AIR MIXTURES INTO THE COMBUSTION CHAMBERS OF INTERNAL COMBUSTION ENGINES; VEHICLE BODY AND FRAME ALIGNMENT MACHINES AND STRUCTURAL REPLACEMENT PARTS THEREFOR; VEHICLE DIP STICKS; VEHICLE ENGINE PARTS, NAMELY, CHARGE AIR COOLERS AND THEIR COMPONENT PARTS; VEHICLE ENGINE PARTS, NAMELY, CRANKCASE BREATHERS; VEHICLE ENGINE PARTS, NAMELY, INTERCOOLERS; VEHICLE ENGINE PARTS, NAMELY, OIL COOLERS; VEHICLE ENGINE PARTS, NAMELY, OIL TANK PLUGS AND CAPS; VEHICLE ENGINE PARTS, NAMELY, OIL TANKS; VEHICLE ENGINE PARTS, NAMELY, PUSH RODS; VEHICLE ENGINE PARTS, NAMELY, ROCKER ARMS; VEHICLE PARTS, NAMELY, CAM COVERS; VEHICLE PARTS, NAMELY, CARBURETORS; VEHICLE PARTS, NAMELY, ENGINE CAM PROTECTORS; VEHICLE PARTS, NAMELY, ENGINE CASES; VEHICLE PARTS, NAMELY, INTAKE MANIFOLDS; VEHICLE PARTS, NAMELY, POWER VALVE FOR CARBURETORS (U.S. CLS. 13, 19, 21, 23, 31, 34 AND 35).

COLLEEN KEARNEY, EXAMINING ATTORNEY

SN 77-889,946. MOTHERS POLISHES WAXES CLEANERS, HUNTINGTON BEACH, CA. FILED 12-9-2009.

POWERBALL 4LIGHTS

THE MARK CONSISTS OF STANDARD CHARACTERS WITHOUT CLAIM TO ANY PARTICULAR FONT, STYLE, SIZE, OR COLOR.

OWNER OF U.S. REG. NOS. 3,028,180, 3,487,737 AND OTHERS.

NO CLAIM IS MADE TO THE EXCLUSIVE RIGHT TO USE "FOR LIGHTS", APART FROM THE MARK AS SHOWN.

FOR POLISHING AND SCRUBBING BRUSH ATTACHMENT FOR USE WITH POWER OPERATED VEHICLE BUFFERS, AND VEHICLE SPONGE ATTACHMENT FOR USE WITH POWER OPERATED VEHICLE BUFFERS (U.S. CLS. 13, 19, 21, 23, 31, 34 AND 35).

EVELYN BRADLEY, EXAMINING ATTORNEY

CLASS 7—(Continued).

SN 77-890,725. CHOI, JAE H., STEVENSON RANCH, CA. FILED 12-10-2009.



NO CLAIM IS MADE TO THE EXCLUSIVE RIGHT TO USE "ALL IN ONE AUTO MAT WASH & DRY SYSTEM", APART FROM THE MARK AS SHOWN.

THE COLOR(S) SILVER AND GOLD IS/ARE CLAIMED AS A FEATURE OF THE MARK.

THE MARK CONSISTS OF A SILVER RHINO STANDING ON THE WORDING "RHINO-MAT" AND THE WORDING "ALL IN ONE AUTO MAT WASH & DRY SYSTEM" UNDERNEATH WITHIN A RECTANGULAR BACKGROUND, WITH SILVER OUTLINING THROUGHOUT THE LETTERING IN "RHINO-MAT" AND AS THE BACKGROUND OF THE RECTANGLE, AND WITH GOLD LETTERING ON "RHINO-MAT" AND "ALL IN ONE AUTO MAT WASH & DRY SYSTEM".

FOR AUTOMATIC FLOOR MAT WASHING AND DRYING MACHINE (U.S. CLS. 13, 19, 21, 23, 31, 34 AND 35).

FIRST USE 1-10-2009; IN COMMERCE 1-10-2009.
CARYN GLASSER, EXAMINING ATTORNEY

SN 77-891,149. 2941538 CANADA INC. MOUNT-ROYAL, QUEBEC, CANADA, FILED 12-11-2009.

STEAMTEK MOP

THE MARK CONSISTS OF STANDARD CHARACTERS WITHOUT CLAIM TO ANY PARTICULAR FONT, STYLE, SIZE, OR COLOR.

NO CLAIM IS MADE TO THE EXCLUSIVE RIGHT TO USE "MOP", APART FROM THE MARK AS SHOWN.

FOR MULTI-PURPOSE STEAM CLEANERS, STEAM CLEANING MACHINES, STEAM MOPS (U.S. CLS. 13, 19, 21, 23, 31, 34 AND 35).

APRIL ROACH, EXAMINING ATTORNEY

SN 77-891,563. OPUS ENVIRONMENTAL FRANCHISOR LLC, LAS VEGAS, NV. FILED 12-11-2009.

ENVIRO-PURE

THE MARK CONSISTS OF STANDARD CHARACTERS WITHOUT CLAIM TO ANY PARTICULAR FONT, STYLE, SIZE, OR COLOR.

FOR ACCELERATED COMPOST MACHINES FOR USE IN COMPOSTING FOOD WASTE (U.S. CLS. 13, 19, 21, 23, 31, 34 AND 35).

FIRST USE 11-12-2009; IN COMMERCE 11-12-2009.
RENEE MCCRAY, EXAMINING ATTORNEY

CLASS 7—(Continued).

SN 77-891,567. OPUS ENVIRONMENTAL FRANCHISOR LLC, LAS VEGAS, NV. FILED 12-11-2009.

OPUS ENVIRONMENTAL

THE MARK CONSISTS OF STANDARD CHARACTERS WITHOUT CLAIM TO ANY PARTICULAR FONT, STYLE, SIZE, OR COLOR.

NO CLAIM IS MADE TO THE EXCLUSIVE RIGHT TO USE "ENVIRONMENTAL", APART FROM THE MARK AS SHOWN.

FOR ACCELERATED COMPOST MACHINES FOR USE IN COMPOSTING FOOD WASTE (U.S. CLS. 13, 19, 21, 23, 31, 34 AND 35).

FIRST USE 11-12-2009; IN COMMERCE 11-12-2009.
RENEE MCCRAY, EXAMINING ATTORNEY

SN 77-892,198. DOALL COMPANY, WHEELING, IL. FILED 12-13-2009.



OWNER OF U.S. REG. NOS. 390,078, 679,957 AND OTHERS.

THE COLOR(S) GREEN, WHITE AND BLACK IS/ARE CLAIMED AS A FEATURE OF THE MARK.

THE MARK CONSISTS OF THE WORD "DOALL" IN GREEN COLOR OUTLINED IN BLACK SUPERIMPOSED OVER A GREEN AND WHITE GLOBE DESIGN.

FOR METAL AND WOOD SAWING, CUTTING AND GRINDING MACHINES AND BLADES (U.S. CLS. 13, 19, 21, 23, 31, 34 AND 35).

FIRST USE 11-15-2009; IN COMMERCE 11-15-2009.
MARGERY A. TIERNEY, EXAMINING ATTORNEY

SN 77-892,267. A&K SOLUTIONS, LLC, BREMEN, KS. FILED 12-13-2009.

EZMT

THE MARK CONSISTS OF STANDARD CHARACTERS WITHOUT CLAIM TO ANY PARTICULAR FONT, STYLE, SIZE, OR COLOR.

FOR PORTABLE LIVESTOCK FEEDERS (U.S. CLS. 13, 19, 21, 23, 31, 34 AND 35).

FIRST USE 5-1-2009; IN COMMERCE 5-1-2009.
JEFF DEFORD, EXAMINING ATTORNEY

CLASS 7—(Continued).

SN 77-893,271. LAM RESEARCH CORPORATION, FREMONT, CA. FILED 12-14-2009.

C3

THE MARK CONSISTS OF STANDARD CHARACTERS WITHOUT CLAIM TO ANY PARTICULAR FONT, STYLE, SIZE, OR COLOR.

FOR COMPONENTS OF SEMICONDUCTOR MANUFACTURING MACHINES FOR REMOVING RESIDUES AND/OR MATERIALS FROM SEMICONDUCTOR WAFERS AND DRYING SEMICONDUCTOR WAFERS, NAMELY, WET PROCESSING CHAMBERS, FLUID DISPENSERS, BRUSHES, AIR BLOWERS, PUMPS, VALVES, FLOW CONTROLLERS, MOTION CONTROLLERS, AND MONITORING SENSORS, ALL SOLD AS INTEGRAL PARTS OF SEMICONDUCTOR MANUFACTURING MACHINES; TECHNOLOGY FOR REMOVING RESIDUES AND/OR MATERIALS FROM SEMICONDUCTOR WAFERS AND DRYING SEMICONDUCTOR WAFERS, COMPRISING WET PROCESSING CHAMBERS, FLUID DISPENSERS, BRUSHES, AIR BLOWERS, PUMPS, VALVES, FLOW CONTROLLERS, MOTION CONTROLLERS, AND MONITORING SENSORS, ALL SOLD AS AN INTEGRAL PART OF SEMICONDUCTOR MANUFACTURING MACHINES (U.S. CLS. 13, 19, 21, 23, 31, 34 AND 35).

MICHAEL SOUDERS, EXAMINING ATTORNEY

SN 77-895,771. CHROMIUM CORPORATION, DALLAS, TX. FILED 12-17-2009.

LPM

THE MARK CONSISTS OF STANDARD CHARACTERS WITHOUT CLAIM TO ANY PARTICULAR FONT, STYLE, SIZE, OR COLOR.

FOR CYLINDER LINERS FOR HIGH HORSE POWER DIESEL ENGINES FOR MARINE VESSELS; CYLINDER LINERS FOR HIGH HORSE POWER DIESEL ENGINES FOR LOCOMOTIVES (U.S. CLS. 13, 19, 21, 23, 31, 34 AND 35).

MORGAN WYNNE, EXAMINING ATTORNEY

CLASS 7—(Continued).

SN 77-896,882. BLOUNT, INC., PORTLAND, RI. FILED 12-18-2009.



THE COLOR(S) RED, BLACK, WHITE, GRAY IS/ARE CLAIMED AS A FEATURE OF THE MARK.

THE MARK CONSISTS OF "G6" IN WHITE WITH SHADING OF BLACK AND GRAY ON A RED RECTANGULAR BACKGROUND.

FOR LAWNMOWER BLADES (U.S. CLS. 13, 19, 21, 23, 31, 34 AND 35).

SHARON MEIER, EXAMINING ATTORNEY

SN 77-902,412. BLOK, HENDRIK, RENO, NV. FILED 12-29-2009.

U-adjust-it

THE MARK CONSISTS OF STANDARD CHARACTERS WITHOUT CLAIM TO ANY PARTICULAR FONT, STYLE, SIZE, OR COLOR.

FOR HYDRAULIC LIFTS FOR VEHICLES (U.S. CLS. 13, 19, 21, 23, 31, 34 AND 35).

ROBIN CHOSID, EXAMINING ATTORNEY

SN 77-911,116. SANDVIK INTELLECTUAL PROPERTY AB, SANDVIKEN, SWEDEN, FILED 1-13-2010.

SYSTEM 2000

THE MARK CONSISTS OF STANDARD CHARACTERS WITHOUT CLAIM TO ANY PARTICULAR FONT, STYLE, SIZE, OR COLOR.

OWNER OF U.S. REG. NOS. 1,565,490 AND 1,582,243.

NO CLAIM IS MADE TO THE EXCLUSIVE RIGHT TO USE "SYSTEM", APART FROM THE MARK AS SHOWN.

FOR MACHINE PARTS, NAMELY, BLADES (U.S. CLS. 13, 19, 21, 23, 31, 34 AND 35).

FIRST USE 11-1-1985; IN COMMERCE 9-12-1988.

WENDY GOODMAN, EXAMINING ATTORNEY

CLASS 7—(Continued).

SN 79-069,686. KORLOY INC., REPUBLIC OF KOREA,
FILED 5-25-2009.

MILL-MAX

THE MARK CONSISTS OF STANDARD CHARACTERS WITHOUT CLAIM TO ANY PARTICULAR FONT, STYLE, SIZE, OR COLOR.

OWNER OF INTERNATIONAL REGISTRATION 1004799 DATED 5-25-2009, EXPIRES 5-25-2019.

FOR MACHINE PARTS, NAMELY, METAL CUTTER BODIES FOR MILLING, METAL CUTTER BODIES FOR BORING, METAL CUTTER BODIES FOR DRILLING (U.S. CLS. 13, 19, 21, 23, 31, 34 AND 35).

KRISTIN DAHLING, EXAMINING ATTORNEY

SN 79-070,678. KORLOY INC., REPUBLIC OF KOREA,
FILED 5-29-2009.

MGT Tool

THE MARK CONSISTS OF STANDARD CHARACTERS WITHOUT CLAIM TO ANY PARTICULAR FONT, STYLE, SIZE, OR COLOR.

OWNER OF INTERNATIONAL REGISTRATION 1007117 DATED 5-29-2009, EXPIRES 5-29-2019.

NO CLAIM IS MADE TO THE EXCLUSIVE RIGHT TO USE "TOOL", APART FROM THE MARK AS SHOWN.

FOR ELECTRIC HAND DRILLS; MACHINE PARTS, NAMELY, MILLING CUTTERS, DRILLING HEADS, REAMERS; ELECTRIC SHEARS; GRINDERS; PNEUMATIC HAMMERS; THREADING MACHINES; OIL HYDRAULIC PRESSES; MILLING MACHINES (U.S. CLS. 13, 19, 21, 23, 31, 34 AND 35).

KRISTIN DAHLING, EXAMINING ATTORNEY

SN 79-070,680. KORLOY INC., REPUBLIC OF KOREA,
FILED 6-2-2009.

KORLOY SP-Drill

THE MARK CONSISTS OF STANDARD CHARACTERS WITHOUT CLAIM TO ANY PARTICULAR FONT, STYLE, SIZE, OR COLOR.

OWNER OF INTERNATIONAL REGISTRATION 1007119 DATED 6-2-2009, EXPIRES 6-2-2019.

OWNER OF U.S. REG. NOS. 2,443,074 AND 3,320,390.

FOR MACHINE PARTS, NAMELY, BITS, MILLING CUTTERS, DRILL CHUCKS, DRILLING HEADS, REAMERS; ELECTRIC HAND DRILLS; POWER DRILLING BITS (U.S. CLS. 13, 19, 21, 23, 31, 34 AND 35).

KRISTIN DAHLING, EXAMINING ATTORNEY

CLASS 7—(Continued).

SN 79-071,588. ALEADER VISION TECHNOLOGY CO., LTD.,
CHINA, FILED 7-1-2009.



OWNER OF INTERNATIONAL REGISTRATION 1009554 DATED 7-1-2009, EXPIRES 7-1-2019.

THE ENGLISH WORDING "ALEADER" HAS NO SIGNIFICANCE IN THE RELEVANT TRADE OR INDUSTRY, AND HAS NO GEOGRAPHICAL SIGNIFICANCE, AND HAS NO MEANING IN A FOREIGN LANGUAGE, AND HAS NO SIGNIFICANCE AS APPLIED TO THE GOODS.

FOR MACHINES FOR THE ELECTRONIC INDUSTRY FOR DETECTING DEFECT OF ELECTRONIC PRODUCTS PRODUCED WITH SMT (SURFACED MOUNTING TECHNOLOGY); WRAPPING MACHINES; WASHING MACHINES FOR CLOTHES; PLASTIC JETTING-MOULDING MACHINES; MACHINE TOOLS FOR METALWORKING, CUTTING MATERIALS; ELEVATORS; STARTERS FOR MOTORS AND ENGINES; METALWORKING SPINNING MACHINES; METALWORKING MACHINES; METALWORKING MACHINES FOR COLD WORKING FOR THE OPTICS (U.S. CLS. 13, 19, 21, 23, 31, 34 AND 35).

KARANENDRA S. CHHINA, EXAMINING ATTORNEY

SN 79-071,773. KORLOY INC., REPUBLIC OF KOREA,
FILED 6-11-2009.

Aero-Mill

THE MARK CONSISTS OF STANDARD CHARACTERS WITHOUT CLAIM TO ANY PARTICULAR FONT, STYLE, SIZE, OR COLOR.

OWNER OF INTERNATIONAL REGISTRATION 1010079 DATED 6-11-2009, EXPIRES 6-11-2019.

FOR TOOL BITS BEING PARTS OF MACHINES; MILLING CUTTERS BEING PARTS OF MACHINES; ELECTRIC HAND HELD DRILLS; DRILLING BITS BEING PARTS OF MACHINES; DRILL CHUCKS BEING PARTS OF MACHINES; DRILLING HEADS BEING PARTS OF MACHINES; REAMERS BEING PARTS OF MACHINES (U.S. CLS. 13, 19, 21, 23, 31, 34 AND 35).

SOPHIA S. KIM, EXAMINING ATTORNEY

SN 79-071,774. KORLOY INC., REPUBLIC OF KOREA,
FILED 6-12-2009.

Cube-Mill

THE MARK CONSISTS OF STANDARD CHARACTERS WITHOUT CLAIM TO ANY PARTICULAR FONT, STYLE, SIZE, OR COLOR.

OWNER OF INTERNATIONAL REGISTRATION 1010080 DATED 6-12-2009, EXPIRES 6-12-2019.

FOR TOOL BITS BEING PARTS OF MACHINES; MILLING CUTTERS BEING PARTS OF MACHINES; ELECTRIC HAND HELD DRILLS; DRILLING BITS BEING PARTS OF MACHINES; DRILL CHUCKS BEING PARTS OF MACHINES; DRILLING HEADS BEING PARTS OF MACHINES; REAMERS BEING PARTS OF MACHINES (U.S. CLS. 13, 19, 21, 23, 31, 34 AND 35).

SOPHIA S. KIM, EXAMINING ATTORNEY

CLASS 7—(Continued).

SN 79-071,977. SOCIETA' INDUSTRIALE COSTRUZIONE MACCHINE AGRICOLE S.P.A., 1-66010 MIGLIANICO (CH), ITALY, FILED 6-10-2009.



OWNER OF INTERNATIONAL REGISTRATION 1010635 DATED 6-10-2009, EXPIRES 6-10-2019.

THE MARK CONSISTS OF THE WORDING "SICMA" IN STYLIZED CHARACTERS UNDER A DESIGN CONSISTING OF TWO MIRRORED CURVED BANDS WITH STEMS SEPARATED BY AN "S" SHAPED SPACE.

THE WORDING "SICMA" HAS NO MEANING IN A FOREIGN LANGUAGE.

FOR MACHINES AND MACHINE TOOLS FOR AGRICULTURE OTHER THAN HAND-OPERATED, NAMELY CULTIVATORS, HARVESTERS, DISK HARROWS, SEEDERS, CHIPPERS, TILLERS, SHREDDERS, LAWN MOWERS, AND FORK LIFTS (U.S. CLS. 13, 19, 21, 23, 31, 34 AND 35).

TASNEEM HUSSAIN, EXAMINING ATTORNEY

CLASS 7—(Continued).

SN 79-072,996. IHLAS PAZARLAMA ANONIM SIRKETI, TURKEY, FILED 4-18-2008.



OWNER OF INTERNATIONAL REGISTRATION 0793221 DATED 6-28-2002, EXPIRES 6-28-2012.

THE COLOR(S) BLACK, WHITE, BLUE AND GREEN IS/ARE CLAIMED AS A FEATURE OF THE MARK.

THE MARK CONSISTS OF THE WORDING "ROBOCLEAN" IN BLACK, AND "AURA" IN BLUE NEXT TO A BLUE CIRCLE AND CURVED SHAPE IN GREEN UNDERLINED IN BLUE, ALL SUPERIMPOSED AGAINST A WHITE RECTANGULAR BACKGROUND OUTLINED IN BLACK, AND THE RECTANGLE SURROUNDED BY A WHITE SQUARE OUTLINED IN BLACK.

FOR MACHINES AND MACHINE TOOLS, NAMELY, DISHWASHERS, CLOTHES WASHING MACHINES, FLOOR POLISHING MACHINES ELECTRICAL OR WITH MOTOR, VACUUM CLEANERS, ELECTRICAL CARPET WASHING MACHINES AND PARTS THEREOF, DUST BAGS FOR VACUUM CLEANERS (U.S. CLS. 13, 19, 21, 23, 31, 34 AND 35).

DEIRDRE ROBERTSON, EXAMINING ATTORNEY

SN 79-072,887. AUTOMAX, FRANCE, FILED 7-23-2009.

Le Bacchus

OWNER OF INTERNATIONAL REGISTRATION 1013221 DATED 7-23-2009, EXPIRES 7-23-2019.

FOR ELECTRIC CUTTERS FOR GARDENING; ELECTRIC PRUNING SHEARS FOR GARDENING; ELECTRIC PRUNING SHEARS FOR HEDGES, TREES, AND VINES (U.S. CLS. 13, 19, 21, 23, 31, 34 AND 35).

KIMBERLY PERRY, EXAMINING ATTORNEY

CLASS 7—(Continued).

SN 79-073,557. TACCHI GIACOMO E FIGLI - S.P.A., ITALY,
FILED 8-13-2009.



PRIORITY DATE OF 8-11-2009 IS CLAIMED.
OWNER OF INTERNATIONAL REGISTRATION 1015119
DATED 8-13-2009, EXPIRES 8-13-2019.

NO CLAIM IS MADE TO THE EXCLUSIVE RIGHT TO
USE "TORN", APART FROM THE MARK AS SHOWN.

THE COLOR(S) RED, BLACK AND GRAY IS/ARE
CLAIMED AS A FEATURE OF THE MARK.

THE MARK CONSISTS OF BLACK LINES IN A CIRCULAR
PATTERN, THE WORDS "TORN" AND "TACCHI" IN
THE COLOR RED AND THE COLOR GRAY APPEARS AS
SHADING UNDER AND AROUND THE WORDS "TORN"
AND "TACCHI", AS WELL AS IN THE INNER PORTION
AND OUTER BORDER IN THE MARK.

THE ENGLISH TRANSLATION OF "TORN" IN THE
MARK IS LATHES.

FOR LATHES AND BORING MACHINES (U.S. CLS. 13,
19, 21, 23, 31, 34 AND 35).

DOMINIC J. FERRAIUOLO, EXAMINING ATTORNEY

SN 79-074,976. ABBRIATA S.R.L., ITALY, FILED 10-8-2009.

ABBRIATA

THE MARK CONSISTS OF STANDARD CHARACTERS
WITHOUT CLAIM TO ANY PARTICULAR FONT, STYLE,
SIZE, OR COLOR.

OWNER OF INTERNATIONAL REGISTRATION 0994337
DATED 12-11-2008, EXPIRES 12-11-2018.

FOR BALERS FOR AGRICULTURAL PURPOSES (U.S.
CLS. 13, 19, 21, 23, 31, 34 AND 35).

SUSAN LESLIE DUBOIS, EXAMINING ATTORNEY

CLASS 7—(Continued).

SN 79-075,888. WENZHOU SEINECA; INTERNATIONAL
CORPORATION, RUI'AN; 325200 ZHEJIANG, CHINA,
FILED 10-28-2009.

SEINECA

OWNER OF INTERNATIONAL REGISTRATION 1020953
DATED 10-28-2009, EXPIRES 10-28-2019.

THE MARK CONSISTS OF THE WORDING "SEINECA"
IN STYLIZED LETTERING.

FOR VEHICLE OIL PUMPS; VEHICLE WATER
PUMPS; LUBRICATING PUMPS FOR AUTOMOTIVE
ENGINES; AUTOMOBILE ENGINE SPARK PLUGS;
IGNITION COILS OF THE AUTOMOBILE ENGINES;
OIL CLEANERS, NAMELY, OIL FILTERS; AUTOMOTIVE
ENGINE COOLING FANS (U.S. CLS. 13, 19, 21, 23,
31, 34 AND 35).

DEBRA LEE, EXAMINING ATTORNEY

CLASS 8—HAND TOOLS

SN 77-563,038. ONTEL PRODUCTS CORPORATION, FAIR-
FIELD, NJ. FILED 9-5-2008.

SURE CLIP

THE MARK CONSISTS OF STANDARD CHARACTERS
WITHOUT CLAIM TO ANY PARTICULAR FONT, STYLE,
SIZE, OR COLOR.

NO CLAIM IS MADE TO THE EXCLUSIVE RIGHT TO
USE "CLIP", APART FROM THE MARK AS SHOWN.

FOR NAIL CLIPPERS (U.S. CLS. 23, 28 AND 44).

FIRST USE 2-28-2009; IN COMMERCE 2-28-2009.

SIMON TENG, EXAMINING ATTORNEY

SN 77-641,018. LUHMANN, WILLIAM VON, FORTVILLE,
IN. FILED 12-29-2008.

Pick Punch

THE MARK CONSISTS OF STANDARD CHARACTERS
WITHOUT CLAIM TO ANY PARTICULAR FONT, STYLE,
SIZE, OR COLOR.

NO CLAIM IS MADE TO THE EXCLUSIVE RIGHT TO
USE "PUNCH", APART FROM THE MARK AS SHOWN.

FOR HAND TOOLS, NAMELY, PUNCHES (U.S. CLS.
23, 28 AND 44).

JAMES A. RAUEN, EXAMINING ATTORNEY

CLASS 8—(Continued).

SN 77-712,940. KAI CORPORATION, TOKYO, JAPAN, FILED 4-13-2009.

KOBAKO

OWNER OF JAPAN REG. NO. 5056376, DATED 6-22-2007, EXPIRES 6-22-2017.

THE MARK CONSISTS OF THE WORD "KOBAKO".
FOR ELECTRIC RAZORS; BLADED OR POINTED HAND TOOLS, NAMELY, NON-ELECTRIC RAZORS, SCISSORS, KITCHEN KNIVES, AND NAIL CLIPPERS; SPOONS, CUTLERY FORKS, NON-ELECTRIC FLAT IRONS, DRESSMAKER'S CHALK SHARPENERS, EYELASH CURLERS, HAIR-REMOVING TWEEZERS; ELECTRIC AND NON-ELECTRIC FINGERNAIL POLISHERS, NAMELY, KITS COMPRISED OF NAIL BUFFERS, SOLD AS A UNIT WITH ABRASIVE NAIL PAPER AND ABRASIVE PASTE (U.S. CLS. 23, 28 AND 44).
EUGENIA MARTIN, EXAMINING ATTORNEY

SN 77-774,583. ANIMALCARE GROUP PLC, MASHAM, RIPON, UNITED KINGDOM, FILED 7-6-2009.

AUTOTAGGER

THE MARK CONSISTS OF STANDARD CHARACTERS WITHOUT CLAIM TO ANY PARTICULAR FONT, STYLE, SIZE, OR COLOR.

PRIORITY CLAIMED UNDER SEC. 44(D) ON ERP NCMNTY TM OFC APPLICATION NO. 007507403, FILED 1-8-2009, REG. NO. 007507403, DATED 7-29-2009, EXPIRES 1-8-2019.

FOR A HAND OPERATED TOOL WHICH IS USED TO AFFIX IDENTIFICATION TAGS TO LIVESTOCK (U.S. CLS. 23, 28 AND 44).

JACQUELINE A. LAVINE, EXAMINING ATTORNEY

CLASS 8—(Continued).

SN 77-878,659. AMES TRUE TEMPER PROPERTIES, INC., WILMINGTON, DE. FILED 11-23-2009.

TITANIUM XTRA

THE MARK CONSISTS OF STANDARD CHARACTERS WITHOUT CLAIM TO ANY PARTICULAR FONT, STYLE, SIZE, OR COLOR.

OWNER OF U.S. REG. NO. 3,674,298.

NO CLAIM IS MADE TO THE EXCLUSIVE RIGHT TO USE "TITANIUM", APART FROM THE MARK AS SHOWN.
FOR MANUALLY OPERATED PRUNING TOOLS, NAMELY, PRUNERS, LOPPERS, HEDGE SHEARS, GRASS SHEARS, PRUNING SAWS, BOW SAWS, FOLDING PRUNING SAWS, SCISSORS, SNIPS, FLORAL SHEARS, AND MACHETES, ALL MADE IN WHOLE OR IN PART, OF TITANIUM (U.S. CLS. 23, 28 AND 44).
MICHAEL GAFFAR, EXAMINING ATTORNEY

SN 77-883,583. MCLELLAND, SHANE, ARROWHEAD, CA. FILED 12-1-2009.

Outlaw Tools

THE MARK CONSISTS OF STANDARD CHARACTERS WITHOUT CLAIM TO ANY PARTICULAR FONT, STYLE, SIZE, OR COLOR.

NO CLAIM IS MADE TO THE EXCLUSIVE RIGHT TO USE "TOOLS", APART FROM THE MARK AS SHOWN.

FOR AUTOMOTIVE BODY REPAIR TOOLS, NAMELY, SANDING BLOCKS (U.S. CLS. 23, 28 AND 44).

SUSAN RICHARDS, EXAMINING ATTORNEY

CLASS 8—(Continued).

SN 77-884,012. HAGGARD ID WIPER, INC., ANGLETON, TX. FILED 12-2-2009.



OWNER OF U.S. REG. NO. 2,049,869.
THE MARK CONSISTS OF THE WORDING "MUD DOG" IN STYLIZED FORM. BELOW THE WORDING IS A STYLIZED CANINE WEARING A HARD HAT EXITING FROM A DRILL PIPE AND CARRYING A WIPER TOOL IN HIS RIGHT PAW. THE CANINE'S HARD HAT HAS A LETTER "H" ON IT, AND HIS CHEST ALSO BEARS A LETTER "H".

FOR HAND-OPERATED, NON-POWER OPERATED WIPER TOOLS FOR CLEANING THE INSIDE OF DRILL PIPES IN OIL FIELDS (U.S. CLS. 23, 28 AND 44).
FIRST USE 5-4-1995; IN COMMERCE 5-4-1995.
NANCY CLARKE, EXAMINING ATTORNEY

SN 77-885,983. ONTEL PRODUCTS CORPORATION, FAIRFIELD, NJ. FILED 12-4-2009.

MONKEY REACHER

THE MARK CONSISTS OF STANDARD CHARACTERS WITHOUT CLAIM TO ANY PARTICULAR FONT, STYLE, SIZE, OR COLOR.

NO CLAIM IS MADE TO THE EXCLUSIVE RIGHT TO USE "REACHER", APART FROM THE MARK AS SHOWN. FOR MANUALLY OPERATED HAND HELD TOOL THAT ALLOWS AN INDIVIDUAL TO GRAB OR RETRIEVE ITEMS OUT OF NORMAL REACH (U.S. CLS. 23, 28 AND 44).

KATHERINE STOIDES, EXAMINING ATTORNEY

CLASS 8—(Continued).

SN 77-887,918. IDEX CORPORATION, NORTHBROOK, IL. FILED 12-7-2009.

IDEX

THE MARK CONSISTS OF STANDARD CHARACTERS WITHOUT CLAIM TO ANY PARTICULAR FONT, STYLE, SIZE, OR COLOR.

OWNER OF U.S. REG. NO. 1,658,795.

THE WORDING "IDEX" HAS NO MEANING IN A FOREIGN LANGUAGE.

FOR HAND TOOLS, NAMELY, HAND-OPERATED PUMPS AND SHEARS; MANUALLY OPERATED HAND TOOLS, NAMELY, HAND TOOLS FOR APPLYING, TIGHTENING AND REMOVING METAL FITTINGS AND METAL CLAMPS AND COMPONENT PARTS THEREFORE AROUND PIPES, TUBES, CABLES, WIRES AND POSTS (U.S. CLS. 23, 28 AND 44).

FIRST USE 1-22-1990; IN COMMERCE 1-22-1990.

JAMES MACFARLANE, EXAMINING ATTORNEY

SN 77-892,089. BUCK KNIVES, INC., POST FALLS, ID. FILED 12-12-2009.

Ibex

THE MARK CONSISTS OF STANDARD CHARACTERS WITHOUT CLAIM TO ANY PARTICULAR FONT, STYLE, SIZE, OR COLOR.

FOR HUNTING KNIVES; KNIVES FOR HOBBY USE; SIDE ARMS, NOT INCLUDING FIREARMS, NAMELY, HUNTING KNIVES; SPORT KNIVES (U.S. CLS. 23, 28 AND 44).

JAMES A. RAUEN, EXAMINING ATTORNEY

SN 77-892,090. BUCK KNIVES, INC., POST FALLS, ID. FILED 12-12-2009.

Fannin

THE MARK CONSISTS OF STANDARD CHARACTERS WITHOUT CLAIM TO ANY PARTICULAR FONT, STYLE, SIZE, OR COLOR.

FOR KNIVES; KNIVES FOR HOBBY USE; SIDE ARMS, NOT INCLUDING FIREARMS, NAMELY, HUNTING KNIVES; SPORT KNIVES (U.S. CLS. 23, 28 AND 44).

JAMES A. RAUEN, EXAMINING ATTORNEY

CLASS 8—(Continued).

SN 77-892,092. BUCK KNIVES, INC., POST FALLS, ID.
FILED 12-12-2009.

Oryx

THE MARK CONSISTS OF STANDARD CHARACTERS WITHOUT CLAIM TO ANY PARTICULAR FONT, STYLE, SIZE, OR COLOR.

FOR KNIVES; KNIVES FOR HOBBY USE; SIDE ARMS, NOT INCLUDING FIREARMS, NAMELY, HUNTING KNIVES; SPORT KNIVES (U.S. CLS. 23, 28 AND 44).
JAMES A. RAUEN, EXAMINING ATTORNEY

SN 77-892,102. BUCK KNIVES, INC., POST FALLS, ID.
FILED 12-12-2009.

Impala

THE MARK CONSISTS OF STANDARD CHARACTERS WITHOUT CLAIM TO ANY PARTICULAR FONT, STYLE, SIZE, OR COLOR.

FOR KNIVES; KNIVES FOR HOBBY USE; SIDE ARMS, NOT INCLUDING FIREARMS, NAMELY, HUNTING KNIVES; SPORT KNIVES (U.S. CLS. 23, 28 AND 44).
JAMES A. RAUEN, EXAMINING ATTORNEY

SN 77-892,103. BUCK KNIVES, INC., POST FALLS, ID.
FILED 12-12-2009.

Tsiu

THE MARK CONSISTS OF STANDARD CHARACTERS WITHOUT CLAIM TO ANY PARTICULAR FONT, STYLE, SIZE, OR COLOR.

FOR KNIVES; KNIVES FOR HOBBY USE; SIDE ARMS, NOT INCLUDING FIREARMS, NAMELY, HUNTING KNIVES; SPORT KNIVES (U.S. CLS. 23, 28 AND 44).
JAMES A. RAUEN, EXAMINING ATTORNEY

CLASS 8—(Continued).

SN 77-892,356. APOLLO INDUSTRIES LIMITED, HANG-ZHOU, HONG KONG, FILED 12-14-2009.

MOTOCENTRIC

THE MARK CONSISTS OF STANDARD CHARACTERS WITHOUT CLAIM TO ANY PARTICULAR FONT, STYLE, SIZE, OR COLOR.

FOR MANUALLY OPERATED SHOP TOOLS FOR WORK ON MOTORCYCLES, NAMELY, CHAIN BREAKER TOOL, CHAIN RIVETING TOOL, CHAIN PRESS TOOL, CHAIN ALIGNMENT TOOL, CARBURETOR TUNING TOOL, CARBURETOR TUNING GAUGE SET, TIRE IRONS, TAPPET ADJUSTMENT TOOLS, VALVE SHIM TOOLS, TAPPET FEELER GAUGE, CARBURETOR JET WRENCHES, CLUTCH HOLDING TOOL, PISTON PIN REMOVING TOOL, SPRING REMOVING TOOL, TIMING COVER WRENCH, OIL FILTER WRENCH, SHOCK ABSORBER WRENCH, AXLE WRENCH, FLY WHEEL PULLER TOOL, CLUTCH PULLER TOOL AND MAGNETO FLYWHEEL PULLER TOOL (U.S. CLS. 23, 28 AND 44).

WILLIAM BRECKENFELD, EXAMINING ATTORNEY

SN 77-895,714. AMES TRUE TEMPER PROPERTIES, INC., WILMINGTON, DE. FILED 12-17-2009.

PLANTER'S PAL

THE MARK CONSISTS OF STANDARD CHARACTERS WITHOUT CLAIM TO ANY PARTICULAR FONT, STYLE, SIZE, OR COLOR.

OWNER OF U.S. REG. NO. 3,304,345.
NO CLAIM IS MADE TO THE EXCLUSIVE RIGHT TO USE "PLANTER'S", APART FROM THE MARK AS SHOWN. FOR MANUALLY OPERATED HAND TOOLS, NAMELY, A COMBINATION PLANTER'S KNIFE/TROWEL (U.S. CLS. 23, 28 AND 44).

MICHAEL GAUFAR, EXAMINING ATTORNEY

SN 77-896,648. KAI U.S.A., LTD., DBA KERSHAW KNIVES, TUALATIN, OR. FILED 12-18-2009.

ASSET

THE MARK CONSISTS OF STANDARD CHARACTERS WITHOUT CLAIM TO ANY PARTICULAR FONT, STYLE, SIZE, OR COLOR.

FOR KNIVES (U.S. CLS. 23, 28 AND 44).
JEFFERY COWARD, EXAMINING ATTORNEY

CLASS 8—(Continued).

SN 77-896,650. KAI U.S.A., LTD., DBA KERSHAW KNIVES, TUALATIN, OR. FILED 12-18-2009.

NERVE

THE MARK CONSISTS OF STANDARD CHARACTERS WITHOUT CLAIM TO ANY PARTICULAR FONT, STYLE, SIZE, OR COLOR.

FOR KNIVES (U.S. CLS. 23, 28 AND 44).
JEFFERY COWARD, EXAMINING ATTORNEY

SN 77-899,092. KAI U.S.A., LTD., DBA KERSHAW KNIVES, TUALATIN, OR. FILED 12-22-2009.

CLASH

THE MARK CONSISTS OF STANDARD CHARACTERS WITHOUT CLAIM TO ANY PARTICULAR FONT, STYLE, SIZE, OR COLOR.

FOR KNIVES (U.S. CLS. 23, 28 AND 44).
JEFFERY COWARD, EXAMINING ATTORNEY

SN 77-911,340. KAI U.S.A., LTD., DBA KERSHAW KNIVES, TUALATIN, OR. FILED 1-13-2010.

RIO

THE MARK CONSISTS OF STANDARD CHARACTERS WITHOUT CLAIM TO ANY PARTICULAR FONT, STYLE, SIZE, OR COLOR.

FOR FOLDING UTILITY KNIVES (U.S. CLS. 23, 28 AND 44).
JEFFERY COWARD, EXAMINING ATTORNEY

SN 77-911,347. KAI U.S.A., LTD., DBA KERSHAW KNIVES, TUALATIN, OR. FILED 1-13-2010.

RAKE

THE MARK CONSISTS OF STANDARD CHARACTERS WITHOUT CLAIM TO ANY PARTICULAR FONT, STYLE, SIZE, OR COLOR.

FOR FOLDING UTILITY KNIVES (U.S. CLS. 23, 28 AND 44).
JEFFERY COWARD, EXAMINING ATTORNEY

CLASS 8—(Continued).

SN 77-920,705. KAI U.S.A., LTD., DBA KERSHAW KNIVES, TUALATIN, OR. FILED 1-26-2010.

TURBULENCE

THE MARK CONSISTS OF STANDARD CHARACTERS WITHOUT CLAIM TO ANY PARTICULAR FONT, STYLE, SIZE, OR COLOR.

FOR KNIVES (U.S. CLS. 23, 28 AND 44).
JEFFERY COWARD, EXAMINING ATTORNEY

SN 77-936,828. DURBIN, THOMAS J., RIVER FOREST, IL. FILED 2-16-2010.

DURABILT

THE MARK CONSISTS OF STANDARD CHARACTERS WITHOUT CLAIM TO ANY PARTICULAR FONT, STYLE, SIZE, OR COLOR.

FOR HAND TOOLS FOR LOAD SECUREMENT, NAMELY, LOAD BINDER, LEVER BINDER, RATCHET BINDER, PULLER (U.S. CLS. 23, 28 AND 44).
FIRST USE 4-15-1995; IN COMMERCE 4-15-1995.
KAELIE KUNG, EXAMINING ATTORNEY

CLASS 9—ELECTRICAL AND SCIENTIFIC APPARATUS

SN 76-475,702. ID SOFTWARE LLC, MESQUITE, TX. FILED 12-9-2002.

QUEST

FOR COMPUTER SOFTWARE GAMES, COMPUTER SOFTWARE GAME PROGRAMS AND COMPUTER GAME CARTRIDGES OR CD-ROMS FOR VIDEO GAMES FOR ENTERTAINMENT USES WITH MANUALS SOLD AS A UNIT (U.S. CLS. 21, 23, 26, 36 AND 38).
TRACY CROSS, EXAMINING ATTORNEY

CLASS 9—(Continued).

SN 76-653,370. UNITRONICS (1989) (R"G) LTD., BEN-GURION AIRPORT 70100, ISRAEL, FILED 1-12-2006.

VisiLogic

THE MARK CONSISTS OF STANDARD CHARACTERS WITHOUT CLAIM TO ANY PARTICULAR FONT, STYLE, SIZE, OR COLOR.

FOR COMPUTER AUTOMATION SOFTWARE FOR USE WITH PROGRAMMABLE LOGIC CONTROLLERS AND HUMAN MACHINE INTERFACE SCREENS; PROGRAMMING ENVIRONMENT SOFTWARE FOR PROGRAMMABLE LOGIC CONTROLLERS; COMPUTER SOFTWARE FOR AUTOMATING WAREHOUSES, DISTRIBUTION CENTERS, CONTROL SYSTEMS AND CONVEYOR SYSTEMS IN MANUFACTURING INDUSTRIES; PROGRAMMING SOFTWARE FOR INDUSTRIAL AUTOMATION, INDUSTRIAL LOGISTICS AND PROGRAMMABLE LOGIC CONTROLLERS; COMPUTER SOFTWARE FOR AUTOMATION, CONTROL AND MANAGEMENT FOR USE IN AUTOMATED LOGISTICS SYSTEMS, MAINLY, AUTOMATIC WAREHOUSES AND DISTRIBUTION SYSTEMS (U.S. CLS. 21, 23, 26, 36 AND 38).

FIRST USE 0-0-2000; IN COMMERCE 0-0-2000.
TINA BROWN, EXAMINING ATTORNEY

CLASS 9—(Continued).

SN 76-696,013. FAST, LARRY, GILLETTE, NJ. FILED 2-27-2009.

SYNERGY

THE MARK CONSISTS OF STANDARD CHARACTERS WITHOUT CLAIM TO ANY PARTICULAR FONT, STYLE, SIZE, OR COLOR.

OWNER OF U.S. REG. NO. 1,273,912.
FOR MUSICAL SOUND RECORDINGS; ELECTRONIC AND DIGITAL DEVICES CONTAINING PRE-RECORDED SOUNDS FOR USE IN THE FIELD OF MUSIC, NAMELY, PRE-RECORDED DIGITAL FILES OF CUSTOM DESIGNED DIGITAL SOUNDS AND SOUND SEQUENCES FOR USE IN THE FIELD OF MUSIC, RECORDED ON CDS AND DVDS, AND ANALOG FORMATS, NAMELY, VINYL DISKS, MAGNETIC TAPE CARTRIDGES AND CASSETTES; PRE-RECORDED DIGITAL MEDIA, NAMELY, PRE-RECORDED AND DVDS AND OTHER DIGITAL AND OPTICAL FORMATS IN THE NATURE OF DIGITAL MEDIA CARDS AND DISK DRIVES, ALL FEATURING MUSIC AND SOUNDS; AUDIO AND VIDEO RECORDINGS DOWNLOADABLE VIA THE INTERNET AND OTHER WIRED AND WIRELESS NETWORKS, ALL FEATURING MUSIC AND SOUNDS; COMPUTER SOFTWARE FEATURING MUSICAL SOUND RECORDINGS AND MUSICAL VIDEO RECORDINGS (U.S. CLS. 21, 23, 26, 36 AND 38).

FIRST USE 7-6-1975; IN COMMERCE 7-6-1975.
KAREN SEVERSON, EXAMINING ATTORNEY

SN 76-689,783. SAFE GLOW CORPORATION, YORBA LINDA, CA. FILED 5-19-2008.



NO CLAIM IS MADE TO THE EXCLUSIVE RIGHT TO USE "GLOW", APART FROM THE MARK AS SHOWN.

THE MARK COMPRISES THE DESIGN OF A WAVY BAND FORMING A STYLIZED LETTER "S" TIPPED BY A SPHERE WITH HIGHLIGHTING AND AN AURA, BOTH WITHIN A RECTANGULAR BACKGROUND. TO THE RIGHT OF THE DESIGN IS THE WORDING "SAFE GLOW" IN STYLIZED FONT.

FOR NON-ELECTRICAL, PHOTOLUMINESCENT SIGNS, EMERGENCY PHOTOLUMINESCENT LIGHTS AND SAFETY MARKERS FOR INSTALLATION IN AND AROUND BUILDINGS TO MARK MEANS OF EGRESS (U.S. CLS. 21, 23, 26, 36 AND 38).

FIRST USE 2-2-2002; IN COMMERCE 2-2-2002.
STEVEN PEREZ, EXAMINING ATTORNEY

SN 76-699,878. FASULA, ELAINE F., SHOKAN, NY. FILED 10-15-2009.



NO CLAIM IS MADE TO THE EXCLUSIVE RIGHT TO USE "US", APART FROM THE MARK AS SHOWN.

THE COLOR(S) BLACK AND GOLD IS/ARE CLAIMED AS A FEATURE OF THE MARK.

THE MARK CONSISTS OF A BLACK RECTANGLE WITH THE DESIGNATIONS "OMBRE" AND "US" IN GOLD, A GOLD LINE, AND GOLD DOT.

THE WORD "OMBRE" IS TRANSLATED AS "SHADE" AND IS THE NAME OF A BOARD GAME.

FOR MULTIPURPOSE LAPTOP COMPUTER CASE (U.S. CLS. 21, 23, 26, 36 AND 38).

DAVID C. REIHNER, EXAMINING ATTORNEY

CLASS 9—(Continued).

SN 76-700,281. SOFT COMPUTER CONSULTANTS, INC., CLEARWATER, FL. FILED 11-9-2009.

SOFTDMI

THE MARK CONSISTS OF STANDARD CHARACTERS WITHOUT CLAIM TO ANY PARTICULAR FONT, STYLE, SIZE, OR COLOR.

FOR COMPUTER DATABASE MANAGEMENT SOFTWARE PROGRAM THAT SUPPORTS DATA MANAGEMENT AND INTERFACES FOR GENETICS SOFTWARE MODULES AS WELL AS OTHER SOFTWARE APPLICATIONS AND THIRD-PARTY SYSTEMS (U.S. CLS. 21, 23, 26, 36 AND 38).

FIRST USE 12-0-2008; IN COMMERCE 12-0-2008.
LAURIE MAYES, EXAMINING ATTORNEY

SN 76-700,596. SOFT COMPUTER CONSULTANTS, INC., CLEARWATER, FL. FILED 11-30-2009.

SOFTREPORTSPLUS

OWNER OF U.S. REG. NO. 3,529,651.
FOR COMPUTER SOFTWARE APPLICATION THAT PROVIDES A CUSTOM AD HOC REPORT DESIGNER, A WEB-BASED CUSTOM AD HOC REPORT LAUNCHER, AND A SYSTEM REPORT LAYOUT EDITOR, AS WELL AS THE ABILITY TO PRODUCE PATIENT CARE REPORTS (U.S. CLS. 21, 23, 26, 36 AND 38).

FIRST USE 3-5-2007; IN COMMERCE 3-5-2007.
LAURIE MAYES, EXAMINING ATTORNEY

SN 76-700,726. DIGITAL VIDEO CREATIONS, INC., SAN DIEGO, CA. FILED 12-7-2009.

Figure 8 Fitness

THE MARK CONSISTS OF STANDARD CHARACTERS WITHOUT CLAIM TO ANY PARTICULAR FONT, STYLE, SIZE, OR COLOR.

NO CLAIM IS MADE TO THE EXCLUSIVE RIGHT TO USE "FITNESS", APART FROM THE MARK AS SHOWN.

FOR DVD CASES; PRE-RECORDED DVDS FEATURING FITNESS MATERIAL, NAMELY, EXERCISE ROUTINES, FITNESS PROGRAMS AND RELATED FITNESS INFORMATION (U.S. CLS. 21, 23, 26, 36 AND 38).

AMY HELLA, EXAMINING ATTORNEY

CLASS 9—(Continued).

SN 76-700,801. IVISIT LLC, SANTA MONICA, CA. FILED 12-11-2009.

IVISIT

THE MARK CONSISTS OF STANDARD CHARACTERS WITHOUT CLAIM TO ANY PARTICULAR FONT, STYLE, SIZE, OR COLOR.

FOR MULTI-PARTY VIDEO CHAT COMPUTER APPLICATION SOFTWARE DISTRIBUTED VIA A GLOBAL COMPUTER INFORMATION NETWORK PRIMARILY TO HOME PERSONAL COMPUTER USERS OF SAID NETWORK, NAMELY, SOFTWARE FOR USE ON A PERSONAL COMPUTER FOR REAL-TIME AUDIO, VIDEO, AND TEXT MESSAGE EXCHANGE VIA SAID PERSONAL COMPUTER OVER A GLOBAL COMPUTER INFORMATION NETWORK; COMPUTER SOFTWARE USED TO MAINTAIN AND MANAGE A COMMUNICATIONS DIRECTORY ON COMPUTER SERVERS (U.S. CLS. 21, 23, 26, 36 AND 38).

FIRST USE 8-1-1997; IN COMMERCE 8-1-1997.
ELI HELLMAN, EXAMINING ATTORNEY

SN 76-700,839. UNIVERSAL CITY STUDIOS LLLP, UNIVERSAL CITY, CA. FILED 12-14-2009.

THE LAND BEFORE TIME

THE MARK CONSISTS OF STANDARD CHARACTERS WITHOUT CLAIM TO ANY PARTICULAR FONT, STYLE, SIZE, OR COLOR.

FOR PRE-RECORDED VIDEO TAPES AND DVDS FEATURING ANIMATED MOTION PICTURES AND TELEVISION PROGRAMMING IN THE FIELD OF CHILDREN'S ENTERTAINMENT; AND DOWNLOADABLE ANIMATED MOTION PICTURES IN THE FIELD OF CHILDREN'S ENTERTAINMENT (U.S. CLS. 21, 23, 26, 36 AND 38).

FIRST USE 7-13-1994; IN COMMERCE 7-13-1994.
JUDITH HELFMAN, EXAMINING ATTORNEY

CLASS 9—(Continued).

SN 76-700,840. SHANY TECHNOLOGY, INC., SAN JOSE, CA.
FILED 12-14-2009.

TOTA

THE MARK CONSISTS OF STANDARD CHARACTERS WITHOUT CLAIM TO ANY PARTICULAR FONT, STYLE, SIZE, OR COLOR.

FOR CLOSED CIRCUIT TELEVISION SYSTEM, NAMELY, CLOSED CIRCUIT TELEVISION SETS, OPTICAL LENSES, CLOSED CIRCUIT TELEVISION CAMERAS, CLOSED CIRCUIT MONITORS, VIDEO SWITCHERS, SCANNERS AND CONTROLLERS FOR CLOSED CIRCUIT TELEVISION SYSTEM, VIDEO DISTRIBUTORS, NAMELY, DISTRIBUTION AMPLIFIERS FOR VIDEO SIGNALS, VIDEO AMPLIFIERS, DIGITAL VIDEO RECORDERS, VIDEO PROCESSORS, VIDEO RECEIVERS, VIDEO TIMERS, FIBER OPTIC TRANSMITTERS, WIRELESS MICROPHONES, BURGLAR ALARMS AND ANTI-INTRUSION ALARMS, EMERGENCY WARNING LIGHTS, INDOOR/OUTDOOR HOUSING FOR CLOSED CIRCUIT TELEVISION CAMERAS, SCANNERS AND PAN/TILT HEADS FOR CLOSED CIRCUIT TELEVISION CAMERAS; VIDEO PHONES; TELEPHONE APPARATUS, NAMELY, INTERCOMS (U.S. CLS. 21, 23, 26, 36 AND 38).

LINDA MICKLEBURGH, EXAMINING ATTORNEY

SN 77-085,144. DIGITAL LIFESTYLES GROUP, INC., WALNUT, CA. FILED 1-17-2007.

Digital Lifestyles

THE MARK CONSISTS OF STANDARD CHARACTERS WITHOUT CLAIM TO ANY PARTICULAR FONT, STYLE, SIZE, OR COLOR.

NO CLAIM IS MADE TO THE EXCLUSIVE RIGHT TO USE "DIGITAL", APART FROM THE MARK AS SHOWN.

FOR DESKTOP COMPUTER SYSTEMS INCLUDING DVD DRIVES, CD DRIVES, COMPUTER HARDWARE AND SOFTWARE; COMPUTER HARDWARE AND COMPUTER SOFTWARE PROGRAMS FOR THE INTEGRATION OF TEXT, GRAPHICS, STILL IMAGE AND MOVING PICTURES INTO AN INTERACTIVE DELIVERY FOR MULTIMEDIA APPLICATIONS; COMPUTER PERIPHERALS; COMPUTER SOFTWARE FOR MANIPULATING DIGITAL INFORMATION FOR USE IN MEDIA APPLICATIONS; COMPUTER SOFTWARE FOR ORGANIZING AND VIEWING DIGITAL IMAGES AND PHOTOGRAPHS; COMPUTER SOFTWARE FOR PROCESSING DIGITAL MUSIC FILES; COMPUTER SOFTWARE FOR PROVIDING AN ON-LINE DATABASE IN THE FIELD OF TRANSACTION PROCESSING TO UPLOAD TRANSACTIONAL DATA, PROVIDE STATISTICAL ANALYSIS, AND PRODUCE NOTIFICATIONS AND REPORTS; COMPUTER SOFTWARE FOR USE IN RELATION TO DIGITAL ANIMATION AND SPECIAL EFFECTS OF IMAGES; COMPUTER SOFTWARE FOR USE IN THE ENCRYPTION AND DECRYPTION OF DIGITAL FILES, INCLUDING VIDEO, TEXT, BINARY, STILL IMAGES, GRAPHICS AND MULTIMEDIA FILES; COMPUTER SOFTWARE FOR USE IN THE SAFEGUARDING OF DIGITAL FILES, INCLUDING VIDEO, TEXT, BINARY, STILL IMAGES, GRAPHICS AND MULTIMEDIA FILES; DIGITAL CAMERAS; DIGITAL CELLULAR PHONES; DIGITAL COLOUR COPIERS; DIGITAL COLOUR PRINTERS; DIGITAL PHONES; DI-

CLASS 9—(Continued).

GITAL PHOTO FRAMES FOR DISPLAYING DIGITAL PICTURES AND VIDEO CLIPS; DIGITAL VIDEO DISC DRIVES; DIGITAL VIDEO RECORDERS; ELECTRON MICROSCOPES; ELECTRONIC ADVERTISEMENT AND MESSAGING DISPLAY UNIT WITH MULTI-NETWORKING (TCP/IP) CAPABILITIES AND REMOTE CONNECTIVITY; ELECTRONIC COMPUTERS; ELECTRONIC LCD ADVERTISEMENT DISPLAY UNIT WITH MULTI-NETWORKING (TCP/IP) CAPABILITIES; LCD LARGE-SCREEN DISPLAYS; LCD PANELS; LCD PROJECTORS USED TO DISPLAY ADVERTISEMENTS; LIQUID CRYSTAL DISPLAY (LCD) PROJECTORS; PERSONAL DIGITAL ASSISTANT COMPUTERS; PERSONAL DIGITAL ASSISTANTS (PDA); PLAYER-OPERATED ELECTRONIC CONTROLLERS FOR ELECTRONIC VIDEO GAME MACHINES; PORTABLE DVD PLAYERS; POWER SUPPLY CONNECTORS AND ADAPTORS FOR USE WITH PORTABLE ELECTRONIC DEVICES; PROGRAMMABLE DIGITAL TELEVISION RECORDERS; TELEVISION ANTENNAS; TELEVISION DECODER; TELEVISION MONITORS; TELEVISION RECEIVERS; TELEVISION SETS; TELEVISION TRANSMITTERS; VIDEO MONITORS (U.S. CLS. 21, 23, 26, 36 AND 38).

FIRST USE 6-28-2004; IN COMMERCE 6-28-2004.

ANGELA DUONG, EXAMINING ATTORNEY

SN 77-131,311. LANTIGUA, JUAN J., BAY SHORE, NY.
FILED 3-14-2007.

SRM

THE MARK CONSISTS OF STANDARD CHARACTERS WITHOUT CLAIM TO ANY PARTICULAR FONT, STYLE, SIZE, OR COLOR.

FOR COMPUTER MOUSE (U.S. CLS. 21, 23, 26, 36 AND 38).

BRENDAN MCCAULEY, EXAMINING ATTORNEY

SN 77-142,906. PRIVERUS SOFTWARE CORPORATION,
RICHMOND HILL, CANADA, FILED 3-28-2007.

PRIVERUS

THE MARK CONSISTS OF STANDARD CHARACTERS WITHOUT CLAIM TO ANY PARTICULAR FONT, STYLE, SIZE, OR COLOR.

PRIORITY CLAIMED UNDER SEC. 44(D) ON CANADA APPLICATION NO. 1322274, FILED 10-31-2006, REG. NO. TMA752737, DATED 11-10-2009, EXPIRES 11-10-2024.

FOR COMPUTER SOFTWARE DESIGNED TO MANAGE THE SCHEDULING OF ACTIVITIES AND THE ASSIGNMENT OF RELATED PHYSICAL AND PERSONNEL RESOURCES FOR PATRONS OF RESORTS, SPAS AND COUNTRY CLUBS (U.S. CLS. 21, 23, 26, 36 AND 38).

SHAILA SETTLES, EXAMINING ATTORNEY

CLASS 9—(Continued).

SN 77-186,292. PUSHBUTTONMUSIC.COM, LLC, LEES SUMMIT, MO. FILED 5-21-2007.

PUSHBUTTONMUSIC.COM

THE MARK CONSISTS OF STANDARD CHARACTERS WITHOUT CLAIM TO ANY PARTICULAR FONT, STYLE, SIZE, OR COLOR.

FOR COMPUTER SOFTWARE FOR THE TRANSMISSION AND STREAMING OF AUDIO, VIDEO, GRAPHICS, AND TEXT OVER COMMUNICATIONS NETWORKS; COMPUTER SOFTWARE FOR DOWNLOADING, STORING, ORGANIZING, MANIPULATING, AND REVIEWING ENTIRE MUSIC AND VIDEO LIBRARIES, AUDIO, VIDEO, GRAPHICS, AND TEXT; COMPUTER SOFTWARE FOR SECURE, ENCRYPTED COMMUNICATIONS AND ELECTRONIC TRANSFER OF AUDIO, VIDEO, TEXT, AND GRAPHICS OVER COMMUNICATIONS NETWORKS; MUSIC, AUDIO, AND VIDEO SELECTION SYSTEMS COMPRISING COMPUTER HARDWARE AND SOFTWARE, NAMELY, MUSIC SERVERS, SPEAKERS, DIGITAL JUKEBOXES, MEDIA PLAYERS, AND TOUCH SCREENS/TOUCHPADS FOR DISTRIBUTING, SELECTING AND PLAYING AUDIO, MUSIC, VIDEO AND RELATED INFORMATION; MUSICAL JUKEBOXES; MUSIC SERVERS; MEDIA PLAYERS; DIGITAL JUKEBOX SYSTEMS, NAMELY, ONE OR MORE MUSICAL JUKEBOXES OR MEDIA PLAYERS CONNECTED ELECTRONICALLY TO SELECT, DOWNLOAD AND PLAY MUSIC AND VIDEO AND RELATED CONTENTS AND PARTS THEREOF (U.S. CLS. 21, 23, 26, 36 AND 38).

DAVID TOOLEY, EXAMINING ATTORNEY

SN 77-235,823. KNOWLEDGE BASED MANAGEMENT LIMITED, LONDON, ENGLAND, FILED 7-23-2007.

MINIVU

THE MARK CONSISTS OF STANDARD CHARACTERS WITHOUT CLAIM TO ANY PARTICULAR FONT, STYLE, SIZE, OR COLOR.

PRIORITY CLAIMED UNDER SEC. 44(D) ON ERPNCMNTY TM OFC APPLICATION NO. 006139026, FILED 7-13-2007, REG. NO. 006139026, DATED 7-13-2007, EXPIRES 7-13-2017.

THE WORDING "MINIVU" HAS NO MEANING IN A FOREIGN LANGUAGE.

FOR COMPUTER SOFTWARE AND PROGRAMS TO DISPLAY DATA AND INFORMATION WITHIN A WEBPAGE (U.S. CLS. 21, 23, 26, 36 AND 38).

LINDA ESTRADA, EXAMINING ATTORNEY

CLASS 9—(Continued).

SN 77-326,457. SITO A CORPORATION, SAN MATEO, CA. FILED 11-9-2007.

Bravo

THE MARK CONSISTS OF STANDARD CHARACTERS WITHOUT CLAIM TO ANY PARTICULAR FONT, STYLE, SIZE, OR COLOR.

FOR PERSONAL COMPUTERS, LAPTOPS, COMPUTER MONITORS, COMPUTER PRINTERS, KEYBOARDS AND OTHER COMPUTER PERIPHERALS (U.S. CLS. 21, 23, 26, 36 AND 38).

GISELLE AGOSTO, EXAMINING ATTORNEY

SN 77-335,398. HELIGON LIMITED, LONDON SW1P 1JA, UNITED KINGDOM, FILED 11-21-2007.

Bling! It

THE MARK CONSISTS OF THE WORDING "BLING! IT" IN STYLIZED FORM AND WITH THE EXCLAMATION POINT STYLIZED TO REPRESENT A DOLLAR SIGN. THE APPLICANT IS NOT CLAIMING COLOR AS A FEATURE OF THE MARK.

FOR COMPUTER SOFTWARE AND COMPUTER PROGRAMS, ALL FOR UPGRADING IMAGES AND PHOTOGRAPHS BY IMPROVING CONTRAST AND SHARPNESS, BY EXTRACTING IMAGES OF PRODUCTS OR INDIVIDUALS AND SUPERIMPOSING THEM ON NEW BACKGROUNDS, BY COLOURING AREAS OF THE IMAGE AND BY ADDING SHADING AND HIGHLIGHTS (U.S. CLS. 21, 23, 26, 36 AND 38).

MARTHA FROMM, EXAMINING ATTORNEY

SN 77-346,683. LG CHEM, LTD., SEOUL, REPUBLIC OF KOREA, FILED 12-7-2007.

ACTIVE SRS

THE MARK CONSISTS OF STANDARD CHARACTERS WITHOUT CLAIM TO ANY PARTICULAR FONT, STYLE, SIZE, OR COLOR.

PRIORITY CLAIMED UNDER SEC. 44(D) ON REPUBLIC OF KOREA APPLICATION NO. 2007-0061615, FILED 11-30-2007, REG. NO. 0761669, DATED 9-18-2008, EXPIRES 9-18-2018.

FOR ELECTRODES, BATTERIES, LITHIUM BATTERIES, STORAGE BATTERIES, SEPARATORS FOR USE IN BATTERIES, SEPARATORS FOR USE IN LITHIUM BATTERIES, SEPARATORS FOR USE IN STORAGE BATTERIES (U.S. CLS. 21, 23, 26, 36 AND 38).

MATTHEW MCDOWELL, EXAMINING ATTORNEY

CLASS 9—(Continued).

SN 77-366,465. MONOSCOOP, B.V., ALKMAAR, NETHERLANDS, FILED 1-8-2008.



OWNER OF ERPN CMNTY TM OFC REG. NO. 005740741, DATED 2-1-2008, EXPIRES 3-7-2017.

NO CLAIM IS MADE TO THE EXCLUSIVE RIGHT TO USE "BINGO", APART FROM THE MARK AS SHOWN.

THE MARK CONSISTS OF STYLIZED WORD "SECRET" IN THREE-DIMENSIONAL LETTERING OVER STYLIZED WORD "BINGO" IN THREE-DIMENSIONAL LETTERING OVER DRAWING OF A MINING CAR.

FOR GAMING DEVICES, NAMELY, GAMING MACHINES, SLOT MACHINES, BINGO MACHINES, WITH OR WITHOUT VIDEO OUTPUT; COMPUTER SOFTWARE AND FIRMWARE FOR GAMES OF CHANCE ON ANY COMPUTERIZED PLATFORM, INCLUDING DEDICATED GAMING CONSOLES, VIDEO BASED SLOT MACHINES, REEL BASED SLOT MACHINES, AND VIDEO LOTTERY TERMINALS (U.S. CLS. 21, 23, 26, 36 AND 38).

MAYUR VAGHANI, EXAMINING ATTORNEY

SN 77-367,174. CELLCO PARTNERSHIP, DBA D/B/A VERIZON WIRELESS, BASKING RIDGE, NJ. FILED 1-9-2008.

ALIAS

THE MARK CONSISTS OF STANDARD CHARACTERS WITHOUT CLAIM TO ANY PARTICULAR FONT, STYLE, SIZE, OR COLOR.

FOR CELLULAR TELEPHONE FEATURING VOICE, DATA AND IMAGE WIRELESS TRANSMISSION SERVICES INCLUDING VOICE, TEXT AND PICTURE MESSAGING, A VIDEO AND STILL IMAGE CAMERA, ALSO FUNCTIONAL TO SHOP AND PURCHASE MUSIC, GAMES AND VIDEO AND SOFTWARE APPLICATIONS OVER THE AIR FOR DOWNLOADING TO THE DEVICE (U.S. CLS. 21, 23, 26, 36 AND 38).

RENEE MCCRAY, EXAMINING ATTORNEY

CLASS 9—(Continued).

SN 77-376,928. ARISTOCRAT TECHNOLOGIES AUSTRALIA PTY LTD, NORTH RYDE, NSW, AUSTRALIA, FILED 1-22-2008.



PRIORITY CLAIMED UNDER SEC. 44(D) ON AUSTRALIA APPLICATION NO. 1189362, FILED 7-26-2007, REG. NO. 1189362, DATED 7-26-2007, EXPIRES 7-26-2017.

NO CLAIM IS MADE TO THE EXCLUSIVE RIGHT TO USE "GAME", APART FROM THE MARK AS SHOWN.

THE MARK CONSISTS OF A POLYGON WITH ONE OR MORE CURVED SIDES OVERLAPPING A SHADED CIRCLE; TWO LIGHTNING BOLTS EXTENDING FROM THE BOTTOM OF EITHER SIDE OF THE POLYGON AND TOUCHING UNDER THE SHADED CIRCLE, THE WORDING "FREE GAME METER" APPEARS ON THE UPPER PART OF THE DESIGN.

FOR GAMING MACHINES, NAMELY, DEVICES WHICH ACCEPT A WAGER (U.S. CLS. 21, 23, 26, 36 AND 38).

NAAKWAMA ANKRAH, EXAMINING ATTORNEY

SN 77-403,751. CHOWSONS HOLDINGS LTD, SEC.1, TAIPEI, TAIWAN, FILED 2-22-2008.

i Watching

THE MARK CONSISTS OF THE STYLIZED WORDING "i WATCHING".

FOR CAMERAS, VIDEO MONITORS, AMPLIFIERS, ELECTRONIC SWITCHERS FOR AUDIO AND VIDEO SIGNALS, MULTIPLEXERS, DIGITAL VIDEO RECORDERS, OPTICAL LENSES; FIRE SAFETY EQUIPMENT, NAMELY, ALARM BELLS, SMOKE DETECTORS, CARBON MONOXIDE DETECTORS; SMOKE DETECTORS, CARBON MONOXIDE DETECTORS, TRANSFORMERS, BATTERIES; ELECTRONIC LOCKS, NAMELY, MAGNETIC LOCKS; PAN-TILT SCANNERS, ELECTRONIC SCANNER CONTROLLERS, EMERGENCY SIGNAL TRANSMITTERS, NAMELY, EMERGENCY BUTTONS; ELECTRIC CONTACTS, NAMELY, MAGNETIC CONTACTS; GPS TRACKING SYSTEMS, ELECTRIC CONTROL PANELS, LIGHTING CONTROL PANELS, SIRENS; ALARM SYSTEMS, NAMELY, BUILDING SECURITY SYSTEMS COMPRISING SOFTWARE AND HARDWARE FOR PROVIDING PICTURE, VIDEO, ALARM STATUS, BUILDING PLANS, AND OTHER INFORMATION TO A REMOTE LOCATION (U.S. CLS. 21, 23, 26, 36 AND 38).

HELENE LIWINSKI, EXAMINING ATTORNEY

CLASS 9—(Continued).

SN 77-404,071. GURVEY, AMY R., UPPER MONTCLAIR, NJ. FILED 2-22-2008.

CLASS 9—(Continued).

SN 77-430,653. ONE LAPTOP PER CHILD ASSOCIATION, INC., CAMBRIDGE, MA. FILED 3-25-2008.

LIVE-FI

THE MARK CONSISTS OF STANDARD CHARACTERS WITHOUT CLAIM TO ANY PARTICULAR FONT, STYLE, SIZE, OR COLOR.

FOR COMPUTER SOFTWARE AND COMPUTER HARDWARE FOR PRODUCING, EDITING, AND EFFECTING AUTHENTICATED DISTRIBUTION, DELIVERY AND RETRIEVAL OF LIVE CONTENT AND LIVE CONTENT RECORDINGS OVER WIRED AND WIRELESS NETWORKS (U.S. CLS. 21, 23, 26, 36 AND 38).

DAVID MILLER, EXAMINING ATTORNEY

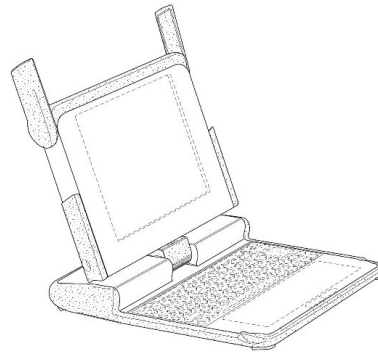

SN 77-414,787. TUFIN SOFTWARE TECHNOLOGIES LTD., RAMAT GAN, ISRAEL, FILED 3-6-2008.

SECURECHANGE

THE MARK CONSISTS OF STANDARD CHARACTERS WITHOUT CLAIM TO ANY PARTICULAR FONT, STYLE, SIZE, OR COLOR.

OWNER OF ISRAEL REG. NO. 209184, DATED 7-9-2009, EXPIRES 4-3-2018.

FOR SOFTWARE FOR USE IN THE FIELD OF INFORMATION TECHNOLOGY MANAGEMENT AND INFORMATION AND NETWORK SECURITY, NAMELY, SOFTWARE FOR AUDITING, OPTIMIZATION AND MANAGING OF SECURITY POLICIES OF COMPUTER SERVERS AND COMPUTER NETWORK HARDWARE AND SOFTWARE DEVICES, FOR MANAGING SECURITY OPERATIONS INVOLVING CONFIGURATION MANAGEMENT AND OPTIMIZATION, SECURITY RISKS MANAGEMENT, BUSINESS CONTINUITY MANAGEMENT, AND FOR AUTOMATION OF CHANGES OF SECURITY POLICIES AND CONFIGURATION OF COMPUTER NETWORK HARDWARE AND SOFTWARE DEVICES (U.S. CLS. 21, 23, 26, 36 AND 38).

KATHLEEN M. VANSTON, EXAMINING ATTORNEY

THE STIPPLING IS FOR SHADING PURPOSES ONLY (INTENDED TO INDICATE THE PORTION OF THE LAPTOP COMPUTER BODY IN A CONTRASTING BRIGHT COLOR).

THE COLOR(S) WHITE AND A CONTRASTING BRIGHT COLOR IS/ARE CLAIMED AS A FEATURE OF THE MARK.

THE MARK CONSISTS OF (1) A THREE-DIMENSIONAL CONFIGURATION OF THE BODY OF A CHILD'S LAPTOP COMPUTER IN THE OPEN POSITION, THE SHAPE OF WHICH IS SHOWN IN SOLID LINES, AND (2) WHITE AND A CONTRASTING BRIGHT COLOR. THE TWO ARMS ARE PIVOTED IN AN UPWARD POSITION. THE SCREEN, KEYS AND KEYPAD ARE SHOWN IN BROKEN LINES IN THE DRAWING AND ARE NOT PART OF THE MARK. THE BODY OF THE LAPTOP IS MADE OF SMOOTH PLASTIC COMPOSED IN TWO DRAMATICALLY CONTRASTING SECTIONS, WITH WHITE ON THE TOP AND BOTTOM, AND BRIGHT COLORS AROUND THE PERIMETER AND CENTRAL HINGE.

SEC. 2(F).

FOR COMPACT, LOW-COST, LAPTOP COMPUTER INTENDED FOR USE BY CHILDREN FOR CHARITABLE AND EDUCATIONAL PURPOSES (U.S. CLS. 21, 23, 26, 36 AND 38).

FIRST USE 11-0-2006; IN COMMERCE 11-0-2007.

LEIGH CAROLINE CASE, EXAMINING ATTORNEY

CLASS 9—(Continued).

SN 77-430,658. ONE LAPTOP PER CHILD ASSOCIATION, INC., CAMBRIDGE, MA. FILED 3-25-2008.

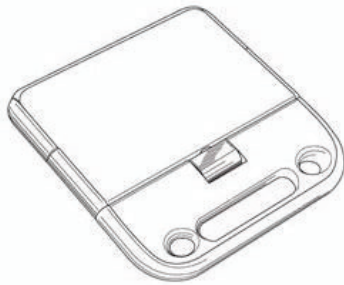

THE STIPPLING IS FOR SHADING PURPOSES ONLY (INTENDED TO INDICATE THE PORTION OF THE LAPTOP COMPUTER BODY IN A CONTRASTING BRIGHT COLOR).

THE COLOR(S) WHITE AND A CONTRASTING BRIGHT COLOR IS/ARE CLAIMED AS A FEATURE OF THE MARK.

THE MARK CONSISTS OF (1) A THREE-DIMENSIONAL CONFIGURATION OF THE BODY OF A CHILD'S LAPTOP COMPUTER IN THE CLOSED POSITION, THE SHAPE OF WHICH IS SHOWN IN SOLID LINES, AND (2) WHITE AND A CONTRASTING BRIGHT COLOR. THE BODY OF THE LAPTOP IS MADE OF SMOOTH PLASTIC COMPOSED IN TWO DRAMATICALLY CONTRASTING SECTIONS, WITH WHITE ON THE TOP AND BOTTOM, AND BRIGHT COLORS AROUND THE PERIMETER AND CENTRAL HINGE.

SEC. 2(F).

FOR COMPACT, LOW-COST, LAPTOP COMPUTER INTENDED FOR USE BY CHILDREN FOR CHARITABLE AND EDUCATIONAL PURPOSES (U.S. CLS. 21, 23, 26, 36 AND 38).

FIRST USE 11-0-2006; IN COMMERCE 11-0-2007.

LEIGH CAROLINE CASE, EXAMINING ATTORNEY

CLASS 9—(Continued).

SN 77-446,578. TOURNAMENT ONE CORP, STAMFORD, CT. FILED 4-11-2008.

CinDi Systems

THE MARK CONSISTS OF STANDARD CHARACTERS WITHOUT CLAIM TO ANY PARTICULAR FONT, STYLE, SIZE, OR COLOR.

NO CLAIM IS MADE TO THE EXCLUSIVE RIGHT TO USE "SYSTEMS", APART FROM THE MARK AS SHOWN.

FOR COMPUTER GAME SOFTWARE; COMPUTER GAME SOFTWARE LIBRARIES; COMPUTER GRAPHICS SOFTWARE; ELECTRONIC GAME SOFTWARE; ELECTRONIC GAME SOFTWARE FOR CELLULAR TELEPHONES; ELECTRONIC GAME SOFTWARE FOR LOTTERY MONITORS; HAND-HELD UNITS FOR PLAYING ELECTRONIC GAMES FOR USE WITH AN EXTERNAL DISPLAY SCREEN OR MONITOR, ELECTRONIC GAME SOFTWARE FOR HANDHELD ELECTRONIC DEVICES; ELECTRONIC GAME SOFTWARE FOR WIRELESS DEVICES; GAME SOFTWARE; GAMING SOFTWARE THAT GENERATES OR DISPLAYS WAGER OUTCOMES OF GAMING MACHINES; INTERACTIVE VIDEO GAMES OF VIRTUAL REALITY COMPRISED OF COMPUTER HARDWARE AND SOFTWARE; VIRTUAL REALITY GAME SOFTWARE; VIDEO GAME SOFTWARE; VIDEO GAME SOFTWARE, NAMELY, A VIDEO CRAPS GAME; INTERACTIVE COMPUTER KIOSKS COMPRISING COMPUTERS, COMPUTER HARDWARE, COMPUTER PERIPHERALS, AND COMPUTER OPERATING SOFTWARE, FOR USE AS GAMBLING AND GAMING MACHINES IN CASINOS, GAMING, LOTTERY, KENO; DOWNLOADABLE SOFTWARE FOR GAMES, CASINO GAMES, GAMING MACHINES, VIDEO LOTTERY TERMINALS, KENO; DOWNLOADABLE COMPUTER SOFTWARE AND FIRMWARE FOR GAMES OF CHANCE ON ANY COMPUTERIZED PLATFORM, INCLUDING DEDICATED GAMING CONSOLES, VIDEO BASED SLOT MACHINES, REEL BASED SLOT MACHINES, AND VIDEO LOTTERY TERMINALS; COMPUTER SOFTWARE FOR USE IN RELATION TO DIGITAL ANIMATION AND SPECIAL EFFECTS OF IMAGES; GAMBLING MACHINES; VIRTUAL REALITY GAME SOFTWARE FOR CASINOS, GAMING, LOTTERY, KENO (U.S. CLS. 21, 23, 26, 36 AND 38).

FIRST USE 4-11-2008; IN COMMERCE 5-15-2009.

MATTHEW MCDOWELL, EXAMINING ATTORNEY

SN 77-458,292. IMG WORLDWIDE, INC., CLEVELAND, OH. FILED 4-25-2008.

FASHION WEEK LIVE

THE MARK CONSISTS OF STANDARD CHARACTERS WITHOUT CLAIM TO ANY PARTICULAR FONT, STYLE, SIZE, OR COLOR.

OWNER OF U.S. REG. NO. 3,396,754.

NO CLAIM IS MADE TO THE EXCLUSIVE RIGHT TO USE "FASHION WEEK", APART FROM THE MARK AS SHOWN.

FOR ELECTRONIC GAME SOFTWARE FOR CELLULAR TELEPHONES AND WIRELESS DEVICES (U.S. CLS. 21, 23, 26, 36 AND 38).

FRED CARL, EXAMINING ATTORNEY

CLASS 9—(Continued).

SN 77-458,295. IMG WORLDWIDE, INC., CLEVELAND, OH. FILED 4-25-2008.

FASHIONWEEKLIVE

THE MARK CONSISTS OF STANDARD CHARACTERS WITHOUT CLAIM TO ANY PARTICULAR FONT, STYLE, SIZE, OR COLOR.

OWNER OF U.S. REG. NO. 3,396,754.
FOR ELECTRONIC GAME SOFTWARE FOR CELLULAR TELEPHONES AND WIRELESS DEVICES (U.S. CLS. 21, 23, 26, 36 AND 38).

FRED CARL, EXAMINING ATTORNEY

SN 77-493,386. INGENIX, INC., EDEN PRAIRIE, MN. FILED 6-6-2008.

SYMMETRY

THE MARK CONSISTS OF STANDARD CHARACTERS WITHOUT CLAIM TO ANY PARTICULAR FONT, STYLE, SIZE, OR COLOR.

OWNER OF U.S. REG. NO. 1,897,086.
FOR COMPUTER SOFTWARE FOR DATA PROCESSING, CLASSIFICATION, MODELING, COMPARISON AND ANALYSIS IN THE FIELD OF HEALTH CARE; COMPUTER DATABASE SOFTWARE FOR UPLOADING DATA, PROVIDING STATISTICAL ANALYSIS AND RISK ASSESSMENT, AND PRODUCING REPORTS IN THE FIELD OF HEALTH CARE (U.S. CLS. 21, 23, 26, 36 AND 38).

FIRST USE 8-0-1994; IN COMMERCE 8-0-1994.
CORY BOONE, EXAMINING ATTORNEY

CLASS 9—(Continued).

SN 77-498,470. SCHMIDT & BENDER GMBH & CO. KG, BIEBERTAL, FED REP GERMANY, FILED 6-13-2008.

BENDER  OPTIK

PRIORITY CLAIMED UNDER SEC. 44(D) ON FED REP GERMANY APPLICATION NO. 30781752.0, FILED 12-14-2007.

OWNER OF FED REP GERMANY REG. NO. 30781752.0, DATED 2-15-2008, EXPIRES 2-15-2018.

OWNER OF U.S. REG. NO. 3,490,471.

NO CLAIM IS MADE TO THE EXCLUSIVE RIGHT TO USE "OPTIK", APART FROM THE MARK AS SHOWN.

THE MARK CONSISTS OF THE WORDS "BENDER" AND "OPTIK" ARE CAPITALIZED. IN BETWEEN THE TWO WORDS IS A CIRCLE WITH A DOT IN THE CENTER OF CIRCLE.

FOR OPTICAL APPARATUS AND INSTRUMENTS, NAMELY, OBSERVATION INSTRUMENTS IN THE NATURE OF TELESCOPIC SIGHTS, SPY GLASSES AND SHORTSIGHT GLASSES, INSTRUMENTS CONTAINING EYEPIECES, NAMELY, OPTICAL GLASSES, PROTECTIVE GLASSES, SPORT GLASSES, FIELD GLASSES, BINOCULARS, TELESCOPES, SPECTROSCOPES, TELESCOPIC SIGHTS FOR FIREARMS, GUN SCOPES, GOLF SCOPES, RIFLE SCOPES, SUN GLASSES, CAMERA OBJECTIVES; OPTICAL LENSES FOR TELESCOPIC SIGHTS FOR FIREARMS, FIELD GLASSES AND SPY GLASSES, PRISMS; RETICULES SOLD AS AN INTEGRAL COMPONENT OF TELESCOPIC SIGHTS FOR FIREARM, OPTICAL MIRRORS, OPTICAL FILTERS; RETICLES AND ILLUMINATED RETICLES SOLD AS AN INTEGRAL COMPONENT OF SCOPES FOR FIREARM; OPTICAL FIBERS, FIBER OPTIC CABLES (U.S. CLS. 21, 23, 26, 36 AND 38).

JOHN DWYER, EXAMINING ATTORNEY

SN 77-534,367. MEIJER, INC., GRAND RAPIDS, MI. FILED 7-30-2008.

GFM

THE MARK CONSISTS OF STANDARD CHARACTERS WITHOUT CLAIM TO ANY PARTICULAR FONT, STYLE, SIZE, OR COLOR.

OWNER OF U.S. REG. NO. 3,329,577.

FOR 35MM CAMERAS; BAGS FOR CAMERAS AND PHOTOGRAPHIC EQUIPMENT; BLANK DIGITAL STORAGE MEDIA; CAMERA CASES; CAMERA TRIPODS; CAMERAS; CD PLAYERS; COMPUTER KEYBOARDS; COMPUTER MICE; COMPUTER PERIPHERAL DEVICES; COMPUTER PERIPHERAL EQUIPMENT; COMPUTER PERIPHERALS; DIGITAL CAMERA ACCESSORY IN THE NATURE OF A DIGITAL PHOTO VIEWER; DIGITAL CAMERAS; DISPOSABLE CAMERAS; FILM CAMERAS; FILM PORTRAIT CAMERAS; HEADPHONES; HEADSETS FOR USE WITH COMPUTERS; LIGHTING DEVICES FOR TAKING PICTURES; MICROPHONES; MOUSEPADS; PORTABLE PHOTOGRAPHY EQUIPMENT, NAMELY, REFLECTORS, TRIPODS, LIGHT STANDS AND SUPPORTS AND BAGS SPECIALLY ADAPTED FOR THESE GOODS; TELEPHONE APPARATUS; TELEPHONE CONNECTORS; TELEPHONE EQUIPMENT, NAMELY, CALLER IDENTIFICATION BOXES; TELEPHONE HEADSETS; TELEPHONE SETS; TELEPHONES; TRIPODS; VIDEO CAMERAS; WEBCAMS; WIRELESS TELEPHONES (U.S. CLS. 21, 23, 26, 36 AND 38).

FIRST USE 5-26-2007; IN COMMERCE 5-26-2007.
EUGENIA MARTIN, EXAMINING ATTORNEY

CLASS 9—(Continued).

SN 77-538,762. THREE AMIGOS LLC, EL CAJON, CA. FILED 8-4-2008.

Focused Image Technology

THE MARK CONSISTS OF STANDARD CHARACTERS WITHOUT CLAIM TO ANY PARTICULAR FONT, STYLE, SIZE, OR COLOR.

NO CLAIM IS MADE TO THE EXCLUSIVE RIGHT TO USE "IMAGE TECHNOLOGY", APART FROM THE MARK AS SHOWN.

FOR AUDIO EQUIPMENT FOR VEHICLES, NAMELY, STEREOS, SPEAKERS, AMPLIFIERS, EQUALIZERS, CROSSOVERS AND SPEAKER HOUSINGS; AUDIO SPEAKER ENCLOSURES; AUDIO SPEAKERS; CABINETS FOR LOUDSPEAKERS; CONSUMER ELECTRONIC PRODUCTS, NAMELY, AUDIO AMPLIFIERS, AUDIO SPEAKERS, AUDIO RECEIVERS, ELECTRICAL AUDIO AND SPEAKER CABLES AND CONNECTORS, HOME THEATER SYSTEMS, AUDIO DECODERS, VIDEO DECODERS, SPEAKERS, POWER CONVERSION DEVICES, POWER CONVERTERS, AND POWER INVERTERS; LOUD SPEAKER SYSTEMS; LOUD SPEAKERS; LOUDSPEAKER CABINETS; LOUDSPEAKER SYSTEMS; LOUDSPEAKERS; LOUDSPEAKERS WITH BUILT IN AMPLIFIERS; LOUDSPEAKERS, HEADPHONES, MICROPHONES AND CD PLAYERS; PUBLIC ADDRESS (PA) AND SOUND SYSTEM ACCESSORIES, NAMELY, MICROPHONE STANDS, SPEAKER STANDS, MICROPHONE CABLES, SPEAKER CABLES, SPEAKER BOXES AND SOUND MIXERS; RACKS FOR LOUDSPEAKERS; SPEAKER ENCLOSURES; WAVE REFLECTORS FOR ACOUSTIC SPEAKERS, LIGHTING APPARATUS, AND AIR FLOW DEVICES (U.S. CLS. 21, 23, 26, 36 AND 38).
EDWARD NELSON, EXAMINING ATTORNEY

SN 77-557,979. IPROP HOLDINGS, LLC, JACKSONVILLE, FL. FILED 8-28-2008.

ACCESSO

THE MARK CONSISTS OF STANDARD CHARACTERS WITHOUT CLAIM TO ANY PARTICULAR FONT, STYLE, SIZE, OR COLOR.

FOR COMPUTER SOFTWARE FOR FACILITATING THE SALE, CREATION, VALIDATION, RECORDING AND REPORTING OF ADMISSION TO ENTERTAINMENT VENUES, ATTRACTIONS, SPORTING VENUES, FAIRS, FESTIVALS, MUSEUMS, THEATRICAL VENUES, CULTURAL EVENTS AND OTHER LOCATIONS; COMPUTER SOFTWARE FOR FACILITATING THE SALE OF TICKETS, MERCHANDISE, RESERVATIONS; COMPUTER SOFTWARE FOR USER AUTHENTICATION OF ELECTRONIC CREDIT AND DEBIT CARD AND ELECTRONIC CHECK TRANSACTIONS VIA A GLOBAL COMPUTER NETWORK (U.S. CLS. 21, 23, 26, 36 AND 38).

GISELLE AGOSTO, EXAMINING ATTORNEY

CLASS 9—(Continued).

SN 77-558,965. CALMAR OPTCOM INC., SUNNYVALE, CA. FILED 8-29-2008.

CALMAR LASER

THE MARK CONSISTS OF STANDARD CHARACTERS WITHOUT CLAIM TO ANY PARTICULAR FONT, STYLE, SIZE, OR COLOR.

NO CLAIM IS MADE TO THE EXCLUSIVE RIGHT TO USE "LASER", APART FROM THE MARK AS SHOWN.

FOR OPTICAL AND LASER INSTRUMENTS, DEVICES, AND ACCESSORIES FOR INDUSTRIAL USE, FOR MEASURING PURPOSES, FOR MEASURING SYSTEMS, FOR WELDING DEVICES, ELECTRONIC AND OPTICAL COMMUNICATIONS INSTRUMENTS AND COMPONENTS, NAMELY, OPTICAL TRANSMITTERS, OPTICAL RECEIVERS, AND COMMUNICATION LINK TESTERS FOR TESTING COMMUNICATION LINKS, RF TUNING DEVICES, NAMELY RESONATORS, NOT FOR MEDICAL USE, NAMELY, FOR USE WITH FIBER OPTIC LASER SOURCES, ULTRA-SHORT PULSE LASERS, FIBER OPTIC LASER AMPLIFIERS, ELECTRICAL PICOSECOND PULSE GENERATORS, CHIRPED LASER PULSE AMPLIFIERS FOR HIGH ENERGY OUTPUT; ACCESSORIES AND SUBSYSTEMS FOR THE ABOVE PRODUCTS, NAMELY, LASERS FOR INDUSTRIAL USE, LASER WELDING DEVICES, LASER MEASURING SYSTEMS; LASER DIODES, LASERS FOR MEASURING PURPOSES, LASERS NOT FOR MEDICAL USE; PRODUCTS AND INSTRUMENTS FOR MULTIPLE PURPOSES INCLUDING SCIENTIFIC MEASUREMENT, IMAGING, GENERATION OF TERAHERTZ RADIATION, AND ENVIRONMENTAL SENSING, NAMELY, RADIATION-MEASURING INSTRUMENTS; SCIENTIFIC INSTRUMENTS, NAMELY, ELECTRONIC ANALYZERS FOR MEASURING, TESTING AND DETECTING CONTAMINANTS AND ENVIRONMENTAL POLLUTANTS; STAND-OFF EXPLOSIVES AND CHEMICAL DETECTION SYSTEM COMPRISING STROBE AND PROBE LASERS, OPTICAL DETECTORS AND DIGITAL SIGNAL PROCESS UNITS; ELECTRIC, ELECTRONIC, OR ELECTROCHEMICAL OXYGEN MONITORS AND SENSORS FOR ENVIRONMENTAL USE; MEDICAL IMAGING APPARATUS FOR SMALL ANIMALS, IN A RESEARCH LABORATORY ENVIRONMENT; ELECTRONIC MAGNETOSTRICTIVE EQUIPMENT, NAMELY, A WAVE GENERATOR, WAVE SENSOR AND WAVE ANALYZER (U.S. CLS. 21, 23, 26, 36 AND 38).

BARBARA RUTLAND, EXAMINING ATTORNEY

CLASS 9—(Continued).

SN 77-563,212. KATHREIN-WERKE KG, 83022 ROSENHEIM, FED REP GERMANY, FILED 9-5-2008.

SmartPlex

THE MARK CONSISTS OF STANDARD CHARACTERS WITHOUT CLAIM TO ANY PARTICULAR FONT, STYLE, SIZE, OR COLOR.

PRIORITY CLAIMED UNDER SEC. 44(D) ON FED REP GERMANY APPLICATION NO. 302008053318, FILED 8-14-2008, REG. NO. 302008053318, DATED 10-14-2008, EXPIRES 8-31-2018.

FOR ELECTRICAL APPARATUS, INSTRUMENTS AND DEVICES, NAMELY, ELECTRONIC COMBINERS FOR RE APPLICATIONS FOR USE IN MOBILE COMMUNICATION SYSTEMS; COMMUNICATION DEVICES FOR THE TRANSMISSION, BROADCASTING, RECEPTION AND PROCESSING OF AUDIO AND VIDEO SIGNALS AND DATA, NAMELY, CONVERTERS, PROTOCOL CONVERTERS, ELECTRONIC COMBINERS FOR CONNECTING ANTENNAS AND RECEIVERS AND/OR TRANSMITTERS, COMBINERS FOR MIXING SIGNALS WITH OR WITHOUT ELECTRONICS AND FILTERS AND ALARM CONTROL DEVICES FOR MASTHEAD ELECTRONICS, NAMELY, ELECTRONIC APPARATUS FOR MONITORING ALARM SYSTEMS IN MAST HEAD AMPLIFIERS, ELECTRIC CONTROL PANELS FOR CONTROLLING ALARMS SYSTEMS IN MAST HEAD LIGHTS; APPARATUS FOR THE TRANSMISSION OF COMMUNICATIONS, ANTENNAS FOR WIRELESS COMMUNICATIONS APPARATUS; ELECTRONIC DEVICES FOR USE IN COMMUNICATION TECHNOLOGY INCLUDING WIDE BAND COMMUNICATION TECHNOLOGY, AND IN TRANSMISSION AND RECEPTION TECHNOLOGY, NAMELY, ELECTRIC CONTROL PANELS FOR MOBILE COMMUNICATION SYSTEMS, ELECTRO-MECHANICAL CONTROLS FOR USE WITH MOBILE COMMUNICATION SYSTEMS AND LOCAL OR REMOTE OPERATION AND MAINTENANCE DEVICES FOR MASTHEAD ELECTRONICS FOR MOBILE COMMUNICATION SYSTEMS, NAMELY, REMOTE CONTROLS; ELECTRONIC DEVICES IN THE FIELD OF MOBILE RADIO AND FOR MOBILE RADIO STATIONS, NAMELY, RADIO TRANSMITTERS AND BASE RECEIVER STATIONS AND ELECTRIC CONTROL PANELS FOR ELECTRONICS INCLUDING CONTROL EQUIPMENTS FOR MASTHEAD ELECTRONICS; ANTENNAS; ANTENNA SYSTEMS FOR MOBILE RADIO AND MOBILE RADIO STATIONS COMPRISED OF ANTENNAS AND ELECTRONIC COMBINERS FOR CONNECTING ANTENNAS AND RECEIVERS, RADIO TRANSMITTERS AND CONTROL EQUIPMENT FOR CONTROLLING THE ANTENNAS, TRANSCIEVERS AND RECEIVERS AND FOR MASTHEAD ELECTRONIC; ACTIVE ANTENNAS; ANTENNAS WITH INTEGRATED COMPONENTS, NAMELY, COMBINERS FOR COMBINING RADIO FREQUENCY SIGNALS FOR CONNECTING SIGNALS FROM OR TO MULTIPLE SOURCES AND FOR CONNECTING SIGNALS FROM OR TO BASE TRANSCIEVER STATIONS, TRANSCIEVERS, AMPLIFIERS, CONTROL ELECTRONICS FOR REMOTE ELECTRICAL TILT AND ALARM CONTROL, ELECTRONIC COMBINERS FOR CONNECTING ANTENNAS AND RECEIVERS; CONVERTERS, NAMELY, ELECTRICAL CONVERTERS AND ELECTRICAL TRANSDUCERS; BIAS TEES AND BIAS TEES WITH PILOT FREQUENCIES; HIGH FREQUENCY SWITCHES; MULTIPLEXERS INCLUDING DIPLEXER, DUPLEXERS AND TRIPLEXERS; FILTERS FOR RADIO INTERFERENCE SUPPRESSION INCLUDING BAND PASS FILTERS; CONTROLLING EQUIPMENT FOR SIGNAL TRANSMISSION FOR USE WITH RADIO MOBILE SYSTEMS, NAMELY, MONITOR SIGNAL AMPLIFIERS, MONITOR MODULES AND ELECTRONIC MONITORS FOR MONITORING REMOTE

CLASS 9—(Continued).

ELECTRICAL TILT AND MASTHEAD ELECTRONICS; ELECTRONIC BYPASS CIRCUITS; CONVERTERS AND ELECTRICAL TRANSDUCERS INCLUDING PROTOCOL, VOLTAGE, AMPERAGE, POWER AND FREQUENCY CONVERTERS AND TRANSDUCERS; DEVICES FOR WIRELESS RADIO TRANSMISSION, NAMELY, PHASE SHIFT DRIVES FOR SETTING A DIFFERENT DOWNTILT ANGLE IN MOBILE RADIO SYSTEM AND REMOTELY OPERATED PHASE SHIFT DRIVES; MODULATORS AND DEMODULATORS; STRUCTURAL PARTS FOR ALL OF THE FOREGOING GOODS (U.S. CLS. 21, 23, 26, 36 AND 38).

SAIMA MAKHDOOM, EXAMINING ATTORNEY

SN 77-575,070. HAZARDOUS SOFTWARE INC., RALEIGH, NC. FILED 9-21-2008.

Hazardous Software

THE MARK CONSISTS OF STANDARD CHARACTERS WITHOUT CLAIM TO ANY PARTICULAR FONT, STYLE, SIZE, OR COLOR.

NO CLAIM IS MADE TO THE EXCLUSIVE RIGHT TO USE "SOFTWARE", APART FROM THE MARK AS SHOWN.

FOR (BASED ON USE IN COMMERCE) COMPUTER SOFTWARE USED IN THE FIELD OF EDUCATION (EDUCATIONAL CHILD CARE, PRIMARY AND SECONDARY SCHOOLS, UNDERGRADUATE AND GRADUATE PROGRAMS, HOMESCHOOLING, PROFESSIONAL DEVELOPMENT) FOR MANAGING AND INTEGRATING TEACHER TRAINING, CURRICULUM MANAGEMENT, WAREHOUSE INVENTORY, SHIPPING, RECEIVING, PURCHASING, AND DEPLOYMENT AND DELIVERY OF SHARED EDUCATIONAL GOODS (EQUIPMENT AND SUPPLIES FOR SCIENCE AND ART EDUCATION, OFFICE SUPPLIES, TEACHER GUIDES, TEST SUPPLIES, BOOKS, MEDIA, GYM EQUIPMENT, EDUCATION TECHNOLOGY INCLUDING COMPUTERS AND SOFTWARE) AMONG TEACHERS AND SCHOOLS. (BASED ON INTENT TO USE) COMPUTER GAME SOFTWARE AND INTERACTIVE VIDEO GAME PROGRAMS EXCLUDING DICE GAME PROGRAMS AND DICE SIMULATIONS (U.S. CLS. 21, 23, 26, 36 AND 38).

FIRST USE 9-17-2007; IN COMMERCE 9-17-2007.

PAUL E. FAHRENKOPF, EXAMINING ATTORNEY

CLASS 9—(Continued).

SN 77-575,074. HAZARDOUS SOFTWARE INC., RALEIGH, NC. FILED 9-21-2008.



**HAZARDOUS
SOFTWARE**

NO CLAIM IS MADE TO THE EXCLUSIVE RIGHT TO USE "SOFTWARE", APART FROM THE MARK AS SHOWN. THE COLOR(S) BLACK, GOLD, AND WHITE IS/ARE CLAIMED AS A FEATURE OF THE MARK.

THE MARK CONSISTS OF A BLACK EXPLODING BOX ON A GOLD BACKGROUND. BLACK RAYS EXTEND FROM THE EXPLODING BOX. A BLACK RECTANGLE OUTLINES THE GOLD BACKGROUND. "HAZARDOUS SOFTWARE" IS IN BLACK LETTERING IS TO THE RIGHT OF THE RECTANGLE ON A WHITE BACKGROUND.

FOR (BASED ON USE IN COMMERCE) COMPUTER SOFTWARE USED IN THE FIELD OF EDUCATION (EDUCATIONAL CHILD CARE, PRIMARY AND SECONDARY SCHOOLS, UNDERGRADUATE AND GRADUATE PROGRAMS, HOMESCHOOLING, PROFESSIONAL DEVELOPMENT) FOR MANAGING AND INTEGRATING TEACHER TRAINING, CURRICULUM MANAGEMENT, WAREHOUSE INVENTORY, SHIPPING, RECEIVING, PURCHASING, AND DEPLOYMENT AND DELIVERY OF SHARED EDUCATIONAL GOODS (EQUIPMENT AND SUPPLIES FOR SCIENCE AND ART EDUCATION, OFFICE SUPPLIES, TEACHER GUIDES, TEST SUPPLIES, BOOKS, MEDIA, GYM EQUIPMENT, EDUCATION TECHNOLOGY INCLUDING COMPUTERS AND SOFTWARE) AMONG TEACHERS AND SCHOOLS. (BASED ON INTENT TO USE) COMPUTER GAME SOFTWARE AND INTERACTIVE VIDEO GAME PROGRAMS EXCLUDING DICE GAMES AND DICE SIMULATIONS (U.S. CLS. 21, 23, 26, 36 AND 38).

FIRST USE 9-20-2008; IN COMMERCE 9-20-2008.
PAUL E. FAHRENKOPF, EXAMINING ATTORNEY

SN 77-580,182. 6440436 CANADA INCORPORATED, DBA GEMME AUDIO, MONTREAL, CANADA, FILED 9-26-2008.



GEMME AUDIO

PRIORITY CLAIMED UNDER SEC. 44(D) ON CANADA APPLICATION NO. 1401133, FILED 6-26-2008, REG. NO. TMA754768, DATED 12-8-2009, EXPIRES 12-8-2024.

NO CLAIM IS MADE TO THE EXCLUSIVE RIGHT TO USE "AUDIO", APART FROM THE MARK AS SHOWN.

THE MARK CONSISTS OF THE WORDING "GEMME AUDIO" BELOW A SPIRAL REPRESENTING THE LETTER "G".

THE ENGLISH TRANSLATION OF "GEMME" IN THE MARK IS "GEM".

FOR AUDIO SPEAKERS (U.S. CLS. 21, 23, 26, 36 AND 38).

H. M. FISHER, EXAMINING ATTORNEY

CLASS 9—(Continued).

SN 77-592,910. FOR WORLD PEACE PTE LTD, SINGAPORE, SINGAPORE, FILED 10-15-2008.

ONENESS TEMPLE

THE MARK CONSISTS OF STANDARD CHARACTERS WITHOUT CLAIM TO ANY PARTICULAR FONT, STYLE, SIZE, OR COLOR.

OWNER OF SINGAPORE REG. NO. TO805925D, DATED 5-7-2008, EXPIRES 5-7-2018.

OWNER OF U.S. REG. NOS. 3,350,992, 3,387,763 AND 3,553,505.

NO CLAIM IS MADE TO THE EXCLUSIVE RIGHT TO USE "TEMPLE", APART FROM THE MARK AS SHOWN.

FOR COMPUTER SOFTWARE FOR THE DISPLAY, ORGANIZATION, TRANSMISSION, RECEPTION AND SEARCHING OF INFORMATION IN THE FIELD OF SELF- AND PERSONAL IMPROVEMENT AND EMPOWERMENT, RELIGION, AND SPIRITUALITY; COMPUTER HARDWARE; DIGITAL MEDIA, NAMELY, CD ROMS, VCDS, DVDS, CINEMATOGRAPHIC FILMS, VIDEOTAPES AND VIDEO DISKS RECORDED WITH RELIGIOUS AND SPIRITUAL MUSIC; VISUAL RECORDINGS AND AUDIO VISUAL RECORDINGS FEATURING RELIGIOUS AND SPIRITUAL MUSIC; COMPUTER PROGRAMS FOR THE DISPLAY, ORGANIZATION, TRANSMISSION, RECEPTION AND SEARCHING OF INFORMATION IN THE FIELD OF SELF- AND PERSONAL IMPROVEMENT AND EMPOWERMENT, RELIGION, AND SPIRITUALITY; DISKS AND TAPES, NAMELY, VIDEO DISKS AND TAPES FEATURING RELIGIOUS AND SPIRITUAL MUSIC AND ISSUES AND SUBJECT MATTER RELATING TO SELF IMPROVEMENT; DOWNLOADABLE ELECTRONIC PUBLICATIONS IN THE NATURE OF BOOKS, MAGAZINES, NEWSLETTERS, BROCHURES AND CATALOGS IN THE FIELD OF SELF- AND PERSONAL IMPROVEMENT AND EMPOWERMENT, RELIGION, AND SPIRITUALITY; ENCODED MAGNETIC CARDS; COMPACT DISCS FEATURING RELIGIOUS AND SPIRITUAL MUSIC; AUDIO AND VIDEO DISCS FEATURING RELIGIOUS AND SPIRITUAL MUSIC AND ISSUES AND SUBJECT MATTER RELATING TO SELF- AND PERSONAL IMPROVEMENT AND EMPOWERMENT, RELIGION, AND SPIRITUALITY; FLOPPY DISCS FEATURING RELIGIOUS AND SPIRITUAL MUSIC AND ISSUES AND SUBJECT MATTER RELATING TO SELF- AND PERSONAL IMPROVEMENT AND EMPOWERMENT, RELIGION, AND SPIRITUALITY; VIDEO TAPES AND CASSETTES FEATURING RELIGIOUS AND SPIRITUAL MUSIC AND ISSUES AND SUBJECT MATTER RELATING TO SELF- AND PERSONAL IMPROVEMENT AND EMPOWERMENT, RELIGION, AND SPIRITUALITY (U.S. CLS. 21, 23, 26, 36 AND 38).

MEGHAN REINHART, EXAMINING ATTORNEY

CLASS 9—(Continued).

SN 77-595,637. EASYLOBBY, INC., FORMERLY CAVALIER SOFTWARE, INC., NEEDHAM, MA. FILED 10-18-2008.

EASYLOBBY

THE MARK CONSISTS OF STANDARD CHARACTERS WITHOUT CLAIM TO ANY PARTICULAR FONT, STYLE, SIZE, OR COLOR.

FOR ELECTRONIC ACCESS CONTROL SYSTEM COMPRISING COMPUTER SOFTWARE AND MAGNETICALLY ENCODED IDENTIFICATION BADGES FOR TRACKING VISITORS AND EVENT MANAGEMENT (U.S. CLS. 21, 23, 26, 36 AND 38).

FIRST USE 6-1-1998; IN COMMERCE 6-1-1998.

HEATHER THOMPSON, EXAMINING ATTORNEY

CLASS 9—(Continued).

SN 77-622,727. NT-MDT SERVICE & LOGISTICS LTD., CASTLETROY, LIMERICK, IRELAND, FILED 11-26-2008.

EXPERTFBA

THE MARK CONSISTS OF STANDARD CHARACTERS WITHOUT CLAIM TO ANY PARTICULAR FONT, STYLE, SIZE, OR COLOR.

FOR AUTOMATIC OPTICAL DEVICE FOR SCANNING PROBE MICROSCOPES, NAMELY, A DEVICE FOR THE AUTOMATIC OPTICAL ALIGNMENT OF MICROSCOPE LASER BEAMS, PROBES, AND PHOTO- DIODES (U.S. CLS. 21, 23, 26, 36 AND 38).

MICHAEL ENGEL, EXAMINING ATTORNEY

SN 77-603,775. SAMSUNG ELECTRONICS CO., LTD., GYEONGGI-DO, REPUBLIC OF KOREA, FILED 10-30-2008.

RVDS

THE MARK CONSISTS OF STANDARD CHARACTERS WITHOUT CLAIM TO ANY PARTICULAR FONT, STYLE, SIZE, OR COLOR.

PRIORITY CLAIMED UNDER SEC. 44(D) ON REPUBLIC OF KOREA APPLICATION NO. 40-2008-0051, FILED 10-29-2008, REG. NO. 0812395, DATED 1-25-2010, EXPIRES 1-25-2020.

FOR MOBILE TELEPHONES; SMART PHONES; ELECTRONIC GAME SOFTWARE FOR MOBILE PHONE; DOWNLOADABLE RING TONES AND MUSIC VIA A GLOBAL COMPUTER NETWORK AND WIRELESS DEVICES; HEADSETS FOR TELEPHONES; HEADSETS FOR USE WITH COMPUTERS; ELECTRIC BATTERY CHARGERS; ELECTRIC RECHARGEABLE BATTERIES; COMPUTERS; PRINTERS FOR COMPUTERS; MONITORS FOR COMPUTERS; PERSONAL DIGITAL ASSISTANTS (PDA); SEMICONDUCTORS; TELEVISION SETS; CAMCORDERS; DIGITAL CAMERAS; DIGITAL SET- TOP BOXES; OPTICAL CABLES; TELEPHONES; DVD PLAYERS; MP3 PLAYERS (U.S. CLS. 21, 23, 26, 36 AND 38).

REGINA DRUMMOND, EXAMINING ATTORNEY

SN 77-622,851. AMERICAN MILLENNIUM CORP. INC., GOLDEN, CO. FILED 11-26-2008.

SatAlarm Monitoring Unit

THE MARK CONSISTS OF STANDARD CHARACTERS WITHOUT CLAIM TO ANY PARTICULAR FONT, STYLE, SIZE, OR COLOR.

NO CLAIM IS MADE TO THE EXCLUSIVE RIGHT TO USE "MONITORING UNIT", APART FROM THE MARK AS SHOWN.

FOR WIRELESS TRACKING AND MONITORING SYSTEM COMPRISED OF WIRED AND WIRELESS SENSORS FOR MONITORING OIL AND GAS ASSETS, NAMELY, TANKS, COMPRESSORS, WELL HEADS, GAS FLOW GENERATORS AND HEAD SWITCHES, AND PARTS THEREOF, AND TRANSCEIVERS, GLOBAL POSITIONING UNITS, SOFTWARE PROTOCOL APPLICATIONS FOR USE WITH SENSORS, TRANSCEIVERS AND GLOBAL POSITIONING UNITS, AND SATELLITE COMMUNICATION DEVICES, NAMELY, TRANSMITTERS, RECEIVERS AND ANTENNAS (U.S. CLS. 21, 23, 26, 36 AND 38).

FIRST USE 5-0-2005; IN COMMERCE 5-0-2005.

AMY KERTGATE, EXAMINING ATTORNEY

CLASS 9—(Continued).

SN 77-630,521. SCM MICROSYSTEMS GMBH, ISMANING, FED REP GERMANY, FILED 12-10-2008.

CHIPDRIVE MYKEY

THE MARK CONSISTS OF STANDARD CHARACTERS WITHOUT CLAIM TO ANY PARTICULAR FONT, STYLE, SIZE, OR COLOR.

PRIORITY CLAIMED UNDER SEC. 44(D) ON ERPN CMNTY TM OFC APPLICATION NO. 007316797, FILED 10-15-2008, REG. NO. 007316797, DATED 5-14-2009, EXPIRES 10-15-2018.

NO CLAIM IS MADE TO THE EXCLUSIVE RIGHT TO USE "CHIP DRIVE", APART FROM THE MARK AS SHOWN.

FOR COMPUTER SOFTWARE FOR USE IN DATA PROCESSING; DATA PROCESSING DEVICES, NAMELY, PERIPHERAL EQUIPMENT FOR COMPUTERS; CODE READERS IN THE NATURE OF MAGNETIC CODED CARD READERS; AND ELECTRONIC CODING UNITS FOR DATA PROCESSING; TIME RECORDING APPARATUS; ACCESS CONTROL AND ALARM MONITORING SYSTEMS; MONEY CARDS WITH ELECTRONIC OR SOLID-STATE MEMORY IN THE NATURE OF MAGNETICALLY ENCODED DEBIT AND CREDIT CARDS, MAGNETICALLY CODED CARDS, AND MAGNETICALLY ENCODED VALUE CARDS WITH ELECTRONIC OR SOLID STATE MEMORY; BLANK SMART CARDS; CARD READING EQUIPMENT; CHIP CARD READERS; COMPUTER CARD ADAPTER; ELECTRONIC CARD READERS; USB HARDWARE AND ENCODED SMART CARDS CONTAINING PROGRAMMING USED TO SECURED SIGN-IN AND SIGN-OFF TO DATA PROCESSING APPLICATIONS, STORING AND MANAGING OF PASSWORDS, ENCRYPTION AND DECRYPTION OF DATA, AND RECORDING AND EVALUATION OF WORKING TIME; ENCODED ELECTRONIC CHIP CARDS FOR IDENTIFYING PARTICULAR USERS OF COMPUTERS AND MOBILE PHONES; FLASH CARD READERS; FLASH MEMORY CARDS; MICROCHIP CARDS; PCMCIA CARDS; SMART CARD READERS; SOFTWARE FOR THE OPERATIONAL MANAGEMENT OF PORTABLE MAGNETIC AND ELECTRONIC CARDS; SOFTWARE FOR THE ENCRYPTION AND DECRYPTION OF DATA; SOFTWARE FOR TIME RECORDING AND EVALUATION (U.S. CLS. 21, 23, 26, 36 AND 38).

ALICE BENMAMAN, EXAMINING ATTORNEY

SN 77-634,697. OCEANIT LABORATORIES, INC., HONOLULU, HI. FILED 12-17-2008.

iFu

THE MARK CONSISTS OF STANDARD CHARACTERS WITHOUT CLAIM TO ANY PARTICULAR FONT, STYLE, SIZE, OR COLOR.

FOR DOWNLOADABLE COMPUTER APPLICATION SOFTWARE FOR MOBILE TELEPHONES AND PORTABLE MEDIA PLAYERS (U.S. CLS. 21, 23, 26, 36 AND 38).

TRACY CROSS, EXAMINING ATTORNEY

CLASS 9—(Continued).

SN 77-635,679. ELECTRIC THEATRE CONTROLS, INC., MIDDLETON, WI. FILED 12-18-2008.

VISION

THE MARK CONSISTS OF STANDARD CHARACTERS WITHOUT CLAIM TO ANY PARTICULAR FONT, STYLE, SIZE, OR COLOR.

FOR ELECTRIC LIGHTING CONTROL CONSOLES (U.S. CLS. 21, 23, 26, 36 AND 38).

SUZANNE BLANE, EXAMINING ATTORNEY

SN 77-638,926. SHARETHIS, INC., CINCINNATI, OH. FILED 12-23-2008.

ONE CLICK SHARING

THE MARK CONSISTS OF STANDARD CHARACTERS WITHOUT CLAIM TO ANY PARTICULAR FONT, STYLE, SIZE, OR COLOR.

NO CLAIM IS MADE TO THE EXCLUSIVE RIGHT TO USE "SHARING", APART FROM THE MARK AS SHOWN.

FOR COMPUTER SOFTWARE, NAMELY, A SOFTWARE PLUG-IN FOR INTERNET BROWSERS AND INTERNET WEBSITES THAT PERMIT USERS TO DOWNLOAD AND EXCHANGE MULTIMEDIA FILES, ARTWORK, TEXT, AUDIO, VIDEO, AND INTERNET WEB URLS (U.S. CLS. 21, 23, 26, 36 AND 38).

COLLEEN DOMBROW, EXAMINING ATTORNEY

SN 77-638,979. SHARETHIS, INC., CINCINNATI, OH. FILED 12-23-2008.

SHARING MADE SIMPLE

THE MARK CONSISTS OF STANDARD CHARACTERS WITHOUT CLAIM TO ANY PARTICULAR FONT, STYLE, SIZE, OR COLOR.

NO CLAIM IS MADE TO THE EXCLUSIVE RIGHT TO USE "SHARING", APART FROM THE MARK AS SHOWN.

FOR COMPUTER SOFTWARE, NAMELY, A SOFTWARE PLUG-IN FOR INTERNET BROWSERS AND INTERNET WEBSITES THAT PERMIT USERS TO DOWNLOAD AND EXCHANGE MULTIMEDIA FILES, ARTWORK, TEXT, AUDIO, VIDEO, AND INTERNET WEB URLS (U.S. CLS. 21, 23, 26, 36 AND 38).

COLLEEN DOMBROW, EXAMINING ATTORNEY

CLASS 9—(Continued).

SN 77-643,042. NOVA GAMING, LLC, GREENVILLE, SC. FILED 1-5-2009.

BLAZIN' HOT KENO

THE MARK CONSISTS OF STANDARD CHARACTERS WITHOUT CLAIM TO ANY PARTICULAR FONT, STYLE, SIZE, OR COLOR.

OWNER OF U.S. REG. NO. 2,967,695.
NO CLAIM IS MADE TO THE EXCLUSIVE RIGHT TO USE "KENO", APART FROM THE MARK AS SHOWN.

FOR GAMING MACHINES, NAMELY, ELECTRONIC SLOT AND BINGO MACHINES (U.S. CLS. 21, 23, 26, 36 AND 38).

FIRST USE 6-9-2009; IN COMMERCE 6-9-2009.
LEIGH LOWRY, EXAMINING ATTORNEY

CLASS 9—(Continued).

SN 77-662,235. ARISTOCRAT TECHNOLOGIES AUSTRALIA PTY LTD, NORTH RYDE, NSW, AUSTRALIA, FILED 2-3-2009.

CONTAGIOUS WILDS

THE MARK CONSISTS OF STANDARD CHARACTERS WITHOUT CLAIM TO ANY PARTICULAR FONT, STYLE, SIZE, OR COLOR.

PRIORITY CLAIMED UNDER SEC. 44(D) ON AUSTRALIA APPLICATION NO. 1257075, FILED 8-14-2008, REG. NO. 1257075, DATED 8-14-2008, EXPIRES 8-14-2018.

FOR GAMING MACHINES (U.S. CLS. 21, 23, 26, 36 AND 38).
SUSAN RICHARDS, EXAMINING ATTORNEY

SN 77-643,084. INFOMEDIA, INC., LOVELAND, CO. FILED 1-5-2009.

iFart

THE MARK CONSISTS OF STANDARD CHARACTERS WITHOUT CLAIM TO ANY PARTICULAR FONT, STYLE, SIZE, OR COLOR.

FOR COMPUTER APPLICATION SOFTWARE FOR MOBILE PHONES (U.S. CLS. 21, 23, 26, 36 AND 38).

FIRST USE 10-14-2008; IN COMMERCE 12-12-2008.
ANGELA DUONG, EXAMINING ATTORNEY

THE MARK CONSISTS OF STANDARD CHARACTERS WITHOUT CLAIM TO ANY PARTICULAR FONT, STYLE, SIZE, OR COLOR.

FOR MUSICAL SOUND RECORDINGS (U.S. CLS. 21, 23, 26, 36 AND 38).
TARAH HARDY, EXAMINING ATTORNEY

SN 77-685,003. PIRIFORM LIMITED, LONDON, W1D 3QL, UNITED KINGDOM, FILED 3-6-2009.

CCLEANER

THE MARK CONSISTS OF STANDARD CHARACTERS WITHOUT CLAIM TO ANY PARTICULAR FONT, STYLE, SIZE, OR COLOR.

PRIORITY CLAIMED UNDER SEC. 44(D) ON ERP N CMNTY TM OFC APPLICATION NO. 007562002, FILED 1-30-2009, REG. NO. 007562002, DATED 11-10-2009, EXPIRES 1-30-2019.

FOR COMPUTER SOFTWARE FOR USE IN OPTIMISING A COMPUTER SYSTEM OR NETWORK WHICH ALLOWS THE SYSTEM OR NETWORK TO WORK FASTER AND MORE SECURELY; COMPUTER SOFTWARE PROGRAMS USED TO OPTIMIZE COMPUTER SYSTEMS AND INCREASE THE USER'S PRIVACY; COMPUTER SOFTWARE FOR USE IN REMOVING UNUSED FILES FROM A COMPUTER SYSTEM; ONLINE ELECTRONIC PUBLICATIONS DOWNLOADABLE FROM THE INTERNET IN THE NATURE OF MAGAZINES, NOTICES, INSTRUCTIONS OR NEWSLETTERS IN THE FIELD OF COMPUTER SOFTWARE (U.S. CLS. 21, 23, 26, 36 AND 38).
KATINA MISTER, EXAMINING ATTORNEY

SN 77-651,980. DIGITAL CRITERION ENTERPRISES, INC., NEW YORK, NY. FILED 1-19-2009.

ATOM APPS

THE MARK CONSISTS OF STANDARD CHARACTERS WITHOUT CLAIM TO ANY PARTICULAR FONT, STYLE, SIZE, OR COLOR.

NO CLAIM IS MADE TO THE EXCLUSIVE RIGHT TO USE "APPS", APART FROM THE MARK AS SHOWN.

FOR DOWNLOADABLE COMPUTER APPLICATION SOFTWARE FOR MOBILE PHONES (U.S. CLS. 21, 23, 26, 36 AND 38).
LINDA MICKLEBURGH, EXAMINING ATTORNEY

CLASS 9—(Continued).

SN 77-690,768. TECHNOLOGY RESEARCH CORPORATION, CLEARWATER, FL. FILED 3-13-2009.

ELECTRA CHECK

THE MARK CONSISTS OF STANDARD CHARACTERS WITHOUT CLAIM TO ANY PARTICULAR FONT, STYLE, SIZE, OR COLOR.

NO CLAIM IS MADE TO THE EXCLUSIVE RIGHT TO USE "CHECK", APART FROM THE MARK AS SHOWN.

FOR ELECTRONIC DIGITAL DEVICES TO BE PLUGGED INTO WALL OUTLETS FOR MONITORING AND TESTING ELECTRICAL OUTLETS AND ELECTRICAL SYSTEMS (U.S. CLS. 21, 23, 26, 36 AND 38).

FIRST USE 9-30-2006; IN COMMERCE 9-30-2006.
ANNE FARRELL, EXAMINING ATTORNEY

SN 77-703,532. 3C INTERACTIVE, LLC, BOCA RATON, FL. FILED 3-31-2009.

ShoutBox

THE MARK CONSISTS OF STANDARD CHARACTERS WITHOUT CLAIM TO ANY PARTICULAR FONT, STYLE, SIZE, OR COLOR.

FOR COMPUTER SOFTWARE THAT COMBINES SHORT MESSAGING SERVICES WITH WEB-BASED CLIENT SERVER APPLICATIONS TO ALLOW INDIVIDUALS AND COMPANIES TO DEVELOP IN VENUE, TEXT-TO-SCREEN MOBILE APPLICATIONS THAT ENABLE THE AUTOMATIC DISPLAY OF TEXT MESSAGE CONTENT ON AN IN-VENUE MONITOR OR DISPLAY (U.S. CLS. 21, 23, 26, 36 AND 38).

FIRST USE 1-5-2007; IN COMMERCE 1-5-2007.
WANDA KAY PRICE, EXAMINING ATTORNEY

CLASS 9—(Continued).

SN 77-705,831. SANDBERG, ANNE, LOS ANGELES, CA. FILED 4-2-2009.

Rapid Skill-Builder

NO CLAIM IS MADE TO THE EXCLUSIVE RIGHT TO USE "SKILL BUILDER", APART FROM THE MARK AS SHOWN.

THE MARK CONSISTS OF THE STYLIZED TEXT "RAPID SKILL-BUILDER"

FOR DOWNLOADABLE ELECTRONIC PUBLICATIONS IN THE NATURE OF BOOKS, GUIDES AND FORMS IN THE FIELD OF ASSERTIVENESS SKILLS, CHANGE MANAGEMENT, COACHING SKILLS, COMPLAINT HANDLING SKILLS, CONFLICT RESOLUTION SKILLS, CORPORATE ETHICS, EMOTIONAL INTELLIGENCE, GOAL AND OBJECTIVE SETTING, IMPROVING CUSTOMER SERVICE, INFLUENCING OTHERS INTERVIEWING AND SELECTION SKILLS, LEADERSHIP SKILLS, LEARNING STYLES, LISTENING SKILLS, MANAGING MEETINGS, MANAGING POOR PERFORMANCE, NEGOTIATING SKILLS, PERSONAL EFFECTIVENESS PRESENTATION SKILLS, PROBLEM SOLVING, SALES EFFECTIVENESS STRESS AND PRESSURE MANAGEMENT, TEAM BUILDING SKILLS, TEAM COMMUNICATION, TELEPHONE SERVICE EXCELLENCE, TIME MANAGEMENT; DOWNLOADABLE PODCASTS IN THE FIELD OF ASSERTIVENESS SKILLS, CHANGE MANAGEMENT, COACHING SKILLS, COMPLAINT HANDLING SKILLS, CONFLICT RESOLUTION SKILLS, CORPORATE ETHICS, EMOTIONAL INTELLIGENCE, GOAL AND OBJECTIVE SETTING, IMPROVING CUSTOMER SERVICE, INFLUENCING OTHERS INTERVIEWING AND SELECTION SKILLS, LEADERSHIP SKILLS, LEARNING STYLES, LISTENING SKILLS, MANAGING MEETINGS, MANAGING POOR PERFORMANCE, NEGOTIATING SKILLS, PERSONAL EFFECTIVENESS PRESENTATION SKILLS, PROBLEM SOLVING, SALES EFFECTIVENESS STRESS AND PRESSURE MANAGEMENT, TEAM BUILDING SKILLS, TEAM COMMUNICATION, TELEPHONE SERVICE EXCELLENCE, TIME MANAGEMENT (U.S. CLS. 21, 23, 26, 36 AND 38).

FIRST USE 2-2-2007; IN COMMERCE 6-2-2008.
KARANENDRA S. CHHINA, EXAMINING ATTORNEY

SN 77-707,662. ECESSA CORPORATION, FORMERLY ASTROCOM CORPORATION, PLYMOUTH, MN. FILED 4-6-2009.



THE MARK CONSISTS OF A STYLIZED, INCOMPLETE CIRCLE WITH A SINGLE STYLIZED BREAK AT THE TOP ACCOMPANIED BY THE WORD "ECESSA".

FOR LAN (LOCAL AREA NETWORK) HARDWARE; WAN (WIDE AREA NETWORK) HARDWARE (U.S. CLS. 21, 23, 26, 36 AND 38).

FIRST USE 3-1-2009; IN COMMERCE 3-1-2009.
MORGAN WYNNE, EXAMINING ATTORNEY

CLASS 9—(Continued).

SN 77-714,196. CASE-ARI, DBA CASE-MATE, TUCKER, GA. FILED 4-15-2009.

smart skin

THE MARK CONSISTS OF STANDARD CHARACTERS WITHOUT CLAIM TO ANY PARTICULAR FONT, STYLE, SIZE, OR COLOR.

NO CLAIM IS MADE TO THE EXCLUSIVE RIGHT TO USE "SKIN", APART FROM THE MARK AS SHOWN.

FOR BAGS AND CASES SPECIALLY ADAPTED FOR HOLDING OR CARRYING PORTABLE TELEPHONES AND TELEPHONE EQUIPMENT AND ACCESSORIES; CAMERA CASES; CARRYING CASES AND CONTAINERS FOR CONTACT LENSES; CARRYING CASES FOR CELL PHONES; CARRYING CASES FOR RADIO PAGERS; CARRYING CASES SPECIALLY ADAPTED FOR POCKET CALCULATORS AND CELLPHONES; CASES FOR ELECTRONIC DIARIES; CASES FOR MOBILE PHONES; CASES FOR TELEPHONES; COMPUTER CARRYING CASES; PROTECTIVE CARRYING CASES FOR PORTABLE MUSIC PLAYERS, NAMELY, MP3 PLAYERS; PROTECTIVE CARRYING CASES SPECIALLY ADAPTED FOR GLOBAL POSITIONING SYSTEM (GPS) APPARATUS; PROTECTIVE CARRYING CASES SPECIALLY ADAPTED FOR PERSONAL DIGITAL ASSISTANTS (PDA); PROTECTIVE CARRYING CASES SPECIALLY ADAPTED FOR VIDEO GAME CONSOLES FOR USE WITH AN EXTERNAL DISPLAY SCREEN OR MONITOR (U.S. CLS. 21, 23, 26, 36 AND 38). FIRST USE 6-1-2008; IN COMMERCE 6-1-2008. AISHA CLARKE, EXAMINING ATTORNEY

SN 77-717,490. ANALOGIX SEMICONDUCTOR, INC., SANTA CLARA, CA. FILED 4-20-2009.

COOLHD

THE MARK CONSISTS OF THE STYLIZED WORDING "COOLHD". FOR TRANSMITTERS OF ELECTRONIC SIGNALS (U.S. CLS. 21, 23, 26, 36 AND 38). AMEEN IMAM, EXAMINING ATTORNEY

CLASS 9—(Continued).

SN 77-721,637. MARTHA STEWART LIVING OMNIMEDIA, INC., NEW YORK, NY. FILED 4-24-2009.

MAD HUNGRY

THE MARK CONSISTS OF STANDARD CHARACTERS WITHOUT CLAIM TO ANY PARTICULAR FONT, STYLE, SIZE, OR COLOR.

FOR AUDIO RECORDINGS, VIDEO RECORDINGS, PRE-RECORDED CDS, PRE-RECORDED DVDS, ALL IN THE FIELDS OF FOOD, COOKING AND ENTERTAINING; DOWNLOADABLE ELECTRONIC PUBLICATIONS, NAMELY, BOOKS, COOKBOOKS, MAGAZINES, PAMPHLETS, TEXTS, RECIPE CARDS, COLUMNS, MAGAZINE FEATURES, MAGAZINE SECTIONS, ARTICLES, NEWSLETTERS, JOURNALS IN THE FIELDS OF FOOD, COOKING AND ENTERTAINING; DOWNLOADABLE FILMS AND TV PROGRAMS FEATURING FOOD, COOKING AND ENTERTAINING VIA AN VIDEO-ON-DEMAND SERVICE (U.S. CLS. 21, 23, 26, 36 AND 38). SUSAN STIGLITZ, EXAMINING ATTORNEY

SN 77-725,479. DISNEY ENTERPRISES, INC., BURBANK, CA. FILED 4-29-2009.

VIPER SLAP

THE MARK CONSISTS OF STANDARD CHARACTERS WITHOUT CLAIM TO ANY PARTICULAR FONT, STYLE, SIZE, OR COLOR.

FOR DECORATIVE REFRIGERATOR MAGNETS (U.S. CLS. 21, 23, 26, 36 AND 38). RONALD DELGIZZI, EXAMINING ATTORNEY

SN 77-726,391. TOKTUMI, INC., SAN FRANCISCO, CA. FILED 4-30-2009.

LINE2

THE MARK CONSISTS OF STANDARD CHARACTERS WITHOUT CLAIM TO ANY PARTICULAR FONT, STYLE, SIZE, OR COLOR.

FOR COMPUTER SOFTWARE FOR USE IN THE FIELD OF MOBILE COMMUNICATIONS TO ADD FUNCTIONALITY TO MOBILE PHONES, NAMELY, SEPARATING HANDLING OF BUSINESS AND PERSONAL CALLERS, PROVIDING REMOTE ACCESS TO BUSINESS TELECOMMUNICATIONS SYSTEMS AND ACCOUNTS, AND PROVIDING A VIRTUAL OFFICE ENVIRONMENT, AND USER MANUALS SOLD AS A UNIT THEREWITH (U.S. CLS. 21, 23, 26, 36 AND 38). KATHERINE STOIDES, EXAMINING ATTORNEY

CLASS 9—(Continued).

SN 77-728,813. VOSSenkEMPER, ERIC B, ENGLEWOOD, CO. FILED 5-4-2009.

KEYADEED

THE MARK CONSISTS OF STANDARD CHARACTERS WITHOUT CLAIM TO ANY PARTICULAR FONT, STYLE, SIZE, OR COLOR.

FOR COMPUTER SOFTWARE FOR LAND SURVEYING, NAMELY, FOR USE IN CREATING LAND DESCRIPTIONS (U.S. CLS. 21, 23, 26, 36 AND 38).

KATHERINE CONNOLLY, EXAMINING ATTORNEY

SN 77-729,123. VELOCS CORPORATION, ATLANTA, GA. FILED 5-5-2009.

VePlanner

THE MARK CONSISTS OF STANDARD CHARACTERS WITHOUT CLAIM TO ANY PARTICULAR FONT, STYLE, SIZE, OR COLOR.

FOR AUTOMATED SYSTEMS, NAMELY, SOFTWARE, HARDWARE AND COMMUNICATIONS DEVICES FOR PLANNING, SCHEDULING, CONTROLLING, MONITORING AND PROVIDING INFORMATION ON TRANSPORTATION ASSETS AND PARTS THEREOF, NAMELY, PROVIDING INFORMATION RELATED TO THE OPTIMIZATION OF LOADING SPACE ON TRANSPORTATION VEHICLES FOR THE PURPOSES OF IMPROVING SUPPLY CHAIN EFFICIENCIES (U.S. CLS. 21, 23, 26, 36 AND 38).

FIRST USE 3-1-2009; IN COMMERCE 4-30-2009.
YAT SYE, LEE, EXAMINING ATTORNEY

SN 77-731,313. PENGZHI TECHNOLOGY (SHENZHEN) CO., LTD., SHENZHEN CITY, CHINA, FILED 5-7-2009.



THE MARK CONSISTS OF A CLOCK DESIGN WITH THE NUMBER "365" ON THE RIGHT SIDE OF THE DESIGN AND THE COMPOUND ELEMENT "CLOCK365", WITH NO SPACES BETWEEN "365" AND "CLOCK", TO THE RIGHT OF THE CLOCK DESIGN.

FOR COMPUTER SOFTWARE FOR PROVIDING VIRTUAL CLOCKS AND CALENDARS THAT CAN BE DOWNLOADED AND INSTALLED AT MOBILE PHONES, DIGITAL PHOTO FRAMES, AND OTHER DIGITAL DEVICES (U.S. CLS. 21, 23, 26, 36 AND 38).

MARY CRAWFORD, EXAMINING ATTORNEY

CLASS 9—(Continued).

SN 77-731,696. APTOS TECHNOLOGY INC., MIAOLI COUNTY, TAIWAN, FILED 5-7-2009.

Gtrackr

THE MARK CONSISTS OF STANDARD CHARACTERS WITHOUT CLAIM TO ANY PARTICULAR FONT, STYLE, SIZE, OR COLOR.

FOR GPS RECEIVERS FOR CALCULATING AND DISPLAYING ROUTES; PORTABLE GPS DEVICES, NAMELY, ELECTRONIC INSTRUMENTS FOR DETERMINING AND OUTPUTTING POSITION AND SPEED; PERSONAL DIGITAL ASSISTANTS FEATURING A GPS RECEIVER AND ELECTRONIC MAPS OF ROADS; ELECTRONIC NAVIGATION DEVICES, NAMELY, GPS RECEIVERS HAVING AN ELECTRONIC COMPASS; NAVIGATION SOFTWARE FOR CALCULATING AND DISPLAYING ROUTES; PORTABLE PERSONAL NAVIGATION DEVICES FOR CALCULATING AND DISPLAYING ROUTES WITH MAPS OF ROADS; ELECTRONIC HANDLED DEVICES, NAMELY, A COMBINATION TWO-WAY RADIO AND GPS RECEIVER FOR CALCULATING AND DISPLAYING ROUTES AND MAPS OF ROADS; COMPUTER SOFTWARE, NAMELY, AN APPLICATION ALLOWING ENHANCED SATELLITE ACQUISITION, SOLD AS A COMPONENT PART OF A GLOBAL POSITIONING SYSTEM (GPS); MOTORCYCLE NAVIGATION SYSTEM FEATURING GPS RECEIVER, DIGITAL MAP DISPLAYS AND TURN-BY-TURN INSTRUCTIONS; HANDHELD GLOBAL POSITIONING SYSTEM (GPS) CONSISTING OF COMPUTERS, COMPUTER SOFTWARE, TRANSMITTERS, RECEIVERS AND NETWORK INTERFACE DEVICES FOR CALCULATING AND DISPLAYING ROUTES AND MAPS OF ROADS; COMPUTER HARDWARE AND SOFTWARE SYSTEM FOR TRACKING PEOPLE, AND PETS USING GPS DATA ON A DEVICE ON THE TRACKED PEOPLE, AND PETS; GLOBAL POSITIONING SYSTEM (GPS) CONSISTING OF COMPUTERS, COMPUTER SOFTWARE, TRANSMITTERS, RECEIVERS, AND NETWORK INTERFACE DEVICES FOR CALCULATING AND DISPLAYING ROUTES AND MAPS OF ROADS; GLOBAL POSITIONING SYSTEM (GPS) DEVICES FOR CALCULATING AND DISPLAYING ROUTES AND MAPS OF ROADS; GPS DATA LOGGER FOR RECORDING TRIPS AND CLASSIFYING THEM INTO DIFFERENT ACCOUNTS (U.S. CLS. 21, 23, 26, 36 AND 38).

CHRISTINE COOPER, EXAMINING ATTORNEY

SN 77-731,699. APTOS TECHNOLOGY INC., MIAOLI COUNTY, TAIWAN, FILED 5-7-2009.

eCaddie

THE MARK CONSISTS OF STANDARD CHARACTERS WITHOUT CLAIM TO ANY PARTICULAR FONT, STYLE, SIZE, OR COLOR.

FOR COMPUTER HARDWARE; GLOBAL POSITIONING SYSTEM (GPS); GPS DATA LOGGER FOR RECORDING TRIPS AND CLASSIFYING THEM INTO DIFFERENT ACCOUNTS; PERSONAL DIGITAL ASSISTANTS (PDA); PERSONAL DIGITAL ASSISTANT COMPUTERS (U.S. CLS. 21, 23, 26, 36 AND 38).

CHRISTINE COOPER, EXAMINING ATTORNEY

CLASS 9—(Continued).

SN 77-732,472. RED.COM, INC., LAKE FOREST, CA. FILED 5-8-2009.

REDLIGHT

THE MARK CONSISTS OF STANDARD CHARACTERS WITHOUT CLAIM TO ANY PARTICULAR FONT, STYLE, SIZE, OR COLOR.

FOR VIDEO PROJECTORS DESIGNED SPECIFICALLY FOR USE FOR VIDEO CREATED ON RED DIGITAL CINEMA BRANDED CAMERAS (U.S. CLS. 21, 23, 26, 36 AND 38).

AMY ALFIERI, EXAMINING ATTORNEY



SN 77-736,777. AMETEK, INC., PAOLI, PA. FILED 5-14-2009.

IMPULSE

THE MARK CONSISTS OF STANDARD CHARACTERS WITHOUT CLAIM TO ANY PARTICULAR FONT, STYLE, SIZE, OR COLOR.

FOR LEVEL MEASUREMENT SENSORS AND DEVICES FOR LIQUIDS, GRANULES AND SLURRIES; TIME-DOMAIN REFLECTOMETERS FOR MEASUREMENT OF LEVEL, DISTANCE, VOLUME AND FLOW OF LIQUIDS, GRANULES AND SLURRIES; LEVEL MEASUREMENT DATA TRANSMITTERS FOR USE WITH LIQUIDS, GRANULES AND SLURRIES; TIME-DOMAIN REFLECTOMETRY DATA TRANSMITTERS FOR MEASUREMENT OF LEVEL, DISTANCE, AND VOLUME OF LIQUIDS, GRANULES AND SLURRIES (U.S. CLS. 21, 23, 26, 36 AND 38).

GRETCHEN ULRICH, EXAMINING ATTORNEY



SN 77-737,278. BOISE BUILDING SOLUTIONS MANUFACTURING, L.L.C., BOISE, ID. FILED 5-14-2009.

BC COLUMN

THE MARK CONSISTS OF STANDARD CHARACTERS WITHOUT CLAIM TO ANY PARTICULAR FONT, STYLE, SIZE, OR COLOR.

OWNER OF U.S. REG. NOS. 1,815,347 AND 2,395,722. NO CLAIM IS MADE TO THE EXCLUSIVE RIGHT TO USE "COLUMN", APART FROM THE MARK AS SHOWN.

FOR COMPUTER SOFTWARE FOR PERFORMING ENGINEERED ANALYSIS TO DESIGN AND SIZE VERTICAL SUPPORTS FOR BUILDINGS AND RESIDENTIAL STRUCTURES (U.S. CLS. 21, 23, 26, 36 AND 38).

FIRST USE 8-0-2008; IN COMMERCE 8-0-2008. TASNEEM HUSSAIN, EXAMINING ATTORNEY

CLASS 9—(Continued).

SN 77-743,545. MOBILE TRIBE MANAGEMENT CORP., DBA MOBILE TRIBE MANAGEMENT CORP., WOODSIDE, CA. FILED 5-22-2009.

Mobile Tribe

THE MARK CONSISTS OF STANDARD CHARACTERS WITHOUT CLAIM TO ANY PARTICULAR FONT, STYLE, SIZE, OR COLOR.

NO CLAIM IS MADE TO THE EXCLUSIVE RIGHT TO USE "MOBILE", APART FROM THE MARK AS SHOWN.

FOR COMMUNICATION SOFTWARE FOR PROVIDING ACCESS TO THE INTERNET (U.S. CLS. 21, 23, 26, 36 AND 38).

FIRST USE 6-1-2006; IN COMMERCE 9-15-2008. SANDRA BUJA, EXAMINING ATTORNEY



SN 77-744,584. NUVOTRONICS, LLC, BLACKSBURG, VA. FILED 5-26-2009.

MILLIMITE

THE MARK CONSISTS OF STANDARD CHARACTERS WITHOUT CLAIM TO ANY PARTICULAR FONT, STYLE, SIZE, OR COLOR.

FOR ELECTRICAL COMPONENTS, NAMELY, MICROWAVE AND MILLIMETER WAVE PASSIVE COMPONENTS FOR RECEIVING, TRANSMITTING, SPLITTING, COUPLING, GENERATING, TERMINATING, FILTERING, SHIFTING AND/OR TRANSFORMING MICROWAVES AND MILLIMETER WAVES (U.S. CLS. 21, 23, 26, 36 AND 38).

AMY KERTGATE, EXAMINING ATTORNEY



SN 77-746,873. GVI SECURITY, INC., CARROLLTON, TX. FILED 5-28-2009.

AUTOIP

THE MARK CONSISTS OF STANDARD CHARACTERS WITHOUT CLAIM TO ANY PARTICULAR FONT, STYLE, SIZE, OR COLOR.

FOR SECURITY PRODUCTS, NAMELY, NETWORK SERVERS AND OPERATING SOFTWARE FOR NETWORK SERVERS AND NETWORK VIDEO CAMERAS (U.S. CLS. 21, 23, 26, 36 AND 38).

CHRISTOPHER BUONGIORNO, EXAMINING ATTORNEY

CLASS 9—(Continued).

SN 77-747,199. UBISOFT ENTERTAINMENT, RENNES, FRANCE, FILED 5-29-2009.

R.U.S.E

THE MARK CONSISTS OF STANDARD CHARACTERS WITHOUT CLAIM TO ANY PARTICULAR FONT, STYLE, SIZE, OR COLOR.

FOR GAME SOFTWARE AND ELECTRONIC GAME PROGRAMS, NAMELY, SOFTWARE GAMES RECORDED ON CD-ROM AND DIGITAL VIDEO DISCS FOR COMPUTERS; SOFTWARE GAMES RECORDED ON CD-ROMS, DIGITAL VIDEO DISCS, AND CARTRIDGES FOR CONSOLE AND INDIVIDUAL, PORTABLE GAMING SYSTEMS; SOFTWARE GAMES THAT ARE DOWNLOADABLE FROM A REMOTE COMPUTER SITE AND ELECTRONIC GAME SOFTWARE FOR MOBILE PHONES, PERSONAL DIGITAL ASSISTANTS, AND HANDHELD COMPUTERS (U.S. CLS. 21, 23, 26, 36 AND 38).

SHAILA SETTLES, EXAMINING ATTORNEY

SN 77-747,724. TRUFFLESOFT INC., DUBLIN, CA. FILED 5-29-2009.

TruffleSoft

THE MARK CONSISTS OF STANDARD CHARACTERS WITHOUT CLAIM TO ANY PARTICULAR FONT, STYLE, SIZE, OR COLOR.

FOR COMPUTER APPLICATION SOFTWARE FOR MOBILE PHONES (U.S. CLS. 21, 23, 26, 36 AND 38).

ANGELA DUONG, EXAMINING ATTORNEY

SN 77-747,823. SONY ELECTRONICS INC., SAN DIEGO, CA. FILED 5-29-2009.

Movie Studio Inspire

THE MARK CONSISTS OF STANDARD CHARACTERS WITHOUT CLAIM TO ANY PARTICULAR FONT, STYLE, SIZE, OR COLOR.

NO CLAIM IS MADE TO THE EXCLUSIVE RIGHT TO USE "MOVIE STUDIO", APART FROM THE MARK AS SHOWN.

FOR COMPUTER SOFTWARE FOR EDITING AND ENCODING AUDIO FILES IN MULTIPLE AUDIO FILE FORMATS (U.S. CLS. 21, 23, 26, 36 AND 38).

ELLEN BURNS, EXAMINING ATTORNEY

CLASS 9—(Continued).

SN 77-748,228. MSC SERVICES CORP., MELVILLE, NY. FILED 5-29-2009.

CAP 100T

THE MARK CONSISTS OF STANDARD CHARACTERS WITHOUT CLAIM TO ANY PARTICULAR FONT, STYLE, SIZE, OR COLOR.

FOR VENDING MACHINE FOR DISPENSING OF TOOLS AND MACHINE SHOP SUPPLIES (U.S. CLS. 21, 23, 26, 36 AND 38).

PAM WILLIS, EXAMINING ATTORNEY

SN 77-748,465. DISCREET PUBLISHING, LLC, NEVADA, NV. FILED 5-31-2009.

Cover Action Pro

THE MARK CONSISTS OF STANDARD CHARACTERS WITHOUT CLAIM TO ANY PARTICULAR FONT, STYLE, SIZE, OR COLOR.

FOR COMPUTER GRAPHICS SOFTWARE (U.S. CLS. 21, 23, 26, 36 AND 38).

FIRST USE 3-1-2006; IN COMMERCE 3-1-2006.

BARBARA A. GOLD, EXAMINING ATTORNEY

SN 77-749,035. NATIONAL APPLIED CONSTRUCTION PRODUCTS INC., AKRON, OH. FILED 6-1-2009.



NO CLAIM IS MADE TO THE EXCLUSIVE RIGHT TO USE "GREEN" AND "ANTI-FRACTURE MEMBRANE", APART FROM THE MARK AS SHOWN.

THE MARK CONSISTS OF THE WORDING "ECB GREEN" AND THE WORDING "ANTI-FRACTURE MEMBRANE"; A RECTANGULAR BAR DESIGN ELEMENT; A CURVED BAR DESIGN ELEMENT; A LEAF DESIGN ELEMENT AND A PARTIAL LEAF DESIGN ELEMENT.

FOR ACOUSTIC MEMBRANES (U.S. CLS. 21, 23, 26, 36 AND 38).

FIRST USE 6-1-2009; IN COMMERCE 6-1-2009.

JENNIFER HETU, EXAMINING ATTORNEY

CLASS 9—(Continued).

SN 77-749,158. VTREE LLC, BENSALEM, PA. FILED 6-1-2009.

MY FOOTBALL LEAGUE

THE MARK CONSISTS OF STANDARD CHARACTERS WITHOUT CLAIM TO ANY PARTICULAR FONT, STYLE, SIZE, OR COLOR.

NO CLAIM IS MADE TO THE EXCLUSIVE RIGHT TO USE "FOOTBALL LEAGUE", APART FROM THE MARK AS SHOWN.

FOR COMPUTER AND VIDEO GAME SOFTWARE SPECIFICALLY DESIGNED FOR INDIVIDUALS WITH PHYSICAL AND/OR MENTAL HANDICAPS USED FOR PHYSICAL THERAPY (U.S. CLS. 21, 23, 26, 36 AND 38).
BRIAN CALLAGHAN, EXAMINING ATTORNEY

CLASS 9—(Continued).

SN 77-751,145. PATSYSTEMS (UK) LTD., LONDON, UNITED KINGDOM, FILED 6-3-2009.

PATSYSTEMS RISK ALERT

THE MARK CONSISTS OF STANDARD CHARACTERS WITHOUT CLAIM TO ANY PARTICULAR FONT, STYLE, SIZE, OR COLOR.

OWNER OF U.S. REG. NOS. 2,719,849 AND 3,428,067.
NO CLAIM IS MADE TO THE EXCLUSIVE RIGHT TO USE "RISK ALERT", APART FROM THE MARK AS SHOWN.

FOR PRE-TRADE RISK MANAGEMENT SOFTWARE THAT ENABLES FIRMS TO IDENTIFY AND WHERE NECESSARY TO PREVENT THE ACCUMULATION OF EXCESSIVE EXPOSURE TO RISK (U.S. CLS. 21, 23, 26, 36 AND 38).
ASMAT KHAN, EXAMINING ATTORNEY

SN 77-749,895. UNIDESK CORPORATION, MARLBOROUGH, MA. FILED 6-2-2009.

CacheCloud

THE MARK CONSISTS OF STANDARD CHARACTERS WITHOUT CLAIM TO ANY PARTICULAR FONT, STYLE, SIZE, OR COLOR.

FOR COMPUTER SOFTWARE, NAMELY, SOFTWARE FEATURING CONFIGURATION MANAGEMENT, OPERATION MANAGEMENT, AND NETWORK MANAGEMENT FOR MANAGING MULTIPLE COMPUTER SYSTEMS WHICH PROVIDE HOSTED DESKTOP APPLICATIONS AND STORAGE (U.S. CLS. 21, 23, 26, 36 AND 38).
ERNEST SHOSHO, EXAMINING ATTORNEY

SN 77-751,761. GVI SECURITY, INC., CARROLLTON, TX. FILED 6-4-2009.

GOIP

THE MARK CONSISTS OF STANDARD CHARACTERS WITHOUT CLAIM TO ANY PARTICULAR FONT, STYLE, SIZE, OR COLOR.

FOR SECURITY PRODUCTS, NAMELY, NETWORK SERVERS AND OPERATING SOFTWARE FOR NETWORK SERVERS AND NETWORK VIDEO CAMERAS (U.S. CLS. 21, 23, 26, 36 AND 38).
CHRISTOPHER BUONGIORNO, EXAMINING ATTORNEY

SN 77-750,022. MOUNTZ, INC., SAN JOSE, CA. FILED 6-2-2009.

TORQUELAB

THE MARK CONSISTS OF STANDARD CHARACTERS WITHOUT CLAIM TO ANY PARTICULAR FONT, STYLE, SIZE, OR COLOR.

FOR PORTABLE DIGITAL TORQUE TESTERS, ANALYZERS AND DATA COLLECTORS (U.S. CLS. 21, 23, 26, 36 AND 38).
FIRST USE 10-11-1991; IN COMMERCE 10-11-1991.
DOMINIC J. FERRAIUOLO, EXAMINING ATTORNEY

SN 77-752,079. SONY ELECTRONICS INC., SAN DIEGO, CA. FILED 6-4-2009.

VIP Protection

THE MARK CONSISTS OF STANDARD CHARACTERS WITHOUT CLAIM TO ANY PARTICULAR FONT, STYLE, SIZE, OR COLOR.

NO CLAIM IS MADE TO THE EXCLUSIVE RIGHT TO USE "PROTECTION", APART FROM THE MARK AS SHOWN.

FOR COMPUTER SOFTWARE TO PROTECT AGAINST COMPUTER VIRUSES, UNAUTHORIZED PERSONS ACCESSING A USER'S COMPUTER AND THEFT OF THE COMPUTER, AS WELL AS TO PROVIDE AUTOMATED ONLINE BACKUP OF A USER'S DATA (U.S. CLS. 21, 23, 26, 36 AND 38).
ELLEN BURNS, EXAMINING ATTORNEY

CLASS 9—(Continued).

SN 77-752,955. FRIENDLY FAMILY PRODUCTIONS, LLC,
LOS ANGELES, CA. FILED 6-5-2009.

THE FIRST FOUR YEARS

THE MARK CONSISTS OF STANDARD CHARACTERS WITHOUT CLAIM TO ANY PARTICULAR FONT, STYLE, SIZE, OR COLOR.

FOR VIDEO RECORDINGS, DVDS, AUDIO RECORDINGS, MOTION PICTURE FILMS, TELEVISION FILMS, DOWNLOADABLE TELEVISION SHOWS AND MOTION PICTURES, DOWNLOADABLE VIDEO RECORDINGS, DOWNLOADABLE AUDIO RECORDINGS, ALL FEATURING FICTIONAL AND NON-FICTIONAL WORKS; DIGITAL RECORDINGS, NAMELY, HIGH-DEFINITION DVDS, CDS, AND CD-ROMS FEATURING FICTIONAL AND NON-FICTIONAL WORKS; DOWNLOADABLE MUSICAL SOUND RECORDINGS; DOWNLOADABLE RING TONES FOR MOBILE PHONES; DOWNLOADABLE AUDIO RECORDINGS, NAMELY, RINGTONES PRESENTED TO MOBILE COMMUNICATIONS DEVICES VIA WIRELESS NETWORKS; DOWNLOADABLE SCREEN SAVERS FOR COMPUTERS AND MOBILE PHONES; DOWNLOADABLE VIDEO RECORDINGS, NAMELY, SCREEN SAVERS PRESENTED TO MOBILE COMMUNICATIONS DEVICES VIA WIRELESS NETWORKS (U.S. CLS. 21, 23, 26, 36 AND 38).

RENEE MCCRAY, EXAMINING ATTORNEY

SN 77-752,984. FRIENDLY FAMILY PRODUCTIONS, LLC,
LOS ANGELES, CA. FILED 6-5-2009.

THESE HAPPY GOLDEN YEARS

THE MARK CONSISTS OF STANDARD CHARACTERS WITHOUT CLAIM TO ANY PARTICULAR FONT, STYLE, SIZE, OR COLOR.

FOR VIDEO RECORDINGS, DVDS, AUDIO RECORDINGS, MOTION PICTURE FILMS, TELEVISION FILMS, DOWNLOADABLE TELEVISION SHOWS AND MOTION PICTURES, DOWNLOADABLE VIDEO RECORDINGS, DOWNLOADABLE AUDIO RECORDINGS, ALL FEATURING FICTIONAL AND NON-FICTIONAL WORKS; DIGITAL RECORDINGS, NAMELY, HIGH-DEFINITION DVDS, CDS, AND CD-ROMS FEATURING FICTIONAL AND NON-FICTIONAL WORKS; DOWNLOADABLE MUSICAL SOUND RECORDINGS; DOWNLOADABLE RING TONES FOR MOBILE PHONES; DOWNLOADABLE AUDIO RECORDINGS, NAMELY, RINGTONES PRESENTED TO MOBILE COMMUNICATIONS DEVICES VIA WIRELESS NETWORKS; DOWNLOADABLE SCREEN SAVERS FOR COMPUTERS AND MOBILE PHONES; DOWNLOADABLE VIDEO RECORDINGS, NAMELY, SCREEN SAVERS PRESENTED TO MOBILE COMMUNICATIONS DEVICES VIA WIRELESS NETWORKS (U.S. CLS. 21, 23, 26, 36 AND 38).

RENEE MCCRAY, EXAMINING ATTORNEY

CLASS 9—(Continued).

SN 77-753,027. FRIENDLY FAMILY PRODUCTIONS, LLC,
LOS ANGELES, CA. FILED 6-5-2009.

BY THE SHORES OF SILVER LAKE

THE MARK CONSISTS OF STANDARD CHARACTERS WITHOUT CLAIM TO ANY PARTICULAR FONT, STYLE, SIZE, OR COLOR.

FOR VIDEO RECORDINGS, DVDS, AUDIO RECORDINGS, MOTION PICTURE FILMS, TELEVISION FILMS, DOWNLOADABLE TELEVISION SHOWS AND MOTION PICTURES, DOWNLOADABLE VIDEO RECORDINGS, DOWNLOADABLE AUDIO RECORDINGS, ALL FEATURING FICTIONAL AND NON-FICTIONAL WORKS; DIGITAL RECORDINGS, NAMELY, HIGH-DEFINITION DVDS, CDS, AND CD-ROMS FEATURING FICTIONAL AND NON-FICTIONAL WORKS; DOWNLOADABLE MUSICAL SOUND RECORDINGS; DOWNLOADABLE RING TONES FOR MOBILE PHONES; DOWNLOADABLE AUDIO RECORDINGS, NAMELY, RINGTONES PRESENTED TO MOBILE COMMUNICATIONS DEVICES VIA WIRELESS NETWORKS; DOWNLOADABLE SCREENSAVERS FOR COMPUTERS AND MOBILE PHONES; DOWNLOADABLE VIDEO RECORDINGS, NAMELY, SCREENSAVERS PRESENTED TO MOBILE COMMUNICATIONS DEVICES VIA WIRELESS NETWORKS (U.S. CLS. 21, 23, 26, 36 AND 38).

RENEE MCCRAY, EXAMINING ATTORNEY

SN 77-754,017. IGT, RENO, NV. FILED 6-8-2009.

RAPID RELOAD

THE MARK CONSISTS OF STANDARD CHARACTERS WITHOUT CLAIM TO ANY PARTICULAR FONT, STYLE, SIZE, OR COLOR.

FOR A FEATURE OF GAMING MACHINES, NAMELY, DEVICES WHICH ACCEPT A WAGER (U.S. CLS. 21, 23, 26, 36 AND 38).

KHANH LE, EXAMINING ATTORNEY

SN 77-754,671. ASIUS TECHNOLOGIES, LLC, LONGMONT,
CO. FILED 6-8-2009.

ADEL

THE MARK CONSISTS OF STANDARD CHARACTERS WITHOUT CLAIM TO ANY PARTICULAR FONT, STYLE, SIZE, OR COLOR.

FOR ACOUSTICALLY ACTUATED PUMPS USED FOR INFLATABLE EAR BUDS; EARPHONE COMPONENTS, NAMELY, INFLATABLE EAR BUDS (U.S. CLS. 21, 23, 26, 36 AND 38).

KEVON CHISOLM, EXAMINING ATTORNEY

CLASS 9—(Continued).

SN 77-755,269. AMERICAN PSYCHOLOGICAL ASSOCIATION, WASHINGTON, DC. FILED 6-9-2009.

CLINICIAN'S RESEARCH DIGEST

THE MARK CONSISTS OF STANDARD CHARACTERS WITHOUT CLAIM TO ANY PARTICULAR FONT, STYLE, SIZE, OR COLOR.

OWNER OF U.S. REG. NO. 1,854,623.

NO CLAIM IS MADE TO THE EXCLUSIVE RIGHT TO USE "DIGEST", APART FROM THE MARK AS SHOWN.

SEC. 2(F) AS TO "CLINICIAN'S RESEARCH".

FOR DOWNLOADABLE ELECTRONIC JOURNALS FEATURING INFORMATION PERTAINING TO THE PSYCHOLOGICAL AND SOCIAL SCIENCES (U.S. CLS. 21, 23, 26, 36 AND 38).

FIRST USE 4-1-2009; IN COMMERCE 4-1-2009.

KATINA MISTER, EXAMINING ATTORNEY

SN 77-757,144. 3 GUYS AND A GIRL LLC, NEW YORK, NY. FILED 6-11-2009.

KRIAN MUSIC GROUP

THE MARK CONSISTS OF STANDARD CHARACTERS WITHOUT CLAIM TO ANY PARTICULAR FONT, STYLE, SIZE, OR COLOR.

NO CLAIM IS MADE TO THE EXCLUSIVE RIGHT TO USE "MUSIC GROUP", APART FROM THE MARK AS SHOWN.

FOR PRE-RECORDED AUDIO TAPES, DISCS AND CASSETTES, VIDEO TAPES, DIGITAL AUDIO AND AUDIO VIDEO TAPES AND DISCS, CDS, DVDS, FEATURING MUSIC AND ENTERTAINMENT IN THE NATURE OF RECORDED MUSIC, MUSIC VIDEOS AND MOVIES, AND PHONOGRAPH RECORDS FEATURING MUSIC; MUSICAL SOUND RECORDINGS AND VIDEO RECORDINGS FEATURING PERFORMANCES OF MUSICAL ARTISTS; DOWNLOADABLE RING TONES, GRAPHICS AND MUSIC VIA A GLOBAL COMPUTER NETWORK AND WIRELESS DEVICES; DOWNLOADABLE MP3S FEATURING MUSIC AND MUSICAL SOUND RECORDINGS; DOWNLOADABLE PHOTOGRAPHS (U.S. CLS. 21, 23, 26, 36 AND 38).

PAULA MAHONEY, EXAMINING ATTORNEY

CLASS 9—(Continued).

SN 77-757,695. STEC, INC., SANTA ANA, CA. FILED 6-11-2009.

MACH8 IOPS

THE MARK CONSISTS OF STANDARD CHARACTERS WITHOUT CLAIM TO ANY PARTICULAR FONT, STYLE, SIZE, OR COLOR.

NO CLAIM IS MADE TO THE EXCLUSIVE RIGHT TO USE "IOPS", APART FROM THE MARK AS SHOWN.

FOR BLANK HARD DRIVES FOR COMPUTERS; COMPUTER FIRMWARE FOR USE IN DATA STORAGE; COMPUTER HARDWARE; COMPUTER HARDWARE FOR HIGH-SPEED PROCESSING AND STORAGE OF DATA USING MULTIPLE CPU'S; COMPUTER MEMORIES; COMPUTER MEMORY HARDWARE; COMPUTER SOFTWARE AND HARDWARE FOR USE IN DATA STORAGE; COMPUTER STORAGE DEVICES, NAMELY, FLASH DRIVES; COMPUTER STORAGE DEVICES, NAMELY, HIGH-SPEED STORAGE SUBSYSTEMS FOR STORAGE AND BACKUP OF ELECTRONIC DATA EITHER LOCALLY OR VIA A TELECOMMUNICATIONS NETWORK; DYNAMIC RANDOM ACCESS MEMORY (DRAM); ELECTRONIC MEMORIES; EXTERNAL COMPUTER HARD DRIVES; FLASH MEMORY CARD; MEMORIES FOR DATA PROCESSING EQUIPMENT; MEMORIES FOR USE WITH COMPUTERS; MEMORY BOARDS; MEMORY CARDS; MEMORY EXPANSION MODULES; REMOVABLE HARD DRIVE BASED COMPUTER BACKUP SYSTEMS (U.S. CLS. 21, 23, 26, 36 AND 38).

FIRST USE 1-2-2008; IN COMMERCE 1-2-2008.

DEZMONA MIZELLE, EXAMINING ATTORNEY

SN 77-758,687. EZCHIP SEMICONDUCTOR LTD., YOKNEAM, ISRAEL, FILED 6-12-2009.

NP-4

THE MARK CONSISTS OF STANDARD CHARACTERS WITHOUT CLAIM TO ANY PARTICULAR FONT, STYLE, SIZE, OR COLOR.

OWNER OF U.S. REG. NO. 2,772,126.

FOR COMPUTER HARDWARE; NETWORK PROCESSOR; SEMICONDUCTOR CHIP (U.S. CLS. 21, 23, 26, 36 AND 38).

HEATHER BIDDULPH, EXAMINING ATTORNEY

CLASS 9—(Continued).

SN 77-759,785. ESSENTIAL SOUND PRODUCTS, INC., ROCHESTER, MI. FILED 6-15-2009.



THE MARK CONSISTS OF THE LETTERS "ESP" IN SCRIPT LETTERING CENTERED, DESCENDING ON A SET OF 5 BARS, SIMILAR TO THE BARS ON WRITTEN MUSIC SHEETS.

FOR A/C POWER CORDS, A/C MULTIPLE POWER OUTLET STRIP, A/C PLUGS AND OUTLETS, A/C POWER LINE CONDITIONERS, A/C POWER SURGE SUPPRESSORS, MALE AND FEMALE IEC ELECTRICAL CONNECTIONS AND JACKS, AND AUDIO AND VIDEO ELECTRONIC CABLES USED TO TRANSMIT SIGNALS BETWEEN ELECTRONIC EQUIPMENT; ALL FOR USE BY THE AUDIO VIDEO ENTERTAINMENT MARKET (U.S. CLS. 21, 23, 26, 36 AND 38).

FIRST USE 1-2-1993; IN COMMERCE 6-12-1995.
CYNTHIA SLOAN, EXAMINING ATTORNEY

SN 77-759,828. ESSENTIAL SOUND PRODUCTS, INC., ROCHESTER, MI. FILED 6-15-2009.

ONE LISTEN, AND NOTHING
ELSE WILL DO.

THE MARK CONSISTS OF STANDARD CHARACTERS WITHOUT CLAIM TO ANY PARTICULAR FONT, STYLE, SIZE, OR COLOR.

FOR A/C POWER CORDS, A/C MULTIPLE POWER OUTLET STRIP, A/C PLUGS AND OUTLETS, A/C POWER LINE CONDITIONERS, A/C POWER SURGE SUPPRESSORS, MALE AND FEMALE IEC ELECTRICAL CONNECTIONS AND JACKS, AND AUDIO AND VIDEO ELECTRONIC CABLES USED TO TRANSMIT SIGNALS BETWEEN ELECTRONIC EQUIPMENT; ALL FOR USE BY THE AUDIO VIDEO ENTERTAINMENT MARKET (U.S. CLS. 21, 23, 26, 36 AND 38).

FIRST USE 1-2-1993; IN COMMERCE 6-12-1995.
CYNTHIA SLOAN, EXAMINING ATTORNEY

CLASS 9—(Continued).

SN 77-760,223. STEC, INC., SANTA ANA, CA. FILED 6-15-2009.

MACH8 MLC

THE MARK CONSISTS OF STANDARD CHARACTERS WITHOUT CLAIM TO ANY PARTICULAR FONT, STYLE, SIZE, OR COLOR.

NO CLAIM IS MADE TO THE EXCLUSIVE RIGHT TO USE "MLC", APART FROM THE MARK AS SHOWN.

FOR BLANK HARD DRIVES FOR COMPUTERS; COMPUTER FIRMWARE FOR USE IN DATA STORAGE; COMPUTER HARDWARE; COMPUTER HARDWARE FOR HIGH-SPEED PROCESSING AND STORAGE OF DATA USING MULTIPLE CPU'S; COMPUTER MEMORIES; COMPUTER MEMORY HARDWARE; COMPUTER SOFTWARE AND HARDWARE FOR USE IN DATA STORAGE; COMPUTER STORAGE DEVICES, NAMELY, FLASH DRIVES; COMPUTER STORAGE DEVICES, NAMELY, HIGH-SPEED STORAGE SUBSYSTEMS FOR STORAGE AND BACKUP OF ELECTRONIC DATA EITHER LOCALLY OR VIA A TELECOMMUNICATIONS NETWORK; DYNAMIC RANDOM ACCESS MEMORY (DRAM); ELECTRONIC MEMORIES; EXTERNAL COMPUTER HARD DRIVES; FLASH MEMORY CARD; MEMORIES FOR DATA PROCESSING EQUIPMENT; MEMORIES FOR USE WITH COMPUTERS; MEMORY BOARDS; MEMORY CARDS; MEMORY EXPANSION MODULES; REMOVABLE HARD DRIVE BASED COMPUTER BACKUP SYSTEMS (U.S. CLS. 21, 23, 26, 36 AND 38).

FIRST USE 1-2-2008; IN COMMERCE 1-2-2008.
DEZMONA MIZELLE, EXAMINING ATTORNEY

SN 77-760,728. GILSON S.A.S., F95400 VILLIERS LE BEL, FRANCE, FILED 6-16-2009.

MACROMAN

THE MARK CONSISTS OF STANDARD CHARACTERS WITHOUT CLAIM TO ANY PARTICULAR FONT, STYLE, SIZE, OR COLOR.

FOR LABORATORY EQUIPMENT, NAMELY, PIPETTE CONTROLLERS AND PARTS AND ACCESSORIES THEREFOR (U.S. CLS. 21, 23, 26, 36 AND 38).

RUSS HERMAN, EXAMINING ATTORNEY

CLASS 9—(Continued).

SN 77-760,926. EMGIE, INC., LOS ANGELES, CA. FILED 6-16-2009.

GOSSY

THE MARK CONSISTS OF STANDARD CHARACTERS WITHOUT CLAIM TO ANY PARTICULAR FONT, STYLE, SIZE, OR COLOR.

FOR SERIES OF MUSICAL SOUND RECORDINGS; SERIES OF AUDIOVISUAL RECORDINGS FEATURING MUSIC; SERIES OF AUDIOVISUAL RECORDINGS FEATURING MUSIC AND DANCE (U.S. CLS. 21, 23, 26, 36 AND 38).

WILLIAM P. SHANAHAN, EXAMINING ATTORNEY

SN 77-761,542. DEL REY, MARIA, HERSHEY, PA. FILED 6-17-2009.

MARIA DEL REY

THE MARK CONSISTS OF STANDARD CHARACTERS WITHOUT CLAIM TO ANY PARTICULAR FONT, STYLE, SIZE, OR COLOR.

THE NAME(S), PORTRAIT(S), AND/OR SIGNATURE(S) SHOWN IN THE MARK IDENTIFIES "MARIA DEL REY", WHOSE CONSENT(S) TO REGISTER IS MADE OF RECORD.

FOR AUDIO AND VIDEO RECORDINGS FEATURING MUSIC (U.S. CLS. 21, 23, 26, 36 AND 38).

FIRST USE 4-6-1992; IN COMMERCE 4-6-1992.
KRISTIN DAHLING, EXAMINING ATTORNEY

SN 77-761,598. REVLON CONSUMER PRODUCTS CORPORATION, NEW YORK, NY. FILED 6-17-2009.

CURLSTAY

THE MARK CONSISTS OF STANDARD CHARACTERS WITHOUT CLAIM TO ANY PARTICULAR FONT, STYLE, SIZE, OR COLOR.

FOR ELECTRIC HAIR CURLING IRONS (U.S. CLS. 21, 23, 26, 36 AND 38).

ODESSA BIBBINS, EXAMINING ATTORNEY

CLASS 9—(Continued).

SN 77-763,147. YANTAI BANTAM REMOTE AUTO INFORMATION SERVICE CO., LTD, YANTAI, CHINA, FILED S.R. 6-18-2009; AM. P.R. 2-6-2010.



NO CLAIM IS MADE TO THE EXCLUSIVE RIGHT TO USE THE NON-LATIN CHARACTERS THAT MEAN "VEHICLE SYSTEM", APART FROM THE MARK AS SHOWN.

THE MARK CONSISTS OF A STYLIZED DESIGN OF THE LETTERS "ARS" WITH BARS ACROSS THE LETTER AND THE NON-LATIN CHARACTERS THAT MEAN "VEHICLE SYSTEM SERVICE NETWORK" IN A RECTANGLE BELOW IT.

THE ENGLISH TRANSLATION OF THE NON-LATIN CHARACTERS IN THE MARK IS "VEHICLE SYSTEM SERVICE NETWORK".

THE NON-LATIN CHARACTERS IN THE MARK TRANSLITERATE TO "QI CHE YUAN CHENG FU WU WANG".

FOR ANTENNAS; FILTERS FOR RADIO INTERFERENCE SUPPRESSION; CONDUCTIVE SILICONE PACKING FOR ELECTRO-MAGNETIC INTERFERENCE; TRANSMITTERS OF ELECTRONIC SIGNALS; ELECTRIC NAVIGATIONAL INSTRUMENTS; RADAR; TELEPHONE TRANSMITTERS; TELECOMMUNICATIONS TRANSMITTERS; VIDEO TELEPHONES; NAVIGATION APPARATUS FOR VEHICLES; PORTABLE TELEPHONES; SATELLITE NAVIGATIONAL SYSTEM, NAMELY, A GLOBAL POSITIONING SYSTEM (GPS); WALKIE-TALKIES; AUDIO-VIDEO RECEIVERS; VEHICLE RADIOS; AMUSEMENT APPARATUS ADAPTED FOR USE WITH AN EXTERNAL DISPLAY SCREEN OR MONITOR; AUTOMATIC ALTITUDE INDICATORS; EMERGENCY SIGNAL TRANSMITTERS; THEFT ALARMS EXCEPT ANTI-THEFT ALARMS FOR VEHICLES; BURGLAR ALARMS EXCEPT ANTI-THEFT ALARMS FOR MOTOR VEHICLES (U.S. CLS. 21, 23, 26, 36 AND 38).

FIRST USE 8-20-2008; IN COMMERCE 12-9-2008.
SALLY SHIH, EXAMINING ATTORNEY

SN 77-763,201. WAGNER, ROBERT M., MCHENRY, IL. FILED 6-18-2009.



NO CLAIM IS MADE TO THE EXCLUSIVE RIGHT TO USE "TRACKING", APART FROM THE MARK AS SHOWN.

THE MARK CONSISTS OF THE WORDS "TRACKING" AND "KEY" IN STYLIZED PRINT WITH A SKELETON KEY THEREWITH.

FOR ELECTRONIC LOCATION AND IMMOBILIZATION DEVICES INSTALLED AFTER PURCHASE FOR USE WITH VEHICLES; ELECTRONIC NAVIGATIONAL AND POSITIONING APPARATUS AND INSTRUMENTS; GLOBAL POSITIONING SYSTEM; GLOBAL POSITIONING SYSTEM (GPS) (U.S. CLS. 21, 23, 26, 36 AND 38).

FIRST USE 3-31-2007; IN COMMERCE 3-31-2007.
PAULA MAHONEY, EXAMINING ATTORNEY

CLASS 9—(Continued).

SN 77-763,515. DISNEY ENTERPRISES, INC., BURBANK, CA. FILED 6-18-2009.

MICKEY BY...

THE MARK CONSISTS OF STANDARD CHARACTERS WITHOUT CLAIM TO ANY PARTICULAR FONT, STYLE, SIZE, OR COLOR.

OWNER OF U.S. REG. NOS. 315,056, 3,115,395 AND OTHERS.

FOR AUDIO AND VIDEO RECORDINGS FEATURING ARTWORK AND ANIMATION; VIDEO GAME CARTRIDGES; VIDEO GAME DISCS; VIDEO GAME SOFTWARE; COMPUTER GAME CARTRIDGES; COMPUTER GAME DISCS; COMPUTER GAME SOFTWARE; CONSUMER ELECTRONICS, NAMELY, DVD PLAYERS, DVD RECORDERS, ELECTRONIC PERSONAL ORGANIZERS, PERSONAL STEREOs, VIDEO PLAYERS, PERSONAL VIDEO PLAYERS, PERSONAL DIGITAL ASSISTANTS, PRINTERS, RADIOS, TELEPHONES, TELEVISION SETS, VIDEO CAMERAS, VIDEO RECORDERS, VIDEO CASSETTE RECORDERS, COMPACT DISC PLAYERS, COMPACT DISC RECORDERS, HEADPHONES, KARAOKE MACHINES, LOUDSPEAKERS, MICROPHONES, MP3 PLAYERS, MODEMS, CALCULATORS, CAMCORDERS, CAMERAS, VIDEO CASSETTE PLAYERS; EYEGLASSES AND SUNGLASSES AND ACCESSORIES THEREFOR, NAMELY, CHAINS, CASES AND ORNAMENTATION; DECORATIVE REFRIGERATOR MAGNETS (U.S. CLS. 21, 23, 26, 36 AND 38).

JASON TURNER, EXAMINING ATTORNEY

SN 77-763,712. BLUEFOCUS MEDIA, SAVANNAH, GA. FILED 6-19-2009.



NO CLAIM IS MADE TO THE EXCLUSIVE RIGHT TO USE "TOURIST ASSISTANCE PORTAL", APART FROM THE MARK AS SHOWN.

THE COLOR(S) RED AND WHITE IS/ARE CLAIMED AS A FEATURE OF THE MARK.

THE MARK CONSISTS OF A RED CIRCLE CONTAINING THE WHITE LETTERING OF THE WORDS "TAP TOURIST ASSISTANCE PORTAL".

FOR COMPUTER SOFTWARE FOR TOUCH SCREEN KIOSKS FOR THE TOURISM INDUSTRY (U.S. CLS. 21, 23, 26, 36 AND 38).

JENNIFER VASQUEZ, EXAMINING ATTORNEY

CLASS 9—(Continued).

SN 77-764,464. FRANKS, STANLEY, SCHENECTADY, NY. AND PELAEZ, MICHAEL, SCHENECTADY, NY. FILED 6-19-2009.

Mustard
Seed ↗

THE MARK CONSISTS OF A CHRISTIAN CROSS THAT IS TO THE RIGHT OF THE WORDS "MUSTARD SEED" AND THAT SLANTS TO THE RIGHT.

FOR COMPACT DISCS FEATURING MUSIC; DOWNLOADABLE MP3 FILES, MP3 RECORDINGS, WEBCASTS AND PODCASTS FEATURING MUSIC (U.S. CLS. 21, 23, 26, 36 AND 38).

KEVON CHISOLM, EXAMINING ATTORNEY

SN 77-764,480. THE WEST AMERICAN CORPORATION, LAYTON, UT. FILED 6-19-2009.



THE MARK CONSISTS OF A GRAPHIC REPRESENTATION OF A HOUSE WITH A GRAPHIC REPRESENTATION OF AN AUDIO SPEAKER DRIVER WITHIN THE HOUSE.

FOR HOME AUDIO EQUIPMENT, NAMELY, AUDIO SPEAKERS, SUBWOOFERS, SWITCHES IN THE NATURE OF SPEAKER SELECTORS, IN-WALL SPEAKERS, IN-CEILING SPEAKERS, OUTDOOR SPEAKERS, ELECTRONIC VOLUME CONTROLS, IN-CEILING SPEAKER BOXES; INFRARED LIGHT TRANSMITTERS AND INFRARED LIGHT RECEIVERS FOR USE WITH HOME AUDIO EQUIPMENT (U.S. CLS. 21, 23, 26, 36 AND 38).

FIRST USE 6-30-2006; IN COMMERCE 6-30-2006.
KATHERINE CHANG, EXAMINING ATTORNEY

CLASS 9—(Continued).

SN 77-765,610. VITEK INDUSTRIAL PRODUCTS, INC., VALENCIA, CA. FILED 6-22-2009.

VITEK

THE MARK CONSISTS OF STANDARD CHARACTERS WITHOUT CLAIM TO ANY PARTICULAR FONT, STYLE, SIZE, OR COLOR.

FOR INTERNET PROTOCOL SURVEILLANCE PRODUCTS, NAMELY, INTERNET PROTOCOL SERVERS AND CAMERAS; DIGITAL VIDEO RECORDERS; INTEGRATED SPEED DOME CAMERAS AND CONTROLLERS; DOME CAMERAS; CAMERAS; INFRARED CAMERAS; VIDEO MONITORS; SECURITY SYSTEMS COMPRISING MATRIX SWITCHERS, SEQUENTIAL SWITCHERS, VIDEO DISTRIBUTION AMPLIFIERS FOR AUDIO AND VIDEO SIGNALS, TWISTED PAIR TRANSCEIVERS, DATA DISTRIBUTION AMPLIFIERS FOR AUDIO AND VIDEO SIGNALS, ACTIVE AND PASSIVE UNSHIELDED TWISTED PAIR COMMUNICATION HUBS; AND CAMERA AND VIDEO ACCESSORIES, NAMELY, MOUNTING DEVICES FOR CAMERAS AND MONITORS AND BOXES SPECIALLY ADAPTED TO HOUSE CAMERAS, LCD MONITOR MOUNTING DEVICES, CAMERA LENSES, POWER TRANSFORMERS FOR AMPLIFICATION AND ELECTRICAL POWER CONNECTORS (U.S. CLS. 21, 23, 26, 36 AND 38).

FIRST USE 5-0-1997; IN COMMERCE 5-0-1997.
JILL PRATER, EXAMINING ATTORNEY

SN 77-766,344. TREK 2000 INTERNATIONAL LTD, LOYANG IND. ESTATE, SINGAPORE, FILED 6-23-2009.

HOLICARD

THE MARK CONSISTS OF STANDARD CHARACTERS WITHOUT CLAIM TO ANY PARTICULAR FONT, STYLE, SIZE, OR COLOR.

FOR COMPUTER HARDWARE AND PERIPHERALS; COMPUTER ACCELERATOR, EXPANSION, GRAPHICS AND INTERFACE BOARDS AND CHIPS; LOCAL AREA NETWORK CARDS, NAMELY, SOLID STATE DRIVE CARDS FOR CONNECTING PORTABLE COMPUTER DEVICES TO COMPUTER NETWORKS, COMPUTER DISK DRIVES; COMPUTER DISKS, NAMELY, BLANK CD-ROMS AND BLANK HD-DVD DISCS; BLANK COMPUTER DISC TAPES; MEDIA, NAMELY, BLANK DVDS, BLANK AUDIO CASSETTES, AND WIRELESS EXTERNAL COMPUTER STORAGE DEVICES, NAMELY, USB FLASH DRIVE, OPTICAL DISK DRIVES, NAMELY, OPTICAL PICK-UP DRIVE, OPTICAL DRIVE AND FLASH DRIVES; ALL FOR THE ACQUISITION, RECORDING, PROCESSING, TRANSMISSION, STORAGE OR OUTPUT OF SOUND, IMAGES AND/OR DATA (U.S. CLS. 21, 23, 26, 36 AND 38).

BENJAMIN OKEKE, EXAMINING ATTORNEY

CLASS 9—(Continued).

SN 77-766,437. PACIFIC SAFETY PRODUCTS INC., KELOWNA, CANADA, FILED 6-23-2009.

READY IS THE ONLY OPTION

THE MARK CONSISTS OF STANDARD CHARACTERS WITHOUT CLAIM TO ANY PARTICULAR FONT, STYLE, SIZE, OR COLOR.

FOR BULLET-RESISTANT HARD AND SOFT BODY ARMOUR, NAMELY, BULLET RESISTANT PANELS, STAB RESISTANT PANELS, COMBINATION STAB/BALLISTIC RESISTANT PANELS, CONCEALABLE VESTS, OUTER VESTS, RESCUE VESTS, TACTICAL VESTS, LOAD-BEARING VESTS, MILITARY VESTS, FRAGMENTATION VESTS, COMBINATION BALLISTIC/FLOTATION VESTS, MEDICAL AND PARAMEDIC PROTECTION VESTS, BULLET-RESISTANT JACKETS, RAPID ENTRY VESTS, CARRIERS FOR BULLET-RESISTANT VESTS; HARD ARMOUR FOR BULLET RESISTANT VESTS AND CLOTHING, NAMELY, PLATES; TRAUMA PADS, NAMELY, SHAPED FOAM WORN UNDER AND OVER BODY ARMOR TO REDUCE THE SHOCK ON THE BODY OF IMPACTS TO THE ARMOR; PROTECTIVE HELMETS (U.S. CLS. 21, 23, 26, 36 AND 38).

GISELLE AGOSTO, EXAMINING ATTORNEY

SN 77-766,819. OWEN, JOSHUA R., ATLANTA, GA. FILED 6-24-2009.

JAKE OWEN

THE MARK CONSISTS OF STANDARD CHARACTERS WITHOUT CLAIM TO ANY PARTICULAR FONT, STYLE, SIZE, OR COLOR.

THE NAME(S), PORTRAIT(S), AND/OR SIGNATURE(S) SHOWN IN THE MARK IDENTIFIES THE PROFESSIONAL NAME OF "JOSHUA R. OWEN", WHOSE CONSENT(S) TO REGISTER IS MADE OF RECORD.

FOR SOUND RECORDINGS FEATURING MUSIC (U.S. CLS. 21, 23, 26, 36 AND 38).

FIRST USE 7-25-2006; IN COMMERCE 7-25-2006.
ROBIN CHOSID, EXAMINING ATTORNEY

CLASS 9—(Continued).

SN 77-766,877. BOUSQUET ENTERPRISES LLC, FREDERICKSBURG, VA. FILED 6-24-2009.

UNKNOWN LADY

THE MARK CONSISTS OF STANDARD CHARACTERS WITHOUT CLAIM TO ANY PARTICULAR FONT, STYLE, SIZE, OR COLOR.

FOR COMPACT DISCS FEATURING INSTRUCTIONS FOR COMPUTER CONTROLLED SEWING MACHINES (U.S. CLS. 21, 23, 26, 36 AND 38).

FIRST USE 9-23-2008; IN COMMERCE 9-23-2008.
CHRISTINE COOPER, EXAMINING ATTORNEY

SN 77-767,119. BOUSQUET ENTERPRISES LLC, FREDERICKSBURG, VA. FILED 6-24-2009.

ELIZABETH

THE STIPPLING IS FOR SHADING PURPOSES. THE NAME(S), PORTRAIT(S), AND/OR SIGNATURE(S) SHOWN IN THE MARK DOES NOT IDENTIFY A PARTICULAR LIVING INDIVIDUAL.

THE MARK CONSISTS OF THE WORD "ELIZABETH" WITH THE ROMAN NUMERAL "I" CROSSING THE WORD "ELIZABETH" BETWEEN THE LETTERS "A" AND "B".

FOR COMPACT DISCS FEATURING INSTRUCTIONS FOR COMPUTER CONTROLLED SEWING MACHINES (U.S. CLS. 21, 23, 26, 36 AND 38).

FIRST USE 9-23-2008; IN COMMERCE 9-23-2008.
CHRISTINE COOPER, EXAMINING ATTORNEY

CLASS 9—(Continued).

SN 77-767,384. OWN LLC, WESTLAKE VILLAGE, CA. FILED 6-24-2009.

OWN

THE MARK CONSISTS OF THE ACRONYM "OWN" IN STYLIZED LETTERS.

FOR PRERECORDED AUDIOVISUAL RECORDINGS, AUDIOTAPES, VIDEOTAPES, VIDEO DISCS, COMPACT DISCS, DVDS AND MULTIMEDIA SOFTWARE RECORDED ON CD-ROM, ALL FEATURING SUBJECTS OF GENERAL HUMAN INTEREST; ELECTRONIC LEARNING GAMES IN THE NATURE OF ELECTRONIC GAME SOFTWARE FOR EDUCATIONAL PURPOSES; VIDEO GAME DISCS; COMPUTER GAME DISCS; ELECTRONIC GAME PROGRAMS; DOWNLOADABLE RING TONES, GRAPHICS, RING BACKS, ANIMATED RINGERS, VIDEO RINGERS AND ANIMATED SCREENSAVERS VIA THE INTERNET AND WIRELESS DEVICES; DIGITAL MEDIA, NAMELY, DOWNLOADABLE PRERECORDED VIDEO CLIPS, PRERECORDED AUDIO CLIPS, TEXT AND GRAPHICS HELD IN ELECTRONIC PERSONAL COMPUTERS AND HANDHELD WIRELESS DEVICES, ALL FEATURING SUBJECTS OF GENERAL HUMAN INTEREST; SUNGLASSES (U.S. CLS. 21, 23, 26, 36 AND 38).

LINDA M. KING, EXAMINING ATTORNEY

SN 77-767,700. TAZZLE, INC., FRANKLIN, TN. FILED 6-24-2009.

TAZZLE

THE MARK CONSISTS OF STANDARD CHARACTERS WITHOUT CLAIM TO ANY PARTICULAR FONT, STYLE, SIZE, OR COLOR.

FOR COMPUTER HARDWARE AND SOFTWARE TO TRANSFER DATA BETWEEN MOBILE DEVICES AND COMPUTERS, COMPUTER PERIPHERALS, DIGITAL CAMERAS, AND OTHER CONSUMER DIGITAL DEVICES, NAMELY, SMARTPHONE DEVICES AND DIGITAL AUDIO PLAYERS (U.S. CLS. 21, 23, 26, 36 AND 38).

BENJAMIN OKEKE, EXAMINING ATTORNEY

CLASS 9—(Continued).

SN 77-768,586. CLEARONE COMMUNICATIONS, SALT LAKE CITY, UT. FILED 6-25-2009.

**WE PUT THE WORLD ON
SPEAKING TERMS**

THE MARK CONSISTS OF STANDARD CHARACTERS WITHOUT CLAIM TO ANY PARTICULAR FONT, STYLE, SIZE, OR COLOR.

OWNER OF U.S. REG. NO. 2,253,287.
FOR ELECTRONIC HARDWARE, NAMELY, LOUD-SPEAKERS, SPEAKERPHONES, TELEPHONE INTERFACES AND MICROPHONES AND COMPUTER SOFTWARE AND FIRMWARE FOR AUDIO CONFERENCING AND AUDIO PROCESSING (U.S. CLS. 21, 23, 26, 36 AND 38).

FIRST USE 4-20-2007; IN COMMERCE 4-20-2007.
ADA HAN, EXAMINING ATTORNEY

SN 77-771,462. JONES, WILLIAM P., KIRKLAND, WA. FILED 6-30-2009.

Planz

THE MARK CONSISTS OF STANDARD CHARACTERS WITHOUT CLAIM TO ANY PARTICULAR FONT, STYLE, SIZE, OR COLOR.

FOR COMPUTER SOFTWARE FOR CREATING SEARCHABLE DATABASES OF INFORMATION AND DATA; COMPUTER SOFTWARE FOR MANIPULATING DIGITAL AUDIO INFORMATION FOR USE IN AUDIO MEDIA APPLICATIONS; COMPUTER SOFTWARE FOR ORGANIZING AND VIEWING DIGITAL IMAGES AND PHOTOGRAPHS; COMPUTER SOFTWARE FOR THE COLLECTION, EDITING, ORGANIZING, MODIFYING, BOOK MARKING, TRANSMISSION, STORAGE AND SHARING OF DATA AND INFORMATION (U.S. CLS. 21, 23, 26, 36 AND 38).

MARC LEIPZIG, EXAMINING ATTORNEY

SN 77-772,656. CELLCO PARTNERSHIP, DBA VERIZON WIRELESS, BASKING RIDGE, NJ. FILED 7-1-2009.

JOYRIDE

THE MARK CONSISTS OF STANDARD CHARACTERS WITHOUT CLAIM TO ANY PARTICULAR FONT, STYLE, SIZE, OR COLOR.

FOR WIRELESS COMMUNICATIONS DEVICE FEATURING VOICE, DATA AND IMAGE TRANSMISSION INCLUDING VOICE, TEXT AND PICTURE MESSAGING, A VIDEO AND STILL IMAGE CAMERA AND AN MP3 MUSIC PLAYER (U.S. CLS. 21, 23, 26, 36 AND 38).

SARA THOMAS, EXAMINING ATTORNEY

CLASS 9—(Continued).

SN 77-773,524. CELLCO PARTNERSHIP, DBA VERIZON WIRELESS, BASKING RIDGE, NJ. FILED 7-2-2009.

ENLIGHTEN

THE MARK CONSISTS OF STANDARD CHARACTERS WITHOUT CLAIM TO ANY PARTICULAR FONT, STYLE, SIZE, OR COLOR.

FOR WIRELESS COMMUNICATIONS DEVICE FEATURING VOICE, DATA AND IMAGE TRANSMISSION INCLUDING VOICE, TEXT AND PICTURE MESSAGING, A VIDEO AND STILL IMAGE CAMERA AND AN MP3 MUSIC PLAYER (U.S. CLS. 21, 23, 26, 36 AND 38).

SARA THOMAS, EXAMINING ATTORNEY

SN 77-774,997. BILLBOARD VIDEO, INC., DBA MULTIMEDIA LED, INC., CORONA, CA. FILED 7-6-2009.

DIGITAL BUS KING

THE MARK CONSISTS OF STANDARD CHARACTERS WITHOUT CLAIM TO ANY PARTICULAR FONT, STYLE, SIZE, OR COLOR.

NO CLAIM IS MADE TO THE EXCLUSIVE RIGHT TO USE "DIGITAL BUS", APART FROM THE MARK AS SHOWN.

FOR DISPLAYS, NAMELY, PROGRAMMABLE, LUMINOUS SIGNS FOR USE ON VEHICLES (U.S. CLS. 21, 23, 26, 36 AND 38).

SKYE YOUNG, EXAMINING ATTORNEY

SN 77-777,289. VICTOR DECASTRO, FAIRFIELD, CT. FILED 7-9-2009.

UNIDESIGN

THE MARK CONSISTS OF "UNIDESIGN" NAME WITH A BIG DOT ON TOP OF THE FIRST LETTER "I".
FOR COMPUTER SOFTWARE FOR GENERATING TYPE FONTS (U.S. CLS. 21, 23, 26, 36 AND 38).

FIRST USE 7-9-2009; IN COMMERCE 7-9-2009.
KAREN BRACEY, EXAMINING ATTORNEY

CLASS 9—(Continued).

SN 77-777,511. CELLCO PARTNERSHIP, DBA VERIZON WIRELESS, BASKING RIDGE, NJ. FILED 7-9-2009.

ILLUSION

THE MARK CONSISTS OF STANDARD CHARACTERS WITHOUT CLAIM TO ANY PARTICULAR FONT, STYLE, SIZE, OR COLOR.

FOR WIRELESS COMMUNICATIONS DEVICE FEATURING VOICE, DATA AND IMAGE TRANSMISSION INCLUDING VOICE, TEXT AND PICTURE MESSAGING, A VIDEO AND STILL IMAGE CAMERA AND AN MP3 MUSIC PLAYER (U.S. CLS. 21, 23, 26, 36 AND 38).

SARA THOMAS, EXAMINING ATTORNEY

SN 77-779,210. BENION, WILLIAM ANTHONY, AKA WHISKIFYRE, JOLIET, IL. FILED S.R. 7-12-2009; AM. P.R. 3-11-2010.

whiskifyre

THE MARK CONSISTS OF STANDARD CHARACTERS WITHOUT CLAIM TO ANY PARTICULAR FONT, STYLE, SIZE, OR COLOR.

FOR COMPACT DISCS FEATURING MUSIC; DIGITAL MUSIC DOWNLOADABLE FROM THE INTERNET (U.S. CLS. 21, 23, 26, 36 AND 38).

VIVIAN MICZNIK FIRST, EXAMINING ATTORNEY

SN 77-779,763. COOPER US, INC., HOUSTON, TX. FILED 7-13-2009.



OWNER OF U.S. REG. NOS. 372,127, 2,015,393 AND OTHERS.

THE MARK CONSISTS OF THE WORD "EDISON" WITH HORIZONTAL LINES BEHIND THE "DISON" PORTION AND A BLACK BOX OUTLINE AROUND THE ENTIRE WORD AND DESIGN.

FOR ELECTRICAL FUSES; ELECTRICAL FUSE BOXES; ELECTRICAL POWER DISTRIBUTION BLOCKS; ELECTRIC FUSE PARTS AND ACCESSORIES, NAMELY, FUSE HOLDERS, FUSE CLIPS, FUSE COVERS, CIRCUIT OVERLOAD PROTECTORS, FUSE PULLERS, FUSE REDUCERS (U.S. CLS. 21, 23, 26, 36 AND 38).

KIMBERLY FRYE, EXAMINING ATTORNEY

CLASS 9—(Continued).

SN 77-779,781. COOPER US, INC., HOUSTON, TX. FILED 7-13-2009.



OWNER OF U.S. REG. NOS. 372,127, 2,015,393 AND OTHERS.

THE MARK CONSISTS OF THE WORD "EDISON" SURROUNDED BY A BLACK BOX OUTLINE.

FOR ELECTRICAL FUSES; ELECTRICAL FUSE BOXES; ELECTRICAL POWER DISTRIBUTION BLOCKS; ELECTRIC FUSE PARTS AND ACCESSORIES, NAMELY, FUSE HOLDERS, FUSE CLIPS, FUSE COVERS, CIRCUIT OVERLOAD PROTECTORS, FUSE PULLERS, FUSE REDUCERS (U.S. CLS. 21, 23, 26, 36 AND 38).

KIMBERLY FRYE, EXAMINING ATTORNEY

SN 77-782,823. MJ CARE, INC., MILWAUKEE, WI. FILED 7-16-2009.



NO CLAIM IS MADE TO THE EXCLUSIVE RIGHT TO USE "PRO 9.1", APART FROM THE MARK AS SHOWN.

THE COLOR(S) PURPLE, GREEN AND BLACK IS/ARE CLAIMED AS A FEATURE OF THE MARK.

THE MARK CONSISTS OF THE WORD "SIMPLY" IN PURPLE, LOWER CASE, JOURNAL FONT, ON THE TOP LEFT OF THE LETTERS "SBS" IN BOLD, GREEN, BELOW THE LAST "S" IS "PRO 9.1" IN BLACK; ABOVE THE WORDS IS THE OUTLINE OF AN APPLE TOP WITH LEAF IN GREEN.

FOR COMPUTER PROGRAMS FOR USE AS A SPREAD SHEET AND DATA GATHERING FOR BILLING (U.S. CLS. 21, 23, 26, 36 AND 38).

FIRST USE 6-1-2009; IN COMMERCE 7-1-2009.

JOHN DALIER, EXAMINING ATTORNEY

CLASS 9—(Continued).

SN 77-784,951. REVITALEYES, LLC, LAWRENCE, KS.
FILED 7-20-2009.



THE COLOR(S) WHITE AND BLUE IS/ARE CLAIMED AS A FEATURE OF THE MARK.

THE MARK CONSISTS OF A PERSON WITH SPREAD ARMS IN WHITE AND AN EYE REPRESENTING THE SUN IN WHITE WITH THE WORDS "REVITALVISION" IN WHITE ON A BLUE BACKGROUND.

FOR MEDICAL SOFTWARE FOR THE NEUROLOGICAL IMPROVEMENT IN VISION (U.S. CLS. 21, 23, 26, 36 AND 38).

FIRST USE 7-20-2009; IN COMMERCE 7-20-2009.
MICHELE SWAIN, EXAMINING ATTORNEY

SN 77-785,500. ESCO TECHNOLOGIES (ASIA) PTE LTD,
486777, SINGAPORE, FILED 7-21-2009.

Isotherm

THE MARK CONSISTS OF THE WORDING "ISOTHERM" IN STYLIZED FONT.

FOR LABORATORY OVENS AND INCUBATORS (U.S. CLS. 21, 23, 26, 36 AND 38).

TASNEEM HUSSAIN, EXAMINING ATTORNEY

SN 77-785,548. ESCO TECHNOLOGIES (ASIA) PTE LTD,
486777, SINGAPORE, FILED 7-21-2009.

Sentinel

THE MARK CONSISTS OF THE WORDING "SENTINEL" IN STYLIZED FONT.

FOR MICROPROCESSOR CONTROL SYSTEMS COMPRISING HARDWARE, SOFTWARE AND LED PANELS TO MONITOR OPERATING CONDITIONS FOR LABORATORY EQUIPMENT AND TO ALERT OPERATORS OF VARIANCES IN OPERATING CONDITIONS SO THAT ADJUSTMENTS CAN BE MADE OR DANGEROUS CONDITIONS IN OPERATION OF LABORATORY EQUIPMENT CAN BE AVOIDED (U.S. CLS. 21, 23, 26, 36 AND 38).

FIRST USE 12-0-2004; IN COMMERCE 3-0-2005.
TASNEEM HUSSAIN, EXAMINING ATTORNEY

CLASS 9—(Continued).

SN 77-786,216. CLEARONE COMMUNICATIONS, SALT LAKE CITY, UT. FILED 7-21-2009.

RAV

THE MARK CONSISTS OF STANDARD CHARACTERS WITHOUT CLAIM TO ANY PARTICULAR FONT, STYLE, SIZE, OR COLOR.

FOR ELECTRONIC HARDWARE, NAMELY, AUDIO MIXERS, LOUDSPEAKERS, MICROPHONES, TELEPHONE INTERFACES FOR AUDIO CONFERENCING AND AUDIO PROCESSING (U.S. CLS. 21, 23, 26, 36 AND 38).

FIRST USE 11-30-2004; IN COMMERCE 11-30-2004.
ADA HAN, EXAMINING ATTORNEY

SN 77-786,741. INTELITEK, INC, MANCHESTER, NH. FILED 7-22-2009.

THE COLOR(S) RED, BLACK AND GRAY IS/ARE CLAIMED AS A FEATURE OF THE MARK.

THE MARK CONSISTS OF THE WORD "LEARNMATE" WITH A SWIRL BEHIND THE LETTERS "MA". THE LETTERS "LEARN" APPEAR IN RED; THE LETTERS "MATE" APPEAR IN BLACK; AND THE SWIRL APPEARS IN GRAY.

FOR COMPUTER PROGRAMS FOR DISTANCE LEARNING AND TRAINING IN THE FIELDS OF ENGINEERING AND MANUFACTURING TECHNOLOGY AND FOR STUDENT AND CLASS MANAGEMENT; EDUCATIONAL SOFTWARE FEATURING INSTRUCTION IN ENGINEERING AND MANUFACTURING TECHNOLOGY (U.S. CLS. 21, 23, 26, 36 AND 38).

FIRST USE 6-1-2002; IN COMMERCE 6-1-2002.
PRISCILLA MILTON, EXAMINING ATTORNEY

CLASS 9—(Continued).

SN 77-786,825. SONY CORPORATION, TOKYO, JAPAN,
FILED 7-22-2009.



NO CLAIM IS MADE TO THE EXCLUSIVE RIGHT TO USE "PIXELS", APART FROM THE MARK AS SHOWN.

THE MARK CONSISTS OF A VERTICAL RECTANGLE COMPRISED OF TWELVE SQUARES AND THE WORDING "12 PIXELS".

FOR PERSONAL COMPUTERS, MOBILE PHONES, APPLICATION SOFTWARE WHICH ENABLES DRAWING PIXEL BASED IMAGERY, TELEVISIONS SETS (U.S. CLS. 21, 23, 26, 36 AND 38).

MARILYN IZZI, EXAMINING ATTORNEY

SN 77-789,098. DNASTAR, INC., MADISON, WI. FILED 7-24-2009.

SEQMAN

THE MARK CONSISTS OF STANDARD CHARACTERS WITHOUT CLAIM TO ANY PARTICULAR FONT, STYLE, SIZE, OR COLOR.

FOR SOFTWARE FOR STORING, ANALYZING AND VISUALIZING DATA RELATING TO NUCLEIC ACID SEQUENCES (U.S. CLS. 21, 23, 26, 36 AND 38).

FIRST USE 12-31-1982; IN COMMERCE 12-31-1982.

DANIEL CAPSHAW, EXAMINING ATTORNEY

SN 77-789,109. DNASTAR, INC., MADISON, WI. FILED 7-24-2009.

NGEN

THE MARK CONSISTS OF STANDARD CHARACTERS WITHOUT CLAIM TO ANY PARTICULAR FONT, STYLE, SIZE, OR COLOR.

FOR SOFTWARE FOR STORING, ANALYZING AND VISUALIZING DATA RELATING TO NUCLEIC ACID SEQUENCES (U.S. CLS. 21, 23, 26, 36 AND 38).

FIRST USE 6-23-2008; IN COMMERCE 6-23-2008.

DANIEL CAPSHAW, EXAMINING ATTORNEY

CLASS 9—(Continued).

SN 77-789,115. DNASTAR, INC., MADISON, WI. FILED 7-24-2009.

QSEQ

THE MARK CONSISTS OF STANDARD CHARACTERS WITHOUT CLAIM TO ANY PARTICULAR FONT, STYLE, SIZE, OR COLOR.

FOR SOFTWARE FOR MANIPULATING DATA RELATING TO NUCLEIC ACID SEQUENCES (U.S. CLS. 21, 23, 26, 36 AND 38).

FIRST USE 11-12-2008; IN COMMERCE 11-12-2008.

DANIEL CAPSHAW, EXAMINING ATTORNEY

SN 77-791,523. SWISS PRECISION INSTRUMENTS, INC., GARDEN GROVE, CA. FILED 7-28-2009.

CERTIFIED RIGHT OUT OF THE BOX

THE MARK CONSISTS OF STANDARD CHARACTERS WITHOUT CLAIM TO ANY PARTICULAR FONT, STYLE, SIZE, OR COLOR.

FOR PRECISION TOOL MEASURING INSTRUMENTS AND TOOL MEASURING INSTRUMENTS, NAMELY, MICROMETERS, DIAL CALIPERS, VERNIER CALIPERS, DIGITAL CALIPERS, DIAL TEST INDICATORS, CYLINDER BORE GAUGES, DIAL THICKNESS GAUGES, COUNTERBORE AND COUNTERSINK GAUGES, HEIGHT GAUGES, CENTER LINE GAUGES, SURFACE GAUGES, INDICATOR HOLDERS AND STANDS, PLANER AND SHAPER GAUGES, RADIUS GAUGES, SCREW PITCH GAUGES, COORDINATE MEASURING MACHINE, STYLI MOUNTED TO MEASURING INSTRUMENTS TO MEASURE DISTANCE, OPTICAL INSPECTION MICROSCOPES AND MAGNIFIERS AND COMPARATORS, GAUGE BLOCKS, FILLET GAUGES, DEPTH GAUGES, GRADUATED MEASURING RULERS, STEEL FOLDING MEASURING RULERS, PROTRACTORS, GAGE BALLS, SET-UP PARALLELS, ANGLE PLATES, VEE-BLOCKS, EDGE AND CENTER FINDERS, FEELER GAGES, PIN GAGES, SCREW PITCH PLUG AND RING GAGES, SOLID AND ADJUSTABLE SQUARES, CALIPERS AND DIVIDERS, HARDNESS TESTERS, PRECISION LEVELS, TACHOMETERS, COATING THICKNESS GAUGES, ULTRASONIC THICKNESS GAUGES, FINISH COMPARATOR PLATES, SURFACE ROUGHNESS TESTERS, AND COMPONENT PARTS USED WITH THE ABOVE GOODS (U.S. CLS. 21, 23, 26, 36 AND 38).

RON FAIRBANKS, EXAMINING ATTORNEY

CLASS 9—(Continued).

SN 77-791,830. STENOGRAPH, L.L.C., ELMHURST, IL. FILED 7-29-2009.

TrueStroke

THE MARK CONSISTS OF STANDARD CHARACTERS WITHOUT CLAIM TO ANY PARTICULAR FONT, STYLE, SIZE, OR COLOR.

FOR ALGORITHMIC SOFTWARE PROGRAMS FOR DETECTING KEY STROKES RELATED TO SHORT-HAND MACHINE WRITING (U.S. CLS. 21, 23, 26, 36 AND 38).

FIRST USE 7-2-2009; IN COMMERCE 7-20-2009.
ANNE E. GUSTASON, EXAMINING ATTORNEY

CLASS 9—(Continued).

SN 77-804,982. IDAHO TECHNOLOGY, INC., SALT LAKE CITY, UT. FILED 8-14-2009.

MAKE FOOD SAFE

THE MARK CONSISTS OF STANDARD CHARACTERS WITHOUT CLAIM TO ANY PARTICULAR FONT, STYLE, SIZE, OR COLOR.

FOR ANALYTICAL INSTRUMENTS, NAMELY, A LABORATORY INSTRUMENT COMBINING A RAPID AIR THERMOCYCLING APPARATUS AND A FLUORIMETER FOR USE IN FOOD TESTING (U.S. CLS. 21, 23, 26, 36 AND 38).

FIRST USE 8-14-2009; IN COMMERCE 8-14-2009.
ANDREW RHIM, EXAMINING ATTORNEY

SN 77-795,320. DISNEY ENTERPRISES, INC., BURBANK, CA. FILED 8-3-2009.

IRON WEASEL

THE MARK CONSISTS OF STANDARD CHARACTERS WITHOUT CLAIM TO ANY PARTICULAR FONT, STYLE, SIZE, OR COLOR.

FOR AUDIO AND VIDEO RECORDINGS FEATURING TELEVISION PROGRAMMING FOR CHILDREN AND MUSICAL PERFORMANCES; VIDEO GAME CARTRIDGES; VIDEO GAME DISCS; VIDEO GAME SOFTWARE; COMPUTER GAME CARTRIDGES; COMPUTER GAME DISCS; COMPUTER GAME SOFTWARE; CONSUMER ELECTRONICS, NAMELY, DVD PLAYERS, DVD RECORDERS, ELECTRONIC PERSONAL ORGANIZERS, PERSONAL STEREOs, VIDEO PLAYERS, PERSONAL VIDEO PLAYERS, PERSONAL DIGITAL ASSISTANTS, PRINTERS, RADIOS, TELEPHONES, TELEVISION SETS, VIDEO CAMERAS, VIDEO RECORDERS, VIDEO CASSETTE RECORDERS, COMPACT DISC PLAYERS, COMPACT DISC RECORDERS, HEADPHONES, KARAOKE MACHINES, LOUDSPEAKERS, MICROPHONES, MP3 PLAYERS, MODEMS, CALCULATORS, CAMCORDERS, CAMERAS, VIDEO CASSETTE PLAYERS; EYEGASSES AND SUNGLASSES AND ACCESSORIES THEREFOR, NAMELY, CASES, CHAINS AND ORNAMENTS; DECORATIVE REFRIGERATOR MAGNETS (U.S. CLS. 21, 23, 26, 36 AND 38).
JASON TURNER, EXAMINING ATTORNEY

SN 77-805,675. SPEEDO HOLDINGS BV, 1082 MD AMSTERDAM, NETHERLANDS, FILED 8-17-2009.

SPEEDO AQUASHOT

THE MARK CONSISTS OF STANDARD CHARACTERS WITHOUT CLAIM TO ANY PARTICULAR FONT, STYLE, SIZE, OR COLOR.

PRIORITY CLAIMED UNDER SEC. 44(D) ON ERPNCMNTY TM OFC APPLICATION NO. 008485971, FILED 8-12-2009, REG. NO. 008485971, DATED 2-10-2010, EXPIRES 8-12-2019.

OWNER OF U.S. REG. NOS. 2,949,224, 3,061,565 AND OTHERS.

FOR CAMERAS; DIGITAL CAMERAS; VIDEO CAMCORDERS; BATTERIES; BATTERY CHARGERS; AC (ALTERNATING CURRENT) ADAPTERS; CASES FOR CAMERAS, DIGITAL CAMERAS AND VIDEO CAMCORDERS; STRAPS FOR CAMERAS, DIGITAL CAMERAS AND VIDEO CAMCORDERS; BAGS FOR CAMERAS, DIGITAL CAMERAS AND VIDEO CAMCORDERS; TRIPODS (U.S. CLS. 21, 23, 26, 36 AND 38).
STEVEN JACKSON, EXAMINING ATTORNEY

CLASS 9—(Continued).

SN 77-806,540. SUMMIT ENTERTAINMENT, LLC, SANTA MONICA, CA. FILED 8-18-2009.

SUMMIT ENTERTAINMENT RECORDS

THE MARK CONSISTS OF STANDARD CHARACTERS WITHOUT CLAIM TO ANY PARTICULAR FONT, STYLE, SIZE, OR COLOR.

OWNER OF U.S. REG. NOS. 2,350,426, 3,756,889 AND OTHERS.

NO CLAIM IS MADE TO THE EXCLUSIVE RIGHT TO USE "ENTERTAINMENT RECORDS", APART FROM THE MARK AS SHOWN.

FOR MUSICAL SOUND RECORDINGS; PRE-RECORDED DVDS AND OTHER AUDIO-VISUAL RECORDINGS FEATURING MUSIC; DOWNLOADABLE VIDEO RECORDINGS FEATURING MUSIC; DOWNLOADABLE MUSICAL SOUND RECORDINGS; AND ELECTRONIC GAMES, NAMELY, ELECTRONIC GAME CARTRIDGES, DISCS AND SOFTWARE (U.S. CLS. 21, 23, 26, 36 AND 38).

LYDIA BELZER, EXAMINING ATTORNEY

SN 77-807,250. BORDEN TECHNOLOGY CORPORATION, KAOHSIUNG, TAIWAN, FILED 8-18-2009.

BORDUN

THE MARK CONSISTS OF THE STYLIZED LETTERS "BORDUN" WITH THE LETTERS BEING FORMED BY BROKEN LINES IN PORTIONS THEREOF.

FOR COMPUTER CHIPS; INTERFACE CARDS FOR DATA PROCESSING EQUIPMENT IN THE FORM OF PRINTED CIRCUITS; INTEGRATED CIRCUITS; ELECTRONIC CIRCUITS; PRINTED CIRCUIT BOARDS; SEMICONDUCTOR CHIPS; INTEGRATED CIRCUIT BOARDS; SILICON CHIPS; MOTHERBOARDS; LARGE SCALE INTEGRATED CIRCUITS (U.S. CLS. 21, 23, 26, 36 AND 38).

JAMES GRIFFIN, EXAMINING ATTORNEY

CLASS 9—(Continued).

SN 77-807,877. ESCO TECHNOLOGIES HOLDING INC., ST. LOUIS, MO. FILED 8-19-2009.

M-360

THE MARK CONSISTS OF STANDARD CHARACTERS WITHOUT CLAIM TO ANY PARTICULAR FONT, STYLE, SIZE, OR COLOR.

FOR BROADBAND WIRELESS NETWORK, NAMELY, MOBILE COMPUTING AND OPERATING PLATFORMS CONSISTING OF DATA TRANSCEIVERS, WIRELESS NETWORKS AND GATEWAYS FOR TWO-WAY GAS, WATER, AND ELECTRIC UTILITY DATA TRANSFER (U.S. CLS. 21, 23, 26, 36 AND 38).

ANGELA DUONG, EXAMINING ATTORNEY

SN 77-808,401. WEATHERVANE STUDIOS LLC, COLUMBIA, MD. FILED 8-19-2009.

SLOLLUSK

THE MARK CONSISTS OF STANDARD CHARACTERS WITHOUT CLAIM TO ANY PARTICULAR FONT, STYLE, SIZE, OR COLOR.

FOR AUDIO RECORDINGS FEATURING MUSIC OR INTERACTIVE FICTION; AUDIO RECORDINGS FEATURING SPOKEN WORD IN THE FIELD OF MUSIC OR INTERACTIVE FICTION (U.S. CLS. 21, 23, 26, 36 AND 38).

FIRST USE 8-1-2009; IN COMMERCE 8-1-2009.

DAWN HAN, EXAMINING ATTORNEY

SN 77-808,898. TREMOR MEDIA, INC., NEW YORK, NY. FILED 8-20-2009.

VCHOICE

THE MARK CONSISTS OF STANDARD CHARACTERS WITHOUT CLAIM TO ANY PARTICULAR FONT, STYLE, SIZE, OR COLOR.

FOR COMPUTER SOFTWARE USED FOR THE DISSEMINATION OF ADVERTISING FOR OTHERS ON THE WEBSITES OF OTHERS VIA THE INTERNET; DOWNLOADABLE MULTIMEDIA FILES CONTAINING GRAPHICS, TEXT, AUDIO AND VIDEO RELATING TO ONLINE ADVERTISING; COMPUTER SOFTWARE, NAMELY, SOFTWARE DEVELOPMENT TOOLS FOR ONLINE ADVERTISING AND CLIENT INTERFACES (U.S. CLS. 21, 23, 26, 36 AND 38).

MARLENE BELL, EXAMINING ATTORNEY

CLASS 9—(Continued).

SN 77-812,308. CREDENZA SOFTWARE INC., TORONTO, CANADA, FILED 8-25-2009.

CREDENZA

THE MARK CONSISTS OF STANDARD CHARACTERS WITHOUT CLAIM TO ANY PARTICULAR FONT, STYLE, SIZE, OR COLOR.

PRIORITY CLAIMED UNDER SEC. 44(D) ON CANADA APPLICATION NO. 1442091, FILED 6-18-2009.

FOR PRACTICE MANAGEMENT SOFTWARE FOR ALL PROFESSIONALS (U.S. CLS. 21, 23, 26, 36 AND 38). FIRST USE 10-21-2009; IN COMMERCE 10-21-2009.

DAVID TAYLOR, EXAMINING ATTORNEY

SN 77-813,584. ANNA AMORESANO, SAN DIEGO, CA. FILED 8-26-2009.



NO CLAIM IS MADE TO THE EXCLUSIVE RIGHT TO USE "TELEMATICS", APART FROM THE MARK AS SHOWN.

THE COLOR(S) RED AND BLACK IS/ARE CLAIMED AS A FEATURE OF THE MARK.

THE MARK CONSISTS OF THE FOLLOWING: A HAWK IN BLACK AND THE COLOR RED IS USED IN THE TAIL OF THE HAWK ICON. SMALL RED ACCENTS APPEAR IN THE LETTER "E" AND LETTER "A" OF WORD "REDTAIL". THE REMAINDER OF THE WORD "REDTAIL" AND ALL OF THE WORD "TELEMATICS" APPEARS IN BLACK".

FOR COMPUTER HARDWARE AND SOFTWARE SYSTEM FOR TRACKING PEOPLE, OBJECTS AND PETS USING GPS DATA ON A DEVICE ON THE TRACKED PEOPLE, OBJECTS AND PETS; GLOBAL POSITIONING SYSTEM (GPS) CONSISTING OF COMPUTERS, COMPUTER SOFTWARE, TRANSMITTERS, RECEIVERS, AND NETWORK INTERFACE DEVICES; GPS / GSM TRACKING DEVICE TO BE WORN ON THE WRIST OF AN ATHLETE DURING ENDURANCE EVENTS; VEHICLE LOCATOR AND RECOVERY DEVICE PROGRAMMED TO USE GLOBAL POSITIONING SYSTEMS (GPS) AND CELLULAR TELECOMMUNICATIONS (U.S. CLS. 21, 23, 26, 36 AND 38).

ANNE FARRELL, EXAMINING ATTORNEY

CLASS 9—(Continued).

SN 77-813,709. MARKET SPECTRUM, INC., WESTERVILLE, OH. FILED 8-27-2009.



NO CLAIM IS MADE TO THE EXCLUSIVE RIGHT TO USE "NAUTIC ALERT", APART FROM THE MARK AS SHOWN.

THE COLOR(S) GREY, YELLOW, BLUE, BLACK, AND WHITE IS/ARE CLAIMED AS A FEATURE OF THE MARK.

THE MARK CONSISTS OF THE WORDS "NAUTIC ALERT" IN THE COLOR WHITE WHEREAS THE FIRST LETTER "N" IS IN THE BLUE RECTANGLE AND THE REST OF THE LETTERS ARE IN THE BLACK RECTANGLE WITH CURVED CORNERS. THE ENTIRE WORDS ARE UNDERLINED WITH A WHITE LINE, BUT THE LETTER "N" IS UNDERLINED WITH A WHITE CURVED LINE DIRECTLY UNDER THE FIRST LEG OF THE "N" AND A WHITE STRAIGHT LINE FOR THE REST OF THE LETTER "N". THE SAID WHITE LINE STARTS IN THE YELLOW RECTANGLE. THE TWO RECTANGLES CONSISTING OF YELLOW AND BLUE ARE INSIDE A GREY SQUARE. THE YELLOW AND BLUE RECTANGLES SYMBOLIZE THE NAUTICAL FLAG COLORS, WHICH MEANS: I WISH TO COMMUNICATE WITH YOU.

FOR APPARATUS FOR TRANSMISSION OF COMMUNICATION (U.S. CLS. 21, 23, 26, 36 AND 38).

MARK T. MULLEN, EXAMINING ATTORNEY

SN 77-813,922. JAGOE TECHNOLOGIES INC., BLAINE, WA. FILED 8-27-2009.

Drillers Dashboard

THE MARK CONSISTS OF STANDARD CHARACTERS WITHOUT CLAIM TO ANY PARTICULAR FONT, STYLE, SIZE, OR COLOR.

NO CLAIM IS MADE TO THE EXCLUSIVE RIGHT TO USE "DRILLERS", APART FROM THE MARK AS SHOWN.

FOR MINERALS DRILLING RIG MONITORING SYSTEM, COMPRISING COMPUTER HARDWARE, SOFTWARE AND ELECTRONIC INSTRUMENTATION FOR COLLECTING, DISPLAYING, MONITORING, AND LOGGING DATA AND PARAMETERS FOR RIG EQUIPMENT AND DRILLING OPERATIONS, AND FOR REPORTING ON OPERATIONAL AND DRILLING DATA IN A SUMMARY FORM, OVER THE INTERNET (U.S. CLS. 21, 23, 26, 36 AND 38).

FIRST USE 6-9-2009; IN COMMERCE 7-6-2009.

SANJEEV VOHRA, EXAMINING ATTORNEY

CLASS 9—(Continued).

SN 77-814,072. CRAIG ANDREW BUSFIELD, TALLEBUDGERA VALLEY, AUSTRALIA, FILED 8-27-2009.

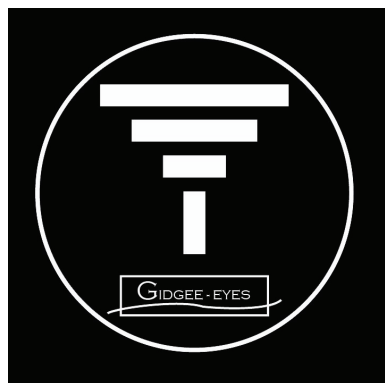

OWNER OF AUSTRALIA REG. NO. 1191284, DATED 8-13-2007, EXPIRES 8-13-2017.

THE MARK CONSISTS OF A SQUARE ENCLOSING A CIRCLE WHICH CONTAINS THREE HORIZONTAL BARS OF VARYING LENGTHS STACKED OVER A VERTICAL BAR BENEATH WHICH VERTICAL BAR APPEAR THE WORDS "GIDGEE - EYES" UNDERSCORED BY A WAVY LINE IN A CLOSED HORIZONTAL RECTANGLE.

FOR CASES ADAPTED FOR SUNGLASSES; FINISHED LENSES FOR SUNGLASSES; FRAMES FOR SUNGLASSES; LENSES FOR SUNGLASSES; STRAPS FOR SUNGLASSES (U.S. CLS. 21, 23, 26, 36 AND 38).

ROBERT LAVACHE, EXAMINING ATTORNEY

SN 77-817,647. PITNEY BOWES INC., STAMFORD, CT. FILED 9-1-2009.

IntelliJet

THE MARK CONSISTS OF STANDARD CHARACTERS WITHOUT CLAIM TO ANY PARTICULAR FONT, STYLE, SIZE, OR COLOR.

FOR PRINTER USED IN A MAIL PRODUCTION ENVIRONMENT (U.S. CLS. 21, 23, 26, 36 AND 38).

ELLEN B. AWRICH, EXAMINING ATTORNEY

CLASS 9—(Continued).

SN 77-818,093. TEXAS MEMORY SYSTEMS, INC., HOUSTON, TX. FILED 9-2-2009.

Texas Memory Systems

THE MARK CONSISTS OF STANDARD CHARACTERS WITHOUT CLAIM TO ANY PARTICULAR FONT, STYLE, SIZE, OR COLOR.

NO CLAIM IS MADE TO THE EXCLUSIVE RIGHT TO USE "MEMORY SYSTEMS", APART FROM THE MARK AS SHOWN.

SEC. 2(F).

FOR COMPUTER MEMORY, NAMELY, BLANK COMPUTER SOLID STATE DISCS (U.S. CLS. 21, 23, 26, 36 AND 38).

FIRST USE 7-1-1978; IN COMMERCE 7-1-1978.

EVELYN BRADLEY, EXAMINING ATTORNEY

SN 77-818,867. TWENTIETH CENTURY FOX FILM CORPORATION, LOS ANGELES, CA. FILED 9-2-2009.

GLEEK

THE MARK CONSISTS OF STANDARD CHARACTERS WITHOUT CLAIM TO ANY PARTICULAR FONT, STYLE, SIZE, OR COLOR.

FOR MOTION PICTURE FILMS FEATURING COMEDY AND MUSIC; PRE-RECORDED DVDS FEATURING COMEDY AND MUSIC; PRE-RECORDED CDS FEATURING COMEDY AND MUSIC; DOWNLOADABLE AUDIO AND VIDEO RECORDINGS FEATURING COMEDY AND MUSIC; DOWNLOADABLE MOTION PICTURES, TELEVISION SHOWS AND VIDEO RECORDINGS FEATURING COMEDY AND MUSIC; DOWNLOADABLE RING TONES, RING BACKS, GRAPHICS, WALLPAPER, GAMES RELATING TO A COMEDY/DRAMA TELEVISION SHOW, AND MUSIC VIA A GLOBAL COMPUTER NETWORK AND WIRELESS DEVICES; COMPUTER SCREEN SAVER SOFTWARE; COMPUTER GAME AND VIDEO GAME SOFTWARE RELATING TO A COMEDY/DRAMA TELEVISION SHOW (U.S. CLS. 21, 23, 26, 36 AND 38).

KATHERINE STOIDES, EXAMINING ATTORNEY

CLASS 9—(Continued).

SN 77-821,208. MR. CAT MUSIC, LLC, DBA LUXURY WAFERS, VALLEY VILLAGE, CA. FILED 9-7-2009.

Luxury Wafers

THE MARK CONSISTS OF STANDARD CHARACTERS WITHOUT CLAIM TO ANY PARTICULAR FONT, STYLE, SIZE, OR COLOR.

FOR DOWNLOADABLE MP3 FILES, MP3 RECORDINGS, ON-LINE DISCUSSION BOARDS, WEBCASTS AND PODCASTS FEATURING MUSIC, AUDIO BOOKS AND NEWS BROADCASTS; DOWNLOADABLE MUSICAL SOUND RECORDINGS; PRE-RECORDED CDS, VIDEO TAPES, LASER DISKS AND DVDS FEATURING MUSIC PERFORMANCE; PRE-RECORDED ELECTRONIC MEDIA FEATURING MUSIC PERFORMANCE (U.S. CLS. 21, 23, 26, 36 AND 38).

FIRST USE 7-10-2008; IN COMMERCE 7-10-2008.
JANICE KIM, EXAMINING ATTORNEY

SN 77-826,633. WILSON, BENJAMIN DAVID, NEW YORK, NY. FILED 9-15-2009.

Cockabilly Records

THE MARK CONSISTS OF STANDARD CHARACTERS WITHOUT CLAIM TO ANY PARTICULAR FONT, STYLE, SIZE, OR COLOR.

NO CLAIM IS MADE TO THE EXCLUSIVE RIGHT TO USE "RECORDS", APART FROM THE MARK AS SHOWN.
FOR MUSICAL SOUND RECORDINGS (U.S. CLS. 21, 23, 26, 36 AND 38).

BARBARA BROWN, EXAMINING ATTORNEY

SN 77-826,842. NEATO ROBOTICS, INC., MOUNTAIN VIEW, CA. FILED 9-15-2009.

RPS TECHNOLOGY

THE MARK CONSISTS OF STANDARD CHARACTERS WITHOUT CLAIM TO ANY PARTICULAR FONT, STYLE, SIZE, OR COLOR.

NO CLAIM IS MADE TO THE EXCLUSIVE RIGHT TO USE "TECHNOLOGY", APART FROM THE MARK AS SHOWN.

FOR ROBOTS FOR HOUSEHOLD PURPOSES AND MAINTENANCE AND STRUCTURAL PARTS AND/OR PARTS THEREOF; CAR WASHING ROBOTS FOR PERSONAL USE AND STRUCTURAL PARTS AND/OR PARTS THEREOF; PERSONAL USE AND HOBBY USE ROBOTS AND STRUCTURAL PARTS AND/OR PARTS THEREOF (U.S. CLS. 21, 23, 26, 36 AND 38).

ANN E. SAPPENFIELD, EXAMINING ATTORNEY

CLASS 9—(Continued).

SN 77-827,705. CARLO SUNSERI LLC, PITTSBURGH, PA. FILED 9-16-2009.

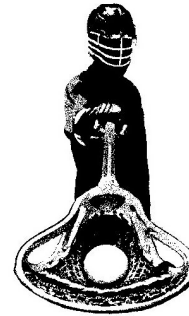

THE STIPPLING IS FOR SHADING PURPOSES ONLY. THE MARK CONSISTS OF A LACROSSE PLAYER WEARING A HELMET AND HOLDING A LACROSSE STICK FILLED WITH A BALL OUT IN FRONT OF HIMSELF.

FOR VIDEO GAME SOFTWARE (U.S. CLS. 21, 23, 26, 36 AND 38).
BERYL GARDNER, EXAMINING ATTORNEY

SN 77-827,934. RETAIL CONTROL SOLUTIONS, INC., NEEDHAM, MA. FILED 9-16-2009.

Retail Control Solutions, Inc.

THE MARK CONSISTS OF STANDARD CHARACTERS WITHOUT CLAIM TO ANY PARTICULAR FONT, STYLE, SIZE, OR COLOR.

NO CLAIM IS MADE TO THE EXCLUSIVE RIGHT TO USE "RETAIL" AND "SOLUTIONS, INC.", APART FROM THE MARK AS SHOWN.

FOR CASH REGISTERS (U.S. CLS. 21, 23, 26, 36 AND 38).

FIRST USE 3-14-1993; IN COMMERCE 3-14-1993.
DAVID TAYLOR, EXAMINING ATTORNEY

SN 77-828,363. MORA, LANCE, LAS VEGAS, NV. FILED 9-17-2009.

Crime Sweepers

THE MARK CONSISTS OF STANDARD CHARACTERS WITHOUT CLAIM TO ANY PARTICULAR FONT, STYLE, SIZE, OR COLOR.

FOR MOTION PICTURE FILMS ABOUT POLICE DRAMA (U.S. CLS. 21, 23, 26, 36 AND 38).

FIRST USE 7-27-2008; IN COMMERCE 9-0-2008.
KAELIE KUNG, EXAMINING ATTORNEY

CLASS 9—(Continued).

SN 77-830,154. SONOSITE, INC., BOTHELL, WA. FILED 9-18-2009.

SONOREMOTE

THE MARK CONSISTS OF STANDARD CHARACTERS WITHOUT CLAIM TO ANY PARTICULAR FONT, STYLE, SIZE, OR COLOR.

FOR COMPUTER PERIPHERALS; CONTROL SYSTEM FOR THE MANAGEMENT AND OPERATION OF MEDICAL ULTRASOUND EQUIPMENT COMPRISED OF COMPUTER HARDWARE, COMPUTER SOFTWARE, AND REMOTE CONTROLS (U.S. CLS. 21, 23, 26, 36 AND 38).

REBECCA EISINGER, EXAMINING ATTORNEY

CLASS 9—(Continued).

SN 77-832,496. RUSSELL NDE SYSTEMS INC., EDMONTON, ALBERTA, CANADA, FILED 9-22-2009.

VERTISCAN

THE MARK CONSISTS OF STANDARD CHARACTERS WITHOUT CLAIM TO ANY PARTICULAR FONT, STYLE, SIZE, OR COLOR.

FOR ELECTROMAGNETIC FLAW DETECTOR FOR WATER WALL TUBES IN BOILERS (U.S. CLS. 21, 23, 26, 36 AND 38).

FIRST USE 12-18-2006; IN COMMERCE 12-18-2006.
LAKEISHA LEWIS, EXAMINING ATTORNEY

SN 77-836,011. TELEBRANDS CORP., FAIRFIELD, NJ. FILED 9-28-2009.

BARK OFF

THE MARK CONSISTS OF STANDARD CHARACTERS WITHOUT CLAIM TO ANY PARTICULAR FONT, STYLE, SIZE, OR COLOR.

NO CLAIM IS MADE TO THE EXCLUSIVE RIGHT TO USE "BARK", APART FROM THE MARK AS SHOWN.

FOR ULTRASONIC DOG TRAINING DEVICE, NAMELY, REMOTE HAND-HELD SIZE ELECTRICAL TRANSMITTER ACTIVATED BY A DOG'S BARK (U.S. CLS. 21, 23, 26, 36 AND 38).

JENNY PARK, EXAMINING ATTORNEY

SN 77-830,334. UBICOM, INC., SAN JOSE, CA. FILED 9-18-2009.

UBICOM64

THE MARK CONSISTS OF STANDARD CHARACTERS WITHOUT CLAIM TO ANY PARTICULAR FONT, STYLE, SIZE, OR COLOR.

OWNER OF U.S. REG. NOS. 2,949,379, 3,121,074 AND 3,710,556.

FOR INSTRUCTION SET ARCHITECTURE MICRO-PROCESSORS; COMPUTER HARDWARE AND COMPUTER PERIPHERALS; COMPUTER SOFTWARE FOR USE IN AUTOMATIC IDENTIFICATION AND PROCESSING OF MEDIA STREAMS; COMPUTER OPERATING SOFTWARE EMBEDDED IN INTERNET PROCESSORS; COMPUTER SOFTWARE EMBEDDED IN INTERNET PROCESSORS FOR USE IN IMPLEMENTING COMMUNICATIONS NETWORKING, FOR USE IN CONTROLLING INPUT/OUTPUT DRIVERS, AND FOR USE IN CONNECTING ELECTRONIC DEVICES TO THE INTERNET; COMPUTER SOFTWARE FOR USE IN IMPLEMENTING COMMUNICATIONS NETWORKING AND INTERNET CONNECTIVITY FUNCTIONS; COMPUTER SOFTWARE FOR USE IN IMPLEMENTING HARDWARE FUNCTIONS; INTEGRATED CIRCUITS, MICRO-PROCESSORS, MICRO CONTROLLERS, CIRCUIT BOARDS AND MODULES FOR USE IN EXECUTING SOFTWARE MODULES (U.S. CLS. 21, 23, 26, 36 AND 38).

ESTHER A. BORSUK, EXAMINING ATTORNEY

SN 77-836,810. TAILOR MADE GAMING LLC, BOZEMAN, MT. FILED 9-29-2009.

NO CLAIM IS MADE TO THE EXCLUSIVE RIGHT TO USE "BINGO", APART FROM THE MARK AS SHOWN.

THE MARK CONSISTS OF THE WORDS "BINGO" AND "SHOCK" ALL IN CAPITALS, HORIZONTALLY CENTERED, WITH THE WORD "BINGO" APPEARING ON TOP OF THE WORD "SHOCK" AND WITH A DARK SHADOW OUTLINING THE LETTERS TO GIVE A 3-D APPEARANCE.

FOR GAMING DEVICES, NAMELY, GAMING MACHINES, SLOT MACHINES, BINGO MACHINES, WITH OR WITHOUT VIDEO OUTPUT (U.S. CLS. 21, 23, 26, 36 AND 38).

FIRST USE 6-8-2009; IN COMMERCE 6-29-2009.
LIEF MARTIN, EXAMINING ATTORNEY

CLASS 9—(Continued).

SN 77-839,197. FORSTON, INC., FORT COLLINS, CO. FILED 10-1-2009.

LAB NAVIGATOR

THE MARK CONSISTS OF STANDARD CHARACTERS WITHOUT CLAIM TO ANY PARTICULAR FONT, STYLE, SIZE, OR COLOR.

NO CLAIM IS MADE TO THE EXCLUSIVE RIGHT TO USE "LAB", APART FROM THE MARK AS SHOWN.

FOR HANDHELD SCIENTIFIC MEASURING DEVICE COMPRISED OF SENSORS AND RELATED COMPUTER SOFTWARE AND HARDWARE FOR MEASURING ELECTRICAL, ELECTROCHEMICAL, POTENTIOMETRIC, POLAROGRAPHIC, CONDUCTOMETRIC, TURBIDIMETRIC, COLORIMETRIC, SPECTROGRAPHIC, CAPACITIVE, FLOW, PRESSURE, OPTICAL AND GASEOUS PARAMETER DATA IN WATER AND WASTEWATER, AND CARBON DIOXIDE AND OXYGEN IN AIR AND FOR LOGGING DATA RELATED TO THESE MEASUREMENTS, FOR USE IN WATER, WASTEWATER AND AIR ANALYSIS (U.S. CLS. 21, 23, 26, 36 AND 38).

EUGENIA MARTIN, EXAMINING ATTORNEY

SN 77-839,230. IRENE SMALLS, BOSTON, MA. FILED 10-1-2009.

LITERACISE

THE MARK CONSISTS OF STANDARD CHARACTERS WITHOUT CLAIM TO ANY PARTICULAR FONT, STYLE, SIZE, OR COLOR.

THE WORDING "LITERACISE" HAS NO MEANING IN A FOREIGN LANGUAGE.

FOR COMPUTER GAME SOFTWARE; DIGITAL MEDIA, NAMELY, DVDS, PRE-RECORDED VIDEO RECORDINGS AND DOWNLOADABLE WEBCASTS, FEATURING EDUCATIONAL PROGRAMS IN THE FIELD OF READING APPRECIATION, WELLNESS, EXERCISE AND FITNESS; DOWNLOADABLE ELECTRONIC PUBLICATIONS IN THE NATURE OF DIGITAL BOOKS IN THE FIELD OF READING APPRECIATION, WELLNESS, EXERCISE AND FITNESS; DOWNLOADABLE PODCASTS IN THE FIELD OF READING APPRECIATION, WELLNESS, EXERCISE AND FITNESS; DOWNLOADABLE WEBCASTS IN THE FIELD OF READING APPRECIATION, WELLNESS, EXERCISE AND FITNESS (U.S. CLS. 21, 23, 26, 36 AND 38).

MYRIAH HABEEB, EXAMINING ATTORNEY

CLASS 9—(Continued).

SN 77-843,710. XUXA PROMOCOES E PRODUCOES ARTISTICAS LTDA., RIO DE JANEIRO, BRAZIL, FILED 10-7-2009.

XUXA

THE MARK CONSISTS OF STANDARD CHARACTERS WITHOUT CLAIM TO ANY PARTICULAR FONT, STYLE, SIZE, OR COLOR.

THE NAME(S), PORTRAIT(S), AND/OR SIGNATURE(S) SHOWN IN THE MARK IDENTIFIES A LIVING INDIVIDUAL, WHOSE CONSENT(S) TO REGISTER IS MADE OF RECORD.

THE WORDING "XUXA" HAS NO MEANING IN A FOREIGN LANGUAGE.

FOR PRE-RECORDED CDS AND DVDS FEATURING MUSIC AND GENERAL ENTERTAINMENT, NAMELY, MUSIC VIDEOS, CHILDREN'S TELEVISION AND MOTION PICTURE ENTERTAINMENT SHOWS, MUSICAL CONCERTS AND MOTION PICTURES, TELEVISION PROGRAMS AND THEATRICAL MOVIE RELEASES FEATURING ADVENTURE AND FANTASY THEMES DIRECTED TO CHILDREN AND THE GENERAL PUBLIC (U.S. CLS. 21, 23, 26, 36 AND 38).

FIRST USE 10-27-1999; IN COMMERCE 10-27-1999.

AMEEN IMAM, EXAMINING ATTORNEY

SN 77-844,341. RESTAURANT DATA CONCEPTS, INC., WARWICK, RI. FILED 10-8-2009.

POSITOUCH

THE MARK CONSISTS OF STANDARD CHARACTERS WITHOUT CLAIM TO ANY PARTICULAR FONT, STYLE, SIZE, OR COLOR.

FOR COMPUTER, COMPUTER PRINTERS AND COMPUTER PROGRAMS FOR USE BY RESTAURANTS, NAMELY, COMPUTER PROGRAMS FOR HANDLING POINT OF SALE TRANSACTIONS, REAL-TIME SALES REPORTS, INVENTORY MANAGEMENT, MANAGEMENT OF RESERVATIONS, PAYROLL, TIMEKEEPING AND TRACKING TIPS (U.S. CLS. 21, 23, 26, 36 AND 38).

FIRST USE 5-1-1984; IN COMMERCE 7-15-1988.

RON FAIRBANKS, EXAMINING ATTORNEY

CLASS 9—(Continued).

SN 77-846,521. MEYER, JULIA I., CHICAGO, IL. FILED 10-12-2009.

THE SUPER BOWL SHUFFLE

THE MARK CONSISTS OF STANDARD CHARACTERS WITHOUT CLAIM TO ANY PARTICULAR FONT, STYLE, SIZE, OR COLOR.

SEC. 2(F).

FOR DIGITAL MEDIA, NAMELY, PRE-RECORDED VIDEO CASSETTES, DIGITAL VIDEO DISCS, DIGITAL VERSATILE DISCS, DOWNLOADABLE AUDIO AND VIDEO RECORDINGS, DVDS, AND HIGH DEFINITION DIGITAL DISCS FEATURING MUSIC, DANCING AND GYMNASTIC PERFORMANCES (U.S. CLS. 21, 23, 26, 36 AND 38).

FIRST USE 12-4-1985; IN COMMERCE 12-4-1985.

ERIN FALK, EXAMINING ATTORNEY

SN 77-847,470. LEGION INTERNATIONAL LIMITED, ST. PETER PORT, GUERNSEY, FILED 10-13-2009.

SPACEWORKS

THE MARK CONSISTS OF STANDARD CHARACTERS WITHOUT CLAIM TO ANY PARTICULAR FONT, STYLE, SIZE, OR COLOR.

PRIORITY CLAIMED UNDER SEC. 44(D) ON ERP NCNTY TM OFC APPLICATION NO. 8286891, FILED 5-7-2009, REG. NO. 008286891, DATED 12-11-2009, EXPIRES 5-7-2019.

FOR SOFTWARE, NAMELY, PEDESTRIAN SIMULATION SOFTWARE THAT ENABLES THE USER TO SIMULATE PEDESTRIAN MOVEMENT WITHIN A DEFINED SPACE (U.S. CLS. 21, 23, 26, 36 AND 38).

SANJEEV VOHRA, EXAMINING ATTORNEY

SN 77-847,525. ATELLIS, INC., WASHINGTON, DC. FILED 10-13-2009.

Smarter Video

THE MARK CONSISTS OF STANDARD CHARACTERS WITHOUT CLAIM TO ANY PARTICULAR FONT, STYLE, SIZE, OR COLOR.

NO CLAIM IS MADE TO THE EXCLUSIVE RIGHT TO USE "VIDEO", APART FROM THE MARK AS SHOWN.

FOR COMPUTER HARDWARE FOR COMMUNICATING AUDIO, VIDEO AND DATA BETWEEN COMPUTERS VIA A GLOBAL COMPUTER NETWORK, WIDE-AREA COMPUTER NETWORKS, AND PEER-TO-PEER COMPUTER NETWORKS; IP VIDEO SERVERS; PC DIGITAL VIDEO RECORDERS; SOUND AND VIDEO RECORDING AND PLAYBACK MACHINES (U.S. CLS. 21, 23, 26, 36 AND 38).

KELLEY WELLS, EXAMINING ATTORNEY

CLASS 9—(Continued).

SN 77-849,674. CAMDEN DOOR CONTROLS, MISSISSAUGA, CANADA, FILED 10-15-2009.

Sure-Wave by Camden

THE MARK CONSISTS OF STANDARD CHARACTERS WITHOUT CLAIM TO ANY PARTICULAR FONT, STYLE, SIZE, OR COLOR.

FOR ELECTRICAL SWITCHES (U.S. CLS. 21, 23, 26, 36 AND 38).

FIRST USE 8-24-2009; IN COMMERCE 8-24-2009.

ELIZABETH HUGHITT, EXAMINING ATTORNEY

SN 77-850,504. TATE, INCORPORATED, ALEXANDRIA, VA. FILED 10-16-2009.

TATE

THE MARK CONSISTS OF STANDARD CHARACTERS WITHOUT CLAIM TO ANY PARTICULAR FONT, STYLE, SIZE, OR COLOR.

OWNER OF U.S. REG. NO. 2,951,012.

SEC. 2(F).

FOR COMPUTER SOFTWARE THAT ALLOWS THE DISSEMINATION OF TRAINING AND EDUCATIONAL MATERIAL FOR MOBILE AND DISTANCE LEARNING; TRACKING DEVICES, NAMELY, COMPUTER HARDWARE AND SOFTWARE FOR TRACKING PEOPLE AND OBJECTS USING GPS DATA ON A DEVICE ON THE TRACKED PEOPLE AND OBJECTS; ENCODED MICRO PARTICULATES, TAGS, AND TAGGANTS OF PLASTIC, METAL OR SILICATE FOR USE IN THE FIELD OF PASSIVE LABELING, TRACING, OR TRACKING OF PERSONS AND VEHICLES; WIRELESS TRANSCEIVERS WITH COLLECTION AND DISPLAY TECHNOLOGY FOR THE STATUS AND TRACKING OF ALL VEHICLE TYPES IN LOCAL ENVIRONMENTS; LUMINOUS SAFETY BEACONS; OPTICAL SENSORS AND RADIO FREQUENCY DEVICES, NAMELY, GROUND TO AIR EMERGENCY SIGNAL TRANSMITTERS THAT ILLUMINATE UPON COMMAND OF THE INDIVIDUAL IN WIRELESS TRANSCEIVERS WITH COLLECTION, DISPLAY, AND SIGNALING TECHNOLOGY THAT SERVE TO ALERT AND CONVEY MESSAGES TO AIRCRAFT PILOTS IN THE EVENT OF EMERGENCY RESCUE SITUATIONS; GLOBAL POSITIONING SYSTEM AND SIGNAL PROCESSORS, NAMELY, CELLULAR BASED OR SATELLITE BASED FOR TRACKING PEOPLE AND OBJECTS USING GPS DATA ON A DEVICE ON THE TRACKED PEOPLE AND OBJECTS; ENCODED MICRO PARTICULATES, TAGS, AND TAGGANTS OF PLASTIC, METAL OR SILICATE FOR USE IN THE FIELD OF PASSIVE LABELING, TRACING, OR TRACKING OF PERSONS AND VEHICLES; WIRELESS TRANSCEIVERS WITH COLLECTION AND DISPLAY TECHNOLOGY FOR THE STATUS AND TRACKING OF ALL VEHICLE TYPES IN LOCAL ENVIRONMENTS (U.S. CLS. 21, 23, 26, 36 AND 38).

SAMUEL E. SHARPER JR., EXAMINING ATTORNEY

CLASS 9—(Continued).

SN 77-850,517. TATE, INCORPORATED, ALEXANDRIA, VA.
FILED 10-16-2009.

TATE INCORPORATED

THE MARK CONSISTS OF STANDARD CHARACTERS WITHOUT CLAIM TO ANY PARTICULAR FONT, STYLE, SIZE, OR COLOR.

OWNER OF U.S. REG. NO. 2,951,012.

NO CLAIM IS MADE TO THE EXCLUSIVE RIGHT TO USE "INCORPORATED", APART FROM THE MARK AS SHOWN.

SEC. 2(F).

FOR COMPUTER SOFTWARE THAT ALLOWS THE DISSEMINATION OF TRAINING AND EDUCATIONAL MATERIAL FOR MOBILE AND DISTANCE LEARNING; TRACKING DEVICES, NAMELY, COMPUTER HARDWARE AND SOFTWARE FOR TRACKING PEOPLE AND OBJECTS USING GPS DATA ON A DEVICE ON THE TRACKED PEOPLE AND OBJECTS; ENCODED MICRO PARTICULATES, TAGS, AND TAGGANTS OF PLASTIC, METAL OR SILICATE FOR USE IN THE FIELD OF PASSIVE LABELING, TRACING, OR TRACKING OF PERSONS AND VEHICLES; WIRELESS TRANSCEIVERS WITH COLLECTION AND DISPLAY TECHNOLOGY FOR THE STATUS AND TRACKING OF ALL VEHICLE TYPES IN LOCAL ENVIRONMENTS; LUMINOUS SAFETY BEACONS; OPTICAL SENSORS AND RADIO FREQUENCY DEVICES, NAMELY, GROUND TO AIR EMERGENCY SIGNAL TRANSMITTERS THAT ILLUMINATE UPON COMMAND OF THE INDIVIDUAL IN WIRELESS TRANSCEIVERS WITH COLLECTION, DISPLAY, AND SIGNALING TECHNOLOGY THAT SERVE TO ALERT AND CONVEY MESSAGES TO AIRCRAFT PILOTS IN THE EVENT OF EMERGENCY RESCUE SITUATIONS; GLOBAL POSITIONING SYSTEM AND SIGNAL PROCESSORS, NAMELY, CELLULAR BASED OR SATELLITE BASED FOR TRACKING PEOPLE AND OBJECTS USING GPS DATA ON A DEVICE ON THE TRACKED PEOPLE AND OBJECTS, ENCODED MICRO PARTICULATES, TAGS, AND TAGGANTS OF PLASTIC, METAL OR SILICATE FOR USE IN THE FIELD OF PASSIVE LABELING, TRACING, OR TRACKING OF PERSONS AND VEHICLES; WIRELESS TRANSCEIVERS WITH COLLECTION AND DISPLAY TECHNOLOGY FOR THE STATUS AND TRACKING OF ALL VEHICLE TYPES IN LOCAL ENVIRONMENTS (U.S. CLS. 21, 23, 26, 36 AND 38).

SAMUEL E. SHARPER JR., EXAMINING ATTORNEY

SN 77-851,040. ONDA, HIDEKI FRANCIS, TOKYO, JAPAN,
FILED 10-16-2009.

EGGSHELL THIN CASE

THE MARK CONSISTS OF STANDARD CHARACTERS WITHOUT CLAIM TO ANY PARTICULAR FONT, STYLE, SIZE, OR COLOR.

NO CLAIM IS MADE TO THE EXCLUSIVE RIGHT TO USE "CASE", APART FROM THE MARK AS SHOWN.

FOR PROTECTIVE COVERS AND CASES FOR CELL PHONES, LAPTOPS AND PORTABLE MEDIA PLAYERS (U.S. CLS. 21, 23, 26, 36 AND 38).

MARK SHINER, EXAMINING ATTORNEY

CLASS 9—(Continued).

SN 77-851,415. RUSSELL NDE SYSTEMS INC., EDMONTON,
ALBERTA, CANADA, FILED 10-19-2009.

HYDRA-SNAKE

THE MARK CONSISTS OF STANDARD CHARACTERS WITHOUT CLAIM TO ANY PARTICULAR FONT, STYLE, SIZE, OR COLOR.

FOR ELECTROMAGNETIC DEVICES FOR THE INTERNAL INSPECTION OF PIPES (U.S. CLS. 21, 23, 26, 36 AND 38).

LAKEISHA LEWIS, EXAMINING ATTORNEY

SN 77-851,866. MASSARO, VENANZIO, SAN DIEGO, CA.
FILED 10-19-2009.

Tekninez

THE MARK CONSISTS OF STANDARD CHARACTERS WITHOUT CLAIM TO ANY PARTICULAR FONT, STYLE, SIZE, OR COLOR.

THE WORDING "TEKNINEZ" HAS NO MEANING IN A FOREIGN LANGUAGE.

FOR EAR PHONES; EAR PLUGS FOR SLEEPING; EAR PLUGS FOR SOUNDPROOFING; EAR PLUGS FOR SWIMMING; EAR PLUGS FOR SWIMMING PURPOSES; EAR PLUGS NOT FOR MEDICAL PURPOSES; EARPHONES; EARPHONES AND HEADPHONES; HANDS FREE DEVICES FOR MOBILE-PHONES; HANDS FREE KITS FOR PHONES; HEADSETS FOR CELLULAR OR MOBILE PHONES; IN-EAR MONITORS NOT FOR MEDICAL PURPOSES; INTERNET PHONES; INTEROPERABLE COMMUNICATION SYSTEM DESIGNED TO PROVIDE RADIO, STREAMING VIDEO, WIRELESS INTERNET, AND VOIP PHONE; KEYBOARDS FOR MOBILE PHONES; MOBILE PHONE STRAPS; MOBILE PHONES; PROTECTIVE COVERS AND CASES FOR CELL PHONES, LAPTOPS AND PORTABLE MEDIA PLAYERS; VIDEO PHONES (U.S. CLS. 21, 23, 26, 36 AND 38).

MICHAEL KEATING, EXAMINING ATTORNEY

SN 77-852,112. MARKZWARE, SANTA ANA, CA. FILED 10-19-2009.

pagezephyr

THE MARK CONSISTS OF THE WORD "PAGEZEPHYR" WITH A LINE UNDERNEATH THE "EZE" PORTION.

FOR COMPUTER SOFTWARE FOR SEARCHING, COMPILING, INDEXING, EDITING AND ORGANIZING INFORMATION FROM PUBLISHING APPLICATIONS, ONTO COMPUTER NETWORKS AND PERSONAL COMPUTERS (U.S. CLS. 21, 23, 26, 36 AND 38).

LAKEISHA LEWIS, EXAMINING ATTORNEY

CLASS 9—(Continued).

SN 77-853,045. CONWAY BARKER INTERSECT, LLC, SILVER SPRING, MD. FILED 10-20-2009.

Memory Catcher

THE MARK CONSISTS OF STANDARD CHARACTERS WITHOUT CLAIM TO ANY PARTICULAR FONT, STYLE, SIZE, OR COLOR.

NO CLAIM IS MADE TO THE EXCLUSIVE RIGHT TO USE "MEMORY", APART FROM THE MARK AS SHOWN.

FOR DIGITAL MEDIA, NAMELY, PRE-RECORDED VIDEO CASSETTES, DIGITAL VIDEO DISCS, DIGITAL VERSATILE DISCS, DOWNLOADABLE AUDIO AND VIDEO RECORDINGS, DVDS, AND HIGH DEFINITION DIGITAL DISCS FEATURING THE TELLING OF LIFE STORIES, EVENTS AND MEMORIES FOR INDIVIDUALS, FAMILIES, AND ORGANIZATIONS (U.S. CLS. 21, 23, 26, 36 AND 38).

FIRST USE 11-21-1999; IN COMMERCE 11-21-1999.
AMY HELLA, EXAMINING ATTORNEY

SN 77-853,203. AINSWORTH GAME TECHNOLOGY LIMITED, NEWINGTON, AUSTRALIA, FILED 10-20-2009.

Dollar King

THE MARK CONSISTS OF STANDARD CHARACTERS WITHOUT CLAIM TO ANY PARTICULAR FONT, STYLE, SIZE, OR COLOR.

NO CLAIM IS MADE TO THE EXCLUSIVE RIGHT TO USE "DOLLAR", APART FROM THE MARK AS SHOWN.

FOR COMPUTER SOFTWARE AND FIRMWARE FOR GAMES OF CHANCE ON ANY COMPUTERIZED PLATFORM, INCLUDING DEDICATED GAMING CONSOLES, VIDEO BASED SLOT MACHINES, REEL BASED SLOT MACHINES, AND VIDEO LOTTERY TERMINALS (U.S. CLS. 21, 23, 26, 36 AND 38).

FRANK LATTUCA, EXAMINING ATTORNEY

SN 77-853,859. UNITED NATURAL FOODS, INC., PROVIDENCE, RI. FILED 10-21-2009.

CLEARVUE

THE MARK CONSISTS OF STANDARD CHARACTERS WITHOUT CLAIM TO ANY PARTICULAR FONT, STYLE, SIZE, OR COLOR.

FOR COMPUTER SOFTWARE, NAMELY, SOFTWARE FOR MONITORING, EVALUATING AND REPORTING ON THE INVENTORIES AND STOCK KEEPING UNIT PERFORMANCE OF SUPPLIERS' PRODUCTS THAT ARE DISTRIBUTED BY THIRD PARTY DISTRIBUTORS IN THE FIELD OF SALES MANAGEMENT (U.S. CLS. 21, 23, 26, 36 AND 38).

FIRST USE 10-19-2009; IN COMMERCE 10-19-2009.
JASON TURNER, EXAMINING ATTORNEY

CLASS 9—(Continued).

SN 77-855,709. IRION S.R.L., TORINO, ITALY, FILED 10-23-2009.

IDQ - Irion Data Quality

THE MARK CONSISTS OF STANDARD CHARACTERS WITHOUT CLAIM TO ANY PARTICULAR FONT, STYLE, SIZE, OR COLOR.

NO CLAIM IS MADE TO THE EXCLUSIVE RIGHT TO USE "DATA QUALITY", APART FROM THE MARK AS SHOWN.

FOR COMPUTER SOFTWARE THAT PROVIDES ENTERPRISE DATA INTEGRATION AND BUSINESS DATA MANAGEMENT ENHANCED WITH DATA QUALITY FUNCTIONS BY COMBINING DATA FROM MANY DIFFERENT DATA SOURCES AND APPLYING USER DEFINED BUSINESS RULES, ALL-IN-ONE SYSTEM WITH RICH AND EASY USER INTERFACE, DATA ENTRY AND AUDIT FUNCTIONS (U.S. CLS. 21, 23, 26, 36 AND 38).

LAKEISHA LEWIS, EXAMINING ATTORNEY

SN 77-856,449. SURETONE RECORDS, LLC, LOS ANGELES, CA. FILED 10-23-2009.

SURETONE

THE MARK CONSISTS OF STANDARD CHARACTERS WITHOUT CLAIM TO ANY PARTICULAR FONT, STYLE, SIZE, OR COLOR.

FOR PRE-RECORDED AUDIO TAPES, DISCS AND CASSETTES, VIDEO TAPES, DISCS AND CASSETTES, DIGITAL AUDIO AND AUDIO VIDEO TAPES AND DISCS, CDS, DVDS, LASER DISCS, AND PHONOGRAPH RECORDS FEATURING MUSIC (U.S. CLS. 21, 23, 26, 36 AND 38).

FIRST USE 5-0-2006; IN COMMERCE 5-0-2006.
LINDA E. BLOHM, EXAMINING ATTORNEY

SN 77-857,126. ENCORE WIRE CORPORATION, MCKINNEY, TX. FILED 10-26-2009.

SUPERBOND MCMP MULTIPURPOSE

THE MARK CONSISTS OF STANDARD CHARACTERS WITHOUT CLAIM TO ANY PARTICULAR FONT, STYLE, SIZE, OR COLOR.

NO CLAIM IS MADE TO THE EXCLUSIVE RIGHT TO USE "MCMP MULTIPURPOSE", APART FROM THE MARK AS SHOWN.

FOR ELECTRICAL CABLES; ELECTRICAL WIRES (U.S. CLS. 21, 23, 26, 36 AND 38).

HELENE LIWINSKI, EXAMINING ATTORNEY

CLASS 9—(Continued).

SN 77-857,673. WARNER BROS. ENTERTAINMENT INC., BURBANK, CA. FILED 10-26-2009.

SONYA BLADE

THE MARK CONSISTS OF STANDARD CHARACTERS WITHOUT CLAIM TO ANY PARTICULAR FONT, STYLE, SIZE, OR COLOR.

OWNER OF U.S. REG. NO. 2,705,252.

"SONYA BLADE" DOES NOT IDENTIFY A LIVING INDIVIDUAL.

FOR MOTION PICTURE FILMS FEATURING COMEDY, DRAMA, ACTION, ADVENTURE AND/OR ANIMATION, AND MOTION PICTURE FILMS FOR BROADCAST ON TELEVISION FEATURING COMEDY, DRAMA, ACTION, ADVENTURE AND/OR ANIMATION; AUDIO TAPES, AUDIO-VIDEO TAPES, AUDIO VIDEO CASSETTES, AUDIO VIDEO DISCS, AND DIGITAL VERSATILE DISCS FEATURING MUSIC, COMEDY, DRAMA, ACTION, ADVENTURE, AND/OR ANIMATION; STEREO HEADPHONES; BATTERIES; CORDLESS TELEPHONES; AUDIO CASSETTE AND CD PLAYERS; CD ROM COMPUTER GAME DISCS; TELEPHONE AND RADIO PAGERS; SHORT MOTION PICTURE FILM CASSETTES FEATURING COMEDY, DRAMA, ACTION, ADVENTURE AND/OR ANIMATION TO BE USED WITH HAND-HELD VIEWERS OR PROJECTORS; VIDEO CASSETTE RECORDERS AND PLAYERS, COMPACT DISC PLAYERS, DIGITAL AUDIO TAPE RECORDERS AND PLAYERS; RADIOS; MOUSE PADS; EYEGLASSES, SUNGLASSES AND CASES THEREFOR; VIDEO AND COMPUTER GAME PROGRAMS; VIDEO GAME CARTRIDGES AND CASSETTES; COMPUTER AND VIDEO GAMES WHICH ARE DESIGNED FOR HARDWARE PLATFORMS, NAMELY, GAME CONSOLES AND PERSONAL COMPUTERS; CD-ROM COMPUTER GAME DISCS AND COMPUTER PROGRAMS, NAMELY, SOFTWARE LINKING DIGITIZED VIDEO AND AUDIO MEDIA TO A GLOBAL COMPUTER INFORMATION NETWORK, CELLULAR TELEPHONE ACCESSORIES, NAMELY, HANDS-FREE ACCESSORIES, CELLULAR TELEPHONE COVERS AND CELLULAR TELEPHONE FACE COVERS; ENCODED MAGNETIC CARDS, NAMELY, PHONE CARDS, CREDIT CARDS, CASH CARDS, DEBIT CARDS AND MAGNETIC KEY CARDS; AND DECORATIVE MAGNETS (U.S. CLS. 21, 23, 26, 36 AND 38).

MATTHEW MCDOWELL, EXAMINING ATTORNEY

CLASS 9—(Continued).

SN 77-858,597. LGC WIRELESS, INC., SAN JOSE, CA. FILED 10-27-2009.

INTERREACH EXPRESS

THE MARK CONSISTS OF STANDARD CHARACTERS WITHOUT CLAIM TO ANY PARTICULAR FONT, STYLE, SIZE, OR COLOR.

OWNER OF U.S. REG. NOS. 2,934,663, 3,074,737 AND 3,112,097.

FOR ANTENNAS FOR WIRELESS COMMUNICATIONS APPARATUS; DISTRIBUTED ANTENNA SYSTEM THAT EXTENDS WIRELESS VOICE AND DATA SIGNALS THROUGHOUT A BUILDING OR A CAMPUS, CONSISTING OF RADIO FREQUENCY HUBS, MULTIPLE ANTENNA UNITS, AMPLIFIERS, COMPUTER HARDWARE AND SOFTWARE CONNECTED THROUGH A STRUCTURED CABLE NETWORK (U.S. CLS. 21, 23, 26, 36 AND 38).

DOMINIC J. FERRAIUOLO, EXAMINING ATTORNEY

SN 77-859,474. T-REX ASSOCIATES, INC, LAKE MARY, FL. FILED 10-28-2009.

DuProcess

THE MARK CONSISTS OF STANDARD CHARACTERS WITHOUT CLAIM TO ANY PARTICULAR FONT, STYLE, SIZE, OR COLOR.

SEC. 2(F).

FOR COMPUTER APPLICATION SOFTWARE FOR THE PURPOSE OF MANAGING PERSONS AND CASES RELATED TO JUSTICE AND COURT SYSTEM (U.S. CLS. 21, 23, 26, 36 AND 38).

FIRST USE 2-15-1996; IN COMMERCE 2-15-1996.

INGRID C. EULIN, EXAMINING ATTORNEY

SN 77-860,059. FRABILL, INC., JACKSON, WI. FILED 10-29-2009.

BENCHMARK

THE MARK CONSISTS OF STANDARD CHARACTERS WITHOUT CLAIM TO ANY PARTICULAR FONT, STYLE, SIZE, OR COLOR.

FOR FISHING EQUIPMENT, NAMELY, A MEASURING DEVICE TO MEASURE THE SIZE OF A CAUGHT FISH (U.S. CLS. 21, 23, 26, 36 AND 38).

FIRST USE 7-1-2009; IN COMMERCE 10-1-2009.

TOBY BULLOFF, EXAMINING ATTORNEY

CLASS 9—(Continued).

SN 77-860,207. ACTOR GENIE INC., LOS ANGELES, CA. FILED 10-29-2009.



NO CLAIM IS MADE TO THE EXCLUSIVE RIGHT TO USE "ACTOR", APART FROM THE MARK AS SHOWN. THE STIPPLING IS FOR SHADING PURPOSES ONLY. THE MARK CONSISTS OF THE STYLIZED WORDS "ACTOR GENIE". AN IMAGE OF A GENIE HOLDING A MOBILE PHONE INSIDE A SQUARE WITH ROUNDED CORNERS TO THE LEFT OF THE STYLIZED WORDS. FOR COMPUTER APPLICATION SOFTWARE FOR MOBILE PHONES FOR PROVIDING INFORMATION CONCERNING PROFESSIONAL ACTING, NAMELY CASTING INFORMATION AND CONTACT INFORMATION (U.S. CLS. 21, 23, 26, 36 AND 38). ANNE FARRELL, EXAMINING ATTORNEY

SN 77-861,452. CORSAIR MEMORY, INC., FREMONT, CA. FILED 10-30-2009.

OBSIDIAN SERIES

THE MARK CONSISTS OF STANDARD CHARACTERS WITHOUT CLAIM TO ANY PARTICULAR FONT, STYLE, SIZE, OR COLOR. NO CLAIM IS MADE TO THE EXCLUSIVE RIGHT TO USE "SERIES", APART FROM THE MARK AS SHOWN. FOR COMPUTER SYSTEM COMPONENTS, NAMELY, COMPUTER CASINGS (U.S. CLS. 21, 23, 26, 36 AND 38). DAVID COLLIER, EXAMINING ATTORNEY

SN 77-863,349. ANDREWS, MELISSA, INVER GROVE HEIGHTS, MN. FILED 11-2-2009.

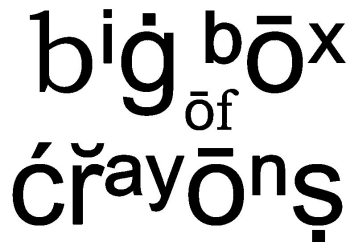

THE MARK CONSISTS OF "BIG BOX OF CRAYONS" WITH STYLIZED FONT DESIGN. FOR DIGITAL MEDIA, NAMELY, DVDS FEATURING KALEIDOSCOPE IMAGERY (U.S. CLS. 21, 23, 26, 36 AND 38). BERYL GARDNER, EXAMINING ATTORNEY

CLASS 9—(Continued).

SN 77-863,861. SAMSUNG ELECTRONICS CO., LTD., GYEONGGI-DO, REPUBLIC OF KOREA, FILED 11-3-2009.



OWNER OF U.S. REG. NOS. 2,882,774, 2,929,519 AND OTHERS. NO CLAIM IS MADE TO THE EXCLUSIVE RIGHT TO USE "LED TV" AND "LED", APART FROM THE MARK AS SHOWN. THE COLOR(S) BLACK, RED, GREEN, BLUE AND GRAY IS/ARE CLAIMED AS A FEATURE OF THE MARK. THE MARK CONSISTS OF THE WORDS "SAMSUNG LED TV SAMSUNG LED TV LED TV LED BY SAMSUNG". IN THE FIRST THREE OCCURRENCES OF "LED", THE "L" AND "D" APPEAR IN THE COLOR BLACK AND THE "E" APPEARS AS THREE HORIZONTAL LINES, THE FIRST LINE IN RED, THE SECOND LINE IN GREEN AND THE THIRD LINE IN BLUE. THE COLOR BLACK APPEARS IN THE FIRST TWO OCCURRENCES OF THE WORDING "SAMSUNG" AND IN THE WORDING "LED BY SAMSUNG". THE COLOR GRAY APPEARS IN ALL THREE OCCURRENCES OF THE WORDING "TV". THE ENGLISH TRANSLATION OF THE WORD "SAMSUNG" IN THE MARK IS THREE STARS. FOR TELEVISION APPARATUS, NAMELY, TELEVISION RECEIVERS, TELEVISION SETS, TELEVISION MONITORS; MONITORS FOR COMPUTERS; DVD PLAYERS; APPARATUS FOR RECORDING AND REPRODUCTION OF SOUND IMAGES; MP3 PLAYERS; AND MOBILE PHONES (U.S. CLS. 21, 23, 26, 36 AND 38). ROBERT LAVACHE, EXAMINING ATTORNEY

SN 77-864,590. SAMSUNG ELECTRONICS CO., LTD., SU-WON-SI, GYEONGGI-DO, REPUBLIC OF KOREA, FILED 11-4-2009.



OWNER OF U.S. REG. NOS. 2,882,774, 2,929,523 AND OTHERS. NO CLAIM IS MADE TO THE EXCLUSIVE RIGHT TO USE "BROWSER", APART FROM THE MARK AS SHOWN. THE COLOR(S) BLUE IS/ARE CLAIMED AS A FEATURE OF THE MARK. THE MARK CONSISTS OF THE WORDING "SAMSUNG DOLPHIN BROWSER" IN WHICH THE "F" IN THE "DOLPHIN" IS FORMED BY A STYLIZED DEPICTION OF A DOLPHIN. ALL ELEMENTS OF THE MARK APPEAR IN THE COLOR BLUE. THE ENGLISH TRANSLATION OF "SAMSUNG" IN THE MARK IS "THREE STARS". FOR SMART PHONES; COMPUTER OPERATING SOFTWARE FOR SMART PHONES (U.S. CLS. 21, 23, 26, 36 AND 38). ROBERT LAVACHE, EXAMINING ATTORNEY

CLASS 9—(Continued).

SN 77-869,670. BALTIC LATVIAN UNIVERSAL ELECTRONICS, LLC, DBA BLUE MICROPHONES, WESTLAKE VILLAGE, CA. FILED 11-10-2009.

Blue Microphones

THE MARK CONSISTS OF STANDARD CHARACTERS WITHOUT CLAIM TO ANY PARTICULAR FONT, STYLE, SIZE, OR COLOR.

OWNER OF U.S. REG. NOS. 2,770,612 AND 3,744,471.

NO CLAIM IS MADE TO THE EXCLUSIVE RIGHT TO USE "MICROPHONES", APART FROM THE MARK AS SHOWN.

SEC. 2(F).

FOR CAMERAS; COMPUTER CAMERAS; DIGITAL CAMERAS; IP (INTERNET PROTOCOL) CAMERAS; LOUDSPEAKERS; HEADPHONES; MICROPHONES AND CD PLAYERS; MICROPHONE CABLES; MICROPHONE MODULES; MICROPHONE STANDS; MICROPHONES; MICROPHONES; MICROPHONES FOR COMMUNICATION DEVICES; MOUNTING DEVICES FOR CAMERAS AND MONITORS; MULTIPLE PURPOSE CAMERAS; PHOTOGRAPHIC CAMERAS; PUBLIC ADDRESS (PA) AND SOUND SYSTEM ACCESSORIES, NAMELY, MICROPHONE STANDS, SPEAKER STANDS, MICROPHONE CABLES, SPEAKER CABLES, SPEAKER BOXES AND SOUND MIXERS; VIDEO CAMERAS (U.S. CLS. 21, 23, 26, 36 AND 38).

FIRST USE 10-12-1995; IN COMMERCE 9-2-1997.

CHARLOTTE CORWIN, EXAMINING ATTORNEY

CLASS 9—(Continued).

SN 77-870,487. ANALOG DEVICES, INC., NORWOOD, MA. FILED 11-11-2009.



OWNER OF U.S. REG. NOS. 2,652,541, 3,121,476 AND OTHERS.

NO CLAIM IS MADE TO THE EXCLUSIVE RIGHT TO USE "PROCESSOR BY ANALOG DEVICES", APART FROM THE MARK AS SHOWN.

THE MARK CONSISTS OF THE WORDS "BLACKFIN PROCESSOR BY ANALOG DEVICES" WITH THE SHAPE OF A FIN IN THE BACKGROUND OF THE WORD "FIN" AND A LINE ON EITHER SIDE OF THE WORD "BY".

FOR INTEGRATED CIRCUITS (U.S. CLS. 21, 23, 26, 36 AND 38).

FIRST USE 9-3-2009; IN COMMERCE 9-3-2009.

JASON TURNER, EXAMINING ATTORNEY

SN 77-870,424. NEW SCALE TECHNOLOGIES, INC., VICTOR, NY. FILED 11-11-2009.

UTAF

THE MARK CONSISTS OF STANDARD CHARACTERS WITHOUT CLAIM TO ANY PARTICULAR FONT, STYLE, SIZE, OR COLOR.

FOR PIEZOELECTRIC ACTUATORS FOR USE IN LOW PROFILE OPTICAL ACTUATION SYSTEMS (U.S. CLS. 21, 23, 26, 36 AND 38).

FIRST USE 5-1-2009; IN COMMERCE 5-1-2009.

YAT SYE, LEE, EXAMINING ATTORNEY

SN 77-870,882. SONY ERICSSON MOBILE COMMUNICATIONS AB, LUND, SWEDEN, FILED 11-12-2009.

PRECISION BY TENSION

THE MARK CONSISTS OF STANDARD CHARACTERS WITHOUT CLAIM TO ANY PARTICULAR FONT, STYLE, SIZE, OR COLOR.

FOR MOBILE PHONES (U.S. CLS. 21, 23, 26, 36 AND 38).

STEVEN JACKSON, EXAMINING ATTORNEY

CLASS 9—(Continued).

SN 77-871,441. WILLIS N. BROWN, JR., DUBLIN, OH. FILED 11-12-2009.

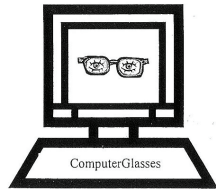

NO CLAIM IS MADE TO THE EXCLUSIVE RIGHT TO USE "COMPUTER GLASSES", APART FROM THE MARK AS SHOWN.

THE STIPPLING IS A FEATURE OF THE MARK AND DOES NOT INDICATE COLOR.

THE MARK CONSISTS OF A DRAWING OF A COMPUTER SCREEN WITH A KEYBOARD ATTACHED. INSIDE THE COMPUTER SCREEN IS A PAIR OF EYEGLASSES WITH A PAIR OF EYES LOOKING OUTWARD, INSIDE THE KEYBOARD AND CENTERED IS THE WORD "COMPUTERGLASSES".

FOR EYEGLASSES DESIGNED TO ALLEVIATE STRAIN AND DISCOMFORT SUFFERED BY THOSE WHO VIEW COMPUTER SCREENS AND MONITORS ON A REGULAR BASIS OR FOR EXTENDED PERIODS (U.S. CLS. 21, 23, 26, 36 AND 38).

FIRST USE 6-20-1992; IN COMMERCE 6-20-1992.
RUSS HERMAN, EXAMINING ATTORNEY

CLASS 9—(Continued).

SN 77-871,644. LEGAL REALITY, LLC, AUBURN, WA. FILED 11-12-2009.



NO CLAIM IS MADE TO THE EXCLUSIVE RIGHT TO USE "LEGAL", APART FROM THE MARK AS SHOWN.

FOR COMPUTER SOFTWARE FOR MANAGEMENT OF LEGAL FORMS BY COLLECTING DATA FROM A USER AND POPULATING THE DATA INTO COURT SUPPLIED FORMS (U.S. CLS. 21, 23, 26, 36 AND 38).

FIRST USE 8-1-2008; IN COMMERCE 4-1-2009.
SIMON TENG, EXAMINING ATTORNEY

SN 77-872,302. ORCHIDWIZ, LLC, MIAMI SHORES, FL. FILED 11-13-2009.

SN 77-871,631. THOMAS RAMIES, DBA WEST 280, PORTOLA VALLEY, CA. AND CLAY BAKER, DBA WEST 280, PORTOLA VALLEY, CA. FILED 11-12-2009.

OrchidWiz

iopener

THE MARK CONSISTS OF STANDARD CHARACTERS WITHOUT CLAIM TO ANY PARTICULAR FONT, STYLE, SIZE, OR COLOR.

FOR PROTECTIVE COVERS AND CASES FOR CELL PHONES, LAPTOPS AND PORTABLE MEDIA PLAYERS (U.S. CLS. 21, 23, 26, 36 AND 38).

SIMON TENG, EXAMINING ATTORNEY

THE MARK CONSISTS OF STANDARD CHARACTERS WITHOUT CLAIM TO ANY PARTICULAR FONT, STYLE, SIZE, OR COLOR.

FOR COMPUTER SOFTWARE FOR THE RESEARCH, COLLECTION, ORGANIZING, PRINTING AND SHARING OF DATA, INFORMATION AND DIGITAL IMAGES RELATED TO BOTANICAL PLANTS, INCLUDING HORTICULTURAL SPECIES AND HYBRIDS (U.S. CLS. 21, 23, 26, 36 AND 38).

FIRST USE 11-7-2005; IN COMMERCE 11-7-2005.
JASON TURNER, EXAMINING ATTORNEY

CLASS 9—(Continued).

SN 77-873,398. WILLIS N. BROWN, JR., DUBLIN, OH. FILED 11-16-2009.

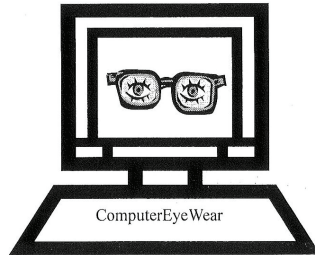

NO CLAIM IS MADE TO THE EXCLUSIVE RIGHT TO USE "COMPUTER EYEWEAR", APART FROM THE MARK AS SHOWN.

THE STIPPLING IS A FEATURE OF THE MARK AND DOES NOT INDICATE COLOR.

THE MARK CONSISTS OF STYLIZED COMPUTER MONITOR WITH EYES PEERING FROM BEHIND EYEGLASSES TOWARD VIEWER AND A STYLIZED KEYBOARD BEARING THE WORDS "COMPUTEREYEWEAR".

FOR EYEGLASSES DESIGNED TO ALLEVIATE STRAIN AND DISCOMFORT SUFFERED BY THOSE WHO VIEW COMPUTER SCREENS AND MONITORS ON A REGULAR BASIS OR FOR EXTENDED PERIODS (U.S. CLS. 21, 23, 26, 36 AND 38).

FIRST USE 6-20-1992; IN COMMERCE 6-20-1992.
RUSS HERMAN, EXAMINING ATTORNEY

SN 77-877,546. MAIN STREET SOFTWARES, INC., GAINESVILLE, FL. FILED 11-20-2009.

CardShield

THE MARK CONSISTS OF STANDARD CHARACTERS WITHOUT CLAIM TO ANY PARTICULAR FONT, STYLE, SIZE, OR COLOR.

FOR COMPUTER SOFTWARE AND HARDWARE FOR DATA PROTECTION; COMPUTER SOFTWARE FOR ENCRYPTION; ELECTRONIC ENCRYPTION UNITS (U.S. CLS. 21, 23, 26, 36 AND 38).

FIRST USE 1-27-2010; IN COMMERCE 1-27-2010.
LINDA M. KING, EXAMINING ATTORNEY

CLASS 9—(Continued).

SN 77-877,684. ALLOUN, CHARLES, SHERMAN OAKS, CA. FILED 11-20-2009.

GARMAN 21C

THE MARK CONSISTS OF STANDARD CHARACTERS WITHOUT CLAIM TO ANY PARTICULAR FONT, STYLE, SIZE, OR COLOR.

FOR COMPUTER SOFTWARE FOR CONTROLLING AND MANAGING CLOTHING MANUFACTURE, NAMELY, ORDER ENTRY, RAW AND FINISHED INVENTORY, WORK IN PROCESS, SHIPPING, BILLING, ACCOUNTS RECEIVABLE AND ALL RELATED ACCOUNTING PROCEDURES (U.S. CLS. 21, 23, 26, 36 AND 38).

REGINA DRUMMOND, EXAMINING ATTORNEY

SN 77-878,245. ANIFX STUDIOS, CLERMONT, FL. FILED 11-21-2009.



THE COLOR(S) BLACK, YELLOW AND WHITE IS/ARE CLAIMED AS A FEATURE OF THE MARK.

THE MARK CONSISTS OF THE WORDS "YO HABLO ESPANOL" IN BLACK COLOR WITH WHITE SHADING OVER A YELLOW SPEECH BUBBLE WITH BLACK BORDER.

THE ENGLISH TRANSLATION OF "YO HABLO ESPANOL" IN THE MARK IS I SPEAK SPANISH.

FOR PRERECORDED AUDIO CDS AND VIDEO DVDS FOR TEACHING THE SPANISH LANGUAGE FOR KIDS (U.S. CLS. 21, 23, 26, 36 AND 38).

FIRST USE 11-21-2009; IN COMMERCE 11-21-2009.
JENNIFER VASQUEZ, EXAMINING ATTORNEY

SN 77-879,049. WESTRICH, MILTON, DAVID, SOUTH ORANGE, NJ. FILED 11-23-2009.

THE MUSCLE METER

THE MARK CONSISTS OF STANDARD CHARACTERS WITHOUT CLAIM TO ANY PARTICULAR FONT, STYLE, SIZE, OR COLOR.

NO CLAIM IS MADE TO THE EXCLUSIVE RIGHT TO USE "METER", APART FROM THE MARK AS SHOWN.

FOR FLOW METERS; WATER METERS (U.S. CLS. 21, 23, 26, 36 AND 38).

TARAH HARDY, EXAMINING ATTORNEY

CLASS 9—(Continued).

SN 77-879,358. AINSWORTH GAME TECHNOLOGY LIMITED, NEWINGTON, AUSTRALIA, FILED 11-23-2009.

Jackpot Zone

THE MARK CONSISTS OF STANDARD CHARACTERS WITHOUT CLAIM TO ANY PARTICULAR FONT, STYLE, SIZE, OR COLOR.

NO CLAIM IS MADE TO THE EXCLUSIVE RIGHT TO USE "JACKPOT", APART FROM THE MARK AS SHOWN.

FOR COMPUTER SOFTWARE AND FIRMWARE FOR GAMES OF CHANCE ON ANY COMPUTERIZED PLATFORM, INCLUDING DEDICATED GAMING CONSOLES, VIDEO BASED SLOT MACHINES, REEL BASED SLOT MACHINES, AND VIDEO LOTTERY TERMINALS (U.S. CLS. 21, 23, 26, 36 AND 38).

FRANK LATTUCA, EXAMINING ATTORNEY

SN 77-879,455. SUBZONE DISTRIBUTING CORPORATION, STONEY CREEK, ONTARIO, CANADA, FILED 11-24-2009.

SUBZONE

THE MARK CONSISTS OF STANDARD CHARACTERS WITHOUT CLAIM TO ANY PARTICULAR FONT, STYLE, SIZE, OR COLOR.

FOR LOUD SPEAKER ENCLOSURES, LOUD SPEAKERS (U.S. CLS. 21, 23, 26, 36 AND 38).

FIRST USE 10-15-2001; IN COMMERCE 10-15-2001.

TARA PATE, EXAMINING ATTORNEY

SN 77-879,801. SENSORMATIC ELECTRONICS, LLC, BOCA RATON, FL. FILED 11-24-2009.

ULTRA•INK

NO CLAIM IS MADE TO THE EXCLUSIVE RIGHT TO USE "INK", APART FROM THE MARK AS SHOWN.

THE MARK CONSISTS OF A DOT BETWEEN "ULTRA" AND "INK".

FOR ELECTRONIC ARTICLE SURVEILLANCE SECURITY TAGS FOR USE AS AN ANTI-SHOPLIFTING APPARATUS FOR USE IN PROTECTION AGAINST THEFT (U.S. CLS. 21, 23, 26, 36 AND 38).

FIRST USE 12-31-2004; IN COMMERCE 12-31-2004.

KYLE PEETE, EXAMINING ATTORNEY

CLASS 9—(Continued).

SN 77-880,553. PARALLELS SOFTWARE INTERNATIONAL, INC., TORTOLA, BR. VIRGIN ISLANDS, FILED 11-25-2009.

CRYSTAL MODE

THE MARK CONSISTS OF STANDARD CHARACTERS WITHOUT CLAIM TO ANY PARTICULAR FONT, STYLE, SIZE, OR COLOR.

NO CLAIM IS MADE TO THE EXCLUSIVE RIGHT TO USE "MODE", APART FROM THE MARK AS SHOWN.

FOR COMPUTER SOFTWARE FOR USE IN HARDWARE VIRTUALIZATION AND OPERATING SYSTEM VIRTUALIZATION; COMPUTER SOFTWARE FOR USE IN HARDWARE EMULATION AND OPERATING SYSTEM EMULATION; COMPUTER SOFTWARE FOR USE IN SEAMLESS INTEGRATION OF NON-NATIVE APPLICATIONS; COMPUTER SOFTWARE FOR USE IN RENDERING DISPLAYS OF ICONS, FILE SYSTEMS AND APPLICATIONS OF GUEST OPERATING SYSTEMS; COMPUTER SOFTWARE FOR USE IN INTEGRATING A VIRTUALIZED OPERATING SYSTEM INTO A NATIVE OPERATING SYSTEM; COMPUTER SOFTWARE FOR USE IN INTEGRATING A NATIVE OPERATING SYSTEM INTO A VIRTUALIZED OPERATING SYSTEM; COMPUTER SOFTWARE FOR USE IN PROVIDING SERVICES OF ONE OPERATING SYSTEM INSIDE ANOTHER OPERATING SYSTEM; COMPUTER SOFTWARE FOR USE IN ENABLING APPLICATIONS FROM ONE OPERATING SYSTEM TO APPEAR AS NATIVE ON ANOTHER OPERATING SYSTEM (U.S. CLS. 21, 23, 26, 36 AND 38).

FIRST USE 11-5-2009; IN COMMERCE 11-5-2009.

PRISCILLA MILTON, EXAMINING ATTORNEY

SN 77-881,033. CELLOMICS INC., PITTSBURGH, PA. FILED 11-25-2009.

IDEV

THE MARK CONSISTS OF STANDARD CHARACTERS WITHOUT CLAIM TO ANY PARTICULAR FONT, STYLE, SIZE, OR COLOR.

FOR IMAGE ACQUISITION AND ANALYSIS SOFTWARE FOR MEASUREMENT AND ANALYSIS OF BIOLOGICAL SPECIMENS (U.S. CLS. 21, 23, 26, 36 AND 38).

VERNA BETH RIRIE, EXAMINING ATTORNEY

CLASS 9—(Continued).

SN 77-881,037. CELLOMICS INC., PITTSBURGH, PA. FILED 11-25-2009.

CELLINSIGHT

THE MARK CONSISTS OF STANDARD CHARACTERS WITHOUT CLAIM TO ANY PARTICULAR FONT, STYLE, SIZE, OR COLOR.

FOR COMPUTERIZED SYSTEM FOR ANALYZING ARRAYS OF CELLS BY LIGHT OPTICAL METHODS COMPRISING LIGHT MICROSCOPE OPTICS, SCANNING HARDWARE, COMPUTER HARDWARE, COMPUTER SOFTWARE (U.S. CLS. 21, 23, 26, 36 AND 38).
VERNA BETH RIRIE, EXAMINING ATTORNEY

SN 77-881,713. FUNTANK LLC, NEW YORK, NY. FILED 11-28-2009.

VectorTD

THE MARK CONSISTS OF STANDARD CHARACTERS WITHOUT CLAIM TO ANY PARTICULAR FONT, STYLE, SIZE, OR COLOR.

FOR COMPUTER GAME PROGRAMS; COMPUTER GAME SOFTWARE; COMPUTER GAME SOFTWARE DOWNLOADABLE FROM A GLOBAL COMPUTER NETWORK; COMPUTER GAME SOFTWARE FOR PERSONAL COMPUTERS AND HOME VIDEO GAME CONSOLES; COMPUTER PROGRAMS FOR GAMES PLAYED ON MOBILE PHONES, PERSONAL DIGITAL ASSISTANTS AND HANDHELD COMPUTERS (U.S. CLS. 21, 23, 26, 36 AND 38).

FIRST USE 2-0-2008; IN COMMERCE 2-0-2008.
ANDREA K. NADELMAN, EXAMINING ATTORNEY

CLASS 9—(Continued).

SN 77-881,777. VERSA ENGINEERING & TECHNOLOGY, INC., BENICIA, CA. FILED 11-29-2009.

PROCEDURE 123

THE MARK CONSISTS OF STANDARD CHARACTERS WITHOUT CLAIM TO ANY PARTICULAR FONT, STYLE, SIZE, OR COLOR.

NO CLAIM IS MADE TO THE EXCLUSIVE RIGHT TO USE "PROCEDURE", APART FROM THE MARK AS SHOWN.

FOR COMPUTER SOFTWARE FOR USE WITH WORD PROCESSING PROGRAMS TO CREATE AND MODIFY COMPLICATED INDUSTRIAL OPERATING AND MAINTENANCE PROCEDURES, FOR CREATING COMPLICATED WRITTEN PROCEDURES FOR HEAVY INDUSTRIAL USERS, AND FOR ALLOWING USERS TO SPEED UP THE CREATION OF CONTROLLED DOCUMENTS THAT MUST COMPLY WITH SAFETY AGENCIES (U.S. CLS. 21, 23, 26, 36 AND 38).

FIRST USE 0-0-2005; IN COMMERCE 0-0-2005.
KAREN BRACEY, EXAMINING ATTORNEY

SN 77-881,875. ARMALASER INC., ALACHUA, FL. FILED 11-30-2009.

STINGRAY

THE MARK CONSISTS OF STANDARD CHARACTERS WITHOUT CLAIM TO ANY PARTICULAR FONT, STYLE, SIZE, OR COLOR.

FOR LASER POINTING DEVICES FOR USE WITH FIREARMS (U.S. CLS. 21, 23, 26, 36 AND 38).

FIRST USE 11-17-2009; IN COMMERCE 11-17-2009.
BARBARA GAYNOR, EXAMINING ATTORNEY

SN 77-882,061. COKER, MICHAEL C., TYLER, TX. FILED 11-30-2009.

imergency

THE MARK CONSISTS OF STANDARD CHARACTERS WITHOUT CLAIM TO ANY PARTICULAR FONT, STYLE, SIZE, OR COLOR.

FOR COMPUTER SOFTWARE FOR COMMUNICATING LOCATION USING GPS OR SIMILAR TECHNOLOGY (U.S. CLS. 21, 23, 26, 36 AND 38).

JOHN DALIER, EXAMINING ATTORNEY

CLASS 9—(Continued).

SN 77-882,139. CTERA NETWORKS LTD., PETACH-TIKVA, ISRAEL, FILED 11-30-2009.

NEXT3

THE MARK CONSISTS OF STANDARD CHARACTERS WITHOUT CLAIM TO ANY PARTICULAR FONT, STYLE, SIZE, OR COLOR.

FOR COMPUTER SOFTWARE USED FOR JOURNALING WITH SNAPSHOTS SUPPORT, NAMELY, A JOURNALING FILE SYSTEM SUPPORTING INCREMENTAL, VOLUME LEVEL SNAPSHOTS (U.S. CLS. 21, 23, 26, 36 AND 38).

KEVON CHISOLM, EXAMINING ATTORNEY

SN 77-882,256. WATERS INDUSTRIES, INC., WEST DUNDEE, IL. FILED 11-30-2009.

SPECLIGHTS

THE MARK CONSISTS OF STANDARD CHARACTERS WITHOUT CLAIM TO ANY PARTICULAR FONT, STYLE, SIZE, OR COLOR.

FOR EYEWEAR (U.S. CLS. 21, 23, 26, 36 AND 38).

KIM SAITO, EXAMINING ATTORNEY

SN 77-882,296. HMH PUBLISHERS LLC, WILMINGTON, DE. FILED 11-30-2009.

CHEMFILE

THE MARK CONSISTS OF STANDARD CHARACTERS WITHOUT CLAIM TO ANY PARTICULAR FONT, STYLE, SIZE, OR COLOR.

OWNER OF U.S. REG. NO. 2,301,714.
FOR COMPUTER PROGRAMS FOR GENERATING AND SCORING TESTS AND QUIZZES, ANSWER KEYS, CREATING WORKSHEETS, SUPPLEMENTAL READING GUIDES, ACTIVITIES ON A GLOBAL COMPUTER INFORMATION NETWORK AND CLASSROOM MANAGEMENT FOR TEACHING CHEMISTRY TO HIGH SCHOOL STUDENTS (U.S. CLS. 21, 23, 26, 36 AND 38).

BENJAMIN OKEKE, EXAMINING ATTORNEY

CLASS 9—(Continued).

SN 77-882,333. HMH PUBLISHERS LLC, WILMINGTON, DE. FILED 11-30-2009.



OWNER OF U.S. REG. NO. 2,249,740.

THE MARK CONSISTS OF THE WORD "HOLT" IN A CIRCLE WITH A SET OF CHEMISTRY VIALS LOCATED ABOVE THE WORD "CHEMFILE" IN A CIRCLE.

FOR COMPUTER PROGRAMS FOR GENERATING AND SCORING TESTS AND QUIZZES, ANSWER KEYS, CREATING WORKSHEETS, SUPPLEMENTAL READING GUIDES, ACTIVITIES ON A GLOBAL COMPUTER INFORMATION NETWORK AND CLASSROOM MANAGEMENT FOR TEACHING CHEMISTRY TO HIGH SCHOOL STUDENTS (U.S. CLS. 21, 23, 26, 36 AND 38).

BENJAMIN OKEKE, EXAMINING ATTORNEY

SN 77-882,890. FORESIGHT IMAGING, LLC, CHELMSFORD, MA. FILED 12-1-2009.

TIMS Consultant

THE MARK CONSISTS OF STANDARD CHARACTERS WITHOUT CLAIM TO ANY PARTICULAR FONT, STYLE, SIZE, OR COLOR.

NO CLAIM IS MADE TO THE EXCLUSIVE RIGHT TO USE "CONSULTANT", APART FROM THE MARK AS SHOWN.

FOR CONCURRENTLY COLLABORATIVE TELECONFERENCING AND VIDEO CONFERENCING SYSTEM, NAMELY, A TELE-MEDICINE MANAGEMENT COMPUTER SERVER, VIDEO IMAGE STREAMING SERVER, A COMPUTER INPUT DEVICE, A COMPUTER OUTPUT DEVICE AND RECORDING DEVICE THAT DISPLAYS MEDICAL IMAGES INCLUDING REAL TIME VIDEO IMAGES DISPLAYING SAID IMAGES ON MULTIPLE DISPLAYS IN MULTIPLE LOCATIONS ALL CONNECTED TO A NETWORK, AN OPERATOR, NAMELY, PERSONS, USERS, CLIENTS HAVING ASSOCIATION WITH SAID MEDICAL IMAGE ALLOWING THE USER THE ABILITY TO CONCURRENTLY COLLABORATE ON SAID IMAGES AND TELESTRATE DIRECTLY OVER THE IMAGE, ANNOTATE, WHITE BOARD AND CHAT ON AND ABOUT THOSE IMAGES INTERACTIVELY, IN LIVE OR PRE-RECORDED FORMATS (U.S. CLS. 21, 23, 26, 36 AND 38).

NAKIA HENRY, EXAMINING ATTORNEY

CLASS 9—(Continued).

SN 77-882,911. GREAT VALLEY LAND CO., VISALIA, CA. FILED 12-1-2009.

RESULTS WITHOUT THE WEIGHT

THE MARK CONSISTS OF STANDARD CHARACTERS WITHOUT CLAIM TO ANY PARTICULAR FONT, STYLE, SIZE, OR COLOR.

NO CLAIM IS MADE TO THE EXCLUSIVE RIGHT TO USE "WEIGHT", APART FROM THE MARK AS SHOWN.

FOR WEIGHT SCALES (U.S. CLS. 21, 23, 26, 36 AND 38).

LYDIA BELZER, EXAMINING ATTORNEY

SN 77-882,912. FORESIGHT IMAGING, LLC, CHELMSFORD, MA. FILED 12-1-2009.

TIMS Mobile

THE MARK CONSISTS OF STANDARD CHARACTERS WITHOUT CLAIM TO ANY PARTICULAR FONT, STYLE, SIZE, OR COLOR.

NO CLAIM IS MADE TO THE EXCLUSIVE RIGHT TO USE "MOBILE", APART FROM THE MARK AS SHOWN.

FOR CONCURRENTLY COLLABORATIVE TELECONFERENCING AND VIDEO CONFERENCING SYSTEM, NAMELY, A TELE-MEDICINE MANAGEMENT COMPUTER SERVER, VIDEO IMAGE STREAMING SERVER, A COMPUTER INPUT DEVICE, A COMPUTER OUTPUT DEVICE AND RECORDING DEVICE THAT DISPLAYS MEDICAL IMAGES INCLUDING REAL TIME VIDEO IMAGES DISPLAYING SAID IMAGES ON MULTIPLE DISPLAYS IN MULTIPLE LOCATIONS ALL CONNECTED TO A NETWORK, AN OPERATOR, NAMELY, PERSONS, USERS, CLIENTS HAVING ASSOCIATION WITH SAID MEDICAL IMAGE ALLOWING THE USER THE ABILITY TO CONCURRENTLY COLLABORATE ON SAID IMAGES AND TELESTRATE DIRECTLY OVER THE IMAGE, ANNOTATE, WHITE BOARD AND CHAT ON AND ABOUT THOSE IMAGES INTERACTIVELY, IN LIVE OR PRE-RECORDED FORMATS (U.S. CLS. 21, 23, 26, 36 AND 38).

NAKIA HENRY, EXAMINING ATTORNEY

CLASS 9—(Continued).

SN 77-882,974. AMPLIFIER RESEARCH CORPORATION, DBA AR WORLDWIDE, SOUDERTON, PA. FILED 12-1-2009.



OWNER OF U.S. REG. NOS. 1,788,797, 3,681,097 AND OTHERS.

NO CLAIM IS MADE TO THE EXCLUSIVE RIGHT TO USE "BATTLE TESTED", APART FROM THE MARK AS SHOWN.

THE COLOR(S) ORANGE, BLACK AND WHITE IS/ARE CLAIMED AS A FEATURE OF THE MARK.

THE MARK CONSISTS OF THE WORDS "BATTLE TESTED" IN WHITE LETTERS INSIDE AN ORANGE CIRCLE, AN ORANGE STRIPE EXTENDING PART-WAY ACROSS THE CIRCLE AND ENDING IN THE LETTERS "AR" ALSO IN ORANGE, AND TWO ORANGE ARCS ON OPPOSITE SIDES OF THE ORANGE STRIPE, ALL ON A BLACK BACKGROUND.

FOR AMPLIFIERS FOR INDUSTRIAL, MILITARY AND RESEARCH APPLICATIONS (U.S. CLS. 21, 23, 26, 36 AND 38).

FIRST USE 12-17-2009; IN COMMERCE 12-17-2009. JAMES GRIFFIN, EXAMINING ATTORNEY

SN 77-883,898. LUXTRON CORPORATION, SANTA CLARA, CA. FILED 12-2-2009.

LUMASMART

THE MARK CONSISTS OF STANDARD CHARACTERS WITHOUT CLAIM TO ANY PARTICULAR FONT, STYLE, SIZE, OR COLOR.

FOR THERMOMETRY MODULE FOR MEASURING TEMPERATURE ASSOCIATED WITH ANY ONE OF A UTILITY TRANSFORMER, A LOAD-TAP CHANGER, AND A POWER SWITCH BAR; THERMOMETRY MODULE FOR MONITORING TEMPERATURE ASSOCIATED WITH ANY ONE OF A UTILITY TRANSFORMER, A LOAD-TAP CHANGER, AND A POWER SWITCH BAR (U.S. CLS. 21, 23, 26, 36 AND 38).

FIRST USE 2-28-2009; IN COMMERCE 2-28-2009. ELLEN BURNS, EXAMINING ATTORNEY

CLASS 9—(Continued).

SN 77-883,918. ANTURIS INC., ROAD TOWN, TORTOLA, BR. VIRGIN ISLANDS, FILED 12-2-2009.

INETIZER

THE MARK CONSISTS OF STANDARD CHARACTERS WITHOUT CLAIM TO ANY PARTICULAR FONT, STYLE, SIZE, OR COLOR.

FOR COMPUTER SOFTWARE FOR ADMINISTRATION OF COMPUTER LOCAL AREA NETWORKS; COMPUTER SOFTWARE FOR ADMINISTRATION OF COMPUTER NETWORKS; COMPUTER SOFTWARE FOR NETWORK MONITORING, MANAGEMENT AND OPTIMIZATION; COMPUTER SOFTWARE FOR NETWORK MONITORING, MANAGEMENT AND OPTIMIZATION THAT MAY BE DOWNLOADED FROM A GLOBAL COMPUTER NETWORK; LAN (LOCAL AREA NETWORK) OPERATING SOFTWARE; SOFTWARE FOR MONITORING AND CONTROLLING COMMUNICATION BETWEEN COMPUTERS AND AUTOMATED MACHINE SYSTEMS; WAN (WIDE AREA NETWORK) OPERATING SOFTWARE (U.S. CLS. 21, 23, 26, 36 AND 38).

SHAUNIA CARLYLE, EXAMINING ATTORNEY

CLASS 9—(Continued).

SN 77-884,019. RADIASHIELD TECHNOLOGIES CORPORATION, NEW YORK, NY. FILED 12-2-2009.

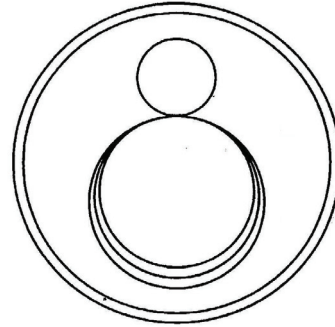

THE MARK CONSISTS TWO CONCENTRIC CIRCLES WITHIN WHICH OTHER CIRCLES FORM A STYLIZED PERSON SHAPE.

FOR RADIATION SHIELDS FOR ELECTRONIC PRODUCTS (U.S. CLS. 21, 23, 26, 36 AND 38).

REBECCA POVARCHUK, EXAMINING ATTORNEY

SN 77-884,250. NIKITIN NIKITA, DBA JETA PANTHER, SOCHI, RUSSIAN FED., FILED 12-2-2009.

Jeta Panther

THE MARK CONSISTS OF STANDARD CHARACTERS WITHOUT CLAIM TO ANY PARTICULAR FONT, STYLE, SIZE, OR COLOR.

FOR DOWNLOADABLE COMPUTER SOFTWARE FOR USE IN GRAPHICS AND ILLUSTRATION (U.S. CLS. 21, 23, 26, 36 AND 38).

ODESSA BIBBINS, EXAMINING ATTORNEY

SN 77-884,006. TELESENSORS, INC., KNOXVILLE, TN. FILED 12-2-2009.



SN 77-884,542. POWERMAND, INC., PORTLAND, OR. FILED 12-2-2009.

LynxSense

THE MARK CONSISTS OF THE LITERAL ELEMENT "PERPETUAL" INCLUDING A PLURALITY OF ARC-LIKE DESIGNS ABOVE THE LITERAL ELEMENT AND A PLURALITY OF NARROW HORIZONTALLY ORIENTED SHAPES FORMING AN UNDERLINING IMPRESSION BENEATH THE LITERAL ELEMENT.

FOR DATA PROCESSORS; ELECTRONIC DATA RECORDERS; WIRELESS COMMUNICATION DEVICES FOR VOICE, DATA OR IMAGE TRANSMISSION (U.S. CLS. 21, 23, 26, 36 AND 38).

ROBIN CHOSID, EXAMINING ATTORNEY

THE MARK CONSISTS OF STANDARD CHARACTERS WITHOUT CLAIM TO ANY PARTICULAR FONT, STYLE, SIZE, OR COLOR.

FOR COMPUTER SOFTWARE AND HARDWARE FOR WIRELESS MESH NETWORK MANAGEMENT, DEVICE COMMUNICATIONS, AND ENERGY MANAGEMENT AND FACILITY DIAGNOSTIC APPLICATIONS (U.S. CLS. 21, 23, 26, 36 AND 38).

FIRST USE 11-1-2009; IN COMMERCE 11-1-2009.

H. M. FISHER, EXAMINING ATTORNEY

CLASS 9—(Continued).

SN 77-884,567. POWERMAND, INC., PORTLAND, OR.
FILED 12-2-2009.

Building Smart Power

THE MARK CONSISTS OF STANDARD CHARACTERS WITHOUT CLAIM TO ANY PARTICULAR FONT, STYLE, SIZE, OR COLOR.

NO CLAIM IS MADE TO THE EXCLUSIVE RIGHT TO USE "SMART POWER", APART FROM THE MARK AS SHOWN.

FOR COMPUTER SOFTWARE AND HARDWARE FOR WIRELESS MESH NETWORK MANAGEMENT, DEVICE COMMUNICATIONS, AND ENERGY MANAGEMENT AND FACILITY DIAGNOSTIC APPLICATIONS (U.S. CLS. 21, 23, 26, 36 AND 38).

FIRST USE 7-22-2009; IN COMMERCE 7-22-2009.
H. M. FISHER, EXAMINING ATTORNEY

CLASS 9—(Continued).

SN 77-884,711. NIELSEN-KELLERMAN, BOOTHWYN, PA.
FILED 12-2-2009.

COX BOX MINI

THE MARK CONSISTS OF STANDARD CHARACTERS WITHOUT CLAIM TO ANY PARTICULAR FONT, STYLE, SIZE, OR COLOR.

OWNER OF U.S. REG. NO. 2,549,188.

NO CLAIM IS MADE TO THE EXCLUSIVE RIGHT TO USE "BOX MINI", APART FROM THE MARK AS SHOWN.

FOR MINIATURE WATERPROOF RECHARGEABLE AMPLIFIERS; AUDIO WATERPROOF SPEAKERS; SPEAKER SYSTEM, NAMELY, MICROPHONE, SPEAKERS, CABLES, BOXES AND MICROPHONE AND SPEAKER STANDS; WATERPROOF ELECTRONIC SOUND AMPLIFICATION, MEASURING AND TIMING INSTRUMENTS USED TO MONITOR ROWING, PADDLING AND KAYAKING CONDITIONS SUCH AS TIME, SPEED, PACE, STROKE RATE AND STROKE COUNT (U.S. CLS. 21, 23, 26, 36 AND 38).

SHANNON TWOHIG, EXAMINING ATTORNEY

SN 77-884,692. W2W ENTERTAINMENT, LLC, AKA W2W RECORDS, HENDERSON, NV. FILED 12-2-2009.



THE COLOR(S) BLACK, WHITE AND RED IS/ARE CLAIMED AS A FEATURE OF THE MARK.

THE MARK CONSISTS OF TWO SIDE-BY-SIDE BLACK "W'S" IN CAPITAL LETTERS, BOTH HAVING WHITE OUTLINING, AND A STYLIZED RED NUMBER "2" HAVING A WHITE OUTLINE AND WHITE Splotches IMPOSED BETWEEN THE "W'S". THE BACKGROUND OF THE MARK IS TRANSPARENT

FOR MUSICAL SOUND RECORDINGS (U.S. CLS. 21, 23, 26, 36 AND 38).

ANDREA HACK, EXAMINING ATTORNEY

SN 77-884,877. MARCIA WIEDER, SAN FRANCISCO, CA.
FILED 12-2-2009.

DREAM UNIVERSITY

THE MARK CONSISTS OF STANDARD CHARACTERS WITHOUT CLAIM TO ANY PARTICULAR FONT, STYLE, SIZE, OR COLOR.

OWNER OF U.S. REG. NO. 2,228,465.

FOR PRE-RECORDED ELECTRONIC MEDIA FEATURING EDUCATIONAL, INSPIRATIONAL AND BUSINESS PROGRAMS IN THE FIELDS OF SETTING AND REACHING PERSONAL AND BUSINESS GOALS, BUSINESS PLANNING AND BUILDING, AGENDA AND TIME MANAGEMENT, LEADERSHIP, MANAGEMENT, EDUCATION, SALES, COMMUNICATION, CORPORATE AND PERSONAL ASSESSMENT AND MEASUREMENT, AND PROFESSIONAL AND PERSONAL DEVELOPMENT (U.S. CLS. 21, 23, 26, 36 AND 38).

KATHLEEN LORENZO, EXAMINING ATTORNEY

CLASS 9—(Continued).

SN 77-884,900. GEOREADER LLC, LEWES, DE. FILED 12-2-2009.



THE COLOR(S) BLUE, BLACK, WHITE AND GRAY IS/ ARE CLAIMED AS A FEATURE OF THE MARK.

THE MARK CONSISTS OF THE STYLIZED WORDING "GEOREADER" BELOW THE DESIGN OF A POINT SHAPED BALLOON HAVING THE DESIGN OF A GLOBE WITHIN IT AND A SHADOW TO THE RIGHT OF THE BALLOON, THE COLOR BLUE APPEARS IN THE LETTERS "GEO" OF THE WORDING "GEOREADER", AND IN THE POINT SHAPED BALLOON. THE COLOR BLACK APPEARS IN THE LETTERS "READER" OF THE WORDING "GEOREADER". THE COLOR WHITE APPEARS IN THE DESIGN OF THE GLOBE. THE COLOR GRAY APPEARS IN THE SHADOW.

FOR DOWNLOADABLE SOFTWARE IN THE NATURE OF A MOBILE APPLICATION FOR USE IN PROVIDING GEOGRAPHIC LOCATION SPECIFIC INFORMATION (U.S. CLS. 21, 23, 26, 36 AND 38).

JAY BESCH, EXAMINING ATTORNEY

SN 77-884,977. HIT'N'MIX LTD, LONDON, UNITED KINGDOM, FILED 12-3-2009.

HIT N MIX

THE MARK CONSISTS OF STANDARD CHARACTERS WITHOUT CLAIM TO ANY PARTICULAR FONT, STYLE, SIZE, OR COLOR.

NO CLAIM IS MADE TO THE EXCLUSIVE RIGHT TO USE "MIX", APART FROM THE MARK AS SHOWN.

FOR COMPUTER HARDWARE AND SOFTWARE FOR PROCESSING DIGITAL MUSIC FILES (U.S. CLS. 21, 23, 26, 36 AND 38).

ELLEN PERKINS, EXAMINING ATTORNEY

CLASS 9—(Continued).

SN 77-884,983. GRACE H. WANG, SEOUL, REPUBLIC OF KOREA, FILED 12-3-2009.

iEnglish

THE MARK CONSISTS OF STANDARD CHARACTERS WITHOUT CLAIM TO ANY PARTICULAR FONT, STYLE, SIZE, OR COLOR.

FOR EDUCATIONAL SOFTWARE RECORDED ON COMPUTER MEDIA FEATURING INSTRUCTION IN ENGLISH LANGUAGE AND EDUCATION (U.S. CLS. 21, 23, 26, 36 AND 38).

PATRICIA EVANKO, EXAMINING ATTORNEY

SN 77-885,113. MODA COLLECTION, LARGO, FL. FILED 12-3-2009.



THE COLOR(S) BLACK, WHITE IS/ARE CLAIMED AS A FEATURE OF THE MARK.

THE MARK CONSISTS OF BLACK BACKGROUND, STYLIZED "X", FOLLOWED BY "ERO" ALL WRITTEN IN THE COLOR WHITE, ENDING WITH A WHITE CIRCLE.

FOR CASES FOR EYEGASSES AND SUNGLASSES; SUNGLASSES (U.S. CLS. 21, 23, 26, 36 AND 38).

SOPHIA S. KIM, EXAMINING ATTORNEY

SN 77-885,116. THE TIFFEN COMPANY, LLC, HAUPPAUGE, NY. FILED 12-3-2009.

TRAVERSE

THE MARK CONSISTS OF STANDARD CHARACTERS WITHOUT CLAIM TO ANY PARTICULAR FONT, STYLE, SIZE, OR COLOR.

FOR TRIPODS FOR CAMERAS (U.S. CLS. 21, 23, 26, 36 AND 38).

SOPHIA S. KIM, EXAMINING ATTORNEY

CLASS 9—(Continued).

SN 77-885,271. ISAAC DANIEL GROUP, INC., MIRAMAR, FL. FILED 12-3-2009.

CLASS 9—(Continued).

SN 77-885,319. SMALL DOG ELECTRONICS, INC., WAITS-FIELD, VT. FILED 12-3-2009.

CHILL PILL
audio

GEO LOCKING

OWNER OF U.S. REG. NO. 3,657,913.

NO CLAIM IS MADE TO THE EXCLUSIVE RIGHT TO USE "AUDIO", APART FROM THE MARK AS SHOWN.

THE MARK CONSISTS OF THE WORDS "CHILL PILL" WITH A DIAGONAL LINE IN THE "P" OF THE WORD "PILL" AND THE WORD "AUDIO" BELOW THE WORD "PILL".

FOR ADAPTERS; APPARATUS FOR RECORDING, TRANSMITTING AND REPRODUCING SOUND AND IMAGES; AUDIO SPEAKERS; BAGS AND CASES SPECIALLY ADAPTED FOR HOLDING OR CARRYING PORTABLE TELEPHONES AND TELEPHONE EQUIPMENT AND ACCESSORIES; BATTERIES; BATTERIES AND BATTERY CHARGERS; BATTERY CHARGERS; BLANK HARD DRIVES FOR COMPUTERS; CABLE CONNECTORS; CASES FOR MOBILE PHONES; COMPUTER STORAGE DEVICES, NAMELY, FLASH DRIVES; CONNECTION CABLES; DC/AC POWER CONVERTERS; DVD PLAYERS; EARPHONES; ELECTRIC CHARGING CABLES; ELECTRICAL CABLES FOR USE IN CONNECTIONS; ELECTRONIC CABLES; ELECTRONIC SOUND MIXING, PROCESSING AND SYNTHESIZING APPARATUS; EXTERNAL COMPUTER HARD DRIVES; HARD DISK DRIVES (HDD); LCD LARGE-SCREEN DISPLAYS; LIQUID CRYSTAL DISPLAY (LCD) PROJECTORS; MICROPHONES; PHONOGRAPHS; PORTABLE AND HANDHELD DIGITAL ELECTRONIC DEVICES FOR RECORDING, ORGANIZING, TRANSMITTING, MANIPULATING, AND REVIEWING TEXT, DATA, IMAGE, AND AUDIO FILES; POWER AMPLIFIERS; POWER CABLES; POWER SUPPLY CONNECTORS AND ADAPTERS FOR USE WITH PORTABLE ELECTRONIC DEVICES; PROTECTIVE CARRYING CASES FOR PORTABLE MUSIC PLAYERS, NAMELY, MP3 PLAYERS; RADIO TRANSMITTERS; USB (UNIVERSAL SERIAL BUS) HARDWARE; AUDIO SPEAKERS FOR USE IN HELMETS (U.S. CLS. 21, 23, 26, 36 AND 38).

FIRST USE 8-5-2008; IN COMMERCE 8-5-2008.

REBECCA EISINGER, EXAMINING ATTORNEY

SN 77-885,396. SMALL DOG ELECTRONICS, INC., WAITS-FIELD, VT. FILED 12-3-2009.

STUBBIE

THE MARK CONSISTS OF STANDARD CHARACTERS WITHOUT CLAIM TO ANY PARTICULAR FONT, STYLE, SIZE, OR COLOR.

FOR WIRELESS COMMUNICATIONS SYSTEMS AND DEVICES, NAMELY, COVERT ALARM LOCATOR APPARATUS CONSISTING OF GLOBAL POSITIONING SYSTEMS (GPS) CONSISTING OF RECEIVERS, CELL PHONES AND ALARM MONITORING SYSTEMS USED TO LOCATE INDIVIDUALS, OBJECTS AND PETS AND GPS ENABLED TRACKING DEVICES FOR TRACKING PEOPLE, OBJECTS, AND PETS (U.S. CLS. 21, 23, 26, 36 AND 38).

TINA BROWN, EXAMINING ATTORNEY

THE MARK CONSISTS OF STANDARD CHARACTERS WITHOUT CLAIM TO ANY PARTICULAR FONT, STYLE, SIZE, OR COLOR.

FOR ADAPTER PLUGS; CONNECTION CABLES; ELECTRICAL PLUG DEVICE ENABLING CONNECTION AND DISCONNECTION OF POWER AND/OR CONTROL CABLES; POWER ADAPTERS FOR COMPUTERS; USB CABLES (U.S. CLS. 21, 23, 26, 36 AND 38).

REBECCA EISINGER, EXAMINING ATTORNEY

CLASS 9—(Continued).

SN 77-885,491. RATIONAL RETENTION LLC, ALBANY, NY.
FILED 12-3-2009.



NO CLAIM IS MADE TO THE EXCLUSIVE RIGHT TO USE "RETENTION", APART FROM THE MARK AS SHOWN.

THE COLOR(S) BLACK, RED, AND GRAY IS/ARE CLAIMED AS A FEATURE OF THE MARK.

THE MARK CONSISTS OF THE WORDS "RATIONAL RETENTION" WHERE THE WORD "RATIONAL" APPEARS ABOVE THE WORD "RETENTION" WITH SEVERAL GRAY DOTS FORMING A GRAY RIGHT-FACING ARROW ON THE LEFT OF THE WORD "RATIONAL" AND SEVERAL RED DOTS FORMING A RED LEFT-FACING ARROW ON THE LEFT OF THE WORD "RETENTION". THE WORD "RATIONAL" APPEARS IN BLACK WITH A RED-DOTTED LETTER "I" AND THE WORD "RETENTION" APPEARS IN GRAY BENEATH THE WORD "RATIONAL".

FOR COMPUTER SOFTWARE FOR USE IN INFORMATION LIFECYCLE MANAGEMENT, INCLUDING RECORD AND DOCUMENT RETENTION, ELECTRONIC DISCOVERY AND LEGAL COMPLIANCE, AND INSTRUCTION MANUALS, SOLD AS A UNIT (U.S. CLS. 21, 23, 26, 36 AND 38).

FIRST USE 5-21-2009; IN COMMERCE 5-21-2009.

TINA BROWN, EXAMINING ATTORNEY

CLASS 9—(Continued).

SN 77-885,497. 745 LLC, BOSTON, MA. FILED 12-3-2009.

WORLD OF OHM

THE MARK CONSISTS OF STANDARD CHARACTERS WITHOUT CLAIM TO ANY PARTICULAR FONT, STYLE, SIZE, OR COLOR.

FOR COMPUTER GAME SOFTWARE, VIDEO GAME SOFTWARE, INTERACTIVE COMPUTER AND VIDEO GAME PROGRAMS, VIDEO GAME CONTROLLERS, VIDEO GAME DISCS AND CARTRIDGES FOR USE BY ONE OR MORE PLAYERS ON VIDEO GAME CONSOLES, DOWNLOADABLE VIDEO GAME SOFTWARE, INTERACTIVE VIDEO GAME SOFTWARE RECORDED ON A CARTRIDGE OR DVD OR CD SOLD AS A UNIT WITH AN ELECTRONIC VIDEO GAME CONTROLLER, INTERACTIVE MULTIMEDIA VIDEO GAME PROGRAMS AND ACCOMPANYING INSTRUCTION AND STRATEGY MANUALS, PRE-RECORDED CD-ROMS AND DVDS FEATURING GAMES, FILMS, AND MUSIC, COMPUTER GAME SOFTWARE, VIDEO GAME SOFTWARE (U.S. CLS. 21, 23, 26, 36 AND 38).

SAMUEL E. SHARPER JR., EXAMINING ATTORNEY

SN 77-885,496. RATIONAL RETENTION LLC, ALBANY, NY.
FILED 12-3-2009.

RATIONAL RETENTION

THE MARK CONSISTS OF STANDARD CHARACTERS WITHOUT CLAIM TO ANY PARTICULAR FONT, STYLE, SIZE, OR COLOR.

NO CLAIM IS MADE TO THE EXCLUSIVE RIGHT TO USE "RETENTION", APART FROM THE MARK AS SHOWN.

FOR COMPUTER SOFTWARE FOR USE IN INFORMATION LIFECYCLE MANAGEMENT, INCLUDING, RECORD AND DOCUMENT RETENTION, ELECTRONIC DISCOVERY AND LEGAL COMPLIANCE, AND INSTRUCTION MANUALS, SOLD AS A UNIT (U.S. CLS. 21, 23, 26, 36 AND 38).

FIRST USE 5-21-2009; IN COMMERCE 5-21-2009.

TINA BROWN, EXAMINING ATTORNEY

SN 77-885,559. PATHFINDER THERAPEUTICS, INC., NASHVILLE, TN. FILED 12-3-2009.

PATHWAY

THE MARK CONSISTS OF STANDARD CHARACTERS WITHOUT CLAIM TO ANY PARTICULAR FONT, STYLE, SIZE, OR COLOR.

FOR IMAGING SOFTWARE TO GUIDE SURGEONS IN PERFORMING LIVER SURGERY (U.S. CLS. 21, 23, 26, 36 AND 38).

ANDREA BUTLER, EXAMINING ATTORNEY

CLASS 9—(Continued).

SN 77-885,915. GUANG DONG HIGHDREAM INTELLECTUALIZED MACHINERY CO., LTD, FOSHAN CITY, GUANGDONG, CHINA, FILED 12-4-2009.



OWNER OF U.S. REG. NO. 3,732,348.
THE MARK CONSISTS OF STYLIZED ROMAN LETTERS "HDM".

FOR SCALES; WEIGHING MACHINES; WEIGH-BRIDGES; LETTER SCALES; WEIGHING APPARATUS AND INSTRUMENTS; STEELYARDS; WEIGHING EQUIPMENT, NAMELY, MEASURING WEIGHTS, SCALES AND BALANCES, AND PRECISION BALANCES (U.S. CLS. 21, 23, 26, 36 AND 38).

FIRST USE 11-10-2005; IN COMMERCE 1-1-2007.
LAURIE MAYES, EXAMINING ATTORNEY

CLASS 9—(Continued).

SN 77-886,145. AWANA CLUBS INTERNATIONAL, STREAMWOOD, IL. FILED 12-4-2009.

T&T Ultimate Adventure

THE MARK CONSISTS OF STANDARD CHARACTERS WITHOUT CLAIM TO ANY PARTICULAR FONT, STYLE, SIZE, OR COLOR.

FOR DIGITAL MATERIALS, NAMELY, CDS, DVDS, AND DOWNLOADABLE MP3 FILES FEATURING RELIGIOUS CONTENT FOR USE IN CONNECTION WITH AN EDUCATIONAL MINISTRY (U.S. CLS. 21, 23, 26, 36 AND 38).

MICHELE SWAIN, EXAMINING ATTORNEY

SN 77-886,186. AWANA CLUBS INTERNATIONAL, STREAMWOOD, IL. FILED 12-4-2009.

T&T Ultimate Challenge

THE MARK CONSISTS OF STANDARD CHARACTERS WITHOUT CLAIM TO ANY PARTICULAR FONT, STYLE, SIZE, OR COLOR.

FOR DIGITAL MATERIALS, NAMELY, CDS, DVDS, AND DOWNLOADABLE MP3 FILES FEATURING RELIGIOUS CONTENT FOR USE IN CONNECTION WITH AN EDUCATIONAL MINISTRY (U.S. CLS. 21, 23, 26, 36 AND 38).

MICHELE SWAIN, EXAMINING ATTORNEY

SN 77-886,029. EAST COMMERCE SOLUTIONS, INC., EAST PROVIDENCE, RI. FILED 12-4-2009.



NO CLAIM IS MADE TO THE EXCLUSIVE RIGHT TO USE "POS", APART FROM THE MARK AS SHOWN.

THE MARK CONSISTS OF THE WORDS "WRITE TOUCH POS THE RIGHT CHOICE IN POS SYSTEMS" IN A STYLIZED LOGO FORM AND PEN DESIGN.

SEC. 2(F) AS TO "WRITE TOUCH POS".

FOR COMPUTER SOFTWARE FOR ORDERING AND WORKFLOW MANAGEMENT, INVENTORY CONTROL, CUSTOMER RELATIONSHIP MANAGEMENT, OFFICE MANAGEMENT FOR MENU, REPORTING, LABOR CONTROL AND POINT OF SALE HARDWARE TERMINALS FOR USE IN ANY INDUSTRY (U.S. CLS. 21, 23, 26, 36 AND 38).

FIRST USE 1-1-1987; IN COMMERCE 1-1-1987.
BARNEY CHARLON, EXAMINING ATTORNEY

SN 77-886,232. COCOON INNOVATIONS, LLC, NEW YORK, NY. FILED 12-4-2009.

Fastback

THE MARK CONSISTS OF STANDARD CHARACTERS WITHOUT CLAIM TO ANY PARTICULAR FONT, STYLE, SIZE, OR COLOR.

FOR PROTECTIVE COVERS AND CASES FOR PORTABLE ELECTRONIC DEVICES; PROTECTIVE COVERS AND CASES FOR MOBILE PHONES; PROTECTIVE COVERS AND CASES FOR PORTABLE MEDIA PLAYERS; CARRYING CASES FOR CELL PHONES (U.S. CLS. 21, 23, 26, 36 AND 38).

LAURA HAMMEL, EXAMINING ATTORNEY

CLASS 9—(Continued).

SN 77-886,278. MY THERAPY SESSION, INC., AKA MYTHERAPYSESSION.COM, MYTHERAPYSESSION, KNOXVILLE, TN. FILED 12-4-2009.

MyTherapySession

THE MARK CONSISTS OF STANDARD CHARACTERS WITHOUT CLAIM TO ANY PARTICULAR FONT, STYLE, SIZE, OR COLOR.

OWNER OF U.S. REG. NO. 3,527,043.
FOR DIGITAL MEDIA, NAMELY, DVDS, DOWNLOADABLE VIDEO FILES AND ASSESSMENT FILES FEATURING INFORMATION ABOUT EMOTIONAL AND MENTAL HEALTH (U.S. CLS. 21, 23, 26, 36 AND 38).

FIRST USE 7-1-2007; IN COMMERCE 9-15-2007.
JOHN HWANG, EXAMINING ATTORNEY

SN 77-886,456. SMALL DOG ELECTRONICS, INC., WAITS-FIELD, VT. FILED 12-4-2009.



NO CLAIM IS MADE TO THE EXCLUSIVE RIGHT TO USE "AUDIO", APART FROM THE MARK AS SHOWN.

THE MARK CONSISTS OF THE STYLIZED INITIALS "CP" IN LOWER CASE, WITH THE "P" HAVING A HORIZONTAL LINE THROUGH IT AND THE WORD "AUDIO" BELOW THE "P".

FOR ADAPTERS; APPARATUS FOR RECORDING, TRANSMITTING AND REPRODUCING SOUND AND IMAGES; AUDIO SPEAKERS; BAGS AND CASES SPECIALLY ADAPTED FOR HOLDING OR CARRYING PORTABLE TELEPHONES AND TELEPHONE EQUIPMENT AND ACCESSORIES; BATTERIES; BATTERIES AND BATTERY CHARGERS; BATTERY CHARGERS; BLANK HARD DRIVES FOR COMPUTERS; CABLE CONNECTORS; CASES FOR MOBILE PHONES; COMPUTER STORAGE DEVICES, NAMELY, FLASH DRIVES; CONNECTION CABLES; DC/AC POWER CONVERTERS; DVD PLAYERS; EARPHONES; ELECTRIC CHARGING CABLES; ELECTRICAL CABLES FOR USE IN CONNECTIONS; ELECTRONIC CABLES; ELECTRONIC SOUND MIXING, PROCESSING AND SYNTHESIZING APPARATUS; EXTERNAL COMPUTER HARD DRIVES; HARD DISK DRIVES (HDD); LCD LARGE-SCREEN DISPLAYS; LIQUID CRYSTAL DISPLAY (LCD) PROJECTORS; MICROPHONES; PHONOGRAPHS; PORTABLE AND HANDHELD DIGITAL ELECTRONIC DEVICES FOR RECORDING, ORGANIZING, TRANSMITTING, MANIPULATING, AND REVIEWING TEXT, DATA, IMAGE, AND AUDIO FILES; POWER AMPLIFIERS; POWER CABLES; POWER SUPPLY CONNECTORS AND ADAPTERS FOR USE WITH PORTABLE ELECTRONIC DEVICES; PROTECTIVE CARRYING CASES FOR PORTABLE MUSIC PLAYERS, NAMELY, MP3 PLAYERS; RADIO TRANSMITTERS; USB (UNIVERSAL SERIAL BUS) HARDWARE; AUDIO SPEAKERS FOR USE IN HELMETS (U.S. CLS. 21, 23, 26, 36 AND 38).

FIRST USE 8-5-2008; IN COMMERCE 8-5-2008.
REBECCA EISINGER, EXAMINING ATTORNEY

CLASS 9—(Continued).

SN 77-886,524. SCHRODER FIDLOW & TITLEY, PLC, RICHMOND, VA. FILED 12-4-2009.

K Michael

THE MARK CONSISTS OF STANDARD CHARACTERS WITHOUT CLAIM TO ANY PARTICULAR FONT, STYLE, SIZE, OR COLOR.

FOR EYEWEAR (U.S. CLS. 21, 23, 26, 36 AND 38).
BRIAN NEVILLE, EXAMINING ATTORNEY

SN 77-886,550. VISUALWARE, INC., TURLOCK, CA. FILED 12-4-2009.

VISUALROUTE

THE MARK CONSISTS OF STANDARD CHARACTERS WITHOUT CLAIM TO ANY PARTICULAR FONT, STYLE, SIZE, OR COLOR.

FOR DOWNLOADABLE COMPUTER SOFTWARE FOR MONITORING AND MANAGING THE PERFORMANCE AND THROUGHPUT OF COMPUTER SYSTEMS AND APPLICATIONS ON LOCAL AND GLOBAL COMPUTER NETWORKS, OR HARDWARE OR SOFTWARE COMPONENTS THEREOF (U.S. CLS. 21, 23, 26, 36 AND 38).

FIRST USE 1-3-2001; IN COMMERCE 1-3-2001.
ELI HELLMAN, EXAMINING ATTORNEY

SN 77-886,588. VELLO SYSTEMS, INC., MILPITAS, CA. FILED 12-4-2009.

Reinvent Your Network

THE MARK CONSISTS OF STANDARD CHARACTERS WITHOUT CLAIM TO ANY PARTICULAR FONT, STYLE, SIZE, OR COLOR.

FOR OPTICAL TRANSPORT SYSTEMS COMPOSED OF HARDWARE, NAMELY, TRANSMITTERS, RECEIVERS, TRANSCEIVERS, AMPLIFIERS, MULTIPLEXERS, OPTICAL CIRCUIT PROTECTION SWITCHES, AND POWER SUPPLIES, AND SOFTWARE FOR USE IN MONITORING AND CONTROLLING THE FOREGOING COMPONENTS, USED TO DELIVER INTERNET, VOICE, VIDEO AND DATA IN CABLE AND TELECOMMUNICATIONS NETWORKS; COMPUTER HARDWARE; COMPUTER HARDWARE AND SOFTWARE FOR INTERCONNECTING, MANAGING, CONTROLLING AND OPERATING COMPUTER NETWORKS; COMPUTER HARDWARE AND SOFTWARE FOR USE IN THE TRANSMISSION AND ROUTING OF INTERNET, VOICE, VIDEO AND DATA COMMUNICATIONS; OPTICAL NETWORK COMPUTER OPERATING SYSTEMS (U.S. CLS. 21, 23, 26, 36 AND 38).

COLLEEN KEARNEY, EXAMINING ATTORNEY

CLASS 9—(Continued).

SN 77-886,612. BIG BAD BOO PRODUCTIONS, INC., NEW YORK, NY. FILED 12-4-2009.

1001 NIGHTS

THE MARK CONSISTS OF STANDARD CHARACTERS WITHOUT CLAIM TO ANY PARTICULAR FONT, STYLE, SIZE, OR COLOR.

FOR DVDS, AND CDS FEATURING ANIMATED CHARACTERS FOR CHILDREN'S ENTERTAINMENT; DOWNLOADABLE RING TONES, MUSIC, ELECTRONIC GAME PROGRAMS, VIDEOS AND IMAGE FILES FEATURING ANIMATED CHARACTERS FOR CHILDREN'S ENTERTAINMENT (U.S. CLS. 21, 23, 26, 36 AND 38).

JOHN WILKE, EXAMINING ATTORNEY

SN 77-886,653. VISUALWARE, INC., TURLOCK, CA. FILED 12-4-2009.

VISUALPULSE

THE MARK CONSISTS OF STANDARD CHARACTERS WITHOUT CLAIM TO ANY PARTICULAR FONT, STYLE, SIZE, OR COLOR.

FOR DOWNLOADABLE COMPUTER SOFTWARE FOR MONITORING AND MANAGING THE PERFORMANCE AND THROUGHPUT OF COMPUTER SYSTEMS AND APPLICATIONS ON LOCAL AND GLOBAL COMPUTER NETWORKS, HARDWARE OR SOFTWARE COMPONENTS THEREOF (U.S. CLS. 21, 23, 26, 36 AND 38).

FIRST USE 1-2-2001; IN COMMERCE 1-2-2001.
ELI HELLMAN, EXAMINING ATTORNEY

SN 77-886,673. BIRDS IN THE HAND, LLC, CHARLOTTESVILLE, VA. FILED 12-4-2009.

BirdsEye

THE MARK CONSISTS OF STANDARD CHARACTERS WITHOUT CLAIM TO ANY PARTICULAR FONT, STYLE, SIZE, OR COLOR.

FOR DOWNLOADABLE SOFTWARE IN THE NATURE OF A MOBILE APPLICATION FOR BIRD SPECIES LOCATION AND IDENTIFICATION (U.S. CLS. 21, 23, 26, 36 AND 38).

FIRST USE 8-1-2009; IN COMMERCE 12-2-2009.
MYRIAH HABEEB, EXAMINING ATTORNEY

CLASS 9—(Continued).

SN 77-886,677. BIG BAD BOO PRODUCTIONS, INC., NEW YORK, NY. FILED 12-4-2009.



THE MARK CONSISTS OF THE STYLIZED WORDS "1001 NIGHTS" WITH CURVED LINES BENEATH "1001" AND "HTS", ONE DIAMOND BEFORE "1001", ONE DIAMOND AFTER "NIGHTS" AND TWO DIAMONDS OVER THE "G".

FOR DVDS, AND CDS FEATURING ANIMATED CHARACTERS FOR CHILDREN'S ENTERTAINMENT; DOWNLOADABLE RING TONES, MUSIC, ELECTRONIC GAME PROGRAMS, VIDEOS AND IMAGE FILES FEATURING ANIMATED CHARACTERS FOR CHILDREN'S ENTERTAINMENT (U.S. CLS. 21, 23, 26, 36 AND 38).

JOHN WILKE, EXAMINING ATTORNEY

SN 77-886,822. MICROSOFT CORPORATION, REDMOND, WA. FILED 12-4-2009.



PRIORITY CLAIMED UNDER SEC. 44(D) ON SOUTH AFRICA APPLICATION NO. 2009/11,164, FILED 6-18-2009.

THE MARK CONSISTS OF A BOX WITH A ROUNDED UPPER LEFT CORNER CONTAINING THE LETTER "P" AND AN IMAGE OF A SHEET OF PAPER.

FOR COMPUTER SOFTWARE FOR PROJECT MANAGEMENT AND RESOURCE MANAGEMENT (U.S. CLS. 21, 23, 26, 36 AND 38).

DAVID TAYLOR, EXAMINING ATTORNEY

CLASS 9—(Continued).

SN 77-887,107. PRIMEPORT, INC., MIAMI, FL. FILED 12-6-2009.

CYPHERLOCK

THE MARK CONSISTS OF STANDARD CHARACTERS WITHOUT CLAIM TO ANY PARTICULAR FONT, STYLE, SIZE, OR COLOR.

FOR COMPUTER SOFTWARE AND HARDWARE FOR SECURING INDIVIDUAL COMPUTERS, COMPUTER NETWORKS AND COMPUTER SYSTEMS (U.S. CLS. 21, 23, 26, 36 AND 38).

JOHN DALIER, EXAMINING ATTORNEY

SN 77-887,117. PRIMEPORT, INC., MIAMI, FL. FILED 12-6-2009.

CYPHERKEY

THE MARK CONSISTS OF STANDARD CHARACTERS WITHOUT CLAIM TO ANY PARTICULAR FONT, STYLE, SIZE, OR COLOR.

FOR COMPUTER SOFTWARE AND HARDWARE FOR SECURING INDIVIDUAL COMPUTERS, COMPUTER NETWORKS AND COMPUTER SYSTEMS (U.S. CLS. 21, 23, 26, 36 AND 38).

JOHN DALIER, EXAMINING ATTORNEY

SN 77-887,118. PRIMEPORT, INC., MIAMI, FL. FILED 12-6-2009.

**NETWORK SECURITY BEGINS AT
THE WORKSTATION**

THE MARK CONSISTS OF STANDARD CHARACTERS WITHOUT CLAIM TO ANY PARTICULAR FONT, STYLE, SIZE, OR COLOR.

FOR COMPUTER SOFTWARE AND HARDWARE FOR SECURING INDIVIDUAL COMPUTERS, COMPUTER NETWORKS AND COMPUTER SYSTEMS (U.S. CLS. 21, 23, 26, 36 AND 38).

JOHN DALIER, EXAMINING ATTORNEY

CLASS 9—(Continued).

SN 77-887,126. SAAD, RAMI M., DBA GLOBAL PARADIGMZ, BURLESON, TX. FILED 12-6-2009.

GLOBAL PARADIGMZ

THE MARK CONSISTS OF STANDARD CHARACTERS WITHOUT CLAIM TO ANY PARTICULAR FONT, STYLE, SIZE, OR COLOR.

NO CLAIM IS MADE TO THE EXCLUSIVE RIGHT TO USE GLOBAL, APART FROM THE MARK AS SHOWN.

FOR COMPUTER E-COMMERCE SOFTWARE TO ALLOW USERS TO PERFORM ELECTRONIC BUSINESS TRANSACTIONS VIA A GLOBAL COMPUTER NETWORK; COMPUTER SOFTWARE FOR ACCESSING INFORMATION DIRECTORIES THAT MAY BE DOWNLOADED FROM THE GLOBAL COMPUTER NETWORK; COMPUTER SOFTWARE FOR GLOBAL SUPPLY CHAIN MANAGEMENT THAT MAY BE DOWNLOADED FROM A GLOBAL COMPUTER NETWORK (U.S. CLS. 21, 23, 26, 36 AND 38).

MARGERY A. TIERNEY, EXAMINING ATTORNEY

SN 77-887,130. SAAD, RAMI M., DBA GLOBAL PARADIGMZ, BURLESON, TX. FILED 12-6-2009.

GRP

THE MARK CONSISTS OF STANDARD CHARACTERS WITHOUT CLAIM TO ANY PARTICULAR FONT, STYLE, SIZE, OR COLOR.

FOR COMPUTER E-COMMERCE SOFTWARE TO ALLOW USERS TO PERFORM ELECTRONIC BUSINESS TRANSACTIONS VIA A GLOBAL COMPUTER NETWORK; COMPUTER SOFTWARE FOR ACCESSING INFORMATION DIRECTORIES THAT MAY BE DOWNLOADED FROM THE GLOBAL COMPUTER NETWORK; COMPUTER SOFTWARE FOR GLOBAL SUPPLY CHAIN MANAGEMENT THAT MAY BE DOWNLOADED FROM A GLOBAL COMPUTER NETWORK (U.S. CLS. 21, 23, 26, 36 AND 38).

MARGERY A. TIERNEY, EXAMINING ATTORNEY

CLASS 9—(Continued).

SN 77-887,224. PICKLE HOPPED LLC, WINCHESTER, MA. FILED 12-7-2009.

Market Maker

THE MARK CONSISTS OF STANDARD CHARACTERS WITHOUT CLAIM TO ANY PARTICULAR FONT, STYLE, SIZE, OR COLOR.

OWNER OF U.S. REG. NO. 3,598,212.

NO CLAIM IS MADE TO THE EXCLUSIVE RIGHT TO USE "MARKET", APART FROM THE MARK AS SHOWN.

FOR COMPUTER GAME SOFTWARE; DOWNLOADABLE ELECTRONIC GAME PROGRAMS; ELECTRONIC GAME PROGRAMS; ELECTRONIC GAME SOFTWARE FOR CELLULAR TELEPHONES; ELECTRONIC GAME SOFTWARE FOR HANDHELD ELECTRONIC DEVICES; VIDEO GAME SOFTWARE (U.S. CLS. 21, 23, 26, 36 AND 38).

FIRST USE 6-7-2009; IN COMMERCE 9-1-2009.
JENNIFER MARTIN, EXAMINING ATTORNEY

CLASS 9—(Continued).

SN 77-887,331. ROCK, PAPER, SCISSORS, L.L.C., CEDAR FALLS, IA. FILED 12-7-2009.

HEALTHMAIL GENERATOR

THE MARK CONSISTS OF STANDARD CHARACTERS WITHOUT CLAIM TO ANY PARTICULAR FONT, STYLE, SIZE, OR COLOR.

FOR ELECTRONIC MAIL MARKETING SOFTWARE, NAMELY, COMPUTER SOFTWARE FOR CREATING, PLANNING, PRODUCING, PRINTING, TRANSMITTING, ROUTING, RENDERING, STREAMING AND MANAGING OF PERSONALIZED DATA, NAMELY, DOCUMENTS, MESSAGES, EMAIL MESSAGES, WEB PAGES, PDA PAGES, TEXT, GRAPHICS, IMAGES, AUDIO, VIDEO AND THE LIKE THROUGH DIFFERENT TELECOMMUNICATION MEDIA CHANNELS IN THE FIELD OF HEALTHCARE (U.S. CLS. 21, 23, 26, 36 AND 38).

FIRST USE 10-17-2009; IN COMMERCE 10-17-2009.
DOUGLAS LEE, EXAMINING ATTORNEY

SN 77-887,422. IDEA RAT, LLC, HERNDON, VA. FILED 12-7-2009.

Idea Rat

THE MARK CONSISTS OF STANDARD CHARACTERS WITHOUT CLAIM TO ANY PARTICULAR FONT, STYLE, SIZE, OR COLOR.

FOR DOWNLOADABLE COMPUTER SOFTWARE FOR DOWNLOADING MULTIMEDIA FILES, WEATHER UPDATES, PACKAGE TRACKING; COMPUTER APPLICATION SOFTWARE FOR MOBILE PHONES FOR DOWNLOADING MULTIMEDIA FILES, WEATHER UPDATES, PACKAGE TRACKING (U.S. CLS. 21, 23, 26, 36 AND 38).

FIRST USE 11-1-2009; IN COMMERCE 11-1-2009.
TAMARA FRAZIER, EXAMINING ATTORNEY

SN 77-887,284. PROA, MARIA SALOME, SAN DIMAS, CA. FILED 12-7-2009.

Argos Eyewear

THE MARK CONSISTS OF STANDARD CHARACTERS WITHOUT CLAIM TO ANY PARTICULAR FONT, STYLE, SIZE, OR COLOR.

NO CLAIM IS MADE TO THE EXCLUSIVE RIGHT TO USE "EYEWEAR", APART FROM THE MARK AS SHOWN.

FOR OPHTHALMIC LENSES; OPTICAL FRAMES; SUNGLASSES (U.S. CLS. 21, 23, 26, 36 AND 38).

FIRST USE 12-1-2009; IN COMMERCE 12-1-2009.
JEFFERY COWARD, EXAMINING ATTORNEY

SN 77-887,458. GE HEALTHCARE LIMITED, BUCKINGHAMSHIRE, UNITED KINGDOM, FILED 12-7-2009.

DATQUANT

THE MARK CONSISTS OF STANDARD CHARACTERS WITHOUT CLAIM TO ANY PARTICULAR FONT, STYLE, SIZE, OR COLOR.

FOR COMPUTER SOFTWARE FOR ANALYZING MEDICAL DIAGNOSTIC IMAGING INFORMATION (U.S. CLS. 21, 23, 26, 36 AND 38).

INGRID C. EULIN, EXAMINING ATTORNEY

CLASS 9—(Continued).

SN 77-887,511. D DIGITAL, INC., INDIAN HEAD PARK, IL. FILED 12-7-2009.



THE MARK CONSISTS OF THE TEXT "DDIGITAL" IN A STYLIZED FONT.
FOR COMPUTER SOFTWARE FOR HOME CONTROL SYSTEMS (U.S. CLS. 21, 23, 26, 36 AND 38).
HENRY S. ZAK, EXAMINING ATTORNEY

SN 77-887,554. OAKLEY, INC., FOOTHILL RANCH, CA. FILED 12-7-2009.



OWNER OF U.S. REG. NOS. 1,984,501, 3,098,281 AND 3,331,124.

NO CLAIM IS MADE TO THE EXCLUSIVE RIGHT TO USE "CUSTOM", APART FROM THE MARK AS SHOWN.

THE MARK CONSISTS OF THE WORDS "O CUSTOM" WITH THE "O" BEING AN ELLIPSOID "O" SHAPE WITHIN A BLACK BOX WHICH CONTAINS SEVERAL WHITE DIAGONAL PARALLEL SPIKE SHAPES THROUGHOUT, AND THE WORD "CUSTOM" BEING IN A STYLIZED FONT.

FOR PROTECTIVE EYEWEAR, NAMELY, SPECTACLES, PRESCRIPTION EYEWEAR, ANTI GLARE GLASSES AND SUNGLASSES AND THEIR PARTS AND ACCESSORIES, NAMELY, REPLACEMENT LENSES, FRAMES, EAR STEMS, AND NOSE PIECES; CASES SPECIALLY ADAPTED FOR SPECTACLES AND SUNGLASSES AND THEIR PARTS AND ACCESSORIES (U.S. CLS. 21, 23, 26, 36 AND 38).

EMILY CARLSEN, EXAMINING ATTORNEY

SN 77-887,566. MANURE SAFETY SOLUTIONS LLC, STANHOPE, IA. FILED 12-7-2009.



THE MARK CONSISTS OF STANDARD CHARACTERS WITHOUT CLAIM TO ANY PARTICULAR FONT, STYLE, SIZE, OR COLOR.

FOR ELECTRIC OR ELECTRONIC SENSORS FOR MONITORING AND MANAGING HYDROGEN SULFIDE IN SWINE PRODUCTION FACILITIES (U.S. CLS. 21, 23, 26, 36 AND 38).

FIRST USE 6-5-2009; IN COMMERCE 6-5-2009.
SHAILA SETTLES, EXAMINING ATTORNEY

CLASS 9—(Continued).

SN 77-887,661. TOP RANK INC., LAS VEGAS, NV. FILED 12-7-2009.



THE MARK CONSISTS OF STANDARD CHARACTERS WITHOUT CLAIM TO ANY PARTICULAR FONT, STYLE, SIZE, OR COLOR.

NO CLAIM IS MADE TO THE EXCLUSIVE RIGHT TO USE "BOXING", APART FROM THE MARK AS SHOWN.

FOR AUDIO AND VIDEO RECORDINGS FEATURING BOXING RELATED EVENTS; DOWNLOADABLE AND STREAMING VIDEO RECORDINGS, FILMS AND AUDIO PROGRAMS FEATURING BOXING RELATED EVENTS AND BOXING PROMOTIONAL CONTENT; PRE-RECORDED DVDS, CDS, VIDEO AND AUDIO TAPES FEATURING BOXING RELATED EVENTS AND BOXING PROMOTIONAL CONTENT (U.S. CLS. 21, 23, 26, 36 AND 38).

BRIAN NEVILLE, EXAMINING ATTORNEY

SN 77-887,823. S2 CORPORATION, BOZEMAN, MT. FILED 12-7-2009.



THE MARK CONSISTS OF STANDARD CHARACTERS WITHOUT CLAIM TO ANY PARTICULAR FONT, STYLE, SIZE, OR COLOR.

FOR ELECTRONIC AND COMPUTER MEMORY CHIPS, RADIO TRANSMITTERS AND RECEIVERS, COMPUTER HARDWARE, RADAR DEVICES IN THE NATURE OF RADAR JAMMING DEVICES, SIGNAL PROCESSORS, AND COMPUTER SOFTWARE USED FOR THE PROCESSING OF RADIO SIGNALS, RADIO FREQUENCIES, RADIO TRANSMISSIONS, RADAR SIGNALS, AND TIME DELAY OF SIGNALS; AND USER MANUALS SOLD AS A UNIT THEREWITH (U.S. CLS. 21, 23, 26, 36 AND 38).

ELIZABETH KAJUBI, EXAMINING ATTORNEY

SN 77-887,853. YOUNG, DOYALD, SHERMAN OAKS, CA. FILED 12-7-2009.



THE MARK CONSISTS OF STANDARD CHARACTERS WITHOUT CLAIM TO ANY PARTICULAR FONT, STYLE, SIZE, OR COLOR.

FOR PRINTING FONTS THAT CAN BE DOWNLOADED PROVIDED BY MEANS OF ELECTRONIC TRANSMISSION; TYPEFACE FONTS RECORDED ON MAGNETIC MEDIA (U.S. CLS. 21, 23, 26, 36 AND 38).

FIRST USE 12-7-2009; IN COMMERCE 12-7-2009.
TRACY CROSS, EXAMINING ATTORNEY

CLASS 9—(Continued).

SN 77-887,993. CREE, INC., DURHAM, NC. FILED 12-7-2009.

EasyWhite

THE MARK CONSISTS OF STANDARD CHARACTERS WITHOUT CLAIM TO ANY PARTICULAR FONT, STYLE, SIZE, OR COLOR.

FOR LIGHT EMITTING DIODES (LEDS) (U.S. CLS. 21, 23, 26, 36 AND 38).

SUSAN RICHARDS, EXAMINING ATTORNEY

CLASS 9—(Continued).

SN 77-888,201. APRICORN, POWAY, CA. FILED 12-8-2009.

NetDock

THE MARK CONSISTS OF STANDARD CHARACTERS WITHOUT CLAIM TO ANY PARTICULAR FONT, STYLE, SIZE, OR COLOR.

FOR COMPUTER HARDWARE AND COMPUTER PERIPHERALS (U.S. CLS. 21, 23, 26, 36 AND 38).

MORGAN WYNNE, EXAMINING ATTORNEY

SN 77-888,052. BETTS, CHRISTOPHER MARCUS, DBA COOL YOUR EYES, KAPOLEI, HI. FILED 12-7-2009.

Cool Your Eyes

THE MARK CONSISTS OF STANDARD CHARACTERS WITHOUT CLAIM TO ANY PARTICULAR FONT, STYLE, SIZE, OR COLOR.

FOR FRAMES FOR SPECTACLES AND SUNGLASSES; LENSES FOR SUNGLASSES; SPECTACLES AND SUNGLASSES (U.S. CLS. 21, 23, 26, 36 AND 38).

KELLY CHOE, EXAMINING ATTORNEY

SN 77-888,203. BRYAN EVANS, STUDIO CITY, CA. FILED 12-8-2009.

CAMCAGE

THE MARK CONSISTS OF STANDARD CHARACTERS WITHOUT CLAIM TO ANY PARTICULAR FONT, STYLE, SIZE, OR COLOR.

FOR CAMERA HARDWARE AND STABILITY ACCESSORY, NAMELY, A CAMERA STAND TO FACILITATE MULTIPLE HAND-HOLDING POSITIONS AND ATTACHMENT OF ADDITIONAL CAMERA ACCESSORIES (U.S. CLS. 21, 23, 26, 36 AND 38).

KAPIL BHANOT, EXAMINING ATTORNEY

SN 77-888,068. MOTOLINGO, INC., BARTLESVILLE, OK. FILED 12-7-2009.

Motolingo

THE MARK CONSISTS OF STANDARD CHARACTERS WITHOUT CLAIM TO ANY PARTICULAR FONT, STYLE, SIZE, OR COLOR.

FOR WIRELESS SOFTWARE, NAMELY, COMPUTER SOFTWARE THAT FACILITATES AND PROVIDES DATA TRANSFER AND COMMUNICATION FROM AND BETWEEN VEHICLES AND COMPUTERS, FROM AND BETWEEN VEHICLE DRIVERS, THIRD PARTIES AND COMPUTERS AND GENERAL MOBILE PHONE MANAGEMENT SOFTWARE SERVICES (U.S. CLS. 21, 23, 26, 36 AND 38).

FIRST USE 10-8-2008; IN COMMERCE 10-8-2008.

KAPIL BHANOT, EXAMINING ATTORNEY

SN 77-888,209. SOFTWARE ANALYSIS AND FORENSIC ENGINEERING CORPORATION, DBA SAFE CORPORATION, CUPERTINO, CA. FILED 12-8-2009.

CodeMeasure

THE MARK CONSISTS OF STANDARD CHARACTERS WITHOUT CLAIM TO ANY PARTICULAR FONT, STYLE, SIZE, OR COLOR.

FOR COMPUTER SOFTWARE DEVELOPMENT TOOLS (U.S. CLS. 21, 23, 26, 36 AND 38).

FIRST USE 12-9-2008; IN COMMERCE 12-7-2009.

ANNE E. GUSTASON, EXAMINING ATTORNEY

CLASS 9—(Continued).

SN 77-888,213. KITEX LTD., DBA GRANT FIDELITY,
CALGARY, ALBERTA, CANADA, FILED 12-8-2009.

Shuguang Treasure

THE MARK CONSISTS OF STANDARD CHARACTERS
WITHOUT CLAIM TO ANY PARTICULAR FONT, STYLE,
SIZE, OR COLOR.

FOR CONSUMER ELECTRONIC PRODUCTS,
NAMELY, AUDIO AMPLIFIERS, AUDIO SPEAKERS,
AUDIO RECEIVERS, ELECTRICAL AUDIO AND
SPEAKER CABLES AND CONNECTORS, HOME THEA-
TER SYSTEMS, AUDIO DECODERS, VIDEO DECO-
DERS, SPEAKERS, POWER CONVERSION DEVICES,
POWER CONVERTERS, AND POWER INVERTERS;
ELECTRIC AND ELECTRONIC CIRCUITS; ELECTRIC
AUDIO PLAYBACK UNITS; ELECTRON TUBES (U.S.
CLS. 21, 23, 26, 36 AND 38).

FIRST USE 1-3-2009; IN COMMERCE 1-3-2009.
ZHALEH DELANEY, EXAMINING ATTORNEY

SN 77-888,230. MCCRONE, VICKI, GATES MILLS, OH.
FILED 12-8-2009.

LITTLE SONGS

THE MARK CONSISTS OF STANDARD CHARACTERS
WITHOUT CLAIM TO ANY PARTICULAR FONT, STYLE,
SIZE, OR COLOR.

NO CLAIM IS MADE TO THE EXCLUSIVE RIGHT TO
USE "SONGS", APART FROM THE MARK AS SHOWN.

FOR PRERECORDED CDS FEATURING MUSIC; PRE-
RECORDED DVDS FEATURING MUSIC VIDEOS (U.S.
CLS. 21, 23, 26, 36 AND 38).

FIRST USE 9-0-2005; IN COMMERCE 9-0-2005.
DAVID TOOLEY, EXAMINING ATTORNEY

SN 77-888,281. ALLRECIPES.COM, INC., SEATTLE, WA.
FILED 12-8-2009.

**ALLRECIPES.COM DINNER
SPINNER PRO**

THE MARK CONSISTS OF STANDARD CHARACTERS
WITHOUT CLAIM TO ANY PARTICULAR FONT, STYLE,
SIZE, OR COLOR.

OWNER OF U.S. REG. NOS. 2,338,667, 3,685,581 AND
OTHERS.

FOR COMPUTER APPLICATION SOFTWARE FOR
MOBILE DEVICES FEATURING RECIPES ORGANIZED
BY DISH, INGREDIENTS OR PREP TIME (U.S. CLS. 21,
23, 26, 36 AND 38).

LINDA LAVACHE, EXAMINING ATTORNEY

CLASS 9—(Continued).

SN 77-888,285. CENTRAL LAKE ARMOR EXPRESS, INC.,
CENTRAL LAKE, MI. FILED 12-8-2009.

REVOLUTION

THE MARK CONSISTS OF STANDARD CHARACTERS
WITHOUT CLAIM TO ANY PARTICULAR FONT, STYLE,
SIZE, OR COLOR.

FOR VESTS FOR HOLDING BODY ARMOR INSERTS
(U.S. CLS. 21, 23, 26, 36 AND 38).

SUSAN STIGLITZ, EXAMINING ATTORNEY

SN 77-888,428. TYLER TECHNOLOGIES, INC., PLANO, TX.
FILED 12-8-2009.

IASWORLD

THE MARK CONSISTS OF STANDARD CHARACTERS
WITHOUT CLAIM TO ANY PARTICULAR FONT, STYLE,
SIZE, OR COLOR.

FOR SOFTWARE FOR USE IN THE ADMINISTRA-
TION AND MANAGEMENT OF PROPERTY VALUA-
TION DATA (U.S. CLS. 21, 23, 26, 36 AND 38).

FIRST USE 10-31-2002; IN COMMERCE 10-31-2002.
CHRISTINE COOPER, EXAMINING ATTORNEY

SN 77-888,442. TYLER TECHNOLOGIES, INC., PLANO, TX.
FILED 12-8-2009.

**EMPOWERING PEOPLE WHO
SERVE THE PUBLIC**

THE MARK CONSISTS OF STANDARD CHARACTERS
WITHOUT CLAIM TO ANY PARTICULAR FONT, STYLE,
SIZE, OR COLOR.

FOR COMPUTER SOFTWARE THAT PROVIDES WEB-
BASED ACCESS TO APPLICATIONS AND SERVICES
THROUGH A WEB OPERATING SYSTEM OR PORTAL
INTERFACE; COMPUTER SOFTWARE FOR CASE MAN-
AGEMENT IN THE FIELD OF JUDICIAL SYSTEMS,
NAMELY, INDEXING OF JUDICIAL CASES, ELECTRO-
NIC FILING, DOCKETING, SCHEDULING, AND RE-
LATED RECORD KEEPING OF CASE HEARINGS,
MOTIONS, DOCUMENTS, AND DEADLINES, CUSTO-
MIZING JUDICIAL FORMS AND DOCUMENTS, RE-
CORDING OF IN-COURT MINUTES, MANAGEMENT
AND TRACKING OF WARRANTS AND WARRANT
HISTORY, MANAGEMENT OF INMATE HISTORY
SUCH AS INMATE INTAKE, COMMISSARY MANAGE-
MENT, CELL ASSIGNMENTS, RISK ASSESSMENTS,
AND EDUCATION, AND FISCAL MANAGEMENT;
COMPUTER SOFTWARE FOR FUND ACCOUNTING
IN THE FIELDS OF GOVERNMENT AGENCIES, MUNI-
CIPALITIES, SCHOOLS, AND NON-PROFIT ORGANI-
ZATIONS; COMPUTER SOFTWARE FOR TRACKING
AND MONITORING VEHICLES; COMPUTER SOFT-
WARE FOR USE IN TRANSPORTATION MANAGE-

CLASS 9—(Continued).

MENT; COMPUTER SOFTWARE FOR ROUTING VEHICLES AND PLANNING AND FORECASTING TERRITORY ATTRIBUTES IN THE FIELD OF TRANSPORTATION MANAGEMENT; COMPUTER TRANSPORTATION SOFTWARE FOR USE IN REDISTRICTING, PLANNING, BOUNDARY ANALYSIS AND SCHOOL BUS ROUTING, MAINTENANCE, TRACKING AND SCHEDULING; COMPUTER SOFTWARE THAT PROVIDES ACCESS TO TRANSPORTATION DATABASES VIA A GLOBAL COMPUTER NETWORK; COMPUTER SOFTWARE FOR PROVIDING AND PROCESSING TRANSPORTATION INFORMATION, NAMELY, VEHICLE AND FLEET MAINTENANCE INFORMATION; SOFTWARE PROGRAMS, NAMELY, TRANSPORTATION SOFTWARE FOR ROUTING AND TRACKING BUSES; COMPUTER SOFTWARE FOR SCHOOL BUS OPERATIONS, ROUTING AND MANAGEMENT; COMPUTER PROGRAMS FOR USE IN ACCOUNTING, ACCOUNTS RECEIVABLE MANAGEMENT, FINANCIAL MANAGEMENT, ASSET MANAGEMENT, PROCUREMENT MANAGEMENT, HUMAN RESOURCES MANAGEMENT, TIME ENTRY, PAYROLL PROCESSING, DOCUMENT MANAGEMENT, COURT CASE MANAGEMENT, MUNICIPAL RECORDS MANAGEMENT, SCHOOL ADMINISTRATION, MANAGEMENT OF TEACHER AND STUDENT DATA, MANAGEMENT OF LAND AND VITAL RECORDS, MANAGEMENT OF CEMETERY INFORMATION, AND LAW ENFORCEMENT DISPATCHING (U.S. CLS. 21, 23, 26, 36 AND 38).

FIRST USE 9-25-2009; IN COMMERCE 9-25-2009.
CHRISTINE COOPER, EXAMINING ATTORNEY

SN 77-888,457. TYLER TECHNOLOGIES, INC., PLANO, TX.
FILED 12-8-2009.



THE COLOR(S) BLUE AND GREEN IS/ARE CLAIMED AS A FEATURE OF THE MARK.

THE MARK CONSISTS OF A SERIES OF DOTS IN BLUE IN A T-SHAPED FORMATION INTERLOCKING WITH ANOTHER SERIES OF DOTS IN GREEN, ALSO IN A T-SHAPED FORMATION.

FOR COMPUTER SOFTWARE THAT PROVIDES WEB-BASED ACCESS TO APPLICATIONS AND SERVICES THROUGH A WEB OPERATING SYSTEM OR PORTAL INTERFACE; COMPUTER SOFTWARE FOR CASE MANAGEMENT IN THE FIELD OF JUDICIAL SYSTEMS, NAMELY, INDEXING OF JUDICIAL CASES, ELECTRONIC FILING, DOCKETING, SCHEDULING, AND RELATED RECORD KEEPING OF CASE HEARINGS, MOTIONS, DOCUMENTS, AND DEADLINES, CUSTOMIZING JUDICIAL FORMS AND DOCUMENTS, RECORDING OF IN-COURT MINUTES, MANAGEMENT AND TRACKING OF WARRANTS AND WARRANT HISTORY, MANAGEMENT OF INMATE HISTORY SUCH AS INMATE INTAKE, COMMISSARY MANAGEMENT, CELL ASSIGNMENTS, RISK ASSESSMENTS, AND EDUCATION, AND FISCAL MANAGEMENT; COMPUTER SOFTWARE FOR FUND ACCOUNTING IN THE FIELDS OF GOVERNMENT AGENCIES, MUNICIPALITIES, SCHOOLS, AND NON-PROFIT ORGANIZATIONS; COMPUTER SOFTWARE FOR TRACKING

CLASS 9—(Continued).

AND MONITORING VEHICLES; COMPUTER SOFTWARE FOR USE IN TRANSPORTATION MANAGEMENT; COMPUTER SOFTWARE FOR ROUTING VEHICLES AND PLANNING AND FORECASTING TERRITORY ATTRIBUTES IN THE FIELD OF TRANSPORTATION MANAGEMENT; COMPUTER TRANSPORTATION SOFTWARE FOR USE IN REDISTRICTING, PLANNING, BOUNDARY ANALYSIS AND SCHOOL BUS ROUTING, MAINTENANCE, TRACKING AND SCHEDULING; COMPUTER SOFTWARE THAT PROVIDES ACCESS TO TRANSPORTATION DATABASES VIA A GLOBAL COMPUTER NETWORK; COMPUTER SOFTWARE FOR PROVIDING AND PROCESSING TRANSPORTATION INFORMATION, NAMELY, VEHICLE AND FLEET MAINTENANCE INFORMATION; SOFTWARE PROGRAMS, NAMELY, TRANSPORTATION SOFTWARE FOR ROUTING AND TRACKING BUSES; COMPUTER SOFTWARE FOR SCHOOL BUS OPERATIONS, ROUTING AND MANAGEMENT; COMPUTER PROGRAMS FOR USE IN ACCOUNTING, ACCOUNTS RECEIVABLE MANAGEMENT, FINANCIAL MANAGEMENT, ASSET MANAGEMENT, PROCUREMENT MANAGEMENT, HUMAN RESOURCES MANAGEMENT, TIME ENTRY, PAYROLL PROCESSING, DOCUMENT MANAGEMENT, COURT CASE MANAGEMENT, MUNICIPAL RECORDS MANAGEMENT, SCHOOL ADMINISTRATION, MANAGEMENT OF TEACHER AND STUDENT DATA, MANAGEMENT OF LAND AND VITAL RECORDS, MANAGEMENT OF CEMETERY INFORMATION, AND LAW ENFORCEMENT DISPATCHING (U.S. CLS. 21, 23, 26, 36 AND 38).

FIRST USE 9-25-2009; IN COMMERCE 9-25-2009.
CHRISTINE COOPER, EXAMINING ATTORNEY

SN 77-888,473. TYLER TECHNOLOGIES, INC., PLANO, TX.
FILED 12-8-2009.

THE COLOR(S) BLUE IS/ARE CLAIMED AS A FEATURE OF THE MARK.

THE MARK CONSISTS OF THE WORD "TYLER" IN STYLIZED FONT IN BLUE.

FOR COMPUTER SOFTWARE THAT PROVIDES WEB-BASED ACCESS TO APPLICATIONS AND SERVICES THROUGH A WEB OPERATING SYSTEM OR PORTAL INTERFACE; COMPUTER SOFTWARE FOR CASE MANAGEMENT IN THE FIELD OF JUDICIAL SYSTEMS, NAMELY, INDEXING OF JUDICIAL CASES, ELECTRONIC FILING, DOCKETING, SCHEDULING, AND RELATED RECORD KEEPING OF CASE HEARINGS, MOTIONS, DOCUMENTS, AND DEADLINES, CUSTOMIZING JUDICIAL FORMS AND DOCUMENTS, RECORDING OF IN-COURT MINUTES, MANAGEMENT AND TRACKING OF WARRANTS AND WARRANT HISTORY, MANAGEMENT OF INMATE HISTORY SUCH AS INMATE INTAKE, COMMISSARY MANAGEMENT, CELL ASSIGNMENTS, RISK ASSESSMENTS, AND EDUCATION, AND FISCAL MANAGEMENT; COMPUTER SOFTWARE FOR FUND ACCOUNTING IN THE FIELDS OF GOVERNMENT AGENCIES, MUNICIPALITIES, SCHOOLS, AND NON-PROFIT ORGANIZATIONS; COMPUTER SOFTWARE FOR TRACKING AND MONITORING VEHICLES; COMPUTER SOFTWARE FOR USE IN TRANSPORTATION MANAGEMENT; COMPUTER SOFTWARE FOR ROUTING VEHICLES AND PLANNING AND FORECASTING TERRITORY ATTRIBUTES IN THE FIELD OF TRANSPORTATION MANAGEMENT; COMPUTER TRANSPORTATION SOFTWARE FOR USE IN REDISTRICTING, PLANNING, BOUNDARY ANALYSIS AND SCHOOL BUS ROUTING, MAINTENANCE, TRACKING

CLASS 9—(Continued).

AND SCHEDULING; COMPUTER SOFTWARE THAT PROVIDES ACCESS TO TRANSPORTATION DATABASES VIA A GLOBAL COMPUTER NETWORK; COMPUTER SOFTWARE FOR PROVIDING AND PROCESSING TRANSPORTATION INFORMATION, NAMELY, VEHICLE AND FLEET MAINTENANCE INFORMATION; SOFTWARE PROGRAMS, NAMELY, TRANSPORTATION SOFTWARE FOR ROUTING AND TRACKING BUSES; COMPUTER SOFTWARE FOR SCHOOL BUS OPERATIONS, ROUTING AND MANAGEMENT; COMPUTER PROGRAMS FOR USE IN ACCOUNTING, ACCOUNTS RECEIVABLE MANAGEMENT, FINANCIAL MANAGEMENT, ASSET MANAGEMENT, PROCUREMENT MANAGEMENT, HUMAN RESOURCES MANAGEMENT, TIME ENTRY, PAYROLL PROCESSING, DOCUMENT MANAGEMENT, COURT CASE MANAGEMENT, MUNICIPAL RECORDS MANAGEMENT, SCHOOL ADMINISTRATION, MANAGEMENT OF TEACHER AND STUDENT DATA, MANAGEMENT OF LAND AND VITAL RECORDS, MANAGEMENT OF CEMETERY INFORMATION, AND LAW ENFORCEMENT DISPATCHING (U.S. CLS. 21, 23, 26, 36 AND 38).

FIRST USE 9-25-2009; IN COMMERCE 9-25-2009.
ASMAT KHAN, EXAMINING ATTORNEY

SN 77-888,485. TYLER TECHNOLOGIES, INC., PLANO, TX.
FILED 12-8-2009.

TYLER

THE MARK CONSISTS OF STANDARD CHARACTERS WITHOUT CLAIM TO ANY PARTICULAR FONT, STYLE, SIZE, OR COLOR.

FOR COMPUTER SOFTWARE THAT PROVIDES WEB-BASED ACCESS TO APPLICATIONS AND SERVICES THROUGH A WEB OPERATING SYSTEM OR PORTAL INTERFACE; COMPUTER SOFTWARE FOR CASE MANAGEMENT IN THE FIELD OF JUDICIAL SYSTEMS, NAMELY, INDEXING OF JUDICIAL CASES, ELECTRONIC FILING, DOCKETING, SCHEDULING, AND RELATED RECORD KEEPING OF CASE HEARINGS, MOTIONS, DOCUMENTS, AND DEADLINES, CUSTOMIZING JUDICIAL FORMS AND DOCUMENTS, RECORDING OF IN-COURT MINUTES, MANAGEMENT AND TRACKING OF WARRANTS AND WARRANT HISTORY, MANAGEMENT OF INMATE HISTORY SUCH AS INMATE INTAKE, COMMISSARY MANAGEMENT, CELL ASSIGNMENTS, RISK ASSESSMENTS, AND EDUCATION, AND FISCAL MANAGEMENT; COMPUTER SOFTWARE FOR FUND ACCOUNTING IN THE FIELDS OF GOVERNMENT AGENCIES, MUNICIPALITIES, SCHOOLS, AND NON-PROFIT ORGANIZATIONS; COMPUTER SOFTWARE FOR TRACKING AND MONITORING VEHICLES; COMPUTER SOFTWARE FOR USE IN TRANSPORTATION MANAGEMENT; COMPUTER SOFTWARE FOR ROUTING VEHICLES AND PLANNING AND FORECASTING TERRITORY ATTRIBUTES IN THE FIELD OF TRANSPORTATION MANAGEMENT; COMPUTER TRANSPORTATION SOFTWARE FOR USE IN REDISTRICTING, PLANNING, BOUNDARY ANALYSIS AND SCHOOL BUS ROUTING, MAINTENANCE, TRACKING AND SCHEDULING; COMPUTER SOFTWARE THAT PROVIDES ACCESS TO TRANSPORTATION DATA-

CLASS 9—(Continued).

BASES VIA A GLOBAL COMPUTER NETWORK; COMPUTER SOFTWARE FOR PROVIDING AND PROCESSING TRANSPORTATION INFORMATION, NAMELY, VEHICLE AND FLEET MAINTENANCE INFORMATION; SOFTWARE PROGRAMS, NAMELY, TRANSPORTATION SOFTWARE FOR ROUTING AND TRACKING BUSES; COMPUTER SOFTWARE FOR SCHOOL BUS OPERATIONS, ROUTING AND MANAGEMENT; COMPUTER PROGRAMS FOR USE IN ACCOUNTING, ACCOUNTS RECEIVABLE MANAGEMENT, FINANCIAL MANAGEMENT, ASSET MANAGEMENT, PROCUREMENT MANAGEMENT, HUMAN RESOURCES MANAGEMENT, TIME ENTRY, PAYROLL PROCESSING, DOCUMENT MANAGEMENT, COURT CASE MANAGEMENT, MUNICIPAL RECORDS MANAGEMENT, SCHOOL ADMINISTRATION, MANAGEMENT OF TEACHER AND STUDENT DATA, MANAGEMENT OF LAND AND VITAL RECORDS, MANAGEMENT OF CEMETERY INFORMATION, AND LAW ENFORCEMENT DISPATCHING (U.S. CLS. 21, 23, 26, 36 AND 38).
FIRST USE 1-31-2008; IN COMMERCE 1-31-2008.
CHRISTINE COOPER, EXAMINING ATTORNEY

SN 77-888,500. ROCK, PAPER, SCISSORS, L.L.C., CEDAR FALLS, IA. FILED 12-8-2009.

DONATION GENERATOR

THE MARK CONSISTS OF STANDARD CHARACTERS WITHOUT CLAIM TO ANY PARTICULAR FONT, STYLE, SIZE, OR COLOR.

NO CLAIM IS MADE TO THE EXCLUSIVE RIGHT TO USE "DONATION", APART FROM THE MARK AS SHOWN. FOR COMPUTER SOFTWARE FOR USE IN CUSTOMER RELATIONSHIP MANAGEMENT (CRM) IN THE FIELD OF CHARITABLE FUNDRAISING (U.S. CLS. 21, 23, 26, 36 AND 38).

FIRST USE 8-12-2009; IN COMMERCE 8-12-2009.
DOUGLAS LEE, EXAMINING ATTORNEY

SN 77-888,506. QUALCOMM INCORPORATED, SAN DIEGO, CA. FILED 12-8-2009.

GPSONEXTRA

THE MARK CONSISTS OF STANDARD CHARACTERS WITHOUT CLAIM TO ANY PARTICULAR FONT, STYLE, SIZE, OR COLOR.

OWNER OF U.S. REG. NO. 2,817,663.
FOR COMPUTER HARDWARE AND SOFTWARE USED FOR DETERMINING THE LOCATION OF WIRELESS TELEPHONE AND DATA COMMUNICATIONS EQUIPMENT (U.S. CLS. 21, 23, 26, 36 AND 38).
TRACY CROSS, EXAMINING ATTORNEY

CLASS 9—(Continued).

SN 77-888,554. BACKCHANNELMEDIA, BOSTON, MA.
FILED 12-8-2009.

BCM

THE MARK CONSISTS OF STANDARD CHARACTERS WITHOUT CLAIM TO ANY PARTICULAR FONT, STYLE, SIZE, OR COLOR.

FOR COMPUTER SOFTWARE FOR PERMITTING INTERACTIVE MULTIMEDIA CONTENT BETWEEN VIEWERS AND TELEVISION PROGRAMS WHEN ACTIVATED BY THE TELEVISION PROGRAM (U.S. CLS. 21, 23, 26, 36 AND 38).

BILL DAWE, EXAMINING ATTORNEY

SN 77-888,614. RAB LIGHTING INC., NORTHVALE, NJ.
FILED 12-8-2009.

TURTLE

THE MARK CONSISTS OF STANDARD CHARACTERS WITHOUT CLAIM TO ANY PARTICULAR FONT, STYLE, SIZE, OR COLOR.

FOR COVERS FOR ELECTRIC OUTLETS; DECORATIVE SWITCH PLATE COVERS; ELECTRIC OUTLET COVERS; SWITCH PLATE COVERS; PROTECTIVE SWITCH PLATE COVERS; COVERPLATES FOR ELECTRICAL JUNCTION BOXES (U.S. CLS. 21, 23, 26, 36 AND 38).

FIRST USE 7-12-2005; IN COMMERCE 7-12-2005.
JENNIFER MARTIN, EXAMINING ATTORNEY

SN 77-888,672. TURNER ENTERTAINMENT CO., BURBANK, CA. FILED 12-8-2009.

DROOPY

THE MARK CONSISTS OF STANDARD CHARACTERS WITHOUT CLAIM TO ANY PARTICULAR FONT, STYLE, SIZE, OR COLOR.

OWNER OF U.S. REG. NO. 2,569,551.
FOR DIGITAL VIDEO DISCS FEATURING ANIMATED TELEVISION AND THEATRICAL SHORTS (U.S. CLS. 21, 23, 26, 36 AND 38).

FIRST USE 2-19-1954; IN COMMERCE 5-15-2007.
ROBIN MITTLER, EXAMINING ATTORNEY

CLASS 9—(Continued).

SN 77-888,711. EWO CORP., ENCINO, CA. FILED 12-8-2009.

THE MARK CONSISTS OF A STYLIZED TERM "I" IN SMALL FONT AND THE TERMS "SPEX" IN CAPITAL FONT WITH A STYLIZED "X".

FOR EYEGLASS HOLDERS IN THE NATURE OF CLASPS FOR ATTACHING EYEGLASSES TO CLOTHING AND OTHER OBJECTS (U.S. CLS. 21, 23, 26, 36 AND 38).

FIRST USE 12-4-2009; IN COMMERCE 12-4-2009.
SUSAN RICHARDS, EXAMINING ATTORNEY

SN 77-888,722. GREENE'S ENERGY GROUP, LLC, HOUSTON, TX. FILED 12-8-2009.

HYDROMAESTRO

THE MARK CONSISTS OF STANDARD CHARACTERS WITHOUT CLAIM TO ANY PARTICULAR FONT, STYLE, SIZE, OR COLOR.

FOR TECHNICAL MEASURING AND TESTING APPARATUS FOR MEASURING, TESTING, AND CHECKING THE INTEGRITY OF OPEN-ENDED PIPES (U.S. CLS. 21, 23, 26, 36 AND 38).

SUSAN RICHARDS, EXAMINING ATTORNEY

SN 77-888,789. MERRILL WILLIAMS AUDIO, LLC, CORDOVA, TN. FILED 12-8-2009.

R.E.A.L.

THE MARK CONSISTS OF STANDARD CHARACTERS WITHOUT CLAIM TO ANY PARTICULAR FONT, STYLE, SIZE, OR COLOR.

FOR PHONOGRAPH RECORD PLAYERS; RECORD PLAYERS (U.S. CLS. 21, 23, 26, 36 AND 38).

CHERYL CLAYTON, EXAMINING ATTORNEY

CLASS 9—(Continued).

SN 77-888,906. RIVERBED TECHNOLOGY, INC., SAN FRANCISCO, CA. FILED 12-8-2009.

VIRTUAL STEELHEAD

THE MARK CONSISTS OF STANDARD CHARACTERS WITHOUT CLAIM TO ANY PARTICULAR FONT, STYLE, SIZE, OR COLOR.

OWNER OF U.S. REG. NO. 2,981,947.

NO CLAIM IS MADE TO THE EXCLUSIVE RIGHT TO USE "VIRTUAL", APART FROM THE MARK AS SHOWN.

FOR SERVER AND NETWORKING SOFTWARE USED TO IMPROVE THE PERFORMANCE OF COMPUTER APPLICATIONS, SERVERS, DATA STORAGE AND COMMUNICATIONS PROTOCOLS USED IN WIDE AREA, LOCAL AREA, OR GLOBAL NETWORKS (U.S. CLS. 21, 23, 26, 36 AND 38).

LINDA LAVACHE, EXAMINING ATTORNEY

CLASS 9—(Continued).

SN 77-889,071. INVARIION, BRADENTON, FL. FILED 12-8-2009.



THE MARK CONSISTS OF THE WORDING "RAPID-PLAN" IN STYLIZED TEXTS WITH A CIRCLE THAT CONTAINS 4 LINES THAT CROSS EACH OTHER TO FORM A SQUARE IN THE MIDDLE OF THE CIRCLE. THERE IS AN ARROW ON THE END OF ONE OF THE LINES. THE DESIGN IS TO THE LEFT OF THE WORDING.

FOR COMPUTER SOFTWARE FOR CREATING TRAFFIC CONTROL PLANS THAT MAY BE DOWNLOADED FROM A GLOBAL COMPUTER NETWORK (U.S. CLS. 21, 23, 26, 36 AND 38).

FIRST USE 2-1-2007; IN COMMERCE 2-1-2007.

DAWN FELDMAN, EXAMINING ATTORNEY

SN 77-889,095. SCOTT A. KESSEL, MAGNOLIA, DE. FILED 12-8-2009.

Bubble Down

THE MARK CONSISTS OF STANDARD CHARACTERS WITHOUT CLAIM TO ANY PARTICULAR FONT, STYLE, SIZE, OR COLOR.

FOR COMPUTER OPERATING PROGRAMS AND COMPUTER OPERATING SYSTEMS (U.S. CLS. 21, 23, 26, 36 AND 38).

SHAILA SETTLES, EXAMINING ATTORNEY

SN 77-888,907. RIVERBED TECHNOLOGY, INC., SAN FRANCISCO, CA. FILED 12-8-2009.

CLOUD STEELHEAD

THE MARK CONSISTS OF STANDARD CHARACTERS WITHOUT CLAIM TO ANY PARTICULAR FONT, STYLE, SIZE, OR COLOR.

OWNER OF U.S. REG. NO. 2,981,947.

NO CLAIM IS MADE TO THE EXCLUSIVE RIGHT TO USE "CLOUD", APART FROM THE MARK AS SHOWN.

FOR SERVER AND NETWORKING SOFTWARE USED TO IMPROVE THE PERFORMANCE OF COMPUTER APPLICATIONS, SERVERS, DATA STORAGE AND COMMUNICATIONS PROTOCOLS USED IN WIDE AREA, LOCAL AREA, OR GLOBAL NETWORKS (U.S. CLS. 21, 23, 26, 36 AND 38).

LINDA LAVACHE, EXAMINING ATTORNEY

SN 77-889,122. OBJECT ID DESIGN PTY LTD, NORTH NARRABEEN, AUSTRALIA, FILED 12-8-2009.

XLInquest

THE MARK CONSISTS OF STANDARD CHARACTERS WITHOUT CLAIM TO ANY PARTICULAR FONT, STYLE, SIZE, OR COLOR.

FOR COMPUTER SOFTWARE FOR SEARCHING AND MANAGING SPREADSHEETS THAT MAY BE DOWNLOADED FROM A GLOBAL COMPUTER NETWORK (U.S. CLS. 21, 23, 26, 36 AND 38).

ALYSSA STEEL, EXAMINING ATTORNEY

CLASS 9—(Continued).

SN 77-889,124. PROTEK MANUFACTURING CORP., TAI-
CHUNG, TAIWAN, FILED 12-8-2009.



THE MARK CONSISTS OF THE WORD "PROTEK" IN A
STYLIZED FONT WITH A FLAME COMING OUT OF THE
"P".

FOR FIRE EXTINGUISHERS; FIRE EXTINGUISHING
APPARATUS; FIRE HOSE NOZZLES; FIRE HYDRANTS;
FIRE SPRINKLERS (U.S. CLS. 21, 23, 26, 36 AND 38).
FIRST USE 2-1-2002; IN COMMERCE 2-1-2002.
LEIGH CAROLINE CASE, EXAMINING ATTORNEY

SN 77-889,221. CAROLINA EAR & HEARING CLINIC, PC,
RALEIGH, NC. FILED 12-9-2009.

REMOTEASSIST

THE MARK CONSISTS OF STANDARD CHARACTERS
WITHOUT CLAIM TO ANY PARTICULAR FONT, STYLE,
SIZE, OR COLOR.

FOR COMPUTER SOFTWARE AND HARDWARE FOR
USE IN AUDIOVISUAL COMMUNICATIONS CARRIED
OUT VIA AN INTERACTIVE GLOBAL COMMUNICA-
TIONS NETWORK, TO MONITOR, CALIBRATE, AD-
JUST AND MAINTAIN COCHLEAR IMPLANT DEVICES
(U.S. CLS. 21, 23, 26, 36 AND 38).
REBECCA EISINGER, EXAMINING ATTORNEY

SN 77-889,222. SKYNET ELECTRONIC CO., LTD., NAN KAN
DIST, TAIPEI, TAIWAN, FILED 12-9-2009.

Nice-On

THE MARK CONSISTS OF "NICE-ON" IN A STYLIZED
TEXT.

FOR LIGHTING BALLASTS; VOLTAGE REGULA-
TORS; ELECTRICAL CONVERTERS; ELECTRICAL RE-
LAYS; LIGHT SWITCHES; CURRENT CONTROLLERS;
ELECTRICAL TRANSFORMERS; PRINTED CIRCUIT
BOARDS; LIGHT DIMMERS; INTEGRATED CIRCUITS
(U.S. CLS. 21, 23, 26, 36 AND 38).
RUDY R. SINGLETON, EXAMINING ATTORNEY

CLASS 9—(Continued).

SN 77-889,399. STARLIGHT CHILDREN'S FOUNDATION,
LOS ANGELES, CA. FILED 12-9-2009.

PC PAL

THE MARK CONSISTS OF STANDARD CHARACTERS
WITHOUT CLAIM TO ANY PARTICULAR FONT, STYLE,
SIZE, OR COLOR.

NO CLAIM IS MADE TO THE EXCLUSIVE RIGHT TO
USE "PC", APART FROM THE MARK AS SHOWN.

FOR LAPTOP COMPUTER FOR USE IN EDUCATION
AND COMMUNICATION BY SERIOUSLY ILL CHIL-
DREN AT HOSPITAL AND OUT-PATIENT MEDICAL
FACILITIES (U.S. CLS. 21, 23, 26, 36 AND 38).

FIRST USE 6-1-2005; IN COMMERCE 6-1-2005.
STEPHEN AQUILA, EXAMINING ATTORNEY

SN 77-889,412. I-ITCH, INC., SOUTHAMPTON, NY. FILED
12-9-2009.



THE MARK CONSISTS OF THE LETTER "I" AND THE
WORD "ITCH" IN A STYLIZED FONT WITH A CIRCLE,
BALL OR DOT BETWEEN THE LETTER "I" AND THE
WORD "ITCH".

FOR DOWNLOADABLE COMPUTER GAME PRO-
GRAMS; DOWNLOADABLE COMPUTER APPLICATION
SOFTWARE FOR USE WITH EDUCATIONAL GAMES
FOR MOBILE PHONES (U.S. CLS. 21, 23, 26, 36 AND 38).
LINDA POWELL, EXAMINING ATTORNEY

SN 77-889,522. PROCELLA AUDIO USA, LLC, DBA PRO-
CELLA AUDIO, VENICE, CA. FILED 12-9-2009.

Procella Audio

THE MARK CONSISTS OF STANDARD CHARACTERS
WITHOUT CLAIM TO ANY PARTICULAR FONT, STYLE,
SIZE, OR COLOR.

NO CLAIM IS MADE TO THE EXCLUSIVE RIGHT TO
USE "AUDIO", APART FROM THE MARK AS SHOWN.

FOR AUDIO/VIDEO COMPONENTS INCLUDING
SPEAKERS, SUBWOOFERS, AMPLIFIERS, PREAMPLI-
FIERS, PROCESSORS, EQUALIZERS AND CROSSOVERS
(U.S. CLS. 21, 23, 26, 36 AND 38).

FIRST USE 6-1-2006; IN COMMERCE 6-1-2006.
SEAN CROWLEY, EXAMINING ATTORNEY

CLASS 9—(Continued).

SN 77-889,592. OPTRONIC TECHNOLOGIES, INC., WATSONVILLE, CA. FILED 12-9-2009.

FUNSCOPE

THE MARK CONSISTS OF STANDARD CHARACTERS WITHOUT CLAIM TO ANY PARTICULAR FONT, STYLE, SIZE, OR COLOR.

FOR TELESCOPES (U.S. CLS. 21, 23, 26, 36 AND 38).
SANJEEV VOHRA, EXAMINING ATTORNEY

SN 77-889,629. BUNGIE LLC, KIRKLAND, WA. FILED 12-9-2009.

Grognok

THE MARK CONSISTS OF STANDARD CHARACTERS WITHOUT CLAIM TO ANY PARTICULAR FONT, STYLE, SIZE, OR COLOR.

THE WORDING "GROGNOK" HAS NO MEANING IN A FOREIGN LANGUAGE.

FOR COMPUTER PROGRAMS FOR EDITING IMAGES, SOUND AND VIDEO; COMPUTER SOFTWARE DEVELOPMENT TOOLS (U.S. CLS. 21, 23, 26, 36 AND 38).

CHARLOTTE CORWIN, EXAMINING ATTORNEY

SN 77-889,640. AQUA POWER SYSTEM, JAPAN, TOKYO, JAPAN, FILED 12-9-2009.

NoPoPo

THE MARK CONSISTS OF THE WORDING "NOPOPO" IN BLACK.

FOR BATTERIES (U.S. CLS. 21, 23, 26, 36 AND 38).
KEVON CHISOLM, EXAMINING ATTORNEY

CLASS 9—(Continued).

SN 77-889,688. SIGHTLOGIX, INC., PRINCETON, NJ. FILED 12-9-2009.

SIGHTSENSOR

THE MARK CONSISTS OF STANDARD CHARACTERS WITHOUT CLAIM TO ANY PARTICULAR FONT, STYLE, SIZE, OR COLOR.

FOR ELECTRONIC EQUIPMENT, NAMELY, CAMERAS, RECEIVERS FOR RECEIVING DATA AND VIDEO INPUT AND DATA PROCESSORS IN THE FIELD OF SECURITY AND SURVEILLANCE; ELECTRONIC EQUIPMENT, NAMELY, HARDWARE FOR PROCESSING AND MANAGING DATA FROM ELECTRONIC SENSORS FOR SECURITY, BUSINESS OPERATIONS, AND LOGISTICAL SUPPORT OF PERSONS AND BUSINESSES; ELECTRONIC SURVEILLANCE EQUIPMENT, NAMELY, HARDWARE FOR THE IDENTIFICATION, TRACKING, MONITORING, AND/OR SECURITY OF GOODS, PROPERTY OR PERSONS; ELECTRONIC SENSORS, NAMELY, OPTICAL, THERMAL, RADAR, LASER, AND SOUND SENSORS FOR MOTION OR ACTIVITY DETECTION (U.S. CLS. 21, 23, 26, 36 AND 38).

FIRST USE 3-28-2007; IN COMMERCE 3-28-2007.

JAMES MACFARLANE, EXAMINING ATTORNEY

SN 77-889,704. SIGHTLOGIX, INC., PRINCETON, NJ. FILED 12-9-2009.

SIGHTMONITOR

THE MARK CONSISTS OF STANDARD CHARACTERS WITHOUT CLAIM TO ANY PARTICULAR FONT, STYLE, SIZE, OR COLOR.

FOR COMPUTER SOFTWARE, NAMELY, COMPUTER SOFTWARE FOR THE MONITORING AND CONFIGURING OF DATA IN THE FIELD OF SECURITY AND SURVEILLANCE; COMPUTER SOFTWARE FOR ANALYSIS, CONVERSION, AND PROCESSING OF IMAGES GENERATED BY COMPUTER MONITORING EQUIPMENT COMPRISING ELECTRONIC SENSORS, NAMELY, OPTICAL, THERMAL, RADAR, LASER, AND SOUND SENSORS FOR MOTION OR ACTIVITY DETECTION; COMPUTER SOFTWARE FOR TRACKING PEOPLE, OBJECTS AND PETS BY GENERATING THEIR GLOBAL POSITIONING SYSTEM (GPS) COORDINATES FROM DATA RECEIVED FROM ELECTRONIC SURVEILLANCE EQUIPMENT; COMPUTER SOFTWARE FOR ORGANIZING AND VIEWING DIGITAL IMAGES AND PHOTOGRAPHS, AND FOR DRAWING GEOGRAPHICAL MAPS AND MAP IMAGES (U.S. CLS. 21, 23, 26, 36 AND 38).

FIRST USE 3-28-2007; IN COMMERCE 3-28-2007.

JAMES MACFARLANE, EXAMINING ATTORNEY

CLASS 9—(Continued).

SN 77-889,734. TECNOLUX INC., BROOKLYN, NY. FILED 12-9-2009.

SILIFLEX

THE MARK CONSISTS OF STANDARD CHARACTERS WITHOUT CLAIM TO ANY PARTICULAR FONT, STYLE, SIZE, OR COLOR.

FOR ELECTRIC CABLES AND WIRES (U.S. CLS. 21, 23, 26, 36 AND 38).

FIRST USE 1-6-2004; IN COMMERCE 4-1-2004.
JUSTINE D. PARKER, EXAMINING ATTORNEY



SN 77-889,745. CAROLINA EAR & HEARING CLINIC, PC, RALEIGH, NC. FILED 12-9-2009.

REMOTE ASSIST

THE MARK CONSISTS OF STANDARD CHARACTERS WITHOUT CLAIM TO ANY PARTICULAR FONT, STYLE, SIZE, OR COLOR.

NO CLAIM IS MADE TO THE EXCLUSIVE RIGHT TO USE "REMOTE", APART FROM THE MARK AS SHOWN.

FOR COMPUTER SOFTWARE AND HARDWARE FOR USE IN AUDIOVISUAL COMMUNICATIONS CARRIED OUT VIA AN INTERACTIVE GLOBAL COMMUNICATIONS NETWORK, TO MONITOR, CALIBRATE, ADJUST AND MAINTAIN COCHLEAR IMPLANT DEVICES (U.S. CLS. 21, 23, 26, 36 AND 38).

REBECCA EISINGER, EXAMINING ATTORNEY



SN 77-889,776. IT PROFESSIONAL CONSULTANTS, BELL, CA. FILED 12-9-2009.

Merge.It Pro

THE MARK CONSISTS OF STANDARD CHARACTERS WITHOUT CLAIM TO ANY PARTICULAR FONT, STYLE, SIZE, OR COLOR.

FOR COMPUTER PROGRAMMES FOR DOCUMENT MANAGEMENT; COMPUTER PROGRAMS FOR CREATING DOCUMENTS UTILIZING A DATABASE TO MERGE THE INFORMATION WITH STYLIZED DOCUMENTS THAT CONTAIN MERGE CODES WHERE THE DATA WILL BE SUBSTITUTED WITH (U.S. CLS. 21, 23, 26, 36 AND 38).

DAVID H. STINE, EXAMINING ATTORNEY

CLASS 9—(Continued).

SN 77-889,781. CAROLINA EAR & HEARING CLINIC, PC, RALEIGH, NC. FILED 12-9-2009.

REMOTE ASSISTANT

THE MARK CONSISTS OF STANDARD CHARACTERS WITHOUT CLAIM TO ANY PARTICULAR FONT, STYLE, SIZE, OR COLOR.

NO CLAIM IS MADE TO THE EXCLUSIVE RIGHT TO USE "REMOTE", APART FROM THE MARK AS SHOWN.

FOR COMPUTER SOFTWARE AND HARDWARE FOR USE IN AUDIOVISUAL COMMUNICATIONS CARRIED OUT VIA AN INTERACTIVE GLOBAL COMMUNICATIONS NETWORK, TO MONITOR, CALIBRATE, ADJUST AND MAINTAIN COCHLEAR IMPLANT DEVICES (U.S. CLS. 21, 23, 26, 36 AND 38).

REBECCA EISINGER, EXAMINING ATTORNEY



SN 77-889,790. TRI-TRONICS COMPANY, INC., TAMPA, FL. FILED 12-9-2009.

COLORWISE

THE MARK CONSISTS OF STANDARD CHARACTERS WITHOUT CLAIM TO ANY PARTICULAR FONT, STYLE, SIZE, OR COLOR.

FOR PHOTOELECTRIC SENSORS (U.S. CLS. 21, 23, 26, 36 AND 38).

FIRST USE 11-9-2009; IN COMMERCE 11-9-2009.
JOHN DALIER, EXAMINING ATTORNEY



SN 77-889,797. MATHESON TRI-GAS, INC., BASKING RIDGE, NJ. FILED 12-9-2009.

LASSO

THE MARK CONSISTS OF STANDARD CHARACTERS WITHOUT CLAIM TO ANY PARTICULAR FONT, STYLE, SIZE, OR COLOR.

FOR RADIO FREQUENCY IDENTIFICATION ("RFID") SYSTEM COMPRISED OF ELECTRONIC HARDWARE, NAMELY, RFID TAGS AND READERS, AND COMPUTER SOFTWARE FOR USE IN CONNECTION WITH SUPPLY CHAIN MANAGEMENT OF GASES TO MONITOR THE LOCATION OF GAS CYLINDERS AND TO MONITOR GAS PRESSURE, GAS LIQUID LEVEL, GAS TEMPERATURE AND GAS LEAKS (U.S. CLS. 21, 23, 26, 36 AND 38).

KATHERINE STOIDES, EXAMINING ATTORNEY

CLASS 9—(Continued).

SN 77-889,807. ROSENBAUM, SCOTT, TUCSON, AZ. FILED 12-9-2009.

SALESTOASTER

THE MARK CONSISTS OF STANDARD CHARACTERS WITHOUT CLAIM TO ANY PARTICULAR FONT, STYLE, SIZE, OR COLOR.

FOR COMPUTER SOFTWARE FOR USE IN MANAGING AND TRACKING SALES LEADS (U.S. CLS. 21, 23, 26, 36 AND 38).

FIRST USE 10-16-2009; IN COMMERCE 10-16-2009.
LINDSEY RUBIN, EXAMINING ATTORNEY

SN 77-889,808. MATHESON TRI-GAS, INC., BASKING RIDGE, NJ. FILED 12-9-2009.

E-LASSO

THE MARK CONSISTS OF STANDARD CHARACTERS WITHOUT CLAIM TO ANY PARTICULAR FONT, STYLE, SIZE, OR COLOR.

FOR RADIO FREQUENCY IDENTIFICATION ("RFID") SYSTEM COMPRISED OF ELECTRONIC HARDWARE, NAMELY, RFID TAGS AND READERS, AND COMPUTER SOFTWARE FOR USE IN CONNECTION WITH SUPPLY CHAIN MANAGEMENT OF GASES TO MONITOR THE LOCATION OF GAS CYLINDERS AND TO MONITOR GAS PRESSURE, GAS LIQUID LEVEL, GAS TEMPERATURE AND GAS LEAKS (U.S. CLS. 21, 23, 26, 36 AND 38).

KATHERINE STOIDES, EXAMINING ATTORNEY

SN 77-889,884. SHUFFLE MASTER, INC., LAS VEGAS, NV. FILED 12-9-2009.

DIGITAL GREEN

THE MARK CONSISTS OF STANDARD CHARACTERS WITHOUT CLAIM TO ANY PARTICULAR FONT, STYLE, SIZE, OR COLOR.

NO CLAIM IS MADE TO THE EXCLUSIVE RIGHT TO USE "DIGITAL", APART FROM THE MARK AS SHOWN.

FOR COMPUTER SOFTWARE FOR USE ON HANDHELD WIRELESS DEVICES, INCLUDING MOBILE PHONES, FOR PROVIDING COUPONS, DISCOUNTS, INCENTIVE REWARD PROGRAM INFORMATION, PAYMENT OPTIONS, PROMOTIONAL MATERIALS AND ADVERTISING TO CUSTOMERS AND FOR TRACKING CONSUMER SPENDING AND LOCATION (U.S. CLS. 21, 23, 26, 36 AND 38).

MICHAEL WIENER, EXAMINING ATTORNEY

CLASS 9—(Continued).

SN 77-889,964. TWENTIETH CENTURY FOX FILM CORPORATION, LOS ANGELES, CA. FILED 12-9-2009.

BOB'S BURGERS

THE MARK CONSISTS OF STANDARD CHARACTERS WITHOUT CLAIM TO ANY PARTICULAR FONT, STYLE, SIZE, OR COLOR.

FOR PRE-RECORDED DVDS FEATURING COMEDY; PRE-RECORDED CDS FEATURING COMEDY AND MUSICAL PERFORMANCES; DOWNLOADABLE AUDIO AND VIDEO RECORDINGS FEATURING COMEDY; DOWNLOADABLE TELEVISION SHOWS AND VIDEO RECORDINGS FEATURING COMEDY; DOWNLOADABLE RING TONES, RING BACKS, GRAPHICS, WALLPAPER, GAMES AND MUSIC VIA A GLOBAL COMPUTER NETWORK AND WIRELESS DEVICES; COMPUTER SCREEN SAVER SOFTWARE; COMPUTER GAME AND VIDEO GAME SOFTWARE (U.S. CLS. 21, 23, 26, 36 AND 38).

JAY FLOWERS, EXAMINING ATTORNEY

SN 77-890,120. PMSI MSA SERVICES, INC., TAMPA, FL. FILED 12-10-2009.

DVT

THE MARK CONSISTS OF STANDARD CHARACTERS WITHOUT CLAIM TO ANY PARTICULAR FONT, STYLE, SIZE, OR COLOR.

FOR COMPUTER SOFTWARE FOR PROVIDING ASSESSMENTS AND ALLOCATION FORECASTS FOR MEDICARE SETTLEMENTS (U.S. CLS. 21, 23, 26, 36 AND 38).

ZHALEH DELANEY, EXAMINING ATTORNEY

SN 77-890,185. ISAAC DANIEL GROUP, MIRAMAR, FL. FILED 12-10-2009.

FANFACE

THE MARK CONSISTS OF STANDARD CHARACTERS WITHOUT CLAIM TO ANY PARTICULAR FONT, STYLE, SIZE, OR COLOR.

FOR COMPUTER HARDWARE AND COMPUTER SOFTWARE PROGRAMS FOR THE INTEGRATION OF MEDIA RECORDINGS INTO AN INTERACTIVE DELIVERY FOR MULTIMEDIA APPLICATIONS (U.S. CLS. 21, 23, 26, 36 AND 38).

KARANENDRA S. CHHINA, EXAMINING ATTORNEY

CLASS 9—(Continued).

SN 77-890,255. ZUUMA INC., CHICAGO, IL. FILED 12-10-2009.

Züuma

THE MARK CONSISTS OF THE STYLIZED WORD "ZÜUMA".
THE WORDING "ZÜUMA" HAS NO MEANING OTHER THAN TRADEMARK SIGNIFICANCE.
FOR NON-METAL MOUNTS FOR ELECTRONIC DEVICES, NAMELY, GPS DEVICES, CELL PHONE, PDA, AND SATELLITE RADIOS (U.S. CLS. 21, 23, 26, 36 AND 38).
TRACY CROSS, EXAMINING ATTORNEY

SN 77-890,294. STRATEQUEST, LLC, SANTA CLARA, CA. FILED 12-10-2009.

pollme

THE MARK CONSISTS OF STANDARD CHARACTERS WITHOUT CLAIM TO ANY PARTICULAR FONT, STYLE, SIZE, OR COLOR.
FOR COMPUTER HARDWARE AND SOFTWARE SYSTEM CONSISTING OF SOFTWARE UTILIZING A GPS FOR TRACKING PEOPLE, OBJECTS AND PETS USING GPS DATA ON A DEVICE ON THE TRACKED PEOPLE, OBJECTS AND PETS (U.S. CLS. 21, 23, 26, 36 AND 38).
FIRST USE 11-1-2009; IN COMMERCE 11-1-2009.
LINDA ORNDORFF, EXAMINING ATTORNEY

SN 77-890,303. STRATEQUEST, LLC, SANTA CLARA, CA. FILED 12-10-2009.

helpme

THE MARK CONSISTS OF STANDARD CHARACTERS WITHOUT CLAIM TO ANY PARTICULAR FONT, STYLE, SIZE, OR COLOR.
FOR COMPUTER HARDWARE AND SOFTWARE SYSTEM CONSISTING OF SOFTWARE UTILIZING A GPS FOR TRACKING PEOPLE, OBJECTS AND PETS USING GPS DATA ON A DEVICE ON THE TRACKED PEOPLE, OBJECTS AND PETS (U.S. CLS. 21, 23, 26, 36 AND 38).
FIRST USE 11-1-2009; IN COMMERCE 11-1-2009.
LINDA ORNDORFF, EXAMINING ATTORNEY

CLASS 9—(Continued).

SN 77-890,310. STRATEQUEST, LLC, SANTA CLARA, CA. FILED 12-10-2009.

alertme

THE MARK CONSISTS OF STANDARD CHARACTERS WITHOUT CLAIM TO ANY PARTICULAR FONT, STYLE, SIZE, OR COLOR.
FOR COMPUTER HARDWARE AND SOFTWARE SYSTEM CONSISTING OF SOFTWARE UTILIZING A GPS FOR TRACKING PEOPLE, OBJECTS AND PETS USING GPS DATA ON A DEVICE ON THE TRACKED PEOPLE, OBJECTS AND PETS (U.S. CLS. 21, 23, 26, 36 AND 38).
FIRST USE 11-1-2009; IN COMMERCE 11-1-2009.
LINDA ORNDORFF, EXAMINING ATTORNEY

SN 77-890,323. STRATEQUEST, LLC, SANTA CLARA, CA. FILED 12-10-2009.

guideme

THE MARK CONSISTS OF STANDARD CHARACTERS WITHOUT CLAIM TO ANY PARTICULAR FONT, STYLE, SIZE, OR COLOR.
FOR COMPUTER HARDWARE AND SOFTWARE SYSTEM CONSISTING OF SOFTWARE UTILIZING A GPS FOR TRACKING PEOPLE, OBJECTS AND PETS USING GPS DATA ON A DEVICE ON THE TRACKED PEOPLE, OBJECTS AND PETS (U.S. CLS. 21, 23, 26, 36 AND 38).
FIRST USE 11-1-2009; IN COMMERCE 11-1-2009.
LINDA ORNDORFF, EXAMINING ATTORNEY

SN 77-890,334. VISTALAB TECHNOLOGIES, INC., MT. KISCO, NY. FILED 12-10-2009.



THE MARK CONSISTS OF THE LETTERS "MLA" OUTLINED BY A RECTANGLE. THE LETTER "A" IS STYLIZED.
FOR PIPETTES; DISPENSABLE TIPS FOR PIPETTES; AND KITS FOR CALIBRATING PIPETTES COMPRISED OF LABORATORY GLASSWARE, REAGENTS AND BLANK GRAPH PAPER (U.S. CLS. 21, 23, 26, 36 AND 38).
FIRST USE 8-23-1994; IN COMMERCE 8-23-1994.
MARY ROSSMAN, EXAMINING ATTORNEY

CLASS 9—(Continued).

SN 77-890,359. VISTALAB TECHNOLOGIES, INC., MT. KISCO, NY. FILED 12-10-2009.

MLA

THE MARK CONSISTS OF STANDARD CHARACTERS WITHOUT CLAIM TO ANY PARTICULAR FONT, STYLE, SIZE, OR COLOR.

FOR PIPETTES; DISPENSABLE TIPS FOR PIPETTES; AND KITS FOR CALIBRATING PIPETTES COMPRISED OF LABORATORY GLASSWARE, REAGENTS AND BLANK GRAPH PAPER (U.S. CLS. 21, 23, 26, 36 AND 38). FIRST USE 8-23-1994; IN COMMERCE 8-23-1994. MARY ROSSMAN, EXAMINING ATTORNEY

SN 77-890,407. CLINICOMP INTERNATIONAL, INC., SAN DIEGO, CA. FILED 12-10-2009.

THE ESSENTRIS EDGE

THE MARK CONSISTS OF STANDARD CHARACTERS WITHOUT CLAIM TO ANY PARTICULAR FONT, STYLE, SIZE, OR COLOR.

OWNER OF U.S. REG. NOS. 3,081,426, 3,145,896 AND OTHERS. FOR COMPUTER SOFTWARE FOR A GLOBAL DATA REPOSITORY SYSTEM FOR ARCHIVING PATIENT ENCOUNTER DATA THROUGHOUT A HEALTH CARE FACILITY FOR RETROSPECTIVE REPORTING AND ANALYSIS (U.S. CLS. 21, 23, 26, 36 AND 38). JANET LEE, EXAMINING ATTORNEY

CLASS 9—(Continued).

SN 77-890,413. BORDER STYLO, LLC, LOS ANGELES, CA. FILED 12-10-2009.

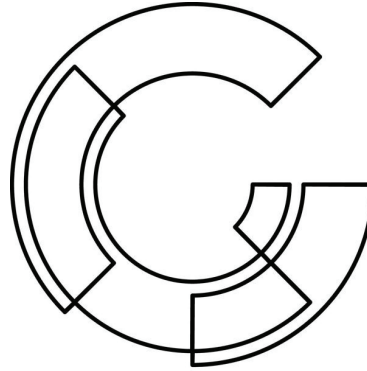

THE MARK CONSISTS OF A PATTERN OF FOUR CONCENTRIC CIRCULAR LINES INTERSECTED BY SIX STRAIGHT RADIAL LINES.

FOR COMPUTER SOFTWARE FOR ENABLING USERS TO CREATE CUSTOMIZABLE TEXT AND VISUAL EFFECTS ON EXISTING WEBSITES, AND TO ENABLE THE VIEWING AND SHARING OF DIGITAL IMAGES, INFORMATION AND DATA AVAILABLE ON GLOBAL COMPUTER NETWORKS; COMPUTER SOFTWARE TO ENABLE BROWSING OF WEBSITES (U.S. CLS. 21, 23, 26, 36 AND 38). MICHAEL WIENER, EXAMINING ATTORNEY

SN 77-890,417. CLINICOMP INTERNATIONAL, INC., SAN DIEGO, CA. FILED 12-10-2009.

ESSENTRIS EVERY PATIENT.
EVERYWHERE.

THE MARK CONSISTS OF STANDARD CHARACTERS WITHOUT CLAIM TO ANY PARTICULAR FONT, STYLE, SIZE, OR COLOR.

OWNER OF U.S. REG. NOS. 3,081,426, 3,145,896 AND OTHERS. FOR COMPUTER SOFTWARE FOR A GLOBAL DATA REPOSITORY SYSTEM FOR ARCHIVING PATIENT ENCOUNTER DATA THROUGHOUT A HEALTH CARE FACILITY FOR RETROSPECTIVE REPORTING AND ANALYSIS (U.S. CLS. 21, 23, 26, 36 AND 38). JANET LEE, EXAMINING ATTORNEY

CLASS 9—(Continued).

SN 77-890,462. IGT, RENO, NV. FILED 12-10-2009.

DIAMONDS OF ATHENS

THE MARK CONSISTS OF STANDARD CHARACTERS WITHOUT CLAIM TO ANY PARTICULAR FONT, STYLE, SIZE, OR COLOR.

FOR GAMING MACHINES, NAMELY, DEVICES WHICH ACCEPT A WAGER (U.S. CLS. 21, 23, 26, 36 AND 38).

LINDA ESTRADA, EXAMINING ATTORNEY

SN 77-890,509. VICTOR TECHNOLOGY LLC, BOLINGBROOK, IL. FILED 12-10-2009.

TouchCalc

THE MARK CONSISTS OF STANDARD CHARACTERS WITHOUT CLAIM TO ANY PARTICULAR FONT, STYLE, SIZE, OR COLOR.

FOR CALCULATING MACHINES; CALCULATING MACHINES AND DATA PROCESSING EQUIPMENT; CALCULATING MACHINES AND DATA-PROCESSING EQUIPMENT; CALCULATING MACHINES, DATA PROCESSING EQUIPMENT AND COMPUTERS; CALCULATING MACHINES, DATA-PROCESSING EQUIPMENT AND COMPUTERS; CALCULATORS; CALCULATORS AND CALCULATING MACHINES; CASES FOR POCKET CALCULATORS; CASH REGISTERS, CALCULATING MACHINES AND DATA PROCESSING EQUIPMENT AND COMPUTERS; CASH REGISTERS, CALCULATING MACHINES, DATA PROCESSING EQUIPMENT AND COMPUTERS; CASH REGISTERS, CALCULATING MACHINES, DATA-PROCESSING EQUIPMENT AND COMPUTERS; ELECTRONIC CALCULATORS; ELECTRONIC DESK CALCULATORS; POCKET CALCULATORS; POCKET-SIZED ELECTRONIC CALCULATORS (U.S. CLS. 21, 23, 26, 36 AND 38).

PAUL CROWLEY, EXAMINING ATTORNEY

CLASS 9—(Continued).

SN 77-890,516. UNIVERSITY OF NORTHWESTERN OHIO, LIMA, OH. FILED 12-10-2009.



NO CLAIM IS MADE TO THE EXCLUSIVE RIGHT TO USE "MOTORSPORTS", APART FROM THE MARK AS SHOWN.

THE COLOR(S) RED, BLACK AND WHITE IS/ARE CLAIMED AS A FEATURE OF THE MARK.

THE MARK CONSISTS OF A RED LARGE "U" OUTLINED IN BLACK AND WHITE WITH THE STYLIZED WORDING "MOTORSPORTS" ARCHED ACROSS MIDDLE IN WHITE LETTERS WITH RED, BLACK, AND WHITE OUTLINING AND THE STYLIZED WORDING "UNOH" IN BLACK AND RED OUTLINED IN WHITE ACROSS THE BOTTOM OF THE "U".

FOR PRE-RECORDED DVDS FEATURING A REALITY SHOW IN THE FIELD OF MOTORSPORTS (U.S. CLS. 21, 23, 26, 36 AND 38).

LIEF MARTIN, EXAMINING ATTORNEY

SN 77-890,580. HPV TECHNOLOGIES, INC., COSTA MESA, CA. FILED 12-10-2009.

THE BOS

THE MARK CONSISTS OF STANDARD CHARACTERS WITHOUT CLAIM TO ANY PARTICULAR FONT, STYLE, SIZE, OR COLOR.

FOR PUBLIC-ADDRESS SYSTEMS AND INSTRUMENTS (U.S. CLS. 21, 23, 26, 36 AND 38).

JOHN SCHUYLER YARD, EXAMINING ATTORNEY

SN 77-890,583. VT SILICON, INC., ATLANTA, GA. FILED 12-10-2009.

DPO

THE MARK CONSISTS OF STANDARD CHARACTERS WITHOUT CLAIM TO ANY PARTICULAR FONT, STYLE, SIZE, OR COLOR.

FOR INTEGRATED CIRCUITS AND COMPONENTS, NAMELY, POWER AMPLIFIERS, FRONT END MODULES AND FRONT END INTEGRATED CIRCUITS, FOR USE IN WIRELESS COMMUNICATIONS AND WIRELESS COMMUNICATION EQUIPMENT (U.S. CLS. 21, 23, 26, 36 AND 38).

JOHN SCHUYLER YARD, EXAMINING ATTORNEY

CLASS 9—(Continued).

SN 77-890,594. MULTIMEDIA GAMES, INC., AUSTIN, TX.
FILED 12-10-2009.

MegaPlay

THE MARK CONSISTS OF STANDARD CHARACTERS WITHOUT CLAIM TO ANY PARTICULAR FONT, STYLE, SIZE, OR COLOR.

FOR GAMING MACHINES, NAMELY, ELECTRONIC SLOT AND BINGO MACHINES; VIDEO LOTTERY TERMINALS (U.S. CLS. 21, 23, 26, 36 AND 38).

APRIL ROACH, EXAMINING ATTORNEY

SN 77-890,620. LOWE PROFILE PRODUCTIONS, INC.,
BEVERLY HILLS, CA. FILED 12-10-2009.



THE MARK CONSISTS OF THE STYLIZED LETTERS "TBP" INSIDE OF AN OVAL SHAPE DESIGN.

FOR GAMING EQUIPMENT, NAMELY, SLOT MACHINES, BLACK JACK MACHINES AND POKER MACHINES, WITH OR WITHOUT VIDEO OUTPUT; COMPUTER GAME PROGRAMS (U.S. CLS. 21, 23, 26, 36 AND 38).

TINA MAI, EXAMINING ATTORNEY

SN 77-890,684. SANDERS COMPANY, INC., STUART, FL.
FILED 12-10-2009.

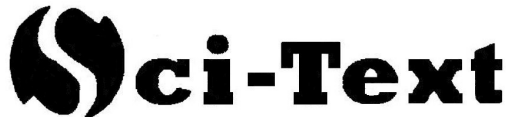

THE MARK CONSISTS OF THE STYLIZED TEXT "SCI-TEXT" WITH THE "S" INSIDE A CIRCLE.

FOR PROGRAMMABLE LOGIC CONTROLLER (PLC) (U.S. CLS. 21, 23, 26, 36 AND 38).

FIRST USE 11-2-2009; IN COMMERCE 11-2-2009.

EUGENIA MARTIN, EXAMINING ATTORNEY

CLASS 9—(Continued).

SN 77-890,709. MENACE AUDIO, INC., BENSALEM, PA.
FILED 12-10-2009.

VOICE SPEAKER

THE MARK CONSISTS OF STANDARD CHARACTERS WITHOUT CLAIM TO ANY PARTICULAR FONT, STYLE, SIZE, OR COLOR.

NO CLAIM IS MADE TO THE EXCLUSIVE RIGHT TO USE "SPEAKER", APART FROM THE MARK AS SHOWN.

FOR AUDIO EQUIPMENT, NAMELY, LOUDSPEAKERS, TWEETERS, WOOFERS, SUBWOOFERS, SPEAKER ENCLOSURES, SPEAKER HORNS (U.S. CLS. 21, 23, 26, 36 AND 38).

HOWARD B. LEVINE, EXAMINING ATTORNEY

SN 77-890,716. DREESE, JOHN, SAGINAW, TX. FILED 12-10-2009.

LIFT HAPPENS

THE MARK CONSISTS OF STANDARD CHARACTERS WITHOUT CLAIM TO ANY PARTICULAR FONT, STYLE, SIZE, OR COLOR.

FOR COMPUTER SOFTWARE PLATFORMS FOR DESIGNING AND ANALYZING AIRFOILS (U.S. CLS. 21, 23, 26, 36 AND 38).

FIRST USE 2-4-2008; IN COMMERCE 3-0-2008.

TOBY BULLOFF, EXAMINING ATTORNEY

SN 77-890,723. MENACE AUDIO, INC., BENSALEM, PA.
FILED 12-10-2009.



NO CLAIM IS MADE TO THE EXCLUSIVE RIGHT TO USE "SPEAKER", APART FROM THE MARK AS SHOWN.

THE MARK CONSISTS OF "VOICE SPEAKER" WITH A SERIES OF ARCULATE LINES NEXT TO THE LETTER "R" IN "SPEAKER".

FOR AUDIO EQUIPMENT, NAMELY, LOUDSPEAKERS, TWEETERS, WOOFERS, SUBWOOFERS, SPEAKER ENCLOSURES, SPEAKER HORNS (U.S. CLS. 21, 23, 26, 36 AND 38).

HOWARD B. LEVINE, EXAMINING ATTORNEY

CLASS 9—(Continued).

SN 77-890,870. SIENNA PRODUCTS, L.L.C., SEDALIA, MO. FILED 12-10-2009.

Color Select Studio 

NO CLAIM IS MADE TO THE EXCLUSIVE RIGHT TO USE "COLOR" OR "STUDIO", APART FROM THE MARK AS SHOWN.

THE MARK CONSISTS OF THE WORDS "COLOR SELECT STUDIO" IN STYLIZED FONT, FOLLOWED BY THREE PARALLEL HORIZONTAL LINES.

FOR COMPUTER SOFTWARE FOR EDITING DIGITAL PHOTOGRAPHS (U.S. CLS. 21, 23, 26, 36 AND 38).

FIRST USE 6-20-2007; IN COMMERCE 6-20-2007.
JAMES MACFARLANE, EXAMINING ATTORNEY

SN 77-891,001. DNJ SOLUTIONS, INC, DBA TRACKMYBAGS, MESA, AZ. FILED 12-10-2009.

TrackMyBags

THE MARK CONSISTS OF STANDARD CHARACTERS WITHOUT CLAIM TO ANY PARTICULAR FONT, STYLE, SIZE, OR COLOR.

FOR COMPUTER HARDWARE AND SOFTWARE SYSTEM FOR TRACKING PEOPLE, OBJECTS AND PETS USING GPS DATA ON A DEVICE ON THE TRACKED PEOPLE, OBJECTS AND PETS (U.S. CLS. 21, 23, 26, 36 AND 38).

REBECCA SMITH, EXAMINING ATTORNEY

SN 77-891,069. STELLA DAVID R, DBA BEATCONNECT.COM, WILMINGTON, DE. FILED 12-11-2009.

Beat Connect

THE MARK CONSISTS OF STANDARD CHARACTERS WITHOUT CLAIM TO ANY PARTICULAR FONT, STYLE, SIZE, OR COLOR.

FOR DIGITAL MUSIC DOWNLOADABLE FROM THE INTERNET; DIGITAL PHOTO FRAMES FOR DISPLAYING DIGITAL PICTURES, VIDEO CLIPS AND MUSIC; DOWNLOADABLE MP3 FILES, MP3 RECORDINGS, ONLINE DISCUSSION BOARDS, WEBCASTS, WEBINARS AND PODCASTS FEATURING MUSIC, AUDIO BOOKS AND NEWS BROADCASTS; DOWNLOADABLE MUSICAL SOUND RECORDINGS; DOWNLOADABLE RING TONES, GRAPHICS AND MUSIC VIA A GLOBAL COMPUTER NETWORK AND WIRELESS DEVICES; DOWNLOADABLE MUSIC VIA THE INTERNET AND WIRELESS DEVICES; MUSICAL SOUND RECORDINGS (U.S. CLS. 21, 23, 26, 36 AND 38).

LOURDES AYALA, EXAMINING ATTORNEY

CLASS 9—(Continued).

SN 77-891,099. EMSI SOFTWARE GMBH, THALGAU, SALZBURG, AUSTRIA, FILED 12-11-2009.

MALWARE

THE MARK CONSISTS OF STANDARD CHARACTERS WITHOUT CLAIM TO ANY PARTICULAR FONT, STYLE, SIZE, OR COLOR.

FOR ANTI-VIRUS SOFTWARE DOWNLOADABLE SOFTWARE; ANTI-SPYWARE SOFTWARE; COMPUTER SOFTWARE AND DOWNLOADABLE SOFTWARE FOR USE IN THE SAFEGUARDING OF DIGITAL FILES, INCLUDING AUDIO, VIDEO, TEXT, BINARY, STILL IMAGES, GRAPHICS AND MULTIMEDIA FILES; DOWNLOADABLE COMPUTER SOFTWARE FOR IDENTIFYING AND REMOVING MALICIOUS SOFTWARE, SO CALLED MALWARE, INCLUDING VIRUSES, TROJANS, BOTS, SPYWARE, ADVERTISING SOFTWARE, ROOTKITS, DIALERS; SOFTWARE AND DOWNLOADABLE SOFTWARE FOR ENSURING THE SECURITY OF ELECTRONIC MAIL (U.S. CLS. 21, 23, 26, 36 AND 38).

FIRST USE 12-0-2003; IN COMMERCE 12-0-2003.
JUDITH HELFMAN, EXAMINING ATTORNEY

SN 77-891,105. STONE CREEK ENTERTAINMENT LLC, RIDGEFIELD, CT. FILED 12-11-2009.

HER PET PEEVES

THE MARK CONSISTS OF STANDARD CHARACTERS WITHOUT CLAIM TO ANY PARTICULAR FONT, STYLE, SIZE, OR COLOR.

FOR DOWNLOADABLE VIDEO GAME SOFTWARE FOR MOBILE DEVICES AND PERSONAL COMPUTERS (U.S. CLS. 21, 23, 26, 36 AND 38).

ELISSA GARBER KON, EXAMINING ATTORNEY

SN 77-891,133. HANSEN ENTERPRISES II, LLC, DBA HANSEN FIRE & SAFETY, COLUMBUS, OH. FILED 12-11-2009.

HAN-SAFE

THE MARK CONSISTS OF STANDARD CHARACTERS WITHOUT CLAIM TO ANY PARTICULAR FONT, STYLE, SIZE, OR COLOR.

FOR FIRE RESISTANT GLOVES, PROTECTIVE WORK GLOVES, GLOVES FOR PROTECTION AGAINST ACCIDENTS (U.S. CLS. 21, 23, 26, 36 AND 38).

ALEXANDER L. POWERS, EXAMINING ATTORNEY

CLASS 9—(Continued).

SN 77-891,164. COBALT DIGITAL, INC., URBANA, IL.
FILED 12-11-2009.

COBALT FUSION

THE MARK CONSISTS OF STANDARD CHARACTERS WITHOUT CLAIM TO ANY PARTICULAR FONT, STYLE, SIZE, OR COLOR.

FOR AUDIO AND VIDEO CIRCUIT BOARDS FOR USE IN TERMINAL BROADCAST ELECTRONICS EQUIPMENT (U.S. CLS. 21, 23, 26, 36 AND 38).

LAURA HAMMEL, EXAMINING ATTORNEY

SN 77-891,332. CANFIELD SCIENTIFIC, INC., FAIRFIELD, NJ. FILED 12-11-2009.

MatchPose

THE MARK CONSISTS OF STANDARD CHARACTERS WITHOUT CLAIM TO ANY PARTICULAR FONT, STYLE, SIZE, OR COLOR.

FOR COMPUTER SOFTWARE FOR USE IN AESTHETIC IMAGE CAPTURE, MANAGEMENT, SIMULATION, AND ANALYSIS (U.S. CLS. 21, 23, 26, 36 AND 38).
FIRST USE 8-2-2005; IN COMMERCE 8-2-2005.

KAPIL BHANOT, EXAMINING ATTORNEY

CLASS 9—(Continued).

SN 77-891,501. MVL RIGHTS LLC, MANHATTAN BEACH, CA. FILED 12-11-2009.



OWNER OF U.S. REG. NOS. 885,486, 3,282,768 AND OTHERS.

THE MARK CONSISTS OF A CIRCULAR DESIGN WITH THE WORDS "AVENGERS ASSEMBLE" AND TWO FIVE-POINTED STARS SURROUNDING A SMALLER CIRCLE CONTAINING THE IMAGE OF AN EAGLE WITH OUTSPREAD WINGS AND A SHIELD AT THE CENTER WITH STRIPES AND STARS ON THE SHIELD.

FOR COMPUTER GAME CARTRIDGES; COMPUTER GAME DISCS; COMPUTER GAME PROGRAMS; COMPUTER GAME SOFTWARE; INTERACTIVE MULTIMEDIA COMPUTER GAME PROGRAM; INTERACTIVE VIDEO GAME PROGRAMS; INTERACTIVE VIDEO GAMES OF VIRTUAL REALITY COMPRISED OF COMPUTER HARDWARE FOR USE WITH AN EXTERNAL MONITOR AND SOFTWARE; PRE-RECORDED CDS, VIDEO TAPES, LASER DISKS AND DVDS FEATURING MUSIC AND/OR LIVE ACTION PROGRAMS OR MOTION PICTURES OR ANIMATED CARTOONS; VIDEO GAME CARTRIDGES; VIDEO GAME DISCS; VIDEO GAME SOFTWARE (U.S. CLS. 21, 23, 26, 36 AND 38).

FLORENTINA BLANDU, EXAMINING ATTORNEY

SN 77-891,565. DUACARRIER ELECTRONICS TECHNOLOGY, INC., KNOXVILLE, TN. FILED 12-11-2009.

VERICOM GLOBAL SOLUTIONS

THE MARK CONSISTS OF STANDARD CHARACTERS WITHOUT CLAIM TO ANY PARTICULAR FONT, STYLE, SIZE, OR COLOR.

NO CLAIM IS MADE TO THE EXCLUSIVE RIGHT TO USE "GLOBAL SOLUTIONS", APART FROM THE MARK AS SHOWN.

FOR AUDIO CABLES; CABLE CONNECTORS; CABLES AND FIBRES FOR THE TRANSMISSION OF SOUNDS AND IMAGES; CABLES FOR ELECTRICAL AND OPTICAL SIGNAL TRANSMISSION SYSTEMS; CABLES FOR ELECTRICAL OR OPTICAL SIGNAL TRANSMISSION; CABLES FOR OPTICAL SIGNAL TRANSMISSION; CABLES, ELECTRIC; COAXIAL CABLES; COAXIAL CABLES INCORPORATING FILTERS; COMPONENT VIDEO CABLES; COMPUTER CABLES; CONNECTING ELECTRICAL CABLES; CONNECTION CABLES; DUCTING FOR ELECTRIC CABLES; ELECTRIC CABLES AND WIRES; ELECTRIC CABLES, WIRES, CONDUCTORS AND CONNECTION FITTINGS THEREFOR; ELECTRIC WIRE AND CABLE; ELECTRIC WIRES AND CABLES; ELECTRICAL AND OPTICAL CABLES; ELECTRICAL CABLES; ELECTRICAL CABLES AND CORDSETS; ELECTRICAL CABLES FOR MUSICAL

CLASS 9—(Continued).

INSTRUMENTS; ELECTRICAL CABLES FOR USE IN CONNECTIONS; ELECTRICAL CABLES WITH INTEGRATED FITTINGS, NAMELY, CORDSETS; ELECTRICAL INTERCONNECT CABLES; ELECTRICAL PLUG DEVICE ENABLING CONNECTION AND DISCONNECTION OF POWER AND/OR CONTROL CABLES; ELECTRONIC CABLES; ETHERNET CABLES; EXTENSION CABLES; FIBER OPTIC CABLES; FIBRE-OPTIC CABLES; GUITAR CABLES; HDMI (HIGH-DEFINITION MULTIMEDIA INTERFACE) APPARATUS AND COMPONENT CABLES SOLD AS A UNIT; HDMI (HIGH-DEFINITION MULTIMEDIA INTERFACE) CABLES; JUMPER CABLES; METAL CABINETS SPECIALLY ADAPTED TO PROTECT TELECOMMUNICATIONS EQUIPMENT IN THE NATURE OF FIBER OPTIC CABLES.; MICROPHONE CABLES; MODEM CABLES; OPTICAL CABLES; OPTICAL FIBER CABLES; OPTICAL FIBERS SOLD AS A COMPONENT OF FIBER OPTICAL CABLES; POWER CABLES; PRINTER CABLES; PROTECTIVE SHEATHS FOR FIBER OPTICAL CABLES; PUBLIC ADDRESS (PA) AND SOUND SYSTEM ACCESSORIES, NAMELY, MICROPHONE STANDS, SPEAKER STANDS, MICROPHONE CABLES, SPEAKER CABLES, SPEAKER BOXES AND SOUND MIXERS; SHEATHS FOR ELECTRIC CABLES; STEREO CABLES; TELECOMMUNICATION CABLES; TELECOMMUNICATIONS CABLES; THREADED CABLE CONNECTORS OF METAL; USB CABLES; VIDEO CABLES (U.S. CLS. 21, 23, 26, 36 AND 38).

JILL PRATER, EXAMINING ATTORNEY

SN 77-891,638. MEMSIC, INC., ANDOVER, MA. FILED 12-11-2009.

MEMSIC

THE MARK CONSISTS OF STANDARD CHARACTERS WITHOUT CLAIM TO ANY PARTICULAR FONT, STYLE, SIZE, OR COLOR.

FOR SENSORS FOR DETECTING INERTIAL MOTION, ACCELERATION, GRAVITY, FORCE, VIBRATION AND VELOCITY, AND SEMICONDUCTORS (U.S. CLS. 21, 23, 26, 36 AND 38).

FIRST USE 6-0-2000; IN COMMERCE 6-0-2000.
SAIMA MAKHDOOM, EXAMINING ATTORNEY

SN 77-891,684. SURVIVOR PRODUCTIONS, LLC, LOS ANGELES, CA. FILED 12-11-2009.

**SURVIVOR OUTWIT OUTPLAY
OUTLAST**

THE MARK CONSISTS OF STANDARD CHARACTERS WITHOUT CLAIM TO ANY PARTICULAR FONT, STYLE, SIZE, OR COLOR.

OWNER OF U.S. REG. NOS. 2,786,996, 3,297,072 AND OTHERS.

FOR CURRENCY AND CREDIT OPERATED SLOT MACHINES AND GAMING DEVICES, NAMELY, GAMING MACHINES FOR USE IN GAMING ESTABLISHMENTS (U.S. CLS. 21, 23, 26, 36 AND 38).

FIRST USE 6-1-2002; IN COMMERCE 6-1-2002.
H. M. FISHER, EXAMINING ATTORNEY

CLASS 9—(Continued).

SN 77-891,757. DATA ROBOTICS, INC., SANTA CLARA, CA. FILED 12-11-2009.

DROBOELITE

THE MARK CONSISTS OF STANDARD CHARACTERS WITHOUT CLAIM TO ANY PARTICULAR FONT, STYLE, SIZE, OR COLOR.

OWNER OF U.S. REG. NO. 3,458,825.

FOR COMPUTER HARDWARE; COMPUTER BACKUP AND STORAGE SYSTEMS WITH MULTIPLE RAID CARTRIDGES (U.S. CLS. 21, 23, 26, 36 AND 38).

ANDREA BUTLER, EXAMINING ATTORNEY

SN 77-891,881. GLOBAL CASH ACCESS, INC., LAS VEGAS, NV. FILED 12-11-2009.

CARDXCHANGE

THE MARK CONSISTS OF STANDARD CHARACTERS WITHOUT CLAIM TO ANY PARTICULAR FONT, STYLE, SIZE, OR COLOR.

FOR SMART CARD-READY TRANSACTION TERMINALS FOR DEBIT AND STORED VALUE CARD TRANSACTIONS, REPLENISHMENT OF FUNDS ON STORED VALUE CARDS AND ELECTRONIC MONEY TRANSFERS IN THE GAMING AND WAGERING INDUSTRY (U.S. CLS. 21, 23, 26, 36 AND 38).

ALEXANDER L. POWERS, EXAMINING ATTORNEY

SN 77-891,915. POMDEVICES, LLC, DURHAM, NC. FILED 12-11-2009.

POMGUARD

THE MARK CONSISTS OF STANDARD CHARACTERS WITHOUT CLAIM TO ANY PARTICULAR FONT, STYLE, SIZE, OR COLOR.

FOR ELECTRONIC DEVICES FOR ASSISTING CARE GIVING FOR SENIORS OR PEOPLE NEEDING ASSISTANCE COMPRISED OF SENSORS FOR DETERMINING STATUS OF PERSON AND APPARATUS FOR SENDING ELECTRONIC ALERTS TO CARE GIVERS (U.S. CLS. 21, 23, 26, 36 AND 38).

NANCY CLARKE, EXAMINING ATTORNEY

CLASS 9—(Continued).

SN 77-891,950. KYOCERA WIRELESS CORP., SAN DIEGO, CA. FILED 12-11-2009.

INNUENDO

THE MARK CONSISTS OF STANDARD CHARACTERS WITHOUT CLAIM TO ANY PARTICULAR FONT, STYLE, SIZE, OR COLOR.

FOR CELL PHONES; CELLULAR PHONES; MOBILE PHONES (U.S. CLS. 21, 23, 26, 36 AND 38).

CHRISTOPHER BUONGIORNO, EXAMINING ATTORNEY

SN 77-891,955. KYOCERA WIRELESS CORP., SAN DIEGO, CA. FILED 12-11-2009.

ADAGIO

THE MARK CONSISTS OF STANDARD CHARACTERS WITHOUT CLAIM TO ANY PARTICULAR FONT, STYLE, SIZE, OR COLOR.

THE ENGLISH TRANSLATION OF "ADAGIO" IN THE MARK IS SLOWLY.

FOR CELL PHONES; CELLULAR PHONES; MOBILE PHONES (U.S. CLS. 21, 23, 26, 36 AND 38).

CHRISTOPHER BUONGIORNO, EXAMINING ATTORNEY

SN 77-891,978. TOUCH TECHNOLOGIES, INC., SAN DIEGO, CA. FILED 12-11-2009.

EZTOUCH

THE MARK CONSISTS OF STANDARD CHARACTERS WITHOUT CLAIM TO ANY PARTICULAR FONT, STYLE, SIZE, OR COLOR.

FOR EYEWEAR; EYEWEAR ACCESSORIES, NAMELY, STRAPS, NECK CORDS AND HEAD STRAPS WHICH RESTRAIN EYEWEAR FROM MOVEMENT ON A WEARER (U.S. CLS. 21, 23, 26, 36 AND 38).

TRACY CROSS, EXAMINING ATTORNEY

CLASS 9—(Continued).

SN 77-891,979. RESURS2 CORPORATION, HARRISON, NJ. FILED 12-11-2009.

HQRP

THE MARK CONSISTS OF STANDARD CHARACTERS WITHOUT CLAIM TO ANY PARTICULAR FONT, STYLE, SIZE, OR COLOR.

OWNER OF U.S. REG. NO. 3,569,941.

FOR ACCUMULATORS; ADAPTERS; APPARATUS AND INSTRUMENTS FOR CONVEYING, DISTRIBUTING, TRANSFORMING, STORING, REGULATING OR CONTROLLING ELECTRIC CURRENT; BAGS AND CASES SPECIALLY ADAPTED FOR HOLDING OR CARRYING PORTABLE TELEPHONES AND TELEPHONE EQUIPMENT AND ACCESSORIES; BAGS FOR CAMERAS AND PHOTOGRAPHIC EQUIPMENT; BATTERIES AND BATTERY CHARGERS; BATTERIES, ELECTRIC; BATTERY CASES; BINOCULARS; CABLE CONNECTORS; CABLES FOR ELECTRICAL AND OPTICAL SIGNAL TRANSMISSION SYSTEMS; CAMERA TRIPODS; CHARGING APPLIANCES FOR RECHARGEABLE EQUIPMENT; COMPUTER HARDWARE AND PERIPHERAL DEVICES; COMPUTER MICE; COMPUTER NETWORK ADAPTERS, SWITCHES, ROUTERS AND HUBS; CONNECTION CABLES; DIGITAL DISC DRIVES; DVD DRIVES; EARPHONES AND HEADPHONES; ELECTRIC CABLES, WIRES, CONDUCTORS AND CONNECTION FITTINGS THEREFOR; ELECTRICAL AND ELECTRONIC CONNECTORS; ELECTRICAL CONTROLLING DEVICES; ELECTRONIC CABLES; ELECTRONIC COMPONENTS FOR COMPUTERS; KEYBOARDS; LCD PANELS; LOUDSPEAKERS, HEADPHONES, MICROPHONES AND CD PLAYERS; LUMINOFLUX METERS; MEASURING APPARATUS FOR TEMPERATURE AND HUMIDITY LEVELS IN GASES AND SOLID SUBSTANCES; MICROPHONES FOR COMMUNICATION DEVICES; MOUNTING DEVICES FOR CAMERAS AND MONITORS; MOUSEPADS; OPTICAL DISC DRIVES; PHOTOVOLTAIC CELLS AND MODULES; PLUG ADAPTORS; POWER CABLES; POWER CONTROLLERS; POWER SUPPLIES; SOLAR BATTERIES; SOLAR CELLS; TACHOMETERS; USB CABLES; VOLTMETERS (U.S. CLS. 21, 23, 26, 36 AND 38).

FIRST USE 5-1-2008; IN COMMERCE 5-1-2008.

TRACY CROSS, EXAMINING ATTORNEY

SN 77-891,980. KYOCERA WIRELESS CORP., SAN DIEGO, CA. FILED 12-11-2009.

VERO

THE MARK CONSISTS OF STANDARD CHARACTERS WITHOUT CLAIM TO ANY PARTICULAR FONT, STYLE, SIZE, OR COLOR.

THE ENGLISH TRANSLATION OF "VERO" IN THE MARK IS "TRUE".

FOR CELL PHONES; CELLULAR PHONES; MOBILE PHONES (U.S. CLS. 21, 23, 26, 36 AND 38).

HOWARD B. LEVINE, EXAMINING ATTORNEY

CLASS 9—(Continued).

SN 77-892,012. LEAPFILE, INC., NEWARK, CA. FILED 12-11-2009.

ODRIVE

THE MARK CONSISTS OF STANDARD CHARACTERS WITHOUT CLAIM TO ANY PARTICULAR FONT, STYLE, SIZE, OR COLOR.

FOR COMPUTER SOFTWARE FOR FILE AND DATA TRANSFERS OVER THE INTERNET AND ACROSS DIFFERENT PLATFORMS; COMPUTER SOFTWARE FOR SHARING AND COLLABORATION OF DATA, INFORMATION, DOCUMENTS, ELECTRONIC FILES, VIDEOS, AUDIO, IMAGES, AND PHOTOS; COMPUTER SOFTWARE FOR DISTRIBUTION OF DATA, INFORMATION, DOCUMENTS, ELECTRONIC FILES, VIDEOS, AUDIO, IMAGES, AND PHOTOS; COMPUTER SOFTWARE FOR MANAGEMENT OF CORPORATE DATA, FILES, CONTENT AND INFORMATION; SOFTWARE FOR ENHANCING, FACILITATING, AUTOMATING AND CREATING FILE PROCESSING AND WORKFLOW (U.S. CLS. 21, 23, 26, 36 AND 38).

DAVID HOFFMAN, EXAMINING ATTORNEY

SN 77-892,071. KYOCERA WIRELESS CORP., SAN DIEGO, CA. FILED 12-12-2009.

MISO

THE MARK CONSISTS OF STANDARD CHARACTERS WITHOUT CLAIM TO ANY PARTICULAR FONT, STYLE, SIZE, OR COLOR.

FOR CELL PHONES; CELLULAR PHONES; MOBILE PHONES (U.S. CLS. 21, 23, 26, 36 AND 38).

HOWARD B. LEVINE, EXAMINING ATTORNEY

SN 77-892,100. STURGES, BENJAMIN, BROOKLYN, NY. FILED 12-12-2009.

SUFFERHEAD

THE MARK CONSISTS OF STANDARD CHARACTERS WITHOUT CLAIM TO ANY PARTICULAR FONT, STYLE, SIZE, OR COLOR.

FOR AUDIO AND VIDEO RECORDINGS FEATURING MUSIC; AUDIO CASSETTES FEATURING MUSIC; AUDIO DIGITAL TAPES FEATURING MUSIC; AUDIO DISCS FEATURING MUSIC; AUDIO HEADPHONES; AUDIO RECORDINGS FEATURING MUSIC; AUDIO TAPES FEATURING MUSIC; BACKLIT SIGNS; BACKPACKS ESPECIALLY ADAPTED FOR HOLDING LAPTOPS; BACKPACKS ESPECIALLY ADAPTED FOR HOLDING LAPTOPS AND NOTEBOOK COMPUTERS; BAGS AND CASES SPECIALLY ADAPTED FOR HOLDING OR CARRYING PORTABLE TELEPHONES AND TELEPHONE EQUIPMENT AND ACCESSORIES; BAGS

CLASS 9—(Continued).

FOR CAMERAS AND PHOTOGRAPHIC EQUIPMENT; BAGS SPECIALLY ADAPTED FOR PROTECTIVE HELMETS; BICYCLE HELMETS; BINDERS FOR CDS; BULLHORN; CARRYING CASES FOR CELL PHONES; CARRYING CASES FOR MOBILE COMPUTERS; CARRYING CASES SPECIALLY ADAPTED FOR POCKET CALCULATORS AND CELLPHONES; CASES FOR DISKETTES AND COMPACT DISKS; CASES FOR EYEGLASSES AND SUNGLASSES; CASES FOR MOBILE PHONES; CD CASES; CD SLEEVES; CD STORAGE RACKS; CD STORAGE WALLETS; CELL PHONE BACKPLATES; CELL PHONE COVERS; CELL PHONE FACEPLATES; CELLULAR PHONE ACCESSORY CHARMS; COMPACT DISCS FEATURING MUSIC; COMPUTER BAGS; COMPUTER CARRYING CASES; COMPUTER GAME DISCS; COMPUTER GAME PROGRAMS; COMPUTER GAME PROGRAMS, CARTRIDGES, AND CASSETTES; COMPUTER GAME SOFTWARE; DECORATIVE CHARMS FOR CELLULAR TELEPHONES; DECORATIVE MAGNETS; DECORATIVE ORNAMENTS FOR CELLULAR TELEPHONES; DECORATIVE REFRIGERATOR MAGNETS; DIGITAL MATERIALS, NAMELY, CDS, DVDS, DOWNLOADABLE AUDIO FILES FEATURING MUSIC; DIGITAL MEDIA, NAMELY, PRE-RECORDED VIDEO CASSETTES, DIGITAL VIDEO DISCS, DIGITAL VERSATILE DISCS, DOWNLOADABLE AUDIO AND VIDEO RECORDINGS, DVDS, AND HIGH DEFINITION DIGITAL DISCS FEATURING MUSIC; DIGITAL MEDIA, NAMELY, CDS, DVDS, DOWNLOADABLE AUDIO FILES FEATURING MUSIC; DIGITAL MUSIC DOWNLOADABLE FROM THE INTERNET; DIGITAL TELEPHONE PLATFORMS AND SOFTWARE; DOWNLOADABLE COMPUTER GAME PROGRAMS; DOWNLOADABLE COMPUTER GRAPHICS; DOWNLOADABLE ELECTRONIC GAME PROGRAMS; DOWNLOADABLE ELECTRONIC NEWSLETTERS DELIVERED BY E-MAIL IN THE FIELD OF MUSIC; DOWNLOADABLE ELECTRONIC PUBLICATIONS IN THE NATURE OF BLOGS, JOURNALS IN THE FIELD OF MUSIC; DOWNLOADABLE FILMS AND TELEVISION PROGRAMS FEATURING MUSIC PROVIDED VIA A VIDEO-ON-DEMAND SERVICE; DOWNLOADABLE GRAPHICS FOR MOBILE PHONES; DOWNLOADABLE MP3 FILES AND MP3 RECORDINGS FEATURING MUSIC; DOWNLOADABLE MP3 FILES, MP3 RECORDINGS, ON-LINE DISCUSSION BOARDS, WEBCASTS, WEBINARS AND PODCASTS FEATURING MUSIC, AUDIO BOOKS AND NEWS BROADCASTS; DOWNLOADABLE MUSICAL SOUND RECORDINGS; DOWNLOADABLE RING TONES AND GRAPHICS FOR MOBILE PHONES; DOWNLOADABLE RING TONES FOR MOBILE PHONES; DOWNLOADABLE RING TONES, GRAPHICS AND MUSIC VIA A GLOBAL COMPUTER NETWORK AND WIRELESS DEVICES; DOWNLOADABLE VIDEO RECORDINGS FEATURING MUSIC; DOWNLOADABLE MUSIC, RING TONES, APPLICATIONS VIA THE INTERNET AND WIRELESS DEVICES; DVD CASES; DVD SLEEVES; DVDS FEATURING MUSIC; EAR PHONES; EARPHONES; EARPHONES AND HEADPHONES; EYEWEAR; FOOTBALL HELMETS; GAS MASKS; GUITAR SKINS FOR ELECTRONIC GUITAR GAME CONTROLLERS; HEADPHONES; HELMETS FOR MOTORCYCLISTS; HOCKEY HELMETS; JACKETS FOR COMPUTER DISKS; JACKETS FOR VIDEO CASSETTES; LAPTOP CARRYING CASES; LASER DISCS FEATURING MUSIC; LCD LARGE-SCREEN DISPLAYS; LCD PANELS; LUMINOUS SIGNS; MECHANICAL SIGNS; MEGAPHONES; MOTION PICTURE FILMS ABOUT MUSIC; MOUSEPADS; MP3 PLAYERS; MP4 PLAYERS; MULTIMEDIA SOFTWARE RECORDED ON CD-ROM FEATURING MUSIC; MUSICAL SOUND RECORDINGS; MUSICAL VIDEO RECORDINGS; NEON SIGNS; NEOPRENE LAPTOP COVERS; NOTEBOOK COMPUTER CARRYING CASES; OPTICAL COMPACT DISCS FEATURING MUSIC; PHONOGRAPH RECORD SLEEVES; PHONOGRAPH RECORDS FEATURING MUSIC; PLASTIC AND CARDBOARD CASES FOR STORING RECORD ALBUMS; PLASTIC CASE USED AS A SECURITY DEVICE FOR PROTECTING AND SECURING DVDS AND OTHER MAGNETIC AND ELECTRONIC MEDIA FROM THEFT; PLASTIC CASES SPECIALLY ADAPTED HOLDING COMPACT DISCS, DVDS AND OTHER ELECTRONIC MEDIA; PRE-RECORDED CDS FEATURING MUSIC; PRE-RECORDED CDS, VIDEO TAPES, LASER DISKS AND DVDS FEATURING MUSIC; PRE-RECORDED DIGITAL MEDIA FEATURING MUSIC; PRE-RECORDED DIGITAL VI-

CLASS 9—(Continued).

DEO DISCS FEATURING MUSIC; PRE-RECORDED DVDS FEATURING MUSIC; PRE-RECORDED ELECTRONIC AND DIGITAL MEDIA FEATURING MUSIC; PRE-RECORDED ELECTRONIC MEDIA FEATURING MUSIC; PRERECORDED AUDIO CASSETTES FEATURING MUSIC; PRERECORDED AUDIO TAPES FEATURING MUSIC; PRERECORDED DIGITAL AUDIO TAPE FEATURING MUSIC; PRERECORDED DIGITAL VIDEO DISKS FEATURING MUSIC; PRERECORDED MAGNETIC DATA CARRIERS FEATURING MUSIC; PRERECORDED VIDEO CASSETTES FEATURING MUSIC; PRERECORDED VIDEO TAPES FEATURING MUSIC; PROTECTION MASKS; PROTECTIVE CARRYING CASES FOR PORTABLE MUSIC PLAYERS, NAMELY, MP3 PLAYERS; PROTECTIVE CARRYING CASES SPECIALLY ADAPTED FOR PERSONAL DIGITAL ASSISTANTS (PDA); PROTECTIVE CARRYING CASES SPECIALLY ADAPTED FOR VIDEO GAME CONSOLES FOR USE WITH AN EXTERNAL DISPLAY SCREEN OR MONITOR; PROTECTIVE CLOTHING; PROTECTIVE CLOTHING AND HEADGEAR; PROTECTIVE HELMETS; REFRIGERATOR MAGNETS; SAFETY HELMETS; SOUND RECORDINGS FEATURING MUSIC; SPORTS GLASSES; SPORTS HELMETS; SUNGLASSES; VIDEO DISCS FEATURING MUSIC; VIDEO DISKS FEATURING MUSIC; VIDEO GAME DISCS; VIDEO GAME TAPE CASSETTES; VIDEO MAGAZINE RECORDED ON ELECTRONIC MEDIA FEATURING MUSIC; VIDEO RECORDINGS FEATURING MUSIC; VIDEO TAPES FEATURING MUSIC; VINYL COVERS SPECIALLY ADAPTED FOR CELL PHONES, MP3 PLAYERS, LAPTOPS, COMPUTERS, PORTABLE SATELLITE RADIOS, PERSONAL DIGITAL ASSISTANTS, REMOTE CONTROLS, AND TELEVISION SATELLITE RECORDERS; VISUAL RECORDINGS AND AUDIOVISUAL RECORDINGS FEATURING MUSIC AND ANIMATION; WELDING HELMETS; WELDING MASKS; WIRELESS ELECTRONIC VISITOR CHIMES; WIRELESS ELECTRONIC VISITOR SIGNAL CHIMES (U.S. CLS. 21, 23, 26, 36 AND 38).

JILL PRATER, EXAMINING ATTORNEY

SN 77-892,113. GAYER, GEOFFREY S., FOUNTAIN VALLEY, CA. FILED 12-12-2009.

Area 51

THE MARK CONSISTS OF STANDARD CHARACTERS WITHOUT CLAIM TO ANY PARTICULAR FONT, STYLE, SIZE, OR COLOR.

FOR EYEWEAR; EYEWEAR ACCESSORIES, NAMELY, STRAPS, NECK CORDS AND HEAD STRAPS WHICH RESTRAIN EYEWEAR FROM MOVEMENT ON A WEARER; EYEWEAR CASES; EYEWEAR RETAINERS; NOSE GUARDS WHICH CAN BE WORN BY ATTACHMENT TO EYEWEAR SUCH AS SUNGLASSES AND SKI GOGGLES; PROTECTIVE EYEWEAR; PROTECTIVE EYEWEAR AND COMPONENT PARTS THEREOF; SAFETY EYEWEAR; SPORTS EYEWEAR (U.S. CLS. 21, 23, 26, 36 AND 38).

FIRST USE 3-1-2008; IN COMMERCE 5-1-2008.

ALICIA COLLINS, EXAMINING ATTORNEY

CLASS 9—(Continued).

SN 77-892,179. DIGI-RESOURCE LLC, BLOOMFIELD HILLS, MI. FILED 12-12-2009.

Digi-Track

THE MARK CONSISTS OF STANDARD CHARACTERS WITHOUT CLAIM TO ANY PARTICULAR FONT, STYLE, SIZE, OR COLOR.

FOR COMPUTER E-COMMERCE SOFTWARE TO ALLOW USERS TO PERFORM ELECTRONIC BUSINESS TRANSACTIONS VIA A GLOBAL COMPUTER NETWORK; COMPUTER SOFTWARE FOR PROVIDING AN ON-LINE DATABASE IN THE FIELD OF TRANSACTION PROCESSING TO UPLOAD TRANSACTIONAL DATA, PROVIDE STATISTICAL ANALYSIS, AND PRODUCE NOTIFICATIONS AND REPORTS; COMPUTER SOFTWARE THAT PROVIDES REAL-TIME, INTEGRATED BUSINESS MANAGEMENT INTELLIGENCE BY COMBINING INFORMATION FROM VARIOUS DATABASES AND PRESENTING IT IN AN EASY-TO-UNDERSTAND USER INTERFACE; COMPUTER SOFTWARE THAT PROVIDES WEB-BASED ACCESS TO APPLICATIONS AND SERVICES THROUGH A WEB OPERATING SYSTEM OR PORTAL INTERFACE (U.S. CLS. 21, 23, 26, 36 AND 38).

FIRST USE 9-1-2007; IN COMMERCE 9-1-2007.

TRACY FLETCHER, EXAMINING ATTORNEY

SN 77-892,266. NUKO TOYS, INC., DBA NUKOTOYS, INC., SAN FRANCISCO, CA. FILED 12-13-2009.

NUKO

THE MARK CONSISTS OF STANDARD CHARACTERS WITHOUT CLAIM TO ANY PARTICULAR FONT, STYLE, SIZE, OR COLOR.

FOR COMPUTER HARDWARE AND PERIPHERAL DEVICES; COMPUTER HARDWARE AND PERIPHERAL DEVICES AND COMPUTER SOFTWARE FOR DATA COMMUNICATION AND TRANSLATING AND TRANSMITTING DATA SOLD THEREWITH (U.S. CLS. 21, 23, 26, 36 AND 38).

JEFF DEFORD, EXAMINING ATTORNEY

CLASS 9—(Continued).

SN 77-892,323. MOON, DARWON, SEOUL, REPUBLIC OF KOREA, AND YOON, DO SHIK, SEOUL, REPUBLIC OF KOREA, AND LEE, HYUN JOO, GYEONGGI-DO, REPUBLIC OF KOREA, FILED 12-13-2009.

SWINGSWING

THE MARK CONSISTS OF STANDARD CHARACTERS WITHOUT CLAIM TO ANY PARTICULAR FONT, STYLE, SIZE, OR COLOR.

FOR ELECTRONIC GAME SOFTWARE FOR CELLULAR TELEPHONES; ELECTRONIC GAME SOFTWARE FOR WIRELESS DEVICES; COMPUTER GAME SOFTWARE; DOWNLOADABLE ELECTRONIC GAME SOFTWARE VIA THE INTERNET AND WIRELESS DEVICES; DOWNLOADABLE ELECTRONIC GAME SOFTWARE VIA CELLULAR TELEPHONES; ELECTRONIC GAME SOFTWARE FOR PORTABLE AND HANDHELD DIGITAL ELECTRONIC DEVICES (U.S. CLS. 21, 23, 26, 36 AND 38).

RICHARD WHITE, EXAMINING ATTORNEY

SN 77-892,325. MOON, DARWON, SEOUL, REPUBLIC OF KOREA, AND YOON, DO SHIK, SEOUL, REPUBLIC OF KOREA, AND LEE, HYUN JOO, GYEONGGI-DO, REPUBLIC OF KOREA, FILED 12-13-2009.

THE MARK CONSISTS OF THE WORD "SWING", ABOVE THE WORD "SWING", WHERE THE WORDS ARE WRITTEN IN A STYLIZED FONT.

FOR ELECTRONIC GAME SOFTWARE FOR CELLULAR TELEPHONES; ELECTRONIC GAME SOFTWARE FOR WIRELESS DEVICES; COMPUTER GAME SOFTWARE; DOWNLOADABLE ELECTRONIC GAME SOFTWARE VIA THE INTERNET AND WIRELESS DEVICES; DOWNLOADABLE ELECTRONIC GAME SOFTWARE VIA CELLULAR TELEPHONES; ELECTRONIC GAME SOFTWARE FOR PORTABLE AND HANDHELD DIGITAL ELECTRONIC DEVICES (U.S. CLS. 21, 23, 26, 36 AND 38).

RICHARD WHITE, EXAMINING ATTORNEY

CLASS 9—(Continued).

SN 77-892,512. JHIH HONG TECHNOLOGY CO., LTD., TAIPEI HSIEN, TAIWAN, FILED 12-14-2009.

JHT

THE MARK CONSISTS OF STANDARD CHARACTERS WITHOUT CLAIM TO ANY PARTICULAR FONT, STYLE, SIZE, OR COLOR.

FOR BATTERIES FOR LIGHTING; BATTERY CHARGERS; ELECTRIC ACCUMULATORS FOR VEHICLES; GALVANIC BATTERIES; HIGH TENSION BATTERIES; SOLAR BATTERIES (U.S. CLS. 21, 23, 26, 36 AND 38).

JUSTINE D. PARKER, EXAMINING ATTORNEY

SN 77-892,565. SHAVLIK TECHNOLOGIES, LLC, ROSEVILLE, MN. FILED 12-14-2009.

SCUPDATES

THE MARK CONSISTS OF STANDARD CHARACTERS WITHOUT CLAIM TO ANY PARTICULAR FONT, STYLE, SIZE, OR COLOR.

FOR SOFTWARE PROGRAM USED TO LOCATE AND DELIVER PATCH DATA AND UPDATES FOR SOFTWARE PRODUCTS (U.S. CLS. 21, 23, 26, 36 AND 38).

NANCY CLARKE, EXAMINING ATTORNEY

SN 77-892,711. PRECISION DIGITAL CORPORATION, HOLLISTON, MA. FILED 12-14-2009.

PROVU

THE MARK CONSISTS OF STANDARD CHARACTERS WITHOUT CLAIM TO ANY PARTICULAR FONT, STYLE, SIZE, OR COLOR.

FOR DIGITAL PROCESS METER FOR DISPLAY OF LIQUID LEVEL, FLOW RATE, TEMPERATURE AND PRESSURE (U.S. CLS. 21, 23, 26, 36 AND 38).

FIRST USE 2-5-2008; IN COMMERCE 2-5-2008.

EMILY CARLSEN, EXAMINING ATTORNEY

CLASS 9—(Continued).

SN 77-892,773. BAILEY, ADRIAN, NEW YORK CITY, NY. FILED 12-14-2009.

HYPNEXERCISE

THE MARK CONSISTS OF STANDARD CHARACTERS WITHOUT CLAIM TO ANY PARTICULAR FONT, STYLE, SIZE, OR COLOR.

FOR AUDIO AND VIDEO RECORDINGS FEATURING EDUCATIONAL AND TRAINING INFORMATION IN THE FIELDS OF PHYSICAL AND MENTAL EXERCISE FOR USE IN PHYSICAL AND MENTAL FITNESS (U.S. CLS. 21, 23, 26, 36 AND 38).

FIRST USE 1-12-2008; IN COMMERCE 1-12-2008.
HOWARD SMIGA, EXAMINING ATTORNEY

SN 77-892,882. VANTAGE ID APPLICATIONS, INC, CHULA VISTA, CA. FILED 12-14-2009.

Quick-Band

THE MARK CONSISTS OF STANDARD CHARACTERS WITHOUT CLAIM TO ANY PARTICULAR FONT, STYLE, SIZE, OR COLOR.

FOR PROGRAMMABLE KEYBOARD DISPLAY/DATA CAPTURE UNIT AND THERMAL PRINTER FOR QUICK, STAND-ALONE PRINTING OF PATIENT ID BRACELETS AND GENERAL PURPOSE LABELS (U.S. CLS. 21, 23, 26, 36 AND 38).

JACQUELINE A. LAVINE, EXAMINING ATTORNEY

SN 77-892,949. WMS GAMING INC., WAUKEGAN, IL. FILED 12-14-2009.

NAUTILUS

THE MARK CONSISTS OF STANDARD CHARACTERS WITHOUT CLAIM TO ANY PARTICULAR FONT, STYLE, SIZE, OR COLOR.

FOR COMPONENTS FOR GAMING MACHINES THAT GENERATE OR DISPLAY WAGER OUTCOMES, NAMELY, CONTROLLERS, DISPLAYS, BUTTON PANELS, BOLSTERS, ELECTRICAL WIRING, AND COMPUTER HARDWARE AND SOFTWARE ASSOCIATED THEREWITH; GAMING MACHINES, NAMELY, DEVICES WHICH ACCEPT A WAGER; GAMING SOFTWARE THAT GENERATES OR DISPLAYS WAGER OUTCOMES OF GAMING MACHINES (U.S. CLS. 21, 23, 26, 36 AND 38).

MICHAEL LITZAU, EXAMINING ATTORNEY

CLASS 9—(Continued).

SN 77-893,172. SCHIEBL, PAUL, HOUSTON, TX. FILED 12-14-2009.



THE MARK CONSISTS OF THE LETTER "S" IN A STYLIZED FONT.

FOR CHIN STRAPS FOR FOOTBALL HELMETS (U.S. CLS. 21, 23, 26, 36 AND 38).

FIRST USE 9-25-2002; IN COMMERCE 9-25-2002.
LAKEISHA LEWIS, EXAMINING ATTORNEY

SN 77-893,279. AGILENET, L.L.C., OXFORD, CT. FILED 12-14-2009.

MONKEYTANKS

THE MARK CONSISTS OF STANDARD CHARACTERS WITHOUT CLAIM TO ANY PARTICULAR FONT, STYLE, SIZE, OR COLOR.

FOR COMPUTER GAME SOFTWARE (U.S. CLS. 21, 23, 26, 36 AND 38).

FIRST USE 3-1-2009; IN COMMERCE 11-0-2009.
SHANNON TWOHIG, EXAMINING ATTORNEY

SN 77-893,295. MARTIN, SANDRINE NADINE, PHILADELPHIA, PA. FILED 12-14-2009.

OmniClinic

THE MARK CONSISTS OF STANDARD CHARACTERS WITHOUT CLAIM TO ANY PARTICULAR FONT, STYLE, SIZE, OR COLOR.

FOR COMPUTER SOFTWARE FOR CONTROLLING AND MANAGING PATIENT MEDICAL INFORMATION; DOWNLOADABLE SOFTWARE IN THE NATURE OF A MOBILE APPLICATION FOR PATIENT INFORMATION MANAGEMENT AND CLINICAL DECISION SUPPORT; MEDICAL SOFTWARE FOR MANAGEMENT OF PATIENT AND CLINICAL DECISION SUPPORT INFORMATION (U.S. CLS. 21, 23, 26, 36 AND 38).

FIRST USE 11-30-2009; IN COMMERCE 12-1-2009.
KATHERINE CHANG, EXAMINING ATTORNEY

CLASS 9—(Continued).

SN 77-893,337. POWERPACT HOLDINGS LLC, MID-LOTHIAN, VA. FILED 12-14-2009.

VOOT

THE MARK CONSISTS OF STANDARD CHARACTERS WITHOUT CLAIM TO ANY PARTICULAR FONT, STYLE, SIZE, OR COLOR.

FOR COMPUTER SOFTWARE FOR USE IN CONDUCTING MARKETING, ADVERTISING, MEDIA USAGE, RATING, MONITORING AND RESEARCH SERVICES, NAMELY, ANALYZING AND PREPARING REPORTS RELATED TO SOCIAL MEDIA WEBSITES, CONTENT AND AUDIENCE ENGAGEMENT FACTORS (U.S. CLS. 21, 23, 26, 36 AND 38).

MARGERY A. TIERNEY, EXAMINING ATTORNEY

SN 77-893,563. RISCO LTD., 75655 RISHON LEZION, ISRAEL, FILED 12-15-2009.

AxesPlus

THE MARK CONSISTS OF STANDARD CHARACTERS WITHOUT CLAIM TO ANY PARTICULAR FONT, STYLE, SIZE, OR COLOR.

FOR ACCESS CONTROL AND ALARM MONITORING SYSTEMS; COMPUTER SOFTWARE FOR SECURITY SYSTEMS IN RELATION TO ACCESS CONTROL AND MONITORING (U.S. CLS. 21, 23, 26, 36 AND 38).

TRACY FLETCHER, EXAMINING ATTORNEY

SN 77-893,599. RENKARA MEDIA GROUP, INVERNESS, IL. FILED 12-15-2009.

Flashcard Champion

THE MARK CONSISTS OF STANDARD CHARACTERS WITHOUT CLAIM TO ANY PARTICULAR FONT, STYLE, SIZE, OR COLOR.

NO CLAIM IS MADE TO THE EXCLUSIVE RIGHT TO USE "FLASHCARD", APART FROM THE MARK AS SHOWN.

FOR DOWNLOADABLE SOFTWARE IN THE NATURE OF A MOBILE APPLICATION USED FOR PRACTICING BASIC MATH AND COIN COUNTING, AND LEARNING U.S. PRESIDENTS, U.S. STATES, EUROPEAN COUNTRIES AND CAPITALS, AND THE PERIODIC TABLE (U.S. CLS. 21, 23, 26, 36 AND 38).

WENDY GOODMAN, EXAMINING ATTORNEY

CLASS 9—(Continued).

SN 77-893,669. LUMZ-N-BLOOMS, LTD., APOPKA, FL. FILED 12-15-2009.



NO CLAIM IS MADE TO THE EXCLUSIVE RIGHT TO USE "LTD.", APART FROM THE MARK AS SHOWN.

THE MARK CONSISTS OF THE STYLIZED TEXT "LUMZ 'N BLOOMS LTD." WITH AN OVAL BELOW AND THE WORDING "BLOOMS" IN A SHADOW AND WITH A LEAF DESIGN IN EACH OF THE LETTERS "O".

FOR LIGHTING BALLASTS; ELECTRIC IGNITERS USED IN CONNECTION WITH BALLASTS TO START DISCHARGE LAMPS; ELECTRICAL CONTROL PANELS USED TO CONTROL HORTICULTURAL AND/OR AQUARIUM LIGHTING OR ACCESSORIES (U.S. CLS. 21, 23, 26, 36 AND 38).

FIRST USE 7-6-2006; IN COMMERCE 7-6-2006.

STEPHEN AQUILA, EXAMINING ATTORNEY

SN 77-893,674. HOME BOX OFFICE, INC., NEW YORK, NY. FILED 12-15-2009.

BIG LOVE

THE MARK CONSISTS OF STANDARD CHARACTERS WITHOUT CLAIM TO ANY PARTICULAR FONT, STYLE, SIZE, OR COLOR.

OWNER OF U.S. REG. NO. 3,600,442.

FOR PRERECORDED DVDS FEATURING A DRAMATIC TELEVISION SERIES; PRERECORDED VIDEO CLIPS AND PROMOTIONAL SPOTS ON DVDS FEATURING CONTENT RELATING TO A DRAMATIC TELEVISION SERIES; PRERECORDED VIDEO SHORTS AND PROMOTIONAL SPOTS ON DVDS FEATURING CONTENT RELATED TO A DRAMATIC TELEVISION SERIES (U.S. CLS. 21, 23, 26, 36 AND 38).

FIRST USE 10-17-2006; IN COMMERCE 10-17-2006.

GIANCARLO CASTRO, EXAMINING ATTORNEY

CLASS 9—(Continued).

SN 77-893,896. SONY ERICSSON MOBILE COMMUNICATIONS AB, LUND, SWEDEN, FILED 12-15-2009.

ELM

THE MARK CONSISTS OF STANDARD CHARACTERS WITHOUT CLAIM TO ANY PARTICULAR FONT, STYLE, SIZE, OR COLOR.

FOR MOBILE PHONES; ACCESSORIES FOR MOBILE PHONES IN THE NATURE OF HEADSETS AND DEVICES FOR HANDS-FREE PHONE USE; AND ACCESSORIES FOR MOBILE PHONES IN THE NATURE OF CHARGERS, BATTERIES, CASES, COVERS, HOLDERS, DOCKING STANDS, AND CABLES (U.S. CLS. 21, 23, 26, 36 AND 38).

STEVEN JACKSON, EXAMINING ATTORNEY

SN 77-893,908. SONY ERICSSON MOBILE COMMUNICATIONS AB, LUND, SWEDEN, FILED 12-15-2009.

HAZEL

THE MARK CONSISTS OF STANDARD CHARACTERS WITHOUT CLAIM TO ANY PARTICULAR FONT, STYLE, SIZE, OR COLOR.

FOR MOBILE PHONES; ACCESSORIES FOR MOBILE PHONES IN THE NATURE OF HEADSETS AND DEVICES FOR HANDS-FREE PHONE USE; AND ACCESSORIES FOR MOBILE PHONES IN THE NATURE OF CHARGERS, BATTERIES, CASES, COVERS, HOLDERS, DOCKING STANDS, AND CABLES (U.S. CLS. 21, 23, 26, 36 AND 38).

STEVEN JACKSON, EXAMINING ATTORNEY

SN 77-894,176. VOHWINKLE, JEREMY, GRANGER, IN. FILED 12-15-2009.

LIFETIREMENT

THE MARK CONSISTS OF STANDARD CHARACTERS WITHOUT CLAIM TO ANY PARTICULAR FONT, STYLE, SIZE, OR COLOR.

FOR ELECTRONIC PUBLICATIONS, NAMELY, BOOKS FEATURING PERSONAL FINANCE RECORDED ON COMPUTER MEDIA (U.S. CLS. 21, 23, 26, 36 AND 38).

DOMINIC J. FERRAIUOLO, EXAMINING ATTORNEY

CLASS 9—(Continued).

SN 77-894,549. SCHOLASTIC INC., NEW YORK, NY. FILED 12-16-2009.

BRAIN PLAY

THE MARK CONSISTS OF STANDARD CHARACTERS WITHOUT CLAIM TO ANY PARTICULAR FONT, STYLE, SIZE, OR COLOR.

OWNER OF U.S. REG. NO. 3,124,865.
FOR DOWNLOADABLE GAMES VIA THE INTERNET AND WIRELESS DEVICES (U.S. CLS. 21, 23, 26, 36 AND 38).

TRACY CROSS, EXAMINING ATTORNEY

SN 77-894,780. TWENTIETH CENTURY FOX FILM CORPORATION, LOS ANGELES, CA. FILED 12-16-2009.

THE DEEP END

THE MARK CONSISTS OF STANDARD CHARACTERS WITHOUT CLAIM TO ANY PARTICULAR FONT, STYLE, SIZE, OR COLOR.

FOR PRE-RECORDED DVDS FEATURING DRAMA; PRE-RECORDED CDS FEATURING DRAMA AND MUSICAL PERFORMANCES; DOWNLOADABLE AUDIO AND VIDEO RECORDINGS FEATURING DRAMA; DOWNLOADABLE TELEVISION SHOWS AND VIDEO RECORDINGS FEATURING DRAMA; DOWNLOADABLE RING TONES, RING BACKS, GRAPHICS, WALLPAPER, GAMES AND MUSIC VIA A GLOBAL COMPUTER NETWORK AND WIRELESS DEVICES; COMPUTER SCREEN SAVER SOFTWARE; COMPUTER GAME AND VIDEO GAME SOFTWARE (U.S. CLS. 21, 23, 26, 36 AND 38).

JAY FLOWERS, EXAMINING ATTORNEY

CLASS 9—(Continued).

SN 77-894,837. VONAGE MARKETING LLC, HOLMDEL, NJ. FILED 12-16-2009.

VONAGE MOBILE

THE MARK CONSISTS OF STANDARD CHARACTERS WITHOUT CLAIM TO ANY PARTICULAR FONT, STYLE, SIZE, OR COLOR.

OWNER OF U.S. REG. NOS. 2,614,773, 3,756,191 AND OTHERS.

NO CLAIM IS MADE TO THE EXCLUSIVE RIGHT TO USE "MOBILE", APART FROM THE MARK AS SHOWN.

FOR DOWNLOADABLE SOFTWARE FOR USE WITH WIRELESS TELECOMMUNICATIONS DEVICES TO PROVIDE WIRELESS TRANSMISSION OF E-MAIL, TEXT, MUSIC, VIDEO, VOICE, STILL IMAGES, INFORMATION, AND DATA, VIA THE INTERNET AND VIA WIRELESS LOCAL AREA NETWORK DEVICES (U.S. CLS. 21, 23, 26, 36 AND 38).

FIRST USE 10-5-2009; IN COMMERCE 10-5-2009.

JAMES MACFARLANE, EXAMINING ATTORNEY

SN 77-895,212. IGT, RENO, NV. FILED 12-16-2009.

SHADOW OF THE PANTHER

THE MARK CONSISTS OF STANDARD CHARACTERS WITHOUT CLAIM TO ANY PARTICULAR FONT, STYLE, SIZE, OR COLOR.

FOR GAMING MACHINES, NAMELY, DEVICES WHICH ACCEPT A WAGER (U.S. CLS. 21, 23, 26, 36 AND 38).

LINDA ESTRADA, EXAMINING ATTORNEY

SN 77-895,753. MARKZWARE, SANTA ANA, CA. FILED 12-17-2009.



OWNER OF U.S. REG. NOS. 2,342,514 AND 2,808,429.

THE MARK CONSISTS OF THE WORD "FLIGHTCHECK" AND DESIGN OF AN EAGLE SUPERIMPOSED ON A SEGMENT OF A MOON WITH "XFR" BELOW. ON EACH SIDE OF THE LETTERS "XFR" THERE ARE TWO PARALLEL LINES.

FOR COMPUTER SOFTWARE FOR USE IN THE PRINT PRODUCTION INDUSTRY FOR CHECKING JOBS BEFORE GOING TO PRESS, NAMELY, SOFTWARE THAT INSPECTS, VERIFIES AND CORRECTS DOCUMENTS AND THEIR COMPONENT PARTS PRIOR TO PRINTING, TRANSMISSION OR RECORDING (U.S. CLS. 21, 23, 26, 36 AND 38).

LAKEISHA LEWIS, EXAMINING ATTORNEY

CLASS 9—(Continued).

SN 77-896,775. AMERICAN AUTOMOBILE ASSOCIATION, INC., HEATHROW, FL. FILED 12-18-2009.

AAA ONBOARD

THE MARK CONSISTS OF STANDARD CHARACTERS WITHOUT CLAIM TO ANY PARTICULAR FONT, STYLE, SIZE, OR COLOR.

OWNER OF U.S. REG. NOS. 703,556, 1,782,222 AND OTHERS.

FOR VEHICLE TRACKING AND COMMUNICATION DEVICES COMPRISED OF CELLULAR RADIO MODULES, COMPUTER SOFTWARE AND COMPUTER HARDWARE, SENSORS, TRANSMITTERS, RECEIVERS AND GLOBAL POSITIONING SATELLITE RECEIVERS, ALL FOR USE IN CONNECTION WITH VEHICLE TRACKING, VEHICLE MONITORING AND DISPATCH OF ROADSIDE ASSISTANCE (U.S. CLS. 21, 23, 26, 36 AND 38).

FIRST USE 11-6-2009; IN COMMERCE 11-6-2009.

TINA MAI, EXAMINING ATTORNEY

SN 77-896,787. LOCKHEED MARTIN CORPORATION, BETHESDA, MD. FILED 12-18-2009.

RQ-170 SENTINEL

THE MARK CONSISTS OF STANDARD CHARACTERS WITHOUT CLAIM TO ANY PARTICULAR FONT, STYLE, SIZE, OR COLOR.

FOR COMPUTER GAME PROGRAMS, INTERACTIVE VIDEO GAME PROGRAMS, VIDEO GAME SOFTWARE (U.S. CLS. 21, 23, 26, 36 AND 38).

STEVEN R. FINE, EXAMINING ATTORNEY

SN 77-896,894. STONE CREEK ENTERTAINMENT LLC, RIDGEFIELD, CT. FILED 12-18-2009.

WOMEN LEAD THE WORLD

THE MARK CONSISTS OF STANDARD CHARACTERS WITHOUT CLAIM TO ANY PARTICULAR FONT, STYLE, SIZE, OR COLOR.

FOR DOWNLOADABLE VIDEO GAME SOFTWARE FOR MOBILE DEVICES AND PERSONAL COMPUTERS (U.S. CLS. 21, 23, 26, 36 AND 38).

ELISSA GARBER KON, EXAMINING ATTORNEY

CLASS 9—(Continued).

SN 77-897,029. WORLD WRESTLING ENTERTAINMENT, INC., NORWALK, CT. FILED 12-18-2009.

TITANTRON

THE MARK CONSISTS OF STANDARD CHARACTERS WITHOUT CLAIM TO ANY PARTICULAR FONT, STYLE, SIZE, OR COLOR.

FOR LARGE SCREEN TELEVISION DISPLAY MONITORS FOR USE IN ARENAS (U.S. CLS. 21, 23, 26, 36 AND 38).

NATALIE POLZER, EXAMINING ATTORNEY

SN 77-897,876. CAN'T STOP PRODUCTIONS INC., NEW YORK, NY. FILED 12-21-2009.

VILLAGE PEOPLE

THE MARK CONSISTS OF STANDARD CHARACTERS WITHOUT CLAIM TO ANY PARTICULAR FONT, STYLE, SIZE, OR COLOR.

FOR COMPACT DISCS FEATURING MUSIC AND VOCALS; DOWNLOADABLE MUSICAL SOUND RECORDINGS (U.S. CLS. 21, 23, 26, 36 AND 38).

FIRST USE 0-0-1988; IN COMMERCE 0-0-1988.

INGA ERVIN, EXAMINING ATTORNEY

SN 77-898,033. ION TORRENT SYSTEMS, INC., SAN FRANCISCO, CA. FILED 12-21-2009.

TORRENT LIVE

THE MARK CONSISTS OF STANDARD CHARACTERS WITHOUT CLAIM TO ANY PARTICULAR FONT, STYLE, SIZE, OR COLOR.

FOR COMPUTER SOFTWARE FOR MONITORING AND CONTROLLING GENOME ANALYZER MACHINES FROM HANDHELD OR MOBILE WIRELESS COMMUNICATION DEVICES CAPABLE OF VOICE, DATA AND/OR IMAGE TRANSMISSION (U.S. CLS. 21, 23, 26, 36 AND 38).

LINDA E. BLOHM, EXAMINING ATTORNEY

CLASS 9—(Continued).

SN 77-898,193. SONY ERICSSON MOBILE COMMUNICATIONS AB, LUND, SWEDEN, FILED 12-21-2009.

SATIO

THE MARK CONSISTS OF STANDARD CHARACTERS WITHOUT CLAIM TO ANY PARTICULAR FONT, STYLE, SIZE, OR COLOR.

FOR MOBILE PHONES; ACCESSORIES FOR MOBILE PHONES IN THE NATURE OF HEADSETS AND DEVICES FOR HANDS-FREE PHONE USE; AND ACCESSORIES FOR MOBILE PHONES IN THE NATURE OF CHARGERS, BATTERIES, CASES, COVERS, HOLDERS, DOCKING STANDS, AND CABLES (U.S. CLS. 21, 23, 26, 36 AND 38).

STEVEN JACKSON, EXAMINING ATTORNEY

SN 77-898,393. 745 LLC, BOSTON, MA. FILED 12-21-2009.

SEVEN45
STUDIOS

NO CLAIM IS MADE TO THE EXCLUSIVE RIGHT TO USE "STUDIOS", APART FROM THE MARK AS SHOWN.

THE MARK CONSISTS OF THE STYLIZED WORD "SEVEN" WITH THE LOWER RIGHT STEM OF THE LETTER "N" IN THE WORD CUT AT AN ANGLE NEXT TO THE NUMBER "45" WITH THE WORDING "STUDIOS" APPEARING BELOW THE STYLIZED WORD "SEVEN".

FOR COMPUTER GAME SOFTWARE, VIDEO GAME SOFTWARE, INTERACTIVE COMPUTER AND VIDEO GAME PROGRAMS, VIDEO GAME CONTROLLERS, VIDEO GAME DISCS AND CARTRIDGES FOR USE BY ONE OR MORE PLAYERS ON VIDEO GAME CONSOLES, DOWNLOADABLE VIDEO GAME SOFTWARE, INTERACTIVE VIDEO GAME SOFTWARE RECORDED ON A CARTRIDGE OR DVD OR CD SOLD AS A UNIT WITH AN ELECTRONIC VIDEO GAME CONTROLLER, INTERACTIVE MULTIMEDIA VIDEO GAME PROGRAMS AND ACCOMPANYING INSTRUCTION AND STRATEGY MANUALS, PRE-RECORDED CD-ROMS AND DVDS FEATURING GAMES, FILMS, AND MUSIC, COMPUTER GAME SOFTWARE, VIDEO GAME SOFTWARE (U.S. CLS. 21, 23, 26, 36 AND 38).

SAMUEL E. SHARPER JR., EXAMINING ATTORNEY

CLASS 9—(Continued).

SN 77-898,782. HOME BOX OFFICE, INC., NEW YORK, NY. FILED 12-22-2009.

ENLIGHTENED

THE MARK CONSISTS OF STANDARD CHARACTERS WITHOUT CLAIM TO ANY PARTICULAR FONT, STYLE, SIZE, OR COLOR.

FOR PRE-RECORDED DVDS FEATURING A TELEVISION SERIES; DOWNLOADABLE SCREENSAVERS, RING TONES AND RING BACKS AVAILABLE VIA A GLOBAL COMPUTER NETWORK AND WIRELESS DEVICES FEATURING CONTENT FROM OR RELATED TO AN ONGOING TELEVISION SERIES; PRE-RECORDED VIDEO CLIPS AND PROMOTIONAL SPOTS ON CDS, VIDEO TAPES AND DVDS FEATURING CONTENT FROM OR RELATED TO A TELEVISION SERIES; PRERECORDED VIDEO SHORTS AND PROMOTIONAL SPOTS ON CDS, VIDEO TAPES AND DVDS FEATURING CONTENT FROM OR RELATED TO A TELEVISION SERIES; DIGITAL MATERIALS, NAMELY, DOWNLOADABLE PRE-RECORDED VIDEO FILES AND GRAPHICS FILES FOR USE IN HANDHELD WIRELESS DEVICES ALL FEATURING CONTENT FROM OR RELATED TO AN ONGOING TELEVISION SERIES; INTERACTIVE ELECTRONIC, COMPUTER AND VIDEO GAME DISKS; HEADPHONES, EARPHONES, EAR BUDS; MOUSE PADS; GAMING DEVICES, NAMELY, GAMING MACHINES, SLOT MACHINES, BINGO MACHINES WITH AND WITHOUT VIDEO OUTPUT, MACHINES FOR PLAYING GAMES OF CHANCE; INTERACTIVE ELECTRONIC GAMES OR VIDEO GAMES DOWNLOADABLE FROM THE INTERNET FEATURING CONTENT FROM OR RELATED TO A TELEVISION SERIES (U.S. CLS. 21, 23, 26, 36 AND 38).

GIANCARLO CASTRO, EXAMINING ATTORNEY

SN 77-898,826. HALLMARK LICENSING, INC., KANSAS CITY, MO. FILED 12-22-2009.

ONE TOUGH CHICK

THE MARK CONSISTS OF STANDARD CHARACTERS WITHOUT CLAIM TO ANY PARTICULAR FONT, STYLE, SIZE, OR COLOR.

FOR DECORATIVE MAGNETS (U.S. CLS. 21, 23, 26, 36 AND 38).

ELIZABETH KAJUBI, EXAMINING ATTORNEY

CLASS 9—(Continued).

SN 77-899,299. ISAAC DANIEL GROUP, INC., MIRAMAR, FL. FILED 12-22-2009.

ICV

THE MARK CONSISTS OF STANDARD CHARACTERS WITHOUT CLAIM TO ANY PARTICULAR FONT, STYLE, SIZE, OR COLOR.

FOR WIRELESS COMMUNICATIONS SYSTEMS AND DEVICES, NAMELY, AN APPARATUS FOR IDENTIFYING AND VERIFYING DATA (U.S. CLS. 21, 23, 26, 36 AND 38).

KARANENDRA S. CHHINA, EXAMINING ATTORNEY

SN 77-899,459. THE TIFFEN COMPANY, LLC, HAUPPAUGE, NY. FILED 12-22-2009.

ProGrip

THE MARK CONSISTS OF STANDARD CHARACTERS WITHOUT CLAIM TO ANY PARTICULAR FONT, STYLE, SIZE, OR COLOR.

FOR CAMERA MOUNTING BASE (U.S. CLS. 21, 23, 26, 36 AND 38).

SOPHIA S. KIM, EXAMINING ATTORNEY

SN 77-900,078. TOSHIBA AMERICA CONSUMER PRODUCTS, L.L.C., WAYNE, NJ. FILED 12-23-2009.

AIR LAGOON

THE MARK CONSISTS OF STANDARD CHARACTERS WITHOUT CLAIM TO ANY PARTICULAR FONT, STYLE, SIZE, OR COLOR.

FOR TELEVISIONS (U.S. CLS. 21, 23, 26, 36 AND 38).

EDWARD FENNESSY, EXAMINING ATTORNEY

CLASS 9—(Continued).

SN 77-900,102. TOSHIBA AMERICA CONSUMER PRODUCTS, L.L.C., WAYNE, NJ. FILED 12-23-2009.

ILLUSION

THE MARK CONSISTS OF STANDARD CHARACTERS WITHOUT CLAIM TO ANY PARTICULAR FONT, STYLE, SIZE, OR COLOR.
FOR TELEVISIONS (U.S. CLS. 21, 23, 26, 36 AND 38).
EDWARD FENNESSY, EXAMINING ATTORNEY

SN 77-900,487. SUSTAINABLE GROUP HOLDINGS LLC, SEATTLE, WA. FILED 12-23-2009.

NO LANDFILL REQUIRED

THE MARK CONSISTS OF STANDARD CHARACTERS WITHOUT CLAIM TO ANY PARTICULAR FONT, STYLE, SIZE, OR COLOR.
FOR CD AND DVD SLEEVES AND CASES (U.S. CLS. 21, 23, 26, 36 AND 38).
LYDIA BELZER, EXAMINING ATTORNEY

SN 77-901,861. ELSTER AMCO WATER, INC., OCALA, FL. FILED 12-29-2009.

EVONET MANAGER

THE MARK CONSISTS OF STANDARD CHARACTERS WITHOUT CLAIM TO ANY PARTICULAR FONT, STYLE, SIZE, OR COLOR.
OWNER OF U.S. REG. NOS. 3,581,207, 3,581,209 AND OTHERS.
NO CLAIM IS MADE TO THE EXCLUSIVE RIGHT TO USE "MANAGER", APART FROM THE MARK AS SHOWN.
FOR COMPUTER SOFTWARE FOR AUTOMATICALLY READING UTILITY METERS (U.S. CLS. 21, 23, 26, 36 AND 38).
FIRST USE 2-0-2008; IN COMMERCE 2-0-2008.
LINDA ESTRADA, EXAMINING ATTORNEY

CLASS 9—(Continued).

SN 77-902,275. SENSOR ELECTRONICS CORPORATION, EDINA, MN. FILED 12-29-2009.

IREVOLUTION

THE MARK CONSISTS OF STANDARD CHARACTERS WITHOUT CLAIM TO ANY PARTICULAR FONT, STYLE, SIZE, OR COLOR.
FOR GAS DETECTORS FOR DETECTING THE PRESENCE OF GAS (U.S. CLS. 21, 23, 26, 36 AND 38).
ALYSSA STEEL, EXAMINING ATTORNEY

SN 77-902,417. XACT TECHNOLOGY, LLC, NEW YORK, NY. FILED 12-29-2009.

XactTrans

THE MARK CONSISTS OF STANDARD CHARACTERS WITHOUT CLAIM TO ANY PARTICULAR FONT, STYLE, SIZE, OR COLOR.
FOR A PORTABLE ELECTRONIC DEVICE COMPRISING A GLOBAL POSITIONING SYSTEM (GPS) RECEIVER AND A WIRELESS COMMUNICATION TRANSCIVER; PORTABLE ELECTRONIC DEVICES SPECIALLY CONFIGURED TO USE GLOBAL POSITIONING SYSTEMS (GPS) AND CELLULAR COMMUNICATIONS FOR TRACKING LOCATIONS OF FIXED ASSETS, NAMELY, SHIPPING CONTAINERS AND HEAVY EQUIPMENT (U.S. CLS. 21, 23, 26, 36 AND 38).
AMEEN IMAM, EXAMINING ATTORNEY

SN 77-904,881. WMS GAMING INC., WAUKEGAN, IL. FILED 1-5-2010.

BONUS CITY

THE MARK CONSISTS OF STANDARD CHARACTERS WITHOUT CLAIM TO ANY PARTICULAR FONT, STYLE, SIZE, OR COLOR.
NO CLAIM IS MADE TO THE EXCLUSIVE RIGHT TO USE "BONUS", APART FROM THE MARK AS SHOWN.
FOR COMPONENTS FOR GAMING MACHINES THAT GENERATE OR DISPLAY WAGER OUTCOMES, NAMELY, CONTROLLERS, DISPLAYS, BUTTON PANELS, BOLSTERS, ELECTRICAL WIRING, AND COMPUTER HARDWARE AND SOFTWARE ASSOCIATED THEREWITH; GAMING MACHINES, NAMELY, DEVICES WHICH ACCEPT A WAGER; GAMING SOFTWARE THAT GENERATES OR DISPLAYS WAGER OUTCOMES OF GAMING MACHINES (U.S. CLS. 21, 23, 26, 36 AND 38).
MICHAEL LITZAU, EXAMINING ATTORNEY

CLASS 9—(Continued).

SN 77-904,882. WMS GAMING INC., WAUKEGAN, IL. FILED 1-5-2010.

QUEEN OF THE APES

THE MARK CONSISTS OF STANDARD CHARACTERS WITHOUT CLAIM TO ANY PARTICULAR FONT, STYLE, SIZE, OR COLOR.

FOR COMPONENTS FOR GAMING MACHINES THAT GENERATE OR DISPLAY WAGER OUTCOMES, NAMELY, CONTROLLERS, DISPLAYS, BUTTON PANELS, BOLSTERS, ELECTRICAL WIRING, AND COMPUTER HARDWARE AND SOFTWARE ASSOCIATED THEREWITH; GAMING MACHINES, NAMELY, DEVICES WHICH ACCEPT A WAGER; GAMING SOFTWARE THAT GENERATES OR DISPLAYS WAGER OUTCOMES OF GAMING MACHINES (U.S. CLS. 21, 23, 26, 36 AND 38).

MICHAEL LITZAU, EXAMINING ATTORNEY

SN 77-906,501. TIME PLAZA INC., ALHAMBRA, CA. FILED 1-6-2010.



THE MARK CONSISTS OF UNICORN WITH THE HEAD TOWARD THE RIGHT HAND SIDE PLUS TWO FRONT LEGS JUMPING AND TWO HIND LEGS STANDING PLUS A COILED TAIL.

FOR CASES FOR EYEGLASSES AND SUNGLASSES; CASES FOR SPECTACLES AND SUNGLASSES; CHAINS FOR SPECTACLES AND FOR SUNGLASSES; FRAMES FOR SPECTACLES AND SUNGLASSES; LENSES FOR SUNGLASSES; NOSE GUARDS WHICH CAN BE WORN BY ATTACHMENT TO EYEWEAR SUCH AS SUNGLASSES AND SKI GOGGLES; SPECTACLES AND SUNGLASSES; SUNGLASS CHAINS AND CORDS; SUNGLASS LENSES; SUNGLASSES; SUNGLASSES AND SPECTACLES (U.S. CLS. 21, 23, 26, 36 AND 38).

FIRST USE 1-11-2005; IN COMMERCE 5-5-2005.
ELIZABETH KAJUBI, EXAMINING ATTORNEY

CLASS 9—(Continued).

SN 77-907,463. OSABOYS LLC, DBA OSABOYS LLC, FOLSOM, CA. FILED 1-7-2010.

HuntFishTracker

THE MARK CONSISTS OF STANDARD CHARACTERS WITHOUT CLAIM TO ANY PARTICULAR FONT, STYLE, SIZE, OR COLOR.

FOR DOWNLOADABLE COMPUTER SOFTWARE FOR USE AS AN APPLICATION IN MOBILE DEVICES AND PORTABLE TELECOMMUNICATION DEVICES THAT ENABLES USER TO TRACK AND COMPILE RECORDS FROM OUTDOOR SPORTING EXCURSIONS (U.S. CLS. 21, 23, 26, 36 AND 38).

YAT SYE, LEE, EXAMINING ATTORNEY

SN 77-912,640. WILNER, ELI, NEW YORK, NY. FILED 1-15-2010.

ELI WILNER

THE MARK CONSISTS OF STANDARD CHARACTERS WITHOUT CLAIM TO ANY PARTICULAR FONT, STYLE, SIZE, OR COLOR.

THE NAME(S), PORTRAIT(S), AND/OR SIGNATURE(S) SHOWN IN THE MARK IDENTIFIES "ELI WILNER", WHOSE CONSENT(S) TO REGISTER IS MADE OF RECORD.

FOR DIGITAL PHOTO FRAMES FOR DISPLAYING DIGITAL PICTURES, VIDEO CLIPS AND MUSIC (U.S. CLS. 21, 23, 26, 36 AND 38).

VIVIAN MICZNIK FIRST, EXAMINING ATTORNEY

SN 77-913,942. QUALCOMM INCORPORATED, SAN DIEGO, CA. FILED 1-18-2010.

RAPTORQ

THE MARK CONSISTS OF STANDARD CHARACTERS WITHOUT CLAIM TO ANY PARTICULAR FONT, STYLE, SIZE, OR COLOR.

OWNER OF U.S. REG. NO. 3,507,464.
FOR COMPUTER HARDWARE AND SOFTWARE FOR FORWARD ERROR CORRECTION IN THE FIELD OF NETWORK AND WIRELESS COMMUNICATION, SET-TOP BOXES AND TELEVISION RECEIVERS (U.S. CLS. 21, 23, 26, 36 AND 38).

TRACY CROSS, EXAMINING ATTORNEY

CLASS 9—(Continued).

SN 77-914,681. WMS GAMING INC., WAUKEGAN, IL. FILED 1-19-2010.

REEL BOOST

THE MARK CONSISTS OF STANDARD CHARACTERS WITHOUT CLAIM TO ANY PARTICULAR FONT, STYLE, SIZE, OR COLOR.

FOR COMPONENTS FOR GAMING MACHINES THAT GENERATE OR DISPLAY WAGER OUTCOMES, NAMELY, CONTROLLERS, DISPLAYS, BUTTON PANELS, BOLSTERS, ELECTRICAL WIRING, AND COMPUTER HARDWARE AND SOFTWARE ASSOCIATED THEREWITH; GAMING MACHINES, NAMELY, DEVICES WHICH ACCEPT A WAGER; GAMING SOFTWARE THAT GENERATES OR DISPLAYS WAGER OUTCOMES OF GAMING MACHINES (U.S. CLS. 21, 23, 26, 36 AND 38).

MICHAEL LITZAU, EXAMINING ATTORNEY

SN 77-915,579. BECON PTY LTD, PORT MELBOURNE VIC, AUSTRALIA, FILED 1-20-2010.

DRAYKO

THE MARK CONSISTS OF STANDARD CHARACTERS WITHOUT CLAIM TO ANY PARTICULAR FONT, STYLE, SIZE, OR COLOR.

FOR PROTECTIVE CLOTHING (U.S. CLS. 21, 23, 26, 36 AND 38).

HOWARD SMIGA, EXAMINING ATTORNEY

SN 77-916,144. SUSTAINABLE GROUP HOLDINGS LLC, SEATTLE, WA. FILED 1-20-2010.



THE MARK CONSISTS OF LEAVES IN A CIRCULAR PATTERN AND THE WORD "REPLAY".

FOR SLEEVES AND CASES FOR DISKETTES, CDS AND DVDS (U.S. CLS. 21, 23, 26, 36 AND 38).

LYDIA BELZER, EXAMINING ATTORNEY

CLASS 9—(Continued).

SN 77-917,216. LOWE PROFILE PRODUCTIONS, INC., BEVERLY HILLS, CA. FILED 1-21-2010.



THE MARK CONSISTS OF THE STYLIZED LETTERS "TBP" INSIDE OF AN OVAL SHAPE DESIGN.

FOR PRE-RECORDED VIDEO CASSETTES AND DVDS FEATURING MOVIE COMPILATIONS; PRE-RECORDED VIDEO CASSETTES AND DVDS FEATURING MUSICAL SOUND RECORDING COMPILATIONS; PRE-RECORDED VIDEO CASSETTES AND DVDS FEATURING MUSIC VIDEO COMPILATIONS (U.S. CLS. 21, 23, 26, 36 AND 38).

TINA MAI, EXAMINING ATTORNEY

SN 77-918,183. LEVITON MANUFACTURING CO., INC., MELVILLE, NY. FILED 1-22-2010.

GREENMAX

THE MARK CONSISTS OF STANDARD CHARACTERS WITHOUT CLAIM TO ANY PARTICULAR FONT, STYLE, SIZE, OR COLOR.

OWNER OF U.S. REG. NOS. 3,071,563, 3,758,359 AND OTHERS.

FOR RELAY LIGHTING CONTROL CABINETS; ELECTRIC SWITCHING, DIMMING AND CONTROL MODULES FOR MONITORING ELECTRIC CURRENT AND ELECTRICAL SIGNALS IN RELAY LIGHTING CONTROL CABINETS; CONTROL CABINETS SPECIALLY ADAPTED FOR RELAY LIGHTING CONTROLS; LIGHTING CONTROLS FOR ENERGY MANAGEMENT (U.S. CLS. 21, 23, 26, 36 AND 38).

DAVID YONTEF, EXAMINING ATTORNEY

SN 77-920,468. ELECTRONIC ARTS INC., REDWOOD CITY, CA. FILED 1-26-2010.

MySims SkyHeroes

THE MARK CONSISTS OF STANDARD CHARACTERS WITHOUT CLAIM TO ANY PARTICULAR FONT, STYLE, SIZE, OR COLOR.

OWNER OF U.S. REG. NO. 3,554,643.

FOR COMPUTER GAME SOFTWARE; COMPUTER GAME SOFTWARE DOWNLOADABLE FROM A GLOBAL COMPUTER NETWORK; VIDEO GAME SOFTWARE (U.S. CLS. 21, 23, 26, 36 AND 38).

CARYN GLASSER, EXAMINING ATTORNEY

CLASS 9—(Continued).

SN 77-920,544. FS&K PUBLISHING, INC., CALABASAS, CA. FILED 1-26-2010.

KNOW THE LAWS THAT CAN PUT
YOUR BUSINESS OUT OF
BUSINESS

THE MARK CONSISTS OF STANDARD CHARACTERS WITHOUT CLAIM TO ANY PARTICULAR FONT, STYLE, SIZE, OR COLOR.

FOR DOWNLOADABLE ELECTRONIC PUBLICATIONS IN THE NATURE OF NEWSLETTERS IN THE FIELD OF EMPLOYMENT AND WORKERS COMPENSATION LAW (U.S. CLS. 21, 23, 26, 36 AND 38).

FIRST USE 1-25-2010; IN COMMERCE 1-25-2010.
KEVIN CORWIN, EXAMINING ATTORNEY

SN 77-921,048. LEVITON MANUFACTURING CO., INC., MELVILLE, NY. FILED 1-27-2010.

IT'S A SNAP

THE MARK CONSISTS OF STANDARD CHARACTERS WITHOUT CLAIM TO ANY PARTICULAR FONT, STYLE, SIZE, OR COLOR.

OWNER OF U.S. REG. NO. 1,215,643.
FOR ELECTRICAL WIRING DEVICES, NAMELY, LIGHTING CONTROLS, ELECTRIC LIGHT DIMMERS, ELECTRICAL RECEPTACLES, ELECTRICAL OUTLETS, ELECTRIC SWITCHES, FACEPLATES IN THE NATURE OF ELECTRICAL OUTLET PLATES AND TELECOMMUNICATION JACKS AND ELECTRIC ACCESS PORT SOCKETS AND CONNECTORS FOR TRANSMITTING AND INTERCONNECTION OF VOICE AND DATA SIGNALS (U.S. CLS. 21, 23, 26, 36 AND 38).

DAVID YONTEF, EXAMINING ATTORNEY

SN 77-921,433. GIBSON GUITAR CORP., NASHVILLE, TN. FILED 1-27-2010.

LAB SERIES

THE MARK CONSISTS OF STANDARD CHARACTERS WITHOUT CLAIM TO ANY PARTICULAR FONT, STYLE, SIZE, OR COLOR.

NO CLAIM IS MADE TO THE EXCLUSIVE RIGHT TO USE "SERIES", APART FROM THE MARK AS SHOWN.

FOR BASS AMPLIFIERS; GUITAR AMPLIFIERS; MUSICAL INSTRUMENT AMPLIFIERS (U.S. CLS. 21, 23, 26, 36 AND 38).

AMY C. KEAN, EXAMINING ATTORNEY

CLASS 9—(Continued).

SN 77-928,814. BECON PTY LTD, PORT MELBOURNE VIC, AUSTRALIA, FILED 2-5-2010.



THE MARK CONSISTS OF THE WORD "DRAYKO" IN UPPER AND LOWERCASE LETTERING WITH A STYLIZED "Y" DESIGN SHOWING THE BOTTOM PORTION OF THE LETTER "Y" FORMING AN ARROW.

FOR PROTECTIVE CLOTHING (U.S. CLS. 21, 23, 26, 36 AND 38).
HOWARD SMIGA, EXAMINING ATTORNEY

SN 77-928,826. BECON PTY LTD, PORT MELBOURNE VIC, AUSTRALIA, FILED 2-5-2010.



THE MARK CONSISTS OF THE LETTER "D" IN A STYLIZED DESIGN SHOWING THE UPPER PORTION OF THE LETTER "D" FORMING AN ARROW.

FOR PROTECTIVE CLOTHING (U.S. CLS. 21, 23, 26, 36 AND 38).
HOWARD SMIGA, EXAMINING ATTORNEY

SN 77-933,234. STONE CREEK ENTERTAINMENT LLC, RIDGFIELD, CT. FILED 2-11-2010.

I WOO YOU

THE MARK CONSISTS OF STANDARD CHARACTERS WITHOUT CLAIM TO ANY PARTICULAR FONT, STYLE, SIZE, OR COLOR.

FOR DOWNLOADABLE VIDEO GAME SOFTWARE FOR MOBILE DEVICES AND PERSONAL COMPUTERS (U.S. CLS. 21, 23, 26, 36 AND 38).

ELISSA GARBER KON, EXAMINING ATTORNEY

CLASS 9—(Continued).

SN 78-880,180. HALSEY, DONALD, DAYTON, OH. FILED 5-10-2006.



FOR VIDEO GAME CONTROLLER, NAMELY, A USER INTERFACE DEVICE WHICH UTILIZES IMPULSES FROM THE USER'S FOREHEAD TO OPERATE A VIDEO GAME (U.S. CLS. 21, 23, 26, 36 AND 38).
JOHN SCHUYLER YARD, EXAMINING ATTORNEY

SN 79-025,643. ESSLOR INTERNATIONAL (COMPAGNIE GENERALE D'OPTIQUE), FRANCE, FILED 5-11-2006.

ACUITY BOOSTER

THE MARK CONSISTS OF STANDARD CHARACTERS WITHOUT CLAIM TO ANY PARTICULAR FONT, STYLE, SIZE, OR COLOR.

PRIORITY DATE OF 11-16-2005 IS CLAIMED.
OWNER OF INTERNATIONAL REGISTRATION 0889750 DATED 5-11-2006, EXPIRES 5-11-2016.
FOR OPHTHALMIC LENSES; SPECTACLE LENSES (U.S. CLS. 21, 23, 26, 36 AND 38).
KEVIN CORWIN, EXAMINING ATTORNEY

SN 79-068,840. GENESYS ELEKTRONIK GMBH, OFFENBURG, FED REP GERMANY, FILED 1-12-2009.

GeneSys

THE MARK CONSISTS OF STANDARD CHARACTERS WITHOUT CLAIM TO ANY PARTICULAR FONT, STYLE, SIZE, OR COLOR.

OWNER OF INTERNATIONAL REGISTRATION 1002786 DATED 1-12-2009, EXPIRES 1-12-2019.

FOR SCIENTIFIC, NAUTICAL, SURVEYING, PHOTOGRAPHIC AND OPTICAL NAVIGATION EQUIPMENT, ACOUSTIC, ELECTRO-MAGNETIC, WEIGHING, MEASURING, SIGNALING, CHECKING, SUPERVISION, AND TEACHING APPARATUS AND INSTRUMENTS AND OTHER ELECTRIC APPARATUS AND INSTRUMENTS, TO THE EXTENT INCLUDED IN THIS CLASS, AND SYSTEMS COMPRISING THE AFOREMENTIONED APPARATUS AND INSTRUMENTS OR CONSISTING OF ANY OF THEM IN WHOLE OR IN PART, NAMELY, GPS (GLOBAL POSITIONING SYSTEM) RECEIVERS, GYROSCOPES, ACCELEROMETERS, COMPASSES, COMPASS SYSTEMS COMPRISED OF COMPASSES, COMPUTER HARDWARE, GYROSCOPES, ACCELEROMETERS, MAGNETIC DIRECTIONAL SENSORS; GYROSCOPES IN THE NATURE OF GYROSCOPE HORIZONS; ATTITUDE AND HEADING REFERENCE SYSTEMS COMPRISED OF COMPUTER HARDWARE AND

CLASS 9—(Continued).

DIRECTIONAL SENSORS; ELECTRIC APPARATUS IN THE NATURE OF COMPUTER HARDWARE AND SOFTWARE, WITH INERTIAL SENSORS FOR DETERMINATION OF ATTITUDE AND HEADING; HEADING STABILISATION APPARATUS IN THE NATURE OF COMPUTER HARDWARE, GYROSCOPES, ACCELEROMETERS, MAGNETIC DIRECTIONAL SENSORS; ELECTRIC APPARATUS IN THE NATURE OF COMPUTER HARDWARE; ELECTRONIC DIRECTIONAL SENSORS FOR HEADING DETERMINATION; LASER DISTANCE MEASURING APPARATUS, LASER SCANNERS; NAVIGATION EQUIPMENT, NAMELY, COMPASSES, AVIONIC SENSOR SYSTEMS IN THE NATURE OF NAVIGATION SYSTEMS FOR VEHICLES AND VESSELS; NAVIGATION SYSTEMS COMPRISED OF COMPUTER HARDWARE, COMPASSES, DIRECTIONAL SENSORS, AND POSITION SENSORS; LEVELING APPARATUS IN THE NATURE OF WATER LEVEL INDICATORS; LEVELING SYSTEMS COMPRISED OF COMPUTER HARDWARE, PRESSURE GAUGES; APPARATUS WITH NORTH-SEEKING GYROSCOPES, NAMELY, GYROSCOPES, COMPASSES, ACCELEROMETERS, MAGNETIC DIRECTIONAL SENSORS, AND COMPUTER HARDWARE; DISTANCE MEASURING APPARATUS, NAMELY, TRIGONOMETRIC DISTANCE MEASUREMENT APPARATUS; TRIGONOMETRIC PROBES, NAMELY, ELECTRIC OR ELECTRONIC SENSORS FOR DETERMINING ATTITUDE, HEADING AND DISTANCE; DISTANCE MEASURING APPARATUS, NAMELY, LASER DISTANCE MEASUREMENT APPARATUS AND RADIO DISTANCE MEASUREMENT APPARATUS; COMPUTER SOFTWARE, NAMELY, COMPUTER OPERATING SYSTEM PROGRAMS, COMPUTER SOFTWARE PROGRAMS FOR CONTROL, AND APPLICATION SOFTWARE PROGRAMS FOR DATA PROCESSING IN ALL OF THE ABOVE GOODS AND GROUPS OF GOODS; NONE OF THE AFOREMENTIONED GOODS BEING FOR USE IN THE FIELDS OF COMPUTER-INTEGRATED TELEPHONY AND NONE OF THE AFOREMENTIONED GOODS BEING IN THE NATURE OF ELECTRICAL INSTALLATIONS AND ELECTRICAL MACHINES FOR WELDING AND BRAZING, POSITIONING DEVICES FOR WELDING AND BRAZING, INSTALLATIONS AND MACHINES FOR ARC WELDING AND FOR ELECTRICAL PLASMA ARC WELDING AND BRAZING (U.S. CLS. 21, 23, 26, 36 AND 38).

KEVIN CORWIN, EXAMINING ATTORNEY

CLASS 9—(Continued).

SN 79-070,793. KARAT GRUPP OÜ, ESTONIA, FILED 12-19-2008.



PRIORITY DATE OF 7-4-2008 IS CLAIMED.
OWNER OF INTERNATIONAL REGISTRATION 1007380
DATED 12-19-2008, EXPIRES 12-19-2018.
THE MARK CONSISTS OF A STYLIZED DESIGN OF AN INFINITY SYMBOL.

FOR PORTABLE COMPUTERS; COMPACT DISC PLAYERS; RECORD PLAYERS; VEHICLE RADIOS; PERSONAL STEREO; TELEVISION APPARATUS FOR PROJECTION PURPOSES; SOUND REPRODUCTION EQUIPMENT FOR CARS, NAMELY, CAR CASSETTE PLAYERS AND CAR CD PLAYERS; JUKE BOXES; INTERFACES FOR COMPUTERS; DIGITAL MATERIALS, NAMELY, CDS, DVDS, LASER DISCS, AND OPTICAL DISCS FEATURING AUDIO AND VIDEO RECORDINGS IN THE FIELD OF MUSIC, MOVIES, PICTURES; AERIALS; SOUND TRANSMITTING APPARATUS FOR CARS; VIDEO SCREENS; HEADPHONES; ELECTRIC NAVIGATIONAL INSTRUMENTS; NAVIGATION APPARATUS FOR VEHICLES; SATELLITE NAVIGATIONAL APPARATUS, NAMELY, A GLOBAL POSITIONING SYSTEM; AUDIO AND VIDEO RECEIVERS; THEFT ALARMS; TELEVISION TRANSMITTERS; WIRELESS AUDIO AND VIDEO TRANSMITTERS; ELECTRIC CONTROL PANELS; LOUDSPEAKERS; VIDEO-RECORDERS; SOUND RECORDING APPARATUS FOR CARS; COMPUTER OPERATING PROGRAMS, RECORDED; DOWNLOADABLE COMPUTER OPERATING PROGRAMS; PORTABLE COMPUTER PERIPHERAL DEVICES; RADAR APPARATUS, NAMELY, RADAR; RADIOS; WALKIE-TALKIES; READERS FOR DATA PROCESSING EQUIPMENT, NAMELY, DIGITAL DATA CARD READERS; PROJECTION SCREENS; ELECTRONIC SIGNAL TRANSMITTERS; TELECOMMUNICATIONS TRANSMITTERS; BLANK OPTICAL DATA CARRIERS; MICROPHONES; TELEPHONE TRANSMITTERS; CCD CAMERAS (U.S. CLS. 21, 23, 26, 36 AND 38).

HAI-LY LAM, EXAMINING ATTORNEY

CLASS 9—(Continued).

SN 79-071,522. SGE ANALYTICAL SCIENCE PTY LTD, AUSTRALIA, FILED 5-14-2009.

EVOL

THE MARK CONSISTS OF STANDARD CHARACTERS WITHOUT CLAIM TO ANY PARTICULAR FONT, STYLE, SIZE, OR COLOR.

OWNER OF INTERNATIONAL REGISTRATION 1009318
DATED 5-14-2009, EXPIRES 5-14-2019.

FOR SCIENTIFIC AND MEASURING EQUIPMENT BEING PRECISION SYRINGES; PRECISION SYRINGES INCORPORATING A DIGITAL DRIVE MEASURING UNIT FOR LABORATORY USE; DIGITAL REGULATING APPARATUS FOR REGULATING THE FLOW OF GASES AND LIQUIDS; DIGITAL MEASURING INSTRUMENTS FOR MEASURING LIQUIDS; DIGITAL LIQUID ANALYSERS; DIGITAL DRIVE UNIT COUPLED TO A PRECISION SYRINGE FOR REGULATING THE FLOW OF GASES AND LIQUIDS; DIGITAL DISPENSERS THAT COUNT OR MEASURE VOLUMETRIC OUTPUT FOR USE WITH GASES AND LIQUIDS (U.S. CLS. 21, 23, 26, 36 AND 38).

DOUGLAS LEE, EXAMINING ATTORNEY

SN 79-072,570. SILVIA LLOPIS LLOPIS.; JOSE DANIEL LLOPIS LLOPIS.; CARLOS LLOPIS LLOPIS, E-46980 PATERNA (VALENCIA), SPAIN, FILED 5-11-2009.

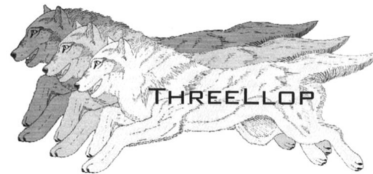

OWNER OF INTERNATIONAL REGISTRATION 1012353
DATED 5-11-2009, EXPIRES 5-11-2019.

THE MARK CONSISTS OF THREE SUPERIMPOSED RUNNING WOLVES WITH THE TERM "THREELLOP" IN THE MIDDLE OF THE FIRST WOLF DESIGN.

FOR ELECTRIC AND ELECTRONIC CIRCUITS, INTEGRATED CIRCUITS, SEMICONDUCTORS, SEMICONDUCTOR DEVICES AND SEMICONDUCTOR CHIPS (U.S. CLS. 21, 23, 26, 36 AND 38).

JAMES STEIN, EXAMINING ATTORNEY

SN 79-073,109. AOYAMA OPTICAL CO., LTD., JAPAN, FILED 8-26-2009.

F a c t o r y 9 0 0

THE MARK CONSISTS OF STANDARD CHARACTERS WITHOUT CLAIM TO ANY PARTICULAR FONT, STYLE, SIZE, OR COLOR.

OWNER OF INTERNATIONAL REGISTRATION 1013818
DATED 8-26-2009, EXPIRES 8-26-2019.

FOR EYEGLASS FRAMES; EYEGLASSES (U.S. CLS. 21, 23, 26, 36 AND 38).

WARREN L. OLANDRIA, EXAMINING ATTORNEY

CLASS 9—(Continued).

SN 79-074,622. ABB LIMITED, UNITED KINGDOM, FILED 7-24-2009.

ORIMASTER

THE MARK CONSISTS OF STANDARD CHARACTERS WITHOUT CLAIM TO ANY PARTICULAR FONT, STYLE, SIZE, OR COLOR.

PRIORITY DATE OF 1-28-2009 IS CLAIMED.

OWNER OF INTERNATIONAL REGISTRATION 1018027 DATED 7-24-2009, EXPIRES 7-24-2019.

FOR FLOWMETERS AND COMPONENT PARTS AND FITTINGS THEREFOR; APPARATUS FOR MEASURING, INDICATING AND RECORDING THE FLOW OF GASES AND LIQUIDS AND COMPONENT PARTS AND FITTINGS THEREFOR (U.S. CLS. 21, 23, 26, 36 AND 38). COLLEEN KEARNEY, EXAMINING ATTORNEY

SN 79-075,368. SIEMENS SCHWEIZ AG, SWITZERLAND, FILED 6-5-2009.

Climatix

THE MARK CONSISTS OF STANDARD CHARACTERS WITHOUT CLAIM TO ANY PARTICULAR FONT, STYLE, SIZE, OR COLOR.

PRIORITY DATE OF 12-16-2008 IS CLAIMED.

OWNER OF INTERNATIONAL REGISTRATION 1019450 DATED 6-5-2009, EXPIRES 6-5-2019.

THE WORDING "CLIMATIX" HAS NO MEANING IN A FOREIGN LANGUAGE.

FOR CONTROLLING, MONITORING, REGULATING AND MEASURING EQUIPMENT FOR HEATING, VENTILATING, AIR CONDITIONING AND REFRIGERATION INSTALLATIONS, NAMELY, ELECTRIC CONTROL PANELS, ELECTRICAL CONTROLLING DEVICES, ELECTRIC METERS; CHECKING APPARATUS FOR HEATING/COMBUSTION, VENTILATION, AIR CONDITIONING AND REFRIGERATION INSTALLATIONS INsofar AS THEY ARE NOT INCLUDED IN OTHER CLASSES, NAMELY, GRADUATION CHECKERS, SCANNERS; FLAME CONTROL EQUIPMENT, NAMELY, FIRE EXTINGUISHING APPARATUS, FIRE SPRINKLERS; COMPUTERS AND COMPUTER SOFTWARE FOR CONTROLLING, MONITORING, REGULATING AND OPERATING COMBUSTION INSTALLATIONS (U.S. CLS. 21, 23, 26, 36 AND 38).

TINA BROWN, EXAMINING ATTORNEY

CLASS 9—(Continued).

SN 79-076,625. OCVACO TECHNOLOGY CO., LTD., CHINA, FILED 11-26-2009.



OWNER OF INTERNATIONAL REGISTRATION 1022906 DATED 11-26-2009, EXPIRES 11-26-2019.

THE COLOR(S) RED IS/ARE CLAIMED AS A FEATURE OF THE MARK.

THE MARK CONSISTS OF A MISCELLANEOUS RED DESIGN THAT RESEMBLES AN IRREGULAR SHAPED CIRCLE.

FOR ELECTRONIC POCKET TRANSLATORS; PORTABLE TELEPHONES; HEADPHONES; CAMERAS; ELECTRICAL WIRES; ELECTRICAL PLUGS AND SOCKETS; EARPHONES; ELECTRIC DOOR BELLS; BATTERY CHARGERS (U.S. CLS. 21, 23, 26, 36 AND 38).

GIANCARLO CASTRO, EXAMINING ATTORNEY

CLASS 10—MEDICAL APPARATUS

SN 76-683,232. PTI PLANIFICATION TECHNOLOGIQUE INDUSTRIELLE INC., TROIS-RIVIÈRES, QUÉBEC, CANADA, FILED 10-22-2007.

NARCOMEDIC

THE MARK CONSISTS OF STANDARD CHARACTERS WITHOUT CLAIM TO ANY PARTICULAR FONT, STYLE, SIZE, OR COLOR.

PRIORITY CLAIMED UNDER SEC. 44(D) ON CANADA APPLICATION NO. 1,348,537, FILED 5-23-2007, REG. NO. TMA750308, DATED 10-15-2009, EXPIRES 10-15-2024.

FOR STAND-ALONE DISPENSING DEVICE LINKED BY NETWORK TO MANAGEMENT SOFTWARE FOR CONTROL, MANAGEMENT, INTEGRATION OF CONTROLLED DRUGS AND PRESCRIBED DRUGS, EXCLUDING MACHINE ADMINISTERED ANESTHETICS, FOR AUTOMATED DISPENSING TO NURSES IN HEALTHCARE ESTABLISHMENT AT NURSING WARD LEVEL (U.S. CLS. 26, 39 AND 44).

DEBRA LEE, EXAMINING ATTORNEY

CLASS 10—(Continued).

SN 76-697,849. THE BELPORT COMPANY, INC., CAMARILLO, CA. FILED 6-10-2009.

LASSO

THE MARK CONSISTS OF STANDARD CHARACTERS WITHOUT CLAIM TO ANY PARTICULAR FONT, STYLE, SIZE, OR COLOR.

FOR DENTAL INSTRUMENTS, NAMELY, GINGIVAL RETRACTION CORDS (U.S. CLS. 26, 39 AND 44).
JENNIFER DIXON, EXAMINING ATTORNEY

CLASS 10—(Continued).

SN 77-199,131. QUILL MEDICAL, INC., NORTH BEND, WA. FILED 6-6-2007.

QUILL

SN 76-700,062. WILLIAM J. FOLZ, III, MARINA DEL REY, CA. FILED 10-26-2009.



THE COLOR(S) BLACK, PURPLE, YELLOW, GREEN, ORANGE, BLUE, PINK IS/ARE CLAIMED AS A FEATURE OF THE MARK.

THE MARK CONSISTS OF THE WORDING "DR. BILLY FEELGOOD'S "HAPPY FEET"" PLUS A HEART DESIGN IN PURPLE WITH A BLACK OUTLINE. THE WORDING "DR. BILLY FEELGOOD'S" IS IN BLACK, THE QUOTATION MARKS AROUND THE WORDING ""HAPPY FEET"" ARE IN YELLOW. ALL OF THE WORDING IN ""HAPPY FEET"" IS IN BLACK BUT IS HIGHLIGHTED IN THE FOLLOWING COLORS. "H" IN PURPLE, "A" IN GREEN, "P" IN ORANGE, "P" IN BLUE, "Y" IN PINK, "F" IN PURPLE, "E" IN GREEN, "E" IN ORANGE, "T" IN BLUE.

FOR FOAM FOOT MASSAGERS IN THE NATURE OF MESSAGE APPARATUS (U.S. CLS. 26, 39 AND 44).
FIRST USE 8-24-2009; IN COMMERCE 8-24-2009.
MATTHEW MCDOWELL, EXAMINING ATTORNEY

THE MARK CONSISTS OF STANDARD CHARACTERS WITHOUT CLAIM TO ANY PARTICULAR FONT, STYLE, SIZE, OR COLOR.

PRIORITY CLAIMED UNDER SEC. 44(D) ON ERPNCMNTY TM OFC APPLICATION NO. 005966627, FILED 6-4-2007, REG. NO. 005966627, DATED 6-4-2007, EXPIRES 6-4-2017.

FOR SURGICAL AND MEDICAL INSTRUMENTS, NAMELY SUTURES, LIGATURES, AND SUTURE KITS COMPRISED OF SUTURES AND NEEDLES (U.S. CLS. 26, 39 AND 44).

AISHA CLARKE, EXAMINING ATTORNEY

SN 77-295,768. OWEN MUMFORD LIMITED, WOODSTOCK, UNITED KINGDOM, FILED 10-4-2007.

SN 77-041,868. BUNNEL, INCORPORATED, SALT LAKE CITY, UT. FILED 11-10-2006.

LIFE PULSE

THE MARK CONSISTS OF STANDARD CHARACTERS WITHOUT CLAIM TO ANY PARTICULAR FONT, STYLE, SIZE, OR COLOR.

FOR MEDICAL VENTILATORS (U.S. CLS. 26, 39 AND 44).

FIRST USE 1-0-1985; IN COMMERCE 1-0-1985.
SARA THOMAS, EXAMINING ATTORNEY

OWNER OF UNITED KINGDOM REG. NO. 006266852, DATED 9-10-2007, EXPIRES 9-10-2017.

NO CLAIM IS MADE TO THE EXCLUSIVE RIGHT TO USE "HEELSTIK PREMIE", APART FROM THE MARK AS SHOWN.

THE MARK CONSISTS OF THE WORD "HEELSTIK" ON TOP OF THE WORD "PREMIE" WITH THE OUTLINE OF A FOOT AND FIVE TOES.

FOR BLOOD SAMPLING APPARATUS AND INSTRUMENTS; BLOOD LANCETS; LANCING DEVICES; SYRINGES AND NEEDLE INJECTION DEVICES FOR MEDICAL PURPOSES; INJECTION SYRINGES; HYPODERMIC SYRINGES; INSULIN INJECTORS SOLD EMPTY; CARTRIDGES FOR MEDICAL SYRINGES (U.S. CLS. 26, 39 AND 44).

JAMES LOVELACE, EXAMINING ATTORNEY

CLASS 10—(Continued).

SN 77-338,618. MEDIGUIDE LTD., HAIFA, ISRAEL, FILED 11-28-2007.

MEDIGUIDE

THE MARK CONSISTS OF STANDARD CHARACTERS WITHOUT CLAIM TO ANY PARTICULAR FONT, STYLE, SIZE, OR COLOR.

PRIORITY CLAIMED UNDER SEC. 44(D) ON ISRAEL APPLICATION NO. 205167, FILED 10-30-2007, REG. NO. 205167, DATED 8-13-2009, EXPIRES 10-30-2017.

FOR MEDICAL IMAGING, NAVIGATION, AND LOCALIZATION/ORIENTATION APPARATUS AND INSTRUMENTS CONSISTING OF MINIATURE SENSORS WORKING IN CONJUNCTION WITH A MEDICAL POSITIONING SYSTEM AND 2D OR 3D MEDICAL IMAGING FOR USE IN ASSOCIATION WITH MINIMAL INVASIVE SURGERY, DIAGNOSTIC AND THERAPEUTICS TOOLS OR DEVICES, NAMELY, GUIDE WIRES, CARDIAC PACING WIRES, CARDIAC RHYTHM MANAGEMENT WIRES, CARDIAC IMAGING WIRES, CATHETERS, MEDICAL ENDOSCOPES, NEEDLES FOR MEDICAL USE, IMAGING CATHETERS, CARDIAC PACING LEADS, PERCUTANEOUS LEADS, PACE-MAKER LEADS, ICD AND DEFIBRILLATOR LEADS, MEDICAL ELECTRODES, STENTS, ARTIFICIAL CARDIAC VALVES, VASCULAR CLOSURE DEVICES AND CARDIAC CLOSURE DEVICES (U.S. CLS. 26, 39 AND 44).

GEOFFREY FOSDICK, EXAMINING ATTORNEY

SN 77-338,622. MEDIGUIDE LTD., HAIFA, ISRAEL, FILED 11-28-2007.

GMPS

THE MARK CONSISTS OF STANDARD CHARACTERS WITHOUT CLAIM TO ANY PARTICULAR FONT, STYLE, SIZE, OR COLOR.

PRIORITY CLAIMED UNDER SEC. 44(D) ON ISRAEL APPLICATION NO. 205056, FILED 10-24-2007, REG. NO. 205056, DATED 3-10-2007, EXPIRES 10-24-2017.

FOR MEDICAL IMAGING, NAVIGATION, AND LOCALIZATION/ORIENTATION APPARATUS AND INSTRUMENTS CONSISTING OF MINIATURE SENSORS WORKING IN CONJUNCTION WITH A MEDICAL POSITIONING SYSTEM AND 2D OR 3D MEDICAL IMAGING FOR USE IN ASSOCIATION WITH MINIMAL INVASIVE SURGERY, DIAGNOSTIC AND THERAPEUTICS TOOLS OR DEVICES, NAMELY, GUIDE WIRES, CARDIAC PACING WIRES, CARDIAC RHYTHM MANAGEMENT WIRES, CARDIAC IMAGING WIRES, CATHETERS, MEDICAL ENDOSCOPES, NEEDLES FOR MEDICAL USE, IMAGING CATHETERS, CARDIAC PACING LEADS, PERCUTANEOUS LEADS, PACE-MAKER LEADS, ICD AND DEFIBRILLATOR LEADS, MEDICAL ELECTRODES, STENTS, ARTIFICIAL CARDIAC VALVES, VASCULAR CLOSURE DEVICES AND CARDIAC CLOSURE DEVICES (U.S. CLS. 26, 39 AND 44).

GEOFFREY FOSDICK, EXAMINING ATTORNEY

CLASS 10—(Continued).

SN 77-349,133. CONMED CORPORATION, UTICA, NY, FILED 12-11-2007.

AXCESS

THE MARK CONSISTS OF STANDARD CHARACTERS WITHOUT CLAIM TO ANY PARTICULAR FONT, STYLE, SIZE, OR COLOR.

FOR MEDICAL DEVICES, NAMELY, PAPILOTOMES (U.S. CLS. 26, 39 AND 44).

JERI J. FICKES, EXAMINING ATTORNEY

SN 77-600,749. HELEN L. CAMPBELL, DBA PICC POCKET, COLUMBUS, OH, FILED 10-26-2008.

PICC POCKET

THE MARK CONSISTS OF STANDARD CHARACTERS WITHOUT CLAIM TO ANY PARTICULAR FONT, STYLE, SIZE, OR COLOR.

FOR MEDICAL INSTRUMENT ORGANIZER SPECIALLY FITTED WITH POCKETS ADAPTED FOR HOLDING MEDICAL INSTRUMENTS (U.S. CLS. 26, 39 AND 44).

FIRST USE 5-1-2006; IN COMMERCE 7-7-2009.

HOWARD SMIGA, EXAMINING ATTORNEY

SN 77-630,803. ICRCO, INC., TORRANCE, CA, FILED 12-10-2008.



THE COLOR(S) BLUE AND WHITE IS/ARE CLAIMED AS A FEATURE OF THE MARK.

THE MARK CONSISTS OF A BLUE OVAL CONTAINING THE LETTERS "ICRco" IN WHITE.

FOR RADIOGRAPHY EQUIPMENT, NAMELY, COMPUTED RADIOGRAPHY APPARATUS AND DIGITAL RADIOGRAPHY APPARATUS FOR CONVERTING IMAGES CREATED BY X-RAY EXPOSURE TO DIGITAL DATA FOR MEDICAL AND DIAGNOSTIC USE (U.S. CLS. 26, 39 AND 44).

FIRST USE 4-1-2004; IN COMMERCE 4-1-2004.

ASMAT KHAN, EXAMINING ATTORNEY

CLASS 10—(Continued).

SN 77-712,312. MEDERI THERAPEUTICS INC., COS COB, CT. FILED 4-13-2009.

MEDERI

THE MARK CONSISTS OF STANDARD CHARACTERS WITHOUT CLAIM TO ANY PARTICULAR FONT, STYLE, SIZE, OR COLOR.

THE WORDING "MEDERI" HAS NO MEANING IN A FOREIGN LANGUAGE.

FOR MEDICAL DEVICES FOR USE IN TREATING INCONTINENCE, UROLOGICAL DISORDERS AND GASTROENTEROLOGICAL DISORDERS (U.S. CLS. 26, 39 AND 44).

ANTHONY RINKER, EXAMINING ATTORNEY

SN 77-714,146. PENNER MANUFACTURING, INC., AURORA, NE. FILED 4-15-2009.

Superior

THE MARK CONSISTS OF STANDARD CHARACTERS WITHOUT CLAIM TO ANY PARTICULAR FONT, STYLE, SIZE, OR COLOR.

SEC. 2(F).

FOR WHIRLPOOL BATHING SYSTEMS CONSISTING OF WHIRLPOOL BATHS FOR USE PRIMARILY IN HOSPITALS, NURSING HOMES AND ASSISTED LIVING FACILITIES FOR THERAPEUTIC USE (U.S. CLS. 26, 39 AND 44).

FIRST USE 3-31-2001; IN COMMERCE 3-31-2001.

DANIEL CAPSHAW, EXAMINING ATTORNEY

SN 77-738,073. LIFEWAVE, INC., DBA LIFEWAVE, INC., NORTH HIGHLANDS, CA. FILED 5-15-2009.

CardioConnect

THE MARK CONSISTS OF STANDARD CHARACTERS WITHOUT CLAIM TO ANY PARTICULAR FONT, STYLE, SIZE, OR COLOR.

FOR MEDICAL DEVICE SENSORS AND APPARATUS USED FOR MONITORING OF CARDIOPULMONARY PHYSIOLOGICAL FUNCTIONS INCLUDING, BUT NOT LIMITED TO, RESPIRATION RATE, RESPIRATION DEPTH, HEART RATE, HEART STROKE VOLUME, AND BLOOD PRESSURE IN VENUES OTHER THAN CARDIAC DIAGNOSTIC FACILITIES (U.S. CLS. 26, 39 AND 44).

HEATHER BIDDULPH, EXAMINING ATTORNEY

CLASS 10—(Continued).

SN 77-738,936. LASALA, MICHAEL A, SAN FRANCISCO, CA. FILED 5-17-2009.

The Nubbin

THE MARK CONSISTS OF STANDARD CHARACTERS WITHOUT CLAIM TO ANY PARTICULAR FONT, STYLE, SIZE, OR COLOR.

FOR NON-VIBRATING APPARATUS FOR ACUPRESSURE THERAPY IN THE NATURE OF A 3 INCH SMOOTH-SURFACED BALL FOR USE WITH ACUPRESSURE POINTS (U.S. CLS. 26, 39 AND 44).

KIM SAITO, EXAMINING ATTORNEY

SN 77-742,057. NATIONAL SPINAL DECOMPRESSION SYSTEM, LLC, DBA ADVANCED BACK CARE, WAYNESFIELD, OH. FILED 5-21-2009.

Evolution DT

THE MARK CONSISTS OF STANDARD CHARACTERS WITHOUT CLAIM TO ANY PARTICULAR FONT, STYLE, SIZE, OR COLOR.

NO CLAIM IS MADE TO THE EXCLUSIVE RIGHT TO USE "DT", APART FROM THE MARK AS SHOWN.

FOR MEDICAL DEVICE, NAMELY, A NON-SURGICAL SPLIT TABLE SPINAL DECOMPRESSION SYSTEM COMPRISED OF A HEAD AND A PELVIC HARNESS RESTRAINT AND AN ELECTRIC ACTUATOR FOR THE TREATMENT OF BACK AND NECK PAIN (U.S. CLS. 26, 39 AND 44).

FIRST USE 5-8-2005; IN COMMERCE 10-12-2005.

GINA HAYES, EXAMINING ATTORNEY

SN 77-746,031. PHARMACO-KINESIS CORPORATION, INGLEWOOD, CA. FILED 5-27-2009.

Intelligent Interbody Fusion Device (IIFD)

THE MARK CONSISTS OF STANDARD CHARACTERS WITHOUT CLAIM TO ANY PARTICULAR FONT, STYLE, SIZE, OR COLOR.

NO CLAIM IS MADE TO THE EXCLUSIVE RIGHT TO USE "INTELLIGENT INTERBODY FUSION DEVICE", APART FROM THE MARK AS SHOWN.

FOR DRUG ADMINISTRATION DEVICES, NAMELY, IMPLANTABLE DEVICES AND SYSTEMS FOR DISPENSING BONE MORPHOGENETIC PROTEINS AND BIOCHEMICALS FOR SPINAL FUSIONS OR ORTHOPEDIC SURGERIES (U.S. CLS. 26, 39 AND 44).

LEIGH LOWRY, EXAMINING ATTORNEY

CLASS 10—(Continued).

SN 77-746,057. PHARMACO-KINESIS CORPORATION, INGLEWOOD, CA. FILED 5-27-2009.

Magnetic BreatherPump (MBP)

THE MARK CONSISTS OF STANDARD CHARACTERS WITHOUT CLAIM TO ANY PARTICULAR FONT, STYLE, SIZE, OR COLOR.

NO CLAIM IS MADE TO THE EXCLUSIVE RIGHT TO USE "MAGNETIC", APART FROM THE MARK AS SHOWN. FOR DRUG ADMINISTRATION DEVICES, NAMELY, IMPLANTABLE SYSTEMS AND DEVICES FOR DISPENSING THERAPEUTICS FOR THE TREATMENT OF BRAIN AND SPINAL CANCERS OR TUMORS (U.S. CLS. 26, 39 AND 44).

LEIGH LOWRY, EXAMINING ATTORNEY

SN 77-748,854. PIVOT MEDICAL, INC., SUNNYVALE, CA. FILED 6-1-2009.

NANOTACK

THE MARK CONSISTS OF STANDARD CHARACTERS WITHOUT CLAIM TO ANY PARTICULAR FONT, STYLE, SIZE, OR COLOR.

FOR MEDICAL DEVICES, NAMELY, INSTRUMENTS FOR USE IN ARTHROSCOPIC SURGERY, NAMELY, ORTHOPEDIC FIXATION DEVICES (U.S. CLS. 26, 39 AND 44).

ELLEN PERKINS, EXAMINING ATTORNEY

SN 77-750,974. WEBER ORTHOPEDIC INC., AKA HELY & WEBER, SANTA PAULA, CA. FILED 6-3-2009.

TINY TITAN

THE MARK CONSISTS OF STANDARD CHARACTERS WITHOUT CLAIM TO ANY PARTICULAR FONT, STYLE, SIZE, OR COLOR.

OWNER OF U.S. REG. NO. 3,504,826. FOR WRIST BRACES FOR ORTHOPEDIC USE (U.S. CLS. 26, 39 AND 44).

FIRST USE 9-2-2008; IN COMMERCE 9-2-2008. BRIAN NEVILLE, EXAMINING ATTORNEY

CLASS 10—(Continued).

SN 77-760,793. CELONOVA BIOSCIENCES, INC., NEWNAN, GA. FILED 6-16-2009.

HEARTBEAD

THE MARK CONSISTS OF STANDARD CHARACTERS WITHOUT CLAIM TO ANY PARTICULAR FONT, STYLE, SIZE, OR COLOR.

FOR COATED AND UNCOATED MEDICAL DEVICES IN THE NATURE OF PARTICLES FOR EMBOLIZATION; COATED AND UNCOATED MEDICAL DEVICES IN THE NATURE OF PARTICLES FOR THERAPEUTIC USE, NAMELY, IMPROVING CARDIAC PERFORMANCE, AND DIAGNOSTIC USE, NAMELY, NUCLEAR MEDICINE DIAGNOSTIC IMAGING; COATED AND UNCOATED MEDICAL DEVICES IN THE NATURE OF PARTICLES FOR EMBOLIZATION, THERAPEUTIC USE IN IMPROVING CARDIAC PERFORMANCE AND DIAGNOSTIC IMAGING USE IN THE FIELD OF TUMOR AND/OR ARTERIOVENEOUS MALFORMATION TREATMENT AND FOR THE TREATMENT OF HYPERTROPHIC OBSTRUCTIVE CARDIOMYOPATHY AND OTHER CONDITIONS AND DISEASES THAT AFFECT THE PERFORMANCE OF A HEART AND TREATABLE WITH SUCH PARTICLES (U.S. CLS. 26, 39 AND 44).

VIVIAN MICZNIK FIRST, EXAMINING ATTORNEY

SN 77-795,253. HAZ/MAT DQE, INC., INDIANAPOLIS, IN. FILED 8-3-2009.

MASCACHE

THE MARK CONSISTS OF STANDARD CHARACTERS WITHOUT CLAIM TO ANY PARTICULAR FONT, STYLE, SIZE, OR COLOR.

FOR MEDICAL KITS FOR PREPARING A TEMPORARY TREATMENT AREA COMPRISED PRIMARILY OF GLOVES FOR MEDICAL PURPOSES, CONTAINERS FOR MEDICAL WASTE, CURTAINS, MEDICAL APPARATUS FOR INTRAVENOUS ADMINISTRATION OF FLUIDS, BIO-HAZARD BAGS, HOLDERS, AND WASTE BINS, RESPIRATORS FOR ARTIFICIAL RESPIRATION, LINENS, MEDICAL GOWNS, SOCKS, PRODUCTS FOR HYGIENE PURPOSES, NAMELY PADS, TEETH CLEANING LOTIONS, AND HAIR BRUSHES, MEDICAL WEARING APPAREL, NAMELY, SCRUB TOPS AND PANTS, BLOOD PRESSURE MEASURING APPARATUS, PILLOWS AND PILLOW CASES, BLANKETS, BED SHEETS, TOWELS, LAB COATS, BEDPANS AND LINERS THEREFOR, SANITIZING WIPES, URINALS, STRETCHERS FOR PATIENT TRANSPORT, DISPOSABLE ADULT AND INFANT DIAPERS, BODY BAGS, PLASTIC SHROUDS AND IDENTIFICATION TAGS THEREFORE, GOGGLES, SHOE COVERS, AND STETHOSCOPES (U.S. CLS. 26, 39 AND 44).

FIRST USE 1-31-2006; IN COMMERCE 1-31-2006. CHRIS WELLS, EXAMINING ATTORNEY

CLASS 10—(Continued).

SN 77-796,812. MEDTRONIC, INC., MINNEAPOLIS, MN.
FILED 8-4-2009.

EGIDA

THE MARK CONSISTS OF STANDARD CHARACTERS WITHOUT CLAIM TO ANY PARTICULAR FONT, STYLE, SIZE, OR COLOR.

FOR IMPLANTABLE CARDIAC DEVICES, NAMELY, DEFIBRILLATORS, AND PARTS THEREFOR (U.S. CLS. 26, 39 AND 44).

INGRID C. EULIN, EXAMINING ATTORNEY

SN 77-809,621. RICCHIO, DOMINIC A., KENOSHA, WI.
FILED 8-20-2009.

SPA BED

THE MARK CONSISTS OF STANDARD CHARACTERS WITHOUT CLAIM TO ANY PARTICULAR FONT, STYLE, SIZE, OR COLOR.

NO CLAIM IS MADE TO THE EXCLUSIVE RIGHT TO USE "BED", APART FROM THE MARK AS SHOWN.

FOR ELECTRIC BODY FLOTATION DRY HYDRO MASSAGE APPARATUS (U.S. CLS. 26, 39 AND 44).

FIRST USE 11-7-1995; IN COMMERCE 11-7-1995.
JENNIFER DIXON, EXAMINING ATTORNEY

SN 77-818,627. IDEXX LABORATORIES, INC., WEST-BROOK, ME. FILED 9-2-2009.

IDEXX PROCYTE DX

THE MARK CONSISTS OF STANDARD CHARACTERS WITHOUT CLAIM TO ANY PARTICULAR FONT, STYLE, SIZE, OR COLOR.

OWNER OF U.S. REG. NOS. 3,459,737, 3,496,074 AND OTHERS.

NO CLAIM IS MADE TO THE EXCLUSIVE RIGHT TO USE "DX", APART FROM THE MARK AS SHOWN.

THE WORDING "PROCYTE" HAS NO MEANING IN A FOREIGN LANGUAGE.

FOR MEDICAL INSTRUMENTS, NAMELY, APPARATUS FOR BLOOD ANALYSIS THROUGH LASER FLOW CYTOMETRY FOR IN-CLINIC VETERINARY USE (U.S. CLS. 26, 39 AND 44).

MAUREEN DALL, EXAMINING ATTORNEY

CLASS 10—(Continued).

SN 77-818,673. IDEXX LABORATORIES, INC., WEST-BROOK, ME. FILED 9-2-2009.

PROCYTE DX

THE MARK CONSISTS OF STANDARD CHARACTERS WITHOUT CLAIM TO ANY PARTICULAR FONT, STYLE, SIZE, OR COLOR.

OWNER OF U.S. REG. NOS. 3,459,737, 3,459,738 AND OTHERS.

NO CLAIM IS MADE TO THE EXCLUSIVE RIGHT TO USE "DX", APART FROM THE MARK AS SHOWN.

THE WORDING "PROCYTE" HAS NO MEANING IN A FOREIGN LANGUAGE.

FOR MEDICAL INSTRUMENTS, NAMELY, APPARATUS FOR BLOOD ANALYSIS THROUGH LASER FLOW CYTOMETRY FOR IN-CLINIC VETERINARY USE (U.S. CLS. 26, 39 AND 44).

MAUREEN DALL, EXAMINING ATTORNEY

SN 77-819,290. GENAIREX, INC., CLEARWATER, FL. FILED 9-3-2009.

Securi-T

THE MARK CONSISTS OF STANDARD CHARACTERS WITHOUT CLAIM TO ANY PARTICULAR FONT, STYLE, SIZE, OR COLOR.

FOR OSTOMY BAGS AND POUCHES, PARTICULARLY COLOSTOMY, UROSTOMY, AND ILEOSTOMY BAGS AND POUCHES; OSTOMY SEALS, FLANGES AND BARRIER RINGS; ALL OF THE FOREGOING FOR MEDICAL PURPOSES AND MEDICAL PARTS, AND FITTINGS FOR THE AFORESAID GOODS (U.S. CLS. 26, 39 AND 44).

FIRST USE 2-1-2001; IN COMMERCE 2-1-2001.
ELLEN PERKINS, EXAMINING ATTORNEY

SN 77-819,766. FENWICK HEARING INSTRUMENTS, PORTLAND, OR. FILED 9-3-2009.

FHI-3000

THE MARK CONSISTS OF STANDARD CHARACTERS WITHOUT CLAIM TO ANY PARTICULAR FONT, STYLE, SIZE, OR COLOR.

FOR DIGITAL HEARING AID (U.S. CLS. 26, 39 AND 44).

FIRST USE 8-1-2009; IN COMMERCE 8-1-2009.
CHRISIE B. KING, EXAMINING ATTORNEY

CLASS 10—(Continued).

SN 77-825,894. ANDERSON, MARK L., SPRING VALLEY, WI. FILED 9-14-2009.

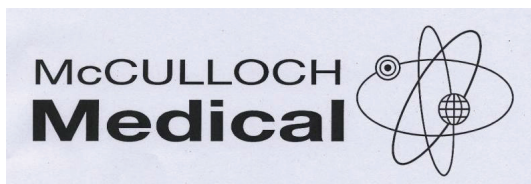

NO CLAIM IS MADE TO THE EXCLUSIVE RIGHT TO USE "MEDICAL", APART FROM THE MARK AS SHOWN.

THE MARK CONSISTS OF THE WORDS "MCCULLOCH" (ALL IN CAPITAL LETTERS, WITH THE EXCEPTION OF THE FIRST "C") "MEDICAL" (INITIAL CAPITAL LETTER ONLY WITH THE REST OF THE WORD BEING IN LOWER CASE), THE WORD "MCCULLOCH" BEING ON TOP OF THE WORD "MEDICAL". TO THE RIGHT OF THE WORDS IS A DESIGN WHICH CONSISTS OF THREE CIRCLES DEPICTING A SOLAR SYSTEM WITH TWO SMALL CIRCLES DEPICTING PLANETS, THE LARGER OF THE TWO HAVING THREE HORIZONTAL LINES AND THREE VERTICAL LINES INSIDE, THE SMALLER OF THE TWO HAVING A CIRCLE INSIDE WITH A DOT IN THE MIDDLE.

FOR VETERINARY MEDICAL DEVICE, NAMELY, ASPIRATOR/RESUSCITATOR FOR CLEARING AND PUMPING AIR INTO AIRWAY PASSAGES IN YOUNG ANIMALS (U.S. CLS. 26, 39 AND 44).

FIRST USE 1-1-1994; IN COMMERCE 1-1-1994.

ANGELA M. MICHELI, EXAMINING ATTORNEY

CLASS 10—(Continued).

SN 77-826,995. AUGMENIX, INC., WALTHAM, MA. FILED 9-15-2009.

AUGMENIX

THE MARK CONSISTS OF STANDARD CHARACTERS WITHOUT CLAIM TO ANY PARTICULAR FONT, STYLE, SIZE, OR COLOR.

FOR PHARMACEUTICAL PREPARATIONS IN THE NATURE OF IMPLANTABLE MATERIALS, NAMELY, PLIABLE, SYNTHETIC HYDROGEL FOR MEDICAL AND SURGICAL PURPOSES; KITS THAT CONTAIN THE HYDROGEL AND/OR POLYMERS THAT REACT TO FORM THE HYDROGEL WHEN COMBINED WITH EACH OTHER AND APPLICATORS THEREFORE FOR USE IN MEDICAL AND SURGICAL PROCEDURES; AND SURGICAL AND MEDICAL APPARATUSES AND INSTRUMENTS (U.S. CLS. 26, 39 AND 44).

KATHERINE STOIDES, EXAMINING ATTORNEY

SN 77-829,705. THINKLABS MEDICAL LLC, CENTENNIAL, CO. FILED 9-18-2009.

SN 77-826,980. AUGMENIX, INC., WALTHAM, MA. FILED 9-15-2009.

SPACEOAR

THE MARK CONSISTS OF STANDARD CHARACTERS WITHOUT CLAIM TO ANY PARTICULAR FONT, STYLE, SIZE, OR COLOR.

FOR PHARMACEUTICAL PREPARATIONS IN THE NATURE OF IMPLANTABLE MATERIALS, NAMELY, PLIABLE, SYNTHETIC HYDROGEL FOR MEDICAL AND SURGICAL PURPOSES; KITS THAT CONTAIN THE HYDROGEL AND/OR POLYMERS THAT REACT TO FORM THE HYDROGEL WHEN COMBINED WITH EACH OTHER AND APPLICATORS THEREFORE FOR USE IN MEDICAL AND SURGICAL PROCEDURES; AND SURGICAL AND MEDICAL APPARATUSES AND INSTRUMENTS (U.S. CLS. 26, 39 AND 44).

KATHERINE STOIDES, EXAMINING ATTORNEY

THE MARK CONSISTS OF STANDARD CHARACTERS WITHOUT CLAIM TO ANY PARTICULAR FONT, STYLE, SIZE, OR COLOR.

NO CLAIM IS MADE TO THE EXCLUSIVE RIGHT TO USE "DEVICES", APART FROM THE MARK AS SHOWN.

FOR EKG MACHINES; INTEGRATED MEDICAL EXAMINATION SYSTEMS COMPRISING MEDICAL DEVICES AND COMPUTER SOFTWARE FOR INFORMATION MANAGEMENT FOR USE IN WEB-BASED PHYSICAL EXAMINATION AND ASSESSMENT OF PATIENTS IN A REMOTE, CLINICAL SETTING; MEDICAL DEVICES FOR MONITORING OXYMETRY, GAS ANALYSIS, VITAL SIGNS, BLOOD PROPERTIES AND RESPIRATORY EVENTS; MEDICAL INSTRUMENTS TO MEASURE BLOOD PRESSURE, CARDIAC OUTPUT AND OTHER PHYSIOLOGICAL AND CARDIOVASCULAR PARAMETERS; MEDICAL PRODUCTS, NAMELY, RESPIRATORY SENSORS; STETHOSCOPES AND SPHYGMOMANOMETERS (U.S. CLS. 26, 39 AND 44).

AMY C. KEAN, EXAMINING ATTORNEY

Devices Without Borders

CLASS 10—(Continued).

SN 77-830,588. CHEWNOODLE, COTATI, CA. FILED 9-20-2009.

Chewnoodle

THE MARK CONSISTS OF STANDARD CHARACTERS WITHOUT CLAIM TO ANY PARTICULAR FONT, STYLE, SIZE, OR COLOR.

FOR THERAPEUTIC DEVICE IN THE NATURE OF A MOTORIZED TUBE ATTACHED TO A LIGHTWEIGHT ALUMINUM CARABINER THAT CAN BE CLIPPED ON TO A SHIRT, BELT LOOP OR STRAP, USED LIKE AN ORAL CHEW TOY TO AID SPECIAL NEEDS CHILDREN IN CHEWING SELF-REGULATION AND JAW MUSCLE STRENGTHENING (U.S. CLS. 26, 39 AND 44).

FIRST USE 9-1-2009; IN COMMERCE 9-15-2009.
NANCY CLARKE, EXAMINING ATTORNEY

CLASS 10—(Continued).

SN 77-850,746. SANOFI-AVENTIS, PARIS, FRANCE, FILED 10-16-2009.

LANTUMETER

THE MARK CONSISTS OF STANDARD CHARACTERS WITHOUT CLAIM TO ANY PARTICULAR FONT, STYLE, SIZE, OR COLOR.

PRIORITY CLAIMED UNDER SEC. 44(D) ON FRANCE APPLICATION NO. 093660312, FILED 6-26-2009, REG. NO. 093660312, DATED 6-26-2009, EXPIRES 6-26-2019.

OWNER OF U.S. REG. NOS. 2,183,182 AND 3,166,325.

FOR MEDICAL MONITORS FOR THE DETECTION, MEASUREMENT AND MONITORING OF PHYSIOLOGICAL SUBSTANCES (U.S. CLS. 26, 39 AND 44).

DAVID ELTON, EXAMINING ATTORNEY

SN 77-850,852. INCEPT BIOSYSTEMS, INC., ANN ARBOR, MI. FILED 10-16-2009.

SMART START

SN 77-835,073. MICROAIRE SURGICAL INSTRUMENTS, LLC, AKA MICROAIRE, CHARLOTTESVILLE, VA. FILED 9-25-2009.

LipoSculptor

THE MARK CONSISTS OF STANDARD CHARACTERS WITHOUT CLAIM TO ANY PARTICULAR FONT, STYLE, SIZE, OR COLOR.

FOR SURGICAL EQUIPMENT FOR USE WITH LIPO-SUCTION, LIPOLYSIS, LIPOPLASTY AND LIPO INJECTION AND REINJECTION; CANNULAE; SURGICAL APPARATUS AND INSTRUMENTS FOR USE IN LIPO-SUCTION LIPOLYSIS, LIPOPLASTY AND LIPO INJECTION AND REINJECTION, NAMELY, HANDLES FOR RECEIVING CANNULAE; ASPIRATION UNITS, NAMELY, ASPIRATORS FOR USE DURING LIPO-SUCTION, LIPOLYSIS, LIPOPLASTY AND LIPO INJECTION AND REINJECTION; SURGICAL APPARATUS AND INSTRUMENTS FOR USE IN LIPO-SUCTION LIPOLYSIS, LIPOPLASTY AND LIPO INJECTION AND REINJECTION, NAMELY, TUMESCENT INFILTRATION UNITS; SURGICAL APPARATUS AND INSTRUMENTS, NAMELY, INFUSION PUMPS; FILTERS, NAMELY, FILTERS FOR ASPIRATION UNITS; TUBING, NAMELY, TUBING FOR USE WITH CANNULAS (U.S. CLS. 26, 39 AND 44).

RICHARD WHITE, EXAMINING ATTORNEY

THE MARK CONSISTS OF STANDARD CHARACTERS WITHOUT CLAIM TO ANY PARTICULAR FONT, STYLE, SIZE, OR COLOR.

FOR LABORATORY EQUIPMENT FOR CLINICAL MEDICAL USE, NAMELY, A CULTURE SYSTEM CONSISTING PRIMARILY OF A PUMP AND CARTRIDGE FOR HOLDING EMBRYOS AND CULTURING MEDIA WHICH SUPPORTS THE GROWTH OF EMBRYOS FOR IN-VITRO FERTILIZATION PROCEDURES (U.S. CLS. 26, 39 AND 44).

FIRST USE 11-11-2009; IN COMMERCE 11-11-2009.
JULIE WATSON, EXAMINING ATTORNEY

SN 77-852,001. EDRD ENTERPRISES, INC, SUNLAND, CA. FILED 10-19-2009.

ED Loop

THE MARK CONSISTS OF STANDARD CHARACTERS WITHOUT CLAIM TO ANY PARTICULAR FONT, STYLE, SIZE, OR COLOR.

NO CLAIM IS MADE TO THE EXCLUSIVE RIGHT TO USE "ED", APART FROM THE MARK AS SHOWN.

FOR CONSTRICTION RINGS FOR USE IN MAINTAINING PENILE RIGIDITY IN MEN WITH ERECTILE DYSFUNCTION (U.S. CLS. 26, 39 AND 44).

DOMINIC J. FERRAIUOLO, EXAMINING ATTORNEY

CLASS 10—(Continued).

SN 77-863,451. MOTION CONTROL, INC., SALT LAKE CITY, UT. FILED 11-3-2009.

MOTION FOOT

THE MARK CONSISTS OF STANDARD CHARACTERS WITHOUT CLAIM TO ANY PARTICULAR FONT, STYLE, SIZE, OR COLOR.

NO CLAIM IS MADE TO THE EXCLUSIVE RIGHT TO USE "FOOT", APART FROM THE MARK AS SHOWN.

FOR FOOT AND ANKLE PROSTHESES, NAMELY, NON-IMPLANTABLE, EXTERNAL FOOT AND ANKLE PROSTHESES (U.S. CLS. 26, 39 AND 44).

FIRST USE 9-24-2009; IN COMMERCE 10-8-2009.
DEIRDRE ROBERTSON, EXAMINING ATTORNEY

SN 77-863,453. MOTION CONTROL, INC., SALT LAKE CITY, UT. FILED 11-3-2009.

MOTION KNEE

THE MARK CONSISTS OF STANDARD CHARACTERS WITHOUT CLAIM TO ANY PARTICULAR FONT, STYLE, SIZE, OR COLOR.

NO CLAIM IS MADE TO THE EXCLUSIVE RIGHT TO USE "KNEE", APART FROM THE MARK AS SHOWN.

FOR KNEE PROSTHESES, NAMELY, NON-IMPLANTABLE, EXTERNAL KNEE PROSTHESES (U.S. CLS. 26, 39 AND 44).

DEIRDRE ROBERTSON, EXAMINING ATTORNEY

SN 77-863,727. GLENVEIGH SURGICAL, LLC, CHATTANOOGA, TN. FILED 11-3-2009.

EBB

THE MARK CONSISTS OF STANDARD CHARACTERS WITHOUT CLAIM TO ANY PARTICULAR FONT, STYLE, SIZE, OR COLOR.

FOR MEDICAL APPARATUS, DEVICES AND INSTRUMENTS, NAMELY, TAMPONADE BALLOON DEVICES FOR USE IN OBSTETRICS AND GYNECOLOGY (U.S. CLS. 26, 39 AND 44).

JOHN DALIER, EXAMINING ATTORNEY

CLASS 10—(Continued).

SN 77-873,805. DURA-METRICS, SANTA ROSA, CA. FILED 11-16-2009.

PUREZIR

THE MARK CONSISTS OF STANDARD CHARACTERS WITHOUT CLAIM TO ANY PARTICULAR FONT, STYLE, SIZE, OR COLOR.

THE WORDING "PUREZIR" HAS NO MEANING IN A FOREIGN LANGUAGE.

FOR DENTAL CROWNS (U.S. CLS. 26, 39 AND 44).
AMEEN IMAM, EXAMINING ATTORNEY

SN 77-874,867. MILLER, LINDA T., WYNCOTE, PA. FILED 11-17-2009.

**THE FUTURE OF COMPRESSION
THERAPY TODAY**

THE MARK CONSISTS OF STANDARD CHARACTERS WITHOUT CLAIM TO ANY PARTICULAR FONT, STYLE, SIZE, OR COLOR.

FOR MEDICAL VASOPNEUMATIC DEVICES USED TO TREAT VASCULAR DISORDERS (U.S. CLS. 26, 39 AND 44).

ALEXANDER L. POWERS, EXAMINING ATTORNEY

CLASS 10—(Continued).

SN 77-881,643. GALEMED CORPORATION, TAIPEI 114, TAIWAN, FILED 11-28-2009.

VENTI.Plus

THE MARK CONSISTS OF THE HIGHLY STYLIZED LETTERING "VENTI.PLUS" WHERE THE "." BETWEEN THE LETTERS "VENTI" AND "PLUS" IS FORMED BY A CIRCLE HAVING AN ARCUATE BAR PASSING THEREIN AND THE "I" IS FORMED OF A CARICATURE OF A HUMAN SHAPE WITH THE WITH A DOT REPRESENTING THE HEAD.

FOR ANESTHETIC MASKS; ANESTHETIC DELIVERY APPARATUS; APPARATUS FOR ARTIFICIAL RESPIRATION; AEROSOL DISPENSERS FOR MEDICAL USE; CANNULAE; CATHETERS AND PARTS AND FITTINGS THEREFOR; CPR (CARDIOPULMONARY RESUSCITATION) MASKS; HYPERBARIC OXYGEN CHAMBERS FOR MEDICAL PURPOSES; INHALERS FOR THERAPEUTIC USE, SOLD EMPTY; INHALERS FOR MEDICAL PURPOSES, SOLD EMPTY; RESPIRATORY MASKS FOR MEDICAL USE; RESPIRATORY MASKS FOR MEDICAL PURPOSES, NAMELY, CONSTANT POSITIVE AIRWAY PRESSURE (CPAP) MASK; MEDICAL APPARATUS, NAMELY, ELECTRIC HEATING DEVICES FOR CURATIVE TREATMENT; MEDICAL DEVICE, NAMELY, CARBON DIOXIDE INDICATORS; NEBULIZERS FOR RESPIRATION THERAPY; OXYGEN MASKS FOR MEDICAL USE; OXYGEN CONCENTRATORS FOR MEDICAL APPLICATIONS; RESPIRATORY MASKS FOR MEDICAL PURPOSES; SUCTION CUPS FOR MEDICAL PURPOSES; VENTILATORS AND ANESTHESIA MACHINES FOR USE IN PATIENT CARE (U.S. CLS. 26, 39 AND 44).

FIRST USE 9-15-2009; IN COMMERCE 10-7-2009.
KAELE KUNG, EXAMINING ATTORNEY

CLASS 10—(Continued).

SN 77-884,719. PRESTIGE AMERITECH. LTD., FORT WORTH, TX. FILED 12-2-2009.

IMPRINTS

THE MARK CONSISTS OF STANDARD CHARACTERS WITHOUT CLAIM TO ANY PARTICULAR FONT, STYLE, SIZE, OR COLOR.

FOR SURGICAL MASKS (U.S. CLS. 26, 39 AND 44).
MEGHAN REINHART, EXAMINING ATTORNEY

SN 77-886,715. PATHWAY MEDICAL TECHNOLOGIES, INC., KIRKLAND, WA. FILED 12-4-2009.

PATHWAY JETWIRE

THE MARK CONSISTS OF STANDARD CHARACTERS WITHOUT CLAIM TO ANY PARTICULAR FONT, STYLE, SIZE, OR COLOR.

OWNER OF U.S. REG. NOS. 3,447,578, 3,648,666 AND OTHERS.

FOR MEDICAL DEVICES, NAMELY, INTERVENTIONAL GUIDEWIRES (U.S. CLS. 26, 39 AND 44).
WENDY JUN, EXAMINING ATTORNEY

SN 77-884,716. PRESTIGE AMERITECH. LTD., FORT WORTH, TX. FILED 12-2-2009.

PROGEAR

THE MARK CONSISTS OF STANDARD CHARACTERS WITHOUT CLAIM TO ANY PARTICULAR FONT, STYLE, SIZE, OR COLOR.

FOR MASKS FOR USE BY MEDICAL PERSONNEL (U.S. CLS. 26, 39 AND 44).

FIRST USE 4-10-2009; IN COMMERCE 4-10-2009.
MEGHAN REINHART, EXAMINING ATTORNEY

SN 77-886,938. PULSE TRACER TECHNOLOGIES INC, DBA LIFESTYLEADVANCE.COM, VANCOUVER BC, CANADA, FILED 12-4-2009.

LifescoreM1

THE MARK CONSISTS OF STANDARD CHARACTERS WITHOUT CLAIM TO ANY PARTICULAR FONT, STYLE, SIZE, OR COLOR.

FOR HEART MONITOR (U.S. CLS. 26, 39 AND 44).

FIRST USE 12-2-2009; IN COMMERCE 12-2-2009.
KATHERINE STOIDES, EXAMINING ATTORNEY

CLASS 10—(Continued).

SN 77-887,004. KISS LIFE LLC, JENSEN BEACH, FL. FILED 12-5-2009.

CRANIOCRADLE

THE MARK CONSISTS OF STANDARD CHARACTERS WITHOUT CLAIM TO ANY PARTICULAR FONT, STYLE, SIZE, OR COLOR.

FOR APPARATUS FOR ACUPRESSURE THERAPY; CERVICAL PILLOWS FOR MEDICAL USE; EXERCISE MACHINES FOR THERAPEUTIC PURPOSES; MANUALLY-OPERATED EXERCISE EQUIPMENT FOR PHYSICAL THERAPY PURPOSES; MEDICAL PRODUCTS, NAMELY, THERAPEUTIC MATTRESS SUPPORT (U.S. CLS. 26, 39 AND 44).

CAROLYN CATALDO, EXAMINING ATTORNEY

CLASS 10—(Continued).

SN 77-887,414. PATTON MEDICAL SERVICES, LP, AUSTIN, TX. FILED 12-7-2009.

I-PORT ADVANCE

THE MARK CONSISTS OF STANDARD CHARACTERS WITHOUT CLAIM TO ANY PARTICULAR FONT, STYLE, SIZE, OR COLOR.

OWNER OF U.S. REG. NO. 3,276,397.
NO CLAIM IS MADE TO THE EXCLUSIVE RIGHT TO USE "ADVANCE", APART FROM THE MARK AS SHOWN. FOR INFUSION DEVICE FOR ADMINISTERING DRUGS (U.S. CLS. 26, 39 AND 44).

FIRST USE 8-4-2009; IN COMMERCE 8-4-2009.
TRACY WHITTAKER-BROWN, EXAMINING ATTORNEY

SN 77-887,050. HEWIT MEDICAL, LLC, TEMPE, AZ. FILED 12-5-2009.

PREPREP

THE MARK CONSISTS OF STANDARD CHARACTERS WITHOUT CLAIM TO ANY PARTICULAR FONT, STYLE, SIZE, OR COLOR.

FOR DISPOSABLE MEDICAL STERILIZATION POUCHES (U.S. CLS. 26, 39 AND 44).

FIRST USE 8-28-2009; IN COMMERCE 12-3-2009.
LAURIE MAYES, EXAMINING ATTORNEY

SN 77-887,808. FERNDALE IP, INC., FERNDALE, MI. FILED 12-7-2009.

VENAPREP

THE MARK CONSISTS OF STANDARD CHARACTERS WITHOUT CLAIM TO ANY PARTICULAR FONT, STYLE, SIZE, OR COLOR.

FOR MEDICAL DEVICES, NAMELY, SKIN ABLATORS (U.S. CLS. 26, 39 AND 44).

HEATHER THOMPSON, EXAMINING ATTORNEY

SN 77-887,272. MARCHETTI, KELLY, NATICK, MA. FILED 12-7-2009.

RE:BOOT

THE MARK CONSISTS OF STANDARD CHARACTERS WITHOUT CLAIM TO ANY PARTICULAR FONT, STYLE, SIZE, OR COLOR.

FOR DECORATIVE OR WATER REPELLANT COVERS FOR ORTHOPEDIC IMMOBILIZATION DEVICES (U.S. CLS. 26, 39 AND 44).

ELISSA GARBER KON, EXAMINING ATTORNEY

SN 77-887,916. PIVOT MEDICAL, INC., SUNNYVALE, CA. FILED 12-7-2009.

SAMURAI

THE MARK CONSISTS OF STANDARD CHARACTERS WITHOUT CLAIM TO ANY PARTICULAR FONT, STYLE, SIZE, OR COLOR.

FOR MEDICAL INSTRUMENTS, NAMELY, SURGICAL BLADES (U.S. CLS. 26, 39 AND 44).

JAMES MACFARLANE, EXAMINING ATTORNEY

CLASS 10—(Continued).

SN 77-888,035. SUPERFEET WORLDWIDE, INC., FERNDALE, WA. FILED 12-7-2009.

SUPERFEET

THE MARK CONSISTS OF STANDARD CHARACTERS WITHOUT CLAIM TO ANY PARTICULAR FONT, STYLE, SIZE, OR COLOR.

OWNER OF U.S. REG. NOS. 1,430,999, 1,543,393 AND 1,901,654.

FOR ORTHOTIC INSERTS FOR FOOTWEAR (U.S. CLS. 26, 39 AND 44).

FIRST USE 9-0-2007; IN COMMERCE 9-0-2007.
KELLY CHOE, EXAMINING ATTORNEY

SN 77-888,055. SUPERFEET WORLDWIDE, INC., FERNDALE, WA. FILED 12-7-2009.

EVERY SHOE. EVERY DAY.

THE MARK CONSISTS OF STANDARD CHARACTERS WITHOUT CLAIM TO ANY PARTICULAR FONT, STYLE, SIZE, OR COLOR.

OWNER OF U.S. REG. NO. 3,355,746.

FOR ORTHOTIC INSERTS FOR FOOTWEAR (U.S. CLS. 26, 39 AND 44).

KELLY CHOE, EXAMINING ATTORNEY

SN 77-888,396. S&G IMPORTS, HOUSTON, TX. FILED 12-8-2009.

BOOZEMATIC

THE MARK CONSISTS OF STANDARD CHARACTERS WITHOUT CLAIM TO ANY PARTICULAR FONT, STYLE, SIZE, OR COLOR.

FOR ALCOHOL BREATH TESTING UNITS; BREATH GAS ANALYZERS FOR MEDICAL DIAGNOSTICS (U.S. CLS. 26, 39 AND 44).

FIRST USE 10-23-2009; IN COMMERCE 10-30-2009.
JASON LOTT, EXAMINING ATTORNEY

CLASS 10—(Continued).

SN 77-888,895. JOHN MAROTTA, DENVER, CO. FILED 12-8-2009.

Emerge Surgical

THE MARK CONSISTS OF STANDARD CHARACTERS WITHOUT CLAIM TO ANY PARTICULAR FONT, STYLE, SIZE, OR COLOR.

NO CLAIM IS MADE TO THE EXCLUSIVE RIGHT TO USE "SURGICAL", APART FROM THE MARK AS SHOWN.

FOR MEDICAL APPARATUS AND INSTRUMENTS FOR USE IN ORTHOPEDIC SURGERY (U.S. CLS. 26, 39 AND 44).

KELLY CHOE, EXAMINING ATTORNEY

SN 77-889,105. CARROLL. WILLIAM, DBA CODA PUBLICATIONS, MCKINLEYVILLE, CA. FILED 12-8-2009.

SaunaSaver

THE MARK CONSISTS OF STANDARD CHARACTERS WITHOUT CLAIM TO ANY PARTICULAR FONT, STYLE, SIZE, OR COLOR.

FOR THERAPEUTIC SAUNAS (U.S. CLS. 26, 39 AND 44).

NICHOLAS ALTREE, EXAMINING ATTORNEY

SN 77-889,384. JOHN MAROTTA, DENVER, CO. FILED 12-9-2009.



THE MARK DESCRIPTION IS AMENDED AS FOLLOWS: THE MARK CONSISTS OF THE LETTER "E" INCORPORATING A "+" SYMBOL, AND BENEATH APPEARS A HALF CIRCLE OR MOON SHAPE DESIGN.

FOR MEDICAL APPARATUS AND INSTRUMENTS FOR USE IN ORTHOPEDIC SURGERY (U.S. CLS. 26, 39 AND 44).

KELLY CHOE, EXAMINING ATTORNEY

CLASS 10—(Continued).

SN 77-889,500. AXIS DENTAL CORPORATION, COPPELL, TX. FILED 12-9-2009.

PROGLOSS

THE MARK CONSISTS OF STANDARD CHARACTERS WITHOUT CLAIM TO ANY PARTICULAR FONT, STYLE, SIZE, OR COLOR.

FOR DENTAL INSTRUMENTS, NAMELY, FINISHERS AND POLISHERS FOR USE ON TEETH AND DENTAL COMPOSITES (U.S. CLS. 26, 39 AND 44).
MARY ROSSMAN, EXAMINING ATTORNEY

SN 77-889,875. XR, LLC, HUNTINGTON BEACH, CA. FILED 12-9-2009.

SIZE MATTERS

THE MARK CONSISTS OF STANDARD CHARACTERS WITHOUT CLAIM TO ANY PARTICULAR FONT, STYLE, SIZE, OR COLOR.

FOR ADULT SEXUAL STIMULATION AIDS, NAMELY, PENIS ENLARGERS AND ANATOMICAL EXPANDERS AND ENLARGERS FOR SEXUALLY EROTIC PURPOSES (U.S. CLS. 26, 39 AND 44).
HENRY S. ZAK, EXAMINING ATTORNEY

SN 77-889,945. ATLANTIC FOOTCARE, INC., OAKLAND, RI. FILED 12-9-2009.

Prothotics

THE MARK CONSISTS OF STANDARD CHARACTERS WITHOUT CLAIM TO ANY PARTICULAR FONT, STYLE, SIZE, OR COLOR.

OWNER OF U.S. REG. NO. 3,453,297.
FOR BIOMECHANICALLY DESIGNED FOOT ORTHOSES FOR USE IN TREATMENT OF MANY CLINICAL PATHOLOGIES DIAGNOSED BY FOOTCARE PROFESSIONALS (U.S. CLS. 26, 39 AND 44).
FIRST USE 11-1-1997; IN COMMERCE 3-1-1998.
ALEX KEAM, EXAMINING ATTORNEY

CLASS 10—(Continued).

SN 77-890,290. BECTON, DICKINSON AND COMPANY, FRANKLIN LAKES, NJ. FILED 12-10-2009.

BD Vialon

THE MARK CONSISTS OF STANDARD CHARACTERS WITHOUT CLAIM TO ANY PARTICULAR FONT, STYLE, SIZE, OR COLOR.

OWNER OF U.S. REG. NOS. 442,281, 2,510,232 AND OTHERS.
FOR MEDICAL TUBING AND CATHETERS (U.S. CLS. 26, 39 AND 44).
FIRST USE 12-31-2000; IN COMMERCE 12-31-2000.
SUZANNE BLANE, EXAMINING ATTORNEY

SN 77-891,280. INTELLIGENT MEDICAL INNOVATIONS, SIALKOT, PAKISTAN, FILED 12-11-2009.

GERATI

THE MARK CONSISTS OF THE TERM "GERATI" IN STYLIZED LETTERING.
FOR MEDICAL AND SURGICAL LAPAROSCOPES (U.S. CLS. 26, 39 AND 44).
FIRST USE 11-18-2009; IN COMMERCE 11-18-2009.
KAREN K. BUSH, EXAMINING ATTORNEY

SN 77-891,764. MEDISCA INC., PLATTSBURGH, NY. FILED 12-11-2009.

ORADOSE

THE MARK CONSISTS OF STANDARD CHARACTERS WITHOUT CLAIM TO ANY PARTICULAR FONT, STYLE, SIZE, OR COLOR.

FOR ORAL DISPENSING SYRINGES (U.S. CLS. 26, 39 AND 44).
ANDREA BUTLER, EXAMINING ATTORNEY

CLASS 10—(Continued).

SN 77-892,170. IMESH SURGICAL, INC., SHELBURNE, VT.
FILED 12-12-2009.

iMesh

THE MARK CONSISTS OF STANDARD CHARACTERS WITHOUT CLAIM TO ANY PARTICULAR FONT, STYLE, SIZE, OR COLOR.

FOR SURGICAL IMPLANTS COMPRISING ARTIFICIAL MATERIAL AND ASSOCIATED SURGICAL INSTRUMENT SETS (U.S. CLS. 26, 39 AND 44).
STEVEN R. FINE, EXAMINING ATTORNEY

CLASS 10—(Continued).

SN 77-894,459. CONCEPTUS, INC., MOUNTAIN VIEW, CA.
FILED 12-16-2009.

ESSURETRAC

THE MARK CONSISTS OF STANDARD CHARACTERS WITHOUT CLAIM TO ANY PARTICULAR FONT, STYLE, SIZE, OR COLOR.

OWNER OF U.S. REG. NOS. 2,719,977, 2,725,358 AND OTHERS.

FOR MEDICAL DEVICE USED IN THE INSERTION OF A NON-SURGICAL PERMANENT BIRTH-CONTROL DEVICE FOR WOMEN INTO A CHANNEL OF A SCOPE FOR USE IN THE FIELD OF MINIMALLY INVASIVE GYNECOLOGICAL PROCEDURES (U.S. CLS. 26, 39 AND 44).
SUSAN RICHARDS, EXAMINING ATTORNEY

SN 77-892,781. SURMODICS, INC., EDEN PRAIRIE, MN.
FILED 12-14-2009.

I-VATION

THE MARK CONSISTS OF STANDARD CHARACTERS WITHOUT CLAIM TO ANY PARTICULAR FONT, STYLE, SIZE, OR COLOR.

FOR OCULAR IMPLANTS FOR DRUG DELIVERY TO THE EYE (U.S. CLS. 26, 39 AND 44).
MATTHEW EINSTEIN, EXAMINING ATTORNEY

SN 77-897,824. BIONIX DEVELOPMENT CORPORATION,
TOLEDO, OH. FILED 12-21-2009.



THE MARK CONSISTS OF THE WORDS "OMNI V" WITH RADIALLY EXTENDING LINES ON THE LETTER "O".

FOR MEDICAL DEVICES FOR POSITIONING EXTERNAL PARTS OF THE BODY DURING NON-SURGICAL MEDICAL PROCEDURES SUCH AS RADIATION THERAPY (U.S. CLS. 26, 39 AND 44).
STEVEN PEREZ, EXAMINING ATTORNEY

SN 77-893,333. CARROLL. WILLIAM, MCKINLEYVILLE,
CA. FILED 12-14-2009.

SaunaSaver+

THE MARK CONSISTS OF STANDARD CHARACTERS WITHOUT CLAIM TO ANY PARTICULAR FONT, STYLE, SIZE, OR COLOR.

FOR THERAPEUTIC SAUNAS (U.S. CLS. 26, 39 AND 44).
NICHOLAS ALTREE, EXAMINING ATTORNEY

SN 77-902,480. LIBERTY HOME PRODUCTS, TUSTIN, CA.
FILED 12-29-2009.

E-Z BLOK

THE MARK CONSISTS OF STANDARD CHARACTERS WITHOUT CLAIM TO ANY PARTICULAR FONT, STYLE, SIZE, OR COLOR.

NO CLAIM IS MADE TO THE EXCLUSIVE RIGHT TO USE "BLOK", APART FROM THE MARK AS SHOWN.

FOR HANDHELD PLASTIC DEVICE USED IN DENTAL PROCEDURES TO PROP OPEN THE MOUTH AND PROTECT THE TONGUE (U.S. CLS. 26, 39 AND 44).
FIRST USE 12-6-2009; IN COMMERCE 12-6-2009.

VERNA BETH RIRIE, EXAMINING ATTORNEY

CLASS 10—(Continued).

SN 77-903,476. OSSUR HF, REYKJAVIK, ICELAND, FILED 12-31-2009.

UNLOADER

THE MARK CONSISTS OF STANDARD CHARACTERS WITHOUT CLAIM TO ANY PARTICULAR FONT, STYLE, SIZE, OR COLOR.

OWNER OF U.S. REG. NOS. 1,690,007, 2,161,047 AND 3,632,596.

FOR MEDICAL KNEE BRACES (U.S. CLS. 26, 39 AND 44).

ANGELA M. MICHELI, EXAMINING ATTORNEY

SN 77-909,688. FERNDALE IP, INC., FERNDALE, MI. FILED 1-12-2010.

VENASITE

THE MARK CONSISTS OF STANDARD CHARACTERS WITHOUT CLAIM TO ANY PARTICULAR FONT, STYLE, SIZE, OR COLOR.

FOR MEDICAL DEVICES, NAMELY, SKIN ABLATORS (U.S. CLS. 26, 39 AND 44).

HEATHER THOMPSON, EXAMINING ATTORNEY

SN 77-911,738. RMO, INC., DENVER, CO. FILED 1-14-2010.

FLI

THE MARK CONSISTS OF STANDARD CHARACTERS WITHOUT CLAIM TO ANY PARTICULAR FONT, STYLE, SIZE, OR COLOR.

FOR ORTHODONTIC APPARATUS AND APPLIANCES, NAMELY, BRACKETS AND TUBES (U.S. CLS. 26, 39 AND 44).

FIRST USE 5-0-2009; IN COMMERCE 5-0-2009.

MARILYN IZZI, EXAMINING ATTORNEY

CLASS 10—(Continued).

SN 77-920,640. INTERSECT ENT, INC., PALO ALTO, CA. FILED 1-26-2010.



THE COLOR(S) RED, PURPLE, CERULEAN, ORANGE, MAROON, DARK BLUE, DARK GREEN, RED-ORANGE AND BLACK IS/ARE CLAIMED AS A FEATURE OF THE MARK.

THE MARK CONSISTS OF TWO INTERSECTING INFINITY SYMBOLS. THE VERTICAL INFINITY SYMBOL IS PRIMARILY DISPLAYED IN RED AND CERULEAN. THE HORIZONTAL INFINITY SYMBOL IS PRIMARILY DISPLAYED IN ORANGE AND PURPLE. WHERE THE RED PORTION OF THE VERTICAL INFINITY SYMBOL INTERSECTS WITH THE HORIZONTAL INFINITY SYMBOL, THE COLORS RED-ORANGE AND MAROON ARE DISPLAYED. WHERE THE CERULEAN PORTION OF THE VERTICAL INFINITY SYMBOL INTERSECTS WITH THE HORIZONTAL INFINITY SYMBOL, THE COLORS DARK GREEN AND DARK BLUE ARE DISPLAYED. THE INTERSECTING POINT OF BOTH INFINITY SYMBOLS IS DISPLAYED IN BLACK.

FOR MEDICAL DEVICES CONSISTING OF ARTIFICIAL MATERIALS FOR THE TREATMENT OF EAR, NOSE, THROAT, SINUS AND RESPIRATORY-RELATED CONDITIONS AND SYMPTOMS, NAMELY, IMPLANTS; DRUG DELIVERY SYSTEMS; SURGICAL DEVICES AND INSTRUMENTS (U.S. CLS. 26, 39 AND 44).

KATHERINE M. DUBRAY, EXAMINING ATTORNEY

SN 77-923,650. AXIS DENTAL CORPORATION, COPPELL, TX. FILED 1-29-2010.

ZIR-CUT

THE MARK CONSISTS OF STANDARD CHARACTERS WITHOUT CLAIM TO ANY PARTICULAR FONT, STYLE, SIZE, OR COLOR.

FOR ROTARY INSTRUMENTS, NAMELY, DIAMOND AND ENDODONTIC ACCESS BURS AND POLISHERS DESIGNED FOR USE ON ZIRCONIA AND PORCELAIN DENTAL RESTORATIONS (U.S. CLS. 26, 39 AND 44).

FIRST USE 5-1-2006; IN COMMERCE 5-19-2006.

MARY ROSSMAN, EXAMINING ATTORNEY

CLASS 10—(Continued).

SN 77-923,986. PATHWAY MEDICAL TECHNOLOGIES, INC., KIRKLAND, WA. FILED 1-29-2010.

ATHERECTOMY EVOLVED

THE MARK CONSISTS OF STANDARD CHARACTERS WITHOUT CLAIM TO ANY PARTICULAR FONT, STYLE, SIZE, OR COLOR.

NO CLAIM IS MADE TO THE EXCLUSIVE RIGHT TO USE "ATHERECTOMY", APART FROM THE MARK AS SHOWN.

FOR MEDICAL DEVICES, NAMELY, INTERVENTIONAL CATHETERS AND ASSOCIATED COMPONENTS, NAMELY, CONSOLE AND CONTROL POD IN CONNECTION WITH THE OPERATION OF THE INTERVENTIONAL CATHETERS (U.S. CLS. 26, 39 AND 44).
WENDY JUN, EXAMINING ATTORNEY

SN 79-065,746. DIAGENIC ASA, NORWAY, FILED 11-3-2008.



The logo for ADtect features the letters 'AD' in a stylized, rounded, teal font, followed by 'tect' in a black, sans-serif font.

PRIORITY DATE OF 10-21-2008 IS CLAIMED.

OWNER OF INTERNATIONAL REGISTRATION 0994552 DATED 11-3-2008, EXPIRES 11-3-2018.

THE COLOR(S) TURQUOISE AND BLACK IS/ARE CLAIMED AS A FEATURE OF THE MARK.

THE MARK CONSISTS OF THE STYLIZED UPPER CASE LETTERS "AD" APPEARING IN THE COLOR TURQUOISE AND THE STYLIZED LOWER CASE LETTERS "TECT" APPEARING IN THE COLOR BLACK.

FOR MEDICAL BLOOD-BASED DIAGNOSTIC TEST KITS FOR USE IN THE FIELD OF DETECTION OF ALZHEIMER'S DISEASE (U.S. CLS. 26, 39 AND 44).
SUZANNE BLANE, EXAMINING ATTORNEY

SN 79-071,643. SIMONE WALDNER, ITALY, FILED 5-26-2009.



The logo for G-EO Systems features the letters 'G-EO' in a large, bold, black, sans-serif font, followed by 'Systems' in a smaller, black, sans-serif font.

THE MARK CONSISTS OF STANDARD CHARACTERS WITHOUT CLAIM TO ANY PARTICULAR FONT, STYLE, SIZE, OR COLOR.

PRIORITY DATE OF 4-3-2009 IS CLAIMED.

OWNER OF INTERNATIONAL REGISTRATION 1009649 DATED 5-26-2009, EXPIRES 5-26-2019.

NO CLAIM IS MADE TO THE EXCLUSIVE RIGHT TO USE "SYSTEMS", APART FROM THE MARK AS SHOWN.

FOR ORTHOPEDIC DEVICES, NAMELY, GAIT DEVICES TO TRAIN AND SIMULATE DIFFERENT WALKING CONDITIONS FOR REHABILITATION OF NEUROLOGICAL AND ORTHOPEDIC PATIENTS, PARTS THEREOF AND EQUIPMENT, NAMELY, ELECTRONIC STIMULATOR FOR NERVES AND MUSCLES AND VIRTUAL REALITY (VR) AND VIRTUAL SCENARIO (VS) DEVICES FOR SIMULATING DAILY ACTIVITIES (U.S. CLS. 26, 39 AND 44).
JESSICA FATHY, EXAMINING ATTORNEY

CLASS 10—(Continued).

SN 79-071,688. ALIFAX S.P.A. CON SOCIO UNICO, ITALY, FILED 6-12-2009.



The logo for SIDE CAR features the words 'SIDE CAR' in a large, bold, black, sans-serif font.

THE MARK CONSISTS OF STANDARD CHARACTERS WITHOUT CLAIM TO ANY PARTICULAR FONT, STYLE, SIZE, OR COLOR.

PRIORITY DATE OF 4-24-2009 IS CLAIMED.

OWNER OF INTERNATIONAL REGISTRATION 1009792 DATED 6-12-2009, EXPIRES 6-12-2019.

FOR MEDICAL DIAGNOSTIC APPARATUS FOR BACTERIOLOGY AND URINARY SCREENING (U.S. CLS. 26, 39 AND 44).

REGINA DRUMMOND, EXAMINING ATTORNEY

SN 79-072,690. BORT GMBH, WEINSTADT-BENZACH, FED REP GERMANY, FILED 8-7-2009.



The logo for ActiveColor features the words 'ActiveColor' in a bold, black, sans-serif font, with 'Active' in a smaller size than 'Color'.

THE MARK CONSISTS OF STANDARD CHARACTERS WITHOUT CLAIM TO ANY PARTICULAR FONT, STYLE, SIZE, OR COLOR.

PRIORITY DATE OF 3-23-2009 IS CLAIMED.

OWNER OF INTERNATIONAL REGISTRATION 1012639 DATED 8-7-2009, EXPIRES 8-7-2019.

FOR ORTHOPEDIC ARTICLES, NAMELY, CLAVICLE BANDAGES, BACK SUPPORTS AND BANDAGES, CERVICAL SUPPORTS, ELBOW BANDAGES AND ORTHOSES, SHOULDER ORTHOSES, SHOULDER BANDAGES, SHOULDER SUPPORTS, ARM BANDAGES AND ORTHOSES, WRIST BANDAGES AND SUPPORTS, FINGER SUPPORTS, THUMB AND HAND BANDAGES AND SUPPORTS, RIB BELTS, KNEE BANDAGES AND BRACES, KNEE SUPPORTS, AND ANKLE AND FOOT SUPPORTS AND BANDAGES (U.S. CLS. 26, 39 AND 44).

MARCIE MILONE, EXAMINING ATTORNEY

SN 79-073,947. SIMPLUS AB, SWEDEN, FILED 8-20-2009.

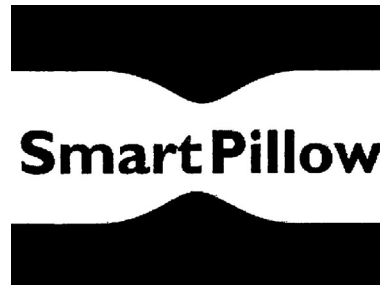

The logo for SmartPillow features a stylized black pillow shape with a white outline, positioned above the words 'SmartPillow' in a bold, black, sans-serif font.

PRIORITY DATE OF 2-23-2009 IS CLAIMED.

OWNER OF INTERNATIONAL REGISTRATION 1016111 DATED 8-20-2009, EXPIRES 8-20-2019.

THE MARK CONSISTS OF THE WORDING "SMARTPILLOW" SUPERIMPOSED ON THE SHAPE OF A PILLOW.

FOR PILLOWS FOR MASSAGE BENCHES, CUSHIONS FOR MEDICAL USE, NAMELY, CUSHIONS FOR MASSAGE BENCHES TO RELIEVE THE PRESSURE ON WOMENS BREASTS (U.S. CLS. 26, 39 AND 44).
LEIGH LOWRY, EXAMINING ATTORNEY

CLASS 11—ENVIRONMENTAL CONTROL APPARATUS

SN 76-696,062. RILIN GROUP, INC., HAUPPAUGE, NY. FILED 3-2-2009.

QUANTUM

THE MARK CONSISTS OF STANDARD CHARACTERS WITHOUT CLAIM TO ANY PARTICULAR FONT, STYLE, SIZE, OR COLOR.

OWNER OF U.S. REG. NOS. 1,668,384 AND 2,356,491. FOR LIGHTING APPARATUS AND INSTALLATIONS, NAMELY, SPOTLIGHTS, FLASHING STROBE LIGHTS (U.S. CLS. 13, 21, 23, 31 AND 34).

FIRST USE 1-17-1978; IN COMMERCE 1-17-1978. KARANENDRA S. CHHINA, EXAMINING ATTORNEY

SN 76-700,723. LAMPLITE, LLC, LOS ANGELES, CA. FILED 12-7-2009.

LAMP LITE

OWNER OF U.S. REG. NO. 2,580,496. SEC. 2(F).

FOR REPLACEMENT LIGHT BULBS FOR LIGHTING APPARATUS, NAMELY, HALOGEN LIGHT BULBS, HALOGEN TRACK LIGHT BULBS, COLORED HALOGEN LIGHT BULBS, DISCHARGE LAMPS AND THEIR FITTINGS, LIGHT BULBS, LED LIGHT BULBS, AND ULTRAVIOLET RAY LAMPS (U.S. CLS. 13, 21, 23, 31 AND 34).

FIRST USE 4-0-1996; IN COMMERCE 4-0-1996. AMY HELLA, EXAMINING ATTORNEY

SN 77-173,214. COMPONENT HARDWARE GROUP, INC., LAKEWOOD, NJ. FILED 5-4-2007.

SANISHOWER

THE MARK CONSISTS OF STANDARD CHARACTERS WITHOUT CLAIM TO ANY PARTICULAR FONT, STYLE, SIZE, OR COLOR.

FOR PLASTIC SHOWERHEADS (U.S. CLS. 13, 21, 23, 31 AND 34).

FIRST USE 6-10-2009; IN COMMERCE 6-10-2009. COLLEEN KEARNEY, EXAMINING ATTORNEY

CLASS 11—(Continued).

SN 77-508,249. AMERICAN DJ SUPPLY, INC., LOS ANGELES, CA. FILED 6-25-2008.

REVO

THE MARK CONSISTS OF STANDARD CHARACTERS WITHOUT CLAIM TO ANY PARTICULAR FONT, STYLE, SIZE, OR COLOR.

FOR ELECTRIC LUMINAIRES FOR ENTERTAINMENT VENUES, INCLUDING LED SPECIAL EFFECTS LIGHTING; ELECTRIC LUMINAIRES THAT PROJECT VARIOUS PATTERNS, DIMENSIONS AND COLORS (U.S. CLS. 13, 21, 23, 31 AND 34).

FIRST USE 6-29-2007; IN COMMERCE 6-29-2007. JOHN KELLY, EXAMINING ATTORNEY

SN 77-571,359. TAYLOR, MICHAEL, ENCINO, CA. FILED 9-16-2008.

JUVELLE

THE MARK CONSISTS OF STANDARD CHARACTERS WITHOUT CLAIM TO ANY PARTICULAR FONT, STYLE, SIZE, OR COLOR.

THE NAME(S), PORTRAIT(S), AND/OR SIGNATURE(S) SHOWN IN THE MARK DOES NOT IDENTIFY A PARTICULAR LIVING INDIVIDUAL.

FOR COMBINED WATER PURIFICATION AND PH BALANCING APPARATUS FOR USE IN THE HOME OR OFFICE (U.S. CLS. 13, 21, 23, 31 AND 34).

FIRST USE 9-15-2008; IN COMMERCE 9-15-2008. JAY BESCH, EXAMINING ATTORNEY

SN 77-598,360. VISION AQUATICS, INC., MOORPARK, CA. FILED 10-22-2008.

TheraStream

THE MARK CONSISTS OF STANDARD CHARACTERS WITHOUT CLAIM TO ANY PARTICULAR FONT, STYLE, SIZE, OR COLOR.

FOR A SINGLE VARIABLE SPEED AXIAL FLOW WATER PUMP WITH DIGITAL CONTROLS, FLOW STRAIGHTENER, AND HORIZONTALLY ORIENTED LAMINAR FLOW DEVICE FOR USE IN AQUATIC THERAPY REHABILITATION AND SPORTS FITNESS RESISTANCE TRAINING (U.S. CLS. 13, 21, 23, 31 AND 34).

FIRST USE 2-25-2007; IN COMMERCE 2-25-2007. ALEXANDER L. POWERS, EXAMINING ATTORNEY

CLASS 11—(Continued).

SN 77-622,964. FIKES PUGET SOUND, INC., KENT, WA. FILED 11-26-2008.



OWNER OF U.S. REG. NOS. 1,857,612 AND 3,341,319. THE MARK CONSISTS OF THE LETTERS "F", "K", "E AND "S", AND AFTER THE "F", A STYLIZED MAN HOLDING A BOX IN HAND SERVING AS THE LETTER "I". FOR DISINFECTANT DISPENSERS FOR TOILETS, ELECTRIC DISPENSERS FOR AIR FRESHENERS AND DEODORIZERS; AIR PURIFYING UNITS, AND DISPENSING UNITS FOR AIR FRESHENERS AND DEODORIZERS FOR COMMERCIAL AND INDUSTRIAL USE; AUTOMATIC FLUSH VALVES FOR URINALS AND COMMODES, AUTO FLUSH SYSTEMS FOR TANK TOILETS COMPRISED OF SENSORS AND VALVES; AND AUTOMATIC SENSOR FAUCET VALVES (U.S. CLS. 13, 21, 23, 31 AND 34).

FIRST USE 11-1-2005; IN COMMERCE 11-1-2005. JENNIFER HETU, EXAMINING ATTORNEY

SN 77-627,682. VENMAR VENTILATION INC., DRUMMONDVILLE, CANADA, FILED 12-5-2008.

EKO

THE MARK CONSISTS OF STANDARD CHARACTERS WITHOUT CLAIM TO ANY PARTICULAR FONT, STYLE, SIZE, OR COLOR.

FOR TURBINE VENTILATION UNITS FOR DOMESTIC AND COMMERCIAL USE; AIR EXCHANGERS FOR CLEANING AND PURIFICATION OF AIR; ENERGY RECOVERY VENTILATORS, APARTMENT VENTILATORS, STOVE VENTILATION HOODS, VENTILATION TURBINE (U.S. CLS. 13, 21, 23, 31 AND 34).

DOMINICK J. SALEMI, EXAMINING ATTORNEY

CLASS 11—(Continued).

SN 77-724,736. AQUASTAR POOL PRODUCTS, INC., RANCHO SANTA MARGARITA, CA. FILED 4-29-2009.

FLOW STAR

THE MARK CONSISTS OF STANDARD CHARACTERS WITHOUT CLAIM TO ANY PARTICULAR FONT, STYLE, SIZE, OR COLOR.

NO CLAIM IS MADE TO THE EXCLUSIVE RIGHT TO USE "FLOW", APART FROM THE MARK AS SHOWN.

FOR SWIMMING POOL DRAIN COVERS; PLUMBING FITTINGS, NAMELY, SWIMMING POOL MAIN DRAINS; SUMP BUCKETS, NAMELY, THE PIT OR BOWL UNDER THE DRAIN COVER ASSEMBLY BEING PARTS OF DRAINS; RETURN PLUMBING FITTINGS FOR USE IN SWIMMING POOLS, NAMELY, DRAINS AND DRAIN COVERS; SUCTION OUTLETS, NAMELY, DRAINS BEING PLUMBING FITTINGS THROUGH WHICH WATER IS DRAWN FROM A POOL OR SPA (U.S. CLS. 13, 21, 23, 31 AND 34).

MATTHEW EINSTEIN, EXAMINING ATTORNEY

SN 77-731,109. SMART LID, LLC, DBA SMART LID, LLC, COLORADO SPRINGS, CO. FILED 5-7-2009.

It remembers to close when
you forget.

THE MARK CONSISTS OF STANDARD CHARACTERS WITHOUT CLAIM TO ANY PARTICULAR FONT, STYLE, SIZE, OR COLOR.

FOR TOILET SEATS (U.S. CLS. 13, 21, 23, 31 AND 34). ALICE BENMAMAN, EXAMINING ATTORNEY

SN 77-734,774. GREEN LIGHTING, LLC, ST. CLOUD, MN. FILED 5-12-2009.

ALPHA-BRITE

THE MARK CONSISTS OF STANDARD CHARACTERS WITHOUT CLAIM TO ANY PARTICULAR FONT, STYLE, SIZE, OR COLOR.

FOR LED LIGHTING, NAMELY, SLOAN LED SIGN MODULES, LED WATERPROOF SIGN MODULES, LED COLOR-JACKETED NEON REPLACEMENT, LED WIRE ROPE LIGHT, LED WALL WASHERS, RGB LED NEON REPLACEMENT, WHITE NEON REPLACEMENT, LED ULTRA-THIN NEON REPLACEMENT, WHITE LED RIBBON FLEX (U.S. CLS. 13, 21, 23, 31 AND 34).

FIRST USE 4-1-2009; IN COMMERCE 4-1-2009.

KHANH LE, EXAMINING ATTORNEY

CLASS 11—(Continued).

SN 77-739,576. CRAFTMADE INTERNATIONAL INC., COPPELL, TX. FILED 5-18-2009.



THE MARK CONSISTS OF THE WORD "PRO" IN SCRIPT LETTERS, WITH THE LETTERS "R" AND "O" CONNECTED TO ONE ANOTHER, WITH A STAR POSITIONED IN THE CENTER OF THE "O".

FOR SPORTS-THEMED CEILING FANS (U.S. CLS. 13, 21, 23, 31 AND 34).

FONG HSU, EXAMINING ATTORNEY

SN 77-753,458. SEARS BRANDS, LLC, HOFFMAN ESTATES, IL. FILED 6-5-2009.



THE MARK CONSISTS OF DESIGN OF A SNOW FLAKE WITH A SPINNING FAN.

FOR REFRIGERATORS AND FREEZERS; COMPONENT FEATURE OF REFRIGERATORS AND FREEZERS THAT QUICKLY CHILLS CONTENTS THEREIN (U.S. CLS. 13, 21, 23, 31 AND 34).

ANDREW LEASER, EXAMINING ATTORNEY

SN 77-755,540. TUNDRA PACKAGING GROUP, LLC, NEE-NAH, WI. FILED 6-9-2009.

TUNDRA

THE MARK CONSISTS OF STANDARD CHARACTERS WITHOUT CLAIM TO ANY PARTICULAR FONT, STYLE, SIZE, OR COLOR.

FOR ICE MELTER, NAMELY, CHEMICAL PREPARATIONS FOR MELTING SNOW AND ICE (U.S. CLS. 13, 21, 23, 31 AND 34).

DAVID I, EXAMINING ATTORNEY

CLASS 11—(Continued).

SN 77-759,190. FERGUSON ENTERPRISES, INC., NEWPORT NEWS, VA. FILED 6-14-2009.

MILAZZO

THE MARK CONSISTS OF STANDARD CHARACTERS WITHOUT CLAIM TO ANY PARTICULAR FONT, STYLE, SIZE, OR COLOR.

FOR PLUMBING FIXTURES, NAMELY, SINKS, PED-ESTAL SINKS, BATH TUBS, BATH TUB JETS, WHIRL-POOL BATHS, BATH INSTALLATIONS; FAUCETS AND FAUCET SPRAYERS; TOILETS AND BIDETS; DRAIN STRUCTURES FOR USE IN SPAS, STEAM ROOMS AND BATHS; SITZ BATHS; SPOUTS FOR AFFIXING ON WALLS FOR BATHS, BASINS, BIDETS; SHOWERS, SHOWER HEADS, HAND HELD SHOWER HEADS, HAND SHOWERS, HAND HELD SHOWERS, SHOWER SPRAYERS, SHOWER HEAD SPRAYERS, SHOWER MIXERS, SHOWER AND BATH CUBICLES, SHOWER BASES, SHOWER CONTROL FITTINGS, NAMELY, ESCUTCHEONS, SHOWER DOORS, SHOWER ENCLOSURES, SHOWER FAUCET EXTENSIONS, SHOWER PANELS, SHOWER SURROUNDS, SHOWER TRAYS, SHOWER TUBS; ELECTRIC TOWEL WARMERS, IN-DOOR ELECTRIC LIGHTING FIXTURES AND CEILING FANS (U.S. CLS. 13, 21, 23, 31 AND 34).

ELLEN B. AWRICH, EXAMINING ATTORNEY

SN 77-765,751. MOEN INCORPORATED, NORTH OLMSTED, OH. FILED 6-23-2009.

BAYSTONE

THE MARK CONSISTS OF STANDARD CHARACTERS WITHOUT CLAIM TO ANY PARTICULAR FONT, STYLE, SIZE, OR COLOR.

FOR TUB/SHOWER DIVERter VALVES; FAUCETS, NAMELY, LAVATORY FAUCETS, KITCHEN FAUCETS, ROMAN TUB FAUCETS AND FAUCET HANDLES; SHOWER AND TUB FIXTURES, NAMELY, TUB SPOUTS AND SHOWER HEADS; SHOWER CONTROL VALVES, TUB/SHOWER CONTROL VALVES; PLUMBING ACCESSORIES, NAMELY, FAUCET SPRAYERS AND KITCHEN SINK SIDE SPRAYERS (U.S. CLS. 13, 21, 23, 31 AND 34).

INGA ERVIN, EXAMINING ATTORNEY

CLASS 11—(Continued).

SN 77-766,909. RAIN HARVESTING PTY. LTD., ROCKLEA, QUEENSLAND, AUSTRALIA, FILED 6-24-2009.

CLEAN RAIN

THE MARK CONSISTS OF STANDARD CHARACTERS WITHOUT CLAIM TO ANY PARTICULAR FONT, STYLE, SIZE, OR COLOR.

OWNER OF AUSTRALIA REG. NO. 1118513, DATED 6-14-2006, EXPIRES 6-14-2016.

NO CLAIM IS MADE TO THE EXCLUSIVE RIGHT TO USE "RAIN", APART FROM THE MARK AS SHOWN.

FOR WATER INSTALLATIONS INCLUDING WATER FLUSHING INSTALLATIONS, NAMELY, WATER DIVERTERS; WATER CONDUIT INSTALLATIONS COMPRISED OF COLLECTION VESSELS FOR RECEIVING A FIRST FLUSH OF WATER FROM A GUTTERING SYSTEM, VALVES FOR DIVERTING THE FLOW TO THE COLLECTION VESSELS AND TO A RAINWATER TANK AND CONDUITS FOR WATER FLOW FROM THE VALVES TO THE TANK; WATER INTAKE APPARATUS, NAMELY, WATER DIVERTERS; FIRST FLUSH WATER DIVERTERS FOR WATER COLLECTION; WATER PURIFICATION INSTALLATIONS AND WATER FILTERING INSTALLATIONS; COMPONENT PARTS, REGULATING AND SAFETY ACCESSORIES FOR WATER APPARATUS, NAMELY, WATER DIVERTERS AND RAIN HEADS INCORPORATING DEBRIS SCREENS; WATER FILTERS (U.S. CLS. 13, 21, 23, 31 AND 34).

CAROLYN CATALDO, EXAMINING ATTORNEY

SN 77-770,795. YONGKANG FIRE-MAPLE CAMPING EQUIPMENT FACTORY, ZHEJIANG PROVINCE, CHINA, FILED 6-30-2009.

Fire-Maple

THE MARK CONSISTS OF STANDARD CHARACTERS WITHOUT CLAIM TO ANY PARTICULAR FONT, STYLE, SIZE, OR COLOR.

FOR BAKING OVENS; BARBECUES AND GRILLS; CHARCOAL GRILLS; ELECTRIC COFFEE MACHINES; ELECTRIC GRILLS; ELECTRIC RADIATORS; ELECTRIC REFRIGERATORS; EXHAUST HOODS FOR KITCHENS; FURNACES; GAS BURNERS; GAS STOVES; MICROWAVE OVENS; SOLAR WATER HEATERS; STERILIZERS (U.S. CLS. 13, 21, 23, 31 AND 34).

FIRST USE 5-30-2008; IN COMMERCE 5-30-2008.

ALEXANDER L. POWERS, EXAMINING ATTORNEY

CLASS 11—(Continued).

SN 77-775,836. SANDY LITTMAN INC., NEWBURGH, NY, FILED 7-7-2009.

THE AMERICAN GLASS LIGHT COMPANY

THE MARK CONSISTS OF STANDARD CHARACTERS WITHOUT CLAIM TO ANY PARTICULAR FONT, STYLE, SIZE, OR COLOR.

OWNER OF U.S. REG. NO. 1,244,360.

NO CLAIM IS MADE TO THE EXCLUSIVE RIGHT TO USE "GLASS LIGHT COMPANY", APART FROM THE MARK AS SHOWN.

SEC. 2(F).

FOR ELECTRIC LIGHTING FIXTURES (U.S. CLS. 13, 21, 23, 31 AND 34).

FIRST USE 10-30-1981; IN COMMERCE 10-30-1981.

SIMON TENG, EXAMINING ATTORNEY

SN 77-778,718. HUBBELL INCORPORATED, ORANGE, CT, FILED 7-10-2009.

SAPHIR

THE MARK CONSISTS OF STANDARD CHARACTERS WITHOUT CLAIM TO ANY PARTICULAR FONT, STYLE, SIZE, OR COLOR.

THE ENGLISH TRANSLATION OF THE WORD "SAPHIR" IN THE MARK IS "SAPPHIRE".

FOR LIGHTING FIXTURES (U.S. CLS. 13, 21, 23, 31 AND 34).

JAY FLOWERS, EXAMINING ATTORNEY

SN 77-795,186. MOEN INCORPORATED, NORTH OLMSTED, OH. FILED 8-3-2009.

WARMFRONT

THE MARK CONSISTS OF STANDARD CHARACTERS WITHOUT CLAIM TO ANY PARTICULAR FONT, STYLE, SIZE, OR COLOR.

FOR HOT WATER CIRCULATING SYSTEMS AND COMPONENTS THEREOF, NAMELY, WATER RE CIRCULATING PUMPS AND BYPASS VALVES (U.S. CLS. 13, 21, 23, 31 AND 34).

INGA ERVIN, EXAMINING ATTORNEY

CLASS 11—(Continued).

SN 77-796,512. TOTO U.S.A., INC., MORROW, GA. FILED 8-4-2009.



NO CLAIM IS MADE TO THE EXCLUSIVE RIGHT TO USE "UHET", APART FROM THE MARK AS SHOWN.

THE MARK CONSISTS OF THE LETTERS "UHET" WITH "HET" IN BLACK BLOCK LETTERING AND THE "U" IN WHITE BLOCK LETTERING WITH A BLACK BACKGROUND BEHIND THE "U".

FOR PLUMBING FIXTURES, NAMELY, TOILETS (U.S. CLS. 13, 21, 23, 31 AND 34).

MARIAM MAHMOUDI, EXAMINING ATTORNEY

SN 77-822,013. TACO, INC., CRANSTON, RI. FILED 9-8-2009.

ZONE SENTRY

THE MARK CONSISTS OF STANDARD CHARACTERS WITHOUT CLAIM TO ANY PARTICULAR FONT, STYLE, SIZE, OR COLOR.

NO CLAIM IS MADE TO THE EXCLUSIVE RIGHT TO USE "ZONE", APART FROM THE MARK AS SHOWN.

FOR TEMPERATURE CONTROL ZONE VALVES FOR USE IN HEATING SYSTEMS (U.S. CLS. 13, 21, 23, 31 AND 34).

B. PARADEWELAI, EXAMINING ATTORNEY

SN 77-830,031. SOCIETE BIC, CLICHY, FRANCE, FILED 9-18-2009.

FLEX WAND

THE MARK CONSISTS OF STANDARD CHARACTERS WITHOUT CLAIM TO ANY PARTICULAR FONT, STYLE, SIZE, OR COLOR.

NO CLAIM IS MADE TO THE EXCLUSIVE RIGHT TO USE "WAND", APART FROM THE MARK AS SHOWN.

FOR LIGHTERS PRIMARILY FOR LIGHTING GRILLS, FIREPLACES AND CANDLES (U.S. CLS. 13, 21, 23, 31 AND 34).

ESTHER BELENKER, EXAMINING ATTORNEY

CLASS 11—(Continued).

SN 77-836,002. ZIMPLISTIC PTE LTD., SINGAPORE, SINGAPORE, FILED 9-28-2009.

ROTIMATIC

THE MARK CONSISTS OF STANDARD CHARACTERS WITHOUT CLAIM TO ANY PARTICULAR FONT, STYLE, SIZE, OR COLOR.

FOR AN ELECTRICAL BREAD MAKING MACHINE FOR DOMESTIC USE AND FOR USE IN SMALL RESTAURANTS OF ALL AGES; AN ELECTRIC GRIDDLE FOR MAKING ROTI AND CHAPATTIS FOR DOMESTIC USE AND FOR USE IN SMALL RESTAURANTS OF ALL AGES (U.S. CLS. 13, 21, 23, 31 AND 34).

LAURIE MAYES, EXAMINING ATTORNEY

SN 77-842,548. COMPONENT HARDWARE GROUP, INC., LAKEWOOD, NJ. FILED 10-6-2009.



OWNER OF U.S. REG. NO. 3,539,930.

THE COLOR(S) RED IS CLAIMED AS A FEATURE OF THE MARK. IS/ARE CLAIMED AS A FEATURE OF THE MARK.

THE MARK CONSISTS OF THE WORDS "FLAME GARD" WITH THE RED FLAME DESIGN SURROUNDING THE LETTER "F". THE LETTER "F" IS IN WHITE AND THE REMAINING LETTERS ARE IN BLACK. THE COLORS WHITE AND BLACK IN THE WORDS "FLAME GARD" ARE INTENDED AS BACKGROUND, OUTLINING, SHADING AND/OR TRANSPARENT AREAS AND ARE NOT PART OF THE MARK.

FOR AIR FILTERING INSTALLATIONS COMPRISED OF MESH AIR FILTERS, MOULDINGS AND DIVIDERS, GREASE CUPS AND DRAINS; CANOPY HOOD LIGHTING FIXTURES AND REPLACEMENT PARTS, NAMELY, DAMPERS IN THE NATURE OF CONTROL DEVICES USED IN AIR DUCTS TO REGULATE THE FLOW OF AIR, HEAT REGISTERS, LIGHT DIFFUSERS, AND SUPPLY GRILLS (U.S. CLS. 13, 21, 23, 31 AND 34).

ERNEST SHOSHO, EXAMINING ATTORNEY

CLASS 11—(Continued).

SN 77-845,420. BSH BOSCH UND SIEMENS HAUSGERAETE GMBH, MUNICH, FED REP GERMANY, FILED 10-9-2009.

Precious Purple

THE MARK CONSISTS OF STANDARD CHARACTERS WITHOUT CLAIM TO ANY PARTICULAR FONT, STYLE, SIZE, OR COLOR.

PRIORITY CLAIMED UNDER SEC. 44(D) ON FED REP GERMANY APPLICATION NO. 302009031877, FILED 5-27-2009, REG. NO. 302009031877, DATED 6-23-2009, EXPIRES 5-31-2019.

NO CLAIM IS MADE TO THE EXCLUSIVE RIGHT TO USE "PURPLE", APART FROM THE MARK AS SHOWN.

FOR HOUSEHOLD AND KITCHEN MACHINES AND EQUIPMENT, NAMELY, TEMPERATURE-CONTROLLED BEVERAGE DISPENSERS; STRUCTURAL PARTS OF THE AFOREMENTIONED GOODS (U.S. CLS. 13, 21, 23, 31 AND 34).

DAVID MURRAY, EXAMINING ATTORNEY

SN 77-860,994. TWIN-STAR INTERNATIONAL INC, DEL-
RAY BEACH, FL. FILED 10-29-2009.

POWER HEAT

THE MARK CONSISTS OF STANDARD CHARACTERS WITHOUT CLAIM TO ANY PARTICULAR FONT, STYLE, SIZE, OR COLOR.

NO CLAIM IS MADE TO THE EXCLUSIVE RIGHT TO USE "HEAT", APART FROM THE MARK AS SHOWN.

FOR ELECTRIC HEATERS, NAMELY, PORTABLE ELECTRIC HEATERS AND ELECTRIC RADIANT HEATERS FOR HOUSEHOLD USE; ELECTRIC SPACE HEATERS, CERAMIC HEATERS, CERAMIC HEATERS, NAMELY, PORTABLE SPACE HEATERS WHICH RADIATE HEAT THROUGH CERAMIC PANELS; PANEL HEATERS, NAMELY, PORTABLE SPACE HEATERS WHICH RADIATE HEAT THROUGH PANELS OF VARIOUS MATERIALS (U.S. CLS. 13, 21, 23, 31 AND 34).

RICHARD WHITE, EXAMINING ATTORNEY

SN 77-863,786. THE FLORIDA STATE UNIVERSITY RE-
SEARCH FOUNDATION, INC., TALLAHASSEE, FL.
FILED 11-3-2009.

SOLAR SAUSAGE

THE MARK CONSISTS OF STANDARD CHARACTERS WITHOUT CLAIM TO ANY PARTICULAR FONT, STYLE, SIZE, OR COLOR.

NO CLAIM IS MADE TO THE EXCLUSIVE RIGHT TO USE "SOLAR", APART FROM THE MARK AS SHOWN.

FOR SOLAR COLLECTORS (U.S. CLS. 13, 21, 23, 31 AND 34).

LINDA M. KING, EXAMINING ATTORNEY

CLASS 11—(Continued).

SN 77-868,091. VICTORIA CLASSICS LTD., NEW YORK, NY.
FILED 11-9-2009.

BRYAN KEITH

THE MARK CONSISTS OF STANDARD CHARACTERS WITHOUT CLAIM TO ANY PARTICULAR FONT, STYLE, SIZE, OR COLOR.

THE NAME(S), PORTRAIT(S), AND/OR SIGNATURE(S) SHOWN IN THE MARK IDENTIFIES "BRYAN KEITH", WHOSE CONSENT(S) TO REGISTER IS MADE OF RECORD.

FOR LAMPS (U.S. CLS. 13, 21, 23, 31 AND 34).
RENEE MCCRAY, EXAMINING ATTORNEY

SN 77-870,533. IEA, INC., KENOSHA, WI. FILED 11-11-2009.

SILVER LININGS

THE MARK CONSISTS OF STANDARD CHARACTERS WITHOUT CLAIM TO ANY PARTICULAR FONT, STYLE, SIZE, OR COLOR.

FOR INDUSTRIAL COOLING CABINETS FEATURING THERMAL MANAGEMENT EQUIPMENT USED TO MAINTAIN PROPER OPERATING TEMPERATURES OF THE ELECTRONIC EQUIPMENT HOUSED THEREIN (U.S. CLS. 13, 21, 23, 31 AND 34).

CHRISTINE COOPER, EXAMINING ATTORNEY

SN 77-870,544. IEA, INC., KENOSHA, WI. FILED 11-11-2009.

RAFTS

THE MARK CONSISTS OF STANDARD CHARACTERS WITHOUT CLAIM TO ANY PARTICULAR FONT, STYLE, SIZE, OR COLOR.

FOR INDUSTRIAL COOLING CABINETS FEATURING THERMAL MANAGEMENT EQUIPMENT USED TO MAINTAIN PROPER OPERATING TEMPERATURES OF THE ELECTRONIC EQUIPMENT HOUSED THEREIN (U.S. CLS. 13, 21, 23, 31 AND 34).

CHRISTINE COOPER, EXAMINING ATTORNEY

CLASS 11—(Continued).

SN 77-872,222. INGRAM, JASON OWENS, PADUCAH, KY.
FILED 11-13-2009.

HVAC DIRECT

THE MARK CONSISTS OF STANDARD CHARACTERS WITHOUT CLAIM TO ANY PARTICULAR FONT, STYLE, SIZE, OR COLOR.

NO CLAIM IS MADE TO THE EXCLUSIVE RIGHT TO USE "HVAC", APART FROM THE MARK AS SHOWN.
FOR HVAC UNITS (U.S. CLS. 13, 21, 23, 31 AND 34).
PAUL MORENO, EXAMINING ATTORNEY

SN 77-876,927. PROLINE AQUATICS CORPORATION, RICHMOND, BC, CANADA, FILED 11-19-2009.

PROLINE AQUATICS

NO CLAIM IS MADE TO THE EXCLUSIVE RIGHT TO USE "AQUATICS", APART FROM THE MARK AS SHOWN.
FOR AQUARIUM FILTERS, AQUARIUM HEATERS, AND AQUARIUM LIGHTS (U.S. CLS. 13, 21, 23, 31 AND 34).

FIRST USE 2-1-2006; IN COMMERCE 2-1-2006.
HEATHER BIDDULPH, EXAMINING ATTORNEY

SN 77-881,754. COOKTEK INDUCTION SYSTEMS, LLC, CHICAGO, IL. FILED 11-29-2009.

THERMACUBE

THE MARK CONSISTS OF STANDARD CHARACTERS WITHOUT CLAIM TO ANY PARTICULAR FONT, STYLE, SIZE, OR COLOR.

FOR INDUCTION COOKING AND HEATING SYSTEM COMPRISED OF INDUCTION COOKTOPS, INDUCTION CHARGERS FOR USE WITH ELECTROMAGNETIC INDUCIBLE PELLETS, AND THERMAL DELIVERY BAG (U.S. CLS. 13, 21, 23, 31 AND 34).
SIMON TENG, EXAMINING ATTORNEY

CLASS 11—(Continued).

SN 77-884,803. THUNDERBIRD FOOD MACHINERY, INC., DALLAS, TX. FILED 12-2-2009.

THUNDERBIRD

THE MARK CONSISTS OF STANDARD CHARACTERS WITHOUT CLAIM TO ANY PARTICULAR FONT, STYLE, SIZE, OR COLOR.

OWNER OF U.S. REG. NO. 1,981,949.
FOR ICE MAKING MACHINES (U.S. CLS. 13, 21, 23, 31 AND 34).
LESLIE RICHARDS, EXAMINING ATTORNEY

SN 77-885,751. P. L. HAWN COMPANY INC., HUNTINGTON BEACH, CA. FILED 12-3-2009.

PUROGUARD

THE MARK CONSISTS OF STANDARD CHARACTERS WITHOUT CLAIM TO ANY PARTICULAR FONT, STYLE, SIZE, OR COLOR.

FOR AIR FILTERS FOR AIR CONDITIONING UNITS; AIR FILTERS FOR DOMESTIC USE; FILTERS AND FILTERING DEVICES FOR AIR AND GAS CONDITIONING (U.S. CLS. 13, 21, 23, 31 AND 34).

PAUL E. FAHRENKOPF, EXAMINING ATTORNEY

SN 77-886,482. UNITED STATES STOVE COMPANY, SOUTH PITTSBURG, TN. FILED 12-4-2009.



NO CLAIM IS MADE TO THE EXCLUSIVE RIGHT TO USE "95% MORE EFFICIENT THAN TRADITIONAL NON-ENERGY SMART MODELS!", APART FROM THE MARK AS SHOWN.

THE COLOR(S) BLACK, GREEN IS/ARE CLAIMED AS A FEATURE OF THE MARK.

THE MARK CONSISTS OF THE WORDING "ENERGY" AND "95% MORE EFFICIENT THAN TRADITIONAL NON-ENERGY SMART MODELS!" IN BLACK, THE WORDING "SMART" IN GREEN WITH A DOLLAR SIGN IN PLACE OF THE LETTER "S", AND A GREEN CRESCENT TO THE RIGHT OF THE WORDING.

FOR SLOW-BURNING STOVES; SOLID FUEL BURNING STOVES; WOOD BURNING STOVES (U.S. CLS. 13, 21, 23, 31 AND 34).

ANGELA DUONG, EXAMINING ATTORNEY

CLASS 11—(Continued).

SN 77-886,980. FLEXCON INDUSTRIES, INC., RANDOLPH, MA. FILED 12-5-2009.



OWNER OF U.S. REG. NO. 1,586,643.

THE MARK CONSISTS OF THE WORDS "JET-RITE" WHICH ARE SUPERIMPOSED OVER A LARGE NUMBER "2" ALL IN AN EYE SHAPED FIGURE. THE WORDS HAVE TWO CURVED LINES OVER THEM FOLLOWING THE TOP OF THE SHAPE. THERE IS A HALF MOON SHAPE ON THE BOTTOM HALF OF THE DESIGN.

FOR WATER WELL TANKS (U.S. CLS. 13, 21, 23, 31 AND 34).

FIRST USE 2-21-2003; IN COMMERCE 2-21-2003.

ANN E. SAPPENFIELD, EXAMINING ATTORNEY

SN 77-887,292. C&A MARKETING, DBA DBROTH, RIDGE-FIELD PARK, NJ. AND KLEIN, ASHER, LAKEWOOD, NJ. FILED 12-7-2009.

Solar Eclipse

THE MARK CONSISTS OF STANDARD CHARACTERS WITHOUT CLAIM TO ANY PARTICULAR FONT, STYLE, SIZE, OR COLOR.

FOR LED (LIGHT EMITTING DIODE) LIGHTING FIXTURES (U.S. CLS. 13, 21, 23, 31 AND 34).

FIRST USE 4-7-2009; IN COMMERCE 4-7-2009.

ANTHONY RINKER, EXAMINING ATTORNEY

SN 77-887,293. STINGER INNOVATIONS, INC., MARLOW, NH. FILED 12-7-2009.

Bee-Z-Smoker

THE MARK CONSISTS OF STANDARD CHARACTERS WITHOUT CLAIM TO ANY PARTICULAR FONT, STYLE, SIZE, OR COLOR.

FOR SMOKE GENERATING MACHINES FOR USE IN BEEKEEPING, NAMELY, BEE SMOKERS (U.S. CLS. 13, 21, 23, 31 AND 34).

ANTHONY RINKER, EXAMINING ATTORNEY

CLASS 11—(Continued).

SN 77-887,948. AQUA BLUE LLC, LAKE BLUFF, IL. FILED 12-7-2009.

NanoPlus

THE MARK CONSISTS OF STANDARD CHARACTERS WITHOUT CLAIM TO ANY PARTICULAR FONT, STYLE, SIZE, OR COLOR.

FOR WATER FILTERS; FILTERING UNITS FOR WATER FILTERING; FILTERS FOR DRINKING WATER; FILTERS MADE OF FIBER FOR WATER FILTRATION; WATER FILTERING APPARATUS; WATER FILTERING UNITS FOR DOMESTIC AND COMMERCIAL USE; WATER CONDITIONING UNITS; WATER FILTRATION PITCHERS SOLD EMPTY; WATER PURIFICATION UNITS; WATER PURIFIERS; WATER TREATMENT EQUIPMENT, NAMELY, CARTRIDGE FILTRATION UNITS; WATER TREATMENT EQUIPMENT, NAMELY, REVERSE OSMOSIS FILTRATION UNITS, AND WATER ABSORBING SURFACES OF FILTERS (U.S. CLS. 13, 21, 23, 31 AND 34).

FIRST USE 10-1-2008; IN COMMERCE 10-1-2008.

JOHN WILKE, EXAMINING ATTORNEY

SN 77-887,995. CREE, INC., DURHAM, NC. FILED 12-7-2009.

EasyWhite

THE MARK CONSISTS OF STANDARD CHARACTERS WITHOUT CLAIM TO ANY PARTICULAR FONT, STYLE, SIZE, OR COLOR.

FOR LED (LIGHT EMITTING DIODE) LIGHTING FIXTURES (U.S. CLS. 13, 21, 23, 31 AND 34).

SUSAN RICHARDS, EXAMINING ATTORNEY

SN 77-888,430. DEVINE, RICHARD W., HOUSTON, TX. FILED 12-8-2009.

CRAVE

THE MARK CONSISTS OF STANDARD CHARACTERS WITHOUT CLAIM TO ANY PARTICULAR FONT, STYLE, SIZE, OR COLOR.

FOR HAIR DRYERS (U.S. CLS. 13, 21, 23, 31 AND 34).

KARANENDRA S. CHHINA, EXAMINING ATTORNEY

CLASS 11—(Continued).

SN 77-888,478. ERNST, NORBERT, KLEINICH, FED REP GERMANY, FILED 12-8-2009.

ASTERA

THE MARK CONSISTS OF STANDARD CHARACTERS WITHOUT CLAIM TO ANY PARTICULAR FONT, STYLE, SIZE, OR COLOR.

FOR LED LIGHT BULBS; LED LIGHT MACHINES; LED LIGHTING FIXTURES FOR INDOOR AND OUTDOOR LIGHTING APPLICATIONS (U.S. CLS. 13, 21, 23, 31 AND 34).

FIRST USE 0-0-2007; IN COMMERCE 0-0-2007.
ESTHER BELENKER, EXAMINING ATTORNEY

SN 77-888,518. RAB LIGHTING INC., NORTHVALE, NJ. FILED 12-8-2009.

ALED

THE MARK CONSISTS OF STANDARD CHARACTERS WITHOUT CLAIM TO ANY PARTICULAR FONT, STYLE, SIZE, OR COLOR.

FOR ELECTRIC LIGHTING FIXTURES; LED (LIGHT EMITTING DIODE) LIGHTING FIXTURES; LED AND HID LIGHT FIXTURES; LIGHTING FIXTURES (U.S. CLS. 13, 21, 23, 31 AND 34).

FIRST USE 11-2-2009; IN COMMERCE 11-2-2009.
JENNIFER MARTIN, EXAMINING ATTORNEY

SN 77-888,531. RAB LIGHTING INC., NORTHVALE, NJ. FILED 12-8-2009.

BLED

THE MARK CONSISTS OF STANDARD CHARACTERS WITHOUT CLAIM TO ANY PARTICULAR FONT, STYLE, SIZE, OR COLOR.

FOR ELECTRIC LIGHTING FIXTURES; LED (LIGHT EMITTING DIODE) LIGHTING FIXTURES; LED AND HID LIGHT FIXTURES; LIGHTING FIXTURES (U.S. CLS. 13, 21, 23, 31 AND 34).

JENNIFER MARTIN, EXAMINING ATTORNEY

CLASS 11—(Continued).

SN 77-888,553. VAT-ENERGIES LLC, FISHERS, IN. FILED 12-8-2009.

VAT

THE MARK CONSISTS OF STANDARD CHARACTERS WITHOUT CLAIM TO ANY PARTICULAR FONT, STYLE, SIZE, OR COLOR.

FOR LIGHT POST LUMINAIRES (U.S. CLS. 13, 21, 23, 31 AND 34).

CHERYL CLAYTON, EXAMINING ATTORNEY

SN 77-888,561. SHERRILL, DAN, LEWISVILLE, TX. FILED 12-8-2009.

FW INSULATION BLANKET

THE MARK CONSISTS OF STANDARD CHARACTERS WITHOUT CLAIM TO ANY PARTICULAR FONT, STYLE, SIZE, OR COLOR.

NO CLAIM IS MADE TO THE EXCLUSIVE RIGHT TO USE "INSULATION BLANKET", APART FROM THE MARK AS SHOWN.

FOR ADJUSTABLE INSULATED ELECTRICALLY HEATED BLANKET FOR CONTAINERS CONTAINING LIQUIDS, FOR INDUSTRIAL USE (U.S. CLS. 13, 21, 23, 31 AND 34).

FIRST USE 6-15-2003; IN COMMERCE 6-15-2003.
LIEF MARTIN, EXAMINING ATTORNEY

SN 77-889,023. JACUZZI INC., CHINO HILLS, CA. FILED 12-8-2009.

TheraPro

THE MARK CONSISTS OF STANDARD CHARACTERS WITHOUT CLAIM TO ANY PARTICULAR FONT, STYLE, SIZE, OR COLOR.

FOR JETS FOR WHIRLPOOL BATHS AND SPAS IN THE NATURE OF HEATED POOLS (U.S. CLS. 13, 21, 23, 31 AND 34).

MARY CRAWFORD, EXAMINING ATTORNEY

CLASS 11—(Continued).

SN 77-889,197. XIAMEN LOTA INTERNATIONAL CO., LTD., JIMEI, XIAMEN, 361022, CHINA, FILED 12-9-2009.

ECO-CLICK

THE MARK CONSISTS OF STANDARD CHARACTERS WITHOUT CLAIM TO ANY PARTICULAR FONT, STYLE, SIZE, OR COLOR.

FOR CARTRIDGE VALVE PERMITTING MULTI-POSITION FLOW FROM A FAUCET (U.S. CLS. 13, 21, 23, 31 AND 34).

JAMES STEIN, EXAMINING ATTORNEY

CLASS 11—(Continued).

SN 77-890,397. SONGZ AUTOMOBILE AIR CONDITIONING CO., LTD., SHANGHAI, CHINA, FILED 12-10-2009.

SONGZ

THE MARK CONSISTS OF THE WORD "SONGZ" WITH DIAGONAL LINES BISECTING THE LETTER "O".

FOR AIR CONDITIONERS FOR VEHICLES; LAMPS; REFRIGERATED SHIPPING CONTAINERS; AIR CONDITIONING APPARATUS; REFRIGERATOR CONDENSERS; LIGHTING APPARATUS FOR VEHICLES; HOT-AIR SPACE HEATING APPARATUS FOR INDUSTRIAL PURPOSES; AIR PURIFYING APPARATUS AND MACHINES; AIR COOLING APPARATUS (U.S. CLS. 13, 21, 23, 31 AND 34).

FIRST USE 9-0-1998; IN COMMERCE 4-0-2009.

COLLEEN KEARNEY, EXAMINING ATTORNEY

SN 77-889,882. MAAX SPAS INDUSTRIES CORP., CHANDLER, AZ. FILED 12-9-2009.

BLUEMAAX

THE MARK CONSISTS OF STANDARD CHARACTERS WITHOUT CLAIM TO ANY PARTICULAR FONT, STYLE, SIZE, OR COLOR.

FOR INSULATION BUILT INTO AND SOLD AS A COMPONENT PART OF SPAS IN THE NATURE OF HEATED POOLS (U.S. CLS. 13, 21, 23, 31 AND 34).

HENRY S. ZAK, EXAMINING ATTORNEY

SN 77-890,597. STINGER INNOVATIONS, INC., MARLOW, NH. FILED 12-10-2009.

Bee-Z-Smoker



Cool Bee Smoke, Without the Choke!

SN 77-890,363. MCGOVERN, KEVIN M, NEW YORK, NY. FILED 12-10-2009.

THE WATER INITIATIVE

THE MARK CONSISTS OF STANDARD CHARACTERS WITHOUT CLAIM TO ANY PARTICULAR FONT, STYLE, SIZE, OR COLOR.

OWNER OF U.S. REG. NO. 3,332,872.

NO CLAIM IS MADE TO THE EXCLUSIVE RIGHT TO USE "WATER", APART FROM THE MARK AS SHOWN.

FOR WATER FILTERING UNITS FOR HOUSEHOLD, OFFICE, AND PERSONAL USES (U.S. CLS. 13, 21, 23, 31 AND 34).

FIRST USE 7-1-2009; IN COMMERCE 7-1-2009.

SUSAN RICHARDS, EXAMINING ATTORNEY

THE MARK CONSISTS OF THE CURVED WORDS "BEE-Z-SMOKER" AND TO THE RIGHT A STYLIZED BEE CARRYING A DRIPPING BUCKET WITH "BZS" ON ITS STOMACH AND IS WEARING SNEAKERS AND A CAP WITH "BZS" ON IT, AND THE WORDS "COOL BEE SMOKE, WITHOUT THE CHOKE!" ARE AT THE BOTTOM.

FOR SMOKE GENERATING MACHINES FOR USE IN BEEKEEPING, NAMELY, BEE SMOKERS (U.S. CLS. 13, 21, 23, 31 AND 34).

ANTHONY RINKER, EXAMINING ATTORNEY

CLASS 11—(Continued).

SN 77-890,635. STINGER INNOVATIONS, INC., MARLOW, NH. FILED 12-10-2009.



THE MARK CONSISTS OF A STYLIZED BEE CARRYING A DRIPPING BUCKET WITH "BZS" ON ITS STOMACH AND IS WEARING SNEAKERS AND A CAP WITH "BZS" ON IT.

FOR SMOKE GENERATING MACHINES FOR USE IN BEEKEEPING, NAMELY, BEE SMOKERS (U.S. CLS. 13, 21, 23, 31 AND 34).

ANTHONY RINKER, EXAMINING ATTORNEY

CLASS 11—(Continued).

SN 77-890,754. SMITH MOUNTAIN INDUSTRIES, INC., FOREST, VA. FILED 12-10-2009.

MIKA

THE MARK CONSISTS OF STANDARD CHARACTERS WITHOUT CLAIM TO ANY PARTICULAR FONT, STYLE, SIZE, OR COLOR.

FOR ELECTRIC ROOM FRAGRANCE DISPENSERS (U.S. CLS. 13, 21, 23, 31 AND 34).

IRA J. GOODSaid, EXAMINING ATTORNEY

SN 77-890,662. HOME LIVING SOLUTIONS LLC, TEMECULA, CA. FILED 12-10-2009.

Glen Ivy

THE MARK CONSISTS OF STANDARD CHARACTERS WITHOUT CLAIM TO ANY PARTICULAR FONT, STYLE, SIZE, OR COLOR.

FOR WALK-IN BATHTUBS (U.S. CLS. 13, 21, 23, 31 AND 34).

TOBY BULLOFF, EXAMINING ATTORNEY



SN 77-890,686. HOME LIVING SOLUTIONS LLC, TEMECULA, CA. FILED 12-10-2009.

Grotto

THE MARK CONSISTS OF STANDARD CHARACTERS WITHOUT CLAIM TO ANY PARTICULAR FONT, STYLE, SIZE, OR COLOR.

FOR WALK-IN BATHTUBS (U.S. CLS. 13, 21, 23, 31 AND 34).

TOBY BULLOFF, EXAMINING ATTORNEY

OWNER OF U.S. REG. NO. 1,898,068.

THE MARK CONSISTS OF A FIRST, LARGER RECTANGLE WITH THE HEAD OF A WOLVERINE LOCATED ON THE BOTTOM, CENTER PORTION OF THE RECTANGLE. AN OUTLINE OF THE BOTTOM OF THE WOLVERINE HEAD EXTENDS BELOW THE BOTTOM OF THE RECTANGLE AND BELOW THE WOLVERINE HEAD. A SECOND, SMALLER RECTANGLE IS LOCATED IN THE CENTER OF THE LARGER RECTANGLE. A HORIZONTAL HOURGLASS IS OVERLAID ON TOP OF THE SMALLER RECTANGLE, AND THE WORD "WOLVERINE" IS LOCATED WITHIN THE HORIZONTAL HOURGLASS.

FOR ELECTRIC HEATERS FOR FLUIDS (U.S. CLS. 13, 21, 23, 31 AND 34).

FIRST USE 7-6-1993; IN COMMERCE 7-6-1993.

JENNIFER HETU, EXAMINING ATTORNEY

CLASS 11—(Continued).

SN 77-891,752. LYONS INDUSTRIES, INC., DOWAGIAC, MI. FILED 12-11-2009.



THE MARK CONSISTS OF THE WORD "LYONS" WRITTEN IN CURSIVE WITH "THE FINISHING TOUCH" FOLLOWED BY A PERIOD UNDERNEATH.

FOR BATHTUBS, WHIRLPOOL TUBS, HEATED SOAKING TUBS, BATHTUB WALLS, SHOWER BASES, SHOWER WALLS, SHOWER DOORS, AND SINKS (U.S. CLS. 13, 21, 23, 31 AND 34).

FIRST USE 11-0-2007; IN COMMERCE 11-0-2007. DARRYL SPRULL, EXAMINING ATTORNEY

CLASS 11—(Continued).

SN 77-899,818. SMITH MOUNTAIN INDUSTRIES, INC., FOREST, VA. FILED 12-23-2009.

WOOD LITE

THE MARK CONSISTS OF STANDARD CHARACTERS WITHOUT CLAIM TO ANY PARTICULAR FONT, STYLE, SIZE, OR COLOR.

FOR ELECTRIC ROOM FRAGRANCE DISPENSERS (U.S. CLS. 13, 21, 23, 31 AND 34). IRA J. GOODSaid, EXAMINING ATTORNEY

SN 77-899,820. SMITH MOUNTAIN INDUSTRIES, INC., FOREST, VA. FILED 12-23-2009.

SN 77-895,459. RAB LIGHTING INC., NORTHVALE, NJ. FILED 12-17-2009.

AJ

THE MARK CONSISTS OF STANDARD CHARACTERS WITHOUT CLAIM TO ANY PARTICULAR FONT, STYLE, SIZE, OR COLOR.

FOR LIGHTING FIXTURES; HID LIGHTING FIXTURES (U.S. CLS. 13, 21, 23, 31 AND 34). JENNIFER MARTIN, EXAMINING ATTORNEY

ARBOR GLOW

THE MARK CONSISTS OF STANDARD CHARACTERS WITHOUT CLAIM TO ANY PARTICULAR FONT, STYLE, SIZE, OR COLOR.

FOR ELECTRIC ROOM FRAGRANCE DISPENSERS (U.S. CLS. 13, 21, 23, 31 AND 34). IRA J. GOODSaid, EXAMINING ATTORNEY

SN 77-902,403. PANASIA CO., LTD., GANGSEO-GU, BUSAN, REPUBLIC OF KOREA, FILED 12-29-2009.

SN 77-897,923. PEPSICO, INC., PURCHASE, NY. FILED 12-21-2009.

PEPSI FUSION

THE MARK CONSISTS OF STANDARD CHARACTERS WITHOUT CLAIM TO ANY PARTICULAR FONT, STYLE, SIZE, OR COLOR.

OWNER OF U.S. REG. NOS. 824,150, 3,359,092 AND OTHERS. FOR REFRIGERATED BEVERAGE DISPENSING UNITS (U.S. CLS. 13, 21, 23, 31 AND 34). ROBIN CHOSID, EXAMINING ATTORNEY

PANOX

THE MARK CONSISTS OF STANDARD CHARACTERS WITHOUT CLAIM TO ANY PARTICULAR FONT, STYLE, SIZE, OR COLOR.

OWNER OF REPUBLIC OF KOREA REG. NO. 0664645, DATED 6-1-2006, EXPIRES 6-1-2016. FOR NITROGEN OXIDES REMOVING INSTALLATION, EXHAUST GASES PURIFYING APPARATUS, AIR PURIFYING APPARATUS (U.S. CLS. 13, 21, 23, 31 AND 34). SOPHIA S. KIM, EXAMINING ATTORNEY

CLASS 11—(Continued).

SN 77-916,050. E. MISHAN & SONS, INC., NEW YORK, NY.
FILED 1-20-2010.

SUPER WAVE

THE MARK CONSISTS OF STANDARD CHARACTERS
WITHOUT CLAIM TO ANY PARTICULAR FONT, STYLE,
SIZE, OR COLOR.

FOR DOMESTIC COOKING OVENS (U.S. CLS. 13, 21,
23, 31 AND 34).

MARCIE MILONE, EXAMINING ATTORNEY

CLASS 11—(Continued).

SN 77-923,658. AS IP HOLDCO, LLC, PISCATAWAY, NJ.
FILED 1-29-2010.

PELHAM

THE MARK CONSISTS OF STANDARD CHARACTERS
WITHOUT CLAIM TO ANY PARTICULAR FONT, STYLE,
SIZE, OR COLOR.

FOR FAUCETS (U.S. CLS. 13, 21, 23, 31 AND 34).

NANCY CLARKE, EXAMINING ATTORNEY

SN 77-921,796. JACUZZI INC., CHINO HILLS, CA. FILED 1-
27-2010.

ESPREE

THE MARK CONSISTS OF STANDARD CHARACTERS
WITHOUT CLAIM TO ANY PARTICULAR FONT, STYLE,
SIZE, OR COLOR.

OWNER OF U.S. REG. NO. 1,355,195.

THE WORDING "ESPREE" HAS NO MEANING IN A
FOREIGN LANGUAGE.

FOR BIDETS; FAUCETS; LAVATORIES; SHOWER
BASES; SHOWER ENCLOSURES; SHOWER FAUCET
EXTENSIONS; SHOWER HEAD SPRAYERS; SHOWER
HEADS; SHOWER SURROUNDS; SHOWER TUBS;
SHOWERS; SINKS (U.S. CLS. 13, 21, 23, 31 AND 34).

MARY CRAWFORD, EXAMINING ATTORNEY

SN 79-069,299. SAECO STRATEGIC SERVICES LIMITED,
DUBLIN 12, IRELAND, FILED 5-12-2009.

SYNTIA

PRIORITY DATE OF 4-6-2009 IS CLAIMED.

OWNER OF INTERNATIONAL REGISTRATION 1003827
DATED 5-12-2009, EXPIRES 5-12-2019.

THE WORDING "SYNTIA" HAS NO MEANING IN A
FOREIGN LANGUAGE.

FOR ELECTRIC COFFEE MACHINES (U.S. CLS. 13, 21,
23, 31 AND 34).

DANIEL CAPSHAW, EXAMINING ATTORNEY

SN 77-923,644. AS IP HOLDCO, LLC, PISCATAWAY, NJ.
FILED 1-29-2010.

LAKESHIRE

THE MARK CONSISTS OF STANDARD CHARACTERS
WITHOUT CLAIM TO ANY PARTICULAR FONT, STYLE,
SIZE, OR COLOR.

FOR FAUCETS (U.S. CLS. 13, 21, 23, 31 AND 34).

NANCY CLARKE, EXAMINING ATTORNEY

SN 79-069,300. SAECO STRATEGIC SERVICES LIMITED,
DUBLIN 12, IRELAND, FILED 5-12-2009.

XELISIS

PRIORITY DATE OF 4-6-2009 IS CLAIMED.

OWNER OF INTERNATIONAL REGISTRATION 1003828
DATED 5-12-2009, EXPIRES 5-12-2019.

THE WORDING "XELISIS" HAS NO MEANING IN A
FOREIGN LANGUAGE.

FOR ELECTRIC COFFEE MACHINES (U.S. CLS. 13, 21,
23, 31 AND 34).

DANIEL CAPSHAW, EXAMINING ATTORNEY

CLASS 11—(Continued).

SN 79-070,589. KONINKLIJKE PHILIPS ELECTRONICS N.V., NETHERLANDS, FILED 6-16-2009.

AQUAFIT

THE MARK CONSISTS OF STANDARD CHARACTERS WITHOUT CLAIM TO ANY PARTICULAR FONT, STYLE, SIZE, OR COLOR.

PRIORITY DATE OF 12-23-2008 IS CLAIMED.

OWNER OF INTERNATIONAL REGISTRATION 1006909 DATED 6-16-2009, EXPIRES 6-16-2019.

FOR ELECTRIC LAMPS AND LAMPS COMPRISING LIGHT EMITTING DIODE (LED) LIGHT SOURCE; LIGHTING FIXTURES; LIGHTING INSTALLATIONS, NAMELY, INDOOR AND OUTDOOR ORNAMENTAL LIGHTING INSTALLATIONS (U.S. CLS. 13, 21, 23, 31 AND 34).

RONALD DELGIZZI, EXAMINING ATTORNEY

CLASS 11—(Continued).

SN 79-070,820. SHANGHAI SHUANGHUA; AUTO PARTS CO., LTD., CHINA, FILED 7-7-2009.



OWNER OF INTERNATIONAL REGISTRATION 1007451 DATED 7-7-2009, EXPIRES 7-7-2019.

THE MARK CONSISTS OF AN INCOMPLETE CIRCLE WITH A HORIZONTAL LINE THROUGH THE MIDDLE FORMING A STYLIZED LETTER "S". THE TOP HALF OF THE CIRCLE CONTAINS THE CHINESE CHARACTER "SHUANG," FOLLOWED BY TWO BIRCH TREES, FOLLOWED BY THE CHINESE CHARACTER "HUA". THE BOTTOM HALF OF THE CIRCLE CONTAINS THE WORDING "SHUANG HUA".

THE NON-LATIN CHARACTERS IN THE MARK TRANSLITERATE TO "SHUANG HUA" AND THIS MEANS "DOUBLE BIRCHES" IN ENGLISH.

FOR AIR CONDITIONERS FOR VEHICLES (U.S. CLS. 13, 21, 23, 31 AND 34).

TINA BROWN, EXAMINING ATTORNEY

SN 79-073,813. KOWA COMPANY, LTD., JAPAN, FILED 9-16-2009.

LUPINUS

THE MARK CONSISTS OF STANDARD CHARACTERS WITHOUT CLAIM TO ANY PARTICULAR FONT, STYLE, SIZE, OR COLOR.

OWNER OF INTERNATIONAL REGISTRATION 1015754 DATED 9-16-2009, EXPIRES 9-16-2019.

FOR ELECTRIC LAMPS; AND OTHER LIGHTING APPARATUS, NAMELY, ELECTRIC LIGHTING FIXTURES, LAMPS, LED LIGHTING FIXTURES (U.S. CLS. 13, 21, 23, 31 AND 34).

BARBARA GAYNOR, EXAMINING ATTORNEY

SN 79-070,593. KONINKLIJKE PHILIPS ELECTRONICS N.V., NETHERLANDS, FILED 6-16-2009.

KIDSPLACE

THE MARK CONSISTS OF STANDARD CHARACTERS WITHOUT CLAIM TO ANY PARTICULAR FONT, STYLE, SIZE, OR COLOR.

PRIORITY DATE OF 12-23-2008 IS CLAIMED.

OWNER OF INTERNATIONAL REGISTRATION 1006916 DATED 6-16-2009, EXPIRES 6-16-2019.

FOR ELECTRIC LAMPS AND LAMPS COMPRISING LIGHT EMITTING DIODE (LED) LIGHT SOURCE; LIGHTING FIXTURES; LIGHTING INSTALLATIONS, NAMELY, INDOOR AND OUTDOOR ORNAMENTAL LIGHTING INSTALLATIONS (U.S. CLS. 13, 21, 23, 31 AND 34).

RONALD DELGIZZI, EXAMINING ATTORNEY

CLASS 12—VEHICLES

SN 77-120,697. PACCAR INC, BELLEVUE, WA. FILED 3-2-2007.

MX

THE MARK CONSISTS OF STANDARD CHARACTERS WITHOUT CLAIM TO ANY PARTICULAR FONT, STYLE, SIZE, OR COLOR.

FOR ENGINES FOR MEDIUM-DUTY AND HEAVY-DUTY TRUCKS (U.S. CLS. 19, 21, 23, 31, 35 AND 44).

FRANK LATTUCA, EXAMINING ATTORNEY

CLASS 12—(Continued).

SN 77-134,605. AUTOMOBILI LAMBORGHINI HOLDING S.P.A., SANT'AGATA BOLOGNESEBO, ITALY, FILED 3-19-2007.

GALLARDO SUPERLEGGERA

THE MARK CONSISTS OF STANDARD CHARACTERS WITHOUT CLAIM TO ANY PARTICULAR FONT, STYLE, SIZE, OR COLOR.

PRIORITY CLAIMED UNDER SEC. 44(D) ON ITALY APPLICATION NO. MI2006C00949, FILED 9-25-2006, REG. NO. 0001212274, DATED 9-22-2009, EXPIRES 9-25-2016.

NO CLAIM IS MADE TO THE EXCLUSIVE RIGHT TO USE "SUPERLEGGERA", APART FROM THE MARK AS SHOWN.

THE ENGLISH TRANSLATION OF THE WORD "GALLARDO" IN THE MARK IS "TRIM, TIDY; IMPOSING, IMPRESSIVE, BOLD, BRAVE".

THE ENGLISH TRANSLATION OF "SUPERLEGGERA" IS "SUPER LIGHT".

FOR LAND VEHICLES AND STRUCTURAL PARTS THEREOF (U.S. CLS. 19, 21, 23, 31, 35 AND 44).

JAMES GRIFFIN, EXAMINING ATTORNEY

SN 77-134,648. AUTOMOBILI LAMBORGHINI HOLDING S.P.A., SANT'AGATA BOLOGNESEBO, ITALY, FILED 3-19-2007.

MURCIÉLAGO SUPERLEGGERA

THE MARK CONSISTS OF STANDARD CHARACTERS WITHOUT CLAIM TO ANY PARTICULAR FONT, STYLE, SIZE, OR COLOR.

PRIORITY CLAIMED UNDER SEC. 44(D) ON ITALY APPLICATION NO. MI2006C00948, FILED 9-25-2006, REG. NO. 0001212273, DATED 9-22-2009, EXPIRES 9-26-2016.

NO CLAIM IS MADE TO THE EXCLUSIVE RIGHT TO USE "SUPERLEGGERA", APART FROM THE MARK AS SHOWN.

THE FOREIGN WORDING IN THE MARK TRANSLATES INTO ENGLISH AS "SUPER LIGHT BAT."

FOR LAND VEHICLES AND STRUCTURAL PARTS THEREOF (U.S. CLS. 19, 21, 23, 31, 35 AND 44).

JAMES GRIFFIN, EXAMINING ATTORNEY

CLASS 12—(Continued).

SN 77-511,342. EXTANG CORPORATION, ANN ARBOR, MI, FILED 6-30-2008.

NO CLAIM IS MADE TO THE EXCLUSIVE RIGHT TO USE "TILT", APART FROM THE MARK AS SHOWN.

THE MARK CONSISTS OF LETTERS "E-Z" HYPHENATED WITH "TILT" IMMEDIATELY FOLLOWING WITH A SLANT ON THE TOP OF THE LAST "T".

FOR FITTED COVERS FOR MOTOR VEHICLES, NAMELY, TONNEAU COVERS (U.S. CLS. 19, 21, 23, 31, 35 AND 44).

FIRST USE 2-1-2001; IN COMMERCE 11-30-2001.
MICHAEL SOUDERS, EXAMINING ATTORNEY

SN 77-653,254. SANLUIS RASSINI INTERNATIONAL, INC., PLYMOUTH, MI, FILED 1-21-2009.

THE MARK CONSISTS OF STANDARD CHARACTERS WITHOUT CLAIM TO ANY PARTICULAR FONT, STYLE, SIZE, OR COLOR.

FOR SUSPENSION SPRINGS FOR MOTOR CARS (U.S. CLS. 19, 21, 23, 31, 35 AND 44).

FIRST USE 9-17-2009; IN COMMERCE 9-17-2009.
MARGARET POWER, EXAMINING ATTORNEY

SN 77-735,236. GSC TECHNOLOGIES CORPORATION, ST. JEAN, CANADA, FILED 5-12-2009.

THE MARK CONSISTS OF STANDARD CHARACTERS WITHOUT CLAIM TO ANY PARTICULAR FONT, STYLE, SIZE, OR COLOR.

FOR CAR TOP CARRIER BAGS FOR CARGO AND LUGGAGE, CAR TOP CARGO CARRIER BOXES AND PARTS AND FITTINGS THEREFOR (U.S. CLS. 19, 21, 23, 31, 35 AND 44).

FONG HSU, EXAMINING ATTORNEY

CLASS 12—(Continued).

SN 77-747,080. LIQUID ROBOTICS, INC., PALO ALTO, CA.
FILED 5-28-2009.

WAVE GLIDER

THE MARK CONSISTS OF STANDARD CHARACTERS WITHOUT CLAIM TO ANY PARTICULAR FONT, STYLE, SIZE, OR COLOR.

NO CLAIM IS MADE TO THE EXCLUSIVE RIGHT TO USE "WAVE", APART FROM THE MARK AS SHOWN.

FOR WATER VEHICLES, NAMELY, UNMANNED BOAT-LIKE VEHICLES WHICH ARE WAVE-POWERED AND CAN OPERATE EITHER AUTONOMOUSLY OR BY REMOTE CONTROL VIA A SATELLITE COMMUNICATIONS LINK, FOR USE AS PLATFORMS FOR MARINE DATA COLLECTION AND SURVEILLANCE EQUIPMENT (U.S. CLS. 19, 21, 23, 31, 35 AND 44).

FIRST USE 5-28-2009; IN COMMERCE 5-28-2009.
STEVEN PEREZ, EXAMINING ATTORNEY

SN 77-747,962. URDIALES, JOSE MARIANO LOPEZ, BARCELONA, SPAIN, FILED 5-29-2009.



PRIORITY CLAIMED UNDER SEC. 44(D) ON ERPN CMNTY TM OFC APPLICATION NO. 008250789, FILED 4-28-2009, REG. NO. 008250789, DATED 1-12-2010, EXPIRES 4-28-2019.

THE COLOR(S) LIGHT GREEN, DARK GREEN, LIGHT BLUE, DARK BLUE AND BLACK IS/ARE CLAIMED AS A FEATURE OF THE MARK.

THE MARK CONSISTS OF A STYLIZED FORM OF "BLOON" WITH THE "B" IN LIGHT AND DARK GREEN, THE "L" IN LIGHT BLUE, THE "OO" ARE LINKED AND APPEAR IN LIGHT AND DARK BLUE AND THE "N" APPEARS IN BLACK AND DARK BLUE.

FOR VEHICLES AND APPARATUS FOR LOCOMOTION BY AIR, NAMELY, VEHICULAR BALLOONS, AEROSTATS, AIRSHIPS, AIR-CUSHION VEHICLES, PARACHUTES; SPACE VEHICLES AND STRUCTURAL PARTS THEREFOR (U.S. CLS. 19, 21, 23, 31, 35 AND 44).

DEBRA LEE, EXAMINING ATTORNEY

CLASS 12—(Continued).

SN 77-760,505. E-Z-DOLLEY, LLC, CORAL SPRINGS, FL.
FILED 6-16-2009.



NO CLAIM IS MADE TO THE EXCLUSIVE RIGHT TO USE "ORIGINAL" & "DOLLY", APART FROM THE MARK AS SHOWN.

THE COLOR(S) GREEN, PURPLE, YELLOW, BLACK AND WHITE IS/ARE CLAIMED AS A FEATURE OF THE MARK.

THE MARK CONSISTS OF THE WORDS "THE ORIGINAL E-Z DOLLEY", WHERE "THE ORIGINAL E-Z" APPEAR IN CAPITAL LETTERS, AND "DOLLEY" IS PRESENTED WITH A CAPITAL "D" AND THE REMAINING LETTERS LOWERCASE. ALL WORDS ARE SUPERIMPOSED OVER A YELLOW SUN DEVICE, WHICH FEATURES A BLACK CART IN THE CENTRAL PORTION OF THE SUN DEVICE, AND THE WORD "ORIGINAL" IN A PURPLE BANNER-TYPE DEVICE LOCATED ABOVE THE CART, WITH THE WORD "THE" PRESENTED IN A GREEN OVAL DEVICE ABOVE THE BANNER. THE WORDS "E-Z DOLLEY", PRESENTED IN GREEN LETTERING OUTLINED BY BLACK AND WHITE, ARE SUPERIMPOSED OVER THE SUN WHERE THE "Z" AND "D" ARE SEPARATED BY THE CART DEVICE.

FOR FOLDABLE WHEELED UTILITY CART (U.S. CLS. 19, 21, 23, 31, 35 AND 44).

CHRIS WELLS, EXAMINING ATTORNEY

SN 77-772,292. CONFEDERATE MOTOR COMPANY, INC., MANDEVILLE, LA. FILED 7-1-2009.

EL BANDITO

THE MARK CONSISTS OF STANDARD CHARACTERS WITHOUT CLAIM TO ANY PARTICULAR FONT, STYLE, SIZE, OR COLOR.

THE MARK HAS NO MEANING IN THE FOREIGN LANGUAGE.

FOR MOTORCYCLES AND STRUCTURAL PARTS THEREFOR (U.S. CLS. 19, 21, 23, 31, 35 AND 44).

FIRST USE 1-1-2009; IN COMMERCE 1-1-2009.

REBECCA SMITH, EXAMINING ATTORNEY

CLASS 12—(Continued).

SN 77-789,125. RACE STAR INDUSTRIES, INC., KEARNEY, MO. FILED 7-24-2009.



NO CLAIM IS MADE TO THE EXCLUSIVE RIGHT TO USE "INDUSTRIES", APART FROM THE MARK AS SHOWN.

THE MARK CONSISTS OF AN ELONGATED STAR WITH THE WORDS "RACE STAR INDUSTRIES" INSIDE THE STAR. THE TOP POINT OF THE STAR HAS A TAIL AND THE TOP OF THE BOTTOM POINT HAS A TAIL AS TO UNDERLINE THE WORD "RACE".

FOR VEHICLE WHEELS (U.S. CLS. 19, 21, 23, 31, 35 AND 44).

FIRST USE 6-1-2009; IN COMMERCE 6-1-2009.
ZACHARY BELLO, EXAMINING ATTORNEY

SN 77-795,406. BRAMMO, INC., ASHLAND, OR. FILED 8-3-2009.

ENERTIA

THE MARK CONSISTS OF STANDARD CHARACTERS WITHOUT CLAIM TO ANY PARTICULAR FONT, STYLE, SIZE, OR COLOR.

FOR STRUCTURAL PARTS FOR MOTORCYCLES (U.S. CLS. 19, 21, 23, 31, 35 AND 44).

ANDREW LEASER, EXAMINING ATTORNEY

SN 77-796,170. HONDA MOTOR CO., LTD., TOKYO, JAPAN, FILED 8-4-2009.

ECON

THE MARK CONSISTS OF STANDARD CHARACTERS WITHOUT CLAIM TO ANY PARTICULAR FONT, STYLE, SIZE, OR COLOR.

FOR AUTOMOBILES FEATURING A SYSTEM COMPRISED OF SENSORS, METERS, COMPUTERS AND READOUT SCREEN THAT CONTINUOUSLY MONITORS ENGINES, THROTTLE CONTROL, CVT(CONTINUOUSLY VARIABLE TRANSMISSION) OPERATION, IDLE-STOP DURATION, AIR CONDITIONING AND CRUISE-CONTROL OPERATION AND CALCULATES HOW TO OPERATE THE VEHICLE FOR MAXIMUM ENERGY EFFICIENCY (U.S. CLS. 19, 21, 23, 31, 35 AND 44).

EUGENIA MARTIN, EXAMINING ATTORNEY

CLASS 12—(Continued).

SN 77-815,098. FORD MOTOR COMPANY, DEARBORN, MI. FILED 8-28-2009.

TRACER

THE MARK CONSISTS OF STANDARD CHARACTERS WITHOUT CLAIM TO ANY PARTICULAR FONT, STYLE, SIZE, OR COLOR.

FOR LAND MOTOR VEHICLES, NAMELY, AUTOMOBILES AND THEIR ENGINES; EXTERIOR INSIGNIA BADGES FOR VEHICLES; VEHICLE ROOFTOP CARGO CARRIERS; SPARE TIRE COVERS FOR VEHICLES; FITTED MOTOR VEHICLE COVERS; BUG DEFLECTORS FOR MOTOR VEHICLES; RUNNING BOARDS FOR MOTOR VEHICLES; MUD FLAPS FOR MOTOR VEHICLES; HITCH PLUGS FOR MOTOR VEHICLES, NAMELY, TRAILER HITCHES; WINDSHIELD SUNSHADES AND LICENSE PLATE FRAMES FOR MOTOR VEHICLES; FITTED TRUCK BED COVERS AND FITTED TRUCK BED LINERS (U.S. CLS. 19, 21, 23, 31, 35 AND 44).

LAURIE KAUFMAN, EXAMINING ATTORNEY

SN 77-826,235. FCS AUTOMOTIVE INTERNATIONAL INC, ROMULUS, MI. FILED 9-14-2009.

US PICC

THE MARK CONSISTS OF STANDARD CHARACTERS WITHOUT CLAIM TO ANY PARTICULAR FONT, STYLE, SIZE, OR COLOR.

NO CLAIM IS MADE TO THE EXCLUSIVE RIGHT TO USE "US", APART FROM THE MARK AS SHOWN.

FOR VEHICLE PARTS, NAMELY, SHOCK ABSORBERS (U.S. CLS. 19, 21, 23, 31, 35 AND 44).

BARBARA BROWN, EXAMINING ATTORNEY

CLASS 12—(Continued).

SN 77-837,836. FIRST BICYCLE COMPONENTS CO., LTD, TAICHUNG HSIEN, TAIWAN, FILED 9-30-2009.

MAGPIE

THE MARK CONSISTS OF STANDARD CHARACTERS WITHOUT CLAIM TO ANY PARTICULAR FONT, STYLE, SIZE, OR COLOR.

FOR BICYCLE BRAKES; BICYCLE CHAINS; BICYCLE FRAMES; BICYCLE KICKSTANDS; BICYCLE PARTS, NAMELY, GEAR WHEELS; BICYCLE PARTS, NAMELY, HANDLE BAR STEMS; BICYCLE PARTS, NAMELY, TUBE CONNECTORS, FRONT FORK COVERS, FRONT FORKS, CRANKSHAFTS, HANDLE BAR STEMS; BICYCLE PEDALS; BICYCLE SADDLES; BICYCLES; DIRECTIONAL SIGNALS FOR VEHICLES; HANDLEBARS; MUDGUARDS; NON-MOTORIZED SCOOTERS; RIMS FOR BICYCLE WHEELS (U.S. CLS. 19, 21, 23, 31, 35 AND 44).

FIRST USE 3-10-2009; IN COMMERCE 9-18-2009.
RAMONA ORTIGA, EXAMINING ATTORNEY

CLASS 12—(Continued).

SN 77-849,317. ALEJANDRO GARCÍA FLORES, ALTAMIRA TAMAULIPAS, MEXICO, AND IRMA ELMA GARCÍA FLORES, ALTAMIRA, TAMAULIPAS, MEXICO, AND JOSE IGNACIO GARCÍA FLORES, ALTAMIRA TAMAULIPAS, MEXICO, AND LEOPOLDO GARCÍA FLORES, ALTAMIRA TAMAULIPAS, MEXICO, FILED 10-15-2009.



NO CLAIM IS MADE TO THE EXCLUSIVE RIGHT TO USE "HEAVY-DUTY", APART FROM THE MARK AS SHOWN.

THE MARK CONSISTS OF THE STYLIZED LETTERING "MC HEAVY-DUTY" ABOVE THREE CRESCENTS.

FOR STRUCTURAL REPAIR PARTS FOR TRUCKS, TRAILERS, AND OTHER MOTOR VEHICLES, NAMELY, LEAF SPRINGS (U.S. CLS. 19, 21, 23, 31, 35 AND 44).
STEPHANIE ALI, EXAMINING ATTORNEY

SN 77-841,256. WESTERN TRAILER CO., BOISE, ID. FILED 10-5-2009.

FORCESTEER

THE MARK CONSISTS OF STANDARD CHARACTERS WITHOUT CLAIM TO ANY PARTICULAR FONT, STYLE, SIZE, OR COLOR.

FOR TRAILERS (U.S. CLS. 19, 21, 23, 31, 35 AND 44).
FIRST USE 8-7-2009; IN COMMERCE 8-7-2009.
KAREN BRACEY, EXAMINING ATTORNEY

SN 77-876,468. SCIO VERUM CORPORATION, PALM BEACH, FL. FILED 11-19-2009.



OWNER OF U.S. REG. NOS. 2,869,705 AND 2,893,388.
THE NAME "BRIAN VICKERS" IDENTIFIES A LIVING INDIVIDUAL WHOSE CONSENT IS OF RECORD.

THE MARK CONSISTS OF THE NAME "BRIAN VICKERS" IN SCRIPT.

FOR LICENSE PLATE HOLDERS; LICENSE PLATE FRAMES (U.S. CLS. 19, 21, 23, 31, 35 AND 44).
FIRST USE 0-0-2005; IN COMMERCE 0-0-2005.
LESLIE RICHARDS, EXAMINING ATTORNEY

CLASS 12—(Continued).

SN 77-876,472. SCIO VERUM CORPORATION, PALM BEACH, FL. FILED 11-19-2009.

BRIAN VICKERS

THE MARK CONSISTS OF STANDARD CHARACTERS WITHOUT CLAIM TO ANY PARTICULAR FONT, STYLE, SIZE, OR COLOR.

OWNER OF U.S. REG. NOS. 2,869,705 AND 2,893,388. THE NAME "BRIAN VICKERS" IDENTIFIES A LIVING INDIVIDUAL WHOSE CONSENT IS OF RECORD. FOR LICENSE PLATE HOLDERS; LICENSE PLATE FRAMES (U.S. CLS. 19, 21, 23, 31, 35 AND 44). FIRST USE 0-0-2005; IN COMMERCE 0-0-2005. LESLIE RICHARDS, EXAMINING ATTORNEY

SN 77-883,226. CONTRACT MANUFACTURER, LLC, MADILL, OK. FILED 12-1-2009.

CARGO MATE

THE MARK CONSISTS OF STANDARD CHARACTERS WITHOUT CLAIM TO ANY PARTICULAR FONT, STYLE, SIZE, OR COLOR.

NO CLAIM IS MADE TO THE EXCLUSIVE RIGHT TO USE "CARGO", APART FROM THE MARK AS SHOWN. FOR CARGO TRAILERS (U.S. CLS. 19, 21, 23, 31, 35 AND 44). FIRST USE 1-13-1993; IN COMMERCE 1-13-1993. CHARLES L. JENKINS, EXAMINING ATTORNEY

SN 77-884,411. HALCORE GROUP, INC., DBA HORTON EMERGENCY VEHICLES, GROVE CITY, OH. FILED 12-2-2009.

Concept 3

THE MARK CONSISTS OF STANDARD CHARACTERS WITHOUT CLAIM TO ANY PARTICULAR FONT, STYLE, SIZE, OR COLOR.

FOR AMBULANCES (U.S. CLS. 19, 21, 23, 31, 35 AND 44). HAI-LY LAM, EXAMINING ATTORNEY

CLASS 12—(Continued).

SN 77-884,881. BUCKET ALL, LLC, LOS ANGELES, CA. FILED 12-2-2009.

BROLL

THE MARK CONSISTS OF STANDARD CHARACTERS WITHOUT CLAIM TO ANY PARTICULAR FONT, STYLE, SIZE, OR COLOR.

FOR CARTS; CARTS, NAMELY, WHEELED, COLLAPSIBLE, CANVAS CARTS FOR TRANSPORTING AND HAULING OBJECTS; GOODS HANDLING CARTS; MOBILE STORAGE CART FOR DOMESTIC AND COMMERCIAL USE; TROLLEYS; WHEEL BARROWS (U.S. CLS. 19, 21, 23, 31, 35 AND 44).

KATHLEEN LORENZO, EXAMINING ATTORNEY

SN 77-886,558. T3 MOTION, INC., COSTA MESA, CA. FILED 12-4-2009.



OWNER OF U.S. REG. NO. 3,511,123. THE COLOR(S) RED, BLUE AND SILVER IS/ARE CLAIMED AS A FEATURE OF THE MARK.

THE MARK CONSISTS OF A SILVER RING ENCIRCLING SILVER ARC SEGMENT PATTERNS WITH A PAIR OF DOWNWARD SILVER PROJECTIONS BELOW THE UPPER ARC SEGMENTS, THEREBY FORMING A FANCIFUL "T", WITH A RED 3 THERE BELOW, ALL ON A BLUE BACKGROUND.

FOR ELECTRIC VEHICLES, NAMELY, THREE-WHEELED AND FOUR-WHEELED VEHICLES (U.S. CLS. 19, 21, 23, 31, 35 AND 44).

JENNIFER HETU, EXAMINING ATTORNEY

SN 77-886,961. RICK SVENDSEN, ROCHESTER, MN. FILED 12-5-2009.

KINGDOM CHOPPERS

THE MARK CONSISTS OF STANDARD CHARACTERS WITHOUT CLAIM TO ANY PARTICULAR FONT, STYLE, SIZE, OR COLOR.

NO CLAIM IS MADE TO THE EXCLUSIVE RIGHT TO USE "CHOPPERS", APART FROM THE MARK AS SHOWN. FOR MOTORCYCLES (U.S. CLS. 19, 21, 23, 31, 35 AND 44).

DAWN FELDMAN, EXAMINING ATTORNEY

CLASS 12—(Continued).

SN 77-887,077. NGUYEN, SON K., SACRAMENTO, CA.
FILED 12-5-2009.

INAP

THE MARK CONSISTS OF STANDARD CHARACTERS WITHOUT CLAIM TO ANY PARTICULAR FONT, STYLE, SIZE, OR COLOR.

FOR PORTABLE HEADREST DEVICES, NAMELY, HEADRESTS DETACHABLY AFFIXED TO THE UPPER PORTION OF SEATS OR CHAIRS IN MOTOR VEHICLES, TRAINS, AND AIRCRAFT (U.S. CLS. 19, 21, 23, 31, 35 AND 44).

HENRY S. ZAK, EXAMINING ATTORNEY

SN 77-888,040. OMNI UNITED (S) PTE LTD., SINGAPORE,
SINGAPORE, FILED 12-7-2009.

OWNER OF U.S. REG. NOS. 3,055,006 AND 3,499,811.
THE MARK CONSISTS OF THE WORD RADAR SHOWN IN A STYLIZED FONT.

FOR TRUCK AND BUS RADIAL TIRES AND INNER TUBES; LIGHT TRUCK RADIAL TIRES AND INNER TUBES; PASSENGER CAR RADIAL TIRES AND INNER TUBES; OFF-ROAD RADIAL TIRES AND INNER TUBES (U.S. CLS. 19, 21, 23, 31, 35 AND 44).

HELENE LIWINSKI, EXAMINING ATTORNEY

SN 77-888,657. SHOWA CORPORATION, GYODA-CITY,
SAITAMA, JAPAN, FILED 12-8-2009.

RA-EPS

THE MARK CONSISTS OF STANDARD CHARACTERS WITHOUT CLAIM TO ANY PARTICULAR FONT, STYLE, SIZE, OR COLOR.

FOR LAND VEHICLE PARTS, NAMELY, ELECTRIC POWER STEERING DEVICES; STEERING GEAR BOXES, SOLD AS AN INTEGRAL COMPONENT OF ELECTRIC POWER STEERING, MOTOR ASSEMBLY, SOLD AS AN INTEGRAL COMPONENT OF ELECTRIC POWER STEERING; SENSOR ASSEMBLY, SOLD AS AN INTEGRAL COMPONENT OF ELECTRIC POWER STEERING (U.S. CLS. 19, 21, 23, 31, 35 AND 44).

KYLE PEETE, EXAMINING ATTORNEY

CLASS 12—(Continued).

SN 77-888,658. SHOWA CORPORATION, GYODA CITY,
SAITAMA, JAPAN, FILED 12-8-2009.

PA-EPS

THE MARK CONSISTS OF STANDARD CHARACTERS WITHOUT CLAIM TO ANY PARTICULAR FONT, STYLE, SIZE, OR COLOR.

FOR LAND VEHICLE PARTS, NAMELY, ELECTRIC POWER STEERING DEVICES; STEERING GEAR BOXES, SOLD AS AN INTEGRAL COMPONENT OF ELECTRIC POWER STEERING, MOTOR ASSEMBLY, SOLD AS AN INTEGRAL COMPONENT OF ELECTRIC POWER STEERING; SENSOR ASSEMBLY, SOLD AS AN INTEGRAL COMPONENT OF ELECTRIC POWER STEERING (U.S. CLS. 19, 21, 23, 31, 35 AND 44).

KYLE PEETE, EXAMINING ATTORNEY

SN 77-888,690. SHOWA CORPORATION, GYODA CITY,
SAITAMA, JAPAN, FILED 12-8-2009.

CA-EPS

THE MARK CONSISTS OF STANDARD CHARACTERS WITHOUT CLAIM TO ANY PARTICULAR FONT, STYLE, SIZE, OR COLOR.

FOR LAND VEHICLE PARTS, NAMELY, ELECTRIC POWER STEERING DEVICES; STEERING GEAR BOXES, SOLD AS AN INTEGRAL COMPONENT OF ELECTRIC POWER STEERING, MOTOR ASSEMBLY, SOLD AS AN INTEGRAL COMPONENT OF ELECTRIC POWER STEERING; SENSOR ASSEMBLY, SOLD AS AN INTEGRAL COMPONENT OF ELECTRIC POWER STEERING (U.S. CLS. 19, 21, 23, 31, 35 AND 44).

KYLE PEETE, EXAMINING ATTORNEY

SN 77-888,763. ALLISON TRANSMISSION, INC., INDIANA-
POLIS, IN. FILED 12-8-2009.

ALLISION TRANSMISSION

THE MARK CONSISTS OF STANDARD CHARACTERS WITHOUT CLAIM TO ANY PARTICULAR FONT, STYLE, SIZE, OR COLOR.

OWNER OF U.S. REG. NOS. 2,625,008, 3,678,354 AND OTHERS.

NO CLAIM IS MADE TO THE EXCLUSIVE RIGHT TO USE "TRANSMISSION", APART FROM THE MARK AS SHOWN.

FOR TRANSMISSIONS FOR LAND VEHICLES AND PARTS THEREOF (U.S. CLS. 19, 21, 23, 31, 35 AND 44).
FIRST USE 0-0-1947; IN COMMERCE 0-0-1947.

MIDGE BUTLER, EXAMINING ATTORNEY

CLASS 12—(Continued).

SN 77-888,776. ALLISON TRANSMISSION, INC., INDIANAPOLIS, IN. FILED 12-8-2009.



THE MARK CONSISTS OF A SERIES OF SWIRLING DESIGNS.

FOR TRANSMISSION FOR LAND VEHICLES AND PARTS THEREOF (U.S. CLS. 19, 21, 23, 31, 35 AND 44).

FIRST USE 6-2-1989; IN COMMERCE 6-2-1989.

MIDGE BUTLER, EXAMINING ATTORNEY

SN 77-888,797. ALLISON TRANSMISSION, INC., INDIANAPOLIS, IN. FILED 12-8-2009.

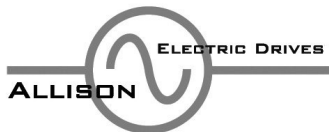

NO CLAIM IS MADE TO THE EXCLUSIVE RIGHT TO USE "ELECTRIC DRIVES", APART FROM THE MARK AS SHOWN.

THE MARK CONSISTS OF A CIRCLE SUPERIMPOSED BY THE WORD "ALLISON" AND THE TERM "ELECTRIC DRIVES" SEPARATED BY A SWIRL LINE.

FOR DRIVETRAINS FOR MOTOR LAND VEHICLES (U.S. CLS. 19, 21, 23, 31, 35 AND 44).

FIRST USE 7-27-2000; IN COMMERCE 7-27-2000.

MIDGE BUTLER, EXAMINING ATTORNEY

CLASS 12—(Continued).

SN 77-888,967. OREGON IRON WORKS, INC., CLACKAMAS, OR. FILED 12-8-2009.

United Streetcar

THE MARK CONSISTS OF STANDARD CHARACTERS WITHOUT CLAIM TO ANY PARTICULAR FONT, STYLE, SIZE, OR COLOR.

NO CLAIM IS MADE TO THE EXCLUSIVE RIGHT TO USE "STREETCAR", APART FROM THE MARK AS SHOWN.

FOR RAIL TRANSIT VEHICLES, NAMELY, ELECTRIC STREETCARS, LIGHT RAIL CARS, MASS TRANSIT AND RAPID TRANSIT CARS, SUBWAY CARS, MONORAIL CARS AND COMMUTER COACHES (U.S. CLS. 19, 21, 23, 31, 35 AND 44).

FIRST USE 5-14-2009; IN COMMERCE 5-14-2009.

BARBARA BROWN, EXAMINING ATTORNEY

SN 77-889,161. ULTRONIX PRODUCTS LTD., GUANGZHOU, 511400, CHINA, FILED 12-9-2009.

ULTRASENSOR

THE MARK CONSISTS OF STANDARD CHARACTERS WITHOUT CLAIM TO ANY PARTICULAR FONT, STYLE, SIZE, OR COLOR.

THE WORDING "ULTRASENSOR" HAS NO MEANING IN A FOREIGN LANGUAGE.

FOR ANTI-SKID CHAINS FOR VEHICLES; ANTI-SKID TEXTILE COVERS FOR TIRES; ANTI-THEFT ALARMS FOR VEHICLES; ANTI-THEFT DEVICES FOR MOTOR CARS; BACK-UP WARNING ALARMS FOR VEHICLES; DIRECTIONAL SIGNALS FOR VEHICLES; REARVIEW MIRRORS; TRAILER HITCHES; TURN SIGNALS FOR VEHICLES; UPHOLSTERY FOR VEHICLES (U.S. CLS. 19, 21, 23, 31, 35 AND 44).

COLLEEN KEARNEY, EXAMINING ATTORNEY

SN 77-889,844. DYNACRAFT BSC, INC., AMERICAN CANYON, MA. FILED 12-9-2009.

REGENERATOR

THE MARK CONSISTS OF STANDARD CHARACTERS WITHOUT CLAIM TO ANY PARTICULAR FONT, STYLE, SIZE, OR COLOR.

FOR BICYCLES (U.S. CLS. 19, 21, 23, 31, 35 AND 44).

FIRST USE 9-1-2009; IN COMMERCE 9-1-2009.

MARLENE BELL, EXAMINING ATTORNEY

CLASS 12—(Continued).

SN 77-890,528. UNIVERSITY OF NORTHWESTERN OHIO, LIMA, OH. FILED 12-10-2009.



THE COLOR(S) RED, BLACK AND WHITE IS/ARE CLAIMED AS A FEATURE OF THE MARK.

THE MARK CONSISTS OF A RED LARGE "U" OUTLINED IN BLACK AND WHITE WITH THE STYLIZED WORDING "MOTORSPORTS" ARCHED ACROSS MIDDLE IN WHITE LETTERS WITH RED, BLACK, AND WHITE OUTLINING AND THE STYLIZED WORDING "UNOH" IN BLACK AND RED OUTLINED IN WHITE ACROSS THE BOTTOM OF THE "U".

FOR LICENSE PLATE FRAMES; TRAILER HITCH COVERS (U.S. CLS. 19, 21, 23, 31, 35 AND 44).

LIEF MARTIN, EXAMINING ATTORNEY

SN 77-890,628. ROBERTS BOAT WORKS LLC, ENGLEWOOD, FL. FILED 12-10-2009.



NO CLAIM IS MADE TO THE EXCLUSIVE RIGHT TO USE "BOATS", APART FROM THE MARK AS SHOWN.

THE MARK CONSISTS OF A SNAKE WITH THE STYLIZED TEXT "SNAKE BOATS".

FOR BOATS, NAMELY, FISHING BOATS, POWER BOATS, SKIFFS, CANOES, KAYAKS (U.S. CLS. 19, 21, 23, 31, 35 AND 44).

ANTHONY RINKER, EXAMINING ATTORNEY

SN 77-890,868. TITAN INTERNATIONAL, INC., QUINCY, IL. FILED 12-10-2009.

TITAN MOVES THE WORLD

THE MARK CONSISTS OF STANDARD CHARACTERS WITHOUT CLAIM TO ANY PARTICULAR FONT, STYLE, SIZE, OR COLOR.

FOR TIRES (U.S. CLS. 19, 21, 23, 31, 35 AND 44).

CAROL SPILS, EXAMINING ATTORNEY

CLASS 12—(Continued).

SN 77-890,998. DART AEROSPACE LTD., HAWKESBURY, CANADA, FILED 12-10-2009.

ULTRAPAW

THE MARK CONSISTS OF STANDARD CHARACTERS WITHOUT CLAIM TO ANY PARTICULAR FONT, STYLE, SIZE, OR COLOR.

FOR HELICOPTER ACCESSORIES, NAMELY, LANDING GEAR SETTTLING PROTECTORS AND PARTS AND FITTINGS FOR SAME (U.S. CLS. 19, 21, 23, 31, 35 AND 44).

TAMARA FRAZIER, EXAMINING ATTORNEY

SN 77-891,042. SIM YING CHEUNG, LA PUENTE, CA. FILED 12-10-2009.

Dauson

THE MARK CONSISTS OF STANDARD CHARACTERS WITHOUT CLAIM TO ANY PARTICULAR FONT, STYLE, SIZE, OR COLOR.

FOR BABY CARRIAGES; BABY CARRIAGES; BABY STROLLERS; CANOPIES FOR BABY STROLLERS; COVERS FOR BABY STROLLERS; PRAMS; RUBBER BABY BUGGY BUMPERS; SAFETY SEATS FOR INFANTS AND CHILDREN FOR VEHICLES; UMBRELLAS TO BE AFFIXED TO BABY STROLLER (U.S. CLS. 19, 21, 23, 31, 35 AND 44).

KAELIE KUNG, EXAMINING ATTORNEY

SN 77-891,220. KUMHO TIRE CO., INC., SEOUL, REPUBLIC OF KOREA, FILED 12-11-2009.

ecowing

THE COLOR(S) GREEN IS/ARE CLAIMED AS A FEATURE OF THE MARK.

THE MARK CONSISTS OF GREEN LETTERS WITH A GREEN LEAF DESIGN IN THE LETTER "O".

FOR TIRES, INNER TUBES, AND MUD FLAPS FOR VEHICLES (U.S. CLS. 19, 21, 23, 31, 35 AND 44).

CHARLES L. JENKINS, EXAMINING ATTORNEY

CLASS 12—(Continued).

SN 77-891,892. KEARINS, WILLIAM J, ANDOVER, MA. FILED 12-11-2009.

CLASS 12—(Continued).

SN 77-892,144. ADVENTURE TRAILERS, TRUCKEE, CA. FILED 12-12-2009.

BoxCycles

THE MARK CONSISTS OF STANDARD CHARACTERS WITHOUT CLAIM TO ANY PARTICULAR FONT, STYLE, SIZE, OR COLOR.
FOR BICYCLES; DELIVERY BICYCLES (U.S. CLS. 19, 21, 23, 31, 35 AND 44).
GILBERT SWIFT, EXAMINING ATTORNEY

SN 77-892,070. THE VEHICLE PRODUCTION GROUP, LLC, TROY, MI. FILED 12-12-2009.

AVIVA

THE MARK CONSISTS OF STANDARD CHARACTERS WITHOUT CLAIM TO ANY PARTICULAR FONT, STYLE, SIZE, OR COLOR.
FOR VEHICLES, NAMELY, AUTOMOBILES (U.S. CLS. 19, 21, 23, 31, 35 AND 44).
GEOFFREY FOSDICK, EXAMINING ATTORNEY

HABITAT

THE MARK CONSISTS OF STANDARD CHARACTERS WITHOUT CLAIM TO ANY PARTICULAR FONT, STYLE, SIZE, OR COLOR.

FOR AUTOMOBILE BODIES; AUTOMOBILE ROOF RACKS; AUTOMOBILES AND STRUCTURAL PARTS THEREFOR; AUTOMOTIVE BODY KITS COMPRISING EXTERNAL STRUCTURAL PARTS OF AUTOMOBILES; AUTOMOTIVE CONVERSIONS; BADGES FOR VEHICLES; BODY PANELS FOR TRUCKS OR SUVs; CAMPERs; CAR-TOP LUGGAGE CARRIERS; CARGO CARRIERS FOR VEHICLES; CARGO STORAGE BINS ESPECIALLY ADAPTED TO FIT IN CARS; CARGO STORAGE BINS ESPECIALLY ADAPTED TO FIT IN TRUCKS OR SUVs; COMBINATION CAMPING RECREATIONAL VEHICLE AND HORSE TRAILER; CONVERTIBLE TOPS FOR VEHICLES; LAND VEHICLES AND STRUCTURAL PARTS THEREFOR; MOBILE STORAGE TANKS; MOTOR CAR CONVERTIBLE TOPS; MOTOR VEHICLES, NAMELY, AUTOMOBILES, TRUCKS, VANS, SPORT UTILITY VEHICLES AND STRUCTURAL PARTS THEREFOR; PICKUP TRUCK CAPS; RECREATIONAL VEHICLE ACCESSORIES, NAMELY, AWNINGS; RECREATIONAL VEHICLES, NAMELY, CAMPERs; RECREATIONAL VEHICLES, NAMELY, TOWABLE TRAILERS; RECREATIONAL VEHICLES, NAMELY, TRUCK CAMPERs; ROOF PANELS FOR LAND VEHICLES; ROOF RACK STORAGE CONTAINERS FOR LAND VEHICLES; SOFT TOPS FOR VEHICLES; STRUCTURAL PARTS FOR AUTOMOBILES; STRUCTURAL PARTS FOR TRUCKS; STRUCTURAL PARTS FOR VANS; TRUCK BED STORAGE ORGANIZERS; TRUCKS AND STRUCTURAL PARTS THEREFOR; VAN CONVERSIONS; VEHICLE BODIES (U.S. CLS. 19, 21, 23, 31, 35 AND 44).

FIRST USE 9-21-2009; IN COMMERCE 10-28-2009.
MARY CRAWFORD, EXAMINING ATTORNEY

SN 77-893,580. MIDSOTA MANUFACTURING, INC., AVON, MN. FILED 12-15-2009.

VERSADUMP

THE MARK CONSISTS OF STANDARD CHARACTERS WITHOUT CLAIM TO ANY PARTICULAR FONT, STYLE, SIZE, OR COLOR.
FOR TRAILERS (U.S. CLS. 19, 21, 23, 31, 35 AND 44).
FIRST USE 2-1-1998; IN COMMERCE 2-28-2000.
JENNIFER HETU, EXAMINING ATTORNEY

CLASS 12—(Continued).

SN 77-894,250. APOLLO INDUSTRIES LIMITED, HANG-ZHOU, HONG KONG, FILED 12-16-2009.

MOTOCENTRIC

THE MARK CONSISTS OF STANDARD CHARACTERS WITHOUT CLAIM TO ANY PARTICULAR FONT, STYLE, SIZE, OR COLOR.

FOR FITTED MOTORCYCLE COVERS; MOTORCYCLE BAGS, NAMELY, TANK BAGS, SADDLE BAGS, SISSY BAR BAGS AND TAIL BAGS (U.S. CLS. 19, 21, 23, 31, 35 AND 44).

WILLIAM BRECKENFELD, EXAMINING ATTORNEY

SN 77-896,786. LOCKHEED MARTIN CORPORATION, BETHESDA, MD. FILED 12-18-2009.

RQ-170 SENTINEL

THE MARK CONSISTS OF STANDARD CHARACTERS WITHOUT CLAIM TO ANY PARTICULAR FONT, STYLE, SIZE, OR COLOR.

FOR UNMANNED AERIAL VEHICLES (UAVS) AND STRUCTURAL PARTS THEREFOR (U.S. CLS. 19, 21, 23, 31, 35 AND 44).

STEVEN R. FINE, EXAMINING ATTORNEY

SN 77-905,479. TITAN INTERNATIONAL, INC., QUINCY, IL. FILED 1-5-2010.

TITAN MOVES THE MILITARY

THE MARK CONSISTS OF STANDARD CHARACTERS WITHOUT CLAIM TO ANY PARTICULAR FONT, STYLE, SIZE, OR COLOR.

FOR TIRES (U.S. CLS. 19, 21, 23, 31, 35 AND 44).

CAROL SPILS, EXAMINING ATTORNEY

CLASS 12—(Continued).

SN 78-828,151. BLACK POINT MARINE, LLC, WILLISTON, FL. FILED 3-3-2006.

BLACKFIN

THE MARK CONSISTS OF THE STYLIZED WORDING "BLACKFIN", HAVING THE LETTER "A" IN THE FORM OF A FIN.

FOR BOATS AND YACHTS (U.S. CLS. 19, 21, 23, 31, 35 AND 44).

FIRST USE 12-28-1987; IN COMMERCE 12-28-1987.

JAY BESCH, EXAMINING ATTORNEY

SN 79-060,405. CAMPAGNOLO S.R.L., ITALY, FILED 6-11-2008.



PRIORITY DATE OF 4-22-2008 IS CLAIMED.

OWNER OF INTERNATIONAL REGISTRATION 0980870 DATED 6-11-2008, EXPIRES 6-11-2018.

THE MARK CONSISTS OF A SUBSTANTIALLY RECTANGULAR BAND HAVING WITHIN IT THE WORDING "2-WAY FIT" IN FANCY BLOCK CAPITAL LETTERS WITH THE NUMBER "2" BIGGER THAN THE OTHER LETTERS. SEC. 2(F).

FOR BICYCLE PARTS, COMPONENTS AND ACCESSORIES, NAMELY, BICYCLE WHEELS, RIMS AND SPOKES FOR BICYCLE WHEELS, PEDALS, WHEEL HUB QUICK RELEASE DEVICES AND WHEEL HUBS COMPRISING SAID DEVICES, BRAKES, BRAKE PADS, DISK BRAKES, TIRES, TUBULAR TIRES, INNER TUBES, CLINCHER TIRES, RIM TAPES FOR TUBELESS TIRES, AND TIRE VALVES (U.S. CLS. 19, 21, 23, 31, 35 AND 44).

WENDY JUN, EXAMINING ATTORNEY

SN 79-068,549. GUSTAV MAGENWIRTH GMBH & CO. KG, FED REP GERMANY, FILED 3-27-2009.

Durin

THE MARK CONSISTS OF STANDARD CHARACTERS WITHOUT CLAIM TO ANY PARTICULAR FONT, STYLE, SIZE, OR COLOR.

OWNER OF INTERNATIONAL REGISTRATION 1002036 DATED 3-27-2009, EXPIRES 3-27-2019.

FOR SUSPENSION FORKS, IN PARTICULAR FOR BICYCLES (U.S. CLS. 19, 21, 23, 31, 35 AND 44).

CAROL SPILS, EXAMINING ATTORNEY

CLASS 12—(Continued).

SN 79-069,643. F.A.C. DI MICHELIN -, FABBRICA ACCESSORI CICLI - S.P.A., ITALY, FILED 1-27-2009.



PRIORITY DATE OF 11-28-2008 IS CLAIMED.
OWNER OF INTERNATIONAL REGISTRATION 1004699
DATED 1-27-2009, EXPIRES 1-27-2019.

THE MARK CONSISTS OF A SIGN DEPICTING THE WORDING "MICHE", IN FANCY CHARACTERS, THE LETTER "M" BEING SLIGHTLY OBLIQUE AND THE LETTER "E" PARTIALLY OMITTED, BECAUSE CUT OFF OBLIQUELY.

THE WORDING "MICHE" HAS NO MEANING IN A FOREIGN LANGUAGE.

FOR BICYCLES, CYCLES, NAMELY, UNICYCLES, TRICYCLES, DELIVERY TRICYCLES, CARRIER TRICYCLES; BICYCLE PARTS, NAMELY, CRANKS FOR BICYCLES, BOTTOM BRACKETS FOR BICYCLES, CHAIN WHEELS FOR BICYCLES, SPROCKETS FOR BICYCLES, HUBS FOR BICYCLES, PEDALS FOR BICYCLES, CHAINS FOR BICYCLES, BRAKES FOR BICYCLES, QUICK RELEASE SHIFT LEVERS FOR BICYCLES, STEERING GEARS FOR BICYCLES, HANDLE BARS FOR BICYCLES, CLAMPS FOR BICYCLES, BELLS FOR BICYCLES, FRAMES FOR BICYCLES, INNER TUBES FOR BICYCLES, MUDGUARDS FOR BICYCLES, AIR PUMPS FOR BICYCLES, RIMS FOR BICYCLES, SADDLES FOR BICYCLES, SPOKES FOR BICYCLES, STANDS FOR BICYCLES, TIRES FOR BICYCLES, BASKETS ADAPTED FOR BICYCLES, DIRECTION INDICATORS FOR BICYCLES, DRESS GUARDS FOR BICYCLES, GEARS FOR BICYCLES, MOTORS FOR BICYCLES, PANNIER BAGS ADAPTED FOR BICYCLES, RIMS FOR WHEELS OF BICYCLES, SADDLE COVERS FOR BICYCLES, TUBELESS TIRES FOR BICYCLES, ANTI-THEFT ALARMS FOR BICYCLES, WHEELS FOR BICYCLES; BICYCLE TRAILERS; ADHESIVE RUBBER PATCHES FOR REPAIRING TUBES OR TIRES, REPAIR KITS FOR INNER TUBES; BANDS FOR WHEEL HUBS (U.S. CLS. 19, 21, 23, 31, 35 AND 44).

SCOTT BIBB, EXAMINING ATTORNEY

CLASS 13—FIREARMS

SN 77-725,803. CROSMAN CORPORATION, EAST BLOOMFIELD, NY. FILED 4-30-2009.



THE MARK CONSISTS OF STANDARD CHARACTERS WITHOUT CLAIM TO ANY PARTICULAR FONT, STYLE, SIZE, OR COLOR.

NO CLAIM IS MADE TO THE EXCLUSIVE RIGHT TO USE "PISTON", APART FROM THE MARK AS SHOWN.

FOR AIRGUNS (U.S. CLS. 2 AND 9).

DOMINICK J. SALEMI, EXAMINING ATTORNEY

CLASS 13—(Continued).

SN 77-739,177. CROSMAN CORPORATION, EAST BLOOMFIELD, NY. FILED 5-18-2009.



NO CLAIM IS MADE TO THE EXCLUSIVE RIGHT TO USE "PISTON", APART FROM THE MARK AS SHOWN.

THE MARK CONSISTS OF THE WORDS "NITRO PISTON" INSIDE OF AN OVAL.

FOR AIRGUNS (U.S. CLS. 2 AND 9).

FIRST USE 6-16-2009; IN COMMERCE 6-19-2009.

DOMINICK J. SALEMI, EXAMINING ATTORNEY

SN 77-747,271. ALLIANT TECHSYSTEMS INC., MINNEAPOLIS, MN. FILED 5-29-2009.



THE MARK CONSISTS OF STANDARD CHARACTERS WITHOUT CLAIM TO ANY PARTICULAR FONT, STYLE, SIZE, OR COLOR.

OWNER OF U.S. REG. NOS. 971,715, 1,898,839 AND OTHERS.

NO CLAIM IS MADE TO THE EXCLUSIVE RIGHT TO USE "BLACK", APART FROM THE MARK AS SHOWN.

FOR BLACK POWDER SUBSTITUTE (U.S. CLS. 2 AND 9).

ANGELA DUONG, EXAMINING ATTORNEY

SN 77-828,029. COMBINED SYSTEMS, INC., JAMESTOWN, PA. FILED 9-16-2009.



THE MARK CONSISTS OF STANDARD CHARACTERS WITHOUT CLAIM TO ANY PARTICULAR FONT, STYLE, SIZE, OR COLOR.

NO CLAIM IS MADE TO THE EXCLUSIVE RIGHT TO USE "SYSTEMS", APART FROM THE MARK AS SHOWN.

FOR EXPLOSIVES; GRENADE LAUNCHERS; GRENADES; MUNITIONS; PYROTECHNICS (U.S. CLS. 2 AND 9).

AND 9).

TIMOTHY FINNEGAN, EXAMINING ATTORNEY

CLASS 13—(Continued).

SN 77-829,544. JAKE'S FIREWORKS INC., PITTSBURG, KS.
FILED 9-18-2009.

Cutting Edge

THE MARK CONSISTS OF STANDARD CHARACTERS
WITHOUT CLAIM TO ANY PARTICULAR FONT, STYLE,
SIZE, OR COLOR.

FOR FIREWORKS (U.S. CLS. 2 AND 9).
FIRST USE 0-0-2009; IN COMMERCE 0-0-2009.
STEPHANIE ALI, EXAMINING ATTORNEY

SN 77-873,323. KRIEGER, JOHN, RICHFIELD, WI. FILED 11-
16-2009.

Obermeyer Approved 5R

THE MARK CONSISTS OF STANDARD CHARACTERS
WITHOUT CLAIM TO ANY PARTICULAR FONT, STYLE,
SIZE, OR COLOR.

NO CLAIM IS MADE TO THE EXCLUSIVE RIGHT TO
USE "APPROVED 5R", APART FROM THE MARK AS
SHOWN.

FOR GUN BARRELS WHICH INCREASE THE ACCU-
RACY OF FIREARMS (U.S. CLS. 2 AND 9).
FIRST USE 10-7-2009; IN COMMERCE 10-15-2009.
CYNTHIA SLOAN, EXAMINING ATTORNEY

SN 77-879,003. B.J. ALAN COMPANY, YOUNGSTOWN, OH.
FILED 11-23-2009.

PHANTOM'S FURY

THE MARK CONSISTS OF STANDARD CHARACTERS
WITHOUT CLAIM TO ANY PARTICULAR FONT, STYLE,
SIZE, OR COLOR.

OWNER OF U.S. REG. NOS. 3,252,958, 3,254,800 AND
3,395,624.
FOR FIREWORKS (U.S. CLS. 2 AND 9).
FIRST USE 2-12-2004; IN COMMERCE 2-12-2004.
NAPOLEON SHARMA, EXAMINING ATTORNEY

CLASS 13—(Continued).

SN 77-880,005. B.J. ALAN COMPANY, YOUNGSTOWN, OH.
FILED 11-24-2009.

TUNGUSKA BLAST

THE MARK CONSISTS OF STANDARD CHARACTERS
WITHOUT CLAIM TO ANY PARTICULAR FONT, STYLE,
SIZE, OR COLOR.

NO CLAIM IS MADE TO THE EXCLUSIVE RIGHT TO
USE "BLAST", APART FROM THE MARK AS SHOWN.
FOR FIREWORKS (U.S. CLS. 2 AND 9).
NAPOLEON SHARMA, EXAMINING ATTORNEY

SN 77-880,097. B.J. ALAN COMPANY, YOUNGSTOWN, OH.
FILED 11-24-2009.

HEAVY HEAVY FUEL

THE MARK CONSISTS OF STANDARD CHARACTERS
WITHOUT CLAIM TO ANY PARTICULAR FONT, STYLE,
SIZE, OR COLOR.

NO CLAIM IS MADE TO THE EXCLUSIVE RIGHT TO
USE "FUEL", APART FROM THE MARK AS SHOWN.
FOR FIREWORKS (U.S. CLS. 2 AND 9).
NAPOLEON SHARMA, EXAMINING ATTORNEY

SN 77-887,047. HORNADY MANUFACTURING COMPANY,
GRAND ISLAND, NE. FILED 12-5-2009.

SPEED KILLS

THE MARK CONSISTS OF STANDARD CHARACTERS
WITHOUT CLAIM TO ANY PARTICULAR FONT, STYLE,
SIZE, OR COLOR.

FOR AMMUNITION (U.S. CLS. 2 AND 9).
LAURIE MAYES, EXAMINING ATTORNEY

CLASS 13—(Continued).

SN 77-889,080. SIG-SAUER, INC., EXETER, NH. FILED 12-8-2009.

X-SIX

THE MARK CONSISTS OF STANDARD CHARACTERS WITHOUT CLAIM TO ANY PARTICULAR FONT, STYLE, SIZE, OR COLOR.
FOR FIREARMS (U.S. CLS. 2 AND 9).
ANNE E. GUSTASON, EXAMINING ATTORNEY

CLASS 13—(Continued).

SN 77-896,100. OLIN CORPORATION, ST. LOUIS, MO. FILED 12-17-2009.

999

THE MARK CONSISTS OF STANDARD CHARACTERS WITHOUT CLAIM TO ANY PARTICULAR FONT, STYLE, SIZE, OR COLOR.
FOR AMMUNITION (U.S. CLS. 2 AND 9).
PAM WILLIS, EXAMINING ATTORNEY

SN 77-889,788. PRECISION REFLEX, INC, NEW BRENNAN, OH. FILED 12-9-2009.



OWNER OF U.S. REG. NO. 3,654,266.
THE MARK CONSISTS OF A GLOBE WITH THE CAPITAL LETTERS "P", "R", "I" SUPERIMPOSED UPON IT.
FOR GUN PARTS (U.S. CLS. 2 AND 9).
FIRST USE 9-0-1999; IN COMMERCE 9-0-1999.
ELISSA GARBER KON, EXAMINING ATTORNEY

SN 77-896,539. CHAFFIN, KEVIN D., VENTURA, CA. AND STATE AMMUNITION INC., VENTURA, CA. FILED 12-18-2009.



NO CLAIM IS MADE TO THE EXCLUSIVE RIGHT TO USE "AMMUNITION" OR THE OUTLINE OF THE UNITED STATES, APART FROM THE MARK AS SHOWN.

THE MARK CONSISTS OF AN OUTER CIRCLE CONTAINING THIRTEEN STARS ALSO ARRANGED IN A CIRCLE, SURROUNDING AN INNER CIRCLE CONTAINING AN OUTLINE OF THE CONTINENTAL UNITED STATES OF AMERICA; AND TO THE RIGHT OF THE DESIGN IS THE WORD "STATE" ABOVE THE ADDITIONAL WORD "AMMUNITION".

FOR AMMUNITION FOR FIREARMS (U.S. CLS. 2 AND 9).

FIRST USE 3-26-2009; IN COMMERCE 12-10-2009.
TINA L. SNAPP, EXAMINING ATTORNEY

SN 77-896,089. OLIN CORPORATION, ST. LOUIS, MO. FILED 12-17-2009.

888

THE MARK CONSISTS OF STANDARD CHARACTERS WITHOUT CLAIM TO ANY PARTICULAR FONT, STYLE, SIZE, OR COLOR.
FOR AMMUNITION (U.S. CLS. 2 AND 9).
PAM WILLIS, EXAMINING ATTORNEY

SN 77-916,993. OLIN CORPORATION, ST. LOUIS, MO. FILED 1-21-2010.

THE BUCK STOPS HERE

THE MARK CONSISTS OF STANDARD CHARACTERS WITHOUT CLAIM TO ANY PARTICULAR FONT, STYLE, SIZE, OR COLOR.
FOR AMMUNITION (U.S. CLS. 2 AND 9).
PAM WILLIS, EXAMINING ATTORNEY

CLASS 14—JEWELRY

SN 76-698,163. CURY, VICTORIA, WEST PALM BEACH, FL.
FILED 6-29-2009.



THE MARK CONSISTS OF THE LITERAL ELEMENT "FAIRY CALLER" REPRESENTED IN STYLIZED FONT AND A DESIGN ELEMENT CONSISTING OF A GRAPHIC REPRESENTATION OF A FAIRY WITH WINGS SITTING WITHIN THE LETTER "C" ON THE LOWER PORTION THEREOF, WITH A SMATTERING OF CROSS-SHAPED STARS APPEARING ABOUT THE FAIRY DESIGN.
FOR JEWELRY (U.S. CLS. 2, 27, 28 AND 50).
FIRST USE 5-14-2009; IN COMMERCE 5-14-2009.
RONALD DELGIZZI, EXAMINING ATTORNEY

CLASS 14—(Continued).

SN 77-321,655. WICKED FASHIONS, INC., FORT LEE, NJ.
FILED 11-5-2007.

THE MARK CONSISTS OF STANDARD CHARACTERS WITHOUT CLAIM TO ANY PARTICULAR FONT, STYLE, SIZE, OR COLOR.
FOR JEWELRY; PRECIOUS AND SEMI-PRECIOUS GEMSTONES; WATCHES; CLOCKS; CHRONOGRAPHS FOR USE AS TIMEPIECES (U.S. CLS. 2, 27, 28 AND 50).
JULIE WATSON, EXAMINING ATTORNEY

SN 77-243,307. SECURELINE, LONG BEACH, CA. FILED 7-31-2007.

THE MARK CONSISTS OF STANDARD CHARACTERS WITHOUT CLAIM TO ANY PARTICULAR FONT, STYLE, SIZE, OR COLOR.
OWNER OF U.S. REG. NO. 3,246,720.
NO CLAIM IS MADE TO THE EXCLUSIVE RIGHT TO USE "USA", APART FROM THE MARK AS SHOWN.
FOR JEWELRY AND WATCHES (U.S. CLS. 2, 27, 28 AND 50).
FIRST USE 7-24-2007; IN COMMERCE 7-24-2007.
TRACY WHITTAKER-BROWN, EXAMINING ATTORNEY

SN 77-478,235. SEEMEDSIGN LLC, ATLANTA, GA. FILED 5-19-2008.

THE MARK CONSISTS OF STANDARD CHARACTERS WITHOUT CLAIM TO ANY PARTICULAR FONT, STYLE, SIZE, OR COLOR.
FOR BRACELETS; BRONZE JEWELRY; BROOCHES; CHARMS; COSTUME JEWELRY; GEMSTONE JEWELRY; JEWELRY; RINGS; WATCHES AND JEWELRY; EARRINGS (U.S. CLS. 2, 27, 28 AND 50).
FIRST USE 2-1-2008; IN COMMERCE 2-1-2008.
JASON TURNER, EXAMINING ATTORNEY

SN 77-271,493. MCGINNIS, KELLY, SAN DIEGO, CA. FILED 9-4-2007.

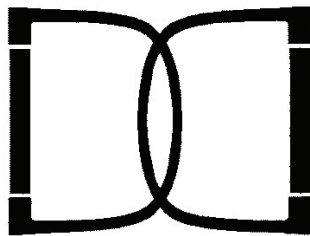

OWNER OF U.S. REG. NO. 2,975,144.
THE MARK CONSISTS OF TWO INTERLOCKING LETTER "D".
FOR JEWELRY (U.S. CLS. 2, 27, 28 AND 50).
EUGENIA MARTIN, EXAMINING ATTORNEY

SN 77-530,650. LUND TRADING, LLC, COLUMBIA, MD.
FILED 7-24-2008.

THE MARK CONSISTS OF STANDARD CHARACTERS WITHOUT CLAIM TO ANY PARTICULAR FONT, STYLE, SIZE, OR COLOR.
FOR BEADS FOR USE IN THE MANUFACTURE OF JEWELRY; BRACELETS; CHARMS; COSTUME JEWELRY (U.S. CLS. 2, 27, 28 AND 50).
EDWARD NELSON, EXAMINING ATTORNEY

CLASS 14—(Continued).

SN 77-695,247. MCL DESIGN, INC., LOUISVILLE, KY.
FILED 3-19-2009.



OWNER OF U.S. REG. NOS. 3,515,493 AND 3,579,018.
NO CLAIM IS MADE TO THE EXCLUSIVE RIGHT TO
USE "EST." AND "1998", APART FROM THE MARK AS
SHOWN.

THE NAME SHOWN IN THE MARK IDENTIFIES "MAT-
THEW CAMPBELL LAURENZA" WHOSE CONSENT TO
REGISTER IS MADE OF RECORD.

THE MARK CONSISTS OF A CREST WITH A CHECK-
ERED SHIELD WITH A CROWN ON TOP WITH THE
LETTERS "M.C.L.", LEAVES AT EACH SIDE AND A
BANNER ACROSS THE BOTTOM WITH THE WORDS
"EST. MATTHEW CAMPBELL LAURENZA 1998".

FOR JEWELRY (U.S. CLS. 2, 27, 28 AND 50).

FIRST USE 5-1-2009; IN COMMERCE 5-1-2009.

MARIAM MAHMOUDI, EXAMINING ATTORNEY

SN 77-725,743. ETTEN ELLER LLC, BROOKLYN, NY. FILED
4-30-2009.

Etten Eller

THE MARK CONSISTS OF STANDARD CHARACTERS
WITHOUT CLAIM TO ANY PARTICULAR FONT, STYLE,
SIZE, OR COLOR.

THE NAME "ETTEN ELLER" DOES NOT IDENTIFY A
LIVING INDIVIDUAL.

THE WORDING "ETTEN ELLER" HAS NO MEANING IN
A FOREIGN LANGUAGE.

FOR BODY JEWELRY; BRACELETS; BROACHES;
BRONZE JEWELRY; BROOCHES; CHARMS; COSTUME
JEWELRY; DIAMOND JEWELRY; GEMSTONE JEW-
ELRY; JEWELRY; JEWELRY AND IMITATION JEW-
ELRY (U.S. CLS. 2, 27, 28 AND 50).

FIRST USE 2-1-2008; IN COMMERCE 5-1-2008.

KAREN BRACEY, EXAMINING ATTORNEY

CLASS 14—(Continued).

SN 77-726,210. INFINITI GROUP INTERNATIONAL, INC.,
DES PLAINES, IL. FILED 4-30-2009.

WAVE

THE MARK CONSISTS OF STANDARD CHARACTERS
WITHOUT CLAIM TO ANY PARTICULAR FONT, STYLE,
SIZE, OR COLOR.

FOR CLOCKS (U.S. CLS. 2, 27, 28 AND 50).

JOHN WILKE, EXAMINING ATTORNEY

SN 77-731,893. MARISOL S.A., JARAGUA DO SUL - SC,
BRAZIL, FILED 5-7-2009.

STEREO FWD

THE MARK CONSISTS OF STANDARD CHARACTERS
WITHOUT CLAIM TO ANY PARTICULAR FONT, STYLE,
SIZE, OR COLOR.

FOR SILVER PERSONAL ORNAMENTS, JEWELLERY
ORNAMENTS OF PRECIOUS METAL, JEWELLERY,
NAMELY, AMULETS, RINGS, JEWELLERY, EARR-
INGS, BROOCHES, WATCH CASES, JEWELLERY CAS-
KETS, KEY RINGS OF PRECIOUS METAL, NAMELY,
TRINKETS AND FOBS, NECKLACES, WATCH CHAINS,
JEWELLERY CHAINS, CHRONOGRAPHS FOR USE AS
WATCHES, CHRONOMETERS, DIAMONDS, PRECIOUS
STONES, NAMELY, SPINEL, PRESENTATION CASES
FOR WATCHES, CASES FOR CLOCKS AND WATCH-
MAKING, THREADS OF PRECIOUS METAL, JEWEL-
LERY OF YELLOW AMBER, IVORY JEWELLERY,
MEDALS, MEDALLIONS, PRECIOUS METAL THREAD,
GOLD THREAD, GOLD UNWROUGHT OR BEATEN,
PRECIOUS STONES, PRECIOUS METAL STONES, SEMI-
PRECIOUS STONES, CHARMS, SILVER THREAD,
THREADS OF PRECIOUS METAL, NAMELY, SPUN
SILVER JEWELRY, SILVER UNWROUGHT OR BEA-
TEN, PASTE JEWELLERY, BRACELETS, WATCH
CHAINS, ATOMIC CLOCKS, MASTER CONTROL
CLOCKS, WRISTWATCHES, SUN DIALS (U.S. CLS. 2,
27, 28 AND 50).

AARON BRODSKY, EXAMINING ATTORNEY

CLASS 14—(Continued).

SN 77-750,190. MILLY LLC, NEW YORK, NY. FILED 6-2-2009.

MILLY

THE MARK CONSISTS OF STANDARD CHARACTERS WITHOUT CLAIM TO ANY PARTICULAR FONT, STYLE, SIZE, OR COLOR.

OWNER OF U.S. REG. NOS. 3,136,107 AND 3,181,915. THE NAME(S), PORTRAIT(S), AND/OR SIGNATURE(S) SHOWN IN THE MARK DOES NOT IDENTIFY A PARTICULAR LIVING INDIVIDUAL.

FOR JEWELRY AND COSTUME JEWELRY (U.S. CLS. 2, 27, 28 AND 50).

FIRST USE 2-0-2005; IN COMMERCE 9-0-2006.
WENDY GOODMAN, EXAMINING ATTORNEY

CLASS 14—(Continued).

SN 77-761,237. R. H. & CO., INC., GLENDALE, CA. FILED 6-16-2009.

NANO TURQUOISE

THE MARK CONSISTS OF STANDARD CHARACTERS WITHOUT CLAIM TO ANY PARTICULAR FONT, STYLE, SIZE, OR COLOR.

NO CLAIM IS MADE TO THE EXCLUSIVE RIGHT TO USE "TURQUOISE", APART FROM THE MARK AS SHOWN.

FOR BODY JEWELRY; BRACELETS; BROACHES; BROOCHES; CHARMS; DIAMOND JEWELRY; GEMSTONE JEWELRY; JEWELRY; JEWELRY AND IMITATION JEWELRY; JEWELRY FOR ATTACHMENT TO CLOTHING; JEWELRY FOR THE HEAD; JEWELRY IN THE NATURE OF ARMBANDS; JEWELRY PINS FOR USE ON HATS; JEWELRY TO BE AFFIXED TO BIKINIS; JEWELRY WATCHES; JEWELRY, NAMELY, AMULETS; JEWELRY, NAMELY, ANKLETS; JEWELRY, NAMELY, CROSSES; JEWELRY, NAMELY, PRECIOUS METAL PLATED REAL LEAVES AND FLOWERS; JEWELRY, NAMELY, STONE PENDANTS; LAPEL PINS; PET JEWELRY; PINS BEING JEWELRY; PLASTIC BRACELETS IN THE NATURE OF JEWELRY; RINGS; RINGS BEING JEWELRY; STAINLESS STEEL JEWELRY BRACELETS; WATCHES AND JEWELRY; WATCHES, CLOCKS, JEWELRY AND IMITATION JEWELRY; ALL CONTAINING TURQUOISE (U.S. CLS. 2, 27, 28 AND 50).

FIRST USE 5-29-2009; IN COMMERCE 5-29-2009.
LEIGH CAROLINE CASE, EXAMINING ATTORNEY

SN 77-753,640. ANNIE AFT, LOS ANGELES, CA. FILED 6-5-2009.

HOPE HEAL HONOR

THE MARK CONSISTS OF STANDARD CHARACTERS WITHOUT CLAIM TO ANY PARTICULAR FONT, STYLE, SIZE, OR COLOR.

FOR JEWELRY (U.S. CLS. 2, 27, 28 AND 50).
FIRST USE 3-5-2007; IN COMMERCE 3-5-2007.
KELLEY WELLS, EXAMINING ATTORNEY

SN 77-765,591. ASHI DIAMONDS, LLC, NEW YORK, NY. FILED 6-22-2009.

BABY DUOS

THE MARK CONSISTS OF STANDARD CHARACTERS WITHOUT CLAIM TO ANY PARTICULAR FONT, STYLE, SIZE, OR COLOR.

NO CLAIM IS MADE TO THE EXCLUSIVE RIGHT TO USE "DUOS", APART FROM THE MARK AS SHOWN.

FOR DIAMOND AND PRECIOUS STONE JEWELRY SET IN PRECIOUS METALS (U.S. CLS. 2, 27, 28 AND 50).
FIRST USE 1-0-2009; IN COMMERCE 3-0-2009.
MICHAEL ENGEL, EXAMINING ATTORNEY

CLASS 14—(Continued).

SN 77-780,945. LC SANKA, INC., NEW YORK, NY. FILED 7-14-2009.

Techno KING

THE MARK CONSISTS OF THE STYLIZED WORDING "TECHNO KING."

FOR CLOCKS AND WATCHES AND OTHER CHRONOMETRIC INSTRUMENTS (U.S. CLS. 2, 27, 28 AND 50).

FIRST USE 7-1-2007; IN COMMERCE 7-1-2007.

LYDIA BELZER, EXAMINING ATTORNEY

SN 77-841,498. EDELMAN SHOE, INC., NEW YORK, NY. FILED 10-5-2009.

LIBBY EDELMAN

THE MARK CONSISTS OF STANDARD CHARACTERS WITHOUT CLAIM TO ANY PARTICULAR FONT, STYLE, SIZE, OR COLOR.

OWNER OF U.S. REG. NO. 3,640,576.

THE NAME(S), PORTRAIT(S), AND/OR SIGNATURE(S) SHOWN IN THE MARK IDENTIFIES "LIBBY EDELMAN", WHOSE CONSENT(S) TO REGISTER IS MADE OF RECORD.

FOR JEWELRY NOT MADE OF PRECIOUS METALS, NAMELY, BRACELETS, NECKLACES AND EARRINGS (U.S. CLS. 2, 27, 28 AND 50).

REBECCA EISINGER, EXAMINING ATTORNEY

SN 77-841,704. SKAGEN DESIGNS, LTD., RENO, NV. FILED 10-5-2009.

LOKKEN

THE MARK CONSISTS OF STANDARD CHARACTERS WITHOUT CLAIM TO ANY PARTICULAR FONT, STYLE, SIZE, OR COLOR.

THE ENGLISH TRANSLATION OF "LOKKEN" IS "TO LURE A PERSON TO A PLACE".

FOR WATCHES (U.S. CLS. 2, 27, 28 AND 50).

MICHAEL GAAFAR, EXAMINING ATTORNEY

CLASS 14—(Continued).

SN 77-870,821. CABADOS, RICK H., CARLSBAD, CA. FILED 11-12-2009.



OWNER OF U.S. REG. NOS. 3,324,629, 3,598,179 AND OTHERS.

NO CLAIM IS MADE TO THE EXCLUSIVE RIGHT TO USE "ORGANIC WATER GENERATOR", APART FROM THE MARK AS SHOWN.

THE COLOR(S) BLUE, GREEN, AND WHITE IS/ARE CLAIMED AS A FEATURE OF THE MARK.

THE MARK CONSISTS OF THE STYLIZED BLUE WORDS "LIFE ORGANIC WATER GENERATOR" AND WAVE AND LEAF AND WATER DROP DESIGN. THE WAVE DESIGN IS BLUE. THE TWO LEAVES ARE GREEN WITH BLUE AND WHITE WATER DROPS.

FOR JEWEL PENDANTS WHICH IMPART POSITIVE WAVELENGTHS INTO WATER AND OTHER FLUIDS; PENDANTS WHICH IMPART POSITIVE WAVELENGTHS INTO WATER AND OTHER FLUIDS (U.S. CLS. 2, 27, 28 AND 50).

FIRST USE 9-15-2009; IN COMMERCE 11-1-2009.

BRIAN PINO, EXAMINING ATTORNEY

SN 77-876,240. I HEART MY GIRLFRIENDS, INC., NEW YORK, NY. FILED 11-19-2009.



THE MARK CONSISTS OF THE WORDS "I MY GIRLFRIENDS" WITH A HEART DESIGN AND SILHOUETTES OF DANCING FIGURES.

FOR JEWELRY; JEWELRY FINDINGS; PENDANTS; LAPEL PINS; ORNAMENTAL LAPEL PINS; PINS BEING JEWELRY; BODY-PIERCING RINGS AND STUDS; EAR CLIPS; TIE PINS; TIE CLIPS; TIE BARS; TIE TACKS; TIE FASTENERS; BOLO TIES WITH PRECIOUS METAL TIPS; CUFF-LINKS; SHIRT STUDS; BADGES OF PRECIOUS METAL; COSTUME JEWELRY; JEWELRY CHAINS; JEWELRY PINS FOR USE ON HATS; HAT ORNAMENTS OF PRECIOUS METAL; SHOE ORNAMENTS OF PRECIOUS METAL; HOLIDAY ORNAMENTS OF PRECIOUS METAL; JEWELRY BOXES AND CASES OF PRECIOUS METAL; KEY HOLDERS OF PRECIOUS METALS; WATCHES; WATCH BRACELETS; WATCH ACCESSORIES, NAMELY, PARTS FOR WATCHES; WRISTWATCHES; POCKET WATCHES; STOP WATCHES; WATCH STRAPS AND BANDS; WATCH CHAINS AND FOBS; WATCH CASES; WATCH BOXES; CLOCKS; ALARM CLOCKS; CLOCKS INCORPORATING RADIOS; WALL CLOCKS; FIGURINES AND SCULPTURES OF PRECIOUS METAL; BUSTS, FIGURES, STATUES AND STATUETTES OF PRECIOUS METAL; LEATHER JEWELRY AND ACCESSORY BOXES; AND JEWELRY BOXES AND JEWELRY CASES NOT OF PRECIOUS METAL OR COMMON METAL (U.S. CLS. 2, 27, 28 AND 50).

LAURIE KAUFMAN, EXAMINING ATTORNEY

CLASS 14—(Continued).

SN 77-876,292. NEVAEH'S DESIGN, LLC., WARWICK, RI. FILED 11-19-2009.



THE MARK CONSISTS OF ANGEL WINGS WITH A HALO OVER ONE OF THE WINGS.
FOR JEWELRY (U.S. CLS. 2, 27, 28 AND 50).
FIRST USE 10-31-2009; IN COMMERCE 10-31-2009.
KATHY DE JONGE, EXAMINING ATTORNEY

CLASS 14—(Continued).

SN 77-876,464. SCIO VERUM CORPORATION, PALM BEACH, FL. FILED 11-19-2009.

BRIAN VICKERS

THE MARK CONSISTS OF STANDARD CHARACTERS WITHOUT CLAIM TO ANY PARTICULAR FONT, STYLE, SIZE, OR COLOR.

OWNER OF U.S. REG. NOS. 2,869,705 AND 2,893,388.
THE NAME "BRIAN VICKERS" IDENTIFIES A LIVING INDIVIDUAL WHOSE CONSENT IS OF RECORD.
FOR CLOCKS; COLLECTIBLE COINS (U.S. CLS. 2, 27, 28 AND 50).
FIRST USE 0-0-2003; IN COMMERCE 0-0-2003.
LESLIE RICHARDS, EXAMINING ATTORNEY

SN 77-877,808. YASMIN AND JAZMIN LLC, LOS ANGELES, CA. FILED 11-20-2009.

Yasmin & Jazmin

SN 77-876,454. SCIO VERUM CORPORATION, PALM BEACH, FL. FILED 11-19-2009.

THE MARK CONSISTS OF STANDARD CHARACTERS WITHOUT CLAIM TO ANY PARTICULAR FONT, STYLE, SIZE, OR COLOR.

FOR JEWELRY (U.S. CLS. 2, 27, 28 AND 50).
FIRST USE 10-0-2009; IN COMMERCE 10-0-2009.
KYLE PEETE, EXAMINING ATTORNEY



SN 77-883,174. PII INDUSTRIES, INC., NEW YORK, NY. FILED 12-1-2009.

Rubba-Bandz

OWNER OF U.S. REG. NOS. 2,869,705 AND 2,893,388.
THE NAME "BRIAN VICKERS" IDENTIFIES A LIVING INDIVIDUAL WHOSE CONSENT IS OF RECORD.
THE MARK CONSISTS OF THE NAME "BRIAN VICKERS" IN SCRIPT.
FOR CLOCKS; COLLECTIBLE COINS (U.S. CLS. 2, 27, 28 AND 50).
FIRST USE 0-0-2003; IN COMMERCE 0-0-2003.
LESLIE RICHARDS, EXAMINING ATTORNEY

THE MARK CONSISTS OF STANDARD CHARACTERS WITHOUT CLAIM TO ANY PARTICULAR FONT, STYLE, SIZE, OR COLOR.

FOR RUBBER OR SILICON WRISTBANDS IN THE NATURE OF A BRACELET (U.S. CLS. 2, 27, 28 AND 50).
FIRST USE 11-30-2009; IN COMMERCE 11-30-2009.
SHAUNIA CARLYLE, EXAMINING ATTORNEY

CLASS 14—(Continued).

SN 77-883,260. BELA CHIC, INCORPORATED, PEMBROKE PINES, FL. FILED 12-1-2009.

Get Your Chic On

THE MARK CONSISTS OF STANDARD CHARACTERS WITHOUT CLAIM TO ANY PARTICULAR FONT, STYLE, SIZE, OR COLOR.

FOR BRACELETS; COSTUME JEWELRY; GEMSTONE JEWELRY; JEWELRY; JEWELRY AND IMITATION JEWELRY; JEWELRY CHAINS; JEWELRY FOR THE HEAD; JEWELRY IN THE NATURE OF ARMBANDS; JEWELRY, NAMELY, CROSSES; PET JEWELRY; PLASTIC BRACELETS IN THE NATURE OF JEWELRY; RINGS; RINGS BEING JEWELRY (U.S. CLS. 2, 27, 28 AND 50).

FIRST USE 8-13-2007; IN COMMERCE 8-13-2007.
DAVID TAYLOR, EXAMINING ATTORNEY

SN 77-884,057. WESTERN CAROLINA UNIVERSITY (NORTH CAROLINA NON-PROFIT EDUCATIONAL INSTITUTE OF THE UNIVERSITY OF NORTH CAROLINA), CULLOWHEE, NC. FILED 12-2-2009.



OWNER OF U.S. REG. NO. 1,554,839.
THE COLOR(S) PURPLE, GOLD AND WHITE IS/ARE CLAIMED AS A FEATURE OF THE MARK.

THE MARK CONSISTS OF THE LETTERS "WCU" WHICH ARE ARRANGED DIAGONALLY DOWNWARD FROM LEFT TO RIGHT. THE CENTER OF EACH LETTER IS WHITE SURROUNDED BY A PURPLE BORDER WHICH IS SURROUNDED BY A GOLD BORDER.

FOR LAPEL PINS AND WATCHES (U.S. CLS. 2, 27, 28 AND 50).

FIRST USE 8-13-2008; IN COMMERCE 8-13-2008.
MARGARET POWER, EXAMINING ATTORNEY

CLASS 14—(Continued).

SN 77-884,462. MOCK, TONYA LEE, DBA PRESCOTT PRINCESS, PRESCOTT, AZ. FILED 12-2-2009.

it's a Tonya

THE MARK CONSISTS OF A STYLIZED VERSION OF THE WORDS "IT'S A TONYA".

FOR BEADS FOR USE IN THE MANUFACTURE OF JEWELRY; BODY JEWELRY; BRACELETS; BRACELETS AND JEWELRY FEATURING ELECTRONIC CHIPS FOR ATTRACTING ENERGY TO THE BODY WHEREIN THE ELECTRONIC CHIPS INCREASE IN POWER IN THE PRESENCE OF ELECTROMAGNETIC FIELDS, FOR THE PURPOSE OF RE-BALANCING THE HUMAN ENERGY FIELD; BROACHES; BRONZE JEWELRY; BROOCHES; CHARMS; CHARMS FOR COLLAR JEWELRY AND BRACELET; COSTUME JEWELRY; DIAMOND JEWELRY; GEMSTONE JEWELRY; IDENTIFICATION BRACELETS; JEWELRY; JEWELRY AND IMITATION JEWELRY; JEWELRY BOXES; JEWELRY BOXES NOT OF METAL; JEWELRY BOXES OF METAL; JEWELRY BOXES OF PRECIOUS METAL; JEWELRY BROOCHES; JEWELRY CASES; JEWELRY CASES NOT OF PRECIOUS METAL; JEWELRY CASES OF PRECIOUS METAL; JEWELRY CHAINS; JEWELRY FINDINGS; JEWELRY FOR ATTACHMENT TO CLOTHING; JEWELRY FOR THE HEAD; JEWELRY IN THE NATURE OF ARMBANDS; JEWELRY MAKING KITS; JEWELRY ORGANIZERS; JEWELRY PINS FOR USE ON HATS; JEWELRY RING HOLDERS; JEWELRY TO BE AFFIXED TO BIKINIS; JEWELRY WATCHES; JEWELRY, NAMELY, AMULETS; JEWELRY, NAMELY, ANKLETS; JEWELRY, NAMELY, CROSSES; JEWELRY, NAMELY, PRECIOUS METAL PLATED REAL LEAVES AND FLOWERS; JEWELRY, NAMELY, STONE PENDANTS; LAPEL PINS; LEATHER JEWELRY AND ACCESSORY BOXES; PET JEWELRY; PINS BEING JEWELRY; PLASTIC BRACELETS IN THE NATURE OF JEWELRY; PRECIOUS AND SEMI-PRECIOUS CRYSTAL STONES AND BEADS FOR USE IN JEWELRY; RINGS; RINGS BEING JEWELRY; STAINLESS STEEL JEWELRY BRACELETS; WATCHES AND JEWELRY; WATCHES, CLOCKS, JEWELRY AND IMITATION JEWELRY (U.S. CLS. 2, 27, 28 AND 50).

ALLISON SCHRODY, EXAMINING ATTORNEY

SN 77-886,297. GASTON, GAYLE, STUDIO CITY, CA. FILED 12-4-2009.

ABSOUTELY FABULOUS

THE MARK CONSISTS OF STANDARD CHARACTERS WITHOUT CLAIM TO ANY PARTICULAR FONT, STYLE, SIZE, OR COLOR.

FOR JEWELRY (U.S. CLS. 2, 27, 28 AND 50).
CARRIE GENOVESE, EXAMINING ATTORNEY

CLASS 14—(Continued).

SN 77-887,752. PHYLLIS BERGMAN, NEW YORK, NY.
FILED 12-7-2009.



THE MARK CONSISTS OF THE LETTER "B" WITH FIVE POINTED STARS IN THE UPPER AND LOWER SEGMENTS OF THE "B" AND SLANTED LINES EMANATING FROM THE "B".

FOR JEWELRY (U.S. CLS. 2, 27, 28 AND 50).
EUGENIA MARTIN, EXAMINING ATTORNEY

SN 77-887,885. LOREE RODKIN MANAGEMENT CORP.,
BEVERLY HILLS, CA. FILED 12-7-2009.

LOREE RODKIN LIFESTYLE

THE MARK CONSISTS OF STANDARD CHARACTERS WITHOUT CLAIM TO ANY PARTICULAR FONT, STYLE, SIZE, OR COLOR.

OWNER OF U.S. REG. NOS. 2,308,683, 3,275,746 AND OTHERS.

THE NAME(S), PORTRAIT(S), AND/OR SIGNATURE(S) SHOWN IN THE MARK IDENTIFIES MS. "LOREE RODKIN", WHOSE CONSENT(S) TO REGISTER IS MADE OF RECORD.

FOR JEWELRY (U.S. CLS. 2, 27, 28 AND 50).
CHARLOTTE CORWIN, EXAMINING ATTORNEY

SN 77-888,118. PAGE, SARAH, COLLEGE STATION, TX.
FILED 12-7-2009.

BELLABEJWELED

THE MARK CONSISTS OF STANDARD CHARACTERS WITHOUT CLAIM TO ANY PARTICULAR FONT, STYLE, SIZE, OR COLOR.

THE WORDING "BELLABEJWELED" HAS NO MEANING IN A FOREIGN LANGUAGE.

FOR BRACELETS; BROOCHES; EARRINGS; JEWELRY; JEWELRY, NAMELY, ANKLETS; NECKLACES; RINGS (U.S. CLS. 2, 27, 28 AND 50).

FIRST USE 9-2-2008; IN COMMERCE 9-2-2008.
BILL DAWE, EXAMINING ATTORNEY

CLASS 14—(Continued).

SN 77-888,258. Y & S DAVIDSON INC., DBA IMPORTING
COSTUME JEWELRY, NEW YORK, NY. FILED 12-8-2009.

Jeune Colette

THE MARK CONSISTS OF STANDARD CHARACTERS WITHOUT CLAIM TO ANY PARTICULAR FONT, STYLE, SIZE, OR COLOR.

THE ENGLISH TRANSLATION OF "JEUNE" IN THE MARK IS "YOUNG".

FOR COSTUME JEWELRY (U.S. CLS. 2, 27, 28 AND 50).

KELLEY WELLS, EXAMINING ATTORNEY

SN 77-889,305. STICKY JEWELRY, INC., ST PETERSBURG,
FL. FILED 12-9-2009.

MentalPause

THE MARK CONSISTS OF STANDARD CHARACTERS WITHOUT CLAIM TO ANY PARTICULAR FONT, STYLE, SIZE, OR COLOR.

FOR BANGLE BRACELETS; BRACELETS; BRACELETS; BRACELETS OF PRECIOUS METAL; IDENTIFICATION BRACELETS; KEY RINGS OF PRECIOUS METAL; NECKLACES; PENDANTS; RINGS; STAINLESS STEEL JEWELRY BRACELETS (U.S. CLS. 2, 27, 28 AND 50).

FIRST USE 12-8-2009; IN COMMERCE 12-8-2009.
CHERYL CLAYTON, EXAMINING ATTORNEY

SN 77-889,369. SYNA INC., FORT LEE, NJ. FILED 12-9-2009.

**a synergy of form,
function & fashion**

THE MARK CONSISTS OF STANDARD CHARACTERS WITHOUT CLAIM TO ANY PARTICULAR FONT, STYLE, SIZE, OR COLOR.

FOR JEWELRY (U.S. CLS. 2, 27, 28 AND 50).
STEVEN R. FINE, EXAMINING ATTORNEY

CLASS 14—(Continued).

SN 77-890,279. DIAMOND TWINS CORPORATION, LAWRENCE, NY. FILED 12-10-2009.

POSTGUIDE

THE MARK CONSISTS OF STANDARD CHARACTERS WITHOUT CLAIM TO ANY PARTICULAR FONT, STYLE, SIZE, OR COLOR.

FOR EARRINGS (U.S. CLS. 2, 27, 28 AND 50).
TRACY WHITTAKER-BROWN, EXAMINING ATTORNEY

CLASS 14—(Continued).

SN 77-892,015. STRANGE MUSIC, INC., BLUE SPRINGS, MO. FILED 12-11-2009.

TECH N9NE

THE MARK CONSISTS OF STANDARD CHARACTERS WITHOUT CLAIM TO ANY PARTICULAR FONT, STYLE, SIZE, OR COLOR.

OWNER OF U.S. REG. NO. 3,721,948.
FOR BODY JEWELRY; BRACELETS; CHARMS; JEWELRY; JEWELRY BOXES; JEWELRY CASES; JEWELRY CHAINS; JEWELRY WATCHES; LEATHER JEWELRY AND ACCESSORY BOXES; RINGS; WATCHES AND JEWELRY (U.S. CLS. 2, 27, 28 AND 50).
ANNE E. GUSTASON, EXAMINING ATTORNEY

SN 77-891,073. CANGLES, LLC, DBA CANGLES, VASSAR, MI. FILED 12-11-2009.

Canglets

THE MARK CONSISTS OF STANDARD CHARACTERS WITHOUT CLAIM TO ANY PARTICULAR FONT, STYLE, SIZE, OR COLOR.

FOR BRACELETS; JEWELRY, NAMELY, ANKLETS (U.S. CLS. 2, 27, 28 AND 50).
TINA L. SNAPP, EXAMINING ATTORNEY

SN 77-892,559. BRANDI WILLIAMS, STUDIO CITY, CA. FILED 12-14-2009.

FAB*RINGS

THE MARK CONSISTS OF STANDARD CHARACTERS WITHOUT CLAIM TO ANY PARTICULAR FONT, STYLE, SIZE, OR COLOR.

FOR EARRINGS; JEWELRY (U.S. CLS. 2, 27, 28 AND 50).
WILLIAM BRECKENFELD, EXAMINING ATTORNEY

SN 77-892,013. STRANGE MUSIC, INC., BLUE SPRINGS, MO. FILED 12-11-2009.

STRANGE MUSIC

THE MARK CONSISTS OF STANDARD CHARACTERS WITHOUT CLAIM TO ANY PARTICULAR FONT, STYLE, SIZE, OR COLOR.

FOR BODY JEWELRY; BRACELETS; CHARMS; JEWELRY; JEWELRY CASES; JEWELRY CHAINS; JEWELRY WATCHES; RINGS; WATCHES, CLOCKS, JEWELRY AND IMITATION JEWELRY (U.S. CLS. 2, 27, 28 AND 50).
ANNE E. GUSTASON, EXAMINING ATTORNEY

SN 77-893,626. KITTY LIKES TO SCRATCH PRODUCTIONS, INC., LOS ANGELES, CA. FILED 12-15-2009.

BOYFRIEND

THE MARK CONSISTS OF STANDARD CHARACTERS WITHOUT CLAIM TO ANY PARTICULAR FONT, STYLE, SIZE, OR COLOR.

FOR JEWELRY AND COSTUME JEWELRY, RINGS, BRACELETS, NECKLACES, TIE BARS, SCARF RINGS, PENDANTS, EAR CLIPS, TIE CLIPS, CUFFLINKS OF PRECIOUS METAL, EARRINGS, KEY HOLDERS MADE OF PRECIOUS METALS, BROOCHES, LAPEL PINS, CLOCKS, WATCHES, CHRONOGRAPHS FOR USE AS WATCHES, CHRONOMETERS (U.S. CLS. 2, 27, 28 AND 50).
ALICIA COLLINS, EXAMINING ATTORNEY

CLASS 14—(Continued).

SN 77-902,502. EINZIGER, MAYA BRENNER, DBA MAYA BRENNER DESIGNS, LOS ANGELES, CA. FILED 12-29-2009.

MAYA BRENNER

THE MARK CONSISTS OF STANDARD CHARACTERS WITHOUT CLAIM TO ANY PARTICULAR FONT, STYLE, SIZE, OR COLOR.

THE NAME "MAYA BRENNER" IDENTIFIES A LIVING INDIVIDUAL WHOSE CONSENT IS OF RECORD. FOR JEWELRY, JEWELRY CHAINS, CHARMS (U.S. CLS. 2, 27, 28 AND 50).

FIRST USE 3-0-1999; IN COMMERCE 3-0-1999.
LESLEY LAMOTHE, EXAMINING ATTORNEY

SN 77-902,504. EINZIGER, MAYA BRENNER, DBA MAYA BRENNER DESIGNS, LOS ANGELES, CA. FILED 12-29-2009.

MAYA BRENNER DESIGNS

THE MARK CONSISTS OF STANDARD CHARACTERS WITHOUT CLAIM TO ANY PARTICULAR FONT, STYLE, SIZE, OR COLOR.

NO CLAIM IS MADE TO THE EXCLUSIVE RIGHT TO USE "DESIGNS", APART FROM THE MARK AS SHOWN.

THE NAME "MAYA BRENNER" IDENTIFIES A LIVING INDIVIDUAL WHOSE CONSENT IS OF RECORD.

FOR JEWELRY, JEWELRY CHAINS, CHARMS (U.S. CLS. 2, 27, 28 AND 50).

FIRST USE 3-0-2000, THE MARK WAS FIRST USED ANYWHERE IN A DIFFERENT FORM OTHER THAN THAT SOUGHT TO BE REGISTERED AT LEAST AS EARLY AS 03/00/1999; IN COMMERCE 3-0-2000, THE MARK WAS FIRST USED IN COMMERCE IN A DIFFERENT FORM OTHER THAN THAT SOUGHT TO BE REGISTERED AT LEAST AS EARLY AS 03/00/1999.

LESLEY LAMOTHE, EXAMINING ATTORNEY

SN 77-924,751. TRUGLO, INC., RICHARDSON, TX. FILED 2-1-2010.

TRUGLO

THE MARK CONSISTS OF STANDARD CHARACTERS WITHOUT CLAIM TO ANY PARTICULAR FONT, STYLE, SIZE, OR COLOR.

OWNER OF U.S. REG. NO. 1,942,958.
FOR WATCHES (U.S. CLS. 2, 27, 28 AND 50).
FIRST USE 5-21-2008; IN COMMERCE 5-21-2008.
LYDIA BELZER, EXAMINING ATTORNEY

CLASS 14—(Continued).

SN 79-071,197. ARTESTONE, S.L., SPAIN, FILED 3-17-2009.

CREARE

THE MARK CONSISTS OF STANDARD CHARACTERS WITHOUT CLAIM TO ANY PARTICULAR FONT, STYLE, SIZE, OR COLOR.

OWNER OF INTERNATIONAL REGISTRATION 1008463 DATED 3-17-2009, EXPIRES 3-17-2019.

THE ENGLISH TRANSLATION OF CREARE IN THE MARK IS TO CREATE.

FOR JEWELRY, PRECIOUS AND SEMIPRECIOUS STONES; BRACELETS; BROOCHES; JEWELRY CHAINS; WATCH CHAINS; TIE PINS; NECKLACES; PENDANTS; EARRINGS; CUFF LINKS; MEDALLIONS; TRINKETS BEING JEWELRY; WATCH BANDS; WATCHES; PRECIOUS METALS AND THEIR ALLOYS; GOODS MADE OF PRECIOUS METAL OR COATED THEREWITH, NAMELY, JEWELRY; TIMEPIECES AND CHRONOMETRIC INSTRUMENTS (U.S. CLS. 2, 27, 28 AND 50).

EVELYN BRADLEY, EXAMINING ATTORNEY

SN 79-072,334. CRYSTAL TIME GMBH, SWITZERLAND, FILED 7-15-2009.

**CRYSTAL TIME**

OWNER OF INTERNATIONAL REGISTRATION 1011654 DATED 7-15-2009, EXPIRES 7-15-2019.

NO CLAIM IS MADE TO THE EXCLUSIVE RIGHT TO USE "CRYSTAL TIME", APART FROM THE MARK AS SHOWN.

THE MARK CONSISTS OF THE WORDING "CRYSTAL TIME" AND A STYLIZED LETTER "C" INSIDE A BOX DESIGN.

FOR HOROLOGICAL AND CHRONOMETRIC INSTRUMENTS; JEWELLERY (U.S. CLS. 2, 27, 28 AND 50).
VERNA BETH RIRIE, EXAMINING ATTORNEY

CLASS 15—MUSICAL INSTRUMENTS

SN 76-698,093. SWIFT DISTRIBUTION, INC., DBA ULTIMATE SUPPORT SYSTEMS, LOVELAND, CO. FILED 6-26-2009.

IQ SERIES

THE MARK CONSISTS OF STANDARD CHARACTERS WITHOUT CLAIM TO ANY PARTICULAR FONT, STYLE, SIZE, OR COLOR.

NO CLAIM IS MADE TO THE EXCLUSIVE RIGHT TO USE "SERIES", APART FROM THE MARK AS SHOWN.

FOR MUSICAL INSTRUMENT STANDS (U.S. CLS. 2, 21 AND 36).

FIRST USE 0-0-1997; IN COMMERCE 0-0-1997.
DAVID TAYLOR, EXAMINING ATTORNEY

CLASS 15—(Continued).

SN 77-783,655. ARMADILLO DISTRIBUTION ENTERPRISES, INC., TAMPA, FL. FILED 7-17-2009.

ARMADILLO

THE MARK CONSISTS OF STANDARD CHARACTERS WITHOUT CLAIM TO ANY PARTICULAR FONT, STYLE, SIZE, OR COLOR.

FOR CASES FOR MUSICAL INSTRUMENTS (U.S. CLS. 2, 21 AND 36).

KATINA MISTER, EXAMINING ATTORNEY

SN 77-836,632. SCHENK GUITARS, AKA SCHENK CONSTRUCTION COMPANY LLC, SILVERDALE, WA. FILED 9-28-2009.

INSIGNIA

THE MARK CONSISTS OF STANDARD CHARACTERS WITHOUT CLAIM TO ANY PARTICULAR FONT, STYLE, SIZE, OR COLOR.

FOR ACOUSTIC GUITARS; BASS GUITARS; ELECTRIC BASS GUITARS; ELECTRIC GUITARS; GUITARS (U.S. CLS. 2, 21 AND 36).

FIRST USE 8-7-2009; IN COMMERCE 8-14-2009.
GINA FINK, EXAMINING ATTORNEY

SN 77-768,153. THE TRUSTEES OF THE THE ECJC GRANTOR TRUST DATED NOVEMBER 19, 2002, WOODLAND HILLS, CA. FILED 6-25-2009.

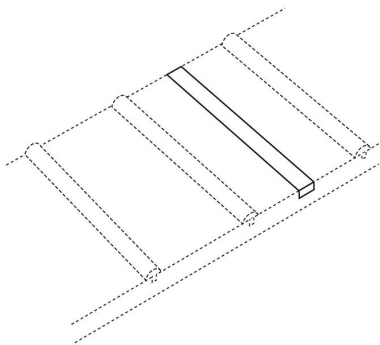

OWNER OF U.S. REG. NOS. 1,347,666, 3,629,585 AND OTHERS.

THE MARK CONSISTS OF A THREE-DIMENSIONAL CONFIGURATION OF AN INLAID FRETBOARD MARKER THAT IS USED AT VARIOUS LOCATIONS ON THE FRETBOARD OF A STRINGED MUSICAL INSTRUMENT. THE DOTTED PHANTOM LINING IN THE DRAWING IS PRESENTED TO SHOW PLACEMENT OF THE MARK ON THE GOODS.

SEC. 2(F).

FOR STRINGED MUSICAL INSTRUMENTS; GUITARS; FRETBOARD MUSICAL INSTRUMENTS; AND TWO HANDED TAPPING FRETBOARD INSTRUMENTS (U.S. CLS. 2, 21 AND 36).

FIRST USE 11-15-2003; IN COMMERCE 11-15-2003.

KARANENDRA S. CHHINA, EXAMINING ATTORNEY

SN 77-887,173. CARABBIA, JAMES, DBA DURANGO GUITAR WORKS, DURANGO, CO. FILED 12-6-2009.

DGW

Durango Guitar Works

NO CLAIM IS MADE TO THE EXCLUSIVE RIGHT TO USE "DURANGO GUITAR WORKS", APART FROM THE MARK AS SHOWN.

THE MARK CONSISTS OF STYLIZED LETTERS "D G W" WITH "DURANGO GUITAR WORKS" WRITTEN BELOW THE LETTERS.

FOR ELECTRIC GUITARS; GUITAR PEDALS; GUITAR PICKS; GUITAR STRAPS; GUITARS (U.S. CLS. 2, 21 AND 36).

SHAILA SETTLES, EXAMINING ATTORNEY

CLASS 15—(Continued).

SN 77-888,754. GIBSON GUITAR CORP., NASHVILLE, TN.
FILED 12-8-2009.

DOT STUDIO

THE MARK CONSISTS OF STANDARD CHARACTERS
WITHOUT CLAIM TO ANY PARTICULAR FONT, STYLE,
SIZE, OR COLOR.

FOR STRING INSTRUMENTS, NAMELY, GUITARS
AND BASSES (U.S. CLS. 2, 21 AND 36).
FIRST USE 1-1-2005; IN COMMERCE 1-1-2005.
AMY C. KEAN, EXAMINING ATTORNEY

SN 77-888,852. GIBSON GUITAR CORP., NASHVILLE, TN.
FILED 12-8-2009.

SHARK FIN

THE MARK CONSISTS OF STANDARD CHARACTERS
WITHOUT CLAIM TO ANY PARTICULAR FONT, STYLE,
SIZE, OR COLOR.

FOR ELECTRIC GUITARS; STRING INSTRUMENTS,
NAMELY, GUITARS AND BASSES (U.S. CLS. 2, 21 AND
36).
FIRST USE 9-4-2009; IN COMMERCE 9-18-2009.
AMY C. KEAN, EXAMINING ATTORNEY

SN 77-890,230. GIBSON GUITAR CORP., NASHVILLE, TN.
FILED 12-10-2009.

TENNESSEAN

THE MARK CONSISTS OF STANDARD CHARACTERS
WITHOUT CLAIM TO ANY PARTICULAR FONT, STYLE,
SIZE, OR COLOR.

FOR STRING INSTRUMENTS, NAMELY, GUITARS
(U.S. CLS. 2, 21 AND 36).
AMY C. KEAN, EXAMINING ATTORNEY

CLASS 15—(Continued).

SN 77-893,195. MOREAU, JUSTIN, STOCKTON, CA. FILED
12-14-2009.

FIREPLANT GUITARS

THE MARK CONSISTS OF STANDARD CHARACTERS
WITHOUT CLAIM TO ANY PARTICULAR FONT, STYLE,
SIZE, OR COLOR.

NO CLAIM IS MADE TO THE EXCLUSIVE RIGHT TO
USE "GUITARS", APART FROM THE MARK AS SHOWN.
FOR GUITARS (U.S. CLS. 2, 21 AND 36).
FIRST USE 11-1-2009; IN COMMERCE 11-1-2009.
TRACY FLETCHER, EXAMINING ATTORNEY

**CLASS 16—PAPER GOODS AND PRINTED
MATTER**

SN 76-688,005. CONSTRUCTION MONITOR, CEDAR CITY,
UT. FILED 3-24-2008.



NO CLAIM IS MADE TO THE EXCLUSIVE RIGHT TO
USE "CONSTRUCTION MONITOR", "WEEKLY BUILDING
PERMITS", "ESTABLISHED 1989" AND "WWW.CON-
STRUCTIONMONITOR.COM", APART FROM THE MARK
AS SHOWN.

THE COLOR(S) BLUE, RED, BLACK AND WHITE IS/ARE
CLAIMED AS A FEATURE OF THE MARK.

THE MARK CONSISTS OF THE WORDING "CONSTRUC-
TION MONITOR" IN BLUE OUTLINED IN BLACK, A
BLACK SKYLINE, WITH BLUE AND WHITE BUILDINGS
AND HOUSES AND RED AND WHITE BUILDINGS AND
HOUSES, "WEEKLY BUILDING PERMITS" AND "ESTAB-
LISHED 1989" ARE IN BLACK AND "WWW.CONSTRUC-
TIONMONITOR.COM" IS IN RED.

FOR PRINTED MATTER, NAMELY, NEWSLETTER
FEATURING NEWLY ISSUED BUILDING PERMIT IN-
FORMATION (U.S. CLS. 2, 5, 22, 23, 29, 37, 38 AND 50).

FIRST USE 0-0-1989; IN COMMERCE 0-0-1989.
DEZMONA MIZELLE, EXAMINING ATTORNEY

SN 76-698,879. DIGGS, MARVIN, SOUTHFIELD, MI. AND
DIGGS, MARIE, SOUTHFIELD, MI. FILED 8-10-2009.

Words Worth Giving

THE MARK CONSISTS OF STANDARD CHARACTERS
WITHOUT CLAIM TO ANY PARTICULAR FONT, STYLE,
SIZE, OR COLOR.

FOR INSPIRATIONAL AND RELIGIOUS GREETING
CARDS, HOLIDAY CARDS, NOTE CARDS, NOTE PADS,
PERSONAL BLANK JOURNALS AND CALENDARS
(U.S. CLS. 2, 5, 22, 23, 29, 37, 38 AND 50).

MARLENE BELL, EXAMINING ATTORNEY

CLASS 16—(Continued).

SN 76-699,805. GLORIA T. LACY, POWHATAN, VA. AND WILLIAM M. LACY JR, POWHATAN, VA. FILED 10-9-2009.

DRIVING WHILE TEXTING KILLS

THE MARK CONSISTS OF STANDARD CHARACTERS WITHOUT CLAIM TO ANY PARTICULAR FONT, STYLE, SIZE, OR COLOR.

FOR BUMPER STICKERS (U.S. CLS. 2, 5, 22, 23, 29, 37, 38 AND 50).

KATHLEEN LORENZO, EXAMINING ATTORNEY

SN 76-699,806. GLORIA T. LACY, POWHATAN, VA. AND WILLIAM M. LACY JR, POWHATAN, VA. FILED 10-9-2009.

MENSAJES DE TEXTO MIENTRAS SE CONDUCE MATA

THE MARK CONSISTS OF STANDARD CHARACTERS WITHOUT CLAIM TO ANY PARTICULAR FONT, STYLE, SIZE, OR COLOR.

THE ENGLISH TRANSLATION OF "MENSAJES DE TEXTO MIENTRAS SE CONDUCE MATA" IS "DRIVING WHILE TEXTING KILLS".

FOR BUMPER STICKERS (U.S. CLS. 2, 5, 22, 23, 29, 37, 38 AND 50).

KATHLEEN LORENZO, EXAMINING ATTORNEY

SN 76-699,807. GLORIA T. LACY, POWHATAN, VA. AND WILLIAM M. LACY JR, POWHATAN, VA. FILED 10-9-2009.

PUT DOWN THAT PHONE BEFORE YOU KILL SOMEONE

THE MARK CONSISTS OF STANDARD CHARACTERS WITHOUT CLAIM TO ANY PARTICULAR FONT, STYLE, SIZE, OR COLOR.

FOR BUMPER STICKERS (U.S. CLS. 2, 5, 22, 23, 29, 37, 38 AND 50).

KATHLEEN LORENZO, EXAMINING ATTORNEY

SN 76-699,808. GLORIA T. LACY, POWHATAN, VA. AND WILLIAM M. LACY JR, POWHATAN, VA. FILED 10-9-2009.

DEJO QUE EL TELEFONO ANTES DE MATAR A ALGUIEN

THE MARK CONSISTS OF STANDARD CHARACTERS WITHOUT CLAIM TO ANY PARTICULAR FONT, STYLE, SIZE, OR COLOR.

THE ENGLISH TRANSLATION OF "DEJO QUE EL TELEFONO ANTES DE MATAR A ALGUIEN" IS "PUT DOWN THAT PHONE BEFORE YOU KILL SOMEONE".

FOR BUMPER STICKERS (U.S. CLS. 2, 5, 22, 23, 29, 37, 38 AND 50).

KATHLEEN LORENZO, EXAMINING ATTORNEY

CLASS 16—(Continued).

SN 76-700,645. ZAHN, JULIETTE SUDI, BOSTON, MA. FILED 12-2-2009.

JOYHERENOW

THE MARK CONSISTS OF STANDARD CHARACTERS WITHOUT CLAIM TO ANY PARTICULAR FONT, STYLE, SIZE, OR COLOR.

FOR PHOTOGRAPHS, POSTCARDS, GREETING CARDS, CALENDARS, PAINTINGS AND BOOKS IN THE FIELD OF ART (U.S. CLS. 2, 5, 22, 23, 29, 37, 38 AND 50).

SEAN CROWLEY, EXAMINING ATTORNEY

SN 76-701,002. MICHAEL COHEN, MARTINEZ, GA. FILED 12-28-2009.

SHARE-IN-THE-CARE

THE MARK CONSISTS OF STANDARD CHARACTERS WITHOUT CLAIM TO ANY PARTICULAR FONT, STYLE, SIZE, OR COLOR.

FOR PRINTED MATTER, NAMELY, CONTRACTS AND CHARTS FOR USE IN TEACHING PET CARE AND PET RESPONSIBILITY TO CHILDREN (U.S. CLS. 2, 5, 22, 23, 29, 37, 38 AND 50).

FIRST USE 10-17-2001; IN COMMERCE 10-17-2001.
DEZMONA MIZELLE, EXAMINING ATTORNEY

SN 77-130,430. WHERE TO DINE IN, LLC, BELLEROSE, NY. FILED 3-14-2007.

The Bottom Line on Where to Dine

THE MARK CONSISTS OF STANDARD CHARACTERS WITHOUT CLAIM TO ANY PARTICULAR FONT, STYLE, SIZE, OR COLOR.

OWNER OF U.S. REG. NO. 3,166,559.

FOR PRINTED PUBLICATIONS, NAMELY, MAGAZINES, BOOKS, BULLETINS AND NEWSLETTERS FOCUSING ON THE RESTAURANT INDUSTRY (U.S. CLS. 2, 5, 22, 23, 29, 37, 38 AND 50).

FIRST USE 1-29-2007; IN COMMERCE 1-29-2007.
STEPHEN AQUILA, EXAMINING ATTORNEY

CLASS 16—(Continued).

SN 77-173,500. KRUGER PRODUCTS LIMITED, MISSISSAUGA, ONTARIO, CANADA, FILED 5-4-2007.



PRIORITY CLAIMED UNDER SEC. 44(D) ON CANADA APPLICATION NO. 1345805, FILED 5-2-2007, REG. NO. TMA740441, DATED 5-21-2009, EXPIRES 5-21-2024.

NO CLAIM IS MADE TO THE EXCLUSIVE RIGHT TO USE "REDUCE", "REUSE", "RECYCLE", "REDUIRE", "REUTILISER" AND "RECYCLER", APART FROM THE MARK AS SHOWN.

THE MARK CONSISTS OF THE WORDS "REDUCE REUSE RECYCLE REDUIRE REUTILISER RECYCLER" INSIDE THE OUTER RING OF A CIRCLE DESIGN CONTAINING THREE ARROWS SURROUNDING A SWAN.

THE FOREIGN WORDING IN THE MARK TRANSLATES INTO ENGLISH AS "REDUCE REUSE RECYCLE".

FOR BATHROOM TISSUE; FACIAL TISSUE; PAPER TOWELS; PAPER NAPKINS (U.S. CLS. 2, 5, 22, 23, 29, 37, 38 AND 50).

CHARLOTTE CORWIN, EXAMINING ATTORNEY

CLASS 16—(Continued).

SN 77-512,144. IBASIS, INC., BURLINGTON, MA. FILED 7-1-2008.

Passport

THE MARK CONSISTS OF STANDARD CHARACTERS WITHOUT CLAIM TO ANY PARTICULAR FONT, STYLE, SIZE, OR COLOR.

FOR PRE-PAID TELEPHONE CALLING CARDS, NOT MAGNETICALLY ENCODED; TELEPHONE CALLING CARDS, NOT MAGNETICALLY ENCODED (U.S. CLS. 2, 5, 22, 23, 29, 37, 38 AND 50).

CIMMERIAN COLEMAN, EXAMINING ATTORNEY

SN 77-512,195. IBASIS, INC., BURLINGTON, MA. FILED 7-1-2008.

SN 77-497,087. DIXON TICONDEROGA COMPANY, HEATHROW, FL. FILED 6-12-2008.

Pasaporte

THE WORLD'S BEST PENCIL

THE MARK CONSISTS OF STANDARD CHARACTERS WITHOUT CLAIM TO ANY PARTICULAR FONT, STYLE, SIZE, OR COLOR.

NO CLAIM IS MADE TO THE EXCLUSIVE RIGHT TO USE "PENCIL", APART FROM THE MARK AS SHOWN.

SEC. 2(F).

FOR PENCILS (U.S. CLS. 2, 5, 22, 23, 29, 37, 38 AND 50). FIRST USE 12-0-1995; IN COMMERCE 12-0-1995.

LINDA M. KING, EXAMINING ATTORNEY

THE MARK CONSISTS OF STANDARD CHARACTERS WITHOUT CLAIM TO ANY PARTICULAR FONT, STYLE, SIZE, OR COLOR.

THE FOREIGN WORDING IN THE MARK TRANSLATES INTO ENGLISH AS "PASSPORT".

FOR PRE-PAID TELEPHONE CALLING CARDS, NOT MAGNETICALLY ENCODED; TELEPHONE CALLING CARDS, NOT MAGNETICALLY ENCODED (U.S. CLS. 2, 5, 22, 23, 29, 37, 38 AND 50).

CIMMERIAN COLEMAN, EXAMINING ATTORNEY

CLASS 16—(Continued).

SN 77-538,145. ALRED, DAVID EDWARD, BRISTOL, UNITED KINGDOM, FILED 8-4-2008.

CLASS 16—(Continued).

SN 77-583,814. NINTENDO OF AMERICA INC., REDMOND, WA. FILED 10-2-2008.

NO LIMITS

THE MARK CONSISTS OF STANDARD CHARACTERS WITHOUT CLAIM TO ANY PARTICULAR FONT, STYLE, SIZE, OR COLOR.

PRIORITY CLAIMED UNDER SEC. 44(D) ON ERP CMNTY TM OFC APPLICATION NO. 007077688, FILED 7-18-2008, REG. NO. 007077688, DATED 3-8-2010, EXPIRES 7-18-2018.

FOR INSTRUCTIONAL AND TEACHING MATERIAL, NAMELY, PRINTED EDUCATIONAL TEXTS AND COURSE MATERIALS, IN THE FIELD OF TRAINING AND COACHING PEOPLE IN THE FIELDS OF SPORT, ENTERTAINMENT AND BUSINESS; BOOKS, BOOKLETS, MAGAZINES, NEWSLETTERS, ALL IN THE FIELD OF PERFORMANCE TRAINING; PRINTED RULES FOR EDUCATIONAL GAMES AND EXERCISES FOR TEACHING AND INSTRUCTIONAL PURPOSES FOR USE IN TEACHING AND DEVELOPING SKILLS AND ENHANCING PERFORMANCE AMONGST PEOPLE WHO ARE REQUIRED TO OPERATE IN HIGH PERFORMANCE SITUATIONS (U.S. CLS. 2, 5, 22, 23, 29, 37, 38 AND 50).

MICHAEL KEATING, EXAMINING ATTORNEY



PRIORITY CLAIMED UNDER SEC. 44(D) ON JAPAN APPLICATION NO. 2008080083, FILED 10-1-2008, REG. NO. 5229091, DATED 5-1-2009, EXPIRES 5-1-2019.

OWNER OF U.S. REG. NOS. 1,213,822, 1,628,966 AND OTHERS.

THE MARK CONSISTS OF THE WORDS "CLUB.NINTENDO", WITH A PERIOD AFTER THE WORD "CLUB"; AND APPEARING BELOW A NEWSBOY STYLE CAP, EMBLazonED WITH A STYLIZED "M".

FOR NOTEBOOKS; MECHANICAL PENCILS; PENCIL CASES; STATIONERY; STUDY MATERIALS, NAMELY, FLASH CARDS; TRADING CARDS; MAGAZINES FEATURING VIDEO GAMES, VIDEO GAMES SYSTEMS AND ACCESSORIES; CATALOGS FEATURING VIDEO GAMES, VIDEO GAMES SYSTEMS AND ACCESSORIES; PAMPHLETS FEATURING VIDEO GAMES, VIDEO GAMES SYSTEMS AND ACCESSORIES; OTHER PRINTED MATTER, NAMELY, POSTERS; BANNERS OF PAPER; FLAGS OF PAPER; PRINTED MATTER AND PUBLICATIONS, NAMELY, ADDRESS BOOKS; BOOK COVERS; BOOKMARKS; BOOKPLATES; CARDBOARD GIFT BOXES; CHILDREN'S BOOKS; COLORING BOOKS AND CHILDREN'S ACTIVITY BOOKS; COMIC BOOKS; DECORATIVE FIGURES ATTACHABLE TO PENCILS; DRAWING RULERS; DRY ERASE WRITING BOARDS; ERASERS; FELT-TIP MARKERS; GIFT WRAPPING PAPER; GREETING CARDS; INVITATION CARDS; IRON-ON TRANSFERS; MAGAZINES, BOOKS, BOOKLETS AND MANUALS REGARDING VIDEO GAMES; MAGNETIC SLATE BOARDS FOR WRITING; MEMO BOARDS; MEMO PADS; NEWSPAPER CARTOONS; NOTEPADS; PAPER BANNERS; PAPER DECORATIONS MOUNTABLE ON DOORS; PAPERBACK BOOKS FOR CHILDREN; PENCIL BOXES WITH MAGNETIC CLOSURES; PENCIL SHARPENERS; PENCILS; PENS; PICTURE STORYBOOKS; POSTCARDS; POSTERS; MULTI-RING BINDERS; SCORE BOOKS; SCRAPBOOKS AND STAMP COLLECTOR BOOKS; SCRATCH PADS; STATIONERY-TYPE PORTFOLIOS; STICKER ALBUMS; STICKERS; STORYBOOK AND AUDIO CASSETTES PACKAGED AS A UNIT (U.S. CLS. 2, 5, 22, 23, 29, 37, 38 AND 50).

APRIL HESIK, EXAMINING ATTORNEY

SN 77-558,218. TRIBUNE MEDIA SERVICES, INC., CHICAGO, IL. FILED 8-28-2008.

WATCH SMARTER

THE MARK CONSISTS OF STANDARD CHARACTERS WITHOUT CLAIM TO ANY PARTICULAR FONT, STYLE, SIZE, OR COLOR.

FOR PRINTED GUIDES FEATURING TELEVISION AND VIDEO VIEWING AND SCHEDULING INFORMATION (U.S. CLS. 2, 5, 22, 23, 29, 37, 38 AND 50).

MYRIAH HABEEB, EXAMINING ATTORNEY

CLASS 16—(Continued).

SN 77-605,063. JENNIFER M. ORTIZ, DBA NOTEPOURRI, LEXINGTON PARK, MD. FILED 10-31-2008.

notepourri

THE MARK CONSISTS OF STANDARD CHARACTERS WITHOUT CLAIM TO ANY PARTICULAR FONT, STYLE, SIZE, OR COLOR.

FOR ADDRESS BOOKS; ADDRESS BOOKS AND DIARIES; ADDRESS LABELS; BLANK JOURNAL BOOKS; BLANK JOURNALS; BLANK WRITING JOURNALS; BRAG BOOKS; CARDS, NAMELY, BUSINESS CARDS, NOTE CARDS, THANK YOU GREETING CARDS, BIRTHDAY GREETING CARDS, BLANK GREETING CARDS, HOLIDAY GREETING CARDS; FILE FOLDERS; GIFT WRAPPING PAPER; GREETING CARDS; GREETING CARDS HAVING A CHRISTIAN MESSAGE; ILLUSTRATION PAPER; INVITATION CARDS; MINI PHOTO ALBUMS; PAPER FOLDERS; PAPER GIFT BAGS; PAPER GIFT TAGS; PAPER GIFT WRAP; PAPER LABELS; PAPER NOTEBOOKS; PAPER PARTY FAVORS; PHOTOGRAPH ALBUM PAGES; PHOTOGRAPH ALBUMS; PHOTOGRAPHIC ALBUMS; POSTCARDS AND GREETING CARDS; PRESENTATION FOLDERS; PRINTED INVITATIONS; PRINTED PAPER LABELS; RUBBER STAMPS; SCRAPBOOK ALBUMS; STATIONERY; STATIONERY FOLDERS; STATIONERY WRITING PAPER AND ENVELOPES; STICKERS; WEDDING ALBUMS (U.S. CLS. 2, 5, 22, 23, 29, 37, 38 AND 50).

FIRST USE 10-18-2006; IN COMMERCE 10-18-2006.
MARIAM MAHMOUDI, EXAMINING ATTORNEY

CLASS 16—(Continued).

SN 77-635,610. JEKYLL ISLAND STATE PARK AUTHORITY, JEKYLL ISLAND, GA. FILED 12-18-2008.



NO CLAIM IS MADE TO THE EXCLUSIVE RIGHT TO USE "GEORGIA" AND "CENTER", APART FROM THE MARK AS SHOWN.

THE MARK CONSISTS OF A DESIGN ELEMENT CONSISTING OF A TURTLE-SHAPED FIGURE TRAILED BY CURVED SHAPES RESEMBLING TRACKS IN THE SAND, THE TURTLE AND TRACKS BEING LOCATED TO THE LEFT OF LITERAL ELEMENT CONSISTING OF THE WORDS "THE GEORGIA SEA TURTLE CENTER" WHERE THE WORD "THE" APPEARS IN THE SMALLEST FONT AND IS LOCATED ABOVE THE WORD "GEORGIA" WHICH IN TURN APPEARS ABOVE THE WORDS "SEA TURTLE", WHICH APPEAR ABOVE WORD "CENTER".

FOR BALL POINT PENS; GREETING CARDS; INK PENS; STICKERS (U.S. CLS. 2, 5, 22, 23, 29, 37, 38 AND 50).

FIRST USE 6-16-2007; IN COMMERCE 6-16-2007.
RONALD DELGIZZI, EXAMINING ATTORNEY

SN 77-646,134. NOVATECH LLC, DBA SYLOET SOLUTIONS INTERNATIONAL, NORTH SALT LAKE, UT. FILED 1-8-2009.

leadergrip

THE MARK CONSISTS OF STANDARD CHARACTERS WITHOUT CLAIM TO ANY PARTICULAR FONT, STYLE, SIZE, OR COLOR.

FOR PRINTED INSTRUCTIONAL, EDUCATIONAL, AND TEACHING MATERIALS IN THE FIELD OF LEADERSHIP (U.S. CLS. 2, 5, 22, 23, 29, 37, 38 AND 50).

FIRST USE 1-15-1999; IN COMMERCE 1-20-2000.
TIMOTHY FINNEGAN, EXAMINING ATTORNEY

SN 77-626,749. DREXEL UNIVERSITY, PHILADELPHIA, PA. FILED 12-4-2008.

POWER OF FOOD SCALE

THE MARK CONSISTS OF STANDARD CHARACTERS WITHOUT CLAIM TO ANY PARTICULAR FONT, STYLE, SIZE, OR COLOR.

NO CLAIM IS MADE TO THE EXCLUSIVE RIGHT TO USE "FOOD SCALE", APART FROM THE MARK AS SHOWN.

FOR PRINTED PAPER SURVEY ANSWER SHEETS FEATURING A SCALE FROM ONE TO FIVE USED TO MEASURE THE PHYSIOLOGICAL INFLUENCE OF THE FOOD ENVIRONMENT (U.S. CLS. 2, 5, 22, 23, 29, 37, 38 AND 50).

FIRST USE 6-25-2001; IN COMMERCE 6-25-2001.
ALLISON HOLTZ, EXAMINING ATTORNEY

SN 77-652,312. MARTIN, LARRY K., ANNISTON, AL. FILED 1-19-2009.

SeriOriginals

FOR LITHOGRAPHIC WORKS OF ART (U.S. CLS. 2, 5, 22, 23, 29, 37, 38 AND 50).

SUSAN RICHARDS, EXAMINING ATTORNEY

CLASS 16—(Continued).

SN 77-664,715. SAMANTHA LANDY MINISTRIES, LA QUINTA, CA. FILED 2-6-2009.

SAVVY SINGLES

THE MARK CONSISTS OF STANDARD CHARACTERS WITHOUT CLAIM TO ANY PARTICULAR FONT, STYLE, SIZE, OR COLOR.

NO CLAIM IS MADE TO THE EXCLUSIVE RIGHT TO USE "SINGLES", APART FROM THE MARK AS SHOWN.

FOR A SERIES OF BOOKS AND WRITTEN ARTICLES IN THE FIELD OF NON-DENOMINATIONAL CHRISTIANITY AS IT APPLIES TO THE LIVES OF NON-MARRIED PEOPLE IN THE MIDDLE AGES AND OLDER (U.S. CLS. 2, 5, 22, 23, 29, 37, 38 AND 50).

FIRST USE 1-1-2004; IN COMMERCE 1-1-2004.

SUNG IN, EXAMINING ATTORNEY

CLASS 16—(Continued).

THE BLUE SECTION IS THE WORD "TEST" IN DARK BLUE AND "TUBE" IN GRAY. ABOVE AND TO THE RIGHT IS THE WORDING "YOUR TEST DAY SURVIVAL KIT" IN BLACK WITH THE WORDING "TEST DAY" UNDERLINED IN BLACK. BELOW THAT IN THE WHITE SECTION IS A PAIR OF HANDS IN THE COLOR PEACH HOLDING FIVE TUBES IN THE COLORS YELLOW, ORANGE, BLUE, GREEN AND BLUE FROM LEFT TO RIGHT. BELOW THE HANDS IS THE WORDING "PACKED TO SUPPORT YOUR BEST TEST PERFORMANCE" IN BLACK.

FOR TEST-TAKING KIT PACKAGED IN CLEAR, PLASTIC TUBE WITH A LID AND/OR HANDLE USED TO AID PERSONS TAKING STANDARDIZED GRAMMAR SCHOOL, JUNIOR HIGH SCHOOL, HIGH SCHOOL, COLLEGE, COLLEGE-ENTRANCE, OR GRADUATE SCHOOL EXAMS COMPRISING PENCILS, PENS, PENCIL SHARPENER, ERASERS, BATTERIES, PAPER CHECKLISTS, FACIAL TISSUES, COUGH DROPS, LIP BALM, HIGHLIGHTER PENS, GUM, MINTS, CANDY, BOTTLE OF WATER, PRETZELS, CEREAL-BASED SNACK BARS, SANITIZING WIPES, JEWELRY, AND PLASTIC BAGS (U.S. CLS. 2, 5, 22, 23, 29, 37, 38 AND 50).

MICHAEL WEBSTER, EXAMINING ATTORNEY

SN 77-693,834. DRAY, ANTOINE, PARIS, FRANCE, FILED 3-18-2009.

LOOK & SEA

THE MARK CONSISTS OF STANDARD CHARACTERS WITHOUT CLAIM TO ANY PARTICULAR FONT, STYLE, SIZE, OR COLOR.

PRIORITY CLAIMED UNDER SEC. 44(D) ON FRANCE APPLICATION NO. 083599701, FILED 9-19-2008, REG. NO. 083599701, DATED 9-19-2008, EXPIRES 9-19-2018.

FOR PRINTED MATTER, NAMELY, BROCHURES IN THE FIELD OF NATURE SCIENCES AND OUTDOOR SPORTS; PHOTOGRAPHS; PRINTED INSTRUCTIONAL AND TEACHING MATERIAL IN THE FIELD OF NATURE SCIENCES; POSTERS; CARDS, NAMELY, TECHNICAL AND CLASSIFICATION FILING CARDS IN THE FIELD OF NATURE SCIENCES AND OUTDOOR SPORTS; PRINTED GUIDES IN THE FIELD OF NATURE SCIENCES AND OUTDOOR SPORT; GRAPHIC PRINTS (U.S. CLS. 2, 5, 22, 23, 29, 37, 38 AND 50).

KIM MONINGHOFF, EXAMINING ATTORNEY

SN 77-710,510. AMERICAN EDUCATIONAL PRODUCTS LLC, FORT COLLINS, CO. FILED 4-9-2009.

Little Shop of Physics

THE MARK CONSISTS OF STANDARD CHARACTERS WITHOUT CLAIM TO ANY PARTICULAR FONT, STYLE, SIZE, OR COLOR.

NO CLAIM IS MADE TO THE EXCLUSIVE RIGHT TO USE "PHYSICS", APART FROM THE MARK AS SHOWN.

FOR PRINTED INSTRUCTIONAL, EDUCATIONAL, AND TEACHING MATERIALS IN THE FIELD OF SCIENCE (U.S. CLS. 2, 5, 22, 23, 29, 37, 38 AND 50).

FIRST USE 12-15-2005; IN COMMERCE 12-15-2005.

ALLISON HOLTZ, EXAMINING ATTORNEY

SN 77-665,163. LINDA CARNEVALE, DBA WWW.MYTEST-TUBE.COM, OLD BROOKVILLE, NY. FILED 2-6-2009.

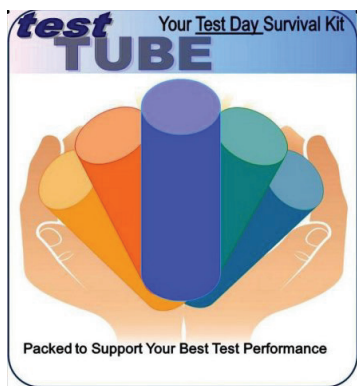

NO CLAIM IS MADE TO THE EXCLUSIVE RIGHT TO USE "YOUR TEST DAY" AND "KIT", APART FROM THE MARK AS SHOWN.

THE STIPPLING IS FOR SHADING PURPOSES ONLY.

THE COLOR(S) BLUE, GRAY, WHITE, BLACK, YELLOW, ORANGE, GREEN AND PEACH IS/ARE CLAIMED AS A FEATURE OF THE MARK.

THE MARK CONSISTS OF A BLUE RECTANGLE WITH ROUNDED CORNERS. AN UPPER SECTION OF THE RECTANGLE CONTAINS A BLUE BACKGROUND THAT FADES FROM DARK TO LIGHT BLUE FROM LEFT TO RIGHT. THE REMAINING BACKGROUND IS WHITE. IN

CLASS 16—(Continued).

SN 77-711,271. LAND O'LAKES, INC., ARDEN HILLS, MN. FILED 4-10-2009.



OWNER OF U.S. REG. NOS. 295,002, 2,884,483 AND 3,154,179.

NO CLAIM IS MADE TO THE EXCLUSIVE RIGHT TO USE "INC.", APART FROM THE MARK AS SHOWN.

THE MARK CONSISTS OF TWO CURVED LINES MAKING A SQUARE WITH A DOT IN THE MIDDLE OF THE TWO LINES WITH THE WORDING "LAND O'LAKES, INC." POSITIONED TO THE RIGHT OF THE DESIGN, UNDER WHICH IS THE WORDING "GROWING TOGETHER".

FOR BALL POINT PENS; BROCHURES ABOUT AGRICULTURE AND DAIRY; BUSINESS CARDS; MAGAZINES AND COLUMNS ABOUT AGRICULTURE AND DAIRY; NOTE PADS; PENCILS (U.S. CLS. 2, 5, 22, 23, 29, 37, 38 AND 50).

FIRST USE 3-27-2009; IN COMMERCE 3-27-2009.
TINA L. SNAPP, EXAMINING ATTORNEY

SN 77-725,535. TOKYOPOP INC., LOS ANGELES, CA. FILED 4-29-2009.

My Dead Girlfriend

THE MARK CONSISTS OF STANDARD CHARACTERS WITHOUT CLAIM TO ANY PARTICULAR FONT, STYLE, SIZE, OR COLOR.

FOR BOOKMARKS; POSTERS (U.S. CLS. 2, 5, 22, 23, 29, 37, 38 AND 50).

FIRST USE 2-13-2007; IN COMMERCE 2-13-2007.
MARILYN IZZI, EXAMINING ATTORNEY

SN 77-732,547. HOME BOX OFFICE, INC., NEW YORK, NY. FILED 5-8-2009.

THE WONDERFUL MALADYS

THE MARK CONSISTS OF STANDARD CHARACTERS WITHOUT CLAIM TO ANY PARTICULAR FONT, STYLE, SIZE, OR COLOR.

FOR PRINTED MATTER, NAMELY, CALENDARS, POSTERS, POSTCARDS, NEWSLETTERS, FAN MAGAZINES, NOTEBOOKS, STICKERS, DECALS, PHOTOGRAPHS, STATIONERY, TEMPORARY TATTOOS, PAPER COASTERS, TRADING CARDS, TRIVIA CARDS AND A SERIES OF BOOKS, ALL FEATURING CONTENT FROM OR RELATING TO AN ONGOING TELEVISION SERIES; PENS, PENCILS (U.S. CLS. 2, 5, 22, 23, 29, 37, 38 AND 50).

FIRST USE 2-28-2007; IN COMMERCE 2-28-2007.
GENE MACIOL, EXAMINING ATTORNEY

CLASS 16—(Continued).

SN 77-735,785. MARSHALL, DOUGLAS, TYLER, TX. FILED 5-13-2009.

THE FACE

THE MARK CONSISTS OF STANDARD CHARACTERS WITHOUT CLAIM TO ANY PARTICULAR FONT, STYLE, SIZE, OR COLOR.

FOR REMOVABLE TATTOOS; TEMPORARY TATTOOS (U.S. CLS. 2, 5, 22, 23, 29, 37, 38 AND 50).

JUSTINE D. PARKER, EXAMINING ATTORNEY

SN 77-736,088. ASSOCIATED HYGIENIC PRODUCTS, LLC, DULUTH, GA. FILED 5-13-2009.

TOTAL STRETCH SYSTEM

THE MARK CONSISTS OF STANDARD CHARACTERS WITHOUT CLAIM TO ANY PARTICULAR FONT, STYLE, SIZE, OR COLOR.

NO CLAIM IS MADE TO THE EXCLUSIVE RIGHT TO USE "STRETCH SYSTEM", APART FROM THE MARK AS SHOWN.

FOR DISPOSABLE DIAPERS AND DISPOSABLE TRAINING PANTS (U.S. CLS. 2, 5, 22, 23, 29, 37, 38 AND 50).

AISHA SALEM, EXAMINING ATTORNEY

SN 77-738,250. EGAN VISUAL INC., WOODBRIDGE, CANADA, FILED 5-15-2009.

VERSA PRO

THE MARK CONSISTS OF STANDARD CHARACTERS WITHOUT CLAIM TO ANY PARTICULAR FONT, STYLE, SIZE, OR COLOR.

PRIORITY CLAIMED UNDER SEC. 44(D) ON CANADA APPLICATION NO. 1426147, FILED 1-29-2009.

FOR DRY ERASE WRITING SURFACES AND PROJECTION SURFACES (U.S. CLS. 2, 5, 22, 23, 29, 37, 38 AND 50).

FIRST USE 2-28-2007; IN COMMERCE 2-28-2007.
SUSAN RICHARDS, EXAMINING ATTORNEY

CLASS 16—(Continued).

SN 77-739,759. TOKYOPOP INC., LOS ANGELES, CA. FILED 5-18-2009.

East Coast Rising

THE MARK CONSISTS OF STANDARD CHARACTERS WITHOUT CLAIM TO ANY PARTICULAR FONT, STYLE, SIZE, OR COLOR.
FOR POSTCARDS; POSTCARDS AND PICTURE POSTCARDS (U.S. CLS. 2, 5, 22, 23, 29, 37, 38 AND 50).
FIRST USE 4-11-2006; IN COMMERCE 4-11-2006.
MARILYN IZZI, EXAMINING ATTORNEY

SN 77-741,489. LISA FELTENSTEIN, MIAMI BEACH, FL. FILED 5-20-2009.

THE COSMIC MOMENT

THE MARK CONSISTS OF STANDARD CHARACTERS WITHOUT CLAIM TO ANY PARTICULAR FONT, STYLE, SIZE, OR COLOR.
OWNER OF U.S. REG. NOS. 2,753,353 AND 2,936,487.
FOR PUBLICATIONS, NAMELY, ARTICLES AND COLUMNS IN THE FIELD OF ASTROLOGY AND NEW AGE ISSUES (U.S. CLS. 2, 5, 22, 23, 29, 37, 38 AND 50).
FIRST USE 2-28-2005; IN COMMERCE 2-28-2005.
CIMMERIAN COLEMAN, EXAMINING ATTORNEY

SN 77-745,852. SCD INTERSCOPE, LLC, SANTA MONICA, CA. FILED 5-27-2009.

STREET DRUM CORPS presents BANG!

THE MARK CONSISTS OF STANDARD CHARACTERS WITHOUT CLAIM TO ANY PARTICULAR FONT, STYLE, SIZE, OR COLOR.
FOR BOOKS AND MAGAZINES IN THE FIELDS OF MUSIC, ENTERTAINMENT, ART AND/OR CULTURE; ADDRESS BOOKS; APPOINTMENT BOOKS; CALENDARS; GREETING CARDS; POST CARDS; PEN AND PENCIL CASES; PENCIL SHARPENERS; PENS; PENCILS; DATE BOOKS; BUMPER STICKERS; DECALS; NOTE PADS; STICKERS; RUBBER STAMPS; TEMPORARY TATTOOS; POSTERS; TRADING CARD MILK BOTTLE CAPS; TRADING CARDS; MONEY CLIPS; AND STATIONERY (U.S. CLS. 2, 5, 22, 23, 29, 37, 38 AND 50).
ANTHONY RINKER, EXAMINING ATTORNEY

CLASS 16—(Continued).

SN 77-746,353. SDC INTERSCOPE, LLC, SANTA MONICA, CA. FILED 5-28-2009.

STREET DRUM CORPS PRESENTS MAN OR MACHINE

THE MARK CONSISTS OF STANDARD CHARACTERS WITHOUT CLAIM TO ANY PARTICULAR FONT, STYLE, SIZE, OR COLOR.

FOR BOOKS AND MAGAZINES IN THE FIELDS OF MUSIC, ENTERTAINMENT, ART AND/OR CULTURE; ADDRESS BOOKS; APPOINTMENT BOOKS; CALENDARS; GREETING CARDS; POST CARDS; PEN AND PENCIL CASES; PENCIL SHARPENERS; PENS; PENCILS; DATE BOOKS; BUMPER STICKERS; DECALS; NOTE PADS; STICKERS; RUBBER STAMPS; TEMPORARY TATTOOS; POSTERS; TRADING CARD MILK BOTTLE CAPS; TRADING CARDS; MONEY CLIPS; AND STATIONERY (U.S. CLS. 2, 5, 22, 23, 29, 37, 38 AND 50).

ANTHONY RINKER, EXAMINING ATTORNEY

SN 77-750,673. GRAPHIQUE DE FRANCE, LTD., WOBURN, MA. FILED 6-3-2009.

Cricket

THE MARK CONSISTS OF STANDARD CHARACTERS WITHOUT CLAIM TO ANY PARTICULAR FONT, STYLE, SIZE, OR COLOR.

FOR STATIONERY, CALENDARS, NOTE PADS, PURSE NOTE PADS, BOXED NOTE CARDS, GREETING CARDS, POSTCARDS, NOTE CARDS, PORTABLE NOTE PADS, DAILY AND WEEKLY DESK PLANNERS, WALL TIME PLANNERS, DESKTOP, BUSINESS, HOME, AND PERSONAL ORGANIZERS, AGENDAS, NOTE PADS IN THE SHAPE OF A CUBE WITH A COMPONENT PHOTO FRAME, WALL DECALS, HOME DECALS, SEASONAL BOXED NOTE AND GREETING CARDS, POSTERS, PRINTS (U.S. CLS. 2, 5, 22, 23, 29, 37, 38 AND 50).
MARK PILARO, EXAMINING ATTORNEY

SN 77-752,172. CLEANER'S SUPPLY, INC., CONKLIN, NY. FILED 6-4-2009.



THE MARK CONSISTS OF THE WORDS "WE CLEAN YOUR CLOTHES ECO-FRIENDLY." ALONG WITH A DESIGN ELEMENT SHOWING THE EARTH.

FOR PAPER GARMENT COVERS FOR USE IN THE LAUNDRY AND DRY-CLEANING INDUSTRY (U.S. CLS. 2, 5, 22, 23, 29, 37, 38 AND 50).

SEAN CROWLEY, EXAMINING ATTORNEY

CLASS 16—(Continued).

SN 77-755,551. NATIONAL AERONAUTICS AND SPACE ADMINISTRATION, WASHINGTON, DC. FILED 6-9-2009.

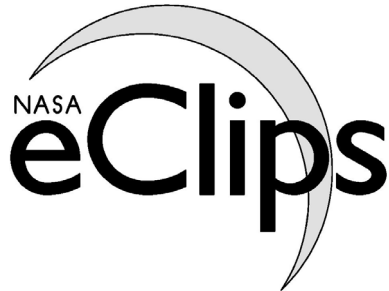

THE MARK CONSISTS OF "NASA" POSITIONED ABOVE THE LETTER "E" IN "ECLIPS"; CRESCENT MOON BEHIND THE LITERAL ELEMENTS, WITH THE MOON EXTENDING BETWEEN THE "P" AND THE "S" IN "CLIPS".

FOR PRINTED TEACHER'S MANUALS FOR INSTRUCTING STUDENTS ABOUT SPACE EXPLORATION, SCIENCE, MATHEMATICS, TECHNOLOGY AND ENGINEERING (U.S. CLS. 2, 5, 22, 23, 29, 37, 38 AND 50). FIRST USE 10-27-2008; IN COMMERCE 10-27-2008. JUDITH HELFMAN, EXAMINING ATTORNEY

CLASS 16—(Continued).

SN 77-756,063. EZ WYP, INC., BROOKLYN, NY. FILED 6-10-2009.

EZ WYP

THE MARK CONSISTS OF STANDARD CHARACTERS WITHOUT CLAIM TO ANY PARTICULAR FONT, STYLE, SIZE, OR COLOR.

NO CLAIM IS MADE TO THE EXCLUSIVE RIGHT TO USE "WIPE", APART FROM THE MARK AS SHOWN.

FOR DISPOSABLE NAPKINS FOR PERSONAL HYGIENIC USE; DISPOSABLE WIPES NOT IMPREGNATED WITH CHEMICALS OR COMPOUNDS FOR PERSONAL HYGIENIC USE (U.S. CLS. 2, 5, 22, 23, 29, 37, 38 AND 50). ROBIN CHOSID, EXAMINING ATTORNEY

SN 77-756,062. EZ WYP, INC., BROOKLYN, NY. FILED 6-10-2009.

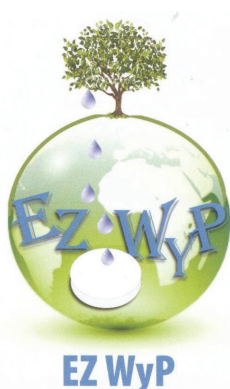

NO CLAIM IS MADE TO THE EXCLUSIVE RIGHT TO USE "WIPE", APART FROM THE MARK AS SHOWN.

THE COLOR(S) BLUE, GREEN, BROWN, AND WHITE IS/ARE CLAIMED AS A FEATURE OF THE MARK.

THE MARK CONSISTS OF A GREEN SPHERE DEPICTING THE EARTH, WITH WHITE CONTINENTS, A GREEN TREE WITH A BROWN TRUNK ON TOP, AND BLUE RAINDROPS FALLING ONTO A WHITE TABLET. THE WORDS, "EZ WYP", ARE WRITTEN THEREIN AND BELOW, IN BLUE.

FOR DISPOSABLE NAPKINS FOR PERSONAL HYGIENIC USE; DISPOSABLE WIPES NOT IMPREGNATED WITH CHEMICALS OR COMPOUNDS FOR PERSONAL HYGIENIC USE (U.S. CLS. 2, 5, 22, 23, 29, 37, 38 AND 50). ROBIN CHOSID, EXAMINING ATTORNEY

SN 77-759,627. NEWPAGE WISCONSIN SYSTEM INC., MIAMISBURG, OH. FILED 6-15-2009.

SPARTANWEB

THE MARK CONSISTS OF STANDARD CHARACTERS WITHOUT CLAIM TO ANY PARTICULAR FONT, STYLE, SIZE, OR COLOR.

FOR PAPER; PRINTING PAPER (U.S. CLS. 2, 5, 22, 23, 29, 37, 38 AND 50).

FIRST USE 0-0-1997; IN COMMERCE 0-0-1997. KEVIN CORWIN, EXAMINING ATTORNEY

SN 77-759,631. NEWPAGE WISCONSIN SYSTEM INC., MIAMISBURG, OH. FILED 6-15-2009.

SPARTANWEB PLUS

THE MARK CONSISTS OF STANDARD CHARACTERS WITHOUT CLAIM TO ANY PARTICULAR FONT, STYLE, SIZE, OR COLOR.

FOR PAPER; PRINTING PAPER (U.S. CLS. 2, 5, 22, 23, 29, 37, 38 AND 50).

FIRST USE 1-0-2008; IN COMMERCE 1-0-2008. KEVIN CORWIN, EXAMINING ATTORNEY

CLASS 16—(Continued).

SN 77-766,342. STILL LENS, LLP, DBA CANVAS PRESS, ROUND ROCK, TX. FILED 6-23-2009.

Canvas Press

THE MARK CONSISTS OF STANDARD CHARACTERS WITHOUT CLAIM TO ANY PARTICULAR FONT, STYLE, SIZE, OR COLOR.

NO CLAIM IS MADE TO THE EXCLUSIVE RIGHT TO USE "CANVAS", APART FROM THE MARK AS SHOWN.

FOR ART PICTURES; ART PRINTS ON CANVAS; GRAPHIC ART REPRODUCTIONS; PRINTED ART REPRODUCTIONS (U.S. CLS. 2, 5, 22, 23, 29, 37, 38 AND 50).

FIRST USE 4-29-2006; IN COMMERCE 4-29-2009.
BENJAMIN OKEKE, EXAMINING ATTORNEY

CLASS 16—(Continued).

SN 77-772,527. CRAYOLA PROPERTIES, INC., EASTON, PA. FILED 7-1-2009.

SN 77-767,406. OWN LLC, WESTLAKE VILLAGE, CA. FILED 6-24-2009.



THE MARK CONSISTS OF THE ACRONYM "OWN" IN STYLIZED LETTERS.

FOR BOOKS, MAGAZINES, NEWSLETTERS, INSTRUCTIONAL MANUALS AND PRINTED INSTRUCTIONAL TEACHING MATERIALS, ALL FEATURING SUBJECTS OF GENERAL HUMAN INTEREST; PHOTOGRAPHS; STATIONERY; ADHESIVES FOR STATIONERY OR HOUSEHOLD USES; ARTISTS' MATERIALS, NAMELY, ARTISTS' BRUSHES AND ARTISTS' PASTELS; PAINT BRUSHES; PLASTIC MATERIAL FOR PACKAGING, NAMELY, PLASTIC BAGS; PRINTERS' TYPE; PRINTING BLOCKS; POSTERS; POSTCARDS; NOTE CARDS; DESK TOP ORGANIZERS; DESK SETS; DESK PADS; BLOTTERS; PERSONAL ORGANIZERS; DIARIES; AGENDAS; PENS; PENCILS; PENCIL CASES; PEN CASES; DRAWING RULERS; BOOKMARKS; BOOK PLATES; BOOK COVERS; PAPER STATIONERY PORTFOLIOS; BINDERS; NOTEBOOKS; COLORING BOOKS; NOTE PADS; NON-ELECTRIC ERASERS; NON-ELECTRIC PENCIL SHARPENERS; STENCILS; STATIONERY LETTER AND WRITING PAPER HOLDERS; FILE FOLDERS; RUBBER STAMPS; BLACKBOARDS; PAPER BAGS; PLASTIC BAGS FOR GENERAL USE; WRAPPING PAPER; TRADING CARDS; CHILDREN'S ACTIVITY BOOKS; EDUCATIONAL ACTIVITY BOOKS IN FIELDS OF GENERAL HUMAN INTEREST; COMPOSITION BOOKS; STICKERS; DECALS; PAPER NAPKINS; PAPER TABLECLOTHS; PLACE MATS OF PAPER; CALENDARS; PAPER, INCLUDING WRITING PAPER, ART PAPER, CONSTRUCTION PAPER; ART AND CRAFTS PAINT KITS; ART PRINTS; COLOR PRINTS; LITHOGRAPHIC PRINTS; PHOTOGRAPHIC PRINTS; COMIC STRIPS; PAPER PARTY FAVORS; PAPER PARTY DECORATIONS; PAPER PARTY BAGS; MAPS (U.S. CLS. 2, 5, 22, 23, 29, 37, 38 AND 50).

LINDA M. KING, EXAMINING ATTORNEY



OWNER OF U.S. REG. NOS. 3,633,574, 3,633,575 AND 3,639,584.

NO CLAIM IS MADE TO THE EXCLUSIVE RIGHT TO USE "MESS FREE" AND "COLOR", APART FROM THE MARK AS SHOWN.

THE MARK CONSISTS OF THE MARK CONSISTS OF THE PHRASE "MESS FREE" HORIZONTALLY POSITIONED DIRECTLY ABOVE THE OUTLINED, VERTICALLY-ARRANGED WORDS "COLOR WONDER".

FOR CRAYONS; STENCILS; INK APPLICATORS FOR USE WITH STENCILS; ART AND CRAFTS PAINT KITS; MARKERS; DRAWING PAPER; COLORING BOOKS; CHILDREN'S ACTIVITY BOOKS; ACTIVITY KITS CONSISTING PRIMARILY OF CRAYONS, MARKERS, COLORING BOOKS AND DRAWING PAPER (U.S. CLS. 2, 5, 22, 23, 29, 37, 38 AND 50).

JESSICA FATHY, EXAMINING ATTORNEY

CLASS 16—(Continued).

SN 77-772,572. CRAYOLA PROPERTIES, INC., EASTON, PA.
FILED 7-1-2009.



OWNER OF U.S. REG. NOS. 3,633,574, 3,633,575 AND 3,639,584.

NO CLAIM IS MADE TO THE EXCLUSIVE RIGHT TO USE "MESS FREE" AND "COLOR", APART FROM THE MARK AS SHOWN.

THE MARK CONSISTS OF THE PHRASE "MESS FREE" HORIZONTALLY POSITIONED DIRECTLY ABOVE THE OUTLINED, VERTICALLY-ARRANGED WORDS "COLOR WONDER" WITH THE PHRASE "THE MAGIC OF COLOR WITHOUT THE MESS!" HORIZONTALLY POSITIONED DIRECTLY BELOW.

FOR CRAYONS; STENCILS; INK APPLICATORS FOR USE WITH STENCILS; ART AND CRAFTS PAINT KITS; MARKERS; DRAWING PAPER; COLORING BOOKS; CHILDREN'S ACTIVITY BOOKS; ACTIVITY KITS CONSISTING PRIMARILY OF CRAYONS, MARKERS, COLORING BOOKS AND DRAWING PAPER (U.S. CLS. 2, 5, 22, 23, 29, 37, 38 AND 50).

JESSICA FATHY, EXAMINING ATTORNEY

SN 77-779,623. NEW IMAGE HOLDINGS LIMITED, TORTOLA, BR. VIRGIN ISLANDS, FILED 7-13-2009.



THE MARK CONSISTS OF THE WORD "SMOOVIE" IN STYLIZED LETTERS OVER A SHADED SWIRL DESIGN WITH A SWIRLED LEAF DESIGN ABOVE THE "I".

FOR TISSUE PAPER, TISSUE ROLLS, JUMBO ROLL TISSUE PAPER, FACIAL TISSUE, TABLE NAPKINS OF PAPER, PAPER SERVIETTES, PAPER HAND TOWELS, HAND WOUND ROLL PAPER TOWELS, MULTI-FOLD PAPER HAND TOWELS, SINGLE FOLD PAPER HAND TOWELS, C-FOLD PAPER HAND TOWELS, KITCHEN TOWELS OF PAPER (U.S. CLS. 2, 5, 22, 23, 29, 37, 38 AND 50).

JORDAN BAKER, EXAMINING ATTORNEY

CLASS 16—(Continued).

SN 77-783,015. MERRILL WESLEY HAUG, RICHMOND, CA.
FILED 7-16-2009.

ETERNAL FRACTAL

THE MARK CONSISTS OF STANDARD CHARACTERS WITHOUT CLAIM TO ANY PARTICULAR FONT, STYLE, SIZE, OR COLOR.

NO CLAIM IS MADE TO THE EXCLUSIVE RIGHT TO USE "FRACTAL", APART FROM THE MARK AS SHOWN.

FOR THREE DIMENSIONAL MODELS FOR EDUCATIONAL PURPOSES, NAMELY, TRIANGULAR BUILDING MODULES USED TO FORM STRUCTURES, MODELS AND SCULPTURES (U.S. CLS. 2, 5, 22, 23, 29, 37, 38 AND 50).

DOMINIC FATHY, EXAMINING ATTORNEY

SN 77-787,981. ELAINE RYAN, LLC, SANTA MONICA, CA.
FILED 7-23-2009.

ELAINE RYAN

THE MARK CONSISTS OF STANDARD CHARACTERS WITHOUT CLAIM TO ANY PARTICULAR FONT, STYLE, SIZE, OR COLOR.

THE NAME(S), PORTRAIT(S), AND/OR SIGNATURE(S) SHOWN IN THE MARK IDENTIFIES "ELAINE RYAN", WHOSE CONSENT(S) TO REGISTER IS MADE OF RECORD.

FOR EDUCATIONAL KITS SOLD AS A UNIT IN THE FIELD OF HOME DECORATING CONSISTING OF EDUCATIONAL BOOKS, DRY ERASABLE PENS, FURNITURE TEMPLATES, PRINT COLOR MATCHING INFORMATION, AND GRID BOARD (U.S. CLS. 2, 5, 22, 23, 29, 37, 38 AND 50).

VIVIAN MICZNIK FIRST, EXAMINING ATTORNEY

SN 77-790,001. ART CLAY WORLD, USA, INC., OAK LAWN, IL. FILED 7-27-2009.

flexiMold

THE MARK CONSISTS OF THE TERM "FLEXIMOLD" IN STYLIZED FONT.

FOR SILICONE MOLDS FOR MODELING CLAYS (U.S. CLS. 2, 5, 22, 23, 29, 37, 38 AND 50).

FIRST USE 7-1-2009; IN COMMERCE 7-1-2009.

JENNIFER MARTIN, EXAMINING ATTORNEY

CLASS 16—(Continued).

SN 77-790,682. WRIGHT, PETER W. D., DELTAVILLE, VA.
FILED 7-27-2009.

WRIGHTSLAW

THE MARK CONSISTS OF STANDARD CHARACTERS WITHOUT CLAIM TO ANY PARTICULAR FONT, STYLE, SIZE, OR COLOR.

SEC. 2(F).
FOR PRINTED MATTER, NAMELY, A SERIES OF NON-FICTION BOOKS IN THE FIELD OF EDUCATIONAL LAW AND ADVOCACY (U.S. CLS. 2, 5, 22, 23, 29, 37, 38 AND 50).

FIRST USE 5-20-1997; IN COMMERCE 5-20-1997.
SHAILA SETTLES, EXAMINING ATTORNEY

SN 77-791,001. STENOGRAPH, L.L.C., ELMHURST, IL.
FILED 7-28-2009.

DIAMANTE

THE MARK CONSISTS OF STANDARD CHARACTERS WITHOUT CLAIM TO ANY PARTICULAR FONT, STYLE, SIZE, OR COLOR.

FOR SHORTHAND WRITING MACHINE (U.S. CLS. 2, 5, 22, 23, 29, 37, 38 AND 50).

FIRST USE 4-22-2009; IN COMMERCE 7-20-2009.
ANNE E. GUSTASON, EXAMINING ATTORNEY

SN 77-794,857. COLLEEN CAMPBELL REID, PARK CITY, UT. FILED 7-31-2009.



THE COLOR(S) GREEN AND WHITE IS/ARE CLAIMED AS A FEATURE OF THE MARK.

THE MARK CONSISTS OF A WHITE TREE OVER A GREEN BACKGROUND.

FOR NON-LUMINOUS AND NON-MECHANICAL NON-METAL SIGNS FOR IDENTIFYING GREEN BUILDING FEATURES IN A STRUCTURE AND CONTAINING INFORMATION ABOUT GREEN BUILDING FEATURES, ECOLOGICAL PRINCIPLES AND GREEN PRODUCTS (U.S. CLS. 2, 5, 22, 23, 29, 37, 38 AND 50).

ESTHER A. BORSUK, EXAMINING ATTORNEY

CLASS 16—(Continued).

SN 77-798,857. BROKER POWER, INC., MANASSAS, VA.
FILED 8-6-2009.

INTERNATIONAL TRADE TODAY

THE MARK CONSISTS OF STANDARD CHARACTERS WITHOUT CLAIM TO ANY PARTICULAR FONT, STYLE, SIZE, OR COLOR.

NO CLAIM IS MADE TO THE EXCLUSIVE RIGHT TO USE "INTERNATIONAL TRADE", APART FROM THE MARK AS SHOWN.

FOR DAILY NEWSLETTERS IN THE FIELD OF INTERNATIONAL TRADE (U.S. CLS. 2, 5, 22, 23, 29, 37, 38 AND 50).

FIRST USE 8-20-1991; IN COMMERCE 8-20-1991.
DAVID C. REIHNER, EXAMINING ATTORNEY

SN 77-798,900. BROKER POWER, INC., MANASSAS, VA.
FILED 8-6-2009.

INTERNATIONAL TRADE WEEKLY

THE MARK CONSISTS OF STANDARD CHARACTERS WITHOUT CLAIM TO ANY PARTICULAR FONT, STYLE, SIZE, OR COLOR.

NO CLAIM IS MADE TO THE EXCLUSIVE RIGHT TO USE "WEEKLY", APART FROM THE MARK AS SHOWN.

SEC. 2(F).
FOR WEEKLY NEWSLETTERS IN THE FIELD OF INTERNATIONAL TRADE (U.S. CLS. 2, 5, 22, 23, 29, 37, 38 AND 50).

FIRST USE 7-1-2004; IN COMMERCE 7-1-2004.
DAVID C. REIHNER, EXAMINING ATTORNEY

SN 77-817,280. READY LEARNER LLC, NEW YORK, NY.
FILED 9-1-2009.

Ready Learner

THE MARK CONSISTS OF STANDARD CHARACTERS WITHOUT CLAIM TO ANY PARTICULAR FONT, STYLE, SIZE, OR COLOR.

FOR PRINTED EDUCATIONAL PRODUCTS, NAMELY, NEWSLETTERS, BOOKLETS, INSTRUCTIONAL MATERIALS, BOOKS, LEARNING CARDS, WORKBOOKS, TEACHER GUIDES, PAMPHLETS, CHARTS, WORKSHEETS, AND FLASH CARDS IN THE FIELDS OF CHILDHOOD EDUCATION AND CHILD DEVELOPMENT (U.S. CLS. 2, 5, 22, 23, 29, 37, 38 AND 50).

MARCIE MILONE, EXAMINING ATTORNEY

CLASS 16—(Continued).

SN 77-823,019. BOOM BOOM! REVOLUTION, INC., SANTA CRUZ, CA. FILED 9-9-2009.

BOOM BOOM! CARDS

THE MARK CONSISTS OF STANDARD CHARACTERS WITHOUT CLAIM TO ANY PARTICULAR FONT, STYLE, SIZE, OR COLOR.

NO CLAIM IS MADE TO THE EXCLUSIVE RIGHT TO USE "CARDS", APART FROM THE MARK AS SHOWN.

FOR PRINTED PRODUCTS IN THE FIELD OF SOCIALLY BENEFICIAL ACTS AND BEHAVIOR, NAMELY, MOTIVATIONAL CARDS (U.S. CLS. 2, 5, 22, 23, 29, 37, 38 AND 50).

FIRST USE 3-1-2007; IN COMMERCE 3-1-2007.

SAMUEL E. SHARPER JR., EXAMINING ATTORNEY

SN 77-824,388. ETERNAL PRESERVATION ASSOCIATES, LLC, BOCA RATON, FL. FILED 9-11-2009.

ACCIDENTAL MUMMIES

THE MARK CONSISTS OF STANDARD CHARACTERS WITHOUT CLAIM TO ANY PARTICULAR FONT, STYLE, SIZE, OR COLOR.

NO CLAIM IS MADE TO THE EXCLUSIVE RIGHT TO USE "MUMMIES", APART FROM THE MARK AS SHOWN.

FOR PRINTED, BOOKS, PAMPHLETS, BROCHURES, SOUVENIR PROGRAMS, EDUCATIONAL, CURRICULUM AND TEACHING MATERIALS ON THE SUBJECTS OF ARCHAEOLOGY, ANTHROPOLOGY AND FORENSIC SCIENCE; POSTCARDS; POSTERS; PRINTS; CALENDARS; STICKERS; MERCHANDISE BAGS; PENCILS; AND PENS (U.S. CLS. 2, 5, 22, 23, 29, 37, 38 AND 50).

PAM WILLIS, EXAMINING ATTORNEY

SN 77-844,976. PAPER TAFFY, AUSTIN, TX. FILED 10-9-2009.

PAPER TAFFY

THE MARK CONSISTS OF STANDARD CHARACTERS WITHOUT CLAIM TO ANY PARTICULAR FONT, STYLE, SIZE, OR COLOR.

NO CLAIM IS MADE TO THE EXCLUSIVE RIGHT TO USE "PAPER", APART FROM THE MARK AS SHOWN.

FOR PAPER GOODS, NAMELY, NOTEPADS, NOTE CARDS, INVITATION CARDS, PRINTED INVITATIONS, ANNOUNCEMENT CARDS, GREETING CARDS, STICKERS, AND DRINK DOTS, NAMELY, DECALS FOR USE IN APPLYING TO DRINK GLASSES FOR IDENTIFICATION PURPOSES, ALL FOR CONSUMERS OF ALL AGES (U.S. CLS. 2, 5, 22, 23, 29, 37, 38 AND 50).

FIRST USE 8-15-2009; IN COMMERCE 9-4-2009.

MARY CRAWFORD, EXAMINING ATTORNEY

CLASS 16—(Continued).

SN 77-855,321. STUSSER, MICHAEL A., SEATTLE, WA. FILED 10-22-2009.

Old Schoogle

THE MARK CONSISTS OF STANDARD CHARACTERS WITHOUT CLAIM TO ANY PARTICULAR FONT, STYLE, SIZE, OR COLOR.

FOR A SERIES OF BOOKS AND WRITTEN ARTICLES IN THE FIELD OF HISTORICAL RESEARCH AND EDUCATION, SPECIFICALLY RELATING TO THE CHRONOLOGICAL EVOLUTION OF INVENTIONS AND CUSTOMS THROUGHOUT HISTORY IN A VARIETY OF FIELDS (U.S. CLS. 2, 5, 22, 23, 29, 37, 38 AND 50).

EVELYN BRADLEY, EXAMINING ATTORNEY

SN 77-856,743. GROSS, STEWART F., TA SKEASEL.COM, PARK CITY, UT. FILED 10-24-2009.



THE MARK CONSISTS OF THE WORD "SKEASEL", WITH THE LETTER "S" IN UPPER CASE, THE LETTERS "EASEL" IN LOWER CASE, AND A LARGE LETTER "K" FORMED BY A SINGLE SKI WITH SHADING AND SKI POLES.

FOR PAINTERS' EASELS (U.S. CLS. 2, 5, 22, 23, 29, 37, 38 AND 50).

FIRST USE 7-4-2009; IN COMMERCE 7-4-2009.

MARY ROSSMAN, EXAMINING ATTORNEY

SN 77-857,264. DAVID LISSNER, CHICAGO, IL. FILED 10-26-2009.

CHICAGO RESTAURANT

THE MARK CONSISTS OF STANDARD CHARACTERS WITHOUT CLAIM TO ANY PARTICULAR FONT, STYLE, SIZE, OR COLOR.

OWNER OF U.S. REG. NO. 2,174,180.

SEC. 2(F).

FOR MAGAZINES FEATURING RESTAURANTS IN CHICAGO; MAGAZINES IN THE FIELD OF HOSPITALITY, GASTRONOMY AND ENTERTAINMENT SERVICES (U.S. CLS. 2, 5, 22, 23, 29, 37, 38 AND 50).

FIRST USE 2-6-1990; IN COMMERCE 2-6-1990.

COLLEEN KEARNEY, EXAMINING ATTORNEY

CLASS 16—(Continued).

SN 77-860,712. KERMIT ZARLEY ENTERPRISES, SCOTTS-DALE, AZ. FILED 10-29-2009.

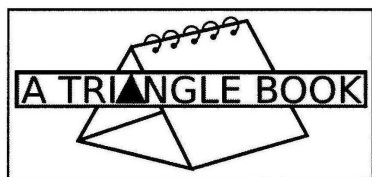

NO CLAIM IS MADE TO THE EXCLUSIVE RIGHT TO USE "BOOK", APART FROM THE MARK AS SHOWN.

THE MARK CONSISTS OF A RECTANGULAR SHAPED BOX AND WITHIN THE BOX IS A PICTURE OF A THREE-PANEL BOOK WITH A SPIRAL BINDING AND SET UP INTO THE READING POSITION. APPEARING CENTERED IN THE MIDDLE OF THE FIRST RECTANGULAR BOX AND LAYING OVER THE PICTURE OF THE THREE-PANEL BOOK IS ANOTHER RECTANGULAR SHAPED BOX AND APPEARING WITHIN THIS BOX ARE THE WORDS "A TRIANGLE BOOK" IN FANCIFUL LETTER. THE LETTER "A" IN THE WORD "TRIANGLE" APPEARS AS A SOLID TRIANGLE FORMING A STYLIZED "A".

FOR THREE-PANEL BOOKS IN THE FIELD OF PUBLISHING; THREE-PANEL NOTEBOOKS; THREE-PANEL COMPOSITION BOOKS (U.S. CLS. 2, 5, 22, 23, 29, 37, 38 AND 50).

ROBERT C. CLARK JR., EXAMINING ATTORNEY

SN 77-867,177. BIRD, LINDA, CHICO, CA. FILED 11-6-2009.

Treasured Talks

THE MARK CONSISTS OF STANDARD CHARACTERS WITHOUT CLAIM TO ANY PARTICULAR FONT, STYLE, SIZE, OR COLOR.

FOR COMMUNICATION KITS EACH CONSISTING OF TWO BOOKLETS FEATURING GUIDANCE FOR MEANINGFUL CONVERSATIONS FOR COUPLES, TWO QUICK REFERENCE GUIDES IN THE FORM OF INDEX CARDS, TWO PLASTIC CONTAINERS WITH AUTHENTIC AND IMITATION GEMSTONES USED TO EXPRESS THOUGHTS AND FEELINGS DESCRIBED IN THE BOOKLETS, AND A DECORATIVE GLASS TRAY TO DISPLAY THE GEMSTONES, THE FOREGOING SOLD AS UNIT (U.S. CLS. 2, 5, 22, 23, 29, 37, 38 AND 50).

FIRST USE 2-1-2009; IN COMMERCE 5-22-2009.
NANCY CLARKE, EXAMINING ATTORNEY

CLASS 16—(Continued).

SN 77-868,199. SANNAH PACKAGING SUPPLIES, INC., ANAHEIM, CA. FILED 11-9-2009.

Hexabox

THE MARK CONSISTS OF STANDARD CHARACTERS WITHOUT CLAIM TO ANY PARTICULAR FONT, STYLE, SIZE, OR COLOR.

FOR CARDBOARD PACKAGING, NAMELY, CARDBOARD BOXES FEATURING HONEYCOMB LAYERS (U.S. CLS. 2, 5, 22, 23, 29, 37, 38 AND 50).

FIRST USE 2-1-2000; IN COMMERCE 2-1-2006.
DORITT L. CARROLL, EXAMINING ATTORNEY

SN 77-871,257. THE NEWARK GROUP, INC., CRANFORD, NJ. FILED 11-12-2009.

NEWGEN

THE MARK CONSISTS OF STANDARD CHARACTERS WITHOUT CLAIM TO ANY PARTICULAR FONT, STYLE, SIZE, OR COLOR.

FOR RECYCLABLE LAMINATED GRAPHIC ILLUSTRATION BOARD OR PAPERBOARD WITH AT LEAST ONE OUTER LAYER SUITABLE FOR PRINTING OR OTHER SURFACE ENHANCEMENT (U.S. CLS. 2, 5, 22, 23, 29, 37, 38 AND 50).

WILLIAM P. SHANAHAN, EXAMINING ATTORNEY

SN 77-871,964. KERR & ASSOCIATES, INC., MONUMENT, CO. FILED 11-13-2009.



THE MARK CONSISTS OF THE WORDING "BLUE DAHLIA" IN A STYLIZED FONT TO THE RIGHT OF A DESIGN THAT CONSISTS OF A STYLIZED FLOWER IN THE NATURE OF A DAHLIA.

FOR GIFT BAGS; TISSUE PAPER; PHOTO ALBUMS; SCRAPBOOKS; STACKING CHIPBOARD PAPER BOXES; FILE FOLDERS; DESK SETS; NOTEPADS; DESK PADS; LASER PAPER GIFT SETS CONSISTING OF LASER PRINT PAPER AND MATCHING ENVELOPES SOLD AS A SET; BLANK JOURNALS; AND OTHER STATIONARY PRODUCTS, NAMELY, NOTE CARDS, PHOTO NOTE CARDS, AND PRINTED PRODUCTS, NAMELY, LISTS FEATURING SHOPPING ITEMS (U.S. CLS. 2, 5, 22, 23, 29, 37, 38 AND 50).

RENEE MCCRAY, EXAMINING ATTORNEY

CLASS 16—(Continued).

SN 77-875,730. CHRISTINA K. FRENCH, DBA FRENCH-PRESS PUBLICATIONS, PITTSBURGH, PA. FILED 11-18-2009.

TABLE magazine

THE MARK CONSISTS OF STANDARD CHARACTERS WITHOUT CLAIM TO ANY PARTICULAR FONT, STYLE, SIZE, OR COLOR.

NO CLAIM IS MADE TO THE EXCLUSIVE RIGHT TO USE "MAGAZINE", APART FROM THE MARK AS SHOWN. FOR GENERAL FEATURE MAGAZINE IN THE FIELD OF FOOD (U.S. CLS. 2, 5, 22, 23, 29, 37, 38 AND 50).

FIRST USE 11-1-2006; IN COMMERCE 2-15-2007.
DAVID HOFFMAN, EXAMINING ATTORNEY

SN 77-876,396. SCIO VERUM CORPORATION, PALM BEACH, FL. FILED 11-19-2009.



OWNER OF U.S. REG. NOS. 2,869,705 AND 2,893,388. THE NAME "BRIAN VICKERS" IDENTIFIES A LIVING INDIVIDUAL WHOSE CONSENT IS OF RECORD.

THE MARK CONSISTS OF THE NAME "BRIAN VICKERS" IN SCRIPT.

FOR DOCUMENT HOLDERS; PHOTOGRAPHS AND PENS (U.S. CLS. 2, 5, 22, 23, 29, 37, 38 AND 50).

FIRST USE 0-0-2003; IN COMMERCE 0-0-2003.
LESLIE RICHARDS, EXAMINING ATTORNEY

SN 77-878,888. EDITORIAL PRIMERA HORA, INC., GUAYNABO, PUERTO RICO, FILED 11-23-2009.

MIMA

THE MARK CONSISTS OF STANDARD CHARACTERS WITHOUT CLAIM TO ANY PARTICULAR FONT, STYLE, SIZE, OR COLOR.

THE ENGLISH TRANSLATION OF MIMA IN THE MARK IS "SHE SPOILS".

FOR PUBLICATIONS, NAMELY, MAGAZINES IN THE FIELD OF PARENTING AND FAMILY (U.S. CLS. 2, 5, 22, 23, 29, 37, 38 AND 50).

FIRST USE 3-1-2010; IN COMMERCE 3-1-2010.
RENEE MCCRAY, EXAMINING ATTORNEY

CLASS 16—(Continued).

SN 77-879,066. MONAVIE LLC, SOUTH JORDAN, UT. FILED 11-23-2009.

MONA·VIE

THE MARK CONSISTS OF STANDARD CHARACTERS WITHOUT CLAIM TO ANY PARTICULAR FONT, STYLE, SIZE, OR COLOR.

OWNER OF U.S. REG. NOS. 3,106,146, 3,111,333 AND OTHERS.

FOR PUBLICATIONS AND PRINTED MATTER, NAMELY, PERIODIC INFORMATIONAL MAGAZINES AND BROCHURES IN THE FIELD OF HEALTH, FITNESS AND WELL-BEING AND BUSINESS MANAGEMENT AND MARKETING; INFORMATIONAL FLYERS PROVIDING INFORMATION ON PERSONAL IMPROVEMENT AND MOTIVATION THROUGH NUTRITIONAL SUPPLEMENTS; BROCHURES EXPLAINING THE BENEFIT OF SELECTED NUTRITIONAL AIDS; NEWSLETTERS IN THE FIELD OF PERSONAL HEALTH MAINTENANCE INVOLVING NUTRITIONAL SUPPLEMENTS (U.S. CLS. 2, 5, 22, 23, 29, 37, 38 AND 50).

NANCY CLARKE, EXAMINING ATTORNEY

SN 77-880,893. ANSWERING, LLC, SHERIDAN, WY. FILED 11-25-2009.

ANSWERRING

THE MARK CONSISTS OF STANDARD CHARACTERS WITHOUT CLAIM TO ANY PARTICULAR FONT, STYLE, SIZE, OR COLOR.

OWNER OF U.S. REG. NOS. 3,720,095 AND 3,720,096.

FOR PORTABLE CARDBOARD SLIDE CHART-TYPE DEVICE THAT PROVIDES ADVICE REGARDING VETERANS' ISSUES (U.S. CLS. 2, 5, 22, 23, 29, 37, 38 AND 50).

HENRY S. ZAK, EXAMINING ATTORNEY

SN 77-882,181. NEAL-SCHUMAN PUBLISHERS, INC., NEW YORK, NY. FILED 11-30-2009.

THE TECH SET

THE MARK CONSISTS OF STANDARD CHARACTERS WITHOUT CLAIM TO ANY PARTICULAR FONT, STYLE, SIZE, OR COLOR.

NO CLAIM IS MADE TO THE EXCLUSIVE RIGHT TO USE "SET", APART FROM THE MARK AS SHOWN.

FOR SERIES OF NON-FICTION BOOKS IN THE FIELD OF LIBRARY OPERATIONS, EACH BOOK AUTHORED BY A DIFFERENT INFORMATION TECHNOLOGY SPECIALIST (U.S. CLS. 2, 5, 22, 23, 29, 37, 38 AND 50).

TINA MAI, EXAMINING ATTORNEY

CLASS 16—(Continued).

SN 77-882,315. BETWEEN FOUR EYES, TIBURON, CA. FILED 11-30-2009.

Mindfulness Without Borders

THE MARK CONSISTS OF STANDARD CHARACTERS WITHOUT CLAIM TO ANY PARTICULAR FONT, STYLE, SIZE, OR COLOR.

FOR EDUCATIONAL PUBLICATIONS, NAMELY, TRAINING MANUALS IN THE FIELD OF SOCIAL AND EMOTIONAL LEARNING (U.S. CLS. 2, 5, 22, 23, 29, 37, 38 AND 50).

COLLEEN KEARNEY, EXAMINING ATTORNEY

CLASS 16—(Continued).

PURPLE, NEXT LIGHT GREEN, NEXT BLUE WITH LIGHT BLUE WAVY LINE PATTERN, NEXT LIGHT GREEN, NEXT FUCHSIA, NEXT DARK GREEN, NEXT YELLOW WITH A LIGHTER YELLOW ARROW PATTERN, NEXT LIGHT GREEN, NEXT PERIWINKLE BLUE, NEXT DARK GREEN, NEXT A GREEN, ORANGE, YELLOW, BLUE AND BLACK PLAID MULTI COLOR, THEN A PINK LEAF IMAGE RESTS ON TOP OF THE LOWER CASE "I" IN IMPERFEKTIONS. UNDERNEATH THE TREE DESIGN THE WORDING "PERFEKT IMPERFEKTIONS" APPEARS IN BLACK.

FOR CHILDREN'S BOOKS (U.S. CLS. 2, 5, 22, 23, 29, 37, 38 AND 50).

KATHRYN COWARD, EXAMINING ATTORNEY

SN 77-883,713. LINCOLN VAL, DALLAS, TX. FILED 12-1-2009.



NO CLAIM IS MADE TO THE EXCLUSIVE RIGHT TO USE "BATHTEACHER", APART FROM THE MARK AS SHOWN.

THE MARK CONSISTS OF THE STYLIZED WORDS "BATHTEACHER BATHTIME. FUNTIME. LEARNTIME." INSIDE AN IMAGE OF AN OVAL WITH WATER DROPS ON BOTH SIDES.

FOR LARGE ADHESIVE VINYL STRIPS WITH PRINTED IMAGES AND EDUCATIONAL CONCEPTS TO BE VIEWED BY TODDLERS AS THEY BATHE (U.S. CLS. 2, 5, 22, 23, 29, 37, 38 AND 50).

JAY FLOWERS, EXAMINING ATTORNEY

SN 77-883,830. ANSWERING, LLC, SHERIDAN, WY. FILED 12-1-2009.



SN 77-883,765. CONANT,LISA K., WAXHAW, NC. AND CATHERINE CARROLL, WAXHAW, NC. AND KELLY LANG-RAMIREZ, WAXHAW, NC. FILED 12-1-2009.



THE COLOR(S) BLACK, DARK GREEN, LIGHT GREEN, PURPLE, FUCHSIA, YELLOW, PERIWINKLE BLUE, WHITE, BLUE, ORANGE AND PINK IS/ARE CLAIMED AS A FEATURE OF THE MARK.

THE MARK CONSISTS OF A BLACK TREE IMAGE WITH DIFFERENT COLORED AND PATTERNED LEAVES WITH A GREEN ARC BELOW IT, THE LEAVES ON THE TREE ARE: A LIGHT GREEN LEAF, NEXT A BLACK AND WHITE POLKA DOT LEAF, NEXT DARK GREEN, NEXT

OWNER OF U.S. REG. NOS. 3,720,095 AND 3,720,096. THE COLOR(S) RED, WHITE AND BLUE IS/ARE CLAIMED AS A FEATURE OF THE MARK.

THE MARK CONSISTS OF A SEMICIRCULAR CURVE RESEMBLING AN AMERICAN FLAG; THE UPPER LEFT OF THE CURVE CONTAINS A BLUE BACKGROUND WITH WHITE STARS, THE REMAINDER OF THE CURVE CONSISTS OF ALTERNATING WHITE AND RED STRIPES; IN THE CENTER OF THE CURVE DESIGN ARE THE WORDS "ANSWER RING" IN WHITE LETTERING.

FOR PORTABLE CARDBOARD SLIDE CHART-TYPE DEVICE THAT PROVIDES ADVICE REGARDING VETERANS' ISSUES (U.S. CLS. 2, 5, 22, 23, 29, 37, 38 AND 50).

HENRY S. ZAK, EXAMINING ATTORNEY

CLASS 16—(Continued).

SN 77-884,044. WESTERN CAROLINA UNIVERSITY (NORTH CAROLINA NON-PROFIT EDUCATIONAL INSTITUTE OF THE UNIVERSITY OF NORTH CAROLINA), CULLOWHEE, NC. FILED 12-2-2009.



OWNER OF U.S. REG. NO. 1,554,839.
THE COLOR(S) PURPLE, GOLD AND WHITE IS/ARE CLAIMED AS A FEATURE OF THE MARK.

THE MARK CONSISTS OF THE LETTERS "WCU" WHICH ARE ARRANGED DIAGONALLY DOWNWARD FROM LEFT TO RIGHT. THE CENTER OF EACH LETTER IS WHITE SURROUNDED BY A PURPLE BORDER WHICH IS SURROUNDED BY A GOLD BORDER.

FOR DECALS, NOTEBOOKS, CALENDARS AND POSTERS (U.S. CLS. 2, 5, 22, 23, 29, 37, 38 AND 50).
FIRST USE 8-13-2008; IN COMMERCE 8-13-2008.
MARGARET POWER, EXAMINING ATTORNEY

SN 77-884,445. SWATTON, JEANINE, DUBLIN, CA. FILED 12-2-2009.

Making Love on the internet

THE MARK CONSISTS OF STANDARD CHARACTERS WITHOUT CLAIM TO ANY PARTICULAR FONT, STYLE, SIZE, OR COLOR.

FOR BOOKS IN THE FIELD OF USING THE INTERNET TO FIND RELATIONSHIPS (U.S. CLS. 2, 5, 22, 23, 29, 37, 38 AND 50).
PAULA MAHONEY, EXAMINING ATTORNEY

SN 77-886,151. AWANA CLUBS INTERNATIONAL, STREAMWOOD, IL. FILED 12-4-2009.

T&T Ultimate Adventure

THE MARK CONSISTS OF STANDARD CHARACTERS WITHOUT CLAIM TO ANY PARTICULAR FONT, STYLE, SIZE, OR COLOR.

FOR PRINTED TEACHING MATERIALS IN THE FIELD OF CHRISTIAN EDUCATION (U.S. CLS. 2, 5, 22, 23, 29, 37, 38 AND 50).
MICHELE SWAIN, EXAMINING ATTORNEY

CLASS 16—(Continued).

SN 77-886,199. AWANA CLUBS INTERNATIONAL, STREAMWOOD, IL. FILED 12-4-2009.

T&T Ultimate Challenge

THE MARK CONSISTS OF STANDARD CHARACTERS WITHOUT CLAIM TO ANY PARTICULAR FONT, STYLE, SIZE, OR COLOR.

FOR PRINTED TEACHING MATERIALS IN THE FIELD OF CHRISTIAN EDUCATION (U.S. CLS. 2, 5, 22, 23, 29, 37, 38 AND 50).

MICHELE SWAIN, EXAMINING ATTORNEY

SN 77-886,543. AMERICAN READING COMPANY, KING OF PRUSSIA, PA. FILED 12-4-2009.



NO CLAIM IS MADE TO THE EXCLUSIVE RIGHT TO USE "BOOKS", APART FROM THE MARK AS SHOWN.

THE COLOR(S) YELLOW, BLACK, BROWN, BLUE, RED, GREEN, WHITE, PINK, AND BEIGE IS/ARE CLAIMED AS A FEATURE OF THE MARK.

THE MARK CONSISTS OF THE STYLIZED WORDING "POTATO CHIP BOOKS" IN YELLOW AND OUTLINED IN BLACK. BELOW THE WORDING IS A PILE OF POTATO CHIPS IN YELLOW AND OUTLINED IN BLACK. IN THE CENTER OF THE POTATO CHIPS IS THE IMAGE OF A BOY WITH BLACK HAIR, BEIGE SKIN, AND PINK CHEEKS, WEARING A BLUE SHIRT OVER A BROWN SHIRT, HOLDING A YELLOW, WHITE, AND BLACK POTATO CHIP BAG, AND READING A SMALL BLACK AND WHITE BOOK. THERE IS A BLACK AND WHITE THOUGHT BUBBLE NEAR THE BOY WITH THE BLACK WORDING "YUM . . .". THERE IS A BLUE AND GREEN BACKGROUND BEHIND THE BOY. BELOW THE DESIGN OF THE BOY AND THE POTATO CHIPS IS THE RED WORDING "SO GOOD YOU CAN'T STOP READING THEM!" IN A YELLOW BANNER OUTLINED IN BLACK.

FOR EDUCATIONAL BOOKS, NAMELY, BOOKS FOR CHILDREN THAT ASSIST THEM IN LEARNING HOW TO READ; CHILDREN'S BOOKS; SKILL CARDS FEATURING READING EXERCISES; FOLDERS; PRINTED CURRICULUM MATERIALS FOR SCHOOL ADMINISTRATORS, TEACHERS AND ADULTS TO CONDUCT A READING PROGRAM AND TO TEACH READING TO STUDENTS FROM PRE-KINDERGARTEN THROUGH SECONDARY SCHOOL (U.S. CLS. 2, 5, 22, 23, 29, 37, 38 AND 50).

FIRST USE 1-0-2009; IN COMMERCE 1-0-2009.
BARBARA GAYNOR, EXAMINING ATTORNEY

CLASS 16—(Continued).

SN 77-886,574. AMERICAN READING COMPANY, KING OF PRUSSIA, PA. FILED 12-4-2009.

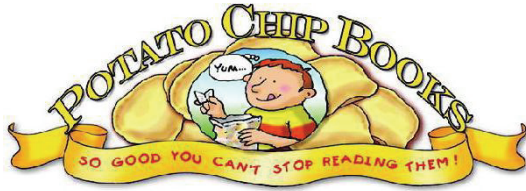

THE COLOR(S) YELLOW, ORANGE, RED, BLACK, WHITE, BLUE, GREEN, PINK, AND PEACH IS/ARE CLAIMED AS A FEATURE OF THE MARK.

THE MARK CONSISTS OF THE STYLIZED WORDING "POTATO CHIP BOOKS" IN YELLOW AND OUTLINED IN BLACK. BELOW THE WORDING IS A PILE OF POTATO CHIPS IN YELLOW AND OUTLINED IN BLACK. IN THE CENTER OF THE POTATO CHIPS IS THE IMAGE OF A BOY WITH ORANGE HAIR, PEACH SKIN, PINK CHEEKS AND TONGUE, WEARING A YELLOW AND ORANGE STRIPED SHIRT, HOLDING A YELLOW, WHITE, AND BLACK POTATO CHIP BAG, AND READING A SMALL BLACK AND WHITE BOOK. THERE IS A BLACK AND WHITE THOUGHT BUBBLE NEAR THE BOY WITH THE BLACK WORDING "YUM . . .". THERE IS A BLUE AND GREEN BACKGROUND BEHIND THE BOY. BELOW THE DESIGN OF THE BOY AND THE POTATO CHIPS IS THE RED WORDING "SO GOOD YOU CAN'T STOP READING THEM!" IN A YELLOW BANNER OUTLINED IN BLACK.

FOR EDUCATIONAL BOOKS, NAMELY, BOOKS FOR CHILDREN THAT ASSIST THEM IN LEARNING HOW TO READ; CHILDREN'S BOOKS; SKILL CARDS FEATURING READING EXERCISES; FOLDERS; PRINTED CURRICULUM MATERIALS FOR SCHOOL ADMINISTRATORS, TEACHERS AND ADULTS TO CONDUCT A READING PROGRAM AND TO TEACH READING TO STUDENTS FROM PRE-KINDERGARTEN THROUGH SECONDARY SCHOOL (U.S. CLS. 2, 5, 22, 23, 29, 37, 38 AND 50).

FIRST USE 1-0-2009; IN COMMERCE 1-0-2009.
BARBARA GAYNOR, EXAMINING ATTORNEY

SN 77-886,596. AMERICAN READING COMPANY, KING OF PRUSSIA, PA. FILED 12-4-2009.

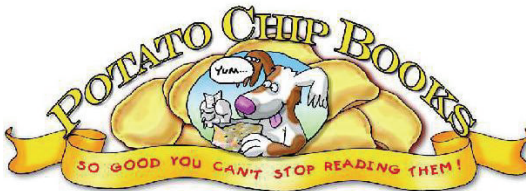

NO CLAIM IS MADE TO THE EXCLUSIVE RIGHT TO USE "BOOKS", APART FROM THE MARK AS SHOWN.

THE COLOR(S) YELLOW, WHITE, BROWN, RED, BLACK, BLUE, GREEN, AND PINK IS/ARE CLAIMED AS A FEATURE OF THE MARK.

THE MARK CONSISTS OF THE STYLIZED WORDING "POTATO CHIP BOOKS" IN YELLOW AND OUTLINED IN BLACK. BELOW THE WORDING IS A PILE OF POTATO CHIPS IN YELLOW AND OUTLINED IN BLACK. IN THE CENTER OF THE POTATO CHIPS IS THE IMAGE OF A

CLASS 16—(Continued).

BROWN AND WHITE DOG WITH A PINK TONGUE AND NOSE, HOLDING A YELLOW, WHITE, AND BLACK POTATO CHIP BAG, AND READING A SMALL BLACK AND WHITE BOOK. THERE IS A BLACK AND WHITE THOUGHT BUBBLE NEAR THE DOG WITH THE BLACK WORDING "YUM . . .". THERE IS A BLUE AND GREEN BACKGROUND BEHIND THE DOG. BELOW THE DESIGN OF THE DOG AND THE POTATO CHIPS IS THE RED WORDING "SO GOOD YOU CAN'T STOP READING THEM!" IN A YELLOW BANNER OUTLINED IN BLACK.

FOR EDUCATIONAL BOOKS, NAMELY, BOOKS FOR CHILDREN THAT ASSIST THEM IN LEARNING HOW TO READ; CHILDREN'S BOOKS; SKILL CARDS FEATURING READING EXERCISES; FOLDERS; PRINTED CURRICULUM MATERIALS FOR SCHOOL ADMINISTRATORS, TEACHERS AND ADULTS TO CONDUCT A READING PROGRAM AND TO TEACH READING TO STUDENTS FROM PRE-KINDERGARTEN THROUGH SECONDARY SCHOOL (U.S. CLS. 2, 5, 22, 23, 29, 37, 38 AND 50).

FIRST USE 1-0-2009; IN COMMERCE 1-0-2009.
BARBARA GAYNOR, EXAMINING ATTORNEY

SN 77-886,617. AMERICAN READING COMPANY, KING OF PRUSSIA, PA. FILED 12-4-2009.



NO CLAIM IS MADE TO THE EXCLUSIVE RIGHT TO USE "BOOKS", APART FROM THE MARK AS SHOWN.

THE COLOR(S) YELLOW, ORANGE, RED, BROWN, BLUE, GREEN, BLACK, WHITE, AND PINK IS/ARE CLAIMED AS A FEATURE OF THE MARK.

THE MARK CONSISTS OF THE STYLIZED WORDING "POTATO CHIP BOOKS" IN YELLOW AND OUTLINED IN BLACK. BELOW THE WORDING IS A PILE OF POTATO CHIPS IN YELLOW AND OUTLINED IN BLACK. IN THE CENTER OF THE POTATO CHIPS IS THE IMAGE OF A GIRL WITH ORANGE HAIR AND TWO YELLOW BOWS IN HER HAIR, BROWN SKIN, A PINK TONGUE, WEARING A YELLOW SHIRT, HOLDING A YELLOW, WHITE, AND BLACK POTATO CHIP BAG, AND READING A SMALL BLACK AND WHITE BOOK. THERE IS A BLACK AND WHITE THOUGHT BUBBLE NEAR THE GIRL WITH THE BLACK WORDING "YUM . . .". THERE IS A BLUE AND GREEN BACKGROUND BEHIND THE GIRL. BELOW THE DESIGN OF THE GIRL AND THE POTATO CHIPS IS THE RED WORDING "SO GOOD YOU CAN'T STOP READING THEM!" IN A YELLOW BANNER OUTLINED IN BLACK.

FOR EDUCATIONAL BOOKS, NAMELY, BOOKS FOR CHILDREN THAT ASSIST THEM IN LEARNING HOW TO READ; CHILDREN'S BOOKS; SKILL CARDS FEATURING READING EXERCISES; FOLDERS; PRINTED CURRICULUM MATERIALS FOR SCHOOL ADMINISTRATORS, TEACHERS AND ADULTS TO CONDUCT A READING PROGRAM AND TO TEACH READING TO STUDENTS FROM PRE-KINDERGARTEN THROUGH SECONDARY SCHOOL (U.S. CLS. 2, 5, 22, 23, 29, 37, 38 AND 50).

FIRST USE 1-1-2009; IN COMMERCE 1-1-2009.
BARBARA GAYNOR, EXAMINING ATTORNEY

CLASS 16—(Continued).

SN 77-886,626. BIG BAD BOO PRODUCTIONS, INC., NEW YORK, NY. FILED 12-4-2009.

1001 NIGHTS

THE MARK CONSISTS OF STANDARD CHARACTERS WITHOUT CLAIM TO ANY PARTICULAR FONT, STYLE, SIZE, OR COLOR.

FOR CHILDREN'S BOOKS, COMIC BOOKS AND EDUCATIONAL BOOKS FEATURING ANIMATED CHARACTERS FOR CHILDREN'S READING (U.S. CLS. 2, 5, 22, 23, 29, 37, 38 AND 50).

JOHN WILKE, EXAMINING ATTORNEY

SN 77-886,690. BIG BAD BOO PRODUCTIONS, INC., NEW YORK, NY. FILED 12-4-2009.

THE MARK CONSISTS OF THE STYLIZED WORDS "1001 NIGHTS" WITH CURVED LINES BENEATH "1001" AND "HTS", ONE DIAMOND BEFORE "1001", ONE DIAMOND AFTER "NIGHTS" AND TWO DIAMONDS OVER THE "G".

FOR CHILDREN'S BOOKS, COMIC BOOKS AND EDUCATIONAL BOOKS FEATURING ANIMATED CHARACTERS FOR CHILDREN'S READING (U.S. CLS. 2, 5, 22, 23, 29, 37, 38 AND 50).

JOHN WILKE, EXAMINING ATTORNEY

SN 77-886,763. IPILOT WORLDWIDE, DBA ICANPILOT, SAINT PAUL, MN. FILED 12-4-2009.

ICanPilot

THE MARK CONSISTS OF STANDARD CHARACTERS WITHOUT CLAIM TO ANY PARTICULAR FONT, STYLE, SIZE, OR COLOR.

FOR EDUCATIONAL KITS SOLD AS A UNIT IN THE FIELD OF BUSINESS STRATEGY CONSISTING PRIMARILY OF PRINTED EDUCATIONAL BOOKS, FLASH CARDS, PRINTED WORKSHEETS AND AN EDUCATIONAL DVD (U.S. CLS. 2, 5, 22, 23, 29, 37, 38 AND 50).

BERYL GARDNER, EXAMINING ATTORNEY

CLASS 16—(Continued).

SN 77-886,824. MCCLATCHY U.S.A., INC., SACRAMENTO, CA. FILED 12-4-2009.

DEJA BLUE

THE MARK CONSISTS OF STANDARD CHARACTERS WITHOUT CLAIM TO ANY PARTICULAR FONT, STYLE, SIZE, OR COLOR.

FOR PAPER PRODUCTS ALL RELATING TO BOISE STATE UNIVERSITY, NAMELY, A SERIES OF NON-FICTION BOOKS ON BOISE STATE UNIVERSITY, BUMPER STICKERS, POSTERS, WRITING PADS, NOTE PADS, GREETING CARDS, STATIONERY, PHOTOGRAPHS (U.S. CLS. 2, 5, 22, 23, 29, 37, 38 AND 50).

MARK SHINER, EXAMINING ATTORNEY

SN 77-887,037. EVANS, SUSAN C, DBA HYDRANGEA AFTERNOON, PUNTA GORDA, FL. FILED 12-5-2009.



THE COLOR(S) PURPLE, VIOLET, GREEN AND BLACK IS/ARE CLAIMED AS A FEATURE OF THE MARK.

THE MARK CONSISTS OF A PURPLE AND VIOLET HYDRANGEA FLOWERS WITH GREEN LEAVES ALL OUTLINED AND HIGHLIGHTED WITH BLACK TO THE LEFT OF THE WORDS "HYDRANGEA AFTERNOON" APPEARING IN GREEN, WITH A GREEN LINE UNDER THE WORDS "HYDRANGEA AFTERNOON".

FOR BOOKMARKS; CARDS, NAMELY, GREETING CARDS, NOTE CARDS; CUSTOMIZABLE JOURNAL BOOKS; MEMORY BOOKS; SCRAPBOOK ALBUMS (U.S. CLS. 2, 5, 22, 23, 29, 37, 38 AND 50).

FIRST USE 8-6-2009; IN COMMERCE 8-6-2009.

THOMAS MANOR, EXAMINING ATTORNEY

CLASS 16—(Continued).

SN 77-887,068. BEYOND123 LLC, EAST SETAUKET, NY.
FILED 12-5-2009.

SpecialLUK

THE MARK CONSISTS OF STANDARD CHARACTERS WITHOUT CLAIM TO ANY PARTICULAR FONT, STYLE, SIZE, OR COLOR.

FOR CHILDREN'S INTERACTIVE EDUCATIONAL BOOKS; EDUCATIONAL PUBLICATIONS, NAMELY, BOOKS, HAND-OUTS, WORKBOOKS, JOURNALS, PLAYBOOKS, WORKSHEETS AND CARDS IN THE FIELD OF RIGHT-BRAIN FITNESS; EDUCATIONAL PUBLICATIONS, NAMELY, EDUCATIONAL LEARNING CARDS, FLASH CARDS, ACTIVITY CARDS, WORKBOOKS, TEXTBOOKS, ACTIVITY BOOKS, STORY BOOKS, PUZZLE BOOKS, PRINTED PUZZLES, TEACHER GUIDES, MANUALS, POSTERS AND EDUCATIONAL BOOKLETS IN THE FIELD OF INTELLECTUAL DEVELOPMENT (U.S. CLS. 2, 5, 22, 29, 37, 38 AND 50).

FIRST USE 5-24-2008; IN COMMERCE 6-22-2008.
LAKEISHA LEWIS, EXAMINING ATTORNEY

SN 77-887,121. JUDITH E. SANDERS, AMHERST, MA.
FILED 12-6-2009.

Grow-On

THE MARK CONSISTS OF STANDARD CHARACTERS WITHOUT CLAIM TO ANY PARTICULAR FONT, STYLE, SIZE, OR COLOR.

FOR A SERIES OF BOOKS AND WRITTEN ARTICLES IN THE FIELD OF ART AND CREATIVITY; A SERIES OF BOOKS, WRITTEN ARTICLES, HANDOUTS AND WORKSHEETS IN THE FIELD OF ART AND CREATIVITY; ADDRESS BOOKS; ADDRESS BOOKS AND DIARIES; ANNIVERSARY BOOKS; APPOINTMENT BOOKS; ART AND PHOTOGRAPH PORTFOLIO CASES; ART PADS; ART PAPER; ART PICTURES; ART PRINTS; ART PRINTS ON CANVAS; ARTS AND CRAFT PAINT KITS; AUTOGRAPH BOOKS; BIRTHDAY BOOKS; BLACKBOARDS AND SCRAP BOOKS; BLANK JOURNAL BOOKS; BOOK COVERS; BOOK MARKS; BOOK PLATES; BOOK-COVER PAPER; BOOKS IN THE FIELD OF ART AND CREATIVITY; BRAG BOOKS; CHILDREN'S ACTIVITY BOOKS; CHILDREN'S BOOKS; CHILDREN'S INTERACTIVE EDUCATIONAL BOOKS; CHILDREN'S ARTS AND CRAFTS PAPER KITS; COFFEE TABLE BOOKS FEATURING ART AND CREATIVITY; COLORING BOOKS; COMMEMORATIVE BOOKS FEATURING ART AND CREATIVITY; CUSTOMIZABLE JOURNAL BOOKS; DATE BOOKS; EDUCATIONAL BOOKS FEATURING ART AND CREATIVITY; EDUCATIONAL KITS SOLD AS A UNIT IN THE FIELD OF ART AND CREATIVITY CONSISTING PRIMARILY OF EDUCATIONAL BOOKS, FLASH CARDS AND WORKSHEETS, AND ALSO INCLUDING AN EDUCATIONAL DVD; EDUCATIONAL PUBLICATIONS, NAMELY, BOOKS, HAND-OUTS, WORKBOOKS, JOURNALS, PLAYBOOKS, WORKSHEETS AND CARDS IN THE FIELD OF RIGHT-BRAIN FITNESS; EDUCATIONAL

CLASS 16—(Continued).

PUBLICATIONS, NAMELY, EDUCATIONAL LEARNING CARDS, FLASH CARDS, ACTIVITY CARDS, WORKBOOKS, TEXTBOOKS, ACTIVITY BOOKS, STORY BOOKS, PUZZLE BOOKS, PRINTED PUZZLES, TEACHER GUIDES, MANUALS, POSTERS AND EDUCATIONAL BOOKLETS IN THE FIELD OF ART AND CREATIVITY; EDUCATIONAL PUBLICATIONS, NAMELY, BOOKS IN THE FIELDS OF ART AND CREATIVITY; ENGAGEMENT BOOKS; GIFT BOOKS FEATURING ART AND CREATIVITY; GRAPHIC ART REPRODUCTIONS; GUEST BOOKS; MANUSCRIPT BOOKS; NOTE BOOKS; PERSONALIZED COLORING BOOKS FOR CHILDREN; PICTURE BOOKS; POCKET MEMORANDUM BOOKS; PRINTED ART REPRODUCTIONS; PROTECTIVE COVERS FOR BOOKS; PUBLICATIONS, NAMELY, BOOKS AND POSTERS IN THE FIELDS OF ART AND CREATIVITY; SERIES OF NON-FICTION BOOKS IN THE FIELD OF ART AND CREATIVITY; SKETCH BOOKS; STORY BOOKS; WORKS OF ART MADE FROM CUSTOM MANUFACTURED PAPER (U.S. CLS. 2, 5, 22, 23, 29, 37, 38 AND 50).

RICHARD WHITE, EXAMINING ATTORNEY

SN 77-887,190. ROY, ANDREA G, DBA VIRTUAL-E-KID,
BOCA RATON, FL. FILED 12-6-2009.

Virtual-e-Kid

THE MARK CONSISTS OF STANDARD CHARACTERS WITHOUT CLAIM TO ANY PARTICULAR FONT, STYLE, SIZE, OR COLOR.

FOR BABY BOOKS; CHILDREN'S ACTIVITY BOOKS; CHILDREN'S BOOKS; CHILDREN'S INTERACTIVE EDUCATIONAL BOOKS (U.S. CLS. 2, 5, 22, 23, 29, 37, 38 AND 50).

JILL PRATER, EXAMINING ATTORNEY

SN 77-887,309. JAMES R. GRAY, EDINA, MN. FILED 12-7-2009.

FLEX

THE MARK CONSISTS OF STANDARD CHARACTERS WITHOUT CLAIM TO ANY PARTICULAR FONT, STYLE, SIZE, OR COLOR.

FOR PUBLICATIONS IN THE FIELD OF PSYCHOLOGY, NAMELY, WORKBOOKS THAT TEACH ADULTS COMMUNICATIONS SKILLS BASED ON PERSONALITY TYPES (U.S. CLS. 2, 5, 22, 23, 29, 37, 38 AND 50).

FIRST USE 1-0-2002; IN COMMERCE 1-0-2002.
CHRIS WELLS, EXAMINING ATTORNEY

CLASS 16—(Continued).

SN 77-887,314. ACTIVE INNOVATION GROUP, LLC, ARLINGTON, VA. FILED 12-7-2009.

PACE TAT

THE MARK CONSISTS OF STANDARD CHARACTERS WITHOUT CLAIM TO ANY PARTICULAR FONT, STYLE, SIZE, OR COLOR.

NO CLAIM IS MADE TO THE EXCLUSIVE RIGHT TO USE "TAT", APART FROM THE MARK AS SHOWN.

FOR REMOVABLE TATTOOS; TEMPORARY TATTOOS (U.S. CLS. 2, 5, 22, 23, 29, 37, 38 AND 50).

FIRST USE 2-1-2007; IN COMMERCE 4-10-2007.
LINDA LAVACHE, EXAMINING ATTORNEY

CLASS 16—(Continued).

SN 77-888,232. THIRD WAVE, INC., ORIENTAL, NC. FILED 12-8-2009.

MILITARY KIDS SPEAK

THE MARK CONSISTS OF STANDARD CHARACTERS WITHOUT CLAIM TO ANY PARTICULAR FONT, STYLE, SIZE, OR COLOR.

NO CLAIM IS MADE TO THE EXCLUSIVE RIGHT TO USE "MILITARY KIDS", APART FROM THE MARK AS SHOWN.

FOR SERIES OF NON-FICTION BOOKS IN THE FIELD OF LIFE AS A CHILD WHO HAS A PARENT IN THE MILITARY (U.S. CLS. 2, 5, 22, 23, 29, 37, 38 AND 50).
KELLEY WELLS, EXAMINING ATTORNEY

SN 77-887,367. BOKEMEYER ART LLC, CYPRESS, TX. FILED 12-7-2009.



THE COLOR(S) BLUE, WHITE, RED AND BLACK IS/ARE CLAIMED AS A FEATURE OF THE MARK.

THE MARK CONSISTS OF THE LETTER "B" COLORED BLUE WITH A WHITE 5 POINT STAR CENTERED AND FOLLOWED BY THE LETTER "A" COLORED WITH THE TOP HALF BEING WHITE AND THE BOTTOM HALF RED, BOTH LETTERS ARE OUTLINED IN A THIN BLACK LINE.

FOR ART PRINTS; ART PRINTS ON CANVAS; CUSTOM PAINTINGS; FRAMED ART PRINTS; FRAMED PAINTINGS; GICLEE PRINTS; PAINTINGS; PAINTINGS AND THEIR REPRODUCTIONS; PRINTED ART REPRODUCTIONS (U.S. CLS. 2, 5, 22, 23, 29, 37, 38 AND 50).

TRACY WHITTAKER-BROWN, EXAMINING ATTORNEY

SN 77-888,353. HALLMARK LICENSING, INC., KANSAS CITY, MO. FILED 12-8-2009.

A LITTLE SLICE OF HAPPY

THE MARK CONSISTS OF STANDARD CHARACTERS WITHOUT CLAIM TO ANY PARTICULAR FONT, STYLE, SIZE, OR COLOR.

OWNER OF U.S. REG. NO. 2,797,744.
FOR GIFT BOOKS FEATURING HUMOR; GREETING CARDS; NOTE CARDS; STATIONERY (U.S. CLS. 2, 5, 22, 23, 29, 37, 38 AND 50).

ELIZABETH KAJUBI, EXAMINING ATTORNEY

SN 77-887,460. MCGOVERN, CLARE, CHATSWORTH, CA. FILED 12-7-2009.

B'EARTH

THE MARK CONSISTS OF STANDARD CHARACTERS WITHOUT CLAIM TO ANY PARTICULAR FONT, STYLE, SIZE, OR COLOR.

FOR ART PRINTS (U.S. CLS. 2, 5, 22, 23, 29, 37, 38 AND 50).

INGRID C. EULIN, EXAMINING ATTORNEY

SN 77-888,433. TYLER TECHNOLOGIES, INC., PLANO, TX. FILED 12-8-2009.

EMPOWERING PEOPLE WHO SERVE THE PUBLIC

THE MARK CONSISTS OF STANDARD CHARACTERS WITHOUT CLAIM TO ANY PARTICULAR FONT, STYLE, SIZE, OR COLOR.

FOR FORMS FOR USE IN SCHOOL ADMINISTRATION, NAMELY, STUDENT SCHEDULE FORMS, GRADE FORMS, ATTENDANCE FORMS, AND STUDENT RECORD FORMS (U.S. CLS. 2, 5, 22, 23, 29, 37, 38 AND 50).

CHRISTINE COOPER, EXAMINING ATTORNEY

CLASS 16—(Continued).

SN 77-888,451. TYLER TECHNOLOGIES, INC., PLANO, TX.
FILED 12-8-2009.



THE COLOR(S) BLUE AND GREEN IS/ARE CLAIMED AS A FEATURE OF THE MARK.

THE MARK CONSISTS OF A SERIES OF DOTS IN BLUE IN A "T"-SHAPED FORMATION INTERLOCKING WITH ANOTHER SERIES OF DOTS IN GREEN, ALSO IN A "T"-SHAPED FORMATION.

FOR FORMS FOR USE IN SCHOOL ADMINISTRATION, NAMELY, STUDENT SCHEDULE FORMS, GRADE FORMS, ATTENDANCE FORMS, AND STUDENT RECORD FORMS (U.S. CLS. 2, 5, 22, 23, 29, 37, 38 AND 50).

CHRISTINE COOPER, EXAMINING ATTORNEY

SN 77-888,470. TYLER TECHNOLOGIES, INC., PLANO, TX.
FILED 12-8-2009.



THE COLOR(S) BLUE IS/ARE CLAIMED AS A FEATURE OF THE MARK.

THE MARK CONSISTS OF THE WORD "TYLER" IN STYLIZED FONT IN BLUE.

FOR FORMS FOR USE IN SCHOOL ADMINISTRATION, NAMELY, STUDENT SCHEDULE FORMS, GRADE FORMS, ATTENDANCE FORMS, AND STUDENT RECORD FORMS (U.S. CLS. 2, 5, 22, 23, 29, 37, 38 AND 50).

ASMAT KHAN, EXAMINING ATTORNEY

CLASS 16—(Continued).

SN 77-888,481. TYLER TECHNOLOGIES, INC., PLANO, TX.
FILED 12-8-2009.

TYLER

THE MARK CONSISTS OF STANDARD CHARACTERS WITHOUT CLAIM TO ANY PARTICULAR FONT, STYLE, SIZE, OR COLOR.

FOR FORMS FOR USE IN SCHOOL ADMINISTRATION, NAMELY, STUDENT SCHEDULE FORMS, GRADE FORMS, ATTENDANCE FORMS, AND STUDENT RECORD FORMS (U.S. CLS. 2, 5, 22, 23, 29, 37, 38 AND 50).

ASMAT KHAN, EXAMINING ATTORNEY

SN 77-888,575. REEL GUN SPORTS, LLC, PALM HARBOR, FL. FILED 12-8-2009.

DESIDER

THE MARK CONSISTS OF STANDARD CHARACTERS WITHOUT CLAIM TO ANY PARTICULAR FONT, STYLE, SIZE, OR COLOR.

FOR DECORATIVE DECALS FOR APPLICATION TO VEHICLES (U.S. CLS. 2, 5, 22, 23, 29, 37, 38 AND 50).

LOURDES AYALA, EXAMINING ATTORNEY

SN 77-888,910. TWISTED LIMB PAPER, LLC, GOSPORT, IN.
FILED 12-8-2009.

REMEMBRANCE TREE

THE MARK CONSISTS OF STANDARD CHARACTERS WITHOUT CLAIM TO ANY PARTICULAR FONT, STYLE, SIZE, OR COLOR.

FOR PAPER GOODS, NAMELY, MEMORIAL NOTE CARDS (U.S. CLS. 2, 5, 22, 23, 29, 37, 38 AND 50).

FIRST USE 5-19-2009; IN COMMERCE 5-19-2009.

DAVID H. STINE, EXAMINING ATTORNEY

CLASS 16—(Continued).

SN 77-888,973. KABUSHIKI KAISHA NIHON MEDIX, DBA JAPAN MEDIX CO., LTD., SHINJUKU-KU, TOKYO, JAPAN, FILED 12-8-2009.

AIR-WIDE

THE MARK CONSISTS OF STANDARD CHARACTERS WITHOUT CLAIM TO ANY PARTICULAR FONT, STYLE, SIZE, OR COLOR.

OWNER OF JAPAN REG. NO. 5290445, DATED 12-25-2009, EXPIRES 12-25-2019.

FOR INFLATABLE PLASTIC BAGS FOR BUFFER PACKAGING (U.S. CLS. 2, 5, 22, 23, 29, 37, 38 AND 50).
MIDGE BUTLER, EXAMINING ATTORNEY

SN 77-889,031. PARKER, CHERYL VALENTINE REEDER, WHEATON, MD. FILED 12-8-2009.

VALENTINE'S NUM-STROLOGY

THE MARK CONSISTS OF STANDARD CHARACTERS WITHOUT CLAIM TO ANY PARTICULAR FONT, STYLE, SIZE, OR COLOR.

FOR BOOKS IN THE FIELD OF NUMEROLOGY (U.S. CLS. 2, 5, 22, 23, 29, 37, 38 AND 50).

MARK SPARACINO, EXAMINING ATTORNEY

SN 77-889,058. HEINZE, AREN N., DBA HOPEWRITER PUBLISHING, HOUSTON, TX. FILED 12-8-2009.

Hopewriter Publishing

THE MARK CONSISTS OF STANDARD CHARACTERS WITHOUT CLAIM TO ANY PARTICULAR FONT, STYLE, SIZE, OR COLOR.

NO CLAIM IS MADE TO THE EXCLUSIVE RIGHT TO USE "PUBLISHING", APART FROM THE MARK AS SHOWN.

FOR SERIES OF FICTION AND NON-FICTION BOOKS ON A VARIETY OF TOPICS (U.S. CLS. 2, 5, 22, 23, 29, 37, 38 AND 50).

FIRST USE 11-10-2009; IN COMMERCE 12-1-2009.
KIMBERLY FRYE, EXAMINING ATTORNEY

CLASS 16—(Continued).

SN 77-889,115. ANDERSON, BRIAN, BOULDER CITY, NV. FILED 12-8-2009.

Illustrated By God

THE MARK CONSISTS OF STANDARD CHARACTERS WITHOUT CLAIM TO ANY PARTICULAR FONT, STYLE, SIZE, OR COLOR.

FOR COFFEE TABLE BOOKS FEATURING PHOTOGRAPHS (U.S. CLS. 2, 5, 22, 23, 29, 37, 38 AND 50).

CYNTHIA SLOAN, EXAMINING ATTORNEY

SN 77-889,302. STEPHEN F. AUSTIN STATE UNIVERSITY ALUMNI ASSOCIATION, NACOGDOCHES, TX. FILED 12-9-2009.

Sawdust

THE MARK CONSISTS OF STANDARD CHARACTERS WITHOUT CLAIM TO ANY PARTICULAR FONT, STYLE, SIZE, OR COLOR.

FOR MAGAZINES FEATURING SUBJECT MATTER RELATED TO THE UNIVERSITY AND ITS ALUMNI (U.S. CLS. 2, 5, 22, 23, 29, 37, 38 AND 50).

FIRST USE 3-0-1973; IN COMMERCE 3-0-1973.

KATHERINE STOIDES, EXAMINING ATTORNEY

SN 77-889,509. FREEMAN LEMUEL G, NEW YORK, NY. FILED 12-9-2009.

Sabra University

THE MARK CONSISTS OF STANDARD CHARACTERS WITHOUT CLAIM TO ANY PARTICULAR FONT, STYLE, SIZE, OR COLOR.

FOR WALL CALENDARS (U.S. CLS. 2, 5, 22, 23, 29, 37, 38 AND 50).

FIRST USE 12-1-2009; IN COMMERCE 12-1-2009.

CHARISMA HAMPTON, EXAMINING ATTORNEY

CLASS 16—(Continued).

SN 77-889,577. TRI-COASTAL DESIGN GROUP, INC., EAST HANOVER, NJ. FILED 12-9-2009.

TOWNHOUSE

THE MARK CONSISTS OF STANDARD CHARACTERS WITHOUT CLAIM TO ANY PARTICULAR FONT, STYLE, SIZE, OR COLOR.

FOR BLANK JOURNALS; BOXES OF CARDBOARD OR PAPER; CALENDARS AND DIARIES; CLIP BOARDS; MEMO PADS; MEMORANDUM BOARDS; NOTE CARDS (U.S. CLS. 2, 5, 22, 23, 29, 37, 38 AND 50).
FIRST USE 11-20-2009; IN COMMERCE 11-20-2009.
BARNEY CHARLON, EXAMINING ATTORNEY

SN 77-889,616. AGC, LLC, CLEVELAND, OH. FILED 12-9-2009.

JUST WINK

THE MARK CONSISTS OF STANDARD CHARACTERS WITHOUT CLAIM TO ANY PARTICULAR FONT, STYLE, SIZE, OR COLOR.

FOR GREETING CARDS (U.S. CLS. 2, 5, 22, 23, 29, 37, 38 AND 50).
REGINA DRUMMOND, EXAMINING ATTORNEY

SN 77-889,958. THE CAGE CARD, LLC, ENCINATAS, CA. FILED 12-9-2009.



THE MARK CONSISTS OF A HUMAN SKULL ABOVE A MARTIAL ARTS BELT. "C.A.G.E." IS DISPLAYED ON ONE END OF THE MARTIAL ARTS BELT.

FOR NOVELTY IDENTIFICATION CARDS (U.S. CLS. 2, 5, 22, 23, 29, 37, 38 AND 50).
FIRST USE 11-30-2009; IN COMMERCE 11-30-2009.
SUSAN LESLIE DUBOIS, EXAMINING ATTORNEY

CLASS 16—(Continued).

SN 77-890,241. APOTHECARY PRODUCTS, INC., BURNSVILLE, MN. FILED 12-10-2009.

ORGMATES

THE MARK CONSISTS OF STANDARD CHARACTERS WITHOUT CLAIM TO ANY PARTICULAR FONT, STYLE, SIZE, OR COLOR.

FOR ORGANIZERS FOR CONTAINING PARTS AND SUPPLIES FOR CRAFT PROJECTS, ART PROJECTS, AND HOBBIES (U.S. CLS. 2, 5, 22, 23, 29, 37, 38 AND 50).
DARRYL SPRULL, EXAMINING ATTORNEY

SN 77-890,555. UNIVERSITY OF NORTHWESTERN OHIO, LIMA, OH. FILED 12-10-2009.



NO CLAIM IS MADE TO THE EXCLUSIVE RIGHT TO USE "MOTORSPORTS", APART FROM THE MARK AS SHOWN.

THE COLOR(S) RED, BLACK AND WHITE IS/ARE CLAIMED AS A FEATURE OF THE MARK.

THE MARK CONSISTS OF A RED LARGE "U" OUTLINED IN BLACK AND WHITE WITH THE STYLIZED WORDING "MOTORSPORTS" ARCHED ACROSS MIDDLE IN WHITE LETTERS WITH RED, BLACK, AND WHITE OUTLINING AND THE STYLIZED WORDING "UNOH" IN BLACK AND RED OUTLINED IN WHITE ACROSS THE BOTTOM OF THE "U".

FOR CALENDARS; DECALS; DESK SETS; FOLDERS; PENCILS; PENS; TEXTBOOKS IN THE FIELD OF AUTOMOTIVE; THREE-RING BINDERS; WIREBOUND BOOKS (U.S. CLS. 2, 5, 22, 23, 29, 37, 38 AND 50).

LIEF MARTIN, EXAMINING ATTORNEY

CLASS 16—(Continued).

SN 77-890,627. TRIB TOTAL MEDIA, INC., PITTSBURGH, PA. FILED 12-10-2009.

Pittsburgh Family & Home

THE MARK CONSISTS OF STANDARD CHARACTERS WITHOUT CLAIM TO ANY PARTICULAR FONT, STYLE, SIZE, OR COLOR.

NO CLAIM IS MADE TO THE EXCLUSIVE RIGHT TO USE "PITTSBURGH FAMILY", APART FROM THE MARK AS SHOWN.

FOR A MAGAZINE FEATURING ARTICLES AND INFORMATION ADDRESSING CONTEMPORARY FAMILY LIFE ISSUES WITH A FOCUS ON THE CITY OF PITTSBURGH AND SURROUNDING AREAS (U.S. CLS. 2, 5, 22, 23, 29, 37, 38 AND 50).

ANTHONY RINKER, EXAMINING ATTORNEY

SN 77-890,876. ANGEL SALES, INC., CHICAGO, IL. FILED 12-10-2009.

AMERICA'S NATURAL WONDERS

THE MARK CONSISTS OF STANDARD CHARACTERS WITHOUT CLAIM TO ANY PARTICULAR FONT, STYLE, SIZE, OR COLOR.

FOR COIN ALBUMS CONTAINING A MAP DESIGN (U.S. CLS. 2, 5, 22, 23, 29, 37, 38 AND 50).

MICHAEL LITZAU, EXAMINING ATTORNEY

SN 77-891,012. GLATZER, TRACEY, SUNRISE, FL. FILED 12-10-2009.

Forever Peace

THE MARK CONSISTS OF STANDARD CHARACTERS WITHOUT CLAIM TO ANY PARTICULAR FONT, STYLE, SIZE, OR COLOR.

FOR ART PRINTS; GREETING CARDS; POSTERS; STATIONERY (U.S. CLS. 2, 5, 22, 23, 29, 37, 38 AND 50).

JUDITH HELFMAN, EXAMINING ATTORNEY

CLASS 16—(Continued).

SN 77-891,079. CHRISCADE.COM LLC, VANCOUVER, WA. FILED 12-11-2009.

Think Without The Box

THE MARK CONSISTS OF STANDARD CHARACTERS WITHOUT CLAIM TO ANY PARTICULAR FONT, STYLE, SIZE, OR COLOR.

FOR SERIES OF BOOKS IN THE FIELDS OF SELF HELP AND SPIRITUAL ISSUES (U.S. CLS. 2, 5, 22, 23, 29, 37, 38 AND 50).

FIRST USE 10-7-2008; IN COMMERCE 10-7-2008.

TINA L. SNAPP, EXAMINING ATTORNEY

SN 77-891,217. WHAT'S BACON?, LLC, HASTINGS, NE. FILED 12-11-2009.



THE MARK CONSISTS OF A PIG STANDING INSIDE A CIRCLE AND WRITTEN ON THAT CIRCLE ARE THE WORDS, "WHAT'S BACON?".

FOR CHILDREN'S STORYBOOKS (U.S. CLS. 2, 5, 22, 23, 29, 37, 38 AND 50).

FIRST USE 9-1-2009; IN COMMERCE 11-20-2009.

KAPIL BHANOT, EXAMINING ATTORNEY

SN 77-891,223. KAUFMAN, LENORE, MANALAPAN, NJ. AND RICHMAN, PERRI, BASKING RIDGE, NJ. FILED 12-11-2009.

zero the hero

THE MARK CONSISTS OF STANDARD CHARACTERS WITHOUT CLAIM TO ANY PARTICULAR FONT, STYLE, SIZE, OR COLOR.

FOR PACKAGED KITS COMPRISING PRINTED INSTRUCTIONAL, EDUCATIONAL, AND TEACHING MATERIALS FOR EDUCATIONAL ACTIVITIES IN THE FIELD OF MATH (U.S. CLS. 2, 5, 22, 23, 29, 37, 38 AND 50).

CHARLES L. JENKINS, EXAMINING ATTORNEY

CLASS 16—(Continued).

SN 77-891,268. WHAT'S BACON?, LLC, HASTINGS, NE.
FILED 12-11-2009.

Fashion Friends

THE MARK CONSISTS OF STANDARD CHARACTERS WITHOUT CLAIM TO ANY PARTICULAR FONT, STYLE, SIZE, OR COLOR.
FOR CHILDREN'S STORYBOOKS (U.S. CLS. 2, 5, 22, 23, 29, 37, 38 AND 50).
FIRST USE 7-1-2009; IN COMMERCE 7-1-2009.
KAPIL BHANOT, EXAMINING ATTORNEY

SN 77-891,378. COLYER JR., JOHN, SEASIDE HEIGHTS, NJ.
FILED 12-11-2009.

TRIALS AND TRIBUTE

THE MARK CONSISTS OF STANDARD CHARACTERS WITHOUT CLAIM TO ANY PARTICULAR FONT, STYLE, SIZE, OR COLOR.
FOR BOOKS IN THE FIELD OF BIOGRAPHIES (U.S. CLS. 2, 5, 22, 23, 29, 37, 38 AND 50).
ELI HELLMAN, EXAMINING ATTORNEY

CLASS 16—(Continued).

SN 77-891,548. MVL RIGHTS LLC, MANHATTAN BEACH, CA. FILED 12-11-2009.



OWNER OF U.S. REG. NOS. 885,486, 3,282,768 AND OTHERS.

THE MARK CONSISTS OF A CIRCULAR DESIGN WITH THE WORDS "AVENGERS ASSEMBLE" AND TWO FIVE-POINTED STARS SURROUNDING A SMALLER CIRCLE CONTAINING THE IMAGE OF AN EAGLE WITH OUTSPREAD WINGS AND A SHIELD AT THE CENTER WITH STRIPES AND STARS ON THE SHIELD.

FOR ALBUMS FOR STICKERS; ALBUMS FOR TRADING CARDS; ARTS AND CRAFT PAINT KITS; BOOK COVERS; BUMPER STICKERS; CALENDARS; CHILDREN'S ACTIVITY BOOKS; CHILDREN'S BOOKS; COLOR PENCILS; COLORING BOOKS; COMIC BOOKS; COMIC STRIPS; DECALS; GREETING CARDS; MAGAZINES FEATURING PRINTED STORIES IN ILLUSTRATED FORM AND COMIC BOOK STORIES AND ARTWORK; NOTE BOOKS; NOTEBOOKS; PAPER PARTY DECORATIONS; PAPER PARTY FAVORS; PEN AND PENCIL CASES AND BOXES; PENCILS; PICTURE BOOKS; POSTERS; PRINTED PERIODICALS IN THE FIELD OF COMIC BOOK STORIES AND ARTWORK; PRINTED VISUALS IN THE NATURE OF COMIC BOOK STORIES AND ARTWORK; ROLE PLAYING GAME EQUIPMENT IN THE NATURE OF GAME BOOK MANUALS; SCHOOL SUPPLY KITS CONTAINING VARIOUS COMBINATIONS OF SELECTED SCHOOL SUPPLIES, NAMELY, WRITING INSTRUMENTS, PENS, PENCILS, MECHANICAL PENCILS, ERASERS, MARKERS, CRAYONS, HIGHLIGHTER PENS, FOLDERS, NOTEBOOKS, PAPER, PROTRACTORS, PAPER CLIPS, PENCIL SHARPENERS, WRITING GRIPS, GLUE AND BOOK MARKS; SERIES OF FICTION BOOKS; STATIONERY; STICKERS; STORY BOOKS; TRADING CARDS (U.S. CLS. 2, 5, 22, 23, 29, 37, 38 AND 50).

FLORENTINA BLANDU, EXAMINING ATTORNEY

SN 77-891,616. AGC, LLC, CLEVELAND, OH. FILED 12-11-2009.

THE MARK CONSISTS OF THE WORDS "MAGIC TOUCH". IN THE WORD "TOUCH" THE LETTER "O" IS A HAND WITH ITS INDEX AND THUMB SHOWING.

FOR GREETING CARDS (U.S. CLS. 2, 5, 22, 23, 29, 37, 38 AND 50).

REGINA DRUMMOND, EXAMINING ATTORNEY

CLASS 16—(Continued).

SN 77-891,990. MACKENZIE, TOM, LYNNWOOD, WA.
FILED 12-11-2009.

TEXTING DOTS

THE MARK CONSISTS OF STANDARD CHARACTERS WITHOUT CLAIM TO ANY PARTICULAR FONT, STYLE, SIZE, OR COLOR.

FOR RUBBER FINGER TIPS (U.S. CLS. 2, 5, 22, 23, 29, 37, 38 AND 50).

FIRST USE 12-4-2009; IN COMMERCE 12-4-2009.
DORITT L. CARROLL, EXAMINING ATTORNEY

CLASS 16—(Continued).

SN 77-892,673. LEE CHILDS, SHERMAN OAKS, CA. FILED
12-14-2009.

The Possessed in 1905

THE MARK CONSISTS OF STANDARD CHARACTERS WITHOUT CLAIM TO ANY PARTICULAR FONT, STYLE, SIZE, OR COLOR.

FOR SERIES OF COMIC BOOKS (U.S. CLS. 2, 5, 22, 23, 29, 37, 38 AND 50).

ELISSA GARBER KON, EXAMINING ATTORNEY

SN 77-892,105. CREATIVE COW LLC, PASO ROBLES, CA.
FILED 12-12-2009.

**BECAUSE A FIRST-CLASS
MAGAZINE DESERVES
FIRST-CLASS DELIVERY**

THE MARK CONSISTS OF STANDARD CHARACTERS WITHOUT CLAIM TO ANY PARTICULAR FONT, STYLE, SIZE, OR COLOR.

FOR MAGAZINES FEATURING INFORMATION AND INSTRUCTION ON DIGITAL IMAGING, CINEMATOGRAPHY, GRAPHIC DESIGN, MOTION GRAPHICS, WEB DESIGN, PHOTO AND VIDEO EDITING, AUDIO EDITING, VIDEO AND AUDIO POST PRODUCTION AND MEDIA PRODUCTION, FORMATTING, AND DISTRIBUTION (U.S. CLS. 2, 5, 22, 23, 29, 37, 38 AND 50).

FIRST USE 10-29-2009; IN COMMERCE 10-29-2009.
JAMES A. RAUEN, EXAMINING ATTORNEY

SN 77-892,963. WORKMAN PUBLISHING CO., INC., NEW
YORK, NY. FILED 12-14-2009.

PAGE-A-WEEK

THE MARK CONSISTS OF STANDARD CHARACTERS WITHOUT CLAIM TO ANY PARTICULAR FONT, STYLE, SIZE, OR COLOR.

OWNER OF U.S. REG. NOS. 1,556,773, 3,683,792 AND OTHERS.

FOR CALENDARS (U.S. CLS. 2, 5, 22, 23, 29, 37, 38 AND 50).

CYNTHIA SLOAN, EXAMINING ATTORNEY

SN 77-892,261. CAMBIOTIS, JOHN, NEW YORK, NY. AND
LEKKAS, ANASTASIA, NEW YORK, NY. FILED 12-13-
2009.

antonio verdi

THE NAME "ANTONIO VERDI" DOES NOT IDENTIFY A LIVING INDIVIDUAL.

THE MARK CONSISTS OF THE STYLIZED WORDING "ANTONIO VERDI".

FOR GIFT SETS CONSISTING PRIMARILY OF MESSAGES PRINTED ON A PAPER SCROLL CONTAINED IN A DECORATIVE WOODEN BOX (U.S. CLS. 2, 5, 22, 23, 29, 37, 38 AND 50).

YAT SYE, LEE, EXAMINING ATTORNEY

SN 77-893,277. HUGHES, AUDRA, CANYON LAKE, TX.
FILED 12-14-2009.

CHRISTEENIANITY
A Directory of Hope for Teens

THE MARK CONSISTS OF THE WORD "CHRISTEENIANITY" WITH THE FIRST "T" BEING A CROSS WITH A CROWN OF THORNS, AND "A DIRECTORY OF HOPE FOR TEENS" UNDERNEATH.

FOR MAGAZINES IN THE FIELD OF TEEN CHRISTIAN-BASED LIFESTYLE (U.S. CLS. 2, 5, 22, 23, 29, 37, 38 AND 50).

FIRST USE 10-16-2009; IN COMMERCE 10-19-2009.
NICHOLAS ALTREE, EXAMINING ATTORNEY

CLASS 16—(Continued).

SN 77-893,345. THINKER INC, LAS VEGAS, NV. FILED 12-14-2009.

New Normal, Inc.

THE MARK CONSISTS OF STANDARD CHARACTERS WITHOUT CLAIM TO ANY PARTICULAR FONT, STYLE, SIZE, OR COLOR.

NO CLAIM IS MADE TO THE EXCLUSIVE RIGHT TO USE "INC.", APART FROM THE MARK AS SHOWN. FOR BOOKS IN THE FIELD OF SELF-IMPROVEMENT (U.S. CLS. 2, 5, 22, 23, 29, 37, 38 AND 50).

DAVID MURRAY, EXAMINING ATTORNEY

SN 77-893,560. ASSOCIATED HYGIENIC PRODUCTS, LLC, DULUTH, GA. FILED 12-15-2009.

SCRAMBLERS

THE MARK CONSISTS OF STANDARD CHARACTERS WITHOUT CLAIM TO ANY PARTICULAR FONT, STYLE, SIZE, OR COLOR.

FOR DISPOSABLE DIAPERS AND DISPOSABLE TRAINING PANTS (U.S. CLS. 2, 5, 22, 23, 29, 37, 38 AND 50).

TINA L. SNAPP, EXAMINING ATTORNEY

SN 77-893,600. BROWN, DONALD E., HUMBLE, TX. FILED 12-15-2009.

P.onit

THE MARK CONSISTS OF STANDARD CHARACTERS WITHOUT CLAIM TO ANY PARTICULAR FONT, STYLE, SIZE, OR COLOR.

FOR PAPER TISSUES (U.S. CLS. 2, 5, 22, 23, 29, 37, 38 AND 50).

COLLEEN KEARNEY, EXAMINING ATTORNEY

CLASS 16—(Continued).

SN 77-893,617. DESIGNEDRESULTS, LLC, WORTHINGTON, OH. FILED 12-15-2009.

IN GOOD ORDER

THE MARK CONSISTS OF STANDARD CHARACTERS WITHOUT CLAIM TO ANY PARTICULAR FONT, STYLE, SIZE, OR COLOR.

FOR PACKAGED KITS COMPRISING PRINTED INSTRUCTIONAL, EDUCATIONAL, AND TEACHING MATERIALS FOR EDUCATIONAL ACTIVITIES IN THE FIELD OF MANAGING HEALTH INFORMATION (U.S. CLS. 2, 5, 22, 23, 29, 37, 38 AND 50).

KELLEY WELLS, EXAMINING ATTORNEY

SN 77-894,037. EXACT SCIENCE PRODUCTIONS LLC, SAN FRANCISCO, CA. FILED 12-15-2009.

EXACT SCIENCE

THE MARK CONSISTS OF STANDARD CHARACTERS WITHOUT CLAIM TO ANY PARTICULAR FONT, STYLE, SIZE, OR COLOR.

OWNER OF U.S. REG. NO. 3,443,822. FOR POSTCARDS; POSTERS; PRINTS; STICKERS (U.S. CLS. 2, 5, 22, 23, 29, 37, 38 AND 50).

GEORGE LORENZO, EXAMINING ATTORNEY

SN 77-894,044. EXACT SCIENCE PRODUCTIONS LLC, SAN FRANCISCO, CA. FILED 12-15-2009.



THE MARK CONSISTS OF A SKULL WITH CROSS-BONES WEARING HEADPHONES.

FOR POSTCARDS; POSTERS; PRINTS; STICKERS (U.S. CLS. 2, 5, 22, 23, 29, 37, 38 AND 50).

GEORGE LORENZO, EXAMINING ATTORNEY

CLASS 16—(Continued).

SN 77-895,720. GOLDEN SHELTERS PRIVATE LIMITED, CHENNAI, TAMIL NADU, INDIA, FILED 12-17-2009.

LIVING IN FREEDOM

THE MARK CONSISTS OF STANDARD CHARACTERS WITHOUT CLAIM TO ANY PARTICULAR FONT, STYLE, SIZE, OR COLOR.

FOR RELIGIOUS BOOKS; RELIGIOUS CIRCULAR LETTERS; PRINTED MATTER, NAMELY, BOOKS, NEWSLETTERS, AND MAGAZINES IN THE FIELD OF SELF- AND PERSONAL IMPROVEMENT AND EMPOWERMENT, RELIGION, AND SPIRITUALITY; BROCHURES ABOUT SELF- AND PERSONAL IMPROVEMENT AND EMPOWERMENT, RELIGION, AND SPIRITUALITY; PRINTED REPORTS ABOUT SELF- AND PERSONAL IMPROVEMENT AND EMPOWERMENT, RELIGION, AND SPIRITUALITY; CATALOGUES IN THE FIELD OF SELF- AND PERSONAL IMPROVEMENT AND EMPOWERMENT, RELIGION, AND SPIRITUALITY; PAPER; CARDBOARD; BOXES OF PAPER OR CARDBOARD; PLACARDS OF PAPER OR CARDBOARD; NEWS BULLETINS; PHOTOGRAPHS, OFFICE REQUISITES, NAMELY, PENS, PENCILS, STAPLERS, PAPER HOLE PUNCHERS, ADHESIVE TAPE AND ADHESIVE TAPE DISPENSERS, RUBBER BANDS AND STATIONERY (U.S. CLS. 2, 5, 22, 23, 29, 37, 38 AND 50).

MAYUR VAGHANI, EXAMINING ATTORNEY

SN 77-898,272. CREATIVE ESSENTIALS, LLC, ARLINGTON, TX, FILED 12-21-2009.

STABLE TABLE

THE MARK CONSISTS OF STANDARD CHARACTERS WITHOUT CLAIM TO ANY PARTICULAR FONT, STYLE, SIZE, OR COLOR.

NO CLAIM IS MADE TO THE EXCLUSIVE RIGHT TO USE "TABLE", APART FROM THE MARK AS SHOWN.

FOR LAP DESKS (U.S. CLS. 2, 5, 22, 23, 29, 37, 38 AND 50).

DOMINIC FATHY, EXAMINING ATTORNEY

CLASS 16—(Continued).

SN 77-902,582. PLATTSCO, INC, DBA THE PHOTO FACTORY, WESTON, FL. FILED 12-30-2009.



THE COLOR(S) GREEN AND BLUE IS/ARE CLAIMED AS A FEATURE OF THE MARK.

THE MARK CONSISTS OF THE WORD "YEARBOOK" IN BLUE AND "LIFE" IN GREEN WITH A GREEN AND BLUE HALF CIRCLE CIRCLING THROUGH THE MIDDLE OF THE WORD "YEARBOOK" AND DROPPING BELOW BOTH WORDS.

FOR SCHOOL YEARBOOKS (U.S. CLS. 2, 5, 22, 23, 29, 37, 38 AND 50).

SUSAN RICHARDS, EXAMINING ATTORNEY

SN 77-903,209. THE IMAGE HOUSE, MERRILLVILLE, IN. FILED 12-30-2009.



NO CLAIM IS MADE TO THE EXCLUSIVE RIGHT TO USE "PICS", APART FROM THE MARK AS SHOWN.

THE MARK CONSISTS OF THE OUTLINED TEXT "U PICS U MAKE YOU FAMOUS!" WITH SILHOUETTES OF VARIOUS SPORTS FIGURES INSIDE THE LARGER LETTER "U", WHICH IS BEHIND "PICS", AND "U MAKE YOU FAMOUS!" IS BELOW "PICS".

FOR DECALS; PAPER BANNERS; STATIONERY; STICKERS (U.S. CLS. 2, 5, 22, 23, 29, 37, 38 AND 50).

FIRST USE 2-1-2008; IN COMMERCE 10-1-2009.
CARRIE GENOVESE, EXAMINING ATTORNEY

CLASS 16—(Continued).

SN 77-907,379. SEIZE THE DEAL, LLC, DALLAS, TX. FILED 1-7-2010.

SEIZE THE DEAL

THE MARK CONSISTS OF STANDARD CHARACTERS WITHOUT CLAIM TO ANY PARTICULAR FONT, STYLE, SIZE, OR COLOR.

FOR COUPONS; GIFT CARDS; PRINTED CERTIFICATES (U.S. CLS. 2, 5, 22, 23, 29, 37, 38 AND 50).
ALICIA COLLINS, EXAMINING ATTORNEY

SN 77-907,386. SEIZE THE DEAL, LLC, DALLAS, TX. FILED 1-7-2010.

THE POWER OF THE GROUP

THE MARK CONSISTS OF STANDARD CHARACTERS WITHOUT CLAIM TO ANY PARTICULAR FONT, STYLE, SIZE, OR COLOR.

FOR COUPONS; GIFT CARDS; PRINTED CERTIFICATES (U.S. CLS. 2, 5, 22, 23, 29, 37, 38 AND 50).
ALICIA COLLINS, EXAMINING ATTORNEY

SN 77-909,191. SKM INDUSTRIES, INC., OLYPHANT, PA. FILED 1-11-2010.

SKM INDUSTRIES

THE MARK CONSISTS OF STANDARD CHARACTERS WITHOUT CLAIM TO ANY PARTICULAR FONT, STYLE, SIZE, OR COLOR.

NO CLAIM IS MADE TO THE EXCLUSIVE RIGHT TO USE "INDUSTRIES", APART FROM THE MARK AS SHOWN.

FOR CORRECTION FLUID FOR TYPE AND DOCUMENTS, CORRECTION PENS, CORRECTION TAPE AND FILM FOR TYPE AND DOCUMENTS; MARKERS; PAINT APPLICATORS IN THE NATURE OF MARKERS (U.S. CLS. 2, 5, 22, 23, 29, 37, 38 AND 50).
KELLY CHOE, EXAMINING ATTORNEY

CLASS 16—(Continued).

SN 77-909,946. HALLMARK LICENSING, INC., KANSAS CITY, MO. FILED 1-12-2010.

SEASONS FROM HALLMARK

THE MARK CONSISTS OF STANDARD CHARACTERS WITHOUT CLAIM TO ANY PARTICULAR FONT, STYLE, SIZE, OR COLOR.

FOR GREETING CARDS (U.S. CLS. 2, 5, 22, 23, 29, 37, 38 AND 50).
ELIZABETH KAJUBI, EXAMINING ATTORNEY

SN 77-911,498. FREMANTLE MEDIA NORTH AMERICA, INC., BURBANK, CA. FILED 1-13-2010.

WHAT CHILLI WANTS

THE MARK CONSISTS OF STANDARD CHARACTERS WITHOUT CLAIM TO ANY PARTICULAR FONT, STYLE, SIZE, OR COLOR.

FOR POSTERS, CALENDARS, NOTEBOOKS, BINDERS, DAILY ORGANIZERS, MEMO PADS, STICKERS, COMIC BOOKS, WRITING PAPER, ENVELOPES, GREETING CARDS, PAPER COASTERS, PAPER MATS, NEWSPAPERS FOR GENERAL CIRCULATION, BOOKS AND MAGAZINES IN THE FIELD OF REALITY SHOWS, NEWSLETTERS IN THE FIELD OF REALITY SHOWS, PHOTOGRAPHS, POSTCARDS, TRADING CARDS, CARDBOARD STAND-UP CUTOUTS FEATURING PHOTOGRAPHS OR ARTWORK, PREPAID PHONE DEBIT CARDS WITHOUT MAGNETIC CODING, TRADING CARD MILK BOTTLE CAPS, AND CUSTOMIZED PERSONAL CHECKS, PAPER PARTY DECORATIONS, PAPER PARTY BAGS, PAPER PARTY FAVORS, GIFT CARD HOLDERS; PAPER CAKE DECORATIONS (U.S. CLS. 2, 5, 22, 23, 29, 37, 38 AND 50).
CAROL SPILS, EXAMINING ATTORNEY

SN 77-915,929. LAROSE INDUSTRIES, LLC, RANDOLPH, NJ. FILED 1-20-2010.

CRA-Z-FLUFF

THE MARK CONSISTS OF STANDARD CHARACTERS WITHOUT CLAIM TO ANY PARTICULAR FONT, STYLE, SIZE, OR COLOR.

FOR MODELING COMPOUNDS; MODELING CLAY ACTIVITY KITS COMPRISING MODELING COMPOUND AND TOYS TO MAKE JEWELRY IN THE NATURE OF FLOWERS, CHARACTERS, BUGS AND VEHICLE SHAPES (U.S. CLS. 2, 5, 22, 23, 29, 37, 38 AND 50).
LINDSEY RUBIN, EXAMINING ATTORNEY

CLASS 16—(Continued).

SN 77-917,035. RODALE INC., EMMAUS, PA. FILED 1-21-2010.

LIVING LIGHTLY FROM THE
GROUND UP

THE MARK CONSISTS OF STANDARD CHARACTERS WITHOUT CLAIM TO ANY PARTICULAR FONT, STYLE, SIZE, OR COLOR.

FOR MAGAZINE IN THE FIELD OF GARDENING, PLANTS, SOIL HEALTH AND DISEASES, COMPOST, WEEDS AND PESTS, GROWING TECHNIQUES, FOODS, NUTRITION, HERBS, LANDSCAPING, LAWN CARE AND GARDEN DESIGN; CONSERVATION AND ENVIRONMENTAL, AND ORGANIC LIVING ISSUES (U.S. CLS. 2, 5, 22, 23, 29, 37, 38 AND 50).

FIRST USE 12-23-2009; IN COMMERCE 12-23-2009.
SUSAN RICHARDS, EXAMINING ATTORNEY

CLASS 16—(Continued).

SN 77-926,104. AMERICAN GEOPHYSICAL UNION, WASHINGTON, DC. FILED 2-2-2010.



THE MARK CONSISTS OF A GRAPHIC PORTION OF INTERLOCKING OVAL DESIGNS TO THE LEFT OF THE LITERAL PORTION, "AGU".

FOR PRINTED PUBLICATIONS, NAMELY, NEWSLETTERS, NEWSPAPERS, JOURNALS, MAGAZINES AND MONOGRAPHS IN THE FIELD OF THE EARTH AND SPACE SCIENCES (U.S. CLS. 2, 5, 22, 23, 29, 37, 38 AND 50).

FIRST USE 1-2-1979; IN COMMERCE 1-2-1979.
ARETHA SOMERVILLE, EXAMINING ATTORNEY

SN 77-917,809. SUSTAINABLE GROUP HOLDINGS LLC, SEATTLE, WA. FILED 1-22-2010.



THE MARK CONSISTS OF LEAVES IN A CIRCULAR PATTERN AND THE WORD "RESTOCK".

FOR RECYCLED PAPER AND CARD STOCK (U.S. CLS. 2, 5, 22, 23, 29, 37, 38 AND 50).

LYDIA BELZER, EXAMINING ATTORNEY

SN 77-926,241. AMERICAN GEOPHYSICAL UNION, WASHINGTON, DC. FILED 2-2-2010.

AGU

THE MARK CONSISTS OF STANDARD CHARACTERS WITHOUT CLAIM TO ANY PARTICULAR FONT, STYLE, SIZE, OR COLOR.

FOR PRINTED PUBLICATIONS, NAMELY, NEWSLETTERS, NEWSPAPERS, JOURNALS, MAGAZINES AND MONOGRAPHS IN THE FIELD OF THE EARTH AND SPACE SCIENCES (U.S. CLS. 2, 5, 22, 23, 29, 37, 38 AND 50).

FIRST USE 1-0-1959; IN COMMERCE 1-0-1959.
ARETHA SOMERVILLE, EXAMINING ATTORNEY

SN 77-925,694. INTERNATIONAL PAPER COMPANY, MEMPHIS, TN. FILED 2-2-2010.

IMAGELOK

THE MARK CONSISTS OF STANDARD CHARACTERS WITHOUT CLAIM TO ANY PARTICULAR FONT, STYLE, SIZE, OR COLOR.

FOR PAPER FOR PRINTING, PUBLICATION, REPRODUCTION, COPYING AND WRITING; COVER PAPER, BOND PAPER, ENVELOPE PAPER, LASER PAPER, OFFSET PAPER, INKJET PAPER, MULTI-PURPOSE PAPER, COMPUTER AND FORMS PAPER (U.S. CLS. 2, 5, 22, 23, 29, 37, 38 AND 50).

APRIL ROACH, EXAMINING ATTORNEY

SN 77-928,344. AGC, LLC, CLEVELAND, OH. FILED 2-4-2010.

inventions

THE MARK CONSISTS OF THE WORD "INVENTIONS". THE LETTER "O" IN THE WORD "INVENTIONS" IS REPLACED WITH A LIGHT BULB.

FOR GREETING CARDS (U.S. CLS. 2, 5, 22, 23, 29, 37, 38 AND 50).

FIRST USE 4-30-2008; IN COMMERCE 4-30-2008.
REGINA DRUMMOND, EXAMINING ATTORNEY

CLASS 16—(Continued).

SN 77-930,684. HALLMARK LICENSING, INC., KANSAS CITY, MO. FILED 2-8-2010.

SEASONS FROM HALLMARK

THE MARK CONSISTS OF STANDARD CHARACTERS WITHOUT CLAIM TO ANY PARTICULAR FONT, STYLE, SIZE, OR COLOR.

FOR GIFT BAGS; GIFT BOXES; GIFT WRAPPING PAPER; PAPER BOWS FOR GIFT WRAP; PAPER GIFT TAGS; PAPER GIFT WRAPPING RIBBONS; PAPER NAPKINS; PAPER TABLECLOTHS; SEALS; STICKERS; TISSUE PAPER (U.S. CLS. 2, 5, 22, 23, 29, 37, 38 AND 50).
ELIZABETH KAJUBI, EXAMINING ATTORNEY

SN 78-920,904. HARTLEY & MARKS PUBLISHERS INC., VANCOUVER, CANADA, FILED 6-30-2006.

HIP POCKET GUIDE

THE MARK CONSISTS OF STANDARD CHARACTERS WITHOUT CLAIM TO ANY PARTICULAR FONT, STYLE, SIZE, OR COLOR.

NO CLAIM IS MADE TO THE EXCLUSIVE RIGHT TO USE "POCKET GUIDE", APART FROM THE MARK AS SHOWN.

FOR PRINTED MATERIALS, NAMELY, JOURNALS, DAY PLANNERS, GUEST ALBUMS FEATURING MESSAGES ON THE SUBJECT OF MOTIVATION, SELF-GROWTH, AFFIRMATIONS, SELF-HELP, ACHIEVEMENT, PHILOSOPHY, POPULAR CULTURE, SEXUALITY, WELLNESS, HEALTH, ENJOYMENT, AMUSEMENT, FAMILY AND ORGANIZATION (U.S. CLS. 2, 5, 22, 23, 29, 37, 38 AND 50).

CARRIE GENOVESE, EXAMINING ATTORNEY

SN 79-069,068. NINGBO MASCUBE IMPORT & EXPORT CORPORATION, 522000 NINGBO, CHINA, FILED 4-7-2009.



OWNER OF INTERNATIONAL REGISTRATION 1003346 DATED 4-7-2009, EXPIRES 4-7-2019.

THE MARK CONSISTS OF THE STYLIZED WORDING "FANS" INSIDE A MISCELLANEOUS DESIGN WITH AN OVERALL RECTANGULAR SHAPE.

FOR NOTE BOOKS; FOLDERS FOR PAPERS; STATIONERY; STEEL PENS; PENCILS; PAINTBRUSHES (U.S. CLS. 2, 5, 22, 23, 29, 37, 38 AND 50).

JENNIFER MARTIN, EXAMINING ATTORNEY

CLASS 16—(Continued).

SN 79-069,809. BRYCE INVESTMENTS PTY LTD, KEIRAVILLE NSW 2500, AUSTRALIA, FILED 2-16-2009.

Fliptez

THE MARK CONSISTS OF STANDARD CHARACTERS WITHOUT CLAIM TO ANY PARTICULAR FONT, STYLE, SIZE, OR COLOR.

OWNER OF INTERNATIONAL REGISTRATION 1005020 DATED 2-16-2009, EXPIRES 2-16-2019.

THE WORDING "FLIPTEZ" HAS NO MEANING IN A FOREIGN LANGUAGE.

FOR ARTISTS' MATERIALS, NAMELY, ARTISTS BRUSHES; COLORED PENCILS; REFILLS FOR COLORED PENCILS; CRAFT PAINTING KITS, INCLUDING COLOURED SHADING POWDER IN INDIVIDUAL SMALL CONTAINERS DERIVED FROM THE MATERIALS USED IN COLOURING IN PENCILS; STATIONERY FOR CHILDREN'S EDUCATIONAL ACTIVITIES; STATIONERY FOR CHILDREN'S PLAYING ACTIVITIES; STATIONERY; ARTISTS' CHARCOALS; ARTISTS' DRAWING MATERIALS, NAMELY, ARTISTS' PENCILS; CHARCOAL PENCILS BEING ARTICLES OF STATIONERY; PENCILS FOR ARTISTS; COLOR PENCILS; COLORED LEAD PENCILS; COLORING PENCILS; CASES FOR PENCILS; MECHANICAL PENCILS; PENCILS; PENCILS FOR COLORING; TOPS FOR PENCILS, NAMELY, DECORATIVE PENCIL TOP ORNAMENTS AND ERASERS (U.S. CLS. 2, 5, 22, 23, 29, 37, 38 AND 50).

KATHLEEN M. VANSTON, EXAMINING ATTORNEY

CLASS 17—RUBBER GOODS

SN 77-615,925. THOMAS HUCHLER, WESTON, FL. FILED 11-17-2008.



THE MARK CONSISTS OF THE TERM "CARGOCUSHION" ENCLOSED IN A GENERALLY RECTANGULAR SHAPED CONTAINER.

FOR INFLATABLE BAGS FOR USE AS "DUNNAGE" TO STABILIZE FREIGHT AND FORM AN AIR CUSHION BETWEEN UNSECURED AND ODD SHAPED CARGO ITEMS ON OCEAN FREIGHT CONTAINERS TO PREVENT CARGO ITEMS FROM SHIFTING THEIR POSITIONS DURING TRANSIT (U.S. CLS. 1, 5, 12, 13, 35 AND 50).

ASMAT KHAN, EXAMINING ATTORNEY

CLASS 17—(Continued).

SN 77-697,601. TENNIS UNIVERSAL INC. (USA), EDMONTON, ALBERTA, CANADA, FILED 3-24-2009.

ELASTICCRACK

THE MARK CONSISTS OF STANDARD CHARACTERS WITHOUT CLAIM TO ANY PARTICULAR FONT, STYLE, SIZE, OR COLOR.

FOR ACRYLIC-BASED SEALANT PREPARATIONS FOR PATCHING OR FILLING CRACKS IN ASPHALT OR CONCRETE FOR TENNIS COURTS, BASKETBALL COURTS, INLINE SKATING TRACKS, RUNNING TRACKS, AND DRIVEWAYS AND WALKWAYS (U.S. CLS. 1, 5, 12, 13, 35 AND 50).

FIRST USE 0-0-2002; IN COMMERCE 0-0-2002.
JESSICA FATHY, EXAMINING ATTORNEY

SN 77-728,059. STO AG, STUEHLINGEN, FED REP GERMANY, FILED 5-4-2009.

STOTHERM LOTUSAN NEXT

THE MARK CONSISTS OF STANDARD CHARACTERS WITHOUT CLAIM TO ANY PARTICULAR FONT, STYLE, SIZE, OR COLOR.

OWNER OF U.S. REG. NOS. 3,358,021, 3,415,247 AND OTHERS.

FOR AN EXTERIOR INSULATION AND FINISH SYSTEM TO PROVIDE DECORATION AND PROTECTION TO BUILDINGS CONSISTING OF ADHESIVE ATTACHMENT OF INSULATION BOARD, BASE COAT EMBEDDED WITH COATED GLASS FIBER MESH AND AN ACRYLIC POLYMER-BASED WALL FINISH COATING IN COMBINATION WITH A LIQUID-APPLIED AIR AND MOISTURE BARRIER INSTALLED ON THE SUBSTRATE (U.S. CLS. 1, 5, 12, 13, 35 AND 50).

JOHN DWYER, EXAMINING ATTORNEY

SN 77-742,226. HIP, LLC, ELKHART, IN. FILED 5-21-2009.

GEOCEL ADVANCED RV EPDM

THE MARK CONSISTS OF STANDARD CHARACTERS WITHOUT CLAIM TO ANY PARTICULAR FONT, STYLE, SIZE, OR COLOR.

OWNER OF U.S. REG. NOS. 1,061,244, 3,432,034 AND OTHERS.

NO CLAIM IS MADE TO THE EXCLUSIVE RIGHT TO USE "ADVANCED RV EPDM", APART FROM THE MARK AS SHOWN.

FOR SEALANTS USED IN THE CONSTRUCTION INDUSTRY, NAMELY, ADHESIVE SEALANTS FOR USE IN ROOFING, SEALANTS FOR BUILDINGS, AND WATERPROOFING SEALANTS (U.S. CLS. 1, 5, 12, 13, 35 AND 50).

MICHAEL ENGEL, EXAMINING ATTORNEY

CLASS 17—(Continued).

SN 77-752,499. EMERALD CONCEPTS, LLC, CLAYTON, MO. FILED 6-4-2009.

PRACTECOL

THE MARK CONSISTS OF STANDARD CHARACTERS WITHOUT CLAIM TO ANY PARTICULAR FONT, STYLE, SIZE, OR COLOR.

FOR ENERGY CONSERVATION PRODUCTS, NAMELY, CAULK, WEATHERSTRIPPING FOR USE IN HOMES, BUILDING INSULATION AND HEAT REFLECTIVE PLASTIC WINDOW FILMS FOR USE IN RESIDENTIAL AND COMMERCIAL SETTINGS (U.S. CLS. 1, 5, 12, 13, 35 AND 50).

LAURIE MAYES, EXAMINING ATTORNEY

SN 77-756,921. ETERNABOND, INC., HAWTHORN WOODS, IL. FILED 6-11-2009.

RVer's Friend

THE MARK CONSISTS OF STANDARD CHARACTERS WITHOUT CLAIM TO ANY PARTICULAR FONT, STYLE, SIZE, OR COLOR.

FOR ADHESIVE TAPE FOR INDUSTRIAL AND COMMERCIAL USE; ADHESIVE SEALANT FOR USE IN ROOFING (U.S. CLS. 1, 5, 12, 13, 35 AND 50).

WENDY JUN, EXAMINING ATTORNEY

SN 77-760,939. HARRY E. SMITH AND ASSOCIATES INC., RILLTON, PA. FILED 6-16-2009.

STOP N HOLD

THE MARK CONSISTS OF STANDARD CHARACTERS WITHOUT CLAIM TO ANY PARTICULAR FONT, STYLE, SIZE, OR COLOR.

FOR RUBBER WHEEL CHOCKS (U.S. CLS. 1, 5, 12, 13, 35 AND 50).

FIRST USE 6-3-2005; IN COMMERCE 6-13-2005.
MARY CRAWFORD, EXAMINING ATTORNEY

CLASS 17—(Continued).

SN 77-763,060. TRUSEAL TECHNOLOGIES, INC., SOLON, OH. FILED 6-18-2009.

INSULEDGE

THE MARK CONSISTS OF STANDARD CHARACTERS WITHOUT CLAIM TO ANY PARTICULAR FONT, STYLE, SIZE, OR COLOR.

FOR ADHESIVE SEALANTS AND SILICONE RUBBER SEALANT FOR USE IN SPACING GLASS PANELS (U.S. CLS. 1, 5, 12, 13, 35 AND 50).

WARREN L. OLANDRIA, EXAMINING ATTORNEY

SN 77-813,777. UNIVERSITY OF CENTRAL FLORIDA RESEARCH FOUNDATION, INC., ORLANDO, FL. FILED 8-27-2009.

BOLD & GOLD SEPTIC

THE MARK CONSISTS OF STANDARD CHARACTERS WITHOUT CLAIM TO ANY PARTICULAR FONT, STYLE, SIZE, OR COLOR.

NO CLAIM IS MADE TO THE EXCLUSIVE RIGHT TO USE "SEPTIC", APART FROM THE MARK AS SHOWN.

FOR ENVIRONMENTAL POLLUTION CONTROL MEDIA MADE OF RUBBER TIRE CRUMBS COMBINED WITH SAND AND WOOD SAW DUST FOR NITROGEN CONTROL FOR ON-SITE WASTEWATER TREATMENT (U.S. CLS. 1, 5, 12, 13, 35 AND 50).

ANGELA M. MICHELI, EXAMINING ATTORNEY

CLASS 17—(Continued).

SN 77-813,783. UNIVERSITY OF CENTRAL FLORIDA RESEARCH FOUNDATION, INC., ORLANDO, FL. FILED 8-27-2009.

BOLD & GOLD STORMWATER

THE MARK CONSISTS OF STANDARD CHARACTERS WITHOUT CLAIM TO ANY PARTICULAR FONT, STYLE, SIZE, OR COLOR.

NO CLAIM IS MADE TO THE EXCLUSIVE RIGHT TO USE "STORMWATER", APART FROM THE MARK AS SHOWN.

FOR GRANULATED MATERIALS, NAMELY, GRANULATED EXPANDED SCHISTS, FOR THE PACKING OF BIOLOGICAL FILTERS USED IN WATER TREATMENT AND IN ODOR TREATMENT; ENVIRONMENTAL POLLUTION CONTROL MEDIA MADE OF RUBBER TIRE CRUMBS COMBINED WITH EXPANDED CLAY AND WOOD SAW DUST FOR PHOSPHORUS CONTROL IN STORMWATER, URBAN RUNOFF AND OTHER LIQUID STREAMS; ENVIRONMENTAL POLLUTION CONTROL MEDIA MADE OF RUBBER TIRE CRUMBS COMBINED WITH SAND AND WOOD SAW DUST FOR NITROGEN CONTROL FOR USE WITH PERVIOUS PAVEMENTS AND BIO FILTRATION RESERVOIRS (U.S. CLS. 1, 5, 12, 13, 35 AND 50).

ANGELA M. MICHELI, EXAMINING ATTORNEY

SN 77-873,094. FLETCHER LEISURE GROUP INC., VILLE ST. LAURENT, QUE, CANADA, FILED 11-16-2009.

CLIMALOFT

THE MARK CONSISTS OF STANDARD CHARACTERS WITHOUT CLAIM TO ANY PARTICULAR FONT, STYLE, SIZE, OR COLOR.

PRIORITY CLAIMED UNDER SEC. 44(D) ON CANADA APPLICATION NO. 1,458,188, FILED 11-6-2009.

FOR INSULATING FABRICS FOR USE IN THE MANUFACTURE OF OUTERWEAR (U.S. CLS. 1, 5, 12, 13, 35 AND 50).

FIRST USE 10-31-2007; IN COMMERCE 10-31-2007.

KATHERINE M. DUBRAY, EXAMINING ATTORNEY

SN 77-883,394. BLOME INTERNATIONAL, INC., O'FALLON, MO. FILED 12-1-2009.

PERLGLASS

THE MARK CONSISTS OF STANDARD CHARACTERS WITHOUT CLAIM TO ANY PARTICULAR FONT, STYLE, SIZE, OR COLOR.

FOR INSULATING MATERIALS, NAMELY, FOAMED GLASS BRICKS, BLOCKS AND TILES (U.S. CLS. 1, 5, 12, 13, 35 AND 50).

NAKIA HENRY, EXAMINING ATTORNEY

CLASS 17—(Continued).

SN 77-883,397. BLOME INTERNATIONAL, INC., O'FALLON, MO. FILED 12-1-2009.

PERLFOAM

THE MARK CONSISTS OF STANDARD CHARACTERS WITHOUT CLAIM TO ANY PARTICULAR FONT, STYLE, SIZE, OR COLOR.

FOR INSULATING MATERIALS, NAMELY, FOAMED GLASS BRICKS, BLOCKS AND TILES (U.S. CLS. 1, 5, 12, 13, 35 AND 50).

NAKIA HENRY, EXAMINING ATTORNEY

CLASS 17—(Continued).

SN 77-892,829. HBD INDUSTRIES, INC., DUBLIN, OH. FILED 12-14-2009.

ULTRAFLEX

THE MARK CONSISTS OF STANDARD CHARACTERS WITHOUT CLAIM TO ANY PARTICULAR FONT, STYLE, SIZE, OR COLOR.

FOR FLEXIBLE THERMOPLASTIC OR RUBBER HOSE HAVING A WIRE OR THERMOPLASTIC HELIX SUPPORT FOR USE IN CONVEYING AIR ALONE OR WITH OTHER MATERIALS (U.S. CLS. 1, 5, 12, 13, 35 AND 50).
FIRST USE 10-21-1971; IN COMMERCE 10-21-1971.

RONALD MCMORROW, EXAMINING ATTORNEY

SN 77-883,430. BLOME INTERNATIONAL, INC., O'FALLON, MO. FILED 12-1-2009.

BLOMEFOAM

THE MARK CONSISTS OF STANDARD CHARACTERS WITHOUT CLAIM TO ANY PARTICULAR FONT, STYLE, SIZE, OR COLOR.

FOR INSULATING MATERIALS, NAMELY, FOAMED GLASS BRICKS, BLOCKS AND TILES (U.S. CLS. 1, 5, 12, 13, 35 AND 50).

NAKIA HENRY, EXAMINING ATTORNEY

SN 77-892,967. HBD INDUSTRIES, INC., DUBLIN, OH. FILED 12-14-2009.

CHLOROCEM

THE MARK CONSISTS OF STANDARD CHARACTERS WITHOUT CLAIM TO ANY PARTICULAR FONT, STYLE, SIZE, OR COLOR.

FOR NON-METALLIC HOSE PIPES FOR CONDUCTING FLUIDS AND FLOWABLE SOLIDS (U.S. CLS. 1, 5, 12, 13, 35 AND 50).

FIRST USE 5-7-1985; IN COMMERCE 5-7-1985.

RONALD MCMORROW, EXAMINING ATTORNEY

SN 77-887,584. SHERRILL, DAN, LEWISVILLE, TX. FILED 12-7-2009.

QUICK COOL

THE MARK CONSISTS OF STANDARD CHARACTERS WITHOUT CLAIM TO ANY PARTICULAR FONT, STYLE, SIZE, OR COLOR.

NO CLAIM IS MADE TO THE EXCLUSIVE RIGHT TO USE "COOL", APART FROM THE MARK AS SHOWN.

FOR INSULATION COMPOSITE JACKETS FOR INJECTION MOLDING MACHINES (U.S. CLS. 1, 5, 12, 13, 35 AND 50).

FIRST USE 6-15-2009; IN COMMERCE 6-15-2009.

LIEF MARTIN, EXAMINING ATTORNEY

SN 77-907,576. PARAGON FILMS, INC., BROKEN ARROW, OK. FILED 1-8-2010.

NEXUS

THE MARK CONSISTS OF STANDARD CHARACTERS WITHOUT CLAIM TO ANY PARTICULAR FONT, STYLE, SIZE, OR COLOR.

FOR PLASTIC STRETCH FILM FOR INDUSTRIAL AND COMMERCIAL PACKAGING (U.S. CLS. 1, 5, 12, 13, 35 AND 50).

DAWN FELDMAN, EXAMINING ATTORNEY

CLASS 18—LEATHER GOODS

SN 76-699,242. MNC STRIBBONS, INC., MIAMI, FL. FILED 8-31-2009.



THE MARK CONSISTS OF THE WORDING "BARKER'S BOWTIQUE" ABOVE A DESIGN OF TWO DOGS FACING EACH OTHER.

FOR PET PRODUCTS, NAMELY, PET RESTRAINING DEVICES CONSISTING OF LEASHES, COLLARS AND HARNESSSES, PET CLOTHING (U.S. CLS. 1, 2, 3, 22 AND 41).

FIRST USE 3-1-2009; IN COMMERCE 3-1-2009.
NICHOLAS ALTREE, EXAMINING ATTORNEY

SN 77-392,077. TILLEY, SAMANTHA, HARWINTON, CT. FILED 2-8-2008.

haute moxie

THE MARK CONSISTS OF STANDARD CHARACTERS WITHOUT CLAIM TO ANY PARTICULAR FONT, STYLE, SIZE, OR COLOR.

FOR BACKPACKS, BOOK BAGS, SPORTS BAGS, BUM BAGS, WALLETS AND HANDBAGS; BAGS AND HOLLERS FOR SPORTS CLOTHING; CLOTHING FOR ANIMALS; CLOTHING FOR DOMESTIC PETS; DOG CLOTHING; EVENING HANDBAGS; HANDBAG FRAMES; HANDBAGS; HANDBAGS FOR MEN; HANDBAGS, PURSES AND WALLETS; LEATHER HANDBAGS; PET CLOTHING (U.S. CLS. 1, 2, 3, 22 AND 41).

LINDA POWELL, EXAMINING ATTORNEY

SN 77-521,483. DIAMOND KREEK PURSE CO., MINNETONKA, MN. FILED 7-14-2008.

DIAMOND KREEK

THE MARK CONSISTS OF STANDARD CHARACTERS WITHOUT CLAIM TO ANY PARTICULAR FONT, STYLE, SIZE, OR COLOR.

NO CLAIM IS MADE TO THE EXCLUSIVE RIGHT TO USE "DIAMOND", APART FROM THE MARK AS SHOWN.

FOR PURSES (U.S. CLS. 1, 2, 3, 22 AND 41).

FIRST USE 5-0-2008; IN COMMERCE 5-0-2008.

STEVEN R. FINE, EXAMINING ATTORNEY

CLASS 18—(Continued).

SN 77-627,161. MAVEN, LLC, SHERMAN OAKS, CA. FILED 12-5-2008.

MAVEN BY TORI SPELLING

THE MARK CONSISTS OF STANDARD CHARACTERS WITHOUT CLAIM TO ANY PARTICULAR FONT, STYLE, SIZE, OR COLOR.

THE NAME "TORI SPELLING" IDENTIFIES A LIVING INDIVIDUAL WHOSE CONSENT IS OF RECORD.

FOR LEATHER AND LEATHER FOR FURNITURE; LEATHER BAGS; UMBRELLAS (U.S. CLS. 1, 2, 3, 22 AND 41).

STEVEN JACKSON, EXAMINING ATTORNEY

SN 77-744,149. VORTEX, INC., AUSTIN, TX. FILED 5-26-2009.

LEATHERFACE

THE MARK CONSISTS OF STANDARD CHARACTERS WITHOUT CLAIM TO ANY PARTICULAR FONT, STYLE, SIZE, OR COLOR.

FOR ATHLETIC BAGS, BEACH BAGS, BOOK BAGS, BUM BAGS, CARRY-ALL BAGS, CLUTCH BAGS, DUFFEL BAGS, GYM BAGS, HIKING BAGS, SCHOOL BAGS, SPORTS BAGS, TOTE BAGS, TRAVEL BAGS, ALL OF THE FOREGOING BEING PROMOTED IN CONNECTION WITH A POPULAR FICTIONAL MOTION PICTURE CHARACTER (U.S. CLS. 1, 2, 3, 22 AND 41).

MAUREEN DALL, EXAMINING ATTORNEY

SN 77-751,991. K. HANSOTIA & CO., INC., MIAMI, FL. FILED 6-4-2009.

RED SEAL

THE MARK CONSISTS OF STANDARD CHARACTERS WITHOUT CLAIM TO ANY PARTICULAR FONT, STYLE, SIZE, OR COLOR.

FOR CARRY-ALL BAGS, LEATHER POUCHES, RUCKSACKS, DUFFLE BAGS, TRAVEL BAGS, TOOL BAGS SOLD EMPTY, BACKPACKS, PURSES, TRUNKS, SUITCASES, GARMENT BAGS FOR TRAVEL, BILLFOLDS, WALLETS, HARNESSSES, LEATHER BAGS, LEATHER BAG LACES, VALISES (U.S. CLS. 1, 2, 3, 22 AND 41).

TRICIA SONNEBORN, EXAMINING ATTORNEY

CLASS 18—(Continued).

SN 77-752,903. MILLY LLC, NEW YORK, NY. FILED 6-5-2009.

MILLY

THE MARK CONSISTS OF STANDARD CHARACTERS WITHOUT CLAIM TO ANY PARTICULAR FONT, STYLE, SIZE, OR COLOR.

OWNER OF U.S. REG. NOS. 3,136,107 AND 3,181,915.

THE NAME(S), PORTRAIT(S), AND/OR SIGNATURE(S) SHOWN IN THE MARK DOES NOT IDENTIFY A PARTICULAR LIVING INDIVIDUAL.

FOR HOBO BAGS, SPORTS BAGS, HANDBAGS, CLUTCHES, PURSES, OVERNIGHT BAGS, TOTE BAGS, GYM BAGS, BEACH BAGS, CARRY-ON BAGS (U.S. CLS. 1, 2, 3, 22 AND 41).

FIRST USE 9-0-2001; IN COMMERCE 2-0-2002.

WENDY GOODMAN, EXAMINING ATTORNEY

CLASS 18—(Continued).

SN 77-760,754. K. HANSOTIA & CO., INC., MIAMI, FL. FILED 6-16-2009.

SECRET AIR SERVICE

THE MARK CONSISTS OF STANDARD CHARACTERS WITHOUT CLAIM TO ANY PARTICULAR FONT, STYLE, SIZE, OR COLOR.

FOR CARRY-ALL BAGS, LEATHER POUCHES, RUCKSACKS, DUFFLE BAGS, TRAVEL BAGS, TOOL BAGS SOLD EMPTY, BACKPACKS, PURSES, TRUNKS, SUITCASES, GARMENT BAGS FOR TRAVEL, BILL-FOLDS, WALLETS, HARNESSSES, LEATHER BAGS, LEATHER BAG LACES, VALISES (U.S. CLS. 1, 2, 3, 22 AND 41).

TRICIA SONNEBORN, EXAMINING ATTORNEY

SN 77-758,567. JEFF FREEDMAN, NEW YORK, NY. AND BILL KITCHEN, HOLDEN, MA. AND DEBRA BACON, HOLDEN, MA. FILED 6-12-2009.

GLITTER LIKE A GIRL

THE MARK CONSISTS OF STANDARD CHARACTERS WITHOUT CLAIM TO ANY PARTICULAR FONT, STYLE, SIZE, OR COLOR.

FOR JEWELRY, NAMELY, ANKLETS; BRACELETS; CHARMS; BROOCHES; CUFFLINKS; TIE BARS; JEWELRY CHAINS; WOODEN JEWELRY; WOODEN JEWELRY BOXES; COSTUME JEWELRY; GEMSTONE JEWELRY; JEWELRY FEATURING PRECIOUS STONES; JEWELRY PLATED WITH PRECIOUS METALS; JEWELRY BOXES, CASES AND ORGANIZERS; AMULETS; NECKLACES; RINGS; KEY CHAINS AS JEWELRY IN THE NATURE OF TRINKETS OR FOBS; KEY CHAINS OF PRECIOUS METAL; KEY HOLDERS OF PRECIOUS METAL; EARRINGS; HOOP EARRINGS; CHOKERS, NAMELY, NECKLACES; CLIP EARRINGS; STUD EARRINGS; EAR STUDS; FANCY KEY RINGS OF PRECIOUS METAL; LEATHER BRACELETS; PENDANTS; WATCHES AND TIARAS; ORNAMENTAL JEWELRY FOR THE HEAD AND HAIR, NAMELY, HAIR CLIPS, PINS, SNAP CLIPS, BARRETTES AND BOWS BEING JEWELRY; JEWELRY, NAMELY, HAIR PINS BEING JEWELRY (U.S. CLS. 1, 2, 3, 22 AND 41).

BRENDAN MCCAULEY, EXAMINING ATTORNEY

SN 77-805,058. 2K6, LLC, NEW YORK, NY. FILED 8-14-2009.



THE MARK CONSISTS OF A DRAWING OF A KNOT, FOR CARRY-ALL BAGS; CLUTCH BAGS; CLUTCH PURSES; TOTE BAGS (U.S. CLS. 1, 2, 3, 22 AND 41). FIRST USE 7-17-2009; IN COMMERCE 7-17-2009. JEAN IM, EXAMINING ATTORNEY

CLASS 18—(Continued).

SN 77-827,533. WEBBING WORLD PRODUCTS CO. LTD.,
CHANG HUA, TAIWAN, FILED 9-16-2009.



THE MARK CONSISTS OF THE WORD "MEOW" NEXT TO A STYLIZED SILHOUETTE OF A CAT.

FOR CLOTHES FOR PETS TO WEAR; PET CLOTHING, NAMELY, PET BELTS; PET COLLARS; PET LEASHES; PET HARNESSSES; PET MUZZLES; PET SHOES; PET BAGS, NAMELY, PET CARRIERS, PET TOTE BAGS AND BACKPACKS FOR PETS TO WEAR (U.S. CLS. 1, 2, 3, 22 AND 41).

FIRST USE 7-0-2008; IN COMMERCE 7-0-2008.

CHARISMA HAMPTON, EXAMINING ATTORNEY

SN 77-835,138. STEVEN S. OH, STUDIO CITY, CA. FILED 9-25-2009.

tama

THE MARK CONSISTS OF STANDARD CHARACTERS WITHOUT CLAIM TO ANY PARTICULAR FONT, STYLE, SIZE, OR COLOR.

FOR BACKPACKS, BOOK BAGS, SPORTS BAGS, BUM BAGS, WALLETS AND HANDBAGS; HANDBAGS; HANDBAGS, PURSES AND WALLETS (U.S. CLS. 1, 2, 3, 22 AND 41).

FIRST USE 5-1-2009; IN COMMERCE 5-24-2009.

BARBARA A. GOLD, EXAMINING ATTORNEY

SN 77-839,384. NATIONAL BEEF PACKING CO., KANSAS CITY, MO. FILED 10-1-2009.

RADIANT BLUE

THE MARK CONSISTS OF STANDARD CHARACTERS WITHOUT CLAIM TO ANY PARTICULAR FONT, STYLE, SIZE, OR COLOR.

NO CLAIM IS MADE TO THE EXCLUSIVE RIGHT TO USE "BLUE", APART FROM THE MARK AS SHOWN.

FOR ANIMAL HIDES SOLD TO OTHERS FOR FURTHER PROCESSING (U.S. CLS. 1, 2, 3, 22 AND 41).

AISHA SALEM, EXAMINING ATTORNEY

CLASS 18—(Continued).

SN 77-843,614. PRESCOTT, MYRA TOBOLOWSKY, DALLAS, TX. AND TOBOLOWSKY, JULIE ZALE, DALLAS, TX. FILED 10-7-2009.



NO CLAIM IS MADE TO THE EXCLUSIVE RIGHT TO USE "CLOTHES", APART FROM THE MARK AS SHOWN.

THE MARK CONSISTS OF THE WORDS "CLOTHES AND GO" IN STYLIZED LETTERING, THE WORDS BEING PLACED ON THREE SHAPES: A PARALLELOGRAM WITH ROUNDED CORNERS, A SMALL CIRCLE, AND A RECTANGULAR-SHAPED GARMENT BAG, RESPECTIVELY. THE GARMENT BAG HAS A CLOTHES HANGER PORTION ON ITS RIGHT EDGE, THE HOOK OF THE CLOTHES HANGER CURVING UPWARD. A PORTION OF THE RIGHT EDGE OF THE PARALLELOGRAM OVERLAPS A PORTION OF THE LEFT EDGE OF THE HORIZONTALLY POSITIONED GARMENT BAG, AND THE SMALL CIRCLE OVERLAPS BOTH A PORTION OF THE PARALLELOGRAM AND A PORTION OF THE GARMENT BAG.

FOR GARMENT BAGS FOR TRAVEL (U.S. CLS. 1, 2, 3, 22 AND 41).

MARC LEIPZIG, EXAMINING ATTORNEY

SN 77-845,121. EDELMAN SHOE, INC., NEW YORK, NY. FILED 10-9-2009.

SAM EDELMAN

THE MARK CONSISTS OF STANDARD CHARACTERS WITHOUT CLAIM TO ANY PARTICULAR FONT, STYLE, SIZE, OR COLOR.

OWNER OF U.S. REG. NO. 3,271,895.

THE NAME(S), PORTRAIT(S), AND/OR SIGNATURE(S) SHOWN IN THE MARK IDENTIFIES "SAM EDELMAN", WHOSE CONSENT(S) TO REGISTER IS MADE OF RECORD.

FOR LUGGAGE, HANDBAGS, PURSES, WALLETS, ALL-PURPOSE TOTE BAGS, ALL-PURPOSE SPORTS BAGS, BACKPACKS (U.S. CLS. 1, 2, 3, 22 AND 41).

REBECCA EISINGER, EXAMINING ATTORNEY

CLASS 18—(Continued).

SN 77-869,596. ROSETTI HANDBAGS AND ACCESSORIES, LTD, NEW YORK, NY. FILED 11-10-2009.

ROSIE BY ROSETTI

THE MARK CONSISTS OF STANDARD CHARACTERS WITHOUT CLAIM TO ANY PARTICULAR FONT, STYLE, SIZE, OR COLOR.

OWNER OF U.S. REG. NOS. 2,332,198 AND 3,741,427.
FOR HANDBAGS, PURSES, WALLETS, TRAVEL BAGS, TOTE BAGS, POCKET BOOKS, BRIEF CASES, BACKPACKS, MESSENGER BAGS, COSMETIC CASES SOLD EMPTY (U.S. CLS. 1, 2, 3, 22 AND 41).

JACLYN KIDWELL WALKER, EXAMINING ATTORNEY

CLASS 18—(Continued).

SN 77-880,218. ZONE CHAMP LTD, CAUSEWAY BAY, CHINA, FILED 11-24-2009.



THE COLOR(S) NOT IS/ARE CLAIMED AS A FEATURE OF THE MARK.

THE MARK CONSISTS OF THE WORDING "FLEUR-DE-LIS" INSIDE OF A RECTANGLE FEATURING SIX FLEUR-DE-LIS DESIGNS AND FLORAL PATTERNS SERVING AS THE INNER BORDER OF THE RECTANGLE.

FOR HANDBAGS, BACKPACKS, TOTE BAGS, PURSES, LUGGAGE AND WALLETS (U.S. CLS. 1, 2, 3, 22 AND 41).

FIRST USE 6-1-2009; IN COMMERCE 6-1-2009.
RICHARD WHITE, EXAMINING ATTORNEY

SN 77-872,084. PYTAK, PAUL, PARMA, OH. AND BHARDWAJ, VANDANA, BROADVIEW HEIGHTS, OH. FILED 11-13-2009.

Key Keeper

THE MARK CONSISTS OF THE WORDING "KEY-KEEPER" REPRESENTED IN STYLIZED FONT.

FOR KEY CASES OF LEATHER OR IMITATION LEATHER (U.S. CLS. 1, 2, 3, 22 AND 41).

WARREN L. OLANDRIA, EXAMINING ATTORNEY

SN 77-883,170. FIBERBUILT UMBRELLAS, LAUDERDALE LAKES, FL. FILED 12-1-2009.

FiberTeak

SN 77-877,832. ANVIL ACQUISITION CORP. DBA ANVIL BRAND SHOE COMPANY, LEXINGTON, IL. FILED 11-20-2009.

ANVIL BRAND SPORT HORSE

THE MARK CONSISTS OF STANDARD CHARACTERS WITHOUT CLAIM TO ANY PARTICULAR FONT, STYLE, SIZE, OR COLOR.

OWNER OF U.S. REG. NO. 3,571,665.
NO CLAIM IS MADE TO THE EXCLUSIVE RIGHT TO USE "BRAND SPORT HORSE", APART FROM THE MARK AS SHOWN.

FOR HORSESHOES (U.S. CLS. 1, 2, 3, 22 AND 41).
JASON TURNER, EXAMINING ATTORNEY

THE MARK CONSISTS OF STANDARD CHARACTERS WITHOUT CLAIM TO ANY PARTICULAR FONT, STYLE, SIZE, OR COLOR.

FOR BEACH UMBRELLAS; FRAMES FOR UMBRELLAS OR PARASOLS; PATIO UMBRELLAS; TABLE UMBRELLAS; TELESCOPIC UMBRELLAS; UMBRELLAS; UMBRELLAS AND PARASOLS; UMBRELLAS AND THEIR PARTS; UMBRELLAS FOR CHILDREN (U.S. CLS. 1, 2, 3, 22 AND 41).

FIRST USE 8-31-2005; IN COMMERCE 9-6-2005.
SHAUNIA CARLYLE, EXAMINING ATTORNEY

CLASS 18—(Continued).

SN 77-885,111. RENOUEV INC., NEW YORK, NY. FILED 12-3-2009.



THE MARK CONSISTS OF TWO STYLIZED "R'S", BACK TO BACK WITHIN A SEMI-CIRCLE, ABOVE THE WORDING "RENOUEV".

THE ENGLISH TRANSLATION OF "RENOUEV" IN THE MARK IS "RENEW."

FOR ALL-PURPOSE CARRYING BAGS; ALL-PURPOSE REUSABLE CARRYING BAGS; CARRY-ALL BAGS; CARRY-ON BAGS; REUSABLE SHOPPING BAGS; TOTE BAGS (U.S. CLS. 1, 2, 3, 22 AND 41).

FIRST USE 10-7-2009; IN COMMERCE 10-7-2009.
DAVID HOFFMAN, EXAMINING ATTORNEY

SN 77-885,816. BURGHARDT, RICHARD, DALLAS, TX. FILED 12-3-2009.

Ashard Richley

THE MARK CONSISTS OF STANDARD CHARACTERS WITHOUT CLAIM TO ANY PARTICULAR FONT, STYLE, SIZE, OR COLOR.

"ASHARD RICHEY" DOES NOT IDENTIFY ANY PARTICULAR LIVING INDIVIDUAL.

FOR HANDBAGS; PURSES (U.S. CLS. 1, 2, 3, 22 AND 41).

FIRST USE 9-1-2009; IN COMMERCE 9-1-2009.
JOHN DWYER, EXAMINING ATTORNEY

SN 77-887,365. THE UNIVERSITY OF ARIZONA ALUMNI ASSOCIATION, TUCSON, AZ. FILED 12-7-2009.

WILDCAT FOR LIFE

THE MARK CONSISTS OF STANDARD CHARACTERS WITHOUT CLAIM TO ANY PARTICULAR FONT, STYLE, SIZE, OR COLOR.

FOR TOTE BAGS, TRAVELING BAGS, LUGGAGE (U.S. CLS. 1, 2, 3, 22 AND 41).

JUDITH HELFMAN, EXAMINING ATTORNEY

CLASS 18—(Continued).

SN 77-887,653. LUCY ACTIVEWEAR, INC., PORTLAND, OR. FILED 12-7-2009.

LUCY

THE MARK CONSISTS OF STANDARD CHARACTERS WITHOUT CLAIM TO ANY PARTICULAR FONT, STYLE, SIZE, OR COLOR.

OWNER OF U.S. REG. NOS. 2,701,054, 2,923,523 AND OTHERS.

FOR BACKPACKS; DUFFLE BAGS; SPORTS BAGS; TOTE BAGS; WAIST PACKS (U.S. CLS. 1, 2, 3, 22 AND 41).

JORDAN BAKER, EXAMINING ATTORNEY

SN 77-888,207. XING AN INTERNATIONAL INC, DBA RAINTEC UMBRELLA, EL MONTE, CA. FILED 12-8-2009.

iRain

THE MARK CONSISTS OF STANDARD CHARACTERS WITHOUT CLAIM TO ANY PARTICULAR FONT, STYLE, SIZE, OR COLOR.

FOR BAGS FOR UMBRELLAS; BEACH UMBRELLAS; BEACH UMBRELLAS; FRAMES FOR UMBRELLAS; FRAMES FOR UMBRELLAS OR PARASOLS; GOLF UMBRELLAS; JAPANESE OILED-PAPER UMBRELLAS (JANOME-GASA); JAPANESE PAPER UMBRELLAS (KARAKASA); METAL PARTS OF UMBRELLAS; PARASOLS; PATIO UMBRELLAS; TABLE UMBRELLAS; TELESCOPIC UMBRELLAS; UMBRELLA BASES; UMBRELLA COVERS; UMBRELLA FRAMES; UMBRELLA HANDLES; UMBRELLA RINGS; UMBRELLAS; UMBRELLAS AND PARASOLS; UMBRELLAS AND THEIR PARTS; UMBRELLAS FOR CHILDREN (U.S. CLS. 1, 2, 3, 22 AND 41).

FIRST USE 11-28-2009; IN COMMERCE 11-28-2009.
AMY KERTGATE, EXAMINING ATTORNEY

SN 77-888,248. PACO & FRIENDS LLC, HOUSTON, TX. FILED 12-8-2009.

DURALEASH

THE MARK CONSISTS OF STANDARD CHARACTERS WITHOUT CLAIM TO ANY PARTICULAR FONT, STYLE, SIZE, OR COLOR.

FOR ANIMAL LEASHES; DOG LEASHES; LEASHES FOR ANIMALS; PET PRODUCTS, NAMELY, PET RESTRAINING DEVICES CONSISTING OF LEASHES, COLLARS, HARNESSES, RESTRAINING STRAPS, AND LEASHES WITH LOCKING DEVICES (U.S. CLS. 1, 2, 3, 22 AND 41).

JUDITH HELFMAN, EXAMINING ATTORNEY

CLASS 18—(Continued).

SN 77-888,799. HL OPERATING COMPANY, LEBANON, TN. FILED 12-8-2009.

URBAN LITE

THE MARK CONSISTS OF STANDARD CHARACTERS WITHOUT CLAIM TO ANY PARTICULAR FONT, STYLE, SIZE, OR COLOR.

NO CLAIM IS MADE TO THE EXCLUSIVE RIGHT TO USE "LITE", APART FROM THE MARK AS SHOWN.

FOR LUGGAGE, GARMENT BAGS FOR TRAVEL, ATTACHÉ CASES, TOTE BAGS, AND BRIEFCASE-TYPE PORTFOLIOS WITH AND WITHOUT HANDLES (U.S. CLS. 1, 2, 3, 22 AND 41).

H. M. FISHER, EXAMINING ATTORNEY

SN 77-888,812. HL OPERATING CORPORATION, LEBANON, TN. FILED 12-8-2009.

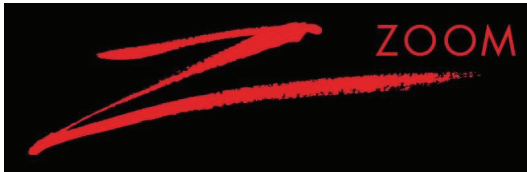

THE COLOR(S) RED AND BLACK IS/ARE CLAIMED AS A FEATURE OF THE MARK.

THE MARK CONSISTS OF THE WORD "ZOOM" IN PLAIN RED FONT FOLLOWING A LARGE STYLIZED RED "Z". ALL CONTAINED A BLACK RECTANGLE.

FOR LUGGAGE, GARMENT BAGS FOR TRAVEL, ATTACHÉ CASES, TOTE BAGS, AND BRIEFCASE-TYPE PORTFOLIOS WITH AND WITHOUT HANDLES (U.S. CLS. 1, 2, 3, 22 AND 41).

ANTHONY RINKER, EXAMINING ATTORNEY

CLASS 18—(Continued).

SN 77-889,973. CENTER FOR GLOBAL IMPACT, INDIANAPOLIS, IN. FILED 12-9-2009.

THE COLOR(S) GREY AND PINK IS/ARE CLAIMED AS A FEATURE OF THE MARK.

THE MARK CONSISTS OF THE WORDING "BYTAVI". THE COLOR GREY APPEARS IN THE WORD "BY". THE COLOR PINK APPEARS IN THE WORD "TAVI".

FOR BABY BACKPACKS; BACKPACKS; BACKPACKS; BACKPACKS, BOOK BAGS, SPORTS BAGS, BUM BAGS, WALLETS AND HANDBAGS; CHANGE PURSES; COIN PURSES; COIN PURSES, NOT OF PRECIOUS METALS; COSMETIC BAGS SOLD EMPTY; EVENING HANDBAGS; FASHION HANDBAGS; HANDBAGS; HANDBAGS, PURSES AND WALLETS; MULTI-PURPOSE PURSES; OVERNIGHT BAGS; OVERNIGHT CASES; PURSES; SCHOOLCHILDREN'S BACKPACKS; SMALL BACKPACKS (U.S. CLS. 1, 2, 3, 22 AND 41).

FIRST USE 11-13-2009; IN COMMERCE 11-18-2009.

EVELYN BRADLEY, EXAMINING ATTORNEY

SN 77-890,195. HL OPERATING CORPORATION, LEBANON, TN. FILED 12-10-2009.

H CONCEPTS

A HARTMANN COMPANY

OWNER OF U.S. REG. NOS. 2,357,677, 3,034,859 AND OTHERS.

NO CLAIM IS MADE TO THE EXCLUSIVE RIGHT TO USE "COMPANY", APART FROM THE MARK AS SHOWN.

THE MARK CONSISTS OF THE LETTER AND WORD "H CONCEPTS" ABOVE THE WORDS "A HARTMANN COMPANY" DIVIDED BY A LINE, ALL IN A PLAIN FONT EXCEPT FOR THE NAME "HARTMANN", WHICH IS STYLIZED.

FOR LUGGAGE, GARMENT BAGS FOR TRAVEL, TRAVEL CARRY-ON BAGS, ATTACHÉ CASES, TOTE BAGS, AND BRIEFCASE-TYPE PORTFOLIOS WITH AND WITHOUT HANDLES (U.S. CLS. 1, 2, 3, 22 AND 41).

ANTHONY RINKER, EXAMINING ATTORNEY

CLASS 18—(Continued).

SN 77-890,352. SCOTT WEITZEL, DBA BARE BONES BAG COMPANY, BRIGHTON, CO. FILED 12-10-2009.

Bare Bones

THE MARK CONSISTS OF STANDARD CHARACTERS WITHOUT CLAIM TO ANY PARTICULAR FONT, STYLE, SIZE, OR COLOR.

FOR LUGGAGE; LUGGAGE AND TRUNKS; STRAPS FOR LUGGAGE (U.S. CLS. 1, 2, 3, 22 AND 41).
KRISTINA MORRIS, EXAMINING ATTORNEY

CLASS 18—(Continued).

SN 77-893,422. HEARST COMMUNICATIONS, INC., NEW YORK, NY. FILED 12-15-2009.



NO CLAIM IS MADE TO THE EXCLUSIVE RIGHT TO USE "TRAVEL" & "1846", APART FROM THE MARK AS SHOWN.

THE MARK CONSISTS OF THE STYLIZED WORDS, LETTERS, AND NUMBERS "TRAVEL", "T&C", AND "1846" SURROUNDED BY A CIRCULAR BORDER COMPOSED OF A MARINERS COMPASS.

FOR BUSINESS CARD CASES; DUFFEL BAGS; GARMENT BAGS FOR TRAVEL; LEATHER BINDERS FOR TRAVEL PURPOSES; LUGGAGE; LUGGAGE TAGS; MESSENGER BAGS; SUITCASES; TOTE BAGS; TRAVEL BAGS; WASH BAGS FOR CARRYING TOILETRIES; WHEELED BAGS (U.S. CLS. 1, 2, 3, 22 AND 41).
KARANENDRA S. CHHINA, EXAMINING ATTORNEY

SN 77-893,621. ROOT, SANDRA, XENIA, OH. FILED 12-15-2009.

KAY WEST

THE MARK CONSISTS OF STANDARD CHARACTERS WITHOUT CLAIM TO ANY PARTICULAR FONT, STYLE, SIZE, OR COLOR.

THE NAME "KAY WEST" DOES NOT IDENTIFY A LIVING INDIVIDUAL.

FOR CUSTOM HAND BAGS, PURSES, WALLETS, CHANGE PURSES, PET TOTE BAGS, PET COLLARS AND LEADS (U.S. CLS. 1, 2, 3, 22 AND 41).

FIRST USE 7-24-1999; IN COMMERCE 7-24-1999.
APRIL HESIK, EXAMINING ATTORNEY

SN 77-900,672. EASY WRAP INC., JONESBORO, GA. FILED 12-23-2009.

Judena Baby Wrap

THE MARK CONSISTS OF STANDARD CHARACTERS WITHOUT CLAIM TO ANY PARTICULAR FONT, STYLE, SIZE, OR COLOR.

OWNER OF U.S. REG. NOS. 2,357,677, 3,034,859 AND OTHERS.

NO CLAIM IS MADE TO THE EXCLUSIVE RIGHT TO USE "PERFORMANCE GEAR" AND "COMPANY", APART FROM THE MARK AS SHOWN.

FOR LUGGAGE, GARMENT BAGS FOR TRAVEL, TRAVEL CARRY-ON BAGS, ATTACHE CASES, TOTE BAGS, AND BRIEFCASE-TYPE PORTFOLIOS WITH AND WITHOUT HANDLES (U.S. CLS. 1, 2, 3, 22 AND 41).
ANTHONY RINKER, EXAMINING ATTORNEY

NO CLAIM IS MADE TO THE EXCLUSIVE RIGHT TO USE "BABY WRAP", APART FROM THE MARK AS SHOWN.

THE MARK CONSISTS OF THE WORDING "JUDENA BABY WRAP" IN STYLIZED FONT.

FOR BABY CARRIERS WORN ON THE BODY (U.S. CLS. 1, 2, 3, 22 AND 41).

ADA HAN, EXAMINING ATTORNEY

SN 77-890,572. HL OPERATING CORPORATION, LEBANON, TN. FILED 12-10-2009.

PERFORMANCE GEAR
H CONCEPTS
A HARTMANN
COMPANY

CLASS 18—(Continued).

SN 77-916,040. AKITA, INC., WILMINGTON, DE. FILED 1-20-2010.

CHARTIS

THE MARK CONSISTS OF STANDARD CHARACTERS WITHOUT CLAIM TO ANY PARTICULAR FONT, STYLE, SIZE, OR COLOR.

FOR CANVAS TOTE BAGS, UMBRELLAS (U.S. CLS. 1, 2, 3, 22 AND 41).

FIRST USE 10-1-2009; IN COMMERCE 10-1-2009.
JASON TURNER, EXAMINING ATTORNEY

CLASS 19—NON-METALLIC BUILDING MATERIALS

SN 76-697,318. REMO, INC., VALENCIA, CA. FILED 5-8-2009.

CROP & GARDEN DEFENSE

THE MARK CONSISTS OF STANDARD CHARACTERS WITHOUT CLAIM TO ANY PARTICULAR FONT, STYLE, SIZE, OR COLOR.

NO CLAIM IS MADE TO THE EXCLUSIVE RIGHT TO USE "CROP AND GARDEN", APART FROM THE MARK AS SHOWN.

FOR WIND-DRIVEN SOUND-EMITTING GARDEN SCULPTURES TO REPEL RODENT AND OTHER INVASIVE GARDEN ANIMALS (U.S. CLS. 1, 12, 33 AND 50).

LINDA MICKLEBURGH, EXAMINING ATTORNEY

SN 78-962,594. LYRIC JEANS, INC., LOS ANGELES, FL. FILED 8-29-2006.

LYRIC CULTURE COUTURE

THE MARK CONSISTS OF STANDARD CHARACTERS WITHOUT CLAIM TO ANY PARTICULAR FONT, STYLE, SIZE, OR COLOR.

NO CLAIM IS MADE TO THE EXCLUSIVE RIGHT TO USE "COUTURE", APART FROM THE MARK AS SHOWN.

FOR HANDBAGS, BACKPACKS, WALLETS, DUFFLE BAGS, GYM BAGS, AND LUGGAGE (U.S. CLS. 1, 2, 3, 22 AND 41).

LAURA HAMMEL, EXAMINING ATTORNEY

SN 76-697,918. ADVANCED DRAINAGE SYSTEMS, INC., HILLIARD, OH. FILED 6-15-2009.

CATCH-IT

THE MARK CONSISTS OF STANDARD CHARACTERS WITHOUT CLAIM TO ANY PARTICULAR FONT, STYLE, SIZE, OR COLOR.

FOR NON-METAL DRAINAGE STRUCTURES, NAMELY, REMOVABLE CATCH BASIN INSERTS IN THE NATURE OF STORM WATER MANAGEMENT DEVICES IN THE NATURE OF NON-METAL CATCHMENT BASINS AND NON-METAL DETENTION BASINS IN THE NATURE OF CISTERNS (U.S. CLS. 1, 12, 33 AND 50).

FIRST USE 10-15-2007; IN COMMERCE 10-15-2007.
JAMES STEIN, EXAMINING ATTORNEY

SN 79-075,500. BRIONI - ROMAN STYLE S.P.A., ITALY, FILED 10-19-2009.

BRIONI

OWNER OF INTERNATIONAL REGISTRATION 0502724 DATED 5-12-1986, EXPIRES 5-12-2016.

OWNER OF U.S. REG. NOS. 670,260, 1,520,410 AND OTHERS.

FOR BRIEFCASES; TOTE BAGS; PASSPORT CASES; BAGS, NAMELY, ALL PURPOSE CARRYING BAGS; ALL PURPOSE SPORT BAGS; SHOULDER BAGS; COSMETIC BAGS SOLD EMPTY; ATTACHE CASES; WALLETS; PURSES; WHEELED BAGS; TOOL BAGS SOLD EMPTY; SCHOOL BAGS; KEYCASES; BUSINESS CARD CASES; CREDIT CARD CASES; TRUNKS; SUITCASES; TRAVELLING BAGS; RUCKSACKS; BACKPACKS; GARMENT BAGS FOR TRAVEL; WAIST PACKS; DUFFEL BAGS; CLUTCH BAGS; UMBRELLAS; PARASOLS; WALKING STICKS (U.S. CLS. 1, 2, 3, 22 AND 41).

VERNA BETH RIRIE, EXAMINING ATTORNEY

SN 77-597,624. SUPPLY-ALL MFG. INC., STONEY CREEK, ON, CANADA, FILED 10-22-2008.



OWNER OF CANADA REG. NO. TMA757714, DATED 1-25-2010, EXPIRES 1-25-2025.

NO CLAIM IS MADE TO THE EXCLUSIVE RIGHT TO USE "OVERLAY", APART FROM THE MARK AS SHOWN.

THE MARK CONSISTS OF THE DESIGN OF FOUR VERSIONS OF THE PHRASE "EZ OVERLAY" FANNING UPWARD.

FOR WOOD AND PARTICLE BOARD TRIM AND MOULDINGS FOR RESIDENTIAL AND COMMERCIAL BUILDINGS, NAMELY, CORNER BLOCKS, PLINTHS, CASINGS, BASEBOARDS, ROSETTES, DECORATIVE TRIM COMPONENTS PARTS, MITER LESS TRIM COMPONENTS PARTS (U.S. CLS. 1, 12, 33 AND 50).

EMILY CARLSEN, EXAMINING ATTORNEY

CLASS 19—(Continued).

SN 77-597,640. SUPPLY-ALL MFG. INC., STONEY CREEK, ON, CANADA, FILED 10-22-2008.

CAP IT

THE MARK CONSISTS OF STANDARD CHARACTERS WITHOUT CLAIM TO ANY PARTICULAR FONT, STYLE, SIZE, OR COLOR.

OWNER OF CANADA REG. NO. TMA757812, DATED 1-26-2010, EXPIRES 1-26-2025.

FOR WOOD AND PARTICLE BOARD TRIM AND MOULDINGS FOR RESIDENTIAL AND COMMERCIAL BUILDINGS, NAMELY, CORNER BLOCKS, PLINTHS, CASINGS, BASEBOARDS, ROSETTES, DECORATIVE TRIM COMPONENTS PARTS, MITER LESS TRIM COMPONENTS PARTS (U.S. CLS. 1, 12, 33 AND 50).

EMILY CARLSEN, EXAMINING ATTORNEY

SN 77-614,916. SURFACE LINKS, LLC, NEW YORK, NY, FILED 11-14-2008.



NO CLAIM IS MADE TO THE EXCLUSIVE RIGHT TO USE "SURFACE", APART FROM THE MARK AS SHOWN.

THE COLOR(S) GREEN AND BLACK IS/ARE CLAIMED AS A FEATURE OF THE MARK.

THE MARK CONSISTS OF THE MARK CONSISTS OF THE LETTERS "S & L" IN GREEN IN A CUBE SHAPE AND THE WORDING "SURFACE LINKS" IN BLACK.

FOR WOOD CELLULOSE VENEER (U.S. CLS. 1, 12, 33 AND 50).

ANNE FARRELL, EXAMINING ATTORNEY

SN 77-635,126. LEGACY QUEST OUTDOORS, LLC, WAYNESVILLE, NC, FILED 12-17-2008.



NO CLAIM IS MADE TO THE EXCLUSIVE RIGHT TO USE "OUTDOORS", APART FROM THE MARK AS SHOWN.

THE COLOR(S) BLACK, WHITE, LIGHT GRAY, DARK GRAY AND ORANGE IS/ARE CLAIMED AS A FEATURE OF THE MARK.

THE MARK CONSISTS OF A HORIZONTAL OUTER OVAL SURROUNDING A HORIZONTAL MIDDLE OVAL WHICH CONTAINS A THIRD, HORIZONTAL INNER OVAL. THE OUTER OVAL IS OUTLINED IN BLACK. THE FILL IN THE OUTER OVAL IS A BLACK, GRAY AND WHITE MARBLE PATTERN. THE OUTER OVAL FRAMES THE MIDDLE OVAL. THERE IS AN ORANGE SLOTTED SCREW HEAD CENTERED ON BOTH THE RIGHT AND LEFT SIDES OF THE OUTER OVAL. THE MIDDLE OVAL

CLASS 19—(Continued).

HAS A BLACK BACKGROUND. CENTERED IN THE TOP THIRD OF THE MIDDLE OVAL IS THE THIRD OR INNER OVAL. THE INNER OVAL SHADES FROM LIGHT GRAY AT THE TOP TO DARK GRAY AT THE BOTTOM, GIVING THE MARK A DIMENSIONAL APPEARANCE. DIRECTLY UNDERNEATH THE INNER OVAL ARE THE WORDS "LEGACY QUEST". DIRECTLY UNDERNEATH THE WORDS "LEGACY QUEST" IS THE WORD "OUTDOORS". THE LETTERS IN "LEGACY QUEST" ARE WHITE WITH BLACK HORIZONTAL STRIPES THROUGHOUT. THE "L" IN "LEGACY" AND THE "Q" IN "QUEST" ARE IN LARGE SIZED UPPER CASE LETTERS. THE REMAINDER OF THE LETTERS IN "LEGACY QUEST" ARE IN SMALLER SIZED UPPER CASE LETTERS. "OUTDOORS" IS PRINTED IN ORANGE SCRIPT WITH AN UPPER CASE "O" AND THE REMAINDER OF THE WORD IN LOWER CASE LETTERS.

FOR LOG HOMES SOLD IN KIT FORM; AND STRUCTURAL PARTS FOR LOG HOMES, NAMELY, MANTLES, RAILS, FLOORING, WALL COVERING, TIMBERS AND BEAMS, SIDING, AND LOG VENEERS (U.S. CLS. 1, 12, 33 AND 50).

KAPIL BHANOT, EXAMINING ATTORNEY

SN 77-638,994. DALEN PRODUCTS, INC., KNOXVILLE, TN, FILED 12-23-2008.

DALEN

THE MARK CONSISTS OF STANDARD CHARACTERS WITHOUT CLAIM TO ANY PARTICULAR FONT, STYLE, SIZE, OR COLOR.

OWNER OF U.S. REG. NO. 3,741,790.

SEC. 2(F).

FOR NON-METAL WIRE FENCING FOR LANDSCAPING AND GARDEN USES TO PROTECT PLANTS, GARDENS, PONDS, AND POOLS FROM BIRDS, PESTS, AND ANIMALS (U.S. CLS. 1, 12, 33 AND 50).

FIRST USE 2-1-2008; IN COMMERCE 2-1-2008.

ANDREW RHIM, EXAMINING ATTORNEY

SN 77-717,250. MODULAR SPACE CORPORATION, BERYN, PA, FILED 4-20-2009.



OWNER OF U.S. REG. NOS. 1,123,065, 3,133,642 AND 3,151,456.

THE MARK CONSISTS OF THE STYLIZED WORDING "MODSAFE" BELOW AN OVAL DESIGN CONTAINING THREE PARTIALLY SHADED SHAPES IN VARIOUS SIZES.

FOR PORTABLE NON-METAL BUILDINGS (U.S. CLS. 1, 12, 33 AND 50).

TIMOTHY FINNEGAN, EXAMINING ATTORNEY

CLASS 19—(Continued).

SN 77-737,324. WALKER & ZANGER, INC., SYLMAR, CA.
FILED 5-14-2009.

HELSINKI

THE MARK CONSISTS OF STANDARD CHARACTERS
WITHOUT CLAIM TO ANY PARTICULAR FONT, STYLE,
SIZE, OR COLOR.

FOR STONE TILES (U.S. CLS. 1, 12, 33 AND 50).
FIRST USE 10-0-2008; IN COMMERCE 10-0-2008.
THOMAS MANOR, EXAMINING ATTORNEY

SN 77-744,353. SWIFF-TRAIN COMPANY, LLC, CORPUS
CHRISTI, TX. FILED 5-26-2009.

EARTHWERKS

THE MARK CONSISTS OF STANDARD CHARACTERS
WITHOUT CLAIM TO ANY PARTICULAR FONT, STYLE,
SIZE, OR COLOR.

OWNER OF U.S. REG. NO. 3,507,558.
FOR VINYL FLOORING (U.S. CLS. 1, 12, 33 AND 50).
TINA MAI, EXAMINING ATTORNEY

SN 77-746,580. EASI-SET INDUSTRIES, MIDLAND, VA.
FILED 5-28-2009.

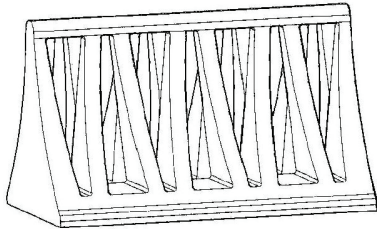

THE MARK CONSISTS OF THE FANCIFUL CONFIGURATION OF A CONCRETE SHORE BARRIER WITH A CURVED-PYRAMIDAL DESIGN EXTENDING ALONG ITS HORIZONTAL AXIS, AND ALTERNATING VERTICALLY ELONGATED TRIANGULAR THROUGH-HOLES.

SEC. 2(F).
FOR CONCRETE SHORE EROSION CONTROL BARRIERS (U.S. CLS. 1, 12, 33 AND 50).
FIRST USE 7-0-1989; IN COMMERCE 7-0-1989.
BARBARA A. GOLD, EXAMINING ATTORNEY

CLASS 19—(Continued).

SN 77-747,500. SWIFF-TRAIN COMPANY, LLC, CORPUS
CHRISTI, TX. FILED 5-29-2009.

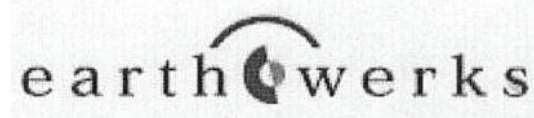

OWNER OF U.S. REG. NO. 3,507,558.
THE MARK CONSISTS OF THE WORD "EARTH" AND
"WERKS" SEPARATED BY A CIRCULAR SYMBOL AND
AN ARC EXTENDING FROM THE "H" TO THE "W".
FOR VINYL FLOORING (U.S. CLS. 1, 12, 33 AND 50).
TINA MAI, EXAMINING ATTORNEY

SN 77-785,038. SIMPSON DOOR COMPANY, TACOMA, WA.
FILED 7-20-2009.

PAMPLONA

THE MARK CONSISTS OF STANDARD CHARACTERS
WITHOUT CLAIM TO ANY PARTICULAR FONT, STYLE,
SIZE, OR COLOR.

FOR WOOD DOORS (U.S. CLS. 1, 12, 33 AND 50).
BRENDAN REGAN, EXAMINING ATTORNEY

SN 77-785,048. SIMPSON DOOR COMPANY, TACOMA, WA.
FILED 7-20-2009.

EMBARCADERO

THE MARK CONSISTS OF STANDARD CHARACTERS
WITHOUT CLAIM TO ANY PARTICULAR FONT, STYLE,
SIZE, OR COLOR.

FOR WOOD DOORS (U.S. CLS. 1, 12, 33 AND 50).
BRENDAN REGAN, EXAMINING ATTORNEY

SN 77-785,057. SIMPSON DOOR COMPANY, TACOMA, WA.
FILED 7-20-2009.

SCARBOROUGH

THE MARK CONSISTS OF STANDARD CHARACTERS
WITHOUT CLAIM TO ANY PARTICULAR FONT, STYLE,
SIZE, OR COLOR.

FOR WOOD DOORS (U.S. CLS. 1, 12, 33 AND 50).
BRENDAN REGAN, EXAMINING ATTORNEY

CLASS 19—(Continued).

SN 77-794,847. COLLEEN CAMPBELL REID, PARK CITY, UT. FILED 7-31-2009.



THE COLOR(S) GREEN AND WHITE IS/ARE CLAIMED AS A FEATURE OF THE MARK.

THE MARK CONSISTS OF AN IMAGE OF GRASS BLADES IN WHITE OVER A GREEN BACKGROUND.

FOR NON-LUMINOUS AND NON-MECHANICAL NON-METAL SIGNS FOR IDENTIFYING GREEN BUILDING FEATURES IN A STRUCTURE AND CONTAINING INFORMATION ABOUT GREEN BUILDING FEATURES, ECOLOGICAL PRINCIPLES AND GREEN PRODUCTS (U.S. CLS. 1, 12, 33 AND 50).

ESTHER A. BORSUK, EXAMINING ATTORNEY

SN 77-794,895. COLLEEN CAMPBELL REID, PARK CITY, UT. FILED 7-31-2009.



THE COLOR(S) RED AND WHITE IS/ARE CLAIMED AS A FEATURE OF THE MARK.

THE MARK CONSISTS OF A WHITE LIGHT BULB OVER A RED BACKGROUND.

FOR NON-LUMINOUS AND NON-MECHANICAL NON-METAL SIGNS FOR IDENTIFYING GREEN BUILDING FEATURES IN A STRUCTURE AND CONTAINING INFORMATION ABOUT GREEN BUILDING FEATURES, ECOLOGICAL PRINCIPLES AND GREEN PRODUCTS (U.S. CLS. 1, 12, 33 AND 50).

ESTHER A. BORSUK, EXAMINING ATTORNEY

CLASS 19—(Continued).

SN 77-798,673. STYLE CREST ENTERPRISES, INC., FREMONT, OH. FILED 8-6-2009.

BLUE RIDGE

THE MARK CONSISTS OF STANDARD CHARACTERS WITHOUT CLAIM TO ANY PARTICULAR FONT, STYLE, SIZE, OR COLOR.

FOR NON-METAL BUILDING PRODUCTS, NAMELY, FOAM CORE WALL PANELS AND FOUNDATION COVERINGS MOLDED TO RESEMBLE STONE (U.S. CLS. 1, 12, 33 AND 50).

JASON TURNER, EXAMINING ATTORNEY

SN 77-829,699. WILENSTEIN MANTELS, LLC, CHESAPEAKE, VA. FILED 9-18-2009.



NO CLAIM IS MADE TO THE EXCLUSIVE RIGHT TO USE "MANTELS", APART FROM THE MARK AS SHOWN.

THE MARK CONSISTS OF THE STYLIZED WORDS "WILENSTEIN MANTELS". AN IMAGE OF A MANTEL MOLDING INSIDE A SQUARE TO THE LEFT OF THE STYLIZED WORDS.

FOR FIREPLACE MANTELS (U.S. CLS. 1, 12, 33 AND 50).

FIRST USE 3-15-2009; IN COMMERCE 5-1-2009.

AMY C. KEAN, EXAMINING ATTORNEY

SN 77-848,694. VIMPORTEX CORPORATION, SMYRNA, GA. FILED 10-14-2009.



NO CLAIM IS MADE TO THE EXCLUSIVE RIGHT TO USE "FLOORS", APART FROM THE MARK AS SHOWN.

THE MARK CONSISTS OF THE STYLIZED TEXT "VECO FLOORS" WITH A CURVED LINE GOING THROUGH THE LETTER "V". AT THE BOTTOM OF THE CURVED LINE IS A SMALL CIRCLE.

FOR BAMBOO FLOORING; CERAMIC TILES FOR FLOORING AND FACING; HARD WOOD FLOORING; LAMINATE FLOORING; PARQUET FLOORING; REINFORCING MATERIALS NOT OF METAL FOR BUILDING PURPOSES; RUBBER FLOORING; VINYL FLOORING (U.S. CLS. 1, 12, 33 AND 50).

MARILYN IZZI, EXAMINING ATTORNEY

CLASS 19—(Continued).

SN 77-886,496. BROCK USA, BOULDER, CO. FILED 12-4-2009.

CLASS 19—(Continued).

SN 77-887,852. STONEXPRESS, INC., KENNESAW, GA. FILED 12-7-2009.

POWERBASE

TILESKIN

THE MARK CONSISTS OF STANDARD CHARACTERS WITHOUT CLAIM TO ANY PARTICULAR FONT, STYLE, SIZE, OR COLOR.
FOR FLOORING UNDERLAYMENTS (U.S. CLS. 1, 12, 33 AND 50).
FIRST USE 5-0-2009; IN COMMERCE 5-0-2009.
ANGELA DUONG, EXAMINING ATTORNEY

THE MARK CONSISTS OF STANDARD CHARACTERS WITHOUT CLAIM TO ANY PARTICULAR FONT, STYLE, SIZE, OR COLOR.
FOR BUILDING STONE; LIMESTONE; MARBLE; NATURAL STONE; SLATE; STONE FOR BUILDING AND CONSTRUCTION (U.S. CLS. 1, 12, 33 AND 50).
PAUL E. FAHRENKOPF, EXAMINING ATTORNEY

SN 77-887,442. ODL, INCORPORATED, ZEELAND, MI. FILED 12-7-2009.

SN 77-887,858. STONEXPRESS, INC., KENNESAW, GA. FILED 12-7-2009.

TRISYS

Tile-Z

THE MARK CONSISTS OF STANDARD CHARACTERS WITHOUT CLAIM TO ANY PARTICULAR FONT, STYLE, SIZE, OR COLOR.
FOR NON-METAL DOORGLASS FRAMES (U.S. CLS. 1, 12, 33 AND 50).
YAT SYE, LEE, EXAMINING ATTORNEY

THE MARK CONSISTS OF STANDARD CHARACTERS WITHOUT CLAIM TO ANY PARTICULAR FONT, STYLE, SIZE, OR COLOR.
FOR BUILDING STONE; LIMESTONE; MARBLE; NATURAL STONE; SLATE; STONE FOR BUILDING AND CONSTRUCTION (U.S. CLS. 1, 12, 33 AND 50).
PAUL E. FAHRENKOPF, EXAMINING ATTORNEY

SN 77-887,666. EMPIRE FOAM, LLC, WINTER GARDEN, FL. FILED 12-7-2009.

SN 77-888,784. COLD SPRING GRANITE COMPANY, COLD SPRING, MN. FILED 12-8-2009.

LTD SYSTEM

IRIDIAN

THE MARK CONSISTS OF STANDARD CHARACTERS WITHOUT CLAIM TO ANY PARTICULAR FONT, STYLE, SIZE, OR COLOR.
NO CLAIM IS MADE TO THE EXCLUSIVE RIGHT TO USE "SYSTEM", APART FROM THE MARK AS SHOWN.
FOR NON-METAL DECORATIVE MOLDINGS AND DECORATIVE TRIM FOR USE IN BUILDING CONSTRUCTION (U.S. CLS. 1, 12, 33 AND 50).
ZHALEH DELANEY, EXAMINING ATTORNEY

THE MARK CONSISTS OF STANDARD CHARACTERS WITHOUT CLAIM TO ANY PARTICULAR FONT, STYLE, SIZE, OR COLOR.
FOR GRANITE, CUT STONE, DIMENSIONAL STONE, SLABS OF GRANITE, AND MONUMENTAL STONE (U.S. CLS. 1, 12, 33 AND 50).
FIRST USE 0-0-1960; IN COMMERCE 0-0-1960.
KELLEY WELLS, EXAMINING ATTORNEY

CLASS 19—(Continued).

SN 77-888,979. LOUISIANA-PACIFIC CORPORATION,
NASHVILLE, TN. FILED 12-8-2009.

FLAMEBLOCK

THE MARK CONSISTS OF STANDARD CHARACTERS
WITHOUT CLAIM TO ANY PARTICULAR FONT, STYLE,
SIZE, OR COLOR.

FOR NON-METAL FIRE RESISTANT STRUCTURAL
BUILDING PANELS (U.S. CLS. 1, 12, 33 AND 50).
KEVIN CORWIN, EXAMINING ATTORNEY

CLASS 19—(Continued).

SN 77-892,389. RES-TEK INC., CARTERSVILLE, GA. FILED
12-14-2009.

PUR-CRETE

THE MARK CONSISTS OF STANDARD CHARACTERS
WITHOUT CLAIM TO ANY PARTICULAR FONT, STYLE,
SIZE, OR COLOR.

FOR URETHANE CEMENT FOR REFURBISHING
CONCRETE FLOORING OR FOR SEALING CONCRETE
FLOORING (U.S. CLS. 1, 12, 33 AND 50).
ADA HAN, EXAMINING ATTORNEY

SN 77-889,736. VERTI-CRETE, SANDY, UT. FILED 12-9-2009.

VERTI-BLOCK

THE MARK CONSISTS OF STANDARD CHARACTERS
WITHOUT CLAIM TO ANY PARTICULAR FONT, STYLE,
SIZE, OR COLOR.

OWNER OF U.S. REG. NOS. 2,871,145 AND 3,249,045.
FOR RETAINING WALL SYSTEM CONSISTING OF
ENGINEERED HOLLOW CEMENT BLOCKS (U.S. CLS. 1,
12, 33 AND 50).
TASNEEM HUSSAIN, EXAMINING ATTORNEY

SN 77-914,894. BATESVILLE SERVICES, INC., BATESVILLE,
IN. FILED 1-19-2010.

DURASTONE

THE MARK CONSISTS OF STANDARD CHARACTERS
WITHOUT CLAIM TO ANY PARTICULAR FONT, STYLE,
SIZE, OR COLOR.

FOR BURIAL VAULTS NOT OF METAL (U.S. CLS. 1,
12, 33 AND 50).
NATALIE POLZER, EXAMINING ATTORNEY

SN 77-890,253. MODULAR ARTS, INC., SEATTLE, WA.
FILED 12-10-2009.

MICROSCAPES

THE MARK CONSISTS OF STANDARD CHARACTERS
WITHOUT CLAIM TO ANY PARTICULAR FONT, STYLE,
SIZE, OR COLOR.

FOR NON-METALLIC BUILDING MATERIALS,
NAMELY, CEMENT-BASED TILES (U.S. CLS. 1, 12, 33
AND 50).
TRACY CROSS, EXAMINING ATTORNEY

SN 77-922,384. LOUISIANA-PACIFIC CORPORATION,
NASHVILLE, TN. FILED 1-28-2010.

SOLIDGUARD

THE MARK CONSISTS OF STANDARD CHARACTERS
WITHOUT CLAIM TO ANY PARTICULAR FONT, STYLE,
SIZE, OR COLOR.

FOR LAMINATED VENEER LUMBER; LAMINATED
STRAND LUMBER; BUILDING MATERIALS, NAMELY,
NON-METAL JOISTS, BEAMS, STUDS AND RIM
BOARD TREATED WITH CHEMICALS THAT RESIST
INSECTS (U.S. CLS. 1, 12, 33 AND 50).
KEVIN CORWIN, EXAMINING ATTORNEY

CLASS 19—(Continued).

SN 79-073,402. GLUNZ AG, 49716 MEPPEN, FED REP GERMANY, FILED 7-31-2009.

AGEPAN

THE MARK CONSISTS OF STANDARD CHARACTERS WITHOUT CLAIM TO ANY PARTICULAR FONT, STYLE, SIZE, OR COLOR.

PRIORITY DATE OF 2-7-2009 IS CLAIMED.

OWNER OF INTERNATIONAL REGISTRATION 1014665 DATED 7-31-2009, EXPIRES 7-31-2019.

FOR BUILDING MATERIALS, NAMELY, WOOD FIBER BOARDS, WOOD STRAND BOARDS, WOOD PARTICLE BOARDS, CELLULOSE FIBER BOARDS, VISCOSE FIBRE BOARDS, MEDIUM DENSITY FIBER BOARDS (MDF), ORIENTED STRAND BOARDS (OSB), BOARDS WITH A DECORATIVE SURFACE, HARD FIBER PLYWOOD, HIGH PRESSURE DECORATIVE LAMINATES (HPL) AND SOFT BOARDS (U.S. CLS. 1, 12, 33 AND 50).

SHAILA SETTLES, EXAMINING ATTORNEY

CLASS 19—(Continued).

SN 79-079,189. FLORIM CERAMICHE -; SOCIETA' PER AZIONI; ABBREVIABILE IN: "FLORIM S.P.A.", ITALY, FILED 11-13-2009.



PRIORITY DATE OF 9-29-2009 IS CLAIMED.
OWNER OF INTERNATIONAL REGISTRATION 1029587 DATED 11-13-2009, EXPIRES 11-13-2019.

THE TRADEMARK CONSISTS OF THE WORDING "WALLIGHT" WRITTEN IN CAPITAL CHARACTERS ARRANGED INSIDE A RECTANGULAR FRAME, OVER THE "I" AND INTERSECTING THE UPPER LINE THERE IS A SMALL SQUARE.

FOR ARTIFICIAL STONE; BUILDING STONE; NON-METALLIC TILES OF CERAMIC AND CLAY; NON-METALLIC TILE PLANKS OF CERAMIC AND CLAY; MOSAICS FOR BUILDING OF CERAMIC AND CLAY; NON-METALLIC BUILDING TILES OF CERAMIC AND CLAY; NON-METAL WALL AND FLOOR TILES FOR BUILDING; NON-METAL PAVING SLABS OF CERAMIC AND CLAY; NON-METAL FLOOR AND WALL PANELS; FITTED NON-METAL PANELS FOR SWIMMING POOL AREA COVERING; NON-METAL SWIMMING POOLS; NON-METAL BUILDING MATERIALS, NAMELY, DIVING BOARDS, NOT OF METAL (U.S. CLS. 1, 12, 33 AND 50).

WILLIAM ROSSMAN, EXAMINING ATTORNEY

SN 79-073,843. GMUNDNER FERTIGTEILE; GESELLSCHAFT M.B.H. & CO. KG., A-4810 GMUNDEN, AUSTRIA, FILED 8-28-2009.

BO-TRAIL

THE MARK CONSISTS OF STANDARD CHARACTERS WITHOUT CLAIM TO ANY PARTICULAR FONT, STYLE, SIZE, OR COLOR.

PRIORITY DATE OF 4-7-2009 IS CLAIMED.

OWNER OF INTERNATIONAL REGISTRATION 1015844 DATED 8-28-2009, EXPIRES 8-28-2019.

FOR PREFABRICATED BUILDING MATERIALS OF CONCRETE AND POLYMER CONCRETE, NAMELY, BLOCKS, BRICKS, POSTS, SLABS, PANELS FOR USE IN STRUCTURAL AND CIVIL ENGINEERING AND ROAD BUILDING; BUILDING MATERIALS, NAMELY, SLABS AND PROFILE STRIPS OF STONE, ARTIFICIAL STONE, CEMENT, CONCRETE OR POLYMER CONCRETE; ROAD TOPPING MATERIAL FOR RAIL OR ROAD CROSSINGS, NAMELY, CONCRETE ROAD PAVEMENT BOARDS (U.S. CLS. 1, 12, 33 AND 50).

STEVEN PEREZ, EXAMINING ATTORNEY

CLASS 20—FURNITURE AND ARTICLES NOT OTHERWISE CLASSIFIED

SN 76-690,270. TRU TECH CORPORATION, TORONTO, ONTARIO, CANADA, FILED 6-4-2008.

BELMONT

THE MARK CONSISTS OF STANDARD CHARACTERS WITHOUT CLAIM TO ANY PARTICULAR FONT, STYLE, SIZE, OR COLOR.

FOR DOOR STOPS OF PLASTIC AND WOOD (U.S. CLS. 2, 13, 22, 25, 32 AND 50).

ELI HELLMAN, EXAMINING ATTORNEY

CLASS 20—(Continued).

SN 76-694,824. PERRY INNOVATION LIMITED, DROITWICH, WORCESTERSHIRE WR9 0QY, UNITED KINGDOM, FILED 12-15-2008.

BABYDAM

PRIORITY CLAIMED UNDER SEC. 44(D) ON EUROPEAN UNION APPLICATION NO. 007193196, FILED 8-27-2008, REG. NO. 007193196, DATED 5-28-2009, EXPIRES 8-27-2018.
FOR PLASTIC BARRIER DEVICES FOR REDUCING THE AMOUNT OF WATER USED IN A RECEPTACLE WHEN BATHING HUMANS AND ANIMALS (U.S. CLS. 2, 13, 22, 25, 32 AND 50).

SUSAN STIGLITZ, EXAMINING ATTORNEY

SN 77-497,813. HIGHMARK, INC, HUNTINGTON BEACH, CA. FILED 6-12-2008.

Coto

THE MARK CONSISTS OF STANDARD CHARACTERS WITHOUT CLAIM TO ANY PARTICULAR FONT, STYLE, SIZE, OR COLOR.
FOR OFFICE FURNITURE (U.S. CLS. 2, 13, 22, 25, 32 AND 50).
THEODORE MCBRIDE, EXAMINING ATTORNEY

CLASS 20—(Continued).

SN 77-620,678. DISNEY ENTERPRISES, INC., BURBANK, CA. FILED 11-24-2008.



OWNER OF U.S. REG. NOS. 3,506,492 AND 3,578,029.
NO CLAIM IS MADE TO THE EXCLUSIVE RIGHT TO USE "DESIGN" AND "KITCHENWARE", "BEDDING", "ROOM DÉCOR", "LIGHTING", "FURNITURE" AND "BATH", APART FROM THE MARK AS SHOWN.

THE MARK CONSISTS OF THE WORDING "DISNEY DESIGN SOLUTION" INSIDE A CIRCLE OF SIX SHADED HEXAGONS. FROM THE TOP AND MOVING TO THE RIGHT, WITHIN EACH HEXAGON IS A STYLIZED REPRESENTATION OF A DINNERWARE SET AND UTENSILS, A BED, A PICTURE FRAME, A LAMP, A CHAIR, AND A BATHTUB. THE WORDING "KITCHENWARE, BEDDING, ROOM DÉCOR, LIGHTING, FURNITURE, BATH" ENCIRCLES THE IMAGE WITH SMALL DOTS BETWEEN EACH TERM.

FOR PICTURE FRAMES; SLEEPING BAGS; MIRRORS; PLASTIC NAME BADGES; PILLOWS; FURNITURE; CABINETS BEING FURNITURE; TOWEL RACKS; NON-METAL HOOKS; BOXES, NAMELY, WOODEN BOXES WITH A LOCKED STORAGE AREA FOR PERSONAL ITEMS, PLASTIC BOXES, TOY BOXES BEING FURNITURE, AND WOOD BOXES (U.S. CLS. 2, 13, 22, 25, 32 AND 50).

MARY BOAGNI, EXAMINING ATTORNEY

SN 77-745,364. ANCHOR HOCKING, LLC, LANCASTER, OH. FILED 5-27-2009.

TrueSeal
by anchor

OWNER OF U.S. REG. NO. 756,056.
THE MARK CONSISTS OF THE WORDS "TRUESEAL BY ANCHOR" IN STYLIZED FONT WITH "TRUESEAL" APPEARING ABOVE "BY ANCHOR".
FOR PLASTIC LIDS FOR GLASS CONTAINERS FOR HOUSEHOLD AND KITCHEN USE (U.S. CLS. 2, 13, 22, 25, 32 AND 50).
JOHN E. MICHOS, EXAMINING ATTORNEY

CLASS 20—(Continued).

SN 77-759,979. JUDI COSTELLO, DBA UNIQUE UPHOLSTERY & INTERIOR DESIGN,LLC, COVINA, CA. FILED 6-15-2009.

BabyBunns.com

THE MARK CONSISTS OF THE NAME "BABYBUNNS.COM".

FOR CHAIR CUSHIONS, BOOSTER CUSHIONS FOR BABIES AND CHILDREN (U.S. CLS. 2, 13, 22, 25, 32 AND 50).

DARRYL SPRUILL, EXAMINING ATTORNEY

SN 77-761,631. HOOVER, BRYAN T., MONROE, GA. FILED 6-17-2009.

The Do Better Chair

THE MARK CONSISTS OF STANDARD CHARACTERS WITHOUT CLAIM TO ANY PARTICULAR FONT, STYLE, SIZE, OR COLOR.

NO CLAIM IS MADE TO THE EXCLUSIVE RIGHT TO USE "CHAIR", APART FROM THE MARK AS SHOWN.

FOR CHAIRS (U.S. CLS. 2, 13, 22, 25, 32 AND 50).
LINDA ORNDORFF, EXAMINING ATTORNEY

SN 77-772,113. FOCUS PRODUCTS GROUP, LLC, VERNON HILLS, IL. FILED 7-1-2009.

WIRETECH

THE MARK CONSISTS OF STANDARD CHARACTERS WITHOUT CLAIM TO ANY PARTICULAR FONT, STYLE, SIZE, OR COLOR.

FOR ADJUSTABLE, MODULAR SHELVING SYSTEMS COMPRISED OF SHELVES, DRAWERS, CASTERS, CONNECTORS, DIVIDERS, HOOKS, LINERS, POSTS, RECEPTACLES AND/OR RACKS (U.S. CLS. 2, 13, 22, 25, 32 AND 50).

FIRST USE 5-0-1996; IN COMMERCE 5-0-1996.
SEAN CROWLEY, EXAMINING ATTORNEY

CLASS 20—(Continued).

SN 77-867,464. ONE-O-NINE INVESTMENTS, INC., DBA THE GARAGE ORGANIZATION COMPANY, PHOENIX, AZ. FILED 11-6-2009.



NO CLAIM IS MADE TO THE EXCLUSIVE RIGHT TO USE "THE GARAGE ORGANIZATION COMPANY" AND "MAXIMIZING YOUR STORAGE SPACE", APART FROM THE MARK AS SHOWN.

THE COLOR(S) RED, BLACK, LIGHT GRAY, MEDIUM GRAY, DARK GRAY IS/ARE CLAIMED AS A FEATURE OF THE MARK.

THE MARK CONSISTS OF THE DESIGN OF A GARAGE WITH MEDIUM GRAY IN THE ANGLED ROOFLINE WITH LINES THRU IT TO RESEMBLE SHINGLES. THE COLOR(S) RED APPEARS AS A TRIANGLE GABLE END UNDER THE ANGLED ROOFLINE. THE COLOR(S) LIGHT GRAY APPEARS IN THE RECTANGLE GARAGE WITH CURVED SIDES TO REFLECT FULLNESS WITH MEDIUM GRAY LINES TO RESEMBLE A BRICK PATTERN. THE COLOR(S) DARK GRAY APPEARS AS THE CURVED SIDES OF THE GARAGE DOOR OPENING INSIDE THE LIGHT GRAY GARAGE WITH BRICK PATTERN LINES. THE COLOR(S) DARK GRAY APPEARS AS FOUR LINES RUNNING THROUGH THE INNER RECTANGLE WITH CURVED SIDES. THE COLOR(S) BLACK APPEARS IN THE WORDING "MAXIMIZING YOUR STORAGE SPACE" BETWEEN THE LINES RUNNING THROUGH THE INNER RECTANGLES OF THE GARAGE DOOR WITH CURVED SIDES. THE COLOR(S) RED APPEARS IN THE WORDING "THE GARAGE ORGANIZATION COMPANY" WHICH APPEARS TO THE RIGHT AND BELOW THE GARAGE.

FOR SHELVING AND COMPONENT PARTS THEREOF, NAMELY, SHELVES AND BRACKETS SOLD AS A UNIT; STORAGE AND ORGANIZATION SYSTEMS COMPRISING SHELVES, DRAWERS, CUPBOARDS, BASKETS AND CLOTHES RODS, SOLD AS A UNIT (U.S. CLS. 2, 13, 22, 25, 32 AND 50).

FIRST USE 7-1-2009; IN COMMERCE 7-1-2009.

MICHAEL WEBSTER, EXAMINING ATTORNEY

SN 77-876,408. SCIO VERUM CORPORATION, PALM BEACH, FL. FILED 11-19-2009.

BRIAN VICKERS

THE MARK CONSISTS OF STANDARD CHARACTERS WITHOUT CLAIM TO ANY PARTICULAR FONT, STYLE, SIZE, OR COLOR.

OWNER OF U.S. REG. NOS. 2,869,705 AND 2,893,388.

THE NAME "BRIAN VICKERS" IDENTIFIES A LIVING INDIVIDUAL WHOSE CONSENT IS OF RECORD.

FOR NON-METAL NOVELTY LICENSE PLATES; SEAT CUSHIONS (U.S. CLS. 2, 13, 22, 25, 32 AND 50).

FIRST USE 0-0-2005; IN COMMERCE 0-0-2005.

LESLIE RICHARDS, EXAMINING ATTORNEY

CLASS 20—(Continued).

SN 77-877,490. KLEAR-VU CORPORATION, FALL RIVER, MA. FILED 11-20-2009.

GRIP-DOT

THE MARK CONSISTS OF STANDARD CHARACTERS WITHOUT CLAIM TO ANY PARTICULAR FONT, STYLE, SIZE, OR COLOR.

FOR CHAIR CUSHIONS AND STOOL CUSHIONS (U.S. CLS. 2, 13, 22, 25, 32 AND 50).

FIRST USE 11-19-2009; IN COMMERCE 11-19-2009.
DEIRDRE ROBERTSON, EXAMINING ATTORNEY

CLASS 20—(Continued).

SN 77-884,637. OUTPAK LLC, BOISE, ID. FILED 12-2-2009.

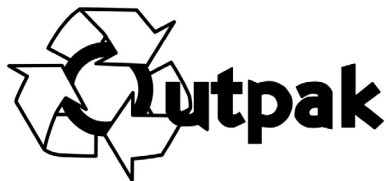

THE MARK CONSISTS OF THE WORDING "OUTPAK" IN STYLIZED LETTERS WITH THE INTEGRATED DESIGN OF THREE-BENT ARROWS, WHICH RESEMBLE A RECYCLING SYMBOL, ENCIRCLING THE LETTER "O" IN A CLOCKWISE DIRECTION.

FOR NONMETALLIC CONTAINERS FOR CONTROLLING, CAPTURING, AND CONTAINING CONCRETE WASHOUT MATERIAL, WASTE CONCRETE, AND BUILDING MATERIAL REFUSE (U.S. CLS. 2, 13, 22, 25, 32 AND 50).

FIRST USE 3-6-2009; IN COMMERCE 8-1-2009.
JUDITH HELFMAN, EXAMINING ATTORNEY

SN 77-880,762. ULTRA PLAY SYSTEMS, INC., RED BUD, IL. FILED 11-25-2009.

ULTRASITE

THE MARK CONSISTS OF STANDARD CHARACTERS WITHOUT CLAIM TO ANY PARTICULAR FONT, STYLE, SIZE, OR COLOR.

FOR OUTDOOR BENCHES AND TABLES (U.S. CLS. 2, 13, 22, 25, 32 AND 50).

FONG HSU, EXAMINING ATTORNEY

SN 77-884,812. WEIDONG ZHANG, CITY OF INDUSTRY, CA. FILED 12-2-2009.

EUKYA

THE MARK CONSISTS OF STANDARD CHARACTERS WITHOUT CLAIM TO ANY PARTICULAR FONT, STYLE, SIZE, OR COLOR.

THE WORDING "EUKYA" HAS NO MEANING IN A FOREIGN LANGUAGE.

FOR SEATS; TABLES (U.S. CLS. 2, 13, 22, 25, 32 AND 50).

FIRST USE 9-1-2002; IN COMMERCE 9-1-2002.
ALLISON SCHRODY, EXAMINING ATTORNEY

SN 77-883,509. SHELLSTONE, INC., FORMERLY ARTFUL WARES, INC., OLD TOWN, ME. FILED 12-1-2009.

SHELLSTONE

THE MARK CONSISTS OF STANDARD CHARACTERS WITHOUT CLAIM TO ANY PARTICULAR FONT, STYLE, SIZE, OR COLOR.

FOR TILE SHAPED WORKS OF ART MADE FROM RECLAIMED SEASHELLS (U.S. CLS. 2, 13, 22, 25, 32 AND 50).

FIRST USE 9-15-2009; IN COMMERCE 9-15-2009.
TRICIA SONNEBORN, EXAMINING ATTORNEY

SN 77-885,119. GREENWADE, ALBERT, CROSBY, TX. FILED 12-3-2009.

KEWLLID

THE MARK CONSISTS OF STANDARD CHARACTERS WITHOUT CLAIM TO ANY PARTICULAR FONT, STYLE, SIZE, OR COLOR.

FOR RECYCLED PLASTIC SUPPORT LIDS FOR 55-GALLON DRUMS OR OTHER WASTE RECEPTACLES TO HOLD BEVERAGE COOLERS WHILE PROVIDING AN OPENING FOR TRASH (U.S. CLS. 2, 13, 22, 25, 32 AND 50).

FIRST USE 10-0-2009; IN COMMERCE 11-2-2009.
SOPHIA S. KIM, EXAMINING ATTORNEY

CLASS 20—(Continued).

SN 77-885,714. ABE WILLIAM MIKOTA AND TAUSHA RAE MAY, HELENA, MT. FILED 12-3-2009.

Not jok'n, outside smok'n

THE MARK CONSISTS OF STANDARD CHARACTERS WITHOUT CLAIM TO ANY PARTICULAR FONT, STYLE, SIZE, OR COLOR.
FOR PLASTIC GOODS, NAMELY, TABLETOP SIGNAGE HOLDERS (U.S. CLS. 2, 13, 22, 25, 32 AND 50).
TINA BROWN, EXAMINING ATTORNEY

SN 77-887,255. STYLEX, INC., DELANCO, NJ. FILED 12-7-2009.

SAVA

THE MARK CONSISTS OF STANDARD CHARACTERS WITHOUT CLAIM TO ANY PARTICULAR FONT, STYLE, SIZE, OR COLOR.
FOR FURNITURE, NAMELY, CHAIRS (U.S. CLS. 2, 13, 22, 25, 32 AND 50).
VIVIAN MICZNIK FIRST, EXAMINING ATTORNEY

SN 77-887,321. NATIONWIDE INDUSTRIES, INC., TAMPA, FL. FILED 12-7-2009.

AQUALATCH

THE MARK CONSISTS OF STANDARD CHARACTERS WITHOUT CLAIM TO ANY PARTICULAR FONT, STYLE, SIZE, OR COLOR.
FOR GATE HARDWARE, NAMELY, NON-METAL MAGNETIC GATE LATCH (U.S. CLS. 2, 13, 22, 25, 32 AND 50).
JASON TURNER, EXAMINING ATTORNEY

CLASS 20—(Continued).

SN 77-887,335. NATIONWIDE INDUSTRIES, INC., TAMPA, FL. FILED 12-7-2009.

SAFE-ALERT

THE MARK CONSISTS OF STANDARD CHARACTERS WITHOUT CLAIM TO ANY PARTICULAR FONT, STYLE, SIZE, OR COLOR.
FOR GATE HARDWARE, NAMELY, NON-METAL MAGNETIC GATE LATCH (U.S. CLS. 2, 13, 22, 25, 32 AND 50).
JASON TURNER, EXAMINING ATTORNEY

SN 77-887,968. ESSENTIAL ENTERPRISES LTD., SURREY, BRITISHCOLUMBIA, CANADA, FILED 12-7-2009.

TCA

THE MARK CONSISTS OF STANDARD CHARACTERS WITHOUT CLAIM TO ANY PARTICULAR FONT, STYLE, SIZE, OR COLOR.
FOR TOOL CABINETS, STORAGE CABINETS, STORAGE SHELVES (U.S. CLS. 2, 13, 22, 25, 32 AND 50).
FIRST USE 12-31-2008; IN COMMERCE 12-31-2008.
ANGELA M. MICHELI, EXAMINING ATTORNEY

SN 77-887,972. SIGMA-TEK LLC, PROVO, UT. FILED 12-7-2009.

GEOSTRUT

THE MARK CONSISTS OF STANDARD CHARACTERS WITHOUT CLAIM TO ANY PARTICULAR FONT, STYLE, SIZE, OR COLOR.
FOR REINFORCING MATERIALS, NAMELY, A CYLINDRICAL, LATTICE STRUCTURE MADE OF CARBON COMPOSITE MATERIALS USED TO BUILD PRODUCTS IN VARIOUS INDUSTRIES SUCH AS THE AEROSPACE, AUTOMOTIVE, COMMUNICATION, CONSTRUCTION, AND SPORTING GOODS INDUSTRIES (U.S. CLS. 2, 13, 22, 25, 32 AND 50).
FIRST USE 8-7-2008; IN COMMERCE 8-15-2008.
ANGELA M. MICHELI, EXAMINING ATTORNEY

CLASS 20—(Continued).

SN 77-888,645. ENGLANDER SLEEP PRODUCTS, L.L.C., BATON ROUGE, LA. FILED 12-8-2009.

LIFE STYLE COOL

THE MARK CONSISTS OF STANDARD CHARACTERS WITHOUT CLAIM TO ANY PARTICULAR FONT, STYLE, SIZE, OR COLOR.

OWNER OF U.S. REG. NO. 947,911.
FOR MATTRESSES AND FOUNDATIONS (U.S. CLS. 2, 13, 22, 25, 32 AND 50).

DOMINICK J. SALEMI, EXAMINING ATTORNEY

CLASS 20—(Continued).

SN 77-889,815. GRAND JK & C LTD, CITY OF INDUSTRY, CA. FILED 12-9-2009.



THE MARK CONSISTS OF THE LITERAL ELEMENT "J & K" INSIDE TWO TRIANGLES.

FOR BATHROOM VANITIES; KITCHEN CABINETS (U.S. CLS. 2, 13, 22, 25, 32 AND 50).

FIRST USE 6-1-2007; IN COMMERCE 6-1-2007.

JASON TURNER, EXAMINING ATTORNEY

SN 77-889,709. GREENWADE, ALBERT, CROSBY, TX. FILED 12-9-2009.



THE MARK CONSISTS OF THE WORD "KEWLLID" WITH A HORIZONTAL LINE THROUGH THE "K" AND "LID" PORTION OF THE WORD. THERE IS A LARGE WATER DROPLET BEHIND THE "KEWLLID", WITH A MEDIUM SIZED WATER DROPLET TO THE LEFT AND A SMALL SIZED WATER DROPLET TO THE RIGHT BELOW THE LARGE WATER DROPLET AND "KEWLLID".

FOR RECYCLED PLASTIC SUPPORT LIDS FOR 55-GALLON DRUMS OR OTHER WASTE RECEPTACLES TO HOLD BEVERAGE COOLERS WHILE PROVIDING AN OPENING FOR TRASH (U.S. CLS. 2, 13, 22, 25, 32 AND 50).

FIRST USE 10-0-2009; IN COMMERCE 11-2-2009.

SOPHIA S. KIM, EXAMINING ATTORNEY

SN 77-890,575. UNIVERSITY OF NORTHWESTERN OHIO, LIMA, OH. FILED 12-10-2009.



THE COLOR(S) RED, BLACK AND WHITE IS/ARE CLAIMED AS A FEATURE OF THE MARK.

THE MARK CONSISTS OF A RED LARGE "U" OUTLINED IN BLACK AND WHITE WITH THE STYLIZED WORDING "MOTORSPORTS" ARCHED ACROSS MIDDLE IN WHITE LETTERS WITH RED, BLACK, AND WHITE OUTLINING AND THE STYLIZED WORDING "UNOH" IN BLACK AND RED OUTLINED IN WHITE ACROSS THE BOTTOM OF THE "U".

FOR NON-METAL KEY RINGS; PICTURE FRAMES (U.S. CLS. 2, 13, 22, 25, 32 AND 50).

LIEF MARTIN, EXAMINING ATTORNEY

CLASS 20—(Continued).

SN 77-892,868. HEARST COMMUNICATIONS, INC., NEW YORK, NY. FILED 12-14-2009.



NO CLAIM IS MADE TO THE EXCLUSIVE RIGHT TO USE "HOME" & "1846", APART FROM THE MARK AS SHOWN.

THE MARK CONSISTS OF THE WORDS, LETTERS, AND NUMBERS "HOME", "T&C", AND "1846" ARRANGED VERTICALLY AND SURROUNDED BY A CIRCULAR BORDER MADE OF A WREATH OF LEAVES.

FOR FURNITURE; MIRRORS; PICTURE FRAMES; PILLOWS (U.S. CLS. 2, 13, 22, 25, 32 AND 50).

KARANENDRA S. CHHINA, EXAMINING ATTORNEY

SN 77-893,080. SHELLSTONE, INC., FORMERLY ARTFUL WARES, INC., OLD TOWN, ME. FILED 12-14-2009.

SHELLSTONE

THE MARK CONSISTS OF STANDARD CHARACTERS WITHOUT CLAIM TO ANY PARTICULAR FONT, STYLE, SIZE, OR COLOR.

FOR CONTAINERS, NOT OF METAL FOR COMMERCIAL USE; NON-METAL BINS; ORNAMENTS MADE OF SEASHELLS, NOT BEING CHRISTMAS TREE ORNAMENTS; PICTURE AND PHOTOGRAPH FRAMES; PICTURE FRAMES; SEA SHELLS (U.S. CLS. 2, 13, 22, 25, 32 AND 50).

FIRST USE 8-15-2009; IN COMMERCE 8-15-2009.
TRICIA SONNEBORN, EXAMINING ATTORNEY

SN 77-894,154. LIFELINK PARTNERS, LLC, LAS VEGAS, NV. FILED 12-15-2009.

LIFELINK

THE MARK CONSISTS OF STANDARD CHARACTERS WITHOUT CLAIM TO ANY PARTICULAR FONT, STYLE, SIZE, OR COLOR.

FOR FUNERARY URNS (U.S. CLS. 2, 13, 22, 25, 32 AND 50).

Laurie Mayes, Examining Attorney

CLASS 20—(Continued).

SN 77-894,463. LAURA BRITT DESIGN, LLC, AUSTIN, TX. FILED 12-16-2009.

VERVANO

THE MARK CONSISTS OF STANDARD CHARACTERS WITHOUT CLAIM TO ANY PARTICULAR FONT, STYLE, SIZE, OR COLOR.

FOR FURNITURE; OUTDOOR FURNITURE (U.S. CLS. 2, 13, 22, 25, 32 AND 50).

SUSAN RICHARDS, EXAMINING ATTORNEY

SN 77-898,842. HALLMARK LICENSING, INC., KANSAS CITY, MO. FILED 12-22-2009.

ONE TOUGH CHICK

THE MARK CONSISTS OF STANDARD CHARACTERS WITHOUT CLAIM TO ANY PARTICULAR FONT, STYLE, SIZE, OR COLOR.

FOR CUSHIONS; PICTURE AND PHOTOGRAPH FRAMES; PILLOWS; WALL PLAQUES MADE OF PLASTIC OR WOOD (U.S. CLS. 2, 13, 22, 25, 32 AND 50).

ELIZABETH KAJUBI, EXAMINING ATTORNEY

SN 77-900,734. THE GORDON PARTNERSHIP, WILMETTE, IL. FILED 12-24-2009.



NO CLAIM IS MADE TO THE EXCLUSIVE RIGHT TO USE "PETS", APART FROM THE MARK AS SHOWN.

THE MARK CONSISTS OF THE WORDS "PETS IN PEACE" BELOW "P.I.P." ALONG WITH THE IMAGE OF A TOMBSTONE AND WINGS AND A HALO.

FOR COFFINS; PET CASKETS (U.S. CLS. 2, 13, 22, 25, 32 AND 50).

MARY ROSSMAN, EXAMINING ATTORNEY

CLASS 20—(Continued).

SN 77-912,654. WILNER, ELI, NEW YORK, NY. FILED 1-15-2010.

ELI WILNER

THE MARK CONSISTS OF STANDARD CHARACTERS WITHOUT CLAIM TO ANY PARTICULAR FONT, STYLE, SIZE, OR COLOR.

THE NAME(S), PORTRAIT(S), AND/OR SIGNATURE(S) SHOWN IN THE MARK IDENTIFIES "ELI WILNER", WHOSE CONSENT(S) TO REGISTER IS MADE OF RECORD.

FOR FRAMES FOR PAINTINGS; PICTURE FRAMES (U.S. CLS. 2, 13, 22, 25, 32 AND 50).

VIVIAN MICZNIK FIRST, EXAMINING ATTORNEY

SN 77-914,997. DREAMWELL, LTD., LAS VEGAS, NV. FILED 1-19-2010.

SIMCO

THE MARK CONSISTS OF STANDARD CHARACTERS WITHOUT CLAIM TO ANY PARTICULAR FONT, STYLE, SIZE, OR COLOR.

FOR MATTRESSES AND BOX SPRINGS (U.S. CLS. 2, 13, 22, 25, 32 AND 50).

TASNEEM HUSSAIN, EXAMINING ATTORNEY

SN 77-916,056. SUSTAINABLE GROUP HOLDINGS LLC, SEATTLE, WA. FILED 1-20-2010.



THE MARK CONSISTS OF LEAVES IN A CIRCULAR PATTERN AND THE WORD "REBADGE".

FOR RECYCLABLE CLEAR PLASTIC NAME BADGE HOLDERS (U.S. CLS. 2, 13, 22, 25, 32 AND 50).

LYDIA BELZER, EXAMINING ATTORNEY

SN 77-923,883. DREAMWELL, LTD., LAS VEGAS, NV. FILED 1-29-2010.



THE MARK CONSISTS OF A CURVED LINE. FOR MATTRESSES AND BOX SPRINGS (U.S. CLS. 2, 13, 22, 25, 32 AND 50).

TASNEEM HUSSAIN, EXAMINING ATTORNEY

CLASS 20—(Continued).

SN 77-923,955. DREAMWELL, LTD., LAS VEGAS, NV. FILED 1-29-2010.



THE MARK CONSISTS OF THE LETTER "B" IN A STYLIZED SCRIPT.

FOR MATTRESSES AND BOX SPRINGS (U.S. CLS. 2, 13, 22, 25, 32 AND 50).

TASNEEM HUSSAIN, EXAMINING ATTORNEY

SN 79-073,671. HINTZ, SIEGFRIED, FED REP GERMANY, FILED 8-22-2009.

QUICKSTOP

OWNER OF INTERNATIONAL REGISTRATION 0657051 DATED 3-5-1996, EXPIRES 3-5-2016.

THE MARK CONSISTS OF THE WORDING "QUICKSTOP" WHEREIN THE LETTER "O" APPEARS AS A DESIGN OF SUPERIMPOSED CIRCLES.

FOR CLOSURES OF PLASTICS FOR CONTAINERS WITH INTEGRAL POURING SPOUTS; CLOSURES OF COMBINED PLASTIC AND METAL FOR CONTAINERS WITH INTEGRAL POURING SPOUTS (U.S. CLS. 2, 13, 22, 25, 32 AND 50).

SKYE YOUNG, EXAMINING ATTORNEY

CLASS 21—HOUSEWARES AND GLASS

SN 76-700,960. TEXAS FOREVER, INC., HOUSTON, TX. FILED 12-22-2009.

KEEP TEXAS TEXAS

THE MARK CONSISTS OF STANDARD CHARACTERS WITHOUT CLAIM TO ANY PARTICULAR FONT, STYLE, SIZE, OR COLOR.

FOR COFFEE CUPS (U.S. CLS. 2, 13, 23, 29, 30, 33, 40 AND 50).

FIRST USE 12-8-2009; IN COMMERCE 12-8-2009.

ALLISON SCHRODY, EXAMINING ATTORNEY

CLASS 21—(Continued).

SN 77-061,989. CAMPING WORLD, INC., BOWLING GREEN, KY. FILED 12-12-2006.

CLASS 21—(Continued).

SN 77-176,914. NEW LINE PRODUCTIONS, INC., NEW YORK, NY. FILED 5-9-2007.

ROAM

Link

THE MARK CONSISTS OF STANDARD CHARACTERS WITHOUT CLAIM TO ANY PARTICULAR FONT, STYLE, SIZE, OR COLOR.

FOR RECREATIONAL VEHICLE ACCESSORIES, NAMELY, PLASTIC STORAGE CONTAINERS FOR DOMESTIC USE THAT ARE ADAPTED FOR USE IN RECREATIONAL VEHICLES; RECREATIONAL VEHICLE ACCESSORIES, NAMELY, COOKING UTENSILS IN THE NATURE OF FUNNELS, SPATULAS, STRAINERS, DISHES, GRILLS, AND STOVE BURNER COVERS, SPICE RACKS, TRAYS, COOKING GRATERS, SINKWARE ORGANIZERS IN THE NATURE OF DISH DRYING RACKS, PLATES, POTS AND PANS, ICE TRAYS, CUPS, BEVERAGE AND DRINKING GLASSES, DISH DRAINS IN THE NATURE OF DRAIN STOPPERS FOR SINKS AND DRAINS AND DISH DRYING RACKS, CUTTING MATS FOR USE IN FOOD PREPARATION, BEVERAGE STIRRERS, GRILLING TONGS, AND CAFETERIA TRAYS THAT ARE ADAPTED FOR USE IN RECREATIONAL VEHICLES; RECREATIONAL VEHICLE ACCESSORIES, NAMELY, WASHING AND SCRUBBING BRUSHES ADAPTED FOR USE IN RECREATIONAL VEHICLES; RECREATIONAL VEHICLE ACCESSORIES, NAMELY, COOKWARE IN THE NATURE OF POTS, PANS, ROASTING PANS, MICRO-WAVE PANS, COOKWARE COVERS IN THE NATURE OF POT AND PAN COVERS, AND COOKING UTENSILS, NAMELY, GRILLS ADAPTED FOR USE IN RECREATIONAL VEHICLES, ALL OF THE AFOREMENTIONED GOODS ARE ADAPTED FOR USE IN RECREATIONAL VEHICLES BUT NOT SPECIALLY FITTED FOR USE IN RECREATION VEHICLES AND COULD BE USED OUTSIDE OF RECREATIONAL VEHICLES (U.S. CLS. 2, 13, 23, 29, 30, 33, 40 AND 50).

TINA BROWN, EXAMINING ATTORNEY

FOR GLASS, CERAMIC AND EARTHENWARE GOODS, NAMELY, BEVERAGE GLASSWARE, COFFEE MUGS, MUGS, JUGS, BOWLS, PLATES, COASTERS NOT OF PAPER AND NOT BEING TABLE LINEN, COFFEE CUPS AND CUPS; DEMITASSE SETS CONSISTING OF CUPS AND SAUCERS; SUGAR AND CREAMER SETS CONSISTING OF SUGAR BOWLS AND CREAMER PITCHERS; INFANT CUPS; COOKIE JARS; CERAMIC, GLASS AND CHINA FIGURINES; NON-ELECTRIC COFFEE POTS NOT OF PRECIOUS METAL; WASTEPAPER BASKETS; ICE BUCKETS; PLASTIC BUCKETS; SHOWER CADDIES; TEA CADDIES; CAKE MOLDS; SCRAPERS FOR HOUSEHOLD PURPOSES, AND CAKE SERVERS; CANTEENS; CHAMPAGNE BUCKETS; PLASTIC COASTERS, COCKTAIL SHAKERS; THERMAL INSULATED CONTAINERS FOR FOOD OR BEVERAGES; COOKIE CUTTERS, CORK SCREWS; CORN COB HOLDERS; PLASTIC WATER BOTTLES SOLD EMPTY; VACUUM BOTTLES; DECANTERS; DRINKING FLASKS; GARDENING GLOVES; RUBBER HOUSEHOLD GLOVES; DINNERWARE; PAPER PLATES AND PAPER CUPS; BRUSHES, NAMELY, HAIR BRUSHES, TOOTH BRUSHES, CLOTHES BRUSHES; KITCHEN UTENSILS, NAMELY, ROLLING PINS, SPATULAS, TURNERS, WHISKS, AND KITCHEN CONTAINERS NOT OF PRECIOUS METAL, SOAP CONTAINERS, HOUSEHOLD FOOD CONTAINERS AND LUNCH BOXES; PLASTIC CUPS AND PLATES, ALL RELATING TO THE CHARACTER OF THE SAME NAME IN THE MOVIE HAIRSPRAY (U.S. CLS. 2, 13, 23, 29, 30, 33, 40 AND 50).

VIVIAN MICZNIK FIRST, EXAMINING ATTORNEY

CLASS 21—(Continued).

SN 77-176,929. NEW LINE PRODUCTIONS, INC., NEW YORK, NY. FILED 5-9-2007.



FOR GLASS, CERAMIC AND EARTHENWARE GOODS, NAMELY, BEVERAGE GLASSWARE, COFFEE MUGS, MUGS, JUGS, BOWLS, PLATES, COASTERS NOT OF PAPER AND NOT BEING TABLE LINEN, COFFEE CUPS AND CUPS; DEMITASSE SETS CONSISTING OF CUPS AND SAUCERS; SUGAR AND CREAMER SETS CONSISTING OF SUGAR BOWLS AND CREAMER PITCHERS; INFANT CUPS; COOKIE JARS; CERAMIC, GLASS AND CHINA FIGURINES; NON-ELECTRIC COFFEE POTS NOT OF PRECIOUS METAL; WASTEPAPER BASKETS; ICE BUCKETS; PLASTIC BUCKETS; SHOWER CADDIES; TEA CADDIES; CAKE MOLDS; SCRAPERS FOR HOUSEHOLD PURPOSES, AND CAKE SERVERS; CANTEENS; CHAMPAGNE BUCKETS; PLASTIC COASTERS, COCKTAIL SHAKERS; THERMAL INSULATED CONTAINERS FOR FOOD OR BEVERAGES; COOKIE CUTTERS, CORK SCREWS; CORN COB HOLDERS; PLASTIC WATER BOTTLES SOLD EMPTY; VACUUM BOTTLES; DECANTERS; DRINKING FLASKS; GARDENING GLOVES; RUBBER HOUSEHOLD GLOVES; DINNERWARE; PAPER PLATES AND PAPER CUPS; BRUSHES, NAMELY, HAIR BRUSHES, TOOTH BRUSHES, CLOTHES BRUSHES; KITCHEN UTENSILS, NAMELY, ROLLING PINS, SPATULAS, TURNERS, WHISKS, AND KITCHEN CONTAINERS NOT OF PRECIOUS METAL, SOAP CONTAINERS, HOUSEHOLD FOOD CONTAINERS AND LUNCH BOXES; PLASTIC CUPS AND PLATES, ALL RELATING TO THE CHARACTER OF THE SAME NAME IN THE MOVIE HAIRSPRAY (U.S. CLS. 2, 13, 23, 29, 30, 33, 40 AND 50).

VIVIAN MICZNIK FIRST, EXAMINING ATTORNEY

SN 77-594,288. TOWERSTAR PETS, LLC., MALVERN, PA. FILED 10-16-2008.

Neater Feeder

THE MARK CONSISTS OF STANDARD CHARACTERS WITHOUT CLAIM TO ANY PARTICULAR FONT, STYLE, SIZE, OR COLOR.

NO CLAIM IS MADE TO THE EXCLUSIVE RIGHT TO USE "FEEDER", APART FROM THE MARK AS SHOWN, FOR FEEDING VESSELS FOR PETS; PET FEEDING DISHES (U.S. CLS. 2, 13, 23, 29, 30, 33, 40 AND 50). FIRST USE 4-3-2009; IN COMMERCE 4-3-2009. AMEEN IMAM, EXAMINING ATTORNEY

CLASS 21—(Continued).

SN 77-635,613. JEKYLL ISLAND STATE PARK AUTHORITY, JEKYLL ISLAND, GA. FILED 12-18-2008.



NO CLAIM IS MADE TO THE EXCLUSIVE RIGHT TO USE "GEORGIA" AND "CENTER", APART FROM THE MARK AS SHOWN.

THE MARK CONSISTS OF A DESIGN ELEMENT CONSISTING OF A TURTLE-SHAPED FIGURE TRAILED BY CURVED SHAPES RESEMBLING TRACKS IN THE SAND, THE TURTLE AND TRACKS BEING LOCATED TO THE LEFT OF LITERAL ELEMENT CONSISTING OF THE WORDS "THE GEORGIA SEA TURTLE CENTER" WHERE THE WORD "THE" APPEARS IN THE SMALLEST FONT AND IS LOCATED ABOVE THE WORD "GEORGIA" WHICH IN TURN APPEARS ABOVE THE WORDS "SEA TURTLE", WHICH APPEAR ABOVE WORD "CENTER".

FOR COASTERS, NOT OF PAPER AND OTHER THAN TABLE LINEN; COFFEE CUPS, TEA CUPS AND MUGS; INSULATING SLEEVE HOLDERS FOR BEVERAGE CANS (U.S. CLS. 2, 13, 23, 29, 30, 33, 40 AND 50).

FIRST USE 6-16-2007; IN COMMERCE 6-16-2007. RONALD DELGIZZI, EXAMINING ATTORNEY

SN 77-742,279. JOHNSON & JOHNSON, NEW BRUNSWICK, NJ. FILED 5-21-2009.



THE MARK CONSISTS OF A BLAZE DESIGN, FOR TOOTHBRUSHES (U.S. CLS. 2, 13, 23, 29, 30, 33, 40 AND 50).

FIRST USE 9-19-1993; IN COMMERCE 9-19-1993. DAVID TAYLOR, EXAMINING ATTORNEY

CLASS 21—(Continued).

SN 77-745,158. REEF ONE LIMITED, HORSHAM ST. FAITH, NORWICH, UNITED KINGDOM, FILED 5-27-2009.

BIORB

THE MARK CONSISTS OF STANDARD CHARACTERS WITHOUT CLAIM TO ANY PARTICULAR FONT, STYLE, SIZE, OR COLOR.

PRIORITY CLAIMED UNDER SEC. 44(D) ON ERPN CMNTY TM OFC APPLICATION NO. 008295801, FILED 5-12-2009.

OWNER OF U.S. REG. NOS. 2,903,709 AND 3,241,092.

FOR AQUARIUM AIR STONES; AQUARIUM COVERS; AQUARIUM FISH NETS; AQUARIUM HOODS; AQUARIUM ORNAMENTS; AQUARIUMS; ARTIFICIAL AQUARIUM LANDSCAPES; FILTERING MATERIALS, NAMELY, FILTERING MATERIALS MADE OF CELLULAR GLASS AND CELLULAR GLASS PARTICLES FOR USE AS A FILTERING MEDIA IN SEWAGE AND WASTE WATER TREATMENT; FUNNELS; INDOOR AQUARIA; INDOOR TERRARIUMS; TERRARIUMS FOR ANIMALS OR INSECTS; TERRARIUMS FOR PLANTS; WATER TANKS (U.S. CLS. 2, 13, 23, 29, 30, 33, 40 AND 50).

FIRST USE 7-12-2003; IN COMMERCE 7-12-2003.
ELLEN BURNS, EXAMINING ATTORNEY

SN 77-752,657. ABITA BREWING COMPANY, LLC, ABITA SPRINGS, LA. FILED 6-4-2009.

PURPLE HAZE

THE MARK CONSISTS OF STANDARD CHARACTERS WITHOUT CLAIM TO ANY PARTICULAR FONT, STYLE, SIZE, OR COLOR.

OWNER OF U.S. REG. NO. 2,282,464.

FOR BEVERAGEWARE; MUGS; CUPS; INSULATED CONTAINERS FOR BEVERAGE CANS FOR DOMESTIC USE; BOTTLE OPENERS; BUCKETS; COASTERS NOT OF PAPER AND NOT BEING TABLE LINEN; COOKING UTENSILS, NAMELY, BARBEQUE BRANDERS; DRINKING STEINS; TRAYS (U.S. CLS. 2, 13, 23, 29, 30, 33, 40 AND 50).

JANET LEE, EXAMINING ATTORNEY

SN 77-754,873. NIGHTBIRD PRODUCTIONS, INC., WEST HOLLYWOOD, CA. FILED 6-8-2009.

NIGHTBIRD

THE MARK CONSISTS OF STANDARD CHARACTERS WITHOUT CLAIM TO ANY PARTICULAR FONT, STYLE, SIZE, OR COLOR.

FOR BEVERAGEWARE (U.S. CLS. 2, 13, 23, 29, 30, 33, 40 AND 50).

TINA BROWN, EXAMINING ATTORNEY

CLASS 21—(Continued).

SN 77-758,209. MCALLISTER, JACK G., RIVERTON, MN. FILED 6-12-2009.

HOLEY

THE MARK CONSISTS OF STANDARD CHARACTERS WITHOUT CLAIM TO ANY PARTICULAR FONT, STYLE, SIZE, OR COLOR.

FOR POTS FOR STARTING SEEDS AND GROWING PLANTS (U.S. CLS. 2, 13, 23, 29, 30, 33, 40 AND 50).
ASMAT KHAN, EXAMINING ATTORNEY

SN 77-759,234. FERGUSON ENTERPRISES, INC., NEWPORT NEWS, VA. FILED 6-14-2009.

LECANTO

THE MARK CONSISTS OF STANDARD CHARACTERS WITHOUT CLAIM TO ANY PARTICULAR FONT, STYLE, SIZE, OR COLOR.

FOR BATHROOM ACCESSORIES, NAMELY, TOWEL BARS, TOWEL RINGS, TOWEL RAILS, TOILET TISSUE HOLDERS, TOOTHBRUSH HOLDERS, CUP HOLDERS, BATHROOM GLASS HOLDER NOT OF PRECIOUS METAL, SOAP DISHES, SOAP DISPENSERS, WASHTUBS AND CUTTING BOARDS FOR STAINLESS STEEL SINKS (U.S. CLS. 2, 13, 23, 29, 30, 33, 40 AND 50).

ELLEN B. AWRICH, EXAMINING ATTORNEY

SN 77-759,236. FERGUSON ENTERPRISES, INC., NEWPORT NEWS, VA. FILED 6-14-2009.

MILAZZO

THE MARK CONSISTS OF STANDARD CHARACTERS WITHOUT CLAIM TO ANY PARTICULAR FONT, STYLE, SIZE, OR COLOR.

FOR BATHROOM ACCESSORIES, NAMELY, TOWEL BARS, TOWEL RINGS, TOWEL RAILS, TOILET TISSUE HOLDERS, TOOTHBRUSH HOLDERS, CUP HOLDERS, BATHROOM GLASS HOLDER NOT OF PRECIOUS METAL, SOAP DISHES, SOAP DISPENSERS, WASHTUBS AND CUTTING BOARDS FOR STAINLESS STEEL SINKS (U.S. CLS. 2, 13, 23, 29, 30, 33, 40 AND 50).

ELLEN B. AWRICH, EXAMINING ATTORNEY

CLASS 21—(Continued).

SN 77-759,414. VEGWARE LTD, EDINBURGH, UNITED KINGDOM, FILED 6-15-2009.

Vegware

THE MARK CONSISTS OF STANDARD CHARACTERS WITHOUT CLAIM TO ANY PARTICULAR FONT, STYLE, SIZE, OR COLOR.

OWNER OF U.S. REG. NO. 3,638,089.

FOR BIODEGRADABLE PAPER PULP-BASED PLATES, BOWLS AND CUPS; DISHES AND PLATES; DISPOSABLE TABLE PLATES; PAPER PLATES; PAPER PLATES AND PAPER CUPS; PLASTIC PLATES; PLATES; SERVINGWARE FOR SERVING FOOD (U.S. CLS. 2, 13, 23, 29, 30, 33, 40 AND 50).

FIRST USE 7-1-2006; IN COMMERCE 7-1-2006.

MARC LEIPZIG, EXAMINING ATTORNEY

SN 77-770,832. SUNBEAM PRODUCTS, INC., BOCA RATON, FL. FILED 6-30-2009.

Oster

OWNER OF U.S. REG. NOS. 2,294,005 AND 2,978,237.
THE MARK CONSISTS OF THE LITERAL ELEMENT "OSTER" WITH A FOUR POINT STAR POSITIONED CENTRALLY WITHIN THE "O" AND HAVING ONE STAR POINT EXTENDING LATERALLY OUTWARDLY INTO THE LETTER "S" OF THE LITERAL ELEMENT.

FOR ANIMAL GROOMING TOOLS, NAMELY, BRUSHES AND COMBS FOR PETS, NAMELY, UNDER-COAT RAKE, SLICKER BRUSH, AND PIN BRUSH (U.S. CLS. 2, 13, 23, 29, 30, 33, 40 AND 50).

FIRST USE 4-30-2004; IN COMMERCE 4-30-2004.

BENJAMIN OKEKE, EXAMINING ATTORNEY

CLASS 21—(Continued).

SN 77-779,504. GORDON J. DIEHL, EAST SETAUKET, NY. FILED 7-13-2009.



THE MARK CONSISTS OF A LARGE SQUARE DESIGN WHICH IS DIVIDED INTO FOUR SMALLER SQUARES BY INTERSECTING HORIZONTAL AND VERTICAL LINES. ANOTHER SMALL SQUARE IS SUPERIMPOSED OVER THE CENTER OF THE LARGE SQUARE DESIGN AND THE STYLIZED WORDING MID², WITH THE "2" APPEARING IN SUPERSCRIPT, APPEARS DIAGONALLY ACROSS THE LARGE SQUARE. THE WORDING "MID² LLC", WITH THE "2" APPEARING IN SUPERSCRIPT, APPEARS IN STYLIZED TEXT BELOW THE LARGE SQUARE DESIGN."

FOR PERSONAL FLUID HYDRATION SYSTEM COMPRISING A FLUID RESERVOIR, A DELIVERY TUBE, A MOUTHPIECE, A CARRYING PACK AND VEST (U.S. CLS. 2, 13, 23, 29, 30, 33, 40 AND 50).

AMY KERTGATE, EXAMINING ATTORNEY

SN 77-797,105. WHITNEY SERVICES, LLC, JERSEY CITY, NJ. FILED 8-4-2009.

ARTIS

THE MARK CONSISTS OF STANDARD CHARACTERS WITHOUT CLAIM TO ANY PARTICULAR FONT, STYLE, SIZE, OR COLOR.

FOR COSMETIC BRUSHES (U.S. CLS. 2, 13, 23, 29, 30, 33, 40 AND 50).

ROBERT C. CLARK JR., EXAMINING ATTORNEY

CLASS 21—(Continued).

SN 77-837,747. DE LA TERRA CONCEPTS, LLC, MURRAY, UT. FILED 9-29-2009.

DE LA TERRA

THE MARK CONSISTS OF STANDARD CHARACTERS WITHOUT CLAIM TO ANY PARTICULAR FONT, STYLE, SIZE, OR COLOR.

THE ENGLISH TRANSLATION OF "DE LA TERRA" IN THE MARK IS "OF THE EARTH".

FOR NON-ELECTRIC COOKWARE FOR USE IN COOKING IN OR ON OVENS, RANGES, MICROWAVE OVENS, TOASTER OVENS, BARBECUE GRILLS, STOVETOPS AND OTHER COOKING APPARATUSES AND ALSO USED FOR PREPARING AND SERVING FOOD; DINNERWARE, INCLUDING WITHOUT LIMITATION, SERVINGWARE FOR SERVING FOOD AND DRINKS; AND BAKEWARE (U.S. CLS. 2, 13, 23, 29, 30, 33, 40 AND 50).

ROBIN MITTLER, EXAMINING ATTORNEY

SN 77-859,717. PENDERGRASS INC, CHAFFEE, MO. FILED 10-28-2009.

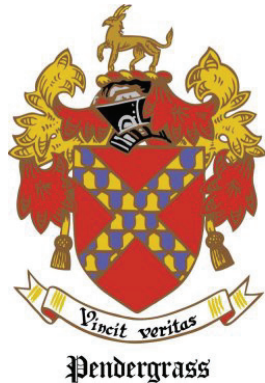

THE COLOR(S) RED, YELLOW, PURPLE, BROWN, BLACK, GRAY, WHITE IS/ARE CLAIMED AS A FEATURE OF THE MARK.

THE MARK CONSISTS OF THE FOLLOWING: THE WORDS "VINCIT VERITAS" AND "PENDERGRASS" IN BLACK, THE SHIELD DESIGN AND FEATHERS AROUND IT ARE IN RED, YELLOW AND BROWN, THE TASSELS IN YELLOW AND BROWN, THE GRIFFON ON TOP OF THE HELMET IS IN YELLOW AND BROWN, THE "X" IN THE MIDDLE OF THE SHIELD IS IN PURPLE, YELLOW AND BROWN, THE HELMET IS IN BROWN, BLACK AND GRAY, THE BANNER IS OUTLINED IN BROWN WITH YELLOW LINES AND A WHITE CENTER.

FOR BATH BRUSHES; EXFOLIATING MITTS MADE OF SISAL; NAIL BRUSHES (U.S. CLS. 2, 13, 23, 29, 30, 33, 40 AND 50).

ANGELA M. MICHELI, EXAMINING ATTORNEY

CLASS 21—(Continued).

SN 77-859,723. PENDERGRASS INC, CHAFFEE, MO. FILED 10-28-2009.



THE COLOR(S) RED, YELLOW, PURPLE, BROWN, BLACK, GRAY, WHITE IS/ARE CLAIMED AS A FEATURE OF THE MARK.

THE MARK CONSISTS OF THE FOLLOWING: THE WORDS "VINCIT VERITAS" AND "TRUTH CONQUERS" IN BLACK, THE SHIELD DESIGN AND FEATHERS AROUND IT ARE IN RED, YELLOW AND BROWN, THE TASSELS IN YELLOW AND BROWN, THE GRIFFON ON TOP OF THE HELMET IS IN YELLOW AND BROWN, THE "X" IN THE MIDDLE OF THE SHIELD IS IN PURPLE, YELLOW AND BROWN, THE HELMET IS IN BROWN, BLACK AND GRAY, THE BANNER IS OUTLINED IN BROWN WITH YELLOW LINES AND A WHITE CENTER.

FOR BATH BRUSHES; EXFOLIATING MITTS MADE OF SISAL; NAIL BRUSHES (U.S. CLS. 2, 13, 23, 29, 30, 33, 40 AND 50).

ANGELA M. MICHELI, EXAMINING ATTORNEY

SN 77-862,680. BURLING, ANGELA, ORANGEVALE, CA. FILED 11-2-2009.

A Bottle of Kids' Energy

THE MARK CONSISTS OF STANDARD CHARACTERS WITHOUT CLAIM TO ANY PARTICULAR FONT, STYLE, SIZE, OR COLOR.

FOR NOVELTY GIFT ITEM, NAMELY, EMPTY BOTTLES WITH POEMS AND ART WORK ON THEM (U.S. CLS. 2, 13, 23, 29, 30, 33, 40 AND 50).

MICHAEL SOUDERS, EXAMINING ATTORNEY

CLASS 21—(Continued).

SN 77-868,095. VICTORIA CLASSICS LTD., NEW YORK, NY. FILED 11-9-2009.

BRYAN KEITH

THE MARK CONSISTS OF STANDARD CHARACTERS WITHOUT CLAIM TO ANY PARTICULAR FONT, STYLE, SIZE, OR COLOR.

THE NAME(S), PORTRAIT(S), AND/OR SIGNATURE(S) SHOWN IN THE MARK IDENTIFIES "BRYAN KEITH", WHOSE CONSENT(S) TO REGISTER IS MADE OF RECORD.

FOR DINNERWARE, BEVERAGE WARE, BAKE WARE, COOKWARE, NAMELY, POTS AND PANS (U.S. CLS. 2, 13, 23, 29, 30, 33, 40 AND 50).

RENEE MCCRAY, EXAMINING ATTORNEY

SN 77-870,014. BELL, NEIL, DARLINGTON, CO. DURHAM, UNITED KINGDOM, FILED 11-11-2009.

LEASHPOD

THE MARK CONSISTS OF STANDARD CHARACTERS WITHOUT CLAIM TO ANY PARTICULAR FONT, STYLE, SIZE, OR COLOR.

FOR CONTAINERS, NAMELY, PORTABLE CONTAINERS FOR PET FECES (U.S. CLS. 2, 13, 23, 29, 30, 33, 40 AND 50).

CURTIS FRENCH, EXAMINING ATTORNEY

SN 77-875,362. PROCTER & GAMBLE BUSINESS SERVICES CANADA COMPANY, HALIFAX, NOVA SCOTIA, CANADA, FILED 11-18-2009.

SENSITIVE CLEAN

THE MARK CONSISTS OF STANDARD CHARACTERS WITHOUT CLAIM TO ANY PARTICULAR FONT, STYLE, SIZE, OR COLOR.

NO CLAIM IS MADE TO THE EXCLUSIVE RIGHT TO USE "CLEAN", APART FROM THE MARK AS SHOWN.

FOR REPLACEMENT HEADS FOR TOOTHBRUSHES AND RECHARGEABLE HANDLES FOR TOOTHBRUSHES (U.S. CLS. 2, 13, 23, 29, 30, 33, 40 AND 50).

WILLIAM ROSSMAN, EXAMINING ATTORNEY

CLASS 21—(Continued).

SN 77-876,253. I HEART MY GIRLFRIENDS, INC., NEW YORK, NY. FILED 11-19-2009.



THE MARK CONSISTS OF THE WORDS "I MY GIRLFRIENDS" WITH A HEART DESIGN AND SILHOUETTES OF DANCING FIGURES.

FOR MUGS, CUPS, GOBLETS, BOTTLES AND GLASS JARS SOLD EMPTY, BOTTLE SQUEEGEES, VACUUM BOTTLES AND SELTZER BOTTLES; DEWAR BOTTLES AND VESSELS; DRINKING VESSELS AND HEAT-INSULATED VESSELS; BOTTLE STANDS; WINE BOTTLE CRADLES; GLASS STORAGE JARS, INSULATING JARS AND COOKIE JARS; NON-METAL JARS FOR JAMS AND JELLIES MADE OF EARTHENWARE, GLASS, PORCELAIN AND PLASTIC; BEER JUGS; DRINKING STEINS; FLASKS; COASTERS NOT OF PAPER AND NOT BEING TABLE LINEN; BARWARE, NAMELY, HIGH BALL GLASSES, SHOT GLASSES, COCKTAIL SHAKERS, CORK SCREWS, CORK HOLDERS, BOTTLE OPENERS, TUMBLERS, WINE GOBLETS, CARAFES, DECANTERS, COOLERS FOR WINE, STANDS FOR COOLERS OF WINE, PITCHERS, BUCKETS AND BEVERAGE STIRRERS; DINNERWARE, BEVERAGEWARE, BEVERAGE GLASSWARE AND DRINKING GLASSES; INSULATING SLEEVE HOLDERS FOR BEVERAGE CANS; FOAM DRINK HOLDERS; BREAD BOXES; HOUSEHOLD CONTAINERS FOR FOODS; CONTAINERS FOR HOUSEHOLD OR KITCHEN USE; ALL PURPOSE PORTABLE HOUSEHOLD CONTAINERS; NON-ELECTRIC KITCHEN CONTAINERS NOT MADE OF PRECIOUS METAL; PORTABLE PLASTIC CONTAINERS FOR STORING HOUSEHOLD AND KITCHEN GOODS; CANTEENS; PORTABLE COOLERS, PORTABLE BEVERAGE COOLERS AND BEVERAGE DISPENSERS; PORTABLE ICE CHESTS FOR FOOD AND BEVERAGES; THERMAL INSULATED CONTAINERS FOR FOOD AND BEVERAGES; THERMAL INSULATED TOTE BAGS FOR FOOD AND BEVERAGES; THERMAL INSULATED WRAP FOR CANS TO KEEP THE CONTENTS COLD OR HOT; SERVIETTE HOLDERS; SERVIETTE RINGS NOT OF PRECIOUS METAL; LUNCH BOXES AND PAILS; INSULATED LUNCH BAGS; TEA KETTLES; COOKING AND KITCHEN UTENSILS AND EQUIPMENT, NAMELY, CUTTING BOARDS, WIRE BASKETS, STRAINERS, STEAMER BASKETS, KITCHEN AND SERVING LADLES, SPATULAS, SERVING TONGS, WHISKS, SKIMMERS, FUNNELS, GARLIC PRESSES, CORN COB HOLDERS, GLASS STOPPERS, COOKIE AND PASTRY CUTTERS, CHEESE GRATERS, REAMERS FOR FRUIT JUICE, EGG SEPARATORS, VEGETABLE MASHERS, MELON BALLERS, ROLLING PINS, ICE CREAM SCOOPS AND ICE SCOOPS, POTS, METAL AND GLASS PANS, PIE PANS, BAKING DISHES, MUFFIN TINS, COOKIE SHEETS, CRUMB BRUSHES, BRUSHES FOR BASTING MEAT AND DISHWASHING BRUSHES, DISH DRYING RACKS, OVEN TO TABLE RACKS, STOVE BURNER COVERS, SPICE RACKS, POULTRY RINGS, RECIPE BOXES, CRUETS NOT OF PRECIOUS METAL, AND CRUET STANDS FOR OIL OR VINEGAR NOT OF PRECIOUS METAL; NON-ELECTRIC COFFEE SERVERS, TEA SERVICES, TEA INFUSERS, TEA BALLS, TEA POTS, AND NON-ELECTRIC KITCHEN CONTAINERS, ALL OF THE FOREGOING NOT OF PRECIOUS METAL; COFFEE MEASURES; BOWLS, PLATES, DISHES AND DISH COVERS; CAKE, CARVER, SPOON, FORK AND KNIFE RESTS; SAUCERS; SERVING PLATTERS; PIE SERVERS; SERVING TRAYS NOT OF PRECIOUS METAL; TRIVETS; SALT AND PEPPER SHAKERS; NON-ELECTRIC JUICERS; COLANDERS FOR HOUSEHOLD USE; WOKS AND HOT POTS; TOOTHPICKS AND TOOTHPICK HOLDERS; ELECTRIC TOOTHBRUSHES; CANISTER SETS; NAPKIN HOLDERS; NAPKIN RINGS NOT OF PRECIOUS METALS; TABLE PLACARD HOLDERS NOT OF PRECIOUS

CLASS 21—(Continued).

METAL; BOXES FOR DISPENSING PAPER TOWELS; HAIR BRUSHES AND COMBS; DISPENSERS FOR HAIR BRUSHES AND COMBS, NAMELY, PLASTIC STORAGE CONTAINERS FOR HOUSEHOLD USE FOR THE STORAGE OF BRUSHES AND COMBS; BATHROOM AND BEAUTY PRODUCTS AND ACCESSORIES, NAMELY, DENTAL FLOSS, TOOTH BRUSHES AND TOOTHBRUSH HOLDERS, CUP HOLDERS, BATH BRUSHES, SPONGES, NATURAL SEA SPONGES, LOOFAH SPONGES, EYEBROW, NAIL AND SHAVING BRUSHES, SHAVING BRUSH HOLDERS AND STANDS, SQUEEGEES FOR SHAVING BRUSHES, PLASTIC BATH RACKS, TOILET BRUSHES AND BRUSH HOLDERS; SOAP BOXES, BRACKETS, CONTAINERS, DISHES, DISPENSERS AND HOLDERS; COTTON BALLS AND COTTON BALL DISPENSERS; COSMETIC AND CLOTHES BRUSHES; CLOTHES DRYING RACKS AND CLOTHES PINS; BABY BATHTUBS; BATHROOM GLASS HOLDER NOT OF PRECIOUS METAL; EARRING ORGANIZER BOARD; CANDLE HOLDERS, CANDLE RINGS AND CANDLESTICKS NOT OF PRECIOUS METAL; CANDLE SNUFFERS; NON-ELECTRIC CANDELABRAS, NOT OF PRECIOUS METAL; GLASS BOXES; BASKETS MADE OF STRAW, CLOTH, WICKER AND WOOD; FITTED PICNIC BASKETS; PLANT AND FLOWER POTS, BOWLS, BASKETS AND SYRINGES; PLASTIC LIDS FOR PLANT POTS; GARDEN SYRINGES AND GARDENING GLOVES; POT CLEANING BRUSHES; SCRAPING AND SCRUBBING BRUSHES; ELECTRIC LINT REMOVERS; VASES; FIGURINES MADE OF CHINA, CRYSTAL, EARTHENWARE, GLASS, PORCELAIN AND TERRA COTTA; WASTEPAPER BASKETS; TRASH CONTAINERS FOR HOUSEHOLD USE; NON-METAL PIGGY BANKS; SOUVENIR AND DECORATIVE PLATES; INCENSE BURNERS; PERFUME BURNERS; PERFUME VAPORIZERS AND SPRAYERS SOLD EMPTY; SHOE HORNS, SHOE, DUSTING, FLOOR AND FIREPLACE BRUSHES; GOLF BRUSH AND BRUSHES FOR BILLIARD TABLES; CLEANING CLOTHS, POLISHING CLOTHS, FURNITURE DUSTERS, DUST PANS AND BROOMS; IRONING BOARDS, SHAPED COVERS FOR IRONING BOARDS, AND HOLDERS FOR HOUSEHOLD IRONS; ORNAMENTAL GLASS SPHERES (U.S. CLS. 2, 13, 23, 29, 30, 33, 40 AND 50).

LAURIE KAUFMAN, EXAMINING ATTORNEY

SN 77-876,441. SCIO VERUM CORPORATION, PALM BEACH, FL. FILED 11-19-2009.



OWNER OF U.S. REG. NOS. 2,869,705 AND 2,893,388. THE NAME "BRIAN VICKERS" IDENTIFIES A LIVING INDIVIDUAL WHOSE CONSENT IS OF RECORD.

THE MARK CONSISTS OF THE NAME "BRIAN VICKERS" IN SCRIPT.

FOR DRINKING GLASSES; GLASS MUGS; PITCHERS; SHOT GLASSES; COFFEE MUGS; TOOTHBRUSHES; CANDY DISHES; INSULATING SLEEVE HOLDERS FOR BEVERAGE CANS AND BOTTLES; PLASTIC WATER BOTTLES SOLD EMPTY (U.S. CLS. 2, 13, 23, 29, 30, 33, 40 AND 50).

FIRST USE 0-0-2004; IN COMMERCE 0-0-2004. LESLIE RICHARDS, EXAMINING ATTORNEY

CLASS 21—(Continued).

SN 77-876,445. SCIO VERUM CORPORATION, PALM BEACH, FL. FILED 11-19-2009.

BRIAN VICKERS

THE MARK CONSISTS OF STANDARD CHARACTERS WITHOUT CLAIM TO ANY PARTICULAR FONT, STYLE, SIZE, OR COLOR.

OWNER OF U.S. REG. NOS. 2,869,705 AND 2,893,388.

THE NAME "BRIAN VICKERS" IDENTIFIES A LIVING INDIVIDUAL WHOSE CONSENT IS OF RECORD.

FOR DRINKING GLASSES; GLASS MUGS; PITCHERS; SHOT GLASSES; COFFEE MUGS; TOOTHBRUSHES; CANDY DISHES; INSULATING SLEEVE HOLDERS FOR BEVERAGE CANS AND BOTTLES; PLASTIC WATER BOTTLES SOLD EMPTY (U.S. CLS. 2, 13, 23, 29, 30, 33, 40 AND 50).

FIRST USE 0-0-2004; IN COMMERCE 0-0-2004. LESLIE RICHARDS, EXAMINING ATTORNEY

SN 77-879,081. MONAVIE LLC, SOUTH JORDAN, UT. FILED 11-23-2009.

MONA·VIE

THE MARK CONSISTS OF STANDARD CHARACTERS WITHOUT CLAIM TO ANY PARTICULAR FONT, STYLE, SIZE, OR COLOR.

OWNER OF U.S. REG. NOS. 3,106,146, 3,111,333 AND OTHERS.

FOR BEVERAGE GLASSWARE; AND SMALL DOMESTIC UTENSILS, NAMELY, NON-ELECTRIC, MANUALLY-OPERATED HAND MIXERS (U.S. CLS. 2, 13, 23, 29, 30, 33, 40 AND 50).

NANCY CLARKE, EXAMINING ATTORNEY

SN 77-879,461. 5 O'CLOCK STEMWARE LLC, WINDERMERE, FL. FILED 11-24-2009.

5 O'CLOCK STEMWARE

THE MARK CONSISTS OF STANDARD CHARACTERS WITHOUT CLAIM TO ANY PARTICULAR FONT, STYLE, SIZE, OR COLOR.

NO CLAIM IS MADE TO THE EXCLUSIVE RIGHT TO USE "STEMWARE", APART FROM THE MARK AS SHOWN.

FOR STEMWARE (U.S. CLS. 2, 13, 23, 29, 30, 33, 40 AND 50).

FIRST USE 4-0-2009; IN COMMERCE 4-0-2009. GEORGE LORENZO, EXAMINING ATTORNEY

CLASS 21—(Continued).

SN 77-883,573. FERGUSON ENTERPRISES, INC., NEWPORT NEWS, VA. FILED 12-1-2009.

CAROVA

THE MARK CONSISTS OF STANDARD CHARACTERS WITHOUT CLAIM TO ANY PARTICULAR FONT, STYLE, SIZE, OR COLOR.

FOR BATHROOM ACCESSORIES, NAMELY, TOWEL BARS, TOWEL RINGS, TOWEL RAILS, TOILET TISSUE HOLDERS, TOOTHBRUSH HOLDERS, CUP HOLDERS, BATHROOM GLASS HOLDER NOT OF PRECIOUS METAL, SOAP DISHES, SOAP DISPENSERS, WASHTUBS AND CUTTING BOARDS FOR STAINLESS STEEL SINKS (U.S. CLS. 2, 13, 23, 29, 30, 33, 40 AND 50).

KIM SAITO, EXAMINING ATTORNEY

CLASS 21—(Continued).

SN 77-883,592. FERGUSON ENTERPRISES, INC., NEWPORT NEWS, VA. FILED 12-1-2009.

FAIRBORN

THE MARK CONSISTS OF STANDARD CHARACTERS WITHOUT CLAIM TO ANY PARTICULAR FONT, STYLE, SIZE, OR COLOR.

FOR BATHROOM ACCESSORIES, NAMELY, TOWEL BARS, TOWEL RINGS, TOWEL RAILS, TOILET TISSUE HOLDERS, TOOTHBRUSH HOLDERS, CUP HOLDERS, BATHROOM GLASS HOLDER NOT OF PRECIOUS METAL, SOAP DISHES, SOAP DISPENSERS, WASHTUBS AND CUTTING BOARDS FOR STAINLESS STEEL SINKS (U.S. CLS. 2, 13, 23, 29, 30, 33, 40 AND 50).

KIM SAITO, EXAMINING ATTORNEY

SN 77-883,580. FERGUSON ENTERPRISES, INC., NEWPORT NEWS, VA. FILED 12-1-2009.

CARTEGA

THE MARK CONSISTS OF STANDARD CHARACTERS WITHOUT CLAIM TO ANY PARTICULAR FONT, STYLE, SIZE, OR COLOR.

FOR BATHROOM ACCESSORIES, NAMELY, TOWEL BARS, TOWEL RINGS, TOWEL RAILS, TOILET TISSUE HOLDERS, TOOTHBRUSH HOLDERS, CUP HOLDERS, BATHROOM GLASS HOLDER NOT OF PRECIOUS METAL, SOAP DISHES, SOAP DISPENSERS, WASHTUBS AND CUTTING BOARDS FOR STAINLESS STEEL SINKS (U.S. CLS. 2, 13, 23, 29, 30, 33, 40 AND 50).

KIM SAITO, EXAMINING ATTORNEY

SN 77-883,597. FERGUSON ENTERPRISES, INC., NEWPORT NEWS, VA. FILED 12-1-2009.

FULTONHAM

THE MARK CONSISTS OF STANDARD CHARACTERS WITHOUT CLAIM TO ANY PARTICULAR FONT, STYLE, SIZE, OR COLOR.

FOR BATHROOM ACCESSORIES, NAMELY, TOWEL BARS, TOWEL RINGS, TOWEL RAILS, TOILET TISSUE HOLDERS, TOOTHBRUSH HOLDERS, CUP HOLDERS, BATHROOM GLASS HOLDER NOT OF PRECIOUS METAL, SOAP DISHES, SOAP DISPENSERS, WASHTUBS AND CUTTING BOARDS FOR STAINLESS STEEL SINKS (U.S. CLS. 2, 13, 23, 29, 30, 33, 40 AND 50).

KIM SAITO, EXAMINING ATTORNEY

SN 77-883,584. FERGUSON ENTERPRISES, INC., NEWPORT NEWS, VA. FILED 12-1-2009.

CASTANEA

THE MARK CONSISTS OF STANDARD CHARACTERS WITHOUT CLAIM TO ANY PARTICULAR FONT, STYLE, SIZE, OR COLOR.

FOR BATHROOM ACCESSORIES, NAMELY, TOWEL BARS, TOWEL RINGS, TOWEL RAILS, TOILET TISSUE HOLDERS, TOOTHBRUSH HOLDERS, CUP HOLDERS, BATHROOM GLASS HOLDER NOT OF PRECIOUS METAL, SOAP DISHES, SOAP DISPENSERS, WASHTUBS AND CUTTING BOARDS FOR STAINLESS STEEL SINKS (U.S. CLS. 2, 13, 23, 29, 30, 33, 40 AND 50).

KIM SAITO, EXAMINING ATTORNEY

SN 77-883,604. FERGUSON ENTERPRISES, INC., NEWPORT NEWS, VA. FILED 12-1-2009.

GABORONE

THE MARK CONSISTS OF STANDARD CHARACTERS WITHOUT CLAIM TO ANY PARTICULAR FONT, STYLE, SIZE, OR COLOR.

FOR BATHROOM ACCESSORIES, NAMELY, TOWEL BARS, TOWEL RINGS, TOWEL RAILS, TOILET TISSUE HOLDERS, TOOTHBRUSH HOLDERS, CUP HOLDERS, BATHROOM GLASS HOLDER NOT OF PRECIOUS METAL, SOAP DISHES, SOAP DISPENSERS, WASHTUBS AND CUTTING BOARDS FOR STAINLESS STEEL SINKS (U.S. CLS. 2, 13, 23, 29, 30, 33, 40 AND 50).

KIM SAITO, EXAMINING ATTORNEY

CLASS 21—(Continued).

SN 77-883,607. FERGUSON ENTERPRISES, INC., NEWPORT NEWS, VA. FILED 12-1-2009.

GLENMORA

THE MARK CONSISTS OF STANDARD CHARACTERS WITHOUT CLAIM TO ANY PARTICULAR FONT, STYLE, SIZE, OR COLOR.

FOR BATHROOM ACCESSORIES, NAMELY, TOWEL BARS, TOWEL RINGS, TOWEL RAILS, TOILET TISSUE HOLDERS, TOOTHBRUSH HOLDERS, CUP HOLDERS, BATHROOM GLASS HOLDER NOT OF PRECIOUS METAL, SOAP DISHES, SOAP DISPENSERS, WASHTUBS AND CUTTING BOARDS FOR STAINLESS STEEL SINKS (U.S. CLS. 2, 13, 23, 29, 30, 33, 40 AND 50).

KIM SAITO, EXAMINING ATTORNEY

SN 77-883,610. FERGUSON ENTERPRISES, INC., NEWPORT NEWS, VA. FILED 12-1-2009.

GLYNDON

THE MARK CONSISTS OF STANDARD CHARACTERS WITHOUT CLAIM TO ANY PARTICULAR FONT, STYLE, SIZE, OR COLOR.

FOR BATHROOM ACCESSORIES, NAMELY, TOWEL BARS, TOWEL RINGS, TOWEL RAILS, TOILET TISSUE HOLDERS, TOOTHBRUSH HOLDERS, CUP HOLDERS, BATHROOM GLASS HOLDER NOT OF PRECIOUS METAL, SOAP DISHES, SOAP DISPENSERS, WASHTUBS AND CUTTING BOARDS FOR STAINLESS STEEL SINKS (U.S. CLS. 2, 13, 23, 29, 30, 33, 40 AND 50).

KIM SAITO, EXAMINING ATTORNEY

SN 77-883,613. FERGUSON ENTERPRISES, INC., NEWPORT NEWS, VA. FILED 12-1-2009.

INGLESIDE

THE MARK CONSISTS OF STANDARD CHARACTERS WITHOUT CLAIM TO ANY PARTICULAR FONT, STYLE, SIZE, OR COLOR.

FOR BATHROOM ACCESSORIES, NAMELY, TOWEL BARS, TOWEL RINGS, TOWEL RAILS, TOILET TISSUE HOLDERS, TOOTHBRUSH HOLDERS, CUP HOLDERS, BATHROOM GLASS HOLDER NOT OF PRECIOUS METAL, SOAP DISHES, SOAP DISPENSERS, WASHTUBS AND CUTTING BOARDS FOR STAINLESS STEEL SINKS (U.S. CLS. 2, 13, 23, 29, 30, 33, 40 AND 50).

KIM SAITO, EXAMINING ATTORNEY

CLASS 21—(Continued).

SN 77-884,025. WESTERN CAROLINA UNIVERSITY (NORTH CAROLINA NON-PROFIT EDUCATIONAL INSTITUTE OF THE UNIVERSITY OF NORTH CAROLINA), CULLOWHEE, NC. FILED 12-2-2009.



OWNER OF U.S. REG. NO. 1,554,839.

THE MARK CONSISTS OF THE LETTERS "WCU" WHICH ARE ARRANGED DIAGONALLY DOWNWARD FROM LEFT TO RIGHT.

FOR CUPS, DRINKING GLASSES, FOAM DRINK HOLDERS AND MUGS (U.S. CLS. 2, 13, 23, 29, 30, 33, 40 AND 50).

FIRST USE 8-13-2008; IN COMMERCE 8-13-2008.

MARGARET POWER, EXAMINING ATTORNEY

SN 77-884,147. RC SOLUTIONS, INC., HOUSTON, TX. FILED 12-2-2009.

RATWHEEL

THE MARK CONSISTS OF STANDARD CHARACTERS WITHOUT CLAIM TO ANY PARTICULAR FONT, STYLE, SIZE, OR COLOR.

FOR RODENT/PEST BAIT STATION ENCLOSED WITHIN A WHEEL (U.S. CLS. 2, 13, 23, 29, 30, 33, 40 AND 50).

FIRST USE 11-10-2006; IN COMMERCE 11-10-2006.

MICHAEL ENGEL, EXAMINING ATTORNEY

SN 77-884,276. DART INDUSTRIES INC., ORLANDO, FL. FILED 12-2-2009.

SIMPLY PERFECT

THE MARK CONSISTS OF STANDARD CHARACTERS WITHOUT CLAIM TO ANY PARTICULAR FONT, STYLE, SIZE, OR COLOR.

FOR PASTRY SHEETS (U.S. CLS. 2, 13, 23, 29, 30, 33, 40 AND 50).

FIRST USE 1-20-1997; IN COMMERCE 1-20-1997.

AARON BRODSKY, EXAMINING ATTORNEY

CLASS 21—(Continued).

SN 77-884,864. BINSHTOCK, EYAL, PALMDALE, CA. AND HOFFMAN, MATTHEW, PALMDALE, CA. FILED 12-2-2009.

GloBowl

THE MARK CONSISTS OF STANDARD CHARACTERS WITHOUT CLAIM TO ANY PARTICULAR FONT, STYLE, SIZE, OR COLOR.

FOR AQUARIUMS; PLANTERS FOR FLOWERS AND PLANTS; WATER TANKS (U.S. CLS. 2, 13, 23, 29, 30, 33, 40 AND 50).

JOHN DALIER, EXAMINING ATTORNEY

CLASS 21—(Continued).

SN 77-886,725. WILDLIFE ALLIES, LLC, PORT CHARLOTTE, FL. FILED 12-4-2009.

Bluebird Convertibles

THE MARK CONSISTS OF STANDARD CHARACTERS WITHOUT CLAIM TO ANY PARTICULAR FONT, STYLE, SIZE, OR COLOR.

NO CLAIM IS MADE TO THE EXCLUSIVE RIGHT TO USE "BLUEBIRD", APART FROM THE MARK AS SHOWN. FOR BIRD HOUSES (U.S. CLS. 2, 13, 23, 29, 30, 33, 40 AND 50).

FIRST USE 11-19-2009; IN COMMERCE 11-26-2009.
DEZMONA MIZELLE, EXAMINING ATTORNEY

SN 77-886,400. CAMOBOOTY, INC., DENVER, CO. FILED 12-4-2009.

Hunt Fun

THE MARK CONSISTS OF STANDARD CHARACTERS WITHOUT CLAIM TO ANY PARTICULAR FONT, STYLE, SIZE, OR COLOR.

FOR FLASKS; FOAM DRINK HOLDERS; MUGS (U.S. CLS. 2, 13, 23, 29, 30, 33, 40 AND 50).

FIRST USE 11-0-2008; IN COMMERCE 11-0-2008.
PATRICIA EVANKO, EXAMINING ATTORNEY

SN 77-888,699. EMSAR, INC., STRATFORD, CT. FILED 12-8-2009.

ECOMIST

THE MARK CONSISTS OF STANDARD CHARACTERS WITHOUT CLAIM TO ANY PARTICULAR FONT, STYLE, SIZE, OR COLOR.

FOR MANUALLY ACTUATED PUMP DISPENSERS FOR ATTACHMENT TO CONTAINERS FOR USE IN DISPENSING LIQUIDS (U.S. CLS. 2, 13, 23, 29, 30, 33, 40 AND 50).

RICHARD WHITE, EXAMINING ATTORNEY

SN 77-886,714. WILDLIFE ALLIES, LLC, PORT CHARLOTTE, FL. FILED 12-4-2009.

Wildlife Allies

THE MARK CONSISTS OF STANDARD CHARACTERS WITHOUT CLAIM TO ANY PARTICULAR FONT, STYLE, SIZE, OR COLOR.

NO CLAIM IS MADE TO THE EXCLUSIVE RIGHT TO USE "WILDLIFE", APART FROM THE MARK AS SHOWN. FOR BIRD HOUSES (U.S. CLS. 2, 13, 23, 29, 30, 33, 40 AND 50).

FIRST USE 11-19-2009; IN COMMERCE 11-26-2009.
DEZMONA MIZELLE, EXAMINING ATTORNEY

SN 77-889,165. TROJAN MARKETING LTD. DBA OUTBACK UK LTD, MAIDSTONE, UNITED KINGDOM, FILED 12-9-2009.



THE COLOR(S) YELLOW AND GREEN IS/ARE CLAIMED AS A FEATURE OF THE MARK.

THE MARK CONSISTS OF THE WORDING "OUTBACK" IN YELLOW STYLIZED FONT. THE WORDING APPEARS ON A GREEN OVAL OUTLINED IN YELLOW.

FOR CAMPING GRILLS (U.S. CLS. 2, 13, 23, 29, 30, 33, 40 AND 50).

KAREN SEVERSON, EXAMINING ATTORNEY

CLASS 21—(Continued).

SN 77-889,181. HOME BOX OFFICE, INC., NEW YORK, NY.
FILED 12-9-2009.

GAME OF THRONES

THE MARK CONSISTS OF STANDARD CHARACTERS WITHOUT CLAIM TO ANY PARTICULAR FONT, STYLE, SIZE, OR COLOR.

FOR COSMETIC BRUSHES, EYE SHADOW BRUSHES, EYEBROW BRUSHES, LIP BRUSHES, MAKE-UP BRUSHES, NAIL BRUSHES, POWDER PUFFS; MUGS, DRINKING GLASSES, SHOT GLASSES, DISHES, PLATES, BOWLS, CUPS, SAUCERS AND TRAYS MADE OF GLASSWARE, PORCELAIN, CERAMIC OR EARTH-ENWARE; WINE BUCKETS, WINE OPENERS, COOLERS FOR WINE, NON-ELECTRIC COFFEE POTS, COFFEE STIRRERS AND NON-ELECTRIC COFFEE GRINDERS; HOUSEHOLD UTENSILS, NAMELY, GRATERS, SPATULAS AND ROLLING PINS; CONTAINERS FOR HOUSEHOLD OR KITCHEN USE, ALL RELATING TO AN ONGOING TELEVISION SERIES (U.S. CLS. 2, 13, 23, 29, 30, 33, 40 AND 50).

GIANCARLO CASTRO, EXAMINING ATTORNEY

CLASS 21—(Continued).

SN 77-890,585. UNIVERSITY OF NORTHWESTERN OHIO,
LIMA, OH. FILED 12-10-2009.



THE COLOR(S) RED, BLACK AND WHITE IS/ARE CLAIMED AS A FEATURE OF THE MARK.

THE MARK CONSISTS OF A RED LARGE "U" OUTLINED IN BLACK AND WHITE WITH THE STYLIZED WORDING "MOTORSPORTS" ARCHED ACROSS MIDDLE IN WHITE LETTERS WITH RED, BLACK, AND WHITE OUTLINING AND THE STYLIZED WORDING "UNOH" IN BLACK AND RED OUTLINED IN WHITE ACROSS THE BOTTOM OF THE "U".

FOR MUGS; PLASTIC WATER BOTTLES SOLD EMPTY; SHOT GLASSES; THERMAL INSULATED CONTAINERS FOR FOOD OR BEVERAGE (U.S. CLS. 2, 13, 23, 29, 30, 33, 40 AND 50).

LIEF MARTIN, EXAMINING ATTORNEY

SN 77-891,493. K-TEC, INC., OREM, UT. FILED 12-11-2009.

WILD SIDE

THE MARK CONSISTS OF STANDARD CHARACTERS WITHOUT CLAIM TO ANY PARTICULAR FONT, STYLE, SIZE, OR COLOR.

FOR JARS FOR BLENDERS (U.S. CLS. 2, 13, 23, 29, 30, 33, 40 AND 50).

STEPHANIE ALI, EXAMINING ATTORNEY

SN 77-891,643. PREVENTIVE TECHNOLOGIES, INC., INDIAN TRAIL, NC. FILED 12-11-2009.

TOWNHOUSE

THE MARK CONSISTS OF STANDARD CHARACTERS WITHOUT CLAIM TO ANY PARTICULAR FONT, STYLE, SIZE, OR COLOR.

FOR MUGS (U.S. CLS. 2, 13, 23, 29, 30, 33, 40 AND 50).
FIRST USE 11-20-2009; IN COMMERCE 11-20-2009.

BARNEY CHARLON, EXAMINING ATTORNEY

THE MARK CONSISTS OF STANDARD CHARACTERS WITHOUT CLAIM TO ANY PARTICULAR FONT, STYLE, SIZE, OR COLOR.

OWNER OF U.S. REG. NO. 2,121,978.
FOR TOOTHBRUSHES (U.S. CLS. 2, 13, 23, 29, 30, 33, 40 AND 50).

SAIMA MAKHDOOM, EXAMINING ATTORNEY

PREVENT

CLASS 21—(Continued).

SN 77-891,751. EPIC PRODUCTS INC., SANTA ANA, CA.
FILED 12-11-2009.

MY GLASS CHARMS

THE MARK CONSISTS OF STANDARD CHARACTERS WITHOUT CLAIM TO ANY PARTICULAR FONT, STYLE, SIZE, OR COLOR.

OWNER OF U.S. REG. NO. 2,561,679.

NO CLAIM IS MADE TO THE EXCLUSIVE RIGHT TO USE "GLASS CHARMS", APART FROM THE MARK AS SHOWN.

FOR IDENTIFICATION CHARMS FOR ATTACHMENT TO A DRINKING GLASS (U.S. CLS. 2, 13, 23, 29, 30, 33, 40 AND 50).

KATHERINE STOIDES, EXAMINING ATTORNEY

SN 77-891,817. EPIC PRODUCTS INC., SANTA ANA, CA.
FILED 12-11-2009.

UPTOWN

THE MARK CONSISTS OF STANDARD CHARACTERS WITHOUT CLAIM TO ANY PARTICULAR FONT, STYLE, SIZE, OR COLOR.

FOR STEMWARE (U.S. CLS. 2, 13, 23, 29, 30, 33, 40 AND 50).

KATHERINE STOIDES, EXAMINING ATTORNEY

SN 77-891,933. KUMMINGS, LINDY, LOS ANGELES, CA.
FILED 12-11-2009.

**SUDDENLY...CLEANING HAS
NEW MEANING!**

THE MARK CONSISTS OF STANDARD CHARACTERS WITHOUT CLAIM TO ANY PARTICULAR FONT, STYLE, SIZE, OR COLOR.

FOR GARDENING GLOVES; HOUSEHOLD GLOVES FOR GENERAL USE (U.S. CLS. 2, 13, 23, 29, 30, 33, 40 AND 50).

FIRST USE 1-0-2003; IN COMMERCE 1-0-2005.

KYLE PEETE, EXAMINING ATTORNEY

CLASS 21—(Continued).

SN 77-891,977. BARRY HOWARD, LOS ANGELES, CA.
FILED 12-11-2009.



NO CLAIM IS MADE TO THE EXCLUSIVE RIGHT TO USE "KITTY", APART FROM THE MARK AS SHOWN.

THE MARK CONSISTS OF THE WORD "KITTY" WITH A DRAWING OF A CAT'S FACE NEXT TO IT, UNDERNEATH ARE THE WORDS "KATCH-IT!" WITH A STYLIZED BAR BELOW THE "CH-".

FOR A DISPOSABLE CAT LITTER BOX WITH TRAY (U.S. CLS. 2, 13, 23, 29, 30, 33, 40 AND 50).

TRACY CROSS, EXAMINING ATTORNEY

SN 77-892,833. HEARST COMMUNICATIONS, INC., NEW YORK, NY. FILED 12-14-2009.



NO CLAIM IS MADE TO THE EXCLUSIVE RIGHT TO USE "CULINARY" & "1846", APART FROM THE MARK AS SHOWN.

THE MARK CONSISTS OF THE WORDS, LETTERS, AND NUMBERS "CULINARY", "T&C", AND "1846" ARRANGED VERTICALLY AND SURROUNDED BY A CIRCULAR SCALLOPED BORDER.

FOR COOKING POTS AND PANS; CUPS AND MUGS; DISHES; PLATES; SAUCERS; SERVING PLATTERS; SERVINGWARE FOR SERVING FOOD AND DRINKS (U.S. CLS. 2, 13, 23, 29, 30, 33, 40 AND 50).

KARANENDRA S. CHHINA, EXAMINING ATTORNEY

CLASS 21—(Continued).

SN 77-898,777. HOME BOX OFFICE, INC., NEW YORK, NY.
FILED 12-22-2009.

ENLIGHTENED

THE MARK CONSISTS OF STANDARD CHARACTERS WITHOUT CLAIM TO ANY PARTICULAR FONT, STYLE, SIZE, OR COLOR.

FOR BEVERAGEWARE, DISHES, PLATES, BOWLS, SAUCERS AND TRAYS MADE OF GLASSWARE, PORCELAIN, CERAMIC OR EARTHENWARE; WINE BUCKETS, WINE OPENERS; HOUSEHOLD AND KITCHEN UTENSILS; CONTAINERS FOR HOUSEHOLD OR KITCHEN USE; PORCELAIN FIGURINES; ALL THE AFOREMENTIONED GOODS RELATED TO A TELEVISION SERIES OF THE SAME NAME (U.S. CLS. 2, 13, 23, 29, 30, 33, 40 AND 50).

GIANCARLO CASTRO, EXAMINING ATTORNEY

SN 77-899,754. JKA, INC., DBA DIVERSIFIED DISTRIBUTION, WOONSOCKET, RI. FILED 12-23-2009.



OWNER OF U.S. REG. NO. 1,382,943.
THE MARK CONSISTS OF THE WORDING "UPSTAGE" WITH A LARGE "U" AND LARGER "S" INSIDE A CIRCLE. FOR MAKE UP BRUSHES (U.S. CLS. 2, 13, 23, 29, 30, 33, 40 AND 50).

FIRST USE 9-0-2003; IN COMMERCE 9-0-2003.
SUSAN RICHARDS, EXAMINING ATTORNEY

SN 77-916,278. KEEP COOL INTERNATIONAL GENERAL PARTNERSHIP, LAFAYETTE, CA. FILED 1-20-2010.

Freezer carrier

THE MARK CONSISTS OF STANDARD CHARACTERS WITHOUT CLAIM TO ANY PARTICULAR FONT, STYLE, SIZE, OR COLOR.

FOR THERMAL INSULATED BAGS FOR FOOD OR BEVERAGES (U.S. CLS. 2, 13, 23, 29, 30, 33, 40 AND 50).
FIRST USE 10-1-1999; IN COMMERCE 2-1-2000.
KATHRYN COWARD, EXAMINING ATTORNEY

CLASS 21—(Continued).

SN 77-916,297. KEEP COOL INTERNATIONAL GENERAL PARTNERSHIP, LAFAYETTE, CA. FILED 1-20-2010.



FOR THERMAL INSULATED BAGS FOR FOOD OR BEVERAGES (U.S. CLS. 2, 13, 23, 29, 30, 33, 40 AND 50).
FIRST USE 10-1-1999; IN COMMERCE 9-1-2001.

KATHRYN COWARD, EXAMINING ATTORNEY

SN 77-919,020. INTERNATIONAL PAPER COMPANY, MEMPHIS, TN. FILED 1-25-2010.

HOLD & GO

THE MARK CONSISTS OF STANDARD CHARACTERS WITHOUT CLAIM TO ANY PARTICULAR FONT, STYLE, SIZE, OR COLOR.

OWNER OF U.S. REG. NO. 3,740,670.
FOR CONTAINERS MADE OF PAPERBOARD FOR USE IN THE FOOD AND BEVERAGE SERVICE INDUSTRY, NAMELY, CUPS (U.S. CLS. 2, 13, 23, 29, 30, 33, 40 AND 50).

FIRST USE 10-31-2009; IN COMMERCE 10-31-2009.
APRIL ROACH, EXAMINING ATTORNEY

SN 77-930,701. HALLMARK LICENSING, INC., KANSAS CITY, MO. FILED 2-8-2010.

SEASONS FROM HALLMARK

THE MARK CONSISTS OF STANDARD CHARACTERS WITHOUT CLAIM TO ANY PARTICULAR FONT, STYLE, SIZE, OR COLOR.

FOR CUPS; PLATES (U.S. CLS. 2, 13, 23, 29, 30, 33, 40 AND 50).

ELIZABETH KAJUBI, EXAMINING ATTORNEY

CLASS 21—(Continued).

SN 77-945,175. MEYER INTELLECTUAL PROPERTIES LIMITED, KOWLOON, HONGKONG, CHINA, FILED 2-25-2010.

Ami-Matin

THE MARK CONSISTS OF STANDARD CHARACTERS WITHOUT CLAIM TO ANY PARTICULAR FONT, STYLE, SIZE, OR COLOR.

THE ENGLISH TRANSLATION OF "AMI-MATIN" IN THE MARK IS "MORNING FRIEND".

FOR NON-ELECTRIC COFFEE MAKERS (U.S. CLS. 2, 13, 23, 29, 30, 33, 40 AND 50).

TASNEEM HUSSAIN, EXAMINING ATTORNEY

CLASS 22—CORDAGE AND FIBERS

SN 77-886,853. RANDOM TRIO CORPORATION, SAN FRANCISCO, CA. FILED 12-4-2009.



NO CLAIM IS MADE TO THE EXCLUSIVE RIGHT TO USE "HANG", APART FROM THE MARK AS SHOWN.

THE MARK CONSISTS OF THE STYLIZED TEXT "HANG 'EM UPS" WITH HALF OF THE "H" REPRESENTING A HANGER.

FOR GARMENT BAGS FOR STORAGE, NAMELY, PLASTIC BAGS FOR MOVING AND STORING CLOTHING ON HANGERS (U.S. CLS. 1, 2, 7, 19, 22, 42 AND 50).
TINA MAI, EXAMINING ATTORNEY

SN 77-955,548. CHROME HEARTS LLC, HOLLYWOOD, CA. FILED 3-10-2010.



THE MARK CONSISTS OF THE DESIGN OF A DAGGER SURROUNDED BY A VINE DESIGN.

FOR GLASS BEVERAGeware, CRYSTAL CARAFES, DISHES, CRYSTAL CANDLESTICKS, VASES AND GLASS BOWLS (U.S. CLS. 2, 13, 23, 29, 30, 33, 40 AND 50).

FIRST USE 1-3-1989; IN COMMERCE 1-3-1989.

KELLY CHOE, EXAMINING ATTORNEY

SN 77-886,896. KRAUSS, TERRI, HINSDALE, IL. FILED 12-4-2009.



THE MARK CONSISTS OF A STYLIZED BORDERED, TWO-TONED OVAL WITH THE TEXT "SORTASACK!" ACROSS THE CENTER, AND THE FIRST "A" IN A CIRCLE.

FOR LAUNDRY BAGS (U.S. CLS. 1, 2, 7, 19, 22, 42 AND 50).

HEATHER BIDDULPH, EXAMINING ATTORNEY

CLASS 22—(Continued).

SN 77-890,643. UNIVERSITY OF NORTHWESTERN OHIO, LIMA, OH. FILED 12-10-2009.



THE COLOR(S) RED, BLACK AND WHITE IS/ARE CLAIMED AS A FEATURE OF THE MARK.

THE MARK CONSISTS OF A RED LARGE "U" OUTLINED IN BLACK AND WHITE WITH THE STYLIZED WORDING "MOTORSPORTS" ARCHED ACROSS MIDDLE IN WHITE LETTERS WITH RED, BLACK, AND WHITE OUTLINING AND THE STYLIZED WORDING "UNOH" IN BLACK AND RED OUTLINED IN WHITE ACROSS THE BOTTOM OF THE "U".

FOR LANYARDS FOR HOLDING BADGES (U.S. CLS. 1, 2, 7, 19, 22, 42 AND 50).

LIEF MARTIN, EXAMINING ATTORNEY

SN 77-892,351. APOLLO INDUSTRIES LIMITED, HANG-ZHOU, HONG KONG, FILED 12-14-2009.

MOTOCENTRIC

THE MARK CONSISTS OF STANDARD CHARACTERS WITHOUT CLAIM TO ANY PARTICULAR FONT, STYLE, SIZE, OR COLOR.

FOR CARGO AND CARRIER EQUIPMENT FOR VEHICLES, NAMELY, TOW ROPES, TOW STRAPS, RATCHET TIE-DOWN STRAPS, QUICK RELEASE TIE DOWN STRAPS, LASHING STRAPS, AND TARP STRAPS (U.S. CLS. 1, 2, 7, 19, 22, 42 AND 50).

WILLIAM BRECKENFELD, EXAMINING ATTORNEY

SN 77-898,224. FIBER BOND CORPORATION, MICHIGAN CITY, IN. FILED 12-21-2009.

SANDCATCHER

THE MARK CONSISTS OF STANDARD CHARACTERS WITHOUT CLAIM TO ANY PARTICULAR FONT, STYLE, SIZE, OR COLOR.

FOR PROTECTIVE FLEXIBLE LINERS FOR GOLF COURSE BUNKERS (U.S. CLS. 1, 2, 7, 19, 22, 42 AND 50).

JENNIFER HETU, EXAMINING ATTORNEY

CLASS 22—(Continued).

SN 79-067,519. TRIPOD (XIAMEN) SPORTING GOODS CO., LTD., CHINA, FILED 3-25-2009.



OWNER OF INTERNATIONAL REGISTRATION 0999508 DATED 3-25-2009, EXPIRES 3-25-2019.

THE STIPPLING IS A FEATURE OF THE MARK AND DOES NOT INDICATE COLOR.

THE MARK CONSISTS OF A DRAWING OF A STYLIZED HEAD OF A SHEEP WITH TWO CURVED HORNS; BEHIND THE HEAD OF THE SHEEP IS A STYLIZED DRAWING OF A MOUNTAIN; THE SHEEP AND MOUNTAIN ARE ENCLOSED IN A CIRCLE; A SECOND CIRCLE SURROUNDS THE CIRCLE AND THE STYLIZED WORDING "BIGHORN" IS ENCLOSED IN THE OUTSIDE CIRCLE WITH A SERIES OF FERN LEAVES.

FOR ROPES; BAGS FOR WASHING HOSIERY; SAILS; HAMMOCKS; AWNINGS OF SYNTHETIC MATERIALS; AWNINGS; POLYESTER STUFFING FIBERS; AWNINGS OF TEXTILE; BAGS OF TEXTILE FOR PACKAGING; TEXTILE FIBERS (U.S. CLS. 1, 2, 7, 19, 22, 42 AND 50).

AMEEN IMAM, EXAMINING ATTORNEY

CLASS 23—YARNS AND THREADS

SN 77-877,408. THRONEBURG, JAMES L., STATESVILLE, NC. FILED 11-20-2009.

THOR·WICK

THE MARK CONSISTS OF STANDARD CHARACTERS WITHOUT CLAIM TO ANY PARTICULAR FONT, STYLE, SIZE, OR COLOR.

OWNER OF U.S. REG. NO. 2,045,109.

FOR YARN FOR USE IN THE MANUFACTURE OF SOCKS (U.S. CL. 43).

FIRST USE 10-22-2002; IN COMMERCE 10-22-2002.

TOBY BULLOFF, EXAMINING ATTORNEY

CLASS 23—(Continued).

SN 77-887,457. SETCORE SPINNING S.A.E., CAIRO, EGYPT, FILED 12-7-2009.



THE MARK CONSISTS OF THE WORDS "LUXTON" UNDERNEATH A CIRCLE COMPRISED OF BENT LINES WHICH GIVE THE APPEARANCE OF AN INWARD SPIRAL.

FOR COTTON YARNS AND THREADS FOR TEXTILE USE; SEWING THREADS FOR USE IN TEXTILES (U.S. CL. 43).

INGRID C. EULIN, EXAMINING ATTORNEY

SN 77-891,307. ASOCIACION DE INVESTIGACION DE LA INDUSTRIA TEXTIL, ALCOY, ALICANTE, SPAIN, FILED 12-11-2009.



OWNER OF U.S. REG. NO. 3,633,631.
NO CLAIM IS MADE TO THE EXCLUSIVE RIGHT TO USE "MADE IN GREEN", APART FROM THE MARK AS SHOWN.

THE COLOR(S) DARK GREEN, LIGHT GREEN AND GREY IS/ARE CLAIMED AS A FEATURE OF THE MARK.

THE MARK CONSISTS OF THE DESIGN OF A FLOWER WITH FIVE PETALS TWO OF THE PETALS ARE IN DARK GREEN AND THREE IN LIGHT GREEN; THE WORDING "MADE IN GREEN" APPEARS ON THE RIGHT LOWER SIDE OF THE FLOWER DESIGN WRITTEN IN STYLIZED GREY LETTERING AND SMALL LETTERS, EXCEPT FOR THE LETTER "G" WHICH IS IN CAPITAL LETTERS.

FOR THREAD FOR TEXTILE USE (U.S. CL. 43).
RONALD MCMORROW, EXAMINING ATTORNEY

CLASS 24—FABRICS

SN 76-664,248. HEFTER, MAX, SUNRISE, FL. FILED 8-7-2006.

CROWN JEWEL

THE MARK CONSISTS OF STANDARD CHARACTERS WITHOUT CLAIM TO ANY PARTICULAR FONT, STYLE, SIZE, OR COLOR.

FOR TOWELS (U.S. CLS. 42 AND 50).
FIRST USE 6-1-2006; IN COMMERCE 6-1-2006.
DAVID YONTEF, EXAMINING ATTORNEY

SN 76-697,695. WELBY, MELISSA, ST. PETERS, MO. FILED 6-1-2009.

MARIAN MAT

NO CLAIM IS MADE TO THE EXCLUSIVE RIGHT TO USE "MAT", APART FROM THE MARK AS SHOWN.

FOR PLACE MATS NOT OF PAPER, PLASTIC PLACE MATS, VINYL PLACE MATS (U.S. CLS. 42 AND 50).

FIRST USE 10-17-2008; IN COMMERCE 4-3-2009.
STEVEN R. FINE, EXAMINING ATTORNEY

SN 77-489,342. KOEHLER, STACI, FISHERS, IN. FILED 6-3-2008.

NAPBAND

THE MARK CONSISTS OF STANDARD CHARACTERS WITHOUT CLAIM TO ANY PARTICULAR FONT, STYLE, SIZE, OR COLOR.

FOR BANDS OF ELASTIC FABRIC TO BE STRETCHED AROUND A PERSON'S FOREHEAD AND MAGNETICALLY COUPLED TO A SEAT TO SUPPORT THE PERSON'S HEAD IN A COMFORTABLE POSITION WHILE THE PERSON IS RESTING IN THE SEAT (U.S. CLS. 42 AND 50).

NAKWAMA ANKRAH, EXAMINING ATTORNEY

CLASS 24—(Continued).

SN 77-725,662. PAUL MONTONE, DEERFIELD BEACH, FL.
FILED 4-30-2009.

Powel the Pocket Towel

THE MARK CONSISTS OF STANDARD CHARACTERS WITHOUT CLAIM TO ANY PARTICULAR FONT, STYLE, SIZE, OR COLOR.

NO CLAIM IS MADE TO THE EXCLUSIVE RIGHT TO USE "THE POCKET TOWEL", APART FROM THE MARK AS SHOWN.

FOR TOWEL WITH BUILT IN POCKET, POUCH OR STORAGE COMPARTMENT (U.S. CLS. 42 AND 50).

LINDA ESTRADA, EXAMINING ATTORNEY

CLASS 24—(Continued).

SN 77-736,950. VALUE CREATION HOME TEXTILE INC.,
WICKAMS CAY 1, TORTOLA, BR.VIRGIN ISLANDS,
FILED 5-14-2009.

Value Beyond

THE MARK CONSISTS OF STANDARD CHARACTERS WITHOUT CLAIM TO ANY PARTICULAR FONT, STYLE, SIZE, OR COLOR.

NO CLAIM IS MADE TO THE EXCLUSIVE RIGHT TO USE "VALUE", APART FROM THE MARK AS SHOWN.

FOR BATH LINEN; BATH TOWELS; BEACH TOWELS; BED AND TABLE LINEN; BED AND TABLE LINEN, WALL HANGINGS OF TEXTILE; BED BLANKETS; BED CANOPIES; BED COVERS; BED LINEN; BED LINEN AND TABLE LINEN; BED PADS; BED SHEETS; BED SHEETS, FITTED BED SHEET COVERS, BED FLAT SHEETS, AND PILLOW CASES USED IN THE BEDDING, HEALTH CARE, HOME-HEALTH CARE AND NURSING HOME INDUSTRIES MADE OF BIODEGRADABLE FILM CREATED FROM RENEWABLE BIO-POLYMER RESOURCES; BED SKIRTS; BED SPREADS; BED THROWS; CHILDREN'S TOWELS; CONTOURED MATTRESS COVERS; COVERINGS OF PLASTIC FOR FURNITURE; COVERS FOR CUSHIONS; CURTAIN FABRIC; CURTAIN LOOPS OF TEXTILE MATERIAL; CURTAIN TIE-BACKS; CURTAINS; CURTAINS AND TOWELS; CURTAINS MADE OF TEXTILE FABRICS; CURTAINS OF TEXTILE OR PLASTIC; CUSHION COVERS; DINING LINENS; DUVET COVERS; FABRIC COVERS FOR USE ON VARIOUS STRAPS; FABRIC TABLE RUNNERS; FABRIC TABLE TOPPERS; FABRIC WINDOW COVERINGS AND TREATMENTS, NAMELY, CURTAINS, DRAPERIES, SHEERS, SWAGS AND VALANCES; FACE TOWELS; FACE TOWELS OF TEXTILES; FITTED FUTON COVERS NOT OF PAPER; FITTED TOILET LID COVERS; FLAME RETARDANT FABRICS FOR THE MANUFACTURE OF BEDDING AND UPHOLSTERED FURNITURE; HAND TOWELS; HAND TOWELS OF TEXTILE; HAND-TOWELS MADE OF TEXTILE FABRICS; HOODED TOWELS; HOUSEHOLD LINEN; KITCHEN LINENS; KITCHEN TOWELS; LARGE BATH TOWELS; LINEN; LINEN CLOTH; MATTRESS COVERS; NET CURTAINS; PILLOW COVERS; PILLOW-TOP, LOW-PROFILE BED SKIRTS; PLACE MATS NOT OF PAPER; PLACE MATS OF TEXTILE MATERIAL; PLASTIC PLACE MATS; PLASTIC TABLE COVERS; SHOWER CURTAINS; SHOWER ROOM CURTAINS; SILK BED BLANKETS; TABLE AND BED LINEN; TABLE CLOTH OF TEXTILE; TABLE CLOTHS NOT OF PAPER; TABLE LINEN; TABLE LINEN OF TEXTILE; TABLE MATS NOT OF PAPER; TABLE NAPKINS OF TEXTILE; TABLE PADS; TEA TOWELS; TERRY TOWELS; TEXTILE PLACE MATS; TOILET TANK COVERS MADE OF FABRIC OR FABRIC SUBSTITUTES; TOWEL SETS; TOWELLING COVERLETS; TOWELS; UNFITTED FABRIC FURNITURE COVERS; UNFITTED FURNITURE COVERS NOT OF PAPER; UNFITTED FUTON COVERS NOT OF PAPER; VINYL PLACE MATS; WINDOW CURTAINS (U.S. CLS. 42 AND 50).

ANDREW LEASER, EXAMINING ATTORNEY

SN 77-736,924. VALUE CREATION HOME TEXTILE INC.,
WICKAMS CAY 1 TORTOLA, BR.VIRGIN ISLANDS,
FILED 5-14-2009.

Home Beyond

THE MARK CONSISTS OF STANDARD CHARACTERS WITHOUT CLAIM TO ANY PARTICULAR FONT, STYLE, SIZE, OR COLOR.

NO CLAIM IS MADE TO THE EXCLUSIVE RIGHT TO USE "HOME", APART FROM THE MARK AS SHOWN.

FOR BATH LINEN; BATH TOWELS; BEACH TOWELS; BED AND TABLE LINEN; BED AND TABLE LINEN, WALL HANGINGS OF TEXTILE; BED BLANKETS; BED LINEN; BED LINEN AND TABLE LINEN; BLANKET THROWS; BLANKETS FOR OUTDOOR USE; CASHMERE BLANKETS; CHILDREN'S BLANKETS; CURTAIN FABRIC; CURTAIN LOOPS OF TEXTILE MATERIAL; CURTAIN TIE-BACKS; CURTAINS; CURTAINS AND TOWELS; CURTAINS MADE OF TEXTILE FABRICS; CURTAINS OF TEXTILE OR PLASTIC; DINING LINENS; DRAPERIES; FABRIC TABLE RUNNERS; FABRIC TABLE TOPPERS; FABRIC WINDOW COVERINGS AND TREATMENTS, NAMELY, CURTAINS, DRAPERIES, SHEERS, SWAGS AND VALANCES; FACE TOWELS; FACE TOWELS OF TEXTILES; HAND TOWELS; HAND TOWELS OF TEXTILE; HAND-TOWELS MADE OF TEXTILE FABRICS; HOODED TOWELS; HOUSEHOLD LINEN; KITCHEN LINENS; KITCHEN TOWELS; LARGE BATH TOWELS; LINEN; LINEN CLOTH; NET CURTAINS; PLACE MATS NOT OF PAPER; PLACE MATS OF TEXTILE MATERIAL; PLASTIC PLACE MATS; PLASTIC TABLE COVERS; RECEIVING BLANKETS; SHOWER CURTAINS; SHOWER ROOM CURTAINS; SILK BED BLANKETS; SILK BLANKETS; TABLE AND BED LINEN; TABLE CLOTH OF TEXTILE; TABLE CLOTHS NOT OF PAPER; TABLE LINEN; TABLE LINEN OF TEXTILE; TABLE MATS NOT OF PAPER; TABLE NAPKINS OF TEXTILE; TABLE PADS; TEA TOWELS; TERRY TOWELS; TEXTILE PLACE MATS; TOWEL SETS; TOWELS; VINYL PLACE MATS; WINDOW CURTAINS (U.S. CLS. 42 AND 50).

ANDREW LEASER, EXAMINING ATTORNEY

CLASS 24—(Continued).

SN 77-754,355. FOCUS PRODUCTS GROUP, LLC, VERNON HILLS, IL. FILED 6-8-2009.

BONE DRY

THE MARK CONSISTS OF STANDARD CHARACTERS WITHOUT CLAIM TO ANY PARTICULAR FONT, STYLE, SIZE, OR COLOR.

NO CLAIM IS MADE TO THE EXCLUSIVE RIGHT TO USE "DRY", APART FROM THE MARK AS SHOWN.

FOR PET TOWELS, PET CLOTHS IN THE NATURE OF TOWELS, PET WASH MITTS, PET DRYING MITTS (U.S. CLS. 42 AND 50).

FIRST USE 3-22-2009; IN COMMERCE 3-22-2009.
SEAN CROWLEY, EXAMINING ATTORNEY

CLASS 24—(Continued).

SN 77-767,004. JOHN RICH & SONS INVESTMENT HOLDING COMPANY, WILMINGTON, DE. FILED 6-24-2009.



OWNER OF U.S. REG. NOS. 3,313,489, 3,541,647 AND OTHERS.

THE MARK CONSISTS OF A SQUARE MADE UP OF FOUR SMALLER SQUARES. THE UPPER RIGHT-HAND AND LOWER LEFT-HAND SQUARES ARE STRIPED.

FOR FLAT, MITT AND WRAPAROUND POTHOLDERS, TEXTILE TABLE CLOTHS, TEXTILE TABLE RUNNERS, TEXTILE NAPKINS, TEXTILE CHARGERS, NAMELY, PLACE MATS, AND TEXTILE PLACE MATS (U.S. CLS. 42 AND 50).

TARA PATE, EXAMINING ATTORNEY

SN 77-763,213. KINKARACO - GREEN BURIAL PRODUCTS, SAN FRANCISCO, CA. FILED 6-18-2009.

PURELIGHT

THE MARK CONSISTS OF STANDARD CHARACTERS WITHOUT CLAIM TO ANY PARTICULAR FONT, STYLE, SIZE, OR COLOR.

FOR SHROUDS; TEXTILES, NAMELY, FUNERAL, BURIAL, AND CREMATION SHROUDS (U.S. CLS. 42 AND 50).

KATHERINE STOIDES, EXAMINING ATTORNEY

SN 77-801,346. ONE THREAD FAIR TRADE, LLC, FORMERLY ONE THREAD FAIR TRADE, LLC, UPLAND, CA. FILED 8-10-2009.

One Thread Fair Trade

THE MARK CONSISTS OF STANDARD CHARACTERS WITHOUT CLAIM TO ANY PARTICULAR FONT, STYLE, SIZE, OR COLOR.

NO CLAIM IS MADE TO THE EXCLUSIVE RIGHT TO USE "FAIR TRADE", APART FROM THE MARK AS SHOWN.

FOR TEXTILE FABRICS FOR HOME AND COMMERCIAL INTERIORS (U.S. CLS. 42 AND 50).

FIRST USE 7-0-2008; IN COMMERCE 7-0-2008.
SUE LAWRENCE, EXAMINING ATTORNEY

CLASS 24—(Continued).

SN 77-817,953. HALAWI, SOUHAIL, DBA CALIFORNIA FASHION HOUSE, GLENDALE, CA. AND CHAYH, AMER, DBA CALIFORNIA FASHION HOUSE, GLENDALE, CA. FILED 9-1-2009.

SIERRA

THE MARK CONSISTS OF STANDARD CHARACTERS WITHOUT CLAIM TO ANY PARTICULAR FONT, STYLE, SIZE, OR COLOR.

FOR BED BLANKETS (U.S. CLS. 42 AND 50).
FIRST USE 1-5-2009; IN COMMERCE 1-5-2009.
SUE LAWRENCE, EXAMINING ATTORNEY

SN 77-868,100. VICTORIA CLASSICS LTD., NEW YORK, NY. FILED 11-9-2009.

BRYAN KEITH

THE MARK CONSISTS OF STANDARD CHARACTERS WITHOUT CLAIM TO ANY PARTICULAR FONT, STYLE, SIZE, OR COLOR.

THE NAME(S), PORTRAIT(S), AND/OR SIGNATURE(S) SHOWN IN THE MARK IDENTIFIES "BRYAN KEITH", WHOSE CONSENT(S) TO REGISTER IS MADE OF RECORD.

FOR CURTAINS, BEDSPREADS, TEXTILE WALL HANGINGS, NON PAPER TABLE CLOTHS, BEDSHEETS AND PILLOW CASES (U.S. CLS. 42 AND 50).
RENEE MCCRAY, EXAMINING ATTORNEY

SN 77-883,993. WEARABLE TOWEL, INC., FISHER ISLAND, FL. FILED 12-2-2009.

WEARABLE Towel ^{IV}

NO CLAIM IS MADE TO THE EXCLUSIVE RIGHT TO USE "WEARABLE TOWEL", APART FROM THE MARK AS SHOWN.

THE MARK CONSISTS OF THE WORD "WEARABLE" IN CAPITAL LETTERS APPEARING IN PLAIN FONT ABOVE THE WORD "TOWEL" IN A FANCIFUL FONT SLANTED TO THE RIGHT WITH THE TOP OF THE "T" APPEARING HORIZONTALLY THROUGH THE "EAR" IN THE WORD "WEARABLE", AND "IVC" APPEARING TO THE RIGHT OF THE WORD "TOWEL" WITH THE "C" SUPERIMPOSED OVER THE "V".

FOR TOWELS, NAMELY, BATH TOWELS, BEACH TOWELS, TERRY CLOTH TOWELS, WRAP AROUND TOWELS (U.S. CLS. 42 AND 50).

FIRST USE 11-24-2009; IN COMMERCE 11-24-2009.
PAM WILLIS, EXAMINING ATTORNEY

CLASS 24—(Continued).

SN 77-886,305. IDEA NUOVA, INC., NEW YORK, NY. FILED 12-4-2009.

DISTRICT 101

THE MARK CONSISTS OF STANDARD CHARACTERS WITHOUT CLAIM TO ANY PARTICULAR FONT, STYLE, SIZE, OR COLOR.

FOR BED BLANKETS; BED CANOPIES; BED COVERS; BED LINEN; BED SHEETS; BED SKIRTS; BED SPREADS; BED THROWS; BLANKET THROWS; COMFORTERS; COVERLETS; DUST RUFFLES; DUVET COVERS; DUVETS; PILLOW CASES; PILLOW COVERS; PILLOW SHAMS; QUILTS (U.S. CLS. 42 AND 50).
STEVEN JACKSON, EXAMINING ATTORNEY

SN 77-886,342. NATCO HOME FASHIONS, WARWICK, RI. FILED 12-4-2009.

KIDSPACE

THE MARK CONSISTS OF STANDARD CHARACTERS WITHOUT CLAIM TO ANY PARTICULAR FONT, STYLE, SIZE, OR COLOR.

FOR FABRIC WINDOW COVERINGS AND TREATMENTS, NAMELY, CURTAINS, DRAPERIES, SHEERS, SWAGS AND VALANCES; BED BLANKETS; BED LINEN; COMFORTERS; CARPETS; RUGS; AREA RUGS (U.S. CLS. 42 AND 50).
RAUL CORDOVA, EXAMINING ATTORNEY

SN 77-887,703. STEPHEN CARDER, CARROLLTON, TX. FILED 12-7-2009.



THE MARK CONSISTS OF THE WORD "MOTOZONE" SLANTED AT 25 DEGREES, PRECEDED BY 6 RECTANGLES SLANTED 25 DEGREES REPRESENTING A CHECKERED FLAG.

FOR MICROFIBER TOWELS (U.S. CLS. 42 AND 50).
KELLY BOULTON, EXAMINING ATTORNEY

CLASS 24—(Continued).

SN 77-887,704. INVISTA NORTH AMERICA S.A R.L., WILMINGTON, DE. FILED 12-7-2009.

THERMOLOFT

THE MARK CONSISTS OF STANDARD CHARACTERS WITHOUT CLAIM TO ANY PARTICULAR FONT, STYLE, SIZE, OR COLOR.

FOR SYNTHETIC FIBER SOLD AS AN INTEGRAL COMPONENT OF COMFORTERS (U.S. CLS. 42 AND 50).
KELLY BOULTON, EXAMINING ATTORNEY

CLASS 24—(Continued).

SN 77-894,134. EXPAND-A-BAND, LLC, GARDENA, CA. FILED 12-15-2009.

WOMB COCOON

THE MARK CONSISTS OF STANDARD CHARACTERS WITHOUT CLAIM TO ANY PARTICULAR FONT, STYLE, SIZE, OR COLOR.

FOR BABY SWADDLING BLANKETS (U.S. CLS. 42 AND 50).
JESSICA A. POWERS, EXAMINING ATTORNEY

SN 77-890,658. UNIVERSITY OF NORTHWESTERN OHIO, LIMA, OH. FILED 12-10-2009.



THE COLOR(S) RED, BLACK AND WHITE IS/ARE CLAIMED AS A FEATURE OF THE MARK.

THE MARK CONSISTS OF A RED LARGE "U" OUTLINED IN BLACK AND WHITE WITH THE STYLIZED WORDING "MOTORSPORTS" ARCHED ACROSS MIDDLE IN WHITE LETTERS WITH RED, BLACK, AND WHITE OUTLINING AND THE STYLIZED WORDING "UNOH" IN BLACK AND RED OUTLINED IN WHITE ACROSS THE BOTTOM OF THE "U".

FOR FELT PENNANTS (U.S. CLS. 42 AND 50).
LIEF MARTIN, EXAMINING ATTORNEY

SN 77-895,015. HEARST COMMUNICATIONS, INC., NEW YORK, NY. FILED 12-16-2009.



NO CLAIM IS MADE TO THE EXCLUSIVE RIGHT TO USE "HOME" & "1846", APART FROM THE MARK AS SHOWN.

THE MARK CONSISTS OF THE WORDS, LETTERS, AND NUMBERS "HOME", "T&C" AND "1846" ARRANGED VERTICALLY AND SURROUNDED BY A CIRCULAR BORDER COMPOSED OF A WREATH OF LEAVES.

FOR BATH LINEN; BED LINEN; CURTAINS; DRAPERIES; SHOWER CURTAINS; TABLE LINEN; WALL HANGINGS OF TEXTILE (U.S. CLS. 42 AND 50).
KARANENDRA S. CHHINA, EXAMINING ATTORNEY

SN 77-891,271. MAYER-PAETZ, INC., INDIANAPOLIS, IN. FILED 12-11-2009.

JEKYLL & HYDE

THE MARK CONSISTS OF STANDARD CHARACTERS WITHOUT CLAIM TO ANY PARTICULAR FONT, STYLE, SIZE, OR COLOR.

FOR UPHOLSTERY FABRICS (U.S. CLS. 42 AND 50).
FIRST USE 12-3-2009; IN COMMERCE 12-3-2009.
KATHLEEN M. VANSTON, EXAMINING ATTORNEY

SN 77-896,165. TWENTIETH CENTURY FOX FILM CORPORATION, LOS ANGELES, CA. FILED 12-17-2009.

**HOPE IS NOT A STRATEGY
LUCK IS NOT A FACTOR
FEAR IS NOT AN OPTION**

THE MARK CONSISTS OF STANDARD CHARACTERS WITHOUT CLAIM TO ANY PARTICULAR FONT, STYLE, SIZE, OR COLOR.

FOR BED, BATH AND TABLE LINENS (U.S. CLS. 42 AND 50).
JAY FLOWERS, EXAMINING ATTORNEY

CLASS 24—(Continued).

SN 77-919,424. JUICY COUTURE, INC., PACOIMA, CA.
FILED 1-25-2010.

COUTURE IN A BAG

THE MARK CONSISTS OF STANDARD CHARACTERS WITHOUT CLAIM TO ANY PARTICULAR FONT, STYLE, SIZE, OR COLOR.

FOR BED SHEETS; DUVET COVERS; PILLOW CASES (U.S. CLS. 42 AND 50).

CURTIS FRENCH, EXAMINING ATTORNEY

CLASS 24—(Continued).

SN 79-071,637. FORMESSE GMBH & CO. KG, FED REP GERMANY, FILED 6-10-2009.

Bella Donna 

OWNER OF INTERNATIONAL REGISTRATION 1009637 DATED 6-10-2009, EXPIRES 6-10-2019.

THE MARK CONSISTS OF THE WORDING "BELLA DONNA". TO THE RIGHT OF THE WORDING THERE ARE THE LETTERS "D" (MIRRORED) AND "B", WITH A CROWN EMBEDDED AT THE POINT WHERE THE LETTERS MEET.

THE ENGLISH TRANSLATION OF "BELLA DONNA" IN THE MARK IS "BEAUTIFUL DAY".

FOR HOME TEXTILES, NAMELY, BED SHEETS AND FITTED BED SHEETS, BED CLOTHES IN THE NATURE OF BED LINEN, BED COVERS, PILLOW SHAMS; HOUSEHOLD LINEN; BED BLANKETS; TRAVEL BLANKETS MADE OF WOOL, COTTON AND SYNTHETIC FIBER; QUILTED BLANKETS MADE OF WOOL, COTTON, SYNTHETIC FIBER AND DOWN; COVERLETS; TABLECLOTH, NOT OF PAPER (U.S. CLS. 42 AND 50).
MICHAEL WIENER, EXAMINING ATTORNEY

SN 77-925,898. WEARABLE TOWEL, INC., FISHER ISLAND, FL. FILED 2-2-2010.

**CLASS 25—CLOTHING**

SN 76-558,330. WEIDER HEALTH AND FITNESS, WOODLAND HILLS, CA. FILED 11-10-2003.

JOE WEIDER

NO CLAIM IS MADE TO THE EXCLUSIVE RIGHT TO USE "WEARABLE TOWEL", APART FROM THE MARK AS SHOWN.

THE MARK CONSISTS OF A RECTANGULAR OUTLINE FRAMING 3 FLATTENED OVALS APPEARING AT THE INSIDE TOP OF THE RECTANGLE WITH THE WORD "WEARABLE" BELOW AND IN ALL CAPITAL LETTERS APPEARING ABOVE THE WORD "TOWEL" SLANTED TO THE RIGHT AND WITH A CAPITAL "T" AND THE ROMAN NUMERALS "IVC" APPEARING TO THE RIGHT OF THE WORD "TOWEL" WITH THE "C" SUPERIMPOSED OVER THE "V" AND PARTIALLY BELOW THE "V".

THE ENGLISH TRANSLATION OF "IVC" IN THE MARK IS "104".

FOR TOWELS (U.S. CLS. 42 AND 50).
FIRST USE 1-8-2010; IN COMMERCE 1-8-2010.
PAM WILLIS, EXAMINING ATTORNEY

OWNER OF U.S. REG. NOS. 1,485,344 AND 2,836,887.
THE NAME "JOE WEIDER" IDENTIFIES A LIVING INDIVIDUAL WHOSE CONSENT IS OF RECORD.

FOR MEN'S, WOMEN'S AND CHILDREN'S APPAREL, NAMELY, SHIRTS, PANTS, T-SHIRTS, SHORTS, BLOUSES, SUITS, SWIMWEAR, LINGERIE, SWEAT-SHIRTS, UNDERWEAR, JACKETS, DRESSES, SKIRTS, GLOVES, BATHROBES, NIGHTGOWNS, SOCKS, HEADWEAR AND FOOTWEAR (U.S. CLS. 22 AND 39).

PAULA MAHONEY, EXAMINING ATTORNEY

CLASS 25—(Continued).

SN 76-696,909. FRENCH, CHRISTIAN, BURBANK, CA. FILED 4-16-2009.



THE MARK CONSISTS OF THE LETTERS "SF" IN A TEARDROP SHAPE ABOVE A RECTANGLE CONTAINING THE WORDING "SI FRENCH". THE TEARDROP SHAPE AND RECTANGLE APPEAR INSIDE OF A LARGER RECTANGLE.

THE ENGLISH TRANSLATION OF THE WORD "SI" IN THE MARK IS "YES".

FOR T-SHIRTS (U.S. CLS. 22 AND 39).
TINA BROWN, EXAMINING ATTORNEY

SN 76-697,285. UZETA, JEREMY, LITTLETON, CO. FILED 5-7-2009.

Corporate Puppet

THE MARK CONSISTS OF STANDARD CHARACTERS WITHOUT CLAIM TO ANY PARTICULAR FONT, STYLE, SIZE, OR COLOR.

FOR SHIRTS (U.S. CLS. 22 AND 39).
FIRST USE 1-26-2004; IN COMMERCE 1-26-2004.
JORDAN BAKER, EXAMINING ATTORNEY

SN 76-697,890. TATIOSSIAN BROS., INC., SUN VALLEY, CA. FILED 6-12-2009.

DONNA BLUE

NO CLAIM IS MADE TO THE EXCLUSIVE RIGHT TO USE "BLUE", APART FROM THE MARK AS SHOWN. "DONNA BLUE" DOES NOT IDENTIFY A LIVING INDIVIDUAL.

FOR WOMEN'S SHOES (U.S. CLS. 22 AND 39).
MARK PILARO, EXAMINING ATTORNEY

CLASS 25—(Continued).

SN 76-698,668. BLACKBELT.TV, INC, SANTA MONICA, CA. FILED 7-28-2009.

KICKS, FLICKS & CHICKS!

THE MARK CONSISTS OF STANDARD CHARACTERS WITHOUT CLAIM TO ANY PARTICULAR FONT, STYLE, SIZE, OR COLOR.

FOR SHIRTS, JACKETS, HATS, PANTS (U.S. CLS. 22 AND 39).
KAREN SEVERSON, EXAMINING ATTORNEY

SN 76-700,746. TIFFANY BURRESS, TOTOWA, NJ. FILED 12-9-2009.

JOI

THE MARK CONSISTS OF STANDARD CHARACTERS WITHOUT CLAIM TO ANY PARTICULAR FONT, STYLE, SIZE, OR COLOR.

FOR MATERNITY CLOTHING, NAMELY, MATERNITY LINGERIE, MATERNITY UNDERWEAR, MATERNITY NEGLIGEEES, MATERNITY HOSIERY, MATERNITY SLEEPWEAR, MATERNITY DAYWEAR, NAMELY, DRESSES, SUITS, T-SHIRTS, JUMPERS, TROUSERS, BLOUSES, SKIRTS, JACKETS, DUNGAREES, JEANS, CARDIGANS, LEGGINGS, SWIMSUITS, JUMPSUITS (U.S. CLS. 22 AND 39).
MARILYN IZZI, EXAMINING ATTORNEY

SN 76-701,272. WALLS INDUSTRIES, INC. CLEBURNE, TEXAS, CLEBURNE, TX. FILED 1-20-2010.

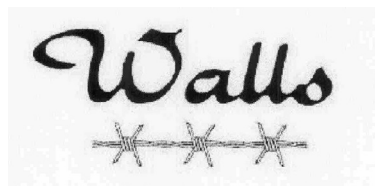

OWNER OF U.S. REG. NOS. 983,385, 2,571,382 AND OTHERS.

THE MARK CONSISTS OF THE WORD WALLS IN A CURSIVE STYLIZED FONT WITH THE LETTER "W" CAPITALIZED AND THE LETTERS "ALLS" IN LOWER CASE. A LOGO CONSISTING OF THREE BARBED WIRE KNOTS ARE BELOW THE MARK.

FOR SWEATSHIRTS, SUITS, COVERALLS, BELTS, SHIRTS, SOCKS, BOOTIES, HOODS, JEANS, DUNGAREES, SHORTS, HOSIERY (U.S. CLS. 22 AND 39).

GINA HAYES, EXAMINING ATTORNEY

CLASS 25—(Continued).

SN 77-113,269. KETTLES, BRYAN, GILFORD, ONTARIO, CANADA, FILED 2-22-2007.

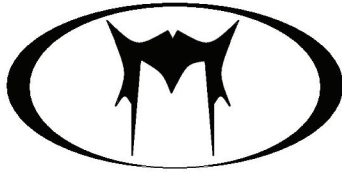

PRIORITY CLAIMED UNDER SEC. 44(D) ON CANADA APPLICATION NO. 1327719, FILED 12-11-2006, REG. NO. TMA755839, DATED 12-21-2009, EXPIRES 12-21-2024.

THE MARK CONSISTS OF STYLIZED "M" IN AN OVAL FOR CLOTHING, NAMELY, SWEAT SHIRTS (U.S. CLS. 22 AND 39).

FRED MANDIR, EXAMINING ATTORNEY

SN 77-126,675. RYAN, CHARLES, SAN DIEGO, CA. FILED S.R. 3-9-2007; AM. P.R. 7-17-2007.

DUKKY

FOR T SHIRTS, HATS, BELTS, SOCKS, UNDERWEAR AND JEANS (U.S. CLS. 22 AND 39).

NAKIA HENRY, EXAMINING ATTORNEY

SN 77-179,375. GAP (APPAREL), LLC, SAN FRANCISCO, CA. FILED 5-11-2007.

BRANNAN'S FAVORITES

THE MARK CONSISTS OF STANDARD CHARACTERS WITHOUT CLAIM TO ANY PARTICULAR FONT, STYLE, SIZE, OR COLOR.

OWNER OF U.S. REG. NO. 2,959,656.

FOR CHILDREN'S CLOTHING, NAMELY, CLOTH BIBS, BODY SUITS, BONNETS, CHILDREN'S HEADWEAR, COATS, DENIMS, DRESSES, INFANT AND TODDLER ONE PIECE CLOTHING, JACKETS, JUMPERS, LEGGINGS, NIGHTCAPS, NIGHTIES, OVERALLS, PANTS, POLO SHIRTS, SHIRTS, SHORTS, SKIRTS, STOCKINGS AND TANK TOPS ALL SOLD VIA RETAIL STORES AND ON-LINE RETAIL STORES (U.S. CLS. 22 AND 39).

FIRST USE 9-0-2005; IN COMMERCE 9-0-2005.

AMY C. KEAN, EXAMINING ATTORNEY

CLASS 25—(Continued).

SN 77-203,400. HAYNES, CARL, FRANKLIN, TN. FILED 6-11-2007.



THE MARK CONSISTS OF THE WORD "CLUBBUSA" PRINTED IN CAPITAL LETTERS. THE FIRST "B" IN "CLUBBUSA" IS REVERSED SO THAT THE "B" FACES TO THE LEFT DIRECTION, RATHER THAN TO THE RIGHT DIRECTION. THE "A" IN "CLUBBUSA" CONTAINS A SMALL DOT, RATHER THAN A HORIZONTAL LINE. THE PHRASE "GET OFF N2 IT" IS LOCATED BELOW THE "CLUBBUSA" WORD. THE "GET OFF N2 IT" PHRASE BEGINS UNDER THE SECOND "B" IN THE "CLUBBUSA" WORD. THE "CLUBBUSA" PHRASE IS OVERLAYED OVER THE JAPANESE KANJI SYMBOL FOR "HAYABUSA" WHICH TRANSLATES INTO ENGLISH AS "PEREGRINE FALCON".

THE FOREIGN WORDING IN THE MARK TRANSLATES INTO ENGLISH AS "PEREGRINE FALCON".

THE NON-LATIN CHARACTER(S) IN THE MARK TRANSLITERATES INTO "HAYABUSA", AND THIS MEANS "PEREGRINE FALCON" IN ENGLISH.

FOR LEATHER JACKETS; T-SHIRTS; JACKETS; COATS; SHIRTS; LEATHER COATS (U.S. CLS. 22 AND 39).

MATTHEW MCDOWELL, EXAMINING ATTORNEY

SN 77-321,638. WICKED FASHIONS, INC., FORT LEE, NJ. FILED 11-5-2007.

WCKD

THE MARK CONSISTS OF "WCKD" IN SCRIPT LETTERS.

FOR WEARING APPAREL, NAMELY, TOPS, BOTTOMS, HEADGEAR IN THE NATURE OF HATS AND CAPS, OUTERWEAR IN THE NATURE OF COATS AND JACKETS, AND FOOTWEAR (U.S. CLS. 22 AND 39).

JULIE WATSON, EXAMINING ATTORNEY

CLASS 25—(Continued).

SN 77-393,802. RAFAELLA APPAREL GROUP, INC., NEW YORK, NY. FILED 2-11-2008.

ELLA

THE MARK CONSISTS OF STANDARD CHARACTERS WITHOUT CLAIM TO ANY PARTICULAR FONT, STYLE, SIZE, OR COLOR.

FOR WOMEN'S SPORTSWEAR AND OUTERWEAR CLOTHING, NAMELY, JEANS, PANTS, SHIRTS, JACKETS, BLAZERS, BLOUSES, T-SHIRTS, SWEATERS, SKIRTS, DRESSES, SUITS, VESTS AND SHORTS (U.S. CLS. 22 AND 39).

SAMUEL E. SHARPER JR., EXAMINING ATTORNEY

CLASS 25—(Continued).

SN 77-466,335. MUN, YEJI, LAS VEGAS, NV. FILED 5-5-2008.

VEGAS GIRL

THE MARK CONSISTS OF STANDARD CHARACTERS WITHOUT CLAIM TO ANY PARTICULAR FONT, STYLE, SIZE, OR COLOR.

FOR TOPS; SHIRTS; PANTS; SKIRTS AND DRESSES; SHORTS; FOOTWEAR FOR WOMEN; WOMEN'S UNDERWEAR; SOCKS AND STOCKINGS; HATS; BOTTOMS (U.S. CLS. 22 AND 39).

INGRID C. EULIN, EXAMINING ATTORNEY

SN 77-402,693. MOMZELLE, TORONTO, CANADA, FILED 2-21-2008.

MOMZELLE

THE MARK CONSISTS OF STANDARD CHARACTERS WITHOUT CLAIM TO ANY PARTICULAR FONT, STYLE, SIZE, OR COLOR.

FOR MATERNITY LINGERIE; MATERNITY SLEEPWEAR; BRAS; NURSING APPAREL, NAMELY, TOPS, DRESSES, NURSING BRAS, NURSING SWIMSUITS, AND MATERNITY WEAR, NAMELY, TOPS, SWEATERS, CARDIGANS, PANTS, DRESSES, SHORTS, SKIRTS (U.S. CLS. 22 AND 39).

FIRST USE 10-12-2007; IN COMMERCE 10-12-2007.

HAI-LY LAM, EXAMINING ATTORNEY

SN 77-515,287. KATIA VAZ, LOS ANGELES, CA. AND GEORGE SOLORZANO, LOS ANGELES, CA. FILED S.R. 7-6-2008; AM. P.R. 3-15-2010.



THE COLOR(S) RED, YELLOW, PURPLE, BLUE, PINK, GREEN AND BLACK IS/ARE CLAIMED AS A FEATURE OF THE MARK.

THE MARK CONSISTS OF A BLACK OVAL OUTLINED IN RED WITHIN THE OVAL IS THE WORDING "RIOHOT". THE LETTER "R" IS RED, THE LETTER "I" IS YELLOW, THE LETTER "O" IS PURPLE, THE LETTER "H" IS BLUE, THE LETTER "O" IS PINK, AND THE LETTER "T" IS GREEN.

THE ENGLISH TRANSLATION OF "RIOHOT" IN THE MARK IS "HOT RIVER".

FOR ATHLETIC APPAREL, NAMELY, SHIRTS, PANTS, JACKETS, FOOTWEAR, HATS AND CAPS, ATHLETIC UNIFORMS (U.S. CLS. 22 AND 39).

CHRISTINA SOBRAL, EXAMINING ATTORNEY

SN 77-436,823. TAG/THE APPAREL GROUP OF NEW YORK INC., GARDENA, CA. FILED 4-1-2008.



NO CLAIM IS MADE TO THE EXCLUSIVE RIGHT TO USE "APPAREL", APART FROM THE MARK AS SHOWN.

FOR BLOUSES, CAPRIS, DRESSES, JEANS, SHIRTS, KNIT SHIRTS, LONG-SLEEVED SHIRTS, SHORT SLEEVED SHIRTS, SLEEPWEAR, SKIRTS AND UNDERWEAR (U.S. CLS. 22 AND 39).

FIRST USE 2-5-2008; IN COMMERCE 2-5-2008.

PAUL E. FAHRENKOPF, EXAMINING ATTORNEY

SN 77-594,675. NIKE, INC., BEAVERTON, OR. FILED 10-17-2008.

CANARINHO

THE MARK CONSISTS OF STANDARD CHARACTERS WITHOUT CLAIM TO ANY PARTICULAR FONT, STYLE, SIZE, OR COLOR.

FOR FOOTWEAR, APPAREL, NAMELY, PANTS, SHORTS, SHIRTS, T-SHIRTS, SWEAT SHIRTS, JACKETS, HATS, CAPS, JERSEYS (U.S. CLS. 22 AND 39).

RICHARD WHITE, EXAMINING ATTORNEY

CLASS 25—(Continued).

SN 77-597,484. THIBAUT, KATHRYN, SCOTTSDALE, AZ. FILED 10-21-2008.

iGreenSox

THE MARK CONSISTS OF STANDARD CHARACTERS WITHOUT CLAIM TO ANY PARTICULAR FONT, STYLE, SIZE, OR COLOR.

FOR SOCKS (U.S. CLS. 22 AND 39).
PAUL E. FAHRENKOPF, EXAMINING ATTORNEY

CLASS 25—(Continued).

SN 77-610,862. LOLLIDUDS, LLC, YPSILANTI, MI. FILED 11-10-2008.

Lolliduds

THE MARK CONSISTS OF STANDARD CHARACTERS WITHOUT CLAIM TO ANY PARTICULAR FONT, STYLE, SIZE, OR COLOR.

FOR INFANT AND TODDLER ONE PIECE CLOTHING; INFANT WEAR; KNIT SHIRTS; LONG-SLEEVED SHIRTS; ONE PIECE GARMENT FOR INFANTS AND TODDLERS; SHIRTS; SHORT-SLEEVED OR LONG-SLEEVED T-SHIRTS; SHORT-SLEEVED SHIRTS; T-SHIRTS; TEE SHIRTS; WEARABLE GARMENTS AND CLOTHING, NAMELY, SHIRTS (U.S. CLS. 22 AND 39).
FIRST USE 8-15-2008; IN COMMERCE 8-15-2008.

RUDY R. SINGLETON, EXAMINING ATTORNEY

SN 77-614,247. LYNNIECIA HARANGUE, NEWPORT BEACH, CA. FILED 11-13-2008.

FONDLE

THE MARK CONSISTS OF STANDARD CHARACTERS WITHOUT CLAIM TO ANY PARTICULAR FONT, STYLE, SIZE, OR COLOR.

FOR CLOTHING, FOOTWEAR AND HEADGEAR, NAMELY, SKIRTS, DRESSES, PANTS, JACKETS, SHIRTS, GOWNS, SHORTS, UNDERWEAR, BRAS, LINGERIE, PAJAMAS, BEACHWEAR, HATS, CAPS, SCARVES, GLOVES, SHOES, SANDALS, HEELS, BOOTS, SOCKS, BELTS (U.S. CLS. 22 AND 39).

KATHERINE E. HALMEN, EXAMINING ATTORNEY

SN 77-609,720. MKARIN INTERNATIONAL - COMÉRCIO IMPORTAÇÃO E EXPORTAÇÃO TÊXTEIS, LDA., LISBON, PORTUGAL, FILED 11-7-2008.



SN 77-614,251. LYNNIECIA HARANGUE, NEWPORT BEACH, CA. FILED 11-13-2008.

COCO BROWN

OWNER OF ERPN CMNTY TM OFC REG. NO. 2887628, DATED 7-15-2004, EXPIRES 10-10-2012.

THE COLOR(S) PINK AND PURPLE IS/ARE CLAIMED AS A FEATURE OF THE MARK.

THE MARK CONSISTS OF STYLIZED PINK LETTERS "M" AND "K" OVERLAPPING ONE ANOTHER, THE OVERLAPPING LINES OF THE LETTERS ARE PURPLE, ABOVE THE LIGHT PURPLE LETTER "M" AND DARK PURPLE WORD "KARIN" WITH THE SAME "M" AND "K" OVERLAPPING STYLE, ALL BORDERED BY A PINK LINE ON THE TOP AND A PINK LINE ON THE BOTTOM.

FOR CLOTHING, NAMELY, WEDDING DRESSES AND NIGHT DRESSES; FOOTWEAR; HEADGEAR, NAMELY, HATS AND VEILS (U.S. CLS. 22 AND 39).

ALICIA COLLINS, EXAMINING ATTORNEY

THE MARK CONSISTS OF STANDARD CHARACTERS WITHOUT CLAIM TO ANY PARTICULAR FONT, STYLE, SIZE, OR COLOR.

THE NAME(S), PORTRAIT(S), AND/OR SIGNATURE(S) SHOWN IN THE MARK DOES NOT IDENTIFY A PARTICULAR LIVING INDIVIDUAL.

FOR CLOTHING, FOOTWEAR AND HEADGEAR, NAMELY, SKIRTS, DRESSES, PANTS, JACKETS, SHIRTS, GOWNS, SHORTS, UNDERWEAR, BRAS, LINGERIE, PAJAMAS, BEACHWEAR, HATS, CAPS, SCARVES, GLOVES, SHOES, SANDALS, HEELS, BOOTS, SOCKS, BELTS (U.S. CLS. 22 AND 39).

KATHERINE E. HALMEN, EXAMINING ATTORNEY

CLASS 25—(Continued).

SN 77-619,953. ELISA ANDRES CARBONELL, S.L., ALICANTE, SPAIN, FILED 11-21-2008.

JARRES

THE MARK CONSISTS OF STANDARD CHARACTERS WITHOUT CLAIM TO ANY PARTICULAR FONT, STYLE, SIZE, OR COLOR.

OWNER OF SPAIN REG. NO. 2.275.778, DATED 12-7-1999, RENEWED AS REG. NO. 2.275.778, DATED 10-16-2009, EXPIRES 12-7-2019.

THE ENGLISH TRANSLATION OF THE WORD "JARRES" IN THE MARK IS "JARS".

FOR CLOTHING FOR CHILDREN, NAMELY, DRESSES, SHIRTS, T-SHIRTS, SKIRTS, TROUSERS, JACKETS, WIND-JACKETS, PADDED JACKETS, RAIN JACKETS, RAINPROOF JACKETS, JUMPERS (U.S. CLS. 22 AND 39).

NELSON SNYDER, EXAMINING ATTORNEY

CLASS 25—(Continued).

SN 77-639,842. BIGGS, DIANE, TORRANCE, CA. FILED 12-24-2008.

DIANE'S BEACHWEAR

THE MARK CONSISTS OF STANDARD CHARACTERS WITHOUT CLAIM TO ANY PARTICULAR FONT, STYLE, SIZE, OR COLOR.

NO CLAIM IS MADE TO THE EXCLUSIVE RIGHT TO USE "BEACHWARE", APART FROM THE MARK AS SHOWN.

FOR BEACH COVERUPS; BEACHWEAR; COVERUPS; HATS; SANDALS; SWIMSUITS; SWIMWEAR (U.S. CLS. 22 AND 39).

FIRST USE 1-1-2003; IN COMMERCE 1-1-2003.

WILLIAM ROSSMAN, EXAMINING ATTORNEY

SN 77-648,294. BEACON FOOTWEAR, INC., WILDWOOD, MO. FILED 1-13-2009.

SOFWEAR

THE MARK CONSISTS OF STANDARD CHARACTERS WITHOUT CLAIM TO ANY PARTICULAR FONT, STYLE, SIZE, OR COLOR.

SEC. 2(F).

FOR LADIES SHOES (U.S. CLS. 22 AND 39).

FIRST USE 0-0-1971; IN COMMERCE 9-0-1999.

DAVID ELTON, EXAMINING ATTORNEY

SN 77-622,529. SIMS, MOLLY, NEW YORK, NY. FILED 11-26-2008.

GRAYCE BY MOLLY SIMS

THE MARK CONSISTS OF STANDARD CHARACTERS WITHOUT CLAIM TO ANY PARTICULAR FONT, STYLE, SIZE, OR COLOR.

THE NAME(S), PORTRAIT(S), AND/OR SIGNATURE(S) SHOWN IN THE MARK IDENTIFIES MOLLY SIMS, WHOSE CONSENT(S) TO REGISTER IS MADE OF RECORD.

FOR CLOTHING AND CLOTHING ACCESSORIES, NAMELY, SHIRTS, PANTS, SWEATERS, SKIRTS, DRESSES, COATS, BELTS, SWIMWEAR, RAINWEAR; SLEEPWEAR AND LOUNGEWEAR, NAMELY, NIGHTGOWNS, PAJAMAS AND ROBES; LINGERIE, NAMELY, UNDERWEAR AND BRAS; SOCKS, HOSIERY, GLOVES, MITTENS AND SCARVES; FOOTWEAR; HEADWEAR (U.S. CLS. 22 AND 39).

SARA THOMAS, EXAMINING ATTORNEY

SN 77-648,487. SAKARA, EDWARD, SAINT-LAURENT, QUEBEC, CANADA, FILED 1-13-2009.

LA FÉE VERTE

THE MARK CONSISTS OF STANDARD CHARACTERS WITHOUT CLAIM TO ANY PARTICULAR FONT, STYLE, SIZE, OR COLOR.

OWNER OF CANADA REG. NO. TMA755263, DATED 12-14-2009, EXPIRES 12-14-2024.

THE ENGLISH TRANSLATION OF "LA FÉE VERTE" IS "THE GREEN FAIRY".

FOR LINGERIE (U.S. CLS. 22 AND 39).

MAUREEN DALL, EXAMINING ATTORNEY

CLASS 25—(Continued).

SN 77-651,987. JAMES DEAN, MCDONOUGH, GA. FILED 1-19-2009.



THE MARK CONSISTS OF A STYLIZED DRAWING OF THE HEAD AND FACE OF A CAT ACCOMPANIED BY THE WORDS "PETE" ON TOP OF THE HEAD AND "THE CAT" UNDERNEATH THE HEAD.

FOR CLOTHING, NAMELY, HATS, CAPS, SHIRTS, T-SHIRTS, SWEATSHIRTS, JACKETS, COATS, PANTS AND PAJAMAS (U.S. CLS. 22 AND 39).

FIRST USE 12-31-1998; IN COMMERCE 12-31-1998.

KATHLEEN M. VANSTON, EXAMINING ATTORNEY

SN 77-663,639. REYES, FRANCES, GUTTENBERG, NJ. FILED 2-4-2009.

Because I'm AfriKAN

THE MARK CONSISTS OF STANDARD CHARACTERS WITHOUT CLAIM TO ANY PARTICULAR FONT, STYLE, SIZE, OR COLOR.

FOR T-SHIRTS (U.S. CLS. 22 AND 39).

FIRST USE 1-0-2008; IN COMMERCE 6-0-2008.

MARY BOAGNI, EXAMINING ATTORNEY

SN 77-663,950. LOWENBAUM, JULIE SLOAN, GLENCOE, IL. FILED 2-5-2009.

Head Over Heels Designs

THE MARK CONSISTS OF STANDARD CHARACTERS WITHOUT CLAIM TO ANY PARTICULAR FONT, STYLE, SIZE, OR COLOR.

NO CLAIM IS MADE TO THE EXCLUSIVE RIGHT TO USE "DESIGNS", APART FROM THE MARK AS SHOWN.

FOR CLOTHING AND CLOTHING ACCESSORIES, NAMELY; WRAPS; SHAWLS; CUFFS, COLLARS; SCARVES; BELTS; JERSEYS; SHIRTS; GLOVES (U.S. CLS. 22 AND 39).

FIRST USE 1-10-2009; IN COMMERCE 1-10-2009.

LESLIE RICHARDS, EXAMINING ATTORNEY

CLASS 25—(Continued).

SN 77-704,188. RX MUSCLE, INC., SEAFORD, NY. FILED 4-1-2009.

RX MUSCLE

THE MARK CONSISTS OF STANDARD CHARACTERS WITHOUT CLAIM TO ANY PARTICULAR FONT, STYLE, SIZE, OR COLOR.

FOR SHIRTS (U.S. CLS. 22 AND 39).

FIRST USE 3-6-2009; IN COMMERCE 3-6-2009.

KARANENDRA S. CHHINA, EXAMINING ATTORNEY

SN 77-713,625. HANNA-BARBERA PRODUCTIONS, INC., BURBANK, CA. FILED 4-14-2009.



OWNER OF U.S. REG. NO. 3,399,935.

NO CLAIM IS MADE TO THE EXCLUSIVE RIGHT TO USE "KIDS", APART FROM THE MARK AS SHOWN.

THE MARK CONSISTS OF CARVED STONE BARING THE WORDS "THE FLINTSTONES CAVE KIDS" WITH A BABY BOY FIGURE STANDING TO THE LEFT WITH AN OBJECT IN HIS RIGHT HAND AND A BABY GIRL FIGURE CRAWLING ON THE RIGHT AND A DINOSAUR BEHIND THE BABY GIRL FIGURE AND CARVED STONE.

SEC. 2(F).

FOR CLOTHING FOR MEN, WOMEN AND CHILDREN, NAMELY, SHIRTS, T-SHIRTS AND TANK TOPS (U.S. CLS. 22 AND 39).

FIRST USE 3-2-2009; IN COMMERCE 3-2-2009.

TIMOTHY FINNEGAN, EXAMINING ATTORNEY

SN 77-722,662. BRITTANY CANTERBERRY, FARMERVILLE, LA. FILED 4-27-2009.

Small Town Girl

THE MARK CONSISTS OF STANDARD CHARACTERS WITHOUT CLAIM TO ANY PARTICULAR FONT, STYLE, SIZE, OR COLOR.

NO CLAIM IS MADE TO THE EXCLUSIVE RIGHT TO USE "GIRL", APART FROM THE MARK AS SHOWN.

FOR CLOTHING, NAMELY, SHIRTS, LONG SLEEVE AND SHORT SLEEVE T-SHIRTS, SWEATSHIRTS, TANKS, AND POLO SHIRTS (U.S. CLS. 22 AND 39).

LINDA POWELL, EXAMINING ATTORNEY

CLASS 25—(Continued).

SN 77-722,844. JOE SNYDER S.A. DE C.V., MÉXICO DF, MEXICO, FILED 4-27-2009.



NO CLAIM IS MADE TO THE EXCLUSIVE RIGHT TO USE "MODA ACTIVA STRETCH", "MEXICO" AND "STRETCH ACTIVE WEAR", APART FROM THE MARK AS SHOWN.

THE NAME(S), PORTRAIT(S), AND/OR SIGNATURE(S) SHOWN IN THE MARK IDENTIFIES THE NICKNAME OF "JOSE DE JESUS VARGAS SNYDER", A LIVING INDIVIDUAL, WHOSE CONSENT(S) TO REGISTER IS MADE OF RECORD.

THE COLOR(S) GRAY, RED, AND BLUE IS/ARE CLAIMED AS A FEATURE OF THE MARK.

THE MARK CONSISTS OF THE FOLLOWING: THE LETTER "J" APPEARS IN BLUE AND IS INTERTWINED WITH THE LETTER "S" IN RED; THE WORD "MEXICO" APPEARS IN RED TO THE RIGHT OF THE "J" AND "S"; THE WORDING "JOE SNYDER" APPEARS IN BLUE WITH A CURVED LINE IN RED BETWEEN THE LETTERS "O" AND "E" AND IS UNDERNEATH THE "J", "S" AND "MEXICO" WORDING; THE WORDING "WWW.JOESNYDER.COM" APPEARS IN RED UNDERNEATH THE WORDING "JOE SNYDER"; ALL OF THE FOREGOING APPEARS INSIDE TWO SEMI-CIRCLES FORMED BY WORDS; THE TOP SEMI-CIRCLE CONTAINS THE WORDING "MODA ACTIVA STRETCH" IN GRAY AND THE BOTTOM SEMI-CIRCLE CONTAINS THE WORDING "STRETCH ACTIVE WEAR" WRITTEN IN GRAY.

THE ENGLISH TRANSLATION OF "MODA" AND "ACTIVA" IN THE MARK IS "FASHION" AND "ACTIVE", RESPECTIVELY.

FOR MEN'S UNDERWEAR (U.S. CLS. 22 AND 39).

FIRST USE 4-1-1984; IN COMMERCE 3-15-2003.

MEGHAN REINHART, EXAMINING ATTORNEY

CLASS 25—(Continued).

SN 77-723,391. PIERPONT, MONIQUE, A CITIZEN OF THE UNITED STATES, DBA NOSE PRINTS, INC, PALM CITY, FL. FILED 4-27-2009.

Keep Wagging

THE MARK CONSISTS OF STANDARD CHARACTERS WITHOUT CLAIM TO ANY PARTICULAR FONT, STYLE, SIZE, OR COLOR.

FOR ATHLETIC APPAREL, NAMELY, SHIRTS, PANTS, JACKETS, FOOTWEAR, HATS AND CAPS, ATHLETIC UNIFORMS; BODY SHIRTS; HOODED SWEAT SHIRTS; KNIT SHIRTS; LONG-SLEEVED SHIRTS; NIGHT SHIRTS; RUGBY SHIRTS; SHORT-SLEEVED OR LONG-SLEEVED T-SHIRTS; SHORT-SLEEVED SHIRTS; SLEEP SHIRTS; SPORT SHIRTS; SPORTS SHIRTS; SPORTS SHIRTS WITH SHORT SLEEVES; SWEAT SHIRTS; T-SHIRTS; TEE SHIRTS; TURTLE NECK SHIRTS; WEARABLE GARMENTS AND CLOTHING, NAMELY, SHIRTS; WIND SHIRTS; YOGA SHIRTS (U.S. CLS. 22 AND 39).

FIRST USE 1-1-2008; IN COMMERCE 1-1-2008.

RONALD DELGIZZI, EXAMINING ATTORNEY

SN 77-727,032. MARATHON MOMS, LLC, CINCINNATI, OH. FILED 5-1-2009.



THE MARK CONSISTS OF TWO CONCENTRIC CIRCLES WITH THE INNERMOST CIRCLE A PARTIALLY SHADED CIRCLE THAT CONTAINS A FLOWER BACKGROUND AND THE LETTERS "MM". A PLAIN LINE CIRCLE SURROUNDS IN THE INNERMOST CIRCLE AND THE WORDS "MARATHON MOMS FOR THE MARATHON OF EVERYDAY LIFE" ARE PRESENTED AROUND THE PLAIN LINE CIRCLE.

FOR APPAREL, NAMELY, SHIRTS, PANTS, JACKETS, FOOTWEAR, HATS AND CAPS, SKIRTS, SWEATSHIRTS, SHORTS, SWEATERS, GLOVES, SWEATBANDS, SPORTS BRAS AND ATHLETIC UNIFORMS (U.S. CLS. 22 AND 39).

FIRST USE 4-28-2009; IN COMMERCE 4-28-2009.

ALLISON HOLTZ, EXAMINING ATTORNEY

CLASS 25—(Continued).

SN 77-730,956. CALIORO, LLC, SCOTTSDALE, AZ. FILED 5-6-2009.

Z3N

THE MARK CONSISTS OF STANDARD CHARACTERS WITHOUT CLAIM TO ANY PARTICULAR FONT, STYLE, SIZE, OR COLOR.

FOR CLOTHING, NAMELY, T-SHIRTS, SHIRTS, SWEATSHIRTS, JACKETS, JEANS, PANTS, AND SWEATERS; FOOTWEAR; HEADGEAR, NAMELY, HATS (U.S. CLS. 22 AND 39).

BENJAMIN OKEKE, EXAMINING ATTORNEY

CLASS 25—(Continued).

SN 77-735,526. BE YOU . BE HAPPY, MCCALLA, AL. FILED 5-12-2009.



SN 77-730,958. CALIORO, LLC, SCOTTSDALE, AZ. FILED 5-6-2009.

OCEANS Z3N

THE MARK CONSISTS OF STANDARD CHARACTERS WITHOUT CLAIM TO ANY PARTICULAR FONT, STYLE, SIZE, OR COLOR.

FOR CLOTHING, NAMELY, T-SHIRTS, SHIRTS, SWEATSHIRTS, JACKETS, JEAN, PANTS, AND SWEATERS; FOOTWEAR; HEADGEAR, NAMELY, HATS (U.S. CLS. 22 AND 39).

BENJAMIN OKEKE, EXAMINING ATTORNEY

THE COLOR(S) YELLOW/GOLD STAR IS/ARE CLAIMED AS A FEATURE OF THE MARK.

THE MARK CONSISTS OF THE WORDS "BE YOU BE HAPPY" WITH A GOLD/YELLOW STAR IN THE MIDDLE. FOR SHORT-SLEEVED OR LONG-SLEEVED T-SHIRTS (U.S. CLS. 22 AND 39).

FIRST USE 7-6-2009; IN COMMERCE 7-6-2009.

ESTHER A. BORSUK, EXAMINING ATTORNEY

SN 77-739,791. MATTARAZI UOMO, INC., LOS ANGELES, CA. FILED 5-18-2009.

MATTARAZI UOMO

SN 77-735,520. BE YOU . BE HAPPY, MCCALLA, AL. FILED 5-12-2009.

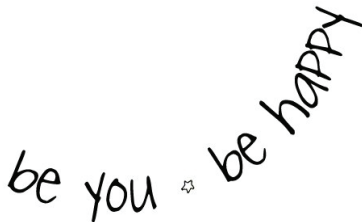

THE MARK CONSISTS OF THE WORDS "BE YOU BE HAPPY", SEPARATED BY A SMALL STAR.

FOR SHORT-SLEEVED OR LONG-SLEEVED T-SHIRTS (U.S. CLS. 22 AND 39).

FIRST USE 7-6-2009; IN COMMERCE 7-6-2009.

ESTHER A. BORSUK, EXAMINING ATTORNEY

THE MARK CONSISTS OF STANDARD CHARACTERS WITHOUT CLAIM TO ANY PARTICULAR FONT, STYLE, SIZE, OR COLOR.

NO CLAIM IS MADE TO THE EXCLUSIVE RIGHT TO USE "UOMO", APART FROM THE MARK AS SHOWN.

THE NAME(S), PORTRAIT(S), AND/OR SIGNATURE(S) SHOWN IN THE MARK DOES NOT IDENTIFY A PARTICULAR LIVING INDIVIDUAL.

THE ENGLISH TRANSLATION OF "UOMO" IN THE MARK IS "MEN".

FOR SUITS, JACKETS, PANTS, SHIRTS AND TIES (U.S. CLS. 22 AND 39).

SUNG IN, EXAMINING ATTORNEY

CLASS 25—(Continued).

SN 77-739,873. TODAYS HEROES, INC., BRAMPTON, CANADA, FILED 5-19-2009.

CLASS 25—(Continued).

SN 77-741,171. LEWIS, DUANE B., DBA GLOBAL SHOT DOCTOR LLC, LAKEWOOD, CO. FILED 5-20-2009.

INSTINCTIVE BRAND

THE MARK CONSISTS OF STANDARD CHARACTERS WITHOUT CLAIM TO ANY PARTICULAR FONT, STYLE, SIZE, OR COLOR.

NO CLAIM IS MADE TO THE EXCLUSIVE RIGHT TO USE "BRAND", APART FROM THE MARK AS SHOWN.

FOR BEANIES; BELTS; BERMUDA SHORTS; BIKINIS; CAPS; FOOTWEAR; HEADWEAR; HOODS; INFANTWEAR; JACKETS; JEANS; JOGGING SUITS; PANTS; POLO SHIRTS; SANDALS; SHIRTS; SHORTS; SWEAT SHIRTS; T-SHIRTS; TANK TOPS (U.S. CLS. 22 AND 39).
ANDREW RHIM, EXAMINING ATTORNEY

SN 77-740,144. JEMMOTT, SHANREKA, DBA JEMM S DESIGNS, QUEENS VILLAGE, NY. FILED 5-19-2009.

LUCKY JEMMS

THE MARK CONSISTS OF STANDARD CHARACTERS WITHOUT CLAIM TO ANY PARTICULAR FONT, STYLE, SIZE, OR COLOR.

FOR ATHLETIC APPAREL, NAMELY, SHIRTS, PANTS, JACKETS, FOOTWEAR, HATS AND CAPS, ATHLETIC UNIFORMS; BALLOON PANTS; BRIEFS; CAPRI PANTS; CARGO PANTS; CLOTHING FOR ATHLETIC USE, NAMELY, PADDED PANTS; DENIMS; DISPOSABLE UNDERWEAR; GOLF PANTS, SHIRTS AND SKIRTS; GYM PANTS; JOGGING PANTS; KNITTED UNDERWEAR; LADIES' UNDERWEAR; LEATHER PANTS; LONG UNDERWEAR; LOUNGE PANTS; MEN'S UNDERWEAR; MOISTURE-WICKING SPORTS PANTS; NON-DISPOSABLE CLOTH TRAINING PANTS; NURSE PANTS; PANTS; PARTS OF CLOTHING, NAMELY, GUSSETS FOR TIGHTS, GUSSETS FOR STOCKINGS, GUSSETS FOR BATHING SUITS, GUSSETS FOR UNDERWEAR, GUSSETS FOR LEOTARDS AND GUSSETS FOR FOOTLETS; PERSPIRATION ABSORBENT UNDERWEAR CLOTHING; PETTI-PANTS; SCIENTIFIC AND TECHNOLOGICAL APPAREL, NAMELY, SHIRTS, PANTS, JACKETS, FOOTWEAR, HATS AND CAPS, UNIFORMS; SKI PANTS; SNOW PANTS; SNOWBOARD PANTS; SPORTS PANTS; STRETCH PANTS; SWEAT PANTS; TAP PANTS; TEE SHIRTS; THERMAL UNDERWEAR; THONGS; TOBOGGAN HATS, PANTS AND CAPS; TRACK PANTS; TRAVEL CLOTHING CONTAINED IN A PACKAGE COMPRISING REVERSIBLE JACKETS, PANTS, SKIRTS, TOPS AND A BELT OR SCARF; UNDERWEAR; UNDERWEAR, NAMELY, BOY SHORTS; WATERPROOF JACKETS AND PANTS; WIND PANTS; WOMEN'S UNDERWEAR; WOVEN OR KNITTED UNDERWEAR; YOGA PANTS (U.S. CLS. 22 AND 39).
FRED MANDIR, EXAMINING ATTORNEY



THE MARK CONSISTS OF AN UPWARD-POINTING ARROW IN BLOCK TYPE FONT.

FOR CLOTHING, NAMELY, WRISTBANDS, HEADBANDS, SHIRTS, HATS (U.S. CLS. 22 AND 39).
FIRST USE 1-1-1999; IN COMMERCE 4-1-2007.
AMY KERTGATE, EXAMINING ATTORNEY

CLASS 25—(Continued).

SN 77-742,793. LIDA WHOLESALE CORPORATION, BRENTWOOD, MD. FILED 5-22-2009.



NO CLAIM IS MADE TO THE EXCLUSIVE RIGHT TO USE "DC", APART FROM THE MARK AS SHOWN. THE COLOR(S) RED IS/ARE CLAIMED AS A FEATURE OF THE MARK.

THE MARK CONSISTS OF THE WORDS "DC MASTER" IN RED COLOR ARRANGED IN TWO LINES WITH "DC" IN THE FIRST LINE AND "MASTER" IN A SMALLER FONT IN THE SECOND LINE DIRECTLY UNDERNEATH "DC". A SMALL STAR-SHAPED SPACE APPEARS BETWEEN THE LETTERS "D" AND "C". THE WHITE REPRESENTS THE BACKGROUND OR A TRANSPARENT AREA AND IS NOT A PART OF THE MARK.

FOR ATHLETIC APPAREL, NAMELY, SHIRTS, PANTS, JACKETS, FOOTWEAR, HATS AND CAPS, ATHLETIC UNIFORMS; BICYCLE GLOVES; BOMBER JACKETS; BOXER BRIEFS; BOXER SHORTS; BRIEFS; DOWN JACKETS; FLEECE SHORTS; FLEECE VESTS; FOOTWEAR FOR MEN; GLOVES; HEAVY JACKETS; HOODED SWEAT SHIRTS; JACKETS AND SOCKS; LEATHER JACKETS; LONG JACKETS; LONG UNDERWEAR; LONG-SLEEVED SHIRTS; MEN'S SOCKS; MEN'S UNDERWEAR; NIGHT SHIRTS; OPEN-NECKED SHIRTS; OUTDOOR GLOVES; POLO SHIRTS; RAIN-PROOF JACKETS; REVERSIBLE JACKETS; SHIRTS; SHORT-SLEEVED OR LONG-SLEEVED T-SHIRTS; SKI GLOVES; SLEEP SHIRTS; SPORT SHIRTS; SPORTS JACKETS; T-SHIRTS; TANK TOPS; THERMAL SOCKS; THERMAL UNDERWEAR; TOPS; TRAVEL CLOTHING CONTAINED IN A PACKAGE COMPRISING REVERSIBLE JACKETS, PANTS, SKIRTS, TOPS AND A BELT OR SCARF; TUBE TOPS; TURTLE NECK SHIRTS; VESTS; WATERPROOF JACKETS AND PANTS; WEARABLE GARMENTS AND CLOTHING, NAMELY, SHIRTS; WIND RESISTANT JACKETS; WIND VESTS; WIND-JACKETS (U.S. CLS. 22 AND 39).

YAT SYE, LEE, EXAMINING ATTORNEY

SN 77-743,243. LOUISE PARIS LTD., NEW YORK, NY. FILED 5-22-2009.

NEW LOOK

THE MARK CONSISTS OF STANDARD CHARACTERS WITHOUT CLAIM TO ANY PARTICULAR FONT, STYLE, SIZE, OR COLOR.

FOR WOMEN'S AND CHILDREN'S WEARING APPAREL, NAMELY, JACKETS, COATS, SHIRTS, TOPS, SKIRTS, DRESSES, ROMPERS, PANTS, SHORTS, TIGHTS AND VESTS (U.S. CLS. 22 AND 39).

SKYE YOUNG, EXAMINING ATTORNEY

CLASS 25—(Continued).

SN 77-744,907. RTI SPORTS VERTRIEB VON SPORTARTIKELN GMBH, URMITZ, FED REP GERMANY, FILED 5-26-2009.



PRIORITY CLAIMED UNDER SEC. 44(D) ON ERPN CMNTY TM OFC APPLICATION NO. 007448517, FILED 11-26-2008, REG. NO. 007448517, DATED 5-20-2009, EXPIRES 11-26-2018.

THE MARK CONSISTS OF THE LETTERS "IRA" IN CYRILLIC LETTERS AND LEAVES CONNECTED BY VINES.

FOR CLOTHING, NAMELY, SHORTS, TOPS, SHIRTS, T-SHIRTS, SWEATSHIRTS, BLOUSES, PANTS, TROUSERS, SOCKS, PULLOVERS, JACKETS AND UNDERWEAR; FOOTWEAR; HEADGEAR, NAMELY, HATS AND CAPS (U.S. CLS. 22 AND 39).

LEIGH CAROLINE CASE, EXAMINING ATTORNEY

SN 77-745,111. TURTLE FUR COMPANY, FORMERLY NORDIC GEAR INC., MORRISVILLE, VT. FILED 5-27-2009.

Lectra Sox

THE MARK CONSISTS OF STANDARD CHARACTERS WITHOUT CLAIM TO ANY PARTICULAR FONT, STYLE, SIZE, OR COLOR.

NO CLAIM IS MADE TO THE EXCLUSIVE RIGHT TO USE "SOX", APART FROM THE MARK AS SHOWN.

"LECTRA" DOES NOT IDENTIFY A LIVING INDIVIDUAL.

FOR BATTERY HEATED SOCKS (U.S. CLS. 22 AND 39).

FIRST USE 1-30-1966; IN COMMERCE 3-25-1966.

LINDA ESTRADA, EXAMINING ATTORNEY

CLASS 25—(Continued).

SN 77-745,499. BONNIE ZOLL, PINELLAS, FL. AND RANDY ZOLL, PINELLAS, FL. FILED 5-27-2009.



OWNER OF U.S. REG. NO. 3,655,339.
THE COLOR(S) BLACK, WHITE, AND ORANGE IS/ARE CLAIMED AS A FEATURE OF THE MARK.

THE MARK CONSISTS OF A WHITE HAND OUTLINED IN ORANGE FORMING AN OK SIGN. THE WORD "THREE" APPEARS IN ORANGE STYLIZED FONT AT THE WRIST OF THE HAND. THE ABOVE ELEMENTS ARE PLACED ON A BLACK RECTANGULAR BACKGROUND.

FOR A-SHIRTS; ATHLETIC APPAREL, NAMELY, SHIRTS, PANTS, JACKETS, FOOTWEAR, HATS AND CAPS, ATHLETIC UNIFORMS; ATHLETIC SHOES; BABY TOPS; BALLOON PANTS; BASELAYER TOPS; BASKETBALL SNEAKERS; BATHING COSTUMES FOR WOMEN; BATHING SUITS FOR MEN; BEACH SHOES; BELTS; BELTS FOR CLOTHING; BERMUDA SHORTS; BODY SHIRTS; BOXER SHORTS; BRAS; BUTTON-FRONT ALOHA SHIRTS; CAMP SHIRTS; CANVAS SHOES; CAPRI PANTS; CAPS; CARGO PANTS; CHILDREN'S AND INFANT'S APPAREL, NAMELY, JUMPERS, OVERALL SLEEPWEAR, PAJAMAS, ROMPERS AND ONE-PIECE GARMENTS; CHILDREN'S HEADWEAR; CLOTHING FOR ATHLETIC USE, NAMELY, PADDED ELBOW COMPRESSION SLEEVES; CLOTHING FOR ATHLETIC USE, NAMELY, PADDED PANTS; CLOTHING FOR ATHLETIC USE, NAMELY, PADDED SHIRTS; CLOTHING FOR ATHLETIC USE, NAMELY, PADDED SHORTS; CLOTHING FOR WEAR IN JUDO PRACTICES; CLOTHING FOR WEAR IN WRESTLING GAMES; CLOTHING, NAMELY, ARM WARMERS; CLOTHING, NAMELY, BASE LAYERS; CLOTHING, NAMELY, FOLK COSTUMES; CLOTHING, NAMELY, HAND-WARMERS; CLOTHING, NAMELY, KHAKIS; CLOTHING, NAMELY, KNEE WARMERS; CLOTHING, NAMELY, MATERNITY BANDS; CLOTHING, NAMELY, NECK TUBES; CLOTHING, NAMELY, THOBES; CLOTHING, NAMELY, WRAP-AROUNDS; COATS FOR MEN AND WOMEN; CROP TOPS; DENIMS; DRESS SHIRTS; FLEECE SHORTS; FOOTWEAR FOR MEN; FOOTWEAR FOR MEN AND WOMEN; FOOTWEAR FOR WOMEN; GYM PANTS; GYM SHORTS; HALTER TOPS; HOODED PULLOVERS; HOODED SWEAT SHIRTS; HOODS; HOODS; INFANT AND TODDLER ONE PIECE CLOTHING; INFANTS' SHOES AND BOOTS; JERSEYS; JOGGING PANTS; LEATHER BELTS; LEATHER SHOES; LEISURE SHOES; LONG-SLEEVED SHIRTS; LOUNGE PANTS; MEN'S AND WOMEN'S JACKETS, COATS, TROUSERS, VESTS; MEN'S SOCKS; MEN'S SUITS; MEN'S SUITS, WOMEN'S SUITS; MEN'S UNDERWEAR; MOISTURE-WICKING SPORTS PANTS; MOISTURE-WICKING SPORTS SHIRTS; MUSCLE TOPS; NIGHT SHIRTS; OPEN-NECKED SHIRTS; OVER SHIRTS; PANTIES, SHORTS AND BRIEFS; PANTS; PETTI-PANTS; PIQUE SHIRTS; POLO SHIRTS; RUGBY SHIRTS; RUGBY SHORTS; RUGBY TOPS; SHIRTS; SHIRTS FOR SUITS; SHOES; SHORT SETS; SHORT TROUSERS; SHORT-SLEEVED OR LONG-SLEEVED T-SHIRTS; SHORT-SLEEVED SHIRTS; SHORTS; SHOULDER WRAPS; SLEEP SHIRTS; SNEAKERS; SPORT SHIRTS; SPORTS BRA; SPORTS BRAS; SPORTS PANTS; SPORTS SHIRTS; SPORTS SHIRTS WITH SHORT SLEEVES; STRETCH PANTS; SUSPENDER BELTS FOR MEN;

CLASS 25—(Continued).

SUSPENDER BELTS FOR WOMEN; SWEAT PANTS; SWEAT SHIRTS; SWEAT SHORTS; T-SHIRTS; TANK TOPS; TANK-TOPS; TAP PANTS; TEE SHIRTS; TIES; TOP COATS; TOPS; TRACK PANTS; TRAVEL CLOTHING CONTAINED IN A PACKAGE COMPRISING REVERSIBLE JACKETS, PANTS, SKIRTS, TOPS AND A BELT OR SCARF; TRIATHLON CLOTHING, NAMELY, TRIATHLON TIGHTS, TRIATHLON SHORTS, TRIATHLON SINGLETS, TRIATHLON SHIRTS, TRIATHLON SUITS; TUBE TOPS; TURTLE NECK SHIRTS; UNDER GARMENTS; UNDERWEAR, NAMELY, BOY SHORTS; WALKING SHORTS; WATERPROOF JACKETS AND PANTS; WEARABLE GARMENTS AND CLOTHING, NAMELY, SHIRTS; WIND PANTS; WIND SHIRTS; WOMEN'S SHOES; WOMEN'S UNDERWEAR; WRAPS (U.S. CLS. 22 AND 39).

STEVEN PEREZ, EXAMINING ATTORNEY

SN 77-746,344. RODEO SPORTS PROMOTIONS, LLC, DECATUR, TX. FILED 5-28-2009.

24/10

THE MARK CONSISTS OF STANDARD CHARACTERS WITHOUT CLAIM TO ANY PARTICULAR FONT, STYLE, SIZE, OR COLOR.

FOR CLOTHING, NAMELY, SHIRTS, HATS AND JACKETS (U.S. CLS. 22 AND 39).

JACQUELINE A. LAVINE, EXAMINING ATTORNEY

SN 77-747,422. BAY BREEZE FARM, LLC, MANORVILLE, NY. FILED 5-29-2009.

The Zipit Breezer

THE MARK CONSISTS OF STANDARD CHARACTERS WITHOUT CLAIM TO ANY PARTICULAR FONT, STYLE, SIZE, OR COLOR.

FOR COVERALLS FOR HORSE GROOMING (U.S. CLS. 22 AND 39).

MARTHA SANTOMARTINO, EXAMINING ATTORNEY

SN 77-747,898. LIKE SISTERZ LLC, WEST BLOOMFIELD, MI. FILED 5-29-2009.

BLINGERZ

THE MARK CONSISTS OF STANDARD CHARACTERS WITHOUT CLAIM TO ANY PARTICULAR FONT, STYLE, SIZE, OR COLOR.

FOR SHOES (U.S. CLS. 22 AND 39).

MARLENE BELL, EXAMINING ATTORNEY

CLASS 25—(Continued).

SN 77-749,711. NINTENDO OF AMERICA INC., REDMOND, WA. FILED 6-2-2009.

STYLE SAVVY

THE MARK CONSISTS OF STANDARD CHARACTERS WITHOUT CLAIM TO ANY PARTICULAR FONT, STYLE, SIZE, OR COLOR.

FOR CLOTHING, NAMELY, BEACH WEAR; BED JACKETS; BELTS; CLOTH BIBS; EAR MUFFS; FLIP FLOPS; FOOTWEAR; GLOVES; HALLOWEEN COSTUMES; HOSIERY; INFANT WEAR; JACKETS; JERSEYS; NIGHTGOWNS; NIGHTSHIRTS; OVERALLS; PAJAMAS; PANTS; PARKAS; PONCHOS; RAINCOATS; RAINWEAR; ROBES; SANDALS; SHORTS; SLEEPWEAR; SMOCKS; SWEAT PANTS; SWEATSHIRTS; SWEATERS; SWIMSUITS; T-SHIRTS; TIES; TIGHTS; TOPS; TROUSERS; VESTS; VISORS; WARM-UP SUITS; WRIST BANDS (U.S. CLS. 22 AND 39).

TARAH HARDY, EXAMINING ATTORNEY

SN 77-750,606. YU YUANG TEXTILE CO., LTD., CHANG-HWA, TAIWAN, FILED 6-3-2009.



THE COLOR(S) GRAY, BLUE, WHITE, BLACK IS/ARE CLAIMED AS A FEATURE OF THE MARK.

THE MARK CONSISTS OF AN OVAL DESIGN SLANTED TO THE RIGHT WITH A BLUE CENTER, OUTLINED WITH A GRAY RIM WITH WHITE HIGHLIGHTS AND BLACK SHADOW. THIS IS BEFORE THE WORD "BRIBB" WRITTEN IN BLACK STYLIZED LETTERS.

FOR SWIM WEAR FOR GENTLEMEN AND LADIES; SWIMSUITS; SWIM TRUNKS; ARTICLES OF CLOTHING FOR GYMNASTICS, NAMELY, GYM PANTS, GYM SHORTS, GYM SUITS; ARTICLES OF CLOTHING FOR SPORTSWEAR, NAMELY, SPORT COATS, SPORT SHIRTS, SPORT STOCKINGS, SPORTS BRA, SPORTS JACKETS, SPORTS JERSEYS AND BREECHES FOR SPORTS, SPORTS PANTS; WET SUITS FOR WATER SKIING; BICYCLING SUITS; MOTORCYCLE RIDING SUITS (U.S. CLS. 22 AND 39).

ESTHER A. BORSUK, EXAMINING ATTORNEY

CLASS 25—(Continued).

SN 77-752,186. JONVALDI LLC, DBA JONVALDI COUTURE, NEW YORK, NY. FILED 6-4-2009.

JonValdí

THE MARK CONSISTS OF STANDARD CHARACTERS WITHOUT CLAIM TO ANY PARTICULAR FONT, STYLE, SIZE, OR COLOR.

THE NAME(S), PORTRAIT(S), AND/OR SIGNATURE(S) SHOWN IN THE MARK DOES NOT IDENTIFY A PARTICULAR LIVING INDIVIDUAL.

SEC. 2(F).

FOR BELTS OF TEXTILE; BRIDESMAID DRESSES; CLOTHING, NAMELY, WRAP-AROUNDS; COATS MADE OF COTTON; CORSETS; DRESS SHIRTS; DRESS SUITS; DRESSES; DRESSES MADE FROM SKINS; DRESSING GOWNS; DRESSING GOWNS AND BATH ROBES; DUSTERS; EVENING DRESSES; FABRIC SOLD AS AN INTEGRAL COMPONENT OF FINISHED CLOTHING ITEMS, NAMELY, PANTS, SHIRTS, SCARVES, DRESSES, JACKETS, COATS, SWEATERS, TOPS, BOTTOMS, GLOVES, VESTS, SKIRTS, SHOES, AND TIES.; FINISHED TEXTILE LININGS FOR GARMENTS; GLOVES AS CLOTHING; HOODS; JACKETS; LACE BOOTS; LEATHER BELTS; LEATHER COATS; LEATHER HEADWEAR; LEATHER JACKETS; LEATHER PANTS; LEATHER SHOES; LEATHER SLIPPERS; MEN'S DRESS SOCKS; MEN'S SUITS; MEN'S SUITS, WOMEN'S SUITS; POCKET SQUARES; SHIRTS FOR SUITS; SHORT SETS; SILK SCARVES; SKIRT SUITS; SKIRTS AND DRESSES; SUIT COATS; SUITS; SUITS OF LEATHER; TIES; TOPS; TRAVEL CLOTHING CONTAINED IN A PACKAGE COMPRISING REVERSIBLE JACKETS, PANTS, SKIRTS, TOPS AND A BELT OR SCARF; TROUSERS OF LEATHER; WEARABLE GARMENTS AND CLOTHING, NAMELY, SHIRTS; WEDDING DRESSES; WOMEN'S CEREMONIAL DRESSES; WRAPS (U.S. CLS. 22 AND 39).

FIRST USE 5-1-1990; IN COMMERCE 4-14-1992.

SEAN CROWLEY, EXAMINING ATTORNEY

SN 77-754,134. THE FLEXX USA, LLC, CHARLESTON, SC. FILED 6-8-2009.

STUDIO FLEXX

THE MARK CONSISTS OF STANDARD CHARACTERS WITHOUT CLAIM TO ANY PARTICULAR FONT, STYLE, SIZE, OR COLOR.

FOR FOOTWEAR (U.S. CLS. 22 AND 39).

FIRST USE 2-15-2010; IN COMMERCE 2-15-2010.

KATHERINE CHANG, EXAMINING ATTORNEY

CLASS 25—(Continued).

SN 77-754,444. WATERS INDUSTRIES, INC., WEST DUNDEE, IL. FILED 6-8-2009.

C.U.B. TECHNOLOGY

THE MARK CONSISTS OF STANDARD CHARACTERS WITHOUT CLAIM TO ANY PARTICULAR FONT, STYLE, SIZE, OR COLOR.

NO CLAIM IS MADE TO THE EXCLUSIVE RIGHT TO USE "TECHNOLOGY", APART FROM THE MARK AS SHOWN.

FOR HEAD WEAR WITH INTEGRATED LIGHTS (U.S. CLS. 22 AND 39).

MARK SHINER, EXAMINING ATTORNEY

SN 77-754,666. JOHN MALOTT, WAUKESHA, WI. FILED 6-8-2009.

Hard Knocks Fights

THE MARK CONSISTS OF STANDARD CHARACTERS WITHOUT CLAIM TO ANY PARTICULAR FONT, STYLE, SIZE, OR COLOR.

FOR ATHLETIC APPAREL, NAMELY, SHIRTS, PANTS, JACKETS, FOOTWEAR, HATS AND CAPS, ATHLETIC UNIFORMS; BODY SHIRTS; HOODED SWEAT SHIRTS; JACKETS; JERSEYS; LONG-SLEEVED SHIRTS; SHIRTS; SHIRTS AND SHORT-SLEEVED SHIRTS; SHORT-SLEEVED OR LONG-SLEEVED T-SHIRTS; SPORT SHIRTS; SPORTS SHIRTS; SPORTS SHIRTS WITH SHORT SLEEVES; SWEAT SHIRTS; T-SHIRTS; TEE SHIRTS; TOPS; TURTLE NECK SHIRTS; WEARABLE GARMENTS AND CLOTHING, NAMELY, SHIRTS (U.S. CLS. 22 AND 39).

KEVON CHISOLM, EXAMINING ATTORNEY

SN 77-754,866. SHADES OF PARADISE LLC, DBA PARADISE SOUVENIR SALES, HARMON, GUAM, FILED 6-8-2009.

I AM SAIPAN

THE MARK CONSISTS OF STANDARD CHARACTERS WITHOUT CLAIM TO ANY PARTICULAR FONT, STYLE, SIZE, OR COLOR.

FOR ATHLETIC APPAREL, NAMELY, SHIRTS, PANTS, JACKETS, FOOTWEAR, HATS AND CAPS, ATHLETIC UNIFORMS; BASEBALL CAPS; BEACH SHOES; BOARD SHORTS; FLIP FLOPS; GOLF CAPS; SANDALS AND BEACH SHOES; SHORT-SLEEVED OR LONG-SLEEVED T-SHIRTS; T-SHIRTS (U.S. CLS. 22 AND 39).

BARBARA RUTLAND, EXAMINING ATTORNEY

CLASS 25—(Continued).

SN 77-754,874. NIGHTBIRD PRODUCTIONS, INC., WEST HOLLYWOOD, CA. FILED 6-8-2009.

NIGHTBIRD

THE MARK CONSISTS OF STANDARD CHARACTERS WITHOUT CLAIM TO ANY PARTICULAR FONT, STYLE, SIZE, OR COLOR.

FOR CLOTHING, NAMELY, T-SHIRTS, SHORTS, PANTS, SWEATSHIRTS, SWEATPANTS, BANDANAS, SCARVES, APRONS, JACKETS, TANK TOPS, VESTS, NECKTIES, ATHLETIC JERSEYS, SHIRTS, SWEATERS, INFANTWEAR, BIBS NOT OF PAPER, LOUNGWEAR, UNDERWEAR, SWIMWEAR, WIND RESISTANT JACKETS, TURTLENECKS, TRACK PANTS AND PONCHOS; HEADWEAR; FOOTWEAR; BELTS (U.S. CLS. 22 AND 39).

TINA BROWN, EXAMINING ATTORNEY

SN 77-755,731. NEWSEAS COMPANY LIMITED, NEW WORLD CENTRE, HONG KONG, FILED 6-9-2009.



THE COLOR(S) WHITE, BLACK, BLUE AND RED IS/ARE CLAIMED AS A FEATURE OF THE MARK.

THE MARK CONSISTS OF A TRIANGLE WITH ROUNDED EDGES AND DIVIDED INTO 3 TRIANGULAR SECTIONS. THE OUTLINE AND DIVIDING LINES OF THE TRIANGLE ARE BLACK. THE LEFT INTERIOR TRIANGLE IS WHITE. THE RIGHT INTERIOR TRIANGLE IS RED. THE BOTTOM INTERIOR TRIANGLE IS BLUE. THE TERM "AXION" IS IN BLACK LOWER-CASE LETTERS BENEATH THE TRIANGLE.

FOR CLOTHING, NAMELY, SHIRTS, T-SHIRTS, SHORTS, SWEATSHIRTS, PULLOVERS, PANTS, JACKETS, COATS, BELTS, SOCKS, HEADWEAR AND FOOTWEAR (U.S. CLS. 22 AND 39).

MICHAEL KEATING, EXAMINING ATTORNEY

CLASS 25—(Continued).

SN 77-756,457. ZOE GEAR, INC., HIALEAH, FL. FILED 6-10-2009.

Zoe Paid

THE MARK CONSISTS OF STANDARD CHARACTERS WITHOUT CLAIM TO ANY PARTICULAR FONT, STYLE, SIZE, OR COLOR.

THE NAME(S), PORTRAIT(S), AND/OR SIGNATURE(S) SHOWN IN THE MARK DOES NOT IDENTIFY A PARTICULAR LIVING INDIVIDUAL.

FOR SHORT-SLEEVED OR LONG-SLEEVED T-SHIRTS; T-SHIRTS; A-SHIRTS; ATHLETIC APPAREL, NAMELY, SHIRTS, PANTS, JACKETS, FOOTWEAR, HATS AND CAPS, ATHLETIC UNIFORMS; BOXER BRIEFS; BOXER SHORTS; FLEECE PULLOVERS; GYM SUITS; HEADGEAR, NAMELY, CAPS, BEANIES, HATS, VISORS, DO RAGS, BANDANAS, HEADBANDS, SKULLIES, SWEATBANDS; HOODED PULLOVERS; HOODED SWEAT SHIRTS; JACKETS; LONG-SLEEVED SHIRTS; LOUNGEWEAR; PAJAMAS; POLO SHIRTS; PULLOVERS; RAINWEAR; ROBES; SHORT-SLEEVED SHIRTS; SHORTS; SOCKS; SWEAT JACKETS; SWEAT SHIRTS; SWEAT SUITS; SWIMWEAR; TANK TOPS; TRACK JACKETS; TRACK SUITS; UNDERWEAR, NAMELY, BOY SHORTS (U.S. CLS. 22 AND 39).

SARA THOMAS, EXAMINING ATTORNEY

CLASS 25—(Continued).

SN 77-757,376. LEE FRY ENTERTAINMENT, LLC, WEST-MONT, IL. FILED 6-11-2009.

TEEN BRAVE

THE MARK CONSISTS OF STANDARD CHARACTERS WITHOUT CLAIM TO ANY PARTICULAR FONT, STYLE, SIZE, OR COLOR.

NO CLAIM IS MADE TO THE EXCLUSIVE RIGHT TO USE "TEEN", APART FROM THE MARK AS SHOWN.

FOR CLOTHING, NAMELY, SHIRTS, PANTS, JACKETS, SWEATSHIRTS, SWEATERS, SHORTS, TOPS, BOTTOMS, DRESSES, BELTS, SCARVES, NECKWEAR AND GLOVES; HEADWEAR; FOOTWEAR (U.S. CLS. 22 AND 39).

CHRISIE B. KING, EXAMINING ATTORNEY

SN 77-756,889. PEACELINE LLC, DBA PEACELINE CLOTHING, LOUISVILLE, KY. FILED 6-10-2009.



NO CLAIM IS MADE TO THE EXCLUSIVE RIGHT TO USE "CLOTHING", APART FROM THE MARK AS SHOWN. THE COLOR(S) GREEN IS/ARE CLAIMED AS A FEATURE OF THE MARK.

THE MARK CONSISTS OF TWO PEACE SIGNS CONNECTED BY A SINGLE LINE IN THE FORM OF A DUMBBELL. EACH PEACE SIGN HAS THREE BREAKS IN THE CIRCUMFERENCE WHERE THREE OF THE FOUR RADIAL LINES MEET THE OUTER CIRCLE, AT EACH BREAK, THAT PART OF THE CIRCUMFERENCE ENDS IN AN ARROW. ON TOP OF THE LINE IS THE WORD "PEACELINE" AND ON THE BOTTOM IS THE WORD "CLOTHING". THE ENTIRE LOGO IS A DARK GREEN.

FOR HATS; HOODED SWEAT SHIRTS; SHORT-SLEEVED OR LONG-SLEEVED T-SHIRTS (U.S. CLS. 22 AND 39).

DOMINIC J. FERRAIUOLO, EXAMINING ATTORNEY

SN 77-757,767. GRACE CHOI, TUSTIN, CA. FILED 6-11-2009.

DON'T HIDE

THE MARK CONSISTS OF STANDARD CHARACTERS WITHOUT CLAIM TO ANY PARTICULAR FONT, STYLE, SIZE, OR COLOR.

FOR CLOTHING, NAMELY, TOPS; HEADWEAR (U.S. CLS. 22 AND 39).

KAELIE KUNG, EXAMINING ATTORNEY

CLASS 25—(Continued).

SN 77-758,154. RED I WEAR, SAN DIEGO, CA. FILED 6-12-2009.

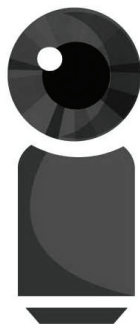

OWNER OF U.S. REG. NO. 3,062,321.
THE MARK CONSISTS OF A STYLIZED LOGO IN THE SHAPE OF THE LETTER "I" WITH AN EYEBALL FOR THE DOT ABOVE THE "I".

FOR CLOTHING, NAMELY, T-SHIRTS, SHIRTS, PANTS, CAPS, HATS, SHORTS, JACKETS, SWEATSHIRTS, WIND RESISTANT JACKETS, SOCKS, BOXERS, TANK TOPS, JEANS, HOODED SWEATSHIRTS, DENIM JACKETS, UNDERWEAR, BOARD SHORTS, BATHING SUITS; SHOES AND FOOTWEAR (U.S. CLS. 22 AND 39).

FIRST USE 6-1-2009; IN COMMERCE 6-1-2009.
HOWARD SMIGA, EXAMINING ATTORNEY

SN 77-758,165. RED I WEAR, SAN DIEGO, CA. FILED 6-12-2009.

RED I WEAR

THE MARK CONSISTS OF STANDARD CHARACTERS WITHOUT CLAIM TO ANY PARTICULAR FONT, STYLE, SIZE, OR COLOR.

OWNER OF U.S. REG. NO. 3,062,321.
NO CLAIM IS MADE TO THE EXCLUSIVE RIGHT TO USE "WEAR", APART FROM THE MARK AS SHOWN.

FOR CLOTHING, NAMELY, T-SHIRTS, SHIRTS, PANTS, CAPS, HATS, SHORTS, JACKETS, SWEATSHIRTS, WIND RESISTANT JACKETS, SOCKS, BOXERS, TANK TOPS, JEANS, HOODED SWEATSHIRTS, DENIM JACKETS, UNDERWEAR, BOARD SHORTS, BATHING SUITS; SHOES AND FOOTWEAR (U.S. CLS. 22 AND 39).

FIRST USE 6-1-2009; IN COMMERCE 6-1-2009.
HOWARD SMIGA, EXAMINING ATTORNEY

CLASS 25—(Continued).

SN 77-758,402. YOE ENTERPRISES INC, CHATTANOOGA, TN. FILED 6-12-2009.



NO CLAIM IS MADE TO THE EXCLUSIVE RIGHT TO USE "TOED", APART FROM THE MARK AS SHOWN.

THE MARK CONSISTS OF THE LETTERS "TOED" SHOWN IN STYLIZED FONT, WITH A FLY APPEARING BETWEEN THE LETTERS "E" AND "D".

FOR SOCKS (U.S. CLS. 22 AND 39).
ESTHER BELENKER, EXAMINING ATTORNEY

SN 77-758,588. JEFF FREEDMAN, NEW YORK, NY. AND BILL KITCHEN, HOLDEN, MA. AND DEBRA BACON, HOLDEN, MA. FILED 6-12-2009.

GLAM LIKE A GIRL

THE MARK CONSISTS OF STANDARD CHARACTERS WITHOUT CLAIM TO ANY PARTICULAR FONT, STYLE, SIZE, OR COLOR.

FOR CLOTHING, NAMELY, BATHING SUITS, BLAZERS, COATS, DRESSES, JACKETS, JOGGING SUITS, SKIRTS, SHORTS, SHIRTS, PANTS, SWEATSHIRTS, SWEATPANTS, T-SHIRTS, TANK TOPS, SOCKS, LEGGINGS, TIGHTS, HOSIERY, UNDERWEAR; HEADGEAR, NAMELY, HATS, CAPS, VISORS, AND HEADBANDS; FOOTWEAR, NAMELY, SHOES, SANDALS, DRESS SHOES, SPORT SHOES AND BOOTS; ATHLETIC WEAR, NAMELY, ATHLETIC UNIFORMS AND WARM UP SUITS (U.S. CLS. 22 AND 39).

BRENDAN MCCAULEY, EXAMINING ATTORNEY

SN 77-760,647. INFINITE APE LLC, IPSWICH, MA. FILED 6-16-2009.

BANANA CANYON

THE MARK CONSISTS OF STANDARD CHARACTERS WITHOUT CLAIM TO ANY PARTICULAR FONT, STYLE, SIZE, OR COLOR.

FOR MEN'S AND WOMEN'S CLOTHING, NAMELY, T-SHIRTS, SHIRTS, SWEATSHIRTS, SWEATERS, HATS, PANTS, GOLF TROUSERS, SHORTS, JACKETS, TANK TOPS, JERSEYS, COATS, SWIMWEAR, FLEECE PULL-OVERS, SWEAT SUITS, JOGGING SUITS, CAPS, VISORS, HEAD BANDS, SUITS, BLAZERS, SCARVES, SLEEPWEAR, AND LOUNGEWEAR (U.S. CLS. 22 AND 39).

JOHN DWYER, EXAMINING ATTORNEY

CLASS 25—(Continued).

SN 77-760,764. MUHAMMAD, MICHELLE DARLENE, DBA QUEEN OF SHEBA TRADING COMPANY, BALTIMORE, MD. FILED 6-16-2009.

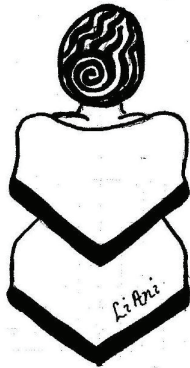

THE MARK CONSISTS OF A STYLIZED DESIGN OF A WOMAN WEARING A SHAWL AND THE WORDING "LIANI".

FOR SHAWLS AND STOLES (U.S. CLS. 22 AND 39).
FIRST USE 9-22-2006; IN COMMERCE 9-22-2006.
JOHN DWYER, EXAMINING ATTORNEY

SN 77-761,329. SOLLIE, KATHERINE M, AUSTIN, MN. AND SOLLIE, STEPHEN P, AUSTIN, MN. FILED 6-16-2009.

Blathering Man

THE MARK CONSISTS OF STANDARD CHARACTERS WITHOUT CLAIM TO ANY PARTICULAR FONT, STYLE, SIZE, OR COLOR.

FOR CLOTHING, NAMELY, SHIRTS, SHORTS, HATS, JACKETS, SWEAT SHIRTS (U.S. CLS. 22 AND 39).
SOPHIA S. KIM, EXAMINING ATTORNEY

CLASS 25—(Continued).

SN 77-763,755. ALL SAINTS RETAIL LIMITED, LONDON, UNITED KINGDOM, FILED 6-19-2009.

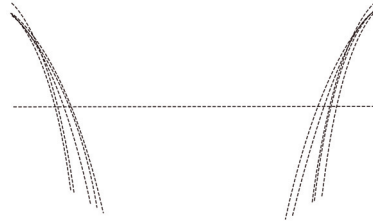

PRIORITY CLAIMED UNDER SEC. 44(D) ON ERPNTY TM OFC APPLICATION NO. 8289605, FILED 5-8-2009, REG. NO. 008289605, DATED 10-21-2009, EXPIRES 5-8-2019.

THE MARK CONSISTS OF TWO PATTERNS FORMING THE IMAGE OF THE TIPS OF AN ANIMAL'S HORNS.

FOR ANKLE BOOTS; ANKLE SOCKS; ANKLETS; ATHLETIC FOOTWEAR; ATHLETIC SHOES; BANDANAS; BASEBALL CAPS; BATHING SUITS; BATHROBES; BEACH COVERUPS; BEACH FOOTWEAR; BEACH SHOES; BEACHWEAR; BELTS; BELTS MADE OF LEATHER; BELTS OF TEXTILE; BERMUDA SHORTS; BIB OVERALLS; BIKINIS; BLAZERS; BLOUSES; BLOUSONS; BOARD SHORTS; BOARDSHORTS; BODY SHAPERS; BODY SUITS; BOOTS; BOTTOMS; BOXER BRIEFS; BOXER SHORTS; BRAS; BRASSIERES; CAMISETTES; CAMISOLES; CANVAS SHOES; CAP VISORS; CAPRI PANTS; CAPRIS; CAPS; CAPS WITH VISORS; CARDIGANS; CHAPS; CHEMISES; CHEMISSETTES; CHILDREN'S HEADWEAR; CLOGS; COATS; COATS FOR MEN AND WOMEN; COATS MADE OF COTTON; COATS OF DENIM; COVERALLS; CYCLISTS' JERSEYS; DECK-SHOES; DENIM JACKETS; DENIMS; DOWN JACKETS; DRESS SHIRTS; DRESS SUITS; DRESSES; DRESSING GOWNS; DUNGAREES; EAR MUFFS; EARBANDS; ESPADRILLES; EVENING DRESSES; EVENING GOWNS; FABRIC BELTS; FLEECE PULLOVERS; FLEECE SHORTS; FLIP FLOPS; FOOTWEAR; FOOTWEAR FOR MEN; FOOTWEAR FOR MEN AND WOMEN; FOOTWEAR FOR WOMEN; FOOTWEAR MADE OF WOOD; FOOTWEAR NOT FOR SPORTS; FOOTWEAR, NAMELY, PUMPS; FOOTWEAR, NAMELY, RUBBERS; GLOVES; GOLF CAPS; GOLF SHIRTS; GOLF TROUSERS; GOWNS; GYM SHORTS; GYM SUITS; HALTER TOPS; HAT BANDS; HATS; HEAD SCARVES; HEAD SWEATBANDS; HEAD WEAR; HEADBANDS; HEADBANDS AGAINST SWEATING; HEADWEAR; HIKING BOOTS; INFANT SLEEPERS; INFANTS' SHOES AND BOOTS; INFANTS' TROUSERS; INFANTWEAR; JACKETS; JEANS; JERSEYS; JOGGING OUTFITS; JOGGING PANTS; JOGGING SUITS; JUMPERS; JUMPSUITS; KNEE HIGHS; KNEE-HIGH STOCKINGS; KNIT SHIRTS; KNITTED CAPS; LADIES' BOOTS; LADIES' SUITS; LADIES' UNDERWEAR; LEATHER BELTS; LEATHER COATS; LEATHER HEADWEAR; LEATHER JACKETS; LEATHER PANTS; LEATHER SHOES; LEATHER SLIPPERS; LEG SHAPERS; LEG WARMERS; LEG-WARMERS; LEGGINGS; LEOTARDS; LEOTARDS AND TIGHTS FOR WOMEN, MEN AND CHILDREN OF NYLON, COTTON OR OTHER TEXTILE FIBERS; LINGERIE; LONG JACKETS; LONG SLEEVED VESTS; LOUNGEWEAR; MEN AND WOMEN JACKETS, COATS, TROUSERS, VESTS; MEN'S SOCKS; MEN'S SUITS; WOMEN'S SUITS; MINISKIRTS; MITTENS; MOCK TURTLE-NECK SWEATERS; NECKTIES; NECKWEAR; NEGLIGENCE; NIGHT GOWNS; NIGHT SHIRTS; NIGHTDRESSES; NIGHTIES; NIGHTWEAR; OPEN-NECKED SHIRTS; OVER COATS; OVER-TROUSERS; OVERALLS; OVERCOATS; OVERSHOES; PAJAMAS; PANTIES; PANTIES, SHORTS AND BRIEFS; PANTS; PANTSUITS; PANTYHOSE; PLAY SUITS; POLO SHIRTS; PONCHOS; PULLOVERS; PUMPS; RAIN BOOTS; RAIN COATS; RAIN JACKETS; RAIN SUITS; RAINCOATS; RAINPROOF JACKETS; RAINWEAR; ROBES; ROMPERS; RUBBER SHOES; RUBBERS; RUGBY SHORTS; RUGBY TOPS; RUNNING SHOES; SANDAL-CLOGS; SANDALS; SASHES; SCARVES; SHAWLS; SHAWLS AND HEADSCARVES; SHAWLS AND STOLES; SHIRTS; SHIRTS FOR SUITS; SHOES; SHORT SETS; SHORT TROUSERS; SHORT-SLEEVED OR LONG-SLEEVED T-

CLASS 25—(Continued).

SHIRTS; SHORT-SLEEVED SHIRTS; SHORTALLS; SHORTS; SILK SCARVES; SINGLETS; SKIRT SUITS; SKIRTS; SKIRTS AND DRESSES; SKORTS; SLACKS; SLEEP SHIRTS; SLEEPING GARMENTS; SLEEPWEAR; SLEEVED OR SLEEVELESS JACKETS; SLEEVELESS JERSEYS; SLIPPERS; SMALL HATS; SNEAKERS; SOCKS; SOCKS AND STOCKINGS; SPORT COATS; SPORT SHIRTS; SPORTS BRA; SPORTS JACKETS; SPORTS JERSEYS; SPORTS SHIRTS; STOCKINGS; SUIT COATS; SUITS; SUITS OF LEATHER; SUN VISORS; SUNSUITS; SWEAT BANDS; SWEAT PANTS; SWEAT SHIRTS; SWEAT SHORTS; SWEAT SUITS; SWEAT-BANDS; SWEATERS; SWIM TRUNKS; SWIM WEAR; SWIM WEAR FOR GENTLEMEN AND LADIES; SWIMMING COSTUMES; SWIMSUITS; T-SHIRTS; TANK TOPS; TANK-TOPS; TANKINIS; TENNIS SHOES; TENNIS WEAR; TOPS; TRACK PANTS; TRACK SUITS; TRACKSUITS; TROUSERS; TROUSERS FOR SWEATING; TRUNKS; TUNICS; TURTLENECK SWEATERS; TURTLENECKS; UNDER GARMENTS; UNDERCLOTHES; UNDERGARMENTS; UNDERPANTS; UNDERSHIRTS; UNDERWEAR; UNITARDS; V-NECK SWEATERS; VESTED SUITS; VESTS; VISORS; WAIST BELTS; WALKING SHORTS; WARM UP SUITS; WIND RESISTANT JACKETS; WINDJAMMERS; WOMEN'S SHOES; WOMEN'S UNDERWEAR; WRAPS; WRIST BANDS; WRISTBANDS (U.S. CLS. 22 AND 39).

RUSS HERMAN, EXAMINING ATTORNEY

SN 77-763,762. ALL SAINTS RETAIL LIMITED, LONDON, UNITED KINGDOM, FILED 6-19-2009.

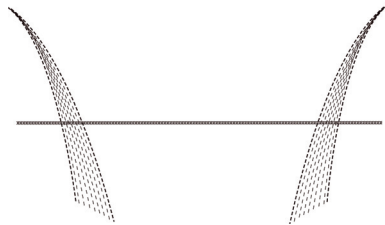

PRIORITY CLAIMED UNDER SEC. 44(D) ON ERP N CMNTY TM OFC APPLICATION NO. 8289654, FILED 5-8-2009, REG. NO. 008289654, DATED 10-26-2009, EXPIRES 5-8-2019.

THE MARK CONSISTS OF TWO PATTERNS FORMING THE IMAGE OF THE TIPS OF AN ANIMAL'S HORNS.

FOR ANKLE BOOTS; ANKLE SOCKS; ANKLETS; ATHLETIC FOOTWEAR; ATHLETIC SHOES; BANDANAS; BASEBALL CAPS; BATHING SUITS; BATHROBES; BEACH COVERUPS; BEACH FOOTWEAR; BEACH SHOES; BEACHWEAR; BELTS; BELTS MADE OF LEATHER; BELTS OF TEXTILE; BERMUDA SHORTS; BIB OVERALLS; BIKINIS; BLAZERS; BLOUSES; BLOUSONS; BOARD SHORTS; BOARDSHORTS; BODY SHAPERS; BODY SUITS; BOOTS; BOTTOMS; BOXER BRIEFS; BOXER SHORTS; BRAS; BRASSIERES; CAMISETTES; CAMISOLES; CANVAS SHOES; CAP VISORS; CAPRI PANTS; CAPRIS; CAPS; CAPS WITH VISORS; CARDIGANS; CHAPS; CHEMISES; CHEMISETTES; CHILDREN'S HEADWEAR; CLOGS; COATS; COATS FOR MEN AND WOMEN; COATS MADE OF COTTON; COATS OF DENIM; COVERALLS; CYCLISTS' JERSEYS; DECK-SHOES; DENIM JACKETS; DENIMS; DOWN JACKETS; DRESS SHIRTS; DRESS SUITS; DRESSES; DRESSING GOWNS; DUNGAREES; EAR MUFFS; EARBANDS; ESPADRILLES; EVENING DRESSES; EVENING GOWNS; FABRIC BELTS; FLEECE PULLOVERS; FLEECE SHORTS; FLIP FLOPS; FOOTWEAR; FOOTWEAR FOR MEN; FOOTWEAR FOR MEN AND WOMEN; FOOTWEAR FOR WOMEN; FOOTWEAR MADE OF WOOD; FOOTWEAR NOT FOR SPORTS; FOOTWEAR, NAMELY, PUMPS; FOOTWEAR, NAMELY, RUBBERS; GLOVES; GOLF CAPS; GOLF SHIRTS; GOLF TROUSERS; GOWNS; GYM SHORTS; GYM SUITS; HALTER TOPS; HAT BANDS; HATS; HEAD SCARVES; HEAD SWEATBANDS; HEAD WEAR; HEADBANDS; HEADBANDS AGAINST SWEATING; HEADWEAR; HIK-

CLASS 25—(Continued).

ING BOOTS; INFANT SLEEPERS; INFANTS' SHOES AND BOOTS; INFANTS' TROUSERS; INFANTWEAR; JACKETS; JEANS; JERSEYS; JOGGING OUTFITS; JOGGING PANTS; JOGGING SUITS; JUMPERS; JUMPSUITS; KNEE HIGHS; KNEE-HIGH STOCKINGS; KNIT SHIRTS; KNITTED CAPS; LADIES' BOOTS; LADIES' SUITS; LADIES' UNDERWEAR; LEATHER BELTS; LEATHER COATS; LEATHER HEADWEAR; LEATHER JACKETS; LEATHER PANTS; LEATHER SHOES; LEATHER SLIPPERS; LEG SHAPERS; LEG WARMERS; LEG-WARMERS; LEGGINGS; LEOTARDS, LEOTARDS AND TIGHTS FOR WOMEN, MEN AND CHILDREN OF NYLON, COTTON OR OTHER TEXTILE FIBERS; LINGERIE; LONG JACKETS; LONG SLEEVED VESTS; LOUNGEWEAR; MEN AND WOMEN JACKETS, COATS, TROUSERS, VESTS; MEN'S SOCKS; MEN'S SUITS; WOMEN'S SUITS; MINISKIRTS; MITTENS; MOCK TURTLE-NECK SWEATERS; NECKTIES; NECKWEAR; NEGLIGENCE; NIGHT GOWNS; NIGHT SHIRTS; NIGHTDRESSES; NIGHTIES; NIGHTWEAR; OPEN-NECKED SHIRTS; OVER COATS; OVER-TROUSERS; OVERALLS; OVERCOATS; OVERSHOES; PAJAMAS; PANTIES; PANTIES, SHORTS AND BRIEFS; PANTS; PANTSUITS; PANTYHOSE; PLAY SUITS; POLO SHIRTS; PONCHOS; PULLOVERS; PUMPS; RAIN BOOTS; RAIN COATS; RAIN JACKETS; RAIN SUITS; RAINCOATS; RAINPROOF JACKETS; RAINWEAR; ROBES; ROMPERS; RUBBER SHOES; RUBBERS; RUGBY SHORTS; RUGBY TOPS; RUNNING SHOES; SANDAL-CLOGS; SANDALS; SASHES; SCARVES; SHAWLS; SHAWLS AND HEADSCARVES; SHAWLS AND STOLEES; SHIRTS; SHIRTS FOR SUITS; SHOES; SHORT SETS; SHORT TROUSERS; SHORT-SLEEVED OR LONG-SLEEVED T-SHIRTS; SHORT-SLEEVED SHIRTS; SHORTALLS; SHORTS; SILK SCARVES; SINGLETS; SKIRT SUITS; SKIRTS; SKIRTS AND DRESSES; SKORTS; SLACKS; SLEEP SHIRTS; SLEEPING GARMENTS; SLEEPWEAR; SLEEVED OR SLEEVELESS JACKETS; SLEEVELESS JERSEYS; SLIPPERS; SMALL HATS; SNEAKERS; SOCKS; SOCKS AND STOCKINGS; SPORT COATS; SPORT SHIRTS; SPORTS BRA; SPORTS JACKETS; SPORTS JERSEYS; SPORTS SHIRTS; STOCKINGS; SUIT COATS; SUITS; SUITS OF LEATHER; SUN VISORS; SUNSUITS; SWEAT BANDS; SWEAT PANTS; SWEAT SHIRTS; SWEAT SHORTS; SWEAT SUITS; SWEAT-BANDS; SWEATERS; SWIM TRUNKS; SWIM WEAR; SWIM WEAR FOR GENTLEMEN AND LADIES; SWIMMING COSTUMES; SWIMSUITS; T-SHIRTS; TANK TOPS; TANK-TOPS; TANKINIS; TENNIS SHOES; TENNIS WEAR; TOPS; TRACK PANTS; TRACK SUITS; TRACKSUITS; TROUSERS; TROUSERS FOR SWEATING; TRUNKS; TUNICS; TURTLENECK SWEATERS; TURTLENECKS; UNDER GARMENTS; UNDERCLOTHES; UNDERGARMENTS; UNDERPANTS; UNDERSHIRTS; UNDERWEAR; UNITARDS; V-NECK SWEATERS; VESTED SUITS; VESTS; VISORS; WAIST BELTS; WALKING SHORTS; WARM UP SUITS; WIND RESISTANT JACKETS; WINDJAMMERS; WOMEN'S SHOES; WOMEN'S UNDERWEAR; WRAPS; WRIST BANDS; WRISTBANDS (U.S. CLS. 22 AND 39).

RUSS HERMAN, EXAMINING ATTORNEY

SN 77-765,010. GREEN LIGHT INNOVATIONS, L.L.C., COTTONWOOD HEIGHTS, UT. FILED 6-22-2009.

CLICKLESS

THE MARK CONSISTS OF STANDARD CHARACTERS WITHOUT CLAIM TO ANY PARTICULAR FONT, STYLE, SIZE, OR COLOR.

FOR HEEL PIECES FOR SHOES FOR USE AS PROTECTIVE COVERINGS FOR HEELS; FITTED SHOE COVERING TO PROTECT THE SOLES OF SHOES (U.S. CLS. 22 AND 39).

SAIMA MAKHDOOM, EXAMINING ATTORNEY

CLASS 25—(Continued).

SN 77-765,171. JAXXWEAR INC., AKA JAXXWEAR, GREENWICH, CT. FILED 6-22-2009.



jaxxwear

THE COLOR(S) SILVER AND BLUE IS/ARE CLAIMED AS A FEATURE OF THE MARK.

THE MARK CONSISTS OF SILVER CUSTOM DRAWN JACK CENTERED ABOVE BLUE COMPANY NAME "JAXXWEAR" IN BRYANT PRO 3 FONT STYLE.

FOR BABY BODYSUITS; CHILDREN'S AND INFANT'S APPAREL, NAMELY, JUMPERS, OVERALL SLEEPWEAR, PAJAMAS, ROMPERS AND ONE-PIECE GARMENTS; INFANT WEAR; INFANTS' TROUSERS; SHIRTS FOR INFANTS, BABIES, TODDLERS AND CHILDREN (U.S. CLS. 22 AND 39).

FIRST USE 1-22-2007; IN COMMERCE 1-22-2007.
THOMAS MANOR, EXAMINING ATTORNEY

SN 77-769,195. A & H SPORTSWEAR CO., INC., STOCKERTOWN, PA. FILED 6-26-2009.

SWIMMER CONTROL

THE MARK CONSISTS OF STANDARD CHARACTERS WITHOUT CLAIM TO ANY PARTICULAR FONT, STYLE, SIZE, OR COLOR.

FOR SWIMWEAR (U.S. CLS. 22 AND 39).
ADA HAN, EXAMINING ATTORNEY

CLASS 25—(Continued).

SN 77-769,965. NBA DEVELOPMENT LEAGUE, LLC, SECAUCUS, NJ. FILED 6-29-2009.



NO CLAIM IS MADE TO THE EXCLUSIVE RIGHT TO USE "SPRINGFIELD", APART FROM THE MARK AS SHOWN.

THE MARK CONSISTS OF THE DEPICTION OF AN ARMORED KNIGHT HOLDING A BASKETBALL STANDING IN FRONT OF A SHIELD WITH THE WORDS "SPRINGFIELD ARMOR".

FOR CLOTHING, NAMELY, HOSIERY, FOOTWEAR, BASKETBALL SHOES, BASKETBALL SNEAKERS, T-SHIRTS, SHIRTS, POLO SHIRTS, SWEATSHIRTS, SWEATPANTS, PANTS, TANK TOPS, JERSEYS, SHORTS, PAJAMAS, SPORT SHIRTS, RUGBY SHIRTS, SWEATERS, BELTS, TIES, NIGHTSHIRTS, HATS, CAPS, VISORS, WARM-UP SUITS, WARM-UP PANTS, WARM-UP TOPS/SHOOTING SHIRTS, JACKETS, WIND RESISTANT JACKETS, PARKAS, COATS, BABY BIBS NOT OF PAPER, HEAD BANDS, WRIST BANDS, APRONS, UNDERGARMENTS, BOXER SHORTS, SLACKS, EAR MUFFS, GLOVES, MITTENS, SCARVES, WOVEN AND KNIT SHIRTS, JERSEY DRESSES, DRESSES, CHEERLEADING DRESSES AND UNIFORMS, SWIM WEAR, BATHING SUITS, SWIMSUITS, BIKINIS, TANKINIS, SWIM TRUNKS, BATHING TRUNKS, BOARD SHORTS, WET SUITS, BEACH COVER-UPS, BATHING SUIT COVER-UPS, BATHING SUIT WRAPS, SANDALS, BEACH SANDALS, BEACH HATS, SUN VISORS, SWIM CAPS, BATHING CAPS, NOVELTY HEADWEAR WITH ATTACHED WIGS, ALL OF THE FOREGOING TO BE USED TO PROMOTE THE SPORT OF BASKETBALL IN CONNECTION WITH THE TRADEMARK OWNER'S PROFESSIONAL BASKETBALL TEAM (U.S. CLS. 22 AND 39).

SHARON MEIER, EXAMINING ATTORNEY

SN 77-770,407. SOLO LIMITED, NEWTON, AUCKLAND, NEW ZEALAND, FILED 6-29-2009.

DERNY

THE MARK CONSISTS OF STANDARD CHARACTERS WITHOUT CLAIM TO ANY PARTICULAR FONT, STYLE, SIZE, OR COLOR.

PRIORITY CLAIMED UNDER SEC. 44(D) ON NEW ZEALAND APPLICATION NO. 802095, FILED 2-4-2009, REG. NO. 802095, DATED 3-4-2009, EXPIRES 3-4-2019.

FOR CLOTHING, NAMELY, SHIRTS, PANTS, SHORTS, JEANS, TROUSERS, SWEATERS, JERSEYS, T-SHIRTS, SOCKS, COATS, JACKETS, VESTS, GLOVES, MITTENS, UNDERWEAR, SCARVES; HEADGEAR, NAMELY, CAPS, HATS, BEANIES; FOOTWEAR (U.S. CLS. 22 AND 39).

DEZMONA MIZELLE, EXAMINING ATTORNEY

CLASS 25—(Continued).

SN 77-771,434. LEE FRY ENTERTAINMENT, LLC, WEST-MONT, IL. FILED 6-30-2009.

COUNTRY MUSIC SMART

THE MARK CONSISTS OF STANDARD CHARACTERS WITHOUT CLAIM TO ANY PARTICULAR FONT, STYLE, SIZE, OR COLOR.

FOR CLOTHING, NAMELY, SHIRTS, PANTS, JACKETS, SWEATSHIRTS, SWEATERS, SHORTS, TOPS, BOTTOMS, DRESSES, BELTS, SCARVES, NECKWEAR AND GLOVES; HEADWEAR; FOOTWEAR (U.S. CLS. 22 AND 39).

CHRISIE B. KING, EXAMINING ATTORNEY

SN 77-771,710. HAURIS, ELIZABETH, MANASSAS, VA. FILED 6-30-2009.



THE MARK CONSISTS OF A SMALL STICK-FIGURE BABY WEARING A DIAPER. ON THE DIAPER APPEARS A SKULL AND CROSSBONES PATTERN. DIRECTLY TO THE RIGHT OF THE BABY, IN-LINE WITH THE BABY, AND APPROXIMATELY THE SAME HEIGHT AS THE BABY, APPEAR THE LETTERS "GEN-Y".

FOR BABY BODYSUITS; BABY BOTTOMS; BABY LAYETTES FOR CLOTHING; CLOTH DIAPERS; INFANT AND TODDLER ONE PIECE CLOTHING; INFANT CLOTH DIAPERS; INFANT DIAPER COVERS; INFANT WEAR; TEXTILE DIAPERS (U.S. CLS. 22 AND 39).

FIRST USE 10-2-2008; IN COMMERCE 11-8-2008.
KATHERINE STOIDES, EXAMINING ATTORNEY

SN 77-773,210. CONNIE HENRIQUEZ, MEDFORD, NY. FILED 7-2-2009.

START LOVING LIFE

THE MARK CONSISTS OF STANDARD CHARACTERS WITHOUT CLAIM TO ANY PARTICULAR FONT, STYLE, SIZE, OR COLOR.

FOR APPAREL, NAMELY, SHIRTS, SHORTS, PANTS, AND DRESSES (U.S. CLS. 22 AND 39).

BARBARA GAYNOR, EXAMINING ATTORNEY

CLASS 25—(Continued).

SN 77-773,253. CONNIE HENRIQUEZ, MEDFORD, NY. FILED 7-2-2009.



THE MARK CONSISTS OF THE STYLIZED PHRASE "START LOVING LIFE" PRECEDED BY A FANCIFUL "S" LETTER SUPERIMPOSED ON A HEART OR LEAF SHAPED DESIGN.

FOR APPAREL, NAMELY, SHIRTS, SHORTS, PANTS, AND DRESSES (U.S. CLS. 22 AND 39).

BARBARA GAYNOR, EXAMINING ATTORNEY

SN 77-773,281. CONNIE HENRIQUEZ, MEDFORD, NY. FILED 7-2-2009.



THE MARK CONSISTS OF THE FANCIFUL "S" LETTER SUPERIMPOSED ON A HEART OR LEAF SHAPED DESIGN.

FOR APPAREL, NAMELY, SHIRTS, SHORTS, PANTS, AND DRESSES (U.S. CLS. 22 AND 39).

BARBARA GAYNOR, EXAMINING ATTORNEY

SN 77-774,833. LAURA FARINA, WASHINGTON, DC. FILED 7-6-2009.

HUGGY DUGGY

THE MARK CONSISTS OF STANDARD CHARACTERS WITHOUT CLAIM TO ANY PARTICULAR FONT, STYLE, SIZE, OR COLOR.

FOR CLOTHING, NAMELY, SHIRTS, PANTS, PAJAMAS, T-SHIRTS, JACKETS, SHORTS, CAPS, HATS, SOCKS, SLIPPERS, SANDALS; FOOTWEAR AND HEADWEAR (U.S. CLS. 22 AND 39).

MARTHA SANTOMARTINO, EXAMINING ATTORNEY

CLASS 25—(Continued).

SN 77-774,948. JERAMON CROSBY., AND CROSBY AMON-RE, DBA FIVE LOCS, ATLANTA, GA. FILED 7-6-2009.

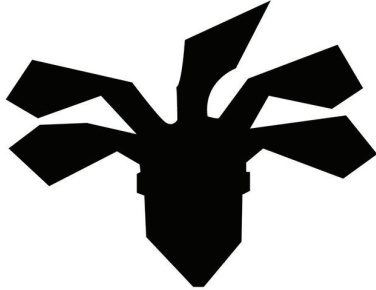

THE MARK CONSISTS OF THE OUTLINE OF A PERSON'S HEAD, WITH FIVE DREAD LOCKS EXTENDING FROM THE HEAD.

FOR WEARABLE GARMENTS AND CLOTHING, NAMELY, SHIRTS (U.S. CLS. 22 AND 39).

RUDY R. SINGLETON, EXAMINING ATTORNEY

SN 77-776,088. RICHMAN, DUKE D.R.S., ORANGE, NJ. FILED 7-7-2009.

RICHMAN CLASSIC COLLECTION

THE MARK CONSISTS OF STANDARD CHARACTERS WITHOUT CLAIM TO ANY PARTICULAR FONT, STYLE, SIZE, OR COLOR.

NO CLAIM IS MADE TO THE EXCLUSIVE RIGHT TO USE "CLASSIC COLLECTION", APART FROM THE MARK AS SHOWN.

FOR A-SHIRTS; ATHLETIC APPAREL, NAMELY, SHIRTS, PANTS, JACKETS, FOOTWEAR, HATS AND CAPS, ATHLETIC UNIFORMS; ATHLETIC SHOES; BELTS; BELTS FOR CLOTHING; BELTS MADE FROM IMITATION LEATHER; BELTS MADE OF LEATHER; BELTS MADE OUT OF CLOTH; BLAZERS; DRESS SHIRTS; DRESS SUITS; DRIVERS; FABRIC BELTS; GARTER BELTS; GOLF SHIRTS; GYM SUITS; HOODED SWEAT SHIRTS; JEANS; LADIES' UNDERWEAR; LEATHER BELTS; LEATHER SHOES; LEISURE SHOES; LINGERIE; LONG-SLEEVED SHIRTS; LOUNGEWEAR; MEN'S UNDERWEAR; MOISTURE-WICKING SPORTS SHIRTS; OPEN-NECKED SHIRTS; PANTS; POLO SHIRTS; RUGBY SHIRTS; SCARVES; SCIENTIFIC AND TECHNOLOGICAL APPAREL, NAMELY, SHIRTS, PANTS, JACKETS, FOOTWEAR, HATS AND CAPS, UNIFORMS; SHIRTS AND SHORT-SLEEVED SHIRTS; SHOES; SHORT-SLEEVED OR LONG-SLEEVED T-SHIRTS; SHORT-SLEEVED SHIRTS; SNEAKERS; SOCKS; SPORTS SHIRTS; SUSPENDER BELTS; SWEAT SHIRTS; SWEATERS; T-SHIRTS; TEE SHIRTS; TIES; TRIATHLON CLOTHING, NAMELY, TRIATHLON TIGHTS, TRIATHLON SHORTS, TRIATHLON SINGLETTS, TRIATHLON SHIRTS, TRIATHLON SUITS; TURTLE NECK SHIRTS; TUXEDO BELTS; TUXEDOS; WAIST BELTS; WOMEN'S SHOES; WORK SHOES AND BOOTS (U.S. CLS. 22 AND 39).

JENNY PARK, EXAMINING ATTORNEY

CLASS 25—(Continued).

SN 77-779,058. PACIFIC HARBORS LLC, SHERWOOD, OR. FILED 7-11-2009.



NO CLAIM IS MADE TO THE EXCLUSIVE RIGHT TO USE "SHEEP", APART FROM THE MARK AS SHOWN.

THE MARK CONSISTS OF THE WORDING "SHEEP TOUCH" IN A STYLIZED FONT, WITH A LETTER "S" SUPERIMPOSED OVER A STYLIZED LETTER "T", ALL WITHIN A CIRCLE BETWEEN THE WORDS "SHEEP" AND "TOUCH", AND WITH A RECTANGLE SURROUNDING THE ENTIRE MARK.

FOR FOOTWEAR MADE IN WHOLE OR SUBSTANTIAL PART OF SHEEP LEATHER OR SHEEP WOOL (U.S. CLS. 22 AND 39).

LIEF MARTIN, EXAMINING ATTORNEY

SN 77-783,194. PST GEAR, INC., TEMECULA, CA. FILED 7-16-2009.



NO CLAIM IS MADE TO THE EXCLUSIVE RIGHT TO USE "PINOY" OR THE GEOGRAPHIC REPRESENTATION OF THE PHILIPPINES, APART FROM THE MARK AS SHOWN.

THE MARK CONSISTS OF THE LETTERS "PST" IN LARGE STYLIZED BLOCK LETTERS. THE LETTER "P" HAS A STAR DESIGN IN THE ROUND PART OF THE LETTER AND 3 FILLED IN STARS ARE SURROUNDING A LARGER STAR-LIKE IMAGE. THE LETTER "S" EXTENDS UNDER THE LEFT SIDE OF THE LETTER "T" AND UNDER THE RIGHT SIDE OF THE LETTER "P". WRITTEN INSIDE THE BOTTOM OF THE LETTER "S" IS THE WORDING "PSTGEAR.COM". APPEARING UNDERNEATH THE LETTERS "PST" IS THE WORDING "PINOY STREET TEAM". ABOVE ALL OF THE TEXT IS A GRAPHIC OF THE PHILIPPINES SUPERIMPOSED ON A DESIGN OF A STAR-LIKE IMAGE, WHICH IS SURROUNDED BY GRAPHICS OF THREE INDIVIDUAL STARS. THE RECTANGULAR SHAPE OF THE BACKGROUND IS NOT CLAIMED AS A FEATURE OF THE MARK.

FOR T-SHIRTS (U.S. CLS. 22 AND 39).
FIRST USE 8-1-2006; IN COMMERCE 8-1-2006.
ALYSSA STEEL, EXAMINING ATTORNEY

CLASS 25—(Continued).

SN 77-787,478. THE ACADEMY OF THERAPEUTIC FOOTWEAR INC., DBA THE ACADEMY OF THERAPEUTIC FOOTWEAR INC., BOYNTON BEACH, FL. FILED 7-22-2009.

MIRACLE FOOTWEAR

THE MARK CONSISTS OF STANDARD CHARACTERS WITHOUT CLAIM TO ANY PARTICULAR FONT, STYLE, SIZE, OR COLOR.

NO CLAIM IS MADE TO THE EXCLUSIVE RIGHT TO USE "FOOTWEAR", APART FROM THE MARK AS SHOWN.

FOR FOOTWEAR (U.S. CLS. 22 AND 39).
STEVEN PEREZ, EXAMINING ATTORNEY

CLASS 25—(Continued).

SN 77-803,626. FUCHS, LESLEE, EVANSVILLE, IN. AND VANHOOSER, MAGGIE, EVANSVILLE, IN. FILED S.R. 8-13-2009; AM. P.R. 3-22-2010.

WOMEN BEHIND BARS

THE MARK CONSISTS OF STANDARD CHARACTERS WITHOUT CLAIM TO ANY PARTICULAR FONT, STYLE, SIZE, OR COLOR.

FOR CLOTHING, NAMELY, HEADWEAR, HATS, VISORS, CAPS, SWEAT BANDS, SHIRTS, SHORTS, PANTS, T-SHIRTS, TANK TOPS, SWEAT SHIRTS, JOGGING SUITS, JACKETS AND FOOTWEAR (U.S. CLS. 22 AND 39).

FIRST USE 7-16-2009; IN COMMERCE 7-16-2009.
KATHY DE JONGE, EXAMINING ATTORNEY

SN 77-820,744. SXE, LLC, SPRING VALLEY, OH. FILED 9-4-2009.

SXE

THE MARK CONSISTS OF STANDARD CHARACTERS WITHOUT CLAIM TO ANY PARTICULAR FONT, STYLE, SIZE, OR COLOR.

FOR ATHLETIC APPAREL, NAMELY, SHIRTS, PANTS, JACKETS, FOOTWEAR, HATS AND CAPS, ATHLETIC UNIFORMS; HATS; PANTS; POLO SHIRTS; SHIRTS; SHORTS (U.S. CLS. 22 AND 39).

FIRST USE 1-1-2007; IN COMMERCE 1-1-2007.
KAPIL BHANOT, EXAMINING ATTORNEY

SN 77-797,729. CHEREM, MOISES ROMANO, AVENTURA, FL. FILED 8-5-2009.



NO CLAIM IS MADE TO THE EXCLUSIVE RIGHT TO USE "FASHION", APART FROM THE MARK AS SHOWN.

THE MARK CONSISTS OF THE PHRASE "IDEOLOGIE...MIND ALTERING FASHION" WITH THE DESIGN OF A FLAME ABOVE A HALF-MOON DEPICTION OF THE HUMAN HEAD.

FOR CLOTHING, NAMELY, ORGANICALLY-MADE T-SHIRTS AND HOODED SWEATSHIRTS (U.S. CLS. 22 AND 39).

SUSAN LESLIE DUBOIS, EXAMINING ATTORNEY

SN 77-820,765. SXE, LLC, SPRING VALLEY, OH. FILED 9-4-2009.



THE MARK CONSISTS OF THE LETTERS "SXE" IN STYLIZING FORM.

FOR ATHLETIC APPAREL, NAMELY, SHIRTS, PANTS, JACKETS, FOOTWEAR, HATS AND CAPS, ATHLETIC UNIFORMS; HATS; PANTS; POLO SHIRTS; SHIRTS; SHORTS (U.S. CLS. 22 AND 39).

FIRST USE 1-1-2009; IN COMMERCE 1-1-2009.
KAPIL BHANOT, EXAMINING ATTORNEY

CLASS 25—(Continued).

SN 77-821,196. SIMMONS, CANDICE, DBA DARE TO BE SWEET, NORTH KINGSTOWN, RI. FILED 9-6-2009.

dare to be sweet

THE MARK CONSISTS OF STANDARD CHARACTERS WITHOUT CLAIM TO ANY PARTICULAR FONT, STYLE, SIZE, OR COLOR.

FOR SHIRTS, SHORTS, PANTS, JACKETS, SOCKS, SLIPPERS, SLEEP WEAR, UNDERWEAR, HATS, BABY BIBS NOT OF PAPER, SCARVES (U.S. CLS. 22 AND 39).
MARCIE MILONE, EXAMINING ATTORNEY

SN 77-826,516. HEART & SOLE SOFTWARE, INC., DECATUR, GA. FILED 9-15-2009.

Dress Ease

THE MARK CONSISTS OF STANDARD CHARACTERS WITHOUT CLAIM TO ANY PARTICULAR FONT, STYLE, SIZE, OR COLOR.

SEC. 2(F).
FOR DRESS SHOES WITH ORTHOPEDIC HEEL PADDING BUILT INTO THE BACK OF THE SHOES TO PREVENT HEEL SLIPPAGE AND FOR SECURING LOOSE SHOES (U.S. CLS. 22 AND 39).
FIRST USE 3-29-1999; IN COMMERCE 3-29-1999.
RON FAIRBANKS, EXAMINING ATTORNEY

SN 77-826,538. HEART & SOLE SOFTWARE, INC., DECATUR, GA. FILED 9-15-2009.

Looks Like A Heel. Walks
Like A Flat.

THE MARK CONSISTS OF STANDARD CHARACTERS WITHOUT CLAIM TO ANY PARTICULAR FONT, STYLE, SIZE, OR COLOR.

OWNER OF U.S. REG. NO. 2,352,659.
SEC. 2(F).
FOR DRESS SHOES WITH ORTHOPEDIC HEEL PADDING BUILT INTO THE BACK OF THE SHOES TO PREVENT HEEL SLIPPAGE AND FOR SECURING LOOSE SHOES (U.S. CLS. 22 AND 39).
FIRST USE 3-29-1999; IN COMMERCE 3-29-1999.
RON FAIRBANKS, EXAMINING ATTORNEY

CLASS 25—(Continued).

SN 77-828,803. MAYBERRY, FRANK A., DETROIT, MI. FILED 9-17-2009.

FRANK ALLEN EST. 1974

THE MARK CONSISTS OF STANDARD CHARACTERS WITHOUT CLAIM TO ANY PARTICULAR FONT, STYLE, SIZE, OR COLOR.

NO CLAIM IS MADE TO THE EXCLUSIVE RIGHT TO USE "EST. 1974", APART FROM THE MARK AS SHOWN. THE NAME "FRANK ALLEN" IDENTIFIES A LIVING INDIVIDUAL WHOSE CONSENT IS OF RECORD.

FOR BOARD SHORTS; BOXER SHORTS; DRESS SHIRTS; GYM PANTS; GYM SHORTS; JACKETS; JEANS; PANTS; POLO SHIRTS; SHIRTS; SHOES; SHORTS; SKIRTS AND DRESSES; SOCKS; SWEAT SHIRTS; T-SHIRTS; UNDERWEAR (U.S. CLS. 22 AND 39).
TOBY BULLOFF, EXAMINING ATTORNEY

SN 77-831,884. U-CHIN, INC., ALHAMBRA, CA. FILED 9-22-2009.



THE COLOR(S) RED, BLUE, ORANGE, BLACK AND GREEN IS/ARE CLAIMED AS A FEATURE OF THE MARK.

THE MARK CONSISTS OF THE WORDS "TAL TAL" IN UPPERCASE STYLIZED FONT IN RED, OUTLINED IN BLACK. BETWEEN THE WORDS IS A DESIGN CONSISTING OF TWO RED HEARTS WITH ORANGE OUTLINE AND A BLACK ARROW PASSING THROUGH THE HEARTS. BEHIND THE HEARTS IS A BLUE GLOBE. BENEATH THE GLOBE IS ORNAMENTAL FRAMEWORK ARCHED TO FRAME THE BOTTOM HALF OF THE GLOBE MADE WITH GREEN LEAVES ON THE RIGHT, AND RED BERRIES ON THE LEFT.

FOR BATHING SUITS; BELTS; BLOUSES; BODY STOCKINGS; BRAS; DRESSES; HATS; HEADWEAR; JACKETS; JEANS; LEGGINGS; LEOTARDS; LINGERIE; NIGHTGOWNS; PANTIES; PANTS; ROBES; SCARVES; SHIRTS; SHOES; SHORTS; SKIRTS; SOCKS; STOCKINGS; SWEATERS; TEDDIES; TOPS; UNDERWEAR (U.S. CLS. 22 AND 39).

FIRST USE 9-0-2009; IN COMMERCE 9-0-2009.
GINA FINK, EXAMINING ATTORNEY

CLASS 25—(Continued).

SN 77-832,204. TRIPLE T TRADING, MARYSVILLE, WA. FILED 9-22-2009.



THE MARK CONSISTS OF A HIGHLY STYLIZED LETTER "N" THAT IS COMPRISED OF TWO TRIANGLES AND A QUADRILATERAL.

FOR FOOTWEAR, NAMELY, COLD WEATHER BOOTS AND SHOES, SLIPPERS, SANDALS, WATER SOCKS, CASUAL SHOES AND BOOTS, ATHLETIC SHOES, HIKING SHOES, CANVAS SHOES AND RUBBER BOOTS (U.S. CLS. 22 AND 39).

FIRST USE 3-9-2009; IN COMMERCE 9-1-2009.
LINDA LAVACHE, EXAMINING ATTORNEY

SN 77-832,415. TOE TALK, LLC, RALEIGH, NC. FILED 9-22-2009.

TOE TALK

THE MARK CONSISTS OF STANDARD CHARACTERS WITHOUT CLAIM TO ANY PARTICULAR FONT, STYLE, SIZE, OR COLOR.

FOR SOCKS (U.S. CLS. 22 AND 39).
RUSS HERMAN, EXAMINING ATTORNEY

CLASS 25—(Continued).

SN 77-839,174. MADERIS, RICK, NEWPORT BEACH, CA. FILED 10-1-2009.



"VIEIRA MADERIS" IDENTIFIES "RICK MADERIS", A LIVING INDIVIDUAL, WHOSE CONSENT IS OF RECORD.

THE MARK CONSISTS OF A DESIGN COMPOSED OF A SQUARE INSIDE A SQUARE CONTAINING FOUR FOUR-POINT STARS WITH ONE AT EACH CORNER AND A DESIGN IN THE CENTER OF THE INNER SQUARE CONSISTING OF A CIRCLE DIVIDED BY MULTIPLE BARS AND BANDS AND AN "S" SHAPED CURVED LINE AND FEATURING A CIRCLE ON THE UPPER SECTION AND A CIRCLE IN THE CENTER ON THE BOTTOM SECTION OF THE DIVIDED CIRCLE. THE WORDING "VIEIRA MADERIS" IS BELOW ELEMENTS OF THE DESIGN.

FOR CLOTHING FOR MEN, WOMEN, NAMELY, COATS, RAINCOATS, SWIMWEAR, BELTS, WAIST-COAT, BLOUSES AND PULLOVERS, JACKETS, TROUSERS, SKIRTS, DRESSES, SUITS, SHIRTS AND CHEMISES, T-SHIRTS, SWEATERS, UNDERWEAR, SOCKS AND STOCKINGS, GLOVES, TIES, SCARFS, HATS AND CAPS, BOOTS, SHOES AND SLIPPERS (U.S. CLS. 22 AND 39).

LINDA ESTRADA, EXAMINING ATTORNEY

SN 77-840,996. KOTABISH, CHING, DBA PINK AUBERGINE, STATEN ISLAND, NY. FILED 10-4-2009.



THE COLOR(S) PURPLE, YELLOW, ORANGE AND GREEN IS/ARE CLAIMED AS A FEATURE OF THE MARK.

THE MARK CONSISTS OF YELLOW CHESTED PURPLE FROG SITTING ON GREEN LILY PAD SURROUNDED BY GREEN WATER RIPPLES AND ORANGE FLOWERS. THE ORANGE WORDS "YUTOPIA" UNDER LILY PAD.

FOR INFANT AND TODDLER ONE PIECE CLOTHING; JERSEYS; KNIT SHIRTS; T-SHIRTS; TEE SHIRTS (U.S. CLS. 22 AND 39).

PAM WILLIS, EXAMINING ATTORNEY

CLASS 25—(Continued).

SN 77-846,086. HIGH, JEWEL T., DBA JUDA'S COLLECTION, CHARLOTTE, NC. FILED 10-10-2009.



NO CLAIM IS MADE TO THE EXCLUSIVE RIGHT TO USE "COLLECTION", APART FROM THE MARK AS SHOWN.

THE COLOR(S) FUSCHIA, LIME GREEN, PURPLE, ORANGE AND BLACK IS/ARE CLAIMED AS A FEATURE OF THE MARK.

THE MARK CONSISTS OF THE WORDING "JUDA COLLECTION" WHERE THE WORD "JUDA" IS ON TOP IN STYLIZED LETTERING AS FOLLOWS: J IN FUCHSIA, U IN LIME GREEN, D IN PURPLE AND "A" IN ORANGE, AND "COLLECTION" IS UNDERNEATH ALL IN BLACK. BETWEEN "JUDA" AND "COLLECTION" ARE TWO HORIZONTAL BLACK LINES. THE WHITE IN THE MARK IS BACKGROUND AREA WHICH IS NOT A PART OF THE MARK.

FOR SHOES (U.S. CLS. 22 AND 39).
REBECCA GILBERT, EXAMINING ATTORNEY

SN 77-847,034. DAVISON, ALAN ROBERT, SALT LAKE CITY, UT. FILED 10-12-2009.

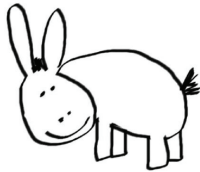

MARK CONSISTS OF A STYLIZED REPRESENTATION OF A DONKEY.

FOR T-SHIRTS (U.S. CLS. 22 AND 39).
FIRST USE 10-8-2009; IN COMMERCE 10-10-2009.
PRISCILLA MILTON, EXAMINING ATTORNEY

SN 77-847,145. DERRICK BRYANT, RALEIGH, NC. FILED 10-12-2009.

Kylen Seth

THE MARK CONSISTS OF STANDARD CHARACTERS WITHOUT CLAIM TO ANY PARTICULAR FONT, STYLE, SIZE, OR COLOR.

THE NAME "KYLEN SETH" IDENTIFIES A LIVING INDIVIDUAL WHOSE CONSENT IS OF RECORD.

FOR ATHLETIC APPAREL, NAMELY, SHIRTS, PANTS, JACKETS, FOOTWEAR, HATS AND CAPS, ATHLETIC UNIFORMS (U.S. CLS. 22 AND 39).

MARIAM MAHMOUDI, EXAMINING ATTORNEY

CLASS 25—(Continued).

SN 77-851,648. MARTHA SAGE VANG, DBA CLOUD WATCHED DESIGNS, SANTA FE, NM. FILED 10-19-2009.

Cloud Watcher Designs

THE MARK CONSISTS OF STANDARD CHARACTERS WITHOUT CLAIM TO ANY PARTICULAR FONT, STYLE, SIZE, OR COLOR.

NO CLAIM IS MADE TO THE EXCLUSIVE RIGHT TO USE "DESIGNS", APART FROM THE MARK AS SHOWN.

FOR CLOTHING, NAMELY, SHIRTS, DRESSES, SHORTS, JACKETS, VESTS AND COATS (U.S. CLS. 22 AND 39).

GENE MACIOL, EXAMINING ATTORNEY

SN 77-854,677. KABIR SM HOLDINGS, INC, NEW YORK, NY. FILED 10-22-2009.



THE NAME(S), PORTRAIT(S), AND/OR SIGNATURE(S) SHOWN IN THE MARK DOES NOT IDENTIFY A PARTICULAR LIVING INDIVIDUAL.

FOR A-SHIRTS; ATHLETIC APPAREL, NAMELY, SHIRTS, PANTS, JACKETS, FOOTWEAR, HATS AND CAPS, ATHLETIC UNIFORMS; BALLOON PANTS; BODY SHIRTS; BUTTON-FRONT ALOHA SHIRTS; CAMOUFLAGE PANTS; CAMOUFLAGE SHIRTS; CAMP SHIRTS; CAPRI PANTS; CARGO PANTS; CHILDREN'S AND INFANT'S APPAREL, NAMELY, JUMPERS, OVER-ALL SLEEPWEAR, PAJAMAS, ROMPERS AND ONE-PIECE GARMENTS; CLOTHING FOR ATHLETIC USE, NAMELY, PADDED PANTS; CLOTHING FOR ATHLETIC USE, NAMELY, PADDED SHIRTS; DENIMS; DRESS SHIRTS; FISHING SHIRTS; GOLF PANTS, SHIRTS AND SKIRTS; GOLF SHIRTS; GYM PANTS; HOODED SWEAT SHIRTS; HUNTING PANTS; HUNTING SHIRTS; JOGGING PANTS; KNIT SHIRTS; LEATHER PANTS; LONG-SLEEVED SHIRTS; LOUNGE PANTS; MOISTURE-WICKING SPORTS PANTS; MOISTURE-WICKING SPORTS SHIRTS; NIGHT SHIRTS; NON-DISPOSABLE CLOTH TRAINING PANTS; NURSE PANTS; OPEN-NECKED SHIRTS; OVER SHIRTS; PANTS; PETTI-PANTS; PIQUE SHIRTS; POLO SHIRTS; RUGBY SHIRTS; SCIENTIFIC AND TECHNOLOGICAL APPAREL, NAMELY, SHIRTS, PANTS, JACKETS, FOOT-

CLASS 25—(Continued).

WEAR, HATS AND CAPS, UNIFORMS; SHIRT FRONTS; SHIRT YOKES; SHIRTS; SHIRTS AND SHORT-SLEEVED SHIRTS; SHIRTS FOR INFANTS, BABIES, TODDLERS AND CHILDREN; SHIRTS FOR SUITS; SHORT-SLEEVED OR LONG-SLEEVED T-SHIRTS; SHORT-SLEEVED SHIRTS; SKI PANTS; SLEEP SHIRTS; SNOW PANTS; SNOWBOARD PANTS; SPORT SHIRTS; SPORTS PANTS; SPORTS SHIRTS; SPORTS SHIRTS WITH SHORT SLEEVES; STRETCH PANTS; SWEAT PANTS; SWEAT SHIRTS; T-SHIRTS; TAP PANTS; TEE SHIRTS; TOBOGGAN HATS, PANTS AND CAPS; TRACK PANTS; TRAVEL CLOTHING CONTAINED IN A PACKAGE COMPRISING REVERSIBLE JACKETS, PANTS, SKIRTS, TOPS AND A BELT OR SCARF; TRIATHLON CLOTHING, NAMELY, TRIATHLON TIGHTS, TRIATHLON SHORTS, TRIATHLON SINGLETS, TRIATHLON SHIRTS, TRIATHLON SUITS; TURTLE NECK SHIRTS; WATERPROOF JACKETS AND PANTS; WEARABLE GARMENTS AND CLOTHING, NAMELY, SHIRTS; WIND PANTS; WIND SHIRTS; YOGA PANTS; YOGA SHIRTS (U.S. CLS. 22 AND 39).

MARK SPARACINO, EXAMINING ATTORNEY

SN 77-855,568. DENIMXWORKS, INC., LOS ANGELES, CA. FILED 10-22-2009.



THE MARK CONSISTS OF A BUTTON DESIGN FORMED BY A CIRCLE CONTAINING CURVED AND STRAIGHT INTERLOCKING BANDS.

FOR CLOTHING, NAMELY, COATS, JACKETS, SHIRTS, BLOUSES, TOPS, SKIRTS, PANTS, DRESSES, SHORTS, T-SHIRTS, SWEATSHIRTS, HATS AND CAPS; KNITWEAR, NAMELY, CAPS, SHIRTS, AND SWEATERS (U.S. CLS. 22 AND 39).

HAI-LY LAM, EXAMINING ATTORNEY

SN 77-856,640. ALLEN, MARK, SOQUEL, CA. AND SECUNDA, BRANT, SOQUEL, CA. FILED 10-24-2009.

Fit Soul Fit Body

THE MARK CONSISTS OF STANDARD CHARACTERS WITHOUT CLAIM TO ANY PARTICULAR FONT, STYLE, SIZE, OR COLOR.

FOR HATS; SWEAT SHIRTS; T-SHIRTS (U.S. CLS. 22 AND 39).

FIRST USE 10-0-2008; IN COMMERCE 10-0-2008.
ANNE FARRELL, EXAMINING ATTORNEY

CLASS 25—(Continued).

SN 77-859,294. SUMMIT SPORTS, INC., FORT WAYNE, IN. FILED 10-28-2009.

KOMETTS

THE MARK CONSISTS OF STANDARD CHARACTERS WITHOUT CLAIM TO ANY PARTICULAR FONT, STYLE, SIZE, OR COLOR.

OWNER OF U.S. REG. NOS. 1,737,215 AND 1,740,290.

THE ENGLISH TRANSLATION OF "KOMETT" IS "COMET".

FOR MEN'S, WOMEN'S AND CHILDREN'S CLOTHING, NAMELY, JERSEYS, SHIRTS, T-SHIRTS, POLO SHIRTS, SWEATSHIRTS, JACKETS, HOODED SWEATSHIRTS, PANTS, HATS, CAPS, KNIT HATS, FLEECE JACKETS AND PANTS (U.S. CLS. 22 AND 39).

FIRST USE 0-0-1953; IN COMMERCE 0-0-1953.

ANDREA BUTLER, EXAMINING ATTORNEY

SN 77-859,357. FREEMAN, DANIEL, MODESTO, CA. FILED 10-28-2009.

FIGHTER ELITE IN THE CAGE OR ON THE STREET

THE MARK CONSISTS OF STANDARD CHARACTERS WITHOUT CLAIM TO ANY PARTICULAR FONT, STYLE, SIZE, OR COLOR.

FOR ATHLETIC APPAREL, NAMELY, SHIRTS, PANTS, JACKETS, FOOTWEAR, HATS AND CAPS, ATHLETIC UNIFORMS (U.S. CLS. 22 AND 39).

ROBERT LAVACHE, EXAMINING ATTORNEY

SN 77-860,092. WHITE, RYAN, DBA INFAMOUS REIGN, METHUEN, MA. FILED 10-29-2009.



THE MARK CONSISTS OF A DESIGN PROFILE OF A HEAD LOOKING LEFT APPEARING WITHIN A SHADED

CLASS 25—(Continued).

SQUARE DESIGN. THE HEAD SHOWS A PROFILE OF A NOSE AND A SLIGHTLY OPENED MOUTH. A DESIGN OF A THREE POINT KING'S CROWN APPEARS ON THE TOP OF THE HEAD. THE DESIGN OF A KING'S CROWN IS SEPARATED BY A BANNER. THE BANNER DESIGN APPEARS UNDERNEATH THE CROWN AND IS AFFIXED TO THE HEAD AND COVERS THE EYES. THE STYLIZED WORDING "INFAMOUS REIGN" APPEARS WITHIN THE BANNER DESIGN. THE WORDING "INFAMOUS" AND "REIGN" APPEAR ON SEPARATE LINES.

FOR HOODS; SHIRTS; SHORT-SLEEVED OR LONG-SLEEVED T-SHIRTS (U.S. CLS. 22 AND 39).

FIRST USE 9-9-2008; IN COMMERCE 10-6-2009.

CIMMERIAN COLEMAN, EXAMINING ATTORNEY

CLASS 25—(Continued).

SN 77-863,641. AMERICAN EASTERN TRADERS, INC., PISCATAWAY, NJ. FILED 11-3-2009.



SN 77-862,810. GUINEY, CONNAUGHT, DBA GILLIE GIRLS, WEYMOUTH, MA. FILED 11-2-2009.

Gillie Girls

THE MARK CONSISTS OF STANDARD CHARACTERS WITHOUT CLAIM TO ANY PARTICULAR FONT, STYLE, SIZE, OR COLOR.

NO CLAIM IS MADE TO THE EXCLUSIVE RIGHT TO USE "GIRLS", APART FROM THE MARK AS SHOWN.

FOR MUFFS; NECKWEAR; SCARVES; SHAWLS AND HEADSCARVES (U.S. CLS. 22 AND 39).

FIRST USE 6-20-2009; IN COMMERCE 6-20-2009.

CHRIS WELLS, EXAMINING ATTORNEY

THE STIPPLING IS FOR SHADING PURPOSES ONLY.

THE MARK CONSISTS OF THE STYLIZED WORDS "GERONIMO". AN IMAGE OF A NATIVE AMERICAN HEAD DRESS ABOVE THE LETTER "G" AND FEATHER DESIGN BELOW THE LETTER "O".

FOR CLOTHING, NAMELY, JACKETS, VESTS, CHAPS, DUSTERS, COATS, WIND RESISTANT JACKETS, PANTS, SKIRTS, SHIRTS, TOPS, LEGGINGS, OVERALLS, GLOVES, HEADWEAR, BELTS, SCARVES, BOOTS, SHOES, SANDALS, WORKOUT PANTS, RAIN SUITS, LEATHER JACKETS (U.S. CLS. 22 AND 39).

SKYE YOUNG, EXAMINING ATTORNEY

SN 77-864,678. NATO BROTHERS LLC, NEW YORK, NY. FILED 11-4-2009.

SN 77-862,912. GYROTONIC SALES CORP., MIAMI BEACH, FL. FILED 11-2-2009.



OWNER OF U.S. REG. NO. 2,729,612.

THE MARK CONSISTS OF THE WORD "GYROTONIC" BENEATH AND ABSTRACT DESIGN CONSISTING OF A CURVED LINE AND A CIRCLE.

FOR FOOTWEAR (U.S. CLS. 22 AND 39).

LINDA POWELL, EXAMINING ATTORNEY



NO CLAIM IS MADE TO THE EXCLUSIVE RIGHT TO USE "NEW YORK", APART FROM THE MARK AS SHOWN.

THE MARK CONSISTS OF A GARMENT LABEL WITH THE WORDS "FANCY NEW YORK" WOVEN IN BLACK ON A WHITE BACKGROUND.

FOR WEDDING DRESSES; WEDDING GOWNS (U.S. CLS. 22 AND 39).

FIRST USE 8-8-2008; IN COMMERCE 4-3-2009.

KATINA MISTER, EXAMINING ATTORNEY

CLASS 25—(Continued).

SN 77-865,264. FORWARD ELEVATION LLC, LAWRENCE, MA. FILED 11-4-2009.

FERONOVO

THE MARK CONSISTS OF STANDARD CHARACTERS WITHOUT CLAIM TO ANY PARTICULAR FONT, STYLE, SIZE, OR COLOR.

THE ENGLISH TRANSLATION OF "FERONOVO" IN THE MARK IS "TO BRING ABOUT SOMETHING NEW".

FOR CLOTHING, NAMELY, BOXER SHORTS, BRIEFS, UNDERWEAR, POLO SHIRTS, SHIRTS, T-SHIRTS, JACKETS, COATS, FABRIC BELTS, LEATHER BELTS, CAPS, HATS, VISORS, BEANIES, FLEECE PULL-OVERS, SWEATERS, JEANS, PANTS, TROUSERS, OVERALLS, SWEAT PANTS, SWEATSHIRTS, TANK TOPS, SHORTS, SWIM SUITS, TRUNKS, BANDANAS, SHOES, SANDALS, FOOTWEAR, THERMAL UNDERWEAR, SOCKS, NIGHT GOWNS, PAJAMAS, WIND SHIRTS, PONCHOS, VESTS, PARKAS, YOGA PANTS, BATH-ROBES, JERSEYS, CLOTH BIBS, CAPRI PANTS, DRESSES, SKIRTS, BLOUSES (U.S. CLS. 22 AND 39).

KATHERINE E. HALMEN, EXAMINING ATTORNEY

SN 77-867,825. HORN, BEVERLY JO, DBA SLIMSHADEEZ, RENTON, WA. FILED 11-8-2009.

SlimShadeez
The Visor with No Strap, No Headache and No Glare!



NO CLAIM IS MADE TO THE EXCLUSIVE RIGHT TO USE "THE VISOR WITH NO STRAP", APART FROM THE MARK AS SHOWN.

THE COLOR(S) LIGHT ORANGE, CYAN, PURPLE, BLACK, BROWN, RED AND GREEN IS/ARE CLAIMED AS A FEATURE OF THE MARK.

THE MARK CONSISTS OF THE NAME OF THE COMPANY "SLIMSHADEEZ" IN LIGHT ORANGE (THE LETTERS S, S AND Z) AND CYAN, THE CATCH PHRASE: "THE VISOR WITH NO STRAP", "NO HEADACHE AND NO GLARE!" IN CYAN AND A DUCK DRESSED IN A VISOR (IN CYAN, BLACK AND RED), A PURPLE SHIRT, A BROWN CHAIN, BLUE PANTS AND GREEN SHOES WITH BROWN LACES.

FOR VISORS (U.S. CLS. 22 AND 39).
FIRST USE 6-9-2009; IN COMMERCE 8-22-2009.
CHRIS WELLS, EXAMINING ATTORNEY

CLASS 25—(Continued).

SN 77-869,445. J J SPARKLE, CITY OF INDUSTRY, CA. FILED 11-10-2009.

J J Sparkle

THE MARK CONSISTS OF STANDARD CHARACTERS WITHOUT CLAIM TO ANY PARTICULAR FONT, STYLE, SIZE, OR COLOR.

THE NAME "J J SPARKLE" DOES NOT IDENTIFY A LIVING INDIVIDUAL.

FOR JEANS (U.S. CLS. 22 AND 39).
ANDREW LEASER, EXAMINING ATTORNEY

SN 77-869,890. CHRISTY, HARRISON GRANT, EASTON, CT. FILED 11-11-2009.

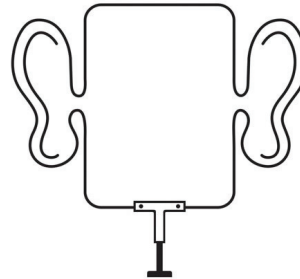

THE MARK CONSISTS OF TELEPROMPTER WITH EARS.

FOR T-SHIRTS (U.S. CLS. 22 AND 39).
PAUL E. FAHRENKOPF, EXAMINING ATTORNEY

SN 77-873,777. COZZUTTO, LYNDON, ABERDEEN, WA. FILED 11-16-2009.

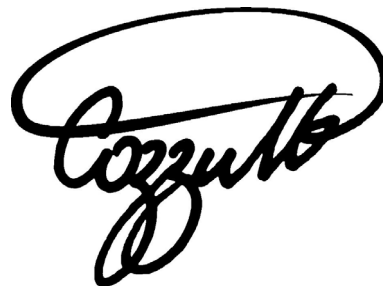

THE MARK CONSISTS OF THE STYLIZED TEXT "COZZUTTO".

FOR APRONS; COATS; HATS; JACKETS; PANTS; ROBES; SCARVES; SHIRTS; SHOES; SWEAT SHIRTS; T-SHIRTS (U.S. CLS. 22 AND 39).

FIRST USE 8-1-2009; IN COMMERCE 8-1-2009.
KATHERINE CHANG, EXAMINING ATTORNEY

CLASS 25—(Continued).

SN 77-874,101. AUBINOE, SCOT M., GAITHERSBURG, MD.
FILED 11-17-2009.



THE MARK CONSISTS OF FINGER PRINT VERTICLE WITH A BOX CENTERED IN THE FINGERPRINT. INSIDE THE BOX WILL BE THE WORDS ON TOP OF EACH OTHER... "ONE LIFE ONE LEGACY BOTH ONE'S" ARE THE SAME COLOR, AND BOTH "LIFE" AND "LEGACY" ARE THE SAME COLOR.

FOR ATHLETIC APPAREL, NAMELY, SHIRTS, PANTS, JACKETS, FOOTWEAR, HATS AND CAPS, ATHLETIC UNIFORMS; OVER SHIRTS; PIQUE SHIRTS; SHIRTS; SHIRTS AND SHORT-SLEEVED SHIRTS; SHORT-SLEEVED OR LONG-SLEEVED T-SHIRTS; SHORT-SLEEVED SHIRTS; SPORT SHIRTS; SPORTS SHIRTS; SPORTS SHIRTS WITH SHORT SLEEVES; SWEAT SHIRTS; T-SHIRTS; TEE SHIRTS; TURTLE NECK SHIRTS; WEARABLE GARMENTS AND CLOTHING, NAMELY, SHIRTS; WIND SHIRTS; YOGA SHIRTS (U.S. CLS. 22 AND 39).

AARON BRODSKY, EXAMINING ATTORNEY

SN 77-876,792. KAPOK LLC, NEW YORK, NY. FILED 11-19-2009.

kapok

THE MARK CONSISTS OF STANDARD CHARACTERS WITHOUT CLAIM TO ANY PARTICULAR FONT, STYLE, SIZE, OR COLOR.

FOR ATHLETIC APPAREL, NAMELY, SHIRTS, PANTS, JACKETS, FOOTWEAR, HATS AND CAPS, ATHLETIC UNIFORMS; BELTS; BELTS FOR CLOTHING; BELTS MADE OUT OF CLOTH; BOTTOMS; CLOTHING, NAMELY, BASE LAYERS; CLOTHING, NAMELY, KHAKIS; JACKETS; JERSEYS; SHORT SETS; TOPS; WEARABLE GARMENTS AND CLOTHING, NAMELY, SHIRTS (U.S. CLS. 22 AND 39).

FRED CARL, EXAMINING ATTORNEY

CLASS 25—(Continued).

SN 77-877,318. PROPPER INTERNATIONAL SALES, INC., ST. CHARLES, MO. FILED 11-20-2009.

PROPPER I.C.E.

THE MARK CONSISTS OF STANDARD CHARACTERS WITHOUT CLAIM TO ANY PARTICULAR FONT, STYLE, SIZE, OR COLOR.

FOR CLOTHING, NAMELY, SHIRTS, HATS, GLOVES, PANTS, SHORTS, VESTS, COATS, UNDERWEAR, SWEATERS, FOOTWEAR, RAINWEAR, TROUSERS, JEANS, JACKETS, PARKAS, COVERALLS; OVERALLS, FLIGHT SUITS, SWEATSHIRTS, SWEATPANTS, VISORS AND PONCHOS (U.S. CLS. 22 AND 39).

CARRIE GENOVESE, EXAMINING ATTORNEY

SN 77-877,840. XCVI LLC, DBA XCVI WEARABLES, LOS ANGELES, CA. FILED 11-20-2009.

Mind  Set

by  XCVI

OWNER OF U.S. REG. NOS. 2,905,758 AND 2,907,740.
THE COLOR(S) BLACK, WHITE, LIGHT RED, AQUA, SILVER IS/ARE CLAIMED AS A FEATURE OF THE MARK.
THE MARK CONSISTS OF THE TERM "MIND" WRITTEN IN STYLIZED FONT, FOLLOWED BY FOUR VERTICAL DOTS IN THE COLORS SILVER, AQUA, LIGHT RED AND BLACK, FOLLOWED BY THE TERM "SET" WRITTEN IN BLACK STYLIZED FONT WHICH IS SLIGHTLY LOWER THAN THE TERM "MIND", THE WORDING "BY XCVI" ON THE BOTTOM RIGHT CORNER IN BLACK STYLIZED FONT AND A BLACK MAZE DESIGN PRECEDING THE NUMERAL "XCVI".

FOR LOUNGEWEAR; YOGA PANTS; YOGA SHIRTS (U.S. CLS. 22 AND 39).

CYNTHIA SLOAN, EXAMINING ATTORNEY

CLASS 25—(Continued).

SN 77-878,877. MEDRANO, JOHN P, BUCKEYE, AZ. FILED 11-23-2009.

king & duck

THE MARK CONSISTS OF STANDARD CHARACTERS WITHOUT CLAIM TO ANY PARTICULAR FONT, STYLE, SIZE, OR COLOR.

FOR CAPS; FLEECE PULLOVERS; HATS; HOODED SWEAT SHIRTS; SWEAT SHIRTS; T-SHIRTS; TEE SHIRTS; A-SHIRTS; ATHLETIC APPAREL, NAMELY, SHIRTS, PANTS, JACKETS, FOOTWEAR, HATS AND CAPS, ATHLETIC UNIFORMS; ATHLETIC FOOTWEAR; ATHLETIC SHOES; ATHLETIC UNIFORMS; BALLOON PANTS; BANDANAS; BASEBALL CAPS; BASKETBALL SNEAKERS; BATH SLIPPERS; BATHING SUITS; BATHING TRUNKS; BEACH FOOTWEAR; BEACHWEAR; BEANIES; BELTS; BELTS FOR CLOTHING; BELTS MADE OF LEATHER; BERMUDA SHORTS; BIB SHORTS; BLAZERS; BOARD SHORTS; BOMBER JACKETS; BOOTS; BOTTOMS; BOW TIES; BOXER BRIEFS; BOXER SHORTS; BRIEFS; CAMOUFLAGE JACKETS; CAMOUFLAGE PANTS; CAMOUFLAGE SHIRTS; CAP VISORS; CAPRI PANTS; CAPS WITH VISORS; CARGO PANTS; CHILDREN'S HEADWEAR; CLOTHING, NAMELY, KHAKIS; COATS; COATS FOR MEN AND WOMEN; COATS OF DENIM; CREW NECK SWEATERS; CREW NECKS; DENIM JACKETS; DENIMS; DOWN JACKETS; DRESS SHIRTS; DRESS SUITS; FISHING SHIRTS; FLEECE SHORTS; FLEECE VESTS; FLIP FLOPS; FOOTWEAR; FOOTWEAR; FOOTWEAR FOR MEN AND WOMEN; GLOVES; GLOVES AS CLOTHING; GOLF CAPS; GOLF PANTS, SHIRTS AND SKIRTS; GOLF SHIRTS; GOLF SHORTS; GYM SHORTS; HAT BANDS; HEAD SCARVES; HEAD SWEATBANDS; HEADWEAR; HEADBANDS FOR CLOTHING; HEADWEAR; HOODED PULLOVERS; HOODS; HOODS; HUNTING SHIRTS; INFANTWEAR; JACKETS; JEANS; JERSEYS; JOGGING OUTFITS; JOGGING PANTS; JOGGING SUITS; KNIT SHIRTS; KNITTED CAPS; KNITTED GLOVES; LEATHER BELTS; LEATHER COATS; LEATHER JACKETS; LEATHER SHOES; LONG-SLEEVED SHIRTS; MEN'S UNDERWEAR; MOCK TURTLE-NECK SWEATERS; MOISTURE-WICKING SPORTS SHIRTS; OPEN-NECKED SHIRTS; PAJAMA BOTTOMS; PANTS; PIQUE SHIRTS; POLO SHIRTS; RUGBY SHIRTS; RUGBY SHORTS; SCARVES; SHIRTS; SHIRTS AND SHORT-SLEEVED SHIRTS; SHIRTS FOR INFANTS, BABIES, TODDLERS AND CHILDREN; SHIRTS FOR SUITS; SHORT TROUSERS; SHORT-SLEEVED OR LONG-SLEEVED T-SHIRTS; SHORT-SLEEVED SHIRTS; SHORTS; SKULL CAPS; SKULLIES; SLACKS; SNEAKERS; SNOWBOARD BOOTS; SNOWBOARD GLOVES; SNOWBOARD MITTENS; SNOWBOARD PANTS; SOCKS; SPORT COATS; SPORT SHIRTS; SPORTS JACKETS; SPORTS JERSEYS; SPORTS PANTS; SPORTS SHIRTS; SPORTS SHIRTS WITH SHORT SLEEVES; SWEAT PANTS; SWEAT SHORTS; SWEATERS; TIES; TOPS; TRACK PANTS; TROUSERS; TURTLE NECK SHIRTS; TURTLENECK SWEATERS; UNDER GARMENTS; UNDERPANTS; UNDERSHIRTS; UNDERWEAR; UNDERWEAR, NAMELY, BOY SHORTS; V-NECK SWEATERS; VESTS; WARM UP SUITS; WATERPROOF JACKETS AND PANTS; WIND RESISTANT JACKETS (U.S. CLS. 22 AND 39).

STEPHANIE ALI, EXAMINING ATTORNEY

CLASS 25—(Continued).

SN 77-879,282. PETRASEK, KEVIN, EL SEGUNDO, CA. FILED 11-23-2009.

SOUTHBAY BUILT

THE MARK CONSISTS OF STANDARD CHARACTERS WITHOUT CLAIM TO ANY PARTICULAR FONT, STYLE, SIZE, OR COLOR.

NO CLAIM IS MADE TO THE EXCLUSIVE RIGHT TO USE "SOUTH BAY", APART FROM THE MARK AS SHOWN.

FOR BOARD SHORTS; HATS; JACKETS; PANTS; SHIRTS; SHOES; SWEAT SHIRTS (U.S. CLS. 22 AND 39).
JESSICA A. POWERS, EXAMINING ATTORNEY

SN 77-879,319. LEVESQUE, CHARLES-HENRI, LEANDER, TX. FILED 11-23-2009.



NO CLAIM IS MADE TO THE EXCLUSIVE RIGHT TO USE "POLO", APART FROM THE MARK AS SHOWN.

THE MARK CONSISTS OF AN OVAL SURROUNDING A CREST WITH TWO POLO STICKS CROSSED BEHIND IT, AN AMERICAN FLAG ON TOP AND A FRENCH FLAG ON BOTTOM AND "ANCHA" ON ONE SIDE OF THE CREST AND "POLO" ON THE OTHER SIDE OF THE CREST. BELOW THE CREST AND ABOVE THE FRENCH FLAG IS A BANNER WITH THE WORDING "LABEUR ET COURAGE".

THE ENGLISH TRANSLATION OF "LABEUR ET COURAGE" IN THE MARK IS "LABOR AND COURAGE". THE WORDING "ANCHA POLO" HAS NO MEANING IN A FOREIGN LANGUAGE.

FOR CLOTHING, NAMELY, HATS, T-SHIRTS, SWEAT SHIRTS, POLO SHIRTS, SHORTS, HENLEYS AND BUTT-DOWN SHIRTS (U.S. CLS. 22 AND 39).

KATINA MISTER, EXAMINING ATTORNEY

CLASS 25—(Continued).

SN 77-879,336. SHARKPROOF PRODUCTIONS, LAGUNA BEACH, CA. FILED 11-23-2009.

SHARKPROOF

THE MARK CONSISTS OF STANDARD CHARACTERS WITHOUT CLAIM TO ANY PARTICULAR FONT, STYLE, SIZE, OR COLOR.

FOR AFTER SKI BOOTS; ANKLE SOCKS; ATHLETIC APPAREL, NAMELY, SHIRTS, PANTS, JACKETS, FOOTWEAR, HATS AND CAPS, ATHLETIC UNIFORMS; ATHLETIC FOOTWEAR; ATHLETIC UNIFORMS; BANDANAS; BASEBALL CAPS; BASEBALL UNIFORMS; BATHING SUITS; BATHING SUITS FOR MEN; BATHING TRUNKS; BATHROBES; BEACH COVER-UPS; BEACH COVERUPS; BEACH FOOTWEAR; BEACH SHOES; BEACHWEAR; BELTS; BELTS FOR CLOTHING; BELTS MADE OF LEATHER; BELTS MADE OUT OF CLOTH; BELTS OF TEXTILE; BERMUDA SHORTS; BIB SHORTS; BIKINIS; BODY SHIRTS; BODY STOCKINGS; BODY SUITS; BOMBER JACKETS; BOXER SHORTS; BOXING SHORTS; BUTTON-FRONT ALOHA SHIRTS; CAPRI PANTS; CAPRIS; CAPS; CAPS WITH VISORS; CARGO PANTS; COATS; COATS FOR MEN AND WOMEN; COATS MADE OF COTTON; COATS OF DENIM; COVERALLS; CREW NECK SWEATERS; DENIM JACKETS; DENIMS; DOWN JACKETS; DRESS SHIRTS; DRESS SUITS; DRESSING GOWNS AND BATH ROBES; EARBANDS; FABRIC BELTS; FISHING SHIRTS; FLEECE PULLOVERS; FLEECE SHORTS; FLEECE VESTS; FLIP FLOPS; FOOTWEAR; FOOTWEAR FOR MEN; FOOTWEAR FOR MEN AND WOMEN; FOOTWEAR FOR TRACK AND FIELD ATHLETICS; FOOTWEAR FOR WOMEN; FOOTWEAR NOT FOR SPORTS; GOLF CAPS; GOLF PANTS, SHIRTS AND SKIRTS; GOLF SHIRTS; GOLF SHOES; GOLF SHORTS; GOLF TROUSERS; GYM PANTS; GYM SHORTS; GYM SUITS; HEAD SCARVES; HEAD SWEATBANDS; HEAD WEAR; HEAVY JACKETS; HOODED SWEAT SHIRTS; HUNTING SHIRTS; JACKETS; JEANS; JOGGING OUTFITS; JOGGING PANTS; JOGGING SUITS; JUDO SUITS; KARATE SUITS; KNIT SHIRTS; KNITTED CAPS; LADIES' SUITS; LEATHER BELTS; LEATHER COATS; LEATHER JACKETS; LIGHT-REFLECTING JACKETS; LONG JACKETS; LONG-SLEEVED SHIRTS; MEN'S AND WOMEN'S JACKETS, COATS, TROUSERS, VESTS; MEN'S SOCKS; MEN'S SUITS; MEN'S SUITS, WOMEN'S SUITS; MOCK TURTLE-NECK SWEATERS; MOISTURE-WICKING SPORTS SHIRTS; MONEY BELTS; MOTORCYCLE JACKETS; NIGHT SHIRTS; OPEN-NECKED SHIRTS; OUTER JACKETS; PANTIES, SHORTS AND BRIEFS; POLO SHIRTS; RAIN COATS; RAIN JACKETS; RAINPROOF JACKETS; RUGBY SHIRTS; RUGBY SHORTS; SANDALCLOGS; SANDALS; SANDALS AND BEACH SHOES; SARONGS; SHIRTS; SHIRTS AND SHORT-SLEEVED SHIRTS; SHIRTS FOR SUITS; SHORT TROUSERS; SHORT-SLEEVED OR LONG-SLEEVED T-SHIRTS; SHORT-SLEEVED SHIRTS; SHORTS; SKI AND SNOWBOARD SHOES AND PARTS THEREOF; SKI BIBS; SKI JACKETS; SKI MASKS; SKI PANTS; SKI SUITS; SKI SUITS FOR COMPETITION; SKI TROUSERS; SKI WEAR; SLEEP SHIRTS; SLEEVED OR SLEEVELESS JACKETS; SNOW BOARDING SUITS; SNOWBOARD PANTS; SPORT COATS; SPORT SHIRTS; SPORTS JACKETS; SPORTS SHIRTS; SPORTS SHIRTS WITH SHORT SLEEVES; SUEDE JACKETS; SUIT COATS; SUITS; SUITS OF LEATHER; SUN VISORS; SURF WEAR; SUSPENDER BELTS; SUSPENDER BELTS FOR MEN; SUSPENDER BELTS FOR WOMEN; SWEAT BANDS; SWEAT JACKETS; SWEAT PANTS; SWEAT SHIRTS; SWEAT SHORTS; SWEAT SUITS; SWEATERS; SWIM TRUNKS; SWIM WEAR; SWIM WEAR FOR GENTLEMEN AND LADIES; SWIMMING TRUNKS; T-SHIRTS; TEE SHIRTS; TENNIS WEAR; THONGS; TOP COATS; TRACK JACKETS;

CLASS 25—(Continued).

TRACK SUITS; TRAINING SUITS; TRENCH COATS; TRIATHLON CLOTHING, NAMELY, TRIATHLON TIGHTS, TRIATHLON SHORTS, TRIATHLON SINGLET, TRIATHLON SHIRTS, TRIATHLON SUITS; TURTLE NECK SHIRTS; TURTLENECK SWEATERS; UNDERWEAR, NAMELY, BOY SHORTS; V-NECK SWEATERS; VESTED SUITS; VISORS; WAIST BELTS; WALKING SHORTS; WARM UP SUITS; WATERPROOF JACKETS AND PANTS; WEARABLE GARMENTS AND CLOTHING, NAMELY, SHIRTS; WIND COATS; WIND PANTS; WIND RESISTANT JACKETS; WIND SHIRTS; WIND VESTS; WIND-JACKETS (U.S. CLS. 22 AND 39).
C. DIONNE CLYBURN, EXAMINING ATTORNEY

SN 77-879,456. REID, ALVIN, FOUNTAIN INN, SC. FILED 11-24-2009.



THE COLOR(S) BLUE AND DARK BLUE IS/ARE CLAIMED AS A FEATURE OF THE MARK.

THE MARK CONSISTS OF A BLUE BARBER CHAIR WITH THE WORDING "ABMAAM" BETWEEN THE TWO DOTS IN DARK BLUE BELOW IT.

FOR CLOTHING, NAMELY, T-SHIRTS, HATS, SWEATSHIRTS, HOODED SWEAT SHIRTS AND TANK TOPS (U.S. CLS. 22 AND 39).

TARA PATE, EXAMINING ATTORNEY

SN 77-879,784. PHANNY SILK GROUP INC., NEW YORK, NY. FILED 11-24-2009.

THESIS

THE MARK CONSISTS OF STANDARD CHARACTERS WITHOUT CLAIM TO ANY PARTICULAR FONT, STYLE, SIZE, OR COLOR.

FOR MEN'S AND WOMEN'S CLOTHING, NAMELY, SHIRTS, T-SHIRTS, BLOUSES, PANTS, SKIRTS, PANTSUITS, SUITS, SLACKS, SHORTS, DRESSES, TOPS, SWEATERS, SWEAT SUITS, SOCKS, JACKETS, COATS, UNDERWEAR, SLIPS, PAJAMAS, SLEEPWEAR, CAPS, HATS, GLOVES (U.S. CLS. 22 AND 39).

DEZMONA MIZELLE, EXAMINING ATTORNEY

CLASS 25—(Continued).

SN 77-879,788. PENNY BEEBE, LITTLE ROCK, AR. FILED 11-24-2009.

CUPCAKE OHH!-VERALLS

THE MARK CONSISTS OF STANDARD CHARACTERS WITHOUT CLAIM TO ANY PARTICULAR FONT, STYLE, SIZE, OR COLOR.

FOR COSTUMES FOR USE IN CHILDREN'S DRESS UP PLAY; HALLOWEEN COSTUMES (U.S. CLS. 22 AND 39).

DEZMONA MIZELLE, EXAMINING ATTORNEY

SN 77-879,813. JENIFER, KEDRICK, BOWIE, MD. FILED 11-24-2009.

WORLD FED

THE MARK CONSISTS OF STANDARD CHARACTERS WITHOUT CLAIM TO ANY PARTICULAR FONT, STYLE, SIZE, OR COLOR.

FOR CLOTHING, NAMELY, SHIRTS, HATS, COATS, JACKETS, FOOTWEAR AND HEADWEAR (U.S. CLS. 22 AND 39).

DOMINICK J. SALEMI, EXAMINING ATTORNEY

SN 77-880,129. PATRIK ERVELL INC., NEW YORK, NY. FILED 11-24-2009.

Patrik Ervell

THE MARK CONSISTS OF STANDARD CHARACTERS WITHOUT CLAIM TO ANY PARTICULAR FONT, STYLE, SIZE, OR COLOR.

THE NAME "PATRIK ERVELL" IDENTIFIES A LIVING INDIVIDUAL WHOSE CONSENT IS OF RECORD.

FOR ANORAKS; BLAZERS; BOARD SHORTS; BOMBER JACKETS; BOOTS; BOTTOMS; BRIEFS; CANVAS SHOES; CAPS; CARDIGANS; CARGO PANTS; CAS-SOCKS; CLOTHING, NAMELY, KHAKIS; COATS; COATS FOR MEN AND WOMEN; COATS MADE OF COTTON; COATS OF DENIM; CREW NECK SWEATERS; CREW NECKS; DECK-SHOES; DENIM JACKETS; DENIMS; DOWN JACKETS; DRESS SHIRTS; DRESS SUITS; DRESSES; DUSTERS; FLEECE PULLOVERS; FLEECE VESTS; FOOTWEAR; FOOTWEAR FOR MEN; FOOTWEAR FOR WOMEN; FOUL WEATHER GEAR; FUR COATS AND JACKETS; GLOVES; GREATCOATS; GYM PANTS; GYM SHORTS; GYM SUITS; HATS; HEADWEAR; HEAVY COATS; HEAVY JACKETS; HIKING BOOTS; HOODED PULLOVERS; HOODED SWEAT SHIRTS; JACKET LINERS; JACKETS; JACKETS AND SOCKS; JEANS; JERSEYS; JOGGING OUTFITS; KNIT FACE MASKS; KNIT SHIRTS; KNITTED CAPS; KNITTED GLOVES; KNITTED UNDERWEAR; LEATHER BELTS; LEATHER COATS; LEATHER JACKETS;

CLASS 25—(Continued).

ETS; LEATHER PANTS; LEATHER SHOES; LEGGINGS; LIGHT-REFLECTING COATS; LIGHT-REFLECTING JACKETS; LONG JACKETS; LONG JOHNS; LONG SLEEVE PULLOVERS; LONG SLEEVED VESTS; LONG UNDERWEAR; LONG-SLEEVED SHIRTS; MEN'S AND WOMEN'S JACKETS, COATS, TROUSERS, VESTS; MEN'S DRESS SOCKS; MEN'S SOCKS; MEN'S SUITS; MEN'S UNDERWEAR; MOCK TURTLE-NECK SWEATERS; MOCKNECKS; NECKTIES; NECKWEAR; OPEN-NECKED SHIRTS; OUTDOOR GLOVES; OUTER JACKETS; OVER SHIRTS; OVERALLS; OVERCOATS; PADDED JACKETS; PANTS; PARKAS; PIQUE SHIRTS; POLO SHIRTS; PONCHOS; PULLOVERS; QUILTED VESTS; RAIN COATS; RAIN JACKETS; RAIN SLICKERS; RAINCOATS; RAINPROOF JACKETS; RAINWEAR; REVERSIBLE JACKETS; RUGBY SHIRTS; SHELL JACKETS; SHIRTS; SHORT-SLEEVED OR LONG-SLEEVED T-SHIRTS; SHORT-SLEEVED SHIRTS; SHORTS; SNEAKERS; SOCKS; SPORT COATS; SPORT SHIRTS; SUEDE JACKETS; SUIT COATS; SUITS; SUITS OF LEATHER; SWEAT PANTS; SWIM WEAR; T-SHIRTS; TANK TOPS; TURTLENECKS; TUXEDOS; V-NECK SWEATERS; VESTS; WIND RESISTANT JACKETS (U.S. CLS. 22 AND 39).

FIRST USE 0-0-2005; IN COMMERCE 0-0-2005.

EMILY CARLSEN, EXAMINING ATTORNEY

SN 77-880,398. SARMIENTO, SAMUEL, APISON, TN. FILED 11-24-2009.



EASTWINDECOTRADERS

ROATAN, HONDURAS

NO CLAIM IS MADE TO THE EXCLUSIVE RIGHT TO USE "ROATAN, HONDURAS", APART FROM THE MARK AS SHOWN.

THE MARK CONSISTS OF A STYLIZED IMAGE OF A SUN. IN THE CENTER OF THE SUN CIRCLE IS AN IMAGE OF A BASILISK LIZARD OR "MONKEY LALA" (BAY ISLAND, HONDURAS NAME). BELOW THE IMAGE OF THE SUN AND THE LIZARD IS THE NAME "EASTWINDECOTRADERS" AND BELOW THAT ARE THE WORDS "ROATAN, HONDURAS".

FOR HATS; JACKETS; SHIRTS (U.S. CLS. 22 AND 39).

FIRST USE 8-28-2009; IN COMMERCE 9-3-2009.

DAVID I, EXAMINING ATTORNEY

SN 77-880,518. ASSOCIATION OF ASPIRING AUTHORS, INC., MADEIRA BEACH, FL. FILED 11-25-2009.

Gambaru

THE MARK CONSISTS OF STANDARD CHARACTERS WITHOUT CLAIM TO ANY PARTICULAR FONT, STYLE, SIZE, OR COLOR.

THE ENGLISH TRANSLATION OF THE WORD GAMBARU IN THE MARK IS "TO TRY HARD" OR "MAKE A GREAT EFFORT".

FOR T-SHIRTS (U.S. CLS. 22 AND 39).

BILL DAWE, EXAMINING ATTORNEY

CLASS 25—(Continued).

SN 77-880,620. KIALOA CANOE PADDLES, INC., BEND, OR.
FILED 11-25-2009.

KIALOA

THE MARK CONSISTS OF STANDARD CHARACTERS WITHOUT CLAIM TO ANY PARTICULAR FONT, STYLE, SIZE, OR COLOR.

OWNER OF U.S. REG. NO. 2,906,634.
THE ENGLISH TRANSLATION OF KIALOA IN THE MARK IS "SLEEK WATER CRAFT".

FOR HATS; SHIRTS; SHORTS (U.S. CLS. 22 AND 39).
FIRST USE 0-0-1992; IN COMMERCE 0-0-1994.
TIMOTHY FINNEGAN, EXAMINING ATTORNEY

SN 77-881,349. COUG & COMPANY INC., BURLINGTON,
CANADA, FILED 11-26-2009.



PRIORITY CLAIMED UNDER SEC. 44(D) ON CANADA APPLICATION NO. 1,459,020, FILED 11-12-2009.

OWNER OF U.S. REG. NOS. 957,246 AND 1,329,672.
NO CLAIM IS MADE TO THE EXCLUSIVE RIGHT TO USE "SINCE 1948", APART FROM THE MARK AS SHOWN.
THE COLOR(S) GREEN AND WHITE IS/ARE CLAIMED AS A FEATURE OF THE MARK.

THE MARK CONSISTS OF A SHADED GREEN SQUARE CONTAINING THE WORDING "COUGAR" IN LARGE WHITE LETTERING IN THE CENTER OF THE SQUARE AND THE WORDING "SINCE 1948" IN SMALL WHITE LETTERING TOWARDS THE BOTTOM OF THE SQUARE.

FOR FOOTWEAR, NAMELY, BOOTS, SHOES, SANDALS AND SLIPPERS (U.S. CLS. 22 AND 39).
ELLEN BURNS, EXAMINING ATTORNEY

CLASS 25—(Continued).

SN 77-881,740. HORTON, MELISSA, N., MOUNTAIN VIEW,
CA. FILED 11-29-2009.



NO CLAIM IS MADE TO THE EXCLUSIVE RIGHT TO USE "SWIM", APART FROM THE MARK AS SHOWN.

THE COLOR(S) BLUE, LIGHT BLUE, DARK BLUE, WHITE, ORANGE, AND BLACK IS/ARE CLAIMED AS A FEATURE OF THE MARK.

THE MARK CONSISTS OF A CIRCULAR LOGO OUTLINED IN BLUE WITH A BLACK DOTTED LINE IN THE OUTLINE AND A LIGHT BLUE FILL COLOR THAT CONTAINS A SMILING ORANGE OCTOPUS WITH BLACK AND WHITE EYES AND A BLACK MOUTH ON THE RIGHT SIDE THAT IS FLOATING ABOVE SMALL DARK BLUE WAVES; BLUE AND BLUE LINED WATER BUBBLES ARE ON THE LEFT SIDE OF THE MARK, THE TERM "WAWA" APPEARS IN DARK BLUE ABOVE THE WAVES AND THE TERM "SWIM" APPEARS IN WHITE BELOW THE WAVES.

FOR SWIMWEAR (U.S. CLS. 22 AND 39).
ANTHONY RINKER, EXAMINING ATTORNEY

SN 77-881,801. RULE 66, LLC, ESCONDIDO, CA. FILED 11-29-2009.



OWNER OF U.S. REG. NO. 3,636,637.
NO CLAIM IS MADE TO THE EXCLUSIVE RIGHT TO USE "PRODUCTS", APART FROM THE MARK AS SHOWN.
THE MARK CONSISTS OF STYLIZED WORDS "TRINITY PRODUCTS".

FOR APPAREL, NAMELY, T-SHIRTS, SHIRTS, SHORTS, PANTS, SWEATSHIRTS, SWEATPANTS, JACKETS, HATS, VISORS, SHOES, SANDALS, JACKETS, UNDERWEAR, SOCKS, AND BELTS (U.S. CLS. 22 AND 39).

FIRST USE 1-1-2008; IN COMMERCE 1-2-2008.
LEIGH CAROLINE CASE, EXAMINING ATTORNEY

CLASS 25—(Continued).

SN 77-882,272. TATAMI SCHUH GMBH, BAD HONNEF, FED REP GERMANY, FILED 11-30-2009.

TATAMI

OWNER OF U.S. REG. NO. 2,443,790.
THE MARK CONSISTS OF THE STYLIZED WORD "TATAMI".

FOR FOOTWEAR, NAMELY, SHOES, BOOTS, SANDALS, CLOGS, SLIPPERS, MULES; INSOLES, SOFT INSOLES, AND FOOTBEDS, NAMELY, CONTOURED INSOLES MADE TO MATCH THE SHAPE OF THE FOOT TO PROVIDE IMPROVED COMFORT, SUPPORT, AND BODY ALIGNMENT AND PROMOTE GENERAL WALKING HEALTH (U.S. CLS. 22 AND 39).

FIRST USE 11-0-2003; IN COMMERCE 3-25-2004.
COLLEEN KEARNEY, EXAMINING ATTORNEY

SN 77-882,950. MLCDESIGNS, LANCASTER, SC. FILED 12-1-2009.

Alluring Aprons

THE MARK CONSISTS OF STANDARD CHARACTERS WITHOUT CLAIM TO ANY PARTICULAR FONT, STYLE, SIZE, OR COLOR.

NO CLAIM IS MADE TO THE EXCLUSIVE RIGHT TO USE "APRONS", APART FROM THE MARK AS SHOWN.

FOR APRONS (U.S. CLS. 22 AND 39).
FIRST USE 9-10-2009; IN COMMERCE 9-10-2009.
ESTHER A. BORSUK, EXAMINING ATTORNEY

SN 77-883,249. THE TRUSTEES OF THE UNIVERSITY OF PENNSYLVANIA, PHILADELPHIA, PA. FILED 12-1-2009.



Penn Medicine

OWNER OF U.S. REG. NOS. 2,143,894, 3,624,424 AND OTHERS.

THE MARK CONSISTS OF THE WORDS "PENN MEDICINE" TO THE RIGHT OF A SHIELD DESIGN.

SEC. 2(F) AS TO "PENN".
FOR CLOTHING, NAMELY, HATS, T-SHIRTS, POLO SHIRTS AND SOCKS (U.S. CLS. 22 AND 39).
FIRST USE 6-1-2009; IN COMMERCE 6-1-2009.
KATHERINE E. HALMEN, EXAMINING ATTORNEY

CLASS 25—(Continued).

SN 77-883,262. THE TRUSTEES OF THE UNIVERSITY OF PENNSYLVANIA, PHILADELPHIA, PA. FILED 12-1-2009.

PENN MEDICINE

THE MARK CONSISTS OF STANDARD CHARACTERS WITHOUT CLAIM TO ANY PARTICULAR FONT, STYLE, SIZE, OR COLOR.

OWNER OF U.S. REG. NOS. 2,143,894, 3,624,424 AND OTHERS.

SEC. 2(F) AS TO "PENN".
FOR CLOTHING, NAMELY, HATS, T-SHIRTS, POLO SHIRTS AND SOCKS (U.S. CLS. 22 AND 39).

FIRST USE 6-1-2009; IN COMMERCE 6-1-2009.
KATHERINE E. HALMEN, EXAMINING ATTORNEY

SN 77-883,531. MEC APPAREL GROUP INC., MIAMI, FL. FILED 12-1-2009.

DEUXMEC

THE MARK CONSISTS OF STANDARD CHARACTERS WITHOUT CLAIM TO ANY PARTICULAR FONT, STYLE, SIZE, OR COLOR.

THE ENGLISH TRANSLATION OF "DEUXMEC" IN THE MARK IS "TWO MEN."

FOR DRESS SHIRTS; JACKETS; PANTS; POLO SHIRTS; SHIRTS; SHORTS; SPORT SHIRTS; SWEATERS; T-SHIRTS; UNDERWEAR (U.S. CLS. 22 AND 39).

AARON BRODSKY, EXAMINING ATTORNEY

SN 77-883,575. CROSSFIT, INC., WASHINGTON, DC. FILED 12-1-2009.



Kettlebear

THE MARK CONSISTS OF A CARTOON BEAR FACE WITH A KETTLEBALL OR EXERCISE WEIGHT HANDLE WITH THE WORDS "KETTLEBEAR" WRITTEN BELOW.

FOR CLOTHING, NAMELY, SHIRTS, HOODED SWEATSHIRTS, SHORTS, PANTS, CLOTH BIBS (U.S. CLS. 22 AND 39).

SUSAN RICHARDS, EXAMINING ATTORNEY

CLASS 25—(Continued).

SN 77-883,593. CHAOSSQUARED, LLC, WESTBURY, NY. FILED 12-1-2009.

BLOOD NIGHT

THE MARK CONSISTS OF STANDARD CHARACTERS WITHOUT CLAIM TO ANY PARTICULAR FONT, STYLE, SIZE, OR COLOR.

FOR FULL LINE OF CLOTHING AND FOOTWEAR; HEADGEAR, NAMELY, HATS, CAPS, VISORS AND BANDANAS; HALLOWEEN COSTUMES AND MASKS SOLD IN CONNECTION THEREWITH; MASQUERADE COSTUMES AND MASKS SOLD IN CONNECTION THEREWITH; NOVELTY HEADWEAR WITH ATTACHED WIGS (U.S. CLS. 22 AND 39).

SIMON TENG, EXAMINING ATTORNEY

CLASS 25—(Continued).

SN 77-883,660. THE ARMOR ALL/STP PRODUCTS COMPANY, OAKLAND, CA. FILED 12-1-2009.



OWNER OF U.S. REG. NOS. 648,087, 1,117,051 AND OTHERS.

THE COLOR(S) WHITE, RED, BLUE AND GRAY IS/ARE CLAIMED AS A FEATURE OF THE MARK.

THE MARK CONSISTS OF THE COLOR WHITE APPEARS IN THE WORDING "STP" AND THE OUTER OVAL; THE COLOR RED APPEARS IN THE INNER OVAL; THE COLOR BLUE APPEARS IN THE OUTLINE OF THE WORDING "STP" AND THE OUTLINE OF THE RED INNER OVAL; AND THE COLOR GRAY APPEARS AS SHADING IN THE WORDING "STP" AND THE OUTER OVAL.

FOR HATS; JACKETS; SHIRTS; SHORTS; SWEAT PANTS; SWEAT SHIRTS; SWEATBANDS; UNDERWEAR (U.S. CLS. 22 AND 39).

SIMON TENG, EXAMINING ATTORNEY

SN 77-883,838. JAKKS PACIFIC, INC., MALIBU, CA. FILED 12-1-2009.

GIRL GOURMET

SN 77-883,659. CHAOSSQUARED, LLC, WESTBURY, NY. FILED 12-1-2009.

**Blood Night: The Legend of
Mary Hatchet**

THE MARK CONSISTS OF STANDARD CHARACTERS WITHOUT CLAIM TO ANY PARTICULAR FONT, STYLE, SIZE, OR COLOR.

THE NAME(S), PORTRAIT(S), AND/OR SIGNATURE(S) SHOWN IN THE MARK DOES NOT IDENTIFY A PARTICULAR LIVING INDIVIDUAL.

FOR FULL LINE OF CLOTHING AND FOOTWEAR; HEADGEAR, NAMELY, HATS, CAPS, VISORS AND BANDANAS; HALLOWEEN COSTUMES AND MASKS SOLD IN CONNECTION THEREWITH; MASQUERADE COSTUMES AND MASKS SOLD IN CONNECTION THEREWITH; NOVELTY HEADWEAR WITH ATTACHED WIGS (U.S. CLS. 22 AND 39).

SIMON TENG, EXAMINING ATTORNEY

THE MARK CONSISTS OF STANDARD CHARACTERS WITHOUT CLAIM TO ANY PARTICULAR FONT, STYLE, SIZE, OR COLOR.

OWNER OF U.S. REG. NOS. 3,573,612 AND 3,573,613.

NO CLAIM IS MADE TO THE EXCLUSIVE RIGHT TO USE "GIRL", APART FROM THE MARK AS SHOWN.

FOR CLOTHING, NAMELY, COATS, OVERCOATS, TRENCH COATS, RAINCOATS, ANORAKS, PARKAS, BLAZERS, JACKETS, CARDIGANS, SPORT COATS, WIND RESISTANT JACKETS, VESTS, DRESSES, CAFTANS, EVENING GOWNS, JUMPERS, SKIRTS, PANTS, SLACKS, TROUSERS, JEANS, DUNGAREES, JUMPSUITS, COVERALLS, GYM SUITS, JOGGING SUITS, SWEAT PANTS, SHORTS, CULOTTES, SWEATERS, PULLOVERS, JERSEYS, SHIRTS, BLOUSES, TUNICS, SWEATSHIRTS, T-SHIRTS, HALTER TOPS, TANK TOPS, BODYSUITS, CAMISOLES, CHEMISES, UNDERSHIRTS, SLIPS, CORSETS, BRASSIERES, BRIEFS, BOXER SHORTS, UNDERPANTS, PANTIES, THERMAL UNDERWEAR, LINGERIE, NIGHTGOWNS, NIGHT SHIRTS, NEGLIGEEES, ROBES, PAJAMAS, APRONS, HOSE, PANTY HOSE, TIGHTS, KNEE HIGH STOCKINGS, LEGGINGS, POCKET SQUARES, SCARVES, SHAWLS, NECKERCHIEFS, GLOVES, MITTENS, BELTS, SASHES, SWIMWEAR, BATHING SUITS, BATHING TRUNKS, BEACHWEAR, THERMAL SOCKS, HEADWEAR, NAMELY, HATS, CAPS, HOODS, AND FOOTWEAR, NAMELY, SHOES, SANDALS, BOOTS, HIGH BOOTS, SLIPPERS, SNEAKERS, ATHLETIC FOOTWEAR; BATHROBES, BEACH COVER-UPS, BERETS, BLANKET SLEEPERS, FOOTWEAR, HALLOWEEN COSTUMES, HEAD BANDS, NECKTIES, NIGHT SHIRTS, SKORTS, SLIPPERS, SOCKS, STOCKINGS, SUSPENDERS AND EARMUFFS (U.S. CLS. 22 AND 39).

CAROLINE WOOD, EXAMINING ATTORNEY

CLASS 25—(Continued).

SN 77-883,917. COX, ALICIA, MORGANTOWN, WV. FILED 12-2-2009.

No More Baggy Bums

THE MARK CONSISTS OF STANDARD CHARACTERS WITHOUT CLAIM TO ANY PARTICULAR FONT, STYLE, SIZE, OR COLOR.

FOR WAIST BANDS; WAIST BELTS; WAIST CINCHERS; WAISTBANDS (U.S. CLS. 22 AND 39).
SHAUNIA CARLYLE, EXAMINING ATTORNEY

CLASS 25—(Continued).

TOP OF THE CIRCULAR DESIGN. THE COLOR GREY APPEARS IN THE BOTTOM RIGHT HALF ARROW DESIGN, IN THE "A" IN "SWAPACOSTUME", IN ".COM" AND IN "WWW". THE COLOR BLUE APPEARS IN THE LEFT HALF ARROW DESIGN AND IN THE WORD "COSTUME" IN THE MARK. THE COLOR GREEN APPEARS IN THE WORD "SWAP" AND THE UPPER RIGHT HALF ARROW DESIGN. THE WHITE IN THE DRAWING REPRESENTS BACKGROUND AREAS ONLY AND IS NOT PART OF THE MARK.

FOR HALLOWEEN COSTUMES (U.S. CLS. 22 AND 39).
MAUREEN DALL, EXAMINING ATTORNEY

SN 77-884,013. WESTERN CAROLINA UNIVERSITY (NORTH CAROLINA NON-PROFIT EDUCATIONAL INSTITUTE OF THE UNIVERSITY OF NORTH CAROLINA), CULLOWHEE, NC. FILED 12-2-2009.



OWNER OF U.S. REG. NO. 1,554,839.
THE COLOR(S) PURPLE, GOLD AND WHITE IS/ARE CLAIMED AS A FEATURE OF THE MARK.

THE MARK CONSISTS OF THE LETTERS "WCU" WHICH ARE ARRANGED DIAGONALLY DOWNWARD FROM LEFT TO RIGHT. THE CENTER OF EACH LETTER IS WHITE SURROUNDED BY A PURPLE BORDER WHICH IS SURROUNDED BY A GOLD BORDER.

FOR JACKETS, BELTS, CAPS, SHIRTS AND SHORTS (U.S. CLS. 22 AND 39).

FIRST USE 8-13-2008; IN COMMERCE 8-13-2008.
MARGARET POWER, EXAMINING ATTORNEY

SN 77-884,193. GARMENT GROUP, INC., LOS ANGELES, CA. FILED 12-2-2009.



SN 77-884,189. EHMER, ERIC, BAY SHORE, NY. FILED 12-2-2009.



THE COLOR(S) BLUE, GREEN, AND GREY IS/ARE CLAIMED AS A FEATURE OF THE MARK.

THE MARK CONSISTS OF A CIRCULAR DESIGN COMPRISED OF THREE HALF ARROW DESIGNS. THE WORDING "WWW. SWAPACOSTUME .COM" APPEARS ON

NO CLAIM IS MADE TO THE EXCLUSIVE RIGHT TO USE "PINK SOCKS", APART FROM THE MARK AS SHOWN.

THE COLOR(S) PINK IS/ARE CLAIMED AS A FEATURE OF THE MARK.

THE MARK CONSISTS OF THE WORDING "PINK SOX". BETWEEN THE TWO WORDS IS THE DESIGN OF A WOMAN RIDING A HORSE. THE ENTIRE MARK IS PINK. THE COLOR WHITE REPRESENTS BACKGROUND AND TRANSPARENT AREAS AND IS NOT CLAIMED AS A FEATURE OF THE MARK.

FOR SOCKS WITH PINK ACCENTS IN THE WEAVING; SOCKS WITH PINK PRINTING ON THE SOCKS (U.S. CLS. 22 AND 39).

WENDY GOODMAN, EXAMINING ATTORNEY

CLASS 25—(Continued).

SN 77-884,862. TROYAN, JOSEPH, ZELIENOPLE, PA. AND MACK, BRYAN, ZELIENOPLE, PA. AND PECK, ANTHONY, ZELIENOPLE, PA. AND CARBOY, THOMAS, ZELIENOPLE, PA. FILED 12-2-2009.



THE MARK CONSISTS OF A CIRCLE WITH AN OUTLINE OF A NOSE AND MUSTACHE, SURROUNDED BY A RING WITH AN OUTLINE CONTAINING THE STYLIZED TEXT "THE FIGHTING WANNSTACHES" WITH AN OUTLINE AND A DROP SHADOW.

FOR CLOTHING, NAMELY, MEN'S AND LADIES' AND CHILDREN'S SHIRTS, SWEATSHIRTS, BABY SHIRTS, CLOTH BIBS, TIES, CAPS, HATS, SCARVES, APRONS, WRIST-BANDS, AND SWEATBANDS (U.S. CLS. 22 AND 39).

FIRST USE 9-1-2009; IN COMMERCE 9-1-2009.
JOHN DALIER, EXAMINING ATTORNEY

SN 77-884,958. VERNIA, BRIAN D., SAN DIEGO, CA. FILED 12-3-2009.

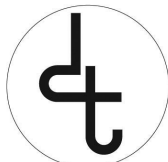

deviltheory:

THE MARK CONSISTS OF INTERLOCKING LOWER-CASE LETTERS "D" AND "T" WITHIN A CIRCLE, BELOW THE CIRCLED LETTERS IS THE WORD "DEVILTHEORY" IN LOWER CASE LETTERS FOLLOWED BY A COLON.

FOR T-SHIRTS (U.S. CLS. 22 AND 39).
MARK PILARO, EXAMINING ATTORNEY

CLASS 25—(Continued).

SN 77-885,004. MEC APPAREL GROUP INC., MIAMI, FL. FILED 12-3-2009.

VIA UOMO

THE MARK CONSISTS OF STANDARD CHARACTERS WITHOUT CLAIM TO ANY PARTICULAR FONT, STYLE, SIZE, OR COLOR.

NO CLAIM IS MADE TO THE EXCLUSIVE RIGHT TO USE "UOMO", APART FROM THE MARK AS SHOWN.

THE ENGLISH TRANSLATION OF "VIA UOMO" IN THE MARK IS "ROAD MAN" OR "STREET MAN".

FOR DRESS SHIRTS; JACKETS; PANTS; POLO SHIRTS; SHIRTS; SHORTS; SPORT SHIRTS; SWEATERS; T-SHIRTS; UNDERWEAR (U.S. CLS. 22 AND 39).

AARON BRODSKY, EXAMINING ATTORNEY

SN 77-885,106. RACK ROOM SHOES OF VIRGINIA LLC, CHARLOTTE, NC. FILED 12-3-2009.

I.C.K.S.

THE MARK CONSISTS OF STANDARD CHARACTERS WITHOUT CLAIM TO ANY PARTICULAR FONT, STYLE, SIZE, OR COLOR.

FOR FOOTWEAR; SOCKS (U.S. CLS. 22 AND 39).

PAUL CROWLEY, EXAMINING ATTORNEY

SN 77-885,108. RACK ROOM SHOES OF VIRGINIA LLC, CHARLOTTE, NC. FILED 12-3-2009.

ICKS

THE MARK CONSISTS OF STANDARD CHARACTERS WITHOUT CLAIM TO ANY PARTICULAR FONT, STYLE, SIZE, OR COLOR.

FOR FOOTWEAR; SOCKS (U.S. CLS. 22 AND 39).

PAUL CROWLEY, EXAMINING ATTORNEY

CLASS 25—(Continued).

SN 77-885,136. CHU SHU, INC., PLEASANTVILLE, NY.
FILED 12-3-2009.

Chu Shu

THE MARK CONSISTS OF STANDARD CHARACTERS WITHOUT CLAIM TO ANY PARTICULAR FONT, STYLE, SIZE, OR COLOR.
FOR SHOE INSERTS FOR PRIMARILY NON-ORTHOPEDIC PURPOSES (U.S. CLS. 22 AND 39).
SOPHIA S. KIM, EXAMINING ATTORNEY

SN 77-885,281. ISAAC DANIEL GROUP, INC., MIRAMAR, FL. FILED 12-3-2009.

I MARKED

THE MARK CONSISTS OF STANDARD CHARACTERS WITHOUT CLAIM TO ANY PARTICULAR FONT, STYLE, SIZE, OR COLOR.

FOR SHOES, FOOTWEAR, T-SHIRTS, SPORTS SHIRTS, SPORTS JERSEYS, SPORTS JACKETS, SPORTS PANTS, TRACK PANTS, SPORTS FLEECE PULLOVERS (U.S. CLS. 22 AND 39).
TINA BROWN, EXAMINING ATTORNEY

SN 77-885,480. RUBIE'S COSTUME CO., INC., RICHMOND HILL, NY. FILED 12-3-2009.

FORSAKEN WARRIORS

THE MARK CONSISTS OF STANDARD CHARACTERS WITHOUT CLAIM TO ANY PARTICULAR FONT, STYLE, SIZE, OR COLOR.

FOR HALLOWEEN COSTUMES AND MASKS SOLD IN CONNECTION THEREWITH; MASQUERADE COSTUMES AND MASKS SOLD IN CONNECTION THEREWITH (U.S. CLS. 22 AND 39).
MARIA-VICTORIA SUAREZ, EXAMINING ATTORNEY

CLASS 25—(Continued).

SN 77-885,503. SPOP, INC., LOS ANGELES, CA. FILED 12-3-2009.

PROTEGE

THE MARK CONSISTS OF STANDARD CHARACTERS WITHOUT CLAIM TO ANY PARTICULAR FONT, STYLE, SIZE, OR COLOR.
FOR SOCKS (U.S. CLS. 22 AND 39).
SAMUEL E. SHARPER JR., EXAMINING ATTORNEY

SN 77-885,724. DIRTYSKIRT, HONOLULU, HI. FILED 12-3-2009.



THE COLOR(S) BLACK, WHITE AND RED IS/ARE CLAIMED AS A FEATURE OF THE MARK.

THE MARK CONSISTS OF THE WORD "DIRTYSKIRT" SHOWN IN A BLACK STYLIZED FONT AND A STYLIZED DESIGN OF HUMAN LIPS APPEARING IN THE COLORS RED AND WHITE.

FOR ATHLETIC APPAREL, NAMELY, SHIRTS, PANTS, JACKETS, FOOTWEAR, HATS AND CAPS, ATHLETIC UNIFORMS (U.S. CLS. 22 AND 39).
DAVID YONTEF, EXAMINING ATTORNEY

SN 77-885,814. MAYS, DARHEL, PLAINFIELD, NJ. FILED 12-3-2009.

MARSHALL ANTHONY

THE MARK CONSISTS OF STANDARD CHARACTERS WITHOUT CLAIM TO ANY PARTICULAR FONT, STYLE, SIZE, OR COLOR.

THE NAME(S), PORTRAIT(S), AND/OR SIGNATURE(S) SHOWN IN THE MARK DOES NOT IDENTIFY A PARTICULAR LIVING INDIVIDUAL.

FOR ASCOTS; BRACES; COATS; GLOVES; HATS; NECKWEAR; PANTS; POCKET SQUARES; SCARVES; SHIRTS; SHOES; SUITS; SUSPENDERS; SWEATERS; TIES; VESTS (U.S. CLS. 22 AND 39).

FIRST USE 12-1-2006; IN COMMERCE 1-1-2009.

MARY ROSSMAN, EXAMINING ATTORNEY

CLASS 25—(Continued).

SN 77-886,164. AWANA CLUBS INTERNATIONAL, STREAMWOOD, IL. FILED 12-4-2009.

T&T Ultimate Adventure

THE MARK CONSISTS OF STANDARD CHARACTERS WITHOUT CLAIM TO ANY PARTICULAR FONT, STYLE, SIZE, OR COLOR.
FOR SHIRTS (U.S. CLS. 22 AND 39).
MICHELE SWAIN, EXAMINING ATTORNEY

SN 77-886,206. AWANA CLUBS INTERNATIONAL, STREAMWOOD, IL. FILED 12-4-2009.

T&T Ultimate Challenge

THE MARK CONSISTS OF STANDARD CHARACTERS WITHOUT CLAIM TO ANY PARTICULAR FONT, STYLE, SIZE, OR COLOR.
FOR SHIRTS (U.S. CLS. 22 AND 39).
MICHELE SWAIN, EXAMINING ATTORNEY

SN 77-886,328. THE FECHHEIMER BROTHERS COMPANY, CINCINNATI, OH. FILED 12-4-2009.

Operational Athlete

THE MARK CONSISTS OF STANDARD CHARACTERS WITHOUT CLAIM TO ANY PARTICULAR FONT, STYLE, SIZE, OR COLOR.
NO CLAIM IS MADE TO THE EXCLUSIVE RIGHT TO USE "ATHLETE", APART FROM THE MARK AS SHOWN.
FOR CLOTHING, NAMELY, SHIRTS AND TROUSERS (U.S. CLS. 22 AND 39).
RENEE MCCRAY, EXAMINING ATTORNEY

CLASS 25—(Continued).

SN 77-886,349. HYBRID PROMOTIONS LLC, CYPRESS, CA. FILED 12-4-2009.

WITH A TWIST

THE MARK CONSISTS OF STANDARD CHARACTERS WITHOUT CLAIM TO ANY PARTICULAR FONT, STYLE, SIZE, OR COLOR.
FOR CLOTHING, NAMELY, SHIRTS, T-SHIRTS, WOVEN SHIRTS, SWEATSHIRTS, FLEECE PULLOVERS, HOODED SWEATSHIRTS, SWEATERS, TANK TOPS, CAMISOLES, LOUNGEWEAR, PAJAMAS, BOXERS, UNDERWEAR, DRESSES, SKIRTS, SWEAT PANTS, PANTS, SHORTS, SWIMWEAR, OUTERWEAR, NAMELY, JACKETS, COATS, VESTS, BELTS, SOCKS, SCARVES AND HEADWEAR, NAMELY, HATS, CAPS AND VISORS (U.S. CLS. 22 AND 39).
COLLEEN DOMBROW, EXAMINING ATTORNEY

SN 77-886,360. CAMOBOOTY, INC., DENVER, CO. FILED 12-4-2009.

Hunt Fun

THE MARK CONSISTS OF STANDARD CHARACTERS WITHOUT CLAIM TO ANY PARTICULAR FONT, STYLE, SIZE, OR COLOR.
FOR APRONS; BANDANAS; FLEECE PULLOVERS; HATS; HEAD SCARVES; HEADWEAR; LINGERIE; PANTS; SHORTS; SWEAT SHIRTS; T-SHIRTS; TANK TOPS (U.S. CLS. 22 AND 39).
FIRST USE 11-0-2008; IN COMMERCE 11-0-2008.
PATRICIA EVANKO, EXAMINING ATTORNEY

SN 77-886,431. LOPEZ, JESUS, HAMPTON, VA. FILED 12-4-2009.

STREET VIOLATAZ

THE MARK CONSISTS OF STANDARD CHARACTERS WITHOUT CLAIM TO ANY PARTICULAR FONT, STYLE, SIZE, OR COLOR.
FOR CAPS; HATS; JACKETS; PANTS; SHIRTS; SHOES; SWEATERS; VESTS (U.S. CLS. 22 AND 39).
JOHN DWYER, EXAMINING ATTORNEY

CLASS 25—(Continued).

SN 77-886,462. JITA DESIGNS, JACKSON, NJ. FILED 12-4-2009.

JITA DESIGNS

THE MARK CONSISTS OF STANDARD CHARACTERS WITHOUT CLAIM TO ANY PARTICULAR FONT, STYLE, SIZE, OR COLOR.

NO CLAIM IS MADE TO THE EXCLUSIVE RIGHT TO USE DESIGNS, APART FROM THE MARK AS SHOWN.

FOR BASEBALL CAPS; JACKETS; SWEAT SHIRTS; T-SHIRTS (U.S. CLS. 22 AND 39).

RON FAIRBANKS, EXAMINING ATTORNEY

SN 77-886,503. RAW EGO, INC., FLUSHING, NY. FILED 12-4-2009.

RAW EGO

THE MARK CONSISTS OF MULTIPLE STYLIZED CAPITAL STANDARD CHARACTER LETTERS SPELLING "RAW EGO".

FOR ATHLETIC APPAREL, NAMELY, SHIRTS, PANTS, JACKETS, FOOTWEAR, HATS AND CAPS, ATHLETIC UNIFORMS; BELTS FOR CLOTHING; BOMBER JACKETS; BOTTOMS; CLOTHING, NAMELY, KHAKIS; COATS FOR MEN AND WOMEN; FABRIC BELTS; HOODED PULLOVERS; HOODED SWEAT SHIRTS; HOODS; HOODS; JERSEYS; JOGGING OUTFITS; JOGGING PANTS; JOGGING SUITS; JUMPERS; PANTS; POLO SHIRTS; PULLOVERS; RUGBY SHIRTS; RUGBY SHORTS; SHELL JACKETS; SHIRTS; SHIRTS AND SHORT-SLEEVED SHIRTS; SPORT SHIRTS; SPORTS JACKETS; SPORTS JERSEYS; SPORTS OVER UNIFORMS; SPORTS SHIRTS WITH SHORT SLEEVES; TRACK JACKETS; TRACK PANTS; TRACK SUITS; TRACK SUITS; VISORS; VOLLEYBALL JERSEYS; WIND-JACKETS; WINDCHEATERS; WINDJAMMERS; WINDSHIRTS (U.S. CLS. 22 AND 39).

ANNE FARRELL, EXAMINING ATTORNEY

CLASS 25—(Continued).

SN 77-886,549. TAKE IT TO THE CROSS, BEN LOMOND, CA. FILED 12-4-2009.



THE MARK CONSISTS OF A CROSS WITH A PATCH OF GRASS UNDERNEATH, A HAMMER TO THE RIGHT OF IT, THE WORD "JESUS" PRINTED IN THE CENTER AND THE WORDS "TAKE IT TO THE CROSS" TO THE LEFT OF IT.

FOR T-SHIRTS (U.S. CLS. 22 AND 39).

FIRST USE 11-22-2008; IN COMMERCE 11-22-2008.

TINA MAI, EXAMINING ATTORNEY

SN 77-886,560. DEANTEX, INC., GREAT NECK, NY. FILED 12-4-2009.

zineli

THE WORDING "ZINELI" HAS NO MEANING IN A FOREIGN LANGUAGE.

FOR ATHLETIC APPAREL, NAMELY, SHIRTS, PANTS, JACKETS, FOOTWEAR, HATS AND CAPS, ATHLETIC UNIFORMS; DENIMS; HOODED SWEAT SHIRTS; LONG-SLEEVED SHIRTS; SHIRTS; SPORT SHIRTS; SWEAT SHIRTS; T-SHIRTS; TANK-TOPS; TOPS; WOMEN'S TOPS, NAMELY, CAMIS (U.S. CLS. 22 AND 39).

FIRST USE 11-7-2007; IN COMMERCE 11-11-2007.

JENNIFER HETU, EXAMINING ATTORNEY

CLASS 25—(Continued).

SN 77-886,561. TAHARI, ELIE, MILLBURN, NJ. FILED 12-4-2009.

TAHARI

THE MARK CONSISTS OF STANDARD CHARACTERS WITHOUT CLAIM TO ANY PARTICULAR FONT, STYLE, SIZE, OR COLOR.

OWNER OF U.S. REG. NOS. 1,489,405, 3,304,885 AND OTHERS.

FOR MEN'S CLOTHING, NAMELY, BELTS, PANTS, SLACKS, JEANS, JEANS JACKETS, SPORT JACKETS, SPORT COATS, BLAZERS, SWEATERS, KNIT SWEATERS, T-SHIRTS, SPORT SHIRTS, DRESS SHIRTS, TIES, SOCKS; OUTERWEAR, NAMELY, VESTS, JACKETS AND COATS; MEN'S FOOTWEAR, NAMELY, DRESS SHOES, CASUAL SHOES, BOOTS, SNEAKERS, SANDALS AND MOCCASINS (U.S. CLS. 22 AND 39).

JENNIFER HETU, EXAMINING ATTORNEY

SN 77-886,979. DEAF EYES BLIND EARS, LLC, GRAYSON, GA. FILED 12-5-2009.



NO CLAIM IS MADE TO THE EXCLUSIVE RIGHT TO USE "WEAR.COM", APART FROM THE MARK AS SHOWN.

THE COLOR(S) RED, BLACK, GREEN, YELLOW, AND WHITE IS/ARE CLAIMED AS A FEATURE OF THE MARK.

THE MARK CONSISTS OF THE WORD "DEBE" IN CALLIGRAPHY WHERE THE LETTER "D" IS RED, THE FIRST LETTER "E" IS BLACK, THE LETTER "B" IS GREEN AND THE SECOND LETTER "E" IS YELLOW. THE WORD "DEBE" SLIGHTLY OVERLAPS THE WORDING "WEAR.COM" BELOW, WHETHER THE WORD "WEAR.COM" IS BLACK AND THE ".COM" IS WHITE WITH A BLACK BORDER. TO THE LEFT OF THE WORDING IS A DESIGN COMPRISED OF FOUR PUZZLE PIECES THAT FORM THE SHAPE OF AFRICA, WHERE THE NORTHWEST SECTION IS A RED PUZZLE PIECE, WHERE THE NORTHEAST SECTION IS A BLACK PUZZLE PIECE, THE SOUTHWEST SECTION IS A GREEN PUZZLE PIECE, AND THE SOUTHEAST SECTION IS A YELLOW PUZZLE PIECE. A YELLOW SHAPE SIMILAR IN FORM TO MADAGASCAR IS RESPECTIVELY LOCATED TO THE RIGHT OF THE AFRICA SHAPE.

FOR ATHLETIC APPAREL, NAMELY, SHIRTS, PANTS, JACKETS, FOOTWEAR, HATS AND CAPS, ATHLETIC UNIFORMS; DENIMS; JEANS (U.S. CLS. 22 AND 39).

LINDA LAVACHE, EXAMINING ATTORNEY

CLASS 25—(Continued).

SN 77-887,038. COVE RAT, LLC, IRVINE, CA. FILED 12-5-2009.

CATALINA COVE RAT

THE MARK CONSISTS OF STANDARD CHARACTERS WITHOUT CLAIM TO ANY PARTICULAR FONT, STYLE, SIZE, OR COLOR.

NO CLAIM IS MADE TO THE EXCLUSIVE RIGHT TO USE "CATALINA", APART FROM THE MARK AS SHOWN. FOR HATS; T-SHIRTS (U.S. CLS. 22 AND 39).

LAURIE MAYES, EXAMINING ATTORNEY

SN 77-887,042. COVE RAT, LLC, IRVINE, CA. FILED 12-5-2009.



NO CLAIM IS MADE TO THE EXCLUSIVE RIGHT TO USE "CATALINA", APART FROM THE MARK AS SHOWN. THE MARK CONSISTS OF THE WORDS "CATALINA COVE RAT" WITH A DESIGN IN THE MIDDLE OF A RAT WITH SUNGLASSES AND A HAT ON A SURFBOARD WITH MOUNTAINS IN THE BACKGROUND.

FOR HATS; T-SHIRTS (U.S. CLS. 22 AND 39).

LAURIE MAYES, EXAMINING ATTORNEY

SN 77-887,043. COVE RAT, LLC, IRVINE, CA. FILED 12-5-2009.

COVE RAT

THE MARK CONSISTS OF STANDARD CHARACTERS WITHOUT CLAIM TO ANY PARTICULAR FONT, STYLE, SIZE, OR COLOR.

FOR HATS; T-SHIRTS (U.S. CLS. 22 AND 39).

LAURIE MAYES, EXAMINING ATTORNEY

CLASS 25—(Continued).

SN 77-887,045. COVE RAT, LLC, IRVINE, CA. FILED 12-5-2009.



THE MARK CONSISTS OF THE WORDS "COVE RAT" WITH A DESIGN IN THE MIDDLE OF A RAT WITH SUNGLASSES AND A HAT ON A SURFBOARD WITH MOUNTAINS IN THE BACKGROUND

FOR HATS; T-SHIRTS (U.S. CLS. 22 AND 39).
LAURIE MAYES, EXAMINING ATTORNEY

SN 77-887,062. MESH, MIKEL, LAHAINA, HI. FILED 12-5-2009.

Krazy Inu

THE MARK CONSISTS OF STANDARD CHARACTERS WITHOUT CLAIM TO ANY PARTICULAR FONT, STYLE, SIZE, OR COLOR.

FOR CLOTHING, NAMELY, T-SHIRTS, LONG-SLEEVE SHIRTS, SHORT-SLEEVE SHIRTS, SWEATSHIRTS, HOODED SWEATSHIRTS, SWEATPANTS, GYM PANTS, GYM SHORTS, SHORTS, PANTS, JACKETS, FOOTWEAR, HATS, CAPS, VISORS, SWIMWEAR, SOCKS, SKIRTS, TANK TOPS (U.S. CLS. 22 AND 39).

PRISCILLA MILTON, EXAMINING ATTORNEY

CLASS 25—(Continued).

SN 77-887,191. LY, MONICA W., DBA GOLDEN CURLY TAIL, OAKLAND, CA. AND CABADDU, JOHN, DBA GOLDEN CURLY TAIL, OAKLAND, CA. FILED 12-6-2009.

Golden Curly Tail

THE MARK CONSISTS OF STANDARD CHARACTERS WITHOUT CLAIM TO ANY PARTICULAR FONT, STYLE, SIZE, OR COLOR.

FOR CHILDREN'S AND INFANT'S APPAREL, NAMELY, JUMPERS, OVERALL SLEEPWEAR, PAJAMAS, ROMPERS AND ONE-PIECE GARMENTS; CHILDREN'S AND INFANTS' CLOTH BIBS; HATS FOR INFANTS, BABIES, TODDLERS AND CHILDREN; INFANT AND TODDLER ONE PIECE CLOTHING; INFANT SLEEPERS; INFANT WEAR; INFANTS' TROUSERS; ONE PIECE GARMENT FOR INFANTS AND TODDLERS; SHIRTS FOR INFANTS, BABIES, TODDLERS AND CHILDREN (U.S. CLS. 22 AND 39).

JILL PRATER, EXAMINING ATTORNEY

SN 77-887,219. MATTHEW EPPS, MECHANICSVILLE, VA. FILED 12-7-2009.

STINKOPOTAMUS

THE MARK CONSISTS OF STANDARD CHARACTERS WITHOUT CLAIM TO ANY PARTICULAR FONT, STYLE, SIZE, OR COLOR.

FOR CLOTHING ACCESSORIES AND APPAREL, NAMELY, T-SHIRTS, SOCKS, HATS, BEANIES, BASEBALL CAPS, SHOES, FLOPPY HATS, JEANS, SHORTS, SWEATSHIRTS AND WOVEN GARMENTS, NAMELY, PAJAMAS, SHIRTS AND PANTS, BABY BIBS, HEAD BANDS, AND GLOVES (U.S. CLS. 22 AND 39).

JOHN E. MICHOS, EXAMINING ATTORNEY

SN 77-887,337. SCOTT, KYMBERLY C., CANDLER, NC. FILED 12-7-2009.

FAITH GIRL

THE MARK CONSISTS OF STANDARD CHARACTERS WITHOUT CLAIM TO ANY PARTICULAR FONT, STYLE, SIZE, OR COLOR.

NO CLAIM IS MADE TO THE EXCLUSIVE RIGHT TO USE "GIRL", APART FROM THE MARK AS SHOWN.

FOR CAPS; GIFT PACKAGES SOLD AS A UNIT CONSISTING PRIMARILY OF A SWEATSHIRT OR A T-SHIRT AND ALSO INCLUDING A COFFEE MUG, A TOTE BAG, AND A BUMPER STICKER; GYM SUITS; HATS FOR INFANTS, BABIES, TODDLERS AND CHILDREN; JACKETS; LADIES' UNDERWEAR; NIGHT SHIRTS; PAJAMAS; AND T-SHIRTS (U.S. CLS. 22 AND 39).

MICHAEL WIENER, EXAMINING ATTORNEY

CLASS 25—(Continued).

SN 77-887,341. HEADSHOT, ONTARIO, NY. FILED 12-7-2009.



THE COLOR(S) RED AND BLACK IS/ARE CLAIMED AS A FEATURE OF THE MARK.

THE MARK CONSISTS OF A CIRCLE WITH CROSS HAIRS AND LINES EXTENDING HORIZONTALLY FROM THE LEFT AND RIGHT OF THE CIRCLE. THE LETTER "H" CROSSES AT THE TOP OF THE CIRCLE, THE LETTER "S" IS IN THE CENTER OF THE CROSSHAIRS, AND THE LETTER "I" CROSSES AT THE BOTTOM OF THE CIRCLE; ALL OF THE FOREGOING ELEMENTS IN RED OVER A BLACK BACKGROUND.

FOR HATS; HEADGEAR, NAMELY, HATS, CAPS, AND BASEBALL CAPS; HOODED SWEAT SHIRTS; HUNTING SHIRTS; SHIRTS; SWEAT SHIRTS; T-SHIRTS; WEARABLE GARMENTS AND CLOTHING, NAMELY, SHIRTS (U.S. CLS. 22 AND 39).

HELENE LIWINSKI, EXAMINING ATTORNEY

SN 77-887,413. TRIMFIT INC., BRISTOL, PA. FILED 12-7-2009.

TRIMFIT KIDS

THE MARK CONSISTS OF STANDARD CHARACTERS WITHOUT CLAIM TO ANY PARTICULAR FONT, STYLE, SIZE, OR COLOR.

OWNER OF U.S. REG. NO. 753,378.

NO CLAIM IS MADE TO THE EXCLUSIVE RIGHT TO USE "KIDS", APART FROM THE MARK AS SHOWN.

FOR SOCKS, TIGHTS AND SLIPPERS (U.S. CLS. 22 AND 39).

FIRST USE 0-0-2001; IN COMMERCE 0-0-2001.

DEBRA LEE, EXAMINING ATTORNEY

CLASS 25—(Continued).

SN 77-887,532. BASHFUL BUMP, LLC, BURLINGAME, CA. FILED 12-7-2009.

BASHFUL BUMP

THE MARK CONSISTS OF STANDARD CHARACTERS WITHOUT CLAIM TO ANY PARTICULAR FONT, STYLE, SIZE, OR COLOR.

FOR CLOTHING, NAMELY, MATERNITY BODY-SUITS (U.S. CLS. 22 AND 39).

ALEXANDER L. POWERS, EXAMINING ATTORNEY

SN 77-887,545. KAHAN, DEBORAH, DENVER, CO. FILED 12-7-2009.

BOOTEASE

THE MARK CONSISTS OF STANDARD CHARACTERS WITHOUT CLAIM TO ANY PARTICULAR FONT, STYLE, SIZE, OR COLOR.

FOR BOOT OR SHOE ACCESSORY, NAMELY, AN ATTACHMENT THAT GOES OVER THE BOOT OR SHOE DESIGNED TO TRANSFORM YOUR BOOTS OR SHOES FROM LOW TO HIGH SHAFT OR SIMPLE TO HIGH FASHION WHILE EXTENDING THE FUNCTION, SEASON AND LIFE OF YOUR BOOTS OR SHOES (U.S. CLS. 22 AND 39).

JORDAN BAKER, EXAMINING ATTORNEY

SN 77-887,553. AMERICAN LIFESTYLE BRANDS LLC, NEW YORK, NY. FILED 12-7-2009.

METAL GENERATION

THE MARK CONSISTS OF STANDARD CHARACTERS WITHOUT CLAIM TO ANY PARTICULAR FONT, STYLE, SIZE, OR COLOR.

FOR BEACHWEAR; BELTS; BLAZERS; BLOUSES; COATS; DENIMS; DRESS SHIRTS; DRESSES; FOOTWEAR; HATS; HEADWEAR; HOSIERY; INFANTWEAR; JACKETS; JEANS; JERSEYS; LADIES' UNDERWEAR; LEGGINGS; LINGERIE; LOUNGEWEAR; NECKWEAR; NIGHTGOWNS; NIGHTWEAR; OUTDOOR GLOVES; OUTER JACKETS; OVER COATS; OVER SHIRTS; PAJAMAS; PANTIES, SHORTS AND BRIEFS; PANTS; POLO SHIRTS; PONCHOS; RAINCOATS; SCARVES; SHIRTS; SHOES; SHORTS; SKIRTS; SKIRTS AND DRESSES; SKORTS; SLACKS; SLEEPWEAR; SLIPOVERS; SLIPPERS; SOCKS; SPORTS SHIRTS; SUITS; SWEAT PANTS; SWEAT SHIRTS; SWEATERS; SWIMWEAR; T-SHIRTS; TANK TOPS; UNDERWEAR; VESTS (U.S. CLS. 22 AND 39).

FIRST USE 11-1-2009; IN COMMERCE 11-1-2009.

ROBERT C. CLARK JR., EXAMINING ATTORNEY

CLASS 25—(Continued).

SN 77-887,570. DOUGLAS L. TIMMONS, SOLANA BEACH, CA. FILED 12-7-2009.

18 GREENS

THE MARK CONSISTS OF STANDARD CHARACTERS WITHOUT CLAIM TO ANY PARTICULAR FONT, STYLE, SIZE, OR COLOR.

FOR CAP VISORS; CAPS; CAPS WITH VISORS; GOLF CAPS; GOLF CLEATS; GOLF PANTS, SHIRTS AND SKIRTS; GOLF SHIRTS; GOLF SHOES; GOLF SHORTS; GOLF SPIKES; GOLF TROUSERS; HAT BANDS; HATS; HATS FOR INFANTS, BABIES, TODDLERS AND CHILDREN; GOLF HEADWEAR; KNITTED CAPS; MOCK TURTLE-NECK SWEATERS; RAIN HATS; SHORT-SLEEVED OR LONG-SLEEVED T-SHIRTS; SUN VISORS; SWEATERS; T-SHIRTS; TURTLENECK SWEATERS; V-NECK SWEATERS; VISORS; WOMEN'S HATS AND HOODS (U.S. CLS. 22 AND 39).

KIM MONINGHOFF, EXAMINING ATTORNEY

SN 77-887,618. MOON SHINE, LP, BEAVERTOWN, PA. FILED 12-7-2009.

LEGENDARY ESSENTIALS

THE MARK CONSISTS OF STANDARD CHARACTERS WITHOUT CLAIM TO ANY PARTICULAR FONT, STYLE, SIZE, OR COLOR.

FOR HEADWEAR; JACKETS; PANTS; SHIRTS; SHORTS (U.S. CLS. 22 AND 39).

FIRST USE 10-1-2009; IN COMMERCE 10-1-2009.
KIMBERLY PERRY, EXAMINING ATTORNEY

CLASS 25—(Continued).

SN 77-887,642. CAMEL NATIONS, LLC, PLANTATION, FL. FILED 12-7-2009.



THE COLOR(S) BROWN AND WHITE IS/ARE CLAIMED AS A FEATURE OF THE MARK.

THE MARK CONSISTS OF THE STYLIZED WORDING "FIRELANE" IN WHITE ON A BROWN RECTANGLE GOING DIAGONALLY ACROSS A BROWN AND WHITE FIRE HYDRANT. THE TOP AND BOTTOM OF THE HYDRANT ARE WHITE WITH BROWN DETAILING. THE MAIN PART OF THE HYDRANT IS BROWN WITH WHITE DETAILING.

FOR BATHING SUITS; CAPRI PANTS; CARGO PANTS; CLOTHING, NAMELY, KHAKIS; DENIMS; DRESS SHIRTS; DRESS SUITS; GLOVES AS CLOTHING; HATS; HATS FOR INFANTS, BABIES, TODDLERS AND CHILDREN; HOODED SWEAT SHIRTS; INFANT AND TODDLER ONE PIECE CLOTHING; JACKETS; JEANS; JERSEYS; KNIT SHIRTS; LONG-SLEEVED SHIRTS; LOUNGE PANTS; MEN'S SUITS, WOMEN'S SUITS; NIGHT SHIRTS; OVER SHIRTS; PANTS; POLO SHIRTS; SHIRTS; SHIRTS AND SHORT-SLEEVED SHIRTS; SHIRTS FOR INFANTS, BABIES, TODDLERS AND CHILDREN; SHOES; SHORT SETS; SHORT-SLEEVED OR LONG-SLEEVED T-SHIRTS; SHORT-SLEEVED SHIRTS; SKIRTS AND DRESSES; SLEEP SHIRTS; SOCKS; SWEAT PANTS; SWEAT SHIRTS; SWEAT SUITS; T-SHIRTS; TOPS; TURTLE NECK SHIRTS; WEARABLE GARMENTS AND CLOTHING, NAMELY, SHIRTS (U.S. CLS. 22 AND 39).

ELLEN B. AWRICH, EXAMINING ATTORNEY

SN 77-887,659. OAKLEY, INC., FOOTHILL RANCH, CA. FILED 12-7-2009.

REPURPOSE, REDESIGN, REINVENT

THE MARK CONSISTS OF STANDARD CHARACTERS WITHOUT CLAIM TO ANY PARTICULAR FONT, STYLE, SIZE, OR COLOR.

FOR CLOTHING, NAMELY, T-SHIRTS, BEACHWEAR, BLOUSES, SPORTS SHIRTS, JERSEYS, SWIMWEAR, SWIMTRUNKS, SHORTS, UNDERWEAR, SHIRTS, PANTS, RACING PANTS, SKI AND SNOWBOARD PANTS AND JACKETS, JEANS, VESTS, JACKETS, WETSUITS, SWEATERS, PULLOVERS, COATS, SWEATPANTS, HEADWEAR, NAMELY, HATS, CAPS, VISORS AND FOOTWEAR, NAMELY, WETSUIT BOOTIES, SHOES, SANDALS, ATHLETIC FOOTWEAR, ALL PURPOSE SPORTS FOOTWEAR, THONGS AND BOOTS (U.S. CLS. 22 AND 39).

EMILY CARLSEN, EXAMINING ATTORNEY

CLASS 25—(Continued).

SN 77-887,692. JONES, KAKKI, LITTLE ROCK, AR. FILED 12-7-2009.

HOGGY-STYLE

THE MARK CONSISTS OF STANDARD CHARACTERS WITHOUT CLAIM TO ANY PARTICULAR FONT, STYLE, SIZE, OR COLOR.

FOR ATHLETIC APPAREL, NAMELY, SHIRTS, PANTS, JACKETS, FOOTWEAR, HATS AND CAPS, ATHLETIC UNIFORMS (U.S. CLS. 22 AND 39).
JENNIFER MARTIN, EXAMINING ATTORNEY

SN 77-887,785. TRINITY DESIGNS, LLC, DBA TRINITY DESIGNS, CEDAREIDGE, CO. FILED 12-7-2009.



THE MARK CONSISTS OF A SWORD, IN THE SHAPE OF A CROSS, AND A SHIELD, HAVING A CROSS IN THE UPPER PORTION OF THE SHIELD.

FOR BASEBALL CAPS; BOARD SHORTS; BOMBER JACKETS; CAMOUFLAGE GLOVES; CAMOUFLAGE JACKETS; CAMOUFLAGE PANTS; CAMOUFLAGE SHIRTS; CAMOUFLAGE VESTS; CARGO PANTS; COATS; COATS FOR MEN AND WOMEN; COATS MADE OF COTTON; COATS OF DENIM; CREW NECK SWEATERS; DENIM JACKETS; DENIMS; DOWN JACKETS; DRESS SHIRTS; DRESSES; FISHERMEN'S JACKETS; FLEECE VESTS; GLOVES AS CLOTHING; GOLF CAPS; GOLF PANTS, SHIRTS AND SKIRTS; GOLF SHIRTS; GOLF SHORTS; GYM PANTS; GYM SHORTS; HATS; HATS FOR INFANTS, BABIES, TODDLERS AND CHILDREN; HEADBANDS FOR CLOTHING; HEAVY JACKETS; HOODED SWEAT SHIRTS; HOODS; HUNTING JACKETS; INFANT AND TODDLER ONE PIECE CLOTHING; JACKETS; JACKETS AND SOCKS; JERSEYS; JOGGING PANTS; LEATHER JACKETS; LONG SLEEVED VESTS; MEN'S AND WOMEN'S JACKETS, COATS, TROUSERS, VESTS; MEN'S DRESS SOCKS; MEN'S SOCKS; MOCK TURTLE-NECK SWEATERS; MOTORCYCLE JACKETS; OPEN-NECKED SHIRTS; OUTER JACKETS; OVER SHIRTS; PANTS; PIQUE SHIRTS; POLO SHIRTS; RAIN COATS; RAIN HATS;

CLASS 25—(Continued).

RAIN JACKETS; RAINPROOF JACKETS; REVERSIBLE JACKETS; RUGBY SHIRTS; RUGBY SHORTS; SHIRTS; SHIRTS AND SHORT-SLEEVED SHIRTS; SHIRTS FOR SUITS; SHORT-SLEEVED OR LONG-SLEEVED T-SHIRTS; SHORT-SLEEVED SHIRTS; SHORTS; SKI JACKETS; SKI PANTS; SLEEVED OR SLEEVELESS JACKETS; SNOW PANTS; SNOWBOARD PANTS; SOCKS; SPORT COATS; SPORT SHIRTS; SPORTS JACKETS; SPORTS PANTS; SPORTS SHIRTS; SPORTS SHIRTS WITH SHORT SLEEVES; SWEAT JACKETS; SWEAT PANTS; SWEAT SHIRTS; SWEAT SHORTS; SWEATERS; T-SHIRTS; TEE SHIRTS; THERMAL SOCKS; TIES; TOPS; TRIATHLON CLOTHING, NAMELY, TRIATHLON TIGHTS, TRIATHLON SHORTS, TRIATHLON SINGLETTS, TRIATHLON SHIRTS, TRIATHLON SUITS; TURTLE NECK SHIRTS; TURTLENECK SWEATERS; V-NECK SWEATERS; WALKING SHORTS; WATERPROOF JACKETS AND PANTS; WEARABLE GARMENTS AND CLOTHING, NAMELY, SHIRTS; WIND COATS; WIND PANTS; WIND RESISTANT JACKETS; WIND SHIRTS (U.S. CLS. 22 AND 39).

C. DIONNE CLYBURN, EXAMINING ATTORNEY

SN 77-887,794. FERNANDEZ, ROMAN, CHULA VISTA, CA. FILED 12-7-2009.

REBEL 4 LIFE

THE MARK CONSISTS OF STANDARD CHARACTERS WITHOUT CLAIM TO ANY PARTICULAR FONT, STYLE, SIZE, OR COLOR.

FOR BANDANAS; BELTS; BIKINIS; BLOUSES; BOXER BRIEFS; BOXER SHORTS; CAPRI PANTS; COATS; DRESS SHIRTS; FOOTWEAR; HATS; HEADWEAR; JACKETS; JEANS; LEATHER JACKETS; PAJAMAS; PANTS; SANDALS; SHIRTS; SHORT-SLEEVED OR LONG-SLEEVED T-SHIRTS; SHORTS; SOCKS; SWEAT PANTS; SWEAT SHORTS; SWEATERS; SWIM TRUNKS; SWIM WEAR; TANK TOPS; UNDERWEAR (U.S. CLS. 22 AND 39).

FIRST USE 5-5-2009; IN COMMERCE 5-5-2009.
PAULA MAHONEY, EXAMINING ATTORNEY

SN 77-887,804. YING, MARDY, WHITTIER, CA. AND YING, NORDY, WHITTIER, CA. FILED 12-7-2009.

ABBY 16

THE MARK CONSISTS OF STANDARD CHARACTERS WITHOUT CLAIM TO ANY PARTICULAR FONT, STYLE, SIZE, OR COLOR.

FOR CLOTHING, NAMELY, SHOES, JEANS, PANTS, OVERALLS, SWEAT PANTS, T-SHIRTS, POLO SHIRTS, SWEATSHIRTS, TANK TOPS, SHORTS, UNDERWEAR, BRIEFS, THERMAL UNDERWEAR, THONGS, PANTIES, SWIM SUITS, TRUNKS, YOGA PANTS, CAPRI PANTS, SPORTS BRAS, BANDANAS, LEATHER BELTS, FABRIC BELTS, CAPS, HATS, BEANIES, VISORS, DRESSES, SKIRTS, BLOUSES, JACKETS, COATS, FLEECE PULL-OVERS, SWEATERS (U.S. CLS. 22 AND 39).

FIRST USE 8-0-2009; IN COMMERCE 8-0-2009.
HEATHER THOMPSON, EXAMINING ATTORNEY

CLASS 25—(Continued).

SN 77-887,974. WILD ATTIRE, INC., GARDEN GROVE, CA. FILED 12-7-2009.

SILK RHINO

THE MARK CONSISTS OF STANDARD CHARACTERS WITHOUT CLAIM TO ANY PARTICULAR FONT, STYLE, SIZE, OR COLOR.

NO CLAIM IS MADE TO THE EXCLUSIVE RIGHT TO USE "SILK", APART FROM THE MARK AS SHOWN.

FOR CLOTHING, NAMELY, TIES MADE OF SILK OR A SILK BLEND (U.S. CLS. 22 AND 39).

ANGELA M. MICHELL, EXAMINING ATTORNEY

CLASS 25—(Continued).

SN 77-888,212. NGUYEN, TUAN, HONOLULU, HI. FILED 12-8-2009.

Alcoholics Unanimous

SN 77-888,143. FABBYS LLC, SEATTLE, WA. FILED 12-7-2009.

THE COLOR(S) BRIGHT PINK, BLACK, WHITE, AND PALE PINK IS/ARE CLAIMED AS A FEATURE OF THE MARK.

THE MARK CONSISTS OF WORD "FABBYS" WITH STYLIZED LETTER "Y" IN BRIGHT PINK THAT FORMS THE SHAPE OF A HIGH HEEL SHOE WITH AN EXCLAMATION MARK IN PALE PINK AT THE END FORMING THE ACTUAL HEEL OF THE HIGH HEEL SHOE.

FOR BALLET SHOES; LEISURE SHOES; WOMEN'S SHOES (U.S. CLS. 22 AND 39).

MARILYN IZZI, EXAMINING ATTORNEY

THE MARK CONSISTS OF STANDARD CHARACTERS WITHOUT CLAIM TO ANY PARTICULAR FONT, STYLE, SIZE, OR COLOR.

FOR A-SHIRTS; ATHLETIC APPAREL, NAMELY, SHIRTS, PANTS, JACKETS, FOOTWEAR, HATS AND CAPS, ATHLETIC UNIFORMS; BALLOON PANTS; BODY SHIRTS; BUTTON-FRONT ALOHA SHIRTS; CAMOUFLAGE PANTS; CAMOUFLAGE SHIRTS; CAMP SHIRTS; CAPRI PANTS; CARGO PANTS; CHEF'S HATS; CLOTHING FOR ATHLETIC USE, NAMELY, PADDED PANTS; CLOTHING FOR ATHLETIC USE, NAMELY, PADDED SHIRTS; DENIMS; DRESS SHIRTS; FISHING SHIRTS; FUR HATS; GOLF PANTS, SHIRTS AND SKIRTS; GOLF SHIRTS; GYM PANTS; HAT BANDS; HATS; HATS FOR INFANTS, BABIES, TODDLERS AND CHILDREN; HOODED SWEAT SHIRTS; HUNTING PANTS; HUNTING SHIRTS; JOGGING PANTS; KNIT SHIRTS; LEATHER PANTS; LEG SHIELDING DEVICE, ATTACHABLE TO AND DETACHABLE FROM A PERSON'S PANTS, COMPRISED OF PADDING TO SHIELD THE LEGS FROM FLYING DEBRIS WHEN MOWING WITH A STRING TRIMMER; LONG-SLEEVED SHIRTS; LOUNGE PANTS; MOISTURE-WICKING SPORTS PANTS; MOISTURE-WICKING SPORTS SHIRTS; NIGHT SHIRTS; NON-DISPOSABLE CLOTH TRAINING PANTS; NURSE PANTS; OPEN-NECKED SHIRTS; OVER SHIRTS; PANTS; PAPER HATS FOR USE AS CLOTHING ITEMS; PARTY HATS; PERSPIRATION ABSORBENT STRAP TO BE USED IN THE BILL OF A HAT; PETTI-PANTS; PIQUE SHIRTS; POLO SHIRTS; RAIN HATS; RUGBY SHIRTS; SCIENTIFIC AND TECHNOLOGICAL APPAREL, NAMELY, SHIRTS, PANTS, JACKETS, FOOTWEAR, HATS AND CAPS, UNIFORMS; SEDGE HATS (SUGE-GASA); SHIRT FRONTS; SHIRT YOKES; SHIRTS; SHIRTS AND SHORT-SLEEVED SHIRTS; SHIRTS FOR INFANTS, BABIES, TODDLERS AND CHILDREN; SHIRTS FOR SUITS; SHORT-SLEEVED OR LONG-SLEEVED T-SHIRTS; SHORT-SLEEVED SHIRTS; SKI PANTS; SLEEP SHIRTS; SMALL HATS; SNOW PANTS; SNOWBOARD PANTS; SPORT SHIRTS; SPORTS PANTS; SPORTS SHIRTS; SPORTS SHIRTS WITH SHORT SLEEVES; STRETCH PANTS; SWEAT PANTS; SWEAT SHIRTS; T-SHIRTS; TAP PANTS; TEE SHIRTS; TOBOGGAN HATS, PANTS AND CAPS; TRACK PANTS; TRAVEL CLOTHING CONTAINED IN A PACKAGE COMPRISING REVERSIBLE JACKETS, PANTS, SKIRTS, TOPS AND A BELT OR SCARF; TRIATHLON CLOTHING, NAMELY, TRIATHLON TIGHTS, TRIATHLON SHORTS, TRIATHLON SINGLETS, TRIATHLON SHIRTS, TRIATHLON SUITS; TURTLE NECK SHIRTS; WATERPROOF JACKETS AND PANTS; WEARABLE GARMENTS AND CLOTHING, NAMELY, SHIRTS; WIND PANTS; WIND SHIRTS; WOMEN'S HATS AND HOODS; WOOLLY HATS; YOGA PANTS; YOGA SHIRTS (U.S. CLS. 22 AND 39).

SHAILA SETTLES, EXAMINING ATTORNEY

SN 77-888,187. WILLIAMS, VINCENT T., CHESTERFIELD, VA. FILED 12-8-2009.

2T222

THE MARK CONSISTS OF STANDARD CHARACTERS WITHOUT CLAIM TO ANY PARTICULAR FONT, STYLE, SIZE, OR COLOR.

FOR POLO SHIRTS; SWEAT SHIRTS; T-SHIRTS; TEE SHIRTS; TURTLE NECK SHIRTS; WEARABLE GARMENTS AND CLOTHING, NAMELY, SHIRTS (U.S. CLS. 22 AND 39).

CHRISTINE BLOMQUIST, EXAMINING ATTORNEY

CLASS 25—(Continued).

SN 77-888,271. ASTURI, PAUL D, PITTSBURGH, PA. FILED 12-8-2009.

euphoradise

THE MARK CONSISTS OF STANDARD CHARACTERS WITHOUT CLAIM TO ANY PARTICULAR FONT, STYLE, SIZE, OR COLOR.

FOR ATHLETIC APPAREL, NAMELY, SHIRTS, PANTS, JACKETS, FOOTWEAR, HATS AND CAPS, ATHLETIC UNIFORMS; T-SHIRTS (U.S. CLS. 22 AND 39).

KATHERINE CHANG, EXAMINING ATTORNEY

SN 77-888,300. MOTHERS IN MIND, EAST SETAUKET, NY. FILED 12-8-2009.

My Snickey

THE MARK CONSISTS OF STANDARD CHARACTERS WITHOUT CLAIM TO ANY PARTICULAR FONT, STYLE, SIZE, OR COLOR.

FOR SCARFS (U.S. CLS. 22 AND 39).
KEVIN CORWIN, EXAMINING ATTORNEY

SN 77-888,327. BEHNOUD, NIMA, NEW YORK, NY. FILED 12-8-2009.



NIMA BEHNOUD

OWNER OF U.S. REG. NO. 3,574,655.
THE NAME(S), PORTRAIT(S), AND/OR SIGNATURE(S) SHOWN IN THE MARK IDENTIFIES "NIMA BEHNOUD", WHOSE CONSENT(S) TO REGISTER IS MADE OF RECORD.

THE MARK CONSISTS OF AN "N" AND "B" OVERLAPPING EACH OTHER TO FORM A DESIGN ABOVE THE WORDS "NIMA BEHNOUD".

FOR SHORT-SLEEVED OR LONG-SLEEVED T-SHIRTS; T-SHIRTS; DRESS SHIRTS; DRESSES; SKIRTS AND DRESSES; PANTS; BELTS (U.S. CLS. 22 AND 39).

FIRST USE 5-31-2009; IN COMMERCE 5-31-2009.
REGINA DRUMMOND, EXAMINING ATTORNEY

CLASS 25—(Continued).

SN 77-888,332. BEHNOUD, NIMA, NEW YORK, NY. FILED 12-8-2009.



THE MARK CONSISTS OF STANDARD CHARACTERS WITHOUT CLAIM TO ANY PARTICULAR FONT, STYLE, SIZE, OR COLOR.

OWNER OF U.S. REG. NO. 3,574,655.
FOR SHORT-SLEEVED OR LONG-SLEEVED T-SHIRTS; T-SHIRTS; DRESS SHIRTS; DRESSES; SKIRTS AND DRESSES; PANTS; BELTS; CAPS (U.S. CLS. 22 AND 39).

REGINA DRUMMOND, EXAMINING ATTORNEY

SN 77-888,386. AMERICAN APOTHECARY CORP., WARREN, NJ. FILED 12-8-2009.



THE MARK CONSISTS OF THE WORDING "AA" WITH A MAGNIFYING GLASS OVER THE SECOND LETTER "A" ENLARGING IT.

FOR T-SHIRTS; JEANS; SCARVES; HATS; HOODED SWEAT SHIRTS; HOODED PULLOVERS (U.S. CLS. 22 AND 39).

WILLIAM ROSSMAN, EXAMINING ATTORNEY

CLASS 25—(Continued).

SN 77-888,452. LEWIS, CHARLES K., NOVI, MI. FILED 12-8-2009.



NO CLAIM IS MADE TO THE EXCLUSIVE RIGHT TO USE "BLACK BIKER GEAR", APART FROM THE MARK AS SHOWN.

THE MARK CONSISTS OF A REVERSE LETTER "B" ATTACHED TO A SHIELD ON THE LEFT SIDE AND A LETTER "B" ATTACHED TO A SHIELD ON THE RIGHT SIDE, WITH A MOTORCYCLE AND THE WORDING "BLACK BIKER GEAR" ON THE INSIDE OF THE SHIELD AND A BANNER UNDER THE SHIELD WITH THE WORDING "SUPPORT BLACK BIKERS" ON IT.

FOR BELTS; BELTS FOR CLOTHING; BELTS MADE OUT OF CLOTH; BIBS NOT OF CLOTH OR PAPER; BOTTOMS; CHILDREN'S AND INFANTS' CLOTH BIBS; CHILDREN'S CLOTH EATING BIBS; CLOTH BIBS; CLOTH BIBS FOR ADULT DINERS; CLOTHING FOR ATHLETIC USE, NAMELY, PADDED ELBOW COMPRESSION SLEEVES; CLOTHING FOR ATHLETIC USE, NAMELY, PADDED PANTS; CLOTHING FOR ATHLETIC USE, NAMELY, PADDED SHIRTS; CLOTHING FOR ATHLETIC USE, NAMELY, PADDED SHORTS; CLOTHING FOR WEAR IN JUDO PRACTICES; CLOTHING FOR WEAR IN WRESTLING GAMES; CLOTHING ITEMS, NAMELY, ADHESIVE POCKETS THAT MAY BE AFFIXED DIRECTLY TO THE BODY AS A DECORATIVE PIECE OF CLOTHING WITH UTILITY; CLOTHING ITEMS, NAMELY, ADHESIVE POCKETS THAT MAY BE AFFIXED DIRECTLY TO THE INSIDE OF CLOTHING FOR STORAGE AND SAFEKEEPING OF PERSONAL ITEMS; CLOTHING, NAMELY, ARM WARMERS; CLOTHING, NAMELY, BASE LAYERS; CLOTHING, NAMELY, FOLK COSTUMES; CLOTHING, NAMELY, HAND-WARMERS; CLOTHING, NAMELY, KHAKIS; CLOTHING, NAMELY, KNEE WARMERS; CLOTHING, NAMELY, MATERNITY BANDS; CLOTHING, NAMELY, NECK TUBES (U.S. CLS. 22 AND 39).

TINA MAI, EXAMINING ATTORNEY

SN 77-888,468. ROYALLWEAR, LLC, RICHMOND, ME. FILED 12-8-2009.



THE MARK CONSISTS OF A DEPICTION OF TWO JOINED FANCIFUL DESIGNS COMPOSED OF A CURVED

CLASS 25—(Continued).

LINE STARTING AT THE BOTTOM LEFT, CURVING TO THE RIGHT AND UP, LOOPING DOWN TO THE LEFT, THEN TO THE RIGHT AND UP, THEN LOOPING DOWN TO THE LEFT, WHICH IS TO THE RIGHT OF THE FIRST UPWARD CURVE, AND DOWN TO THE LEVEL OF THE CURVED LINE AT THE BOTTOM LEFT BUT CURVING TO THE RIGHT, AND ENDING AT THE SAME LEVEL OF THE CURVED LINE AT THE BOTTOM LEFT. THE TWO HALVES OF THE DESIGN ARE MIRROR IMAGES OF EACH OTHER.

FOR CLOTHING, NAMELY, TOPS, BOTTOMS, JACKETS, COATS, ROBES, GOWNS, SMOCKS, TUNICS, CHEMISES (U.S. CLS. 22 AND 39).

ESTHER BELENKER, EXAMINING ATTORNEY

SN 77-888,542. STRATO TRADING GROUP, INC., NEW YORK, NY. FILED 12-8-2009.



THE MARK CONSISTS OF EIGHT POINTED STAR WITHIN A CIRCLE.

FOR JACKETS (U.S. CLS. 22 AND 39).
ARETHA SOMERVILLE, EXAMINING ATTORNEY

SN 77-888,547. STRATO TRADING GROUP, INC., NEW YORK, NY. FILED 12-8-2009.

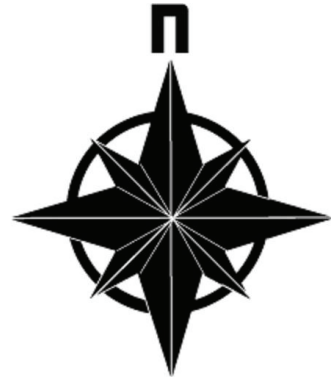

THE MARK CONSISTS OF THE LETTER N OVER AN EIGHT POINTED STAR WITHIN A CIRCLE.

FOR JACKETS (U.S. CLS. 22 AND 39).
ARETHA SOMERVILLE, EXAMINING ATTORNEY

CLASS 25—(Continued).

SN 77-888,856. CHRISTINA BRACKEN, INC., AKA ZEM-GEAR, KEY BISCAYNE, FL. FILED 12-8-2009.



THE MARK CONSISTS OF THE LETTERS "Z","E","M" INSIDE A PARTIAL CIRCLE ADJACENT TO A SMALLER OVAL.

FOR ATHLETIC FOOTWEAR; ATHLETIC SHOES; BASEBALL CAPS; BEACH SHOES; BERMUDA SHORTS; BOARD SHORTS; BOOTIES; CAPS WITH VISORS; SHIRTS; SHOES; SHORT-SLEEVED OR LONG-SLEEVED T-SHIRTS; SHORT-SLEEVED SHIRTS; SHORTS; SPORT SHIRTS; SPORTS SHIRTS; SPORTS SHIRTS WITH SHORT SLEEVES; SWEAT SHIRTS; SWEAT SHORTS; T-SHIRTS; TANK TOPS; VISORS (U.S. CLS. 22 AND 39).
FIRST USE 10-1-2009; IN COMMERCE 10-1-2009.
AMY C. KEAN, EXAMINING ATTORNEY

CLASS 25—(Continued).

SN 77-889,085. SPORTS-AHOLIC, INC., LENEXA, KS. FILED 12-8-2009.

RECOVERY IS NOT AN OPTION

THE MARK CONSISTS OF STANDARD CHARACTERS WITHOUT CLAIM TO ANY PARTICULAR FONT, STYLE, SIZE, OR COLOR.

FOR HATS; SHIRTS; SWEAT SHIRTS (U.S. CLS. 22 AND 39).
FIRST USE 2-28-2007; IN COMMERCE 2-28-2007.
LAURA HAMMEL, EXAMINING ATTORNEY

SN 77-888,918. EASTON, RICHARD, SANTA MARIA, CA. FILED 12-8-2009.

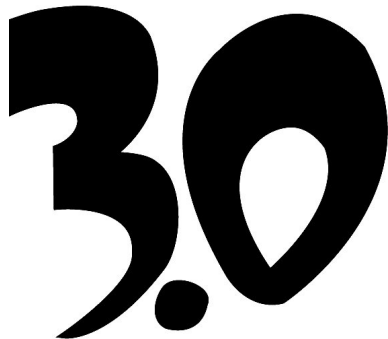

THE MARK CONSISTS OF THE STYLIZED TEXT "3.0". FOR HATS; JACKETS; SHIRTS; SHORTS; SOCKS; SWEAT SHIRTS; TANK TOPS; WRISTBANDS (U.S. CLS. 22 AND 39).

FIRST USE 7-1-2009; IN COMMERCE 8-1-2009.
WANDA KAY PRICE, EXAMINING ATTORNEY

SN 77-889,101. BOWSER, JOHN S., MARYSVILLE, OH. AND BOWSER, STEVEN J, CANADIAN LAKES, MI. FILED 12-8-2009.

ALOTAMUS

THE MARK CONSISTS OF STANDARD CHARACTERS WITHOUT CLAIM TO ANY PARTICULAR FONT, STYLE, SIZE, OR COLOR.

FOR A-SHIRTS; ATHLETIC APPAREL, NAMELY, SHIRTS, PANTS, JACKETS, FOOTWEAR, HATS AND CAPS, ATHLETIC UNIFORMS; BODY SHIRTS; BUTTON-FRONT ALOHA SHIRTS; CAMOUFLAGE SHIRTS; CAMP SHIRTS; CHEF'S HATS; CLOTHING FOR ATHLETIC USE, NAMELY, PADDED SHIRTS; FISHING SHIRTS; GOLF PANTS, SHIRTS AND SKIRTS; GOLF SHIRTS; HAT BANDS; HATS; HOODED SWEAT SHIRTS; HUNTING SHIRTS; KNIT SHIRTS; LONG-SLEEVED SHIRTS; MOISTURE-WICKING SPORTS SHIRTS; NIGHT SHIRTS; OPEN-NECKED SHIRTS; OVER SHIRTS; PARTY HATS; PERSPIRATION ABSORBENT STRAP TO BE USED IN THE BILL OF A HAT; PIQUE SHIRTS; POLO SHIRTS; RUGBY SHIRTS; SCIENTIFIC AND TECHNOLOGICAL APPAREL, NAMELY, SHIRTS, PANTS, JACKETS, FOOTWEAR, HATS AND CAPS, UNIFORMS; SHIRT FRONTS; SHIRT YOKES; SHIRTS; SHIRTS AND SHORT-SLEEVED SHIRTS; SHIRTS FOR INFANTS, BABIES, TODDLERS AND CHILDREN; SHIRTS FOR SUITS; SHORT-SLEEVED OR LONG-SLEEVED T-SHIRTS; SHORT-SLEEVED SHIRTS; SLEEP SHIRTS; SMALL HATS; SPORT SHIRTS; SPORTS SHIRTS; SPORTS SHIRTS WITH SHORT SLEEVES; SWEAT SHIRTS; T-SHIRTS; TEE SHIRTS; TOBOGGAN HATS, PANTS AND CAPS; TRIATHLON CLOTHING, NAMELY, TRIATHLON TIGHTS, TRIATHLON SHORTS, TRIATHLON SINGLETS, TRIATHLON SHIRTS, TRIATHLON SUITS; TURTLE NECK SHIRTS; WEARABLE GARMENTS AND CLOTHING, NAMELY, SHIRTS; WIND SHIRTS; WOMEN'S HATS AND HOODS; WOOLLY HATS; YOGA SHIRTS (U.S. CLS. 22 AND 39).
RICHARD WHITE, EXAMINING ATTORNEY

SN 77-889,074. SEPULVEDA, JOSEPH B., SANDY, UT. FILED 12-8-2009.

DNACYCLING

THE MARK CONSISTS OF STANDARD CHARACTERS WITHOUT CLAIM TO ANY PARTICULAR FONT, STYLE, SIZE, OR COLOR.

FOR ATHLETIC APPAREL, NAMELY, SHIRTS, PANTS, JACKETS, FOOTWEAR, HATS AND CAPS, ATHLETIC UNIFORMS (U.S. CLS. 22 AND 39).
FIRST USE 2-0-2004; IN COMMERCE 2-0-2004.
DAWN FELDMAN, EXAMINING ATTORNEY

CLASS 25—(Continued).

SN 77-889,116. SUAREZ, ALEXANDER, POMPANO BEACH, FL. FILED 12-8-2009.

CAMPPAIN

THE MARK CONSISTS OF THE STYLIZED TEXT "CAMP-PAIN".

FOR BANDANAS; HATS; HOODED SWEAT SHIRTS; SHOES; SOCKS; T-SHIRTS (U.S. CLS. 22 AND 39). FIRST USE 4-1-2003; IN COMMERCE 1-1-2009. STEPHEN AQUILA, EXAMINING ATTORNEY

SN 77-889,347. HARDWATER CLOTHING USA INC., WILMINGTON, DE. FILED 12-9-2009.

JARED LANG

THE MARK CONSISTS OF STANDARD CHARACTERS WITHOUT CLAIM TO ANY PARTICULAR FONT, STYLE, SIZE, OR COLOR.

THE NAME(S), PORTRAIT(S), AND/OR SIGNATURE(S) SHOWN IN THE MARK IDENTIFIES "JARED LANGLEBEN", WHOSE CONSENT(S) TO REGISTER IS MADE OF RECORD.

FOR T-SHIRTS, SHIRTS, BLOUSES, SWEATERS, POLO SHIRTS AND JACKETS (U.S. CLS. 22 AND 39). BARBARA A. GOLD, EXAMINING ATTORNEY

SN 77-889,367. FORTUNE FASHIONS INDUSTRIES LLC, SANTA BARBARA, CA. FILED 12-9-2009.

MODERN BASICS

THE MARK CONSISTS OF STANDARD CHARACTERS WITHOUT CLAIM TO ANY PARTICULAR FONT, STYLE, SIZE, OR COLOR.

NO CLAIM IS MADE TO THE EXCLUSIVE RIGHT TO USE "BASICS", APART FROM THE MARK AS SHOWN.

FOR BASEBALL CAPS; CAPS; HATS; HEADGEAR, NAMELY, BASEBALL CAPS, BEANIES, AND CAPS; HEADWEAR; SHIRTS; SHIRTS AND SHORT-SLEEVED SHIRTS; SHORT-SLEEVED OR LONG-SLEEVED T-SHIRTS; SHORT-SLEEVED SHIRTS; SWEAT SHIRTS; T-SHIRTS; TOPS; WEARABLE GARMENTS AND CLOTHING, NAMELY, SHIRTS (U.S. CLS. 22 AND 39).

REBECCA POVARCHUK, EXAMINING ATTORNEY

CLASS 25—(Continued).

SN 77-889,588. I AM HUMAN, LLC, AUSTIN, TX. FILED 12-9-2009.

I Am Human

THE MARK CONSISTS OF STANDARD CHARACTERS WITHOUT CLAIM TO ANY PARTICULAR FONT, STYLE, SIZE, OR COLOR.

FOR HOODED SWEAT SHIRTS; PANTS; SHIRTS; SHORTS; WEARABLE GARMENTS AND CLOTHING, NAMELY, SHIRTS (U.S. CLS. 22 AND 39).

SEAN CROWLEY, EXAMINING ATTORNEY

SN 77-889,663. KID DANGEROUS, LLC, LOS ANGELES, CA. FILED 12-9-2009.

THE MARK CONSISTS OF THE STYLIZED WORD "LA" APPEARING ABOVE THE WORD "DON'T" WITH A HEART DESIGN AND THE LETTER "U" APPEARING UNDERNEATH.

FOR SHIRTS, TOPS, T-SHIRTS, SWEAT SHIRTS, TANK TOPS (U.S. CLS. 22 AND 39).

FIRST USE 10-12-2006; IN COMMERCE 5-1-2007.

AMY KERTGATE, EXAMINING ATTORNEY

SN 77-889,667. GAME SPORTSWEAR, LTD., YORKTOWN HEIGHTS, NY. FILED 12-9-2009.

G GAME 360°

THE MARK CONSISTS OF STANDARD CHARACTERS WITHOUT CLAIM TO ANY PARTICULAR FONT, STYLE, SIZE, OR COLOR.

OWNER OF U.S. REG. NOS. 2,374,092, 3,689,802 AND OTHERS.

FOR CLOTHING, NAMELY, WORKWEAR IN THE NATURE OF JACKETS WITH AND WITHOUT HOODS, WORK SHIRTS, WORK PANTS, WORK VESTS, AND ZIPPERED TURTLENECK SHIRTS (U.S. CLS. 22 AND 39).

AMY KERTGATE, EXAMINING ATTORNEY

CLASS 25—(Continued).

SN 77-889,724. ANSARI, SARAH, ALPINE, CA. FILED 12-9-2009.

THE MARK CONSISTS OF THE STYLIZED TEXT "ARTI-ZARA TREASURES FROM THE EAST" WITH A 3-PRONGED LEAF ON TOP OF THE "Z".

FOR COATS; DRESSES; JACKETS; PANTS; SCARVES; SHIRTS; SHOES; SKIRTS; SWEAT SHIRTS; VESTS (U.S. CLS. 22 AND 39).

FIRST USE 1-1-2003; IN COMMERCE 1-1-2003.
LAURA KOVALSKY, EXAMINING ATTORNEY

SN 77-889,740. GOLDSTEIN, LORI, NEW YORK, NY. FILED 12-9-2009.

TOGETHER FOREVER

THE MARK CONSISTS OF STANDARD CHARACTERS WITHOUT CLAIM TO ANY PARTICULAR FONT, STYLE, SIZE, OR COLOR.

FOR UNDERGARMENTS (U.S. CLS. 22 AND 39).
DAVID H. STINE, EXAMINING ATTORNEY

SN 77-889,859. BARNES, LINDA SERCK, CYPRESS, CA. FILED 12-9-2009.

CANCER WARRIOR

THE MARK CONSISTS OF STANDARD CHARACTERS WITHOUT CLAIM TO ANY PARTICULAR FONT, STYLE, SIZE, OR COLOR.

FOR CAPS; JACKETS; SCARVES; SOCKS; SWEAT SHIRTS; T-SHIRTS; TIES (U.S. CLS. 22 AND 39).
MORGAN WYNNE, EXAMINING ATTORNEY

CLASS 25—(Continued).

SN 77-889,878. SCOTT SHELINGOSKI, ABSECON, NJ. FILED 12-9-2009.

THE MARK CONSISTS OF THE LETTERS "DVNC" IN A STYLIZED FONT CALLED ABBERATION.

FOR HOODED SWEAT SHIRTS; LONG-SLEEVED SHIRTS; SHORT-SLEEVED OR LONG-SLEEVED T-SHIRTS; SWEAT SHIRTS; T-SHIRTS; TEE SHIRTS (U.S. CLS. 22 AND 39).

HENRY S. ZAK, EXAMINING ATTORNEY

SN 77-889,933. ROBBINS, WARREN D., SAN RAFAEL, CA. FILED 12-9-2009.

RAW IDEA

THE MARK CONSISTS OF STANDARD CHARACTERS WITHOUT CLAIM TO ANY PARTICULAR FONT, STYLE, SIZE, OR COLOR.

FOR ATHLETIC APPAREL, NAMELY, SHIRTS, PANTS, JACKETS, FOOTWEAR, HATS AND CAPS, ATHLETIC UNIFORMS; CAPS; HEADWEAR; HOODED SWEAT SHIRTS; KNIT SHIRTS; LONG-SLEEVED SHIRTS; PIQUE SHIRTS; POLO SHIRTS; SKULLIES; SWEAT SHIRTS; T-SHIRTS; TEE SHIRTS (U.S. CLS. 22 AND 39).

ANDREA HACK, EXAMINING ATTORNEY

CLASS 25—(Continued).

SN 77-889,951. ANDY PAIGE, INC., NEW YORK, NY. FILED 12-9-2009.



NO CLAIM IS MADE TO THE EXCLUSIVE RIGHT TO USE "GARTER", APART FROM THE MARK AS SHOWN.

THE MARK CONSISTS OF THE STYLIZED WORDS "GIRLY GO GARTER". AN IMAGE OF A WOMAN DRESSED IN A DRESS WITH HEELS IN THE BACKGROUND OF THE STYLIZED WORDS.

FOR CLOTHING ACCESSORIES, NAMELY, A GARTER THAT HAS POCKETS TO CARRY SMALL ITEMS (U.S. CLS. 22 AND 39).

ALEX KEAM, EXAMINING ATTORNEY

CLASS 25—(Continued).

SN 77-890,000. SWINE '09, LLC, WEST NEWTON, MA. FILED 12-9-2009.

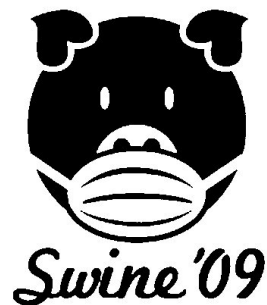

THE MARK CONSISTS OF A PIG WEARING A MASK THAT CONTAINS STREAKS. THERE IS A SPACE BETWEEN THE PIG'S EARS AND THE PIG, WHERE THE BACKGROUND FILLS THE SPACE; JUST BELOW THE PIG IS "SWINE '09".

FOR HATS; HOODED SWEAT SHIRTS; SWEAT SHIRTS; T-SHIRTS (U.S. CLS. 22 AND 39).

SUE LAWRENCE, EXAMINING ATTORNEY

SN 77-889,998. WOW DESIGNS, INC., DBA RED CHAPTER CLOTHING, WHITTIER, CA. FILED 12-9-2009.

RED CHAPTER

THE MARK CONSISTS OF STANDARD CHARACTERS WITHOUT CLAIM TO ANY PARTICULAR FONT, STYLE, SIZE, OR COLOR.

FOR T-SHIRTS, HOODED SWEATSHIRTS, CAPS (U.S. CLS. 22 AND 39).

FIRST USE 8-0-2008; IN COMMERCE 8-0-2008.
SUSAN RICHARDS, EXAMINING ATTORNEY

SN 77-890,016. CHAPARRO, NEYSA, FITCHBURG, WI. FILED 12-9-2009.

Latino Punto

THE MARK CONSISTS OF STANDARD CHARACTERS WITHOUT CLAIM TO ANY PARTICULAR FONT, STYLE, SIZE, OR COLOR.

THE ENGLISH TRANSLATION OF "LATINO PUNTO" IN THE MARK IS "LATINO PERIOD" OR "LATINO THAT'S IT".

FOR SHIRTS (U.S. CLS. 22 AND 39).
PAM WILLIS, EXAMINING ATTORNEY

CLASS 25—(Continued).

SN 77-890,020. FEAR NO FASHION, INC, VALENCIA, CA. FILED 12-9-2009.

Hollywood Slim

THE MARK CONSISTS OF STANDARD CHARACTERS WITHOUT CLAIM TO ANY PARTICULAR FONT, STYLE, SIZE, OR COLOR.

NO CLAIM IS MADE TO THE EXCLUSIVE RIGHT TO USE "HOLLYWOOD", APART FROM THE MARK AS SHOWN.

FOR BODY SHIRTS; MUSCLE TOPS; SHAPEWEAR, NAMELY, COMPRESSION UNDERGARMENTS, COMPRESSION TOPS, COMPRESSION SHORTS; SHORT-SLEEVED OR LONG-SLEEVED T-SHIRTS; T-SHIRTS; TANK TOPS; UNDERGARMENTS; YOGA PANTS; YOGA SHIRTS (U.S. CLS. 22 AND 39).

BRENDAN MCCAULEY, EXAMINING ATTORNEY

SN 77-890,058. GUY ATTAL, BEVERLY HILLS, CA. FILED 12-9-2009.

BROKLAN

THE MARK CONSISTS OF STANDARD CHARACTERS WITHOUT CLAIM TO ANY PARTICULAR FONT, STYLE, SIZE, OR COLOR.

FOR CLOTHING, NAMELY, MEN'S, WOMEN'S, MISCY'S, JUNIORS', CHILDREN'S AND INFANTS' JEANS, PANTS, TROUSERS, CAPRIS, LEGGINGS, SHORTS, OVERALLS, SKIRTS, DRESSES, TOPS, T-SHIRTS, SWEATSHIRTS, BLOUSES, SHIRTS, JACKETS, VESTS, COATS, SWEATERS, CARDIGANS, SCARVES, SOCKS, BANDANAS, NECKTIES, BELTS, BOOTS, SANDALS, FOOTWEAR, HATS, CAPS, HEADWEAR, UNDERWEAR, LINGERIE, PAJAMAS, SWIMWEAR, AND GLOVES (U.S. CLS. 22 AND 39).

MARILYN IZZI, EXAMINING ATTORNEY

SN 77-890,059. THE CAGE CARD, LLC, ENCINATAS, CA. FILED 12-9-2009.



THE MARK CONSISTS OF A HUMAN SKULL ABOVE A MARTIAL ARTS BELT. "C.A.G.E." IS DISPLAYED ON ONE END OF THE MARTIAL ARTS BELT.

FOR ATHLETIC APPAREL, NAMELY, SHIRTS, PANTS, JACKETS, FOOTWEAR, HATS AND CAPS, ATHLETIC UNIFORMS (U.S. CLS. 22 AND 39).

SUSAN LESLIE DUBOIS, EXAMINING ATTORNEY

CLASS 25—(Continued).

SN 77-890,094. GEGINO INC., SAN FRANCISCO, CA. FILED 12-10-2009.

Gegino

THE MARK CONSISTS OF STANDARD CHARACTERS WITHOUT CLAIM TO ANY PARTICULAR FONT, STYLE, SIZE, OR COLOR.

FOR FOOTWEAR FOR MEN AND WOMEN; WEDDING DRESSES; WEDDING GOWNS (U.S. CLS. 22 AND 39).

JUDITH HELFMAN, EXAMINING ATTORNEY

SN 77-890,126. TEXMART LTD., KOWLOON, HONG KONG, HONG KONG, FILED 12-10-2009.

STORM WARRIORS

THE MARK CONSISTS OF STANDARD CHARACTERS WITHOUT CLAIM TO ANY PARTICULAR FONT, STYLE, SIZE, OR COLOR.

FOR BELTS; DRESSES; GLOVES AS CLOTHING; JACKETS; JERSEYS; LEATHER BELTS; PANTS; SCARVES; SHIRTS; SOCKS; STOCKINGS; SWEATERS; TIES; TOPS; WEARABLE GARMENTS AND CLOTHING, NAMELY, SHIRTS (U.S. CLS. 22 AND 39).

KELLEY WELLS, EXAMINING ATTORNEY

SN 77-890,309. JITA DESIGNS, JACKSON, NJ. FILED 12-10-2009.

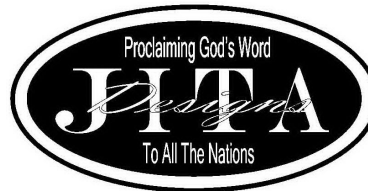

NO CLAIM IS MADE TO THE EXCLUSIVE RIGHT TO USE "DESIGNS", APART FROM THE MARK AS SHOWN.

THE MARK CONSISTS OF THE STYLIZED TEXT "JITA DESIGNS PROCLAIMING GOD'S WORD TO ALL THE NATIONS" INSIDE TWO OVALS.

FOR BASEBALL CAPS; JACKETS; SHIRTS (U.S. CLS. 22 AND 39).

RON FAIRBANKS, EXAMINING ATTORNEY

CLASS 25—(Continued).

SN 77-890,574. IM READY-MADE, LLC, NEW YORK, NY. FILED 12-10-2009.

IsaacMizrahiLive

THE MARK CONSISTS OF STANDARD CHARACTERS WITHOUT CLAIM TO ANY PARTICULAR FONT, STYLE, SIZE, OR COLOR.

OWNER OF U.S. REG. NOS. 1,524,672, 3,293,902 AND OTHERS.

THE NAME(S), PORTRAIT(S), AND/OR SIGNATURE(S) SHOWN IN THE MARK IDENTIFIES "ISAAC MIZRAHI", WHOSE CONSENT(S) TO REGISTER IS MADE OF RECORD.

FOR BELTS FOR CLOTHING; BLOUSES; COATS; DENIM JACKETS; DENIMS; DRESS SUITS; DRESSES; FOOTWEAR; GLOVES; HATS; JEANS; LINGERIE; NIGHTWEAR; PANTS; SCARVES; SHIRTS; SHOES; SKIRTS; SWEATERS; SWIMWEAR; WEDDING DRESSES (U.S. CLS. 22 AND 39).

MARILYN IZZI, EXAMINING ATTORNEY

CLASS 25—(Continued).

SN 77-890,607. WILLTEX ENTERPRISES, INC., TULLAHO-MA, TN. FILED 12-10-2009.



THE COLOR(S) BLACK, YELLOW AND RED IS/ARE CLAIMED AS A FEATURE OF THE MARK.

THE MARK CONSISTS OF YELLOW FLAMES AGAINST A BLACK BACKGROUND SURROUNDED BY A RED CIRCLE WITH A RED BANNER ACROSS THE FLAMES WITH "MMX" IN YELLOW ON THE BANNER.

FOR BOTTOMS; LONG UNDERWEAR; TOPS (U.S. CLS. 22 AND 39).

ELISSA GARBER KON, EXAMINING ATTORNEY

SN 77-890,665. SALTWATER REPUBLIC, LLC, VERO BEACH, FL. FILED 12-10-2009.



THE MARK CONSISTS OF A FISH, A SUN AND WAVES WITH THE STYLIZED TEXT "SALTWATER REPUBLIC".

FOR CLOTHING, NAMELY, T-SHIRTS, CAPS, POLO SHIRTS, FLEECE SWEATSHIRTS, FLEECE JACKETS, AND FLEECE CAPS (U.S. CLS. 22 AND 39).

CHARLOTTE CORWIN, EXAMINING ATTORNEY

SN 77-890,599. BLANCO ALDOMAR, S L, ALMANSA, ALBACETE, SPAIN, FILED 12-10-2009.

MGN

THE MARK CONSISTS OF STANDARD CHARACTERS WITHOUT CLAIM TO ANY PARTICULAR FONT, STYLE, SIZE, OR COLOR.

FOR SHOES (U.S. CLS. 22 AND 39).

LYDIA BELZER, EXAMINING ATTORNEY

SN 77-890,681. OLE LEGENDS, LLC, WEST PALM BEACH, FL. FILED 12-10-2009.

OLE LEGENDS

THE MARK CONSISTS OF STANDARD CHARACTERS WITHOUT CLAIM TO ANY PARTICULAR FONT, STYLE, SIZE, OR COLOR.

FOR CLOTHING, NAMELY, HATS, SHIRTS, AND JACKETS (U.S. CLS. 22 AND 39).

JUSTINE D. PARKER, EXAMINING ATTORNEY

CLASS 25—(Continued).

SN 77-890,703. SUHA CHLOE HEMMAT, SAN DIEGO, CA. AND NICOLETTE THERMOS, SAN DIEGO, CA. FILED 12-10-2009.

TAINTED ENTROPY

THE MARK CONSISTS OF STANDARD CHARACTERS WITHOUT CLAIM TO ANY PARTICULAR FONT, STYLE, SIZE, OR COLOR.

FOR DENIMS, DRESS SHIRTS, HATS, LOUNGE PANTS, NIGHT SHIRTS, OPEN-NECKED SHIRTS, POLO SHIRTS, T-SHIRTS, FLEECE VESTS; MEN'S AND WOMEN'S JACKETS, COATS, TROUSERS AND VESTS (U.S. CLS. 22 AND 39).

SUSAN STIGLITZ, EXAMINING ATTORNEY

SN 77-890,710. COLUMBIA SPORTSWEAR NORTH AMERICA, INC., PORTLAND, OR. FILED 12-10-2009.

AIRGILL

THE MARK CONSISTS OF STANDARD CHARACTERS WITHOUT CLAIM TO ANY PARTICULAR FONT, STYLE, SIZE, OR COLOR.

FOR HATS; PANTS; SHIRTS; SHORTS (U.S. CLS. 22 AND 39).

LINDA MICKLEBURGH, EXAMINING ATTORNEY

SN 77-890,721. LOWE PROFILE PRODUCTIONS, INC., BEVERLY HILLS, CA. FILED 12-10-2009.



THE MARK CONSISTS OF THE STYLIZED LETTERS "TBP" INSIDE OF AN OVAL SHAPE DESIGN.

FOR CLOTHING, NAMELY, T-SHIRTS, SHIRTS, PANTS, SHORTS, SWEATERS, SWEAT SHIRTS, SWEAT PANTS, CAPS, HATS, SCARVES AND JACKETS (U.S. CLS. 22 AND 39).

TINA MAI, EXAMINING ATTORNEY

CLASS 25—(Continued).

SN 77-890,815. JOSH SUHRE DESIGN, LLC, CINCINNATI, OH. FILED 12-10-2009.

Cut & Wax & Grind & Shine.

THE MARK CONSISTS OF STANDARD CHARACTERS WITHOUT CLAIM TO ANY PARTICULAR FONT, STYLE, SIZE, OR COLOR.

FOR HATS; SHIRTS; SWEAT SHIRTS (U.S. CLS. 22 AND 39).

MARY ROSSMAN, EXAMINING ATTORNEY

SN 77-890,947. HANSON, AIMEE, MENDOCINO, CA. FILED 12-10-2009.

**HALF BAKED IN MENDOCINO
...WHERE IT'S OK TO COOK
WITH A LITTLE POT.**

THE MARK CONSISTS OF STANDARD CHARACTERS WITHOUT CLAIM TO ANY PARTICULAR FONT, STYLE, SIZE, OR COLOR.

NO CLAIM IS MADE TO THE EXCLUSIVE RIGHT TO USE "MENDOCINO", APART FROM THE MARK AS SHOWN.

FOR T-SHIRTS (U.S. CLS. 22 AND 39).

FIRST USE 8-1-2009; IN COMMERCE 9-1-2009.

MATTHEW KLINE, EXAMINING ATTORNEY

SN 77-891,024. PITTMAN, BOBBY, CYPRESS, CA. FILED 12-10-2009.

Realize Clothing

THE MARK CONSISTS OF STANDARD CHARACTERS WITHOUT CLAIM TO ANY PARTICULAR FONT, STYLE, SIZE, OR COLOR.

NO CLAIM IS MADE TO THE EXCLUSIVE RIGHT TO USE "CLOTHING", APART FROM THE MARK AS SHOWN.

FOR HATS; SHORTS; T-SHIRTS (U.S. CLS. 22 AND 39).

COLLEEN KEARNEY, EXAMINING ATTORNEY

CLASS 25—(Continued).

SN 77-891,192. CONTI. WILLIAM L., SAN MACOS, CA.
FILED 12-11-2009.

Respect The Bolt

THE MARK CONSISTS OF STANDARD CHARACTERS
WITHOUT CLAIM TO ANY PARTICULAR FONT, STYLE,
SIZE, OR COLOR.

FOR T-SHIRTS (U.S. CLS. 22 AND 39).
MICHAEL GAAFAR, EXAMINING ATTORNEY

CLASS 25—(Continued).

SN 77-891,297. ALEXANDER, LONNIE, RAPID CITY, SD.
FILED 12-11-2009.



THE MARK CONSISTS OF A FIVE POINT STAR WITH
THE BOTTOM HALF IMPOSED OVER A CURVED BAND.
FOR CAPS; JACKETS; PANTS; SHIRTS; SHOES;
SHORTS (U.S. CLS. 22 AND 39).

TARAH HARDY, EXAMINING ATTORNEY

SN 77-891,246. QUICKSWIFT LIMITED, ROAD TOWN,
TORTOLA, BR.VIRGIN ISLANDS, FILED 12-11-2009.



THE MARK CONSISTS OF THREE CIRCLES JOINED
TOGETHER. THERE IS A FOURTH COMPLETE CIRCLE
THAT IS INDEPENDENT OF THE OTHER THREE CIRCLES.

FOR T-SHIRTS, SHORTS, SWEATPANTS, WARM-UP
PANTS, SWIMWEAR, PANTS, JACKETS, JEANS,
SHIRTS, TANK TOPS, SWEATERS, SWEATSHIRTS,
TOPS, BOTTOMS, HEADWEAR AND FOOTWEAR (U.S.
CLS. 22 AND 39).

JORDAN BAKER, EXAMINING ATTORNEY

SN 77-891,358. FORGAY, MATTHEW, MORENO VALLEY,
CA. FILED 12-11-2009.

WALKENHURST

THE MARK CONSISTS OF STANDARD CHARACTERS
WITHOUT CLAIM TO ANY PARTICULAR FONT, STYLE,
SIZE, OR COLOR.

FOR HATS; T-SHIRTS (U.S. CLS. 22 AND 39).
TINA MAI, EXAMINING ATTORNEY

SN 77-891,249. QUICKSWIFT LIMITED, ROAD TOWN,
TORTOLA, BR.VIRGIN ISLANDS, FILED 12-11-2009.

AMBIGUOUS

THE MARK CONSISTS OF STANDARD CHARACTERS
WITHOUT CLAIM TO ANY PARTICULAR FONT, STYLE,
SIZE, OR COLOR.

FOR T-SHIRTS, SHORTS, SWEATPANTS, WARM-UP
PANTS, SWIMWEAR, PANTS, JACKETS, JEANS,
SHIRTS, TANK TOPS, SWEATERS, SWEATSHIRTS,
TOPS, BOTTOMS, HEADWEAR AND FOOTWEAR (U.S.
CLS. 22 AND 39).

JORDAN BAKER, EXAMINING ATTORNEY

SN 77-891,365. RUIZ, MADELYN, BRONX, NY. FILED 12-11-
2009.

NUKLEKTIK

THE MARK CONSISTS OF STANDARD CHARACTERS
WITHOUT CLAIM TO ANY PARTICULAR FONT, STYLE,
SIZE, OR COLOR.

FOR GLOVES; HATS; HOODED SWEAT SHIRTS;
JACKETS; PANTS; SHIRTS; SHOES; SWEATERS (U.S.
CLS. 22 AND 39).

CIMMERIAN COLEMAN, EXAMINING ATTORNEY

CLASS 25—(Continued).

SN 77-891,368. A.S. KING GROUP, WARREN, PA. FILED 12-11-2009.

Protect Your Junk

THE MARK CONSISTS OF STANDARD CHARACTERS WITHOUT CLAIM TO ANY PARTICULAR FONT, STYLE, SIZE, OR COLOR.

FOR SHORT-SLEEVED OR LONG-SLEEVED T-SHIRTS; T-SHIRTS (U.S. CLS. 22 AND 39).

FIRST USE 9-1-2009; IN COMMERCE 11-26-2009.
CIMMERIAN COLEMAN, EXAMINING ATTORNEY

SN 77-891,372. TERRY, CRAIG, NORTHRIDGE, CA. FILED 12-11-2009.

ParaPunk

THE MARK CONSISTS OF STANDARD CHARACTERS WITHOUT CLAIM TO ANY PARTICULAR FONT, STYLE, SIZE, OR COLOR.

THE ENGLISH TRANSLATION OF "PARA" IN THE MARK IS "FOR".

FOR HATS; JACKETS; PANTS; SHIRTS; SHOES; SOCKS; SWEATBANDS (U.S. CLS. 22 AND 39).

FIRST USE 11-0-2009; IN COMMERCE 11-0-2009.
CIMMERIAN COLEMAN, EXAMINING ATTORNEY

SN 77-891,375. FJMJ ADMINISTRADORA DE BENS E PARTICIPAÇÕES LTDA, SANTA CATARINA, BRAZIL, FILED 12-11-2009.

naguchi

THE MARK CONSISTS OF THE "NAGUCHI" IN STYLIZED LETTERS.

THE WORDING "NAGUCHI" HAS NO MEANING IN A FOREIGN LANGUAGE.

FOR DRESSES; HEADGEAR, NAMELY, HATS AND CAPS; HEADWEAR; JACKETS; LINGERIE; PANTS; PANTYHOSE; SCARVES; SHIRTS; SHOES; SHORTS; SKIRTS; SOCKS; SWEATERS; T-SHIRTS; UNDERWEAR (U.S. CLS. 22 AND 39).

CIMMERIAN COLEMAN, EXAMINING ATTORNEY

CLASS 25—(Continued).

SN 77-891,427. MUIRHEAD, TODD, STONE MOUNTAIN, GA. FILED 12-11-2009.



Outdoor Collection
STANDING PINE

NO CLAIM IS MADE TO THE EXCLUSIVE RIGHT TO USE "OUTDOOR COLLECTION", APART FROM THE MARK AS SHOWN.

THE COLOR(S) BLACK, BROWN, AND TAN IS/ARE CLAIMED AS A FEATURE OF THE MARK.

THE MARK CONSISTS OF THE PINE TREE IS HALF BROWN AND HALF BLACK IN FRONT OF A TAN MOON. STANDING PINE WORDS ARE IN BLACK WITH A BROWN PINE CONE DOTTING THE "I" IN PINE. OUTDOOR COLLECTION IS IN BROWN.

FOR ATHLETIC APPAREL, NAMELY, SHIRTS, PANTS, JACKETS, FOOTWEAR, HATS AND CAPS, ATHLETIC UNIFORMS; CAMOUFLAGE PANTS; CAMOUFLAGE SHIRTS; CAMP SHIRTS; HOODED SWEAT SHIRTS; HUNTING PANTS; HUNTING SHIRTS; LONG-SLEEVED SHIRTS; LOUNGE PANTS; MOISTURE-WICKING SPORTS PANTS; MOISTURE-WICKING SPORTS SHIRTS; NIGHT SHIRTS; OVER SHIRTS; PANTS; SHIRTS; SHIRTS AND SHORT-SLEEVED SHIRTS; SHIRTS FOR INFANTS, BABIES, TODDLERS AND CHILDREN; SHORT-SLEEVED OR LONG-SLEEVED T-SHIRTS; SHORT-SLEEVED SHIRTS; SPORTS PANTS; SPORTS SHIRTS; SPORTS SHIRTS WITH SHORT SLEEVES; STRETCH PANTS; SWEAT PANTS; SWEAT SHIRTS; T-SHIRTS; TEE SHIRTS; TURTLE NECK SHIRTS; WATERPROOF JACKETS AND PANTS; WEARABLE GARMENTS AND CLOTHING, NAMELY, SHIRTS (U.S. CLS. 22 AND 39).

SUSAN RICHARDS, EXAMINING ATTORNEY

SN 77-891,434. GRAA INNOVATIONS, LLC, LAS VEGAS, NV, FILED 12-11-2009.

WEAK LEGS COMMAND STRONG
LEGS OBEY

THE MARK CONSISTS OF STANDARD CHARACTERS WITHOUT CLAIM TO ANY PARTICULAR FONT, STYLE, SIZE, OR COLOR.

FOR FOOTWEAR (U.S. CLS. 22 AND 39).

CIMMERIAN COLEMAN, EXAMINING ATTORNEY

CLASS 25—(Continued).

SN 77-891,458. MCGUIRE, GARY FORD, MURFREESBORO, TN. FILED 12-11-2009.

DULL GUY

THE MARK CONSISTS OF STANDARD CHARACTERS WITHOUT CLAIM TO ANY PARTICULAR FONT, STYLE, SIZE, OR COLOR.

FOR PANTS; SHIRTS (U.S. CLS. 22 AND 39).
GEORGE LORENZO, EXAMINING ATTORNEY

SN 77-891,463. GRAA INNOVATIONS, LLC, LAS VEGAS, NV. FILED 12-11-2009.

PLAN YOUR WORK WORK YOUR PLAN

THE MARK CONSISTS OF STANDARD CHARACTERS WITHOUT CLAIM TO ANY PARTICULAR FONT, STYLE, SIZE, OR COLOR.

FOR FOOTWEAR (U.S. CLS. 22 AND 39).
CIMMERIAN COLEMAN, EXAMINING ATTORNEY

SN 77-891,475. MCGUIRE, GARY FORD, MURFREESBORO, TN. FILED 12-11-2009.

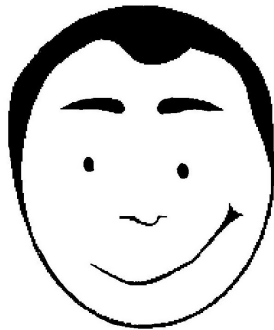

THE MARK CONSISTS OF A CARTOON-LIKE DRAWING OF A MAN'S FACE.
FOR PANTS; SHIRTS (U.S. CLS. 22 AND 39).
GEORGE LORENZO, EXAMINING ATTORNEY

CLASS 25—(Continued).

SN 77-891,542. MVL RIGHTS LLC, MANHATTAN BEACH, CA. FILED 12-11-2009.



OWNER OF U.S. REG. NOS. 885,486, 3,282,768 AND OTHERS.

THE MARK CONSISTS OF A CIRCULAR DESIGN WITH THE WORDS "AVENGERS ASSEMBLE" AND TWO FIVE-POINTED STARS SURROUNDING A SMALLER CIRCLE CONTAINING THE IMAGE OF AN EAGLE WITH OUTSPREAD WINGS AND A SHIELD AT THE CENTER WITH STRIPES AND STARS ON THE SHIELD.

FOR BEACH SHOES; BELTS; BOOTS; CAPS; COATS; GLOVES; HALLOWEEN COSTUMES; HALLOWEEN COSTUMES AND MASKS SOLD IN CONNECTION THEREWITH; HATS; HEADBANDS; HOODED SWEAT SHIRTS; JACKETS; MASQUERADE COSTUMES AND MASKS SOLD IN CONNECTION THEREWITH; OVERALLS; PANTS; RAINWEAR; ROBES; SANDALS; SCARVES; SHIRTS; SHOES; SHORTS; SLACKS; SLEEPING GARMENTS; SNEAKERS; SOCKS; SUSPENDERS; SWEAT PANTS; SWEAT SHIRTS; SWIM WEAR; T-SHIRTS; TIES; UNDERWEAR; VESTS; VISORS (U.S. CLS. 22 AND 39).

FLORENTINA BLANDU, EXAMINING ATTORNEY

SN 77-891,568. ALL, RAYMOND, APOPKA, FL. FILED 12-11-2009.

JUNGLIST

THE MARK CONSISTS OF STANDARD CHARACTERS WITHOUT CLAIM TO ANY PARTICULAR FONT, STYLE, SIZE, OR COLOR.

FOR CLOTHING, NAMELY, T-SHIRTS, JACKETS AND CAPS (U.S. CLS. 22 AND 39).

GEORGE LORENZO, EXAMINING ATTORNEY

CLASS 25—(Continued).

SN 77-891,574. MVL RIGHTS LLC, MANHATTAN BEACH, CA. FILED 12-11-2009.

HALL OF ARMOR

THE MARK CONSISTS OF STANDARD CHARACTERS WITHOUT CLAIM TO ANY PARTICULAR FONT, STYLE, SIZE, OR COLOR.

FOR BEACH SHOES; BELTS; BOOTS; CAPS; COATS; GLOVES; HALLOWEEN COSTUMES; HALLOWEEN COSTUMES AND MASKS SOLD IN CONNECTION THEREWITH; HATS; HEADBANDS; HOODED SWEAT SHIRTS; JACKETS; MASQUERADE COSTUMES AND MASKS SOLD IN CONNECTION THEREWITH; OVERALLS; PANTS; RAINWEAR; ROBES; SANDALS; SCARVES; SHIRTS; SHOES; SHORTS; SLACKS; SLEEPING GARMENTS; SNEAKERS; SOCKS; SUSPENDERS; SWEAT PANTS; SWEAT SHIRTS; SWIM WEAR; T-SHIRTS; TIES; UNDERWEAR; VESTS; VISORS (U.S. CLS. 22 AND 39).

FLORENTINA BLANDU, EXAMINING ATTORNEY

SN 77-891,721. JACK VICTOR LIMITED, MONTREAL, CANADA, FILED 12-11-2009.

RIVIERA TRAVELER

THE MARK CONSISTS OF STANDARD CHARACTERS WITHOUT CLAIM TO ANY PARTICULAR FONT, STYLE, SIZE, OR COLOR.

OWNER OF U.S. REG. NOS. 229,285, 2,103,661 AND 2,815,714.

FOR DRESS SUITS; JACKETS; PANTS; SPORT COATS (U.S. CLS. 22 AND 39).

STEPHANIE ALI, EXAMINING ATTORNEY

SN 77-891,898. CHOI, JOHNNY CHUN, ARCADIA, CA. FILED 12-11-2009.

AVITUS

THE MARK CONSISTS OF STANDARD CHARACTERS WITHOUT CLAIM TO ANY PARTICULAR FONT, STYLE, SIZE, OR COLOR.

FOR A-SHIRTS; ATHLETIC APPAREL, NAMELY, SHIRTS, PANTS, JACKETS, FOOTWEAR, HATS AND CAPS, ATHLETIC UNIFORMS; BODY SHIRTS; BUT-TON-FRONT ALOHA SHIRTS; CAMOUFLAGE SHIRTS; CAMP SHIRTS; CLOTHING FOR ATHLETIC USE, NAMELY, PADDED SHIRTS; DRESS SHIRTS; FISHING SHIRTS; GOLF PANTS, SHIRTS AND SKIRTS; GOLF SHIRTS; HOODED SWEAT SHIRTS; HUNTING SHIRTS; KNIT SHIRTS (U.S. CLS. 22 AND 39).

GEORGE LORENZO, EXAMINING ATTORNEY

CLASS 25—(Continued).

SN 77-891,951. CHOI, JOHNNY CHUN, ARCADIA, CA. FILED 12-11-2009.



THE MARK CONSISTS OF EMBLEM WITH WINGS COLORED BLACK.

FOR A-SHIRTS; ATHLETIC APPAREL, NAMELY, SHIRTS, PANTS, JACKETS, FOOTWEAR, HATS AND CAPS, ATHLETIC UNIFORMS; BODY SHIRTS; BUT-TON-FRONT ALOHA SHIRTS; CAMOUFLAGE SHIRTS; CAMP SHIRTS; CLOTHING FOR ATHLETIC USE, NAMELY, PADDED SHIRTS; DRESS SHIRTS; FISHING SHIRTS; GOLF PANTS, SHIRTS AND SKIRTS; GOLF SHIRTS; HOODED SWEAT SHIRTS; HUNTING SHIRTS; KNIT SHIRTS (U.S. CLS. 22 AND 39).

FIRST USE 4-15-2007; IN COMMERCE 4-15-2009.
GEORGE LORENZO, EXAMINING ATTORNEY

SN 77-892,184. GOMEZ, FERNANDO NSI, WASHINGTON DC, DC. FILED 12-13-2009.

EROZY

THE MARK CONSISTS OF STANDARD CHARACTERS WITHOUT CLAIM TO ANY PARTICULAR FONT, STYLE, SIZE, OR COLOR.

FOR ATHLETIC APPAREL, NAMELY, SHIRTS, PANTS, JACKETS, FOOTWEAR, HATS AND CAPS, ATHLETIC UNIFORMS (U.S. CLS. 22 AND 39).

JACQUELINE A. LAVINE, EXAMINING ATTORNEY

SN 77-892,357. APOLLO INDUSTRIES LIMITED, HANG-ZHOU, HONG KONG, FILED 12-14-2009.

MOTOCENTRIC

THE MARK CONSISTS OF STANDARD CHARACTERS WITHOUT CLAIM TO ANY PARTICULAR FONT, STYLE, SIZE, OR COLOR.

FOR GLOVES; HATS; HEADWEAR; JACKETS; SHIRTS; TOPS (U.S. CLS. 22 AND 39).

WILLIAM BRECKENFELD, EXAMINING ATTORNEY

CLASS 25—(Continued).

SN 77-892,430. SAMUEL SHAWN KLEMENT, DOTHAN, AL.
FILED 12-14-2009.

HUNTIN' IS GOOD!

THE MARK CONSISTS OF STANDARD CHARACTERS WITHOUT CLAIM TO ANY PARTICULAR FONT, STYLE, SIZE, OR COLOR.

FOR SPORTS CLOTHING, NAMELY, T-SHIRTS, CAPS, SHORTS, WARM-UP SUITS, GOLF SHIRTS, AND SOCKS (U.S. CLS. 22 AND 39).

FIRST USE 6-1-2009; IN COMMERCE 6-1-2009.
DAWN FELDMAN, EXAMINING ATTORNEY

SN 77-892,538. WATERS III, JAMES H., WILMINGTON, NC.
FILED 12-14-2009.

SMART AND WITTY

THE MARK CONSISTS OF STANDARD CHARACTERS WITHOUT CLAIM TO ANY PARTICULAR FONT, STYLE, SIZE, OR COLOR.

FOR CLOTHING, NAMELY, T-SHIRTS, SWEAT SHIRTS, CAPS, AND VISORS (U.S. CLS. 22 AND 39).

FIRST USE 5-6-2008; IN COMMERCE 5-6-2008.
DAVID MILLER, EXAMINING ATTORNEY

SN 77-892,587. KIMBERLY POPOVICH, MCHENRY, IL.
FILED 12-14-2009.

"Please excuse the
noise...Our children are
busy making happy
memories"

THE MARK CONSISTS OF STANDARD CHARACTERS WITHOUT CLAIM TO ANY PARTICULAR FONT, STYLE, SIZE, OR COLOR.

FOR COATS; HATS; JACKETS AND SOCKS; JEANS; SHIRTS; SPORTS JERSEYS; SWEATERS (U.S. CLS. 22 AND 39).

JEAN IM, EXAMINING ATTORNEY

CLASS 25—(Continued).

SN 77-892,626. REDCATS USA, L.P., INDIANAPOLIS, IN.
FILED 12-14-2009.

♥denim 24/7

OWNER OF U.S. REG. NO. 2,921,453.
NO CLAIM IS MADE TO THE EXCLUSIVE RIGHT TO USE "DENIM", APART FROM THE MARK AS SHOWN.

THE MARK CONSISTS OF THE WORD "DENIM" AND THE NUMBERS "24" FOLLOWED BY A SLASH SYMBOL FOLLOWED BY A "7" WITH A HEART SHAPED DESIGN TO THE LEFT OF THE "DENIM 24/7" PHRASE.

FOR BELTS; BLAZERS; BLOUSES; BODY SUITS; CAPRIS; DRESSES; DUSTERS; HATS; JACKETS; JEANS; LEGGINGS; PANTS; SHIRTS; SHOES; SKIRTS; T-SHIRTS; TUNICS (U.S. CLS. 22 AND 39).

SALLY SHIH, EXAMINING ATTORNEY

SN 77-892,770. ADORABLE JUNIOR GARMENTS INC.,
VILLE ST-LAURENT, QU, CANADA, FILED 12-14-2009.

NOVELTI

THE MARK CONSISTS OF STANDARD CHARACTERS WITHOUT CLAIM TO ANY PARTICULAR FONT, STYLE, SIZE, OR COLOR.

FOR MEN'S, WOMEN'S AND CHILDREN'S OUTERWEAR, NAMELY, JACKETS, COATS AND RAINCOATS (U.S. CLS. 22 AND 39).

FIRST USE 12-0-1993; IN COMMERCE 1-0-1996.

LINDA E. BLOHM, EXAMINING ATTORNEY

SN 77-892,875. SHERALVEN ENTERPRISES LTD., COM-
MACK, NY. FILED 12-14-2009.

SMELL ME

THE MARK CONSISTS OF STANDARD CHARACTERS WITHOUT CLAIM TO ANY PARTICULAR FONT, STYLE, SIZE, OR COLOR.

FOR T-SHIRTS (U.S. CLS. 22 AND 39).

KIM SAITO, EXAMINING ATTORNEY

CLASS 25—(Continued).

SN 77-892,934. ZHANG, XIAOMEI, MOUNTAINVIEW, CA.
FILED 12-14-2009.

**CALI
HOLI**

THE MARK CONSISTS OF THE WORDS "CALI HOLI" IN STAGGERED FORMAT.
FOR WEARABLE GARMENTS AND CLOTHING, NAMELY, SHIRTS (U.S. CLS. 22 AND 39).
FIRST USE 12-4-2009; IN COMMERCE 12-9-2009.
MICHELE SWAIN, EXAMINING ATTORNEY

SN 77-892,978. VANS, INC., CYPRESS, CA. FILED 12-14-2009.



THE MARK CONSISTS OF A STYLIZED REPRESENTATION OF THE LETTER "S" IN A BOX.
FOR FOOTWEAR AND CLOTHING, NAMELY, T-SHIRTS, SHIRTS, SWEATSHIRTS, PANTS, SHORTS, DENIM, SWEATER, JACKETS, HATS, CAPS, BEANIES, BELTS, BOXERS, SOCKS, SCARVES (U.S. CLS. 22 AND 39).
FIRST USE 6-1-2005; IN COMMERCE 6-1-2005.
FRED MANDIR, EXAMINING ATTORNEY

SN 77-893,027. FRUIT OF THE LOOM, INC., BOWLING GREEN, KY. FILED 12-14-2009.

FRUIT SPUN

THE MARK CONSISTS OF STANDARD CHARACTERS WITHOUT CLAIM TO ANY PARTICULAR FONT, STYLE, SIZE, OR COLOR.
FOR T-SHIRTS (U.S. CLS. 22 AND 39).
FIRST USE 5-15-2009; IN COMMERCE 5-15-2009.
DOUGLAS LEE, EXAMINING ATTORNEY

CLASS 25—(Continued).

SN 77-893,288. MAURICE R. RUTLEDGE, NORTH LAS VEGAS, NV. FILED 12-14-2009.

PHRESH MYNT

THE MARK CONSISTS OF STANDARD CHARACTERS WITHOUT CLAIM TO ANY PARTICULAR FONT, STYLE, SIZE, OR COLOR.

FOR MENS AND WOMENS CLOTHING, NAMELY, BATHING SUITS, BEACH COVER UPS, BELTS, COATS, DRESSES, HEAD BANDS, JACKETS, JERSEYS, PAJAMAS, PANTS, DENIM JEANS, RAINWEAR, SHIRTS, SHORTS, SKIRTS, SWEAT PANTS, SWEAT SHIRTS, SWEATERS, SWIM SUITS, T-SHIRTS, TANK TOPS, VESTS, WIND-RESISTANT JACKETS, FOOTWEAR, HEADWEAR, UNDERWEAR, NIGHT WEAR, NAMELY, LINGERIE (U.S. CLS. 22 AND 39).
MICHELE SWAIN, EXAMINING ATTORNEY

SN 77-893,336. SILLS ENTERPRISES, DBA HATCHIE BOTTOM OUTDOOR PRODUCTS, JACKSON, TN. FILED 12-14-2009.

SILLSPORT CHEER

THE MARK CONSISTS OF STANDARD CHARACTERS WITHOUT CLAIM TO ANY PARTICULAR FONT, STYLE, SIZE, OR COLOR.

FOR ATHLETIC APPAREL, NAMELY, SHIRTS, PANTS, JACKETS, FOOTWEAR, HATS AND CAPS, ATHLETIC UNIFORMS (U.S. CLS. 22 AND 39).
FIRST USE 3-1-2009; IN COMMERCE 3-30-2009.
LINDA E. BLOHM, EXAMINING ATTORNEY

SN 77-893,691. RAHIMZADEH, BARDIA, OCEANSIDE, CA. FILED 12-15-2009.

TRUE HONOR

THE MARK CONSISTS OF STANDARD CHARACTERS WITHOUT CLAIM TO ANY PARTICULAR FONT, STYLE, SIZE, OR COLOR.

FOR BEANIES; BELTS; BOARD SHORTS; GLOVES; HATS; JACKETS; JUMPSUITS; PANTS; SCARVES; SHIRTS; SHOES; SHORTS; SOCKS; SWEAT PANTS; SWEAT SHIRTS; SWIM TRUNKS; TANK TOPS; UNDERWEAR (U.S. CLS. 22 AND 39).
FIRST USE 7-7-2007; IN COMMERCE 7-7-2007.
THEODORE MCBRIDE, EXAMINING ATTORNEY

CLASS 25—(Continued).

SN 77-893,695. JACK VICTOR LIMITED, MONTREAL, CANADA, FILED 12-15-2009.

RR
RIVIERA
TRAVELER

OWNER OF U.S. REG. NOS. 229,285, 2,103,661 AND 2,815,714.

THE MARK CONSISTS OF ONE STYLIZED, BACKWARDS CAPITAL "R" AND ONE STYLIZED CAPITAL "R" OVER A LINE, UNDER WHICH CONTAINS THE STYLIZED WORD "RIVIERA", WHICH IS OVER THE STYLIZED WORD "TRAVELER".

FOR DRESS SUITS; JACKETS; PANTS; SPORTS COATS (U.S. CLS. 22 AND 39).
STEPHANIE ALI, EXAMINING ATTORNEY

CLASS 25—(Continued).

SN 77-894,049. EXACT SCIENCE PRODUCTIONS LLC, SAN FRANCISCO, CA. FILED 12-15-2009.



THE MARK CONSISTS OF A SKULL WITH CROSS-BONES WEARING HEADPHONES.

FOR HEADWEAR; SHIRTS; SWEAT SHIRTS (U.S. CLS. 22 AND 39).

GEORGE LORENZO, EXAMINING ATTORNEY

SN 77-894,187. FOGLIA, JOSEPH, CORAL SPRINGS, FL. FILED 12-15-2009.

BULLETLUES

THE MARK CONSISTS OF STANDARD CHARACTERS WITHOUT CLAIM TO ANY PARTICULAR FONT, STYLE, SIZE, OR COLOR.

FOR BELTS; JEANS (U.S. CLS. 22 AND 39).

DOMINIC J. FERRAIUOLO, EXAMINING ATTORNEY

SN 77-893,989. THE TRUSTEES OF THE DOUGLAS A. MARCHISELLO TRUST, A MISSOURI TRUST, COMPRISING DOUGLAS A. MARCHISELLO, A CITIZEN OF THE UNITED STATES, KANSAS CITY, MO. FILED 12-15-2009.

MOUNTAINAIRE

THE MARK CONSISTS OF STANDARD CHARACTERS WITHOUT CLAIM TO ANY PARTICULAR FONT, STYLE, SIZE, OR COLOR.

FOR T-SHIRTS, LONG-SLEEVED T-SHIRTS, SWEATSHIRTS, POLO SHIRTS, RUGBY SHIRTS, WOVEN SHIRTS, JEANS, CASUAL PANTS, SHORTS, DRESS PANTS, JACKETS, BLAZERS, VESTS, TOP COATS, SKIRTS, SWIM WEAR, TANK TOPS, SWEATERS, AND HEADWEAR FOR MEN, WOMEN, AND CHILDREN (U.S. CLS. 22 AND 39).

GEOFFREY FOSDICK, EXAMINING ATTORNEY

SN 77-894,422. PHI KAPPA THETA FRATERNITY, CARMEL, IN. FILED 12-16-2009.



OWNER OF U.S. REG. NOS. 1,612,875, 3,253,649 AND OTHERS.

THE MARK CONSISTS OF A COAT OF ARMS DESIGN WITHIN WHICH IS A DESIGN OF A TEMPLE, SUN, EMBATTLED WALL AND THREE GENERALLY-SHAPED

CLASS 25—(Continued).

OVAL FIGURES. A DESIGN OF A HELMET IS DEPICTED ON TOP OF THE COAT OF ARMS. THE COAT OF ARMS IS SUPERIMPOSED OVER A CROSSED SWORD AND SHOVEL. A BRANCH OF LEAVES CREATES A BORDER OVER THE TOP HALF OF THE COAT OF ARMS. THE GREEK ALPHABET LETTER RHO IS SUPERIMPOSED OVER THE GREEK ALPHABET LETTER CHI AT THE TOP OF THE MARK, WITH RAYS EMITTING THEREFROM. THE GREEK WORDS "PHI KAPPA THETA" ARE DEPICTED BENEATH THE COAT OF ARMS WITHIN A BANNER.

THE WORDING "PHI KAPPA THETA" IDENTIFY LETTERS OF THE GREEK ALPHABET.

FOR HEADWEAR; SHIRTS; SWEAT SHIRTS (U.S. CLS. 22 AND 39).

FIRST USE 0-0-1970; IN COMMERCE 0-0-1970.

KATHERINE STOIDES, EXAMINING ATTORNEY

SN 77-894,468. KELGRO INCORPORATED, WOODLAND HILLS, CA. FILED 12-16-2009.



NO CLAIM IS MADE TO THE EXCLUSIVE RIGHT TO USE "LOS ANGELES", APART FROM THE MARK AS SHOWN.

THE COLOR BLACK REPRESENTS BACKGROUND AND IS NOT A PART OF THE MARK.

FOR BELTS; CAPS; CARDIGANS; COATS; DRESSES; FLIP FLOPS; HATS; HOODED SWEAT SHIRTS; JACKETS; SCARVES; SHIRTS AND SHORT-SLEEVED SHIRTS; SHOES; SHORT-SLEEVED OR LONG-SLEEVED T-SHIRTS; SHORTS; SWEAT PANTS; SWEAT SHIRTS; SWEATERS; SWIMSUITS; TANK TOPS; THERMAL UNDERWEAR; TUNICS; WRAPS (U.S. CLS. 22 AND 39).

SUSAN RICHARDS, EXAMINING ATTORNEY

SN 77-894,670. THE VERMONT TEDDY BEAR COMPANY, INC., SHELBURNE, VT. FILED 12-16-2009.



NO CLAIM IS MADE TO THE EXCLUSIVE RIGHT TO USE "SNUGGLE SUIT", APART FROM THE MARK AS SHOWN.

THE MARK CONSISTS OF A CLOUD SHAPE WITH "SNUGGLE SUIT" WITHIN THE CLOUD SHAPE.

FOR LOUNGEWEAR (U.S. CLS. 22 AND 39).

KIMBERLY FRYE, EXAMINING ATTORNEY

CLASS 25—(Continued).

SN 77-895,756. BRADBURN, MICHAEL E., CAMARILLO, CA. AND BRADBURN, MARIA YOLANDA, CAMARILLO, CA. FILED 12-17-2009.



THE MARK CONSISTS OF A STYLIZED DEPICTION OF A BOXING GLOVE CONTAINING A PARTIAL CUT-OUT OF THE PAD EXPOSING 2 FINGERS, AND LACES PARTIALLY LACED WITH THE ENDS TRAILING BELOW THE GLOVE.

FOR JACKETS; SHIRTS; SHORTS; SWEAT PANTS; SWEAT SHIRTS; T-SHIRTS (U.S. CLS. 22 AND 39).

MARY CRAWFORD, EXAMINING ATTORNEY

SN 77-896,094. MEC APPAREL GROUP INC., MIAMI, FL. FILED 12-17-2009.

VIA RAGAZZA

THE MARK CONSISTS OF STANDARD CHARACTERS WITHOUT CLAIM TO ANY PARTICULAR FONT, STYLE, SIZE, OR COLOR.

NO CLAIM IS MADE TO THE EXCLUSIVE RIGHT TO USE "RAGAZZA", APART FROM THE MARK AS SHOWN. THE ENGLISH TRANSLATION OF "VIA RAGAZZA" IN THE MARK IS "GIRL STREET" OR "WOMAN STREET".

FOR DRESS SHIRTS; JACKETS; PANTS; POLO SHIRTS; SHIRTS; SHORTS; SPORT SHIRTS; SWEATERS; T-SHIRTS; UNDERWEAR (U.S. CLS. 22 AND 39).

AARON BRODSKY, EXAMINING ATTORNEY

SN 77-896,853. GSG INC., MONTPELIER, VT. FILED 12-18-2009.

DOUBLE DIAMOND

THE MARK CONSISTS OF STANDARD CHARACTERS WITHOUT CLAIM TO ANY PARTICULAR FONT, STYLE, SIZE, OR COLOR.

FOR CLOTHING FOR ATHLETIC USE, NAMELY, VESTS, HATS, GAITERS, JACKETS, SHIRTS, PANTS, GLOVES AND MITTENS SUITABLE FOR SKIING (U.S. CLS. 22 AND 39).

BERNICE MIDDLETON, EXAMINING ATTORNEY

CLASS 25—(Continued).

SN 77-896,859. LEONE, MATTHEW, EAST NORTHPORT, NY. FILED 12-18-2009.

Be Perfect

THE MARK CONSISTS OF STANDARD CHARACTERS WITHOUT CLAIM TO ANY PARTICULAR FONT, STYLE, SIZE, OR COLOR.

FOR ATHLETIC APPAREL, NAMELY, SHIRTS, PANTS, JACKETS, FOOTWEAR, HATS AND CAPS, ATHLETIC UNIFORMS (U.S. CLS. 22 AND 39).
SUNG IN, EXAMINING ATTORNEY

SN 77-897,650. TERRY, PSYCHELIA V., DBA PSYCHE INSPIRED, LAS VEGAS, NV. FILED 12-19-2009.

URBAN INTIMATES LINGERIE

THE MARK CONSISTS OF STANDARD CHARACTERS WITHOUT CLAIM TO ANY PARTICULAR FONT, STYLE, SIZE, OR COLOR.

NO CLAIM IS MADE TO THE EXCLUSIVE RIGHT TO USE "INTIMATES LINGERIE", APART FROM THE MARK AS SHOWN.

FOR CLOTHING, NAMELY, LINGERIE (U.S. CLS. 22 AND 39).
BARBARA A. GOLD, EXAMINING ATTORNEY

SN 77-898,213. GERSON & GERSON, INC., NEW YORK, NY. FILED 12-21-2009.



NO CLAIM IS MADE TO THE EXCLUSIVE RIGHT TO USE "GIRLS DRESS SHOP", APART FROM THE MARK AS SHOWN.

THE MARK CONSISTS OF THE WORD "GIRLSDRESS-SHOP" IN STYLIZED LETTERING AND HANGER DESIGN. FOR GIRLS' DRESSES, SLIPS AND PETTICOATS (U.S. CLS. 22 AND 39).

FIRST USE 7-0-2006; IN COMMERCE 7-0-2006.
JOHN DWYER, EXAMINING ATTORNEY

CLASS 25—(Continued).

SN 77-898,382. EDUARDO BAYAO, DBA RICSSEN, SAN DIEGO, CA. FILED 12-21-2009.

Funny Slippers by Ricsen

THE MARK CONSISTS OF STANDARD CHARACTERS WITHOUT CLAIM TO ANY PARTICULAR FONT, STYLE, SIZE, OR COLOR.

NO CLAIM IS MADE TO THE EXCLUSIVE RIGHT TO USE "SLIPPERS", APART FROM THE MARK AS SHOWN. FOR FOOTWEAR; SLIPPERS (U.S. CLS. 22 AND 39).
FIRST USE 10-0-2009; IN COMMERCE 10-0-2009.
ALICE BENMAMAN, EXAMINING ATTORNEY

SN 77-898,793. REDCATS USA, L.P., INDIANAPOLIS, IN. FILED 12-22-2009.

DREAMS & CO.

THE MARK CONSISTS OF STANDARD CHARACTERS WITHOUT CLAIM TO ANY PARTICULAR FONT, STYLE, SIZE, OR COLOR.

OWNER OF U.S. REG. NO. 2,805,755.
FOR BOXER BRIEFS; BRAS; BRIEFS; PANTIES; SLIPPER SOCKS (U.S. CLS. 22 AND 39).
SALLY SHIH, EXAMINING ATTORNEY

SN 77-900,908. CHILSON ENTERPRISES, INC., IRVING, TX. FILED 12-24-2009.

WWS2012 WE WILL SURVIVE 2012

THE MARK CONSISTS OF STANDARD CHARACTERS WITHOUT CLAIM TO ANY PARTICULAR FONT, STYLE, SIZE, OR COLOR.

FOR CLOTHING, NAMELY, HATS, BALL CAPS, KNIT CAPS, SHIRTS, TOPS, VESTS, BLOUSES, SWEATERS, SWEATSHIRTS, SHORTS, SKIRTS, PANTS, TROUSERS, SLACKS, OVERALLS, JEANS, SWEATPANTS, DRESSES, FOOTWEAR, SOCKS, STOCKINGS, TIGHTS, PANTY-HOSE, SCARVES, TIES, SUSPENDERS, GLOVES, BELTS, SLIPPERS, COATS, JACKETS, PARKAS, WIND RESISTANT JACKETS, UNDERWEAR, LOUNGING PANTS AND TOPS, PAJAMAS, LONG UNDERWEAR, ROBES, MENS BRIEFS AND BOXERS, LEATHER PANTS, LEATHER COATS, LEATHER TOPS, LEATHER SKIRTS, LEATHER DRESSES, LEATHER VESTS, AND UNIFORMS, NAMELY, UNIFORM SLACKS, UNIFORM SHIRTS, UNIFORM JACKETS, AND UNIFORM SWEATERS (U.S. CLS. 22 AND 39).

SHAUNIA CARLYLE, EXAMINING ATTORNEY

CLASS 25—(Continued).

SN 77-901,134. ABUTIN, RABESPIERRE, AKA LEONARDO ABUTIN, JR, KENT, WA. FILED 12-27-2009.

KAPITAN KIDLAT

THE MARK CONSISTS OF STANDARD CHARACTERS WITHOUT CLAIM TO ANY PARTICULAR FONT, STYLE, SIZE, OR COLOR.

THE ENGLISH TRANSLATION OF "KAPITAN KIDLAT" IN THE MARK IS "CAPTAIN LIGHTNING".

FOR SPORTS SHIRTS; T-SHIRTS (U.S. CLS. 22 AND 39).

JASON LOTT, EXAMINING ATTORNEY

SN 77-902,114. PROPÉT GLOBAL LIMITED, AUBURN, WA. FILED 12-29-2009.

WEATHERWALKER

THE MARK CONSISTS OF STANDARD CHARACTERS WITHOUT CLAIM TO ANY PARTICULAR FONT, STYLE, SIZE, OR COLOR.

FOR FOOTWEAR (U.S. CLS. 22 AND 39).

FIRST USE 1-0-2004; IN COMMERCE 9-0-2004.

TRICIA SONNEBORN, EXAMINING ATTORNEY

SN 77-905,752. REDCATS USA, L.P., INDIANAPOLIS, IN. FILED 1-6-2010.

SEAM SCIENCE

THE MARK CONSISTS OF STANDARD CHARACTERS WITHOUT CLAIM TO ANY PARTICULAR FONT, STYLE, SIZE, OR COLOR.

FOR DRESSES; T-SHIRTS; TOPS (U.S. CLS. 22 AND 39).

SALLY SHIH, EXAMINING ATTORNEY

CLASS 25—(Continued).

SN 77-906,843. SPORTY MOMMAS, PINECREST, FL. FILED 1-7-2010.

SPORTY MOMMAS

THE MARK CONSISTS OF STANDARD CHARACTERS WITHOUT CLAIM TO ANY PARTICULAR FONT, STYLE, SIZE, OR COLOR.

NO CLAIM IS MADE TO THE EXCLUSIVE RIGHT TO USE "SPORTY", APART FROM THE MARK AS SHOWN.

FOR BANDANAS; LINGERIE; PANTS; SHIRTS (U.S. CLS. 22 AND 39).

FIRST USE 11-7-2009; IN COMMERCE 11-7-2009.

WENDY GOODMAN, EXAMINING ATTORNEY

SN 77-910,479. NYBC LLC, NORTH BRUNSWICK, NJ. FILED 1-12-2010.

D2D
DARE 2 DIFFER

THE MARK CONSISTS OF THE LITERAL ELEMENT "D2D" WITH A VERTICAL LINE APPEARING IN THE MIDDLE OF THE NUMBER "2", WHICH APPEARS DIRECTLY ABOVE THE TEXT "DARE 2 DIFFER".

FOR COATS; HATS; JACKETS; JEANS; PANTS; SHIRTS; SWEAT PANTS; SWEAT SHIRTS; TEE SHIRTS; UNDERWEAR (U.S. CLS. 22 AND 39).

DAVID COLLIER, EXAMINING ATTORNEY

SN 77-910,678. INTERNATIONAL INTIMATES INC., NEW YORK, NY. FILED 1-13-2010.

Suite
800

THE MARK CONSISTS OF "SUITE 800" IN STYLIZED FONT TYPE.

FOR CLOTHING AND APPAREL, NAMELY, UNDERGARMENTS, LINGERIE AND SLEEPWEAR (U.S. CLS. 22 AND 39).

DORITT L. CARROLL, EXAMINING ATTORNEY

CLASS 25—(Continued).

SN 77-910,686. INTERNATIONAL INTIMATES INC., NEW YORK, NY. FILED 1-13-2010.

SUITE 800

THE MARK CONSISTS OF STANDARD CHARACTERS WITHOUT CLAIM TO ANY PARTICULAR FONT, STYLE, SIZE, OR COLOR.

FOR CLOTHING AND APPAREL, NAMELY, UNDERGARMENTS, LINGERIE AND SLEEPWEAR (U.S. CLS. 22 AND 39).

DORITT L. CARROLL, EXAMINING ATTORNEY

SN 77-913,037. DANSKO, LLC, WEST GROVE, PA. FILED 1-15-2010.

DANSKO

THE MARK CONSISTS OF STANDARD CHARACTERS WITHOUT CLAIM TO ANY PARTICULAR FONT, STYLE, SIZE, OR COLOR.

OWNER OF U.S. REG. NOS. 3,264,216, 3,265,196 AND OTHERS.

FOR SOCKS (U.S. CLS. 22 AND 39).

JENNIFER MARTIN, EXAMINING ATTORNEY

SN 77-915,489. TEXMART LTD., DBA TEXMART LTD., HONG KONG, HONG KONG, FILED 1-20-2010.

7th earl

THE MARK CONSISTS OF STANDARD CHARACTERS WITHOUT CLAIM TO ANY PARTICULAR FONT, STYLE, SIZE, OR COLOR.

FOR BELTS; DRESSES; GLOVES AS CLOTHING; JACKETS; JERSEYS; LEATHER BELTS; PANTS; SCARVES; SHIRTS; SOCKS; STOCKINGS; SWEATERS; TIES; TOPS; WEARABLE GARMENTS AND CLOTHING, NAMELY, SHIRTS (U.S. CLS. 22 AND 39).

KELLEY WELLS, EXAMINING ATTORNEY

CLASS 25—(Continued).

SN 77-919,221. ALEXANDER, LONNIE, RAPID CITY, SD. FILED 1-25-2010.



THE MARK CONSISTS OF THE STYLIZED TEXT "GP" IN OBLIQUE SHAPES.

FOR HATS; JACKETS; PANTS; SHIRTS; SHOES; SOCKS (U.S. CLS. 22 AND 39).

TARAH HARDY, EXAMINING ATTORNEY

SN 77-921,586. SHOES FOR CREWS, LLC, WEST PALM BEACH, FL. FILED 1-27-2010.

STAYFIT

THE MARK CONSISTS OF STANDARD CHARACTERS WITHOUT CLAIM TO ANY PARTICULAR FONT, STYLE, SIZE, OR COLOR.

FOR SLIP RESISTANT FOOTWEAR (U.S. CLS. 22 AND 39).

JOHN DALIER, EXAMINING ATTORNEY

SN 77-930,188. SONS OF THE CONFEDERATE STATES, INC., GAINESVILLE, FL. FILED 2-8-2010.



THE MARK CONSISTS OF THE WORD "MUDBUDDYS" IN STYLIZED FONT WITH DROPLETS TO RESEMBLE MUD FROM THE LETTERS "M", "U", "Y" AND "S".

FOR T-SHIRTS (U.S. CLS. 22 AND 39).

FIRST USE 1-1-2010; IN COMMERCE 1-1-2010.

CARYN GLASSER, EXAMINING ATTORNEY

CLASS 25—(Continued).

SN 77-930,209. COLUMBIA SPORTSWEAR NORTH AMERICA, INC., PORTLAND, OR. FILED 2-8-2010.

BACK HUGGER

THE MARK CONSISTS OF STANDARD CHARACTERS WITHOUT CLAIM TO ANY PARTICULAR FONT, STYLE, SIZE, OR COLOR.

FOR PANTS; SHORTS; SKI PANTS; SKIRTS; SWEAT PANTS (U.S. CLS. 22 AND 39).
LINDA MICKLEBURGH, EXAMINING ATTORNEY

SN 77-930,937. THE VERMONT TEDDY BEAR COMPANY, INC., SHELBURNE, VT. FILED 2-8-2010.

**Pajamas you'll live in.
Jeans you'll sleep in.**

THE MARK CONSISTS OF STANDARD CHARACTERS WITHOUT CLAIM TO ANY PARTICULAR FONT, STYLE, SIZE, OR COLOR.

FOR LOUNGEWEAR (U.S. CLS. 22 AND 39).
FIRST USE 12-7-2009; IN COMMERCE 12-7-2009.
KIMBERLY FRYE, EXAMINING ATTORNEY

SN 77-949,385. COLUMBIA SPORTSWEAR NORTH AMERICA, INC., PORTLAND, OR. FILED 3-3-2010.

OMNI-WICK

THE MARK CONSISTS OF STANDARD CHARACTERS WITHOUT CLAIM TO ANY PARTICULAR FONT, STYLE, SIZE, OR COLOR.

FOR COATS; FOOTWEAR; GAITERS; GLOVES; HEADWEAR; JACKETS; MITTENS; PANTS; PARKAS; RAIN SUITS; SCARVES; SHIRTS; SHORTS; SKI BIBS; SKI SUITS; SKIRTS; SOCKS; SWEAT PANTS; SWEAT SUITS; SWEATERS; THERMAL UNDERWEAR; VESTS (U.S. CLS. 22 AND 39).
LINDA MICKLEBURGH, EXAMINING ATTORNEY

CLASS 25—(Continued).

SN 77-979,027. CRYSTAL ROCK OLGA AUDIGIER IRREVOCABLE TRUST, BEVERLY HILLS, CA. FILED 5-4-2009.



OWNER OF U.S. REG. NO. 3,548,146.

THE MARK CONSISTS OF THE WORDS "CRYSTAL ROCK" IN STYLIZED FORM; A STAR IS SUPERIMPOSED ON EACH LETTER "R" IN THE WORDS "CRYSTAL" AND "ROCK"; A REPRESENTATION OF A WING APPEARS IMMEDIATELY UNDER THE WORD "CRYSTAL" AND PRECEDING THE WORD "ROCK".

FOR CLOTHING, NAMELY, SHORTS, DRESSES, SHIRTS, JACKETS, COATS, T-SHIRTS, LONG SLEEVED T-SHIRTS, TANK TOPS, SKIRTS, PANTS, JEANS, SWEATPANTS, SWEATSHORTS, SWEAT JACKETS, HOODED SWEATSHIRTS, LOUNGEWEAR, SWIMWEAR, SWEATERS, LEGGINGS, FOOTWEAR, AND HEADWEAR (U.S. CLS. 22 AND 39).

FIRST USE 12-0-2007; IN COMMERCE 12-0-2007.
ERNEST SHOSHO, EXAMINING ATTORNEY

SN 79-065,005. VENICE BEACH GMBH, FED REP GERMANY, FILED 9-17-2008.



OWNER OF INTERNATIONAL REGISTRATION 0926485 DATED 3-28-2007, EXPIRES 3-28-2017.

OWNER OF U.S. REG. NOS. 2,596,877, 2,710,656 AND 2,763,247.

THE MARK CONSISTS OF THE WORDING "VENICE BEACH" AND A CURVED LINE DESIGN ABOVE THE WORDING.

FOR CLOTHING, NAMELY, TOPS, SHIRTS, T-SHIRTS, POLO SHIRTS, SPORT SHIRTS, SPORTS JERSEYS, JACKETS, SWEATERS, PANTS, YOGA PANTS, LEGGINGS, SPORT TROUSERS, EXERCISE SHORTS, SHORTS, SKIRTS, DRESSES, JOGGING SUITS, LOUNGE SUITS, SHOULDER WRAPS, BELTS, SOCKS, LEG WARMERS, SWIMSUITS, BIKINIS, SWIM SHORTS, BATHROBES, SPORTS GLOVES, NAMELY, BICYCLING GLOVES, HEAD SCARVES, NIGHTWEAR AND UNDERWEAR; FOOTWEAR, NAMELY, SPORTING FOOTWEAR, SHOES, SLIPPERS, BEACH SLIPPERS, HEADGEAR, NAMELY, VISORS AND CAPS (U.S. CLS. 22 AND 39).

SHARON MEIER, EXAMINING ATTORNEY

CLASS 25—(Continued).

SN 79-067,867. CALZATURIFICIO SPRING S.R.L., ITALY, FILED 12-16-2008.

MARIO BRUNI

OWNER OF INTERNATIONAL REGISTRATION 0754049 DATED 1-31-2001, EXPIRES 1-31-2011.

OWNER OF U.S. REG. NO. 1,591,035.

THE NAME(S), PORTRAIT(S), AND/OR SIGNATURE(S) SHOWN IN THE MARK DOES NOT IDENTIFY A PARTICULAR LIVING INDIVIDUAL.

THE MARK CONSISTS OF THE STYLIZED PHRASE "MARIO BRUNI" WITH A SINGLE HORIZONTAL BAR ABOVE THE LETTERS ARI0 IN "MARIO" AND A SINGLE HORIZONTAL BAR ABOVE THE LETTERS RUNI IN "BRUNI" WHEREIN THE HORIZONTAL BARS LINE UP WITH THE TOPS OF THE LETTERS M AND B, RESPECTIVELY

FOR CLOTHING, NAMELY, SWEATERS, CARDIGANS, SUITS, TROUSERS, SHORTS, JUMPERS, RAINCOATS, STOCKINGS AND SOCKS, GARTER BELTS, SKI-TROUSERS, FUR COATS, OVERCOATS, JACKETS, SKIRTS, DRESSES, UNDERSHIRTS, T-SHIRTS, SPORT T-SHIRTS, BLOUSES, SHIRT-COLLARS, SHIRTS, FOU-LARDS, BEACHWEAR, SWIMSUITS, BIKINI, TRACK SUITS, UNDERWEAR, BRAS, BRASSIERES, CORSETS, PETTICOATS, BRIEFS AND BIKINI BRIEFS, VESTS, NIGHTGOWNS, NEGLIGEEES, PYJAMAS, GLOVES, SHAWLS, SCARVES, NECKTIES, BOW TIES, BELTS, SUSPENDERS, FOOTWEAR AND HEADGEAR, NAMELY, HATS AND CAPS (U.S. CLS. 22 AND 39).

MYRIAH HABEEB, EXAMINING ATTORNEY

SN 79-070,335. ADIVON SPORTING GOODS (CHINA) CO., LTD., FUJIAN, CHINA, FILED 6-16-2009.

adivon

OWNER OF INTERNATIONAL REGISTRATION 1006310 DATED 6-16-2009, EXPIRES 6-16-2019.

FOR CLOTHING, NAMELY, LAYETTES, BATHING SUITS; FOOTBALL SHOES; SHOES; HATS; HOSIERY; GLOVES; NECKTIES; BELTS (U.S. CLS. 22 AND 39).

JAY FLOWERS, EXAMINING ATTORNEY

CLASS 25—(Continued).

SN 79-072,472. PROFEET GMBH, FED REP GERMANY, FILED 6-22-2009.



OWNER OF INTERNATIONAL REGISTRATION 1012020 DATED 6-22-2009, EXPIRES 6-22-2019.

THE MARK CONSISTS OF A STYLIZED LETTER "F" FOR CLOTHING, NAMELY, PANTS, JACKETS, SCARVES, SWEAT-SHIRTS, PULLOVERS, SWEATERS; FOOTWEAR; HEADGEAR, NAMELY, HATS AND CAPS; UNDERWEAR MADE OF FUNCTIONAL TEXTILES; AND STOCKINGS AND HEAD SCARVES (U.S. CLS. 22 AND 39).

DEBRA LEE, EXAMINING ATTORNEY

CLASS 26—FANCY GOODS

SN 76-699,664. THORN, DEBORAH J., MONSON, MA. FILED 9-28-2009.

Klench Fastener

THE MARK CONSISTS OF STANDARD CHARACTERS WITHOUT CLAIM TO ANY PARTICULAR FONT, STYLE, SIZE, OR COLOR.

NO CLAIM IS MADE TO THE EXCLUSIVE RIGHT TO USE "FASTENER", APART FROM THE MARK AS SHOWN.

FOR FASTENER MADE PRIMARILY OF POLYUR-ETHANE FOR AFFIXING BADGES, INSIGNIA AND NAMETAGS TO CLOTHING (U.S. CLS. 37, 39, 40, 42 AND 50).

FIRST USE 11-3-1998; IN COMMERCE 11-3-1998.

JACQUELINE A. LAVINE, EXAMINING ATTORNEY

SN 77-634,446. JEKYL ISLAND STATE PARK AUTHORITY, JEKYL ISLAND, GA. FILED 12-16-2008.

GEORGIA SEA TURTLE CENTER

THE MARK CONSISTS OF STANDARD CHARACTERS WITHOUT CLAIM TO ANY PARTICULAR FONT, STYLE, SIZE, OR COLOR.

NO CLAIM IS MADE TO THE EXCLUSIVE RIGHT TO USE "GEORGIA" AND "CENTER", APART FROM THE MARK AS SHOWN.

FOR EMBROIDERED PATCHES FOR CLOTHING (U.S. CLS. 37, 39, 40, 42 AND 50).

FIRST USE 6-16-2007; IN COMMERCE 6-16-2007.

RONALD DELGIZZI, EXAMINING ATTORNEY

CLASS 26—(Continued).

SN 77-635,628. JEKYLL ISLAND STATE PARK AUTHORITY, JEKYLL ISLAND, GA. FILED 12-18-2008.



NO CLAIM IS MADE TO THE EXCLUSIVE RIGHT TO USE "GEORGIA" AND "CENTER", APART FROM THE MARK AS SHOWN.

THE MARK CONSISTS OF A DESIGN ELEMENT CONSISTING OF A TURTLE-SHAPED FIGURE LOCATED TO THE LEFT OF THE LITERAL ELEMENT CONSISTING OF THE WORDS "GEORGIA SEA TURTLE CENTER" WHERE THE WORD "GEORGIA" APPEARS ABOVE THE WORDS "SEA TURTLE", WHICH APPEAR ABOVE THE WORD "CENTER".

FOR EMBROIDERED PATCHES FOR CLOTHING (U.S. CLS. 37, 39, 40, 42 AND 50).
FIRST USE 6-16-2007; IN COMMERCE 6-16-2007.
RONALD DELGIZZI, EXAMINING ATTORNEY

SN 77-743,125. VORTEX, INC., AUSTIN, TX. FILED 5-22-2009.

LEATHERFACE

THE MARK CONSISTS OF STANDARD CHARACTERS WITHOUT CLAIM TO ANY PARTICULAR FONT, STYLE, SIZE, OR COLOR.

FOR BELT BUCKLES, CLOTHING BUCKLES, HAIR BUCKLES, SHOE BUCKLES, STRAP BUCKLES, ALL OF THE FOREGOING BEING PROMOTED IN CONNECTION WITH A POPULAR FICTIONAL MOTION PICTURE CHARACTER (U.S. CLS. 37, 39, 40, 42 AND 50).
MAUREEN DALL, EXAMINING ATTORNEY

SN 77-747,858. LIKE SISTERZ LLC, WEST BLOOMFIELD, MI. FILED 5-29-2009.

BLINGERZ

THE MARK CONSISTS OF STANDARD CHARACTERS WITHOUT CLAIM TO ANY PARTICULAR FONT, STYLE, SIZE, OR COLOR.

FOR DECORATIVE ELEMENTS, NAMELY, SHOE ORNAMENTS NOT OF PRECIOUS METAL (U.S. CLS. 37, 39, 40, 42 AND 50).
FIRST USE 1-1-2008; IN COMMERCE 7-30-2008.
MARLENE BELL, EXAMINING ATTORNEY

CLASS 26—(Continued).

SN 77-752,150. PIA PRODUCTS, INC, HARTSDALE, NY. FILED 6-4-2009.

TENDER TUGS

THE MARK CONSISTS OF STANDARD CHARACTERS WITHOUT CLAIM TO ANY PARTICULAR FONT, STYLE, SIZE, OR COLOR.

FOR CHILDREN'S SAFETY GARMENTS, NAMELY, CHILD RESTRAINING DEVICES IN THE NATURES OF HARNESSSES (U.S. CLS. 37, 39, 40, 42 AND 50).

KHANH LE, EXAMINING ATTORNEY

SN 77-867,717. KAPLAN, LEONORA, PASSAIC, NJ. FILED 11-7-2009.

MAC

THE MARK CONSISTS OF STANDARD CHARACTERS WITHOUT CLAIM TO ANY PARTICULAR FONT, STYLE, SIZE, OR COLOR.

FOR HAIR PIECES AND WIGS (U.S. CLS. 37, 39, 40, 42 AND 50).

FIRST USE 11-1-2006; IN COMMERCE 11-1-2006.
ARETHA SOMERVILLE, EXAMINING ATTORNEY

SN 77-883,840. JAKKS PACIFIC, INC., MALIBU, CA. FILED 12-1-2009.

GIRL GOURMET

THE MARK CONSISTS OF STANDARD CHARACTERS WITHOUT CLAIM TO ANY PARTICULAR FONT, STYLE, SIZE, OR COLOR.

OWNER OF U.S. REG. NOS. 3,573,612 AND 3,573,613.
NO CLAIM IS MADE TO THE EXCLUSIVE RIGHT TO USE GIRL, APART FROM THE MARK AS SHOWN.

FOR HAIR ACCESSORIES, NAMELY, TWISTER, SNAP CLIPS, CLAWCLIPS, JAWCLIPS, RIBBONS AND BRAIDS, RIBBONS FOR WRAPPING, BOWS FOR WRAPPING, TEA COSIES, ELASTIC RIBBONS, FABRIC APPLIQUÉS, SHOE LACES, ORNAMENTAL NOVELTY PINS, BUTTONS, MITTEN CLIPS, BARRETTES, HAIR BANDS, PONYTAIL HOLDERS, ARTIFICIAL FLOWERS (U.S. CLS. 37, 39, 40, 42 AND 50).

CAROLINE WOOD, EXAMINING ATTORNEY

CLASS 26—(Continued).

SN 77-887,461. ONE KNOT HAIRNET LLC, EAST FAIRFIELD, VT. FILED 12-7-2009.

ONE KNOT

THE MARK CONSISTS OF STANDARD CHARACTERS WITHOUT CLAIM TO ANY PARTICULAR FONT, STYLE, SIZE, OR COLOR.

FOR HAIR NETS (U.S. CLS. 37, 39, 40, 42 AND 50).
FIRST USE 6-24-2009; IN COMMERCE 8-10-2009.
INGRID C. EULIN, EXAMINING ATTORNEY

CLASS 26—(Continued).

SN 77-898,868. HALLMARK LICENSING, INC., KANSAS CITY, MO. FILED 12-22-2009.

ONE TOUGH CHICK

THE MARK CONSISTS OF STANDARD CHARACTERS WITHOUT CLAIM TO ANY PARTICULAR FONT, STYLE, SIZE, OR COLOR.

FOR NOVELTY BUTTONS (U.S. CLS. 37, 39, 40, 42 AND 50).
ELIZABETH KAJUBI, EXAMINING ATTORNEY

SN 77-888,627. BEAUTY PLUS TRADING CO., INC., MOONACHIE, NJ. FILED 12-8-2009.

BORN YAKY

THE MARK CONSISTS OF STANDARD CHARACTERS WITHOUT CLAIM TO ANY PARTICULAR FONT, STYLE, SIZE, OR COLOR.

NO CLAIM IS MADE TO THE EXCLUSIVE RIGHT TO USE "YAKY", APART FROM THE MARK AS SHOWN.
FOR HAIR EXTENSIONS AND WIGS (U.S. CLS. 37, 39, 40, 42 AND 50).
KARANENDRA S. CHHINA, EXAMINING ATTORNEY

SN 77-914,033. BEAUTY PLUS TRADING CO., INC., MOONACHIE, NJ. FILED 1-18-2010.

IDEAL COLLECTION

THE MARK CONSISTS OF STANDARD CHARACTERS WITHOUT CLAIM TO ANY PARTICULAR FONT, STYLE, SIZE, OR COLOR.

NO CLAIM IS MADE TO THE EXCLUSIVE RIGHT TO USE "COLLECTION", APART FROM THE MARK AS SHOWN.
FOR HAIR EXTENSIONS AND WIGS (U.S. CLS. 37, 39, 40, 42 AND 50).
KARANENDRA S. CHHINA, EXAMINING ATTORNEY

SN 77-891,244. BEAUTY PLUS TRADING CO., INC., MOONACHIE, NJ. FILED 12-11-2009.

KISS ME

THE MARK CONSISTS OF STANDARD CHARACTERS WITHOUT CLAIM TO ANY PARTICULAR FONT, STYLE, SIZE, OR COLOR.

FOR HAIR EXTENSIONS AND WIGS (U.S. CLS. 37, 39, 40, 42 AND 50).
KARANENDRA S. CHHINA, EXAMINING ATTORNEY

SN 77-914,060. BEAUTY PLUS TRADING CO., INC., MOONACHIE, NJ. FILED 1-18-2010.

WI

THE MARK CONSISTS OF STANDARD CHARACTERS WITHOUT CLAIM TO ANY PARTICULAR FONT, STYLE, SIZE, OR COLOR.

FOR HAIR EXTENSIONS AND WIGS (U.S. CLS. 37, 39, 40, 42 AND 50).
KARANENDRA S. CHHINA, EXAMINING ATTORNEY

CLASS 26—(Continued).

SN 77-914,074. BEAUTY PLUS TRADING CO., INC., MOON-ACHIE, NJ. FILED 1-18-2010.

BEAUTY IS EXPRESSION

THE MARK CONSISTS OF STANDARD CHARACTERS WITHOUT CLAIM TO ANY PARTICULAR FONT, STYLE, SIZE, OR COLOR.

FOR HAIR EXTENSIONS AND WIGS (U.S. CLS. 37, 39, 40, 42 AND 50).

KARANENDRA S. CHHINA, EXAMINING ATTORNEY



SN 77-930,713. HALLMARK LICENSING, INC., KANSAS CITY, MO. FILED 2-8-2010.

SEASONS FROM HALLMARK

THE MARK CONSISTS OF STANDARD CHARACTERS WITHOUT CLAIM TO ANY PARTICULAR FONT, STYLE, SIZE, OR COLOR.

FOR BOWS FOR GIFT WRAPPING; RIBBONS FOR GIFT WRAPPING (U.S. CLS. 37, 39, 40, 42 AND 50).

ELIZABETH KAJUBI, EXAMINING ATTORNEY



CLASS 27—FLOOR COVERINGS

SN 77-149,691. GODFREY HIRST AUSTRALIA PTY LTD., SOUTH GEELONG VICTORIA, AUSTRALIA, FILED 4-5-2007.

GODFREY HIRST A TRADITION OF EXCELLENCE

THE MARK CONSISTS OF STANDARD CHARACTERS WITHOUT CLAIM TO ANY PARTICULAR FONT, STYLE, SIZE, OR COLOR.

OWNER OF AUSTRALIA REG. NO. 1169661, DATED 4-14-2008, EXPIRES 4-2-2017.

"THE NAME(S), PORTRAIT(S), AND/OR SIGNATURE(S) SHOWN IN THE MARK DOES NOT IDENTIFY A PARTICULAR LIVING INDIVIDUAL."

FOR CARPETS, CARPET TILES, FLOOR COVERINGS, CARPET UNDERLAYS; RUGS, FLOOR MATS (U.S. CLS. 19, 20, 37, 42 AND 50).

FIRST USE 1-25-2005; IN COMMERCE 1-25-2005.

NORA BUCHANAN WILL, EXAMINING ATTORNEY

CLASS 27—(Continued).

SN 77-743,204. SWIFF-TRAIN COMPANY, LLC, CORPUS CHRISTI, TX. FILED 5-22-2009.

EARTHWERKS

THE MARK CONSISTS OF STANDARD CHARACTERS WITHOUT CLAIM TO ANY PARTICULAR FONT, STYLE, SIZE, OR COLOR.

OWNER OF U.S. REG. NO. 3,507,558.

FOR CARPETING (U.S. CLS. 19, 20, 37, 42 AND 50).

TINA MAI, EXAMINING ATTORNEY



SN 77-743,213. SWIFF-TRAIN COMPANY, LLC, CORPUS CHRISTI, TX. FILED 5-22-2009.

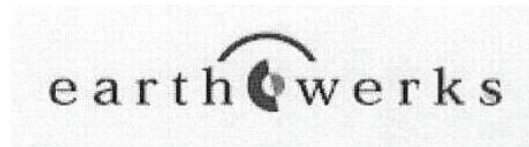

OWNER OF U.S. REG. NO. 3,507,558.

THE MARK CONSISTS OF THE WORD "EARTH" AND "WERKS" SEPARATED BY A CIRCULAR SYMBOL AND AN ARC EXTENDING FROM THE "H" TO THE "W".

FOR CARPETING (U.S. CLS. 19, 20, 37, 42 AND 50).

TINA MAI, EXAMINING ATTORNEY



SN 77-883,508. URCUTE ENTERTAINMENT, LLC, BRIDGEPORT, CT. FILED 12-1-2009.

WED CARPET

THE MARK CONSISTS OF STANDARD CHARACTERS WITHOUT CLAIM TO ANY PARTICULAR FONT, STYLE, SIZE, OR COLOR.

FOR ENTERTAINMENT PARTY PACKAGE KITS COMPRISING CARPET AND CONTAINING DECORATIONS, PROPS, AND BACKDROPS TO BE USED FOR ENTERTAINMENT PURPOSES (U.S. CLS. 19, 20, 37, 42 AND 50).

TRICIA SONNEBORN, EXAMINING ATTORNEY

CLASS 27—(Continued).

SN 77-888,147. INTERNATIONAL MARKET ACCESS LIMITED, DBA INTERNATIONAL MARKET ACCESS LIMITED, SHAUKEIWAN, HONG KONG, FILED 12-7-2009.

5TH AVENUE

THE MARK CONSISTS OF STANDARD CHARACTERS WITHOUT CLAIM TO ANY PARTICULAR FONT, STYLE, SIZE, OR COLOR.

FOR CARPETS FOR AUTOMOBILES; FLOOR MATS FOR AUTOMOBILES; FLOOR MATS FOR VEHICLES; VEHICLE CARPETS (U.S. CLS. 19, 20, 37, 42 AND 50).
FIRST USE 10-5-2009; IN COMMERCE 12-1-2009.
JORDAN BAKER, EXAMINING ATTORNEY

SN 77-888,371. MILLIKEN & COMPANY, SPARTANBURG, SC. FILED 12-8-2009.

THE MARK CONSISTS OF LOWER CASE "b" WITH SUPERSCRIP "2".
FOR BACKING FOR CARPET TILE (U.S. CLS. 19, 20, 37, 42 AND 50).
PAUL E. FAHRENKOPF, EXAMINING ATTORNEY

SN 77-888,390. MILLIKEN & COMPANY, SPARTANBURG, SC. FILED 12-8-2009.

THE MARK CONSISTS OF LOWER CASE "b" WITH SUPERSCRIP "2" WITHIN A SQUARE.
FOR BACKING FOR CARPET TILE (U.S. CLS. 19, 20, 37, 42 AND 50).
PAUL E. FAHRENKOPF, EXAMINING ATTORNEY

CLASS 27—(Continued).

SN 77-888,618. INVISTA NORTH AMERICA S.A R.L., WILMINGTON, DE. FILED 12-8-2009.

ECOSOFT

THE MARK CONSISTS OF STANDARD CHARACTERS WITHOUT CLAIM TO ANY PARTICULAR FONT, STYLE, SIZE, OR COLOR.

OWNER OF U.S. REG. NO. 2,700,721.
FOR SYNTHETIC FIBER SOLD AS AN INTEGRAL COMPONENT OF CARPET; CARPETS AND RUGS (U.S. CLS. 19, 20, 37, 42 AND 50).
KELLY BOULTON, EXAMINING ATTORNEY

SN 77-888,994. ARZU, INC., CHICAGO, IL. FILED 12-8-2009.

ARZU

THE MARK CONSISTS OF STANDARD CHARACTERS WITHOUT CLAIM TO ANY PARTICULAR FONT, STYLE, SIZE, OR COLOR.

OWNER OF U.S. REG. NO. 3,056,936.
THE ENGLISH TRANSLATION OF "ARZU" IN THE MARK IS "HOPE".
FOR RUGS (U.S. CLS. 19, 20, 37, 42 AND 50).
FIRST USE 9-0-2003; IN COMMERCE 9-0-2003.
WILLIAM VERHOSEK, EXAMINING ATTORNEY

SN 77-890,525. E. MISHAN & SONS, INC., NEW YORK, NY. FILED 12-10-2009.

GELLINI

THE MARK CONSISTS OF STANDARD CHARACTERS WITHOUT CLAIM TO ANY PARTICULAR FONT, STYLE, SIZE, OR COLOR.

THE WORDING "GELLINI" HAS NO MEANING IN A FOREIGN LANGUAGE.
FOR FLOOR MATS (U.S. CLS. 19, 20, 37, 42 AND 50).
MARCIE MILONE, EXAMINING ATTORNEY

CLASS 27—(Continued).

SN 78-629,350. L&P PROPERTY MANAGEMENT COMPANY, SOUTH GATE, CA. FILED 5-13-2005.

CUSH-N-LOC

THE MARK CONSISTS OF STANDARD CHARACTERS WITHOUT CLAIM TO ANY PARTICULAR FONT, STYLE, SIZE, OR COLOR.

FOR NON-SLIP AND CUSHIONING RUG UNDERLAYMENTS (U.S. CLS. 19, 20, 37, 42 AND 50).
FIRST USE 12-31-1999; IN COMMERCE 12-31-1999.
RON FAIRBANKS, EXAMINING ATTORNEY

CLASS 28—(Continued).

SN 76-700,833. KRISTINA DAMPIER, HURST, TX. FILED 12-14-2009.

COOKYCATS

THE MARK CONSISTS OF STANDARD CHARACTERS WITHOUT CLAIM TO ANY PARTICULAR FONT, STYLE, SIZE, OR COLOR.

FOR STUFFED TOY ANIMALS (U.S. CLS. 22, 23, 38 AND 50).
KATHERINE STOIDES, EXAMINING ATTORNEY

SN 79-068,326. NINGBO HUANGGULIN HANDICRAFT PRODUCTS CO., LTD; (NINGBO HUANGGULIN GONGYIPIN; YOUXIAN GONGSI), CHINA, FILED 4-3-2009.

黄古林

OWNER OF INTERNATIONAL REGISTRATION 1001456 DATED 4-3-2009, EXPIRES 4-3-2019.

THE ENGLISH TRANSLATION OF THE FOREIGN WORD(S) IN THE MARK IS: THE FIRST CHARACTER MEANS "YELLOW", THE SECOND "ANCIENT" AND THE THIRD "FOREST", THE TERMS TOGETHER ARE MEANINGLESS AND HAVE NO GEOGRAPHICAL SIGNIFICANCE AND NO NO MEANING IN BUSINESS.

THE TRANSLITERATION OF THE NON-LATIN CHARACTERS IN THE MARK IS: HUANG GU LIN.

FOR FLOOR MATS FOR USE IN THE HOME; NON-TEXTILE WALL HANGINGS (U.S. CLS. 19, 20, 37, 42 AND 50).

HOWARD B. LEVINE, EXAMINING ATTORNEY

SN 77-566,081. IMPERIAL TOY LLC, NORTH HILLS, CA. FILED 9-9-2008.



OWNER OF U.S. REG. NO. 2,138,766.
NO CLAIM IS MADE TO THE EXCLUSIVE RIGHT TO USE "BUBBLES" AND "BEST BUBBLES", APART FROM THE MARK AS SHOWN.

THE COLOR(S) DARK BLUE, LIGHT BLUE, GREEN, RED, WHITE AND BLACK IS/ARE CLAIMED AS A FEATURE OF THE MARK.

THE MARK CONSISTS OF THE WORDING "EARTH'S BEST BUBBLES" APPEARING INSIDE OF TWO CIRCLES AND ARCHED OVER AN IMAGE OF A GLOBE. THE WORDING "SUPER MIRACLE BUBBLES" IS SUPERIMPOSED OVER THE GLOBE AND IMAGES OF BUBBLES APPEAR ON BOTH SIDES OF THE WORDING. THE COLOR LIGHT BLUE APPEARS IN THE BUBBLES AND IN THE INNER CIRCLE; THE COLOR GREEN APPEARS IN THE OUTER CIRCLE, IN THE GLOBE AND IN THE WORDING "MIRACLE BUBBLES"; THE COLOR WHITE APPEARS IN THE WORDING "EARTH'S BEST BUBBLES" AND "SUPER" AND IN THE BUBBLES; THE COLOR DARK BLUE APPEARS IN THE GLOBE; THE COLOR BLACK OUTLINES THE WORDING "MIRACLE BUBBLES"; AND THE COLOR RED APPEARS IN THE OVAL OUTSIDE OF THE WORD "SUPER".

FOR BUBBLE TOY SETS AND BUBBLE TOYS, NAMELY, TOY WANDS, BUBBLE SOAP SOLUTION, TOY BUBBLE-MAKING MACHINES; TOY BUBBLE-MAKING MACHINES AND PARTS AND ACCESSORIES THEREOF, SOLD AS A UNIT (U.S. CLS. 22, 23, 38 AND 50).

FIRST USE 2-1-2008; IN COMMERCE 2-1-2008.
LAURIE KAUFMAN, EXAMINING ATTORNEY

CLASS 28—TOYS AND SPORTING GOODS

SN 76-700,728. GAMES & INVENTIONS, INC., PUERTO RICO, FILED 12-8-2009.

MEXICOPOLY

THE MARK CONSISTS OF STANDARD CHARACTERS WITHOUT CLAIM TO ANY PARTICULAR FONT, STYLE, SIZE, OR COLOR.

FOR BOARD GAMES (U.S. CLS. 22, 23, 38 AND 50).
AMY KERTGATE, EXAMINING ATTORNEY

CLASS 28—(Continued).

SN 77-582,170. ASEITY DEVELOPMENT, LLC, OKLAHOMA CITY, OK. FILED 9-30-2008.

EMPEROR CHESS

THE MARK CONSISTS OF STANDARD CHARACTERS WITHOUT CLAIM TO ANY PARTICULAR FONT, STYLE, SIZE, OR COLOR.

NO CLAIM IS MADE TO THE EXCLUSIVE RIGHT TO USE "CHESS", APART FROM THE MARK AS SHOWN.

FOR BOARD GAMES; CHESS GAMES (U.S. CLS. 22, 23, 38 AND 50).

LESLEY LAMOTHE, EXAMINING ATTORNEY

CLASS 28—(Continued).

SN 77-659,376. TWEEN BRANDS INVESTMENT, LLC, NEW ALBANY, OH. FILED 1-29-2009.

ME-SO MONSTERS

THE MARK CONSISTS OF STANDARD CHARACTERS WITHOUT CLAIM TO ANY PARTICULAR FONT, STYLE, SIZE, OR COLOR.

FOR PLUSH TOYS; TOY FIGURES (U.S. CLS. 22, 23, 38 AND 50).

DAVID YONTEF, EXAMINING ATTORNEY

SN 77-694,921. SPIN MASTER LTD., TORONTO ONTARIO, CANADA, FILED 3-19-2009.

BAKUGAN TRAP

THE MARK CONSISTS OF STANDARD CHARACTERS WITHOUT CLAIM TO ANY PARTICULAR FONT, STYLE, SIZE, OR COLOR.

PRIORITY CLAIMED UNDER SEC. 44(D) ON CANADA APPLICATION NO. 1428668, FILED 2-23-2009, REG. NO. TMA757892, DATED 1-26-2010, EXPIRES 1-26-2025.

OWNER OF U.S. REG. NO. 3,490,360.

THE WORDING "BAKUGAN" HAS NO MEANING IN A FOREIGN LANGUAGE.

FOR TOYS, GAMES AND PLAYTHINGS, NAMELY, COLLECTABLE GAME PIECES, GAME PIECES THAT TRANSFORM INTO ACTION FIGURES; DOLL CLOTHING, NAMELY, ACTION FIGURE CLOTHING (U.S. CLS. 22, 23, 38 AND 50).

KATHRYN COWARD, EXAMINING ATTORNEY

SN 77-635,751. JAKKS PACIFIC, INC., MALIBU, CA. FILED 12-18-2008.

SHOENISTAS

THE MARK CONSISTS OF STANDARD CHARACTERS WITHOUT CLAIM TO ANY PARTICULAR FONT, STYLE, SIZE, OR COLOR.

FOR TOYS, GAMES AND PLAYTHINGS, NAMELY, DOLLS, TOY VEHICLES, ACTION FIGURES, TOY FIGURES, SPINNING TOYS, AND PLAY SETS AND ACCESSORIES FOR ALL OF THE AFOREMENTIONED; TOY GUNS AND ACCESSORIES THEREFOR; KITES, INFANT TOYS, PLUSH TOYS, TOY FIGURE MOLDS, BABY MULTIPLE ACTIVITY TOYS, BATH TOYS, CHILDREN'S MULTIPLE ACTIVITY TOYS, CONSTRUCTION TOYS; ELECTRONIC LEARNING TOYS, FLOATS FOR RECREATIONAL USE, NAMELY, FOAM SWIM FLOATS FOR RECREATIONAL USE; HANDHELD UNIT FOR PLAYING VIDEO GAMES OTHER THAN THOSE ADAPTED FOR USE WITH AN EXTERNAL DISPLAY SCREEN OR MONITOR, STAND ALONE VIDEO GAME MACHINES; ACTION SKILL GAMES, ACTION TARGET GAMES, ACTION-TYPE TARGET GAMES, BOARD GAMES, BUILDING GAMES, CHESS GAMES, MANIPULATIVE GAMES, MARBLES FOR GAMES, MEMORY GAMES, PARLOR GAMES, PARTY GAMES, PLAYING CARDS AND CARD GAMES, ROLE PLAYING GAMES, TOY, NAMELY, BATTERY-POWERED COMPUTER GAME WITH LCD SCREEN WHICH FEATURES ANIMATION AND SOUND EFFECTS, TRADING CARD GAMES (U.S. CLS. 22, 23, 38 AND 50).

DAVID I, EXAMINING ATTORNEY

SN 77-705,600. AMERICAN EDUCATIONAL PRODUCTS LLC, FORT COLLINS, CO. FILED 4-2-2009.

"Math Attack" Racing Game

THE MARK CONSISTS OF STANDARD CHARACTERS WITHOUT CLAIM TO ANY PARTICULAR FONT, STYLE, SIZE, OR COLOR.

NO CLAIM IS MADE TO THE EXCLUSIVE RIGHT TO USE "MATH" AND "RACING GAME", APART FROM THE MARK AS SHOWN.

FOR A GAME COMPRISING A BOARD AND DICE FOR TEACHING ACCURACY AND SPEED IN MATHEMATICS (U.S. CLS. 22, 23, 38 AND 50).

FIRST USE 9-30-1997; IN COMMERCE 9-30-1997.

ALLISON HOLTZ, EXAMINING ATTORNEY

CLASS 28—(Continued).

SN 77-708,090. BEUKEVELD, CHRISTOPHER B, SURREY, BC, CANADA, FILED 4-7-2009.

Tact-Tiles

THE MARK CONSISTS OF STANDARD CHARACTERS WITHOUT CLAIM TO ANY PARTICULAR FONT, STYLE, SIZE, OR COLOR.

THE WORDING "TACT-TILES" HAS NO MEANING IN A FOREIGN LANGUAGE.

SEC. 2(F).
FOR ROLE PLAYING GAMES (U.S. CLS. 22, 23, 38 AND 50).

PAULA MAHONEY, EXAMINING ATTORNEY

SN 77-713,334. WOHLFAHRT, HARALD, ROTHENBURG, FED REP GERMANY, FILED 4-14-2009.

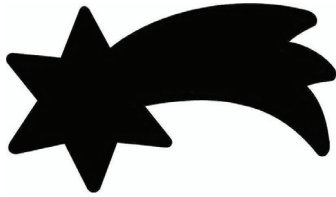

THE MARK CONSISTS OF A SHOOTING STAR DESIGN. FOR CHRISTMAS TREE ORNAMENTS AND DECORATIONS (U.S. CLS. 22, 23, 38 AND 50).

ROBIN CHOSID, EXAMINING ATTORNEY

SN 77-717,889. SHOOT THE MOON PRODUCTS II, LLC, PLEASANTON, CA. FILED 4-20-2009.

NANO MOTO

THE MARK CONSISTS OF STANDARD CHARACTERS WITHOUT CLAIM TO ANY PARTICULAR FONT, STYLE, SIZE, OR COLOR.

FOR TOY VEHICLES; PLAY SETS IN THE NATURE OF TOY VEHICLES, TRACK SETS, ROADWAYS AND ACCESSORIES THEREFOR; TOY VEHICLE LAUNCHERS; TOY CHARACTERS ASSOCIATED WITH DIFFERENT TYPES OF VEHICLES; ELECTRONIC TOY VEHICLE RACING SETS (U.S. CLS. 22, 23, 38 AND 50).

KATHERINE CONNOLLY, EXAMINING ATTORNEY

CLASS 28—(Continued).

SN 77-731,245. MATTEL, INC., EL SEGUNDO, CA. FILED 5-7-2009.

DUAL IMPACT

THE MARK CONSISTS OF STANDARD CHARACTERS WITHOUT CLAIM TO ANY PARTICULAR FONT, STYLE, SIZE, OR COLOR.

FOR TOYS, GAMES AND PLAYTHINGS, NAMELY, TOY ACTION FIGURES AND ACCESSORIES THEREFOR (U.S. CLS. 22, 23, 38 AND 50).

WON TEAK OH, EXAMINING ATTORNEY

SN 77-734,482. HUNG DAT INDUSTRIAL COMPANY, KOW-LOON, HONG KONG, FILED 5-12-2009.



NO CLAIM IS MADE TO THE EXCLUSIVE RIGHT TO USE "GAME", APART FROM THE MARK AS SHOWN.

THE COLOR(S) BLUE, YELLOW, RED, WHITE, GREY AND BLACK IS/ARE CLAIMED AS A FEATURE OF THE MARK.

THE MARK CONSISTS OF THE FOLLOWING: A RECTANGULAR BLUE BORDER CONTAINING THE FOLLOWING ELEMENTS: A LARGE SIZED NUMERAL "1", IN BLUE WITH A WHITE BORDER; SUPERIMPOSED OVER THIS ELEMENT ARE THE WORDS "SUPED UP" IN YELLOW; A CHECKERBOARD RECTANGULAR PATTERN IN BLACK AND WHITE APPEARS AT EITHER END OF THIS WORD; BELOW THIS WORD IS A RED OVAL, WITH A WHITE AND GREY BORDER, CONTAINING THE WORDS "THE AMAZING MILEAGE MARATHON GAME" IN WHITE.

FOR BOARD GAMES; EQUIPMENT SOLD AS A UNIT FOR PLAYING BOARD GAMES COMPOSED PRIMARILY OF BOARDS, MOVABLE PIECES, DICE AND CARDS; PLAYMATS FOR GAMES; GAMES UTILIZING PLAYMATS; DOLLS AND FIGURINES USED ON PLAYMATS (U.S. CLS. 22, 23, 38 AND 50).

HENRY S. ZAK, EXAMINING ATTORNEY

CLASS 28—(Continued).

SN 77-739,056. MASCOTTE HOLDINGS, INC., NEW YORK, NY. FILED 5-18-2009.

YEEZY

THE MARK CONSISTS OF STANDARD CHARACTERS WITHOUT CLAIM TO ANY PARTICULAR FONT, STYLE, SIZE, OR COLOR.

THE NAME "YEEZY" IN THE MARK IDENTIFIES KANYE WEST'S NICKNAME

FOR PLUSH TOYS; DOLLS AND DOLL ACCESSORIES; DOLL COSTUMES; BOARD GAMES; PARLOR GAMES; CARD GAMES; JIGSAW PUZZLES; MANIPULATIVE AND CUBE PUZZLES; MANIPULATIVE GAMES; EDUCATIONAL BOARD GAMES; BOARD GAMES ADAPTABLE TO MECHANICAL APPARATUS AND APPLICATIONS; ACTION FIGURES AND ACCESSORIES THEREFOR; MECHANICAL AND ELECTRONIC ACTION TOYS; CASES FOR ACTION FIGURES; CASES FOR TOY STRUCTURES AND VEHICLES; BOBBLE HEAD TOY FIGURES, BOBBLE HEAD ACTION FIGURES, ACTION SKILL GAMES AND ACTION TARGET GAMES; PLAYSETS FOR ACTION FIGURES AND DOLLS; CHILDREN'S ACTION ROLE-PLAYING PLAYSETS AND ACTION PLAYSETS, NAMELY, TOY VEHICLE PLAYSETS; AERODYNAMIC FLYING DISCS FOR PLAYING TOSS-TYPE GAME; ARCADE GAMES; YO-YOS; BATH TOYS; BATTERY OPERATED ACTION TOYS; POP UP TOYS; PRINTING TOYS; PINBALL MACHINES; PULL TOYS; PUNCHING TOYS; PUPPETS; RIDE-ON TOYS; ROLE PLAYING GAMES; CRIB ACTIVITY TOYS NAMELY MOBILES AND CLUTCH BALL; DART GAMES; DICE; DISC TOSS TOYS; ELECTRIC ACTION TOYS; ELECTRIC PLASTIC TOY FIGURINES; ELECTRICAL, MECHANICAL AND BATTERY OPERATED ACTION TOYS; ELECTRONIC ACTION SKILL GAMES; ELECTRONIC PINBALL GAMES; EQUIPMENT SOLD AS A UNIT FOR PLAYING A BOARD GAME AND MANIPULATIVE AND CUBE-TYPE PUZZLE GAMES; HAND-HELD UNIT FOR PLAYING VIDEO GAMES AND ACCESSORIES THEREFOR; AMUSEMENT GAME MACHINES; AMUSEMENT PARK RIDES; COIN-OPERATED AMUSEMENT MACHINES; FANTASY CHARACTER TOYS; AUDIO/VISUAL TOY PROJECTORS AND ACCESSORIES THEREFOR; BALLOONS; BEACH BALLS; BEACH TOYS; BEAN BAGS; BENDABLE TOYS; CHILDREN'S PLAY COSMETICS; ARTIFICIAL CHRISTMAS GARLANDS, CHRISTMAS STOCKINGS, CHRISTMAS TREE SKIRTS, TINSEL FOR DECORATING CHRISTMAS TREES, CHRISTMAS TREE ORNAMENTS, NAMELY, BELLS, CHRISTMAS TREE ORNAMENTS, NON-ILLUMINATING, NON-ELECTRIC CHRISTMAS TREE DECORATIONS, AND CHRISTMAS TREE ORNAMENTS; COIN-OPERATED VIDEO GAMES; COLLECTABLE AND POSITIONABLE TOY FIGURES; CONSTRUCTION TOYS; COSTUME MASKS; CRAFT SETS FOR DECORATING BALLOONS; HAND-HELD LCD GAME MACHINES AND HAND-HELD ACTION SKILL GAMES; GAMING TABLES; STAND ALONE VIDEO GAME MACHINES; TOY GUM FIGURE MAKERS; TOY BUBBLE GUM DISPENSERS; HAND-HELD UNIT FOR PLAYING ELECTRONIC GAMES; HAND-HELD ACTION SKILL GAMES; NON-ELECTRONIC HAND-HELD VIDEO GAMES AND ACTION SKILL GAMES; HI-BOUNCE BALLS; INFANT TOYS; INFLATABLE POOL TOYS; INFLATABLE SWIMMING POOLS; INFLATABLE MATTRESSES FOR RECREATIONAL USE; INFLATABLE TOYS; IN-LINE SKATES; INFLATABLE INNER TUBES FOR AQUATIC RECREATIONAL USE; WATER SKIS; KITES, KITE STRINGS, KITE TAILS, KITE REELS, KITE LINES, KITE PARTS, AND KITE HANDLES; FACE MASKS; MODEL PLASTIC TOY FIGURINES; MUSICAL TOYS; MUSIC BOX TOYS; NON ELECTRONIC PINBALL GAMES; NON ELECTRONIC ARCADE GAMES; NON-RIDING TRANSPORTATION TOYS; PARTY FAVORS IN THE NATURE OF CRACKERS AND NOISEMAKERS; FLOATING RECREATIONAL LOUNGE CHAIRS; PLASTIC CHARACTER TOYS; PLAY FIGURES; PLAYSETS FOR ACTION FIG-

CLASS 28—(Continued).

URES; PLAYSETS FOR TOY VEHICLES; RUBBER CHARACTER TOYS; SAND TOYS; TOY SCOOTERS; SKATEBOARDS; SOFT SCULPTURE TOYS; SPINNING TOPS GAME; SPORTS BALLS; SQUEEZABLE SQUEAKING TOYS; STUFFED TOYS; SURFBOARDS; SWIM FINS; TABLE TOP ACTION SKILL GAMES; TOY ACTION FIGURES; TOY ACTION FIGURE ACCESSORIES; TOY BANKS; TOY BELTS; TOY BOXES; TOY BUILDING BLOCKS AND CONNECTING LINKS FOR THE SAME; TOY CANDY DISPENSERS AND HOLDERS; TOY CHAMPIONSHIP BELTS; TOY FILM CARTRIDGES AND VIEWERS THEREFOR; TOY FIGURES; TOY FOAM WEAPONS; TOY MINIATURE DOLLS; TOY MODEL HOBBY CRAFT KITS; TOY MODEL VEHICLES AND RELATED ACCESSORIES THEREFOR SOLD AS UNITS; TOY MODELING COMPOUND AND ACCESSORIES THEREFOR; TOY MUSICAL INSTRUMENTS; TOY PEDAL CARS; TOY PLAYSETS FOR ACTION FIGURES AND DOLLS, CHILDREN'S ACTION ROLE-PLAYING PLAYSETS; TOY SNOW GLOBES; TOY VEHICLES; TOY VEHICLES MADE OF NON-PRECIOUS METALS; TOY WATCHES; TOY WEAPONS; TOY WRESTLING GEAR SETS; TOY WRESTLING RINGS; EXERCISE TRAMPOLINES; STAND ALONE VIDEO OUTPUT GAME MACHINES; PLAY SWIMMING POOLS, SWIM FLOATS FOR RECREATIONAL USE, AND INFLATABLE SWIMMING TOYS; WATER SQUIRTING TOYS; WIND-UP TOYS; POCKET-SIZED ELECTRONIC GAMES; SPORTING EQUIPMENT, NAMELY, BASEBALLS, FOOTBALLS, BASKETBALLS, SOCCER BALLS, SOFTBALLS, HANDBALLS, TENNIS BALLS, SQUASH BALLS, VOLLEYBALLS, TENNIS RACQUETS, HOCKEY GLOVES, HOCKEY PUCKS, HOCKEY STICKS, BADMINTON RACQUETS, BADMINTON BIRDIES, BASEBALL BATS, BASEBALL GLOVES, SNOWBOARDS, BASKETBALL HOOPS AND NETS, SURF-FINS, SKIS, SKI POLES, RACQUETS FOR SQUASH AND RACQUET BALL, GOLF CLUBS, GOLF BALLS, GOLF TEES, ROLLER SKATES AND ICE SKATES AND ACCESSORIES THEREFOR; EXERCISE EQUIPMENT, NAMELY, PERSONAL EXERCISE MATS, TREADMILLS, WEIGHTS, WRIST WEIGHTS, WEIGHT CUFFS, GYMNAS TIC APPARATUS, MEDICINE BALLS, PUNCHING BAGS, PUNCHING BALLS AND ACCESSORIES THEREFOR (U.S. CLS. 22, 23, 38 AND 50).

ALICE BENMAMAN, EXAMINING ATTORNEY

SN 77-755,183. LEANNIE GLOBAL LIMITED, KOWLOON, HONG KONG, CHINA, FILED 6-9-2009.

Senson

THE MARK CONSISTS OF STANDARD CHARACTERS WITHOUT CLAIM TO ANY PARTICULAR FONT, STYLE, SIZE, OR COLOR.

FOR DOLL ACCESSORIES; DOLLS; HEADGEAR FOR DOLLS (U.S. CLS. 22, 23, 38 AND 50).

FIRST USE 1-1-2009; IN COMMERCE 1-1-2009.

TRACY CROSS, EXAMINING ATTORNEY

CLASS 28—(Continued).

SN 77-759,254. ALLERGEZE INC., PORT WASHINGTON, NY. FILED 6-14-2009.

ALLERGEZE

THE MARK CONSISTS OF STANDARD CHARACTERS WITHOUT CLAIM TO ANY PARTICULAR FONT, STYLE, SIZE, OR COLOR.

FOR STUFFED ANIMALS WITH ANTI-ALLEGENIC HERBS (U.S. CLS. 22, 23, 38 AND 50).

JACQUELINE A. LAVINE, EXAMINING ATTORNEY

SN 77-763,607. ECOSMART LLC., RESTON, VA. FILED 6-19-2009.

EcoKites

THE MARK CONSISTS OF STANDARD CHARACTERS WITHOUT CLAIM TO ANY PARTICULAR FONT, STYLE, SIZE, OR COLOR.

FOR KITES (U.S. CLS. 22, 23, 38 AND 50).
FIRST USE 4-27-2009; IN COMMERCE 6-5-2009.
FRED MANDIR, EXAMINING ATTORNEY

SN 77-763,610. ECOSMART LLC., RESTON, VA. FILED 6-19-2009.

SmartKites

THE MARK CONSISTS OF STANDARD CHARACTERS WITHOUT CLAIM TO ANY PARTICULAR FONT, STYLE, SIZE, OR COLOR.

FOR KITES (U.S. CLS. 22, 23, 38 AND 50).
FIRST USE 4-27-2009; IN COMMERCE 6-5-2009.
FRED MANDIR, EXAMINING ATTORNEY

CLASS 28—(Continued).

SN 77-772,295. WANG, QIUPING, NORCROSS, GA. FILED 7-1-2009.



THE COLOR(S) BLUE, BLACK, WHITE IS/ARE CLAIMED AS A FEATURE OF THE MARK.

THE MARK CONSISTS OF THE FOLLOWING: TWO EAGLE'S WINGS IN BLACK WITH A SHIELD IN THE CENTER OF THE WINGS. THE SHIELD HAS A BLACK BACKGROUND WITH A WHITE LETTER "B". THERE IS A WHITE INNER OUTLINE AND A BLUE MIDDLE OUTLINE WITH A BLACK OUTLINE ON THE SHIELD. THERE IS A BANNER ACROSS THE SHIELD THAT CONTAINS THE WORDS "BLUE EAGLE" IN WHITE ON A BLACK BACKGROUND. THERE IS AN INNER WHITE OUTLINE WITH A BLUE MIDDLE OUTLINE AND A BLACK OUTLINE ON THE BANNER.

FOR SKATEBOARD WHEELS; SKATEBOARDS; TOY SCOOTERS (U.S. CLS. 22, 23, 38 AND 50).

ANNE FARRELL, EXAMINING ATTORNEY

SN 77-774,716. DUEL CO., INC, FUKUOKA-SHI, FUKUOKA, JAPAN, FILED 7-6-2009.

SUSHI

THE MARK CONSISTS OF STANDARD CHARACTERS WITHOUT CLAIM TO ANY PARTICULAR FONT, STYLE, SIZE, OR COLOR.

FOR FISHING TACKLE (U.S. CLS. 22, 23, 38 AND 50).
NANCY CLARKE, EXAMINING ATTORNEY

SN 77-784,312. BRUCE KEVIN JOHNE, DBA PNEU-POWER CUES, XTREME BILLIARDS GEAR, SAINT AUGUSTINE, FL. FILED 7-18-2009.



X-treme Billiards Gear

NO CLAIM IS MADE TO THE EXCLUSIVE RIGHT TO USE "CUES" AND "BILLIARDS GEAR", APART FROM THE MARK AS SHOWN.

THE COLOR(S) GREEN, RED, ORANGE, WHITE, BLACK IS/ARE CLAIMED AS A FEATURE OF THE MARK.

THE MARK CONSISTS OF AN OVAL THAT IS OUTLINED IN RED AND GREEN IN THE INTERIOR. THE LETTERS "PNEU-" APPEAR ON THE LEFT SIDE OF THE OVAL IN WHITE LETTERS OUTLINED IN BLACK. THE WORD "POWER" APPEARS UNDER THE "U" IN "PNEU" IN BLACK LETTERS. THREE RED AND BLACK LINES APPEAR FROM THE LEFT SIDE OF THE OVAL THROUGH THE WORD "POWER" WITH THE MIDDLE LINE EXTEND-

CLASS 28—(Continued).

ING BEYOND THE "R" IN "POWER." A BLACK CRESCENT RESEMBLING A BACKWARD "C" IS INSIDE THE GREEN PORTION OF THE OVAL ON THE RIGHT SIDE. INSIDE THE CRESCENT IS AN ORANGE HALO IN THE CENTER OF THE CRESCENT. THE WORD "CUES" APPEARS TO THE RIGHT OF THE HALO WITH THE LETTER "C" PRESENTED IN WHITE LETTERS OUTLINED IN RED AND WITH THE LETTERS "UES" IN GREEN LETTERS. BELOW OVAL ARE THE WORDS "X-TREME BILLIARDS GEAR" IN RED LETTERS.

FOR BILLIARD CUES; BILLIARD EQUIPMENT; BILLIARD GAME PLAYING EQUIPMENT; BILLIARD TIPS; POOL CUE CASES; POOL CUE TIPS; POOL CUES (U.S. CLS. 22, 23, 38 AND 50).

ALLISON HOLTZ, EXAMINING ATTORNEY

CLASS 28—(Continued).

SN 77-799,070. WOODSTOCK ENTERPRISES, INC., KIRKLAND, QUEBEC, CANADA, FILED 8-6-2009.

SWEETPEE

SN 77-790,265. TWENTIETH CENTURY FOX FILM CORPORATION, LOS ANGELES, CA. FILED 7-27-2009.

AVTR

THE MARK CONSISTS OF STANDARD CHARACTERS WITHOUT CLAIM TO ANY PARTICULAR FONT, STYLE, SIZE, OR COLOR.

FOR NOVELTY FAKE URINE KITS FOR PRACTICAL JOKES COMPRISED OF A DISPENSING BLADDER BAG WITH BELT, SYNTHETIC URINE, AT LEAST ONE HEATING PAD, AND AT LEAST ONE TEMPERATURE INDICATING STRIP, SOLD WITH AND WITHOUT A SYRINGE FOR THE PURPOSES OF PLAYING URINE PRANKS ON PERSONS; PARTS AND RE-FILLS FOR THE FOREGOING, NAMELY, RE-FILL CONTAINERS OF FAKE URINE (U.S. CLS. 22, 23, 38 AND 50).

BILL DAWE, EXAMINING ATTORNEY

THE MARK CONSISTS OF STANDARD CHARACTERS WITHOUT CLAIM TO ANY PARTICULAR FONT, STYLE, SIZE, OR COLOR.

FOR CHRISTMAS TREE DECORATIONS EXCEPT CONFECTIONERY OR ILLUMINATION ARTICLES; CHRISTMAS TREE ORNAMENTS; TOYS, GAMES, AND PLAYTHINGS, NAMELY, HAND HELD UNITS FOR PLAYING ELECTRONIC GAMES OTHER THAN THOSE ADAPTED FOR USE WITH AN EXTERNAL DISPLAY SCREEN OR MONITOR, DOLLS AND DOLL CLOTHING, TOY FIGURES, PLUSH TOYS, BATHTUB TOYS, RUBBER CHARACTER TOYS, BENDABLE TOYS, WIND-UP TOYS, TOY BUILDING BLOCKS, JIGSAW AND MANIPULATIVE PUZZLES, TOY ACTION FIGURES AND ACCESSORIES THEREFOR, ACTION FIGURE PLAY ENVIRONMENTS, PARTY GAMES, PARLOR GAMES, ROLE PLAYING GAMES, BOARD GAMES, ACTION SKILL GAMES, CARD GAMES, PLAYING CARDS, FLYING DISCS, TOY JEWELRY, TOY WATCHES, DART BOARDS, TOY VEHICLES AND ACCESSORIES THEREFOR, SIT-IN AND RIDE-ON TOY VEHICLES, COMBINATION PLAY AND INDOOR SLUMBER TENTS, HAND HELD PUPPETS, TOY BANKS, WATER SQUIRTING TOYS, TOY PISTOLS, PINBALL AND ARCADE GAME MACHINES, BALLOONS, HOBBY CRAFT KITS COMPRISED OF TOY FIGURE PLASTIC MOLDS, FASTENERS FOR ATTACHING TOY FIGURE MOLDS, AND DECORATIVE ACCESSORIES FOR MOLDED TOY FIGURES, COSTUME MASKS; SPORTING GOODS AND EQUIPMENT, NAMELY, BALLS FOR GAMES, BALLS FOR SPORTS, TENNIS RACKETS, SKATEBOARDS, FLOTATION DEVICES FOR RECREATIONAL USE, NAMELY, INFLATABLE BALLS AND WATER WINGS (U.S. CLS. 22, 23, 38 AND 50).

JOHN E. MICHOS, EXAMINING ATTORNEY

SN 77-800,564. SHOE CASE STORES, INC., BELLMORE, NY. FILED 8-10-2009.

WARK

THE MARK CONSISTS OF STANDARD CHARACTERS WITHOUT CLAIM TO ANY PARTICULAR FONT, STYLE, SIZE, OR COLOR.

FOR EXERCISE MACHINES (U.S. CLS. 22, 23, 38 AND 50).

ROBIN MITTLER, EXAMINING ATTORNEY

CLASS 28—(Continued).

SN 77-807,951. PARADISE KIDS, LLC, GREENWICH, CT. FILED 8-19-2009.



NO CLAIM IS MADE TO THE EXCLUSIVE RIGHT TO USE "POSABLES", APART FROM THE MARK AS SHOWN. THE MARK CONSISTS OF THE WORDING "PARADISE" ABOVE THE WORDING "POZ-ABLES" WITH BOTH IN STYLIZED LETTERING AND THREE 5-POINT STARS IN VARYING SIZES TO THE RIGHT OF THE WORDING "PARADISE" AND THREE 5-POINT STARS OF VARYING SIZES TO THE LEFT OF THE WORDING "POZ-ABLES".

FOR COLLECTABLE TOY FIGURES; DOLL ACCESSORIES; DOLL CLOTHING; DOLLS; DOLLS AND ACCESSORIES THEREFOR; DOLLS AND PLAYSETS THEREFOR; FANTASY CHARACTER TOYS; MODELED PLASTIC TOY FIGURINES; MOLDED TOY FIGURES; PLASTIC CHARACTER TOYS; PLUSH TOYS; POSITIONABLE TOY FIGURES; SOFT SCULPTURE PLUSH TOYS; SOFT SCULPTURE TOYS; STUFFED AND PLUSH TOYS; STUFFED TOY ANIMALS; TOY ACTION FIGURES; TOY ACTION FIGURES AND ACCESSORIES THEREFOR; TOY ANIMALS; TOY ANIMALS AND ACCESSORIES THEREFOR; TOY FIGURES (U.S. CLS. 22, 23, 38 AND 50).

SUZANNE BLANE, EXAMINING ATTORNEY

SN 77-818,822. TWENTIETH CENTURY FOX FILM CORPORATION, LOS ANGELES, CA. FILED 9-2-2009.

GLEEK

THE MARK CONSISTS OF STANDARD CHARACTERS WITHOUT CLAIM TO ANY PARTICULAR FONT, STYLE, SIZE, OR COLOR.

FOR CHRISTMAS TREE DECORATIONS; CHRISTMAS TREE ORNAMENTS; HAND HELD UNITS FOR PLAYING ELECTRONIC GAMES; DOLLS AND DOLL CLOTHING; TOY FIGURES; PLUSH TOYS; BATHTUB TOYS; RUBBER CHARACTER TOYS; BENDABLE TOYS; WIND-UP TOYS; TOY BUILDING BLOCKS; JIGSAW AND MANIPULATIVE PUZZLES; TOY ACTION FIGURES AND ACCESSORIES THEREFOR; ACTION FIGURE PLAY ENVIRONMENTS; PARTY GAMES, PARLOR GAMES AND ROLE PLAYING GAMES ALL RELATING TO A COMEDY/DRAMA TELEVISION SHOW; BOARD GAMES; ACTION SKILL GAMES; FLYING DISCS; TOY JEWELRY; TOY WATCHES; DART BOARDS; TOY VEHICLES AND ACCESSORIES THEREFOR; SIT-IN AND RIDE-ON TOY VEHICLES; INDOOR SLUMBER AND PLAY TENTS; HAND HELD PUPPETS; TOY BANKS; WATER SQUIRTING TOYS; TOY PISTOLS; PINBALL AND ARCADE GAME MACHINES; BALLS FOR GAMES; BALLS FOR SPORTS; TENNIS RACKETS; SKATEBOARDS; BALLOONS; HOBBY CRAFT KITS COMPRISED OF TOY FIGURE PLASTIC MOLDS, FASTENERS FOR ATTACHING TOY FIGURE MOLDS, AND DECORATIVE ACCESSORIES FOR MOLDED TOY FIGURES; FLOTATION DEVICES FOR RECREATIONAL USE, NAMELY, INFLATABLE BALLS AND WATER WINGS; COSTUME MASKS (U.S. CLS. 22, 23, 38 AND 50).

KATHERINE STOIDES, EXAMINING ATTORNEY

CLASS 28—(Continued).

SN 77-821,976. BROCKMEYER, ERIC L., VIERA, FL. FILED 9-8-2009.



NO CLAIM IS MADE TO THE EXCLUSIVE RIGHT TO USE "ROADSTERS", APART FROM THE MARK AS SHOWN.

THE MARK CONSISTS OF THE WORD "ROADSTERS" WRITTEN IN STYLIZED SCRIPT AND UNDERLINED BY A STYLIZED, TRIANGULAR WING CONSISTING OF A SERIES OF HORIZONTAL STRAIGHT BANDS THAT DECREASE IN LENGTH FROM TOP TO BOTTOM, WHICH ARE OUTLINED BY A SINGLE TRIANGULAR LINE.

FOR CHILDREN'S RIDE-ON TOYS (U.S. CLS. 22, 23, 38 AND 50).

MYRIAH HABEEB, EXAMINING ATTORNEY

SN 77-823,989. WILD PLANET ENTERTAINMENT, INC., SAN FRANCISCO, CA. FILED 9-10-2009.

FLIPPER FRENZY

THE MARK CONSISTS OF STANDARD CHARACTERS WITHOUT CLAIM TO ANY PARTICULAR FONT, STYLE, SIZE, OR COLOR.

FOR TOYS, GAMES, AND PLAYTHINGS, NAMELY, ACTIVE RUNNING GAME FOLLOWING COMMANDS OF A HANDHELD ELECTRONIC UNIT (U.S. CLS. 22, 23, 38 AND 50).

BARBARA A. GOLD, EXAMINING ATTORNEY

SN 77-826,223. MATTEL, INC., EL SEGUNDO, CA. FILED 9-14-2009.

HOT HAULERS

THE MARK CONSISTS OF STANDARD CHARACTERS WITHOUT CLAIM TO ANY PARTICULAR FONT, STYLE, SIZE, OR COLOR.

NO CLAIM IS MADE TO THE EXCLUSIVE RIGHT TO USE "HAULERS", APART FROM THE MARK AS SHOWN. FOR TOYS, GAMES AND PLAYTHINGS, NAMELY, TOY VEHICLES AND ACCESSORIES THEREFOR (U.S. CLS. 22, 23, 38 AND 50).

FIRST USE 2-16-2010; IN COMMERCE 2-16-2010. LEIGH LOWRY, EXAMINING ATTORNEY

CLASS 28—(Continued).

SN 77-833,508. CEPIA INC., NYC, NY. FILED 9-23-2009.



NO CLAIM IS MADE TO THE EXCLUSIVE RIGHT TO USE "BALL", APART FROM THE MARK AS SHOWN.

THE MARK CONSISTS OF THE LETTER "Z" IN A CIRCLE FOLLOWED BY THE WORDING "BALL" OUTSIDE OF THE CIRCLE. THE LEFT OF THE LETTER "B" IS SHAPED AROUND THE CIRCLE.

FOR ACTION SKILL GAMES; BOARD GAMES (U.S. CLS. 22, 23, 38 AND 50).

FIRST USE 1-1-2009; IN COMMERCE 9-1-2009.
RAMONA ORTIGA, EXAMINING ATTORNEY

SN 77-840,170. MACKINAC ISLAND PRESS, INC., TRAVERSE CITY, MI. FILED 10-2-2009.



THE MARK CONSISTS OF "SEW-N-LOVE" WORDS WITH A DISTINCTIVE TYPEFACE AND A HEART BEHIND THE LETTER -N-

FOR PLUSH DOLLS; PLUSH TOYS; SOFT SCULPTURE PLUSH TOYS; STUFFED AND PLUSH TOYS (U.S. CLS. 22, 23, 38 AND 50).

REGINA DRUMMOND, EXAMINING ATTORNEY

SN 77-860,822. SILVERLIT LIMITED, CAUSEWAY BAY, HONG KON, HONG KONG, FILED 10-29-2009.

POWER IN SPEED

THE MARK CONSISTS OF STANDARD CHARACTERS WITHOUT CLAIM TO ANY PARTICULAR FONT, STYLE, SIZE, OR COLOR.

FOR TOYS, NAMELY, TOY WATERCRAFT, VEHICLES, FIGURES, AIRCRAFT, HELICOPTERS, SPACECRAFT AND ACCESSORIES THEREFOR; ACTION SKILL GAMES; BOARD GAMES; CASES FOR TOYS AND TOY ACCESSORIES; PUZZLE GAMES; TOY WEAPONS; ELECTRONICALLY-OPERATED TOY VEHICLES, AIRCRAFT, HELICOPTERS, AND SPACECRAFT; EDUCATIONAL TOYS FOR THE PURPOSE OF TEACHING READING, LANGUAGE, MATH, MUSIC, SPELLING AND REASONING; MULTIPLE ACTIVITY TOYS; AND MOTORIZED, REMOTE AND RADIO-CONTROLLED TOY VEHICLES, AIRCRAFT, HELICOPTERS, AND SPACECRAFT (U.S. CLS. 22, 23, 38 AND 50).

STEPHEN AQUILA, EXAMINING ATTORNEY

CLASS 28—(Continued).

SN 77-871,218. DAVIDSON, LAWRENCE P, DBA LAWRENCE P DAVIDSON, INDIAN ORCHARD, MA. FILED 11-12-2009.

Land-Um Tackle

THE MARK CONSISTS OF STANDARD CHARACTERS WITHOUT CLAIM TO ANY PARTICULAR FONT, STYLE, SIZE, OR COLOR.

NO CLAIM IS MADE TO THE EXCLUSIVE RIGHT TO USE "TACKLE", APART FROM THE MARK AS SHOWN.

FOR FISHING TACKLE (U.S. CLS. 22, 23, 38 AND 50).
JAY BESCH, EXAMINING ATTORNEY

SN 77-874,083. GOLF IMPACT, LLC, FT. LAUDERDALE, FL. FILED 11-17-2009.

GOLF DYNAMICS PRO

THE MARK CONSISTS OF STANDARD CHARACTERS WITHOUT CLAIM TO ANY PARTICULAR FONT, STYLE, SIZE, OR COLOR.

NO CLAIM IS MADE TO THE EXCLUSIVE RIGHT TO USE "GOLF" AND "PRO", APART FROM THE MARK AS SHOWN.

FOR GOLF CLUB SWING AIDS, NAMELY, A GOLF SWING ANALYZER (U.S. CLS. 22, 23, 38 AND 50).

FIRST USE 11-5-2009; IN COMMERCE 11-5-2009.

TIMOTHY FINNEGAN, EXAMINING ATTORNEY

SN 77-876,267. I HEART MY GIRLFRIENDS, INC., NEW YORK, NY. FILED 11-19-2009.



THE MARK CONSISTS OF THE WORDS "I MY GIRLFRIENDS" WITH A HEART DESIGN AND SILHOUETTES OF DANCING FIGURES.

FOR TOYS AND PLAYTHINGS, NAMELY, PLAYING CARDS, PLAY FIGURES, TOY FIGURES, POSITIONABLE TOY FIGURES, BOBBLE HEAD TOY FIGURES, BOBBLE HEAD ACTION FIGURES, ACTION FIGURES AND ACCESSORIES THEREFOR, PLAYSETS FOR ACTION FIGURES, TOY ACTION FIGURES, TOY ACTION FIGURES AND ACCESSORIES THEREFOR, MODELED PLASTIC TOY FIGURINES, PLASTIC CHARACTER TOYS, RUBBER CHARACTER TOYS, CASES FOR ACTION FIGURES, ELECTRIC AND MECHANICAL ACTION TOYS, MECHANICAL TOYS, BATTERY OPERATED ACTION TOYS, AERODYNAMIC FLYING DISCS FOR PLAYING TOSS-TYPE GAMES, WIND-UP WALKING TOYS, BENDABLE TOYS, PUNCHING TOYS, COLLECTABLE TOY FIGURES, ELECTRIC ACTION

CLASS 28—(Continued).

TOYS, FANTASY CHARACTER TOYS, CONSTRUCTION TOYS, ELECTRONICALLY OPERATED TOY MOTOR VEHICLES, INFLATABLE TOYS, PLUSH TOYS, SOFT SCULPTURE PLUSH TOYS, SOFT SCULPTURE TOYS, SQUEEZABLE SQUEAKING TOYS, SQUEEZE TOYS, POP UP TOYS, MUSICAL TOYS, MUSIC BOX TOYS, PRINTING TOYS, PULL TOYS, PUSH TOYS, RIDE-ON TOYS, SAND TOYS, SANDBOX TOYS, BATH TOYS, SKETCHING TOYS, PARTY FAVORS IN THE NATURE OF SMALL TOYS AND NOISEMAKERS, CASES FOR TOY STRUCTURES, CASES FOR TOY VEHICLES, TOY BANKS, TOY BOXES, STUFFED TOYS, STUFFED TOY ANIMALS, TEDDY BEARS, DOLLS AND ACCESSORIES THEREFOR, DOLLS AND PLAYSETS THEREFOR, DOLL COSTUMES, DOLL CLOTHING, DOLL CASES, DOLL HOUSES, DOLL FURNITURE, DOLL HOUSE FURNISHINGS, PUPPETS, BALLOONS, ACTION SKILL GAMES, BOARD GAMES, PARLOR GAMES, BACKGAMMON GAME SETS, POKER CHIPS, PUZZLES, JIGSAW PUZZLES, MANIPULATIVE AND CUBE PUZZLES, MANIPULATIVE GAMES, CARD GAMES, KITES, KITE STRING, KITE TAILS, KITE REELS, KITE LINES, KITE HANDLES, KITE PARTS, BEAN BAGS, DICE AND YO-YOS; INFLATABLE MATTRESSES FOR RECREATIONAL USE; INFLATABLE INNER TUBES FOR AQUATIC RECREATIONAL USE; FLOATING RECREATIONAL LOUNGE CHAIRS AND SWIM FLOATS FOR RECREATIONAL USE; INFLATABLE POOL TOYS AND INFLATABLE SWIMMING POOLS; WATER SKIS, SKATEBOARDS, INLINE SKATES AND TOY SCOOTERS; TOY WEAPONS, TOY BELTS, WATER SQUIRTING TOYS, TOY WRESTLING GEAR SETS AND TOY WRESTLING RINGS; BASKETBALL TABLE TOP GAMES, PADDLE BALL GAMES, BINGO GAME PLAYING EQUIPMENT, GAME EQUIPMENT IN THE NATURE OF CHIPS, BILLIARD BALLS, CUES AND CUE HOLDERS; BILLIARD GAME PLAYING EQUIPMENT; BILLIARD TABLES; BOWLING BALLS, AND ACCESSORIES THEREFOR, NAMELY, BOWLING BAGS, GLOVES AND PINS; SPORTING GOODS, NAMELY, BEACH BALLS, BASKETBALLS, BASEBALLS, SOFTBALLS, SPORT BALLS, BASEBALL AND SOFTBALL BATS, GOLF CLUBS, GOLF CLUB SHAFTS, GOLF IRONS, GOLF PUTTERS, GOLF CLUB HEADS, GOLF CLUB INSERTS, GOLF BALLS, GOLF BALL SLEEVES, GOLF ACCESSORY POUCHES, GOLF BAGS, GOLF PUTTER COVERS, HEAD COVERS FOR GOLF CLUBS, GOLF BAG MARKERS, NAMELY, TAGS FOR GOLF BAGS; GOLF BAG PEGS, GOLF BAG COVERS, GOLF BAG TAGS, GOLF GLOVES, GOLF BALL RETRIEVERS, GOLF FLAGS, GOLF TEES, GOLF TEE MARKERS, GOLF TOWEL CLIPS FOR ATTACHMENT TO GOLF BAGS, NON-MOTORIZED GOLF CARTS, ATHLETIC SUPPORTERS, ATHLETIC TAPE, SHOULDER PAD ELASTIC FOR ATHLETIC USE, SHOULDER PAD LACES AND LACELOCKS FOR ATHLETIC USE, THROAT PROTECTORS FOR ATHLETIC USE, ELBOW GUARDS AND PADS FOR ATHLETIC USE, HAND PADS FOR ATHLETIC USE, KNEE GUARDS AND PADS FOR ATHLETIC USE, LEG GUARDS AND WEIGHTS FOR ATHLETIC USE, HAND PADS FOR ATHLETIC USE, KNEE GUARDS AND PADS FOR ATHLETIC USE, LEG GUARDS AND WEIGHTS FOR ATHLETIC USE, SHIN GUARDS AND PADS FOR ATHLETIC USE; BARBELLS AND DUMBBELLS; ARCADE GAMES, ELECTRONIC AND NON-ELECTRONIC PINBALL GAMES AND GAMING TABLES; HAND HELD UNIT FOR PLAYING VIDEO GAMES OTHER THAN THOSE ADAPTED FOR USE WITH AN EXTERNAL DISPLAY SCREEN OR MONITOR AND ACCESSORIES THEREFOR, HAND HELD UNIT FOR PLAYING ELECTRONIC GAMES OTHER THAN THOSE ADAPTED FOR USE WITH AN EXTERNAL DISPLAY SCREEN OR MONITOR AND COIN-OPERATED VIDEO GAMES; HANDHELD LCD GAME MACHINES AND HAND HELD ACTION SKILL GAMES; STAND ALONE VIDEO OUTPUT GAME MACHINES; STAND ALONE VIDEO GAME MACHINES; COIN-OPERATED VIDEO GAMES; ELECTRONIC EDUCATIONAL GAME MACHINES FOR CHILDREN; EQUIPMENT SOLD AS A UNIT FOR PLAYING BOARD GAMES, CARD GAMES, MEMORY GAMES, AND ACTION-TYPE TARGET GAMES; AUDIO AND VIDEO TOY PROJECTORS AND ACCESSORIES THEREFOR; CHRISTMAS TREE ACCESSORIES, NAMELY, ORNAMENTS, STOCKINGS, TREE SKIRTS, TINSEL, BELLS, NON-ILLUMINATING AND NON-ELECTRIC TREE DECORATIONS; CHILDREN'S PLAY COSMETICS;

CLASS 28—(Continued).

FACE MASKS; TOY WATCHES, TOY SNOW GLOBES, TOY MUSICAL INSTRUMENTS, AND TOY PEDAL CARS; TOY GUM MAKERS AND TOY BUBBLE GUM DISPENSERS; TOY CANDY DISPENSERS AND HOLDERS; TOY MODEL HOBBY CRAFT KITS; TOY MODEL VEHICLES AND RELATED ACCESSORIES THEREFOR SOLD AS UNITS; TOY MODELING COMPOUND AND ACCESSORIES THEREFOR; PROMOTIONAL GAME MATERIALS AND GAME CARDS; ROLE PLAYING GAMES; TOY IN THE NATURE OF A BATTERY-POWERED COMPUTER GAME WITH LCD SCREEN WHICH FEATURES ANIMATION AND SOUND EFFECTS (U.S. CLS. 22, 23, 38 AND 50).

LAURIE KAUFMAN, EXAMINING ATTORNEY

SN 77-876,389. SCIO VERUM CORPORATION, PALM BEACH, FL. FILED 11-19-2009.



OWNER OF U.S. REG. NOS. 2,869,705 AND 2,893,388. THE NAME "BRIAN VICKERS" IDENTIFIES A LIVING INDIVIDUAL WHOSE CONSENT IS OF RECORD.

THE MARK CONSISTS OF THE NAME "BRIAN VICKERS" IN SCRIPT.

FOR SCALE COLLECTOR MODEL VEHICLES AND TOY MODEL VEHICLES (U.S. CLS. 22, 23, 38 AND 50).

FIRST USE 0-0-2002; IN COMMERCE 0-0-2002. LESLIE RICHARDS, EXAMINING ATTORNEY

SN 77-878,146. 1000 WEST, INC., HERSHEY, PA. FILED 11-21-2009.

MINI-"T"

THE MARK CONSISTS OF STANDARD CHARACTERS WITHOUT CLAIM TO ANY PARTICULAR FONT, STYLE, SIZE, OR COLOR.

FOR FISH HOOK REMOVERS (U.S. CLS. 22, 23, 38 AND 50).

FIRST USE 11-10-2009; IN COMMERCE 11-10-2009. JANET LEE, EXAMINING ATTORNEY

CLASS 28—(Continued).

SN 77-878,191. ODYSSEY PETS LLC, DBA ODYSSEY PETS, DALLAS, TX. FILED 11-21-2009.

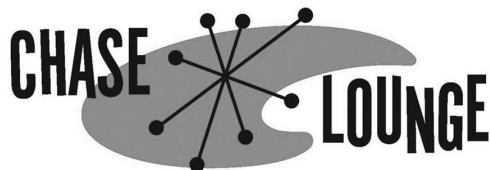

THE MARK CONSISTS OF THE PHRASE "CHASE LOUNGE" ALONG WITH A STYLIZED EIGHT-POINTED STAR AND ARTIST PALLETTE.

FOR COMBINATION CAT TOY WITH BALL, CATNIP HOLDER, AND CAT BED (U.S. CLS. 22, 23, 38 AND 50). FIRST USE 3-31-2009; IN COMMERCE 4-21-2009. PAUL E. FAHRENKOPF, EXAMINING ATTORNEY

CLASS 28—(Continued).

SN 77-880,902. LANZONI, WILLIAM, WALLINGFORD, CT. FILED 11-25-2009.



NO CLAIM IS MADE TO THE EXCLUSIVE RIGHT TO USE "FLY RODS", "WALLINGFORD CONNECTICUT" AND "WWW.MILLRIVERFLYRODS.COM", APART FROM THE MARK AS SHOWN.

THE MARK CONSISTS OF TWO STYLIZED OVALS (AN INNER AND AN OUTER) WITH A FLY ROD AND REEL IN FRONT OF MOUNTAINS AND WATER INSIDE THE INNER OVAL.

FOR FISHING FLIES; FISHING FLY BOXES; FISHING LEADERS; FISHING LINES; FISHING RODS; REELS FOR FISHING (U.S. CLS. 22, 23, 38 AND 50).

FIRST USE 8-1-2009; IN COMMERCE 11-1-2009.

HENRY S. ZAK, EXAMINING ATTORNEY

SN 77-885,384. GARCIA, ADALBERTO, PROVIDENCE, RI. FILED 12-3-2009.

BETEYAH

THE MARK CONSISTS OF STANDARD CHARACTERS WITHOUT CLAIM TO ANY PARTICULAR FONT, STYLE, SIZE, OR COLOR.

THE WORDING "BETEYAH" HAS NO MEANING IN A FOREIGN LANGUAGE.

FOR SPORTING EQUIPMENT, NAMELY, A STICK BAT AND PLASTIC DISC SOLD AS A UNIT FOR PLAYING A GAME DERIVED FROM BASEBALL (U.S. CLS. 22, 23, 38 AND 50).

JAY FLOWERS, EXAMINING ATTORNEY

SN 77-880,354. AIRFLOW COLLECTIBLES INC., ORANGE, CA. FILED 11-24-2009.



NO CLAIM IS MADE TO THE EXCLUSIVE RIGHT TO USE "COLLECTIBLES INC." AND "ORANGE CALIF.", APART FROM THE MARK AS SHOWN.

THE MARK CONSISTS OF TWO WINGS ONE ON THE LEFT WITH THE STYLIZED TEXT "ORANGE" AND ONE ON THE RIGHT WITH THE STYLIZED TEXT "CALIF.". THERE IS TWO CIRCLES IN THE CENTER. ON THE INNER CIRCLE THERE IS THE STYLIZED TEXT "AFC" AND ON THE OUTER CIRCLE THERE IS THE STYLIZED TEXT "AIRFLOW COLLECTIBLES INC.".

FOR CHILDREN'S RIDE ON TOY VEHICLES (U.S. CLS. 22, 23, 38 AND 50).

FIRST USE 12-1-1999; IN COMMERCE 12-1-1999.

LEIGH CAROLINE CASE, EXAMINING ATTORNEY

SN 77-885,571. CHRISTMAS BY KREBS CORPORATION, IRVING, TX. FILED 12-3-2009.

Santa's Shatterproof

THE MARK CONSISTS OF STANDARD CHARACTERS WITHOUT CLAIM TO ANY PARTICULAR FONT, STYLE, SIZE, OR COLOR.

NO CLAIM IS MADE TO THE EXCLUSIVE RIGHT TO USE SHATTERPROOF, APART FROM THE MARK AS SHOWN.

FOR CHRISTMAS TREE ORNAMENTS AND DECORATIONS (U.S. CLS. 22, 23, 38 AND 50).

FIRST USE 12-1-2009; IN COMMERCE 12-1-2009.

CAROL SPILS, EXAMINING ATTORNEY

CLASS 28—(Continued).

SN 77-885,572. MARLOWE VOORHIES RESEARCH, LLC, NEWTON, MA. FILED 12-3-2009.



THE COLOR(S) ORANGE IS/ARE CLAIMED AS A FEATURE OF THE MARK.

THE MARK CONSISTS OF THE TERM "AIRPORT" IN AN ORANGE STYLIZED FONT. THE RECTANGULAR SHAPE AND GRAY COLOR OF THE BACKGROUND ARE NOT CLAIMED AS FEATURES OF THE MARK.

FOR NEEDLES FOR PUMPS FOR INFLATING SPORTS EQUIPMENT, NAMELY, INFLATABLE BALLS (U.S. CLS. 22, 23, 38 AND 50).

ALYSSA STEEL, EXAMINING ATTORNEY

SN 77-885,962. RR2, INC., WESTON, MA. FILED 12-4-2009.

A Knock, A Fox, & a Peddler's Box

THE MARK CONSISTS OF STANDARD CHARACTERS WITHOUT CLAIM TO ANY PARTICULAR FONT, STYLE, SIZE, OR COLOR.

FOR BOARD GAMES; EQUIPMENT SOLD AS A UNIT FOR PLAYING BOARD GAMES (U.S. CLS. 22, 23, 38 AND 50).

SANJEEV VOHRA, EXAMINING ATTORNEY

SN 77-885,992. CYI, INC., CHATSWORTH, CA. FILED 12-4-2009.

BIG BANG ROCKET

THE MARK CONSISTS OF STANDARD CHARACTERS WITHOUT CLAIM TO ANY PARTICULAR FONT, STYLE, SIZE, OR COLOR.

NO CLAIM IS MADE TO THE EXCLUSIVE RIGHT TO USE "ROCKET", APART FROM THE MARK AS SHOWN.

FOR TOYS, NAMELY, TOY NOISEMAKERS (U.S. CLS. 22, 23, 38 AND 50).

JESSICA A. POWERS, EXAMINING ATTORNEY

CLASS 28—(Continued).

SN 77-886,465. HAYWOOD HOUSE INC., PIGEON FORGE, TN. FILED 12-4-2009.

VPX1000

THE MARK CONSISTS OF STANDARD CHARACTERS WITHOUT CLAIM TO ANY PARTICULAR FONT, STYLE, SIZE, OR COLOR.

FOR VIBRATING APPARATUS USED IN FITNESS AND EXERCISE PROGRAMS TO STIMULATE MUSCLES AND INCREASE STRENGTH AND PHYSICAL PERFORMANCE (U.S. CLS. 22, 23, 38 AND 50).

FIRST USE 12-1-2008; IN COMMERCE 12-1-2008.

RON FAIRBANKS, EXAMINING ATTORNEY

SN 77-886,606. BIG BAD BOO PRODUCTIONS, INC., NEW YORK, NY. FILED 12-4-2009.

1001 NIGHTS

THE MARK CONSISTS OF STANDARD CHARACTERS WITHOUT CLAIM TO ANY PARTICULAR FONT, STYLE, SIZE, OR COLOR.

FOR TOYS, NAMELY, PLUSH TOYS, MOLDED AND ACTION FIGURES, BOARD GAMES; ELECTRONIC GAMES, NAMELY, ARCADE-TYPE ELECTRONIC VIDEO GAMES (U.S. CLS. 22, 23, 38 AND 50).

JOHN WILKE, EXAMINING ATTORNEY

SN 77-886,668. BIG BAD BOO PRODUCTIONS, INC., NEW YORK, NY. FILED 12-4-2009.



THE MARK CONSISTS OF THE STYLIZED WORDS "1001 NIGHTS" WITH CURVED LINES BENEATH "1001" AND "HTS", ONE DIAMOND BEFORE "1001", ONE DIAMOND AFTER "NIGHTS" AND TWO DIAMONDS OVER THE "G".

FOR TOYS, NAMELY, PLUSH TOYS, MOLDED AND ACTION FIGURES, BOARD GAMES; ELECTRONIC GAMES, NAMELY, ARCADE-TYPE ELECTRONIC VIDEO GAMES (U.S. CLS. 22, 23, 38 AND 50).

JOHN WILKE, EXAMINING ATTORNEY

CLASS 28—(Continued).

SN 77-886,959. ROLLAXER LLC, ENCINO, CA. FILED 12-5-2009.



NO CLAIM IS MADE TO THE EXCLUSIVE RIGHT TO USE "SYSTEM", "FASCIAL" AND "TRAINING", APART FROM THE MARK AS SHOWN.

THE MARK CONSISTS OF 4 ARROWS CREATING THE IMAGE OF A CIRCLE, WITH THE WORDING "F.I.T. 4 SYSTEM FASCIAL INTEGRITY TRAINING" LOCATED TO THE RIGHT OF THE IMAGE.

FOR MANUALLY-OPERATED EXERCISE EQUIPMENT; MANUALLY-OPERATED EXERCISE EQUIPMENT FOR PHYSICAL FITNESS PURPOSES (U.S. CLS. 22, 23, 38 AND 50).

DAWN FELDMAN, EXAMINING ATTORNEY

SN 77-887,046. STAR BLUE STUDIO, INC., NEW YORK, NY. FILED 12-5-2009.

THE HAT SHOP FAIRY

THE MARK CONSISTS OF STANDARD CHARACTERS WITHOUT CLAIM TO ANY PARTICULAR FONT, STYLE, SIZE, OR COLOR.

NO CLAIM IS MADE TO THE EXCLUSIVE RIGHT TO USE "FAIRY", APART FROM THE MARK AS SHOWN.

FOR DOLLS, DOLL CLOTHING AND DOLL ACCESSORIES (U.S. CLS. 22, 23, 38 AND 50).

BRIAN PINO, EXAMINING ATTORNEY

SN 77-887,247. HASBRO, INC., PAWTUCKET, RI. FILED 12-7-2009.

TREAD SHIFTERS

THE MARK CONSISTS OF STANDARD CHARACTERS WITHOUT CLAIM TO ANY PARTICULAR FONT, STYLE, SIZE, OR COLOR.

FOR TOY VEHICLES AND ACCESSORIES FOR USE THEREWITH (U.S. CLS. 22, 23, 38 AND 50).

LYDIA BELZER, EXAMINING ATTORNEY

CLASS 28—(Continued).

SN 77-887,650. HOLMES, GARY, DBA DOG DIGGIN DESIGNS, LAS VEGAS, NV. FILED 12-7-2009.

DOG DIGGIN DESIGNS

THE MARK CONSISTS OF STANDARD CHARACTERS WITHOUT CLAIM TO ANY PARTICULAR FONT, STYLE, SIZE, OR COLOR.

NO CLAIM IS MADE TO THE EXCLUSIVE RIGHT TO USE "DESIGNS", APART FROM THE MARK AS SHOWN.

FOR PLUSH TOYS; STUFFED TOYS (U.S. CLS. 22, 23, 38 AND 50).

ZHALEH DELANEY, EXAMINING ATTORNEY

SN 77-887,742. COLOR ME HOUSE INC., SHERWOOD, OR. FILED 12-7-2009.

COLOR ME HOUSE

THE MARK CONSISTS OF STANDARD CHARACTERS WITHOUT CLAIM TO ANY PARTICULAR FONT, STYLE, SIZE, OR COLOR.

NO CLAIM IS MADE TO THE EXCLUSIVE RIGHT TO USE "HOUSE", APART FROM THE MARK AS SHOWN.

FOR PLAY HOUSES (U.S. CLS. 22, 23, 38 AND 50).

FIRST USE 6-26-2008; IN COMMERCE 6-26-2008.

JOHN SCHUYLER YARD, EXAMINING ATTORNEY

SN 77-887,770. COLOR ME HOUSE INC., SHERWOOD, OR. FILED 12-7-2009.

COLOR ME ROCKET

THE MARK CONSISTS OF STANDARD CHARACTERS WITHOUT CLAIM TO ANY PARTICULAR FONT, STYLE, SIZE, OR COLOR.

NO CLAIM IS MADE TO THE EXCLUSIVE RIGHT TO USE "ROCKET", APART FROM THE MARK AS SHOWN.

FOR PLAY HOUSES (U.S. CLS. 22, 23, 38 AND 50).

FIRST USE 6-1-2008; IN COMMERCE 8-1-2008.

JOHN SCHUYLER YARD, EXAMINING ATTORNEY

CLASS 28—(Continued).

SN 77-887,799. COLOR ME HOUSE INC., SHERWOOD, OR.
FILED 12-7-2009.

COLOR ME CASTLE

THE MARK CONSISTS OF STANDARD CHARACTERS WITHOUT CLAIM TO ANY PARTICULAR FONT, STYLE, SIZE, OR COLOR.

NO CLAIM IS MADE TO THE EXCLUSIVE RIGHT TO USE "CASTLE", APART FROM THE MARK AS SHOWN. FOR PLAY HOUSES (U.S. CLS. 22, 23, 38 AND 50). JOHN SCHUYLER YARD, EXAMINING ATTORNEY

CLASS 28—(Continued).

SN 77-887,969. TERRY BALL, DAYTON, NV. AND DEANN BALL, DAYTON, NV. FILED 12-7-2009.

FLIP-N-TARGET

THE MARK CONSISTS OF STANDARD CHARACTERS WITHOUT CLAIM TO ANY PARTICULAR FONT, STYLE, SIZE, OR COLOR.

FOR FIREARM TARGET STANDS (U.S. CLS. 22, 23, 38 AND 50).

FIRST USE 9-9-2009; IN COMMERCE 9-9-2009.
ANGELA M. MICHELI, EXAMINING ATTORNEY

SN 77-887,821. COLOR ME HOUSE INC., SHERWOOD, OR.
FILED 12-7-2009.

COLOR ME GINGERBREAD HOUSE

THE MARK CONSISTS OF STANDARD CHARACTERS WITHOUT CLAIM TO ANY PARTICULAR FONT, STYLE, SIZE, OR COLOR.

NO CLAIM IS MADE TO THE EXCLUSIVE RIGHT TO USE "GINGERBREAD HOUSE", APART FROM THE MARK AS SHOWN.

FOR PLAY HOUSES (U.S. CLS. 22, 23, 38 AND 50).
JOHN SCHUYLER YARD, EXAMINING ATTORNEY

SN 77-888,142. SHENZHEN XINGYAOHUA INDUSTRIAL CO., LTD., SHENZHEN, CHINA, FILED 12-7-2009.



THE MARK CONSISTS OF THE STYLIZED LETTERS "ZD" WITH LINES DEPICTING SPEED OR PROPULSION.

FOR ELECTRIC ACTION TOYS; ELECTRONIC TOY VEHICLES; PROTECTIVE SUPPORTS FOR SHOULDERS AND ELBOWS; SCALE MODEL AIRPLANES; SCALE MODEL VEHICLES; SPRING BOARDS; TOY AIRPLANES; TOY CARS; WEIGHT LIFTING BELTS (U.S. CLS. 22, 23, 38 AND 50).

FIRST USE 5-20-2006; IN COMMERCE 5-20-2006.
MARILYN IZZI, EXAMINING ATTORNEY

SN 77-887,848. AUGUSTA NATIONAL, INC., AUGUSTA, GA.
FILED 12-7-2009.

MASTERS

THE MARK CONSISTS OF STANDARD CHARACTERS WITHOUT CLAIM TO ANY PARTICULAR FONT, STYLE, SIZE, OR COLOR.

OWNER OF U.S. REG. NOS. 361,678, 1,470,536 AND OTHERS.

FOR GOLF CLUBS AND GOLF BALLS (U.S. CLS. 22, 23, 38 AND 50).

FIRST USE 4-0-1998; IN COMMERCE 4-0-1998.

ANGELA M. MICHELI, EXAMINING ATTORNEY

SN 77-888,219. HASBRO, INC., PAWTUCKET, RI. FILED 12-8-2009.

PRECIOUS HUGS

THE MARK CONSISTS OF STANDARD CHARACTERS WITHOUT CLAIM TO ANY PARTICULAR FONT, STYLE, SIZE, OR COLOR.

FOR DOLLS, DOLL CLOTHING AND DOLL ACCESSORIES (U.S. CLS. 22, 23, 38 AND 50).

LYDIA BELZER, EXAMINING ATTORNEY

CLASS 28—(Continued).

SN 77-888,229. MASKMAN BY DESIGN, LLC, SNOHOMISH, WA. FILED 12-8-2009.

MASKMAN BY DESIGN

THE MARK CONSISTS OF STANDARD CHARACTERS WITHOUT CLAIM TO ANY PARTICULAR FONT, STYLE, SIZE, OR COLOR.

FOR HAND-PAINTED OR SILKSCREEN FACE MASKS (U.S. CLS. 22, 23, 38 AND 50).

ANNE E. GUSTASON, EXAMINING ATTORNEY

CLASS 28—(Continued).

SN 77-888,434. PURE FISHING, INC., COLUMBIA, SC. FILED 12-8-2009.

BRUTE STRENGTH

THE MARK CONSISTS OF STANDARD CHARACTERS WITHOUT CLAIM TO ANY PARTICULAR FONT, STYLE, SIZE, OR COLOR.

FOR SPORTING GOODS, NAMELY, FISHING LINE (U.S. CLS. 22, 23, 38 AND 50).

TINA MAI, EXAMINING ATTORNEY

SN 77-888,276. KIEFFABER MEDIA INC, SOUTHLAKE, TX. FILED 12-8-2009.

TRACK & ATTACK

THE MARK CONSISTS OF STANDARD CHARACTERS WITHOUT CLAIM TO ANY PARTICULAR FONT, STYLE, SIZE, OR COLOR.

FOR BASEBALL AND SOFTBALL TRAINING APPARATUS USED FOR A BATTER TO IMPROVE BAT SWINGING AND CONTACT PERFORMANCE (U.S. CLS. 22, 23, 38 AND 50).

DAVID MURRAY, EXAMINING ATTORNEY

SN 77-888,440. PURE FISHING, INC., COLUMBIA, SC. FILED 12-8-2009.

FLUOROCAST

THE MARK CONSISTS OF STANDARD CHARACTERS WITHOUT CLAIM TO ANY PARTICULAR FONT, STYLE, SIZE, OR COLOR.

FOR SPORTING GOODS, NAMELY, FISHING LINE (U.S. CLS. 22, 23, 38 AND 50).

TINA MAI, EXAMINING ATTORNEY

SN 77-888,315. STEELFIT STRENGTH SYSTEMS, LLC, MONROVIA, MD. FILED 12-8-2009.

STEELFIT

THE MARK CONSISTS OF STANDARD CHARACTERS WITHOUT CLAIM TO ANY PARTICULAR FONT, STYLE, SIZE, OR COLOR.

FOR EXERCISE BARS; EXERCISE MACHINES (U.S. CLS. 22, 23, 38 AND 50).

MATTHEW KLINE, EXAMINING ATTORNEY

SN 77-888,445. PURE FISHING, INC., COLUMBIA, SC. FILED 12-8-2009.

TRANSOPTIC

THE MARK CONSISTS OF STANDARD CHARACTERS WITHOUT CLAIM TO ANY PARTICULAR FONT, STYLE, SIZE, OR COLOR.

FOR SPORTING GOODS, NAMELY, FISHING LINE (U.S. CLS. 22, 23, 38 AND 50).

TINA MAI, EXAMINING ATTORNEY

CLASS 28—(Continued).

SN 77-888,617. THE CHIP ROOM LLC, MILFORD, MI. FILED 12-8-2009.

Bahamia 

THE MARK CONSISTS OF THE WORD "BAHAMIA" WITH A LOTUS FLOWER DESIGN ABOVE THE LETTER "I".

FOR GAMING EQUIPMENT, NAMELY, POKER CHIPS (U.S. CLS. 22, 23, 38 AND 50).
FIRST USE 11-1-2009; IN COMMERCE 11-1-2009.
HOWARD SMIGA, EXAMINING ATTORNEY

CLASS 28—(Continued).

SN 77-888,891. THOSE CHARACTERS FROM CLEVELAND, INC., CLEVELAND, OH. FILED 12-8-2009.

BERRYKIN

THE MARK CONSISTS OF STANDARD CHARACTERS WITHOUT CLAIM TO ANY PARTICULAR FONT, STYLE, SIZE, OR COLOR.

FOR PLUSH TOYS; TOY ACTION FIGURES AND ACCESSORIES THEREFOR; TOY FIGURES (U.S. CLS. 22, 23, 38 AND 50).
ODESSA BIBBINS, EXAMINING ATTORNEY

SN 77-888,734. L.V.R. INVESTISSEMENTS ET IMMOBILIER, PARIS., FRANCE, FILED 12-8-2009.

S.I.C.

THE MARK CONSISTS OF STANDARD CHARACTERS WITHOUT CLAIM TO ANY PARTICULAR FONT, STYLE, SIZE, OR COLOR.

FOR PLAYING CARDS (U.S. CLS. 22, 23, 38 AND 50).
FIRST USE 5-0-2002; IN COMMERCE 6-0-2002.
RICHARD WHITE, EXAMINING ATTORNEY

SN 77-888,952. LORI GRANT, LONG BEACH, NY. FILED 12-8-2009.

DORM DUDE

SN 77-888,887. THOSE CHARACTERS FROM CLEVELAND, INC., CLEVELAND, OH. FILED 12-8-2009.

BERRYKINS

THE MARK CONSISTS OF STANDARD CHARACTERS WITHOUT CLAIM TO ANY PARTICULAR FONT, STYLE, SIZE, OR COLOR.

FOR PLUSH TOYS; TOY ACTION FIGURES AND ACCESSORIES THEREFOR; TOY FIGURES (U.S. CLS. 22, 23, 38 AND 50).
ODESSA BIBBINS, EXAMINING ATTORNEY

THE MARK CONSISTS OF STANDARD CHARACTERS WITHOUT CLAIM TO ANY PARTICULAR FONT, STYLE, SIZE, OR COLOR.

FOR DOLLS; POSITIONABLE TOY FIGURES (U.S. CLS. 22, 23, 38 AND 50).
ROBIN CHOSID, EXAMINING ATTORNEY

CLASS 28—(Continued).

SN 77-888,984. FINAL SCOOP DESIGNS, LTD., DBA READY TO PLAY GROUP LTD., R2P PET, LTD. & R2P PRODUCTS LTD., MACAU, CHINA, FILED 12-8-2009.



NO CLAIM IS MADE TO THE EXCLUSIVE RIGHT TO USE "HIGH VIZ TECHNOLOGY", APART FROM THE MARK AS SHOWN.

THE COLOR(S) YELLOW, WHITE, BLACK, PURPLE AND GRAY IS/ARE CLAIMED AS A FEATURE OF THE MARK.

THE MARK CONSISTS OF THE STYLIZED WORDS "HIGH VIZ TECHNOLOGY" WITHIN A STYLIZED DESIGN OF A CIRCLE HAVING A WHITE AND GRAY PERIMETER AND IN WHICH THE WORDING "HIGH VIZ" IS COLORED BLACK AGAINST A WHITE BACKGROUND AND APPEARS BETWEEN A FIRST SEMI-CIRCLE COLORED YELLOW AND A SECOND SEMI-CIRCLE COLORED PURPLE, AND THE WORD "TECHNOLOGY" IS COLORED WHITE AGAINST THE PURPLE SEMI-CIRCLE.

FOR PET TOYS (U.S. CLS. 22, 23, 38 AND 50).
FIRST USE 6-1-2007; IN COMMERCE 9-1-2007.
ANDREW RHIM, EXAMINING ATTORNEY

SN 77-889,021. INFUNITUM INC., CHICAGO, IL. FILED 12-8-2009.

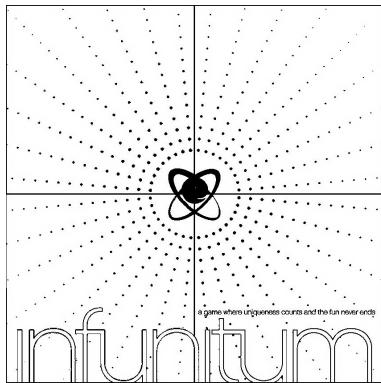

THE MARK CONSISTS OF 4 BOXES, 2 STACKED ON TOP OF EACH OTHER, SIDE BY SIDE. A CIRCULAR FACE AND ITS 2 RINGS ARE CENTERED WHERE ALL 4 BOXES INTERSECT. CIRCLES OF DOTS SURROUND THE FACE, WITH THE NAME "INFUNITUM" DISPLAYED ALONG THE BOTTOM 2 BOXES AND "A GAME WHERE UNIQUENESS COUNTS AND THE FUN NEVER ENDS" ABOVE THE LETTERS "ITUM" IN THE BOTTOM RIGHT BOX.

FOR BOARD GAMES (U.S. CLS. 22, 23, 38 AND 50).
FIRST USE 9-1-2009; IN COMMERCE 9-1-2009.
APRIL HESIK, EXAMINING ATTORNEY

CLASS 28—(Continued).

SN 77-889,025. OUT OF THE BOX PUBLISHING, INC., DODGEVILLE, WI. FILED 12-8-2009.

BUG OUT

THE MARK CONSISTS OF STANDARD CHARACTERS WITHOUT CLAIM TO ANY PARTICULAR FONT, STYLE, SIZE, OR COLOR.

FOR CARD GAMES (U.S. CLS. 22, 23, 38 AND 50).
MARK SPARACINO, EXAMINING ATTORNEY

SN 77-889,150. CORY KELLY, KELSEYVILLE, CA. FILED 12-9-2009.

RESILIENT

THE MARK CONSISTS OF STANDARD CHARACTERS WITHOUT CLAIM TO ANY PARTICULAR FONT, STYLE, SIZE, OR COLOR.

FOR SPORTS EQUIPMENT FOR BOXING AND MARTIAL ARTS, NAMELY, BOXING GLOVES, BOXING BAGS, PUNCHING MITTS, BELLY PROTECTORS, GROIN PROTECTORS AND SHIN GUARDS (U.S. CLS. 22, 23, 38 AND 50).

ANDREA BUTLER, EXAMINING ATTORNEY

SN 77-889,607. FERGUSON, PATRICK JOSEPH, PORTLAND, OR. FILED 12-9-2009.

BioLure

THE MARK CONSISTS OF STANDARD CHARACTERS WITHOUT CLAIM TO ANY PARTICULAR FONT, STYLE, SIZE, OR COLOR.

FOR FISH ATTRACTANTS; FISHING FLIES; FISHING LEADERS; FISHING LINES; FISHING LURE BOXES; FISHING LURE PARTS; FISHING LURES; FISHING LURES, NAMELY, LEECHES; FISHING LURES, NAMELY, PLASTIC WORMS; FISHING LURES, NAMELY, SPOONS; FISHING SINKERS; FISHING TACKLE; FISHING TACKLE, NAMELY, BOBBERS; FISHING TACKLE, NAMELY, LIGHTED BOBBERS; FISHING WEIGHTS; FLIES FOR USE IN FISHING; FLOATS FOR FISHING; LINES FOR FISHING; LURES FOR FISHING; LURES FOR HUNTING OR FISHING; SCENT LURES FOR HUNTING OR FISHING (U.S. CLS. 22, 23, 38 AND 50).

RICHARD WHITE, EXAMINING ATTORNEY

CLASS 28—(Continued).

SN 77-889,738. JACKSON-PEARSON, GERALYN, DETROIT, MI. FILED 12-9-2009.

ON THE BRIGHT SIDE

THE MARK CONSISTS OF STANDARD CHARACTERS WITHOUT CLAIM TO ANY PARTICULAR FONT, STYLE, SIZE, OR COLOR.

FOR GAME EQUIPMENT, NAMELY, ACTIVITY CARDS AND DICE, SOLD TOGETHER AS A UNIT FOR PLAYING A GAME TO PROMOTE MENTAL STIMULATION OF PLAYERS (U.S. CLS. 22, 23, 38 AND 50).

JORDAN BAKER, EXAMINING ATTORNEY

CLASS 28—(Continued).

SN 77-890,007. NELSON, DAVID, CALABASAS, CA. AND LUCAS, JOHN, CALABASAS, CA. FILED 12-9-2009.

Play Anywhere.-Play NOW!

THE MARK CONSISTS OF STANDARD CHARACTERS WITHOUT CLAIM TO ANY PARTICULAR FONT, STYLE, SIZE, OR COLOR.

FOR PORTABLE SPORTS NETS AND GOALS FOR SOCCER, BASEBALL, LACROSSE, HOCKEY, SOFTBALL, AND FOOTBALL (U.S. CLS. 22, 23, 38 AND 50).

FIRST USE 10-16-2009; IN COMMERCE 10-16-2009.

LINDSEY RUBIN, EXAMINING ATTORNEY

SN 77-890,347. GLOBAL MANUFACTURING ASSOCIATES, INC., AURORA, OH. FILED 12-10-2009.

X FLITE

THE MARK CONSISTS OF STANDARD CHARACTERS WITHOUT CLAIM TO ANY PARTICULAR FONT, STYLE, SIZE, OR COLOR.

FOR ARCHERY BOWS (U.S. CLS. 22, 23, 38 AND 50).

FIRST USE 10-0-2009; IN COMMERCE 10-0-2009.

SAIMA MAKHDOOM, EXAMINING ATTORNEY

SN 77-889,907. SILVERLIT LIMITED, CAUSEWAYBAY, HONG KONG, HONG KONG, FILED 12-9-2009.

POWER IN FUN

THE MARK CONSISTS OF STANDARD CHARACTERS WITHOUT CLAIM TO ANY PARTICULAR FONT, STYLE, SIZE, OR COLOR.

FOR TOYS, NAMELY, TOY WATERCRAFT, VEHICLES, FIGURES, AIRCRAFT, HELICOPTERS AND SPACECRAFT AND ACCESSORIES THEREFOR; MOLDED, PLASTIC AND FABRIC TOY FIGURINES; MOLDED, PLASTIC AND FABRIC TOYS IN THE NATURE OF DOLLS, VEHICLES, STRUCTURES, ANIMALS, AND FIGURINES; PLUSH TOYS AND PLUSH TOY FIGURINES; ACTION SKILL GAMES; BOARD GAMES; CASES FOR TOY VEHICLES AND FIGURINES AND TOY VEHICLES AND ACCESSORIES FOR TOY FIGURINES; PUZZLE GAMES; INFANT TOYS; PRESCHOOL TOYS IN THE NATURE OF DOLLS, VEHICLES, STRUCTURES, ANIMALS, AND FIGURINES; DOLLS AND ACCESSORIES THEREFOR; DOLL PLAYSETS; ELECTRONICALLY-OPERATED TOY VEHICLES, AIRCRAFT, HELICOPTERS AND SPACECRAFT; EDUCATIONAL TOYS FOR THE PURPOSE OF TEACHING READING, MATH, MUSIC, SPELLING AND REASONING; CHILDREN'S MULTIPLE ACTIVITY TOYS; TOY CONSTRUCTION SETS; AND MOTORIZED, REMOTE, INFRARED AND RADIO-CONTROLLED TOY VEHICLES, AIRCRAFT, HELICOPTERS AND SPACECRAFT; SCALE MODEL VEHICLES, AIRCRAFT, HELICOPTERS, AND SPACECRAFT; TOY MINI-CAR GAME SETS AND ACCESSORIES THEREFOR (U.S. CLS. 22, 23, 38 AND 50).

STEPHEN AQUILA, EXAMINING ATTORNEY

SN 77-890,570. SINGH, RAVINDER, SAN JOSE, CA. FILED 12-10-2009.

WISE N WEALTHY

THE MARK CONSISTS OF STANDARD CHARACTERS WITHOUT CLAIM TO ANY PARTICULAR FONT, STYLE, SIZE, OR COLOR.

FOR BOARD GAMES (U.S. CLS. 22, 23, 38 AND 50).

CHARLOTTE CORWIN, EXAMINING ATTORNEY

CLASS 28—(Continued).

SN 77-890,699. UNIVERSITY OF NORTHWESTERN OHIO, LIMA, OH. FILED 12-10-2009.



THE COLOR(S) RED, BLACK AND WHITE IS/ARE CLAIMED AS A FEATURE OF THE MARK.

THE MARK CONSISTS OF A RED LARGE "U" OUTLINED IN BLACK AND WHITE WITH THE STYLIZED WORDING "MOTORSPORTS" ARCHED ACROSS MIDDLE IN WHITE LETTERS WITH RED, BLACK, AND WHITE OUTLINING AND THE STYLIZED WORDING "UNOH" IN BLACK AND RED OUTLINED IN WHITE ACROSS THE BOTTOM OF THE "U".

FOR CHRISTMAS TREE ORNAMENTS AND DECORATIONS; STUFFED TOY ANIMALS (U.S. CLS. 22, 23, 38 AND 50).

LIEF MARTIN, EXAMINING ATTORNEY

SN 77-890,728. LOWE PROFILE PRODUCTIONS, INC., BEVERLY HILLS, CA. FILED 12-10-2009.



THE MARK CONSISTS OF THE STYLIZED LETTERS "TBP" INSIDE OF AN OVAL SHAPE DESIGN.

FOR GAMES, NAMELY, BOARD GAMES, CARD GAMES, POKER SETS COMPRISED OF CARDS, CHIPS; LOTTERY TICKETS; SCRATCH CARDS FOR PLAYING LOTTERY GAMES; LOTTERY WHEELS; LOTTERY CARDS; SCRATCH LOTTERY TICKETS OR GAME CARDS USED IN CONJUNCTION WITH GAMES OF CHANCE FOR CASH PRIZES; DICE GAMES; PLAYING CARDS (U.S. CLS. 22, 23, 38 AND 50).

TINA MAI, EXAMINING ATTORNEY

CLASS 28—(Continued).

SN 77-890,770. PREMIUM BALLOON ACCESSORIES, INC., SHARON CENTER, OH. FILED 12-10-2009.

WALKER WEIGHT

THE MARK CONSISTS OF STANDARD CHARACTERS WITHOUT CLAIM TO ANY PARTICULAR FONT, STYLE, SIZE, OR COLOR.

NO CLAIM IS MADE TO THE EXCLUSIVE RIGHT TO USE "WEIGHT", APART FROM THE MARK AS SHOWN. FOR WEIGHTS FOR BALLOONS (U.S. CLS. 22, 23, 38 AND 50).

GEORGE LORENZO, EXAMINING ATTORNEY

SN 77-891,006. TOPMIXUSA - LLC, WESTFIELD, NJ. FILED 12-10-2009.

TOPMIX USA

THE MARK CONSISTS OF STANDARD CHARACTERS WITHOUT CLAIM TO ANY PARTICULAR FONT, STYLE, SIZE, OR COLOR.

NO CLAIM IS MADE TO THE EXCLUSIVE RIGHT TO USE "USA", APART FROM THE MARK AS SHOWN. FOR ARTIFICIAL FISHING BAIT; PACKAGED FREEZE-DRIED FISHING BAIT (U.S. CLS. 22, 23, 38 AND 50).

LINDA MICKLEBURGH, EXAMINING ATTORNEY

SN 77-891,096. WILD PLANET ENTERTAINMENT, INC., SAN FRANCISCO, CA. FILED 12-11-2009.

DENKOSEKKA

THE MARK CONSISTS OF STANDARD CHARACTERS WITHOUT CLAIM TO ANY PARTICULAR FONT, STYLE, SIZE, OR COLOR.

THE ENGLISH TRANSLATION OF "DENKOSEKKA" IN THE MARK IS LIGHTNING SPEED.

FOR EQUIPMENT SOLD AS A UNIT FOR PLAYING A PARLOR GAME (U.S. CLS. 22, 23, 38 AND 50).

AARON BRODSKY, EXAMINING ATTORNEY

CLASS 28—(Continued).

CLASS 28—(Continued).

SN 77-891,488. MVL RIGHTS LLC, MANHATTAN BEACH, CA. FILED 12-11-2009.

SN 77-891,433. KOSTICK WOODWORKING, MEDFORD, MA. FILED 12-11-2009.



Tetraxis

OWNER OF U.S. REG. NOS. 885,486, 3,282,768 AND OTHERS.

THE MARK CONSISTS OF A CIRCULAR DESIGN WITH THE WORDS "AVENGERS ASSEMBLE" AND TWO FIVE-POINTED STARS SURROUNDING A SMALLER CIRCLE CONTAINING THE IMAGE OF AN EAGLE WITH OUTSPREAD WINGS AND A SHIELD AT THE CENTER WITH STRIPES AND STARS ON THE SHIELD.

FOR ACTION FIGURES AND ACCESSORIES THEREFOR; ARCADE GAMES; BALLOONS; BALLS FOR GAMES; BATTERY OPERATED ACTION TOYS; BEAN BAG DOLLS; BENDABLE TOYS; BOARD GAMES; BOBBLE HEAD DOLLS; CARD GAMES; CHESS SETS; CHILDREN'S MULTIPLE ACTIVITY TOYS; CHRISTMAS TREE DECORATIONS; COIN-OPERATED VIDEO GAMES; DOLLS AND ACCESSORIES THEREFOR; FLYING DISCS; GAME TABLES; HAND HELD UNITS FOR PLAYING VIDEO GAMES OTHER THAN THOSE ADAPTED FOR USE WITH AN EXTERNAL DISPLAY SCREEN OR MONITOR; HAND-HELD GAMES WITH LIQUID CRYSTAL DISPLAYS; INFLATABLE BOP BAGS; INFLATABLE POOLS FOR RECREATIONAL USE; INFLATABLE TOYS; JIGSAW PUZZLES; JUMP ROPES; KITES; MECHANICAL ACTION TOYS; PINBALL GAMES; PINBALL-TYPE GAMES; PLAYING CARDS; PLAYSETS FOR USE WITH TOY ACTION FIGURES AND FOR MAKE BELIEVE PLAY BATTLE OR ADVENTURE ACTIVITIES; PLUSH TOYS; PUPPETS; RADIO CONTROLLED TOY VEHICLES; ROLE PLAYING GAMES; ROLLER SKATES; RUBBER BALLS; SNOW BOARDS; SNOW SLEDS FOR RECREATIONAL USE; SOFT SCULPTURE TOYS; STUFFED TOY ANIMALS; SURF BOARDS; SURF FINS; SWIM BOARDS FOR RECREATIONAL USE; SWIM FINS; TARGET GAMES; TOY ACTION FIGURES AND ACCESSORIES THEREFOR; TOY MASKS; TOY MODEL HOBBYCRAFT KITS; TOY VEHICLES; TOY WATCHES; TOY WEAPONS; WATER SQUIRTING TOYS; YO-YOS (U.S. CLS. 22, 23, 38 AND 50).

FLORENTINA BLANDU, EXAMINING ATTORNEY

THE MARK CONSISTS OF STANDARD CHARACTERS WITHOUT CLAIM TO ANY PARTICULAR FONT, STYLE, SIZE, OR COLOR.

FOR PUZZLES CONSISTING OF THE INTERSECTION OF FOUR COMPOSITE BEAMS, OR BUNDLES ABOUT A COMMON CENTER (U.S. CLS. 22, 23, 38 AND 50).

FIRST USE 10-5-1992; IN COMMERCE 8-28-2008.

SUSAN RICHARDS, EXAMINING ATTORNEY

CLASS 28—(Continued).

SN 77-891,555. MVL RIGHTS LLC, MANHATTAN BEACH, CA. FILED 12-11-2009.

HALL OF ARMOR

THE MARK CONSISTS OF STANDARD CHARACTERS WITHOUT CLAIM TO ANY PARTICULAR FONT, STYLE, SIZE, OR COLOR.

FOR ACTION FIGURES AND ACCESSORIES THEREFOR; ARCADE GAMES; BALLOONS; BALLS FOR GAMES; BATTERY OPERATED ACTION TOYS; BEAN BAG DOLLS; BENDABLE TOYS; BOARD GAMES; BOBBLE HEAD DOLLS; CARD GAMES; CHESS SETS; CHILDREN'S MULTIPLE ACTIVITY TOYS; CHRISTMAS TREE DECORATIONS; COIN-OPERATED VIDEO GAMES; DOLLS AND ACCESSORIES THEREFOR; FLYING DISCS; GAME TABLES; HAND HELD UNITS FOR PLAYING VIDEO GAMES OTHER THAN THOSE ADAPTED FOR USE WITH AN EXTERNAL DISPLAY SCREEN OR MONITOR; HAND-HELD GAMES WITH LIQUID CRYSTAL DISPLAYS; INFLATABLE BOP BAGS; INFLATABLE POOLS FOR RECREATIONAL USE; INFLATABLE TOYS; JIGSAW PUZZLES; JUMP ROPES; KITES; MECHANICAL ACTION TOYS; PINBALL GAMES; PINBALL-TYPE GAMES; PLAYING CARDS; PLAYSETS FOR USE WITH TOY ACTION FIGURES AND FOR MAKE BELIEVE PLAY BATTLE OR ADVENTURE ACTIVITIES; PLUSH TOYS; PUPPETS; RADIO CONTROLLED TOY VEHICLES; ROLE PLAYING GAMES; ROLLER SKATES; RUBBER BALLS; SNOW BOARDS; SNOW SLEDS FOR RECREATIONAL USE; SOFT SCULPTURE TOYS; STUFFED TOY ANIMALS; SURF BOARDS; SURF FINS; SWIM BOARDS FOR RECREATIONAL USE; SWIM FINS; TARGET GAMES; TOY ACTION FIGURES AND ACCESSORIES THEREFOR; TOY MASKS; TOY MODEL HOBBYCRAFT KITS; TOY VEHICLES; TOY WATCHES; TOY WEAPONS; WATER SQUIRTING TOYS; YO-YOS (U.S. CLS. 22, 38 AND 50).

FLORENTINA BLANDU, EXAMINING ATTORNEY

CLASS 28—(Continued).

SN 77-891,640. GANZ, WOODBRIDGE, ONT, CANADA, FILED 12-11-2009.

LUVKINZ

THE MARK CONSISTS OF STANDARD CHARACTERS WITHOUT CLAIM TO ANY PARTICULAR FONT, STYLE, SIZE, OR COLOR.

OWNER OF U.S. REG. NOS. 3,015,923, 3,207,641 AND 3,565,414.

FOR TOYS AND GAMES, NAMELY, RUBBER ACTION BALLS, SPORTS BALLS, SOCCER BALLS, TENNIS BALLS, ACTION FIGURES, STAND ALONE VIDEO GAME MACHINES, PLUSH DOLLS, PLUSH TOYS, MULTIPLE ACTIVITY TOYS FOR BABIES, RATTLES, BALLOONS, TOY BANKS, BATH TOYS, BOARD GAMES, CARD GAMES, DOLL CLOTHING, CRIB MOBILES, CRIB TOYS, DOLL ACCESSORIES; PARTY FAVORS IN THE NATURE OF SMALL TOYS AND NOISEMAKERS, DARTBOARDS, JIGSAW PUZZLES, KITES, COSTUME MASKS, TOY MOBILES, WATER SQUIRTING TOYS, PAPER DOLLS, PUPPETS, ROLLER SKATES AND IN-LINE SKATES, SOFT SCULPTURE DOLLS, DOG TOYS, TARGET GAMES, CHRISTMAS TREE ORNAMENTS, AND CHRISTMAS STOCKINGS (U.S. CLS. 22, 23, 38 AND 50).

SAIMA MAKHDOOM, EXAMINING ATTORNEY

SN 77-891,788. PARLEY ENTERTAINMENT, INC., RALEIGH, NC. FILED 12-11-2009.

IF ALL THE WORLD'S A STAGE, WE'RE ALL STARS

THE MARK CONSISTS OF STANDARD CHARACTERS WITHOUT CLAIM TO ANY PARTICULAR FONT, STYLE, SIZE, OR COLOR.

FOR GAMES, NAMELY, PARLOR GAMES, PARTY GAMES, CARD GAMES AND BOARD GAMES (U.S. CLS. 22, 23, 38 AND 50).

SUSAN RICHARDS, EXAMINING ATTORNEY

SN 77-891,850. PARLEY ENTERTAINMENT, INC., RALEIGH, NC. FILED 12-11-2009.

BECAUSE YOU FIRST NEED TO MEET

THE MARK CONSISTS OF STANDARD CHARACTERS WITHOUT CLAIM TO ANY PARTICULAR FONT, STYLE, SIZE, OR COLOR.

FOR GAMES, NAMELY, PARLOR GAMES, PARTY GAMES, CARD GAMES AND BOARD GAMES (U.S. CLS. 22, 23, 38 AND 50).

SUSAN RICHARDS, EXAMINING ATTORNEY

CLASS 28—(Continued).

SN 77-892,093. BOYLES, CHARLES L., TA TATER 'NA JUG, JACKSON, MS. FILED 12-12-2009.

TATER 'N A JUG

THE MARK CONSISTS OF STANDARD CHARACTERS WITHOUT CLAIM TO ANY PARTICULAR FONT, STYLE, SIZE, OR COLOR.
FOR DEER ATTRACTANTS; DEER LURES (U.S. CLS. 22, 23, 38 AND 50).
FIRST USE 6-1-2009; IN COMMERCE 12-1-2009.
JILL PRATER, EXAMINING ATTORNEY

CLASS 28—(Continued).

SN 77-892,295. ISHIKAWA, JAMES, REGO PARK, NY. FILED 12-13-2009.

FLiPPiNWORDZ

THE MARK CONSISTS OF STANDARD CHARACTERS WITHOUT CLAIM TO ANY PARTICULAR FONT, STYLE, SIZE, OR COLOR.
FOR TABLETOP GAMES (U.S. CLS. 22, 23, 38 AND 50).
DAVID H. STINE, EXAMINING ATTORNEY

SN 77-892,141. FRIJOLITOS, INC., MONTEBELLO, CA. FILED 12-12-2009.

PEPE

THE MARK CONSISTS OF STANDARD CHARACTERS WITHOUT CLAIM TO ANY PARTICULAR FONT, STYLE, SIZE, OR COLOR.
FOR STUFFED AND PLUSH TOYS (U.S. CLS. 22, 23, 38 AND 50).
DOMINIC FATHY, EXAMINING ATTORNEY

SN 77-892,363. THOMSON, TREVOR, LONDON, GREAT BRITAIN, FILED 12-14-2009.

WORDQI

THE MARK CONSISTS OF STANDARD CHARACTERS WITHOUT CLAIM TO ANY PARTICULAR FONT, STYLE, SIZE, OR COLOR.
FOR CARD GAMES (U.S. CLS. 22, 23, 38 AND 50).
ERIN FALK, EXAMINING ATTORNEY

SN 77-892,143. FRIJOLITOS, INC., MONTEBELLO, CA. FILED 12-12-2009.

BUNUELO

THE MARK CONSISTS OF STANDARD CHARACTERS WITHOUT CLAIM TO ANY PARTICULAR FONT, STYLE, SIZE, OR COLOR.
FOR STUFFED AND PLUSH TOYS (U.S. CLS. 22, 23, 38 AND 50).
DOMINIC FATHY, EXAMINING ATTORNEY

SN 77-892,517. XTC PRODUCTS INCORPORATED, DBA HUGG-A-PLANET, ESSEX JCT., VT. FILED 12-14-2009.

HUGG-A-PLANET

THE MARK CONSISTS OF STANDARD CHARACTERS WITHOUT CLAIM TO ANY PARTICULAR FONT, STYLE, SIZE, OR COLOR.
FOR STUFFED TOYS, NAMELY, DOLLS, GLOBES AND BALLS (U.S. CLS. 22, 23, 38 AND 50).
FIRST USE 7-31-1983; IN COMMERCE 7-31-1983.
IRA J. GOODSaid, EXAMINING ATTORNEY

CLASS 28—(Continued).

SN 77-892,542. ROBERTS, DANIEL N., SANTA MONICA, CA. FILED 12-14-2009.

Cush

THE MARK CONSISTS OF STANDARD CHARACTERS WITHOUT CLAIM TO ANY PARTICULAR FONT, STYLE, SIZE, OR COLOR.

FOR KNEE PADS FOR ATHLETIC USE; YOGA BLOCKS; YOGA MATS (U.S. CLS. 22, 23, 38 AND 50).
DOMINICK J. SALEMI, EXAMINING ATTORNEY

SN 77-893,325. FREELANCE INVENTORS INC., BROOKLYN, NY. FILED 12-14-2009.

PORT-X

THE MARK CONSISTS OF STANDARD CHARACTERS WITHOUT CLAIM TO ANY PARTICULAR FONT, STYLE, SIZE, OR COLOR.

FOR ACCESSORY FOR MANUALLY-OPERATED EXERCISE EQUIPMENT, NAMELY, ACCESSORY ATTACHMENT TO INCREASE MUSCLE RESISTANCE; EXERCISE EQUIPMENT, NAMELY, CHEST PULLS; EXERCISE EQUIPMENT, NAMELY, SHOULDER STRETCHER USING A CABLE; EXERCISE EQUIPMENT, NAMELY, SHOULDER STRETCHER USING RESISTANCE CABLES; MANUALLY-OPERATED EXERCISE EQUIPMENT; MANUALLY-OPERATED EXERCISE EQUIPMENT FOR PHYSICAL FITNESS PURPOSES (U.S. CLS. 22, 23, 38 AND 50).
JENNIFER VASQUEZ, EXAMINING ATTORNEY

SN 77-894,207. LOWE PROFILE PRODUCTIONS, INC., BEVERLY HILLS, CA. FILED 12-15-2009.



THE MARK CONSISTS OF THE STYLIZED LETTERS "TBP" INSIDE OF AN OVAL SHAPE DESIGN.

FOR DOLLS; DOLL ACCESSORIES (U.S. CLS. 22, 23, 38 AND 50).

TINA MAI, EXAMINING ATTORNEY

CLASS 28—(Continued).

SN 77-894,553. SCHOLASTIC INC., NEW YORK, NY. FILED 12-16-2009.

BRAIN PLAY

THE MARK CONSISTS OF STANDARD CHARACTERS WITHOUT CLAIM TO ANY PARTICULAR FONT, STYLE, SIZE, OR COLOR.

OWNER OF U.S. REG. NO. 3,124,865.
FOR TOYS, NAMELY, HANDHELD UNITS FOR PLAYING ELECTRONIC GAMES; ELECTRONIC LEARNING TOYS (U.S. CLS. 22, 23, 38 AND 50).
TRACY CROSS, EXAMINING ATTORNEY

SN 77-895,511. BUSTOUT POKER, LLC, CHAPIN, SC. FILED 12-17-2009.

BUSTOUT

THE MARK CONSISTS OF STANDARD CHARACTERS WITHOUT CLAIM TO ANY PARTICULAR FONT, STYLE, SIZE, OR COLOR.

FOR BOARD GAMES; GAME TABLES; GAMING EQUIPMENT, NAMELY, POKER CHIPS; PLAYING CARD CASES; PLAYING CARDS; POKER CARD GUARDS (U.S. CLS. 22, 23, 38 AND 50).
HOWARD SMIGA, EXAMINING ATTORNEY

SN 77-896,785. LOCKHEED MARTIN CORPORATION, BETHESDA, MD. FILED 12-18-2009.

RQ-170 SENTINEL

THE MARK CONSISTS OF STANDARD CHARACTERS WITHOUT CLAIM TO ANY PARTICULAR FONT, STYLE, SIZE, OR COLOR.

FOR TOYS AND PLAYTHINGS, NAMELY, SCALE MODEL VEHICLES, TOY VEHICLES, MODEL VEHICLE KITS; REMOTE CONTROL TOYS, NAMELY, UNMANNED AERIAL VEHICLES (U.S. CLS. 22, 23, 38 AND 50).

STEVEN R. FINE, EXAMINING ATTORNEY

CLASS 28—(Continued).

SN 77-897,026. THINKFUN INC., ALEXANDRIA, VA. FILED 12-18-2009.

CLASS 28—(Continued).

SN 77-898,650. BIG BUCK LLC, SIMPSONVILLE, SC. FILED 12-21-2009.

ZIG-ZAG KNOT

THE MARK CONSISTS OF STANDARD CHARACTERS WITHOUT CLAIM TO ANY PARTICULAR FONT, STYLE, SIZE, OR COLOR.

NO CLAIM IS MADE TO THE EXCLUSIVE RIGHT TO USE "KNOT", APART FROM THE MARK AS SHOWN.

FOR MANIPULATIVE PUZZLES (U.S. CLS. 22, 23, 38 AND 50).

JOHN DWYER, EXAMINING ATTORNEY

Corn-Fusion

THE MARK CONSISTS OF STANDARD CHARACTERS WITHOUT CLAIM TO ANY PARTICULAR FONT, STYLE, SIZE, OR COLOR.

FOR DEER ATTRACTANTS (U.S. CLS. 22, 23, 38 AND 50).

KATHERINE STOIDES, EXAMINING ATTORNEY

SN 77-897,413. SILVERLIT LIMITED, CAUSEWAY BAY, HONG KONG, FILED 12-18-2009.

SN 77-899,706. SILVERLIT LIMITED, CAUSEWAY BAY, HONG KONG, FILED 12-22-2009.

MIMI AND FRIENDS

THE MARK CONSISTS OF STANDARD CHARACTERS WITHOUT CLAIM TO ANY PARTICULAR FONT, STYLE, SIZE, OR COLOR.

FOR TOYS, NAMELY, TOY WATERCRAFT, VEHICLES, FIGURES, AIRCRAFT, HELICOPTERS AND SPACECRAFT AND ACCESSORIES THEREFOR; MOLDED, PLASTIC AND FABRIC TOY FIGURINES; MOLDED, PLASTIC AND FABRIC TOYS IN THE NATURE OF DOLLS, VEHICLES, STRUCTURES, ANIMALS, AND FIGURINES; PLUSH TOYS AND PLUSH TOY FIGURINES; ACTION SKILL GAMES; BOARD GAMES; CASES FOR TOY VEHICLES AND FIGURINES AND TOY VEHICLES AND ACCESSORIES FOR TOY FIGURINES; PUZZLE GAMES; INFANT TOYS; PRESCHOOL TOYS IN THE NATURE OF DOLLS, VEHICLES, STRUCTURES, ANIMALS, AND FIGURINES; DOLLS AND ACCESSORIES THEREFOR; DOLL PLAYSETS; DOLL CLOTHES; DOLL FURNITURE; ELECTRONICALLY-OPERATED TOY VEHICLES, AIRCRAFT, HELICOPTERS, AND SPACECRAFT; EDUCATIONAL TOYS FOR THE PURPOSE OF TEACHING READING, MATH, MUSIC, SPELLING AND REASONING; CHILDREN'S MULTIPLE ACTIVITY TOYS; BATH TOYS; TOY MUSICAL INSTRUMENTS; MEMORY GAMES; BENDABLE TOYS; TOYS FOR PETS; TOY CONSTRUCTION SETS; AND MOTORIZED, REMOTE, INFRARED AND RADIO-CONTROLLED TOY VEHICLES, AIRCRAFT, HELICOPTERS, AND SPACECRAFT; SCALE MODEL VEHICLES, AIRCRAFT, HELICOPTERS, AND SPACECRAFT; TOY MINI-CAR GAME SETS AND ACCESSORIES THEREFOR (U.S. CLS. 22, 23, 38 AND 50).

STEPHEN AQUILA, EXAMINING ATTORNEY

POWER IN

THE MARK CONSISTS OF STANDARD CHARACTERS WITHOUT CLAIM TO ANY PARTICULAR FONT, STYLE, SIZE, OR COLOR.

FOR TOYS, NAMELY, TOY WATERCRAFT, VEHICLES, FIGURES, AIRCRAFT, HELICOPTERS AND SPACECRAFT AND ACCESSORIES THEREFOR; MOLDED, PLASTIC AND FABRIC TOY FIGURINES; MOLDED, PLASTIC AND FABRIC TOYS IN THE NATURE OF DOLLS, VEHICLES, STRUCTURES, ANIMALS, AND FIGURINES; PLUSH TOYS AND PLUSH TOY FIGURINES; ACTION SKILL GAMES; BOARD GAMES; CASES FOR TOY VEHICLES AND FIGURINES AND TOY VEHICLES AND ACCESSORIES FOR TOY FIGURINES; PUZZLE GAMES; INFANT TOYS; PRESCHOOL TOYS IN THE NATURE OF DOLLS, VEHICLES, STRUCTURES, ANIMALS, AND FIGURINES; DOLLS AND ACCESSORIES THEREFOR; DOLL PLAYSETS; ELECTRONICALLY-OPERATED TOY VEHICLES, AIRCRAFT, HELICOPTERS AND SPACECRAFT; EDUCATIONAL TOYS FOR THE PURPOSE OF TEACHING READING, MATH, MUSIC, SPELLING AND REASONING; CHILDREN'S MULTIPLE ACTIVITY TOYS; TOY CONSTRUCTION SETS; AND MOTORIZED, REMOTE, INFRARED AND RADIO-CONTROLLED TOY VEHICLES, AIRCRAFT, HELICOPTERS AND SPACECRAFT; SCALE MODEL VEHICLES, AIRCRAFT, HELICOPTERS AND SPACECRAFT; TOY MINI-CAR GAME SETS AND ACCESSORIES THEREFOR (U.S. CLS. 22, 23, 38 AND 50).

STEPHEN AQUILA, EXAMINING ATTORNEY

CLASS 28—(Continued).

SN 77-906,182. WGI INNOVATIONS, LTD., GRAND PRAIRIE, TX. FILED 1-6-2010.

ECHO

THE MARK CONSISTS OF STANDARD CHARACTERS WITHOUT CLAIM TO ANY PARTICULAR FONT, STYLE, SIZE, OR COLOR.

FOR ELECTRONIC ANIMAL CALLS FOR RECREATION AND HUNTING ACTIVITIES (U.S. CLS. 22, 23, 38 AND 50).

STEVEN PEREZ, EXAMINING ATTORNEY

SN 77-909,844. HOLDERMAN, WESTON, OCEANSIDE, CA. AND ANDERSON, BRIAN, OCEANSIDE, CA. FILED 1-12-2010.

seaward vessel

THE MARK CONSISTS OF STANDARD CHARACTERS WITHOUT CLAIM TO ANY PARTICULAR FONT, STYLE, SIZE, OR COLOR.

FOR SURFBOARDS (U.S. CLS. 22, 23, 38 AND 50). FIRST USE 12-9-2009; IN COMMERCE 12-9-2009. CYNTHIA SLOAN, EXAMINING ATTORNEY

SN 77-911,418. FINAL SCOOP DESIGNS, LTD., DBA READY TO PLAY GROUP LTD., R2P PET, LTD. & R2P PRODUCTS LTD., MACAU, CHINA, FILED 1-13-2010.

GNAWBBERS

THE MARK CONSISTS OF STANDARD CHARACTERS WITHOUT CLAIM TO ANY PARTICULAR FONT, STYLE, SIZE, OR COLOR.

FOR PET TOYS (U.S. CLS. 22, 23, 38 AND 50). ANDREW RHIM, EXAMINING ATTORNEY

CLASS 28—(Continued).

SN 77-913,235. CALLAWAY GOLF COMPANY, CARLSBAD, CA. FILED 1-15-2010.

X-24 HOT

THE MARK CONSISTS OF STANDARD CHARACTERS WITHOUT CLAIM TO ANY PARTICULAR FONT, STYLE, SIZE, OR COLOR.

FOR GOLF CLUBS (U.S. CLS. 22, 23, 38 AND 50). REBECCA GILBERT, EXAMINING ATTORNEY

SN 77-917,794. CALLAWAY GOLF COMPANY, CARLSBAD, CA. FILED 1-22-2010.

LEGACY APEX

THE MARK CONSISTS OF STANDARD CHARACTERS WITHOUT CLAIM TO ANY PARTICULAR FONT, STYLE, SIZE, OR COLOR.

OWNER OF U.S. REG. NOS. 896,409 AND 1,026,881. FOR GOLF BAGS; GOLF BALLS; GOLF CLUBS; HEAD COVERS FOR GOLF CLUBS (U.S. CLS. 22, 23, 38 AND 50).

REBECCA GILBERT, EXAMINING ATTORNEY

SN 77-917,805. CALLAWAY GOLF COMPANY, CARLSBAD, CA. FILED 1-22-2010.

Forged AeroComposite

THE MARK CONSISTS OF STANDARD CHARACTERS WITHOUT CLAIM TO ANY PARTICULAR FONT, STYLE, SIZE, OR COLOR.

NO CLAIM IS MADE TO THE EXCLUSIVE RIGHT TO USE "FORGED", APART FROM THE MARK AS SHOWN. FOR GOLF BAGS; GOLF BALLS; GOLF CLUBS; HEAD COVERS FOR GOLF CLUBS (U.S. CLS. 22, 23, 38 AND 50).

REBECCA GILBERT, EXAMINING ATTORNEY

CLASS 28—(Continued).

SN 77-918,125. ONTEL PRODUCTS CORPORATION, FAIRFIELD, NJ. FILED 1-22-2010.

MIGHTY MAX

THE MARK CONSISTS OF STANDARD CHARACTERS WITHOUT CLAIM TO ANY PARTICULAR FONT, STYLE, SIZE, OR COLOR.

FOR MANUALLY-OPERATED EXERCISE EQUIPMENT; EXERCISE MACHINES (U.S. CLS. 22, 23, 38 AND 50).

KATHERINE STOIDES, EXAMINING ATTORNEY

SN 77-919,764. CJ PRODUCTS LLC, OCEANSIDE, CA. FILED 1-25-2010.

Wall Pets

THE MARK CONSISTS OF STANDARD CHARACTERS WITHOUT CLAIM TO ANY PARTICULAR FONT, STYLE, SIZE, OR COLOR.

NO CLAIM IS MADE TO THE EXCLUSIVE RIGHT TO USE "WALL", APART FROM THE MARK AS SHOWN.

FOR PLUSH OR STUFFED TOY ANIMALS ADAPTED TO BE ADHERED TO VERTICAL SURFACES (U.S. CLS. 22, 23, 38 AND 50).

SUSAN RICHARDS, EXAMINING ATTORNEY

SN 77-920,555. CALLAWAY GOLF COMPANY, CARLSBAD, CA. FILED 1-26-2010.

D.A.R.T.

THE MARK CONSISTS OF STANDARD CHARACTERS WITHOUT CLAIM TO ANY PARTICULAR FONT, STYLE, SIZE, OR COLOR.

FOR GOLF CLUBS; HEAD COVERS FOR GOLF CLUBS (U.S. CLS. 22, 23, 38 AND 50).

REBECCA GILBERT, EXAMINING ATTORNEY

CLASS 28—(Continued).

SN 77-920,562. CALLAWAY GOLF COMPANY, CARLSBAD, CA. FILED 1-26-2010.

X-ACT

THE MARK CONSISTS OF STANDARD CHARACTERS WITHOUT CLAIM TO ANY PARTICULAR FONT, STYLE, SIZE, OR COLOR.

FOR GOLF CLUBS; HEAD COVERS FOR GOLF CLUBS (U.S. CLS. 22, 23, 38 AND 50).

REBECCA GILBERT, EXAMINING ATTORNEY

SN 77-920,776. SILVERLIT LIMITED, CAUSEWAY BAY, HONG KONG, HONG KONG, FILED 1-26-2010.



THE COLOR(S) LIGHT BLUE, DARK BLUE, WHITE, AND BLACK IS/ARE CLAIMED AS A FEATURE OF THE MARK.

THE MARK CONSISTS OF A DARK BLUE OVAL WITH A LIGHT BLUE OVAL WITHIN IT, WITH A BLACK LINE BETWEEN THE TWO OVALS, AND THE WORDS "POWER IN FUN" SUPERIMPOSED ON THE OVALS IN BLACK LETTERS OUTLINED IN WHITE, WITH A BLACK QUARTER-ARC ABOVE AND TO THE RIGHT OVER THE WORD "FUN".

FOR TOYS, NAMELY, TOY WATERCRAFT, VEHICLES, FIGURES, AIRCRAFT, HELICOPTERS AND SPACECRAFT AND ACCESSORIES THEREFOR; MOLDED, PLASTIC AND FABRIC TOY FIGURINES; MOLDED, PLASTIC AND FABRIC TOYS IN THE NATURE OF DOLLS, VEHICLES, STRUCTURES, ANIMALS, AND FIGURINES; PLUSH TOYS AND PLUSH TOY FIGURINES; ACTION SKILL GAMES; BOARD GAMES; CASES FOR TOY VEHICLES AND FIGURINES AND TOY VEHICLES AND ACCESSORIES FOR TOY FIGURINES; PUZZLE GAMES; INFANT TOYS; PRESCHOOL TOYS IN THE NATURE OF DOLLS, VEHICLES, STRUCTURES, ANIMALS, AND FIGURINES; DOLLS AND ACCESSORIES THEREFOR; DOLL PLAYSETS; ELECTRONICALLY-OPERATED TOY VEHICLES, AIRCRAFT, HELICOPTERS, AND SPACECRAFT; EDUCATIONAL TOYS FOR THE PURPOSE OF TEACHING READING, MATH, MUSIC, SPELLING AND REASONING; CHILDREN'S MULTIPLE ACTIVITY TOYS; TOY CONSTRUCTION SETS; AND MOTORIZED, REMOTE, INFRARED AND RADIO-CONTROLLED TOY VEHICLES, AIRCRAFT, HELICOPTERS, AND SPACECRAFT; SCALE MODEL VEHICLES, AIRCRAFT, HELICOPTERS AND SPACECRAFT; TOY MINI-CAR GAME SETS AND ACCESSORIES THEREFOR (U.S. CLS. 22, 23, 38 AND 50).

STEPHEN AQUILA, EXAMINING ATTORNEY

CLASS 28—(Continued).

SN 77-920,803. SILVERLIT LIMITED, CAUSEWAY BAY,-
HONG KONG, HONG KONG, FILED 1-26-2010.



THE COLOR(S) BLACK, BLUE, AND WHITE IS/ARE CLAIMED AS A FEATURE OF THE MARK.

THE MARK CONSISTS OF THE WORDING "POWER IN" IN WHITE LETTERS ENCLOSED IN A BLACK TRAPEZOID BACKGROUND WITH FIVE HORIZONTAL BLUE "STREAKS" ADJACENT TO THE LETTER "P" AND THE WORD "AIR" IN WHITE LETTERS CONTAINED IN A BLUE RECTANGLE THAT IS HALF-BELOW AND SUPERIMPOSED ON THE LOWER LEFT OF THE BLACK TRAPEZOID.

FOR TOYS, NAMELY, TOY WATERCRAFT, VEHICLES, FIGURES, AIRCRAFT, HELICOPTERS, SPACECRAFT, AND ACCESSORIES THEREFOR; ACTION SKILL GAMES; BOARD GAMES; CASES FOR TOY AIRCRAFT, HELICOPTERS, AND FIGURINES; ACCESSORIES FOR TOY AIRCRAFT, HELICOPTERS, AND FIGURINES; PUZZLE GAMES; TOY WEAPONS; ELECTRONICALLY-OPERATED TOY VEHICLES, AIRCRAFT, HELICOPTERS AND SPACECRAFT; EDUCATIONAL TOYS FOR THE PURPOSE OF TEACHING READING, MATH, MUSIC, SPELLING AND REASONING; CHILDREN'S MULTIPLE ACTIVITY TOYS; AND MOTORIZED, REMOTE AND RADIO-CONTROLLED TOY VEHICLES, AIRCRAFT, HELICOPTERS, AND SPACECRAFT (U.S. CLS. 22, 23, 38 AND 50).

STEPHEN AQUILA, EXAMINING ATTORNEY

SN 77-920,826. SILVERLIT LIMITED, CAUSEWAY BAY,-
HONG KONG, HONG KONG, FILED 1-26-2010.



THE COLOR(S) RED, BLACK AND WHITE IS/ARE CLAIMED AS A FEATURE OF THE MARK.

THE MARK CONSISTS OF THE WORDS "POWER IN" IN WHITE ENCLOSED IN A BLACK TRAPEZOIDAL BACKGROUND WITH FIVE RED STREAKS ADJACENT TO THE LETTER "P" AND THE WORD "SPEED" IN WHITE CONTAINED IN A RED RECTANGULAR FRAME.

FOR TOYS, NAMELY, TOY WATERCRAFT, VEHICLES, FIGURES, AIRCRAFT, HELICOPTERS, SPACECRAFT, AND ACCESSORIES THEREFOR; ACTION SKILL GAMES, BOARD GAMES, CASES FOR TOY VEHICLES AND FIGURINES; ACCESSORIES FOR TOY VEHICLES AND FIGURINES; PUZZLE GAMES; TOY WEAPONS; ELECTRONICALLY-OPERATED TOY VEHICLES, AIRCRAFT, HELICOPTERS, AND SPACECRAFT; EDUCATIONAL TOYS FOR THE PURPOSE OF TEACHING READING, MATH, MUSIC, SPELLING AND REASONING; CHILDREN'S MULTIPLE ACTIVITY TOYS; AND MOTORIZED, REMOTE AND RADIO-CONTROLLED TOY VEHICLES, AIRCRAFT, HELICOPTERS, AND SPACECRAFT (U.S. CLS. 22, 23, 38 AND 50).

STEPHEN AQUILA, EXAMINING ATTORNEY

CLASS 28—(Continued).

SN 77-921,301. PETER SUI LUN FONG, MONTEREY PARK,
CA. FILED 1-27-2010.

EM

THE MARK CONSISTS OF STANDARD CHARACTERS WITHOUT CLAIM TO ANY PARTICULAR FONT, STYLE, SIZE, OR COLOR.

FOR TOYS, NAMELY, DOLLS, FASHION DOLLS, ELECTRONIC DOLLS, ANIMATED DOLLS, DOLL CLOTHING AND DOLL ACCESSORIES (U.S. CLS. 22, 23, 38 AND 50).

JASON TURNER, EXAMINING ATTORNEY

SN 77-923,014. SILVERLIT LIMITED, CAUSEWAY BAY,-
HONG KONG, HONG KONG, FILED 1-28-2010.



THE MARK CONSISTS OF THE WORDS "MIMI & FRIENDS" SET IN FRONT OF A CARTOON-LIKE CHARACTER OF A GIRL WITH ANTENNAE, A LADY-BUG, SNAIL AND BUTTERFLY WITH A LANDSCAPE BACKGROUND WITH STARS, TREES, AND A HOUSE, ALL SET WITHIN A ROUGHLY CIRCULAR FRAME WITHIN A RECTANGULAR FRAME.

FOR TOYS, NAMELY, TOY WATERCRAFTS, VEHICLES, FIGURES, AIRCRAFT, HELICOPTERS AND SPACECRAFT AND ACCESSORIES THEREFOR; MOLDED, PLASTIC AND FABRIC TOY FIGURINES; MOLDED, PLASTIC AND FABRIC TOYS IN THE NATURE OF DOLLS, VEHICLES, STRUCTURES, ANIMALS, AND FIGURINES; PLUSH TOYS AND PLUSH TOY FIGURINES; ACTION SKILL GAMES; BOARD GAMES; CASES FOR TOY VEHICLES AND FIGURINES; ACCESSORIES FOR TOY VEHICLES AND FIGURINES; PUZZLE GAMES; INFANT TOYS; PRESCHOOL TOYS IN THE NATURE OF IN THE NATURE OF DOLLS, VEHICLES, STRUCTURES, ANIMALS, AND FIGURINES; DOLLS AND ACCESSORIES THEREFOR; DOLL PLAYSETS; DOLL CLOTHES; DOLL FURNITURE; ELECTRONICALLY-OPERATED TOY VEHICLES, AIRCRAFT, HELICOPTERS, AND SPACECRAFT; EDUCATIONAL TOYS FOR THE PURPOSE OF TEACHING READING, MATH, MUSIC, SPELLING AND REASONING; CHILDREN'S MULTIPLE ACTIVITY TOYS; BATH TOYS; TOY MUSICAL INSTRUMENTS; MEMORY GAMES; BENDABLE TOYS; TOYS FOR PETS; TOY CONSTRUCTION SETS; AND MOTORIZED, REMOTE, INFRARED AND RADIO-CONTROLLED TOY VEHICLES, AIRCRAFT, HELICOPTERS, AND SPACECRAFT; SCALE MODEL VEHICLES, AIRCRAFT, HELICOPTERS, AND SPACECRAFT; TOY MINI-CAR GAME SETS AND ACCESSORIES THEREFOR (U.S. CLS. 22, 23, 38 AND 50).

STEPHEN AQUILA, EXAMINING ATTORNEY

CLASS 28—(Continued).

SN 77-924,216. HASBRO, INC., PAWTUCKET, RI. FILED 1-30-2010.

TREADSHIFTERS

THE MARK CONSISTS OF STANDARD CHARACTERS WITHOUT CLAIM TO ANY PARTICULAR FONT, STYLE, SIZE, OR COLOR.

FOR TOY VEHICLES AND ACCESSORIES FOR USE THEREWITH (U.S. CLS. 22, 23, 38 AND 50).
LYDIA BELZER, EXAMINING ATTORNEY

SN 77-924,540. IDEA NUOVA, INC., NEW YORK, NY. FILED 2-1-2010.

CUTIE FRIEND

THE MARK CONSISTS OF STANDARD CHARACTERS WITHOUT CLAIM TO ANY PARTICULAR FONT, STYLE, SIZE, OR COLOR.

FOR STUFFED AND PLUSH TOYS (U.S. CLS. 22, 23, 38 AND 50).
STEVEN JACKSON, EXAMINING ATTORNEY

SN 77-929,609. CALLAWAY GOLF COMPANY, CARLSBAD, CA. FILED 2-5-2010.

Play With An Edge

THE MARK CONSISTS OF STANDARD CHARACTERS WITHOUT CLAIM TO ANY PARTICULAR FONT, STYLE, SIZE, OR COLOR.

FOR GOLF CLUBS (U.S. CLS. 22, 23, 38 AND 50).
REBECCA GILBERT, EXAMINING ATTORNEY

CLASS 28—(Continued).

SN 77-932,300. HALLMARK LICENSING, INC., KANSAS CITY, MO. FILED 2-10-2010.

SEASONS FROM HALLMARK

THE MARK CONSISTS OF STANDARD CHARACTERS WITHOUT CLAIM TO ANY PARTICULAR FONT, STYLE, SIZE, OR COLOR.

FOR CHRISTMAS TREE ORNAMENTS (U.S. CLS. 22, 23, 38 AND 50).
ELIZABETH KAJUBI, EXAMINING ATTORNEY

SN 77-978,963. GIANT TREE HOUSE, LLC, DBA GIANT TREE HOUSE, LLC, BEXLEY, OH. FILED 5-13-2009.

GIANT TREE HOUSE

THE MARK CONSISTS OF STANDARD CHARACTERS WITHOUT CLAIM TO ANY PARTICULAR FONT, STYLE, SIZE, OR COLOR.

FOR BADMINTON SETS; CROQUET SETS; DART GAMES; FLYING SAUCERS; FOOT BALLS; GOLF BALLS; GOLF CLUBS; JUMP ROPES; LACROSSE BALLS; LACROSSE STICKS; PADDLE BALL GAMES; PET TOYS; PLAY YARDS IN THE NATURE OF OUTDOOR PLAY STRUCTURES; RIDE-ON TOYS; RING GAMES; SAND TOYS; SOCCER BALLS; TENNIS RACQUETS; BASEBALL BATS; TOY BUTTERFLY NETS (U.S. CLS. 22, 23, 38 AND 50).
BARBARA GAYNOR, EXAMINING ATTORNEY

SN 79-068,914. ANGEL PLAYING CARDS CO., LTD., JAPAN, FILED 4-28-2009.



OWNER OF INTERNATIONAL REGISTRATION 1002966 DATED 4-28-2009, EXPIRES 4-28-2019.

THE MARK CONSISTS OF A DESIGN HAVING AN OUTER RECTANGLE REPRESENTED BY A THICK LINE AND AN INNER RECTANGLE AND HAVING AN ARRAY OF CRISS-CROSSING DIAGONAL LINES IN A LATTICE PATTERN IN THE INNER BORDERED AREA, A BLANK AREA OF UNIFORM WIDTH LOCATED BETWEEN THE TWO RECTANGLES.

FOR PLAYING CARDS (U.S. CLS. 22, 23, 38 AND 50).
H. M. FISHER, EXAMINING ATTORNEY

CLASS 28—(Continued).

SN 79-069,993. FIN CONTROL SYSTEMS PTY LTD, AUSTRALIA, FILED 5-7-2009.

GREEN FLEX

THE MARK CONSISTS OF STANDARD CHARACTERS WITHOUT CLAIM TO ANY PARTICULAR FONT, STYLE, SIZE, OR COLOR.

PRIORITY DATE OF 2-6-2009 IS CLAIMED.

OWNER OF INTERNATIONAL REGISTRATION 1005538 DATED 5-7-2009, EXPIRES 5-7-2019.

FOR FINS FOR SURFBOARDS AND FIN PLUGS FOR ATTACHING SUCH FINS TO SURFBOARDS (U.S. CLS. 22, 23, 38 AND 50).

MICHAEL ENGEL, EXAMINING ATTORNEY

SN 79-070,676. IR ROBOT CO., LTD, REPUBLIC OF KOREA, FILED 5-21-2009.

MaruBot

OWNER OF INTERNATIONAL REGISTRATION 1007114 DATED 5-21-2009, EXPIRES 5-21-2019.

THE MARK CONSISTS OF THE WORDING "MARUBOT" IN STYLIZED FONT.

THE WORDING "MARUBOT" HAS NO MEANING IN A FOREIGN LANGUAGE.

FOR RADIO-CONTROLLED TOY VEHICLES; TOYS, NAMELY, DOLLS, TOY AIRPLANES, TOY ANIMALS, TOY ARMOR, TOY BAKEDWARE AND COOKWARE, TOY BANKS, TOY BOATS, TOY BUILDING BLOCKS, TOY CHRISTMAS TREES, TOY FIGURES, TOY FURNITURE, TOY GUNS, TOY HOUSES, TOY MOBILES, TOY MUSIC BOXES, TOY ROBOTS, TOY TOOLS, TOY WATCHES, TOY WEAPONS; TOY VEHICLES; SCALE MODEL VEHICLES; AMUSEMENT MACHINES AUTOMATIC AND COIN-OPERATED; TABLES FOR INDOOR FOOTBALL; GAMES, NAMELY, HAND-HELD GAMES WITH LIQUID CRYSTAL DISPLAY; GAMES OTHER THAN THOSE ADAPTED FOR USE WITH AN EXTERNAL DISPLAY SCREEN OR MONITOR, NAMELY, STAND ALONE VIDEO GAME MACHINES; APPARATUS FOR ELECTRONIC GAMES OTHER THAN THOSE ADAPTED FOR USE WITH AN EXTERNAL DISPLAY SCREEN OR MONITOR (U.S. CLS. 22, 23, 38 AND 50).

SUZANNE BLANE, EXAMINING ATTORNEY

CLASS 28—(Continued).

SN 79-073,412. IDÉPIKENE DA, NORWAY, FILED 6-4-2009.



OWNER OF INTERNATIONAL REGISTRATION 1014694 DATED 6-4-2009, EXPIRES 6-4-2019.

THE COLOR(S) RED AND BLUE IS/ARE CLAIMED AS A FEATURE OF THE MARK.

THE MARK CONSISTS OF THE FOLLOWING: THE WORDS "SKI GRIP" IN STYLIZED RED FONT, AND A RED AND BLUE SKI WITH A BLUE HANDLE FORMING THE LETTER "I" IN THE WORDS "SKI" AND "GRIP". THE COLOR WHITE CONSTITUTES BACKGROUND, OUTLINING, SHADING OR TRANSPARENT AREAS, AND IS NOT PART OF THE MARK.

FOR CARRYING HANDLES IN THE NATURE OF TEXTILE STRAPS, HAVING A CLOSURE OF HOOK AND LOOP FASTENING TAPE, SPECIALLY ADAPTED FOR SKIS (U.S. CLS. 22, 23, 38 AND 50).

LIEF MARTIN, EXAMINING ATTORNEY

SN 79-076,377. MOGENS RUD SVENDSEN, DK-8370 HADSTEN, DENMARK, FILED 10-29-2009.



OWNER OF INTERNATIONAL REGISTRATION 1022208 DATED 10-29-2009, EXPIRES 10-29-2019.

THE MARK CONSISTS OF THE STYLIZED WORD "QLUDO" ABOVE A CURVED LINE THAT HAS A SHADOW BENEATH IT.

THE WORDING "QLUDO" HAS NO MEANING IN A FOREIGN LANGUAGE.

FOR GAMES AND PLAYTHINGS, NAMELY, BOARD GAMES AND A GAME PLAYED WITH A TETHERED BALL; GYMNAS TIC AND SPORTING ARTICLES NOT INCLUDED IN OTHER CLASSES, NAMELY, GYMNAS TIC APPARATUSES, GYMNAS TIC PARALLEL BARS, GYMNAS TIC VAULTING HORSES; AND DECORATIONS FOR CHRISTMAS TREES (U.S. CLS. 22, 23, 38 AND 50).

MAUREEN DALL, EXAMINING ATTORNEY

CLASS 28—(Continued).

SN 79-078,083. TAMASU CO., LTD., JAPAN, FILED 12-10-2009.



The logo for "Inner fiber" features the words "Inner fiber" in a cursive, script font. The word "Inner" is written in a smaller size than "fiber". A thin, curved line arches over the top of the word "fiber", starting from the letter 'i' and ending at the letter 'r'.

OWNER OF INTERNATIONAL REGISTRATION 1026790 DATED 12-10-2009, EXPIRES 12-10-2019.
FOR TABLE TENNIS PADDLES; RUBBER SHEETS FOR USE AS IMPACT SURFACE OF TABLE TENNIS RACKETS; TABLE TENNIS PADDLE CASES; TABLE TENNIS TABLES (U.S. CLS. 22, 23, 38 AND 50).
JAMES STEIN, EXAMINING ATTORNEY

CLASS 29—(Continued).

SN 76-699,903. JOHN HOFMEISTER & SON, INC., CHICAGO, IL. FILED 10-16-2009.

CARIBBEAN SELECT

THE MARK CONSISTS OF STANDARD CHARACTERS WITHOUT CLAIM TO ANY PARTICULAR FONT, STYLE, SIZE, OR COLOR.

NO CLAIM IS MADE TO THE EXCLUSIVE RIGHT TO USE "CARIBBEAN", APART FROM THE MARK AS SHOWN.

FOR HAM (U.S. CL. 46).

FIRST USE 7-22-2009; IN COMMERCE 7-22-2009.

MICHAEL WIENER, EXAMINING ATTORNEY

SN 76-700,377. WHITE TOQUE INC., SECAUCUS, NJ. FILED 11-16-2009.

FRENCH GARDEN

THE MARK CONSISTS OF STANDARD CHARACTERS WITHOUT CLAIM TO ANY PARTICULAR FONT, STYLE, SIZE, OR COLOR.

NO CLAIM IS MADE TO THE EXCLUSIVE RIGHT TO USE "FRENCH", APART FROM THE MARK AS SHOWN.

FOR FROZEN VEGETABLES (U.S. CL. 46).

FIRST USE 2-1-2009; IN COMMERCE 2-1-2009.

RUSS HERMAN, EXAMINING ATTORNEY

CLASS 29—MEATS AND PROCESSED FOODS

SN 76-697,728. PACIFIC MARINE RESOURCES LLC, EL MONTE, CA. FILED 6-2-2009.



NO CLAIM IS MADE TO THE EXCLUSIVE RIGHT TO USE "BEST", APART FROM THE MARK AS SHOWN.

THE COLOR(S) BLACK, GOLD AND BLUE IS/ARE CLAIMED AS A FEATURE OF THE MARK.

THE MARK CONSISTS OF THE WORDING "BEST OCEAN" IN BLACK ON A GOLD BACKGROUND. BELOW THE WORDING "BEST OCEAN" IS A BLACK LINE AND BELOW THE BLACK LINE IS A BLUE WAVE. THE WORDING AND DESIGN ELEMENTS APPEAR WITHIN THE SHAPE OF A CIRCLE OUTLINED IN BLACK.

FOR FROZEN SEAFOOD, FROZEN FISH BALLS, FROZEN SHRIMP BALLS AND FROZEN VEGETABLES (U.S. CL. 46).

JESSICA FATHY, EXAMINING ATTORNEY

SN 77-458,722. HENRY'S HOLDINGS, LLC, COMMERCE, CA. FILED 4-25-2008.

SUN HARVEST

THE MARK CONSISTS OF STANDARD CHARACTERS WITHOUT CLAIM TO ANY PARTICULAR FONT, STYLE, SIZE, OR COLOR.

OWNER OF U.S. REG. NOS. 1,736,903, 3,440,589 AND OTHERS.

FOR SNACK MIX CONSISTING PRIMARILY OF PROCESSED FRUITS, PROCESSED NUTS AND/OR RAISINS; PROCESSED NUTS; PEANUT BUTTER; FRUIT-BASED ORGANIC FOOD BARS; DRIED BEANS; MILK; CHEESE; BUTTER; EGGS; EDIBLE OILS; VEGETABLE OILS; CANNED FRUITS AND VEGETABLES; FROZEN FRUITS; FROZEN VEGETABLES; FRENCH FRIED POTATOES; PROCESSED POTATOES; PROCESSED VEGETABLES; PROCESSED OLIVES; CANNED TOMATOES; CANNED FISH; PROCESSED PEPPERS; PICKLES; BACON; SOUPS; VEGETABLE CHIPS; POTATO CHIPS; EGGPLANT PARMIGIANA; DRIED FRUITS; TOMATO PASTE (U.S. CL. 46).

SCOTT BIBB, EXAMINING ATTORNEY

CLASS 29—(Continued).

SN 77-760,174. AVOCADO OIL NEW ZEALAND LIMITED, BAY OF PLENTY, NEW ZEALAND, FILED 6-15-2009.



OWNER OF NEW ZEALAND REG. NO. 796587, DATED 3-26-2009, EXPIRES 9-24-2018.

THE MARK CONSISTS OF THE TERM "GROVE" IN STYLIZED FRONT WITH THE "O" IN "GROVE" REPRESENTED BY A SHADED CIRCLE.

FOR EDIBLE OILS AND FATS; AVOCADO OIL (U.S. CL. 46).

CURTIS FRENCH, EXAMINING ATTORNEY

SN 77-764,105. JLS INTERNATIONAL FOODS, INC., SCHAUMBURG, IL. FILED 6-19-2009.

CHEESEPREP

THE MARK CONSISTS OF STANDARD CHARACTERS WITHOUT CLAIM TO ANY PARTICULAR FONT, STYLE, SIZE, OR COLOR.

OWNER OF U.S. REG. NO. 2,784,795.
FOR DAIRY PRODUCTS, NAMELY, CHEESE; DAIRY PRODUCTS EXCLUDING ICE CREAM, ICE MILK AND FROZEN YOGURT (U.S. CL. 46).

BERYL GARDNER, EXAMINING ATTORNEY

SN 77-775,369. LINK SNACKS, INC., MINONG, WI. FILED 7-7-2009.



OWNER OF U.S. REG. NOS. 3,309,934 AND 3,477,313.
THE MARK CONSISTS OF THE WORDS "THE SASQUATCH BIG STICK" OUTLINED IN A FOOTPRINT LIKE DESIGN AND A FOOT DESIGN INSIDE THE "Q" IN "SASQUATCH".

FOR MEAT SNACKS (U.S. CL. 46).
MARY BOAGNI, EXAMINING ATTORNEY

CLASS 29—(Continued).

SN 77-783,332. AB HOLDINGS, LLC, BOISE, ID. FILED 7-17-2009.

WESTERN KIWAMI

THE MARK CONSISTS OF STANDARD CHARACTERS WITHOUT CLAIM TO ANY PARTICULAR FONT, STYLE, SIZE, OR COLOR.

OWNER OF U.S. REG. NOS. 3,069,052 AND 3,203,749.
THE ENGLISH TRANSLATION OF "KIWAMI" IN THE MARK IS "EXTREME" OR "ULTIMATE".

FOR MEAT; FROZEN MEAT; PREPARED MEAT; PRESERVED MEAT; PROCESSED MEAT; BEEF; PORK; HAMBURGER; HAM; CUT MEATS; DELI MEATS; FRANKFURTERS; BEEF CARCASSES; CUT PORTIONS OF BEEF BOTH PACKAGED AND NON-PACKAGED; GROUND BEEF (U.S. CL. 46).

MATTHEW PAPPAS, EXAMINING ATTORNEY

SN 77-791,208. TWENTIETH CENTURY FOX FILM CORPORATION, LOS ANGELES, CA. FILED 7-28-2009.

AVTR

THE MARK CONSISTS OF STANDARD CHARACTERS WITHOUT CLAIM TO ANY PARTICULAR FONT, STYLE, SIZE, OR COLOR.

FOR CHEESE; CHEESE AND CRACKER COMBINATIONS; CHEESE SPREAD; CANDIED FRUIT; CHOCOLATE MILK; DAIRY PRODUCTS EXCLUDING ICE CREAM, ICE MILK AND FROZEN YOGURT; DIPS EXCLUDING SAUCES AND SALSAS USED AS DIPS; DRIED FRUITS; DRINKING YOGURTS; FROZEN MEALS CONSISTING PRIMARILY OF MEAT, FISH, POULTRY OR VEGETABLES; FRUIT PRESERVES; FRUIT-BASED SNACK FOOD; JAMS; JELLIES; MILK BEVERAGES WITH HIGH MILK CONTENT; MEATS; PROCESSED NUTS; NUT-BASED SNACK FOODS; PEANUT BUTTER; POTATO CHIPS; POTATO-BASED SNACK FOODS; POWDERED MILK FOR FOOD PURPOSES; RAISINS; SNACK MIX CONSISTING PRIMARILY OF PROCESSED FRUITS, PROCESSED NUTS AND/OR RAISINS; SOUP; SOUP MIXES; YOGURT (U.S. CL. 46).

JOHN E. MICHOS, EXAMINING ATTORNEY

CLASS 29—(Continued).

SN 77-805,865. E. & J. GALLO WINERY, MODESTO, CA.
FILED 8-17-2009.

VINOLIO

THE MARK CONSISTS OF STANDARD CHARACTERS WITHOUT CLAIM TO ANY PARTICULAR FONT, STYLE, SIZE, OR COLOR.

THE WORDING "VINOLIO" HAS NO MEANING IN A FOREIGN LANGUAGE.

FOR EDIBLE OILS; GRAPE SEED OIL (U.S. CL. 46).
ROBERT C. CLARK JR., EXAMINING ATTORNEY

SN 77-814,968. YOPLAIT MARQUES INTERNATIONALES,
PARIS, FRANCE, FILED 8-28-2009.

KNOW YOUR GIRLS

THE MARK CONSISTS OF STANDARD CHARACTERS WITHOUT CLAIM TO ANY PARTICULAR FONT, STYLE, SIZE, OR COLOR.

FOR DAIRY PRODUCTS EXCLUDING ICE CREAM, ICE MILK AND FROZEN YOGURT (U.S. CL. 46).

ROBERT C. CLARK JR., EXAMINING ATTORNEY

SN 77-816,125. POULTRY PRODUCTS COMPANY OF NEW
ENGLAND, INC., HOOKSETT, NH. FILED 8-31-2009.



THE MARK CONSISTS OF A HOUSE AND LANDSCAPE SHOWN INSIDE A CIRCLE WITH THE STYLIZED WORDING "FORT HALIFAX" CUTTING THROUGH THE CIRCLE BUT OVER THE TOP OF THE HOUSE AND LANDSCAPE AND WITH A BANNER CONTAINING THE WORDING "FORT HALIFAX" AND THE YEAR "1754" CUTTING OFF THE BOTTOM OF THE CIRCLE BELOW THE HOUSE AND LANDSCAPE.

FOR LARD (U.S. CL. 46).
FIRST USE 12-31-2005; IN COMMERCE 12-31-2005.
MICHAEL LITZAU, EXAMINING ATTORNEY

CLASS 29—(Continued).

SN 77-817,594. GOURMET FOOD IMPORTS, LLC, LAFAYETTE, CA. FILED 9-1-2009.



THE COLOR(S) YELLOW, GREEN AND WHITE IS/ARE CLAIMED AS A FEATURE OF THE MARK.

THE MARK CONSISTS OF YELLOW SUN ABOVE A GREEN HILL WITH THE WORDS "COUNTRY ROAD" IN WHITE.

FOR CHEESE, YOGURT, BULGARIAN CHEESE, BULGARIAN YOGURT, BULGARIAN SHEEP'S MILK CHEESE, BULGARIAN SHEEP'S MILK YOGURT (U.S. CL. 46).

FIRST USE 4-12-2007; IN COMMERCE 4-12-2007.
JANET LEE, EXAMINING ATTORNEY

SN 77-817,819. GOURMET FOOD IMPORTS, LLC, LAFAYETTE, CA. FILED 9-1-2009.



THE COLOR(S) WHITE, GREEN, BROWN, REDDISH-BROWN AND BLACK IS/ARE CLAIMED AS A FEATURE OF THE MARK.

THE MARK CONSISTS OF A WHITE SHEEP WITH BROWN HEAD AND BLACK LEGS, WITH A WHITE-BODIED ROOSTER ON ITS BACK, THE ROOSTER HAVING A REDDISH-BROWN HEAD AND TAIL AND BROWN FEET, ALL ON A GREEN PASTURE WITH GREEN MOUNTAIN AND REDDISH-BROWN HOUSE IN THE BACKGROUND, AND EVERYTHING IS ENCIRCLED IN A GREEN CIRCLE.

FOR CHEESE, YOGURT, BULGARIAN CHEESE, BULGARIAN YOGURT, BULGARIAN SHEEP'S MILK CHEESE, BULGARIAN SHEEP'S MILK YOGURT (U.S. CL. 46).

FIRST USE 4-12-2007; IN COMMERCE 4-12-2007.
JANET LEE, EXAMINING ATTORNEY

CLASS 29—(Continued).

SN 77-817,843. GOURMET FOOD IMPORTS, LLC, LAFAYETTE, CA. FILED 9-1-2009.



THE COLOR(S) WHITE, OFF-WHITE, GREEN, TAN, BLUE AND BLACK IS/ARE CLAIMED AS A FEATURE OF THE MARK.

THE MARK CONSISTS OF THE FOLLOWING: AN OFF-WHITE SHEEP WITH TAN EARS, BLACK EYES AND BLACK OUTLINES IN A GREEN MEADOW WITH GREEN TREES AND A BLACK AND WHITE HOUSE, AND A BLUE SKY WITH WHITE CLOUDS IN THE BACKGROUND.

FOR CHEESE, YOGURT, BULGARIAN CHEESE, BULGARIAN YOGURT, BULGARIAN SHEEP'S MILK CHEESE, BULGARIAN SHEEP'S MILK YOGURT (U.S. CL. 46).

FIRST USE 4-12-2007; IN COMMERCE 4-12-2007.
JANET LEE, EXAMINING ATTORNEY

SN 77-826,529. CORNFIELDS, INC., WAUKEGAN, IL. FILED 9-15-2009.

SKINNY STICKS

THE MARK CONSISTS OF STANDARD CHARACTERS WITHOUT CLAIM TO ANY PARTICULAR FONT, STYLE, SIZE, OR COLOR.

NO CLAIM IS MADE TO THE EXCLUSIVE RIGHT TO USE "STICKS", APART FROM THE MARK AS SHOWN.

FOR POTATO-BASED SNACK FOODS; VEGETABLE-BASED SNACK FOODS (U.S. CL. 46).

FIRST USE 2-0-1992; IN COMMERCE 4-0-1992.
MEGHAN REINHART, EXAMINING ATTORNEY

CLASS 29—(Continued).

SN 77-845,506. UNITED NATURAL FOODS, INC., PROVIDENCE, RI. FILED 10-9-2009.



OWNER OF U.S. REG. NO. 2,858,711.

NO CLAIM IS MADE TO THE EXCLUSIVE RIGHT TO USE "MEDITERRANEAN ORGANIC", APART FROM THE MARK AS SHOWN.

THE COLOR(S) BLUE, WHITE, YELLOW, ORANGE AND RED IS/ARE CLAIMED AS A FEATURE OF THE MARK.

THE MARK CONSISTS OF THE WORDS "MEDITERRANEAN ORGANIC" IN WHITE IN A BLUE BOX WITH A WAVY BOTTOM EDGE WITH A LETTER "M" IN RED IN THE MIDDLE OF A SUNBURST WITH ALTERNATING YELLOW AND ORANGE RAYS WITH A WHITE CIRCLE AROUND THE "M" TO THE LEFT OF THE BLUE BOX.

FOR CANNED AND BOTTLED VEGETABLES, DRIED VEGETABLES, FRUIT PRESERVES, MARMALADES AND STUFFED GRAPE LEAVES MADE IN WHOLE OR SUBSTANTIAL PART OF ORGANIC INGREDIENTS (U.S. CL. 46).

FIRST USE 8-0-2007; IN COMMERCE 8-0-2007.
JASON TURNER, EXAMINING ATTORNEY

SN 77-846,413. WHITEY'S RESTAURANT, INC., RICHFIELD, OH. FILED 10-12-2009.

BURGER BUDDIES

THE MARK CONSISTS OF STANDARD CHARACTERS WITHOUT CLAIM TO ANY PARTICULAR FONT, STYLE, SIZE, OR COLOR.

NO CLAIM IS MADE TO THE EXCLUSIVE RIGHT TO USE "BURGER", APART FROM THE MARK AS SHOWN.

FOR FOOD, NAMELY, SIDE ORDER ITEMS, NAMELY, FRENCH FRIED POTATOES, ONION RINGS, AND PROCESSED VEGETABLES (U.S. CL. 46).

FIRST USE 0-0-1979; IN COMMERCE 0-0-1979.
FRANK LATTUCA, EXAMINING ATTORNEY

CLASS 29—(Continued).

SN 77-847,973. LAURA CHENEL'S CHEVRE, INC., SONOMA, CA. FILED 10-13-2009.



OWNER OF U.S. REG. NOS. 2,300,898 AND 3,168,284.
 NO CLAIM IS MADE TO THE EXCLUSIVE RIGHT TO USE "CHEVRE", APART FROM THE MARK AS SHOWN.
 THE NAME "LAURA CHENEL" IDENTIFIES A LIVING INDIVIDUAL WHOSE CONSENT IS OF RECORD.
 THE COLOR(S) BLACK, ORANGE, WHITE, TAN AND RED IS/ARE CLAIMED AS A FEATURE OF THE MARK.
 THE MARK CONSISTS OF INCOMPLETE CONCENTRIC CIRCLES HAVING A BLACK LINE AS THE OUTER-MOST CIRCLE ENCOMPASSING A NARROW CIRCULAR BAND IN THE COLOR ORANGE, A LARGER CIRCULAR BAND IN THE COLOR BLACK, A NARROW CIRCULAR BAND IN THE COLOR TAN AND AN INNER CIRCLE IN THE COLOR ORANGE. THE WORDS "LAURA CHENEL'S CHEVRE" IN CURVED STYLIZED SCRIPT IN THE COLOR WHITE APPEAR INSIDE THE LARGER BLACK BAND ABOVE THE HEAD OF A GOAT IN WHITE WITH BLACK OUTLINING AND FEATURES EXTENDING OVER THE ORANGE INNER CIRCLE, THE TAN BAND AND INTO THE BLACK BAND. FLOWER-LIKE DINGBATS IN THE COLOR RED APPEAR BELOW THE LETTERS "L" AND THE FINAL LETTER "E". AT THE BOTTOM OF THE MARK IS A BANNER DESIGN IN THE COLOR RED OUTLINED IN BLACK WITH THE WORD "BLOSSOM" APPEARING INSIDE THE BANNER IN THE COLOR WHITE.
 FOR GOAT'S MILK CHEESE (U.S. CL. 46).
 FIRST USE 9-1-2009; IN COMMERCE 9-1-2009.
 VERNA BETH RIRIE, EXAMINING ATTORNEY

SN 77-860,397. LIDESTRI FOODS, INC., FAIRPORT, NY. FILED 10-29-2009.

**FRANCESCO RINALDI TO BE
SMART**

THE MARK CONSISTS OF STANDARD CHARACTERS WITHOUT CLAIM TO ANY PARTICULAR FONT, STYLE, SIZE, OR COLOR.
 OWNER OF U.S. REG. NOS. 1,237,506, 1,354,502 AND 3,500,657.
 THE NAME(S), PORTRAIT(S), AND/OR SIGNATURE(S) SHOWN IN THE MARK DOES NOT IDENTIFY A PARTICULAR LIVING INDIVIDUAL.
 FOR BLENDED OIL; CANOLA OIL; COOKING OIL; EDIBLE OIL; NUTRITIONAL OILS FOR FOOD PURPOSES; OLIVE OIL; VEGETABLE OILS (U.S. CL. 46).
 LESLIE RICHARDS, EXAMINING ATTORNEY

CLASS 29—(Continued).

SN 77-867,428. MONTALVAN'S SALES, INC., ONTARIO, CA. FILED 11-6-2009.

POLLO LISTO

THE MARK CONSISTS OF STANDARD CHARACTERS WITHOUT CLAIM TO ANY PARTICULAR FONT, STYLE, SIZE, OR COLOR.
 NO CLAIM IS MADE TO THE EXCLUSIVE RIGHT TO USE "POLLO", APART FROM THE MARK AS SHOWN.
 THE ENGLISH TRANSLATION OF "POLLO LISTO" IN THE MARK IS "CHICKEN READY".
 FOR BOUILLON, BOUILLON CONCENTRATES, CHICKEN BOUILLON, CONSOMMÉ, BROTH, CHICKEN, AND CHICKEN STOCK (U.S. CL. 46).
 CAROLYN CATALDO, EXAMINING ATTORNEY

SN 77-867,941. ROKAVIAR, INC., MIAMI, FL. FILED 11-9-2009.



OWNER OF U.S. REG. NO. 2,715,923.
 THE MARK CONSISTS OF THE WORD "ROKAVIAR" IN STYLIZED FONT ABOVE A CROWN DESIGN CENTERED BELOW, TWO FISH FACING EACH OTHER BELOW THE CROWN DESIGN WITH THREE HORIZONTALLY CENTERED ROWS OF WAVY LINES DEPICTING WATER BETWEEN THE FISH.
 FOR PROCESSED FISH FOR FOOD PURPOSES, AND CAVIAR (U.S. CL. 46).
 KIMBERLY FRYE, EXAMINING ATTORNEY

CLASS 29—(Continued).

SN 77-870,091. CALIFRESH OF CALIFORNIA, LLC, SANGER, CA. FILED 11-11-2009.



THE COLOR(S) DARK GREEN, GREEN, LIGHT GREEN, BLACK, BLUE, WHITE, BEIGE, YELLOW, RED AND BROWN IS/ARE CLAIMED AS A FEATURE OF THE MARK.

THE MARK CONSISTS OF A LIGHT GREEN CHICKPEA OUTLINED WITH DARK GREEN AND WITH GREEN SHADING. THE CHICKPEA HAS BLUE, BLACK AND WHITE EYES. THE CHICKPEA IS WEARING A BEIGE MEXICAN STYLE HAT THAT HAS YELLOW DETAIL AND BLUE OUTLINE ON THE BRIM, AND RED AND GREEN DETAIL AROUND THE CENTER OF THE HAT. THE TOP AND BOTTOM OF THE HAT ARE OUTLINED IN BROWN.

FOR BEAN DIP; DIP MIXES; DIPS; PROCESSED BEANS; SNACK DIPS; SNACK FOOD DIPS (U.S. CL. 46).
JENNIFER VASQUEZ, EXAMINING ATTORNEY

SN 77-882,314. ATLANTIKA, INC., NEW CANAAN, CT. FILED 11-30-2009.



THE MARK CONSISTS OF THE WORD "ATLANTIKA" AND THE IMAGE OF A FISH IN A CIRCLE.
FOR FRESH SEAFOOD (U.S. CL. 46).
TARA PATE, EXAMINING ATTORNEY

SN 77-882,895. OCEAN APPROVED LLC, PORTLAND, ME. FILED 12-1-2009.

OCEAN APPROVED

THE MARK CONSISTS OF STANDARD CHARACTERS WITHOUT CLAIM TO ANY PARTICULAR FONT, STYLE, SIZE, OR COLOR.
FOR PROCESSED, EDIBLE SEAWEED (U.S. CL. 46).
FIRST USE 5-25-2006; IN COMMERCE 4-27-2009.
SKYE YOUNG, EXAMINING ATTORNEY

CLASS 29—(Continued).

SN 77-884,335. SABOR DE ESPAÑA, INC., MIAMI, FL. FILED 12-2-2009.

Nuestra Herencia

THE MARK CONSISTS OF STANDARD CHARACTERS WITHOUT CLAIM TO ANY PARTICULAR FONT, STYLE, SIZE, OR COLOR.

THE ENGLISH TRANSLATION OF "NUESTRA HERENCIA" IN THE MARK IS "OUR HERITAGE".

FOR HAM (U.S. CL. 46).
FIRST USE 11-28-2009; IN COMMERCE 11-28-2009.
JEFF DEFORD, EXAMINING ATTORNEY

SN 77-884,348. CONAGRA FOODS RDM, INC., OMAHA, NE. FILED 12-2-2009.



OWNER OF U.S. REG. NOS. 2,320,457, 3,209,277 AND 3,209,280.

THE MARK CONSISTS OF A STYLIZED LETTER "M" PLACED ABOVE THE WORDS "THE MAX", ALONG THE WORD "MAX" BEING UNDERLINED.

FOR PACKAGED MEAT SNACKS (U.S. CL. 46).
SEAN CROWLEY, EXAMINING ATTORNEY

SN 77-884,379. WOODMAN'S SEA PRODUCTS LIMITED, NEWFOUNDLAND, CANADA, FILED 12-2-2009.



OWNER OF U.S. REG. NO. 1,380,638.
THE MARK CONSISTS OF THREE LINES OF GEOMETRIC FISH SHAPES, EACH FOLLOWED BY THE WORD "BAYSHORE".
FOR FRESH AND FROZEN FISH AND SHELLFISH (U.S. CL. 46).
FIRST USE 1-22-1985; IN COMMERCE 1-28-1985.
JOHN DALIER, EXAMINING ATTORNEY

CLASS 29—(Continued).

SN 77-884,464. KLAPPER, DENISE, REDWOOD CITY, CA.
FILED 12-2-2009.



NO CLAIM IS MADE TO THE EXCLUSIVE RIGHT TO USE "JERKY COMPANY", APART FROM THE MARK AS SHOWN.

THE MARK CONSISTS OF "GREENLIGHT JERKY COMPANY" WITH A TRAFFIC LIGHT ON THE RIGHT. FOR JERKY (U.S. CL. 46).
ALLISON SCHRODY, EXAMINING ATTORNEY

CLASS 29—(Continued).

SN 77-886,727. MEI, YUE QUIN WILLIAM, CHICAGO, IL.
FILED 12-4-2009.



THE COLOR(S) RED, BLACK, WHITE AND GOLD IS/ARE CLAIMED AS A FEATURE OF THE MARK.

THE MARK CONSISTS OF THE IMAGE OF A DRAGON IN GOLD WITH WHITE CLAWS BEHIND A RED BANNER WITH ASIAN CHARACTERS WRITTEN IN BLACK AND OUTLINE IN WHITE AND BENEATH THAT BANNER A SECOND RED BANNER WITH THE WORDS "KING OF KING" WRITTEN IN WHITE.

THE NON-LATIN CHARACTERS IN THE MARK TRANSLITERATE TO HUANG SHANG HUANG AND THIS MEANS "KING OF KING" IN ENGLISH.

FOR PRESERVED MEATS AND SAUSAGES (U.S. CL. 46).

PRISCILLA MILTON, EXAMINING ATTORNEY

SN 77-885,771. SLADE GORTON & CO., INC., BOSTON, MA.
FILED 12-3-2009.

Rocky Bay

THE MARK CONSISTS OF STANDARD CHARACTERS WITHOUT CLAIM TO ANY PARTICULAR FONT, STYLE, SIZE, OR COLOR.

OWNER OF U.S. REG. NO. 2,298,341.
FOR FISH; SEAFOOD (U.S. CL. 46).
FIRST USE 11-1-1928; IN COMMERCE 11-1-1928.
KIMBERLY PERRY, EXAMINING ATTORNEY

SN 77-886,225. PROMOTION IN MOTION, INC., CLOSTER, NJ. FILED 12-4-2009.

SUNNY FRUITS

THE MARK CONSISTS OF STANDARD CHARACTERS WITHOUT CLAIM TO ANY PARTICULAR FONT, STYLE, SIZE, OR COLOR.

NO CLAIM IS MADE TO THE EXCLUSIVE RIGHT TO USE "FRUITS", APART FROM THE MARK AS SHOWN.

FOR PROCESSED FRUIT SNACKS MADE FROM FRUIT JUICE AND/OR FRUIT PUREE; FRUIT BASED SNACK FOODS, NAMELY, FRUIT ROLLS; FRUIT BARS, NAMELY, PROCESSED FRUIT BASED FOOD BARS; FRUIT BASED SNACK FOODS COMPRISED OF FRUIT COMPONENTS; FRUIT BASED SNACK FOODS COMPRISED OF FRUIT AND YOGURT COMPONENTS; FRUIT BASED SNACK FOODS COMPRISED OF FRUIT AND GRANOLA COMPONENTS; AND FRUIT BASED SNACK FOODS COMPRISED OF FRUIT, YOGURT AND GRANOLA COMPONENTS (U.S. CL. 46).

ELIZABETH HUGHITT, EXAMINING ATTORNEY

SN 77-886,819. MODA INTERNATIONAL MARKETING, INC., NEW YORK, NY. FILED 12-4-2009.

UGLY APPLE

THE MARK CONSISTS OF STANDARD CHARACTERS WITHOUT CLAIM TO ANY PARTICULAR FONT, STYLE, SIZE, OR COLOR.

NO CLAIM IS MADE TO THE EXCLUSIVE RIGHT TO USE "APPLE", APART FROM THE MARK AS SHOWN.

FOR APPLESAUCE; COMPOTES; FRUIT-BASED SNACK FOOD (U.S. CL. 46).

LINDA MICKLEBURGH, EXAMINING ATTORNEY

CLASS 29—(Continued).

SN 77-887,253. DRYAK, LORAIN HAASE, BLAIR, WI. FILED 12-7-2009.

Gifted Earth Originals

THE MARK CONSISTS OF STANDARD CHARACTERS WITHOUT CLAIM TO ANY PARTICULAR FONT, STYLE, SIZE, OR COLOR.

NO CLAIM IS MADE TO THE EXCLUSIVE RIGHT TO USE "ORIGINALS", APART FROM THE MARK AS SHOWN.
 FOR DRIED EGGS; EGG PRODUCT; EGG SUBSTITUTE; EGG WHITES; EGG YOLKS; EGGS; FROZEN EGGS; HEN EGGS; MEAT, FRUIT AND VEGETABLE JELLIES, JAMS, EGGS; PROCESSED EGGS (U.S. CL. 46).
 VIVIAN MICZNIK FIRST, EXAMINING ATTORNEY

SN 77-887,451. LA CENSE BEEF LLC, DILLON, MT. FILED 12-7-2009.

**GRASS FED. BETTER BEEF.
 BETTER WORLD.**

THE MARK CONSISTS OF STANDARD CHARACTERS WITHOUT CLAIM TO ANY PARTICULAR FONT, STYLE, SIZE, OR COLOR.

NO CLAIM IS MADE TO THE EXCLUSIVE RIGHT TO USE "GRASS FED" AND "BETTER BEEF", APART FROM THE MARK AS SHOWN.
 FOR BEEF (U.S. CL. 46).
 YAT SYE, LEE, EXAMINING ATTORNEY

SN 77-887,452. LA CENSE BEEF LLC, DILLON, MT. FILED 12-7-2009.

BETTER BEEF. BETTER WORLD.

THE MARK CONSISTS OF STANDARD CHARACTERS WITHOUT CLAIM TO ANY PARTICULAR FONT, STYLE, SIZE, OR COLOR.

NO CLAIM IS MADE TO THE EXCLUSIVE RIGHT TO USE "BETTER BEEF", APART FROM THE MARK AS SHOWN.
 FOR BEEF (U.S. CL. 46).
 YAT SYE, LEE, EXAMINING ATTORNEY

CLASS 29—(Continued).

SN 77-887,515. SHEPHERD, JOE, WARSAW, IN. FILED 12-7-2009.



NO CLAIM IS MADE TO THE EXCLUSIVE RIGHT TO USE "JERKY", APART FROM THE MARK AS SHOWN.

THE MARK CONSISTS OF A STEER DANCING UPRIGHT ON ITS HIND LEGS, WEARING A BANDANNA AROUND ITS NECK, AND HOLDING A PIECE OF WOOD WITH THE WORDS "WILDLY DIFFERENT" ON IT; A STYLIZED OVAL EXTENDS FROM THE STEER DESIGN TO WORDING APPEARING ABOVE THIS ANIMAL. THE WORD "REDNECK" IS SHOWN IN STYLIZED LETTERING CONSISTING OF SIMULATED WOOD WITH CRACKS APPEARING AT THE TOP AND BOTTOM OF EACH LETTER, AND A HORIZONTAL DARK BAND APPEARING IN THE CENTER OF THE WORD, CONTAINING STARS, ONE STAR IN EACH LETTER; BELOW THIS TERM IS THE PHRASE "ALMOST PERFECT JERKY".
 FOR BEEF JERKY (U.S. CL. 46).
 HENRY S. ZAK, EXAMINING ATTORNEY

SN 77-887,763. PROMOTION IN MOTION, INC., CLOSTER, NJ. FILED 12-7-2009.

SLICE FRUIT SNACKS

THE MARK CONSISTS OF STANDARD CHARACTERS WITHOUT CLAIM TO ANY PARTICULAR FONT, STYLE, SIZE, OR COLOR.

NO CLAIM IS MADE TO THE EXCLUSIVE RIGHT TO USE "FRUIT SNACKS", APART FROM THE MARK AS SHOWN.
 FOR PROCESSED FRUIT SNACKS MADE FROM FRUIT JUICE AND/OR FRUIT PUREE; FRUIT BASED SNACK FOODS, NAMELY, FRUIT ROLLS; FRUIT BARS, NAMELY, PROCESSED FRUIT BASED FOOD BARS; FRUIT BASED SNACK FOODS COMPRISED OF FRUIT COMPONENTS; FRUIT BASED SNACK FOODS COMPRISED OF FRUIT AND YOGURT COMPONENTS; FRUIT BASED SNACK FOODS COMPRISED OF FRUIT AND GRANOLA COMPONENTS; AND FRUIT BASED SNACK FOODS COMPRISED OF FRUIT, YOGURT AND GRANOLA COMPONENTS (U.S. CL. 46).
 ELIZABETH HUGHITT, EXAMINING ATTORNEY

CLASS 29—(Continued).

SN 77-887,854. TYSON FRESH MEATS, INC., SPRINGDALE, AR. FILED 12-7-2009.

festivo

THE MARK CONSISTS OF STANDARD CHARACTERS WITHOUT CLAIM TO ANY PARTICULAR FONT, STYLE, SIZE, OR COLOR.

THE ENGLISH TRANSLATION OF "FESTIVO" IN THE MARK IS FESTIVE.

FOR VARIETY MEATS, NAMELY, BEEF, POULTRY, PORK, AND GAME; MEAT COMBINATIONS CONSISTING PRIMARILY OF BEEF, POULTRY, PORK, AND GAME (U.S. CL. 46).

WARREN L. OLANDRIA, EXAMINING ATTORNEY

CLASS 29—(Continued).

SN 77-888,865. SUNSHINE RAISIN CORPORATION, DBA NATIONAL RAISIN CO., FOWLER, CA. FILED 12-8-2009.

RAISELS

THE MARK CONSISTS OF STANDARD CHARACTERS WITHOUT CLAIM TO ANY PARTICULAR FONT, STYLE, SIZE, OR COLOR.

FOR FLAVORED RAISINS (U.S. CL. 46).

BRENDAN MCCAULEY, EXAMINING ATTORNEY

SN 77-887,914. SABRA DIPPING COMPANY, LLC, ASTORIA, NY. FILED 12-7-2009.

SABRA DAIRY

THE MARK CONSISTS OF STANDARD CHARACTERS WITHOUT CLAIM TO ANY PARTICULAR FONT, STYLE, SIZE, OR COLOR.

OWNER OF U.S. REG. NOS. 2,414,891 AND 2,982,651.

NO CLAIM IS MADE TO THE EXCLUSIVE RIGHT TO USE "DAIRY", APART FROM THE MARK AS SHOWN.

THE ENGLISH TRANSLATION OF "SABRA" IN THE MARK IS NATIVE BORN IN THE LANGUAGE HEBREW.

FOR MILK PRODUCTS, NAMELY, FRESH MILK, SOFT CHEESE, HARD CHEESE, CREAM OF YOGURT, CREAM OF YOGURT IN VARIOUS FLAVORS, AND WHIPPED CREAM (U.S. CL. 46).

ADA HAN, EXAMINING ATTORNEY

SN 77-889,252. JFC, INC., ST. CLOUD, MN. FILED 12-9-2009.

SUNNY ROOST

THE MARK CONSISTS OF STANDARD CHARACTERS WITHOUT CLAIM TO ANY PARTICULAR FONT, STYLE, SIZE, OR COLOR.

FOR POULTRY (U.S. CL. 46).

FIRST USE 10-26-2009; IN COMMERCE 10-26-2009.

RON FAIRBANKS, EXAMINING ATTORNEY

SN 77-888,382. VANCE'S FOODS, INC., SACRAMENTO, CA. FILED 12-8-2009.



OWNER OF U.S. REG. NOS. 2,401,593 AND 3,233,243. THE MARK CONSISTS OF THE LETTERS "SNO" FOLLOWED BY A SNOWFLAKE DESIGN AND THE LETTER "E".

FOR SOY-BASED FOOD BEVERAGE USED AS A MILK SUBSTITUTE (U.S. CL. 46).

FIRST USE 0-0-2006; IN COMMERCE 0-0-2006.

NICHOLAS COLEMAN, EXAMINING ATTORNEY

SN 77-889,315. WHITEWAVE SERVICES, INC., DALLAS, UT. FILED 12-9-2009.

THE PERFECT CUP, ANYWHERE

THE MARK CONSISTS OF STANDARD CHARACTERS WITHOUT CLAIM TO ANY PARTICULAR FONT, STYLE, SIZE, OR COLOR.

FOR NON-DAIRY CREAMER (U.S. CL. 46).

CHERYL CLAYTON, EXAMINING ATTORNEY

CLASS 29—(Continued).

SN 77-890,649. DATER, CHRISTIE S., MESA, AZ. FILED 12-10-2009.

PickleLady Pickles

THE MARK CONSISTS OF STANDARD CHARACTERS WITHOUT CLAIM TO ANY PARTICULAR FONT, STYLE, SIZE, OR COLOR.

NO CLAIM IS MADE TO THE EXCLUSIVE RIGHT TO USE "PICKLES", APART FROM THE MARK AS SHOWN.

FOR EDIBLE OILS AND FATS, PRESERVES AND PICKLES; EDIBLE OILS AND FATS, PRESERVES, PICKLES; PICKLED JALAPENOS; PICKLED VEGETABLES; PICKLES; SPICY PICKLES (U.S. CL. 46).

JENNIFER DIXON, EXAMINING ATTORNEY

SN 77-890,762. DONGWON F&B CO., LTD., SEOUL, REPUBLIC OF KOREA, FILED 12-10-2009.

PASI

THE MARK CONSISTS OF STANDARD CHARACTERS WITHOUT CLAIM TO ANY PARTICULAR FONT, STYLE, SIZE, OR COLOR.

FOR PROCESSED EDIBLE SEAWEED; FROZEN FISH; STEAMED OR TOASTED CAKES OF FISH PASTE; PICKLED FISH; CANNED FISH; BOTTLED FISH; SMOKED FISH (U.S. CL. 46).

ASMAT KHAN, EXAMINING ATTORNEY

SN 77-891,432. HERBST ANDY, DBA RACE NUTS, COPPEROPOLIS, CA. FILED 12-11-2009.

Race Nuts

THE MARK CONSISTS OF STANDARD CHARACTERS WITHOUT CLAIM TO ANY PARTICULAR FONT, STYLE, SIZE, OR COLOR.

NO CLAIM IS MADE TO THE EXCLUSIVE RIGHT TO USE "NUTS", APART FROM THE MARK AS SHOWN.

FOR ROASTED NUTS; SNACK MIX CONSISTING OF DEHYDRATED FRUIT AND PROCESSED NUTS; SNACK MIX CONSISTING OF PRIMARILY OF PROCESSED NUTS, SEEDS, DRIED FRUIT AND ALSO INCLUDING CHOCOLATE; SNACK MIX CONSISTING OF WASABI PEAS, PROCESSED NUTS, DEHYDRATED FRUIT AND/OR RAISINS; SNACK MIX CONSISTING PRIMARILY OF PROCESSED FRUITS, PROCESSED NUTS AND/OR RAISINS; TRAIL MIX CONSISTING PRIMARILY OF PROCESSED NUTS, SEEDS, DRIED FRUIT AND ALSO INCLUDING CHOCOLATE (U.S. CL. 46).

JEFF DEFORD, EXAMINING ATTORNEY

CLASS 29—(Continued).

SN 77-891,780. ROLL, LANCE, CARLSBAD, CA. FILED 12-11-2009.

LOVE IS THE ULTIMATE SPICE

THE MARK CONSISTS OF STANDARD CHARACTERS WITHOUT CLAIM TO ANY PARTICULAR FONT, STYLE, SIZE, OR COLOR.

FOR PREPARED AND PACKAGED MEALS CONSISTING OF MEAT, FISH, POULTRY AND VEGETABLES, BEEF STOCK, BROTH, CHICKEN, CHICKEN STOCK, FISH STOCK, EXTRACTS FOR SOUPS (U.S. CL. 46).

FIRST USE 8-1-2009; IN COMMERCE 8-1-2009.

KELLEY WELLS, EXAMINING ATTORNEY

SN 77-892,545. TYSON FOODS, INC., SPRINGDALE, AR. FILED 12-14-2009.

TWISTIN' STRIPS

THE MARK CONSISTS OF STANDARD CHARACTERS WITHOUT CLAIM TO ANY PARTICULAR FONT, STYLE, SIZE, OR COLOR.

NO CLAIM IS MADE TO THE EXCLUSIVE RIGHT TO USE "STRIPS", APART FROM THE MARK AS SHOWN.

FOR CHICKEN (U.S. CL. 46).

DOUGLAS LEE, EXAMINING ATTORNEY

SN 77-892,664. NOGA DAIRY INC., FARMINGDALE, FL. FILED 12-14-2009.

NOGA DELIGHT

THE MARK CONSISTS OF STANDARD CHARACTERS WITHOUT CLAIM TO ANY PARTICULAR FONT, STYLE, SIZE, OR COLOR.

OWNER OF U.S. REG. NO. 3,198,370.

FOR DRINKING YOGURTS; YOGURT; YOGURT-BASED BEVERAGES (U.S. CL. 46).

ELLEN B. AWRICH, EXAMINING ATTORNEY

CLASS 29—(Continued).

SN 77-892,802. OLOMOMO NUT COMPANY, LLC,
BOULDER, CO. FILED 12-14-2009.



THE MARK CONSISTS OF A DANCING MONKEY.
FOR ROASTED NUTS; SEASONED NUTS (U.S. CL. 46).
FIRST USE 6-6-2009; IN COMMERCE 6-14-2009.
TARAH HARDY, EXAMINING ATTORNEY

CLASS 29—(Continued).

SN 77-893,589. PAC FILL, INC., DBA SUN DAIRY, LOS
ANGELES, CA. FILED 12-15-2009.

Somayeh

THE MARK CONSISTS OF STANDARD CHARACTERS
WITHOUT CLAIM TO ANY PARTICULAR FONT, STYLE,
SIZE, OR COLOR.
FOR MILK PRODUCTS, NAMELY, WHEY, CURD,
AND YOGURT (U.S. CL. 46).
FIRST USE 12-14-2009; IN COMMERCE 12-14-2009.
ALICIA COLLINS, EXAMINING ATTORNEY

SN 77-896,027. ABBOTT LABORATORIES, ABBOTT PARK,
IL. FILED 12-17-2009.

PEDIASURE SIDEKICKS

SN 77-892,839. HEARST COMMUNICATIONS, INC., NEW
YORK, NY. FILED 12-14-2009.



THE MARK CONSISTS OF STANDARD CHARACTERS
WITHOUT CLAIM TO ANY PARTICULAR FONT, STYLE,
SIZE, OR COLOR.
OWNER OF U.S. REG. NOS. 1,475,612 AND 3,331,889.
FOR READY TO DRINK DAIRY BASED PROTEIN
FOOD BEVERAGES (U.S. CL. 46).
KATHERINE CONNOLLY, EXAMINING ATTORNEY

SN 77-896,863. OLOMOMO NUT COMPANY, LLC,
BOULDER, CO. FILED 12-18-2009.

WICKED GOOD NUTS

NO CLAIM IS MADE TO THE EXCLUSIVE RIGHT TO
USE "CULINARY" & "1846", APART FROM THE MARK AS
SHOWN.

THE MARK CONSISTS OF THE WORDS, LETTERS, AND
NUMBERS "CULINARY", "T&C", AND "1846" ARRANGED
VERTICALLY AND SURROUNDED BY A CIRCULAR
SCALLOPED BORDER.

FOR EDIBLE OILS; JELLIES AND JAMS; SNACK MIX
CONSISTING PRIMARILY OF PROCESSED FRUITS,
PROCESSED NUTS AND/OR RAISINS; SOUP MIXES
(U.S. CL. 46).

KARANENDRA S. CHHINA, EXAMINING ATTORNEY

THE MARK CONSISTS OF STANDARD CHARACTERS
WITHOUT CLAIM TO ANY PARTICULAR FONT, STYLE,
SIZE, OR COLOR.

NO CLAIM IS MADE TO THE EXCLUSIVE RIGHT TO
USE "NUTS", APART FROM THE MARK AS SHOWN.

FOR ROASTED NUTS; SEASONED NUTS (U.S. CL. 46).
FIRST USE 6-6-2009; IN COMMERCE 6-14-2009.

TARAH HARDY, EXAMINING ATTORNEY

CLASS 29—(Continued).

SN 77-901,864. WHITEWAVE SERVICES, INC., DALLAS, TX.
FILED 12-29-2009.

MIA MORNING

THE MARK CONSISTS OF STANDARD CHARACTERS WITHOUT CLAIM TO ANY PARTICULAR FONT, STYLE, SIZE, OR COLOR.
FOR DAIRY-BASED BEVERAGES (U.S. CL. 46).
CHERYL CLAYTON, EXAMINING ATTORNEY

SN 77-925,114. CARGILL, INCORPORATED, WAYZATA, MN. FILED 2-1-2010.

THE FLAVOR OF TRADITION

THE MARK CONSISTS OF STANDARD CHARACTERS WITHOUT CLAIM TO ANY PARTICULAR FONT, STYLE, SIZE, OR COLOR.
FOR EDIBLE OILS AND EDIBLE FATS (U.S. CL. 46).
KATHERINE STOIDES, EXAMINING ATTORNEY

SN 79-076,792. TARTUFITALIA DI URBANI PAOLO & C.; S.A.S., ITALY, FILED 10-26-2009.

**LE MONDE DE LA TRUFFE**

PRIORITY DATE OF 9-30-2009 IS CLAIMED.
OWNER OF INTERNATIONAL REGISTRATION 1023434 DATED 10-26-2009, EXPIRES 10-26-2019.

THE MARK CONSISTS OF THE WORDING "LE MONDE DE LA TRUFFLE" UNDER THE DESIGN OF A SHIELD CONTAINING TRUFFLES IN THE CENTER AND CONTAINING A CROWN ON THE TOP OF THE SHIELD WITH TWO LIONS ON THE SIDES OF THE SHIELD STANDING ON A BANNER UNDER THE SHIELD.

THE ENGLISH TRANSLATION OF THE FOREIGN WORD(S) IN THE MARK IS: THE WORLD OF THE TRUFFLE.

FOR PRESERVED, DRIED AND TINNED TRUFFLES AND MUSHROOMS; TRUFFLE OIL AND MUSHROOM FLAVOURED OIL; TRUFFLE BASED PASTES; FROZEN TRUFFLES AND MUSHROOMS (U.S. CL. 46).

CAROL SPILS, EXAMINING ATTORNEY

CLASS 29—(Continued).

SN 79-078,884. ARRIGONI VALTALEGGIO S.P.A., ITALY, FILED 12-10-2009.



PRIORITY DATE OF 8-3-2009 IS CLAIMED.
OWNER OF INTERNATIONAL REGISTRATION 1028737 DATED 12-10-2009, EXPIRES 12-10-2019.

THE MARK CONSISTS OF A SIGN DEPICTING A HEXAGONAL LABEL WITH BLUNTED CORNERS INSIDE WHICH THERE IS THE WORDING "ARRIGONI VALTALEGGIO" WRITTEN IN FANCY CHARACTERS; THE FIRST WORD BEING PLACED ABOVE THE OTHER ONE.

FOR CHEESE, MILK, DAIRY PRODUCTS EXCLUDING ICE CREAM, ICE MILK AND FROZEN YOGURT; MILK PRODUCTS EXCLUDING ICE CREAM, ICE MILK AND FROZEN YOGURT (U.S. CL. 46).

TRACY FLETCHER, EXAMINING ATTORNEY

CLASS 30—STAPLE FOODS

SN 76-700,214. IMPERIAL FOOD SERVICE, INC, SOUTH ELGIN, IL. FILED 11-3-2009.



NO CLAIM IS MADE TO THE EXCLUSIVE RIGHT TO USE "PREMIUM SANDWICH COLLECTION", APART FROM THE MARK AS SHOWN.

THE MARK CONSISTS OF THE STYLIZED LETTERS PSC ARRANGED IN SIDE-BY-SIDE RELATION WITH THE LETTER "S" HAVING A FONT LARGER THAN THE LETTERS "P" OR "C" AND WITH ALL THE LETTERS PSC BEING CENTERED ON A COMPLETELY OR PARTIALLY SHADED OVAL HAVING THE WORDS PREMIUM SANDWICH COLLECTION ARRANGED IN SUBSTANTIALLY SURROUNDING RELATION RELATIVE THERETO.

FOR PREPACKAGED KITS FOR MAKING HAND-HELD SANDWICHES, CONSISTING PRIMARILY OF A VARIETY OF MEATS WITH BREAD (U.S. CL. 46).

FIRST USE 9-24-2009; IN COMMERCE 9-24-2009.

KATHERINE E. HALMEN, EXAMINING ATTORNEY

CLASS 30—(Continued).

SN 76-700,702. JONES, JAMES GORDON, THURMOND, NC.
FILED 12-7-2009.



THE MARK CONSISTS OF THE WORDING "BECOME 1 WITH THE BIRD" WITH WINGS OUTSTRETCHED FROM THE NUMBER "1".

FOR SPICE RUBS, NAMELY, DRY TURKEY RUB; SPICES (U.S. CL. 46).

JENNIFER HETU, EXAMINING ATTORNEY

SN 76-700,802. PRINCETON VANGUARD, LLC, SKILLMAN, NJ. FILED 12-11-2009.

PRETZEL CRISPS

THE MARK CONSISTS OF STANDARD CHARACTERS WITHOUT CLAIM TO ANY PARTICULAR FONT, STYLE, SIZE, OR COLOR.

OWNER OF U.S. REG. NO. 2,980,303.

NO CLAIM IS MADE TO THE EXCLUSIVE RIGHT TO USE "PRETZEL", APART FROM THE MARK AS SHOWN. SEC. 2(F).

FOR PRETZEL CRACKERS (U.S. CL. 46).

FIRST USE 10-6-2004; IN COMMERCE 10-6-2004.

CHARLOTTE CORWIN, EXAMINING ATTORNEY

SN 77-345,918. WM. WRIGLEY JR. COMPANY, CHICAGO, IL. FILED 12-6-2007.

LUSH

THE MARK CONSISTS OF STANDARD CHARACTERS WITHOUT CLAIM TO ANY PARTICULAR FONT, STYLE, SIZE, OR COLOR.

FOR CHEWING GUM (U.S. CL. 46).

JILL C. ALT, EXAMINING ATTORNEY

CLASS 30—(Continued).

SN 77-361,476. MCRAE'S FOODS, LLC, HUNTSVILLE, AL.
FILED 12-29-2007.



NO CLAIM IS MADE TO THE EXCLUSIVE RIGHT TO USE "FOODS", APART FROM THE MARK AS SHOWN.

THE COLOR(S) MAUVE AND BURGUNDY IS/ARE CLAIMED AS A FEATURE OF THE MARK.

THE MARK CONSISTS OF AN ABSTRACT IMAGE IN MAUVE INSIDE A BURGUNDY OVAL. THE WORDING "MCRAE'S FOODS" APPEARS IN BURGUNDY.

FOR BARBECUE SAUCE (U.S. CL. 46).

SKYE YOUNG, EXAMINING ATTORNEY

SN 77-400,104. JONMOR INVESTMENTS, INC., WILMINGTON, DE. FILED 2-19-2008.



OWNER OF U.S. REG. NOS. 1,054,792, 2,847,525 AND 2,897,136.

NO CLAIM IS MADE TO THE EXCLUSIVE RIGHT TO USE "NATURALS", APART FROM THE MARK AS SHOWN.

THE NAME "JOHN MORRELL" DOES NOT IDENTIFY A LIVING INDIVIDUAL.

THE COLOR(S) RED, GOLD, BLACK, CREAM, BEIGE IS/ARE CLAIMED AS A FEATURE OF THE MARK.

THE MARK CONSISTS OF A RED OVAL SEAL OUTLINED IN GOLD AND BLACK. AT THE TOP OF THE OVAL SEAL ARE THE WORDS "JOHN MORRELL" IN SMALL, GOLD-COLORED, BLOCK PRINT. IN THE MIDDLE OF THE OVAL SEAL IS THE WORD "BISTRO" IN LARGE, CREAM-COLORED SCRIPT, OUTLINED IN BLACK. BELOW THE WORD "BISTRO" IS THE WORD "NATURALS" IN BLACK PRINT WITHIN A GOLD RIBBON BANNER HAVING BEIGE TRIM AT THE TOP AND BOTTOM OF THE BANNER. THE COLOR RED WITHIN THE OVAL CONTRASTS BETWEEN A BRIGHT RED AT THE CENTER AND FADES INTO A DEEPER RED AT THE BORDERS OF THE OVAL.

FOR SANDWICHES; SANDWICH WRAPS (U.S. CL. 46).

JULIE GUTTADAURO, EXAMINING ATTORNEY

CLASS 30—(Continued).

SN 77-458,715. HENRY'S HOLDINGS, LLC, COMMERCE, CA. FILED 4-25-2008.

SUN HARVEST

THE MARK CONSISTS OF STANDARD CHARACTERS WITHOUT CLAIM TO ANY PARTICULAR FONT, STYLE, SIZE, OR COLOR.

OWNER OF U.S. REG. NOS. 1,736,903, 3,440,589 AND OTHERS.

FOR BREAD; BREAD ROLLS; BUNS; TORTILLAS; CORN CHIPS; TORTILLA CHIPS; CRACKERS; PASTRIES; COOKIES; READY-TO-EAT CEREALS; OAT-MEAL; PROCESSED OATS; CORN MEAL; GRITS; WAFFLES; BURRITOS; LASAGNA; PASTA; PREPARED MEALS CONSISTING PRIMARILY OF PASTA OR RICE; INSTANT CHINESE NOODLES; PIZZAS; POPCORN; WHEAT-BASED SNACK FOODS; SALSA; SAUCES; TOMATO SAUCE; PASTA SAUCE; BARBEQUE SAUCE; TARTAR SAUCE; KETCHUP; MUSTARD; RELISH; MAYONNAISE; SALAD DRESSING; HONEY; VINEGAR; SPICE RUBS; MAPLE SYRUP; CANDY; COCOA MIXES; ICE CREAM; FRUIT ICE BAR; CHEESE FLAVORED PUFFED CORN SNACKS (U.S. CL. 46).

SCOTT BIBB, EXAMINING ATTORNEY

SN 77-517,330. CLINGENPEEL, DAVID, MANAKIN, VA. FILED 7-9-2008.

KOOL BEANZ

THE MARK CONSISTS OF STANDARD CHARACTERS WITHOUT CLAIM TO ANY PARTICULAR FONT, STYLE, SIZE, OR COLOR.

NO CLAIM IS MADE TO THE EXCLUSIVE RIGHT TO USE "BEANS", APART FROM THE MARK AS SHOWN.

FOR JELLY BEANS (U.S. CL. 46).

MARK T. MULLEN, EXAMINING ATTORNEY

CLASS 30—(Continued).

SN 77-587,459. AL-FAKHER FOR TOBACCO TRADING AND AGENCIES CO. LTD., AMMAN 11191, JORDAN, FILED 10-7-2008.



OWNER OF U.S. REG. NO. 2,782,619.

THE NAME(S), PORTRAIT(S), AND/OR SIGNATURE(S) SHOWN IN THE MARK DOES NOT IDENTIFY A PARTICULAR LIVING INDIVIDUAL.

THE COLOR(S) RED, WHITE, BLACK AND YELLOW IS/ARE CLAIMED AS A FEATURE OF THE MARK.

THE MARK CONSISTS OF THE WORDS "AL FAKHER" AND ITS ARABIC EQUIVALENT IN WHITE, OUTLINED IN RED AND BLACK, ABOVE A CROWN IN RED AND YELLOW, ABOVE A YELLOW CIRCLE OUTLINED IN RED WITH THE ARABIC CHARACTERS FOR THE WORDS "AL FAKHER" INSIDE IN RED, AND, BELOW THAT, A YELLOW RIBBON OUTLINED IN RED WITH THE WORDS "AL FAKHER" IN RED ON THE RIBBON.

THE NON-LATIN CHARACTERS IN THE MARK TRANSLITERATE TO "AL FAKHER", AND THIS HAS NO MEANING IN A FOREIGN LANGUAGE.

FOR COFFEE (U.S. CL. 46).

ANDREA K. NADELMAN, EXAMINING ATTORNEY

SN 77-665,769. HARRIS, BRUCE A., ENTERPRISE, AL. AND HARRIS, GREGORY F., ENTERPRISE, AL. AND HARRIS, TERRY A., ENTERPRISE, AL. FILED 2-7-2009.

Gladys's Sweet Potato Pie

THE MARK CONSISTS OF STANDARD CHARACTERS WITHOUT CLAIM TO ANY PARTICULAR FONT, STYLE, SIZE, OR COLOR.

NO CLAIM IS MADE TO THE EXCLUSIVE RIGHT TO USE "SWEET POTATO PIE", APART FROM THE MARK AS SHOWN.

FOR PIES (U.S. CL. 46).

AMY ALFIERI, EXAMINING ATTORNEY

CLASS 30—(Continued).

SN 77-677,757. PBM PRODUCTS, LLC, GORDONSVILLE, VA.
FILED 2-25-2009.

CLASS 30—(Continued).

SN 77-690,825. WRIGHT, MONSERAT ANGELIKA, BEN-
BROOK, TX. FILED 3-13-2009.

LITTLE BREAKFASTS

THE MARK CONSISTS OF STANDARD CHARACTERS WITHOUT CLAIM TO ANY PARTICULAR FONT, STYLE, SIZE, OR COLOR.

OWNER OF U.S. REG. NOS. 3,381,945, 3,381,946 AND 3,381,947.

NO CLAIM IS MADE TO THE EXCLUSIVE RIGHT TO USE "BREAKFASTS", APART FROM THE MARK AS SHOWN.

FOR FOOD FOR TODDLERS, NAMELY, OATMEAL (U.S. CL. 46).

EDWARD NELSON, EXAMINING ATTORNEY



SN 77-677,763. PBM PRODUCTS, LLC, GORDONSVILLE, VA.
FILED 2-25-2009.

MY LITTLE BREAKFASTS

THE MARK CONSISTS OF STANDARD CHARACTERS WITHOUT CLAIM TO ANY PARTICULAR FONT, STYLE, SIZE, OR COLOR.

OWNER OF U.S. REG. NOS. 3,381,945, 3,381,946 AND 3,381,947.

NO CLAIM IS MADE TO THE EXCLUSIVE RIGHT TO USE "BREAKFASTS", APART FROM THE MARK AS SHOWN.

FOR FOOD FOR TODDLERS, NAMELY, OATMEAL (U.S. CL. 46).

EDWARD NELSON, EXAMINING ATTORNEY

NO CLAIM IS MADE TO THE EXCLUSIVE RIGHT TO USE "GOURMET FOODS", APART FROM THE MARK AS SHOWN.

THE COLOR(S) BLACK, RED, YELLOW, GREEN, GRAY AND BROWN IS/ARE CLAIMED AS A FEATURE OF THE MARK.

THE MARK CONSISTS OF THE TERM "KETZLER'S" IN WHITE AND BLACK LETTERS PLACED ABOVE A CREST; THE CREST CONSIST OF HERALDRY IN THE COLORS GREEN, YELLOW, BLACK AND RED, ABOVE A GRAY HELMET, ABOVE A SHIELD SHOWING TWO STANDING LIONS ON EITHER SIDE OF A STYLIZED OAK TREE, ALL ON A BLACK, YELLOW, RED AND GREEN BANDED LAYERED BACKGROUND; THE WORDING "GOURMET FOODS" APPEARS BELOW THE CREST DESIGN ELEMENTS IN WHITE AND BLACK LETTERS.

FOR SALAD DRESSINGS; SALSA; GARLIC MAYONNAISE; FROZEN ENTREES CONSISTING PRIMARILY OF PASTA OR RICE; SPAGHETTI AND MEATBALLS; COOKIES (U.S. CL. 46).

JOHN DALIER, EXAMINING ATTORNEY

CLASS 30—(Continued).

SN 77-710,965. KAY PARTNERSHIP, ALBUQUERQUE, NM. FILED 4-9-2009.



THE COLOR(S) BLACK, BROWN, WHITE, BLUE, GREEN, SILVER AND ORANGE IS/ARE CLAIMED AS A FEATURE OF THE MARK.

THE MARK CONSISTS OF A MALE FIGURE IN BROWN STANDING FACING FORWARD, HAVING BLACK HAIR, MUSTACHE, AND BEARD, AND HOLDING WHITE CIGARETTE PAPER IN ONE HAND AND A WHITE BOTTLE WITH ORANGE LABEL IN THE OTHER HAND, AND WEARING A WHITE LONG-SLEEVE SHIRT, BLUE PANTS WITH BROWN BELT AND SILVER BUCKLE, BLACK SHOES, AND BLACK SUNGLASSES WITH A GREEN LEAFY IMAGE REFLECTED IN LENSES.

FOR FLAVORINGS FOR TOBACCO (U.S. CL. 46).
FIRST USE 3-13-2002; IN COMMERCE 3-13-2002.
CURTIS FRENCH, EXAMINING ATTORNEY

SN 77-713,407. HEARTLAND HEALTH SOLUTIONS, LLC, BRENTWOOD, TN. FILED 4-14-2009.

smarter 

THE COLOR(S) BROWN, ORANGE, GREEN AND WHITE IS/ARE CLAIMED AS A FEATURE OF THE MARK.

THE MARK CONSISTS OF THE WORD "SMARTER" IN BROWN, THE DESIGN OF A FLOWER IN ORANGE AND A HUE OF GREENS WITH A WHITE CENTER, AND ORANGE LINES ABOVE AND BELOW WITH A WHITE BACKGROUND IN THE CENTER.

FOR FOOD COMPOSITIONS CONTAINING WHEAT STARCH, TAPIOCA STARCH, BARLEY STARCH, OAT STARCH, POTATO STARCH, RICE STARCH, CORN FLOUR, CEREAL GRAIN OR A MIXTURE THEREOF, NAMELY, PASTA, NOODLES, BREAKFAST CEREALS, PANCAKES, WAFFLES, PASTRIES, COOKIES, BROWNIES, CAKES, BREAD, UNLEAVENED BREAD, PIZZA DOUGH, TORTILLAS, PREPARED FOODS WITH OR WITHOUT CHEESE OR VEGETABLES IN THE NATURE OF AN ENTREE CONSISTING PRIMARILY OF PASTA, CORN BASED SNACK FOODS, RICE BASED SNACK FOODS, FLOUR AND FOOD STARCH, ALL OF WHICH HAVE A REDUCED GLYCEMIC INDEX (U.S. CL. 46).

FIRST USE 12-1-2009; IN COMMERCE 12-1-2009.
SHAILA SETTLES, EXAMINING ATTORNEY

CLASS 30—(Continued).

SN 77-729,600. HAWAIIAN PACIFIC RESTAURANT GROUP, INC., HONOLULU, HI. FILED 5-5-2009.

ROY'S

THE MARK CONSISTS OF STANDARD CHARACTERS WITHOUT CLAIM TO ANY PARTICULAR FONT, STYLE, SIZE, OR COLOR.

OWNER OF U.S. REG. NO. 2,329,827.

THE NAME "ROY YAMAGUCHI" IDENTIFIES A LIVING INDIVIDUAL WHOSE CONSENT IS OF RECORD.

FOR SALAD DRESSINGS, MARINADES, SAUCES, DIPPING SAUCES AND GLAZES FOR FISH, MEAT AND POULTRY (U.S. CL. 46).

FIRST USE 9-1-2007; IN COMMERCE 11-7-2007.

GINA FINK, EXAMINING ATTORNEY

SN 77-740,420. PINNACLE FOODS GROUP LLC, MOUNTAIN LAKES, NJ. FILED 5-19-2009.

LITTLE LENDER'S

THE MARK CONSISTS OF STANDARD CHARACTERS WITHOUT CLAIM TO ANY PARTICULAR FONT, STYLE, SIZE, OR COLOR.

OWNER OF U.S. REG. NOS. 1,172,496, 2,775,738 AND 2,963,537.

NO CLAIM IS MADE TO THE EXCLUSIVE RIGHT TO USE "LITTLE", APART FROM THE MARK AS SHOWN.

FOR BAGELS (U.S. CL. 46).

FIRST USE 1-30-2009; IN COMMERCE 1-30-2009.

CORY BOONE, EXAMINING ATTORNEY

SN 77-746,568. JACKIE CHESSER, SHOREWOOD, WI. FILED 5-28-2009.

Goody Gourmets

THE MARK CONSISTS OF STANDARD CHARACTERS WITHOUT CLAIM TO ANY PARTICULAR FONT, STYLE, SIZE, OR COLOR.

NO CLAIM IS MADE TO THE EXCLUSIVE RIGHT TO USE "GOURMET'S", APART FROM THE MARK AS SHOWN.

FOR CHOCOLATE AND CHOCOLATES; POPCORN (U.S. CL. 46).

FIRST USE 10-12-2005; IN COMMERCE 12-1-2006.

CHRIS WELLS, EXAMINING ATTORNEY

CLASS 30—(Continued).

SN 77-746,884. ABF GRAIN PRODUCTS LIMITED, LONDON, UNITED KINGDOM, FILED 5-28-2009.

TOLLY BOY

THE MARK CONSISTS OF STANDARD CHARACTERS WITHOUT CLAIM TO ANY PARTICULAR FONT, STYLE, SIZE, OR COLOR.

OWNER OF UNITED KINGDOM REG. NO. 880395, DATED 6-3-1965, RENEWED AS REG. NO. 880395, DATED 2-26-2010, EXPIRES 6-3-2020.

FOR RICE (U.S. CL. 46).

MATTHEW PAPPAS, EXAMINING ATTORNEY

SN 77-752,399. KRAFT FOODS BELGIUM INTELLECTUAL PROPERTY BVBA, 1500 HALLE, BELGIUM, FILED 6-4-2009.

COTE D'OR, THE SOUL OF CHOCOLATE

THE MARK CONSISTS OF STANDARD CHARACTERS WITHOUT CLAIM TO ANY PARTICULAR FONT, STYLE, SIZE, OR COLOR.

OWNER OF U.S. REG. NOS. 294,075, 1,242,243 AND 1,382,522.

NO CLAIM IS MADE TO THE EXCLUSIVE RIGHT TO USE "CHOCOLATE", APART FROM THE MARK AS SHOWN.

THE ENGLISH TRANSLATION OF "COTE D'OR" IN THE MARK IS "GOLD COAST".

FOR CHOCOLATE; CHOCOLATE BARS (U.S. CL. 46).

TINA BROWN, EXAMINING ATTORNEY

SN 77-753,730. CORNFIELDS, INC., WAUKEGAN, IL. FILED 6-5-2009.



THE MARK CONSISTS OF A HIGHLY STYLIZED IMAGE OF A GENERIC ANTLERED DEER IN A RECTANGULAR PRESENTATION.

FOR CONFECTIONS, NAMELY, CANDY COATED POPCORN FOR SALE AT RETAIL (U.S. CL. 46).

LINDA POWELL, EXAMINING ATTORNEY

CLASS 30—(Continued).

SN 77-756,548. SPANGLER CANDY COMPANY, BRYAN, OH. FILED 6-10-2009.

Beanstalks

THE MARK CONSISTS OF STANDARD CHARACTERS WITHOUT CLAIM TO ANY PARTICULAR FONT, STYLE, SIZE, OR COLOR.

FOR CANDY (U.S. CL. 46).

LAKEISHA LEWIS, EXAMINING ATTORNEY

SN 77-762,183. ROMAN MEAL COMPANY, TACOMA, WA. FILED 6-17-2009.

HEALTHY ELEMENTS

THE MARK CONSISTS OF STANDARD CHARACTERS WITHOUT CLAIM TO ANY PARTICULAR FONT, STYLE, SIZE, OR COLOR.

NO CLAIM IS MADE TO THE EXCLUSIVE RIGHT TO USE "HEALTHY", APART FROM THE MARK AS SHOWN.

FOR BAKERY GOODS; BREAD; BREAKFAST CEREALS; CEREAL BASED SNACK FOOD; COOKIES; CRACKERS (U.S. CL. 46).

WENDY JUN, EXAMINING ATTORNEY

SN 77-766,634. COMESTIBLES ALDOR S.A., YUMBO, VALLE DEL CAUCA, COLOMBIA, FILED 6-23-2009.

YOGUETA

THE MARK CONSISTS OF STANDARD CHARACTERS WITHOUT CLAIM TO ANY PARTICULAR FONT, STYLE, SIZE, OR COLOR.

OWNER OF COLOMBIA REG. NO. 235534, DATED 3-23-2001, EXPIRES 3-23-2011.

OWNER OF COLOMBIA REG. NO. 235534, DATED 3-23-2001, EXPIRES 3-23-2011.

OWNER OF U.S. REG. NO. 3,459,610.

THE WORDING "YOGUETA" HAS NO MEANING IN A FOREIGN LANGUAGE.

FOR BAKING POWDERS; BREAD; CANDY; CEREAL-BASED SNACK FOODS; COCOA; COFFEE AND ARTIFICIAL COFFEE; FLOUR; HONEY; ICE; ICE CREAM; ICE-CREAM; MOLASSES SYRUP; MUSTARD; PASTRY; PROCESSED CEREAL-BASED FOOD TO BE USED AS A BREAKFAST FOOD. SNACK FOOD OR INGREDIENT FOR MAKING OTHER FOODS; RICE; SAGE; SALT; SAUCES; SEASONINGS; SPICES; SUGAR; TAPIOCA; TEA; VINEGAR; YEAST (U.S. CL. 46).

SOPHIA S. KIM, EXAMINING ATTORNEY

CLASS 30—(Continued).

SN 77-770,554. MARS, INCORPORATED, MCLEAN, VA. FILED 6-29-2009.



OWNER OF U.S. REG. NOS. 3,458,629, 3,580,965 AND 3,606,392.

THE MARK CONSISTS OF A STYLIZED IMAGE OF A HUMAN BEING WITH OUTSTRETCHED ARMS PROTRUDING FROM A SWIRL DESIGN, ABOVE THE WORDS "BRIGHTER TOMORROW AT ORIGIN" AND ALL CONTAINED IN RECTANGLE.

FOR COFFEE; TEA (U.S. CL. 46).
FIRST USE 10-0-2008; IN COMMERCE 10-0-2008.
TARAH HARDY, EXAMINING ATTORNEY

SN 77-784,648. SCHWAN'S IP, LLC, MARSHALL, MN. FILED 7-20-2009.

TONY'S PIZZA

THE MARK CONSISTS OF STANDARD CHARACTERS WITHOUT CLAIM TO ANY PARTICULAR FONT, STYLE, SIZE, OR COLOR.

OWNER OF U.S. REG. NOS. 2,328,636, 2,849,630 AND OTHERS.

NO CLAIM IS MADE TO THE EXCLUSIVE RIGHT TO USE "PIZZA", APART FROM THE MARK AS SHOWN.

FOR PIZZA (U.S. CL. 46).
EMILY CARLSEN, EXAMINING ATTORNEY

CLASS 30—(Continued).

SN 77-797,058. COMESTIBLES ALDOR S.A., YUMBO, VALLE DEL CAUCA, COLOMBIA, FILED 8-4-2009.

ALDOR

THE MARK CONSISTS OF STANDARD CHARACTERS WITHOUT CLAIM TO ANY PARTICULAR FONT, STYLE, SIZE, OR COLOR.

OWNER OF COLOMBIA REG. NO. 165653, DATED 8-24-1994, EXPIRES 8-24-2014.

THE WORDING "ALDOR" HAS NO MEANING IN A FOREIGN LANGUAGE.

FOR BAKERY GOODS; BAKERY PRODUCTS; BAKING POWDERS; BREAD; CAKES; CANDY; CEREAL-BASED SNACK FOODS; COCOA; COFFEE AND COFFEE SUBSTITUTES; EDIBLE SALT; FLOUR; HONEY; ICE; ICE CREAM; MOLASSES SYRUP; MUSTARD; PROCESSED CEREAL-BASED FOOD TO BE USED AS A BREAKFAST FOOD, SNACK FOOD OR INGREDIENT FOR MAKING OTHER FOODS; RICE; SAGO; SALT; SAUCES; SEASONINGS; SPICES; SUGAR; TAPIOCA; TEA; VINEGAR; YEAST (U.S. CL. 46).

SOPHIA S. KIM, EXAMINING ATTORNEY

SN 77-800,998. KELLOGG NORTH AMERICA COMPANY, BATTLE CREEK, MI. FILED 8-10-2009.

COOKIE PARADE

THE MARK CONSISTS OF STANDARD CHARACTERS WITHOUT CLAIM TO ANY PARTICULAR FONT, STYLE, SIZE, OR COLOR.

NO CLAIM IS MADE TO THE EXCLUSIVE RIGHT TO USE "COOKIE", APART FROM THE MARK AS SHOWN.

FOR COOKIES (U.S. CL. 46).
MORGAN WYNNE, EXAMINING ATTORNEY

SN 77-815,562. GLABE, ALAN, SACRAMENTO, CA. FILED 8-28-2009.

Salad Buzz

THE MARK CONSISTS OF STANDARD CHARACTERS WITHOUT CLAIM TO ANY PARTICULAR FONT, STYLE, SIZE, OR COLOR.

NO CLAIM IS MADE TO THE EXCLUSIVE RIGHT TO USE "SALAD", APART FROM THE MARK AS SHOWN.

FOR SALAD DRESSING (U.S. CL. 46).
CHERYL CLAYTON, EXAMINING ATTORNEY

CLASS 30—(Continued).

SN 77-818,241. LANCE MFG. LLC, CHARLOTTE, NC. FILED 9-2-2009.

GARDEN CRISP

THE MARK CONSISTS OF STANDARD CHARACTERS WITHOUT CLAIM TO ANY PARTICULAR FONT, STYLE, SIZE, OR COLOR.

NO CLAIM IS MADE TO THE EXCLUSIVE RIGHT TO USE "CRISP", APART FROM THE MARK AS SHOWN. FOR CRACKERS (U.S. CL. 46).
DEZMONA MIZELLE, EXAMINING ATTORNEY

SN 77-821,487. TEREOS, ORIGNY SAINTE BENOITE, FRANCE, FILED 9-8-2009.

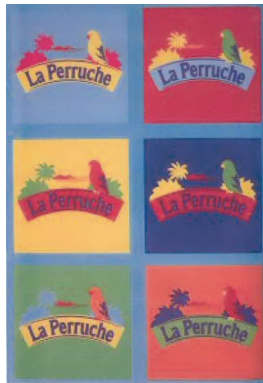

PRIORITY CLAIMED UNDER SEC. 44(D) ON FRANCE APPLICATION NO. 09/3649150, FILED 5-7-2009, REG. NO. 09/3649150, DATED 5-7-2009, EXPIRES 5-7-2019.

OWNER OF U.S. REG. NOS. 3,389,102, 3,395,076 AND OTHERS.

THE COLOR(S) LIGHT BLUE, DARK BLUE, YELLOW, ORANGE, RED, AND GREEN IS/ARE CLAIMED AS A FEATURE OF THE MARK.

THE MARK CONSISTS OF SIX SQUARES THAT TOGETHER FORM A RECTANGULAR DESIGN ELEMENT; EACH SQUARE CONTAINS THE WORDING "LA PERRUCHE" WITHIN A BANNER AND A PARAKEET, TREES, AND CLOUDS. BEGINNING AT THE TOP RIGHT AND CONTINUING CLOCKWISE, THERE IS A RED SQUARE WITH THE WORDING "LA PERRUCHE" IN DARK BLUE WITHIN A LIGHT BLUE AND DARK BLUE BANNER, WITH A GREEN, YELLOW, AND DARK BLUE PARAKEET, YELLOW TREES AND CLOUDS. NEXT IS A DARK BLUE SQUARE WITH THE WORDING "LA PERRUCHE" IN DARK BLUE WITHIN A RED AND DARK BLUE BANNER, WITH A GREEN, YELLOW, AND DARK BLUE PARAKEET, YELLOW TREES AND RED CLOUDS. NEXT IS AN ORANGE SQUARE WITH THE WORDING "LA PERRUCHE" IN DARK BLUE WITHIN A GREEN AND DARK BLUE BANNER, WITH A RED, YELLOW, AND DARK BLUE PARAKEET, DARK BLUE TREES AND RED CLOUDS. NEXT IS A GREEN SQUARE WITH THE WORDING "LA PERRUCHE" IN DARK BLUE WITHIN A YELLOW AND DARK BLUE BANNER, WITH AN ORANGE, RED, AND DARK BLUE PARAKEET, LIGHT BLUE TREES AND

CLASS 30—(Continued).

RED CLOUDS. NEXT IS A YELLOW SQUARE WITH THE WORDING "LA PERRUCHE" IN DARK BLUE WITHIN A RED AND DARK BLUE BANNER, WITH A RED, YELLOW, AND DARK BLUE PARAKEET, GREEN TREES AND RED CLOUDS. LASTLY, THERE IS A LIGHT BLUE SQUARE WITH THE WORDING "LA PERRUCHE" IN DARK BLUE WITHIN A YELLOW AND DARK BLUE BANNER, WITH A RED, YELLOW, AND DARK BLUE PARAKEET, RED TREES AND RED CLOUDS. LIGHT BLUE BORDERS EACH SQUARE.

THE ENGLISH TRANSLATION OF "LA PERRUCHE" IN THE MARK IS THE PARAKEET.

FOR SUGAR (U.S. CL. 46).

JENNIFER HETU, EXAMINING ATTORNEY

SN 77-825,169. LA DIVINA GELATERIA, LLC, NEW ORLEANS, LA. FILED 9-11-2009.

La Divina Caffaina

THE MARK CONSISTS OF STANDARD CHARACTERS WITHOUT CLAIM TO ANY PARTICULAR FONT, STYLE, SIZE, OR COLOR.

NO CLAIM IS MADE TO THE EXCLUSIVE RIGHT TO USE "CAFFEINA", APART FROM THE MARK AS SHOWN. THE ENGLISH TRANSLATION OF "LA DIVINA CAFFEINA" IN THE MARK IS "THE DIVINE CAFFEINE".

FOR CHOCOLATE; COFFEE; COFFEE AND TEA; COFFEE BASED BEVERAGES; ESPRESSO; HOT CHOCOLATE (U.S. CL. 46).

JENNIFER HETU, EXAMINING ATTORNEY

SN 77-826,324. COBIA CREATIONS, LLC, PROVO, UT. FILED 9-14-2009.

Tree Street Grains

THE MARK CONSISTS OF STANDARD CHARACTERS WITHOUT CLAIM TO ANY PARTICULAR FONT, STYLE, SIZE, OR COLOR.

NO CLAIM IS MADE TO THE EXCLUSIVE RIGHT TO USE "GRAINS", APART FROM THE MARK AS SHOWN.

FOR (BASED ON USE IN COMMERCE) PANCAKE MIXES (BASED ON INTENT TO USE) BREAD; BREAD MIXES; COOKIES AND CRACKERS (U.S. CL. 46).

FIRST USE 7-15-2009; IN COMMERCE 7-16-2009.

DAVID TAYLOR, EXAMINING ATTORNEY

CLASS 30—(Continued).

SN 77-827,008. CRYSTAL GEYSER WATER COMPANY, SAN FRANCISCO, CA. FILED 9-15-2009.

CALIFORNIA TO A TEA

THE MARK CONSISTS OF STANDARD CHARACTERS WITHOUT CLAIM TO ANY PARTICULAR FONT, STYLE, SIZE, OR COLOR.

NO CLAIM IS MADE TO THE EXCLUSIVE RIGHT TO USE "CALIFORNIA", APART FROM THE MARK AS SHOWN.

FOR BEVERAGES, NAMELY, ICED TEA AND TEA-BASED BEVERAGES FLAVORED WITH FRUIT, EXCLUDING HERBAL TEAS FOR MEDICINAL USE (U.S. CL. 46).

MARC LEIPZIG, EXAMINING ATTORNEY

SN 77-841,463. PR TEA CO., INC., DORADO, PUERTO RICO, FILED 10-5-2009.



NO CLAIM IS MADE TO THE EXCLUSIVE RIGHT TO USE "CO.", APART FROM THE MARK AS SHOWN.

THE COLOR(S) RED, BROWN, BLACK, YELLOW AND GREEN IS/ARE CLAIMED AS A FEATURE OF THE MARK.

THE COLOR RED APPEARS IN THE LETTERS "PR;" THE COLOR BROWN APPEARS IN THE WORDING "TEA;" THE COLOR BLACK APPEARS IN THE WORDING "CO.;" THE COLOR GREEN APPEARS IN THE LEAF; THE COLOR YELLOW APPEARS IN THE STEM. PRTEA IS THE SAME WORD AND CO. IS A SEPARATE WORD.

FOR BEVERAGES MADE OF TEA; BLACK TEA; CHAI TEA; COFFEE AND TEA; FLAVOURINGS OF TEA; FRUIT TEAS; GREEN TEA; HERB TEA; HERBAL TEA; ICED TEA; INSTANT TEA; JAPANESE GREEN TEA; LIME TEA; MIXES IN THE NATURE OF CONCENTRATES, SYRUPS OR POWDERS USED IN THE PREPARATION OF TEA BASED BEVERAGES; OOLONG TEA; SAGE TEA; TEA; TEA BAGS; TEA EXTRACTS; TEA FOR INFUSIONS; TEA OF PARCHED POWDER OF BARLEY WITH HUSK (MUGI-CHA); TEA OF SALTY KELP POWDER (KOMBU-CHA); TEA PODS; TEA-BASED BEVERAGES; TEA-BASED BEVERAGES WITH FRUIT FLAVORING (U.S. CL. 46).

LEIGH LOWRY, EXAMINING ATTORNEY

CLASS 30—(Continued).

SN 77-844,295. BOURBON COFFEE NORTH AMERICA, INC., ARLINGTON, VA. FILED 10-8-2009.



NO CLAIM IS MADE TO THE EXCLUSIVE RIGHT TO USE "VIRUNGA", APART FROM THE MARK AS SHOWN.

THE MARK CONSISTS OF A CREST WITH A DIAMOND BORDER AND A RIBBON INSIDE IT WITH THE WORD "VIRUNGA". ALSO INSIDE THE CRESTS ARE AN ADULT GORILLA AND BABY GORILLA. LEAVES AND BRUSH ARE BEHIND THE CREST.

FOR COFFEE; COFFEE BEANS (U.S. CL. 46).

FIRST USE 10-5-2009; IN COMMERCE 10-5-2009.

GIANCARLO CASTRO, EXAMINING ATTORNEY

SN 77-844,310. BOURBON COFFEE NORTH AMERICA, INC., ARLINGTON, VA. FILED 10-8-2009.



NO CLAIM IS MADE TO THE EXCLUSIVE RIGHT TO USE "KIVU LAKE", APART FROM THE MARK AS SHOWN.

THE MARK CONSISTS OF CREST CONTAINING A RIBBON WITH THE WORDS "KIVU LAKE" INSIDE IT. ALSO INSIDE THE CREST IS A ROW BOAT, A LAKE, AND A TREE WHOSE BRANCHES EXTEND OUTSIDE THE CREST.

FOR COFFEE; COFFEE BEANS (U.S. CL. 46).

FIRST USE 10-5-2009; IN COMMERCE 10-5-2009.

GIANCARLO CASTRO, EXAMINING ATTORNEY

CLASS 30—(Continued).

SN 77-844,327. BOURBON COFFEE NORTH AMERICA, INC., ARLINGTON, VA. FILED 10-8-2009.



NO CLAIM IS MADE TO THE EXCLUSIVE RIGHT TO USE "KIZI RIFT", APART FROM THE MARK AS SHOWN. THE MARK CONSISTS OF A CREST BORDERED WITH LINES AND PLUS MARKS SURROUNDING A RIBBON WITH THE WORDS "KIZI RIFT". IN THE CREST ARE FIVE FLOWERS.

FOR COFFEE; COFFEE BEANS (U.S. CL. 46).
FIRST USE 10-5-2009; IN COMMERCE 10-5-2009.
GIANCARLO CASTRO, EXAMINING ATTORNEY

CLASS 30—(Continued).

SN 77-854,318. BIMBO BAKERIES USA, INC., FORT WORTH, TX. FILED 10-21-2009.

HOME BAKE VALUE

THE MARK CONSISTS OF STANDARD CHARACTERS WITHOUT CLAIM TO ANY PARTICULAR FONT, STYLE, SIZE, OR COLOR.

NO CLAIM IS MADE TO THE EXCLUSIVE RIGHT TO USE "HOME BAKE", APART FROM THE MARK AS SHOWN.

FOR BREAD, ROLLS, SWEET BAKERY GOODS (U.S. CL. 46).

TRACY FLETCHER, EXAMINING ATTORNEY

SN 77-854,896. VERMONT NUT FREE CHOCOLATES COMPANY INCORPORATED, GRAND ISLE, VT. FILED 10-22-2009.

TANABAR

THE MARK CONSISTS OF STANDARD CHARACTERS WITHOUT CLAIM TO ANY PARTICULAR FONT, STYLE, SIZE, OR COLOR.

FOR GRANOLA BARS (U.S. CL. 46).

FIRST USE 3-1-2010; IN COMMERCE 3-1-2010.

SARA THOMAS, EXAMINING ATTORNEY

SN 77-852,609. CANEL'S, S.A. DE C.V., SAN LUIS POTOSI, MEXICO, FILED 10-20-2009.

PRIORITY CLAIMED UNDER SEC. 44(D) ON MEXICO APPLICATION NO. 1021413, FILED 7-22-2009, REG. NO. 1117798, DATED 7-22-2009, EXPIRES 7-22-2019.

OWNER OF U.S. REG. NOS. 1,458,568 AND 1,566,188.

THE MARK CONSISTS OF THE STYLIZED WORD "CANEL'S".

THE WORDING "CANEL'S" HAS NO MEANING IN A FOREIGN LANGUAGE.

SEC. 2(F).

FOR CONFECTIONERY, NAMELY, CANDIES, CARAMELS, CHOCOLATES AND CHEWING GUM (U.S. CL. 46).

APRIL ROACH, EXAMINING ATTORNEY

SN 77-856,981. NORMAN LOVE CONFECTIONS, INC., FORT MYERS, FL. FILED 10-26-2009.

S'MORE LOVE

THE MARK CONSISTS OF STANDARD CHARACTERS WITHOUT CLAIM TO ANY PARTICULAR FONT, STYLE, SIZE, OR COLOR.

NO CLAIM IS MADE TO THE EXCLUSIVE RIGHT TO USE "S'MORE", APART FROM THE MARK AS SHOWN.

FOR CANDIES AND CHOCOLATES; HAND-CRAFTED CANDY AND CHOCOLATES; BAKERY DESSERTS; DESSERT MOUSSE; DESSERT PUDDINGS; PASTRIES; CAKES; BROWNIES; COOKIES; CANDY AND CHOCOLATES, NAMELY, CREAMS AND NOUGATS; BOXED CANDIES AND CHOCOLATES; INDIVIDUAL DESSERT AND SPECIALTY CAKES; CHOCOLATES, NAMELY, CHOCOLATE NOVELTIES; AND CANDY AND CHOCOLATE BARS; SPECIALTY COFFEES; CROISSANTS; MUFFINS; DANISHES; CAPPUCCINOS; BISCOTTI; HOT CHOCOLATE; HOT TEA; AND ICED TEA; ICE CREAM; ICE CREAM DESSERTS; GELATO; FROZEN DESSERTS OF CREAM OR CHOCOLATE (U.S. CL. 46).

FIRST USE 9-1-2009; IN COMMERCE 9-1-2009.

MORGAN WYNNE, EXAMINING ATTORNEY

CLASS 30—(Continued).

SN 77-857,218. BIMBO BAKERIES USA, INC., FORT WORTH, TX. FILED 10-26-2009.



NO CLAIM IS MADE TO THE EXCLUSIVE RIGHT TO USE "HOME BAKE", APART FROM THE MARK AS SHOWN.

THE MARK CONSISTS OF STYLIZED DESIGN OF SMOKE ABOVE CHIMNEY AND ROOFTOP, WHICH IS ABOVE THE WORD "HOME". THE WORD "BAKE" IS BELOW "HOME" AND THE WORD "VALUE" IS BELOW "BAKE".

FOR BREAD, ROLLS AND SWEET BAKERY GOODS (U.S. CL. 46).

TRACY FLETCHER, EXAMINING ATTORNEY

CLASS 30—(Continued).

SN 77-857,295. JUNIOR JOHNSON ENTERPRISES, INC., HAMPTONVILLE, NC. FILED 10-26-2009.

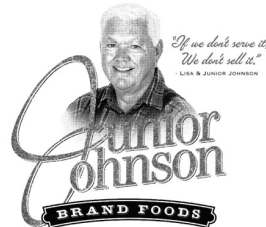

OWNER OF U.S. REG. NOS. 3,429,780, 3,477,638 AND OTHERS.

NO CLAIM IS MADE TO THE EXCLUSIVE RIGHT TO USE "BRAND FOODS", APART FROM THE MARK AS SHOWN.

THE STIPPLING IS FOR SHADING PURPOSES ONLY.

THE NAME(S), PORTRAIT(S), AND/OR SIGNATURE(S) SHOWN IN THE MARK IDENTIFIES ROBERT G. JOHNSON, JR., AKA JUNIOR JOHNSON, AND LISA JOHNSON, WHOSE CONSENT(S) TO REGISTER IS MADE OF RECORD.

THE MARK CONSISTS OF AN IMAGE OF THE BUST OF "JUNIOR JOHNSON" WEARING A PLAID SHIRT APPEARING ABOVE HIS STYLIZED SIGNATURE "JUNIOR JOHNSON" WHERE THE TERMS SHARE THE SAME LETTER "J", AND BELOW THE SIGNATURE IS A STYLIZED BANNER CONTAINING THE WORDS "BRAND FOODS". TO THE RIGHT OF THE GRAPHIC OF "JUNIOR JOHNSON" IS THE PHRASE "IF WE DON'T SERVE IT, WE DON'T SELL IT." BELOW THAT IS A HYPHEN FOLLOWED BY THE NAMES "LISA & JUNIOR JOHNSON".

FOR BISCUITS; MEAT PRODUCTS WRAPPED IN DOUGH, NAMELY, A HOT DOG BAKED IN BISCUIT DOUGH, COMMONLY REFERRED TO AS "PIGS IN A BLANKET" (U.S. CL. 46).

FIRST USE 10-2-2009; IN COMMERCE 10-2-2009.

ALYSSA STEEL, EXAMINING ATTORNEY

SN 77-858,309. GARDEN FRESH SALSA COMPANY INC., FERNDALE, MI. FILED 10-27-2009.

WILD MILD

THE MARK CONSISTS OF STANDARD CHARACTERS WITHOUT CLAIM TO ANY PARTICULAR FONT, STYLE, SIZE, OR COLOR.

FOR TOMATO SALSA (U.S. CL. 46).

FIRST USE 5-31-1997; IN COMMERCE 5-31-1997.

JOHN E. MICHOS, EXAMINING ATTORNEY

CLASS 30—(Continued).

SN 77-863,038. ELEMENT TEA, LLC, DBA ELEMENT TEA, DENVER, CO. FILED 11-2-2009.



NO CLAIM IS MADE TO THE EXCLUSIVE RIGHT TO USE "TEA", APART FROM THE MARK AS SHOWN.

THE MARK CONSISTS OF THREE, LOTUS-LIKE, FLOWER DESIGNS THAT ARE EMBEDDED WITHIN EACH OTHER. THEY ALTERNATE COLOR AND INCREASE IN SIZE. THERE IS A CIRCLE AROUND THE LARGEST FLOWER THAT TOUCHES THE TIPS OF EACH PETAL. THE FLOWER DESIGN APPEARS TO THE LEFT OF THE WORDING "ELEMENT TEA". BELOW THE WORDING "ELEMENT TEA" APPEARS THE WORDING "BE IN YOUR ELEMENT".

FOR TEA; TEA BAGS; TEA FOR INFUSIONS (U.S. CL. 46).

FIRST USE 8-6-2009; IN COMMERCE 10-28-2009.
MICHAEL SOUDERS, EXAMINING ATTORNEY

CLASS 30—(Continued).

THE SHADED AREA BEHIND THE UMBRELLA; THE COLOR BLUE APPEARS IN THE SHADED AREA BEHIND THE TORSO AND LEGS OF THE MAN; THE COLOR GREEN APPEARS IN THE SHADED BAR BELOW THE DEPICTION OF THE MAN AND ABOVE THE WORDING "POPCORN"; THE COLOR WHITE APPEARS IN THE UN-SHADED AREAS OF THE POPCORN, IN THE UN-SHADED AREAS OF THE MAN, IN THE UN-SHADED AREAS OF THE UMBRELLA, AND IN THE UN-SHADED AREAS OF RECTANGLE CONTAINING THE MARK.

FOR POPPED POPCORN (U.S. CL. 46).
FIRST USE 9-29-2003; IN COMMERCE 9-29-2003.
MICHAEL GAAFAR, EXAMINING ATTORNEY

SN 77-865,631. GARY SELTZER, HIGHLAND PARK, IL. FILED 11-5-2009.



NO CLAIM IS MADE TO THE EXCLUSIVE RIGHT TO USE "POPCORN", APART FROM THE MARK AS SHOWN.

THE NAME(S), PORTRAIT(S), AND/OR SIGNATURE(S) SHOWN IN THE MARK DOES NOT IDENTIFY A PARTICULAR LIVING INDIVIDUAL.

THE COLOR(S) BLACK, WHITE, YELLOW, BLUE, AND GREEN IS/ARE CLAIMED AS A FEATURE OF THE MARK.

THE MARK CONSISTS OF THE WORDING "GARY POPPINS" SET ABOVE A STYLIZED DEPICTION OF A MAN WEARING A HAT HOLDING AN OPEN UMBRELLA ABOVE HIS HEAD WITH POPPED POPCORN FALLING FROM UNDERNEATH THE OPEN UMBRELLA, ALL SET ABOVE THE WORDING "POPCORN", WITH A SHADED BAR PLACED BETWEEN THE DEPICTION OF THE MAN AND THE WORDING "POPCORN", WITH ALL OF THE FOREGOING SET INSIDE A RECTANGLE. THE COLOR BLACK APPEARS IN THE WORDING "GARY POPPINS" AND "POPCORN", IN THE OUTLINE AND DETAIL LINES OF THE MAN, IN THE OUTLINE AND DETAIL LINES OF THE POPPED POPCORN, IN THE OUTLINE AND DETAIL LINES OF THE UMBRELLA, AND IN THE OUTER BORDER OF THE MARK; THE COLOR YELLOW APPEARS IN

SN 77-865,712. GENERAL MILLS IP HOLDINGS I, LLC, MINNEAPOLIS, MN. FILED 11-5-2009.

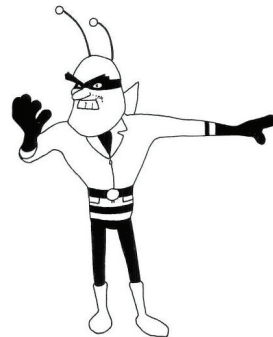

THE MARK CONSISTS OF THE DESIGN OF A CARTOON CHARACTER RESEMBLING A BEE WITH A HUMAN FACE WEARING A MASK OVER HIS EYES.

FOR PROCESSED CEREAL-BASED FOOD TO BE USED AS A BREAKFAST FOOD, SNACK FOOD OR INGREDIENT FOR MAKING OTHER FOODS (U.S. CL. 46).

DAWN HAN, EXAMINING ATTORNEY

CLASS 30—(Continued).

SN 77-865,720. GENERAL MILLS IP HOLDINGS I, LLC, MINNEAPOLIS, MN. FILED 11-5-2009.

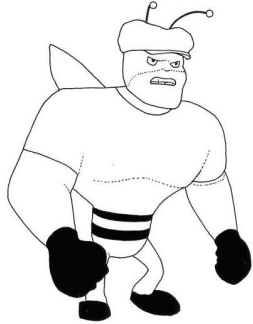

THE MARK CONSISTS OF THE DESIGN OF A CARTOON CHARACTER RESEMBLING A BEE WITH A HUMAN FACE WEARING A HAT.

FOR PROCESSED CEREAL-BASED FOOD TO BE USED AS A BREAKFAST FOOD, SNACK FOOD OR INGREDIENT FOR MAKING OTHER FOODS (U.S. CL. 46).

DAWN HAN, EXAMINING ATTORNEY

SN 77-871,336. J.S. POLAK KONINKLIJKE SPECERIJEN-MAALDERIJ B.V., 8331 TJ STEENWIJK, NETHERLANDS, FILED 11-12-2009.



NO CLAIM IS MADE TO THE EXCLUSIVE RIGHT TO USE "BAKERY SPICES", APART FROM THE MARK AS SHOWN.

THE NAME "SUMAT" DOES NOT IDENTIFY A LIVING INDIVIDUAL.

THE COLOR(S) PINK AND GRAY IS/ARE CLAIMED AS A FEATURE OF THE MARK.

THE MARK CONSISTS OF THE WORDING "SUMAT BAKERY SPICES" IN THE COLOR GRAY WITH A PINK VERTICAL, RECTANGULAR IMAGE FEATURING CURVED LINES AND A FLORAL DESIGN PROTRUDING FROM THE TOP IN BETWEEN THE WORDS "SUMAT" AND "BAKERY".

THE WORDING "SUMAT" HAS NO MEANING IN A FOREIGN LANGUAGE.

FOR BAKING SPICES; FLAVOR ENHANCERS USED IN FOOD AND BEVERAGE PRODUCTS; FLAVOURINGS AND SEASONINGS; GARDEN HERBS, PRESERVED; PROCESSED HERBS; SEASONING MIXES; SEASONING PASTES; SPICE BLENDS; SPICES (U.S. CL. 46).

RONALD DELGIZZI, EXAMINING ATTORNEY

CLASS 30—(Continued).

SN 77-875,133. AMERICAN SUGAR REFINING, INC., YONKERS, NY. FILED 11-18-2009.

DOMINO BRANDS

THE MARK CONSISTS OF STANDARD CHARACTERS WITHOUT CLAIM TO ANY PARTICULAR FONT, STYLE, SIZE, OR COLOR.

OWNER OF U.S. REG. NOS. 73,099, 1,280,877 AND 2,717,484.

NO CLAIM IS MADE TO THE EXCLUSIVE RIGHT TO USE "BRANDS", APART FROM THE MARK AS SHOWN.

FOR SUGAR, SUGAR CUBES, DIRECT COMPACTING SUGAR, DIRECT TABLETING SUGAR, CINNAMON SUGAR, CONFECTIONERS SUGAR, BROWN SUGAR, BROWN FREE-FLOWING SUGAR, FONDANT SUGAR, HARD SUGAR, SUGAR AND SUGAR SUBSTITUTE PRODUCT FOR USE AS A FOOD FLAVOR AND TEXTURE MODIFIER, MOLASSES, MOLASSES GRANULES, HONEY GRANULES, INVERT SUGAR, INVERT SUGAR SYRUPS, SUGAR SYRUPS, POWDERED SUGAR WITH CORNSTARCH, POWDERED SUGAR WITH MALTODEXTRIN, CO-CRYSTALLIZED SUGAR, SWEETENER COMPOSITION, NAMELY, A BLEND OF PRIMARILY SUGAR AND ONE OR MORE ARTIFICIAL SWEETENERS (U.S. CL. 46).

KHANH LE, EXAMINING ATTORNEY

SN 77-875,343. CHEVYS RESTAURANTS, LLC, CYPRESS, CA. FILED 11-18-2009.

CHEVYS FRESH MEX

THE MARK CONSISTS OF STANDARD CHARACTERS WITHOUT CLAIM TO ANY PARTICULAR FONT, STYLE, SIZE, OR COLOR.

OWNER OF U.S. REG. NOS. 2,066,652, 3,170,878 AND OTHERS.

NO CLAIM IS MADE TO THE EXCLUSIVE RIGHT TO USE "FRESH MEX", APART FROM THE MARK AS SHOWN.

FOR FROZEN, PREPARED OR PACKAGED MEALS CONSISTING PRIMARILY OF TORTILLAS AND BEANS; SALSAS; SAUCES; MARINADES (U.S. CL. 46).

PRISCILLA MILTON, EXAMINING ATTORNEY

CLASS 30—(Continued).

SN 77-883,774. DESSERTED, LTD., CLEVELAND, OH. FILED 12-1-2009.

CRUNCH COAT

THE MARK CONSISTS OF STANDARD CHARACTERS WITHOUT CLAIM TO ANY PARTICULAR FONT, STYLE, SIZE, OR COLOR.

NO CLAIM IS MADE TO THE EXCLUSIVE RIGHT TO USE "CRUNCH", APART FROM THE MARK AS SHOWN. FOR NUT TOPPING FOR ICE CREAM (U.S. CL. 46). FIRST USE 2-26-2007; IN COMMERCE 2-26-2007. STEVEN JACKSON, EXAMINING ATTORNEY

SN 77-885,153. LA PETITE PERLE, SCOTTSDALE, AZ. FILED 12-3-2009.

Les Petites Perles

THE MARK CONSISTS OF STANDARD CHARACTERS WITHOUT CLAIM TO ANY PARTICULAR FONT, STYLE, SIZE, OR COLOR.

THE ENGLISH TRANSLATION OF "LES PETITES PERLES" IN THE MARK IS THE LITTLE PEARLS. FOR MACAROONS; PASTRIES (U.S. CL. 46). PAUL CROWLEY, EXAMINING ATTORNEY

SN 77-885,363. THE SAUCE WORKS, POTTSTOWN, PA. FILED 12-3-2009.



NO CLAIM IS MADE TO THE EXCLUSIVE RIGHT TO USE "THE SAUCE WORKS U.S.A.", APART FROM THE MARK AS SHOWN.

THE MARK CONSISTS OF THE WORDING "THE SAUCE WORKS U.S.A." APPEARING BETWEEN TWO CONCENTRIC CIRCLES, WITH THE DESIGN OF A PAN AND A SPOON APPEARING IN THE CENTER OF THE CIRCLES. FOR BARBECUE SAUCE; SAUCES (U.S. CL. 46). MARK PILARO, EXAMINING ATTORNEY

CLASS 30—(Continued).

SN 77-885,621. P.A. FOOD SDN BHD, SEMENYIH, SELANGOR, MALAYSIA, FILED 12-3-2009.



THE COLOR(S) YELLOW AND RED IS/ARE CLAIMED AS A FEATURE OF THE MARK.

THE MARK CONSISTS OF THE WORD "PA" IN THE COLOR RED INSIDE A RED OVAL OVER A YELLOW BACKGROUND.

FOR PUFF PASTRY; SPRING ROLLS; SAMOSAS; CURRY PASTE; FOOD PASTES, NAMELY, CHILI PASTE FOR USE AS A SEASONING, BEAN PASTE, CURRY PASTE, GARLIC PASTE, AND SEASONING PASTES; HOT CHILLI BEAN PASTE; FARINACEOUS FOOD PASTES FOR HUMAN CONSUMPTION; BUNS; PANCAKES; PASTRY; CONFECTIONERY MADE OF SUGAR (U.S. CL. 46).

KATHERINE CHANG, EXAMINING ATTORNEY

SN 77-886,396. MAKE A SHAKE INC, TA MAKE A SHAKE INC, FORT LAUDERDALE, FL. FILED 12-4-2009.



THE COLOR(S) YELLOW, BLUE, BLACK AND WHITE IS/ARE CLAIMED AS A FEATURE OF THE MARK.

THE MARK CONSISTS OF A CIRCLE WITH A BLACK AND WHITE BORDER, CONTAINING A BLACK AND WHITE COW AGAINST A BLUE BACKGROUND, WITH THE WORDS "MAKE A SHAKE" IN YELLOW.

FOR MILK SHAKES; SHAKES (U.S. CL. 46).

ELISSA GARBER KON, EXAMINING ATTORNEY

CLASS 30—(Continued).

SN 77-886,742. UNCLE DAN'S, INC., SPOKANE, WA. FILED 12-4-2009.

UNCLE DAN'S

THE MARK CONSISTS OF STANDARD CHARACTERS WITHOUT CLAIM TO ANY PARTICULAR FONT, STYLE, SIZE, OR COLOR.

OWNER OF U.S. REG. NO. 848,265.
FOR DRY SEASONING MIXES FOR MAKING SALAD DRESSINGS (U.S. CL. 46).
FIRST USE 5-23-1966; IN COMMERCE 7-1-1966.
RUSS HERMAN, EXAMINING ATTORNEY

CLASS 30—(Continued).

SN 77-887,506. TRIPPLE RED CORP, DBA ANTIDOTE, LONG ISLAND CITY, NY. FILED 12-7-2009.

Antidote

THE MARK CONSISTS OF STANDARD CHARACTERS WITHOUT CLAIM TO ANY PARTICULAR FONT, STYLE, SIZE, OR COLOR.

FOR CONFECTIONERIES, NAMELY, SNACK FOODS, NAMELY, CHOCOLATE; FILLED CHOCOLATE; PREPARED COCOA AND COCOA-BASED BEVERAGES (U.S. CL. 46).
HENRY S. ZAK, EXAMINING ATTORNEY

SN 77-887,305. E.A. SWEEN COMPANY, EDEN PRAIRIE, MN. FILED 12-7-2009.

GRILLED GRABS

THE MARK CONSISTS OF STANDARD CHARACTERS WITHOUT CLAIM TO ANY PARTICULAR FONT, STYLE, SIZE, OR COLOR.

NO CLAIM IS MADE TO THE EXCLUSIVE RIGHT TO USE "GRILLED", APART FROM THE MARK AS SHOWN.
FOR SANDWICHES (U.S. CL. 46).
MATTHEW EINSTEIN, EXAMINING ATTORNEY

SN 77-887,558. KLAASTAD, PAULA, BRONXVILLE, NY. FILED 12-7-2009.

**The Poodle Dog Cafe
Original Phoney Pepperoni**

THE MARK CONSISTS OF STANDARD CHARACTERS WITHOUT CLAIM TO ANY PARTICULAR FONT, STYLE, SIZE, OR COLOR.

NO CLAIM IS MADE TO THE EXCLUSIVE RIGHT TO USE "ORIGINAL PHONEY PEPPERONI", APART FROM THE MARK AS SHOWN.
FOR NON-DAIRY FROZEN CONFECTIONS (U.S. CL. 46).
APRIL ROACH, EXAMINING ATTORNEY

SN 77-887,388. CINCOTTA, JENNIFER JOSLIN, WESTPORT, MA. FILED 12-7-2009.

**Eat Your Vegetables! Pasta
Sauce**

THE MARK CONSISTS OF STANDARD CHARACTERS WITHOUT CLAIM TO ANY PARTICULAR FONT, STYLE, SIZE, OR COLOR.

NO CLAIM IS MADE TO THE EXCLUSIVE RIGHT TO USE "PASTA SAUCE", APART FROM THE MARK AS SHOWN.
FOR PASTA SAUCE; PIZZA SAUCE (U.S. CL. 46).
APRIL ROACH, EXAMINING ATTORNEY

SN 77-887,586. KLAASTAD, PAULA, BRONXVILLE, NY. FILED 12-7-2009.

**The Poodle Dog Cafe
Original Phoney Baloney**

THE MARK CONSISTS OF STANDARD CHARACTERS WITHOUT CLAIM TO ANY PARTICULAR FONT, STYLE, SIZE, OR COLOR.

NO CLAIM IS MADE TO THE EXCLUSIVE RIGHT TO USE "ORIGINAL", APART FROM THE MARK AS SHOWN.
FOR NON-DAIRY FROZEN CONFECTIONS (U.S. CL. 46).
APRIL ROACH, EXAMINING ATTORNEY

CLASS 30—(Continued).

SN 77-887,810. KUSUMA COORAY, HONOLULU, HI. FILED 12-7-2009.

CHEF COORAY'S

THE MARK CONSISTS OF STANDARD CHARACTERS WITHOUT CLAIM TO ANY PARTICULAR FONT, STYLE, SIZE, OR COLOR.
THE NAME "CHEF COORAY'S" IDENTIFIES A LIVING INDIVIDUAL WHOSE CONSENT IS OF RECORD.
FOR CHUTNEY; CURRY POWDER; SPICES (U.S. CL. 46).
FIRST USE 9-1-1996; IN COMMERCE 9-1-1996.
HEATHER THOMPSON, EXAMINING ATTORNEY

CLASS 30—(Continued).

SN 77-888,834. SAGE BERLIN, AKA BERLIN INTERNATIONAL, CORAOPOLIS, PA. FILED 12-8-2009.

I PROMISED YOU A MIRACLE

THE MARK CONSISTS OF STANDARD CHARACTERS WITHOUT CLAIM TO ANY PARTICULAR FONT, STYLE, SIZE, OR COLOR.
FOR SALAD DRESSING (U.S. CL. 46).
CAROLINE WOOD, EXAMINING ATTORNEY

SN 77-888,908. HARRIS, TRACY, ELK GROVE, CA. FILED 12-8-2009.

SN 77-888,169. REGIN, PAUL, V., DBA ROYAL ENGLISH TOFFEE, ALAMEDA, CA. FILED 12-7-2009.

ROYAL ENGLISH

THE MARK CONSISTS OF STANDARD CHARACTERS WITHOUT CLAIM TO ANY PARTICULAR FONT, STYLE, SIZE, OR COLOR.
FOR CANDY, TOFFEE, AND SWEETS (U.S. CL. 46).
JENNY PARK, EXAMINING ATTORNEY

901 Memphis Barbecue

THE MARK CONSISTS OF STANDARD CHARACTERS WITHOUT CLAIM TO ANY PARTICULAR FONT, STYLE, SIZE, OR COLOR.
NO CLAIM IS MADE TO THE EXCLUSIVE RIGHT TO USE "MEMPHIS BARBECUE", APART FROM THE MARK AS SHOWN.
FOR BARBECUE DRY RUB; BARBECUE SAUCE; SEASONINGS (U.S. CL. 46).
FIRST USE 8-1-2003; IN COMMERCE 2-1-2004.
DAVID YONTEF, EXAMINING ATTORNEY

SN 77-888,794. SAGE BERLIN, AKA BERLIN INTERNATIONAL, CORAOPOLIS, PA. FILED 12-8-2009.

SN 77-889,133. COURTNEY WULFE, HOUSTON, TX. FILED 12-8-2009.

ONE WORLD MANY FLAVORS

THE MARK CONSISTS OF STANDARD CHARACTERS WITHOUT CLAIM TO ANY PARTICULAR FONT, STYLE, SIZE, OR COLOR.
FOR CORN-BASED SNACK FOODS (U.S. CL. 46).
CAROLINE WOOD, EXAMINING ATTORNEY

brittlicious

THE MARK CONSISTS OF STANDARD CHARACTERS WITHOUT CLAIM TO ANY PARTICULAR FONT, STYLE, SIZE, OR COLOR.
FOR CANDIES (U.S. CL. 46).
CYNTHIA SLOAN, EXAMINING ATTORNEY

CLASS 30—(Continued).

SN 77-889,381. COURTIN, JEAN-DENIS M, CHICAGO, IL. AND DREYFUS, JULIEN H., MIAMI, FL. FILED 12-9-2009.

MILKINA

THE MARK CONSISTS OF STANDARD CHARACTERS WITHOUT CLAIM TO ANY PARTICULAR FONT, STYLE, SIZE, OR COLOR.

FOR GRAIN-BASED BEVERAGES (U.S. CL. 46).
STEVEN R. FINE, EXAMINING ATTORNEY

SN 77-889,858. AYERS, STEVE, RIO LINDA, CA. AND WICKHAM, CONNIE, RIO LINDA, CA. FILED 12-9-2009.

HANZEL & PRETZEL

THE MARK CONSISTS OF STANDARD CHARACTERS WITHOUT CLAIM TO ANY PARTICULAR FONT, STYLE, SIZE, OR COLOR.

NO CLAIM IS MADE TO THE EXCLUSIVE RIGHT TO USE "PRETZEL", APART FROM THE MARK AS SHOWN.
FOR CHOCOLATES AND CHOCOLATE BASED READY TO EAT CANDIES AND SNACKS (U.S. CL. 46).
FIRST USE 1-1-2008; IN COMMERCE 2-7-2008.
LINDSEY RUBIN, EXAMINING ATTORNEY

SN 77-889,887. GODIVA CHOCOLATIER, INC., NEW YORK, NY. FILED 12-9-2009.

GOLDEN MOMENTS

THE MARK CONSISTS OF STANDARD CHARACTERS WITHOUT CLAIM TO ANY PARTICULAR FONT, STYLE, SIZE, OR COLOR.

FOR CHOCOLATE, CANDY, HOT CHOCOLATE, COCOA, BISCUITS, COOKIES, PASTRIES, CHOCOLATE TRUFFLES AND CARAMELS (U.S. CL. 46).
ELISSA GARBER KON, EXAMINING ATTORNEY

CLASS 30—(Continued).

SN 77-889,983. SOUTHERNGIRL CAKES, LLC, UPPER MARLBORO, MD. FILED 12-9-2009.



THE COLOR(S) DARK BROWN, LIGHT BROWN, AND PEACH IS/ARE CLAIMED AS A FEATURE OF THE MARK.

THE MARK CONSISTS OF A CAKE WITH LIGHT BROWN AND PEACH COLOR WITH PEACH SMOKE. THE CAKE TAKES THE PLACE OF THE "O" IN SOUTHERN. "SOUTHERN GIRL" HAS DARK BROWN TEXT.

FOR BAKERY DESSERTS; BAKERY GOODS; BAKERY PRODUCTS; BAKERY PRODUCTS, NAMELY, SWEET BAKERY GOODS; MIXES FOR BAKERY GOODS (U.S. CL. 46).

FIRST USE 10-2-2009; IN COMMERCE 10-2-2009.
ALEX KEAM, EXAMINING ATTORNEY

SN 77-890,517. ORAHEALTH CORPORATION, BELLEVUE, WA. FILED 12-10-2009.

CHOCOMELTS

THE MARK CONSISTS OF STANDARD CHARACTERS WITHOUT CLAIM TO ANY PARTICULAR FONT, STYLE, SIZE, OR COLOR.

FOR CANDY (U.S. CL. 46).
JOHN DWYER, EXAMINING ATTORNEY

SN 77-890,559. ORAHEALTH CORPORATION, BELLEVUE, WA. FILED 12-10-2009.

COCOAMELTS

THE MARK CONSISTS OF STANDARD CHARACTERS WITHOUT CLAIM TO ANY PARTICULAR FONT, STYLE, SIZE, OR COLOR.

FOR CANDY (U.S. CL. 46).
JOHN DWYER, EXAMINING ATTORNEY

CLASS 30—(Continued).

SN 77-890,632. KOZY SHACK, INC., HICKSVILLE, NY.
FILED 12-10-2009.



THE COLOR(S) RED AND WHITE IS/ARE CLAIMED AS
A FEATURE OF THE MARK.

THE MARK CONSISTS OF RED STYLIZED LETTERS
WITH WHITE SHADING IN THE UPPER LEFT PORTION
OF THE LETTERS. "SMARTGELS" IS ONE WORD WITH A
CAPITAL "G" IN THE MIDDLE. THE "L" IN "GELS"
CONSISTS OF A STYLIZED RED SPOON WITH WHITE
SHADING IN THE UPPER PORTION OF THE SPOON.

FOR FLAVORED AND SWEETENED GELATINS (U.S.
CL. 46).

FIRST USE 8-31-2009; IN COMMERCE 8-31-2009.
ANTHONY RINKER, EXAMINING ATTORNEY

SN 77-890,980. GALAXY GRANOLA, LLC, SAN RAFAEL,
CA. FILED 12-10-2009.

Fruit Not Fat

THE MARK CONSISTS OF STANDARD CHARACTERS
WITHOUT CLAIM TO ANY PARTICULAR FONT, STYLE,
SIZE, OR COLOR.

FOR GRANOLA CEREAL (U.S. CL. 46).

FIRST USE 10-12-2009; IN COMMERCE 10-12-2009.
NATALIE POLZER, EXAMINING ATTORNEY

SN 77-891,068. ALTAVIDA, INC., DBA KOMBUCHA BOTA-
NICA, SANTA CRUZ, CA. FILED 12-11-2009.

Kombucha Botanica

THE MARK CONSISTS OF STANDARD CHARACTERS
WITHOUT CLAIM TO ANY PARTICULAR FONT, STYLE,
SIZE, OR COLOR.

NO CLAIM IS MADE TO THE EXCLUSIVE RIGHT TO
USE "KOMBUCHA", APART FROM THE MARK AS
SHOWN.

FOR TEA-BASED BEVERAGES WITH FRUIT FLA-
VORING (U.S. CL. 46).

FIRST USE 2-15-2006; IN COMMERCE 2-15-2006.
LINDA E. BLOHM, EXAMINING ATTORNEY

CLASS 30—(Continued).

SN 77-891,714. BAGLEY ARGENTINA S.A., PROVINCIA DE
CORDOBA, ARGENTINA, FILED 12-11-2009.

NUTRILECHE

THE MARK CONSISTS OF STANDARD CHARACTERS
WITHOUT CLAIM TO ANY PARTICULAR FONT, STYLE,
SIZE, OR COLOR.

OWNER OF ARGENTINA REG. NO. 1.914.191, DATED 7-
22-2003, EXPIRES 2-18-2013.

FOR SWEET MILK COOKIES (U.S. CL. 46).
TRACY CROSS, EXAMINING ATTORNEY

SN 77-891,869. JOSE NETRO, LAWNSDALE, CA. AND LUIS
NETRO, LAWNSDALE, CA. FILED 12-11-2009.

La Exquisita

THE MARK CONSISTS OF STANDARD CHARACTERS
WITHOUT CLAIM TO ANY PARTICULAR FONT, STYLE,
SIZE, OR COLOR.

THE ENGLISH TRANSLATION OF "LA EXQUISITA" IS
THE EXQUISITE.

FOR CONDIMENT, NAMELY, PEPPER SAUCE; HOT
SAUCE (U.S. CL. 46).

FIRST USE 2-1-2009; IN COMMERCE 2-1-2009.
JESSICA FATHY, EXAMINING ATTORNEY

SN 77-892,281. PRETZELICIOUS, INC., TARRYTOWN, NY.
FILED 12-13-2009.

Pretzelicious

THE MARK CONSISTS OF STANDARD CHARACTERS
WITHOUT CLAIM TO ANY PARTICULAR FONT, STYLE,
SIZE, OR COLOR.

FOR PRETZELS, NAMELY, PRETZELS COVERED
WITH CHOCOLATE, FLAVORED CHOCOLATE, SPRIN-
KLES AND OTHER CONFECTIONS (U.S. CL. 46).

FIRST USE 4-22-2009; IN COMMERCE 4-22-2009.
JEFF DEFORD, EXAMINING ATTORNEY

CLASS 30—(Continued).

SN 77-892,539. JUST POP IN, INC., INDIANAPOLIS, IN. FILED 12-14-2009.

POP LIFE

THE MARK CONSISTS OF STANDARD CHARACTERS WITHOUT CLAIM TO ANY PARTICULAR FONT, STYLE, SIZE, OR COLOR.

OWNER OF U.S. REG. NOS. 3,188,728 AND 3,617,398. FOR POPCORN (U.S. CL. 46). FIRST USE 11-0-2008; IN COMMERCE 8-6-2009. MICHAEL KEATING, EXAMINING ATTORNEY

CLASS 30—(Continued).

SN 77-893,859. F'REAL FOODS, LLC, ORINDA, CA. FILED 12-15-2009.

LIFEBLENDS

THE MARK CONSISTS OF STANDARD CHARACTERS WITHOUT CLAIM TO ANY PARTICULAR FONT, STYLE, SIZE, OR COLOR.

FOR MILKSHAKES AND FROZEN BLENDED CONFECTIONS, COFFEE, TEA, COCOA AND ESPRESSO BEVERAGES, CHOCOLATE, CANDY AND FROZEN CONFECTIONS (U.S. CL. 46).

TRACY FLETCHER, EXAMINING ATTORNEY

SN 77-892,848. HEARST COMMUNICATIONS, INC., NEW YORK, NY. FILED 12-14-2009.



NO CLAIM IS MADE TO THE EXCLUSIVE RIGHT TO USE "CULINARY" & "1846", APART FROM THE MARK AS SHOWN.

THE MARK CONSISTS OF THE WORDS, LETTERS, AND NUMBERS "CULINARY", "T&C", AND "1846" ARRANGED VERTICALLY AND SURROUNDED BY A CIRCULAR SCALLOPED BORDER.

FOR BAKERY PRODUCTS; CANDY; DRY SPICE RUB FOR MEATS AND FISH; GARDEN HERBS, PRESERVED; KETCHUP; MIXES FOR BAKERY GOODS; MUSTARD; PACKAGED MEAL MIXES CONSISTING PRIMARILY OF PASTA OR RICE; SALAD DRESSINGS; SAUCES; SWEETS (U.S. CL. 46).

KARANENDRA S. CHHINA, EXAMINING ATTORNEY

SN 77-895,053. SKY-J ENTERPRISE LTD., CO., DBA PEACH-WAVE FROZEN YOGURT, EDMOND, OK. FILED 12-16-2009.

Peachwave Frozen Yogurt

THE MARK CONSISTS OF STANDARD CHARACTERS WITHOUT CLAIM TO ANY PARTICULAR FONT, STYLE, SIZE, OR COLOR.

NO CLAIM IS MADE TO THE EXCLUSIVE RIGHT TO USE "FROZEN YOGURT", APART FROM THE MARK AS SHOWN.

FOR FROZEN CONFECTIONERY; FROZEN CONFECTIONS; FROZEN CONFECTIONS, NAMELY, FREEZER POPS; FROZEN COOKIE DOUGH; FROZEN DESSERT CONSISTING OF FRUIT AND CREAM OR CREAM SUBSTITUTES; FROZEN SOY-BASED DESSERTS; FROZEN YOGHURT; FROZEN YOGURT; FROZEN YOGURT CONFECTIONS; FROZEN YOGURT MIXES; NON-DAIRY FROZEN CONFECTIONS; PRE-PROCESSED MIXES FOR MAKING NON-DAIRY FROZEN CONFECTIONS (U.S. CL. 46).

TARA PATE, EXAMINING ATTORNEY

SN 77-893,569. GAGA'S, INC., WARWICK, RI. FILED 12-15-2009.

GAGA

THE MARK CONSISTS OF STANDARD CHARACTERS WITHOUT CLAIM TO ANY PARTICULAR FONT, STYLE, SIZE, OR COLOR.

OWNER OF U.S. REG. NOS. 2,980,568 AND 3,281,716. FOR FROZEN CONFECTIONS; FROZEN YOGURT; FRUIT ICE BAR; ICE CREAM; SHERBET (U.S. CL. 46). FIRST USE 1-1-2008; IN COMMERCE 1-1-2008. CHARLOTTE CORWIN, EXAMINING ATTORNEY

CLASS 30—(Continued).

SN 77-901,285. AJINOMOTO CO., INC., CHUO-KU, TOKYO, JAPAN, FILED 12-28-2009.

AJIMATE

THE MARK CONSISTS OF STANDARD CHARACTERS WITHOUT CLAIM TO ANY PARTICULAR FONT, STYLE, SIZE, OR COLOR.

OWNER OF U.S. REG. NO. 850,671.

FOR COFFEE; COCOA; TEA; SUGAR; RICE; TAPIOCA; SAGO; ARTIFICIAL COFFEE; FLOUR AND PREPARATIONS MADE FROM CEREALS, NAMELY, BREAKFAST CEREALS, CEREAL BASED SNACK FOOD, READY TO EAT, CEREAL DERIVED FOOD BARS, READY-TO-EAT CEREALS; BREAD; PASTRY AND CONFECTIONERY, NAMELY, CANDY, CHOCOLATE, CONFECTIONERY CHIPS FOR BAKING; ICES; HONEY, TREACLE; YEAST; BAKING-POWDER; SALT; MUSTARD; VINEGAR; SAUCES; SOY SAUCE; SPICES; ICE; SEASONINGS; FLAVORINGS; FLAVOR ENHANCERS USED IN FOOD AND BEVERAGE PRODUCTS; PEPPER; SALAD DRESSINGS; MAYONNAISE; SUGAR; NATURAL SWEETENERS; HYDROLYZED PROTEIN FOR SEASONING PURPOSES; SEASONINGS CONTAINING HYDROLYZED PROTEIN; RICE; NOODLES; INSTANT NOODLES; PROCESSED CEREALS; PASTAS; PROCESSED FOODS, NAMELY, BEEF BOWL AND TERIYAKI CHICKEN BOWL; FROZEN MEALS CONSISTING PRIMARILY OF RICE, NOODLES, DUMPLINGS AND PASTA; MEAT TENDERIZERS; CEREAL BASED NUTRIENT-DENSE SNACK BARS; SEASONINGS IN THE NATURE OF SALT REDUCERS, SALT SUBSTITUTE MIXED SEASONING; SALT SUBSTITUTES FOR USE IN FOOD; CORN CHIPS; TORTILLA CHIPS; CHEESE PUFFS; PRETZELS; POPCORNS; CRACKERS; SNACK FOOD IN GENERAL, NAMELY, RICE BASED SNACK FOOD, CHEESE FLAVORED SNACK FOOD (U.S. CL. 46).

KEVON CHISOLM, EXAMINING ATTORNEY

SN 77-902,308. GOLDEN TEMPLE OF OREGON, LLC, EUGENE, OR, FILED 12-29-2009.

THROAT COMFORT

THE MARK CONSISTS OF STANDARD CHARACTERS WITHOUT CLAIM TO ANY PARTICULAR FONT, STYLE, SIZE, OR COLOR.

OWNER OF U.S. REG. NO. 2,230,981.

SEC. 2(F) AS TO "THROAT".

FOR HERBAL TEA; TEA (U.S. CL. 46).

FIRST USE 3-1-1995; IN COMMERCE 3-1-1995.

SUSAN RICHARDS, EXAMINING ATTORNEY

CLASS 30—(Continued).

SN 77-902,314. GOLDEN TEMPLE OF OREGON, LLC, EUGENE, OR, FILED 12-29-2009.

GET REGULAR

THE MARK CONSISTS OF STANDARD CHARACTERS WITHOUT CLAIM TO ANY PARTICULAR FONT, STYLE, SIZE, OR COLOR.

OWNER OF U.S. REG. NO. 2,230,980.

NO CLAIM IS MADE TO THE EXCLUSIVE RIGHT TO USE "REGULAR", APART FROM THE MARK AS SHOWN. FOR HERBAL TEA; TEA (U.S. CL. 46).

FIRST USE 6-0-1990; IN COMMERCE 6-0-1990.

SUSAN RICHARDS, EXAMINING ATTORNEY

SN 77-905,076. BRI-CO TRADING INC., CONCORD, ONTARIO, CANADA, FILED 1-5-2010.

COOL RUNNINGS

THE MARK CONSISTS OF STANDARD CHARACTERS WITHOUT CLAIM TO ANY PARTICULAR FONT, STYLE, SIZE, OR COLOR.

OWNER OF CANADA REG. NO. TMA605,969, DATED 3-23-2004, EXPIRES 3-23-2019.

FOR SPICES (U.S. CL. 46).

MORGAN WYNNE, EXAMINING ATTORNEY

SN 77-919,409. GRUPO BIMBO, S.A. B. DE C.V., MEXICO CITY, MEXICO, FILED 1-25-2010.

TAKIS NITRO

THE MARK CONSISTS OF STANDARD CHARACTERS WITHOUT CLAIM TO ANY PARTICULAR FONT, STYLE, SIZE, OR COLOR.

OWNER OF U.S. REG. NOS. 2,770,663 AND 3,529,708.

FOR FRIED CORN SNACKS AND FRIED WHEAT FLOUR SNACKS (U.S. CL. 46).

MARY ROSSMAN, EXAMINING ATTORNEY

CLASS 30—(Continued).

SN 77-921,561. CARGILL, INCORPORATED, WAYZATA, MN. FILED 1-27-2010.

BRINEMAKER SELECT

THE MARK CONSISTS OF STANDARD CHARACTERS WITHOUT CLAIM TO ANY PARTICULAR FONT, STYLE, SIZE, OR COLOR.

NO CLAIM IS MADE TO THE EXCLUSIVE RIGHT TO USE "SELECT", APART FROM THE MARK AS SHOWN.

FOR SALT (U.S. CL. 46).

KATHERINE STOIDES, EXAMINING ATTORNEY

SN 77-922,794. THE QUAKER OATS COMPANY, CHICAGO, IL. FILED 1-28-2010.

LIFE

THE MARK CONSISTS OF STANDARD CHARACTERS WITHOUT CLAIM TO ANY PARTICULAR FONT, STYLE, SIZE, OR COLOR.

OWNER OF U.S. REG. NOS. 372,072, 3,151,004 AND OTHERS.

FOR HOT CEREALS IN THE NATURE OF BREAKFAST CEREALS; CEREAL-BASED FOOD BARS, NAMELY, READY TO EAT, CEREAL DERIVED FOOD BARS; GRAIN-BASED FOOD BARS ALSO CONTAINING CHOCOLATE, NUTS AND/OR FRUITS; GRANOLA-BASED SNACK FOOD (U.S. CL. 46).

SUSAN RICHARDS, EXAMINING ATTORNEY

SN 77-923,794. GRUPO BIMBO, S.A. B. DE C.V., MEXICO CITY, MEXICO, FILED 1-29-2010.

MASK

THE MARK CONSISTS OF STANDARD CHARACTERS WITHOUT CLAIM TO ANY PARTICULAR FONT, STYLE, SIZE, OR COLOR.

FOR CHEWING GUM (U.S. CL. 46).

MARY ROSSMAN, EXAMINING ATTORNEY

CLASS 30—(Continued).

SN 77-937,519. TASTE OF HAPPINESS, LLC, SAN FRANCISCO, CA. FILED 2-17-2010.

Taste of Happiness

THE MARK CONSISTS OF STANDARD CHARACTERS WITHOUT CLAIM TO ANY PARTICULAR FONT, STYLE, SIZE, OR COLOR.

FOR GLUTEN-FREE CUPCAKES, CHOCOLATE TRUFFLES, CAKES, CONFECTIONERY MADE OF CHOCOLATE, CONFECTIONERY MADE OF SUGAR, CHOCOLATES, CANDY AND FROSTING; CUPCAKES, CHOCOLATE TRUFFLES CAKES, CONFECTIONERY MADE OF CHOCOLATE, CONFECTIONERY MADE OF SUGAR, CHOCOLATES, CANDY AND FROSTING (U.S. CL. 46).

JUDITH HELFMAN, EXAMINING ATTORNEY

SN 77-945,595. THE QUAKER OATS COMPANY, CHICAGO, IL. FILED 2-26-2010.

FACTS OF LIFE

THE MARK CONSISTS OF STANDARD CHARACTERS WITHOUT CLAIM TO ANY PARTICULAR FONT, STYLE, SIZE, OR COLOR.

OWNER OF U.S. REG. NOS. 372,072, 1,758,570 AND OTHERS.

FOR BREAKFAST CEREALS, GRAIN-BASED SNACK BARS, GRANOLA-BASED SNACKS, CEREAL-BASED SNACKS, COOKIES (U.S. CL. 46).

SUSAN RICHARDS, EXAMINING ATTORNEY

SN 78-144,034. HERSHEY CHOCOLATE & CONFECTIONERY CORPORATION, WHEAT RIDGE, CO. FILED 7-15-2002.



OWNER OF U.S. REG. NO. 2,579,644.

THE STIPPLING SHOWN IN THE DRAWING IS A FEATURE OF THE MARK AND IS NOT INTENDED TO INDICATE COLOR.

THE MARK CONSISTS OF THE WORDS "TO GO" IN STYLIZED DESIGN WITH AN EXCLAMATION POINT AFTER THE WORDS "TO GO" THAT INCORPORATES THE DESIGN OF A TRAFFIC SIGNAL LIGHT.

FOR CANDY (U.S. CL. 46).

FIRST USE 10-14-2002; IN COMMERCE 10-14-2002.

SUE LAWRENCE, EXAMINING ATTORNEY

CLASS 30—(Continued).

SN 78-330,334. MOLINO DE TRIGO DE JIQUILPAN SA DE CV, JIQUILPAN, MEXICO, FILED 11-19-2003.



NO CLAIM IS MADE TO THE EXCLUSIVE RIGHT TO USE "BLANCA", APART FROM THE MARK AS SHOWN. THE FOREIGN WORDING IN THE MARK TRANSLATES INTO ENGLISH AS WHITE SWAN. FOR FLOUR (U.S. CL. 46).
JOSETTE BEVERLY, EXAMINING ATTORNEY

SN 79-067,259. BISCOTTIFICIO BELLI S.R.L.; DI SAVERIO D'ONOFRIO & C., ITALY, FILED 3-13-2009.



PRIORITY DATE OF 1-16-2009 IS CLAIMED. OWNER OF INTERNATIONAL REGISTRATION 0998733 DATED 3-13-2009, EXPIRES 3-13-2019. THE NAME(S), PORTRAIT(S), AND/OR SIGNATURE(S) SHOWN IN THE MARK IDENTIFIES BARBARA BELLI AND GIOVANNI BELLI, WHOSE CONSENT(S) TO REGISTER IS MADE OF RECORD. THE MARK CONSISTS OF A LARGE STYLIZED LETTER "B". THE TOP HOLE IN THE LETTER "B" IS SHADED. BETWEEN THE TOP AND BOTTOM HOLES APPEARS A CROWN. IN THE BOTTOM HOLE APPEARS ANOTHER, SMALLER STYLIZED LETTER "B". BENEATH THE LARGE STYLIZED LETTER "B" APPEARS THE WORDING "BISCOTTIFICIO BELLI". THE ENGLISH TRANSLATION OF "BISCOTTIFICIO" IN THE MARK IS BISCUIT FACTORY. FOR BISCUITS, TARTS, CAKES MADE WITH CEREALS, TARTS AND CAKES FILLED AND COATED WITH CREAMS AND CHOCOLATE (U.S. CL. 46).
MICHAEL WIENER, EXAMINING ATTORNEY

CLASS 30—(Continued).

SN 79-070,526. INOSTRANNOE OBCHTCHESTVO; S OGRANITCHENNOI; OTVETSTVENNOSTIOU "MOROZPRODUKT", BELARUS, FILED 5-18-2009.



OWNER OF INTERNATIONAL REGISTRATION 0986641 DATED 8-29-2008, EXPIRES 8-29-2018. NO CLAIM IS MADE TO THE EXCLUSIVE RIGHT TO USE "THE NON-LATIN CHARACTERS THAT MEAN ICE CREAM, PLAIN", APART FROM THE MARK AS SHOWN. THE COLOR(S) BLUE AND WHITE IS/ARE CLAIMED AS A FEATURE OF THE MARK. THE MARK CONSISTS OF A REPETITIVE TWO-DIMENSIONAL DESIGN, AS IT APPEARS APPLIED TO THE SURFACE OF PACKAGING, OF A STYLIZED SUN WITH FACE AND THE WORDING TRANSLITERATED AS MOROZHENOYE PLOMBIR "20 KOPEYEK". THE NON-LATIN CHARACTERS IN THE MARK TRANSLITERATE TO MOROZHENOYE PLOMBIR "20 KOPEYEK" AND THIS MEANS ICE CREAM, PLAIN, 20 COPECKS IN ENGLISH. FOR ICE CREAM (U.S. CL. 46).
HANNO RITTNER, EXAMINING ATTORNEY

SN 79-072,343. BELCOMAR, NAAMLOZE VENNOOTSCHAP, BELGIUM, FILED 7-16-2009.

GAVARNY

THE MARK CONSISTS OF STANDARD CHARACTERS WITHOUT CLAIM TO ANY PARTICULAR FONT, STYLE, SIZE, OR COLOR. PRIORITY DATE OF 5-28-2009 IS CLAIMED. OWNER OF INTERNATIONAL REGISTRATION 1011701 DATED 7-16-2009, EXPIRES 7-16-2019. FOR PASTRY; CONFECTIONERIES, NAMELY, SNACK FOODS, NAMELY, CHOCOLATE; CONFECTIONERY, NAMELY, PASTILLES; CRYSTAL SUGAR PIECES; FONDANT FROZEN CONFECTIONARY, EDIBLE ICES; CHOCOLATE AND CHOCOLATES; PRALINES; BISCUITS (U.S. CL. 46).
ANGELA M. MICHELI, EXAMINING ATTORNEY

CLASS 31—NATURAL AGRICULTURAL PRODUCTS

SN 76-690,345. FLINT, PHILIP J., ATLANTA, GA. FILED 6-6-2008.

Flint River Ranch

THE MARK CONSISTS OF STANDARD CHARACTERS WITHOUT CLAIM TO ANY PARTICULAR FONT, STYLE, SIZE, OR COLOR.

FOR PET FOOD (U.S. CLS. 1 AND 46).
FIRST USE 10-12-1993; IN COMMERCE 10-12-1993.
CHRIS WELLS, EXAMINING ATTORNEY

SN 76-700,762. SUNTORY FLOWERS LIMITED, TOKYO, JAPAN, FILED 12-10-2009.

SUNGELONIA

THE MARK CONSISTS OF STANDARD CHARACTERS WITHOUT CLAIM TO ANY PARTICULAR FONT, STYLE, SIZE, OR COLOR.

FOR SEEDLINGS, LIVE PLANTS AND FLOWERS (U.S. CLS. 1 AND 46).
JAMES STEIN, EXAMINING ATTORNEY

SN 76-700,764. SUNTORY FLOWERS LIMITED, TOKYO, JAPAN, FILED 12-10-2009.

NEOWAVE

THE MARK CONSISTS OF STANDARD CHARACTERS WITHOUT CLAIM TO ANY PARTICULAR FONT, STYLE, SIZE, OR COLOR.

FOR SEEDLINGS, LIVE PLANTS AND FLOWERS (U.S. CLS. 1 AND 46).
JAMES STEIN, EXAMINING ATTORNEY

CLASS 31—(Continued).

SN 77-458,717. HENRY'S HOLDINGS, LLC, COMMERCE, CA. FILED 4-25-2008.

SUN HARVEST

THE MARK CONSISTS OF STANDARD CHARACTERS WITHOUT CLAIM TO ANY PARTICULAR FONT, STYLE, SIZE, OR COLOR.

OWNER OF U.S. REG. NOS. 3,125,951 AND 3,440,589.
FOR RAW NUTS (U.S. CLS. 1 AND 46).
SCOTT BIBB, EXAMINING ATTORNEY

SN 77-525,146. INLINE NURSERIES INC., CHILLIWACK, CANADA, FILED 7-17-2008.



PRIORITY CLAIMED UNDER SEC. 44(D) ON CANADA APPLICATION NO. 1401793, FILED 7-2-2008, REG. NO. 1401793, DATED 3-11-2010, EXPIRES 3-11-2025.

NO CLAIM IS MADE TO THE EXCLUSIVE RIGHT TO USE "GREEN", APART FROM THE MARK AS SHOWN.

THE MARK CONSISTS OF A GLOBE WITH A SILHOUETTE OF A PERSON HOLDING A TREE AND A SHOVEL. THERE ARE THREE TREES TO THE RIGHT OF THE PERSON. THE ENTIRE DESIGN IS WITHIN A CIRCLE BORDER. INSIDE THE BORDER IS THE WORDING "REDUCE YOUR CARBON FOOTPRINT". ABOVE THE DESIGN IN LARGE STYLIZED FONT IS THE WORDING "PLANET GREEN".

FOR OUTDOOR LIVE PLANTS, NAMELY, EXTERIOR LANDSCAPE PLANTS, TREES AND SHRUBS (U.S. CLS. 1 AND 46).

FIRST USE 3-28-2008; IN COMMERCE 5-28-2008.
KAPIL BHANOT, EXAMINING ATTORNEY

CLASS 31—(Continued).

SN 77-734,412. MID AMERICA PET FOOD LLC, MT. PLEASANT, TX. FILED 5-11-2009.

DVM Diet

THE MARK CONSISTS OF STANDARD CHARACTERS WITHOUT CLAIM TO ANY PARTICULAR FONT, STYLE, SIZE, OR COLOR.
NO CLAIM IS MADE TO THE EXCLUSIVE RIGHT TO USE "DIET", APART FROM THE MARK AS SHOWN.
FOR PET FOOD (U.S. CLS. 1 AND 46).
ADA HAN, EXAMINING ATTORNEY

CLASS 31—(Continued).

SN 77-772,918. GOOD, ALBERT L., DBA ALG ENTERPRISES, DELANO, CA. FILED 7-1-2009.

CASTLE ROCK SELECT

THE MARK CONSISTS OF STANDARD CHARACTERS WITHOUT CLAIM TO ANY PARTICULAR FONT, STYLE, SIZE, OR COLOR.
OWNER OF U.S. REG. NO. 3,538,212.
NO CLAIM IS MADE TO THE EXCLUSIVE RIGHT TO USE "SELECT", APART FROM THE MARK AS SHOWN.
FOR FRESH FRUITS, NAMELY, TABLE GRAPES (U.S. CLS. 1 AND 46).
BENJAMIN OKEKE, EXAMINING ATTORNEY

SN 77-736,311. NATURA PET PRODUCTS, INC., DAVIS, CA. FILED 5-13-2009.

NATURA

THE MARK CONSISTS OF STANDARD CHARACTERS WITHOUT CLAIM TO ANY PARTICULAR FONT, STYLE, SIZE, OR COLOR.
THE ENGLISH TRANSLATION OF "NATURA" IN THE MARK IS "NATURE."
FOR PET FOOD (U.S. CLS. 1 AND 46).
DAVID C. REIHNER, EXAMINING ATTORNEY

SN 77-783,161. ADVANCED BUSINESS STRATEGIES, LLC, BEAVERTON, OR. FILED 7-16-2009.

BIG MOUNTAIN

THE MARK CONSISTS OF STANDARD CHARACTERS WITHOUT CLAIM TO ANY PARTICULAR FONT, STYLE, SIZE, OR COLOR.
FOR WOOD SHAVINGS FOR PET BEDDING (U.S. CLS. 1 AND 46).
YAT SYE, LEE, EXAMINING ATTORNEY

SN 77-756,852. NATURAL PRODUCTS FOR PETS, INC., CANOGA PARK, CA. FILED 6-10-2009.

MEOWIN' GOURMET

THE MARK CONSISTS OF STANDARD CHARACTERS WITHOUT CLAIM TO ANY PARTICULAR FONT, STYLE, SIZE, OR COLOR.
FOR EDIBLE PET TREATS; DIETARY SUPPLEMENTS FOR PETS; PET FEEDING AND DRINKING DISHES AND BOWLS (U.S. CLS. 1 AND 46).
CHRIS WELLS, EXAMINING ATTORNEY

SN 77-794,747. TYSON PET PRODUCTS, INC., SPRINGDLAE, AR. FILED 7-31-2009.

PURE CHEWS

THE MARK CONSISTS OF STANDARD CHARACTERS WITHOUT CLAIM TO ANY PARTICULAR FONT, STYLE, SIZE, OR COLOR.
NO CLAIM IS MADE TO THE EXCLUSIVE RIGHT TO USE "CHEWS", APART FROM THE MARK AS SHOWN.
FOR PET TREATS AND PET SNACKS (U.S. CLS. 1 AND 46).
JACQUELINE A. LAVINE, EXAMINING ATTORNEY

CLASS 31—(Continued).

SN 77-809,836. AM SOD, INCORPORATED, ESCONDIDO, CA. FILED 8-21-2009.



THE COLOR(S) BLUE, GREEN, WHITE AND GRAY IS/ ARE CLAIMED AS A FEATURE OF THE MARK.
 THE MARK CONSISTS OF A STYLIZED WATER DROP IN BLUE WITH A BLUE GLOBE INSIDE A CIRCULAR SHIELD, A GREEN GRASS DESIGN BACKGROUND WITH THE WORDS "WATER RIGHT WATER LESS" IN WHITE ON A CIRCULAR BLUE BACKGROUND OUTLINED IN GRAY.
 FOR SOD (U.S. CLS. 1 AND 46).
 STEPHANIE ALI, EXAMINING ATTORNEY

SN 77-810,060. BARRAGAN, CLAUDIA, COTO DE CAZA, CA. AND BARRAGAN CALVILLO, JOAQUIN F., COTO DE CAZA, CA. AND BARRAGAN CALVILLO, CARLOS, COTO DE CAZA, CA. FILED 8-21-2009.

ALEJANDRINA

THE MARK CONSISTS OF STANDARD CHARACTERS WITHOUT CLAIM TO ANY PARTICULAR FONT, STYLE, SIZE, OR COLOR.
 THE NAME(S), PORTRAIT(S), AND/OR SIGNATURE(S) SHOWN IN THE MARK DOES NOT IDENTIFY A PARTICULAR LIVING INDIVIDUAL.
 FOR FRESH FRUIT AND VEGETABLES (U.S. CLS. 1 AND 46).
 FIRST USE 1-1-1976; IN COMMERCE 1-1-1997.
 LINDA ESTRADA, EXAMINING ATTORNEY

CLASS 31—(Continued).

SN 77-838,161. BARRAGAN, CLAUDIA, COTO DE CAZA, CA. AND BARRAGAN CALVILLO, JOAQUIN F., COTO DE CAZA, CA. AND BARRAGAN CALVILLO, CARLOS, COTO DE CAZA, CA. FILED 9-30-2009.



THE NAME(S), PORTRAIT(S), AND/OR SIGNATURE(S) SHOWN IN THE MARK DOES NOT IDENTIFY A PARTICULAR LIVING INDIVIDUAL.
 THE MARK CONSISTS OF A SHADED-RECTANGLE WITH ROUNDED EDGES AND THE WORD "ALEJANDRINA" IN THE MIDDLE, AND A CIRCLE IN THE TOP, MIDDLE OF THE RECTANGLE WITH A PICTURE OF AN AVOCADO CUT IN HALF IN THE CENTER OF THE CIRCLE.
 FOR FRESH FRUIT AND VEGETABLES (U.S. CLS. 1 AND 46).
 FIRST USE 10-1-2008; IN COMMERCE 3-19-2009.
 LINDA ESTRADA, EXAMINING ATTORNEY

SN 77-847,495. BARRAGAN, CLAUDIA, COTO DE CAZA, CA. AND BARRAGAN CALVILLO, JOAQUIN F., COTO DE CAZA, CA. AND BARRAGAN CALVILLO, CARLOS, COTO DE CAZA, CA. FILED 10-13-2009.



THE NAME(S), PORTRAIT(S), AND/OR SIGNATURE(S) SHOWN IN THE MARK DOES NOT IDENTIFY A PARTICULAR LIVING INDIVIDUAL.
 THE MARK CONSISTS OF A RIBBON BANNER WITH THE WORD "ALEJANDRINA" IN THE MIDDLE OF THE BANNER.
 FOR FRESH FRUIT AND VEGETABLES (U.S. CLS. 1 AND 46).
 FIRST USE 1-1-1976; IN COMMERCE 1-1-1997.
 LINDA ESTRADA, EXAMINING ATTORNEY

CLASS 31—(Continued).

SN 77-860,268. GREEN FUSE BOTANICALS, INC., SANTA MONICA, CA. FILED 10-29-2009.

SWEET GEORGIA

THE MARK CONSISTS OF STANDARD CHARACTERS WITHOUT CLAIM TO ANY PARTICULAR FONT, STYLE, SIZE, OR COLOR.

NO CLAIM IS MADE TO THE EXCLUSIVE RIGHT TO USE "SWEET", APART FROM THE MARK AS SHOWN.

FOR LIVE PLANTS, NAMELY, IPOMOEA BATATAS (U.S. CLS. 1 AND 46).

LINDA E. BLOHM, EXAMINING ATTORNEY

CLASS 31—(Continued).

SN 77-884,510. J.E. RICH CO., TUSTIN, CA. FILED 12-2-2009.



OWNER OF U.S. REG. NO. 3,096,473.
THE MARK CONSISTS OF THE STYLIZED WORD "BAKELS" WITH A HEART ABOVE THE WORD.
FOR PET FOOD (U.S. CLS. 1 AND 46).
FIRST USE 12-1-2004; IN COMMERCE 12-1-2004.
KATHERINE E. HALMEN, EXAMINING ATTORNEY

SN 77-862,138. INTEGRADORA DE FRUTAS FINAS SOCONUSCO S.A. DE C.V., TA FRUTAS FINAS SOCONUSCO, TAPACHULA, MEXICO, FILED 10-31-2009.



NO CLAIM IS MADE TO THE EXCLUSIVE RIGHT TO USE "FRUTAS FINAS SOCONUSCO", APART FROM THE MARK AS SHOWN.

THE COLOR(S) GREEN, ORANGE, RED, YELLOW AND WHITE IS/ARE CLAIMED AS A FEATURE OF THE MARK.

THE MARK CONSISTS OF THE WORDING "FRUTAS FINAS SOCONUSCO" AND DESIGN. THE BACKGROUND OF THE MARK IS WHITE, CENTERED AT THE TOP IS THE WORDING "FRUTAS FINAS", WRITTEN IN GREEN CAPITAL LETTERS, OUTLINED IN RED. THE FONT TYPE IS ARIAL AND THE TEXT IS CURVED. BELOW IS A STYLIZED HALF SUN WHOSE BODY IS YELLOW AND HAS RED RAYS AROUND IT, THE TIPS OF THE RAYS ARE YELLOW AGAIN, RESEMBLING A SUNSET. IN THE MIDDLE OF THE SUN'S BODY IS A RED MAYAN PYRAMID. THE SUN AND THE PYRAMID ARE SET ON A GREEN PLATFORM, THIS PLATFORM IS THE UPPER SIDE OF WHAT COULD BE A BOWL, IN THE MIDDLE OF THIS BOWL ARE SIX NORMAL SIZED YELLOW AND ORANGE MANGOS, FOUR ALIGNED IN A BACK ROW, TWO IN THE FRONT ROW AND ONE BABY MANGO. AT THE BOTTOM OF THE LAST TWO, ONE OF THESE TWO MANGOS IN THE FRONT IS PEELED. AT THE BASE OF THE DESIGN IS A GREEN RECTANGLE, WHICH SEEMS A PART OF THE BOWL. WRITTEN ON THE RECTANGLE IS THE TERM "SOCONUSCO" IN WHITE CAPITAL LETTERS. THE TERM "SOCONUSCO" IS UNDERLINED IN RED.

THE ENGLISH TRANSLATION OF "FRUTAS FINAS" IN THE MARK IS FINE FRUITS.

FOR FRESH MANGOS (U.S. CLS. 1 AND 46).
FIRST USE 2-15-1998; IN COMMERCE 2-15-1998.
MARLENE BELL, EXAMINING ATTORNEY

SN 77-885,191. FRESH IS BEST, INC., FORMERLY COMPANION NATURAL PET FOOD, LLC, MILWAUKEE, WI. FILED 12-3-2009.



NO CLAIM IS MADE TO THE EXCLUSIVE RIGHT TO USE "NATURAL PET FOOD", APART FROM THE MARK AS SHOWN.

THE MARK CONSISTS OF A DESIGN OF A CAT AND DOG FORMING A CIRCLE. THE WORDING "FRESH IS BEST" APPEARS INSIDE THE CIRCLE ABOVE THE WORDING "NATURAL PET FOOD"

FOR PET FOOD, DOG TREATS AND CAT TREATS (U.S. CLS. 1 AND 46).

MARC LEIPZIG, EXAMINING ATTORNEY

CLASS 31—(Continued).

SN 77-886,474. ABSORBENT PRODUCTS LTD., KAMLOOPS, B.C., CANADA, FILED 12-4-2009.

KOZY KITTY

THE MARK CONSISTS OF STANDARD CHARACTERS WITHOUT CLAIM TO ANY PARTICULAR FONT, STYLE, SIZE, OR COLOR.

NO CLAIM IS MADE TO THE EXCLUSIVE RIGHT TO USE "KITTY", APART FROM THE MARK AS SHOWN.

FOR PET LITTER (U.S. CLS. 1 AND 46).

FIRST USE 8-31-1995; IN COMMERCE 8-31-1995.

JEFFERY COWARD, EXAMINING ATTORNEY

CLASS 31—(Continued).

SN 77-886,552. FEDERAL HYBRIDS, INC., ELGIN, IA, FILED 12-4-2009.

FEDERAL HYBRIDS

THE MARK CONSISTS OF STANDARD CHARACTERS WITHOUT CLAIM TO ANY PARTICULAR FONT, STYLE, SIZE, OR COLOR.

OWNER OF U.S. REG. NOS. 2,981,905 AND 2,983,979.

NO CLAIM IS MADE TO THE EXCLUSIVE RIGHT TO USE "HYBRIDS", APART FROM THE MARK AS SHOWN.

FOR AGRICULTURAL SEEDS, NAMELY, SOYBEAN SEED (U.S. CLS. 1 AND 46).

FIRST USE 4-0-2006; IN COMMERCE 4-0-2006.

ROBIN MITTLER, EXAMINING ATTORNEY

SN 77-888,786. SUNX ENERGY, INC., ADELANTO, CA, FILED 12-8-2009.

SN 77-886,505. FEDERAL HYBRIDS, INC., ELGIN, IA, FILED 12-4-2009.

Camx

THE MARK CONSISTS OF STANDARD CHARACTERS WITHOUT CLAIM TO ANY PARTICULAR FONT, STYLE, SIZE, OR COLOR.

FOR SEEDS, NAMELY, INEDIBLE SEED CROP FOR USE AS AN OIL SEED FOR BIOFUEL PRODUCTION AND DISTRIBUTION (U.S. CLS. 1 AND 46).

KRISTINA MORRIS, EXAMINING ATTORNEY



SN 77-889,918. J. FRANK SCHMIDT & SON CO., BORING, OR, FILED 12-9-2009.

OWNER OF U.S. REG. NOS. 2,981,905 AND 2,983,979.
NO CLAIM IS MADE TO THE EXCLUSIVE RIGHT TO USE "HYBRIDS QUALITY HYBRIDS SINCE 1932", APART FROM THE MARK AS SHOWN.

THE MARK CONSISTS OF WORDS "FEDERAL HYBRIDS" TO RIGHT OF THREE VERTICAL BARS OF ALTERNATING SOLID AND OUTLINED WITH THE TOPS OF THE BARS SLANTED TO THE LEFT; UNDERLINING THE BARS AND THE WORDS IS A SOLID BACKGROUND WITH THREE OUTLINED FIVE-POINTED STARS TO THE LEFT OF THE OUTLINED WORDS "QUALITY HYBRIDS SINCE 1932".

FOR AGRICULTURAL SEEDS, NAMELY, SOYBEAN SEED (U.S. CLS. 1 AND 46).

FIRST USE 4-0-2006; IN COMMERCE 4-0-2006.

ROBIN MITTLER, EXAMINING ATTORNEY

SUMMERBURST

THE MARK CONSISTS OF STANDARD CHARACTERS WITHOUT CLAIM TO ANY PARTICULAR FONT, STYLE, SIZE, OR COLOR.

FOR LIVING TREES (U.S. CLS. 1 AND 46).

SUE LAWRENCE, EXAMINING ATTORNEY

CLASS 31—(Continued).

SN 77-889,921. J. FRANK SCHMIDT & SON CO., BORING,
OR. FILED 12-9-2009.

FLASHFIRE

THE MARK CONSISTS OF STANDARD CHARACTERS
WITHOUT CLAIM TO ANY PARTICULAR FONT, STYLE,
SIZE, OR COLOR.

FOR LIVING TREES (U.S. CLS. 1 AND 46).
SUE LAWRENCE, EXAMINING ATTORNEY

SN 77-889,926. J. FRANK SCHMIDT & SON CO., BORING,
OR. FILED 12-9-2009.

WESTERN SON

THE MARK CONSISTS OF STANDARD CHARACTERS
WITHOUT CLAIM TO ANY PARTICULAR FONT, STYLE,
SIZE, OR COLOR.

FOR LIVING PLANTS (U.S. CLS. 1 AND 46).
SUE LAWRENCE, EXAMINING ATTORNEY

SN 77-889,929. J. FRANK SCHMIDT & SON CO., BORING,
OR. FILED 12-9-2009.

NORTHERN GLOW

THE MARK CONSISTS OF STANDARD CHARACTERS
WITHOUT CLAIM TO ANY PARTICULAR FONT, STYLE,
SIZE, OR COLOR.

OWNER OF U.S. REG. NO. 1,862,680.
FOR LIVING PLANTS (U.S. CLS. 1 AND 46).
SUE LAWRENCE, EXAMINING ATTORNEY

SN 77-891,222. SPEARFISH PELLET COMPANY, LLC,
SPEARFISH, SD. FILED 12-11-2009.

STALL PRO

THE MARK CONSISTS OF STANDARD CHARACTERS
WITHOUT CLAIM TO ANY PARTICULAR FONT, STYLE,
SIZE, OR COLOR.

FOR WOOD SHAVINGS FOR ANIMAL BEDDING
(U.S. CLS. 1 AND 46).
NAAKWAMA ANKRAH, EXAMINING ATTORNEY

CLASS 31—(Continued).

SN 77-891,593. PLANT DEVELOPMENT SERVICES, INC.,
LOXLEY, AL. FILED 12-11-2009.

SOUTHGATE

THE MARK CONSISTS OF STANDARD CHARACTERS
WITHOUT CLAIM TO ANY PARTICULAR FONT, STYLE,
SIZE, OR COLOR.

FOR LIVING PLANTS (U.S. CLS. 1 AND 46).
FLORENTINA BLANDU, EXAMINING ATTORNEY

SN 77-892,825. ZELENKA NURSERY, L.L.C., GRAND HA-
VEN, MI. FILED 12-14-2009.

NATURAL LIFE

THE MARK CONSISTS OF STANDARD CHARACTERS
WITHOUT CLAIM TO ANY PARTICULAR FONT, STYLE,
SIZE, OR COLOR.

FOR LIVE PLANTS (U.S. CLS. 1 AND 46).
FIRST USE 6-7-1996; IN COMMERCE 6-7-1996.
KARANENDRA S. CHHINA, EXAMINING ATTORNEY

SN 77-892,847. ZELENKA NURSERY, L.L.C., GRAND HA-
VEN, MI. FILED 12-14-2009.



THE MARK CONSISTS OF A CIRCLE COMPOSED OF
TWO ARROWS ENCIRCLING A STYLIZED FLOWER, A
LEAF, AND AN EVERGREEN SPRIG, ABOVE THE STY-
LIZED WORDING "NATURAL LIFE".

FOR LIVE PLANTS (U.S. CLS. 1 AND 46).
FIRST USE 6-7-1996; IN COMMERCE 6-7-1996.
KARANENDRA S. CHHINA, EXAMINING ATTORNEY

CLASS 31—(Continued).

SN 77-893,692. HI-TEK RATIONS, INC., DUBLIN, GA. FILED 12-15-2009.

KIBBLETIME

THE MARK CONSISTS OF STANDARD CHARACTERS WITHOUT CLAIM TO ANY PARTICULAR FONT, STYLE, SIZE, OR COLOR.
FOR DOG FOOD (U.S. CLS. 1 AND 46).
THEODORE MCBRIDE, EXAMINING ATTORNEY

SN 77-897,840. GRAIN PROCESSING CORPORATION, MUSCATINE, IA. FILED 12-21-2009.

**BUY THE BEST. OR SMELL
THE REST.**

THE MARK CONSISTS OF STANDARD CHARACTERS WITHOUT CLAIM TO ANY PARTICULAR FONT, STYLE, SIZE, OR COLOR.
FOR CAT LITTER, ANIMAL LITTER (U.S. CLS. 1 AND 46).
NAAKWAMA ANKRAH, EXAMINING ATTORNEY

SN 77-898,618. SPRINT HORTICULTURE PTY LTD., ERINA, NEW SOUTH WALES, AUSTRALIA, FILED 12-21-2009.

FLOR DE
Alegría
MANDEVILLA

NO CLAIM IS MADE TO THE EXCLUSIVE RIGHT TO USE "FLOR" AND "MANDEVILLA", APART FROM THE MARK AS SHOWN.

THE MARK CONSISTS OF THE WORDS "FLOR DE ALEGRIA MANDEVILLA" WITH THE WORDS "FLOR DE" APPEARING ABOVE THE WORD "ALEGRIA", AND THE WORD "MANDEVILLA" LOCATED BELOW AND TO THE LEFT OF THE WORD "ALEGRIA".

THE ENGLISH TRANSLATION OF "FLOR DE ALEGRIA" IN THE MARK IS FLOWER OF HAPPINESS.

FOR LIVING PLANTS, NAMELY, MANDEVILLAS (U.S. CLS. 1 AND 46).

TRACY FLETCHER, EXAMINING ATTORNEY

CLASS 31—(Continued).

SN 77-898,633. J. FRANK SCHMIDT & SON CO., BORING, OR. FILED 12-21-2009.

EMERALD AVENUE

THE MARK CONSISTS OF STANDARD CHARACTERS WITHOUT CLAIM TO ANY PARTICULAR FONT, STYLE, SIZE, OR COLOR.
OWNER OF U.S. REG. NOS. 2,531,374, 3,280,614 AND 3,694,085.
FOR LIVING PLANTS (U.S. CLS. 1 AND 46).
SUE LAWRENCE, EXAMINING ATTORNEY

SN 77-901,931. M.I. INDUSTRIES, INC., LINCOLN, NE. FILED 12-29-2009.

HOMESTYLE BY PRAIRIE

THE MARK CONSISTS OF STANDARD CHARACTERS WITHOUT CLAIM TO ANY PARTICULAR FONT, STYLE, SIZE, OR COLOR.
OWNER OF U.S. REG. NO. 3,505,939.
FOR ANIMAL FOODSTUFFS; PET FOOD; PET TREATS (U.S. CLS. 1 AND 46).
JENNIFER MARTIN, EXAMINING ATTORNEY

SN 77-907,599. SYNGENTA PARTICIPATIONS AG, BASEL, SWITZERLAND, FILED 1-8-2010.

Solinda

THE MARK CONSISTS OF STANDARD CHARACTERS WITHOUT CLAIM TO ANY PARTICULAR FONT, STYLE, SIZE, OR COLOR.

FOR FRESH FRUITS, NAMELY, MELONS (U.S. CLS. 1 AND 46).

JENNIFER MARTIN, EXAMINING ATTORNEY

CLASS 31—(Continued).

SN 77-910,714. BAYER AKTIENGESELLSCHAFT, 51373 LEVERKUSEN, FED REP GERMANY, FILED 1-13-2010.

TWINLINK

THE MARK CONSISTS OF STANDARD CHARACTERS WITHOUT CLAIM TO ANY PARTICULAR FONT, STYLE, SIZE, OR COLOR.
FOR AGRICULTURAL GRAINS FOR PLANTING (U.S. CLS. 1 AND 46).
ELLEN BURNS, EXAMINING ATTORNEY

SN 77-914,370. M.I. INDUSTRIES, INC., LINCOLN, NE. FILED 1-19-2010.

**EMPOWERING PEOPLE TO
TRANSFORM THE LIVES OF PETS**

THE MARK CONSISTS OF STANDARD CHARACTERS WITHOUT CLAIM TO ANY PARTICULAR FONT, STYLE, SIZE, OR COLOR.
FOR ANIMAL FOODSTUFFS; PET FOOD; PET TREATS (U.S. CLS. 1 AND 46).
JENNIFER MARTIN, EXAMINING ATTORNEY

SN 78-897,471. MASTRONARDI PRODUCE LTD., SANTA BARBARA, CA. FILED 5-31-2006.

TASTE THE WORLD'S FLAVORS

THE MARK CONSISTS OF STANDARD CHARACTERS WITHOUT CLAIM TO ANY PARTICULAR FONT, STYLE, SIZE, OR COLOR.
PRIORITY CLAIMED UNDER SEC. 44(D) ON CANADA APPLICATION NO. 1300156, FILED 5-3-2006, REG. NO. TMA682171, DATED 2-23-2007, EXPIRES 2-23-2022.
FOR HYDROPONIC FRESH TOMATOES (U.S. CLS. 1 AND 46).
FIRST USE 5-1-2006; IN COMMERCE 5-1-2006.
PATRICIA EVANKO, EXAMINING ATTORNEY

CLASS 31—(Continued).

SN 79-062,471. SELECTA KLEMM GMBH & CO. KG, FED REP GERMANY, FILED 11-14-2008.

Trixi

THE MARK CONSISTS OF STANDARD CHARACTERS WITHOUT CLAIM TO ANY PARTICULAR FONT, STYLE, SIZE, OR COLOR.

PRIORITY DATE OF 10-27-2008 IS CLAIMED.
OWNER OF INTERNATIONAL REGISTRATION 0985880 DATED 11-14-2008, EXPIRES 11-14-2018.
FOR LIVING PLANTS AND NATURAL FLOWERS, NAMELY, PORTOGRANDE, LOBELIA, VERBENA, NEMESIA, DIASCIA, DAHLIA, OSTEOSPERMUM, POTTED CARNATIONS, PETUNIA, PELARGONIUM, NEW GUINEA IMPATIENS AND ARGYRANTHEMUM; PROPAGATION MATERIAL OF CALIBRACHOA, PORTOGRANDE, LOBELIA, VERBENA, NEMESIA, DIASCIA, DAHLIA, OSTEOSPERMUM, POTTED CARNATIONS, PETUNIA, PELARGONIUM, NEW GUINEA IMPATIENS AND ARGYRANTHEMUM, NAMELY, SEEDS, BULBS, SHOOTS, SEEDLINGS, PLANT CELLS, PLANT TISSUES, GRAFTS AND BUDS (U.S. CLS. 1 AND 46).
LEIGH LOWRY, EXAMINING ATTORNEY

SN 79-069,208. LIDL STIFTUNG & CO. KG, FED REP GERMANY, FILED 5-7-2009.

pepito

THE MARK CONSISTS OF STANDARD CHARACTERS WITHOUT CLAIM TO ANY PARTICULAR FONT, STYLE, SIZE, OR COLOR.

PRIORITY DATE OF 11-13-2008 IS CLAIMED.
OWNER OF INTERNATIONAL REGISTRATION 1003743 DATED 5-7-2009, EXPIRES 5-7-2019.
OWNER OF U.S. REG. NO. 2,920,651.
THE WORDING "PEPITO" HAS NO MEANING IN A FOREIGN LANGUAGE.
FOR SAND LITTER FOR PETS, NAMELY, ANIMAL LITTER CONTAINING SAND; BIRD GRITS, NAMELY, BIRD SEED; ANIMAL LITTER, CAT LITTER AND LITTER FOR SMALL ANIMALS; HAY, CHOPPED STRAW FOR ANIMAL BEDDING; FOODSTUFFS FOR ANIMALS, ANIMAL FEED, ADDITIVES FOR ANIMAL FOODSTUFFS, NOT FOR MEDICAL PURPOSES, CHEWING PRODUCTS FOR ANIMALS, NAMELY, DIGESTIBLE CHEWING BONES FOR DOGS, AND EDIBLE CHEWS FOR ANIMALS; ANIMAL BEVERAGES (U.S. CLS. 1 AND 46).
MYRIAH HABEEB, EXAMINING ATTORNEY

CLASS 31—(Continued).

SN 79-072,576. JUNGPFANZEN GRÜNEWALD GMBH, FED REP GERMANY, FILED 5-18-2009.

STARLIAS

THE MARK CONSISTS OF STANDARD CHARACTERS WITHOUT CLAIM TO ANY PARTICULAR FONT, STYLE, SIZE, OR COLOR.

PRIORITY DATE OF 11-19-2008 IS CLAIMED.

OWNER OF INTERNATIONAL REGISTRATION 1012365 DATED 5-18-2009, EXPIRES 5-18-2019.

FOR AGRICULTURAL, HORTICULTURAL AND FORESTRY PRODUCTS, NAMELY, SEEDS AND BULBS FOR AGRICULTURAL PURPOSES, AGRICULTURAL SEEDS, SPORES AND SPAWN FOR AGRICULTURAL PURPOSES, AGRICULTURAL GRAINS FOR PLANTING, SEEDS AND BULBS FOR HORTICULTURAL PURPOSES, LIVING TREES, NON-DEBARKED TIMBER, UNSAWN TIMBER, RAW TIMBER, UNPROCESSED TIMBER; GRAINS, NAMELY, UNPROCESSED GRAINS, AGRICULTURAL AND HORTICULTURAL GRAINS FOR PLANTING; FRESH FRUITS AND VEGETABLES; AGRICULTURAL AND HORTICULTURAL SEEDS, NAMELY, CROP SEEDS, GRASS SEEDS, PLANT SEEDS; NATURAL PLANTS AND FLOWERS, NAMELY, LIVE ORNAMENTAL PLANTS, LIVE YOUNG ORNAMENTAL PLANTS, LIVE ROOTED AND UNROOTED CUTTINGS OF ORNAMENTAL PLANTS AND HERBS FOR PROPAGATION, FRESH HERBS, LIVE FLOWERING PLANTS, LIVING PLANTS, LIVING FRUIT PLANTS, LIVE FLOWERS; FOODSTUFFS FOR ANIMALS, MALT FOR BREWING AND DISTILLING, INCLUDED IN THIS CLASS (U.S. CLS. 1 AND 46).

DAVID ELTON, EXAMINING ATTORNEY

SN 79-077,442. SUNTORY FLOWERS LIMITED, JAPAN, FILED 12-10-2009.

GRANVIA

THE MARK CONSISTS OF STANDARD CHARACTERS WITHOUT CLAIM TO ANY PARTICULAR FONT, STYLE, SIZE, OR COLOR.

PRIORITY DATE OF 11-27-2009 IS CLAIMED.

OWNER OF INTERNATIONAL REGISTRATION 1025246 DATED 12-10-2009, EXPIRES 12-10-2019.

FOR SEEDLINGS, LIVE PLANTS AND FLOWERS (U.S. CLS. 1 AND 46).

MICHAEL WIENER, EXAMINING ATTORNEY

SN 79-077,443. SUNTORY FLOWERS LIMITED, JAPAN, FILED 12-10-2009.

KIRARA

THE MARK CONSISTS OF STANDARD CHARACTERS WITHOUT CLAIM TO ANY PARTICULAR FONT, STYLE, SIZE, OR COLOR.

PRIORITY DATE OF 11-27-2009 IS CLAIMED.

OWNER OF INTERNATIONAL REGISTRATION 1025247 DATED 12-10-2009, EXPIRES 12-10-2019.

FOR SEEDLINGS, LIVE PLANTS AND FLOWERS (U.S. CLS. 1 AND 46).

MICHAEL WIENER, EXAMINING ATTORNEY

CLASS 31—(Continued).

SN 79-077,444. SUNTORY FLOWERS LIMITED, JAPAN, FILED 12-10-2009.

TOPCORN

THE MARK CONSISTS OF STANDARD CHARACTERS WITHOUT CLAIM TO ANY PARTICULAR FONT, STYLE, SIZE, OR COLOR.

PRIORITY DATE OF 11-27-2009 IS CLAIMED.

OWNER OF INTERNATIONAL REGISTRATION 1025248 DATED 12-10-2009, EXPIRES 12-10-2019.

FOR SEEDLINGS, LIVE PLANTS AND FLOWERS (U.S. CLS. 1 AND 46).

MICHAEL WIENER, EXAMINING ATTORNEY

SN 79-077,445. SUNTORY FLOWERS LIMITED, JAPAN, FILED 12-10-2009.

PARASOL LADY

THE MARK CONSISTS OF STANDARD CHARACTERS WITHOUT CLAIM TO ANY PARTICULAR FONT, STYLE, SIZE, OR COLOR.

PRIORITY DATE OF 11-27-2009 IS CLAIMED.

OWNER OF INTERNATIONAL REGISTRATION 1025249 DATED 12-10-2009, EXPIRES 12-10-2019.

FOR SEEDLINGS, LIVE PLANTS AND FLOWERS (U.S. CLS. 1 AND 46).

JAMES STEIN, EXAMINING ATTORNEY

SN 79-078,133. TECHNICAL INTERNATIONAL AG, SWITZERLAND, FILED 12-8-2009.

PRIVIUM

THE MARK CONSISTS OF STANDARD CHARACTERS WITHOUT CLAIM TO ANY PARTICULAR FONT, STYLE, SIZE, OR COLOR.

PRIORITY DATE OF 9-1-2009 IS CLAIMED.

OWNER OF INTERNATIONAL REGISTRATION 1026916 DATED 12-8-2009, EXPIRES 12-8-2019.

FOR DOG AND CAT FOOD (U.S. CLS. 1 AND 46).

JANET LEE, EXAMINING ATTORNEY

CLASS 32—LIGHT BEVERAGES

SN 76-695,880. THEP PADUNG PORN COCONUT COMPANY LIMITED, BANGKOK, THAILAND, FILED 2-20-2009.



OWNER OF U.S. REG. NO. 1,300,807.

NO CLAIM IS MADE TO THE EXCLUSIVE RIGHT TO USE "THE DESIGN OF COCONUTS", APART FROM THE MARK AS SHOWN.

THE MARK CONSISTS OF A DESIGN OF A MAN WEARING A HEADBAND AND HOLDING A COCONUT IN ONE HAND AND AN OAR IN THE OTHER HAND, THE WORD "CHAOKOH", A PICTORIAL REPRESENTATION OF COCONUT HALVES, AND THAI CHARACTERS.

THE ENGLISH TRANSLATION OF THE WORD "CHAOKOH" IN THE MARK IS ISLANDER.

THE NON-LATIN CHARACTERS IN THE MARK TRANSLITERATE TO "CHAOKOH" AND THIS MEANS "ISLANDER" IN ENGLISH.

FOR COCONUT MILK (U.S. CLS. 45, 46 AND 48).

FIRST USE 2-18-1985; IN COMMERCE 2-18-1985.

KATHLEEN LORENZO, EXAMINING ATTORNEY

SN 76-700,122. AUGUST SCHELL BREWING COMPANY, NEW ULM, MN. FILED 10-30-2009.

HOPFENMALZ

THE MARK CONSISTS OF THE WORD "HOPFENMALZ" IN A STYLIZED FONT.

THE WORDING "HOPFENMALZ" HAS NO MEANING IN A FOREIGN LANGUAGE.

FOR BEER (U.S. CLS. 45, 46 AND 48).

FIRST USE 6-1-2009; IN COMMERCE 6-1-2009.

MARLENE BELL, EXAMINING ATTORNEY

SN 77-458,720. HENRY'S HOLDINGS, LLC, COMMERCE, CA. FILED 4-25-2008.

SUN HARVEST

THE MARK CONSISTS OF STANDARD CHARACTERS WITHOUT CLAIM TO ANY PARTICULAR FONT, STYLE, SIZE, OR COLOR.

OWNER OF U.S. REG. NOS. 1,736,903, 3,440,589 AND OTHERS.

FOR FRUIT JUICE; FRUIT DRINKS; COCONUT MILK; SODA POPS; DRINKING WATER; SPARKLING WATER (U.S. CLS. 45, 46 AND 48).

SCOTT BIBB, EXAMINING ATTORNEY

CLASS 32—(Continued).

SN 77-590,082. FRUTAS CONCENTRADAS, S.A. DE C.V., MÉXICO, D.F., MEXICO, FILED 10-10-2008.



PRIORITY CLAIMED UNDER SEC. 44(D) ON MEXICO APPLICATION NO. 963178, FILED 9-24-2008.

NO CLAIM IS MADE TO THE EXCLUSIVE RIGHT TO USE "AQUA LATTE", APART FROM THE MARK AS SHOWN.

THE MARK CONSISTS OF THE WORDS "AQUA LATTE FINEL" IN STYLIZED UPPER CASE LETTERS, STACKED ONE UPON THE OTHER. "FINEL" APPEARS IN A DIFFERENT AND SMALLER TYPEFACE. TWO CURLING LINES EXTEND VERTICALLY FROM THE LETTER "U" IN "AQUA".

THE WORDING "FINEL" HAS NO MEANING IN A FOREIGN LANGUAGE.

FOR FLAVORED WATERS (U.S. CLS. 45, 46 AND 48).

MARLENE BELL, EXAMINING ATTORNEY

SN 77-600,617. AUDELIZ LEBRON CORP., DBA AUDELIZ LEBRON CORP., CAGUAS, PUERTO RICO, FILED 10-25-2008.



NO CLAIM IS MADE TO THE EXCLUSIVE RIGHT TO USE "MALTA", APART FROM THE MARK AS SHOWN.

THE COLOR(S) BLACK, GOLD, WHITE, BLUE, RED AND GRAY IS/ARE CLAIMED AS A FEATURE OF THE MARK.

THE MARK CONSISTS OF A BLACK ROOSTER HEAD OUTLINED IN GOLD AND WHITE WITH THE WORDING "MALTA" IN WHITE OUTLINED BY GRAY AND BLACK UNDER THE ROOSTER HEAD. UNDER THE WORDING "MALTA" IS A RED RECTANGLE OUTLINED IN GOLD WITH THE WORD "GALLITO" IN WHITE. THE ENTIRE MARK IS SHADOWED IN BLUE.

THE ENGLISH TRANSLATION OF "MALTA GALLITO" IN THE MARK IS "LITTLE ROOSTER MALT".

FOR COLAS; SOFT DRINKS, NAMELY, MALT DRINKS NON-ALCOHOLIC (U.S. CLS. 45, 46 AND 48).

DAWN FELDMAN, EXAMINING ATTORNEY

CLASS 32—(Continued).

SN 77-607,160. NIAGARA BOTTLING, LLC, ONTARIO, CA. FILED 11-4-2008.

ECO-AIR BOTTLE

THE MARK CONSISTS OF STANDARD CHARACTERS WITHOUT CLAIM TO ANY PARTICULAR FONT, STYLE, SIZE, OR COLOR.

NO CLAIM IS MADE TO THE EXCLUSIVE RIGHT TO USE "BOTTLE", APART FROM THE MARK AS SHOWN.

FOR DRINKING WATER, PURIFIED BOTTLED DRINKING WATER, SPRING WATER, DRINKING WATER WITH MINERALS ADDED (U.S. CLS. 45, 46 AND 48).

PAULA MAHONEY, EXAMINING ATTORNEY

SN 77-676,297. MARGO'S BARK SODA CO., LLC., BEVERLY HILLS, CA. FILED 2-23-2009.

MARGO'S BARK

THE MARK CONSISTS OF STANDARD CHARACTERS WITHOUT CLAIM TO ANY PARTICULAR FONT, STYLE, SIZE, OR COLOR.

NO CLAIM IS MADE TO THE EXCLUSIVE RIGHT TO USE "BARK", APART FROM THE MARK AS SHOWN.

FOR BOTTLED DRINKING WATER; ENERGY DRINKS; FRUIT JUICES AND FRUIT DRINKS; SOFT DRINKS (U.S. CLS. 45, 46 AND 48).

KIM MONINGHOFF, EXAMINING ATTORNEY

SN 77-790,044. DS WATERS OF AMERICA, INC., ATLANTA, GA. FILED 7-27-2009.

RENEW

THE MARK CONSISTS OF STANDARD CHARACTERS WITHOUT CLAIM TO ANY PARTICULAR FONT, STYLE, SIZE, OR COLOR.

FOR POWDERS USED IN THE PREPARATION OF NON-ALCOHOLIC FRUIT FLAVORED BEVERAGES (U.S. CLS. 45, 46 AND 48).

KAREN BRACEY, EXAMINING ATTORNEY

CLASS 32—(Continued).

SN 77-791,568. TERRY HARRIS, CORDOVA, TN. FILED 7-28-2009.

SLOW-MO

THE MARK CONSISTS OF STANDARD CHARACTERS WITHOUT CLAIM TO ANY PARTICULAR FONT, STYLE, SIZE, OR COLOR.

FOR SOFT DRINKS, NAMELY, CARBONATED SOFT DRINKS THAT CONTAIN CALMING AGENTS (U.S. CLS. 45, 46 AND 48).

RONALD DELGIZZI, EXAMINING ATTORNEY

SN 77-817,556. JAMES R. WELLER, LOS ANGELES, CA. FILED 9-1-2009.

RAINFOREST COLA

THE MARK CONSISTS OF STANDARD CHARACTERS WITHOUT CLAIM TO ANY PARTICULAR FONT, STYLE, SIZE, OR COLOR.

NO CLAIM IS MADE TO THE EXCLUSIVE RIGHT TO USE "COLA", APART FROM THE MARK AS SHOWN.

FOR NON-ALCOHOLIC BEVERAGES, NAMELY, CARBONATED BEVERAGES (U.S. CLS. 45, 46 AND 48).

ANDREW LEASER, EXAMINING ATTORNEY

SN 77-829,084. THE COCA-COLA COMPANY, ATLANTA, GA. FILED 9-17-2009.

DIET COKE

THE MARK CONSISTS OF STANDARD CHARACTERS WITHOUT CLAIM TO ANY PARTICULAR FONT, STYLE, SIZE, OR COLOR.

OWNER OF U.S. REG. NOS. 415,755, 3,347,889 AND OTHERS.

NO CLAIM IS MADE TO THE EXCLUSIVE RIGHT TO USE "DIET", APART FROM THE MARK AS SHOWN.

FOR NON-ALCOHOLIC BEVERAGES, NAMELY, SOFT DRINKS; AND SYRUPS AND CONCENTRATES FOR MAKING NON-ALCOHOLIC BEVERAGES NAMELY SOFT DRINKS (U.S. CLS. 45, 46 AND 48).

FIRST USE 7-0-1982; IN COMMERCE 8-9-1982.

HAI-LY LAM, EXAMINING ATTORNEY

CLASS 32—(Continued).

SN 77-845,034. H & H PRODUCTS CO., ORLANDO, FL.
FILED 10-9-2009.

JUICE BURST

THE MARK CONSISTS OF STANDARD CHARACTERS WITHOUT CLAIM TO ANY PARTICULAR FONT, STYLE, SIZE, OR COLOR.

NO CLAIM IS MADE TO THE EXCLUSIVE RIGHT TO USE "JUICE", APART FROM THE MARK AS SHOWN.

FOR NON-ALCOHOLIC JUICE CONCENTRATES USED IN THE PREPARATION OF JUICE BEVERAGES (U.S. CLS. 45, 46 AND 48).

FIRST USE 9-0-1989; IN COMMERCE 9-0-1989.

WILLIAM P. SHANAHAN, EXAMINING ATTORNEY

CLASS 32—(Continued).

SN 77-881,424. OKF CORPORATION, SEONGNAM, GYEONGGI-DO, REPUBLIC OF KOREA, FILED 11-27-2009.

OKF SPARKLING FRESH

THE MARK CONSISTS OF STANDARD CHARACTERS WITHOUT CLAIM TO ANY PARTICULAR FONT, STYLE, SIZE, OR COLOR.

OWNER OF U.S. REG. NO. 3,727,340.

NO CLAIM IS MADE TO THE EXCLUSIVE RIGHT TO USE "SPARKLING FRESH", APART FROM THE MARK AS SHOWN.

FOR NON-ALCOHOLIC FRUIT AND VEGETABLE JUICE BEVERAGES; AERATED WATER (U.S. CLS. 45, 46 AND 48).

AMY KERTGATE, EXAMINING ATTORNEY

SN 77-879,728. BOWEN & BOWEN LTD., BELIZE CITY, BELIZE, FILED 11-24-2009.

BELIKIN STOUT

THE MARK CONSISTS OF STANDARD CHARACTERS WITHOUT CLAIM TO ANY PARTICULAR FONT, STYLE, SIZE, OR COLOR.

OWNER OF BELIZE REG. NO. 1390.03, DATED 1-23-2003, EXPIRES 1-23-2013.

NO CLAIM IS MADE TO THE EXCLUSIVE RIGHT TO USE "STOUT", APART FROM THE MARK AS SHOWN.

THE WORDING "BELIKIN" HAS NO MEANING IN A FOREIGN LANGUAGE.

FOR STOUT (U.S. CLS. 45, 46 AND 48).

BILL DAWE, EXAMINING ATTORNEY

SN 77-885,761. 666 VENTURES, LLC, ALBUQUERQUE, NM. FILED 12-3-2009.

ELECTRIC CHAIR BLUE RASPBERRY

THE MARK CONSISTS OF STANDARD CHARACTERS WITHOUT CLAIM TO ANY PARTICULAR FONT, STYLE, SIZE, OR COLOR.

NO CLAIM IS MADE TO THE EXCLUSIVE RIGHT TO USE "BLUE RASPBERRY", APART FROM THE MARK AS SHOWN.

FOR POWDERS USED IN THE PREPARATION OF ISOTONIC SPORTS DRINKS AND SPORTS BEVERAGES; SPORTS DRINKS (U.S. CLS. 45, 46 AND 48).

FIRST USE 2-24-2010; IN COMMERCE 2-24-2010.

AMY HELLA, EXAMINING ATTORNEY

SN 77-879,731. BOWEN & BOWEN LTD., BELIZE CITY, BELIZE, FILED 11-24-2009.

BELIKIN BEER

THE MARK CONSISTS OF STANDARD CHARACTERS WITHOUT CLAIM TO ANY PARTICULAR FONT, STYLE, SIZE, OR COLOR.

OWNER OF BELIZE REG. NO. 1395.03, DATED 1-23-2003, EXPIRES 1-23-2013.

NO CLAIM IS MADE TO THE EXCLUSIVE RIGHT TO USE "BEER", APART FROM THE MARK AS SHOWN.

THE WORDING "BELIKIN" HAS NO MEANING IN A FOREIGN LANGUAGE.

FOR BEER (U.S. CLS. 45, 46 AND 48).

BILL DAWE, EXAMINING ATTORNEY

SN 77-885,767. 666 VENTURES, LLC, ALBUQUERQUE, NM. FILED 12-3-2009.

LUCIFER'S LEMONADE

THE MARK CONSISTS OF STANDARD CHARACTERS WITHOUT CLAIM TO ANY PARTICULAR FONT, STYLE, SIZE, OR COLOR.

NO CLAIM IS MADE TO THE EXCLUSIVE RIGHT TO USE "LEMONADE", APART FROM THE MARK AS SHOWN.

FOR POWDERS USED IN THE PREPARATION OF ISOTONIC SPORTS DRINKS AND SPORTS BEVERAGES; SPORTS DRINKS (U.S. CLS. 45, 46 AND 48).

FIRST USE 2-24-2010; IN COMMERCE 2-24-2010.

AMY HELLA, EXAMINING ATTORNEY

CLASS 32—(Continued).

SN 77-885,770. 666 VENTURES, LLC, ALBUQUERQUE, NM.
FILED 12-3-2009.

HELLFIRE ORANGE

THE MARK CONSISTS OF STANDARD CHARACTERS WITHOUT CLAIM TO ANY PARTICULAR FONT, STYLE, SIZE, OR COLOR.

NO CLAIM IS MADE TO THE EXCLUSIVE RIGHT TO USE "ORANGE", APART FROM THE MARK AS SHOWN.

FOR POWDERS USED IN THE PREPARATION OF ISOTONIC SPORTS DRINKS AND SPORTS BEVERAGES; SPORTS DRINKS (U.S. CLS. 45, 46 AND 48).

FIRST USE 2-24-2010; IN COMMERCE 2-24-2010.
AMY HELLA, EXAMINING ATTORNEY

SN 77-886,119. SUNLAND BRANDS, INC., AGOURA HILLS, CA. FILED 12-4-2009.

PŪRVANA

THE MARK CONSISTS OF THE WORD "PURVANA" IN BLOCK LETTERS. ABOVE THE "U" IN "PURVANA" IS AN ACCENT LINE.

FOR FRUIT JUICES AND FRUIT SMOOTHIES (U.S. CLS. 45, 46 AND 48).

WILLIAM BRECKENFELD, EXAMINING ATTORNEY

SN 77-887,497. SPRECHER BREWING COMPANY, DBA CHAMELEON BREWING COMPANY, GLENDALE, WI. FILED 12-7-2009.

Hop on Top

THE MARK CONSISTS OF STANDARD CHARACTERS WITHOUT CLAIM TO ANY PARTICULAR FONT, STYLE, SIZE, OR COLOR.

FOR BREWED MALT-BASED ALCOHOLIC BEVERAGE IN THE NATURE OF A BEER (U.S. CLS. 45, 46 AND 48).

FIRST USE 6-5-2009; IN COMMERCE 6-5-2009.
HENRY S. ZAK, EXAMINING ATTORNEY

CLASS 32—(Continued).

SN 77-888,033. SOUTHERN PRESS & PACKING, INC., ALMA, GA. FILED 12-7-2009.

REGENERATE

THE MARK CONSISTS OF STANDARD CHARACTERS WITHOUT CLAIM TO ANY PARTICULAR FONT, STYLE, SIZE, OR COLOR.

FOR BLUEBERRY JUICE (U.S. CLS. 45, 46 AND 48).
APRIL HESIK, EXAMINING ATTORNEY

SN 77-888,802. WELCH FOODS INC., A COOPERATIVE, CONCORD, MA. FILED 12-8-2009.

HEALTHY START

THE MARK CONSISTS OF STANDARD CHARACTERS WITHOUT CLAIM TO ANY PARTICULAR FONT, STYLE, SIZE, OR COLOR.

FOR FRUIT JUICES; FRUIT DRINKS CONTAINING FRUIT JUICE; FRUIT FLAVORED DRINKS; CONCENTRATES USED IN THE PREPARATION OF FRUIT DRINKS; NON-ALCOHOLIC FRUIT COCKTAILS (U.S. CLS. 45, 46 AND 48).

KATINA MISTER, EXAMINING ATTORNEY

SN 77-890,013. DIVER'S D\LYTE, RIDGELAND, MS. FILED 12-9-2009.

SURFER'S D\LYTE

THE MARK CONSISTS OF STANDARD CHARACTERS WITHOUT CLAIM TO ANY PARTICULAR FONT, STYLE, SIZE, OR COLOR.

NO CLAIM IS MADE TO THE EXCLUSIVE RIGHT TO USE "SURFER'S", APART FROM THE MARK AS SHOWN.

FOR SPORTS DRINKS, NAMELY, ENERGY DRINKS (U.S. CLS. 45, 46 AND 48).

ADA HAN, EXAMINING ATTORNEY

CLASS 32—(Continued).

SN 77-890,707. LAKEFRONT BREWERY, INC., MILWAUKEE, WI. FILED 12-10-2009.

FIXED GEAR

THE MARK CONSISTS OF STANDARD CHARACTERS WITHOUT CLAIM TO ANY PARTICULAR FONT, STYLE, SIZE, OR COLOR.

FOR BEER (U.S. CLS. 45, 46 AND 48).
FIRST USE 12-10-2009; IN COMMERCE 12-10-2009.
MICHAEL WIENER, EXAMINING ATTORNEY

CLASS 32—(Continued).

SN 77-891,059. B&I OVERSEAS TRADING INC, VAN NUYS, CA. FILED 12-10-2009.

švyturys

THE MARK CONSISTS OF STANDARD CHARACTERS WITHOUT CLAIM TO ANY PARTICULAR FONT, STYLE, SIZE, OR COLOR.

FOR BEER (U.S. CLS. 45, 46 AND 48).
FIRST USE 1-1-1784; IN COMMERCE 4-1-2004.
TINA L. SNAPP, EXAMINING ATTORNEY

SN 77-890,733. LOWE PROFILE PRODUCTIONS, INC., BEVERLY HILLS, CA. FILED 12-10-2009.



THE MARK CONSISTS OF THE STYLIZED LETTERS "TBP" INSIDE OF AN OVAL SHAPE DESIGN.

FOR BEERS; BOTTLED WATER; MINERAL AND AERATED WATERS AND OTHER NON-ALCOHOLIC DRINKS, NAMELY, FRUIT JUICES, LEMONADES, SOFT DRINKS, ENERGY DRINKS, ALL THE AFORESAID DRINKS SPARKLING OR NONSPARKLING (U.S. CLS. 45, 46 AND 48).

TINA MAI, EXAMINING ATTORNEY

SN 77-891,240. TALLGRASS BREWING COMPANY, MANHATTAN, KS. FILED 12-11-2009.



NO CLAIM IS MADE TO THE EXCLUSIVE RIGHT TO USE "BREWING CO.", APART FROM THE MARK AS SHOWN.

THE COLOR(S) RED, YELLOW, WHITE, IS/ARE CLAIMED AS A FEATURE OF THE MARK.

THE MARK CONSISTS OF THE NAME "TALLGRASS" IN RED OVER A BENT OVER YELLOW WHEAT STOCK, WITH A RED BANNER BELOW THE WHEAT WITH THE PHRASE "BREWING CO." IN WHITE.

FOR BEER (U.S. CLS. 45, 46 AND 48).
FIRST USE 8-1-2007; IN COMMERCE 8-7-2007.
ERIN FALK, EXAMINING ATTORNEY

SN 77-891,027. DALE, RUSSELL, BEVERLY HILLS, CA. FILED 12-10-2009.

BRAWLERS BEER

THE MARK CONSISTS OF STANDARD CHARACTERS WITHOUT CLAIM TO ANY PARTICULAR FONT, STYLE, SIZE, OR COLOR.

NO CLAIM IS MADE TO THE EXCLUSIVE RIGHT TO USE "BEER", APART FROM THE MARK AS SHOWN.

FOR BEER (U.S. CLS. 45, 46 AND 48).
MICHAEL WIENER, EXAMINING ATTORNEY

SN 77-891,262. PEPSICO, INC., PURCHASE, NY. FILED 12-11-2009.

WHEN LIFE THROWS YOU LEMONS, ADD SOME LIMES AND BUBBLES

THE MARK CONSISTS OF STANDARD CHARACTERS WITHOUT CLAIM TO ANY PARTICULAR FONT, STYLE, SIZE, OR COLOR.

FOR SOFT DRINKS (U.S. CLS. 45, 46 AND 48).
ROBIN CHOSID, EXAMINING ATTORNEY

CLASS 32—(Continued).

SN 77-893,682. PEPSICO, INC., PURCHASE, NY. FILED 12-15-2009.

CAN YOU REFRESH THE WORLD?

THE MARK CONSISTS OF STANDARD CHARACTERS WITHOUT CLAIM TO ANY PARTICULAR FONT, STYLE, SIZE, OR COLOR.
FOR SOFT DRINKS (U.S. CLS. 45, 46 AND 48).
ROBIN CHOSID, EXAMINING ATTORNEY

SN 77-898,311. 666 VENTURES, LLC, ALBUQUERQUE, NM. FILED 12-21-2009.

APPLE ANARCHY

THE MARK CONSISTS OF STANDARD CHARACTERS WITHOUT CLAIM TO ANY PARTICULAR FONT, STYLE, SIZE, OR COLOR.
NO CLAIM IS MADE TO THE EXCLUSIVE RIGHT TO USE "APPLE", APART FROM THE MARK AS SHOWN.
FOR POWDERS USED IN THE PREPARATION OF ISOTONIC SPORTS DRINKS AND SPORTS BEVERAGES; SPORTS DRINKS (U.S. CLS. 45, 46 AND 48).
AMY HELLA, EXAMINING ATTORNEY

SN 77-898,319. 666 VENTURES, LLC, ALBUQUERQUE, NM. FILED 12-21-2009.

WRATH OF GRAPES

THE MARK CONSISTS OF STANDARD CHARACTERS WITHOUT CLAIM TO ANY PARTICULAR FONT, STYLE, SIZE, OR COLOR.
FOR POWDERS USED IN THE PREPARATION OF ISOTONIC SPORTS DRINKS AND SPORTS BEVERAGES; SPORTS DRINKS (U.S. CLS. 45, 46 AND 48).
AMY HELLA, EXAMINING ATTORNEY

CLASS 32—(Continued).

SN 77-902,266. PEPSICO, INC., PURCHASE, NY. FILED 12-29-2009.

PUT OUR MONEY WHERE YOUR MOUTH IS

THE MARK CONSISTS OF STANDARD CHARACTERS WITHOUT CLAIM TO ANY PARTICULAR FONT, STYLE, SIZE, OR COLOR.
FOR SOFT DRINKS (U.S. CLS. 45, 46 AND 48).
ROBIN CHOSID, EXAMINING ATTORNEY

SN 77-904,232. PEPSICO, INC., PURCHASE, NY. FILED 1-4-2010.



THE COLOR(S) RED AND WHITE IS/ARE CLAIMED AS A FEATURE OF THE MARK.
THE MARK CONSISTS OF A WHITE HOUSE DESIGN INSIDE A WHITE CHASING ARROW DESIGN ON A RED CIRCULAR BACKGROUND. UNDERNEATH THE DESIGN IS A RED SHADOW-LIKE REFLECTION.
FOR SOFT DRINKS (U.S. CLS. 45, 46 AND 48).
ROBIN CHOSID, EXAMINING ATTORNEY

SN 77-906,389. RACETRAC PETROLEUM, INC., ATLANTA, GA. FILED 1-6-2010.

NUMBSKULL

THE MARK CONSISTS OF STANDARD CHARACTERS WITHOUT CLAIM TO ANY PARTICULAR FONT, STYLE, SIZE, OR COLOR.
FOR CARBONATED AND NON-CARBONATED, NON-ALCOHOLIC FROZEN FLAVORED BEVERAGES (U.S. CLS. 45, 46 AND 48).
KAPIL BHANOT, EXAMINING ATTORNEY

CLASS 32—(Continued).

SN 77-909,307. PEPSICO, INC., PURCHASE, NY. FILED 1-11-2010.

WINNER TAKE ALL

THE MARK CONSISTS OF STANDARD CHARACTERS WITHOUT CLAIM TO ANY PARTICULAR FONT, STYLE, SIZE, OR COLOR.
FOR SOFT DRINKS (U.S. CLS. 45, 46 AND 48).
ROBIN CHOSID, EXAMINING ATTORNEY

SN 77-922,623. VILLAGE PANTRY, LLC, WILMINGTON, NC. FILED 1-28-2010.

THIRST STOP

THE MARK CONSISTS OF STANDARD CHARACTERS WITHOUT CLAIM TO ANY PARTICULAR FONT, STYLE, SIZE, OR COLOR.
FOR BEVERAGES, NAMELY, SODA POP, DRINKING WATER, FRUIT JUICES AND FROZEN FLAVORED DRINKS (U.S. CLS. 45, 46 AND 48).
FIRST USE 1-0-2005; IN COMMERCE 1-0-2005.
NAPOLEON SHARMA, EXAMINING ATTORNEY

SN 78-770,011. STUART, GOLD, BOCA RATON, FL. FILED 12-9-2005.

H2Ology

THE MARK CONSISTS OF STANDARD CHARACTERS WITHOUT CLAIM TO ANY PARTICULAR FONT, STYLE, SIZE, OR COLOR.
FOR DRINKING WATER; FLAVORED WATERS (U.S. CLS. 45, 46 AND 48).
BARNEY CHARLON, EXAMINING ATTORNEY

CLASS 32—(Continued).

SN 79-066,146. BARRONS EUROPE AG, LIECHTENSTEIN, FILED 1-21-2009.

FALCCUN

THE MARK CONSISTS OF STANDARD CHARACTERS WITHOUT CLAIM TO ANY PARTICULAR FONT, STYLE, SIZE, OR COLOR.

PRIORITY DATE OF 7-23-2008 IS CLAIMED.
OWNER OF INTERNATIONAL REGISTRATION 0995696 DATED 1-21-2009, EXPIRES 1-21-2019.

FOR MIXED BEVERAGES CONTAINING BEER; MINERAL AND AERATED WATERS; FRUIT DRINKS AND FRUIT JUICES; SYRUPS AND OTHER PREPARATIONS FOR MAKING BEVERAGES, ENERGY DRINKS, SPORT DRINKS; ISOTOMIC DRINKS, STIMULATION DRINKS; ALL THE AFOREMENTIONED GOODS NOT FOR MEDICAL USE (U.S. CLS. 45, 46 AND 48).
NATALIE POLZER, EXAMINING ATTORNEY

CLASS 33—WINES AND SPIRITS

SN 76-700,583. COLLIER, NANCY, HACKENSACK, NJ. FILED 11-27-2009.

THE REAL HOUSE WINES OF NEW JERSEY

THE MARK CONSISTS OF STANDARD CHARACTERS WITHOUT CLAIM TO ANY PARTICULAR FONT, STYLE, SIZE, OR COLOR.

NO CLAIM IS MADE TO THE EXCLUSIVE RIGHT TO USE "HOUSE WINES OF NEW JERSEY", APART FROM THE MARK AS SHOWN.

FOR WINE (U.S. CLS. 47 AND 49).
KAREN SEVERSON, EXAMINING ATTORNEY

SN 77-079,528. VERGELEGEN WINES (PROPRIETARY) LIMITED, WESTERN CAPE, SOUTH AFRICA, FILED 1-10-2007.



FOR ALCOHOLIC BEVERAGES, NAMELY, WINES AND SPARKLING WINES (U.S. CLS. 47 AND 49).
FIRST USE 6-0-2005; IN COMMERCE 6-0-2005.
DAVID I, EXAMINING ATTORNEY

CLASS 33—(Continued).

SN 77-225,703. WAWEL BRANDS LLC, GLENVIEW, IL. FILED 7-10-2007.

WAWEL

THE MARK CONSISTS OF STANDARD CHARACTERS WITHOUT CLAIM TO ANY PARTICULAR FONT, STYLE, SIZE, OR COLOR.

FOR ALCOHOLIC BEVERAGES, NAMELY, VODKA, WINE, GIN, SCOTCH, BOURBON, BRANDY (U.S. CLS. 47 AND 49).

JAY BESCH, EXAMINING ATTORNEY

SN 77-450,029. INNOVATIVE LIQUORS, LLC, HOLLYWOOD, FL. FILED 4-16-2008.

HARD CANDY

THE MARK CONSISTS OF STANDARD CHARACTERS WITHOUT CLAIM TO ANY PARTICULAR FONT, STYLE, SIZE, OR COLOR.

FOR ALCOHOLIC BEVERAGES, NAMELY, DISTILLED LIQUOR AND SPIRITS (U.S. CLS. 47 AND 49).

ANGELA DUONG, EXAMINING ATTORNEY

SN 77-483,301. JON STEINSSON, ENCINO, CA. FILED 5-26-2008.

yo!

THE MARK CONSISTS OF STANDARD CHARACTERS WITHOUT CLAIM TO ANY PARTICULAR FONT, STYLE, SIZE, OR COLOR.

FOR VODKA; WINE COOLERS (U.S. CLS. 47 AND 49).

KATHLEEN M. VANSTON, EXAMINING ATTORNEY

CLASS 33—(Continued).

SN 77-502,207. LA FAMILLE DES GRANDS VINS ET SPIRITUEUX (FGVS), NUITS SAINT GEORGES, FRANCE, FILED 6-18-2008.

VICEROY

THE MARK CONSISTS OF STANDARD CHARACTERS WITHOUT CLAIM TO ANY PARTICULAR FONT, STYLE, SIZE, OR COLOR.

PRIORITY CLAIMED UNDER SEC. 44(D) ON FRANCE APPLICATION NO. 083568639, FILED 4-10-2008, REG. NO. 083568639, DATED 4-10-2008, EXPIRES 4-10-2018.

FOR ALCOHOLIC BEVERAGES EXCEPT BEERS, NAMELY, WINES, SANGRIA, HARD CIDERS, PREPARED ALCOHOLIC COCKTAILS, APERITIFS, AFTER-DINNER LIQUEURS, LIQUEURS, DISTILLED SPIRITS AND BRANDIES, NAMELY, BRANDY, TEQUILA, RUM, VODKA, WHISKY, GIN, CALVADOS, SCHNAPPS, COGNAC, PORT, SCOTCH, KIRSCH, SHERRY (U.S. CLS. 47 AND 49).

LINDA ESTRADA, EXAMINING ATTORNEY

SN 77-586,697. TEQUILA SUPREMO, S.A. DE C.V., ZAPO-PAN, MEXICO, FILED 10-6-2008.

CASCO CAMARENA

THE MARK CONSISTS OF STANDARD CHARACTERS WITHOUT CLAIM TO ANY PARTICULAR FONT, STYLE, SIZE, OR COLOR.

OWNER OF U.S. REG. NOS. 2,013,506 AND 3,574,282. NO CLAIM IS MADE TO THE EXCLUSIVE RIGHT TO USE "CASCO", APART FROM THE MARK AS SHOWN.

THE ENGLISH TRANSLATION OF "CASCO" IN THE MARK IS CASK.

FOR TEQUILA (U.S. CLS. 47 AND 49).

MARY BOAGNI, EXAMINING ATTORNEY

SN 77-586,722. TEQUILA SUPREMO, S.A. DE C.V., ZAPO-PAN, MEXICO, FILED 10-6-2008.

CASCO VIEJO DE CAMARENA'S

THE MARK CONSISTS OF STANDARD CHARACTERS WITHOUT CLAIM TO ANY PARTICULAR FONT, STYLE, SIZE, OR COLOR.

OWNER OF U.S. REG. NOS. 2,013,506 AND 3,574,282. THE ENGLISH TRANSLATION OF "CASCO VIEJO DE CAMARENA'S" IN THE MARK IS OLD CASK OF CAMARENA'S.

FOR TEQUILA (U.S. CLS. 47 AND 49).

MARY BOAGNI, EXAMINING ATTORNEY

CLASS 33—(Continued).

SN 77-651,517. VEUVE CLICQUOT PONSARDIN, MAISON FONDEE EN 1772, REIMS 51100, FRANCE, FILED 1-16-2009.



OWNER OF U.S. REG. NOS. 1,201,370, 2,425,553 AND OTHERS.

THE NAME "VEUVE CLICQUOT PONSARDIN" DOES NOT IDENTIFY A LIVING INDIVIDUAL.

THE COLOR(S) RED, BLACK, PINK, AND ORANGE IS/ ARE CLAIMED AS A FEATURE OF THE MARK.

THE MARK CONSISTS OF A FOUR-SIDED LABEL DESIGN. AT THE TOP OF THE LABEL IS A LOGO CONSISTING OF THE LETTERS "VCP" AND A STYLIZED ANCHOR ON A BACKGROUND OF A CIRCLE WITHIN A SIX-POINTED STAR. IN THE CENTER OF THE LABEL ARE AN ORANGE SQUARE AND THE WORDS "VEUVE CLICQUOT PONSARDIN". THE WORDS "VEUVE CLICQUOT PONSARDIN" ALSO APPEAR IN SIGNATURE FORM. THE BACKGROUND OF THE LABEL IS PINK. THE SIX-POINTED STAR, CIRCLE AND ANCHOR DESIGN, THE LETTERS "VCP", THE WORDING "VEUVE CLICQUOT PONSARDIN MAISON FONDEE EN 1772", THE SCROLLING LINE DESIGNS AND THE RECTANGULAR BORDER OF THE LABEL ARE BLACK. THE WORDS "VEUVE CLICQUOT PONSARDIN" IN SIGNATURE FORM AND THE LINE EMANATING FROM THE SIGNATURE ARE RED.

THE ENGLISH TRANSLATION OF "VEUVE" IN THE MARK IS WIDOW.

FOR CHAMPAGNE (U.S. CLS. 47 AND 49).
BRENDAN MCCAULEY, EXAMINING ATTORNEY

SN 77-690,293. STRANGER & STRANGER LTD, LONDON, UNITED KINGDOM, FILED 3-13-2009.

SERIO

THE MARK CONSISTS OF STANDARD CHARACTERS WITHOUT CLAIM TO ANY PARTICULAR FONT, STYLE, SIZE, OR COLOR.

THE ENGLISH TRANSLATION OF THE WORD "SERIO" IN THE MARK IS DIGNIFIED.

FOR ALCOHOLIC BEVERAGES EXCEPT BEERS (U.S. CLS. 47 AND 49).

ESTHER A. BORSUK, EXAMINING ATTORNEY

CLASS 33—(Continued).

SN 77-736,471. CROSBY ROAMANN LLC, NEW YORK, NY, FILED 5-13-2009.

CROSBY ROAMANN

THE MARK CONSISTS OF STANDARD CHARACTERS WITHOUT CLAIM TO ANY PARTICULAR FONT, STYLE, SIZE, OR COLOR.

THE NAME "CROSBY ROAMANN" DOES NOT IDENTIFY A LIVING INDIVIDUAL.

FOR WINE (U.S. CLS. 47 AND 49).
KATHRYN COWARD, EXAMINING ATTORNEY

SN 77-737,637. SANTA TERESA S.A., ISLA DE MAIPO, CHILE, FILED 5-15-2009.

SANTA INES

THE MARK CONSISTS OF STANDARD CHARACTERS WITHOUT CLAIM TO ANY PARTICULAR FONT, STYLE, SIZE, OR COLOR.

OWNER OF CHILE REG. NO. 599141, DATED 7-10-1991, EXPIRES 7-10-2011.

THE ENGLISH TRANSLATION OF "SANTA" IN THE MARK IS SAINT.

FOR WINES (U.S. CLS. 47 AND 49).
DEBRA LEE, EXAMINING ATTORNEY

SN 77-738,933. AMADIO, DANNIEL CAJETAN DELANO, TA AMADIO WINES PTY LTD, ADELAIDE, AUSTRALIA, FILED 5-17-2009.



AMADIO

THE MARK CONSISTS OF THE WORDING "AMADIO". ABOVE THE WORDING IS A SHIELD DESIGN. ON THE SHIELD APPEARS THE LETTER "D" AND THREE MOUNTAIN PEAKS. ABOVE THE SHIELD APPEARS A HELMET. BELOW THE SHIELD IS A BANNER WITH THE WORDING "CONSTANTIA ET LABORE" ON IT.

THE ENGLISH TRANSLATION OF "CONSTANTIA ET LABORE" IS "CONSISTENCE IN LABOR AND WORK."

FOR GRAPE WINE; RED WINE; RED WINES; SPARKLING WINES; TABLE WINES; WHITE WINE (U.S. CLS. 47 AND 49).

FIRST USE 12-9-2004; IN COMMERCE 3-27-2006.
KATHERINE CONNOLLY, EXAMINING ATTORNEY

CLASS 33—(Continued).

SN 77-743,407. THE MOB INCORPORATED, LITTLETON, CO. FILED 5-22-2009.

MOB

THE MARK CONSISTS OF STANDARD CHARACTERS WITHOUT CLAIM TO ANY PARTICULAR FONT, STYLE, SIZE, OR COLOR.

FOR ALCOHOLIC BEVERAGES EXCEPT BEERS; LIQUOR; WINE (U.S. CLS. 47 AND 49).

LINDA POWELL, EXAMINING ATTORNEY

CLASS 33—(Continued).

SN 77-746,567. SCHMITT SÖHNE GMBH WEINKELLEREI, LONGUICH, FED REP GERMANY, FILED 5-28-2009.



NO CLAIM IS MADE TO THE EXCLUSIVE RIGHT TO USE "RIESLING", APART FROM THE MARK AS SHOWN.

THE COLOR(S) BLUE, BLACK AND PURPLE IS/ARE CLAIMED AS A FEATURE OF THE MARK.

THE MARK CONSISTS OF A BLUE AND WHITE FISH, WHITE AND PURPLE CHICKEN AND BLUE PIG STACKED ON TOP OF A SPOTTED BLUE, PURPLE AND WHITE COW ABOVE THE WORDS "ANYTHING GOES RIESLING" WITH A BACKGROUND DESIGN OF TERMS RELATED TO DIFFERENT FOODS.

FOR WINES (U.S. CLS. 47 AND 49).

FIRST USE 2-9-2009; IN COMMERCE 2-9-2009.

CHRIS WELLS, EXAMINING ATTORNEY

SN 77-747,385. IMPULSORA ROMBO, S.A. DE C.V., SANTIAGO DE QUERÉTARO, MEXICO, FILED 5-29-2009.

TERRAFIRME

THE MARK CONSISTS OF STANDARD CHARACTERS WITHOUT CLAIM TO ANY PARTICULAR FONT, STYLE, SIZE, OR COLOR.

FOR ALCOHOLIC BEVERAGES, NAMELY, TEQUILA (U.S. CLS. 47 AND 49).

MARY ROSSMAN, EXAMINING ATTORNEY

SN 77-744,098. ENDEAVOUR VINEYARDS PTY. LTD., ABBOTSFORD, VICTORIA, AUSTRALIA, FILED 5-26-2009.

CLAYFORK VINEYARD

THE MARK CONSISTS OF STANDARD CHARACTERS WITHOUT CLAIM TO ANY PARTICULAR FONT, STYLE, SIZE, OR COLOR.

PRIORITY CLAIMED UNDER SEC. 44(D) ON AUSTRALIA APPLICATION NO. 1275002, FILED 11-28-2008.

OWNER OF AUSTRALIA REG. NO. 1275002, DATED 11-28-2008, EXPIRES 11-28-2018.

NO CLAIM IS MADE TO THE EXCLUSIVE RIGHT TO USE "VINEYARD", APART FROM THE MARK AS SHOWN.

FOR ALCOHOLIC BEVERAGES, NAMELY, WINES AND SPIRITS (U.S. CLS. 47 AND 49).

LINDA M. KING, EXAMINING ATTORNEY

SN 77-755,093. SEGHESSIO WINERIES, INC., HEALDSBURG, CA. FILED 6-9-2009.

FAMILY TABLE

THE MARK CONSISTS OF STANDARD CHARACTERS WITHOUT CLAIM TO ANY PARTICULAR FONT, STYLE, SIZE, OR COLOR.

FOR WINE (U.S. CLS. 47 AND 49).

DOMINIC FATHY, EXAMINING ATTORNEY

CLASS 33—(Continued).

SN 77-760,115. TAKARA SAKE USA INC., BERKELEY, CA.
FILED 6-15-2009.

GOKAI

THE MARK CONSISTS OF STANDARD CHARACTERS
WITHOUT CLAIM TO ANY PARTICULAR FONT, STYLE,
SIZE, OR COLOR.

THE ENGLISH TRANSLATION OF "GOKAI" IS DY-
NAMIC.

FOR SAKE (U.S. CLS. 47 AND 49).
JOHN KELLY, EXAMINING ATTORNEY

CLASS 33—(Continued).

SN 77-772,906. E. & J. GALLO WINERY, MODESTO, CA.
FILED 7-1-2009.

KAMEHAMEHA

THE MARK CONSISTS OF STANDARD CHARACTERS
WITHOUT CLAIM TO ANY PARTICULAR FONT, STYLE,
SIZE, OR COLOR.

THE LIKENESS (OR, "PORTRAIT") IN THE MARK DOES
NOT IDENTIFY A LIVING INDIVIDUAL.

THE WORDING "KAMEHAMEHA" HAS NO MEANING
IN A FOREIGN LANGUAGE.

FOR ALCOHOLIC BEVERAGES, NAMELY, SPIRITS
(U.S. CLS. 47 AND 49).

ROBERT C. CLARK JR., EXAMINING ATTORNEY

SN 77-760,899. HEAVEN HILL DISTILLERIES, INC., BARDS-
TOWN, KY. FILED 6-16-2009.

ROQ CANDY

THE MARK CONSISTS OF STANDARD CHARACTERS
WITHOUT CLAIM TO ANY PARTICULAR FONT, STYLE,
SIZE, OR COLOR.

NO CLAIM IS MADE TO THE EXCLUSIVE RIGHT TO
USE "CANDY", APART FROM THE MARK AS SHOWN.

FOR PREPARED ALCOHOLIC COCKTAIL HAVING A
CANDY-LIKE FLAVOR (U.S. CLS. 47 AND 49).

FIRST USE 6-16-2008; IN COMMERCE 6-16-2008.
JAY BESCH, EXAMINING ATTORNEY

SN 77-772,987. INNOVATIVE LIQUORS, LLC, HOLLY-
WOOD, FL. FILED 7-2-2009.

CALLOWS

THE MARK CONSISTS OF STANDARD CHARACTERS
WITHOUT CLAIM TO ANY PARTICULAR FONT, STYLE,
SIZE, OR COLOR.

FOR ALCOHOLIC BEVERAGES, NAMELY, LIQUEUR
(U.S. CLS. 47 AND 49).

JESSICA A. POWERS, EXAMINING ATTORNEY

SN 77-771,577. COHN, BRUCE R., GLEN ELLEN, CA. FILED
6-30-2009.

COUPE CUVEE

THE MARK CONSISTS OF STANDARD CHARACTERS
WITHOUT CLAIM TO ANY PARTICULAR FONT, STYLE,
SIZE, OR COLOR.

NO CLAIM IS MADE TO THE EXCLUSIVE RIGHT TO
USE "CUVEE", APART FROM THE MARK AS SHOWN.

THE ENGLISH TRANSLATION OF "CUVEE" IN THE
MARK IS "BATCH" OR "BLEND".

FOR WINE (U.S. CLS. 47 AND 49).
JANET LEE, EXAMINING ATTORNEY

SN 77-786,210. PROXIMO SPIRITS, INC., NEW YORK, NY.
FILED 7-21-2009.



THE MARK CONSISTS OF THE WORDS "THE KRAKEN"
APPEARING WITHIN A SHIELD. A REPRESENTATION OF
A SEA MONSTER SIMILAR TO A GIANT SQUID, AND A
THREE-MASTED SHIP IN THE MONSTER'S TENTACLES.

FOR RUM (U.S. CLS. 47 AND 49).
FIRST USE 8-1-2009; IN COMMERCE 8-1-2009.
KIM SAITO, EXAMINING ATTORNEY

CLASS 33—(Continued).

SN 77-797,510. VIÑA SAN PEDRO TARAPACÁ S.A., SANTIAGO, CHILE, FILED 8-5-2009.

KANKANA

THE MARK CONSISTS OF STANDARD CHARACTERS WITHOUT CLAIM TO ANY PARTICULAR FONT, STYLE, SIZE, OR COLOR.

THE NAME "KANKANA DOES NOT IDENTIFY A LIVING INDIVIDUAL.

THE WORDING "KANKANA" HAS NO MEANING IN A FOREIGN LANGUAGE.

FOR WINES (U.S. CLS. 47 AND 49).

SAIMA MAKHDOOM, EXAMINING ATTORNEY

CLASS 33—(Continued).

SN 77-833,049. GRUPO PENAFLORES S.A., BUENOS AIRES PROVINCE, ARGENTINA, FILED 9-23-2009.

ALMA MORA

THE MARK CONSISTS OF STANDARD CHARACTERS WITHOUT CLAIM TO ANY PARTICULAR FONT, STYLE, SIZE, OR COLOR.

THE NAME(S), PORTRAIT(S), AND/OR SIGNATURE(S) SHOWN IN THE MARK DOES NOT IDENTIFY A PARTICULAR LIVING INDIVIDUAL.

THE ENGLISH TRANSLATION OF "ALMA MORA" IN THE MARK IS BLACKBERRY SOUL.

FOR WINES (U.S. CLS. 47 AND 49).

SKYE YOUNG, EXAMINING ATTORNEY

SN 77-812,129. LNJ GROUP, LLC, ROSLYN HEIGHTS, NY, FILED 8-25-2009.

24 KARAT CLASSIQUE

THE MARK CONSISTS OF STANDARD CHARACTERS WITHOUT CLAIM TO ANY PARTICULAR FONT, STYLE, SIZE, OR COLOR.

THE ENGLISH TRANSLATION OF "KARAT" IN THE MARK IS CARAT.

FOR ALCOHOLIC BEVERAGE PRODUCED FROM A BREWED MALT BASE WITH NATURAL FLAVORS; DISTILLED SPIRITS; LIQUEURS; PREPARED ALCOHOLIC COCKTAIL (U.S. CLS. 47 AND 49).

SOPHIA S. KIM, EXAMINING ATTORNEY

SN 77-871,444. PUSSEY'S (2001) LTD., TORTOLA, BR. VIRGIN ISLANDS, FILED 11-12-2009.

Charlie T's

THE MARK CONSISTS OF STANDARD CHARACTERS WITHOUT CLAIM TO ANY PARTICULAR FONT, STYLE, SIZE, OR COLOR.

THE NAME(S), PORTRAIT(S), AND/OR SIGNATURE(S) SHOWN IN THE MARK IDENTIFIES CHARLES TOBIAS, WHOSE CONSENT(S) TO REGISTER IS MADE OF RECORD.

FOR RUM (U.S. CLS. 47 AND 49).

RUSS HERMAN, EXAMINING ATTORNEY

SN 77-825,736. BONARRIGO, MERRILL, BRYAN, TX. AND BONARRIGO, PAUL, BRYAN, TX. FILED 9-14-2009.

TEX ZIN

THE MARK CONSISTS OF STANDARD CHARACTERS WITHOUT CLAIM TO ANY PARTICULAR FONT, STYLE, SIZE, OR COLOR.

FOR GRAPE WINE (U.S. CLS. 47 AND 49).

FIRST USE 6-29-1998; IN COMMERCE 6-29-1998.

JEFFERY COWARD, EXAMINING ATTORNEY

SN 77-871,975. PUSSEY'S RUM LIMITED, TORTOLA, BR. VIRGIN ISLANDS, FILED 11-13-2009.

RACER CHASER RUM COCKTAIL

THE MARK CONSISTS OF STANDARD CHARACTERS WITHOUT CLAIM TO ANY PARTICULAR FONT, STYLE, SIZE, OR COLOR.

NO CLAIM IS MADE TO THE EXCLUSIVE RIGHT TO USE "RUM COCKTAIL", APART FROM THE MARK AS SHOWN.

FOR LOW PROOF RUM BASED READY TO DRINK COCKTAIL (U.S. CLS. 47 AND 49).

FLORENTINA BLANDU, EXAMINING ATTORNEY

CLASS 33—(Continued).

SN 77-872,608. OLE SMOKY DISTILLERY, LLC, SEVIERVILLE, TN. FILED 11-13-2009.

OLE SMOKY

THE MARK CONSISTS OF STANDARD CHARACTERS WITHOUT CLAIM TO ANY PARTICULAR FONT, STYLE, SIZE, OR COLOR.

NO CLAIM IS MADE TO THE EXCLUSIVE RIGHT TO USE "SMOKY", APART FROM THE MARK AS SHOWN.

FOR ALCOHOLIC BEVERAGES, NAMELY, WHISKEY DISTILLED FROM CORN MASH, WHISKEY, AND VODKA ; LIQUOR (U.S. CLS. 47 AND 49).

AARON BRODSKY, EXAMINING ATTORNEY

SN 77-873,842. OLE SMOKY DISTILLERY, LLC, SEVIERVILLE, TN. FILED 11-16-2009.

**OLE SMOKY MOONSHINE
CHERRIES**

THE MARK CONSISTS OF STANDARD CHARACTERS WITHOUT CLAIM TO ANY PARTICULAR FONT, STYLE, SIZE, OR COLOR.

NO CLAIM IS MADE TO THE EXCLUSIVE RIGHT TO USE "SMOKY MOONSHINE CHERRIES", APART FROM THE MARK AS SHOWN.

FOR ALCOHOLIC BEVERAGES CONTAINING FRUIT, NAMELY, WHISKY AND UN-AGED WHISKY CONTAINING CHERRIES (U.S. CLS. 47 AND 49).

AARON BRODSKY, EXAMINING ATTORNEY

CLASS 33—(Continued).

SN 77-881,400. ZHUJI JIDI KNITTING CO., LTD., ZHEJIANG PROVINCE, CHINA, FILED 11-27-2009.



THE MARK CONSISTS OF A DESIGNED FLOWER WITH THE WORD "JIDI" AND TWO CHINESE CHARACTERS BELOW.

THE WORDING "JIDI" HAS NO MEANING IN A FOREIGN LANGUAGE.

THE NON-LATIN CHARACTERS IN THE MARK TRANSLITERATE TO "JI DI" AND THIS HAS NO MEANING IN A FOREIGN LANGUAGE.

FOR ALCOHOLIC BEVERAGES CONTAINING FRUIT; ALCOHOLIC COCKTAIL MIXES; APERTIFS; ARAK; BRANDY; DISTILLED SPIRITS OF RICE (AWAMORI); HYDROMEL; SPIRITS; VODKA; WINE (U.S. CLS. 47 AND 49).

FIRST USE 10-11-2009; IN COMMERCE 11-1-2009.
ALLISON SCHRODY, EXAMINING ATTORNEY

SN 77-881,551. DIAMOND HONG, INC., BROOKLYN, NY. FILED 11-27-2009.

**金
標**

THE MARK CONSISTS OF TWO NON-LATIN CHARACTERS.

THE ENGLISH TRANSLATION OF "JIN," "BIAO" IN THE MARK IS GOLD SIGN.

THE NON-LATIN CHARACTERS IN THE MARK TRANSLITERATE TO "JIN," "BIAO" AND THIS MEANS GOLD SIGN IN ENGLISH.

FOR WINES AND LIQUEURS (U.S. CLS. 47 AND 49).
PATRICIA EVANKO, EXAMINING ATTORNEY

CLASS 33—(Continued).

SN 77-881,703. ACQUIESCE VINEYARDS, LLC, ACAMPO, CA. FILED 11-28-2009.

SLEEPING HEAD WINERY

THE MARK CONSISTS OF STANDARD CHARACTERS WITHOUT CLAIM TO ANY PARTICULAR FONT, STYLE, SIZE, OR COLOR.

NO CLAIM IS MADE TO THE EXCLUSIVE RIGHT TO USE "WINERY", APART FROM THE MARK AS SHOWN. FOR GRAPE WINE (U.S. CLS. 47 AND 49).
CHRIS WELLS, EXAMINING ATTORNEY

SN 77-882,628. OBSHESTVO S OGRANICHENNOI OT-VETSTVENNOSTIU "GLAVSPIRITTREST", MOSCOW REGION, PUSHKINO, RUSSIAN FED., FILED 11-30-2009.



OWNER OF U.S. REG. NO. 3,744,765.
THE MARK CONSISTS OF A LABEL DESIGN CONTAINING THE WORDS "GREEN MARK" AND THE WORD "GLAVSPIRITTREST" AND A BOTTLE DESIGN IN THE CENTER.

THE ENGLISH TRANSLATION OF THE WORD "GLAVSPIRITTREST" IN THE MARK IS MAIN SPIRIT COMPANY. FOR VODKA (U.S. CLS. 47 AND 49).
MARK SPARACINO, EXAMINING ATTORNEY

SN 77-885,069. STONE VILLA WINE CELLARS, INC., ACME, PA. FILED 12-3-2009.

PADRE'S ROSÉ

THE MARK CONSISTS OF STANDARD CHARACTERS WITHOUT CLAIM TO ANY PARTICULAR FONT, STYLE, SIZE, OR COLOR.

OWNER OF U.S. REG. NO. 3,700,662.
NO CLAIM IS MADE TO THE EXCLUSIVE RIGHT TO USE "ROSÉ", APART FROM THE MARK AS SHOWN. THE ENGLISH TRANSLATION OF "PADRE" IN THE MARK IS "FATHER".
FOR WINE (U.S. CLS. 47 AND 49).
FIRST USE 4-20-2000; IN COMMERCE 5-31-2000.
LAKEISHA LEWIS, EXAMINING ATTORNEY

CLASS 33—(Continued).

SN 77-885,081. STONE VILLA WINE CELLARS, INC., ACME, PA. FILED 12-3-2009.

PADRE'S WHITE

THE MARK CONSISTS OF STANDARD CHARACTERS WITHOUT CLAIM TO ANY PARTICULAR FONT, STYLE, SIZE, OR COLOR.

OWNER OF U.S. REG. NO. 3,700,662.
NO CLAIM IS MADE TO THE EXCLUSIVE RIGHT TO USE "WHITE", APART FROM THE MARK AS SHOWN. THE ENGLISH TRANSLATION OF "PADRE" IN THE MARK IS "FATHER".
FOR WINE (U.S. CLS. 47 AND 49).
FIRST USE 4-20-2000; IN COMMERCE 5-31-2000.
LAKEISHA LEWIS, EXAMINING ATTORNEY

SN 77-885,439. VERMONT MAPLE BRANDY LLC, RICHFORD, VT. FILED 12-3-2009.



NO CLAIM IS MADE TO THE EXCLUSIVE RIGHT TO USE "VERMONT MAPLE BRANDY", APART FROM THE MARK AS SHOWN.

THE MARK CONSISTS OF THE WORDING "VERMONT MAPLE BRANDY" INSIDE OF A RECTANGLE WITH A DOUBLE BORDER AND A DESIGN CONTAINING TWO LEAVES BELOW THE RECTANGLE. THE TERM "VERMONT" APPEARS BETWEEN TWO HORIZONTAL LINES ABOVE THE WORDING "MAPLE BRANDY".

FOR DISTILLED SPIRITS (U.S. CLS. 47 AND 49).
LINDA M. KING, EXAMINING ATTORNEY

SN 77-885,763. SUTTER HOME WINERY, INC., ST. HELENA, CA. FILED 12-3-2009.

CLOUD'S NEST VINEYARD

THE MARK CONSISTS OF STANDARD CHARACTERS WITHOUT CLAIM TO ANY PARTICULAR FONT, STYLE, SIZE, OR COLOR.

NO CLAIM IS MADE TO THE EXCLUSIVE RIGHT TO USE "VINEYARD", APART FROM THE MARK AS SHOWN. FOR ALCOHOLIC BEVERAGES EXCEPT BEERS (U.S. CLS. 47 AND 49).
FIRST USE 8-1-2009; IN COMMERCE 8-1-2009.
KIMBERLY PERRY, EXAMINING ATTORNEY

CLASS 33—(Continued).

SN 77-886,168. BREWER, EDWARD N, ROCHESTER, NY.
FILED 12-4-2009.

EnGin

THE MARK CONSISTS OF STANDARD CHARACTERS WITHOUT CLAIM TO ANY PARTICULAR FONT, STYLE, SIZE, OR COLOR.

THE WORDING "ENGIN" HAS NO MEANING IN A FOREIGN LANGUAGE.

FOR ALCOHOLIC BEVERAGES EXCEPT BEERS (U.S. CLS. 47 AND 49).

LINDSEY RUBIN, EXAMINING ATTORNEY

CLASS 33—(Continued).

SN 77-886,781. JOHN A. LASSETER AND NANCY T. LASSETER, TRUSTEES OF THE LASSETER LIVING TRUST, GLEN ELLEN, CA. FILED 12-4-2009.

Reminiscence

THE MARK CONSISTS OF STANDARD CHARACTERS WITHOUT CLAIM TO ANY PARTICULAR FONT, STYLE, SIZE, OR COLOR.

FOR WINES (U.S. CLS. 47 AND 49).

LINDA POWELL, EXAMINING ATTORNEY

SN 77-886,662. WASABE BEVERAGES INC, OAKLAND, CA.
FILED 12-4-2009.

SABÉ SAKE

THE MARK CONSISTS OF STANDARD CHARACTERS WITHOUT CLAIM TO ANY PARTICULAR FONT, STYLE, SIZE, OR COLOR.

NO CLAIM IS MADE TO THE EXCLUSIVE RIGHT TO USE "SAKE", APART FROM THE MARK AS SHOWN.

THE ENGLISH TRANSLATION OF "SABÉ" IN THE MARK IS THE BEAUTY THAT COMES WITH AGE.

FOR DISTILLED SPIRITS; DISTILLED SPIRITS OF RICE (AWAMORI); GIN; JAPANESE WHITE LIQUOR (SHOCHU); LIQUEURS; POTABLE SPIRITS; SAKE; SPIRITS; SPIRITS AND LIQUEURS; VODKA (U.S. CLS. 47 AND 49).

KRISTIN CARLSON, EXAMINING ATTORNEY

SN 77-887,249. KRITZER, CRAIG H, DAHLONEGA, GA.
FILED 12-7-2009.

AN EAST COAST WEST COAST WINE

THE MARK CONSISTS OF STANDARD CHARACTERS WITHOUT CLAIM TO ANY PARTICULAR FONT, STYLE, SIZE, OR COLOR.

NO CLAIM IS MADE TO THE EXCLUSIVE RIGHT TO USE "WINE", APART FROM THE MARK AS SHOWN.

FOR WINE (U.S. CLS. 47 AND 49).

FIRST USE 12-5-2009; IN COMMERCE 12-5-2009.

VIVIAN MICZNIK FIRST, EXAMINING ATTORNEY

SN 77-886,773. JOHN A. LASSETER AND NANCY T. LASSETER, TRUSTEES OF THE LASSETER LIVING TRUST, GLEN ELLEN, CA. FILED 12-4-2009.

AMONT

THE MARK CONSISTS OF STANDARD CHARACTERS WITHOUT CLAIM TO ANY PARTICULAR FONT, STYLE, SIZE, OR COLOR.

THE ENGLISH TRANSLATION OF 'AMONT' IN THE MARK IS 'UPSTREAM WATER'.

FOR WINES (U.S. CLS. 47 AND 49).

LINDA POWELL, EXAMINING ATTORNEY

SN 77-887,270. KRITZER, CRAIG H., DAHLONEGA, GA.
FILED 12-7-2009.

A WEST COAST EAST COAST WINE

THE MARK CONSISTS OF STANDARD CHARACTERS WITHOUT CLAIM TO ANY PARTICULAR FONT, STYLE, SIZE, OR COLOR.

NO CLAIM IS MADE TO THE EXCLUSIVE RIGHT TO USE "WINE", APART FROM THE MARK AS SHOWN.

FOR WINE (U.S. CLS. 47 AND 49).

FIRST USE 7-4-2009; IN COMMERCE 7-4-2009.

VIVIAN MICZNIK FIRST, EXAMINING ATTORNEY

CLASS 33—(Continued).

SN 77-887,342. WINE SCOUT INTERNATIONAL, NAPA, CA.
FILED 12-7-2009.

JAILBIRD

THE MARK CONSISTS OF STANDARD CHARACTERS
WITHOUT CLAIM TO ANY PARTICULAR FONT, STYLE,
SIZE, OR COLOR.

FOR ALCOHOLIC BEVERAGES EXCEPT BEERS (U.S.
CLS. 47 AND 49).

HELENE LIWINSKI, EXAMINING ATTORNEY

CLASS 33—(Continued).

SN 77-887,884. NICKLAUS COMPANIES, LLC, NORTH
PALM BEACH, FL. FILED 12-7-2009.

NICKLAUS

THE MARK CONSISTS OF STANDARD CHARACTERS
WITHOUT CLAIM TO ANY PARTICULAR FONT, STYLE,
SIZE, OR COLOR.

OWNER OF U.S. REG. NOS. 2,646,151, 3,757,997 AND
OTHERS.

FOR WINE (U.S. CLS. 47 AND 49).

CHARLOTTE CORWIN, EXAMINING ATTORNEY

SN 77-887,462. MCNAB RIDGE WINERY, LLC, UKIAH, CA.
FILED 12-7-2009.

Zinzilla

THE MARK CONSISTS OF STANDARD CHARACTERS
WITHOUT CLAIM TO ANY PARTICULAR FONT, STYLE,
SIZE, OR COLOR.

FOR WINES (U.S. CLS. 47 AND 49).

FIRST USE 3-6-2007; IN COMMERCE 3-6-2007.

INGRID C. EULIN, EXAMINING ATTORNEY

SN 77-888,184. GOAMERICAGO BEVERAGES LLC, SHORE-
HAM, VT. FILED 12-8-2009.

WHISTLEPIG WHISKEY

THE MARK CONSISTS OF STANDARD CHARACTERS
WITHOUT CLAIM TO ANY PARTICULAR FONT, STYLE,
SIZE, OR COLOR.

NO CLAIM IS MADE TO THE EXCLUSIVE RIGHT TO
USE "WHISKEY", APART FROM THE MARK AS SHOWN.

FOR ALCOHOLIC BEVERAGES EXCEPT BEERS;
WHISKEY (U.S. CLS. 47 AND 49).

SHAILA SETTLES, EXAMINING ATTORNEY

SN 77-887,478. LION NATHAN WINE PTY LIMITED, SYD-
NEY, AUSTRALIA, FILED 12-7-2009.

KAPUKA

THE MARK CONSISTS OF STANDARD CHARACTERS
WITHOUT CLAIM TO ANY PARTICULAR FONT, STYLE,
SIZE, OR COLOR.

FOR WINES (U.S. CLS. 47 AND 49).

JASON BLAIR, EXAMINING ATTORNEY

SN 77-888,886. SIDNEY FRANK IMPORTING CO., INC.,
NEW ROCHELLE, NY. FILED 12-8-2009.

AMERICAN HARVEST

THE MARK CONSISTS OF STANDARD CHARACTERS
WITHOUT CLAIM TO ANY PARTICULAR FONT, STYLE,
SIZE, OR COLOR.

NO CLAIM IS MADE TO THE EXCLUSIVE RIGHT TO
USE "AMERICAN", APART FROM THE MARK AS SHOWN.

FOR VODKA (U.S. CLS. 47 AND 49).

ODESSA BIBBINS, EXAMINING ATTORNEY

CLASS 33—(Continued).

SN 77-888,905. LE CEP II, INC., CARLTON, OR. FILED 12-8-2009.

ANNE AMIE VINEYARDS

THE MARK CONSISTS OF STANDARD CHARACTERS WITHOUT CLAIM TO ANY PARTICULAR FONT, STYLE, SIZE, OR COLOR.

OWNER OF U.S. REG. NO. 2,789,254.

NO CLAIM IS MADE TO THE EXCLUSIVE RIGHT TO USE "VINEYARDS", APART FROM THE MARK AS SHOWN.

FOR WINE (U.S. CLS. 47 AND 49).

FIRST USE 2-0-2007; IN COMMERCE 2-0-2007.

ANNE E. GUSTASON, EXAMINING ATTORNEY

SN 77-889,009. PREMIUM BLEND, INC., HIALEAH, FL. FILED 12-8-2009.

SI NO ES DE ESPAÑA, NO ES SANGRIA

THE MARK CONSISTS OF STANDARD CHARACTERS WITHOUT CLAIM TO ANY PARTICULAR FONT, STYLE, SIZE, OR COLOR.

THE ENGLISH TRANSLATION OF "SI NO ES DE ESPAÑA, NO ES SANGRIA" IN THE MARK IS "IF IT'S NOT FROM SPAIN, IT'S NOT SANGRIA"

FOR ALCOHOLIC BEVERAGES EXCEPT BEERS; SANGRIA (U.S. CLS. 47 AND 49).

SHANNON TWOHIG, EXAMINING ATTORNEY

SN 77-889,011. PREMIUM BLEND, INC., HIALEAH, FL. FILED 12-8-2009.

IF IT'S NOT FROM SPAIN, IT'S NOT SANGRIA

THE MARK CONSISTS OF STANDARD CHARACTERS WITHOUT CLAIM TO ANY PARTICULAR FONT, STYLE, SIZE, OR COLOR.

FOR ALCOHOLIC BEVERAGES EXCEPT BEERS; SANGRIA (U.S. CLS. 47 AND 49).

SHANNON TWOHIG, EXAMINING ATTORNEY

CLASS 33—(Continued).

SN 77-889,346. DEVOTION SPIRITS, INC., SAN FRANCISCO, CA. FILED 12-9-2009.

DEVOTION

THE MARK CONSISTS OF STANDARD CHARACTERS WITHOUT CLAIM TO ANY PARTICULAR FONT, STYLE, SIZE, OR COLOR.

FOR SPIRITS (U.S. CLS. 47 AND 49).

FIRST USE 11-6-2009; IN COMMERCE 11-6-2009.

BARBARA A. GOLD, EXAMINING ATTORNEY

SN 77-890,071. TRUMBULL-HART, LLC, DBA TULPEN CELLARS, MILTON FREEWATER, OR. FILED 12-10-2009.

TULPEN CELLARS

THE MARK CONSISTS OF STANDARD CHARACTERS WITHOUT CLAIM TO ANY PARTICULAR FONT, STYLE, SIZE, OR COLOR.

NO CLAIM IS MADE TO THE EXCLUSIVE RIGHT TO USE "CELLARS", APART FROM THE MARK AS SHOWN.

THE ENGLISH TRANSLATION OF "TULPEN" IN THE MARK IS TULIP.

FOR WINES (U.S. CLS. 47 AND 49).

FIRST USE 9-10-2008; IN COMMERCE 10-20-2008.

FLORENTINA BLANDU, EXAMINING ATTORNEY

SN 77-890,605. E. & J. GALLO WINERY, MODESTO, CA. FILED 12-10-2009.

LA ANTONIA

THE MARK CONSISTS OF STANDARD CHARACTERS WITHOUT CLAIM TO ANY PARTICULAR FONT, STYLE, SIZE, OR COLOR.

FOR WINES (U.S. CLS. 47 AND 49).

MICHAEL GAFFAR, EXAMINING ATTORNEY

CLASS 33—(Continued).

SN 77-890,667. CRISPIN PORTER & BOGUSKY LLC, MIAMI, FL. FILED 12-10-2009.

ANGEL'S ENVY

THE MARK CONSISTS OF STANDARD CHARACTERS WITHOUT CLAIM TO ANY PARTICULAR FONT, STYLE, SIZE, OR COLOR.

FOR BOURBON (U.S. CLS. 47 AND 49).
JUSTINE D. PARKER, EXAMINING ATTORNEY

CLASS 33—(Continued).

SN 77-890,779. ROTH, ALBERT COKE, III, KNEWICK, WA. FILED 12-10-2009.

AURIC

THE MARK CONSISTS OF STANDARD CHARACTERS WITHOUT CLAIM TO ANY PARTICULAR FONT, STYLE, SIZE, OR COLOR.

FOR WINES (U.S. CLS. 47 AND 49).
THOMAS MANOR, EXAMINING ATTORNEY

SN 77-890,772. VINAGIUM, LLC, KNEWICK, WA. FILED 12-10-2009.

VINAGIUM

THE MARK CONSISTS OF STANDARD CHARACTERS WITHOUT CLAIM TO ANY PARTICULAR FONT, STYLE, SIZE, OR COLOR.

FOR WINES (U.S. CLS. 47 AND 49).
THOMAS MANOR, EXAMINING ATTORNEY

SN 77-890,821. ELVIS PRESLEY ENTERPRISES, INC., MEMPHIS, TN. FILED 12-10-2009.

JAILHOUSE ROCK

THE MARK CONSISTS OF STANDARD CHARACTERS WITHOUT CLAIM TO ANY PARTICULAR FONT, STYLE, SIZE, OR COLOR.

OWNER OF U.S. REG. NOS. 2,646,469, 3,238,136 AND OTHERS.
FOR WINE (U.S. CLS. 47 AND 49).
FIRST USE 12-31-2005; IN COMMERCE 12-31-2005.
MORGAN WYNNE, EXAMINING ATTORNEY

SN 77-890,778. LOWE PROFILE PRODUCTIONS, INC., BEVERLY HILLS, CA. FILED 12-10-2009.



THE MARK CONSISTS OF THE STYLIZED LETTERS "TBP" INSIDE OF AN OVAL SHAPE DESIGN.

FOR ALCOHOLIC BEVERAGES EXCEPT BEERS, NAMELY, WINE, DISTILLED LIQUOR, VODKA, RUM, TEQUILA, WINE COOLERS (U.S. CLS. 47 AND 49).
TINA MAI, EXAMINING ATTORNEY

SN 77-890,842. ELVIS PRESLEY ENTERPRISES, INC., MEMPHIS, TN. FILED 12-10-2009.

BLUE HAWAII

THE MARK CONSISTS OF STANDARD CHARACTERS WITHOUT CLAIM TO ANY PARTICULAR FONT, STYLE, SIZE, OR COLOR.

OWNER OF U.S. REG. NO. 3,331,963.
FOR WINE (U.S. CLS. 47 AND 49).
FIRST USE 12-31-2008; IN COMMERCE 12-31-2008.
MORGAN WYNNE, EXAMINING ATTORNEY

CLASS 33—(Continued).

SN 77-890,883. ELVIS PRESLEY ENTERPRISES, INC., MEMPHIS, TN. FILED 12-10-2009.

THE KING OF ROCK 'N ROLL

THE MARK CONSISTS OF STANDARD CHARACTERS WITHOUT CLAIM TO ANY PARTICULAR FONT, STYLE, SIZE, OR COLOR.

OWNER OF U.S. REG. NOS. 2,145,957, 2,895,756 AND 3,004,117.

FOR WINE (U.S. CLS. 47 AND 49).
MORGAN WYNNE, EXAMINING ATTORNEY

SN 77-891,050. VASSTROM, LEIF W, DBA SUPRA BRANDS GROUP, NAPA, CA. FILED 12-10-2009.

TELLUS

THE MARK CONSISTS OF STANDARD CHARACTERS WITHOUT CLAIM TO ANY PARTICULAR FONT, STYLE, SIZE, OR COLOR.

FOR PORT WINES; RED WINES; TABLE WINES; WHITE WINE; WINE; WINES; WINES AND LIQUEURS; WINES AND SPARKLING WINES (U.S. CLS. 47 AND 49).
TINA L. SNAPP, EXAMINING ATTORNEY

SN 77-891,195. BRONCO WINE COMPANY, CERES, CA. FILED 12-11-2009.

NAPA CROSSING

THE MARK CONSISTS OF STANDARD CHARACTERS WITHOUT CLAIM TO ANY PARTICULAR FONT, STYLE, SIZE, OR COLOR.

NO CLAIM IS MADE TO THE EXCLUSIVE RIGHT TO USE "NAPA", APART FROM THE MARK AS SHOWN.

FOR WINE (U.S. CLS. 47 AND 49).
SUSAN STIGLITZ, EXAMINING ATTORNEY

CLASS 33—(Continued).

SN 77-892,041. THE HESS COLLECTION WINERY, NAPA, CA. FILED 12-11-2009.



THE NAME(S), PORTRAIT(S), AND/OR SIGNATURE(S) SHOWN IN THE MARK DOES NOT IDENTIFY A PARTICULAR LIVING INDIVIDUAL.

THE MARK CONSISTS OF THE STYLIZED IMAGE OF A WOMAN WEARING A DIADEM ON HER HEAD AND STANDING ON A DUCK-SHAPED BOAT.

FOR WINES (U.S. CLS. 47 AND 49).
FIRST USE 2-1-2009; IN COMMERCE 2-1-2009.
ANN E. SAPPENFIELD, EXAMINING ATTORNEY

SN 77-892,140. CASTILLO DE FELICIANA VINEYARD AND WINERY, LLC, REDMOND, WA. FILED 12-12-2009.

CASTILLO DE FELICIANA

THE MARK CONSISTS OF STANDARD CHARACTERS WITHOUT CLAIM TO ANY PARTICULAR FONT, STYLE, SIZE, OR COLOR.

THE ENGLISH TRANSLATION OF "CASTILLO" IN THE MARK IS CASTLE. THE WORDING "FELICIANA" HAS NO MEANING IN A FOREIGN LANGUAGE.

FOR WINES (U.S. CLS. 47 AND 49).
FIRST USE 6-26-2009; IN COMMERCE 10-3-2009.
ALICIA COLLINS, EXAMINING ATTORNEY

SN 77-892,727. FERRARI-CARANO VINEYARDS AND WINERY, LLC, HEALDSBURG, CA. FILED 12-14-2009.

BELLA LUCE

THE MARK CONSISTS OF STANDARD CHARACTERS WITHOUT CLAIM TO ANY PARTICULAR FONT, STYLE, SIZE, OR COLOR.

THE ENGLISH TRANSLATION OF "BELLA LUCE" IN THE MARK IS BEAUTIFUL LIGHT.

FOR WINES (U.S. CLS. 47 AND 49).
GEORGE LORENZO, EXAMINING ATTORNEY

CLASS 33—(Continued).

SN 77-893,950. E. & J. GALLO WINERY, MODESTO, CA.
FILED 12-15-2009.

E&J ON PLAY

THE MARK CONSISTS OF STANDARD CHARACTERS
WITHOUT CLAIM TO ANY PARTICULAR FONT, STYLE,
SIZE, OR COLOR.

OWNER OF U.S. REG. NOS. 1,054,058 AND 2,058,297.
FOR BRANDY (U.S. CLS. 47 AND 49).
MICHAEL GAAFAR, EXAMINING ATTORNEY

CLASS 33—(Continued).

SN 77-899,428. MORAIS VINEYARDS AND WINERY, INC.,
BEALETON, VA. FILED 12-22-2009.



THE MARK CONSISTS OF A WREATH OF BRANCHES
ENCIRCLING THE LETTERS "MV".
FOR WINES (U.S. CLS. 47 AND 49).
DOMINIC J. FERRAIUOLO, EXAMINING ATTORNEY

SN 77-894,099. LA FIRMA GROUP, SANTA PAULA, CA.
FILED 12-15-2009.



THE MARK CONSISTS OF IMAGE OF A QUILL WITH
INK DROPS BELOW THE POINT OF THE QUILL.
FOR TEQUILA (U.S. CLS. 47 AND 49).
DAVID MILLER, EXAMINING ATTORNEY

SN 77-901,807. THE WINE GROUP LLC, TRACY, CA. FILED
12-28-2009.



SN 77-899,079. INVERSIONES COUSINO MACUL S.A.,
PEÑALOLÉN, SANTIAGO, CHILE, FILED 12-22-2009.

MACUL

THE MARK CONSISTS OF STANDARD CHARACTERS
WITHOUT CLAIM TO ANY PARTICULAR FONT, STYLE,
SIZE, OR COLOR.

OWNER OF CHILE REG. NO. 516759, DATED 6-15-1998,
EXPIRES 6-15-2018.

OWNER OF U.S. REG. NO. 1,527,277.
FOR WINES (U.S. CLS. 47 AND 49).

JOHN DWYER, EXAMINING ATTORNEY

NO CLAIM IS MADE TO THE EXCLUSIVE RIGHT TO
USE "VINEYARDS" OR "CHARDONNAY 2005 CENTRAL
COAST", APART FROM THE MARK AS SHOWN.

THE MARK CONSISTS OF A BOX SHAPE ENCLOSING
THE DESIGN OF A STYLIZED CUPCAKE OVER A CREST
COMPOSED OF RIBBONS AND LEAVES. THE CREST
APPEARS OVER THE WORDS "CUPCAKE VINEYARDS
ANGEL'S FOOD CHARDONNAY 2005 CENTRAL COAST"
IN A STYLIZED SCRIPT.

FOR WINE (U.S. CLS. 47 AND 49).

MICHAEL ENGEL, EXAMINING ATTORNEY

CLASS 33—(Continued).

SN 77-906,211. AZIENDA AGRICOLA GIUSEPPE MASCARELLO E FIGLIO DI MAURO MASCARELLO E C., S.S., CASTIGLIONE FALLETTO, ITALY, FILED 1-6-2010.

CA' D'MORISSIO

THE MARK CONSISTS OF STANDARD CHARACTERS WITHOUT CLAIM TO ANY PARTICULAR FONT, STYLE, SIZE, OR COLOR.

THE WORDING "CA' D'MORISSIO" HAS NO MEANING IN A FOREIGN LANGUAGE.
FOR WINES (U.S. CLS. 47 AND 49).
FIRST USE 4-27-2001; IN COMMERCE 4-27-2001.
KAREN BRACEY, EXAMINING ATTORNEY

CLASS 33—(Continued).

SN 77-907,048. JOHN A. LASSETER AND NANCY T. LASSETER, TRUSTEES OF THE LASSETER LIVING TRUST, GLEN ELLEN, CA. FILED 1-7-2010.

BRICOLAGE

THE MARK CONSISTS OF STANDARD CHARACTERS WITHOUT CLAIM TO ANY PARTICULAR FONT, STYLE, SIZE, OR COLOR.

THE ENGLISH TRANSLATION OF "BRICOLAGE" IN THE MARK IS AN ASSEMBLAGE OF FOUND MATERIALS.
FOR WINES (U.S. CLS. 47 AND 49).
LINDA POWELL, EXAMINING ATTORNEY

SN 77-907,006. JOHN A. LASSETER AND NANCY T. LASSETER, TRUSTEES OF THE LASSETER LIVING TRUST, GLEN ELLEN, CA. FILED 1-7-2010.

MESMERISER

THE MARK CONSISTS OF STANDARD CHARACTERS WITHOUT CLAIM TO ANY PARTICULAR FONT, STYLE, SIZE, OR COLOR.

THE ENGLISH TRANSLATION OF "MESMERISER" IN THE MARK IS MESMERIZE.
FOR WINES (U.S. CLS. 47 AND 49).
LINDA POWELL, EXAMINING ATTORNEY

SN 77-908,042. CATENA, ERNESTO, BUENOS AIRES, ARGENTINA, FILED 1-8-2010.

NAKBÉ

THE MARK CONSISTS OF STANDARD CHARACTERS WITHOUT CLAIM TO ANY PARTICULAR FONT, STYLE, SIZE, OR COLOR.

THE WORDING "NAKBÉ" HAS NO MEANING IN A FOREIGN LANGUAGE.
FOR WINES (U.S. CLS. 47 AND 49).
ESTHER BELENKER, EXAMINING ATTORNEY

SN 77-907,030. JOHN A. LASSETER AND NANCY T. LASSETER, TRUSTEES OF THE LASSETER LIVING TRUST, GLEN ELLEN, CA. FILED 1-7-2010.

RAVISSANT

THE MARK CONSISTS OF STANDARD CHARACTERS WITHOUT CLAIM TO ANY PARTICULAR FONT, STYLE, SIZE, OR COLOR.

THE ENGLISH TRANSLATION OF "RAVISSANT" IN THE MARK IS LOVELY.
FOR WINES (U.S. CLS. 47 AND 49).
LINDA POWELL, EXAMINING ATTORNEY

SN 77-909,383. WINE SCOUT INTERNATIONAL, NAPA, CA. FILED 1-11-2010.

BOUNTY HUNTER BLEND

THE MARK CONSISTS OF STANDARD CHARACTERS WITHOUT CLAIM TO ANY PARTICULAR FONT, STYLE, SIZE, OR COLOR.

OWNER OF U.S. REG. NOS. 2,311,360, 3,571,812 AND OTHERS.
NO CLAIM IS MADE TO THE EXCLUSIVE RIGHT TO USE "BLEND", APART FROM THE MARK AS SHOWN.
FOR ALCOHOLIC BEVERAGES EXCEPT BEERS (U.S. CLS. 47 AND 49).
HELENE LIWINSKI, EXAMINING ATTORNEY

CLASS 33—(Continued).

SN 77-911,950. BRONCO WINE COMPANY, CERES, CA.
FILED 1-14-2010.

COTTON WOOD CREEK

THE MARK CONSISTS OF STANDARD CHARACTERS
WITHOUT CLAIM TO ANY PARTICULAR FONT, STYLE,
SIZE, OR COLOR.
FOR WINE (U.S. CLS. 47 AND 49).
SUSAN STIGLITZ, EXAMINING ATTORNEY

SN 77-913,356. WASABE BEVERAGES INC, OAKLAND, CA.
FILED 1-15-2010.

THINK GREEN. GO BLUE.

THE MARK CONSISTS OF STANDARD CHARACTERS
WITHOUT CLAIM TO ANY PARTICULAR FONT, STYLE,
SIZE, OR COLOR.
NO CLAIM IS MADE TO THE EXCLUSIVE RIGHT TO
USE "GREEN", APART FROM THE MARK AS SHOWN.
FOR DISTILLED SPIRITS; DISTILLED SPIRITS OF
RICE (AWAMORI); GIN; POTABLE SPIRITS; SAKE;
SPIRITS; SPIRITS AND LIQUEURS; VODKA (U.S. CLS.
47 AND 49).
KRISTIN CARLSON, EXAMINING ATTORNEY

SN 77-917,454. SODA CANYON LLC, DBA RIVERA VINE-
YARDS, WALNUT CREEK, CA. FILED 1-22-2010.

Magnanimous

THE MARK CONSISTS OF STANDARD CHARACTERS
WITHOUT CLAIM TO ANY PARTICULAR FONT, STYLE,
SIZE, OR COLOR.
FOR STILL WINES (U.S. CLS. 47 AND 49).
SUSAN RICHARDS, EXAMINING ATTORNEY

CLASS 33—(Continued).

SN 77-918,517. O'NEILL BEVERAGE CO., LTD., PARLIER,
CA. FILED 1-22-2010.

BACK STORY

THE MARK CONSISTS OF STANDARD CHARACTERS
WITHOUT CLAIM TO ANY PARTICULAR FONT, STYLE,
SIZE, OR COLOR.
FOR WINE (U.S. CLS. 47 AND 49).
APRIL ROACH, EXAMINING ATTORNEY

SN 77-918,519. O'NEILL BEVERAGE CO., LTD., PARLIER,
CA. FILED 1-22-2010.

CLOUD BREAK

THE MARK CONSISTS OF STANDARD CHARACTERS
WITHOUT CLAIM TO ANY PARTICULAR FONT, STYLE,
SIZE, OR COLOR.
FOR WINE (U.S. CLS. 47 AND 49).
APRIL ROACH, EXAMINING ATTORNEY

SN 77-918,523. O'NEILL BEVERAGE CO., LTD., PARLIER,
CA. FILED 1-22-2010.

CURLYCUE

THE MARK CONSISTS OF STANDARD CHARACTERS
WITHOUT CLAIM TO ANY PARTICULAR FONT, STYLE,
SIZE, OR COLOR.
FOR WINE (U.S. CLS. 47 AND 49).
APRIL ROACH, EXAMINING ATTORNEY

SN 77-918,527. O'NEILL BEVERAGE CO., LTD., PARLIER,
CA. FILED 1-22-2010.

FIREBRAND

THE MARK CONSISTS OF STANDARD CHARACTERS
WITHOUT CLAIM TO ANY PARTICULAR FONT, STYLE,
SIZE, OR COLOR.
FOR WINE (U.S. CLS. 47 AND 49).
APRIL ROACH, EXAMINING ATTORNEY

CLASS 33—(Continued).

SN 77-918,532. O'NEILL BEVERAGE CO., LTD., PARLIER, CA. FILED 1-22-2010.

GOOSE CHASE

THE MARK CONSISTS OF STANDARD CHARACTERS WITHOUT CLAIM TO ANY PARTICULAR FONT, STYLE, SIZE, OR COLOR.
FOR WINE (U.S. CLS. 47 AND 49).
APRIL ROACH, EXAMINING ATTORNEY



SN 77-918,534. O'NEILL BEVERAGE CO., LTD., PARLIER, CA. FILED 1-22-2010.

GROUNDSWELL

THE MARK CONSISTS OF STANDARD CHARACTERS WITHOUT CLAIM TO ANY PARTICULAR FONT, STYLE, SIZE, OR COLOR.
FOR WINE (U.S. CLS. 47 AND 49).
APRIL ROACH, EXAMINING ATTORNEY



SN 77-918,538. O'NEILL BEVERAGE CO., LTD., PARLIER, CA. FILED 1-22-2010.

HANDSPRING

THE MARK CONSISTS OF STANDARD CHARACTERS WITHOUT CLAIM TO ANY PARTICULAR FONT, STYLE, SIZE, OR COLOR.
FOR WINE (U.S. CLS. 47 AND 49).
APRIL ROACH, EXAMINING ATTORNEY



SN 77-919,099. SUTTER HOME WINERY, INC., ST. HELENA, CA. FILED 1-25-2010.

PACIFIC HEIGHTS

THE MARK CONSISTS OF STANDARD CHARACTERS WITHOUT CLAIM TO ANY PARTICULAR FONT, STYLE, SIZE, OR COLOR.
FOR ALCOHOLIC BEVERAGES EXCEPT BEERS (U.S. CLS. 47 AND 49).
KIMBERLY PERRY, EXAMINING ATTORNEY

CLASS 33—(Continued).

SN 77-919,104. SUTTER HOME WINERY, INC., ST. HELENA, CA. FILED 1-25-2010.

SHADOW POND

THE MARK CONSISTS OF STANDARD CHARACTERS WITHOUT CLAIM TO ANY PARTICULAR FONT, STYLE, SIZE, OR COLOR.
FOR ALCOHOLIC BEVERAGES EXCEPT BEERS (U.S. CLS. 47 AND 49).
KIMBERLY PERRY, EXAMINING ATTORNEY



SN 77-920,960. HEAVEN HILL DISTILLERIES, INC., BARDS-TOWN, KY. FILED 1-27-2010.

FULTON'S HARVEST PUMPKIN PIE CREAM LIQUEUR

THE MARK CONSISTS OF STANDARD CHARACTERS WITHOUT CLAIM TO ANY PARTICULAR FONT, STYLE, SIZE, OR COLOR.
NO CLAIM IS MADE TO THE EXCLUSIVE RIGHT TO USE "CREAM LIQUEUR", APART FROM THE MARK AS SHOWN.
FOR LIQUEURS (U.S. CLS. 47 AND 49).
TRACY FLETCHER, EXAMINING ATTORNEY



SN 77-927,289. DEVOTION SPIRITS, INC., SAN FRANCISCO, CA. FILED 2-3-2010.

GET DEVOTED

THE MARK CONSISTS OF STANDARD CHARACTERS WITHOUT CLAIM TO ANY PARTICULAR FONT, STYLE, SIZE, OR COLOR.
FOR SPIRITS (U.S. CLS. 47 AND 49).
BARBARA A. GOLD, EXAMINING ATTORNEY

CLASS 33—(Continued).

SN 78-955,535. CBF, LLC, ALBUQUERQUE, NM. FILED 8-18-2006.

RED STATES WINERY

THE MARK CONSISTS OF STANDARD CHARACTERS WITHOUT CLAIM TO ANY PARTICULAR FONT, STYLE, SIZE, OR COLOR.

NO CLAIM IS MADE TO THE EXCLUSIVE RIGHT TO USE "WINERY", APART FROM THE MARK AS SHOWN.

FOR WINE (U.S. CLS. 47 AND 49).

BARBARA RUTLAND, EXAMINING ATTORNEY

SN 79-065,998. COCA SOLER, S.L., SPAIN, FILED 10-7-2008.



PRIORITY DATE OF 9-4-2008 IS CLAIMED.
OWNER OF INTERNATIONAL REGISTRATION 0995255
DATED 10-7-2008, EXPIRES 10-7-2018.

THE COLOR(S) GREEN, BLACK, GRAY, BLUE AND WHITE IS/ARE CLAIMED AS A FEATURE OF THE MARK.

THE MARK CONSISTS OF THE STYLIZED FACE OF A WOMAN DRINKING WINE FROM A STEMMED GLASS WITH THE TERM "ART" ABOVE THE TERM "PUR" ABOVE THE WINE IN THE GLASS. THE COLOR GREEN APPEARS IN THE WINE IN THE TERM "PUR"; THE COLOR BLACK APPEARS IN THE OUTLINE AROUND THE STEMMED GLASS, IN THE FACE OF THE WOMAN AND IN THE TERM "ART"; THE COLOR GRAY APPEARS IN THE SHADING IN THE GLASS AND IN THE SHADING ON THE WOMAN'S FACE; THE COLOR BLUE APPEARS IN THE SHADING ON THE TOP OF THE STEM OF THE GLASS; THE COLOR WHITE APPEARS IN THE WOMAN'S FACE.

THE ENGLISH TRANSLATION OF "PUR" IN THE MARK IS PUR.

FOR ALCOHOLIC BEVERAGES EXCEPT BEER (U.S. CLS. 47 AND 49).

MYRIAH HABEEB, EXAMINING ATTORNEY

CLASS 33—(Continued).

SN 79-068,544. DOUBLE EAGLE BRANDS 2 N.V., NETHERLAND ANTILLES, FILED 4-27-2009.

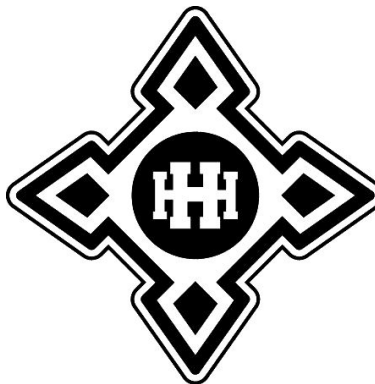

PRIORITY DATE OF 4-9-2009 IS CLAIMED.
OWNER OF INTERNATIONAL REGISTRATION 1002027
DATED 4-27-2009, EXPIRES 4-27-2019.

THE MARK CONSISTS OF A STYLIZED FOUR-POINT STAR WHEREIN EACH OF THE FOUR POINTS LOOKS SIMILAR TO AN ARROW HEAD AND IN THE CENTER OF EACH POINT IS A DIAMOND AND IN THE CENTER OF THE FOUR POINT STAR IS A CIRCLE WITH THE STYLIZED LETTERS "HH" OR "HHH" WHEREIN ONE LETTER "H" IS SUPERIMPOSED ON TOP OF A SECOND LETTER "H" THAT IS SHORTER AND WIDER.

FOR ALCOHOLIC BEVERAGES, EXCEPT BEERS (U.S. CLS. 47 AND 49).

MYRIAH HABEEB, EXAMINING ATTORNEY

SN 79-074,083. TENUTA SANTOME' DI SPINAZZE' ALAN, ITALY, FILED 9-22-2009.

SANTOME'

THE MARK CONSISTS OF STANDARD CHARACTERS WITHOUT CLAIM TO ANY PARTICULAR FONT, STYLE, SIZE, OR COLOR.

OWNER OF INTERNATIONAL REGISTRATION 1016543
DATED 9-22-2009, EXPIRES 9-22-2019.

OWNER OF U.S. REG. NO. 3,265,379.

SEC. 2(F).

FOR WINES (U.S. CLS. 47 AND 49).

TINA BROWN, EXAMINING ATTORNEY

SN 79-074,086. CANTINA SOCIALE MONTELLIANA E DEI COLLI ASOLANI; S.C.A., MONTEBELLUNA (TV), ITALY, FILED 9-11-2009.

MONTELLIANA

THE MARK CONSISTS OF STANDARD CHARACTERS WITHOUT CLAIM TO ANY PARTICULAR FONT, STYLE, SIZE, OR COLOR.

PRIORITY DATE OF 4-2-2009 IS CLAIMED.
OWNER OF INTERNATIONAL REGISTRATION 1016552
DATED 9-11-2009, EXPIRES 9-11-2019.

THE WORDS, "MONTELLIANA" OR "MONT ELLIANA", HAVE NO ENGLISH TRANSLATION AND NO MEANING IN A FOREIGN LANGUAGE.

FOR WINES (U.S. CLS. 47 AND 49).

BARBARA A. GOLD, EXAMINING ATTORNEY

CLASS 33—(Continued).

SN 79-074,088. CANTINA SOCIALE MONTELLIANA E DEI COLLI ASOLANI; S.C.A., ITALY, FILED 9-11-2009.

MONTASOLO

THE MARK CONSISTS OF STANDARD CHARACTERS WITHOUT CLAIM TO ANY PARTICULAR FONT, STYLE, SIZE, OR COLOR.

PRIORITY DATE OF 4-2-2009 IS CLAIMED.

OWNER OF INTERNATIONAL REGISTRATION 1016554 DATED 9-11-2009, EXPIRES 9-11-2019.

THE WORD "MONTASOLO" HAVE NO MEANING (AND THEREFORE CANNOT BE TRANSLATED).

FOR WINES (U.S. CLS. 47 AND 49).

BARBARA A. GOLD, EXAMINING ATTORNEY

CLASS 33—(Continued).

SN 79-076,055. DOMAINE DES BROIX S.A.S., FRANCE, FILED 10-15-2009.

SN 79-074,413. YONETSURU SAKE BREWERY CO., LTD., JAPAN, FILED 8-28-2009.

YONETSURU KAPPA

PRIORITY DATE OF 7-29-2009 IS CLAIMED.

OWNER OF INTERNATIONAL REGISTRATION 1017408 DATED 8-28-2009, EXPIRES 8-28-2019.

NO CLAIM IS MADE TO THE EXCLUSIVE RIGHT TO USE THE NON-LATIN CHARACTER TRANSLATED AS "RICE", APART FROM THE MARK AS SHOWN.

THE MARK COMPRISES THE WORDING "YONETSURU KAPPA" PRESENTED IN STYLIZED LATIN AND NON-LATIN FONTS. THE TERM "YONETSURU" IN THE MARK HAS NO PARTICULAR ENGLISH TRANSLATION BUT IS A COMBINATION OF THE JAPANESE WORDS "YONE," MEANING "RICE," AND "TSURU," MEANING "A CRANE." THE TERM "KAPPA" REFERS TO A TYPE OF WATER SPRITE IN JAPANESE FOLKLORE. THE LARGER NON-LATIN HIRAGANA CHARACTERS ON THE LEFT SIDE OF THE MARK FORM THE WORD "KAPPA" AND THE SMALLER KANJI CHARACTERS DEPICT THE WORDS "YONE" AND "TSURU."

THE TRANSLITERATION OF THE NON-LATIN CHARACTERS IN THE MARK IS "YONETSURU KAPPA".

FOR JAPANESE LIQUORS; SAKE (U.S. CLS. 47 AND 49).

STEVEN PEREZ, EXAMINING ATTORNEY

PRIORITY DATE OF 5-4-2009 IS CLAIMED.

OWNER OF INTERNATIONAL REGISTRATION 1021441 DATED 10-15-2009, EXPIRES 10-15-2019.

FOR ALCOHOLIC BEVERAGES, NAMELY, COGNAC, BRANDY, VODKA; HARD CIDERS; APERITIFS; ALCOHOL OR BRANDY BASED LIQUEURS AND SPIRITS AROMATIZED WITH FRUITS, BERRIES OR PLANTS; WINES; ALCOHOLIC EXTRACTS OR ESSENCES FROM FRUITS, BERRIES OR PLANTS (U.S. CLS. 47 AND 49).

RAUL CORDOVA, EXAMINING ATTORNEY

CLASS 34—SMOKERS' ARTICLES

SN 76-700,878. NEW HAMPSHIRE CIGARS LLC, MANCHESTER, NH. FILED 12-16-2009.

END OF DAYS

THE MARK CONSISTS OF STANDARD CHARACTERS WITHOUT CLAIM TO ANY PARTICULAR FONT, STYLE, SIZE, OR COLOR.

FOR CIGARS AND CIGAR ACCESSORIES, NAMELY, CIGAR BOXES, CIGAR CASES, CIGAR CUTTERS, CIGAR HOLDERS, CIGAR LIGHTERS, CIGAR TUBES, AND CIGAR HUMIDIFIERS (U.S. CLS. 2, 8, 9 AND 17).

LINDA E. BLOHM, EXAMINING ATTORNEY

CLASS 34—(Continued).

SN 77-274,239. TIERNEY LOGISTICS LLC, KING OF PRUSSIA, PA. FILED 9-7-2007.

ABANDERO

THE MARK CONSISTS OF STANDARD CHARACTERS WITHOUT CLAIM TO ANY PARTICULAR FONT, STYLE, SIZE, OR COLOR.

AN ENGLISH TRANSLATION OF THE WORD "ABANDERO" IS TAKE A LEADING ROLE, CHAMPION A CAUSE, REGISTER.

FOR CIGARS, TOBACCO, CIGAR BOXES, CIGAR HOLDERS NOT OF PRECIOUS METAL, ASHTRAYS, CIGAR CUTTERS, HUMIDORS AND CIGAR TUBES (U.S. CLS. 2, 8, 9 AND 17).

AMY C. KEAN, EXAMINING ATTORNEY

SN 77-315,970. MASRI, RODNEY, STATESBORO, GA. FILED 10-29-2007.

DUKES

THE MARK CONSISTS OF STANDARD CHARACTERS WITHOUT CLAIM TO ANY PARTICULAR FONT, STYLE, SIZE, OR COLOR.

FOR SMOKELESS TOBACCO (U.S. CLS. 2, 8, 9 AND 17).

FIRST USE 7-1-2007; IN COMMERCE 7-1-2007.

MARLENE BELL, EXAMINING ATTORNEY

SN 77-400,005. TABACOS MATA FINA INDUSTRIA E COMERCIO DE CHARUTOS LTDA., CENTRO-CRUZ DAS ALMAS, BRAZIL, FILED 2-19-2008.

MONTE PASCOAL

THE MARK CONSISTS OF STANDARD CHARACTERS WITHOUT CLAIM TO ANY PARTICULAR FONT, STYLE, SIZE, OR COLOR.

PRIORITY CLAIMED UNDER SEC. 44(D) ON BRAZIL APPLICATION NO. 900453141, FILED 8-17-2007, REG. NO. 900453141, DATED 8-17-2007, EXPIRES 8-17-2017.

THE FOREIGN WORDING IN THE MARK TRANSLATES INTO ENGLISH AS MOUNT EASTER.

FOR CIGARS, CIGARILLOS, MATCHES, CIGARETTE LIGHTERS NOT FOR LAND VEHICLES, CIGARETTE LIGHTERS NOT OF PRECIOUS METAL, CIGAR HUMIDORS, ASHTRAYS AND CIGAR CUTTERS (U.S. CLS. 2, 8, 9 AND 17).

NAKIA HENRY, EXAMINING ATTORNEY

CLASS 34—(Continued).

SN 77-641,731. GREEN SMOKE, INC., DBA GREEN SMOKE, AVENTURA, FL. FILED 12-30-2008.

Green Smoke

THE MARK CONSISTS OF STANDARD CHARACTERS WITHOUT CLAIM TO ANY PARTICULAR FONT, STYLE, SIZE, OR COLOR.

SEC. 2(F).

FOR ELECTRONIC CIGARETTES THAT EMIT VAPOR AND REDUCE HARM TO THE ENVIRONMENT (U.S. CLS. 2, 8, 9 AND 17).

FIRST USE 11-4-2004; IN COMMERCE 11-4-2004.

BERYL GARDNER, EXAMINING ATTORNEY

SN 77-734,831. ITC LIMITED, KOLKATA, INDIA, FILED 5-12-2009.



OWNER OF U.S. REG. NOS. 2,780,585 AND 2,795,949.
NO CLAIM IS MADE TO THE EXCLUSIVE RIGHT TO USE "LIGHTS BOX", "FILTER KINGS", "IMPECCABLE BLEND OF EXCLUSIVE TOBACCOS", "20 CLASS A CIGARETTES" AND "CLASSIC", APART FROM THE MARK AS SHOWN.

THE COLOR(S) RED, GOLD AND BLUE IS/ARE CLAIMED AS A FEATURE OF THE MARK.

THE MARK CONSISTS OF THE DESIGN OF THE FRONT OF A CIGARETTE PACKAGE CONSISTING OF A BLUE RECTANGLE WITH A GOLD AND RED CREST COMPRISING OF TWO LION DESIGNS IN GOLD TO THE LEFT AND RIGHT OF A SHIELD THAT IS OUTLINED IN GOLD AND HAS A LETTER "C" IN GOLD AGAINST A RED BACKGROUND, A CROWN ABOVE IT AND A BANNER BELOW IT, ALL IN GOLD, OVER THE WORDING "LIGHTS BOX" IN GOLD, OVER A GOLD LINE, OVER THE WORDING "ROYALE CLASSIC" IN GOLD, WHERE THE WORD "CLASSIC" IS UNDERLINED BY A GOLD LINE, OVER THE WORDING "IMPECCABLE BLEND OF EXCLUSIVE TOBACCOS" IN GOLD WITH THE WORDING "20 CLASS A CIGARETTES" IN GOLD AT THE BOTTOM OF THE BLUE RECTANGLE. TO THE LEFT OF THE BLUE RECTANGLE IS A GOLD RECTANGLE SAID RECTANGLE VERTICALLY DISPLAYING THE WORDS "FILTER KINGS" IN DARKER GOLD. THE DOTTED OUTLINE IS INTENDED TO SHOW THE POSITION OF THE MARK ON THE FRONT OF A CIGARETTE PACKAGE AND IS NOT PART OF THE MARK.

FOR CIGARETTES (U.S. CLS. 2, 8, 9 AND 17).

SARA THOMAS, EXAMINING ATTORNEY

CLASS 34—(Continued).

SN 77-809,914. FRIEDMAN & KLINGE CIGAR COMPANY, ST. LOUIS, MO. FILED 8-21-2009.



NO CLAIM IS MADE TO THE EXCLUSIVE RIGHT TO USE "HECHO A MANO" AND "NICARAGUA", APART FROM THE MARK AS SHOWN.

THE COLOR(S) RED, BLACK, WHITE, BLUE, GOLD AND GRAY IS/ARE CLAIMED AS A FEATURE OF THE MARK.

THE MARK CONSISTS OF A CIRCULAR DESIGN OF A WHITE COLOR SPANISH STYLE BUILDING LOOKING OVER A PORT WITH BOATS IN WHITE AND BLACK ON BLUE WATER WITH GRAY MOUNTAINS BEYOND THAT ON THE HORIZON. THE CIRCLE DRAWING HAS A GOLD SCROLL AROUND IT AND A RED PATTERN BACKGROUND. THE BACKGROUND IS SHOWN IN DOTTED LINES WITHOUT REGARD TO ANY SHAPE OF THE BACKGROUND. THE WORDING IS ALL IN WHITE, WITH THE WORD "COSTA" ABOVE THE DESIGN, THE WORD "BLANCA" BELOW THE DESIGN, WITH "HECHO A MANO" TO THE LEFT OF THE DESIGN AND "NICARAGUA" TO THE RIGHT OF THE DESIGN WITH A HORIZONTAL GOLD LINE INTERSPERSED AMONG THE WORDS TO THE LEFT AND RIGHT OF THE DESIGN. BELOW THE WORD "BLANCA" IS THE WORDING "INSPIRADO POR LA COSTA DE ESPAÑA" IN THE COLOR WHITE.

THE ENGLISH TRANSLATION OF "COSTA BLANCA", "HECHO A MANO", AND "INSPIRADO POR LA COSTA DE ESPAÑA" IS "WHITE COAST" AND "HANDMADE" AND "INSPIRED BY THE COAST OF SPAIN".

FOR CIGARS HAND MADE IN NICARAGUA (U.S. CLS. 2, 8, 9 AND 17).

FIRST USE 8-9-2009; IN COMMERCE 8-9-2009.
LINDA POWELL, EXAMINING ATTORNEY

SN 77-811,184. FAIRMONT HOLDINGS, INC., DANIA, FL. FILED 8-24-2009.

Alec Bradley Mundial

THE MARK CONSISTS OF STANDARD CHARACTERS WITHOUT CLAIM TO ANY PARTICULAR FONT, STYLE, SIZE, OR COLOR.

THE NAME(S), PORTRAIT(S), AND/OR SIGNATURE(S) SHOWN IN THE MARK DOES NOT IDENTIFY A PARTICULAR LIVING INDIVIDUAL.

THE ENGLISH TRANSLATION OF "MUNDIAL" IN THE MARK IS "WORLD."

FOR CIGARS, TOBACCO, CIGAR BOXES AND CIGAR TUBES (U.S. CLS. 2, 8, 9 AND 17).

FIRST USE 5-1-2009; IN COMMERCE 5-1-2009.
LINDA MICKLEBURGH, EXAMINING ATTORNEY

CLASS 34—(Continued).

SN 77-841,672. SWEDISH MATCH NORTH EUROPE AB, STOCKHOLM, SWEDEN, FILED 10-5-2009.



PRIORITY CLAIMED UNDER SEC. 44(D) ON SWEDEN APPLICATION NO. 2009/07412, FILED 9-25-2009.

PRIORITY CLAIMED UNDER SEC. 44(D) ON SWEDEN APPLICATION NO. 2009/07412, FILED 9-25-2009.

OWNER OF SWEDEN REG. NO. 408283, DATED 12-11-2009, EXPIRES 12-11-2019.

THE COLOR(S) BLACK AND RED IS/ARE CLAIMED AS A FEATURE OF THE MARK.

THE MARK CONSISTS OF THE NUMERALS 0102 WHEREIN 01 IS THE COLOR BLACK AND 02 IS THE COLOR RED.

FOR TOBACCO; MATCHES; TOBACCO SUBSTITUTES NOT FOR MEDICAL PURPOSES; SNUFF AND TOBACCO ALTERNATIVES IN THE FORM OF PRODUCTS BASED ON VEGETABLE FIBERS FOR ORAL USE, NOT FOR CONSUMPTION; SNUFF; TOBACCO FREE SNUFF; HERBAL SNUFF (U.S. CLS. 2, 8, 9 AND 17).

TARAH HARDY, EXAMINING ATTORNEY

SN 77-887,560. U.S. SMOKELESS TOBACCO MANUFACTURING COMPANY LLC, NASHVILLE, TN. FILED 12-7-2009.



OWNER OF U.S. REG. NOS. 504,609, 2,086,020 AND 2,523,910.

THE MARK CONSISTS OF AN IRREGULAR SHAPED OVAL WITH THE WORD "SKOAL" LOCATED ACROSS THE MIDDLE.

FOR SMOKELESS TOBACCO (U.S. CLS. 2, 8, 9 AND 17).

FIRST USE 11-6-2007; IN COMMERCE 11-11-2007.
NICHOLAS COLEMAN, EXAMINING ATTORNEY

CLASS 34—(Continued).

SN 77-888,909. SWISHER INTERNATIONAL, INC., JACKSONVILLE, FL. FILED 12-8-2009.

YOUR SWEET TIMES START HERE

THE MARK CONSISTS OF STANDARD CHARACTERS WITHOUT CLAIM TO ANY PARTICULAR FONT, STYLE, SIZE, OR COLOR.

FOR CIGARS (U.S. CLS. 2, 8, 9 AND 17).
FIRST USE 4-3-2009; IN COMMERCE 4-3-2009.
MIDGE BUTLER, EXAMINING ATTORNEY

SN 77-889,547. C.A.T. TOBACCO CORP., AKA TORAÑO CIGARS, MIAMI, FL. FILED 12-9-2009.

MASTER BY CARLOS TORAÑO

THE MARK CONSISTS OF STANDARD CHARACTERS WITHOUT CLAIM TO ANY PARTICULAR FONT, STYLE, SIZE, OR COLOR.

OWNER OF U.S. REG. NOS. 2,064,589, 3,127,301 AND OTHERS.

THE NAME(S), PORTRAIT(S), AND/OR SIGNATURE(S) SHOWN IN THE MARK IDENTIFIES "CARLOS TORAÑO", WHOSE CONSENT(S) TO REGISTER IS MADE OF RECORD.

FOR CIGARS (U.S. CLS. 2, 8, 9 AND 17).
JILL PRATER, EXAMINING ATTORNEY

SN 77-891,654. NIKOLAZZI ENTERPRISES LLC, LOS ANGELES, CA. FILED 12-11-2009.



NO CLAIM IS MADE TO THE EXCLUSIVE RIGHT TO USE "SMOKE", APART FROM THE MARK AS SHOWN.

THE MARK CONSISTS OF A KNIGHT CHESS PIECE. THERE IS A CIRCLE AROUND THE KNIGHT IN A GREEK GEOMETRIC DESIGN. AROUND THE OUTER OF THE CIRCLE THERE IS A LAURAL WREATH. ON TOP OF THE CIRCLE THERE IS THE STYLIZED TEXT "ROBO SMOKE".

FOR ELECTRONIC CIGARETTES; ELECTRONIC CIGARS; ELECTRONIC SMOKING PIPES (U.S. CLS. 2, 8, 9 AND 17).

H. M. FISHER, EXAMINING ATTORNEY

CLASS 34—(Continued).

SN 77-892,096. BROWN LEAF CIGAR CO., DAVIE, FL. FILED 12-12-2009.

Torero

THE MARK CONSISTS OF STANDARD CHARACTERS WITHOUT CLAIM TO ANY PARTICULAR FONT, STYLE, SIZE, OR COLOR.

THE ENGLISH TRANSLATION OF "TORERO" IN THE MARK IS BULLFIGHTER.

FOR TOBACCO PRODUCTS, NAMELY, CIGARS (U.S. CLS. 2, 8, 9 AND 17).

JILL PRATER, EXAMINING ATTORNEY

SN 77-892,139. CHEROKEE TOBACCO COMPANY, LLC, SOUTH BOSTON, VA. FILED 12-12-2009.

HAPPY VALLEY

THE MARK CONSISTS OF STANDARD CHARACTERS WITHOUT CLAIM TO ANY PARTICULAR FONT, STYLE, SIZE, OR COLOR.

FOR CIGARETTES AND OTHER TOBACCO PRODUCTS, NAMELY, CIGARS, ROLL-YOUR-OWN TOBACCO, PIPE TOBACCO, CHEWING TOBACCO AND SMOKELESS TOBACCO (U.S. CLS. 2, 8, 9 AND 17).

MICHAEL LITZAU, EXAMINING ATTORNEY

SN 77-892,639. THOMPSON & CO. OF TAMPA, INC., TAMPA, FL. FILED 12-14-2009.

EXPLORER

THE MARK CONSISTS OF STANDARD CHARACTERS WITHOUT CLAIM TO ANY PARTICULAR FONT, STYLE, SIZE, OR COLOR.

FOR CIGARS (U.S. CLS. 2, 8, 9 AND 17).

JUSTINE D. PARKER, EXAMINING ATTORNEY

CLASS 34—(Continued).

SN 77-900,252. CIGARS INTERNATIONAL, INC., BATH, PA. FILED 12-23-2009.

MARK TWAIN

THE MARK CONSISTS OF STANDARD CHARACTERS WITHOUT CLAIM TO ANY PARTICULAR FONT, STYLE, SIZE, OR COLOR.
FOR CIGARS (U.S. CLS. 2, 8, 9 AND 17).
REBECCA POVARCHUK, EXAMINING ATTORNEY

SN 77-901,579. U.S. SMOKELESS TOBACCO MANUFACTURING COMPANY LLC, NASHVILLE, TN. FILED 12-28-2009.

SKOAL UP

THE MARK CONSISTS OF STANDARD CHARACTERS WITHOUT CLAIM TO ANY PARTICULAR FONT, STYLE, SIZE, OR COLOR.
OWNER OF U.S. REG. NOS. 504,609, 1,344,928 AND OTHERS.
FOR SMOKELESS TOBACCO (U.S. CLS. 2, 8, 9 AND 17).
NICHOLAS COLEMAN, EXAMINING ATTORNEY

SN 77-923,152. CIGARS INTERNATIONAL, INC., BATH, PA. FILED 1-29-2010.

RED EYE

THE MARK CONSISTS OF STANDARD CHARACTERS WITHOUT CLAIM TO ANY PARTICULAR FONT, STYLE, SIZE, OR COLOR.
FOR CIGARS (U.S. CLS. 2, 8, 9 AND 17).
REBECCA POVARCHUK, EXAMINING ATTORNEY

CLASS 34—(Continued).

SN 79-076,147. JOH. WILH. VON EICKEN GMBH, 23556 LÜBECK, FED REP GERMANY, FILED 7-23-2009.

One Million

THE MARK CONSISTS OF STANDARD CHARACTERS WITHOUT CLAIM TO ANY PARTICULAR FONT, STYLE, SIZE, OR COLOR.
OWNER OF INTERNATIONAL REGISTRATION 1021685 DATED 7-23-2009, EXPIRES 7-23-2019.
FOR TOBACCO: TOBACCO PRODUCTS, NAMELY, CIGARETTES, CIGARILLOS, CIGARS, SMOKING TOBACCO, WATER PIPE TOBACCO, SNUFF, CIGARETTES PAPER; SMOKER'S ARTICLES, NAMELY, LIGHTERS, ASHTRAYS (U.S. CLS. 2, 8, 9 AND 17).
EUGENIA MARTIN, EXAMINING ATTORNEY

SERVICE MARKS

CLASS 35—ADVERTISING AND BUSINESS

SN 76-689,033. SERAPHIN BUSINESS AND INCOME TAX SERVICE, INC., BROOKLYN, NY. FILED 4-25-2008.

YOU RELAX WHILE WE DO THE TAX LOVED BY MILLIONS

THE MARK CONSISTS OF STANDARD CHARACTERS WITHOUT CLAIM TO ANY PARTICULAR FONT, STYLE, SIZE, OR COLOR.
FOR ACCOUNTING SERVICES; BUSINESS MANAGEMENT; COMPUTERIZED ACCOUNTING SERVICES; CONSULTING AND INFORMATION CONCERNING ACCOUNTING; COST ACCOUNTING BUSINESS INFORMATION AND ACCOUNTING ADVISORY SERVICES; BUSINESS MANAGEMENT; CONSULTATION; BUSINESS AUDITING; BOOKKEEPING; BOOKKEEPING FOR ELECTRONIC FUNDS TRANSFER; SHAREHOLDER RECORD KEEPING SERVICES; TAX FILING SERVICES; TAX PREPARATION; ADVISORY SERVICES RELATING TO BUSINESS MANAGEMENT AND BUSINESS OPERATIONS; BUSINESS MANAGEMENT FOR A TRADE COMPANY AND FOR A SERVICE COMPANY; CUSTOMER SERVICE MANAGEMENT FOR OTHERS; BUSINESS PLANNING; PROVIDING PUBLIC SECTOR CHANNEL STRATEGY DEVELOPMENT AND MANAGEMENT SERVICES; RECORDS MANAGEMENT SERVICES, NAMELY, DOCUMENT INDEXING FOR OTHERS; BUSINESS MANAGEMENT INFORMATION ON A WIDE VARIETY OF TOPICS TO SERVICE PROVIDING PROFESSIONALS; CONSULTING SERVICES IN BUSINESS LEADERSHIP DEVELOPMENT AND BUSINESS MANAGEMENT; INFORMATION, ADVISORY AND CONSULTANCY SERVICES RELATING TO BUSINESS AND MANAGEMENT OR BUSINESS ADMINISTRATION, INCLUDING SUCH SERVICES PROVIDED ON LINE OR VIA THE INTERNET (U.S. CLS. 100, 101 AND 102).
FIRST USE 10-1-2007; IN COMMERCE 10-1-2007.
DOMINICK J. SALEMI, EXAMINING ATTORNEY

CLASS 35—(Continued).

SN 76-697,891. SWEET QUARTET LLC, ACTON, MA. FILED 6-12-2009.

FREQUENT BITER

THE MARK CONSISTS OF STANDARD CHARACTERS WITHOUT CLAIM TO ANY PARTICULAR FONT, STYLE, SIZE, OR COLOR.

FOR ARRANGING AND CONDUCTING AN INCENTIVE AWARD PROGRAM TO PROMOTE THE SALE OF FOODS AND DRINKS, ADVERTISING SERVICES (U.S. CLS. 100, 101 AND 102).

KATHERINE CHANG, EXAMINING ATTORNEY

CLASS 35—(Continued).

SN 76-700,417. BLUMNER, BETHBRYCE CONWAY, BOGOTA, NJ. FILED 11-18-2009.

COGNITIVOLOGY

THE MARK CONSISTS OF STANDARD CHARACTERS WITHOUT CLAIM TO ANY PARTICULAR FONT, STYLE, SIZE, OR COLOR.

FOR PUBLIC ADVOCACY TO PROMOTE AWARENESS OF INTEGRATED HUMAN DEVELOPMENT BASED ON THREE COGNITIVE PROCESSES OF KNOWLEDGE (U.S. CLS. 100, 101 AND 102).

FIRST USE 7-8-2009; IN COMMERCE 7-8-2009.
MICHELE SWAIN, EXAMINING ATTORNEY

SN 76-697,924. WALLINGFORD SALES COMPANY, BENTONVILLE, AR. FILED 6-15-2009.



OWNER OF U.S. REG. NO. 2,947,483.

THE MARK CONSISTS OF THE LETTERS "WSC" WITHIN TWO CONCENTRIC CIRCLES. WATER DROPLETS APPEAR ABOVE THE LETTERS, A SWIRL DESIGN APPEARS BELOW THE LETTERS, AND A BRIGHT REFLECTION APPEARS IN THE TOP RIGHT OF THE CIRCLE DESIGN.

FOR WHOLESALE AND RETAIL STORE SERVICES, AND ON-LINE RETAIL STORE SERVICES FEATURING PLUMBING PRODUCTS (U.S. CLS. 100, 101 AND 102).

FIRST USE 3-20-2009; IN COMMERCE 3-20-2009.
JAMES STEIN, EXAMINING ATTORNEY

SN 76-699,431. OJEDA, NEIT, MIAMI, FL. FILED 9-14-2009.

TIME IS GOLD

THE MARK CONSISTS OF STANDARD CHARACTERS WITHOUT CLAIM TO ANY PARTICULAR FONT, STYLE, SIZE, OR COLOR.

NO CLAIM IS MADE TO THE EXCLUSIVE RIGHT TO USE "GOLD", APART FROM THE MARK AS SHOWN.

FOR PURCHASING GOLD FOR OTHERS; RETAIL STORE SERVICES FEATURING GOLD (U.S. CLS. 100, 101 AND 102).

ARETHA SOMERVILLE, EXAMINING ATTORNEY

SN 76-700,490. AOL INC., DULLES, VA. FILED 11-20-2009.

SEED

THE MARK CONSISTS OF STANDARD CHARACTERS WITHOUT CLAIM TO ANY PARTICULAR FONT, STYLE, SIZE, OR COLOR.

FOR PROMOTION OF ONLINE PUBLISHING OPPORTUNITIES (U.S. CLS. 100, 101 AND 102).

VIVIAN MICZNIK FIRST, EXAMINING ATTORNEY

SN 76-700,936. TENNESSEE DEPARTMENT OF TOURIST DEVELOPMENT, NASHVILLE, TN. FILED 12-22-2009.



OWNER OF U.S. REG. NOS. 3,021,992 AND 3,245,966.
NO CLAIM IS MADE TO THE EXCLUSIVE RIGHT TO USE "NASHVILLE'S TRACE" AND "TENNESSEE TRAIL & BYWAY", APART FROM THE MARK AS SHOWN.

THE COLOR(S) BLACK, ORANGE, RED, AND TAN IS/ ARE CLAIMED AS A FEATURE OF THE MARK.

THE MARK CONSISTS OF THE WORDING "NASHVILLE'S TRACE" IN STYLIZED FORMAT OVER A CIRCLE AND MUSICAL NOTE DESIGN, WITH THE WORDS "BACKSTAGE TO BACKROADS" IN STYLIZED FORMAT BETWEEN TWO LINES, AND ALL ABOVE THE WORDS "A DISCOVER TENNESSEE TRAIL & BYWAY" IN STYLIZED FORMAT. THE COLOR BLACK APPEARS IN THE "NASHVILLE'S", "BACKSTAGE TO BACKROADS", AND "A DISCOVER TENNESSEE TRAIL & BYWAY" WORDING, THE OUTLINE OF THE CIRCLE, THE OUTLINE OF THE WORD "TRACE", AND THE SHADING AND SHADOWING IN THE

CLASS 35—(Continued).

MARK, THE COLOR ORANGE APPEARS IN THE BOTTOM FADE OF THE INTERIOR OF THE "TRACE" WORDING IN THE MARK, THE COLOR RED APPEARS IN THE MUSICAL NOTE DESIGN, THE TWO HORIZONTAL LINES, AND IN THE TOP FADE OF THE INTERIOR OF THE "TRACE" WORDING IN THE MARK, AND THE COLOR TAN APPEARS IN THE TEXTURED CENTER OF THE CIRCLE IN THE MARK. THE MARK APPEARS ON A TRANSPARENT BACKGROUND AND NO OTHER COLORS ARE CLAIMED.

FOR PROMOTING TOURISM IN STATE OF TENNESSEE (U.S. CLS. 100, 101 AND 102).

FIRST USE 9-16-2009; IN COMMERCE 9-16-2009.
JASON LOTT, EXAMINING ATTORNEY

SN 76-700,939. TENNESSEE DEPARTMENT OF TOURIST DEVELOPMENT, NASHVILLE, TN. FILED 12-22-2009.



OWNER OF U.S. REG. NOS. 3,021,992 AND 3,245,966.
NO CLAIM IS MADE TO THE EXCLUSIVE RIGHT TO USE "TENNESSEE," "TRAIL," AND "TENNESSEE TRAIL & BYWAY", APART FROM THE MARK AS SHOWN.

THE COLOR(S) BLACK, BROWN, GREEN, GRAY, YELLOW, AND WHITE IS/ARE CLAIMED AS A FEATURE OF THE MARK.

THE MARK CONSISTS OF THE PHRASE "OLD TENNESSEE" IN STYLIZED FONT OVER A CIRCULAR RING DESIGN CONTAINING A CANNON AND HILLSIDE SCENE, WHICH IS OVERLAID BY A BANNER READING "SETTLERS TO SOLDIERS TRAIL" IN STYLIZED FONT, ALL ABOVE THE PHRASE "A DISCOVER TENNESSEE TRAIL & BYWAY." THE COLOR BLACK APPEARS IN THE OUTLINE OF THE "OLD TENNESSEE" WORDING, THE OUTLINE OF THE BANNER, THE EXTERIOR OF THE OUTER RING CIRCLE DESIGN, THE INTERIOR RING OF THE RING CIRCLE DESIGN, THE CANNON DESIGN, THE "SETTLERS TO SOLDIERS TRAIL" WORDING, THE "A DISCOVER TENNESSEE TRAIL & BYWAY" WORDING, AND THE SHADING AND SHADOWING IN THE MARK. THE COLOR BROWN APPEARS IN THE WOOD-LIKE ASPECTS OF THE CANNON DESIGN IN THE MARK, THE COLOR GREEN APPEARS IN THE HILLS, PATH, AND GRASS OF THE HILLSIDE SCENE IN THE MARK, THE COLOR GRAY APPEARS IN THE HIGHLIGHTS OF THE CANNON DESIGN AND THE INTERIOR PART OF THE RING CIRCLE DESIGN IN THE MARK, THE COLOR YELLOW APPEARS IN THE SUNRISE DESIGN AND THE INTERIOR OF THE BANNER IN THE MARK, AND THE COLOR WHITE APPEARS IN THE INTERIOR OF THE "OLD TENNESSEE" WORDING IN THE MARK. THE MARK APPEARS ON A TRANSPARENT BACKGROUND AND NO OTHER COLORS ARE CLAIMED.

FOR PROMOTING TOURISM IN STATE OF TENNESSEE (U.S. CLS. 100, 101 AND 102).

FIRST USE 9-16-2009; IN COMMERCE 9-16-2009.
JASON LOTT, EXAMINING ATTORNEY

CLASS 35—(Continued).

SN 76-701,057. TENNESSEE DEPARTMENT OF TOURIST DEVELOPMENT, NASHVILLE, TN. FILED 1-4-2010.



OWNER OF U.S. REG. NOS. 3,021,992 AND 3,245,966.
NO CLAIM IS MADE TO THE EXCLUSIVE RIGHT TO USE "TENNESSEE TRAILS & BYWAYS", APART FROM THE MARK AS SHOWN.

THE COLOR(S) BLACK, BROWN, GREEN, BLUE, AND WHITE IS/ARE CLAIMED AS A FEATURE OF THE MARK.

THE MARK CONSISTS OF THE PHRASE "DISCOVER TENNESSEE" IN STYLIZED FORMAT BENEATH A SEMI-CIRCULAR DESIGN OF TREES AND A ROAD ON A HILLY LANDSCAPE, ALL OVER A BANNER CONTAINING THE WORDS "TRAILS & BYWAYS" IN STYLIZED FORMAT. THE COLOR BLACK APPEARS IN THE OUTLINE OF THE "DISCOVER TENNESSEE" WORDING, THE BOTTOM FADE OF THE INTERIOR OF THE "TENNESSEE" WORDING, THE OUTLINE OF THE LANDSCAPE DESIGN, THE ROAD IN THE LANDSCAPE DESIGN, THE INTERIOR OF THE BANNER DESIGN, AND IN THE SHADING AND SHADOWING IN THE MARK. THE COLOR BROWN APPEARS IN THE TOP FADE OF THE INTERIOR OF THE "DISCOVER TENNESSEE" WORDING IN THE MARK, THE COLOR GREEN APPEARS IN THE TREES AND GRASS IN THE MARK, THE COLOR BLUE APPEARS IN THE SKY DESIGN IN THE MARK, AND THE COLOR WHITE APPEARS IN THE HIGHLIGHTING OF THE SKY DESIGN AND IN THE "TRAILS & BYWAYS" WORDING IN THE MARK. THE MARK APPEARS ON A TRANSPARENT BACKGROUND AND NO OTHER COLORS ARE CLAIMED.

FOR PROMOTING TOURISM IN STATE OF TENNESSEE (U.S. CLS. 100, 101 AND 102).

FIRST USE 9-16-2009; IN COMMERCE 9-16-2009.
JASON LOTT, EXAMINING ATTORNEY

SN 77-321,679. WICKED FASHIONS, INC., FORT LEE, NJ. FILED 11-5-2007.

WCKD

THE MARK CONSISTS OF STANDARD CHARACTERS WITHOUT CLAIM TO ANY PARTICULAR FONT, STYLE, SIZE, OR COLOR.

FOR RETAIL STORES SERVICES FEATURING CLOTHING AND FASHION ACCESSORIES (U.S. CLS. 100, 101 AND 102).

JULIE WATSON, EXAMINING ATTORNEY

CLASS 35—(Continued).

SN 77-393,420. NEWBAY MEDIA LLC, NEW YORK, NY. FILED 2-11-2008.



OWNER OF U.S. REG. NOS. 2,006,354, 3,116,246 AND OTHERS.

NO CLAIM IS MADE TO THE EXCLUSIVE RIGHT TO USE "GUITAR", APART FROM THE MARK AS SHOWN.

THE MARK CONSISTS OF AN IMAGE OF A MAN PLAYING A GUITAR BENEATH THE IMAGE ARE THE WORDS GUITARPLAYER AND BELOW THAT ARE THE WORDS "GUITAR SUPERSTAR" INSIDE A RECTANGLE.

SEC. 2(F) AS TO "GUITAR PLAYER".
FOR PROMOTING TALENT SHOWS FOR THIRD PARTIES (U.S. CLS. 100, 101 AND 102).

ANNE FARRELL, EXAMINING ATTORNEY

SN 77-460,440. GILL ACTION FUND, DENVER, CO. FILED 4-29-2008.

POLITICAL OUTGIVING

THE MARK CONSISTS OF STANDARD CHARACTERS WITHOUT CLAIM TO ANY PARTICULAR FONT, STYLE, SIZE, OR COLOR.

NO CLAIM IS MADE TO THE EXCLUSIVE RIGHT TO USE "POLITICAL", APART FROM THE MARK AS SHOWN.

FOR POLITICAL ADVOCACY SERVICES, NAMELY, DEVELOPING AND IMPLEMENTING POLITICAL STRATEGIES TO PROMOTE THE INTERESTS OF GAY, LESBIAN, TRANSGENDER AND BISEXUAL PERSONS (U.S. CLS. 100, 101 AND 102).

ELIZABETH HUGHITT, EXAMINING ATTORNEY

CLASS 35—(Continued).

SN 77-462,350. CHRISTUS HEALTH, HOUSTON, TX. FILED 4-30-2008.

CHRISTUS CAREADVANTAGE

THE MARK CONSISTS OF STANDARD CHARACTERS WITHOUT CLAIM TO ANY PARTICULAR FONT, STYLE, SIZE, OR COLOR.

OWNER OF U.S. REG. NOS. 2,517,857, 2,517,892 AND OTHERS.

FOR ADMINISTRATION OF A DISCOUNT PROGRAM FOR ENABLING PARTICIPANTS TO OBTAIN DISCOUNTS ON HEALTH SERVICES (U.S. CLS. 100, 101 AND 102).

ANDREA K. NADELMAN, EXAMINING ATTORNEY

SN 77-482,881. STUNSL GROUP, LLC, THE, AUSTIN, TX. FILED 5-23-2008.

v-Ops

THE MARK CONSISTS OF STANDARD CHARACTERS WITHOUT CLAIM TO ANY PARTICULAR FONT, STYLE, SIZE, OR COLOR.

FOR BUSINESS OPERATIONS CONSULTATION SERVICES IN THE FIELD OF MATERIALS MANAGEMENT, SUPPLY CHAIN MANAGEMENT, QUALITY, MANUFACTURING MANAGEMENT AND MANUFACTURING ENGINEERING (U.S. CLS. 100, 101 AND 102).

ANDREA K. NADELMAN, EXAMINING ATTORNEY

SN 77-501,562. THE PAPERCLIP CLUB, LLC, CEDARHURST, NY. FILED 6-18-2008.

PaperclipClub

THE COLOR(S) WHITE, BLACK, AND RED IS/ARE CLAIMED AS A FEATURE OF THE MARK.

THE MARK CONSISTS OF IN ONE STRAIGHT LINE SPELLED OUT TO SAY PAPERCLIPCLUB: THE WORD "PAPER" IN WHITE LETTERS WITH A BLACK OUTLINE, A RED LETTER "C" WITH A BLACK OUTLINE, A WHITE PAPERCLIP IN THE PLACE OF THE LETTER "L" WITH A BLACK BACKGROUND, THE LETTERS "I", "P" AND "C" IN RED WITH A BLACK OUTLINE, A WHITE PAPERCLIP IN THE PLACE OF THE LETTER "L" WITH A BLACK BACKGROUND, AND THE LETTERS "U" AND "B" IN RED WITH A BLACK OUTLINE.

FOR ON-LINE WHOLESALE AND RETAIL STORE SERVICES FEATURING OFFICE AND HOME OFFICE SUPPLIES (U.S. CLS. 100, 101 AND 102).

FIRST USE 10-31-2006; IN COMMERCE 10-31-2006.

KATHLEEN M. VANSTON, EXAMINING ATTORNEY

CLASS 35—(Continued).

SN 77-509,987. CLARENDON CAPITAL CORPORATION, ATLANTA, GA. FILED 6-27-2008.



Outdoor Advertising

NO CLAIM IS MADE TO THE EXCLUSIVE RIGHT TO USE "CLARENDON MEDIA OUTDOOR ADVERTISING", APART FROM THE MARK AS SHOWN.

THE COLOR(S) GREEN, BLUE, YELLOW, WHITE AND RED IS/ARE CLAIMED AS A FEATURE OF THE MARK.

THE MARK CONSISTS OF A GREEN BOX WITH THE WORDING "CLARENDON MEDIA" IN WHITE LETTERS; THEN A RECTANGULAR BOX UNDERNEATH IN BLUE, A RECTANGULAR BOX UNDERNEATH IN YELLOW, A RECTANGULAR BOX UNDERNEATH IN RED WITH A FINAL ALL WHITE BOX WITH THE WORDING "OUTDOOR ADVERTISING" IN RED.

FOR ELECTRONIC BILLBOARD ADVERTISING; OUT-OF-HOME ADVERTISING SERVICES, NAMELY, RENTAL OF ADVERTISING SPACE, AND PREPARING AND PLACING ADVERTISEMENTS FOR OTHERS; RENTAL OF ADVERTISING SPACE; RENTAL OF SIGNS FOR ADVERTISING PURPOSES (U.S. CLS. 100, 101 AND 102).

REGINA DRUMMOND, EXAMINING ATTORNEY

SN 77-512,963. INTELLIGENT BEAUTY, LLC, EL SEGUNDO, CA. FILED 7-1-2008.

OWNER OF U.S. REG. NOS. 3,509,811, 3,538,407 AND 3,720,620.

NO CLAIM IS MADE TO THE EXCLUSIVE RIGHT TO USE "BEAUTY", APART FROM THE MARK AS SHOWN.

THE COLOR(S) BLACK AND RED IS/ARE CLAIMED AS A FEATURE OF THE MARK.

THE MARK CONSISTS OF THE WORD "BEAUTY" IN BLACK, STYLIZED LETTERING TO THE LEFT OF THE WORD "FIX" IN RED TEXT.

FOR ONLINE RETAIL STORE SERVICES FEATURING SKIN CARE PRODUCTS AND COSMETICS PROVIDED TO CONSUMERS ON A SUBSCRIPTION BASIS (U.S. CLS. 100, 101 AND 102).

RON FAIRBANKS, EXAMINING ATTORNEY

CLASS 35—(Continued).

SN 77-534,435. CPC, INC, DBA CARROLL PUBLISHING, BETHESDA, MD. FILED 7-30-2008.

MilSearch

THE MARK CONSISTS OF STANDARD CHARACTERS WITHOUT CLAIM TO ANY PARTICULAR FONT, STYLE, SIZE, OR COLOR.

FOR COMPILATION AND SYSTEMIZATION OF INFORMATION INTO COMPUTER DATABASES (U.S. CLS. 100, 101 AND 102).

FIRST USE 2-1-2003; IN COMMERCE 2-1-2003.

ANN E. SAPPENFIELD, EXAMINING ATTORNEY

SN 77-571,335. GREAT LAKES HEMOPHILIA FOUNDATION, MILWAUKEE, WI. FILED 9-16-2008.

TODAY'S CARE. TOMORROW'S
CURE.

THE MARK CONSISTS OF STANDARD CHARACTERS WITHOUT CLAIM TO ANY PARTICULAR FONT, STYLE, SIZE, OR COLOR.

FOR PUBLIC ADVOCACY TO PROMOTE AWARENESS OF HEMOPHILIA AND OTHER BLOOD DISORDERS; PROMOTING PUBLIC AWARENESS THE NEED TO FUND SCIENTIFIC RESEARCH IN THE FIELD OF HEMOPHILIA AND OTHER BLOOD DISORDERS; PROMOTING AWARENESS OF THE NEED TO PROVIDE SUPPORT TO INDIVIDUALS AND FAMILIES AFFECTED BY HEMOPHILIA AND OTHER BLOOD DISORDERS (U.S. CLS. 100, 101 AND 102).

FIRST USE 1-1-1989; IN COMMERCE 1-1-1989.

RON FAIRBANKS, EXAMINING ATTORNEY

CLASS 35—(Continued).

SN 77-576,983. ENSERVIO, INC., NATICK, MA. FILED 9-23-2008.



OWNER OF U.S. REG. NOS. 3,350,120 AND 3,540,022.
NO CLAIM IS MADE TO THE EXCLUSIVE RIGHT TO USE "SELECT" AND "CONTENTS", APART FROM THE MARK AS SHOWN.

THE COLOR(S) GOLD, BLACK, AND WHITE IS/ARE CLAIMED AS A FEATURE OF THE MARK.

THE MARK CONSISTS OF THE WORD "ENSERVIO" IN BLACK IN THE UPPER LEFT-HAND CORNER OF A RECTANGULAR AREA. THE WORD "SELECT" APPEARS IN GOLD SCRIPT FONT BELOW THE WORD "ENSERVIO" AND FILLS MOST OF THE RECTANGULAR AREA. THE WORDING "THE CONTENTS CONCIERGE" APPEARS IN GOLD IN THE LOWER HORIZONTAL BORDER OF THE RECTANGULAR AREA.

FOR OUTSOURCING SERVICES FOR THE INSURANCE INDUSTRY (U.S. CLS. 100, 101 AND 102).

FIRST USE 5-15-2008; IN COMMERCE 5-15-2008.
SUZANNE BLANE, EXAMINING ATTORNEY

SN 77-578,129. AB HOLDINGS, LLC, BOISE, ID. FILED 9-24-2008.

RANCHO EL ORO

THE MARK CONSISTS OF STANDARD CHARACTERS WITHOUT CLAIM TO ANY PARTICULAR FONT, STYLE, SIZE, OR COLOR.

NO CLAIM IS MADE TO THE EXCLUSIVE RIGHT TO USE "RANCHO", APART FROM THE MARK AS SHOWN.

THE ENGLISH TRANSLATION OF "RANCHO" IS RANCH AND THE ENGLISH TRANSLATION OF "EL ORO" IS THE GOLD.

FOR CATALOG ORDERING SERVICES, MAIL ORDER CATALOG SERVICES, AND RETAIL SERVICES BY DIRECT SOLICITATION BY SALES AGENTS IN THE FIELD OF HIGH QUALITY BEEF, BEEF OFFAL, BEEF CARCASSES, PACKAGED BEEF AND NON-PACKAGED BEEF, PORK, HAMBURGER, HAM, CUT MEATS, DELI MEATS, FRANKFURTERS, GIFT BASKETS; RETAIL AND WHOLESALE STORE SERVICES FEATURING HIGH QUALITY BEEF, BEEF OFFAL, BEEF CARCASSES, PACKAGED BEEF AND NON-PACKAGED BEEF, PORK, HAMBURGER, HAM, CUT MEATS, DELI MEATS, FRANKFURTERS, GIFT BASKETS; BUTCHER SHOP; WHOLESALE FOOD DISTRIBUTORSHIP SERVICES; LOGISTICS MANAGEMENT SERVICES IN THE FIELD OF TRANSPORTATION OF MEAT; DISTRIBUTORSHIPS IN THE FIELD OF MEAT (U.S. CLS. 100, 101 AND 102).

KHANH LE, EXAMINING ATTORNEY

CLASS 35—(Continued).

SN 77-578,135. AB HOLDINGS, LLC, BOISE, ID. FILED 9-24-2008.



NO CLAIM IS MADE TO THE EXCLUSIVE RIGHT TO USE "RANCHO", "BEEF", AND "CARNE", APART FROM THE MARK AS SHOWN.

THE MARK CONSISTS OF THE WORDS "RANCHO EL ORO BEEF" IN STYLIZED TEXT, SURROUNDED BY DECORATIVE LINES. THE UPPER LEFT CORNER OF THE MARK CONTAINS THE GRAPHIC IMAGE OF A SILHOUETTE OF A BODY OF A COW ENCOMPASSED IN A CIRCLE WITH THE WORDS "EL ORO CARNE" IN STYLIZED TEXT.

THE ENGLISH TRANSLATION OF "RANCHO" IS RANCH, THE ENGLISH TRANSLATION OF "EL ORO" IS THE GOLD, AND THE ENGLISH TRANSLATION OF "CARNE" IS MEAT.

FOR CATALOG ORDERING SERVICES, MAIL ORDER CATALOG SERVICES, AND RETAIL SERVICES BY DIRECT SOLICITATION BY SALES AGENTS IN THE FIELD OF HIGH QUALITY BEEF, BEEF OFFAL, BEEF CARCASSES, PACKAGED BEEF AND NON-PACKAGED BEEF, PORK, HAMBURGER, HAM, CUT MEATS, DELI MEATS, FRANKFURTERS, GIFT BASKETS; RETAIL AND WHOLESALE STORE SERVICES FEATURING HIGH QUALITY BEEF, BEEF OFFAL, BEEF CARCASSES, PACKAGED BEEF AND NON-PACKAGED BEEF, PORK, HAMBURGER, HAM, CUT MEATS, DELI MEATS, FRANKFURTERS, GIFT BASKETS; BUTCHER SHOP; WHOLESALE FOOD DISTRIBUTORSHIP SERVICES; LOGISTICS MANAGEMENT SERVICES IN THE FIELD OF TRANSPORTATION OF MEAT; DISTRIBUTORSHIPS IN THE FIELD OF MEAT (U.S. CLS. 100, 101 AND 102).

KHANH LE, EXAMINING ATTORNEY

SN 77-589,756. ACORN PRODUCTS CO., LLC, LEWISTON, ME. FILED 10-9-2008.

ACORN

THE MARK CONSISTS OF STANDARD CHARACTERS WITHOUT CLAIM TO ANY PARTICULAR FONT, STYLE, SIZE, OR COLOR.

OWNER OF U.S. REG. NOS. 2,763,070, 2,874,173 AND OTHERS.

FOR RETAIL STORE AND ON-LINE RETAIL STORE SERVICES FEATURING FOOTWEAR, CLOTHING AND CLOTHING ACCESSORIES (U.S. CLS. 100, 101 AND 102).

FIRST USE 5-30-2007; IN COMMERCE 5-30-2007.

REBECCA POVARCHUK, EXAMINING ATTORNEY

CLASS 35—(Continued).

SN 77-589,762. ACORN PRODUCTS CO., LLC, LEWISTON, ME. FILED 10-9-2008.



OWNER OF U.S. REG. NOS. 2,763,070, 2,874,173 AND OTHERS.

THE MARK CONSISTS OF FANCIFUL DEPICTION OF AN ACORN.

FOR RETAIL STORE AND ON-LINE RETAIL STORE SERVICES FEATURING FOOTWEAR, CLOTHING AND CLOTHING ACCESSORIES (U.S. CLS. 100, 101 AND 102).

FIRST USE 5-30-2007; IN COMMERCE 5-30-2007.

REBECCA POVARCHUK, EXAMINING ATTORNEY

CLASS 35—(Continued).

SN 77-595,548. USER EXCHANGE PLATFORMS, SAN FRANCISCO, CA. FILED 10-18-2008.



NO CLAIM IS MADE TO THE EXCLUSIVE RIGHT TO USE "PRO", APART FROM THE MARK AS SHOWN.

THE MARK CONSISTS OF CAPITAL LETTER "I", FOLLOWED BY WORD "FIND" ROTATED 90 DEGREES COUNTERCLOCKWISE, FOLLOWED BY WORD "PRO".

FOR CONNECTING SELECTED PROFESSIONALS IN THE FIELDS OF ACCOUNTANCY, JURISPRUDENCE, FINANCIAL ADVISORY, AND INSURANCE WITH BUYERS OF PROFESSIONAL SERVICES VIA INTERNET OR OTHER COMPUTER NETWORK AUCTION SYSTEM WHERE BUYERS SUBMIT THEIR SERVICE REQUESTS AND PROFESSIONALS BID TO PROVIDE REQUESTED SERVICES (U.S. CLS. 100, 101 AND 102).

FIRST USE 7-5-2008; IN COMMERCE 10-16-2008.

HAI-LY LAM, EXAMINING ATTORNEY

SN 77-598,692. GEOMETRIC LIMITED, MUMBAI, INDIA, FILED 10-23-2008.

SN 77-590,148. GFK HEALTHCARE, LP, BLUE BELL, PA. FILED 10-10-2008.

FLEXIBLE RESOURCES,
RESPONSIVE TO YOUR
EVOLVING CHALLENGES:
MARKETING RESEARCH BUILT
FOR YOU



Geometric

OWNER OF U.S. REG. NO. 2,766,459.
THE MARK CONSISTS OF A ROUND DISK SHAPE FORMED OF PARTIAL CONCENTRIC RINGS APPEARING ABOVE THE WORD "GEOMETRIC".

FOR ADVISORY SERVICES RELATING TO BUSINESS MANAGEMENT AND BUSINESS OPERATIONS, NAMELY, BUSINESS PROCESS MANAGEMENT CONSULTATION IN CONNECTION WITH PRODUCT DESIGN AND MANUFACTURING (U.S. CLS. 100, 101 AND 102).

FIRST USE 10-19-2007; IN COMMERCE 10-19-2007.

STEVEN PEREZ, EXAMINING ATTORNEY

THE MARK CONSISTS OF STANDARD CHARACTERS WITHOUT CLAIM TO ANY PARTICULAR FONT, STYLE, SIZE, OR COLOR.

FOR MARKET RESEARCH SERVICES IN THE MEDICAL, PHARMACEUTICAL, SURGICAL AND HEALTHCARE FIELDS (U.S. CLS. 100, 101 AND 102).

RONALD DELGIZZI, EXAMINING ATTORNEY

CLASS 35—(Continued).

SN 77-607,079. SUNPORCH STRUCTURES, INC., WESTPORT, CT. FILED 11-4-2008.



OWNER OF U.S. REG. NOS. 1,930,493 AND 2,655,856.
THE MARK CONSISTS OF THE STYLIZED WORDING "SUNPORCH" WITH A STYLIZED SUN OVER THE LETTER "H". THE RAYS OF THE STYLIZED SUN FORM A CURVED, ARCHING SHAPE ABOVE THE "ORCH" PORTION OF THE WORDING "PORCH".

SEC. 2(F) AS TO "SUNPORCH".

FOR RETAIL STORE AND ONLINE RETAIL STORE SERVICES FEATURING PREFABRICATED SUNROOMS; MAIL-ORDER CATALOG SERVICES FEATURING PREFABRICATED SUNROOMS (U.S. CLS. 100, 101 AND 102).

FIRST USE 1-0-2000; IN COMMERCE 1-0-2000.

JULIE VEPPUMTHARA, EXAMINING ATTORNEY

CLASS 35—(Continued).

SN 77-620,342. MISUMARU SANDYO CO. LTD., EHIME-KEN, JAPAN, FILED 11-24-2008.

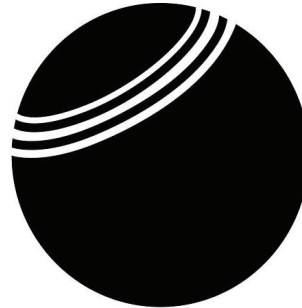

MISUMARU

THE NAME(S), PORTRAIT(S), AND/OR SIGNATURE(S) SHOWN IN THE MARK DOES NOT IDENTIFY A PARTICULAR LIVING INDIVIDUAL.

THE MARK CONSISTS OF A ROUND BALL WHICH IS TRANSVERSED BY A SERIES OF TWO CURVED LINES, WITH A SMALL AMOUNT OF SPACE BETWEEN THEM, WHICH DIVIDE THE ROUND BALL INTO TWO PORTIONS, WITH THE WORDS "MISUMARU" IN CAPITAL LETTERS UNDERNEATH.

FOR WHOLESALE DISTRIBUTORSHIPS IN THE FIELD OF PLASTIC AND PAPER BAGS AND CONTAINERS (U.S. CLS. 100, 101 AND 102).

JENNIFER MARTIN, EXAMINING ATTORNEY

SN 77-619,930. PITCH360 INCORPORATED, DOWNTOWN, PA. FILED 11-21-2008.

PITCH360

THE MARK CONSISTS OF STANDARD CHARACTERS WITHOUT CLAIM TO ANY PARTICULAR FONT, STYLE, SIZE, OR COLOR.

FOR PUBLIC RELATIONS SERVICES, NAMELY, DEVELOPING COMMUNICATIONS AND MARKETING CAMPAIGNS FOR OTHERS, CREATING AND DISSEMINATING PROMOTIONAL MATTER FOR OTHERS, AND PROVIDING CONSULTATION SERVICES IN CONNECTION WITH COMMUNICATIONS AND MARKETING CAMPAIGNS FOR OTHERS (U.S. CLS. 100, 101 AND 102).

VIVIAN MICZNIK FIRST, EXAMINING ATTORNEY

SN 77-622,065. TASTE OF THE GAME, INC., MOON TOWNSHIP, PA. FILED 11-25-2008.

TASTE OF THE GAME

THE MARK CONSISTS OF STANDARD CHARACTERS WITHOUT CLAIM TO ANY PARTICULAR FONT, STYLE, SIZE, OR COLOR.

FOR ORGANIZING VOLUNTEER ACTIVITIES AND FIELD TRIPS TO ALLOW STUDENTS TO LEARN ABOUT ATHLETICS, PHYSICAL FITNESS AND/OR NUTRITION (U.S. CLS. 100, 101 AND 102).

GINA HAYES, EXAMINING ATTORNEY

CLASS 35—(Continued).

SN 77-623,460. BDI, PHARMA, INC., COLUMBIA, SC. FILED 12-1-2008.

**PARTNERSHIP IN PRACTICE
BDI PROMOTIONS**

THE MARK CONSISTS OF STANDARD CHARACTERS WITHOUT CLAIM TO ANY PARTICULAR FONT, STYLE, SIZE, OR COLOR.

OWNER OF U.S. REG. NO. 3,564,356.

NO CLAIM IS MADE TO THE EXCLUSIVE RIGHT TO USE "PARTNERSHIP" AND "PROMOTIONS", APART FROM THE MARK AS SHOWN.

FOR ADVERTISING AND MARKETING; ADVERTISING AND PROMOTIONAL SERVICES; ADVERTISING SERVICES (U.S. CLS. 100, 101 AND 102).

FIRST USE 1-21-2008; IN COMMERCE 1-21-2008.

ASMAT KHAN, EXAMINING ATTORNEY

CLASS 35—(Continued).

SN 77-637,865. BRAG, LLC, LOUISVILLE, KY. FILED 12-22-2008.

**Practical Tactical
Personal Security**

THE MARK CONSISTS OF STANDARD CHARACTERS WITHOUT CLAIM TO ANY PARTICULAR FONT, STYLE, SIZE, OR COLOR.

NO CLAIM IS MADE TO THE EXCLUSIVE RIGHT TO USE "TACTICAL PERSONAL SECURITY", APART FROM THE MARK AS SHOWN.

FOR ON-LINE RETAIL STORE SERVICES FEATURING PERSONAL PROTECTION GOODS AND FIREARMS ACCESSORIES; RETAIL SHOPS FEATURING PERSONAL PROTECTION GOODS AND FIREARMS ACCESSORIES (U.S. CLS. 100, 101 AND 102).

DOMINIC J. FERRAIUOLO, EXAMINING ATTORNEY

SN 77-626,619. MARTIN, CYNTHIA PRIMO, WILMINGTON, DE. FILED 12-4-2008.



NO CLAIM IS MADE TO THE EXCLUSIVE RIGHT TO USE "TRUSTEES OF COLOR", APART FROM THE MARK AS SHOWN.

THE COLOR(S) BLACK, WHITE, GREY, PURPLE, IS/ARE CLAIMED AS A FEATURE OF THE MARK.

THE MARK CONSISTS OF A RECTANGULAR BOX CONTAINING ADDITIONAL BOXES FEATURING WORDS AND DESIGNS. THE OUTER BOX IS BLACK AND HAS ROUNDED CORNERS AND A SLIGHT SHADING EFFECT AT ITS BOTTOM AND RIGHT EDGES. IN THE TOP TWO-THIRDS OF THE BLACK BOX, THERE IS ANOTHER RECTANGULAR BOX WITH ROUNDED CORNERS, BUT A WHITE BACKGROUND. INSIDE THIS TOP WHITE BOX, THE LETTERS "T O C" APPEAR IN BLACK, WITH TOUCHES OF GRAY RAYS THAT GIVE THE LETTERS THE APPEARANCE OF A RADIAL, METALLIC SHIMMER. IN THE BOTTOM THIRD OF THE BLACK BOX, THERE IS A WIDE, SHORT RECTANGULAR BOX, AGAIN WITH ROUNDED CORNERS AND A WHITE BACKGROUND. IN THIS LOWER BOX, THE WORDING "TRUSTEES OF COLOR" APPEARS IN PURPLE.

FOR PROVIDING CONSUMER INFORMATION SERVICES REGARDING CHARITABLE ORGANIZATIONS AND CAUSES; PROVIDING BUSINESS DIRECTORY SERVICES ASSISTING CONSUMERS IN FINDING CHARITABLE ORGANIZATIONS AND CAUSES; PROMOTING THE CHARITIES OF OTHERS; CONDUCTING BUSINESS SURVEYS CONCERNING CHARITIES AND CONSUMER PREFERENCES FOR CHARITABLE ACTIVITIES; BUSINESS SERVICES, NAMELY, MATCHING POTENTIAL INVESTORS, DONORS, EMPLOYEES, AND VOLUNTEERS WITH LIKE-MINDED ORGANIZATIONS NEEDING FUNDING OR STAFFING (U.S. CLS. 100, 101 AND 102).

CORY BOONE, EXAMINING ATTORNEY

SN 77-640,767. UNLIMITED INTERNATIONAL, MUSASHI-NO-SHI, TOKYO, JAPAN, FILED 12-29-2008.

Unlimited International

THE MARK CONSISTS OF STANDARD CHARACTERS WITHOUT CLAIM TO ANY PARTICULAR FONT, STYLE, SIZE, OR COLOR.

NO CLAIM IS MADE TO THE EXCLUSIVE RIGHT TO USE "INTERNATIONAL", APART FROM THE MARK AS SHOWN.

FOR ADVERTISING AND PROMOTION SERVICES AND RELATED CONSULTING; BRAND IMAGERY CONSULTING SERVICES; BRANDING SERVICES, NAMELY, CONSULTING, DEVELOPMENT, MANAGEMENT AND MARKETING OF BRANDS FOR BUSINESSES; BUSINESS CONSULTING SERVICES RELATING TO PRODUCT DISTRIBUTION, OPERATIONS MANAGEMENT SERVICES, LOGISTICS, REVERSE LOGISTICS, SUPPLY CHAIN, AND PRODUCTION SYSTEMS AND DISTRIBUTION SOLUTIONS; BUSINESS CONSULTING AND BUSINESS INFORMATION FOR ENTERPRISES; BUSINESS CONSULTING AND INFORMATION SERVICES; BUSINESS CONSULTING SERVICES IN THE FIELD OF ORGANIZATIONAL CHANGE MANAGEMENT; BUSINESS CONSULTING SERVICES, NAMELY, PROVIDING ASSISTANCE IN DEVELOPMENT OF BUSINESS STRATEGIES AND CREATIVE IDEATION; BUSINESS CONSULTING SERVICES RELATING TO THE INTEGRATION OF THE AREAS OF BUSINESS PROCESS TECHNOLOGY, ORGANIZATIONAL LEARNING, CHANGE MANAGEMENT, AND OPERATIONAL SUSTAINABILITY; BUSINESS CONSULTING AND ADVISORY SERVICES IN THE FIELD OF ENERGY EFFICIENCY; BUSINESS CONSULTING, INQUIRIES OR INFORMATION; BUSINESS CONSULTING, MANAGEMENT, PLANNING AND SUPERVISION; BUSINESS DEVELOPMENT CONSULTING SERVICES; BUSINESS DEVELOPMENT CONSULTING SERVICES; BUSINESS MANAGEMENT CONSULTING AND ADVISORY SERVICES; BUSINESS MANAGEMENT CONSULTING; BUSINESS MANAGEMENT CONSULTING IN THE FIELD OF TEAM DEVELOPMENT; BUSINESS MANAGEMENT CONSULTING WITH RELATION TO STRATEGY, MARKETING, SALES, OPERATION, PRODUCT DESIGN PARTICULARLY SPECIALIZING IN THE USE OF ANALYTIC AND STATISTIC MODELS FOR THE UNDERSTANDING AND PREDICTING OF CONSU-

CLASS 35—(Continued).

MERS, BUSINESSES, AND MARKET TRENDS AND ACTIONS; BUSINESS MARKETING AND DIRECT MAIL CONSULTING SERVICES; BUSINESS MARKETING CONSULTING SERVICES; BUSINESS MONITORING AND CONSULTING SERVICES, NAMELY, TRACKING WEB SITES AND APPLICATIONS OF OTHERS TO PROVIDE STRATEGY, INSIGHT, MARKETING, SALES, OPERATION, PRODUCT DESIGN, PARTICULARLY SPECIALIZING IN THE USE OF ANALYTIC AND STATISTIC MODELS FOR THE UNDERSTANDING AND PREDICTING OF CONSUMERS, BUSINESSES, AND MARKET TRENDS AND ACTIONS; BUSINESS ORGANIZATION CONSULTING; BUSINESS ORGANIZATION AND MANAGEMENT CONSULTING; BUSINESS ORGANIZATION CONSULTING; BUSINESS RELOCATION CONSULTING; BUSINESS SUPPORT SERVICES, NAMELY, BUSINESS CONSULTING TO FREELANCERS, START-UPS, EXISTING BUSINESSES AND NON-PROFIT ORGANIZATIONS; BUSINESS VENTURE DEVELOPMENT AND FORMATION CONSULTING SERVICES FOR THE RENEWABLE ENERGY INDUSTRY; CONSULTING AND INFORMATION CONCERNING ACCOUNTING; CONSULTING IN SALES TECHNIQUES AND SALES PROGRAMMES; CONSULTING IN THE FIELDS OF BUSINESS ORGANIZATION AND MANAGEMENT; CORPORATE IMAGE CONSULTING SERVICES; DISASTER RECOVERY SERVICES, NAMELY, BUSINESS PLANNING AND BUSINESS CONTINUITY CONSULTING; ECONOMIC CONSULTING AND INFORMATION FOR THE INDUSTRIAL AND COMMERCIAL SECTORS, FOR PLANNING, ORGANIZING, MONITORING AND CARRYING OUT UNIQUE AND COMPLEX PROJECTS IN DIFFERENT SECTORS OF ONE OR SEVERAL COMPANIES, EITHER ON-LINE OR PERSON-TO-PERSON; MANAGEMENT AND BUSINESS CONSULTING SERVICES IN THE FIELD OF FOREIGN DIRECT INVESTMENTS AND MARKET DEVELOPMENT; MANAGEMENT AND BUSINESS CONSULTING SERVICES IN THE FIELD OF TRAINING AND RECRUITMENT; MARKETING AND CONSULTING SERVICES IN THE FIELD OF PROMOTING AND TRACKING THE GOODS, SERVICES, AND BRANDS OF OTHERS THROUGH ALL PUBLIC COMMUNICATION MEANS, PARTICULARLY SPECIALIZING IN THE USE OF MOBILE, SOCIAL, AND PRINT MEDIA TO DRIVE CONSUMER INTEREST, ENGAGEMENT AND ACTION; MARKETING CONSULTING; NEW BUSINESS VENTURE DEVELOPMENT AND FORMATION CONSULTING SERVICES; PROFESSIONAL BUSINESS CONSULTING; PROMOTION AND MARKETING SERVICES AND RELATED CONSULTING; PROVIDING BUSINESS MANAGEMENT INFORMATION IN CONNECTION WITH CONSULTING AND ADVISORY SERVICES IN THE FIELD OF STRATEGIC PLANNING; PROVIDING CONSULTING SERVICES IN THE FIELD OF FACILITATING THE PLANNING, BUYING, AND SELLING OF MEDIA; PROVIDING ORGANIZATIONAL DEVELOPMENT CONSULTING SERVICES (U.S. CLS. 100, 101 AND 102).

FIRST USE 6-11-2003; IN COMMERCE 12-17-2008.
HENRY S. ZAK, EXAMINING ATTORNEY

SN 77-647,237. MOC, PETER CHI PHU, MONTEREY PARK, CA. FILED 1-11-2009.

ChaseBuy

THE MARK CONSISTS OF STANDARD CHARACTERS WITHOUT CLAIM TO ANY PARTICULAR FONT, STYLE, SIZE, OR COLOR.

FOR OPERATING ON-LINE MARKETPLACES FOR SELLERS OF GOODS AND/OR SERVICES (U.S. CLS. 100, 101 AND 102).

FIRST USE 1-1-2007; IN COMMERCE 1-1-2008.
JULIE WATSON, EXAMINING ATTORNEY

CLASS 35—(Continued).

SN 77-651,971. FRANS, MARK, SAN ANTONIO, TX. FILED 1-19-2009.



The logo for 'alamotickets' features the word 'alamotickets' in a lowercase, sans-serif font. Above the letters 'a', 'l', 'a', and 'm' is a decorative, scalloped border that arches over the text.

NO CLAIM IS MADE TO THE EXCLUSIVE RIGHT TO USE "ALAMO TICKETS", APART FROM THE MARK AS SHOWN.

THE MARK CONSISTS OF A DECORATIVE BORDER, INCLUDING SCALLOPED AND RUFFLED EDGES, BEGINNING ON THE LEFT SIDE OF THE FIRST LETTER "A" AND CONTINUING ACROSS THE LETTERS "L", "A", "M", "O" AND "T".

FOR ONLINE AND TELEPHONE ORDERING SERVICES IN FIELD OF TICKETS TO CONCERTS, SHOWS, SPORTING EVENTS AND OTHER ENTERTAINMENT EVENTS (U.S. CLS. 100, 101 AND 102).

FIRST USE 9-11-2002; IN COMMERCE 9-11-2002.
RUDY R. SINGLETON, EXAMINING ATTORNEY

SN 77-653,404. GENCO HOLDINGS, INC., PITTSBURGH, PA. FILED 1-21-2009.



The logo for 'GENCO SUPPLY CHAIN SOLUTIONS' features the word 'GENCO' in a bold, sans-serif font inside a black circle. To the right of the circle, the words 'SUPPLY CHAIN SOLUTIONS' are written in a smaller, sans-serif font.

OWNER OF U.S. REG. NO. 3,374,897.

NO CLAIM IS MADE TO THE EXCLUSIVE RIGHT TO USE "SUPPLY CHAIN SOLUTIONS", APART FROM THE MARK AS SHOWN.

THE MARK CONSISTS OF THE LETTER "G" AND THE WORDS "GENCO SUPPLY CHAIN SOLUTIONS".

FOR THIRD-PARTY LOGISTIC PROVIDER SERVICES, NAMELY, BUSINESS MANAGEMENT SERVICES, NAMELY, MANAGING CONTRACT LOGISTICS, SUPPLY CHAIN LOGISTICS WITH RESPECT TO PARCEL NEGOTIATION AND AUDITS, REVERSE LOGISTICS, FREIGHT LOGISTICS MANAGEMENT WITH RESPECT TO DAMAGE OF FREIGHT, LIQUIDATION OF THE PRODUCTS OF OTHERS, SUPPLY CHAIN MANAGEMENT SERVICES WITH RESPECT TO PHARMACEUTICALS, FREIGHT LOGISTICS MANAGEMENT FOR GOVERNMENTS, SUPPLY CHAIN MANAGEMENT SERVICES, NAMELY, SUPPLY CHAIN LOGISTICS MANAGEMENT WITH RESPECT TO TECHNOLOGY; THIRD-PARTY LOGISTIC PROVIDER SERVICES, NAMELY, TRANSPORTATION LOGISTICS SERVICES, NAMELY, ARRANGING THE TRANSPORTATION OF THE GOODS FOR OTHERS (U.S. CLS. 100, 101 AND 102).

FIRST USE 9-0-2007; IN COMMERCE 9-0-2007.
SETH A. RAPPAPORT, EXAMINING ATTORNEY

CLASS 35—(Continued).

SN 77-654,899. OPUSMARK, LLC, PLANO, TX. FILED 1-22-2009.

OpusMark

THE MARK CONSISTS OF STANDARD CHARACTERS WITHOUT CLAIM TO ANY PARTICULAR FONT, STYLE, SIZE, OR COLOR.

FOR BUSINESS MANAGEMENT CONSULTATION (U.S. CLS. 100, 101 AND 102).

FIRST USE 1-20-2009; IN COMMERCE 2-1-2009.
SUZANNE BLANE, EXAMINING ATTORNEY

SN 77-655,452. DEUTSCHE TELEKOM A.G., BONN, FED REP GERMANY, FILED 1-23-2009.



The logo for "STREET GIGS" features the words "STREET" and "GIGS" in a bold, stylized, blocky font. The letters are white with a thick black outline, and they are set against a black background. The "GIGS" part is slightly larger and more prominent than "STREET".

PRIORITY CLAIMED UNDER SEC. 44(D) ON ERPN CMNTY TM OFC APPLICATION NO. 007517881, FILED 1-13-2009, REG. NO. 007517881, DATED 10-28-2009, EXPIRES 1-13-2019.

PRIORITY CLAIMED UNDER SEC. 44(D) ON FED REP GERMANY APPLICATION NO. 302008047717, FILED 7-24-2008, REG. NO. 302008047717, DATED 7-24-2008, EXPIRES 7-24-2018.

THE MARK CONSISTS OF THE PHRASE "STREET GIGS" IN CAPITAL LETTERS OUTLINED BY A THIN LINE, ALL AGAINST A DECORATIVE BACKGROUND.

FOR PROMOTING THE CONCERTS OF OTHERS; ARRANGING PERSONAL APPEARANCES BY PERSONS WORKING IN THE FIELDS OF FILM, MUSIC, TELEVISION, ENTERTAINMENT AND SPORT; ON-LINE RETAIL STORE SERVICES FEATURING DOWNLOADABLE SOUND, MUSIC, IMAGE, VIDEO AND GAME FILES; ADVERTISING SERVICES, NAMELY, PROMOTING AND MARKETING THE GOODS AND SERVICES OF OTHERS IN THE FIELD OF ENTERTAINMENT; PRODUCT MERCHANDISING; BUSINESS ADMINISTRATION AND MANAGEMENT (U.S. CLS. 100, 101 AND 102).

SHAILA SETTLES, EXAMINING ATTORNEY

CLASS 35—(Continued).

SN 77-665,710. VALDEZ, JAMES A., GOOSE CREEK, SC. FILED 2-7-2009.

GOLD BUYERS OF AMERICA.COM

THE MARK CONSISTS OF STANDARD CHARACTERS WITHOUT CLAIM TO ANY PARTICULAR FONT, STYLE, SIZE, OR COLOR.

NO CLAIM IS MADE TO THE EXCLUSIVE RIGHT TO USE "GOLD BUYERS", APART FROM THE MARK AS SHOWN.

SEC. 2(F).

FOR SCRAP DEALERSHIP SERVICES FEATURING SHIPPING KITS REQUESTED BY CUSTOMERS WHO SEND IN THEIR UNWANTED PRECIOUS METALS FOR PROCESSING AND PAYMENT (U.S. CLS. 100, 101 AND 102).

FIRST USE 4-30-2003; IN COMMERCE 4-30-2003.

TARAH HARDY, EXAMINING ATTORNEY

SN 77-678,490. TENNIS INDUSTRY ASSOCIATION, HILTON HEAD ISLAND, SC. FILED 2-25-2009.

GrowingTennis

THE MARK CONSISTS OF STANDARD CHARACTERS WITHOUT CLAIM TO ANY PARTICULAR FONT, STYLE, SIZE, OR COLOR.

FOR PROMOTION, ADVERTISING AND MARKETING OF ON-LINE WEB SITES; ADVERTISING AGENCIES, NAMELY, PROMOTING THE SERVICES OF TENNIS BUSINESS THROUGH THE DISTRIBUTION OF PRINTED AND AUDIO PROMOTIONAL MATERIALS AND BY RENDERING SALES PROMOTION ADVICE; ADVERTISING, MARKETING AND PROMOTION SERVICES (U.S. CLS. 100, 101 AND 102).

FIRST USE 9-1-2000; IN COMMERCE 9-1-2000.

ASMAT KHAN, EXAMINING ATTORNEY

SN 77-702,636. YOUVENT LLC, KINNELON, NJ. FILED 3-30-2009.



The logo for "youvent.com" features the word "youvent" in a lowercase, rounded, sans-serif font. The "o" in "you" is replaced by a smiling face with two dots for eyes. Below the "nt" in "vent" are three small circles, resembling a tennis ball. The ".com" is in a smaller, standard sans-serif font.

THE MARK CONSISTS OF THE STYLIZED TEXT "YOUVENT.COM" WITH THREE DOT-LIKE SMILING FACE IMAGES BELOW THE LETTERS "N" AND "T" AND ONE IN PLACE OF THE LETTER "O" IN "YOUVENT.COM".

FOR PROVIDING A WEB SITE WHERE USERS CAN POST RATINGS, REVIEWS AND RECOMMENDATIONS ON PRODUCTS AND SERVICES (U.S. CLS. 100, 101 AND 102).

CHERYL CLAYTON, EXAMINING ATTORNEY

CLASS 35—(Continued).

SN 77-705,953. GREEN BULLION FINANCIAL SERVICES, LLC, POMPANO BEACH, FL. FILED 4-3-2009.

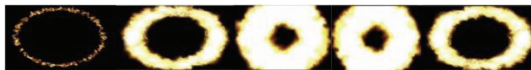

THE MARK CONSISTS OF A MOTION MARK THAT CONSISTS OF A CIRCULAR RING OF FIRE THAT EXPANDS OUTWARD AND INWARD AND THEN CONTRACTS BACK TO ITS ORIGINAL FORM.

FOR SCRAP DEALERSHIP IN THE FIELD OF SCRAP GOLD, SILVER, AND PLATINUM (U.S. CLS. 100, 101 AND 102).

FIRST USE 4-0-2007; IN COMMERCE 4-0-2007.
INGRID C. EULIN, EXAMINING ATTORNEY

SN 77-713,147. THE DAFT GROUP, LLC, PALO ALTO, CA. FILED 4-14-2009.

ASKOV FINLAYSON

THE MARK CONSISTS OF STANDARD CHARACTERS WITHOUT CLAIM TO ANY PARTICULAR FONT, STYLE, SIZE, OR COLOR.

"ASKOV FINLAYSON" DOES NOT IDENTIFY A LIVING INDIVIDUAL.

FOR RETAIL STORE SERVICES FEATURING CLOTHING (U.S. CLS. 100, 101 AND 102).

CHERYL CLAYTON, EXAMINING ATTORNEY

SN 77-713,582. RMSG, LLC, HAMILTON, NJ. FILED 4-14-2009.



NO CLAIM IS MADE TO THE EXCLUSIVE RIGHT TO USE "INTERACTIVE", APART FROM THE MARK AS SHOWN.

THE MARK CONSISTS OF THE WORDING "ROSETTA" AND THE MID-SECTION OF A STYLIZED HUMAN FIGURE IN DARK BLUE; THE WORDING "INTERACTIVE. RELEVANCE. RESULTS." AND THE LOWER BODY OF A STYLIZED HUMAN FIGURE IN LIGHT BLUE; THE DESIGN OF THE HEAD AND UPPER BODY OF A STYLIZED HUMAN FIGURE IN GREEN; AND CIRCLE OR SPHERE CONTAINING THE STYLIZED HUMAN FIGURE IN WHITE.

FOR BUSINESS MANAGEMENT AND CONSULTATION IN THE FIELDS OF PROVIDING DATA, ANALYTICAL TECHNIQUES, MARKETING, INFORMATION TECHNOLOGY, WEB SITE DESIGN AND DEVELOPMENT, APPLICATION AND BUSINESS SYSTEMS INTEGRATION, AND DIGITAL BUSINESS DEVELOPMENT (U.S. CLS. 100, 101 AND 102).

FIRST USE 1-5-2009; IN COMMERCE 1-5-2009.
JOHN SCHUYLER YARD, EXAMINING ATTORNEY

CLASS 35—(Continued).

SN 77-716,146. AUTOMATED ENERGY, INC., OKLAHOMA CITY, OK. FILED 4-17-2009.

HOME MPG

THE MARK CONSISTS OF STANDARD CHARACTERS WITHOUT CLAIM TO ANY PARTICULAR FONT, STYLE, SIZE, OR COLOR.

NO CLAIM IS MADE TO THE EXCLUSIVE RIGHT TO USE "HOME", APART FROM THE MARK AS SHOWN.

FOR ENERGY AUDITING AND USAGE MANAGEMENT, NAMELY, POWER MANAGEMENT SERVICES FOR THIRD PARTIES AND LOAD PROFILING FOR THIRD PARTIES TO MANAGE USAGE (U.S. CLS. 100, 101 AND 102).

FIRST USE 1-31-2009; IN COMMERCE 1-31-2009.
MAYUR VAGHANI, EXAMINING ATTORNEY

SN 77-724,864. NATIONAL PARK TRUST INC., ROCKVILLE, MD. FILED 4-29-2009.

BUDDY BISON

THE MARK CONSISTS OF STANDARD CHARACTERS WITHOUT CLAIM TO ANY PARTICULAR FONT, STYLE, SIZE, OR COLOR.

FOR PROMOTING PUBLIC AWARENESS OF PARKS TO CHILDREN FOR CULTIVATING INTEREST IN YOUTHS PERTAINING TO CONSERVATIONISM AND THE ENVIRONMENT (U.S. CLS. 100, 101 AND 102).

JAMES STEIN, EXAMINING ATTORNEY

SN 77-725,316. USA SEVENS LLC, ORANGEBURG, NY. FILED 4-29-2009.

RUGBY MAGAZINE ALL AMERICANS

THE MARK CONSISTS OF STANDARD CHARACTERS WITHOUT CLAIM TO ANY PARTICULAR FONT, STYLE, SIZE, OR COLOR.

NO CLAIM IS MADE TO THE EXCLUSIVE RIGHT TO USE "RUGBY MAGAZINE", APART FROM THE MARK AS SHOWN.

FOR ADVERTISING AND PROMOTIONAL SERVICES; ON-LINE RETAIL STORE SERVICES FEATURING CLOTHING AND SPORTS RELATED MERCHANDISE; PROMOTING SPORTS COMPETITIONS OR EVENTS OF OTHERS; PROMOTING, SPONSORING AND ADMINISTERING AMATEUR ATHLETIC PROGRAMS AND ACTIVITIES; PROVIDING ON-LINE REGISTRATION SERVICES FOR SPORTS TOURNAMENTS (U.S. CLS. 100, 101 AND 102).

JILL C. ALT, EXAMINING ATTORNEY

CLASS 35—(Continued).

SN 77-725,342. USA SEVENS LLC, ORANGEBURG, NY.
FILED 4-29-2009.

RUGBY MAGAZINE ALL WORLD
TEAM

THE MARK CONSISTS OF STANDARD CHARACTERS WITHOUT CLAIM TO ANY PARTICULAR FONT, STYLE, SIZE, OR COLOR.

NO CLAIM IS MADE TO THE EXCLUSIVE RIGHT TO USE "RUGBY MAGAZINE", APART FROM THE MARK AS SHOWN.

FOR ADVERTISING AND PROMOTIONAL SERVICES; ON-LINE RETAIL STORE SERVICES FEATURING CLOTHING AND SPORTS RELATED MERCHANDISE; PROMOTING SPORTS COMPETITIONS OR EVENTS OF OTHERS; PROMOTING, SPONSORING AND ADMINISTERING AMATEUR ATHLETIC PROGRAMS AND ACTIVITIES; PROVIDING ON-LINE REGISTRATION SERVICES FOR SPORTS TOURNAMENTS (U.S. CLS. 100, 101 AND 102).

JILL C. ALT, EXAMINING ATTORNEY

CLASS 35—(Continued).

SN 77-730,953. NIKKEN, INC., IRVINE, CA. FILED 5-6-2009.

5 Pillars of Health

THE MARK CONSISTS OF STANDARD CHARACTERS WITHOUT CLAIM TO ANY PARTICULAR FONT, STYLE, SIZE, OR COLOR.

OWNER OF U.S. REG. NO. 2,793,698.

NO CLAIM IS MADE TO THE EXCLUSIVE RIGHT TO USE "HEALTH", APART FROM THE MARK AS SHOWN.

FOR MULTILEVEL MARKETING BUSINESS SERVICES IN THE FIELD OF GENERAL CONSUMER MERCHANDISE SUCH AS THERAPEUTIC MAGNETIC PRODUCTS, FURNITURE, BEDDING, MASSAGE DEVICES, DIETARY AND/OR FOOD SUPPLEMENTS, COSMETICS AND TOILETRIES, CLOTHING, JEWELRY, DOMESTIC WATER TREATMENT SYSTEMS, DOMESTIC AIR TREATMENT SYSTEMS, CLOTHING, GIFTS, GROCERIES AND FOOD, TOYS, ELECTRONICS, SPORTS AND OUTDOOR EQUIPMENT, HOME FURNISHINGS, AND HOME APPLIANCES; BUSINESS MANAGEMENT AND BUSINESS CONSULTATION SERVICES PROVIDED TO MULTILEVEL MARKETING DISTRIBUTORS AND RETAIL CUSTOMERS OF SUCH DISTRIBUTORS; AND BUSINESS INFORMATION SERVICES IN THE NATURE OF PROVIDING INFORMATION ON SMALL BUSINESS OPERATION AND SMALL BUSINESS OPPORTUNITIES VIA ONLINE ELECTRONIC COMPUTER NETWORKS (U.S. CLS. 100, 101 AND 102).

FIRST USE 10-0-1999; IN COMMERCE 10-0-1999.

ESTHER BELENKER, EXAMINING ATTORNEY

SN 77-734,181. FIELD ASSETS SERVICES, INC., AUSTIN, TX.
FILED 5-11-2009.

SN 77-729,493. THREE DOG BAKERY, INC., KANSAS CITY,
MO. FILED 5-5-2009.



IT'S A DOG'S LIFE

THE MARK CONSISTS OF STANDARD CHARACTERS WITHOUT CLAIM TO ANY PARTICULAR FONT, STYLE, SIZE, OR COLOR.

FOR FRANCHISING SERVICES, NAMELY, OFFERING TECHNICAL AND BUSINESS MANAGEMENT ASSISTANCE IN THE ESTABLISHMENT AND OPERATION OF RETAIL BAKERIES FEATURING PET TREATS, PET FOOD AND PET SNACKS (U.S. CLS. 100, 101 AND 102).

SIMON TENG, EXAMINING ATTORNEY

NO CLAIM IS MADE TO THE EXCLUSIVE RIGHT TO USE "ASSET SERVICES", APART FROM THE MARK AS SHOWN.

THE MARK CONSISTS OF A STYLIZED DRAWING OF TWO CONCENTRIC CIRCLES WITH TWELVE DOTS ON THE PERIMETER OF THE OUTER MOST CIRCLE; A STYLIZED DRAWING OF AN OUTLINE OF A BUILDING IS CONTAINED INSIDE THE INNER-CIRCLE; THE STYLIZED WORDING "FIELD ASSET SERVICES" APPEARS TO THE RIGHT OF THE STYLIZED DRAWING AND THE STYLIZED WORDING "FASTRACK" APPEARS BELOW THE WORDING "FIELD ASSET SERVICES".

FOR PROVIDING A WEB-BASED SYSTEM AND ON-LINE PORTAL FOR CLIENTS, VENDORS, REAL ESTATE AGENTS AND ATTORNEYS FOR ARRANGING FOR THE REPAIR AND MAINTENANCE OF HOMES AND COMMERCIAL BUILDINGS (U.S. CLS. 100, 101 AND 102).

FIRST USE 3-25-2009; IN COMMERCE 5-8-2009.

AMEEN IMAM, EXAMINING ATTORNEY

CLASS 35—(Continued).

SN 77-735,128. DJ AUTOMOTIVE INFORMATION SERVICES, INC., DBA CYBERCALC.COM, DALLAS, TX. FILED 5-12-2009.

CLASS 35—(Continued).

SN 77-737,556. METACAREERS, LLC, LAS VEGAS, NV. FILED 5-14-2009.

SET YOUR PRICE!

THE MARK CONSISTS OF STANDARD CHARACTERS WITHOUT CLAIM TO ANY PARTICULAR FONT, STYLE, SIZE, OR COLOR.

FOR PROVIDING A WEBSITE THAT ENABLES POTENTIAL VEHICLE BUYERS TO RECEIVE QUOTATIONS FROM MULTIPLE COMPETITIVE SOURCES AND SELLERS OF VEHICLES AND TO NEGOTIATE THE PRICE OF SUCH VEHICLES (U.S. CLS. 100, 101 AND 102).

GINA HAYES, EXAMINING ATTORNEY

THE CAREER ACTIVATOR

SN 77-735,788. ISLAMIC RELIEF WORLDWIDE, BIRMINGHAM, UNITED KINGDOM, FILED 5-13-2009.

ISLAMIC RELIEF WORLDWIDE

THE MARK CONSISTS OF STANDARD CHARACTERS WITHOUT CLAIM TO ANY PARTICULAR FONT, STYLE, SIZE, OR COLOR.

OWNER OF ERPN CMNTY TM OFC REG. NO. 005806062, DATED 4-24-2008, EXPIRES 4-2-2017.

OWNER OF U.S. REG. NOS. 3,302,215, 3,302,270 AND OTHERS.

NO CLAIM IS MADE TO THE EXCLUSIVE RIGHT TO USE "WORLDWIDE", APART FROM THE MARK AS SHOWN.

SEC. 2(F) AS TO "ISLAMIC RELIEF".

FOR CHARITABLE SERVICES, NAMELY, BUSINESS MANAGEMENT AND BUSINESS ADMINISTRATION, ORGANIZING AND CONDUCTING VOLUNTEER PROGRAMS AND COMMUNITY SERVICE PROJECTS; PROMOTING PUBLIC AWARENESS OF THE NEED FOR HUMANITARIAN AID AND DEVELOPMENT SERVICES ALL IN THE FIELDS OF EMERGENCY AID, FINANCIAL SERVICES, FOOD, HEALTH CARE, HOUSING, EDUCATION, JOBS, CLEAN WATER, AND IN THE FIELD OF MEDICAL ASSISTANCE TO REFUGEES AND NEEDY PERSONS; DEVELOPING AND COORDINATING VOLUNTEER PROJECTS AND COMMUNITY SERVICE PROJECTS FOR CHARITABLE ORGANIZATIONS (U.S. CLS. 100, 101 AND 102).

FIRST USE 1-1-2007; IN COMMERCE 1-1-2007.

MELISSA VALLILLO, EXAMINING ATTORNEY

THE MARK CONSISTS OF STANDARD CHARACTERS WITHOUT CLAIM TO ANY PARTICULAR FONT, STYLE, SIZE, OR COLOR.

NO CLAIM IS MADE TO THE EXCLUSIVE RIGHT TO USE "CAREER", APART FROM THE MARK AS SHOWN.

FOR CAREER TRANSITION CONSULTING SERVICES FEATURING RESUME PLANNING, PERSONAL BRANDING AND PERSONAL PROMOTION FOR CAREER GROWTH, INTERVIEW STRATEGIES AND TECHNIQUES FOR CAREER GROWTH, CAREER NETWORKING STRATEGIES AND CAREER NETWORK PROFILES, BUSINESS LEADERSHIP SKILL DEVELOPMENT, CAREER MANAGEMENT, TIME MANAGEMENT FOR BUSINESS PURPOSES, BUSINESS MEETING STRATEGIES AND BUSINESS CONSULTING REGARDING BUSINESS ETIQUETTE; AND PROVIDING INFORMATION IN THE FIELD OF CAREER TRANSITION CONSULTING SERVICES, NAMELY, RESUME PLANNING, PERSONAL BRANDING, PERSONAL PROMOTION, INTERVIEW STRATEGIES AND TECHNIQUES FOR CAREER GROWTH, CAREER NETWORKING STRATEGIES AND CAREER NETWORK PROFILES, BUSINESS LEADERSHIP SKILL DEVELOPMENT, CAREER MANAGEMENT, TIME MANAGEMENT FOR BUSINESS PURPOSES, BUSINESS MEETING STRATEGIES AND BUSINESS CONSULTING REGARDING BUSINESS ETIQUETTE (U.S. CLS. 100, 101 AND 102).

SIMON TENG, EXAMINING ATTORNEY

CLASS 35—(Continued).

SN 77-738,875. SYSTEMS TECHNOLOGY FORUM, LTD.,
FREDERICKSBURG, VA. FILED 5-17-2009.

CLASS 35—(Continued).

SN 77-738,882. SYSTEMS TECHNOLOGY FORUM, LTD.,
FREDERICKSBURG, VA. FILED 5-17-2009.

SYSTEMS TECHNOLOGY FORUM



THE MARK CONSISTS OF STANDARD CHARACTERS WITHOUT CLAIM TO ANY PARTICULAR FONT, STYLE, SIZE, OR COLOR.

NO CLAIM IS MADE TO THE EXCLUSIVE RIGHT TO USE "SYSTEMS TECHNOLOGY", APART FROM THE MARK AS SHOWN.

FOR BUSINESS MANAGEMENT AND OPERATION ASSISTANCE FOR BUSINESSES AND GOVERNMENT; COMMERCIAL ASSISTANCE RELATING TO SYSTEM IMPLEMENTATION AND SYSTEM INTEGRATION; BUSINESS CONSULTING SERVICES AND STRATEGIC PLANNING OF INFORMATION MANAGEMENT AND INFORMATION TECHNOLOGY; BUSINESS CONSULTING SERVICES RELATING TO ELECTRONIC COMMERCE AND ELECTRONIC BUSINESS OPERATIONS; DATA PROCESSING BY MEANS OF A COMPUTER; BUSINESS CONSULTING SERVICES RELATING TO PRODUCT DISTRIBUTION, OPERATIONS MANAGEMENT SERVICES, LOGISTICS, REVERSE LOGISTICS, SUPPLY CHAIN, AND PRODUCTION SYSTEMS AND DISTRIBUTION SOLUTIONS; ADVISORY SERVICES RELATING TO BUSINESS MANAGEMENT AND BUSINESS OPERATIONS AND FINANCIAL RECORDS MANAGEMENT (U.S. CLS. 100, 101 AND 102).

FIRST USE 4-17-2003; IN COMMERCE 4-17-2003.
DAVID HOFFMAN, EXAMINING ATTORNEY

NO CLAIM IS MADE TO THE EXCLUSIVE RIGHT TO USE "SYSTEMS TECHNOLOGY", APART FROM THE MARK AS SHOWN.

THE MARK CONSISTS OF AN UNIFORM OVAL INCLUDING THE WORDING STF AND SYSTEMS TECHNOLOGY FORUM AND CONTAINING A CRESCENT SHAPE BORDERING THE STF WORDING.

FOR BUSINESS MANAGEMENT AND OPERATION ASSISTANCE FOR BUSINESSES AND GOVERNMENT; COMMERCIAL ASSISTANCE RELATING TO SYSTEM IMPLEMENTATION AND SYSTEM INTEGRATION; BUSINESS CONSULTING SERVICES AND STRATEGIC PLANNING OF INFORMATION MANAGEMENT AND INFORMATION TECHNOLOGY; BUSINESS CONSULTING SERVICES RELATING TO ELECTRONIC COMMERCE AND ELECTRONIC BUSINESS OPERATIONS; DATA PROCESSING BY MEANS OF A COMPUTER; BUSINESS CONSULTING SERVICES RELATING TO PRODUCT DISTRIBUTION, OPERATIONS MANAGEMENT SERVICES, LOGISTICS, REVERSE LOGISTICS, SUPPLY CHAIN, AND PRODUCTION SYSTEMS AND DISTRIBUTION SOLUTIONS; ADVISORY SERVICES RELATING TO BUSINESS MANAGEMENT AND BUSINESS OPERATIONS AND FINANCIAL RECORDS MANAGEMENT (U.S. CLS. 100, 101 AND 102).

FIRST USE 1-0-2004; IN COMMERCE 1-0-2004.
DAVID HOFFMAN, EXAMINING ATTORNEY

SN 77-740,931. SNYDER'S GATEWAY, INC., BREEZEWOOD,
PA. FILED 5-20-2009.

TRAVELER'S OASIS

THE MARK CONSISTS OF STANDARD CHARACTERS WITHOUT CLAIM TO ANY PARTICULAR FONT, STYLE, SIZE, OR COLOR.

FOR RETAIL SHOPS FEATURING FOOD COURTS LOCATED IN RETAIL CONVENIENCE STORES; RETAIL STORE SERVICES FEATURING CONVENIENCE STORE ITEMS AND GASOLINE (U.S. CLS. 100, 101 AND 102).

JESSICA FATHY, EXAMINING ATTORNEY

CLASS 35—(Continued).

SN 77-741,410. MEDIAMOBZ, INC., FORMERLY BID4VID, INC., LOS GATOS, CA. FILED 5-20-2009.

MEDIAmobz

THE STIPPLING IS A FEATURE OF THE MARK AND DOES NOT INDICATE COLOR.

THE COLOR(S) FUCHSIA AND GREY IS/ARE CLAIMED AS A FEATURE OF THE MARK.

THE MARK CONSISTS OF THE SINGLE WORD "MEDIAMOBZ", WITH NO SPACES, WITH THE LETTERS "MEDIA" IN UPPER CASE AND IN A FUCHSIA COLOR, AND THE LETTERS "MOBZ" IN LOWER CASE AND IN A GRAY COLOR.

FOR OPERATING ON-LINE MARKETPLACES FEATURING BUYERS AND PRODUCERS OF VIDEO AND OTHER FORMS OF MEDIA (U.S. CLS. 100, 101 AND 102).
PAUL E. FAHRENKOPF, EXAMINING ATTORNEY

SN 77-743,208. THOUGHT SOLUTIONSMARKETING, INC., WINSTON-SALEM, NC. FILED 5-22-2009.

THOUGHT SOLUTIONS MARKETING

THE MARK CONSISTS OF STANDARD CHARACTERS WITHOUT CLAIM TO ANY PARTICULAR FONT, STYLE, SIZE, OR COLOR.

NO CLAIM IS MADE TO THE EXCLUSIVE RIGHT TO USE "MARKETING", APART FROM THE MARK AS SHOWN.

FOR ADVERTISING, PROMOTION AND MARKETING SERVICES; SALES PROMOTION SERVICES (U.S. CLS. 100, 101 AND 102).

ALLISON HOLTZ, EXAMINING ATTORNEY

CLASS 35—(Continued).

SN 77-743,448. NURTUREBABY, INC., DULUTH, GA. FILED 5-22-2009.



THE COLOR(S) DARK GREEN, LIGHT GREEN, RED, ORANGE, AND BROWN IS/ARE CLAIMED AS A FEATURE OF THE MARK.

THE MARK CONSISTS OF A TREE WITH DARK GREEN AND LIGHT GREEN LEAVES AND BROWN BRANCHES BEARING ORANGE AND RED FRUIT. THERE ARE TWO BROWN BIRDS FLYING ABOVE THE TREE. HANGING FROM THE TREE IS A BROWN SWING. BELOW THE TREE AND SWING ARE THE LETTERS "NURTUREBABY" WRITTEN IN CURSIVE IN THE COLOR BROWN.

FOR ADVERTISING AND PUBLICITY SERVICES, NAMELY, PROMOTING THE GOODS, SERVICES, BRAND IDENTITY AND COMMERCIAL INFORMATION AND NEWS OF THIRD PARTIES THROUGH PRINT, AUDIO, VIDEO, DIGITAL AND ON-LINE MEDIUM (U.S. CLS. 100, 101 AND 102).

FIRST USE 4-1-2008; IN COMMERCE 5-1-2009.
MARC LEIPZIG, EXAMINING ATTORNEY

SN 77-744,060. FANBRIDGE, INC., NEW YORK, NY. FILED 5-26-2009.

FANBRIDGE

THE MARK CONSISTS OF STANDARD CHARACTERS WITHOUT CLAIM TO ANY PARTICULAR FONT, STYLE, SIZE, OR COLOR.

FOR CUSTOMER RELATIONSHIP MANAGEMENT SERVICES IN THE NATURE OF FAN RELATIONSHIP MANAGEMENT SERVICES; DATABASE MANAGEMENT OF FAN LISTS (U.S. CLS. 100, 101 AND 102).

FIRST USE 5-17-2006; IN COMMERCE 5-17-2006.
AMEEN IMAM, EXAMINING ATTORNEY

CLASS 35—(Continued).

SN 77-744,549. THE TRIZETTO GROUP, INC., GREENWOOD VILLAGE, CO. FILED 5-26-2009.

THE FINAL MILE IN HEALTHCARE

THE MARK CONSISTS OF STANDARD CHARACTERS WITHOUT CLAIM TO ANY PARTICULAR FONT, STYLE, SIZE, OR COLOR.

FOR MANAGEMENT AND COMPILATION OF COMPUTERIZED DATABASES; BUSINESS CONSULTATION SERVICES; MANAGED CARE SERVICES, NAMELY, ELECTRONIC PROCESSING OF HEALTH CARE INFORMATION (U.S. CLS. 100, 101 AND 102).

SAIMA MAKHDOOM, EXAMINING ATTORNEY

SN 77-746,953. POLICYLINK, OAKLAND, CA. FILED 5-28-2009.

Demand Equity Now

THE MARK CONSISTS OF STANDARD CHARACTERS WITHOUT CLAIM TO ANY PARTICULAR FONT, STYLE, SIZE, OR COLOR.

FOR PROMOTING PUBLIC AWARENESS OF THE NEED FOR ADVANCEMENT OF ECONOMIC AND SOCIAL EQUITY IN DISADVANTAGED COMMUNITIES VIA ONLINE NETWORKS AND PRINTED MATERIALS (U.S. CLS. 100, 101 AND 102).

FIRST USE 2-1-2009; IN COMMERCE 5-21-2009.
LESLIE RICHARDS, EXAMINING ATTORNEY

SN 77-747,649. WRIGLEYVILLE SPORTS, INC., BENSENVILLE, IL. FILED 5-29-2009.



OWNER OF U.S. REG. NOS. 3,235,487 AND 3,362,412.
NO CLAIM IS MADE TO THE EXCLUSIVE RIGHT TO USE "THE PITTSBURGH FAN", APART FROM THE MARK AS SHOWN.

THE COLOR(S) BLACK, YELLOW, BROWN, GREY, AND WHITE IS/ARE CLAIMED AS A FEATURE OF THE MARK.

THE MARK CONSISTS OF THE WORD "THE". ATTACHED TO THE LETTER "H" IS A FLAGPOLE FLYING A FLAG THAT FEATURES TWO CROSSED BASEBALL BATS. UNDERNEATH THE WORD "THE" IS A CURVED LINE. THE WORD "PITTSBURGH" IS ON THE NEXT LINE DOWN, WITH A FOOTBALL APPEARING AS THE DOT

CLASS 35—(Continued).

FOR THE LETTER "I", AND A HOCKEY STICK APPEARING AS PART OF THE LETTER "H". THE WORD "FAN" APPEARS ON THE NEXT LINE DOWN, BELOW "PITTSBURGH". ALL THREE WORDS IN THE MARK ARE SUPERIMPOSED OVER AN OVAL-SHAPED BACKGROUND DESIGN. THE COLOR WHITE APPEARS IN THE BATS ON THE FLAG, AND IN THE LACES ON THE FOOTBALL. THE COLOR BROWN APPEARS IN THE BACKGROUND OF THE FOOTBALL. THE COLOR YELLOW APPEARS IN THE WORD "PITTSBURGH". THE COLOR GREY APPEARS IN THE OVAL SHAPED BACKGROUND DESIGN. THE COLOR BLACK APPEARS IN THE WORDS "THE" AND "FAN", IN THE FLAGPOLE AND FLAG DESIGN, IN THE CURVED LINE UNDERNEATH "THE", IN THE ACCENTS ON THE HOCKEY STICK, AND IN THE OUTLINES OF THE WORD "PITTSBURGH".

FOR RETAIL STORE AND ON-LINE RETAIL STORE SERVICES FEATURING SPORTS TEAMS CLOTHING, MEMORABILIA, AND GENERAL CONSUMER SPORTS MERCHANDISE (U.S. CLS. 100, 101 AND 102).

FIRST USE 9-12-2007; IN COMMERCE 4-7-2008.
NANCY CLARKE, EXAMINING ATTORNEY

SN 77-748,442. SKATEBOARD MARKETING LTD., VALLEY STREAM, NY. FILED 5-31-2009.

Skateboard Marketing Ltd.

THE MARK CONSISTS OF STANDARD CHARACTERS WITHOUT CLAIM TO ANY PARTICULAR FONT, STYLE, SIZE, OR COLOR.

NO CLAIM IS MADE TO THE EXCLUSIVE RIGHT TO USE "MARKETING LTD.", APART FROM THE MARK AS SHOWN.

FOR ADVERTISING AND BUSINESS SERVICES, NAMELY, PROVIDING AN ONLINE WEBSITES WHERE ADVERTISERS, MARKETERS, AND CONTENT PROVIDERS CAN INTERACT WITH USERS FOR ADVERTISING, BRANDING, AND PROMOTING KNOWLEDGE, PRODUCTS, AND SERVICES, AND TRADESHOWS, ON BEHALF OF THEMSELVES AND OTHERS, AND FOR EVALUATING AND RATING THE SAME, ALL THE FOREGOING RELEVANT TO HUMAN ACTIVITIES AFFECTING CLIMATE CHANGE AND RELATED FIELDS; ADVERTISING AND MARKETING; ADVERTISING AND MARKETING SERVICES, NAMELY, PROMOTING THE GOODS AND SERVICES OF OTHERS; ADVERTISING SERVICES, NAMELY, PROMOTING AND MARKETING THE GOODS AND SERVICES OF OTHERS IN THE FIELD OF UPSCALE CHOICES SUCH AS CULTURAL EVENTS, RESTAURANTS, SHOPPING, AND TRAVEL VIA PRINT AND ELECTRONIC MEDIA; ADVERTISING SERVICES, NAMELY, PROMOTING AND MARKETING THE GOODS AND SERVICES OF OTHERS THROUGH ALL PUBLIC COMMUNICATION MEANS; ADVERTISING SERVICES, PUBLIC RELATIONS AND MARKETING SERVICES, NAMELY, PROMOTING AND MARKETING THE GOODS AND SERVICES OF OTHERS THROUGH ALL PUBLIC COMMUNICATION MEANS; ADVERTISING, MARKETING AND PROMOTING THE GOODS AND SERVICES OF OTHERS USING KIOSKS; ADVERTISING, MARKETING AND PROMOTION SERVICES; ADVERTISING, MARKETING AND PROMOTIONAL SERVICES FOR AUTOMOTIVE DEALERSHIPS; ADVERTISING, MARKETING AND PROMOTIONAL SERVICES FOR THE DONATION OF HUMAN BLOOD THAT EXACTLY MATCHES THE BLOOD TYPE OF INDIVIDUALS NEEDING TRANSFUSIONS; ADVERTISING, MARKETING AND PROMOTIONAL SERVICES RELATED TO ALL INDUSTRIES FOR THE PURPOSE OF FACILITATING NETWORKING AND SOCIALIZING OPPORTUNITIES FOR BUSINESS PURPOSES; ADVERTISING, PROMOTION AND MARKETING SERVICES IN THE NATURE OF E-MAIL BLAST CAMPAIGNS FOR OTHERS; ARRANGING AND

CLASS 35—(Continued).

CONDUCTING MARKETING PROMOTIONAL EVENTS FOR OTHERS; BRANDING SERVICES, NAMELY, CONSULTING, DEVELOPMENT, MANAGEMENT AND MARKETING OF BRANDS FOR BUSINESSES; BUSINESS CONSULTATION AND MANAGEMENT REGARDING MARKETING ACTIVITIES AND LAUNCHING OF NEW PRODUCTS; BUSINESS TO BUSINESS DIRECT MARKETING SERVICES; CONDUCTING BUSINESS AND MARKET RESEARCH SURVEYS; CONDUCTING MARKETING STUDIES; COOPERATIVE ADVERTISING AND MARKETING; COOPERATIVE ADVERTISING AND MARKETING SERVICES BY WAY OF SOLICITATION, CUSTOMER SERVICE AND PROVIDING MARKETING INFORMATION VIA WEB SITES ON A GLOBAL COMPUTER NETWORK; CREATIVE MARKETING DESIGN SERVICES; CUSTOM WRITING SERVICES COMPRISING PUBLIC RELATIONS AND MARKETING MATERIALS FOR THE AUDIO, VIDEO AND TECHNOLOGY INDUSTRIES; DIRECT MARKETING ADVERTISING FOR OTHERS; DIRECT MARKETING CONSULTING SERVICES; DIRECT MARKETING SERVICES; ENTERTAINMENT MARKETING SERVICES, NAMELY, MARKETING, PROMOTION AND ADVERTISING FOR INDEPENDENT RECORDING ARTISTS (U.S. CLS. 100, 101 AND 102).

FIRST USE 8-12-1991; IN COMMERCE 8-12-1991.
TARAH HARDY, EXAMINING ATTORNEY

CLASS 35—(Continued).

SN 77-749,190. SUMMIT SOLUTIONS, INC., DBA SUMMITQWEST, DAYTON, OH. FILED 6-1-2009.

ALWAYS FORWARD

THE MARK CONSISTS OF STANDARD CHARACTERS WITHOUT CLAIM TO ANY PARTICULAR FONT, STYLE, SIZE, OR COLOR.

FOR BUSINESS SERVICES, NAMELY, BUSINESS CONSULTING AND INFORMATION SERVICES, MANAGEMENT CONSULTING SERVICES; BUSINESS MARKETING SERVICES, BUSINESS PROJECT AND PROGRAM MANAGEMENT SERVICES IN THE FIELDS OF CUSTOMIZED BUSINESS AND INFORMATION SERVICES; BUSINESS INTELLIGENCE SERVICES, BUSINESS MARKETING PROGRAM MANAGEMENT SERVICES, BUSINESS RISK MANAGEMENT SERVICES, AND ONLINE GROUND TRANSPORTATION MANAGEMENT SERVICES, NAMELY, TRANSPORTATION MANAGEMENT SERVICES AND PLANNING AND COORDINATING TRANSPORTATION OF PEOPLE FOR OTHERS (U.S. CLS. 100, 101 AND 102).

FIRST USE 0-0-2003; IN COMMERCE 0-0-2003.
KYLE PEETE, EXAMINING ATTORNEY

SN 77-749,188. NE COLORADO CELLULAR, INC., D.B.A. VIAERO WIRELESS, FORT MORGAN, CO. FILED 6-1-2009.



OWNER OF U.S. REG. NOS. 3,227,070, 3,241,501 AND OTHERS.

THE MARK CONSISTS OF THE WORDS "MY VIAERO" WITH A DESIGN OF THREE CURVED LINES ABOVE THE DOT IN THE LETTER "I" AND ABOVE THE LETTER "A".

FOR PROVIDING A WEBSITE AT WHICH CUSTOMERS CAN MANAGE ACCOUNT INFORMATION RELATED TO TELECOMMUNICATIONS PRODUCTS AND SERVICES (U.S. CLS. 100, 101 AND 102).

MARY CRAWFORD, EXAMINING ATTORNEY

SN 77-749,191. SUMMIT SOLUTIONS, INC., DBA SUMMITQWEST, DAYTON, OH. FILED 6-1-2009.

SUMMITQWEST

THE MARK CONSISTS OF STANDARD CHARACTERS WITHOUT CLAIM TO ANY PARTICULAR FONT, STYLE, SIZE, OR COLOR.

FOR BUSINESS SERVICES, NAMELY, BUSINESS CONSULTING AND INFORMATION SERVICES, MANAGEMENT CONSULTING SERVICES; BUSINESS MARKETING SERVICES, BUSINESS PROJECT AND PROGRAM MANAGEMENT SERVICES IN THE FIELDS OF CUSTOMIZED BUSINESS AND INFORMATION SERVICES; BUSINESS INTELLIGENCE SERVICES, BUSINESS MARKETING PROGRAM MANAGEMENT SERVICES, BUSINESS RISK MANAGEMENT SERVICES, AND ONLINE GROUND TRANSPORTATION MANAGEMENT SERVICES, NAMELY, TRANSPORTATION MANAGEMENT SERVICES AND PLANNING AND COORDINATING TRANSPORTATION OF PEOPLE FOR OTHERS (U.S. CLS. 100, 101 AND 102).

FIRST USE 0-0-2003; IN COMMERCE 0-0-2003.
KYLE PEETE, EXAMINING ATTORNEY

CLASS 35—(Continued).

SN 77-749,254. SUMMIT SOLUTIONS, INC., DBA SUMMITQWEST, DAYTON, OH. FILED 6-1-2009.

SUMMITGROUND

THE MARK CONSISTS OF STANDARD CHARACTERS WITHOUT CLAIM TO ANY PARTICULAR FONT, STYLE, SIZE, OR COLOR.

FOR BUSINESS SERVICES, NAMELY, BUSINESS CONSULTING AND INFORMATION SERVICES, ON-LINE GROUND TRANSPORTATION MANAGEMENT SERVICES, NAMELY, TRANSPORTATION MANAGEMENT SERVICES AND PLANNING AND COORDINATING TRANSPORTATION OF PEOPLE FOR OTHERS (U.S. CLS. 100, 101 AND 102).

FIRST USE 0-0-2008; IN COMMERCE 0-0-2008.

KYLE PEETE, EXAMINING ATTORNEY

CLASS 35—(Continued).

SN 77-751,301. LADIES OF CHARITY OF THE UNITED STATES, EARTH CITY, MO. FILED 6-3-2009.

LADIES OF CHARITY OF THE UNITED STATES OF AMERICA

THE MARK CONSISTS OF STANDARD CHARACTERS WITHOUT CLAIM TO ANY PARTICULAR FONT, STYLE, SIZE, OR COLOR.

SEC. 2(F).
FOR CHARITABLE SERVICES, NAMELY, ORGANIZING AND CONDUCTING VOLUNTEER PROGRAMS AND COMMUNITY SERVICE PROJECTS TO PROVIDE ASSISTANCE AND SERVICES TO NEEDY, UNDERPRIVILEGED AND MARGINALIZED PERSONS (U.S. CLS. 100, 101 AND 102).

FIRST USE 0-0-1857; IN COMMERCE 0-0-1960.

CHRIS WELLS, EXAMINING ATTORNEY

SN 77-749,318. SUMMIT SOLUTIONS, INC., DBA SUMMITQWEST, DAYTON, OH. FILED 6-1-2009.



SummitQwest
ALWAYS FORWARD

THE COLOR(S) WHITE, BLUE AND BLACK IS/ARE CLAIMED AS A FEATURE OF THE MARK.

THE MARK CONSISTS OF A BLUE TRIANGLE WITH WHITE CENTER, WITH THE WORDS "ALWAYS" DISPLAYED IN BLACK, THE WORD "FORWARD" DISPLAYED IN BLUE AND THE WORD "SUMMITQWEST" DISPLAYED IN BLACK.

FOR BUSINESS SERVICES, NAMELY, BUSINESS CONSULTING AND INFORMATION SERVICES, MANAGEMENT CONSULTING SERVICES; BUSINESS MARKETING SERVICES, BUSINESS PROJECT AND PROGRAM MANAGEMENT SERVICES IN THE FIELDS OF CUSTOMIZED BUSINESS AND INFORMATION SERVICES; BUSINESS INTELLIGENCE SERVICES, BUSINESS MARKETING PROGRAM MANAGEMENT SERVICES, BUSINESS RISK MANAGEMENT SERVICES, AND ONLINE GROUND TRANSPORTATION MANAGEMENT SERVICES, NAMELY, TRANSPORTATION MANAGEMENT SERVICES AND PLANNING AND COORDINATING TRANSPORTATION OF PEOPLE FOR OTHERS (U.S. CLS. 100, 101 AND 102).

FIRST USE 0-0-2003; IN COMMERCE 0-0-2003.

KYLE PEETE, EXAMINING ATTORNEY

SN 77-752,005. UPICK STORAGE, LLC, MADISONVILLE, LA. FILED 6-4-2009.



THE COLOR(S) WHITE, BLUE, AND ORANGE IS/ARE CLAIMED AS A FEATURE OF THE MARK.

THE MARK CONSISTS OF "UPICKSTORAGE.COM" IN WHITE LETTERS AND "THE BEST WAY TO SHOP FOR STORAGE... PERIOD." IN ORANGE LETTERS ON A BLUE BACKGROUND.

FOR ON-LINE ADVERTISING ON COMPUTER COMMUNICATION NETWORKS; ON-LINE AUCTION SERVICES; PROVIDING A WEBSITE USED TO PLACE ON-LINE COMMERCIAL ORDERS IN THE FIELD OF STORAGE FACILITIES; PROVIDING AN ON-LINE DIRECTORY INFORMATION SERVICE FEATURING INFORMATION REGARDING STORAGE FACILITIES (U.S. CLS. 100, 101 AND 102).

FIRST USE 6-2-2009; IN COMMERCE 6-2-2009.

ELIZABETH KAJUBI, EXAMINING ATTORNEY

CLASS 35—(Continued).

SN 77-752,060. UPICK STORAGE, LLC, MADISONVILLE, LA. FILED 6-4-2009.

The best way to shop for storage... Period.

THE MARK CONSISTS OF STANDARD CHARACTERS WITHOUT CLAIM TO ANY PARTICULAR FONT, STYLE, SIZE, OR COLOR.

FOR ON-LINE ADVERTISING ON COMPUTER COMMUNICATION NETWORKS; ON-LINE AUCTION SERVICES; PROVIDING A WEBSITE USED TO PLACE ON-LINE COMMERCIAL ORDERS IN THE FIELD OF STORAGE FACILITIES; PROVIDING AN ON-LINE DIRECTORY INFORMATION SERVICE FEATURING INFORMATION REGARDING STORAGE FACILITIES (U.S. CLS. 100, 101 AND 102).

FIRST USE 6-2-2009; IN COMMERCE 6-2-2009.
ELIZABETH KAJUBI, EXAMINING ATTORNEY

SN 77-752,112. JOBBITZ.COM, LLC, ASHEVILLE, NC. FILED 6-4-2009.

JOBBITZ

THE MARK CONSISTS OF STANDARD CHARACTERS WITHOUT CLAIM TO ANY PARTICULAR FONT, STYLE, SIZE, OR COLOR.

FOR PROVIDING ONLINE INFORMATION CONCERNING THE AVAILABILITY OF SHORT TERM, NEIGHBORHOOD JOBS (U.S. CLS. 100, 101 AND 102).

FIRST USE 5-25-2009; IN COMMERCE 5-25-2009.
GINA FINK, EXAMINING ATTORNEY

SN 77-752,246. HAVERTY FURNITURE COMPANIES, INC., ATLANTA, GA. FILED 6-4-2009.

HAVERTYS

THE MARK CONSISTS OF STANDARD CHARACTERS WITHOUT CLAIM TO ANY PARTICULAR FONT, STYLE, SIZE, OR COLOR.

OWNER OF U.S. REG. NOS. 2,180,799, 2,182,529 AND 2,516,767.
SEC. 2(F).

FOR RETAIL STORE SERVICES IN THE FIELD OF HOUSEHOLD FURNISHINGS (U.S. CLS. 100, 101 AND 102).

FIRST USE 6-0-1994, THE MARK WAS FIRST USED ANYWHERE IN A DIFFERENT FORM OTHER THAN THAT SOUGHT TO BE REGISTERED AT LEAST AS EARLY AS 00/00/1885.; IN COMMERCE 6-0-1994, THE MARK WAS FIRST USED IN COMMERCE IN A DIFFERENT FORM OTHER THAN THAT SOUGHT TO BE REGISTERED AT LEAST AS EARLY AS 00/00/1885..

JUSTINE D. PARKER, EXAMINING ATTORNEY

CLASS 35—(Continued).

SN 77-752,756. LADIES OF CHARITY OF THE UNITED STATES, EARTH CITY, MO. FILED 6-5-2009.



NO CLAIM IS MADE TO THE EXCLUSIVE RIGHT TO USE "LADIES OF CHARITY", APART FROM THE MARK AS SHOWN.

THE MARK CONSISTS OF A SHIELD WITH A CROSS, AN ANCHOR, A HEART AND THE WORDS "LADIES OF CHARITY" WITHIN THE SHIELD.

FOR CHARITABLE SERVICES, NAMELY, ORGANIZING AND CONDUCTING VOLUNTEER PROGRAMS AND COMMUNITY SERVICE PROJECTS TO PROVIDE ASSISTANCE AND SERVICES TO NEEDY, UNDERPRIVILEGED AND MARGINALIZED PERSONS (U.S. CLS. 100, 101 AND 102).

FIRST USE 0-0-1857; IN COMMERCE 0-0-1960.
CHRIS WELLS, EXAMINING ATTORNEY

SN 77-753,634. TEACAKE BAKE SHOP, LLC, OAKLAND, CA. FILED 6-5-2009.

SWEETEN YOUR DAY

THE MARK CONSISTS OF STANDARD CHARACTERS WITHOUT CLAIM TO ANY PARTICULAR FONT, STYLE, SIZE, OR COLOR.

OWNER OF U.S. REG. NO. 3,670,145.
FOR RETAIL STORE SERVICES FEATURING BAKED GOODS AND DRY MIXES FOR BAKED GOODS (U.S. CLS. 100, 101 AND 102).

FIRST USE 3-15-2007; IN COMMERCE 3-15-2007.
VERNA BETH RIRIE, EXAMINING ATTORNEY

CLASS 35—(Continued).

SN 77-754,581. SEARS BRANDS, LLC, HOFFMAN ESTATES, ILL. FILED 6-8-2009.

ONE STORE FITS ALL

THE MARK CONSISTS OF STANDARD CHARACTERS WITHOUT CLAIM TO ANY PARTICULAR FONT, STYLE, SIZE, OR COLOR.

FOR RETAIL STORE SERVICES FEATURING ATHLETIC CLOTHING, CLOTHING, CLOTHING ACCESSORIES AND FOOTWEAR (U.S. CLS. 100, 101 AND 102).
SHAILA SETTLES, EXAMINING ATTORNEY

SN 77-754,846. VEGAN BARBARIAN, INC., BEVERLY HILLS, CA. FILED 6-8-2009.

Vegan Barbarian

THE MARK CONSISTS OF STANDARD CHARACTERS WITHOUT CLAIM TO ANY PARTICULAR FONT, STYLE, SIZE, OR COLOR.

NO CLAIM IS MADE TO THE EXCLUSIVE RIGHT TO USE "VEGAN", APART FROM THE MARK AS SHOWN.

FOR MAIL ORDER SERVICES FEATURING CLOTHING, ACCESSORIES, PURSES, BAGS, TOTES, BACKPACKS, TRAVEL BAGS, WALLETS, FOOTWEAR, SHOES, BOOTIES, HEADWEAR, LUGGAGE, PET SUPPLIES, PET CLOTHING AND PET ACCESSORIES; ONLINE RETAIL STORE SERVICES FEATURING CLOTHING, ACCESSORIES, PURSES, BAGS, TOTES, BACKPACKS, TRAVEL BAGS, WALLETS, FOOTWEAR, SHOES, BOOTIES, HEADWEAR, LUGGAGE, PET SUPPLIES, PET CLOTHING AND PET ACCESSORIES; RETAIL STORE SERVICES FEATURING CLOTHING, ACCESSORIES, PURSES, BAGS, TOTES, BACKPACKS, TRAVEL BAGS, WALLETS, FOOTWEAR, SHOES, BOOTIES, HEADWEAR, LUGGAGE, PET SUPPLIES, PET CLOTHING AND PET ACCESSORIES; ALL OF THE FOREGOING SERVICES FEATURE VEGAN AND VEGETARIAN-FRIENDLY ITEMS (U.S. CLS. 100, 101 AND 102).

TOBY BULLOFF, EXAMINING ATTORNEY

SN 77-754,895. BEVBLITZ, LLC, THOUSAND OAKS, CA. FILED 6-8-2009.

BevBlitz

THE MARK CONSISTS OF STANDARD CHARACTERS WITHOUT CLAIM TO ANY PARTICULAR FONT, STYLE, SIZE, OR COLOR.

FOR OUTSOURCING IN THE FIELD OF WINE AND SPIRITS SALES (U.S. CLS. 100, 101 AND 102).

FIRST USE 5-16-2009; IN COMMERCE 5-16-2009.
JOHN WILKE, EXAMINING ATTORNEY

CLASS 35—(Continued).

SN 77-755,138. MINNESOTA TURKEY GROWERS ASSOCIATION, BUFFALO, MN. FILED 6-9-2009.



NO CLAIM IS MADE TO THE EXCLUSIVE RIGHT TO USE "TURKEY", APART FROM THE MARK AS SHOWN.

THE MARK CONSISTS OF A BLACK BACKGROUND WITH FANNED OUT STYLIZED ORANGE TURKEY FEATHERS THAT ARE OUTLINED IN BLACK WITH WHITE ON THE TIPS. UNDERNEATH THE FEATHERS IS AN OBLONG WITH THE WORDING "MINNESOTA TURKEY" IN WHITE.

SEC. 2(F) AS TO "MINNESOTA TURKEY".

FOR ASSOCIATION SERVICES, NAMELY, PROMOTING THE INTEREST OF TURKEY FARMERS, PROCESSORS, AND ALLIED BUSINESSES THROUGH ADVOCACY, RESEARCH, SUPPORT, PROMOTIONAL ACTIVITIES AND INFORMATIONAL RESOURCES (U.S. CLS. 100, 101 AND 102).

FIRST USE 6-1-2007; IN COMMERCE 6-1-2007.

ROBIN CHOSID, EXAMINING ATTORNEY

SN 77-755,297. KELLY-MOORE PAINT COMPANY, INC., SAN CARLOS, CA. FILED 6-9-2009.

EARTH FIRST

THE MARK CONSISTS OF STANDARD CHARACTERS WITHOUT CLAIM TO ANY PARTICULAR FONT, STYLE, SIZE, OR COLOR.

FOR RETAIL PAINT STORE SERVICES; PROVIDING CONSUMER PRODUCT INFORMATION IN THE FIELDS OF PAINTS AND COATINGS; PROMOTING PUBLIC AWARENESS OF GOVERNMENT REGULATIONS RELATING TO HEALTH, SAFETY AND THE ENVIRONMENT IN THE PAINT AND RELATED COATINGS INDUSTRY; RETAIL PAINT STORE SERVICES FEATURING PAINTS, COATINGS, PAINT SUPPLIES, PAINT-RELATED PRODUCTS, PAINT KITS, COLOR CARDS, PAINT BRUSHES, AND PRINTED MATERIALS TO AID ARTISTS, ARCHITECTS, AND CONSUMERS IN THE SELECTION AND COORDINATION OF COLORS; PROVIDING A WEBSITE AND ONLINE INFORMATION FEATURING CONSUMER INFORMATION IN THE FIELDS OF PAINTS, COATINGS; PROVIDING ONLINE RETAIL STORE SERVICES FEATURING PAINTS, COATINGS, PAINT SUPPLIES AND PRINTED MATERIALS ABOUT PAINTS AND COLOR COORDINATION (U.S. CLS. 100, 101 AND 102).

BENJAMIN OKEKE, EXAMINING ATTORNEY

CLASS 35—(Continued).

SN 77-756,613. LOS PISTOLEROS CENTRAL TEXAS, ELGIN, TX. FILED 6-10-2009.

LOS PISTOLEROS CENTRAL
TEXAS

THE MARK CONSISTS OF STANDARD CHARACTERS WITHOUT CLAIM TO ANY PARTICULAR FONT, STYLE, SIZE, OR COLOR.

NO CLAIM IS MADE TO THE EXCLUSIVE RIGHT TO USE "CENTRAL TEXAS", APART FROM THE MARK AS SHOWN.

THE ENGLISH TRANSLATION OF LOS PISTOLEROS IN THE MARK IS THE GUNMEN.

FOR CHARITABLE SERVICES, NAMELY, ORGANIZING AND CONDUCTING VOLUNTEER PROGRAMS AND COMMUNITY SERVICE PROJECTS; CHARITABLE SERVICES, NAMELY, ORGANIZING AND CONDUCTING VOLUNTEER PROGRAMS AND COMMUNITY SERVICE PROJECTS AIMED AT INCREASING SUPPORT AND MORALE OF FAMILIES OF DECEASED WAR VETERANS, WAR VETERANS, CURRENT MEMBERS AND FUTURE MEMBERS OF THE U.S. MILITARY (U.S. CLS. 100, 101 AND 102).

JANICE L. MCMORROW, EXAMINING ATTORNEY

SN 77-756,853. PROSTAR HEALTHCARE, LLC, IRVINE, CA. FILED 6-10-2009.

PROSTAR
HEALTHCARE

NO CLAIM IS MADE TO THE EXCLUSIVE RIGHT TO USE "HEALTHCARE", APART FROM THE MARK AS SHOWN.

THE MARK CONSISTS OF THE STYLIZED TEXT "PROSTAR HEALTHCARE" WITH A SWOOSH AND A STAR.

FOR EMPLOYMENT STAFFING IN THE FIELD OF HEALTHCARE, HOME CARE, HOME HEALTHCARE, NURSING, AND MEDICINE (U.S. CLS. 100, 101 AND 102).

FIRST USE 5-18-2009; IN COMMERCE 5-18-2009.
CHRIS WELLS, EXAMINING ATTORNEY

CLASS 35—(Continued).

SN 77-758,274. JEFFREY A. WALKER SR., DAYTON, OH. FILED 6-12-2009.

DAYTON GEMS

THE MARK CONSISTS OF STANDARD CHARACTERS WITHOUT CLAIM TO ANY PARTICULAR FONT, STYLE, SIZE, OR COLOR.

NO CLAIM IS MADE TO THE EXCLUSIVE RIGHT TO USE "DAYTON", APART FROM THE MARK AS SHOWN.

FOR PROMOTING HOCKEY COMPETITIONS AND EVENTS OF OTHERS (U.S. CLS. 100, 101 AND 102).

CHRISTINE COOPER, EXAMINING ATTORNEY

SN 77-759,324. CHATHAM COUNTY-SAVANNAH METROPOLITAN PLANNING COMMISSION, SAVANNAH, GA. FILED 6-15-2009.

coastal
commuters

NO CLAIM IS MADE TO THE EXCLUSIVE RIGHT TO USE "COASTAL COMMUTERS", APART FROM THE MARK AS SHOWN.

THE MARK CONSISTS OF A CIRCLE REPRESENTING A HUMAN HEAD WITH A LINE CURVED UP ON THE LEFT HAND SIDE AND STRETCHING OUT HORIZONTALLY REPRESENTING HUMAN ARMS AND SHOULDERS. BELOW THAT IS THE WORD "COASTAL" AND "COMMUTERS" IS BELOW IT AND FINALLY BELOW IT IS A HORIZONTAL LINE THAT REPRESENTS HUMAN LEGS AND THAT LINE DROPS VERTICALLY AT THE END TO REPRESENT THE BOTTOM OF HUMAN LEGS AND FEET.

FOR PROMOTING THE USE OF ALTERNATIVE MEANS OF TRANSPORTATION (U.S. CLS. 100, 101 AND 102).

FIRST USE 4-18-2008; IN COMMERCE 4-18-2008.
KIMBERLY FRYE, EXAMINING ATTORNEY

CLASS 35—(Continued).

SN 77-760,106. EDUCATIONAL TESTING SERVICE, AKA ETS, PRINCETON, NJ. FILED 6-15-2009.



OWNER OF U.S. REG. NOS. 558,879, 1,166,461 AND 2,363,333.

NO CLAIM IS MADE TO THE EXCLUSIVE RIGHT TO USE "PREFERRED ASSOCIATE", APART FROM THE MARK AS SHOWN.

FOR RETAIL STORE SERVICES FEATURING INTERNET-DELIVERED TEACHING AND LEARNING EDUCATIONAL MATERIALS; MAIL ORDER SERVICES FEATURING INTERNET-DELIVERED TEACHING AND LEARNING EDUCATIONAL MATERIALS; ONLINE RETAIL STORE SERVICES FEATURING INTERNET-DELIVERED TEACHING AND LEARNING EDUCATIONAL MATERIALS; INDEPENDENT SALES REPRESENTATIVES IN THE FIELD OF INTERNET-DELIVERED TEACHING AND LEARNING EDUCATIONAL MATERIALS AND SERVICES (U.S. CLS. 100, 101 AND 102).

ALLISON SCHRODY, EXAMINING ATTORNEY

SN 77-760,541. KNAB, JENNIFER WILSON, TAMPA, FL. FILED 6-16-2009.

NOTHING TO HIDE

THE MARK CONSISTS OF STANDARD CHARACTERS WITHOUT CLAIM TO ANY PARTICULAR FONT, STYLE, SIZE, OR COLOR.

FOR ON-LINE RETAIL STORE SERVICES FEATURING CLOTHING AND ACCESSORIES; WHOLESALE DISTRIBUTORSHIPS FEATURING CLOTHING AND ACCESSORIES (U.S. CLS. 100, 101 AND 102).

JUSTINE D. PARKER, EXAMINING ATTORNEY

SN 77-760,611. VITA-MIX CORPORATION, CLEVELAND, OH. FILED 6-16-2009.

VITA-PARTY

THE MARK CONSISTS OF STANDARD CHARACTERS WITHOUT CLAIM TO ANY PARTICULAR FONT, STYLE, SIZE, OR COLOR.

FOR RETAIL SHOP-AT-HOME PARTY SERVICES FEATURING BLENDERS (U.S. CLS. 100, 101 AND 102).

FIRST USE 6-12-2009; IN COMMERCE 6-12-2009.

TARA PATE, EXAMINING ATTORNEY

CLASS 35—(Continued).

SN 77-760,737. HOMETOWN INTERNET MARKETING, L.L.C., EAST GRAND RAPIDS, MI. FILED 6-16-2009.



THE COLOR(S) RED, WHITE AND LIGHT BLUE IS/ARE CLAIMED AS A FEATURE OF THE MARK.

THE MARK CONSISTS OF RED SQUARE WITH WHITE BLOCK "H". UPPER RIGHT AND LOWER LEFT CORNERS OF BOX ARE ROUNDED OFF AND LIGHT BLUE SHADOW OF SQUARE ON RIGHT SIDE AND BOTTOM.

FOR ADVERTISING AND MARKETING (U.S. CLS. 100, 101 AND 102).

FIRST USE 11-18-2008; IN COMMERCE 11-18-2008.

NORA BUCHANAN WILL, EXAMINING ATTORNEY

SN 77-762,517. SPECIAL KIDS CRUSADE, INC., MONTEREY, CA. FILED 6-17-2009.



NO CLAIM IS MADE TO THE EXCLUSIVE RIGHT TO USE "SPECIAL KIDS CRUSADE", APART FROM THE MARK AS SHOWN.

THE MARK CONSISTS OF THREE HANDS REACHING UPWARD IN A SQUARE WITH STARS IN THE BACKGROUND OVER THE TEXT "SPECIAL KIDS CRUSADE" (FONT IS HOEFLER), SEPARATED BY A THIN UNDERLINE AND THE WORDS "HELPING SPECIAL KIDS REACH FOR THE STARS" (FONT IS HOEFLER) STACKED UNDERNEATH.

FOR PUBLIC ADVOCACY TO PROMOTE AWARENESS OF DISABLED CHILDREN AND THEIR FAMILIES LIVING IN MONTEREY COUNTY, CALIFORNIA (U.S. CLS. 100, 101 AND 102).

FIRST USE 3-0-2007; IN COMMERCE 3-0-2007.

CHARLOTTE CORWIN, EXAMINING ATTORNEY

CLASS 35—(Continued).

SN 77-764,239. DYNAMIC RESPONSE GROUP, INC., MIAMI, FL. FILED 6-19-2009.



NO CLAIM IS MADE TO THE EXCLUSIVE RIGHT TO USE "GROUP", APART FROM THE MARK AS SHOWN.

THE MARK CONSISTS OF A RECTANGLE WITH ROUNDED CORNERS ENCLOSING THE PHRASE "DYNAMIC RESPONSE GROUP" STYLIZED IN LOWER CASE LETTERS.

FOR ADVERTISING SERVICES, NAMELY, PROMOTING AND MARKETING THE GOODS AND SERVICES OF OTHERS THROUGH ALL PUBLIC COMMUNICATION MEANS (U.S. CLS. 100, 101 AND 102).

JENNIFER MARTIN, EXAMINING ATTORNEY

SN 77-764,984. SCHRADER REAL ESTATE & AUCTION COMPANY, INC., COLUMBIA CITY, IN. FILED 6-22-2009.

MAXIMUM MARKETING METHOD

THE MARK CONSISTS OF STANDARD CHARACTERS WITHOUT CLAIM TO ANY PARTICULAR FONT, STYLE, SIZE, OR COLOR.

NO CLAIM IS MADE TO THE EXCLUSIVE RIGHT TO USE "MARKETING METHOD", APART FROM THE MARK AS SHOWN.

FOR REAL ESTATE AUCTIONS (U.S. CLS. 100, 101 AND 102).

FIRST USE 9-30-1998; IN COMMERCE 9-30-1998.
CHRIS WELLS, EXAMINING ATTORNEY

SN 77-766,713. EDWIN WATTS GOLF SHOPS LLC, FORT WALTON BEACH, FL. FILED 6-24-2009.

THE WATTS GUYS

THE MARK CONSISTS OF STANDARD CHARACTERS WITHOUT CLAIM TO ANY PARTICULAR FONT, STYLE, SIZE, OR COLOR.

FOR RETAIL GOLF SHOPS AND CATALOG ORDERING SERVICES FEATURING GOLF EQUIPMENT AND PROVIDING CONSULTATION TO CONSUMERS REGARDING THE SELECTION OF PRODUCTS TO BE PURCHASED IN THE FIELD OF GOLF (U.S. CLS. 100, 101 AND 102).

FIRST USE 3-6-2009; IN COMMERCE 3-6-2009.
JUDITH HELFMAN, EXAMINING ATTORNEY

CLASS 35—(Continued).

SN 77-767,368. FOUR QUEENS, INC., LAS VEGAS, NV. FILED 6-24-2009.

THE CLUB OF CLUBS

THE MARK CONSISTS OF STANDARD CHARACTERS WITHOUT CLAIM TO ANY PARTICULAR FONT, STYLE, SIZE, OR COLOR.

NO CLAIM IS MADE TO THE EXCLUSIVE RIGHT TO USE "CLUB", APART FROM THE MARK AS SHOWN.

FOR CUSTOMER LOYALTY SERVICES, NAMELY, INCENTIVE PROGRAMS TO PROMOTE FREQUENT CUSTOMER PATRONAGE THROUGH REWARDS GIVEN TO CASINO PLAYERS (U.S. CLS. 100, 101 AND 102).

ALLISON HOLTZ, EXAMINING ATTORNEY

SN 77-767,462. WORDLY WEDDINGS LLC, CROMWELL, CT. FILED 6-24-2009.



NO CLAIM IS MADE TO THE EXCLUSIVE RIGHT TO USE "WEDDINGS" AND "FAVORS & GIFTS", APART FROM THE MARK AS SHOWN.

THE MARK CONSISTS OF AN IMAGE OF AN EN-CIRCLED EARTH OVER THE WORD "WORDLY", ABOVE THE WORD "WEDDINGS", WITH INTERLOCKING "D" AND "D" IN THE MIDDLE OF THE WORD, ABOVE THE WORDING "FAVORS & GIFTS INSPIRED BY OUR WORLD".

FOR ON-LINE RETAIL STORE SERVICES FEATURING WEDDING GIFTS, WEDDING FAVORS, WEDDING ACCESSORIES, PARTY FAVORS, PARTY GIFTS, PARTY ACCESSORIES, INVITATIONS AND STATIONERY, RELIGIOUS ARTICLES; RETAIL STORE SERVICES FEATURING WEDDING GIFTS, WEDDING FAVORS, WEDDING ACCESSORIES, PARTY FAVORS, PARTY GIFTS, PARTY ACCESSORIES, INVITATIONS AND STATIONERY, RELIGIOUS ARTICLES (U.S. CLS. 100, 101 AND 102).

FIRST USE 1-30-2008; IN COMMERCE 1-30-2008.
ELISSA GARBER KON, EXAMINING ATTORNEY

CLASS 35—(Continued).

SN 77-767,472. WORDLY WEDDINGS LLC, CROMWELL, CT. FILED 6-24-2009.

worldly weddings

THE MARK CONSISTS OF STANDARD CHARACTERS WITHOUT CLAIM TO ANY PARTICULAR FONT, STYLE, SIZE, OR COLOR.

NO CLAIM IS MADE TO THE EXCLUSIVE RIGHT TO USE "WEDDINGS", APART FROM THE MARK AS SHOWN.

FOR ON-LINE RETAIL STORE SERVICES FEATURING WEDDING GIFTS, WEDDING FAVORS, WEDDING ACCESSORIES, PARTY FAVORS, PARTY GIFTS, PARTY ACCESSORIES, INVITATIONS AND STATIONERY, RELIGIOUS ARTICLES; RETAIL STORE SERVICES FEATURING WEDDING GIFTS, WEDDING FAVORS, WEDDING ACCESSORIES, PARTY FAVORS, PARTY GIFTS, PARTY ACCESSORIES, INVITATIONS AND STATIONERY, RELIGIOUS ARTICLES (U.S. CLS. 100, 101 AND 102).

FIRST USE 1-30-2008; IN COMMERCE 1-30-2008.
ELISSA GARBER KON, EXAMINING ATTORNEY

SN 77-767,536. MENTAL DISABILITY RIGHTS INTERNATIONAL, WASHINGTON, DC. FILED 6-24-2009.

Disability Rights International

THE MARK CONSISTS OF STANDARD CHARACTERS WITHOUT CLAIM TO ANY PARTICULAR FONT, STYLE, SIZE, OR COLOR.

NO CLAIM IS MADE TO THE EXCLUSIVE RIGHT TO USE "DISABILITY", APART FROM THE MARK AS SHOWN.

SEC. 2(F).

FOR PUBLIC ADVOCACY TO PROMOTE AWARENESS OF HUMAN RIGHTS AND FULL PARTICIPATION IN SOCIETY OF PEOPLE WITH MENTAL DISABILITIES WORLDWIDE (U.S. CLS. 100, 101 AND 102).

CHRIS WELLS, EXAMINING ATTORNEY

SN 77-768,220. BAILEY & HASKELL ASSOCIATES, INC., ONEIDA, NY. FILED 6-25-2009.

Employsmart

THE MARK CONSISTS OF STANDARD CHARACTERS WITHOUT CLAIM TO ANY PARTICULAR FONT, STYLE, SIZE, OR COLOR.

FOR PHYSICAL AND COGNITIVE TESTING TO DETERMINE EMPLOYMENT SKILLS (U.S. CLS. 100, 101 AND 102).

FIRST USE 5-8-2009; IN COMMERCE 5-8-2009.
BARBARA GAYNOR, EXAMINING ATTORNEY

CLASS 35—(Continued).

SN 77-771,845. IPM ASSET SOLUTIONS, INC., HOUSTON, TX. FILED S.R. 6-30-2009; AM. P.R. 3-23-2010.



Tracking the information that keeps you on track

NO CLAIM IS MADE TO THE EXCLUSIVE RIGHT TO USE "FIND A FILE", APART FROM THE MARK AS SHOWN.

THE COLOR(S) DARK GRAY, BLUE, RED, YELLOW, BROWN, BLACK, WHITE, AQUA, LIGHT GRAY, GRAY, PEACH, ORANGE AND PINK IS/ARE CLAIMED AS A FEATURE OF THE MARK.

THE MARK CONSISTS OF THE WORDING "FIND A" IN DARK GRAY WITH A RED STAR ON EACH SIDE OF THE WORD "A" ALL APPEARING ABOVE THE WORD "FILE" IN BLUE WITH THE LETTER "I" DOTTED WITH A HOLLOW YELLOW CIRCLE; TO THE RIGHT OF ALL OF THAT IS THE DESIGN OF A BROWN HOUND FACING RIGHT WITH BLACK NOSE AND FRECKLES, AND BLACK AND WHITE EYE, WEARING AN AQUA COLLAR WITH YELLOW TAG, AND HOLDING A YELLOW FILE FOLDER WITH LIGHT GRAY, PEACH, PINK, YELLOW, ORANGE, AND GRAY, PAGES IN ITS MOUTH, AND A LIGHT GRAY PAGE FLOATING BELOW IT, WITH BLACK USED THROUGH THE DESIGN AS OUTLINING AND LINES ON THE PAGES; A RED LINE APPEARS BELOW ALL OF THAT, AND THE WORDING "TRACKING THE INFORMATION THAT KEEPS YOU ON TRACK" APPEARING BELOW THAT IN THE COLOR BLACK.

FOR COMPUTERIZED DATABASE MANAGEMENT (U.S. CLS. 100, 101 AND 102).

SANDRA BUJA, EXAMINING ATTORNEY

SN 77-772,106. KOPP, CARYN, BEDMINSTER, NJ. FILED 7-1-2009.

Chief Door Opener

THE MARK CONSISTS OF STANDARD CHARACTERS WITHOUT CLAIM TO ANY PARTICULAR FONT, STYLE, SIZE, OR COLOR.

FOR COLD CALLING IN THE NATURE OF TELEMARKETING; APPOINTMENT GENERATION, NAMELY, TELEMARKETING; LEAD GENERATION; CONSULTING IN MESSAGE DEVELOPMENT, NAMELY, BRAND DEVELOPMENT SERVICES FOR CLIENTS; AND CONSULTING IN SALES TECHNIQUES IN THE NATURE OF RESPONDING TO OBJECTIONS BY SALES PROSPECTS (U.S. CLS. 100, 101 AND 102).

FIRST USE 6-1-2008; IN COMMERCE 7-1-2008.

KELLY CHOE, EXAMINING ATTORNEY

CLASS 35—(Continued).

SN 77-772,126. KOPP, CARYN, BEDMINSTER, NJ. FILED 7-1-2009.

Door Opener

THE MARK CONSISTS OF STANDARD CHARACTERS WITHOUT CLAIM TO ANY PARTICULAR FONT, STYLE, SIZE, OR COLOR.

FOR COLD CALLING IN THE NATURE OF TELEMARKETING; APPOINTMENT GENERATION, NAMELY, TELEMARKETING; LEAD GENERATION; CONSULTING IN MESSAGE DEVELOPMENT, NAMELY, BRAND DEVELOPMENT SERVICES FOR CLIENTS; AND CONSULTING IN SALES TECHNIQUES IN THE NATURE OF RESPONDING TO OBJECTIONS BY SALES PROSPECTS (U.S. CLS. 100, 101 AND 102).

FIRST USE 7-1-2008; IN COMMERCE 7-1-2008.
KELLY CHOE, EXAMINING ATTORNEY

SN 77-778,242. MERRIE ALLISON, PHILADELPHIA, PA. FILED 7-10-2009.

katwaria

THE MARK CONSISTS OF STANDARD CHARACTERS WITHOUT CLAIM TO ANY PARTICULAR FONT, STYLE, SIZE, OR COLOR.

THE WORDING KATWARIA HAS NO MEANING IN A FOREIGN LANGUAGE.

FOR BUSINESS CONSULTATION IN THE FIELD OF CONSUMER GOODS DESIGN (U.S. CLS. 100, 101 AND 102).

GIANCARLO CASTRO, EXAMINING ATTORNEY

SN 77-778,253. MERRIE ALLISON, PHILADELPHIA, PA. FILED 7-10-2009.

katwaria.net

THE MARK CONSISTS OF STANDARD CHARACTERS WITHOUT CLAIM TO ANY PARTICULAR FONT, STYLE, SIZE, OR COLOR.

THE WORDING "KATWARIA" HAS NO MEANING IN A FOREIGN LANGUAGE.

FOR BUSINESS CONSULTATION IN THE FIELD OF CONSUMER GOODS DESIGN (U.S. CLS. 100, 101 AND 102).

GIANCARLO CASTRO, EXAMINING ATTORNEY

CLASS 35—(Continued).

SN 77-780,575. LEVITON MANUFACTURING CO., INC., MELVILLE, NY. FILED 7-14-2009.

COUNTER COACH

THE MARK CONSISTS OF STANDARD CHARACTERS WITHOUT CLAIM TO ANY PARTICULAR FONT, STYLE, SIZE, OR COLOR.

FOR PROVIDING CONSUMER INFORMATION IN THE FIELD OF ELECTRICAL AND ELECTRONICS PRODUCTS, NAMELY, ELECTRICAL WIRING, ELECTRICAL OUTLETS, ELECTRICAL SWITCHES AND ELECTRICAL PANELS, AND TELECOMMUNICATIONS AND DATA NETWORKING PRODUCTS FOR THE PURPOSE OF MAKING PURCHASING DECISIONS; AND PROVIDING CONSUMER INFORMATION IN THE FIELD OF NETWORKING OF HOME CONTROLS, NAMELY, WIRELESS AND WIRED LIGHTING CONTROLS, THERMOSTAT AND HEATING CONTROLS AND HOME AUDIO AND VIDEO CONTROLS, FOR THE PURPOSE OF MAKING PURCHASING DECISIONS (U.S. CLS. 100, 101 AND 102).

KATHERINE STOIDES, EXAMINING ATTORNEY

SN 77-781,984. JONES SODA CO. (USA) INC., SEATTLE, WA. FILED 7-15-2009.

ROADTRIP JONES

THE MARK CONSISTS OF STANDARD CHARACTERS WITHOUT CLAIM TO ANY PARTICULAR FONT, STYLE, SIZE, OR COLOR.

OWNER OF U.S. REG. NOS. 2,118,528, 2,837,569 AND OTHERS.

FOR PROVISION OF BEVERAGES, NAMELY, ONLINE RETAIL STORE SERVICES FEATURING BEVERAGES; DISTRIBUTORSHIP SERVICES IN THE FIELD OF BEVERAGES (U.S. CLS. 100, 101 AND 102).

ALLISON SCHRODY, EXAMINING ATTORNEY

CLASS 35—(Continued).

SN 77-782,033. APG, L.P., HOUSTON, TX. FILED 7-15-2009.

**AMERICAN PACKING AND
GASKET COMPANY**

THE MARK CONSISTS OF STANDARD CHARACTERS WITHOUT CLAIM TO ANY PARTICULAR FONT, STYLE, SIZE, OR COLOR.

NO CLAIM IS MADE TO THE EXCLUSIVE RIGHT TO USE "PACKING AND GASKET COMPANY", APART FROM THE MARK AS SHOWN.

SEC. 2(F).

FOR WHOLESALE DISTRIBUTORSHIPS FEATURING GASKETS, O-RINGS, HYDRAULIC SEALS, INDUSTRIAL HOSE COUPLINGS, PACKING AND GASKET MATERIALS, INDUSTRIAL GLASS PRODUCTS, SHEET PLASTIC, ADHESIVES AND SEALANTS (U.S. CLS. 100, 101 AND 102).

FIRST USE 6-15-1943; IN COMMERCE 6-15-1943.
LINDA M. KING, EXAMINING ATTORNEY

CLASS 35—(Continued).

SN 77-784,804. EDIBLE ARRANGEMENTS, LLC, WALLINGFORD, CT. FILED 7-20-2009.

REAL FRUIT. NO KIDDING.

THE MARK CONSISTS OF STANDARD CHARACTERS WITHOUT CLAIM TO ANY PARTICULAR FONT, STYLE, SIZE, OR COLOR.

NO CLAIM IS MADE TO THE EXCLUSIVE RIGHT TO USE "REAL FRUIT", APART FROM THE MARK AS SHOWN.

FOR ON-LINE AND RETAIL STORE SERVICES IN THE FIELD OF FRESH FRUIT, NAMELY, FRUIT-BASED BEVERAGES, FRUIT-BASED SALADS, FRUIT PIECES, FRUIT ARRANGED IN CONTAINERS AS FLORAL DESIGNS, FRUIT PIECES COVERED IN EDIBLE COATINGS, AND FRUIT AT LEAST PARTIALLY COVERED IN EDIBLE COATINGS AND ARRANGED IN CONTAINERS AS FLORAL DESIGNS (U.S. CLS. 100, 101 AND 102).

FIRST USE 6-1-2009; IN COMMERCE 6-16-2009.
NATALIE POLZER, EXAMINING ATTORNEY

SN 77-783,169. BONVIVANT, INC., CHATSWORTH, CA. FILED 7-16-2009.

usa link

THE MARK CONSISTS OF STANDARD CHARACTERS WITHOUT CLAIM TO ANY PARTICULAR FONT, STYLE, SIZE, OR COLOR.

FOR ON-LINE RETAIL STORE SERVICES FEATURING INKJET AND TONER PRINTER CARTRIDGES, INKJET AND TONER PRINTER INK, FILLED, RE-FILLED, RECYCLED, COMPATIBLE, REPLACEMENT INKJET AND LASER TONER PRINTER CARTRIDGES (U.S. CLS. 100, 101 AND 102).

FIRST USE 2-12-2008; IN COMMERCE 6-10-2008.
SHAILA SETTLES, EXAMINING ATTORNEY

SN 77-785,066. THE KROGER CO. OF MICHIGAN, NORTH LIVONIA, MI. FILED 7-20-2009.

LILIES FOR THE FILLIES

THE MARK CONSISTS OF STANDARD CHARACTERS WITHOUT CLAIM TO ANY PARTICULAR FONT, STYLE, SIZE, OR COLOR.

FOR PROMOTING PUBLIC AWARENESS OF THE HORSE RACE FOR THREE-YEAR-OLD THOROUGHBRED FILLIES STAGED ANNUALLY IN LOUISVILLE, KENTUCKY; PROVIDING MARKETING AND PROMOTION OF SPECIAL EVENTS (U.S. CLS. 100, 101 AND 102).

FIRST USE 1-1-1991; IN COMMERCE 1-1-1991.
STEPHANIE ALI, EXAMINING ATTORNEY

CLASS 35—(Continued).

SN 77-785,884. VANTAGE SOLUTIONS, LLC, CHICAGO, IL. FILED 7-21-2009.



OWNER OF U.S. REG. NOS. 2,794,064 AND 2,796,925.
NO CLAIM IS MADE TO THE EXCLUSIVE RIGHT TO USE "SOLUTIONS LLC", APART FROM THE MARK AS SHOWN.

THE COLOR(S) RED, ORANGE AND BLACK IS/ARE CLAIMED AS A FEATURE OF THE MARK.

THE MARK CONSISTS OF THE WORDING, "VANTAGE", WHEREIN THE "V" PORTION OF THE MARK IS DEPICTED AS A STYLIZED PERSON WITH OUTSTRETCHED ARMS IN THE COLOR RED AND ORANGE, AND THE REST OF THE WORD APPEARS IN THE COLOR BLACK, AND APPEARING BELOW IS THE WORDING, "SOLUTIONS LLC" IN THE COLOR ORANGE; THE COLOR WHITE IS NOT A FEATURE OF THE MARK BUT MERELY REPRESENTS A TRANSPARENT BACKGROUND.

FOR CONSULTING SERVICES IN THE FIELD OF HUMAN RESOURCES DEVELOPMENT, NAMELY, FOR THE PROMOTION OF EMPLOYEE RETENTION AND INCREASED PRODUCTIVITY FOR EMPLOYEES AND EMPLOYERS; CONSULTING SERVICES IN THE FIELD OF HUMAN RESOURCES DEVELOPMENT, NAMELY, UTILIZING TECHNOLOGY FOR THE PROMOTION OF EMPLOYEE RETENTION, CAREER GROWTH AND INCREASED PRODUCTIVITY FOR EMPLOYEES AND EMPLOYERS; EMPLOYMENT COUNSELING AND RECRUITING; EMPLOYMENT RECRUITING CONSULTATION; HUMAN RESOURCES CONSULTATION; HUMAN RESOURCES MANAGEMENT; PERSONNEL CONSULTANCY; PROVIDING EMPLOYMENT COUNSELING INFORMATION ON HOW TO SUCCESSFULLY TRANSITION JOBS FOR MATURE WORKERS; SERVING AS A HUMAN RESOURCES DEPARTMENT FOR OTHERS (U.S. CLS. 100, 101 AND 102).

FIRST USE 5-15-1999; IN COMMERCE 5-15-1999.
KELLY CHOE, EXAMINING ATTORNEY

SN 77-788,100. FREESTYLE PUBLIC RELATIONS LLC, WEST DES MOINES, IA. FILED 7-23-2009.

ZESAZ

THE MARK CONSISTS OF STANDARD CHARACTERS WITHOUT CLAIM TO ANY PARTICULAR FONT, STYLE, SIZE, OR COLOR.

THE WORDING "ZESAZ" HAS NO MEANING IN A FOREIGN LANGUAGE.

FOR ON-LINE BUSINESS AND PUBLIC RELATIONS NETWORKING SERVICES (U.S. CLS. 100, 101 AND 102).

FIRST USE 7-22-2009; IN COMMERCE 7-22-2009.
JENNIFER VASQUEZ, EXAMINING ATTORNEY

CLASS 35—(Continued).

SN 77-789,722. TEAGUE, KEVIN W, NEW YORK, NY. FILED 7-26-2009.

1 GOOD I

THE MARK CONSISTS OF STANDARD CHARACTERS WITHOUT CLAIM TO ANY PARTICULAR FONT, STYLE, SIZE, OR COLOR.

FOR ADVERTISING AND PUBLICITY SERVICES, NAMELY, PROMOTING THE GOODS, SERVICES, BRAND IDENTITY AND COMMERCIAL INFORMATION AND NEWS OF THIRD PARTIES THROUGH PRINT, AUDIO, VIDEO, DIGITAL AND ON-LINE MEDIUM; BRAND IMAGERY CONSULTING SERVICES; BRAND POSITIONING SERVICES (U.S. CLS. 100, 101 AND 102).

SIMON TENG, EXAMINING ATTORNEY

SN 77-792,615. UNITED PARCEL SERVICE OF AMERICA, INC., ATLANTA, GA. FILED 7-29-2009.

UPS IMPORT CONTROL

THE MARK CONSISTS OF STANDARD CHARACTERS WITHOUT CLAIM TO ANY PARTICULAR FONT, STYLE, SIZE, OR COLOR.

OWNER OF U.S. REG. NOS. 735,064, 3,538,859 AND OTHERS.

NO CLAIM IS MADE TO THE EXCLUSIVE RIGHT TO USE "IMPORT CONTROL", APART FROM THE MARK AS SHOWN.

FOR BUSINESS MANAGEMENT SERVICES, BUSINESS CONSULTING SERVICES, BUSINESS ADMINISTRATION SERVICES, OFFICE FUNCTION SERVICES, MANAGEMENT ASSISTANCE SERVICES, MANAGEMENT CONSULTING SERVICES, CUSTOM CLEARANCE SERVICES, DATA PROCESSING SERVICES, PROVIDING AUTOMATED INFORMATION FOR CUSTOMERS IDENTIFYING SHIPPING ACCOUNT INFORMATION OVER A GLOBAL COMPUTER NETWORK FOR IMPORT SHIPMENTS; MANAGEMENT OF TRACKING, PERFORMANCE, CLAIMS, BILLING AND BROKERAGE SHIPMENT DATA (U.S. CLS. 100, 101 AND 102).

PRISCILLA MILTON, EXAMINING ATTORNEY

CLASS 35—(Continued).

SN 77-793,645. WORLD MARKET CENTER VENTURE, LLC,
LAS VEGAS, NV. FILED 7-30-2009.



NO CLAIM IS MADE TO THE EXCLUSIVE RIGHT TO USE "LAS VEGAS", APART FROM THE MARK AS SHOWN. THE COLOR(S) DARK GREEN, LIGHT GREEN, BLUE AND WHITE IS/ARE CLAIMED AS A FEATURE OF THE MARK.

THE MARK CONSISTS OF A STYLIZED SPHERE IN DARK GREEN AND LIGHT GREEN, HAVING TWO CURVED WHITE LINES AND A CURVED BLUE LINE IN THE LOWER CENTER OF THE SPHERE. ONE OF THE CURVED WHITE LINES DIVIDES THE SPHERE AND THE OTHER CURVED WHITE LINE RUNS THROUGH BOTH HALVES AND A CURVED BLUE LINE IS IN THE MIDDLE. TO THE RIGHT OF THE DESIGN OF THE SPHERE ARE THE STYLIZED WORDS, "ONE GOOD WORLD LAS VEGAS" IN A STACKED FORMATION WITH UNDERLINES UNDER "ONE", "GOOD", AND "WORLD". THE WORD "ONE" IS IN DARK GREEN AND HAS A LIGHT GREEN LINE UNDERNEATH. THE WORD "GOOD" IS IN LIGHT GREEN AND HAS A LIGHT GREEN LINE UNDERNEATH. THE WORD "WORLD" IS IN BLUE AND HAS A LIGHT GREEN LINE UNDERNEATH. THE WORDS "LAS VEGAS" ARE IN LIGHT GREEN.

FOR ARRANGING, ORGANIZING, PROMOTING AND CONDUCTING TRADE EXHIBITIONS, TRADE CONVENTIONS, TRADE SHOWS AND TRADE FAIRS, ALL FOR BUSINESS AND PROMOTIONAL PURPOSES IN THE FIELDS OF HOME, OFFICE AND HOSPITALITY FURNISHINGS; ADVERTISING AND MARKETING OF TRADE SHOWROOMS AND RELATED SHOWROOM FACILITIES AND SERVICES OF OTHERS TO MANUFACTURERS OF GOODS IN THE FIELDS OF HOME, OFFICE AND HOSPITALITY FURNISHINGS; ADVERTISING AND MARKETING OF TRADE SHOWROOMS OF OTHERS FOR DISPLAY AND EXHIBITION OF GOODS OF MANUFACTURERS IN THE FIELDS OF HOME, OFFICE AND HOSPITALITY FURNISHINGS TO RETAILERS OF HOME, OFFICE AND HOSPITALITY FURNISHINGS; RETAIL STORE SERVICES FEATURING A WIDE VARIETY OF CONSUMER GOODS OF OTHERS (U.S. CLS. 100, 101 AND 102).

JAY BESCH, EXAMINING ATTORNEY

SN 77-794,059. AMERICAN DIABETES ASSOCIATION, INC.,
ALEXANDRIA, VA. FILED 7-31-2009.

RED RIDER

THE MARK CONSISTS OF STANDARD CHARACTERS WITHOUT CLAIM TO ANY PARTICULAR FONT, STYLE, SIZE, OR COLOR.

FOR PROMOTING PUBLIC AWARENESS OF SUPPORTING INDIVIDUALS WITH DIABETES (U.S. CLS. 100, 101 AND 102).

FIRST USE 10-31-2008; IN COMMERCE 10-31-2008.

DOMINIC J. FERRAIUOLO, EXAMINING ATTORNEY

CLASS 35—(Continued).

SN 77-796,423. PEIKER/PIATCHEK ASSOCIATES, INC., ST.
LOUIS, MO. FILED 8-4-2009.

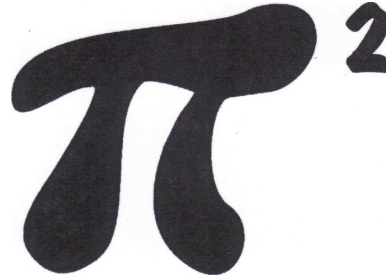

THE MARK CONSISTS OF AN ITALICIZED VERSION OF THE GREEK LETTER "PI" WITH A SUPERSCRIPT OF THE NUMBER "2" AT THE UPPER RIGHT. THE LOGO CAN BE STATED AS "PI SQUARED".

SEC. 2(F).

FOR MANUFACTURER REPRESENTATIVES IN THE FIELD OF PETROLEUM, AUTOMOTIVE, COMMERCIAL, AND INDUSTRIAL EQUIPMENT (U.S. CLS. 100, 101 AND 102).

FIRST USE 1-1-1970; IN COMMERCE 1-1-1970.

VERNA BETH RIRIE, EXAMINING ATTORNEY

SN 77-800,553. SHOE CASE STORES, INC., BELLMORE, NY.
FILED 8-10-2009.

SHOE CASE

THE MARK CONSISTS OF STANDARD CHARACTERS WITHOUT CLAIM TO ANY PARTICULAR FONT, STYLE, SIZE, OR COLOR.

NO CLAIM IS MADE TO THE EXCLUSIVE RIGHT TO USE "SHOE", APART FROM THE MARK AS SHOWN.

FOR RETAIL STORE AND ON-LINE RETAIL STORE SERVICES FEATURING FOOTWEAR AND CLOTHING (U.S. CLS. 100, 101 AND 102).

ROBIN MITTLER, EXAMINING ATTORNEY

CLASS 35—(Continued).

SN 77-809,563. LA RECRUITMENT LIMITED, ABERDEEN, UNITED KINGDOM, FILED 8-20-2009.



NO CLAIM IS MADE TO THE EXCLUSIVE RIGHT TO USE "RECRUITMENT", APART FROM THE MARK AS SHOWN.

THE COLOR(S) PURPLE AND GREEN IS/ARE CLAIMED AS A FEATURE OF THE MARK.

THE MARK CONSISTS OF THE WORDING "L.A. RECRUITMENT" IN PURPLE BELOW A STYLIZED GREEN "A" OVERLAYING A STYLIZED PURPLE "L".

FOR PERSONNEL PLACEMENT AND RECRUITMENT (U.S. CLS. 100, 101 AND 102).

GIANCARLO CASTRO, EXAMINING ATTORNEY

SN 77-809,720. JACOBS, JEFFREY, DBA SOUTHWEST SPECIALTY FOOD, INC., GOODYEAR, AZ. FILED 8-21-2009.

Have An Ass Kickin' Day!

THE MARK CONSISTS OF STANDARD CHARACTERS WITHOUT CLAIM TO ANY PARTICULAR FONT, STYLE, SIZE, OR COLOR.

OWNER OF U.S. REG. NOS. 2,173,047, 2,934,053 AND OTHERS.

FOR MAIL-ORDER CATALOGS, RETAIL STORES, AND WHOLESALE DISTRIBUTORSHIPS FEATURING COFFEE MUGS, GREETING CARDS, GIFT WRAP, HATS, CAPS, SHIRTS, APRONS, JELLY, PROCESSED PEPPERS, STUFFED OLIVES, PROCESSED PEANUTS AND PISTACHIOS, SOUP MIX, BEEF JERKY, CORN CHIPS, AND MAYONNAISE, DRY FOOD SEASONINGS AND MIXES, SALSA, WING SAUCE, STEAK SAUCE, TERIYAKI SAUCE, HOT SAUCE, BARBECUE SAUCE, MUSTARD, KETCHUP, BEAN DIP, POPCORN SEASONING, MARINADE AND BREAD MIX, BEER, WINE, BOTTLED WATER, BEER BREWING KITS, NON-ALCOHOLIC MIXES FOR MAKING MARGARITAS AND BLOODY MARY'S, JELLY BEANS, PEANUT BRITTLE, SOFT CHEWS, CARAMEL CORN, CHILI MIX CONSISTING OF FLOUR, SPICES AND BEANS, AND GIFT BASKETS AND SETS OF THE FOREGOING FOOD ITEMS (U.S. CLS. 100, 101 AND 102).

FIRST USE 9-9-1994; IN COMMERCE 9-9-1994.
ANDREW LEASER, EXAMINING ATTORNEY

CLASS 35—(Continued).

SN 77-810,940. SANDS RESEARCH, INC., EL PASO, TX. FILED 8-24-2009.



SANDS RESEARCH

NO CLAIM IS MADE TO THE EXCLUSIVE RIGHT TO USE "RESEARCH", APART FROM THE MARK AS SHOWN.

THE MARK CONSISTS OF THE WORDING "SANDS RESEARCH" IN STYLIZED FONT WHERE THE LETTER "C" IS UNDERLINED TO THE RIGHT OF A CIRCLE CONTAINING A LETTER "R" IN THE MIDDLE WITH TWO JOINED CONCENTRIC CURVED LINES ABOVE AND BELOW THE LETTER "R".

FOR BUSINESS, CONSUMER, MARKET AND CONSUMER MARKETING RESEARCH AND CONSULTING SERVICES IN THE FIELD OF MARKETING AND ADVERTISING (U.S. CLS. 100, 101 AND 102).

FIRST USE 3-0-2007; IN COMMERCE 3-0-2007.

TINA BROWN, EXAMINING ATTORNEY

SN 77-813,319. ASHLEY, INC. T/A FATHER MARTIN'S ASHLEY, HAVRE DE GRACE, MD. FILED 8-26-2009.

A Timeless Message of Hope & Recovery

THE MARK CONSISTS OF STANDARD CHARACTERS WITHOUT CLAIM TO ANY PARTICULAR FONT, STYLE, SIZE, OR COLOR.

FOR ONLINE RETAIL STORE SERVICES FEATURING SUBSTANCE ABUSE AND RECOVERY MATERIALS (U.S. CLS. 100, 101 AND 102).

FIRST USE 3-15-2007; IN COMMERCE 3-15-2007.

MARTHA FROMM, EXAMINING ATTORNEY

SN 77-814,026. UFORCE, INC., EDINA, MN. FILED 8-27-2009.

UFORCE

THE MARK CONSISTS OF STANDARD CHARACTERS WITHOUT CLAIM TO ANY PARTICULAR FONT, STYLE, SIZE, OR COLOR.

FOR PROVIDING AN INTERACTIVE WEBSITE FOR CONNECTING SELLERS WITH BUYERS FOR FACILITATING OFFER EXCHANGES (U.S. CLS. 100, 101 AND 102).

VERNA BETH RIRIE, EXAMINING ATTORNEY

CLASS 35—(Continued).

SN 77-814,199. MATREX EXHIBITS, INC., ADDISON, IL.
FILED 8-27-2009.



THE MARK CONSISTS OF A CIRCLE WITH THE LINE OF THE CIRCLE ON THE UPPER RIGHT HAND PORTION OF THE CIRCLE CONSISTING OF A SERIES OF DOTS WITH THE LETTERS "P","S" IN THE CENTER OF THE CIRCLE. THE WORDS "PERFORMANCESCIENCE" ARE NEXT TO THE CIRCLE ON THE RIGHT WITH THE WORDS "EVERY MINUTE COUNTS" DIRECTLY BELOW THE WORDS "PERFORMANCESCIENCE".

FOR BUSINESS MARKETING SERVICES (U.S. CLS. 100, 101 AND 102).

FIRST USE 4-27-2009; IN COMMERCE 4-27-2009.
LAKEISHA LEWIS, EXAMINING ATTORNEY

SN 77-814,791. DEAN SCHWARTZ, MIAMI BEACH, FL.
FILED 8-28-2009.

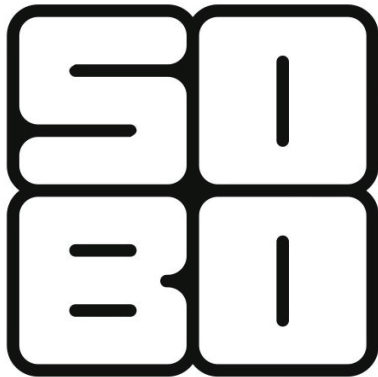

THE MARK CONSISTS OF THE LETTERS "SO BO" IN A BOX FORMATION WITH THE LETTERS "SO" DIRECTLY OVER THE LETTERS "BO".

THE WORDING "SOBO" HAS NO MEANING IN A FOREIGN LANGUAGE.

FOR ADVERTISING, MARKETING AND PROMOTION SERVICES; ADVERTISING, MARKETING AND PROMOTIONAL SERVICES RELATED TO ALL INDUSTRIES FOR THE PURPOSE OF FACILITATING NETWORKING AND SOCIALIZING OPPORTUNITIES FOR BUSINESS PURPOSES; ADVERTISING, PROMOTION AND MARKETING SERVICES IN THE NATURE OF E-MAIL BLAST CAMPAIGNS FOR OTHERS; ADVICE IN THE FIELD OF BUSINESS MANAGEMENT AND MARKETING; ANALYSIS OF MARKET RESEARCH DATA AND STATISTICS; ARRANGING AND CONDUCTING MARKETING PROMOTIONAL EVENTS FOR OTHERS; ASSISTANCE, ADVISORY SERVICES AND CONSULTANCY WITH REGARD TO BUSINESS PLANNING, BUSINESS ANALYSIS, BUSINESS MANAGEMENT, BUSINESS ORGANIZATION, MARKETING AND CUSTOMER ANALYSIS; BRANDING SERVICES, NAMELY, CONSULTING, DEVELOPMENT, MANAGEMENT AND MARKETING OF BRANDS FOR BUSINESSES; BUSINESS CONSULTATION AND MANAGEMENT REGARDING MARKETING ACTIVITIES AND LAUNCHING OF NEW PRODUCTS; BUSINESS MANAGEMENT CONSULTING WITH RELATION TO STRATEGY, MARKETING, PRODUCTION, PERSONNEL AND RETAIL SALE MATTERS; BUSINESS MARKETING CONSULTING SERVICES; BUSINESS MARKETING SERVICES; BUSINESS MONITORING AND CONSULTING SERVICES, NAMELY, TRACKING WEB SITES AND APPLICATIONS

CLASS 35—(Continued).

OF OTHERS TO PROVIDE STRATEGY, INSIGHT, MARKETING, SALES, OPERATION, PRODUCT DESIGN, PARTICULARLY SPECIALIZING IN THE USE OF ANALYTIC AND STATISTIC MODELS FOR THE UNDERSTANDING AND PREDICTING OF CONSUMERS, BUSINESSES, AND MARKET TRENDS AND ACTIONS; BUSINESS TO BUSINESS DIRECT MARKETING SERVICES; COLLECTION OF MARKET RESEARCH INFORMATION; CONDUCTING MARKETING STUDIES; CONSULTING SERVICES IN THE FIELD OF INTERNET MARKETING; CONSUMER MARKETING RESEARCH AND CONSULTING RELATED THERETO; CONSUMER STRATEGY BUSINESS CONSULTING IN THE FIELDS OF MARKETING, SALES, OPERATION, AND PRODUCT DESIGN PARTICULARLY SPECIALIZING IN THE USE OF ANALYTIC MODELS FOR THE UNDERSTANDING AND PREDICTING OF CONSUMER, BUSINESS, AND RETAIL MARKET TRENDS AND ACTIONS; COOPERATIVE ADVERTISING AND MARKETING; COOPERATIVE ADVERTISING AND MARKETING SERVICES BY WAY OF SOLICITATION, CUSTOMER SERVICE AND PROVIDING MARKETING INFORMATION VIA WEB SITES ON A GLOBAL COMPUTER NETWORK; CREATION OF MARKETING TOOLS DESIGNED TO INCREASE A CLIENT COMPANY'S KNOWLEDGE OF CUSTOMER NEEDS, AND ITS COMPETITORS' PRODUCTS AND SERVICES, PRICING, ADVERTISING STRATEGY AND SALES STRATEGY; CREATIVE MARKETING DESIGN SERVICES; DEVELOPMENT OF MARKETING STRATEGIES AND CONCEPTS; DIRECT MARKETING ADVERTISING FOR OTHERS; DIRECT MARKETING CONSULTING SERVICES; DIRECT MARKETING SERVICES; ENTERTAINMENT MARKETING SERVICES, NAMELY, MARKETING, PROMOTION AND ADVERTISING FOR INDEPENDENT RECORDING ARTISTS; GENERAL BUSINESS MERCHANDISING SERVICES, NAMELY, MARKETING; MARKETING AND BRANDING SERVICES, NAMELY, PERFORMING CONSUMER INSIGHT AND BRAND STRATEGY OF COMPANY LOGOS; MARKETING AND CONSULTING SERVICES IN THE FIELD OF PROMOTING AND TRACKING THE GOODS, SERVICES, AND BRANDS OF OTHERS THROUGH ALL PUBLIC COMMUNICATION MEANS, PARTICULARLY SPECIALIZING IN THE USE OF MOBILE, SOCIAL, AND PRINT MEDIA TO DRIVE CONSUMER INTEREST, ENGAGEMENT AND ACTION; MARKETING CONSULTING; MARKETING SERVICES, NAMELY, CONDUCTING CONSUMER TRACKING BEHAVIOR RESEARCH AND CONSUMER TREND ANALYSIS; MARKETING SERVICES, NAMELY, CONSUMER MARKETING RESEARCH; MARKETING SERVICES, NAMELY, PROVIDING INFORMATIONAL WEB PAGES DESIGNED TO GENERATE SALES TRAFFIC VIA HYPERLINKS TO OTHER WEB SITES; MARKETING, ADVERTISING, AND PROMOTING THE RETAIL GOODS AND SERVICES OF OTHERS TO WIRELESS ELECTRONIC DEVICES; ON-LINE ADVERTISING AND MARKETING SERVICES; PROMOTING, ADVERTISING AND MARKETING OF THE ON-LINE WEB SITES OF OTHERS; PROMOTING, ADVERTISING AND MARKETING THE ON-LINE DATABASES AND ELECTRONIC PUBLICATIONS OF OTHERS; PROMOTION AND MARKETING SERVICES AND RELATED CONSULTING; PROMOTION, ADVERTISING AND MARKETING OF ON-LINE WEBSITES; PROMOTIONAL SERVICES, NAMELY, GUERRILLA MARKETING SERVICES; PROVIDING ADVERTISING, MARKETING AND PROMOTIONAL SERVICES, NAMELY, DEVELOPMENT OF ADVERTISING CAMPAIGNS FOR HISPANIC MARKET; PROVIDING ADVERTISING, MARKETING AND PROMOTIONAL SERVICES, NAMELY, DEVELOPMENT OF ADVERTISING CAMPAIGNS PROVIDED THROUGH CABLE TELEVISION BROADCAST, WEB CASTS, RADIO BROADCASTS, NEWSPAPERS, MAGAZINES, ONLINE BANNERS, OUTDOOR BILLBOARDS, WILD POSTINGS, BUS AND SUBWAY ADS; PROVIDING BUSINESS MARKETING INFORMATION; PROVIDING MARKETING AND PROMOTION OF SPECIAL EVENTS; PROVIDING PROMOTIONAL MARKETING SERVICES TO BUSINESSES IN THE BROADBAND AND MEDIA INDUSTRIES; PROVIDING PUBLIC SECTOR BUSINESS AND MARKET INTELLIGENCE; SOCIAL MEDIA STRATEGY

CLASS 35—(Continued).

AND MARKETING CONSULTANCY FOCUSING ON HELPING CLIENTS CREATE AND EXTEND THEIR PRODUCT AND BRAND STRATEGIES BY BUILDING VIRALLY ENGAGING MARKETING SOLUTIONS; THE BRINGING TOGETHER, FOR THE BENEFIT OF OTHERS, OF A VARIETY OF GOODS AND SERVICES, ENABLING CUSTOMERS TO CONVENIENTLY VIEW AND PURCHASE THOSE GOODS AND SERVICES FROM AN INTERNET WEB SITE PARTICULARLY SPECIALIZING IN THE MARKETING OF THE SALE OF GOODS AND SERVICES OF OTHERS (U.S. CLS. 100, 101 AND 102).

ALLISON SCHRODY, EXAMINING ATTORNEY

SN 77-815,798. DIGITABLE MEDIA SOLUTIONS, INC., BOYNTON BEACH, FL. FILED 8-28-2009.



NO CLAIM IS MADE TO THE EXCLUSIVE RIGHT TO USE "MEDIA SOLUTIONS, INC.", APART FROM THE MARK AS SHOWN.

THE MARK CONSISTS OF A CURVED BAND, WITH THE WORDING "DIGITABLE MEDIA SOLUTIONS, INC." FOR ADVERTISING, MARKETING AND PROMOTION SERVICES (U.S. CLS. 100, 101 AND 102).

DAVID H. STINE, EXAMINING ATTORNEY

SN 77-816,700. CAMMY'S CREPES, LLC, STRONGSVILLE, OH. FILED 8-31-2009.



NO CLAIM IS MADE TO THE EXCLUSIVE RIGHT TO USE "CREPES", APART FROM THE MARK AS SHOWN.

THE NAME(S), PORTRAIT(S), AND/OR SIGNATURE(S) SHOWN IN THE MARK IDENTIFIES "CAMMY", WHOSE CONSENT(S) TO REGISTER IS MADE OF RECORD.

THE MARK CONSISTS OF THE WORDS "CAMMY'S CREPES", WITH THE WORD "CAMMY'S" DIRECTLY ABOVE THE WORD "CREPES", IN THE CENTER OF A DARK CIRCLE WITH TWO SEMI-CIRCLES OUTLINING THE LEFT AND RIGHT SIDES OF THE WORDS "CAMMY'S CREPES" WITHIN THE DARK CIRCLE.

FOR RETAIL BAKERY SHOPS (U.S. CLS. 100, 101 AND 102).

TRACY FLETCHER, EXAMINING ATTORNEY

CLASS 35—(Continued).

SN 77-819,407. R&K SALES, FORT WORTH, TX. FILED 9-3-2009.

Spot's Gift Shop

THE MARK CONSISTS OF STANDARD CHARACTERS WITHOUT CLAIM TO ANY PARTICULAR FONT, STYLE, SIZE, OR COLOR.

NO CLAIM IS MADE TO THE EXCLUSIVE RIGHT TO USE "GIFT SHOP", APART FROM THE MARK AS SHOWN. FOR RETAIL NOVELTY SHOP SERVICES FEATURING GIFT AND NOVELTY ITEMS (U.S. CLS. 100, 101 AND 102).

FIRST USE 6-1-2009; IN COMMERCE 6-1-2009.

VIVIAN MICZNIK FIRST, EXAMINING ATTORNEY

SN 77-821,573. PURCHASING MANAGEMENT INTERNATIONAL, DALLAS, TX. FILED 9-8-2009.



THE MARK CONSISTS OF THE LETTERS "P", "M", "I" SEPARATED BY VERTICAL LINES.

FOR PURCHASING FURNITURE, FIXTURES AND EQUIPMENT FOR HOTELS, MOTELS, RESTAURANTS OR OTHERS (U.S. CLS. 100, 101 AND 102).

FIRST USE 8-0-1994; IN COMMERCE 8-0-1994.

HENRY S. ZAK, EXAMINING ATTORNEY

SN 77-829,711. ZIA BUSINESS PARTNERS, INC., HAVERFORD, PA. FILED 9-18-2009.

Experts in the art and science of human resources management

THE MARK CONSISTS OF STANDARD CHARACTERS WITHOUT CLAIM TO ANY PARTICULAR FONT, STYLE, SIZE, OR COLOR.

NO CLAIM IS MADE TO THE EXCLUSIVE RIGHT TO USE "HUMAN RESOURCES MANAGEMENT", APART FROM THE MARK AS SHOWN.

FOR BUSINESS ORGANIZATION AND MANAGEMENT CONSULTING; BUSINESS ORGANIZATION CONSULTING; CONSULTING SERVICES IN THE FIELD OF HUMAN RESOURCES DEVELOPMENT, NAMELY, FOR THE PROMOTION OF EMPLOYEE RETENTION, CAREER GROWTH, AND INCREASED PRODUCTIVITY FOR EMPLOYEES AND EMPLOYERS; HUMAN RESOURCES CONSULTATION (U.S. CLS. 100, 101 AND 102).

FIRST USE 5-1-2009; IN COMMERCE 5-1-2009.

JASON TURNER, EXAMINING ATTORNEY

CLASS 35—(Continued).

SN 77-830,262. WAVE ENERGY DRINK, LLC, MOORESVILLE, NC. FILED 9-18-2009.

WAVE ENERGY DRINK

THE MARK CONSISTS OF STANDARD CHARACTERS WITHOUT CLAIM TO ANY PARTICULAR FONT, STYLE, SIZE, OR COLOR.

NO CLAIM IS MADE TO THE EXCLUSIVE RIGHT TO USE "ENERGY DRINK", APART FROM THE MARK AS SHOWN.

FOR FRANCHISE SERVICES, NAMELY, OFFERING BUSINESS MANAGEMENT ASSISTANCE IN THE ESTABLISHMENT AND OPERATION OF NON-ALCOHOLIC BEVERAGE DISTRIBUTION FRANCHISES (U.S. CLS. 100, 101 AND 102).

FIRST USE 10-30-2009; IN COMMERCE 11-0-2009.
CHRISTINE COOPER, EXAMINING ATTORNEY

SN 77-830,264. WAVE ENERGY DRINK, LLC, MOORESVILLE, NC. FILED 9-18-2009.



NO CLAIM IS MADE TO THE EXCLUSIVE RIGHT TO USE "ENERGY DRINK", APART FROM THE MARK AS SHOWN.

THE MARK CONSISTS OF STYLIZED WORD "WAVE" ABOVE THE WORDS "ENERGY DRINK".

FOR FRANCHISE SERVICES, NAMELY, OFFERING BUSINESS MANAGEMENT ASSISTANCE IN THE ESTABLISHMENT AND OPERATION OF NON-ALCOHOLIC BEVERAGE DISTRIBUTION FRANCHISES (U.S. CLS. 100, 101 AND 102).

FIRST USE 10-30-2009; IN COMMERCE 11-0-2009.
CHRISTINE COOPER, EXAMINING ATTORNEY

CLASS 35—(Continued).

SN 77-830,348. SCHAFFER, NEAL, NEWPORT BEACH, CA. FILED 9-18-2009.



NO CLAIM IS MADE TO THE EXCLUSIVE RIGHT TO USE "NETWORKING", APART FROM THE MARK AS SHOWN.

THE MARK CONSISTS OF A FANCIFUL GRAPHIC REPRESENTATION OF A WINDMILL INSIDE A PARTIALLY SHADED SQUARE WITH CURVED CORNERS, AND A SILHOUETTE OF A PERSON STANDING NEXT TO THE WINDMILL, WITH THE WORDING, "WINDMILL" TO THE RIGHT, WITH "NETWORKING" BELOW.

FOR BUSINESS CONSULTATION IN THE FIELD OF INTERNET-BASED SOCIAL MEDIA AND SOCIAL NETWORKING TECHNOLOGY (U.S. CLS. 100, 101 AND 102).

FIRST USE 7-8-2009; IN COMMERCE 7-8-2009.
ODESSA BIBBINS, EXAMINING ATTORNEY

SN 77-831,695. NEW CUSTOMERS NOW MARKETING L.L.C., HOWELL, MI. FILED 9-22-2009.

NEW CUSTOMERS NOW!

THE MARK CONSISTS OF STANDARD CHARACTERS WITHOUT CLAIM TO ANY PARTICULAR FONT, STYLE, SIZE, OR COLOR.

FOR PROVIDING MARKETING ASSISTANCE FOR OTHERS (U.S. CLS. 100, 101 AND 102).

FIRST USE 3-15-2006; IN COMMERCE 3-15-2006.
BARBARA BROWN, EXAMINING ATTORNEY

SN 77-833,971. CATHERINE MAYER, DBA CATHERINE MAYER AMBIENT ART, SEATTLE, WA. FILED 9-24-2009.

**catherine mayer
ambient art**

THE MARK CONSISTS OF STANDARD CHARACTERS WITHOUT CLAIM TO ANY PARTICULAR FONT, STYLE, SIZE, OR COLOR.

THE NAME "CATHERINE MAYER" IDENTIFIES A LIVING INDIVIDUAL WHOSE CONSENT IS OF RECORD.

FOR ASSISTANCE AND CONSULTATION WITH BUSINESS MANAGEMENT; ASSISTANCE AND CONSULTATION WITH CUSTOMER RELATIONSHIP MANAGEMENT; ASSISTANCE AND CONSULTATION WITH PROVIDING OFFICE FUNCTIONS (U.S. CLS. 100, 101 AND 102).

ANGELA DUONG, EXAMINING ATTORNEY

CLASS 35—(Continued).

SN 77-835,092. CALWEN INC., DBA RESCUE SOURCE, WILTON, CA. FILED S.R. 9-25-2009; AM. P.R. 3-26-2010.

Rescue Source

THE MARK CONSISTS OF STANDARD CHARACTERS WITHOUT CLAIM TO ANY PARTICULAR FONT, STYLE, SIZE, OR COLOR.

NO CLAIM IS MADE TO THE EXCLUSIVE RIGHT TO USE "RESCUE", APART FROM THE MARK AS SHOWN. SEC. 2(F).

FOR ON-LINE RETAIL STORE SERVICES AND RETAIL STORE SERVICES FEATURING RESCUE EQUIPMENT, SUPPLIES AND ACCESSORIES (U.S. CLS. 100, 101 AND 102).

FIRST USE 3-15-1991; IN COMMERCE 3-15-1991.
TIMOTHY FINNEGAN, EXAMINING ATTORNEY

SN 77-835,303. GVV GROUP, LLC, HIGHLAND PARK, IL. FILED 9-25-2009.

ICLUNKIT

THE MARK CONSISTS OF STANDARD CHARACTERS WITHOUT CLAIM TO ANY PARTICULAR FONT, STYLE, SIZE, OR COLOR.

FOR BUSINESS CONSULTING SERVICES; PROVIDING A WEBSITE OFFERING CONSUMER INFORMATION IN THE FIELD OF MONETARY REBATES FOR THE PURCHASE OF ENERGY EFFICIENT CONSUMER GOODS (U.S. CLS. 100, 101 AND 102).

SKYE YOUNG, EXAMINING ATTORNEY

SN 77-836,366. DEALERSKINS, INC., NASHVILLE, TN. FILED 9-28-2009.

PSYCHIC SALES

THE MARK CONSISTS OF STANDARD CHARACTERS WITHOUT CLAIM TO ANY PARTICULAR FONT, STYLE, SIZE, OR COLOR.

NO CLAIM IS MADE TO THE EXCLUSIVE RIGHT TO USE "SALES", APART FROM THE MARK AS SHOWN.

FOR MARKETING SERVICES, NAMELY, LEAD GENERATION SERVICES FOR OTHERS IN THE AUTOMOTIVE INDUSTRY (U.S. CLS. 100, 101 AND 102).

FIRST USE 1-0-2008; IN COMMERCE 1-0-2008.
ALEXANDER L. POWERS, EXAMINING ATTORNEY

CLASS 35—(Continued).

SN 77-837,178. AMERICAN TRUCK BUSINESS SERVICES, LLC, DBA ATBS, LAKEWOOD, CO. FILED 9-29-2009.



NO CLAIM IS MADE TO THE EXCLUSIVE RIGHT TO USE "REAL ESTATE", APART FROM THE MARK AS SHOWN.

THE COLOR(S) BLACK AND PANTONE 125 GOLD IS/ ARE CLAIMED AS A FEATURE OF THE MARK.

THE MARK CONSISTS OF STANDARD ALPHA CHARACTERS "ATBS" IN ALL CAPITALS IN BLACK LETTERING. THE "A" IS LARGER WITH TWO HORIZONTAL GOLD LINES IN PANTONE 125 GOLD FORMING THE CROSS BAR OF THE "A". THE TOP LINE IS THINNER THAN THE LOWER LINE. THE GOLD LINES EXTEND TO THE RIGHT AND "TBS" SITS ON TOP OF THE GOLD LINES. THE WORDS "REAL ESTATE" IN ALL CAPITALS AND IN BLACK LETTERING SIT TO THE RIGHT OF THE "A" UNDERNEATH THE GOLD LINES.

FOR BUSINESS MANAGEMENT CONSULTING, TAX PREPARATION, TAX CONSULTATION, TAX ADVICE AND TAX INFORMATION SERVICES, BOOKKEEPING, ACCOUNTING SERVICES, ACCOUNTING CONSULTATION, PAYROLL PREPARATION, AND PAYROLL PROCESSING SERVICES FOR REAL ESTATE PROFESSIONALS (U.S. CLS. 100, 101 AND 102).

FIRST USE 1-5-2009; IN COMMERCE 1-5-2009.
SUSAN RICHARDS, EXAMINING ATTORNEY

SN 77-837,250. STREAMLINED MARKETING SYSTEMS, INC., DBA GOGO20, TALLAHASSEE, FL. FILED 9-29-2009.

GOGO20

THE MARK CONSISTS OF STANDARD CHARACTERS WITHOUT CLAIM TO ANY PARTICULAR FONT, STYLE, SIZE, OR COLOR.

FOR DISCOUNT DISTRIBUTORSHIP SERVICES PROVIDED VIA THE INTERNET IN THE FIELD OF DISCOUNTED GENERAL CONSUMER MERCHANDISE (U.S. CLS. 100, 101 AND 102).

FIRST USE 9-29-2009; IN COMMERCE 9-29-2009.
SKYE YOUNG, EXAMINING ATTORNEY

CLASS 35—(Continued).

SN 77-837,647. BIG BOB'S FLOORING OUTLET OF AMERICA, INC., SHAWNEE MISSION, KS. FILED 9-29-2009.

HOME OF THE BEST GOOD BUYS

THE MARK CONSISTS OF STANDARD CHARACTERS WITHOUT CLAIM TO ANY PARTICULAR FONT, STYLE, SIZE, OR COLOR.

FOR RETAIL STORE SERVICES AND WHOLESALE DISTRIBUTORSHIP SERVICES IN THE FIELD OF FLOORING, CARPETING, MATTRESSES AND FURNITURE; FRANCHISING SERVICES, NAMELY, OFFERING BUSINESS MANAGEMENT ASSISTANCE IN THE ESTABLISHMENT AND/OR OPERATION OF FLOORING, CARPETING, MATTRESSES AND FURNITURE RETAIL STORES; ADVERTISING SERVICES FOR FLOORING, CARPETING, MATTRESSES AND FURNITURE RETAIL STORES (U.S. CLS. 100, 101 AND 102).

FIRST USE 9-1-2009; IN COMMERCE 9-1-2009.
COLLEEN KEARNEY, EXAMINING ATTORNEY

SN 77-839,082. YESSTYLE FASHION, INC., SAN BRUNO, CA. FILED 10-1-2009.

YESSTYLE

THE COLOR(S) GREEN AND BLACK IS/ARE CLAIMED AS A FEATURE OF THE MARK.

THE MARK CONSISTS OF THE LITERAL ELEMENT "YES" IN GREEN ADJOINED TO THE LITERAL ELEMENT "STYLE" IN BLACK.

FOR RETAIL STORES FEATURING COSMETIC PRODUCTS, SKINCARE PRODUCTS, CLOTHING, INTIMATE WEAR, SPORTWEAR, FOOTWEAR, BAGS, HEADGEAR, JEWELRY PRODUCTS, WATCHES, PRECIOUS METAL, ORNAMENTAL OBJECTS, HOME DECORATION PRODUCTS, HOUSEWARES, ELECTRONICS, BATH AND BEDDING PRODUCTS, BOOKS, MAGAZINES, GIFTS, SOUVENIRS, FASHION ACCESSORIES (U.S. CLS. 100, 101 AND 102).

FIRST USE 9-23-2009; IN COMMERCE 9-23-2009.
CHERYL CLAYTON, EXAMINING ATTORNEY

SN 77-840,218. DENNIS J. DAYES, DBA THE DAYES' ENTERPRISE LLC - - STARMNGT STAFFING, BRONX, NY. FILED 10-2-2009.

StarMNGT STAFFING
BELIEVING THRIVING • NOT JUST SURVIVING

NO CLAIM IS MADE TO THE EXCLUSIVE RIGHT TO USE "STAFFING", APART FROM THE MARK AS SHOWN. THE COLOR(S) GREEN, WHITE AND LIGHT BLUE IS/ARE CLAIMED AS A FEATURE OF THE MARK.

THE MARK CONSISTS OF THE WORDING "STARMNGT STAFFING", ALL SHOWN IN STYLIZED FONT, WITH THE

CLASS 35—(Continued).

WORDS IN LIGHT BLUE EXCEPT "STAR", WHICH IS SHOWN IN GREEN, WITH TWO STYLIZED "S"'S WHICH FORM ONE LARGE LETTER "S" BETWEEN "MNGT" AND "STAFFING", THE "S" ON THE LEFT SHOWN IN GREEN AND THE "S" ON THE RIGHT SHOWN IN LIGHT BLUE, ALL SHOWN ABOVE A GREEN LINE WHICH IS ABOVE THE WORDING "BELIEVING THRIVING - NOT JUST SURVIVING", WITH A DOT BETWEEN "THRIVING" AND "NOT", IN LIGHT BLUE, ALL SHOWN AGAINST A WHITE BACKGROUND.

FOR EMPLOYMENT AGENCY SERVICES, NAMELY, FILLING THE TEMPORARY AND PERMANENT STAFFING NEEDS OF BUSINESSES; EMPLOYMENT HIRING, RECRUITING, PLACEMENT, STAFFING AND CAREER NETWORKING SERVICES (U.S. CLS. 100, 101 AND 102).

ESTHER BELENKER, EXAMINING ATTORNEY

SN 77-840,314. THE ASSOCIATION OF FORMER STUDENTS, COLLEGE STATION, TX. FILED 10-2-2009.



NO CLAIM IS MADE TO THE EXCLUSIVE RIGHT TO USE "ASSOCIATION", APART FROM THE MARK AS SHOWN.

THE MARK CONSISTS OF THE TEXT "THE ASSOCIATION OF FORMER STUDENTS" ADJACENT A RING.

SEC. 2(F) AS TO " THE ASSOCIATION OF FORMER STUDENTS"

FOR ASSOCIATION SERVICES, NAMELY, PROMOTING THE INTERESTS OF ALUMNI (U.S. CLS. 100, 101 AND 102).

FIRST USE 1-1-2001; IN COMMERCE 1-1-2001.
LESLEY LAMOTHE, EXAMINING ATTORNEY

SN 77-841,735. ARCHIFORM LIMITED CORPORATION, FREEPORT GRAND BAHAMA, BAHAMAS, FILED 10-5-2009.

ENVISION 3D

THE MARK CONSISTS OF STANDARD CHARACTERS WITHOUT CLAIM TO ANY PARTICULAR FONT, STYLE, SIZE, OR COLOR.

NO CLAIM IS MADE TO THE EXCLUSIVE RIGHT TO USE "3D", APART FROM THE MARK AS SHOWN.

FOR ADVERTISING MEDIA DESIGN SERVICES, NAMELY, DESIGN OF IMAGES, TEXTS, AUDIO AND VIDEOS USED TO PROMOTE THE GOODS AND SERVICES OF OTHERS (U.S. CLS. 100, 101 AND 102).

FIRST USE 9-20-2009; IN COMMERCE 9-20-2009.
EDWARD FENNESSY, EXAMINING ATTORNEY

CLASS 35—(Continued).

SN 77-843,845. CAPITALWILL LLC, ALPINE, UT. FILED 10-7-2009.



THE MARK CONSISTS OF THE LETTER "C" WITH WINGS INSIDE A BOX AND THE BOX IS TO THE LEFT OF THE WORDS "WINGCASH".

FOR PROVIDING AN ON-LINE COMPUTER WEBSITE THAT PROVIDES COMMERCIAL FINANCIAL TRANSACTION DATA, TRANSACTION REPORTING, CLEARING OF FINANCIAL TRANSACTIONS, RECONCILIATION OF FINANCIAL TRANSACTIONS, SETTLEMENT OF FINANCIAL TRANSACTIONS, ACCOUNTING FEATURES, AND ACCOUNT MANAGEMENT FOR USE BY MEMBERS OF AN ON-LINE COMMUNITY VIA A GLOBAL COMPUTER NETWORK (U.S. CLS. 100, 101 AND 102).

FIRST USE 5-27-2009; IN COMMERCE 5-27-2009.
DOMINICK J. SALEMI, EXAMINING ATTORNEY

SN 77-845,874. BASELINE CONSULTING GROUP, SHERMAN OAKS, CA. FILED 10-9-2009.

BI PORTFOLIO

THE MARK CONSISTS OF STANDARD CHARACTERS WITHOUT CLAIM TO ANY PARTICULAR FONT, STYLE, SIZE, OR COLOR.

NO CLAIM IS MADE TO THE EXCLUSIVE RIGHT TO USE "PORTFOLIO", APART FROM THE MARK AS SHOWN.

FOR BUSINESS ADVISORY SERVICES; BUSINESS MANAGEMENT; BUSINESS MANAGEMENT CONSULTING; BUSINESS ORGANIZATION CONSULTING; BUSINESS RESEARCH; BUSINESS APPRAISALS; BUSINESS PLANNING; BUSINESS INFORMATION SERVICES FOR THIRD PARTIES IN THE FIELD OF DATA SEARCHES IN DATABASES, NAMELY, DATA COMPILING AND ANALYZING RELATING TO BUSINESS MANAGEMENT INFORMATION; BUSINESS INFORMATION SERVICES IN THE FIELDS OF PROCESSES AND METHODOLOGIES USED IN BUSINESS, MANAGEMENT AND COMMERCE; BUSINESS INFORMATION SERVICES IN THE FIELD OF BUSINESS MATTERS AND MARKETING, ECONOMIC FORECASTING AND ANALYSIS, AND HEALTHCARE BUSINESS MARKETS; ACQUISITION AND MERGER CONSULTATION; PERSONNEL RECRUITMENT SERVICES AND PERSONNEL RECRUITMENT MANAGEMENT; BUSINESS MARKETING SERVICES (U.S. CLS. 100, 101 AND 102).

FIRST USE 8-0-2000; IN COMMERCE 8-0-2000.
CHRISTINA SOBRAL, EXAMINING ATTORNEY

CLASS 35—(Continued).

SN 77-846,706. WATSON REALTY CORP., JACKSONVILLE, FL. FILED 10-12-2009.

WATSON CARES

THE MARK CONSISTS OF STANDARD CHARACTERS WITHOUT CLAIM TO ANY PARTICULAR FONT, STYLE, SIZE, OR COLOR.

OWNER OF U.S. REG. NOS. 2,576,221 AND 3,639,104.

THE NAME(S), PORTRAIT(S), AND/OR SIGNATURE(S) SHOWN IN THE MARK IDENTIFIES WILLIAM A. WATSON, JR., WHOSE CONSENT(S) TO REGISTER IS MADE OF RECORD.

FOR PROMOTING PUBLIC AWARENESS OF THE NEED FOR CHARITABLE GIVING AND COMMUNITY INVOLVEMENT; PROMOTING PUBLIC AWARENESS OF THE NEED FOR CHARITABLE GIVING, AND COMMUNITY SERVICE AND INVOLVEMENT; PROMOTING THE CHARITABLE SERVICES OF OTHERS, NAMELY, PROVIDING INDIVIDUALS WITH INFORMATION FOR THE PURPOSE OF MAKING DONATIONS TO CHARITIES; DEVELOPING AND COORDINATING VOLUNTEER PROJECTS FOR CHARITABLE ORGANIZATIONS (U.S. CLS. 100, 101 AND 102).
LOURDES AYALA, EXAMINING ATTORNEY

SN 77-847,217. AHOLD LICENSING SARL, GENEVA, SWITZERLAND, FILED 10-13-2009.

GREAT GRAPE-A-RAMA

THE MARK CONSISTS OF STANDARD CHARACTERS WITHOUT CLAIM TO ANY PARTICULAR FONT, STYLE, SIZE, OR COLOR.

NO CLAIM IS MADE TO THE EXCLUSIVE RIGHT TO USE "GREAT", APART FROM THE MARK AS SHOWN.

FOR SUPERMARKETS (U.S. CLS. 100, 101 AND 102).

FIRST USE 8-0-1996; IN COMMERCE 8-0-1996.

DOMINIC J. FERRAIUOLO, EXAMINING ATTORNEY

CLASS 35—(Continued).

SN 77-848,383. AIRPORTBARS.COM, LLC, PORTLAND, OR.
FILED 10-14-2009.



NO CLAIM IS MADE TO THE EXCLUSIVE RIGHT TO USE "AIRPORTBARS.COM", APART FROM THE MARK AS SHOWN.

THE COLOR(S) BROWN, RED, YELLOW, WHITE, BLUE IS/ARE CLAIMED AS A FEATURE OF THE MARK.

THE MARK CONSISTS OF A BROWN BOTTLE WITH AIRPLANE WINGS ON IT FLYING THROUGH TWO CIRCLES; THE INNER CIRCLE IS RED AND THE OUTER CIRCLE IS BLUE. THE TWO CIRCLES ARE DIVIDED BY A YELLOW RING, WITH A YELLOW BORDER AROUND THE OUTER CIRCLE. IN THE OUTER CIRCLE THE WORDING "AIRPORTBARS.COM" IS WRITTEN IN WHITE IN AN ARCED FASHION ON THE UPPER ARC OF THE CIRCLE.

FOR PROVIDING ONLINE CONSUMER INFORMATION FEATURING CONSUMER REVIEWS OF PRODUCTS AND SERVICES AND COMPILATION AND COMMENTS OF PRODUCTS AND SERVICES OF AIRPORT BARS (U.S. CLS. 100, 101 AND 102).

FIRST USE 1-13-2007; IN COMMERCE 1-17-2009.
TINA MAI, EXAMINING ATTORNEY

CLASS 35—(Continued).

SN 77-852,217. MOTIVATED MOVERS, INC., PELHAM, AL.
FILED 10-19-2009.



NO CLAIM IS MADE TO THE EXCLUSIVE RIGHT TO USE "MOVERS", APART FROM THE MARK AS SHOWN.

THE STIPPLING IS FOR SHADING PURPOSES ONLY.
THE MARK CONSISTS OF THE WORDING "MOTIVATED MOVERS" IN LARGE BLOCK LETTERS WITH A SHADOW EFFECT; ALSO, AN IMAGE OF MAN LIFTING THE "M" OF "MOTIVATED" AS IF HE WERE MOVING A BOX; THE MAN IS WEARING A HAT WITH THE TEXT "MM" ON IT.

FOR MOVING AND RELOCATION SERVICES, NAMELY, PLANNING AND IMPLEMENTING MOVES OF HOMES AND OFFICES (U.S. CLS. 100, 101 AND 102).

FIRST USE 1-1-2008; IN COMMERCE 1-1-2008.
TIMOTHY FINNEGAN, EXAMINING ATTORNEY

SN 77-849,935. BASELINE CONSULTING GROUP, SHERMAN OAKS, CA. FILED 10-15-2009.

BI APPLICATION PORTFOLIO

THE MARK CONSISTS OF STANDARD CHARACTERS WITHOUT CLAIM TO ANY PARTICULAR FONT, STYLE, SIZE, OR COLOR.

NO CLAIM IS MADE TO THE EXCLUSIVE RIGHT TO USE "APPLICATION PORTFOLIO", APART FROM THE MARK AS SHOWN.

FOR BUSINESS ADVISORY SERVICES; BUSINESS MANAGEMENT; BUSINESS MANAGEMENT CONSULTING; BUSINESS ORGANIZATION CONSULTING; BUSINESS RESEARCH; BUSINESS APPRAISALS; BUSINESS PLANNING; BUSINESS INFORMATION SERVICES FOR THIRD PARTIES IN THE FIELD OF DATA SEARCHES IN DATABASES, NAMELY, DATA COMPILING AND ANALYZING RELATING TO BUSINESS MANAGEMENT INFORMATION; BUSINESS INFORMATION SERVICES IN THE FIELDS OF PROCESSES AND METHODOLOGIES USED IN BUSINESS, MANAGEMENT AND COMMERCE; BUSINESS INFORMATION SERVICES IN THE FIELD OF BUSINESS MATTERS AND MARKETING, ECONOMIC FORECASTING AND ANALYSIS, AND HEALTHCARE BUSINESS MARKETS; ACQUISITION AND MERGER CONSULTATION; PERSONNEL RECRUITMENT SERVICES AND PERSONNEL RECRUITMENT MANAGEMENT; BUSINESS MARKETING SERVICES (U.S. CLS. 100, 101 AND 102).

FIRST USE 8-0-2000; IN COMMERCE 8-0-2000.
CHRISTINA SOBRAL, EXAMINING ATTORNEY

SN 77-852,957. ATKIVA L.L.C., NORTH MIAMI BEACH, FL.
FILED 10-20-2009.

ATKIVA

THE MARK CONSISTS OF STANDARD CHARACTERS WITHOUT CLAIM TO ANY PARTICULAR FONT, STYLE, SIZE, OR COLOR.

THE WORDING "ATKIVA" HAS NO MEANING IN A FOREIGN LANGUAGE.

FOR IMPORT AND EXPORT AGENCIES (U.S. CLS. 100, 101 AND 102).

KATHLEEN M. VANSTON, EXAMINING ATTORNEY

CLASS 35—(Continued).

SN 77-853,142. BERKELEY HALL CLUB, INC., BLUFFTON, SC. FILED 10-20-2009.



BERKELEY HALL

THE MARK CONSISTS OF THE WORDS "BERKELEY HALL" BELOW AN IMAGE OF A SHIELD OR CREST FEATURING TEN (10) FIGURATIVE DESIGN ELEMENTS IN THE SHAPE OF CROSSES AND A CHEVRON.

FOR RETAIL STORE SERVICES FEATURING GOLF ACCESSORIES, ARTWORK, GOLF COURSE FLAGS, GOLF GLOVES, GOLF MITTS, CIGARS, CHRISTMAS ORNAMENTS, GIFT BOXES, HANDBAGS, SHOE TREES, BLAZER CRESTS, MOUSE PADS, BOWLS, WINE BOTTLES, UMBRELLAS, WINE RACKS, BLANKETS, PILLOWS, HEAD COVERS FOR GOLF CLUBS, PUTTER COVERS, GOLF BAGS, GOLF BALLS, HAT CLIPS, GOLF BALL MARKERS, COASTERS, MAGNETS, CLOCKS, BOOKMARKS, GOLF BAG TAGS, KEY CHAINS, GOLF TOWELS, PENS, MARKERS, NOTE CARDS, YARDAGE AND DISTANCE GUIDES, LUGGAGE, BAGS, DUFFLE BAGS, SHOULDER BAGS, VALETS, GLASSWARE, PLASTIC CUPS AND ICE BUCKETS (U.S. CLS. 100, 101 AND 102).

FIRST USE 10-10-2000; IN COMMERCE 10-10-2000.
LAURIE MAYES, EXAMINING ATTORNEY

SN 77-854,453. ARCH STANTON, LLC, MARLBOROUGH, MA. FILED 10-21-2009.

GOLD FOR GOD

THE MARK CONSISTS OF STANDARD CHARACTERS WITHOUT CLAIM TO ANY PARTICULAR FONT, STYLE, SIZE, OR COLOR.

NO CLAIM IS MADE TO THE EXCLUSIVE RIGHT TO USE "GOLD", APART FROM THE MARK AS SHOWN.

FOR SCRAP DEALERSHIP IN THE NATURE OF BUYING SCRAP, NAMELY, GOLD, PLATINUM AND SILVER, JEWELRY, DIAMONDS, WATCHES, COINS, ART AND ANTIQUES AND LUXURY CARS FROM BUSINESSES AND CHARITIES NATIONWIDE; COORDINATING THE COLLECTION OF THESE ITEMS VIA DIRECT MAIL AND THE WORLD WIDE WEB NETWORK (U.S. CLS. 100, 101 AND 102).

MARLENE BELL, EXAMINING ATTORNEY

CLASS 35—(Continued).

SN 77-854,655. HOWARD CAPITAL MANAGEMENT, INC., ROSWELL, GA. FILED 10-22-2009.

401(k) Optimizer

THE MARK CONSISTS OF STANDARD CHARACTERS WITHOUT CLAIM TO ANY PARTICULAR FONT, STYLE, SIZE, OR COLOR.

NO CLAIM IS MADE TO THE EXCLUSIVE RIGHT TO USE "401(K)", APART FROM THE MARK AS SHOWN.

FOR PREPARING FINANCIAL REPORTS FOR OTHERS (U.S. CLS. 100, 101 AND 102).

FIRST USE 11-1-2008; IN COMMERCE 11-1-2008.
TRACY WHITTAKER-BROWN, EXAMINING ATTORNEY

SN 77-854,865. MEDPRO SYSTEMS, LLC, MT. ARLINGTON, NJ. FILED 10-22-2009.

Sampleability

THE MARK CONSISTS OF STANDARD CHARACTERS WITHOUT CLAIM TO ANY PARTICULAR FONT, STYLE, SIZE, OR COLOR.

FOR ELECTRONIC MATCHING SERVICES COMBINING PROPRIETARY ALGORITHMS AND OTHER MATHEMATICAL OPERATIONS WITH A DATABASE CONTAINING LICENSING INFORMATION ABOUT HEALTHCARE PROFESSIONALS FOR THE PURPOSE OF DETERMINING THE ELIGIBILITY OF HEALTHCARE PRACTITIONERS IDENTIFIED BY CUSTOMERS TO RECEIVE PHARMACEUTICAL PRODUCTS (U.S. CLS. 100, 101 AND 102).

FIRST USE 7-11-2002; IN COMMERCE 7-11-2002.
ALLISON SCHRODY, EXAMINING ATTORNEY

CLASS 35—(Continued).

SN 77-855,026. THE NATIONAL WASHINGTON-ROCHAMBEAU REVOLUTIONARY ROUTE ASSOCIATION, INC., NEWARK, DE. FILED 10-22-2009.



THE COLOR(S) RED, WHITE, BLUE, AND GOLD IS/ARE CLAIMED AS A FEATURE OF THE MARK.

THE MARK CONSISTS OF A RECTANGULAR BLUE BACKGROUND CONTAINING A WHITE SHIELD EXTENDING NEARLY TO THE EDGES OF THE RECTANGLE, A BLUE RECTANGLE INSIDE AND EXTENDING NEARLY TO THE EDGES OF THE UPPER HALF OF THE SHIELD, THE TEXT "W3R" WITH THE "3" ALIGNED SLIGHTLY BELOW THE "W" AND THE "R" IN WHITE WITHIN THE BLUE RECTANGLE AND SIX, WHITE, FIVE-POINTED STARS IN A LINE BELOW THE TEXT ALSO WITHIN THE BLUE RECTANGLE, THREE WHITE AND TWO RED ALTERNATING VERTICAL STRIPES LOCATED IN THE BOTTOM LEFT QUADRANT OF THE SHIELD, AND A GOLD FLEUR DE LIS OUTLINED IN BLUE LOCATED IN THE BOTTOM RIGHT QUADRANT OF THE SHIELD.

FOR CHARITABLE SERVICES, NAMELY, PROMOTING AWARENESS, ORGANIZING AND CONDUCTING VOLUNTEER PROGRAMS AND COMMUNITY SERVICE PROJECTS FOR THE BENEFIT OF PRESERVING THE WASHINGTON-ROCHAMBEAU REVOLUTIONARY ROUTE (U.S. CLS. 100, 101 AND 102).

FIRST USE 5-0-2006; IN COMMERCE 5-0-2006.

ROBERT C. CLARK JR., EXAMINING ATTORNEY

SN 77-855,754. MCJUNKIN RED MAN CORPORATION, CHARLESTON, WV. FILED 10-23-2009.

GLOBAL SUPPLIER OF CHOICE

THE MARK CONSISTS OF STANDARD CHARACTERS WITHOUT CLAIM TO ANY PARTICULAR FONT, STYLE, SIZE, OR COLOR.

NO CLAIM IS MADE TO THE EXCLUSIVE RIGHT TO USE "GLOBAL SUPPLIER", APART FROM THE MARK AS SHOWN.

FOR DISTRIBUTORSHIP SERVICES OF INDUSTRIAL AND ENERGY-RELATED PIPES, VALVES, FITTINGS AND VALVE AUTOMATION, AND SPECIALTY-RELATED OIL FIELD EQUIPMENT AND SUPPLIES (U.S. CLS. 100, 101 AND 102).

KATHERINE M. DUBRAY, EXAMINING ATTORNEY

CLASS 35—(Continued).

SN 77-855,911. ADVANTAGE PARTNERS, INC., CLEVELAND, OH. FILED 10-23-2009.

camp*out

THE MARK CONSISTS OF STANDARD CHARACTERS WITHOUT CLAIM TO ANY PARTICULAR FONT, STYLE, SIZE, OR COLOR.

FOR EXECUTIVE RECRUITING SERVICES (U.S. CLS. 100, 101 AND 102).

FIRST USE 10-15-2009; IN COMMERCE 10-15-2009.

KIMBERLY PERRY, EXAMINING ATTORNEY

SN 77-856,011. SCENEWISE, INC., EL SEGUNDO, CA. FILED 10-23-2009.

BLENDED INSIGHTS

THE MARK CONSISTS OF STANDARD CHARACTERS WITHOUT CLAIM TO ANY PARTICULAR FONT, STYLE, SIZE, OR COLOR.

FOR PROVIDING CAREER AND OCCUPATIONAL INFORMATION (U.S. CLS. 100, 101 AND 102).

DAVID COLLIER, EXAMINING ATTORNEY

SN 77-856,023. SCENEWISE, INC., EL SEGUNDO, CA. FILED 10-23-2009.

MAKE MEDIA WORK

THE MARK CONSISTS OF STANDARD CHARACTERS WITHOUT CLAIM TO ANY PARTICULAR FONT, STYLE, SIZE, OR COLOR.

FOR PROVIDING CAREER AND OCCUPATIONAL INFORMATION (U.S. CLS. 100, 101 AND 102).

DAVID COLLIER, EXAMINING ATTORNEY

CLASS 35—(Continued).

SN 77-856,040. SCENEWISE, INC., EL SEGUNDO, CA. FILED 10-23-2009.

WORKFORCE ALIGNED

THE MARK CONSISTS OF STANDARD CHARACTERS WITHOUT CLAIM TO ANY PARTICULAR FONT, STYLE, SIZE, OR COLOR.

NO CLAIM IS MADE TO THE EXCLUSIVE RIGHT TO USE "WORKFORCE", APART FROM THE MARK AS SHOWN.

FOR PROVIDING CAREER AND OCCUPATIONAL INFORMATION (U.S. CLS. 100, 101 AND 102).

DAVID COLLIER, EXAMINING ATTORNEY

CLASS 35—(Continued).

SN 77-857,496. NATIONAL WILDLIFE CONTROL OPERATORS ASSOCIATION, INC., INDIANAPOLIS, IN. FILED 10-26-2009.



OWNER OF U.S. REG. NO. 3,487,150.

NO CLAIM IS MADE TO THE EXCLUSIVE RIGHT TO USE "NATIONAL WILDLIFE CONTROL OPERATORS ASSOCIATION", "SERVICE", AND THE DEPICTION OF THE OUTLINE OF THE MAP OF THE UNITED STATES, APART FROM THE MARK AS SHOWN.

FOR ASSOCIATION SERVICES, NAMELY, PROMOTING THE INTERESTS OF WILDLIFE CONTROL OPERATORS (U.S. CLS. 100, 101 AND 102).

FIRST USE 2-28-1999; IN COMMERCE 2-28-1999.

SIMON TENG, EXAMINING ATTORNEY

SN 77-857,198. TIDEWATER CONSULTING SERVICES, LLC, GAINESVILLE, GA. FILED 10-26-2009.

SN 77-858,867. RED ARME, LLC, NEW YORK, NY. FILED 10-27-2009.

**A Fearless Heart... A Willing Combatant!**

NO CLAIM IS MADE TO THE EXCLUSIVE RIGHT TO USE "CHARTER", APART FROM THE MARK AS SHOWN.

THE MARK CONSISTS OF THE WORDS "THE CHARTER LIFE" IN STYLIZED FONT TO THE RIGHT OF AN ABSTRACT IMAGE OF A FISHING VESSEL/YACHT WITH A MAIN HULL AND THREE UPPER DECKS.

FOR ONLINE ADVERTISING, MARKETING AND PROMOTION SERVICES IN CONNECTION WITH FISHING CHARTERS, YACHT CHARTERS AND OTHER MARINE RELATED SERVICES OF OTHERS (U.S. CLS. 100, 101 AND 102).

FIRST USE 9-12-2008; IN COMMERCE 9-12-2008.

STEVEN PEREZ, EXAMINING ATTORNEY

THE MARK CONSISTS OF STANDARD CHARACTERS WITHOUT CLAIM TO ANY PARTICULAR FONT, STYLE, SIZE, OR COLOR.

FOR ON-LINE RETAIL STORE SERVICES FEATURING CLOTHING AND HEADGEAR (U.S. CLS. 100, 101 AND 102).

FIRST USE 10-0-2009; IN COMMERCE 10-0-2009.

SAIMA MAKHDOOM, EXAMINING ATTORNEY

CLASS 35—(Continued).

SN 77-858,963. PILBARA GROUP INC., VIRGINIA BEACH, VA. FILED 10-28-2009.



The logo for PILBARA GROUP INC features the word "pil" in blue, "bara" in orange, and "group inc" in blue. A blue arc is positioned above the "i" in "pil".

PRIORITY CLAIMED UNDER SEC. 44(D) ON AUSTRALIA APPLICATION NO. 1322627, FILED 10-2-2009.

NO CLAIM IS MADE TO THE EXCLUSIVE RIGHT TO USE "GROUP INC", APART FROM THE MARK AS SHOWN.

THE COLOR(S) BLUE AND ORANGE IS/ARE CLAIMED AS A FEATURE OF THE MARK.

THE MARK CONSISTS OF THE BLUE LETTERS "PIL" FOLLOWED BY AN ORANGE DOT, FOLLOWED BY THE BLUE LETTER "B" FOLLOWED BY AN ORANGE "A" FOLLOWED BY THE BLUE LETTERS "RA". THIS IS FOLLOWED BY THE BLUE WORDING "GROUP" AND THEN THE ORANGE WORDING "INC". A BLUE EYEBROW APPEARS ABOVE THE ORANGE "A".

FOR BUSINESS MANAGEMENT CONSULTANCY SERVICES (U.S. CLS. 100, 101 AND 102).

FIRST USE 10-17-2003; IN COMMERCE 10-17-2003.

LYDIA BELZER, EXAMINING ATTORNEY

CLASS 35—(Continued).

SN 77-861,416. FLEXIBLE PACKAGING ASSOCIATION, LINTHICUM, MD. FILED 10-30-2009.



OWNER OF U.S. REG. NO. 3,236,073.

THE MARK CONSISTS OF THE WORDS "LESS RESOURCES. LESS FOOTPRINT. MORE VALUE. FLEXIBLE PACKAGING" ENCIRCLING A WAVE OF CIRCLES THAT ARE SMALLER AT THE BOTTOM AND BECOME INCREMENTALLY LARGER TOWARDS THE TOP.

SEC. 2(F) AS TO "FLEXIBLE PACKAGING".

FOR PROMOTING PUBLIC AWARENESS OF ENVIRONMENTAL, ECOLOGICAL, AND SUSTAINABILITY ISSUES RELATED TO PRODUCT PACKAGING; ASSOCIATION SERVICES, NAMELY, PROMOTING MEMBER INTERESTS IN THE FIELD OF ENVIRONMENTAL, ECOLOGICAL, AND SUSTAINABILITY ISSUES RELATED TO PRODUCT PACKAGING; LOBBYING SERVICES, NAMELY, PROMOTING THE INTERESTS OF MEMBER COMPANIES IN THE FIELD OF POLITICS, LEGISLATION, AND REGULATION RELATED TO ENVIRONMENTAL, ECOLOGICAL, AND SUSTAINABILITY ISSUES RELATED TO PRODUCT PACKAGING (U.S. CLS. 100, 101 AND 102).

DAVID COLLIER, EXAMINING ATTORNEY

SN 77-859,795. VARSITYPLAZA LLC, ASHBURN, VA. FILED 10-28-2009.



The logo for SurveySay.com features the word "SurveySay" in a serif font, with "Survey" in black and "Say" in a lighter grey. ".com" is written in a smaller, sans-serif font to the right.

THE MARK CONSISTS OF STANDARD CHARACTERS WITHOUT CLAIM TO ANY PARTICULAR FONT, STYLE, SIZE, OR COLOR.

FOR ONLINE BUSINESS RESEARCH SERVICES THAT FACILITATE USERS TO PARTICIPATE IN MARKETING RESEARCH COMPANY SURVEY PANELS RELATED TO EVERYDAY CONSUMER PRODUCTS AND SERVICES (U.S. CLS. 100, 101 AND 102).

FIRST USE 10-15-2009; IN COMMERCE 10-15-2009.

KATHERINE CONNOLLY, EXAMINING ATTORNEY

SN 77-861,437. FLEXIBLE PACKAGING ASSOCIATION, LINTHICUM, MD. FILED 10-30-2009.



OWNER OF U.S. REG. NO. 3,236,073.

THE MARK CONSISTS OF A WAVE OF CIRCLES THAT ARE SMALLER AT THE BOTTOM AND BECOME INCREMENTALLY LARGER TOWARDS THE TOP IN BETWEEN THE WORDS "FLEXIBLE" AND "PACKAGING" WITH THE WORDS "LESS RESOURCES. LESS FOOTPRINT. MORE VALUE." UNDERNEATH THE WORD "PACKAGING".

SEC. 2(F) AS TO "FLEXIBLE PACKAGING".

FOR PROMOTING PUBLIC AWARENESS OF ENVIRONMENTAL, ECOLOGICAL, AND SUSTAINABILITY ISSUES RELATED TO PRODUCT PACKAGING; ASSOCIATION SERVICES, NAMELY, PROMOTING MEMBER INTERESTS IN THE FIELD OF ENVIRONMENTAL, ECOLOGICAL, AND SUSTAINABILITY ISSUES RELATED TO PRODUCT PACKAGING; LOBBYING SERVICES, NAMELY, PROMOTING THE INTERESTS OF MEMBER COMPANIES IN THE FIELD OF POLITICS, LEGISLATION, AND REGULATION RELATED TO ENVIRONMENTAL, ECOLOGICAL, AND SUSTAINABILITY ISSUES RELATED TO PRODUCT PACKAGING (U.S. CLS. 100, 101 AND 102).

DAVID COLLIER, EXAMINING ATTORNEY

CLASS 35—(Continued).

SN 77-861,449. FLEXIBLE PACKAGING ASSOCIATION, LINTHICUM, MD. FILED 10-30-2009.



OWNER OF U.S. REG. NO. 3,236,073.
THE MARK CONSISTS OF A WAVE OF CIRCLES THAT ARE SMALLER AT THE BOTTOM AND BECOME INCREMENTALLY LARGER TOWARDS THE TOP TO THE RIGHT OF THE WORD "FLEXIBLE" ABOVE THE WORD "PACKAGING" WITH THE WORDS "LESS RESOURCES, LESS FOOTPRINT, MORE VALUE," UNDERNEATH THE WORD "PACKAGING".

SEC. 2(F) AS TO "FLEXIBLE PACKAGING".
FOR PROMOTING PUBLIC AWARENESS OF ENVIRONMENTAL, ECOLOGICAL, AND SUSTAINABILITY ISSUES RELATED TO PRODUCT PACKAGING; ASSOCIATION SERVICES, NAMELY, PROMOTING MEMBER INTERESTS IN THE FIELD OF ENVIRONMENTAL, ECOLOGICAL, AND SUSTAINABILITY ISSUES RELATED TO PRODUCT PACKAGING; LOBBYING SERVICES, NAMELY, PROMOTING THE INTERESTS OF MEMBER COMPANIES IN THE FIELD OF POLITICS, LEGISLATION, AND REGULATION RELATED TO ENVIRONMENTAL, ECOLOGICAL, AND SUSTAINABILITY ISSUES RELATED TO PRODUCT PACKAGING (U.S. CLS. 100, 101 AND 102).

DAVID COLLIER, EXAMINING ATTORNEY

SN 77-862,833. COMMERCE CORP, BALTIMORE, MD. FILED 11-2-2009.



NO CLAIM IS MADE TO THE EXCLUSIVE RIGHT TO USE "DESIGNS", APART FROM THE MARK AS SHOWN.

THE NAME "MICHAEL CARR" IDENTIFIES A LIVING INDIVIDUAL WHOSE CONSENT IS OF RECORD.

THE COLOR(S) GREEN AND BEIGE IS/ARE CLAIMED AS A FEATURE OF THE MARK.

THE MARK CONSISTS OF THREE BEIGE AND GREEN STACKED PLANTERS AND A DARK GREEN BULLFROG AMID GREEN LEAVES AND GREEN GRASS, AND THE TERMS "MICHAEL CARR" APPEAR IN GREEN AND "DESIGNS" APPEARS IN DARK GREEN.

FOR WHOLESALE DISTRIBUTORSHIPS FEATURING LAWN AND GARDEN FIGURINES AND PLANTERS (U.S. CLS. 100, 101 AND 102).

FIRST USE 10-31-2006; IN COMMERCE 10-31-2006.
ELIZABETH KAJUBI, EXAMINING ATTORNEY

CLASS 35—(Continued).

SN 77-864,063. ALLIANT ENERGY CORPORATION, MADISON, WI. FILED 11-3-2009.

POWER THINKER

THE MARK CONSISTS OF STANDARD CHARACTERS WITHOUT CLAIM TO ANY PARTICULAR FONT, STYLE, SIZE, OR COLOR.

OWNER OF U.S. REG. NOS. 2,176,549, 3,240,979 AND OTHERS.

FOR PROVIDING INFORMATION IN THE FIELD OF ENERGY EFFICIENCY; PROMOTING PUBLIC AWARENESS OF ENERGY CONSERVATION AND ENERGY MANAGEMENT VIA THE PROVISION OF INFORMATION AND ECONOMIC INCENTIVES TO ENERGY COMPANY CUSTOMERS; PROMOTING PUBLIC AWARENESS OF RENEWABLE ENERGY BY PROVIDING RENEWABLE ENERGY PROGRAMS FOR RESIDENTIAL AND COMMERCIAL CUSTOMERS; PROMOTING THE GOODS AND SERVICES OF OTHERS BY PROVIDING CASH REBATES FOR THE GOODS AND SERVICES OF OTHERS AND THUS ENCOURAGING ENERGY-EFFICIENT PRACTICES, EQUIPMENT AND MEASURES; ENERGY EFFICIENCY CONSULTATION SERVICES; ENERGY USE MANAGEMENT INFORMATION SERVICES; PROMOTING PUBLIC AWARENESS OF ENERGY EFFICIENCY AND ENERGY CONSERVATION THROUGH DIGITAL ELECTRIC AND GAS METER PROGRAMS; PROMOTING PUBLIC AWARENESS OF ENERGY EFFICIENCY AND ENERGY CONSERVATION THROUGH INTERRUPTIBLE ENERGY PROGRAMS (U.S. CLS. 100, 101 AND 102).

GINA FINK, EXAMINING ATTORNEY

SN 77-865,921. TURNBULL, ROBERT STEWART, DBA BUSINESS PHYSICS, SUNNYVALE, CA. FILED 11-5-2009.

BUSINESS PHYSICS

THE MARK CONSISTS OF STANDARD CHARACTERS WITHOUT CLAIM TO ANY PARTICULAR FONT, STYLE, SIZE, OR COLOR.

NO CLAIM IS MADE TO THE EXCLUSIVE RIGHT TO USE "BUSINESS", APART FROM THE MARK AS SHOWN.
FOR BUSINESS CONSULTATION SERVICES (U.S. CLS. 100, 101 AND 102).

FIRST USE 8-5-1998; IN COMMERCE 8-5-1998.
SEAN CROWLEY, EXAMINING ATTORNEY

CLASS 35—(Continued).

SN 77-866,668. WOKIE ENTERPRISES, LLC, FORMERLY WEBSITE COACH, L.L.P., HOUSTON, TX. FILED 11-6-2009.

SITECOACH

THE MARK CONSISTS OF STANDARD CHARACTERS WITHOUT CLAIM TO ANY PARTICULAR FONT, STYLE, SIZE, OR COLOR.

FOR ADVERTISING AND MARKETING SERVICES, NAMELY, PROMOTING THE GOODS AND SERVICES OF OTHERS (U.S. CLS. 100, 101 AND 102).

FIRST USE 2-3-1998; IN COMMERCE 2-3-1998.
GISELLE AGOSTO, EXAMINING ATTORNEY

SN 77-866,987. HURLEY, DAVID, MOUNT DORA, FL. FILED 11-6-2009.

NEW LIFE HEALTH & WELLNESS
CENTER

THE MARK CONSISTS OF STANDARD CHARACTERS WITHOUT CLAIM TO ANY PARTICULAR FONT, STYLE, SIZE, OR COLOR.

NO CLAIM IS MADE TO THE EXCLUSIVE RIGHT TO USE "CENTER", APART FROM THE MARK AS SHOWN.

FOR RETAIL STORE SERVICES FEATURING COOKWARE, KITCHEN UTENSILS, KITCHEN EQUIPMENT AND APPLIANCES, KITCHEN LINENS, AND CONTAINERS FOR HOUSEHOLD OR KITCHEN USE (U.S. CLS. 100, 101 AND 102).

LESLEY LAMOTHE, EXAMINING ATTORNEY

SN 77-867,968. OCTI-TECH LIMITED, LLC, CHARLESTON, SC. FILED 11-9-2009.

OCTI-TECH

THE MARK CONSISTS OF STANDARD CHARACTERS WITHOUT CLAIM TO ANY PARTICULAR FONT, STYLE, SIZE, OR COLOR.

FOR RETAIL SERVICES BY DIRECT SOLICITATION BY SALES AGENTS IN THE FIELD OF DIGITAL PRINTING; ON-LINE RETAIL STORE SERVICES FEATURING DIGITAL PRINTING PRODUCTS; WHOLESALE AND ON-LINE WHOLESALE STORE SERVICES FEATURING DIGITAL PRINTING PRODUCTS AND SERVICES; WHOLESALE DISTRIBUTORSHIPS FEATURING DIGITAL PRINTING PRODUCTS (U.S. CLS. 100, 101 AND 102).

JUDITH HELFMAN, EXAMINING ATTORNEY

CLASS 35—(Continued).

SN 77-868,064. COUCHBUSTERS, INC., FLORAL PARK, NY. FILED 11-9-2009.



THE COLOR(S) RED, BLACK AND WHITE IS/ARE CLAIMED AS A FEATURE OF THE MARK.

THE MARK CONSISTS OF A SMILING RED CARTOON CHARACTER POTATO THAT JUMPS OFF A WHITE COUCH WITH A RED SPRING WITH THE WORDING "COUCH" IN RED AND "BUSTERS" IN BLACK.

FOR JOB PLACEMENT (U.S. CLS. 100, 101 AND 102).
FIRST USE 10-29-2007; IN COMMERCE 10-29-2007.
WON TEAK OH, EXAMINING ATTORNEY

SN 77-868,065. EDELSBACHER DESIGN GROUP, INC., DBA HAPPY HOUR JOKER, SARASOTA, FL. FILED 11-9-2009.

Happy Hour Joker

THE MARK CONSISTS OF STANDARD CHARACTERS WITHOUT CLAIM TO ANY PARTICULAR FONT, STYLE, SIZE, OR COLOR.

NO CLAIM IS MADE TO THE EXCLUSIVE RIGHT TO USE "HAPPY HOUR", APART FROM THE MARK AS SHOWN.

FOR PROVIDING A WEB SITE WHICH FEATURES ADVERTISEMENTS FOR RESTAURANTS AND BARS SERVICES OF OTHERS; MEMBERSHIP CLUB SERVICES PROVIDING ADDITIONAL TIME OF HAPPY HOUR PROMOTIONS VIA A WEB SITE (U.S. CLS. 100, 101 AND 102).

WON TEAK OH, EXAMINING ATTORNEY

CLASS 35—(Continued).

SN 77-868,189. 8FOLD, LIVINGSTON, NJ. FILED 11-9-2009.



NO CLAIM IS MADE TO THE EXCLUSIVE RIGHT TO USE "INTEGRATED CREATIVE WORKS", APART FROM THE MARK AS SHOWN.

THE MARK CONSISTS OF A SYMBOL BEFORE THE WORDS "8FOLD". THE SYMBOL REPRESENTS THE NAME AND IS A COMBINATION OF THE NUMBER "8" AND THE LETTER "F". THE "8" IS NOT CLOSED AT THE TOP RIGHT TO FORM THE "F".

FOR ADVERTISING AGENCIES, NAMELY, PROMOTING THE SERVICES OF FRANCHISE AND NON-FRANCHISE COMPANIES IN THE AREAS OF FOOD SERVICE, BUSINESS SERVICE, CONSUMER PRODUCTS, REAL ESTATE, FINANCIAL MANAGEMENT, CONSTRUCTION, MANUFACTURING, PHARMACEUTICAL, TELECOMMUNICATIONS, TECHNOLOGY, SOCIAL SERVICES, AND ENVIRONMENTAL ISSUES THROUGH THE DISTRIBUTION OF PRINTED AND AUDIO PROMOTIONAL MATERIALS AND BY RENDERING SALES PROMOTION ADVICE; ADVERTISING AGENCIES; ADVERTISING AGENCIES, NAMELY, PROMOTING THE GOODS AND SERVICES OF OTHERS; ADVERTISING AGENCIES PROVIDING THE STRATEGY, DESIGN AND EXECUTION OF PROGRAMS TO PROMOTE BUSINESSES IN THE FOOD AND FOOD SERVICE INDUSTRIES; ADVERTISING AGENCY SPECIALIZING IN THE DESIGN AND EXECUTION OF WORD OF MOUTH, VIRAL, BUZZ AND EXPERIENTIAL MARKETING PROGRAMS; ADVERTISING AND ADVERTISEMENT SERVICES; ADVERTISING AND BUSINESS ADVICE RELATING TO TELEMATICS' SERVICES; ADVERTISING AND COMMERCIAL INFORMATION SERVICES, VIA THE INTERNET; ADVERTISING AND MARKETING; ADVERTISING AND MARKETING SERVICES, NAMELY, PROMOTING THE GOODS AND SERVICES OF OTHERS; ADVERTISING AND PROMOTION SERVICES AND RELATED CONSULTING; ADVERTISING AND PROMOTIONAL SERVICES; ADVERTISING AND PROMOTING THE GOODS AND SERVICES OF A VISUAL ARTIST; ADVERTISING AND PUBLICITY SERVICES; ADVERTISING AND PUBLICITY SERVICES, NAMELY, PROMOTING THE GOODS, SERVICES, BRAND IDENTITY AND COMMERCIAL INFORMATION AND NEWS OF THIRD PARTIES THROUGH PRINT, AUDIO, VIDEO, DIGITAL AND ON-LINE MEDIUM; ADVERTISING BUSINESS ESPECIALLY IN THE FIELD OF TELEMATIC AND TELEPHONE NETWORKS; ADVERTISING BY TRANSMISSION OF ON-LINE PUBLICITY FOR THIRD PARTIES THROUGH ELECTRONIC COMMUNICATIONS NETWORKS; ADVERTISING CONSULTATION; ADVERTISING FLYER DISTRIBUTION; ADVERTISING IN PERIODICALS, BROCHURES AND NEWSPAPERS; ADVERTISING PARTICULARLY SERVICES FOR THE PROMOTION OF GOODS; ADVERTISING RELATING TO PHARMACEUTICAL PRODUCTS AND IN-VIVO IMAGING PRODUCTS; ADVERTISING SERVICES, NAMELY, CREATING CORPORATE LOGOS FOR OTHERS; ADVERTISING SERVICES, NAMELY, CREATING CORPORATE AND BRAND IDENTITY FOR OTHERS; ADVERTISING SERVICES, NAMELY, PROMOTING THE FOOD AND WINE OF OTHERS; ADVERTISING SERVICES, NAMELY, PROMOTING AND MARKETING THE GOODS AND SERVICES OF OTHERS THROUGH ALL PUBLIC COMMUNICATION MEANS; ADVERTISING SERVICES, PUBLIC RELATIONS AND MARKETING SERVICES, NAMELY, PROMOTING AND MARKETING THE GOODS AND SERVICES OF OTHERS THROUGH ALL PUBLIC COMMUNICATION MEANS; ADVERTISING SERVICES RELATING TO SANDWICHES; ADVERTISING SERVICES, NAMELY, PROMOTING THE SANDWICHES OF OTHERS; ADVERTISING SERVICES, NAMELY, PROMOTING AND MARKETING THE GOODS AND SERVICES OF

CLASS 35—(Continued).

OTHERS IN THE FIELD OF UPSCALE CHOICES SUCH AS CULTURAL EVENTS, RESTAURANTS, SHOPPING, AND TRAVEL VIA PRINT AND ELECTRONIC MEDIA; ADVERTISING SERVICES, NAMELY, PRODUCTION OF SPECIAL EFFECTS INCLUDING MODEL-MAKING SERVICES, COMPUTER-GENERATED IMAGERY AND COMPUTER-GENERATED GRAPHICS FOR THE PRODUCTION OF COMMERCIALS; ADVERTISING SERVICES, NAMELY, COST-PER-ACTION ON-LINE ADVERTISING; ADVERTISING SERVICES, NAMELY, PROMOTING CAR DEALERSHIPS OF OTHERS; ADVERTISING SERVICES, NAMELY, PROMOTING THE BRANDS, GOODS AND SERVICES OF OTHERS; ADVERTISING TEXT PUBLICATION SERVICES; ADVERTISING THROUGH ALL PUBLIC COMMUNICATION MEANS; ADVERTISING VIA ELECTRONIC MEDIA AND SPECIFICALLY THE INTERNET; ADVERTISING, INCLUDING ON-LINE ADVERTISING ON A COMPUTER NETWORK; ADVERTISING, MARKETING AND PROMOTION SERVICES; ADVERTISING, MARKETING AND PROMOTIONAL SERVICES FOR AUTOMOTIVE DEALERSHIPS; ADVERTISING, MARKETING AND PROMOTIONAL SERVICES RELATED TO ALL INDUSTRIES FOR THE PURPOSE OF FACILITATING NETWORKING AND SOCIALIZING OPPORTUNITIES FOR BUSINESS PURPOSES; ADVERTISING, MARKETING AND PROMOTIONAL SERVICES FOR LIGHT AND HEAVY EQUIPMENT DEALERSHIPS; ADVERTISING, MARKETING AND PROMOTING THE GOODS AND SERVICES OF OTHERS USING KIOSKS; ADVERTISING, PROMOTION AND MARKETING SERVICES IN THE NATURE OF E-MAIL BLAST CAMPAIGNS FOR OTHERS; CINEMA ADVERTISING; CONSUMER LOYALTY SERVICES FOR COMMERCIAL, PROMOTIONAL, AND/OR ADVERTISING PURPOSES, NAMELY, ADMINISTRATION OF FREQUENT FLYER PROGRAM THAT ALLOWS MEMBERS TO REDEEM MILES FOR POINTS OR AWARDS OFFERED BY OTHER LOYALTY PROGRAMS; CREATING AND UPDATING ADVERTISING MATERIAL; CREATION OF MARKETING TOOLS DESIGNED TO INCREASE A CLIENT COMPANY'S KNOWLEDGE OF CUSTOMER NEEDS, AND ITS COMPETITORS' PRODUCTS AND SERVICES, PRICING, ADVERTISING STRATEGY AND SALES STRATEGY; DESIGN OF ADVERTISING MATERIALS FOR OTHERS; DESIGN OF ADVERTISING FLYERS FOR OTHERS; DESIGN OF ADVERTISING BROCHURES FOR OTHERS; DESIGN OF INTERNET ADVERTISING; DEVELOPING ADVERTISING CAMPAIGNS FOR OTHERS GEARED TOWARD ENVIRONMENTAL ISSUES; DIRECT ADVERTISING; DIRECT MARKETING ADVERTISING FOR OTHERS; DISSEMINATION OF ADVERTISING FOR OTHERS VIA THE INTERNET; DISSEMINATION OF ADVERTISING MATTER; DISSEMINATION OF ADVERTISING, SCHEDULING AND MANAGING OF TRAINING COURSES AND PROGRAMS FOR OTHERS VIA A GLOBAL COMPUTER NETWORK; DISSEMINATION OF ADVERTISEMENTS AND OF ADVERTISING MATERIAL; DISSEMINATION OF ADVERTISING FOR OTHERS VIA AN ON-LINE COMMUNICATIONS NETWORK ON THE INTERNET; DISSEMINATION OF ADVERTISING MATERIAL INCLUDING LEAFLETS, BROCHURES, OTHER PRINTED MATERIAL, ONLINE BANNER ADS, WEBSITES, SOCIAL MEDIA, PUBLIC RELATIONS, CUSTOM APPLICATIONS, MOBILE MEDIA, POINT OF PURCHASE DISPLAYS, AND OUTDOOR SIGNAGE; DISSEMINATION OF ADVERTISING FOR OTHERS VIA PUBLIC AND PRIVATE WIRELESS NETWORKS FOR DISPLAY ON MOBILE DEVICES; DISTRIBUTION AND DISSEMINATION OF ADVERTISING MATERIALS INCLUDING LEAFLETS, BROCHURES, OTHER PRINTED MATERIAL, ONLINE BANNER ADS, WEBSITES, SOCIAL MEDIA, PUBLIC RELATIONS, CUSTOM APPLICATIONS, MOBILE MEDIA, POINT OF PURCHASE DISPLAYS, AND OUTDOOR SIGNAGE; DISTRIBUTION OF ADVERTISING MAIL AND OF ADVERTISING SUPPLEMENTS ATTACHED TO REGULAR EDITIONS; DISTRIBUTION OF ADVERTISING MATERIALS; ELECTRONIC BILLBOARD ADVERTISING; ENTERTAINMENT MARKETING SERVICES, NAMELY, MARKETING, PROMOTION AND ADVERTISING FOR INDEPENDENT RECORDING ARTISTS; INTERNET ADVERTISING SERVICES; ISSUING AND UPDATING OF ADVERTISING TEXTS; LAYOUT SERVICES FOR ADVERTISING PURPOSES; MARKETING AND ADVERTISING SERVICES FOR AUTOMOBILE DEALERSHIPS;

CLASS 35—(Continued).

MARKETING, ADVERTISING AND PROMOTING THE GOODS AND SERVICES OF OTHERS IN THE FIELD OF TRAVEL AND TOURISM, NAMELY, PROVIDING INFORMATION VIA MAIL AND ELECTRONIC MAIL; MARKETING, ADVERTISING, AND PROMOTING THE RETAIL GOODS AND SERVICES OF OTHERS TO WIRELESS ELECTRONIC DEVICES; MUSIC SELECTION SERVICES FOR USE IN ADVERTISING; ONLINE ADVERTISING VIA A COMPUTER COMMUNICATIONS NETWORK; ON-LINE ADVERTISING ON COMPUTER COMMUNICATION NETWORKS; ON-LINE ADVERTISING AND MARKETING SERVICES; ON-LINE ADVERTISING SERVICES FOR OTHERS; PREPARATION AND REALIZATION OF MEDIA AND ADVERTISING PLANS AND CONCEPTS; PREPARATION OF CUSTOM OR NON-CUSTOM ADVERTISING FOR BUSINESSES FOR DISSEMINATION VIA THE WEB, CD OR DVD FOR OPTIONAL UPLOAD OR DOWNLOAD TO A COMPUTER; PREPARING AUDIOVISUAL PRESENTATIONS FOR USE IN ADVERTISING; PREPARING SPEECHES AND ORAL PRESENTATIONS FOR OTHERS FOR USE IN ADVERTISING; PRODUCTION OF ADVERTISING MATTER AND COMMERCIALS; PRODUCTION OF FILM AND TELEVISION ADVERTISING; PROVIDING ADVERTISING, MARKETING AND PROMOTIONAL SERVICES FOR THE PHARMACEUTICAL AND MEDICAL PRODUCTS OF OTHERS; PROVIDING ADVERTISING, MARKETING AND PROMOTIONAL SERVICES FOR THE PHARMACEUTICAL AND MEDICAL INDUSTRY; PROVIDING ADVERTISING, MARKETING AND PROMOTIONAL SERVICES, NAMELY, DEVELOPMENT OF ADVERTISING CAMPAIGNS FOR TELEVISION, PRINT MEDIA, CD-ROM, WEBSITES, MOBILE DEVICES, POINT OF PURCHASE DISPLAY, CONSUMER PRODUCTS, AND OUTDOOR SIGNAGE; PROVIDING ADVERTISING SERVICES USING 3D AND ANIMATION DESIGNS; PROVIDING ADVERTISING SERVICES; PROVIDING ADVERTISING AND ADVERTISEMENT SERVICES; PROVIDING ADVERTISING SERVICE TO DISTRIBUTE ADVERTISEMENTS FOR DISPLAY ON INTERNET, NAMELY, IN WEBSITES, SOCIAL CONVERSATIONS OVER THE INTERNET, EMAILS, MICROBLOGS, BLOGS, ELECTRONIC MESSAGES, INSTANT MESSAGES, TEXT MESSAGES, MULTIMEDIA MESSAGES, SOCIAL NETWORKS, STATUS UPDATES, FORUMS, ELECTRONIC BULLETIN BOARDS; ADVERTISING, MARKETING AND PROMOTIONAL SERVICES, NAMELY, DEVELOPMENT OF ADVERTISING CAMPAIGNS PROVIDED THROUGH CABLE TELEVISION BROADCAST, WEB CASTS, RADIO BROADCASTS, NEWSPAPERS, MAGAZINES, ONLINE BANNERS, OUTDOOR BILLBOARDS, WILD POSTINGS, BUS AND SUBWAY ADS; REAL ESTATE ADVERTISING SERVICES; SERVICES OF ADVERTISING AGENCIES; SPECIALTY MERCHANDISING SERVICES, NAMELY, PROMOTING THE GOODS AND SERVICES OF OTHERS THROUGH THE DISTRIBUTION OF CUSTOMIZED ADVERTISING MATERIALS, NAMELY, LEAFLETS, BROCHURES, OTHER PRINTED MATERIAL, ONLINE BANNER ADS, WEBSITES, SOCIAL MEDIA, PUBLIC RELATIONS, CUSTOM APPLICATIONS, MOBILE MEDIA, POINT OF PURCHASE DISPLAYS, AND OUTDOOR SIGNAGE; TELEVISION ADVERTISING AGENCIES (U.S. CLS. 100, 101 AND 102).

FIRST USE 6-17-2009; IN COMMERCE 6-17-2009.
DOMINICK J. SALEMI, EXAMINING ATTORNEY

CLASS 35—(Continued).

SN 77-870,432. WATSON REALTY CORP., JACKSONVILLE, FL. FILED 11-11-2009.



THE NAME(S), PORTRAIT(S), AND/OR SIGNATURE(S) SHOWN IN THE MARK IDENTIFIES WILLIAM A. WATSON, JR., WHOSE CONSENT(S) TO REGISTER IS MADE OF RECORD.

THE COLOR(S) RED, WHITE, AND BLUE IS/ARE CLAIMED AS A FEATURE OF THE MARK.

THE MARK CONSISTS OF THE WORD "WATSON" IN BLUE LETTERS OUTLINED IN WHITE APPEARING IN FRONT OF A RED HEART AND THE WORD "CARES" IN RED OUTLINED IN WHITE BELOW THE HEART, THE TWO WORDS SEPARATED BY A RED AND BLUE RING CIRCLING THE LOWER PART OF THE HEART.

FOR PROMOTING PUBLIC AWARENESS OF THE NEED FOR CHARITABLE GIVING AND COMMUNITY INVOLVEMENT; PROMOTING PUBLIC AWARENESS OF THE NEED FOR CHARITABLE GIVING, AND COMMUNITY SERVICE AND INVOLVEMENT; PROMOTING THE CHARITABLE SERVICES OF OTHERS, NAMELY, PROVIDING INDIVIDUALS WITH INFORMATION FOR THE PURPOSE OF MAKING DONATIONS TO CHARITIES; DEVELOPING AND COORDINATING VOLUNTEER PROJECTS FOR CHARITABLE ORGANIZATIONS (U.S. CLS. 100, 101 AND 102).
LOURDES AYALA, EXAMINING ATTORNEY

SN 77-870,853. ROBERT BRANDT, MIAMI, FL. FILED 11-12-2009.

BONERBIKER

THE MARK CONSISTS OF STANDARD CHARACTERS WITHOUT CLAIM TO ANY PARTICULAR FONT, STYLE, SIZE, OR COLOR.

THE WORDING "BONERBIKER" HAS NO MEANING IN A FOREIGN LANGUAGE.

FOR PRODUCT MERCHANDISING (U.S. CLS. 100, 101 AND 102).

CHARISMA HAMPTON, EXAMINING ATTORNEY

CLASS 35—(Continued).

SN 77-871,132. BLACKMER, ALEXANDER E., LOVELAND, CO. FILED 11-12-2009.

SOLARIS ENERGY INC.

THE MARK CONSISTS OF STANDARD CHARACTERS WITHOUT CLAIM TO ANY PARTICULAR FONT, STYLE, SIZE, OR COLOR.

NO CLAIM IS MADE TO THE EXCLUSIVE RIGHT TO USE "ENERGY INC.", APART FROM THE MARK AS SHOWN.

FOR ENERGY MANAGEMENT SERVICES, NAMELY, PROVIDING A SERVICE THAT ALLOWS CUSTOMERS TO PURCHASE ENERGY, NAMELY, ELECTRICITY, NATURAL GAS AND RENEWABLE ENERGY, AT A FIXED PRICE (U.S. CLS. 100, 101 AND 102).

PRISCILLA MILTON, EXAMINING ATTORNEY

SN 77-872,140. 4SIGHT SUPPLY CHAIN GROUP, PARAMUS, NJ. FILED 11-13-2009.



NO CLAIM IS MADE TO THE EXCLUSIVE RIGHT TO USE "SUPPLY CHAIN GROUP", APART FROM THE MARK AS SHOWN.

THE COLOR(S) DARK BLUE, LIGHT BLUE, BLUE, GRAY, BLACK, WHITE, TAN IS/ARE CLAIMED AS A FEATURE OF THE MARK.

THE MARK CONSISTS OF THE NUMBER "4" AND THE DOT ABOVE THE "I" IN "4SIGHT" ARE TAN IN COLOR, THE WORD "SIGHT" IS LIGHT BLUE IN COLOR, THE PHRASE "SUPPLY CHAIN GROUP" AND THE LINES BEFORE AND AFTER THE PHRASE ARE DARK BLUE IN COLOR, THE WORD "4SIGHT" IS SHADOWED IN WHITE, THE OVAL SHAPE BELOW THE GRAPHIC EYE IS GRAY IN COLOR, THE TWO ARCS ABOVE AND BELOW THE EYE ARE DARK BLUE IN COLOR, THERE IS A SMALLER TRANSPARENT ARC BELOW THE DARK BLUE ARC OVER THE EYE THAT IS GRAY IN COLOR, THE OUTER CIRCLE OF THE EYE IS BLUE AND LIGHT BLUE IN COLOR, THE MIDDLE CIRCLE OF THE EYE IS DARK BLUE AND BLACK IN COLOR, THE INNER CIRCLE OF THE EYE IS WHITE IN COLOR, THERE IS A VERTICAL LINE THROUGH THE CENTER OF THE EYE THAT IS TAN IN COLOR, THE RECTANGLE ON THE LEFT SIDE OF THE EYE IS TAN FADING TO WHITE FROM RIGHT TO LEFT, THE TRIANGLE INSIDE THE RECTANGLE IS TAN IN COLOR.

FOR BUSINESS CONSULTING SERVICES RELATING TO PRODUCT DISTRIBUTION, OPERATIONS MANAGEMENT SERVICES, LOGISTICS, REVERSE LOGISTICS, SUPPLY CHAIN, AND PRODUCTION SYSTEMS AND DISTRIBUTION SOLUTIONS; BUSINESS MANAGEMENT SERVICES, NAMELY, MANAGING LOGISTICS, REVERSE LOGISTICS, SUPPLY CHAIN SERVICES, SUPPLY CHAIN VISIBILITY AND SYNCHRONIZATION, SUPPLY AND DEMAND FORECASTING AND PRODUCT DISTRIBUTION PROCESSES FOR OTHERS; SUPPLY CHAIN MANAGEMENT SERVICES (U.S. CLS. 100, 101 AND 102).

FIRST USE 7-6-2009; IN COMMERCE 10-5-2009.
ALEXANDER L. POWERS, EXAMINING ATTORNEY

CLASS 35—(Continued).

SN 77-872,553. TRUCKHUNT.COM, LLC, EL PASO, TX. FILED 11-13-2009.



NO CLAIM IS MADE TO THE EXCLUSIVE RIGHT TO USE ".COM", APART FROM THE MARK AS SHOWN.

THE MARK CONSISTS OF THE GRILL OF A TRUCK WITH THE WORD "TRUCKHUNT.COM" IN THE CENTER OF THE TRUCK GRILL.

FOR ONLINE ADVERTISING FOR TRUCK AND TRAILER BUYERS AND SELLERS (U.S. CLS. 100, 101 AND 102).

FIRST USE 7-27-2009; IN COMMERCE 7-27-2009.
AARON BRODSKY, EXAMINING ATTORNEY

SN 77-874,483. BELLEWETHER, LTD., LEE'S SUMMIT, MO. FILED 11-17-2009.

THE ACTUAL ENTREPRENEUR

THE MARK CONSISTS OF STANDARD CHARACTERS WITHOUT CLAIM TO ANY PARTICULAR FONT, STYLE, SIZE, OR COLOR.

NO CLAIM IS MADE TO THE EXCLUSIVE RIGHT TO USE "ENTREPRENEUR", APART FROM THE MARK AS SHOWN.

FOR PROVIDING BUSINESS INFORMATION TO OTHERS VIA THE INTERNET IN THE SMALL AND MEDIUM BUSINESS FIELD, NAMELY, BUSINESS PLANNING, START UP AND DEVELOPMENT INFORMATION (U.S. CLS. 100, 101 AND 102).

ELLEN B. AWRICH, EXAMINING ATTORNEY

CLASS 35—(Continued).

SN 77-875,943. MAXWELL DOG, STUDIO CITY, CA. FILED 11-18-2009.

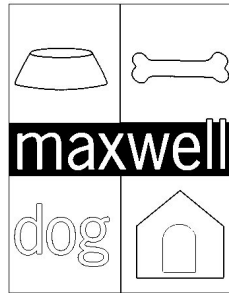

NO CLAIM IS MADE TO THE EXCLUSIVE RIGHT TO USE "DOG", APART FROM THE MARK AS SHOWN.

THE NAME MAXWELL DOES NOT IDENTIFY A LIVING INDIVIDUAL.

THE MARK CONSISTS OF FOUR SQUARES WITH THE STYLIZED TEXT "MAXWELL" IN THE MIDDLE. THE UPPER LEFT QUADRANT HAS A DESIGN OF A FOOD BOWL. THE UPPER RIGHT QUADRANT HAS A DESIGN OF A BONE. THE LOWER LEFT QUADRANT HAS THE STYLIZED TEXT "DOG" AND THE LOWER RIGHT QUADRANT HAS A DESIGN OF A HOUSE.

FOR RETAIL PET STORES (U.S. CLS. 100, 101 AND 102).

FIRST USE 8-30-2002; IN COMMERCE 10-30-2002.
LINDSEY RUBIN, EXAMINING ATTORNEY

SN 77-876,257. PATRIOT MAJORITY, WASHINGTON, DC. FILED 11-19-2009.

Patriot Majority

THE MARK CONSISTS OF STANDARD CHARACTERS WITHOUT CLAIM TO ANY PARTICULAR FONT, STYLE, SIZE, OR COLOR.

FOR INFORMATION ABOUT POLITICAL ELECTIONS; POLITICAL ACTION COMMITTEE SERVICES, NAMELY, PROMOTING THE INTERESTS OF AMERICANS TO PURSUE NEW POLICIES THAT STRENGTHEN OUR NATIONAL SECURITY, BOOST THE ECONOMY, ACHIEVE ENERGY INDEPENDENCE, MAKE HEALTH CARE AFFORDABLE, PROVIDE QUALITY EDUCATION AND PROTECT PUBLIC SAFETY IN THE FIELD OF POLITICS; PROVIDING A WEBSITE FEATURING INFORMATION ABOUT POLITICAL ISSUES (U.S. CLS. 100, 101 AND 102).

FIRST USE 8-31-2006; IN COMMERCE 8-31-2006.
SUSAN LESLIE DUBOIS, EXAMINING ATTORNEY

CLASS 35—(Continued).

SN 77-876,271. I HEART MY GIRLFRIENDS, INC., NEW YORK, NY. FILED 11-19-2009.



THE MARK CONSISTS OF THE WORDS "I MY GIRLFRIENDS" WITH A HEART DESIGN AND SILHOUETTES OF DANCING FIGURES.

FOR CHARITABLE SERVICES, NAMELY, ORGANIZING AND CONDUCTING VOLUNTEER PROGRAMS AND COMMUNITY SERVICE PROJECTS, PROMOTING PUBLIC AWARENESS ABOUT POVERTY IN THE UNITED STATES THROUGH A MEDIA FAST PROGRAM CONDUCTED BY YOUNG PEOPLE; CHARITABLE SERVICES, NAMELY, COORDINATION OF THE PROCUREMENT AND DISTRIBUTION OF FOOD DONATIONS FROM MANUFACTURERS, WHOLESALERS, RETAILERS, AND GOVERNMENT AGENCIES TO ORGANIZATIONS PROVIDING FREE FOOD TO NEEDY PEOPLE; CHARITABLE SERVICES, NAMELY, ORGANIZING YOUTH GROUPS TO UNDERTAKE PROJECTS TO BENEFIT THE NEEDY AND THE COMMUNITY TO ENCOURAGE LEADERSHIP, CHARACTER, COMPASSION, AND GOOD CITIZENSHIP; CHARITABLE SERVICES, NAMELY, ORGANIZING WOMEN'S GROUPS TO UNDERTAKE PROJECTS WHICH BENEFIT THE HOMELESS, ABUSED, AT RISK WOMEN AND WOMEN IN TRANSITION AND IN PAIN, WHILE ENCOURAGING EMPOWERMENT AMONG WOMEN OF ALL AGES AND ETHNICITIES; CHARITABLE SERVICES, NAMELY, PROVIDING ADMINISTRATION AND MANAGEMENT OF CARE FACILITIES, HOUSING FACILITIES, AND NURSING HOME FACILITIES FOR OTHERS, NAMELY, THE ELDERLY, CHILDREN IN NEED, AND ADULTS WITH DISABILITIES; CHARITABLE SERVICES, NAMELY, ORGANIZING AND CONDUCTING VOLUNTEER PROGRAMS AND COMMUNITY SERVICE PROJECTS AIMED AT INCREASING SUPPORT AND MORALE OF MEMBERS OF THE U.S. MILITARY; CHARITABLE SERVICES, NAMELY, ORGANIZING YOUTH GROUPS TO UNDERTAKE CHARITABLE PROJECTS IN THE FIELD OF DISASTER RESPONSE; CHARITABLE SERVICES, NAMELY, PROMOTING ENVIRONMENTAL AWARENESS TO CHILDREN; CHARITABLE SERVICES, NAMELY, COORDINATION OF THE PROCUREMENT AND DISTRIBUTION OF HOLIDAY GIFT DONATIONS FROM THE GENERAL PUBLIC TO ORPHANED CHILDREN; ORGANIZING AND DEVELOPING PROJECTS THAT AIM TO IMPROVE THE LIVES OF UNDERPRIVILEGED AND IMPOVERISHED PEOPLE; DEVELOPING AND COORDINATING VOLUNTEER PROJECTS FOR CHARITABLE ORGANIZATIONS; DEVELOPING AND MANAGING THE CHARITABLE GIVING PROGRAMS OF OTHERS; ASSISTING OTHERS IN THE ESTABLISHMENT OF CHARITABLE ORGANIZATIONS; ORGANIZING AND CONDUCTING CHARITY AUCTIONS FOR CHARITABLE FUND RAISING PURPOSES; PROMOTING THE CHARITABLE SERVICES OF OTHERS, NAMELY, PROVIDING INDIVIDUALS WITH INFORMATION FOR THE PURPOSE OF MAKING DONATIONS TO CHARITIES; PROMOTING THE CHARITABLE GIVING OF OTHERS, NAMELY, TRACKING AND PUBLICIZING CHARITABLE DONATIONS AND RANDOM ACTS OF KINDNESS; PROMOTIONAL SERVICES, NAMELY, PROMOTING THE CHARITIES OF OTHERS; PROMOTING THE INTERESTS OF CHARITIES AND ORGANIZATIONS CONCERNED WITH BRINGING COMMUNITIES TOGETHER TO PROMOTE EDUCATION AND INSPIRE CHANGE; PROMOTING PUBLIC AWARENESS OF THE NEED FOR COMMUNITY AWARENESS, SOCIAL CHANGE AND EDUCATION; RETAIL STORES, WHOLESALE STORES, MAIL ORDER SERVICES, ON-LINE ORDERING SERVICES AND ON-LINE RETAIL STORE SERVICES, ELECTRONIC RETAIL STORE SERVICES VIA COMPUTERS, AND

CLASS 35—(Continued).

RETAIL STORE SERVICES AVAILABLE THROUGH COMPUTER COMMUNICATIONS AND INTERACTIVE TELEVISION, ALL OF THE AFORESAID FEATURING RECORDED PRODUCT, MUSIC RELATED ITEMS, PROMOTIONAL ITEMS SUCH AS MOUSE PADS, MAGNETS, PAPER WEIGHTS, TRANSPORT AND STORAGE CASES, MUGS, GLASSES AND COASTERS, COMPUTER GOODS, SOFTWARE, GAMES, TOYS AND PLAYTHINGS, PLUSH TOYS, TEDDY BEARS AND ACCESSORIES THEREFOR, DOLLS AND ACCESSORIES THEREFOR, SPORTING GOODS AND EQUIPMENT, BAGS AND ACCESSORIES THEREFOR, CLOTHING AND ACCESSORIES THEREFOR, FOOTWEAR, HEADWEAR, EYEWEAR AND ACCESSORIES THEREFOR, JEWELRY AND WATCHES AND ACCESSORIES THEREFOR, ITEMS OF PRECIOUS METAL, CLOCKS, PRINTED PROMOTIONAL MATTER SUCH AS POSTERS, CALENDARS, STICKERS, STATIONERY AND RELATED MATTER, BOOKS AND PUBLICATIONS, NOVELTY ITEMS AND ORNAMENTS AND HAIR ACCESSORIES (U.S. CLS. 100, 101 AND 102).

Laurie Kaufman, Examining Attorney

SN 77-876,290. KAMRID MANAGEMENT GROUP LLC, FAYETTEVILLE, AR. FILED 11-19-2009.

Flip Flops Etc

THE MARK CONSISTS OF STANDARD CHARACTERS WITHOUT CLAIM TO ANY PARTICULAR FONT, STYLE, SIZE, OR COLOR.

NO CLAIM IS MADE TO THE EXCLUSIVE RIGHT TO USE "FLIP FLOPS", APART FROM THE MARK AS SHOWN.

FOR RETAIL STORE AND ON-LINE RETAIL STORE SERVICES FEATURING FLIP FLOP SANDALS, SLIPPERS AND RELATED ACCESSORIES, NAMELY, APPAREL, HANDBAGS AND JEWELRY (U.S. CLS. 100, 101 AND 102).

Kathy de Jonge, Examining Attorney

CLASS 35—(Continued).

SN 77-877,653. BUSINESS TRANSITIONS, LLC, DBA FP TRANSITIONS, PORTLAND, OR. FILED 11-20-2009.



OWNER OF U.S. REG. NO. 3,646,991.

NO CLAIM IS MADE TO THE EXCLUSIVE RIGHT TO USE "TRANSITIONS", APART FROM THE MARK AS SHOWN.

THE COLOR(S) BLUE AND GRAY IS/ARE CLAIMED AS A FEATURE OF THE MARK.

THE MARK CONSISTS OF TWO INTERTWINED TRIANGLES WITH A SMALLER BLUE TRIANGLE INTERLOCKING WITH A LARGER GRAY TRIANGLE. TO THE RIGHT OF THE TRIANGLES IS THE WORDING "FP TRANSITIONS" IN THE COLOR BLUE WITH THE LETTERS "FP" OVER THE WORD "TRANSITIONS".

FOR BUSINESS CONSULTATION IN THE FIELD OF BUSINESS FORMATION, BUSINESS CONTINUITY AND SUCCESSION PLANNING, BUSINESS TRANSITION, BUSINESS APPRAISALS, PURCHASES AND SALES (U.S. CLS. 100, 101 AND 102).

FIRST USE 9-30-1999; IN COMMERCE 9-30-1999.

David Murray, Examining Attorney

SN 77-877,674. CREDIT KARMA, SAN FRANCISCO, CA. FILED 11-20-2009.

CREDIT KARMA

THE MARK CONSISTS OF STANDARD CHARACTERS WITHOUT CLAIM TO ANY PARTICULAR FONT, STYLE, SIZE, OR COLOR.

NO CLAIM IS MADE TO THE EXCLUSIVE RIGHT TO USE "CREDIT", APART FROM THE MARK AS SHOWN.

FOR MONITORING CONSUMERS' CREDIT REPORTS; PROVIDING ADVERTISEMENT AND PROMOTION SERVICES FOR OTHERS BASED ON CREDIT REPORTS (U.S. CLS. 100, 101 AND 102).

FIRST USE 2-1-2008; IN COMMERCE 2-1-2008.

Regina Drummond, Examining Attorney

CLASS 35—(Continued).

SN 77-877,951. TIX 4 CAUSE, LLC, NAPERVILLE, IL. FILED 11-20-2009.

Where giving is the main
event

THE MARK CONSISTS OF STANDARD CHARACTERS WITHOUT CLAIM TO ANY PARTICULAR FONT, STYLE, SIZE, OR COLOR.

FOR ONLINE TICKET MARKETPLACE FOR SELLERS AND BUYERS OF TICKETS FOR SPORTING EVENTS, MUSICAL CONCERTS AND OTHER ENTERTAINMENT EVENTS; BUSINESS MANAGEMENT CONSULTING SERVICES, NAMELY, PROVIDING CHARITABLE ORGANIZATIONS WITH ASSISTANCE IN MANAGING FUND-RAISING OPERATIONS (U.S. CLS. 100, 101 AND 102).

MARTHA FROMM, EXAMINING ATTORNEY

SN 77-879,100. MONAVIE LLC, SOUTH JORDAN, UT. FILED 11-23-2009.

MONA·VIE

THE MARK CONSISTS OF STANDARD CHARACTERS WITHOUT CLAIM TO ANY PARTICULAR FONT, STYLE, SIZE, OR COLOR.

OWNER OF U.S. REG. NOS. 3,106,146, 3,111,333 AND OTHERS.

FOR PROVIDING INFORMATION IN THE FIELDS OF DIRECT MARKETING AND THE BUSINESS ASPECTS OF DEVELOPING SMALL BUSINESSES; RENDERING TECHNICAL ASSISTANCE IN THE NATURE OF CONSULTING WITH OTHERS ABOUT THE BUSINESS ASPECTS OF ESTABLISHING AND OPERATING DISTRIBUTORSHIPS, WHOLESALE STORE SERVICES, AND RETAIL STORE SERVICES, ALL OF THE FOREGOING FEATURING NUTRITIONAL AND DIETARY SUPPLEMENTS, BEVERAGES, AND JUICES; PRODUCT MERCHANDISING SERVICES IN THE FIELD OF NUTRITIONAL AND DIETARY SUPPLEMENTS, BEVERAGES AND JUICES (U.S. CLS. 100, 101 AND 102).

NANCY CLARKE, EXAMINING ATTORNEY

CLASS 35—(Continued).

SN 77-879,323. GLOBAL HANDMADE HOPE, PARK RIDGE, IL. FILED 11-23-2009.

global handmade hope



*a fair trade
store, together
we can make
a difference*

NO CLAIM IS MADE TO THE EXCLUSIVE RIGHT TO USE "A FAIR TRADE STORE", APART FROM THE MARK AS SHOWN.

THE MARK CONSISTS OF A GLOBE WITH TWO HAND PRINTS, ONE ON EACH SIDE AND DIRECTLY BELOW THE GLOBE IS AN UPWARD FACING ARCH ABOVE AND ATTACHED TO A DOWNWARD FACING ARCH. THE WORDS "GLOBAL HANDMADE HOPE" ARE ABOVE THE GLOBE AND THE WORDS "A FAIR TRADE STORE, TOGETHER WE CAN MAKE A DIFFERENCE" ARE TO THE RIGHT OF THE GLOBE.

FOR RETAIL STORES FEATURING FAIR TRADE PRODUCTS AND GLOBAL ARTISANS WORK, NAMELY, JEWELRY, PURSES, RUGS, COFFEE, CHOCOLATE, OLIVE OIL, CHRISTMAS DECORATIONS, BASKETS, POTTERY, SOAP, CLOTHING, VARIOUS GIFT AND HOUSEHOLD ITEMS (U.S. CLS. 100, 101 AND 102).

FIRST USE 10-1-2009; IN COMMERCE 10-1-2009.
ASMAT KHAN, EXAMINING ATTORNEY

SN 77-880,476. PETZEN PRODUCTS, LLC, OGDEN, UT. FILED 11-25-2009.

pet  zen

NO CLAIM IS MADE TO THE EXCLUSIVE RIGHT TO USE "PET", APART FROM THE MARK AS SHOWN.

THE MARK CONSISTS OF THE WORDS "PET" AND "ZEN" WITH TWO SEMI CIRCLES BETWEEN THE WORDS. THE TOP SEMI-CIRCLE HAS A TRIANGLE CUTTING THROUGH THE TOP LINE. THE BOTTOM SEMI-CIRCLE HAS A TRIANGLE CUTTING THROUGH THE BOTTOM LINE.

FOR ON-LINE RETAIL STORE SERVICES FEATURING PET PRODUCTS (U.S. CLS. 100, 101 AND 102).

FIRST USE 2-28-2007; IN COMMERCE 2-28-2007.
PRISCILLA MILTON, EXAMINING ATTORNEY

CLASS 35—(Continued).

SN 77-880,607. FSC FRANCHISE CO., LLC, TAMPA, FL. FILED 11-25-2009.

ST. PRACTICE DAY

THE MARK CONSISTS OF STANDARD CHARACTERS WITHOUT CLAIM TO ANY PARTICULAR FONT, STYLE, SIZE, OR COLOR.

FOR ADMINISTERING OF A MONTHLY DISCOUNT PROGRAM ENABLING PARTICIPANTS TO OBTAIN DISCOUNTS THROUGH USE OF A DISCOUNT CARD (U.S. CLS. 100, 101 AND 102).

FIRST USE 4-17-2009; IN COMMERCE 4-17-2009.
CORY BOONE, EXAMINING ATTORNEY

SN 77-880,638. NATIONAL VOLUNTARY ORGANIZATIONS ACTIVE IN DISASTER, INC., AKA NATIONAL VOAD; NVOAD, ARLINGTON, VA. FILED 11-25-2009.

National Voluntary Organizations Active in Disaster

THE MARK CONSISTS OF STANDARD CHARACTERS WITHOUT CLAIM TO ANY PARTICULAR FONT, STYLE, SIZE, OR COLOR.

NO CLAIM IS MADE TO THE EXCLUSIVE RIGHT TO USE "ORGANIZATIONS", APART FROM THE MARK AS SHOWN.

SEC. 2(F).

FOR ASSOCIATION SERVICES, NAMELY, PROMOTING COMMUNICATION, COORDINATION, COOPERATION, AND COLLABORATION AMONG DISASTER RESPONSE ORGANIZATIONS (U.S. CLS. 100, 101 AND 102).

FIRST USE 7-15-1970; IN COMMERCE 7-15-1970.
ESTHER BELENKER, EXAMINING ATTORNEY

SN 77-880,811. GARDENIA VENTURES, MELBOURNE, FL. FILED 11-25-2009.

advancing technologies to build a better world

THE MARK CONSISTS OF STANDARD CHARACTERS WITHOUT CLAIM TO ANY PARTICULAR FONT, STYLE, SIZE, OR COLOR.

FOR BUSINESS VENTURE DEVELOPMENT AND FORMATION CONSULTING SERVICES FOR THE RENEWABLE ENERGY INDUSTRY; NEW BUSINESS VENTURE DEVELOPMENT AND FORMATION CONSULTING SERVICES (U.S. CLS. 100, 101 AND 102).

FIRST USE 9-1-2009; IN COMMERCE 9-1-2009.
KAREN BRACEY, EXAMINING ATTORNEY

CLASS 35—(Continued).

SN 77-881,474. PRESCRIPTION HEALTH NETWORK, LLC, ST. PETERSBURG, FL. FILED 11-27-2009.



NO CLAIM IS MADE TO THE EXCLUSIVE RIGHT TO USE "HEALTH NETWORK", APART FROM THE MARK AS SHOWN.

THE MARK CONSISTS OF STYLIZED HUMAN SHAPE. FOR OFFERING BUSINESS MANAGEMENT ASSISTANCE IN THE ESTABLISHMENT AND/OR OPERATION OF MEDICALLY SUPERVISED WEIGHT LOSS PROGRAMS (U.S. CLS. 100, 101 AND 102).

LINDA ORNDORFF, EXAMINING ATTORNEY

SN 77-881,482. ARTISTS FOR CONSERVATION FOUNDATION, INC., NORTH VANCOUVER, BC, CANADA, FILED 11-27-2009.



THE COLOR(S) YELLOW, BLACK, BLUE, WHITE AND GRAY IS/ARE CLAIMED AS A FEATURE OF THE MARK.

THE MARK CONSISTS OF THE ARTISTIC RENDERING OF A BUTTERFLY IN BLUE, BLACK, GRAY, AND WHITE ON A YELLOW BACKGROUND WITH A BLACK OUTLINE. THE BUTTERFLY EYES ARE WHITE. THE BUTTERFLY BODY AND WINGS ARE BLACK, BLUE, AND GRAY. THE SQUARE EDGES ARE BLACK, WHITE, AND BLACK.

FOR ASSOCIATION SERVICES, NAMELY, PROMOTING THE INTERESTS OF CONSERVATIONISTS AND THE ENVIRONMENT; PROMOTING PUBLIC AWARENESS OF ENVIRONMENTAL ISSUES AND INITIATIVES (U.S. CLS. 100, 101 AND 102).

FIRST USE 0-0-2004; IN COMMERCE 0-0-2004.
BRIAN PINO, EXAMINING ATTORNEY

CLASS 35—(Continued).

SN 77-881,501. BOOBY BLUEFOOT, LLC, BOULDER, CO. FILED 11-27-2009.



NO CLAIM IS MADE TO THE EXCLUSIVE RIGHT TO USE "THERAPEUTICS", APART FROM THE MARK AS SHOWN.

THE COLOR(S) BLACK, WHITE AND BLUE IS/ARE CLAIMED AS A FEATURE OF THE MARK.

THE WORDING "BOOBY BLUEFOOT LIFESTYLE THERAPEUTICS" APPEARS AT LEFT IN BLACK, EXCEPT FOR THE BLUE COLORED WORD "BLUE"; A BLACK BIRD WITH BLUE FEET AND A WHITE EYE APPEARS AT THE RIGHT.

FOR WHOLESALE AND RETAIL STORE SERVICES AND ON-LINE RETAIL AND WHOLESALE STORE SERVICES FEATURING DIETARY SUPPLEMENTS, COSMETICS, HEALTHCARE, PERSONAL FITNESS, PERSONAL CARE, SELF-HELP, ECOLOGICALLY SENSITIVE PRODUCTS, EDUCATIONAL, PHILOSOPHICAL, SPIRITUAL AND/OR SCIENTIFIC PRODUCTS, CLOTHING, YOGA, NUTRITION, HOUSEWARES, OFFICE AND CHILDREN'S PRODUCTS (U.S. CLS. 100, 101 AND 102).

FIRST USE 10-14-2007; IN COMMERCE 11-2-2009.
GILBERT SWIFT, EXAMINING ATTORNEY

SN 77-881,528. GREENBERRY WIRELESS INC., CENTREVILLE, VA. FILED 11-27-2009.



NO CLAIM IS MADE TO THE EXCLUSIVE RIGHT TO USE "WIRELESS", APART FROM THE MARK AS SHOWN.

THE COLOR(S) BROWN, GREEN AND WHITE IS/ARE CLAIMED AS A FEATURE OF THE MARK.

THE MARK CONSISTS OF A BROWN OVAL WITH THREE GREEN CIRCLES. THE WORDS "GREENBERRY WIRELESS" IN WHITE AND THE PHRASE "STAYING CONNECTED IN A GREENER WORLD" IN WHITE.

FOR ON-LINE RETAIL STORE SERVICES FEATURING WIRELESS CARRIER PRODUCTS (U.S. CLS. 100, 101 AND 102).

ROBERT C. CLARK JR., EXAMINING ATTORNEY

CLASS 35—(Continued).

SN 77-881,657. PALDY, MATTHEW G., NEW YORK, NY. FILED 11-28-2009.

Therapy Next

THE MARK CONSISTS OF STANDARD CHARACTERS WITHOUT CLAIM TO ANY PARTICULAR FONT, STYLE, SIZE, OR COLOR.

NO CLAIM IS MADE TO THE EXCLUSIVE RIGHT TO USE "THERAPY", APART FROM THE MARK AS SHOWN. FOR PROVIDING A WEB SITE FEATURING PRODUCT RATINGS OF THE CONSUMER GOODS AND SERVICES OF OTHERS IN THE FIELD OF THERAPY (U.S. CLS. 100, 101 AND 102).

FIRST USE 11-5-2009; IN COMMERCE 11-5-2009.
KAELIE KUNG, EXAMINING ATTORNEY

SN 77-882,092. RUSSEL SCOTT, LLC, MEQUON, WI. FILED 11-30-2009.



NO CLAIM IS MADE TO THE EXCLUSIVE RIGHT TO USE "GOLF OUTLET", APART FROM THE MARK AS SHOWN.

THE MARK CONSISTS OF A GOLF BALL ON A TEE WITH THE WORD "GOLF" ABOVE THE WORD "OUTLET" ALL WITHIN A CIRCLE.

FOR ON-LINE RETAIL STORE SERVICES FEATURING GOLF RELATED PRODUCTS; RETAIL DISCOUNT STORE SERVICES IN THE FIELD OF GOLF RELATED PRODUCTS; RETAIL OUTLETS FEATURING GOLF RELATED PRODUCTS; RETAIL SPORTING GOODS STORES; RETAIL STORE AND ON-LINE RETAIL STORE SERVICES FEATURING GOLF RELATED PRODUCTS (U.S. CLS. 100, 101 AND 102).

FIRST USE 4-15-2008; IN COMMERCE 4-15-2008.
PAUL F. GAST, EXAMINING ATTORNEY

CLASS 35—(Continued).

SN 77-882,207. DEBENEDITTS, THERESA, BELLPORT, NY. FILED 11-30-2009.

PIPPA ENTERTAINMENT

THE MARK CONSISTS OF STANDARD CHARACTERS WITHOUT CLAIM TO ANY PARTICULAR FONT, STYLE, SIZE, OR COLOR.

NO CLAIM IS MADE TO THE EXCLUSIVE RIGHT TO USE "ENTERTAINMENT", APART FROM THE MARK AS SHOWN.

FOR ADVERTISING, MARKETING AND PROMOTION SERVICES; ON-LINE RETAIL STORE SERVICES FEATURING USED RECORDS (U.S. CLS. 100, 101 AND 102).

DAVID ELTON, EXAMINING ATTORNEY

SN 77-882,416. BTWEEN THE SHEETS CORPORATION, DBA THE LINEN TREE, SCOTTSDALE, AZ. FILED 11-30-2009.

The Linen Tree

THE MARK CONSISTS OF THE WORDING "THE LINEN TREE" IN A STYLIZED, SCRIPT-TYPE FONT.

FOR COMPUTERIZED ON-LINE RETAIL STORE SERVICES IN THE FIELD OF HOME FURNISHINGS, HOUSEWARES, BEDDING, HOME DECOR, FRAGRANCED GOODS IN THE NATURE OF CANDLES, REED DIFFUSERS, PERFUME, BODY WASH, SOAP, BODY CREAM, BODY SPRAY, EAU DE TOILETTE, EAU DE PARFUM, BODY LOTION, HAND CREAM, DUSTING POWDER, SKIN MOISTURIZER, BATH GEL, BATH OILS, AND BATH SALTS, AND TEXTILE ITEMS OF WOVEN AND/OR KNITTED FIBERS IN THE NATURE OF TABLE CLOTHS, BED LINENS, CURTAINS, DINING LINENS, WALL DECORATIONS, FLOOR COVERINGS, AND TOWELS; CUSTOMER SERVICES, NAMELY, PROVIDING CUSTOMER SERVICE AND PRODUCT INQUIRY SERVICES VIA TELEPHONE AND E-MAIL FOR OTHERS; TELEPHONE ORDER-TAKING SERVICES FOR OTHERS (U.S. CLS. 100, 101 AND 102).

FIRST USE 1-1-1995; IN COMMERCE 1-1-1995.

JAMES MACFARLANE, EXAMINING ATTORNEY

SN 77-882,590. YOU & ME TECHNOLOGY, LLC, DBA MAKABOO, ST. LOUIS, MO. FILED 11-30-2009.

MAKABOO

THE MARK CONSISTS OF STANDARD CHARACTERS WITHOUT CLAIM TO ANY PARTICULAR FONT, STYLE, SIZE, OR COLOR.

FOR ON-LINE RETAIL STORE SERVICES FEATURING PERSONALIZED CLOTHING AND GIFTS FOR INFANTS, TODDLERS, AND CHILDREN (U.S. CLS. 100, 101 AND 102).

AARON BRODSKY, EXAMINING ATTORNEY

CLASS 35—(Continued).

SN 77-882,972. GROUND FLOOR MEDIA, INC., DENVER, CO. FILED 12-1-2009.

DIGITAL SNAPSHOT

THE MARK CONSISTS OF STANDARD CHARACTERS WITHOUT CLAIM TO ANY PARTICULAR FONT, STYLE, SIZE, OR COLOR.

FOR BUSINESS RESEARCH SERVICE IN THE FIELD OF MARKETING AND ON-LINE MARKETING MEDIA THAT ALLOWS THE USER TO ANALYZE OPINION TRENDS CONTAINED IN DATA, DOCUMENTS, AUDIO, VIDEO AND IMAGES ON THE INTERNET (U.S. CLS. 100, 101 AND 102).

FIRST USE 12-22-2008; IN COMMERCE 12-22-2008.

JAMES GRIFFIN, EXAMINING ATTORNEY

SN 77-883,003. VOICES INSISTING ON PURSUITSAFETY, MAGALIA, CA. FILED 12-1-2009.

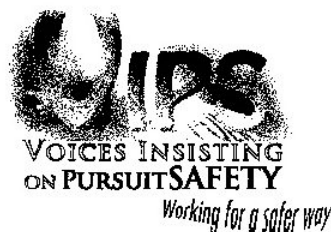

THE STIPPLING IS FOR SHADING PURPOSES ONLY.

THE MARK CONSISTS OF THE STYLIZED TEXT "VIPS VOICES INSISTING ON PURSUITSAFETY WORKING FOR A SAFER WAY" WITH THE STYLIZED TEXT "POL" ON THE BACKGROUND.

FOR PROMOTING PUBLIC AWARENESS OF MINIMIZING AND PREVENTING LOSS OF LIFE TO INNOCENT BYSTANDERS AS SOMETIMES CAUSED DURING PEACE OFFICER VEHICULAR PURSUITS OF SUSPECTED CRIMINALS AND HIGH SPEED EMERGENCY RESPONDERS (U.S. CLS. 100, 101 AND 102).

FIRST USE 6-30-2007; IN COMMERCE 6-30-2007.

PAULA MAHONEY, EXAMINING ATTORNEY

SN 77-883,131. CASTELLI, LOU, MAPLEWOOD, NJ. FILED 12-1-2009.

Summit Recreation Group LLC

THE MARK CONSISTS OF STANDARD CHARACTERS WITHOUT CLAIM TO ANY PARTICULAR FONT, STYLE, SIZE, OR COLOR.

NO CLAIM IS MADE TO THE EXCLUSIVE RIGHT TO USE "RECREATION GROUP LLC", APART FROM THE MARK AS SHOWN.

FOR PROVIDING OPERATIONAL BUSINESS CONSULTING SERVICES FOR MUNICIPAL RECREATION DEPARTMENTS (U.S. CLS. 100, 101 AND 102).

ODESSA BIBBINS, EXAMINING ATTORNEY

CLASS 35—(Continued).

SN 77-883,138. ABC A BABY CONSIGNMENT, LLC, DAVIE, FL. FILED 12-1-2009.

Saving Today for Your Children's Tomorrow

THE MARK CONSISTS OF STANDARD CHARACTERS WITHOUT CLAIM TO ANY PARTICULAR FONT, STYLE, SIZE, OR COLOR.

FOR RETAIL CONSIGNMENT STORES FEATURING CHILDREN'S CLOTHING, TOYS, CRIBS, HIGHCHAIRS AND MATERNITY WEAR THAT ARE BELOW RETAIL VALUE RESULTING IN A SAVINGS FOR A YOUTH'S FUTURE (U.S. CLS. 100, 101 AND 102).

FIRST USE 11-1-2008; IN COMMERCE 11-1-2008.
MARK SPARACINO, EXAMINING ATTORNEY

SN 77-883,147. THE WHITE ROOM MOUNTAIN SHOP, INC., WHITEFISH, MT. FILED 12-1-2009.



NO CLAIM IS MADE TO THE EXCLUSIVE RIGHT TO USE "MOUNTAIN SHOP", APART FROM THE MARK AS SHOWN.

THE MARK CONSISTS OF THE STYLIZED TEXT "THE WHITE ROOM MOUNTAIN SHOP" AND AN IMAGE OF A SKIER GOING DIRECTLY THROUGH THE WORDS.

FOR RETAIL SHOPS FEATURING HIGH END SKI EQUIPMENT (U.S. CLS. 100, 101 AND 102).

FIRST USE 10-1-2005; IN COMMERCE 11-15-2005.
MARK SPARACINO, EXAMINING ATTORNEY

SN 77-883,529. EXPRESS TAX SERVICE, INC., KANSAS CITY, MO. FILED 12-1-2009.

YOUR NEIGHBORHOOD TAX SERVICE

THE MARK CONSISTS OF STANDARD CHARACTERS WITHOUT CLAIM TO ANY PARTICULAR FONT, STYLE, SIZE, OR COLOR.

NO CLAIM IS MADE TO THE EXCLUSIVE RIGHT TO USE "TAX SERVICE ", APART FROM THE MARK AS SHOWN.

FOR TAX PREPARATION SERVICES, TAX FILING SERVICES, BOOKKEEPING, PAYROLL PREPARATION, PAYROLL PROCESSING SERVICES (U.S. CLS. 100, 101 AND 102).

FIRST USE 12-20-2007; IN COMMERCE 12-20-2007.
SANI KHOURI, EXAMINING ATTORNEY

CLASS 35—(Continued).

SN 77-883,790. JKHM CORP., LOS ANGELES, CA. FILED 12-1-2009.

ABSOLUTE YOGI

THE MARK CONSISTS OF STANDARD CHARACTERS WITHOUT CLAIM TO ANY PARTICULAR FONT, STYLE, SIZE, OR COLOR.

NO CLAIM IS MADE TO THE EXCLUSIVE RIGHT TO USE "YOGI", APART FROM THE MARK AS SHOWN.

FOR RETAIL STORE SERVICES FEATURING YOGA PRODUCTS, NAMELY, CLOTHING, MATS, TOWELS, MAT CARRIERS, MAT BAGS, BLANKETS, PILLOWS, PROPS, STRAPS, AND IMPLEMENTS (U.S. CLS. 100, 101 AND 102).

FIRST USE 4-14-2006; IN COMMERCE 4-14-2006.
SOPHIA S. KIM, EXAMINING ATTORNEY

SN 77-883,999. ROSE GROUP MARKETING, LP, SOUTHLAKE, TX. FILED 12-2-2009.

Return on Energy

THE MARK CONSISTS OF STANDARD CHARACTERS WITHOUT CLAIM TO ANY PARTICULAR FONT, STYLE, SIZE, OR COLOR.

FOR ADVERTISING AND MARKETING; BUSINESS CONSULTATION AND MANAGEMENT REGARDING MARKETING ACTIVITIES AND LAUNCHING OF NEW PRODUCTS; BUSINESS MARKETING CONSULTING SERVICES; BUSINESS MARKETING SERVICES; CREATIVE MARKETING DESIGN SERVICES; DEVELOPMENT OF MARKETING STRATEGIES AND CONCEPTS; MARKETING AND CONSULTING SERVICES IN THE FIELD OF PROMOTING AND TRACKING THE GOODS, SERVICES, AND BRANDS OF OTHERS THROUGH ALL PUBLIC COMMUNICATION MEANS, PARTICULARLY SPECIALIZING IN THE USE OF MOBILE, SOCIAL, AND PRINT MEDIA TO DRIVE CONSUMER INTEREST, ENGAGEMENT AND ACTION; MARKETING PLAN DEVELOPMENT; SOCIAL MEDIA STRATEGY AND MARKETING CONSULTANCY FOCUSING ON HELPING CLIENTS CREATE AND EXTEND THEIR PRODUCT AND BRAND STRATEGIES BY BUILDING VIRALLY ENGAGING MARKETING SOLUTIONS (U.S. CLS. 100, 101 AND 102).

ODESSA BIBBINS, EXAMINING ATTORNEY

CLASS 35—(Continued).

SN 77-884,011. CONTRACT PARTNERS PLUS, LLC, PORT WASHINGTON, NY. FILED S.R. 12-2-2009; AM. P.R. 3-16-2010.

Contract Partners Plus

THE MARK CONSISTS OF STANDARD CHARACTERS WITHOUT CLAIM TO ANY PARTICULAR FONT, STYLE, SIZE, OR COLOR.

NO CLAIM IS MADE TO THE EXCLUSIVE RIGHT TO USE "CONTRACT", APART FROM THE MARK AS SHOWN.

FOR BUSINESS CONSULTING SERVICES IN THE FIELD OF PROCURING OF CONTRACTS FOR THE PURCHASE AND SALE OF GOODS (U.S. CLS. 100, 101 AND 102).

FIRST USE 6-1-2009; IN COMMERCE 6-1-2009.
RENEE MCCRAY, EXAMINING ATTORNEY

CLASS 35—(Continued).

SN 77-885,132. MOBULAR TECHNOLOGIES, INC., HUNTSVILLE, AL. FILED 12-3-2009.

SUMMARY PRO AR

THE MARK CONSISTS OF STANDARD CHARACTERS WITHOUT CLAIM TO ANY PARTICULAR FONT, STYLE, SIZE, OR COLOR.

NO CLAIM IS MADE TO THE EXCLUSIVE RIGHT TO USE "SUMMARY PRO", APART FROM THE MARK AS SHOWN.

FOR PREPARING STATUTORILY COMPLIANT ELECTRONIC SECURITIES AND FINANCIAL REPORTS FOR OTHERS (U.S. CLS. 100, 101 AND 102).

FIRST USE 3-31-2009; IN COMMERCE 3-31-2009.
SOPHIA S. KIM, EXAMINING ATTORNEY

SN 77-885,147. WILLIS, STEVE, COTTAGEVILLE, SC. FILED 12-3-2009.

Road Disciples

THE MARK CONSISTS OF STANDARD CHARACTERS WITHOUT CLAIM TO ANY PARTICULAR FONT, STYLE, SIZE, OR COLOR.

FOR CLUB SERVICES, NAMELY, PROMOTING THE INTERESTS OF MOTORCYCLISTS AND MOTORCYCLE ENTHUSIASTS (U.S. CLS. 100, 101 AND 102).

FIRST USE 7-4-1994; IN COMMERCE 7-4-1994.
SOPHIA S. KIM, EXAMINING ATTORNEY

SN 77-885,218. APERTOR HOSPITALITY, LLC, HENDERSON, NV. FILED 12-3-2009.

APERTOR HOSPITALITY

THE MARK CONSISTS OF STANDARD CHARACTERS WITHOUT CLAIM TO ANY PARTICULAR FONT, STYLE, SIZE, OR COLOR.

NO CLAIM IS MADE TO THE EXCLUSIVE RIGHT TO USE "HOSPITALITY", APART FROM THE MARK AS SHOWN.

FOR ADVISORY SERVICES WITH REGARD TO BUSINESS PLANNING, BUSINESS ANALYSIS, BUSINESS MANAGEMENT, BUSINESS ORGANIZATION, MARKETING AND CUSTOMER ANALYSIS; BUSINESS AUDITING; BUSINESS ACQUISITION AND MERGER CONSULTATION; BUSINESS MANAGEMENT; BUSINESS OPERATIONS AND BUSINESS ADMINISTRATION (U.S. CLS. 100, 101 AND 102).

PATRICIA EVANKO, EXAMINING ATTORNEY

SN 77-884,791. POA BROTHERS, LLC, NAPLES, FL. FILED 12-2-2009.



NO CLAIM IS MADE TO THE EXCLUSIVE RIGHT TO USE "EST. MMIV", APART FROM THE MARK AS SHOWN.

THE MARK CONSISTS OF A CARTOON PICTURE OF A MAN WEARING A SUIT HOLDING HIS PANT POCKETS OUT WITH HIS HANDS. THE STYLIZED TEXT "A MAN SCORNE D .COM" IS ON A RING ENCLONG THE CARTOON. THE STYLIZED TEXT "BROTHERHOOD EST. MMIV" IS LOCATED UNDER THE DRAWING.

FOR ON-LINE RETAIL STORE SERVICES FEATURING CLOTHING, NAMELY, SHIRTS, HATS, JACKETS, SWEATSHIRTS, AND NOVELTY ITEMS, NAMELY, STICKERS, PINS, CUPS, BANNERS, CALENDARS (U.S. CLS. 100, 101 AND 102).

JOHN DWYER, EXAMINING ATTORNEY

CLASS 35—(Continued).

SN 77-885,257. APERTOR HOSPITALITY, LLC, HENDERSON, NV. FILED 12-3-2009.



NO CLAIM IS MADE TO THE EXCLUSIVE RIGHT TO USE "HOSPITALITY", APART FROM THE MARK AS SHOWN.

THE MARK CONSISTS OF FOUR LINES FORMING VARIOUS SHAPES POSITIONED TO THE LEFT OF THE TEXT "APERTOR" WHICH SITS ABOVE AND SLIGHTLY TO THE LEFT OF THE TEXT "HOSPITALITY".

FOR ADVISORY SERVICES WITH REGARD TO BUSINESS PLANNING, BUSINESS ANALYSIS, BUSINESS MANAGEMENT, BUSINESS ORGANIZATION, MARKETING AND CUSTOMER ANALYSIS; BUSINESS AUDITING; BUSINESS ACQUISITION AND MERGER CONSULTATION; BUSINESS MANAGEMENT; BUSINESS OPERATIONS AND BUSINESS ADMINISTRATION (U.S. CLS. 100, 101 AND 102).

PATRICIA EVANKO, EXAMINING ATTORNEY

CLASS 35—(Continued).

SN 77-885,665. OOO BOUTIQUE, WALNUT, CA. FILED 12-3-2009.

OOO BOUTIQUE

THE MARK CONSISTS OF STANDARD CHARACTERS WITHOUT CLAIM TO ANY PARTICULAR FONT, STYLE, SIZE, OR COLOR.

NO CLAIM IS MADE TO THE EXCLUSIVE RIGHT TO USE "BOUTIQUE", APART FROM THE MARK AS SHOWN.

FOR WHOLESALE AND RETAIL STORE SERVICES FEATURING ADULT NOVELTY ITEMS, CONDOMS, CLOTHING, HEALTH PRODUCTS, ADULT SEXUAL STIMULATION AIDS, CONTRACEPTIVE PRODUCTS (U.S. CLS. 100, 101 AND 102).

JESSICA A. POWERS, EXAMINING ATTORNEY

SN 77-885,430. SPAN ENTERPRISES LLC, DBA FILEAFTER.COM, ROCK HILL, SC. FILED 12-3-2009.

FileAfter

THE MARK CONSISTS OF STANDARD CHARACTERS WITHOUT CLAIM TO ANY PARTICULAR FONT, STYLE, SIZE, OR COLOR.

FOR TAX FILING SERVICES; TAX PREPARATION (U.S. CLS. 100, 101 AND 102).

FIRST USE 12-20-2009; IN COMMERCE 1-26-2010.

SUNG IN, EXAMINING ATTORNEY

SN 77-885,718. GAMING STANDARDS ASSOCIATION, FREMONT, CA. FILED 12-3-2009.

GAMING STANDARDS



ASSOCIATION

SN 77-885,476. RENN, AARON M., CHICAGO, IL. FILED 12-3-2009.

www.urbanophile.com

THE MARK CONSISTS OF STANDARD CHARACTERS WITHOUT CLAIM TO ANY PARTICULAR FONT, STYLE, SIZE, OR COLOR.

FOR BUSINESS CONSULTING AND INFORMATION SERVICES (U.S. CLS. 100, 101 AND 102).

MARIA-VICTORIA SUAREZ, EXAMINING ATTORNEY

NO CLAIM IS MADE TO THE EXCLUSIVE RIGHT TO USE "GAMING STANDARDS ASSOCIATION", APART FROM THE MARK AS SHOWN.

THE MARK CONSISTS OF THE WORDS "GAMING STANDARDS ASSOCIATION" AND A STYLIZED PUZZLE-PIECE DESIGN.

FOR ASSOCIATION SERVICES, NAMELY, PROMOTING THE INTERESTS OF MANUFACTURERS, SUPPLIERS, OPERATORS AND REGULATORS IN THE GAMING INDUSTRY (U.S. CLS. 100, 101 AND 102).

FIRST USE 11-0-2009; IN COMMERCE 11-0-2009.

DAVID YONTEF, EXAMINING ATTORNEY

CLASS 35—(Continued).

SN 77-885,776. REDYNS MEDICAL, LLC, LOS ANGELES, CA. FILED 12-3-2009.

Invent Yourself

THE MARK CONSISTS OF STANDARD CHARACTERS WITHOUT CLAIM TO ANY PARTICULAR FONT, STYLE, SIZE, OR COLOR.

FOR BUSINESS ADVISORY SERVICES, CONSULTANCY AND INFORMATION; BUSINESS CONSULTATION; BUSINESS CONSULTATION AND MANAGEMENT REGARDING MARKETING ACTIVITIES AND LAUNCHING OF NEW PRODUCTS; BUSINESS CONSULTATION IN THE FIELD OF MEDICAL DEVICE DESIGN AND DEVELOPMENT; CONSULTING SERVICES IN THE FIELD OF MEDICAL PRODUCT APPROVAL FOR COMMERCIAL PURPOSES (U.S. CLS. 100, 101 AND 102).

KIMBERLY PERRY, EXAMINING ATTORNEY

SN 77-885,868. SPORTY MOMMAS, PINECREST, FL. FILED 12-3-2009.



NO CLAIM IS MADE TO THE EXCLUSIVE RIGHT TO USE "SPORTY", APART FROM THE MARK AS SHOWN.

THE MARK CONSISTS OF THE WORDING "SPORTY MOMMAS" APPEARING BETWEEN TWO HORIZONTAL LINES, ALL BENEATH THE SILHOUETTE OF THREE WOMEN.

FOR ON-LINE RETAIL STORE SERVICES FEATURING JEWELRY, CLOTHING AND BOOKS (U.S. CLS. 100, 101 AND 102).

WENDY GOODMAN, EXAMINING ATTORNEY

CLASS 35—(Continued).

SN 77-885,943. GHIGLIAZZA, RICARDO ANDRES, CIUDAD DE BUENOS AIRES, ARGENTINA, FILED 12-4-2009.



THE COLOR(S) GREY, GREEN, BLUE AND BLACK IS/ ARE CLAIMED AS A FEATURE OF THE MARK.

THE MARK CONSISTS OF THE LITERAL ELEMENT "HUMAN" IS IN BLACK, THE LITERAL ELEMENT "SCORING" IS IN GREY. THERE ARE FOUR REPRESENTATIONS OF PERSONS. STARTING FROM THE LEFT, THE FIRST PERSON IS BLACK, THE SECOND IS BLUE, THE THIRD ONE IS GREEN AND THE LAST ONE IS GREY.

FOR HUMAN RESOURCE ANALYSIS AND CONSULTING SERVICES; HUMAN RESOURCES SERVICES, NAMELY, PERSONNEL SELECTION FOR OTHERS (U.S. CLS. 100, 101 AND 102).

LAKEISHA LEWIS, EXAMINING ATTORNEY

SN 77-886,036. NEFF, KRIS L., WESTERVILLE, OH. AND BLANKENBECKLER, JEFFREY A., WESTERVILLE, OH. FILED 12-4-2009.

WE CREATE SMILES

THE MARK CONSISTS OF STANDARD CHARACTERS WITHOUT CLAIM TO ANY PARTICULAR FONT, STYLE, SIZE, OR COLOR.

FOR DENTAL OFFICE MARKETING AND PRACTICE MANAGEMENT FOR OTHERS (U.S. CLS. 100, 101 AND 102).

KRISTINA MORRIS, EXAMINING ATTORNEY

SN 77-886,234. WHIZZBANG STUDIOS, LLC, NIWOT, CO. FILED 12-4-2009.

Whizzbang Studios

THE MARK CONSISTS OF STANDARD CHARACTERS WITHOUT CLAIM TO ANY PARTICULAR FONT, STYLE, SIZE, OR COLOR.

NO CLAIM IS MADE TO THE EXCLUSIVE RIGHT TO USE "STUDIOS", APART FROM THE MARK AS SHOWN.

FOR BRANDING SERVICES, NAMELY, CONSULTING, DEVELOPMENT, MANAGEMENT AND MARKETING OF BRANDS FOR BUSINESSES (U.S. CLS. 100, 101 AND 102).

FIRST USE 5-8-2004; IN COMMERCE 7-27-2004.

LAURA HAMMEL, EXAMINING ATTORNEY

CLASS 35—(Continued).

SN 77-886,238. SINCLAIR, RODRICK, DBA THE GOODIE BOX COMPANY, CULVER CITY, CA. FILED 12-4-2009.

The Goodie Box Company

THE MARK CONSISTS OF STANDARD CHARACTERS WITHOUT CLAIM TO ANY PARTICULAR FONT, STYLE, SIZE, OR COLOR.

NO CLAIM IS MADE TO THE EXCLUSIVE RIGHT TO USE "COMPANY", APART FROM THE MARK AS SHOWN.

FOR RETAIL STORE AND ON-LINE RETAIL STORE SERVICES FEATURING COSMETICS, SKIN CARE PRODUCTS, SKIN CLEANING PRODUCTS, MOISTURIZING PRODUCTS, HAIRCARE PRODUCTS, GROOMING PRODUCTS, CLOTHING, HANDBAGS, FASHION ACCESSORIES (U.S. CLS. 100, 101 AND 102).

FIRST USE 1-1-2009; IN COMMERCE 1-1-2009.

TASNEEM HUSSAIN, EXAMINING ATTORNEY

SN 77-886,300. INFINITIVE, DULLES, VA. FILED 12-4-2009.

Optimize Your Capabilities

THE MARK CONSISTS OF STANDARD CHARACTERS WITHOUT CLAIM TO ANY PARTICULAR FONT, STYLE, SIZE, OR COLOR.

FOR BUSINESS MANAGEMENT CONSULTANCY AS WELL AS DEVELOPMENT OF PROCESSES FOR THE ANALYSIS AND THE IMPLEMENTATION OF STRATEGY PLANS AND MANAGEMENT PROJECTS (U.S. CLS. 100, 101 AND 102).

FIRST USE 11-15-2009; IN COMMERCE 12-1-2009.

SHANNON TWOHIG, EXAMINING ATTORNEY

SN 77-886,408. ANDREWS, RICHARD B., LANCASTER, PA. AND KARIN S. ANDREWS, LANCASTER, PA. FILED 12-4-2009.

Honest Eyes

THE MARK CONSISTS OF STANDARD CHARACTERS WITHOUT CLAIM TO ANY PARTICULAR FONT, STYLE, SIZE, OR COLOR.

NO CLAIM IS MADE TO THE EXCLUSIVE RIGHT TO USE "EYES", APART FROM THE MARK AS SHOWN.

FOR RETAIL STORE SERVICES FEATURING OPTICAL PRODUCTS INCLUDING EYEGLASSES, LENSES AND ACCESSORIES (U.S. CLS. 100, 101 AND 102).

CHARLES L. JENKINS, EXAMINING ATTORNEY

CLASS 35—(Continued).

SN 77-886,454. DEPASTINO, TODD, PITTSBURGH, PA. FILED 12-4-2009.



NO CLAIM IS MADE TO THE EXCLUSIVE RIGHT TO USE "VETERANS", APART FROM THE MARK AS SHOWN.

THE MARK CONSISTS OF A CIRCULAR BAND WITH THE STYLIZED TEXT "VETERANS BREAKFAST CLUB" AND TWO STARS. IN THE CENTER OF THE BAND THERE IS A COFFEE MUG WITH STEAM COMING OUT. THE MUG HAS A BAND AROUND THE TOP WITH THREE STARS.

FOR ASSOCIATION SERVICES, NAMELY, PROMOTING THE INTERESTS OF WAR VETERANS (U.S. CLS. 100, 101 AND 102).

FIRST USE 6-22-2009; IN COMMERCE 6-30-2009.

RON FAIRBANKS, EXAMINING ATTORNEY

SN 77-886,478. ROSS & BARUZZINI, INC., WEBSTER GROVES, MO. FILED 12-4-2009.

CODA

THE MARK CONSISTS OF STANDARD CHARACTERS WITHOUT CLAIM TO ANY PARTICULAR FONT, STYLE, SIZE, OR COLOR.

FOR BUSINESS MANAGEMENT AND CONSULTATION IN THE FIELD OF DOMAIN AWARENESS (U.S. CLS. 100, 101 AND 102).

ANGELA DUONG, EXAMINING ATTORNEY

SN 77-886,506. THE FRAGRANCE FOUNDATION, INC., NEW YORK, NY. FILED 12-4-2009.

ONE MIGHTY DROP

THE MARK CONSISTS OF STANDARD CHARACTERS WITHOUT CLAIM TO ANY PARTICULAR FONT, STYLE, SIZE, OR COLOR.

FOR PROMOTING PUBLIC AWARENESS OF FRAGRANCES TO ENHANCE THE PUBLIC'S APPRECIATION OF FRAGRANCES (U.S. CLS. 100, 101 AND 102).

CHRISTINE COOPER, EXAMINING ATTORNEY

CLASS 35—(Continued).

SN 77-886,684. PRECURSOR LLC, MCLEAN, VA. FILED 12-4-2009.

CONSUMERSIDE

THE MARK CONSISTS OF STANDARD CHARACTERS WITHOUT CLAIM TO ANY PARTICULAR FONT, STYLE, SIZE, OR COLOR.

FOR COMMERCIAL INFORMATION AND ADVICE FOR CONSUMERS; COMPUTERIZED ON-LINE ORDERING FEATURING GENERAL MERCHANDISE AND GENERAL CONSUMER GOODS; CONSUMER RESEARCH; PROVIDING A WEB SITE FEATURING PRODUCT RATINGS OF THE CONSUMER GOODS AND SERVICES OF OTHERS IN THE FIELD OF ALL CONSUMER GOODS AND PRODUCTS; PROVIDING A WEB SITE FEATURING PRODUCT RATINGS OF THE CONSUMER GOODS OF OTHERS IN THE FIELD OF ALL CONSUMER GOODS; PROVIDING A WEB SITE FEATURING PRODUCT RATINGS OF THE CONSUMER SERVICES OF OTHERS IN THE FIELD OF ALL CONSUMER SERVICES; PROVIDING CONSUMER PRODUCT INFORMATION VIA THE INTERNET; PROVIDING INFORMATION ABOUT AND MAKING REFERRALS IN THE FIELD OF CONSUMER PRODUCTS AND SERVICES FOR RETAIL SERVICES CONCERNING PRODUCTS, SERVICES, EVENTS, ACTIVITIES, ATTRACTIONS AND FACILITIES IN PARTICULAR GEOGRAPHIC LOCATIONS (U.S. CLS. 100, 101 AND 102).

JEFFERY COWARD, EXAMINING ATTORNEY

SN 77-886,720. WILDLIFE ALLIES, LLC, PORT CHARLOTTE, FL. FILED 12-4-2009.

Wildlife Allies

THE MARK CONSISTS OF STANDARD CHARACTERS WITHOUT CLAIM TO ANY PARTICULAR FONT, STYLE, SIZE, OR COLOR.

NO CLAIM IS MADE TO THE EXCLUSIVE RIGHT TO USE "WILDLIFE", APART FROM THE MARK AS SHOWN. FOR WHOLESALE STORES FEATURING WILDLIFE AND ANIMAL PRODUCTS (U.S. CLS. 100, 101 AND 102). FIRST USE 11-19-2009; IN COMMERCE 11-26-2009. DEZMONA MIZELLE, EXAMINING ATTORNEY

CLASS 35—(Continued).

SN 77-886,847. THE STOCKROOM, INC., LOS ANGELES, CA. FILED 12-4-2009.

Life's too short for mediocre sex

THE MARK CONSISTS OF STANDARD CHARACTERS WITHOUT CLAIM TO ANY PARTICULAR FONT, STYLE, SIZE, OR COLOR.

FOR RETAIL STORE AND ON-LINE RETAIL STORE SERVICES FEATURING ADULT PRODUCTS, NAMELY, ADULT NOVELTIES, SEXUAL AIDS, AND TOYS, ADULT VIDEOS, MAGAZINES, BOOKS, AND PRINTED MATERIALS, CLOTHING, SHOES, LEATHER ACCESSORIES, FETISH WEAR, UNDERWEAR, CORSETS, SHIRTS, GLOVES, SKIRTS, STOCKINGS, PANTS, CONDOMS, LINGERIE, MOISTURIZING AND LUBRICATING CREAMS, BODY LOTIONS AND OILS (U.S. CLS. 100, 101 AND 102).

FIRST USE 12-1-2008; IN COMMERCE 12-1-2008.

TINA L. SNAPP, EXAMINING ATTORNEY

SN 77-886,897. SLIDE4LESS, OAKLAND, CA. FILED 12-4-2009.

VAPORIZE IT

THE MARK CONSISTS OF STANDARD CHARACTERS WITHOUT CLAIM TO ANY PARTICULAR FONT, STYLE, SIZE, OR COLOR.

FOR DISTRIBUTORSHIP SERVICES IN THE FIELD OF VAPORIZERS AND VAPORIZER PARTS; RETAIL STORE SERVICES FEATURING VAPORIZERS AND VAPORIZER PARTS (U.S. CLS. 100, 101 AND 102).

FIRST USE 1-1-2003; IN COMMERCE 1-1-2003.

HEATHER BIDDULPH, EXAMINING ATTORNEY

SN 77-886,904. WINN, TERRI, PASO ROBLES, CA. FILED 12-4-2009.



THE STIPPLING IS FOR SHADING PURPOSES ONLY. THE MARK CONSISTS OF FOUR CONNECTED STYLISTED HOUSES ABOVE THE WORDING "WINNLIST YOUR SELECT AGENT CONNECTION."

FOR REAL ESTATE REFERRAL SERVICE (U.S. CLS. 100, 101 AND 102).

JASON BLAIR, EXAMINING ATTORNEY

CLASS 35—(Continued).

SN 77-887,048. THOMAS R. KESSLER, ZAPOPAN, JALISCO, MEXICO, FILED 12-5-2009.



THE COLOR(S) BLACK, BLUE IS/ARE CLAIMED AS A FEATURE OF THE MARK.

THE MARK CONSISTS OF A CURVED VERTICAL BLUE LINE TOUCHED BY A BLACK CIRCLE ON ITS LOWER END, FOLLOWED BY A CURVED VERTICAL BLACK LINE TOUCHED BY A BLUE CIRCLE ON ITS UPPER END, FOLLOWED BY BLACK LETTERS "AKTALITA".

FOR TRANSPORTATION LOGISTICS SERVICES, NAMELY, ARRANGING THE TRANSPORTATION OF GOODS FOR OTHERS; TRANSPORTATION MANAGEMENT SERVICES, NAMELY, PLANNING AND COORDINATING TRANSPORTATION OF PEOPLE FOR OTHERS (U.S. CLS. 100, 101 AND 102).

LAURIE MAYES, EXAMINING ATTORNEY

SN 77-887,105. DABBY, IRIT, DBA TAGGING & REWARD SYSTEM FOR ONLINE ADVERTISING, HAIFA, ISRAEL, FILED 12-6-2009.

GoodyTag

THE MARK CONSISTS OF STANDARD CHARACTERS WITHOUT CLAIM TO ANY PARTICULAR FONT, STYLE, SIZE, OR COLOR.

FOR ADVERTISING AND BUSINESS SERVICES, NAMELY, PROVIDING AN ONLINE WEBSITE WHERE ADVERTISERS, MARKETERS, AND CONTENT PROVIDERS CAN INTERACT WITH USERS FOR ADVERTISING, BRANDING, AND PROMOTING KNOWLEDGE, PRODUCTS, AND SERVICES, AND TRADESHOWS, ON BEHALF OF THEMSELVES AND OTHERS, AND FOR EVALUATING AND RATING THE SAME, ALL THE FOREGOING RELEVANT TO HUMAN ACTIVITIES AFFECTING CLIMATE CHANGE AND RELATED FIELDS; ADVERTISING SERVICES, NAMELY, PROMOTING AND MARKETING THE GOODS AND SERVICES OF OTHERS IN THE FIELD OF UPSCALE CHOICES SUCH AS CULTURAL EVENTS, RESTAURANTS, SHOPPING, AND TRAVEL VIA PRINT AND ELECTRONIC MEDIA; ADVERTISING SERVICES, NAMELY, PROMOTING THE BRANDS, GOODS AND SERVICES OF OTHERS; ADVERTISING VIA ELECTRONIC MEDIA AND SPECIFICALLY THE INTERNET; ADVERTISING, INCLUDING ON-LINE ADVERTISING ON A COMPUTER NETWORK (U.S. CLS. 100, 101 AND 102).

FIRST USE 5-6-2009; IN COMMERCE 11-12-2009.
BRENDAN MCCAULEY, EXAMINING ATTORNEY

CLASS 35—(Continued).

SN 77-887,115. SZWED, CRAIG M., DBA CRAIGSZWED-NET, UNION, CT. FILED 12-6-2009.

"Where my labors of love
can become your treasures."

THE MARK CONSISTS OF STANDARD CHARACTERS WITHOUT CLAIM TO ANY PARTICULAR FONT, STYLE, SIZE, OR COLOR.

FOR ON-LINE RETAIL STORE SERVICES FEATURING ORIGINAL BOOKS, E-BOOKS, PHOTOGRAPHS; PROMOTIONAL SERVICES, NAMELY, PROVIDING A WEBSITE AT WHICH ARTISTS CAN SHOWCASE THEIR TALENTS VIA AN ONLINE PORTFOLIO (U.S. CLS. 100, 101 AND 102).

FIRST USE 12-5-2009; IN COMMERCE 12-5-2009.
RICHARD WHITE, EXAMINING ATTORNEY

SN 77-887,129. UNITECH CONSULTING, INC., DBA UNITAX, FAIRFAX, VA. FILED 12-6-2009.

UNITAX

THE MARK CONSISTS OF STANDARD CHARACTERS WITHOUT CLAIM TO ANY PARTICULAR FONT, STYLE, SIZE, OR COLOR.

FOR TAX AND TAXATION PLANNING, ADVICE, INFORMATION AND CONSULTANCY SERVICES (U.S. CLS. 100, 101 AND 102).

FIRST USE 10-8-2009; IN COMMERCE 10-8-2009.
BRENDAN MCCAULEY, EXAMINING ATTORNEY

SN 77-887,160. MARTIN, AARON C., BEECH ISLAND, SC. FILED 12-6-2009.

♣INSOMNIA♣

CADDIES COULDN'T FIND CLUBS THIS EASY!

THE MARK CONSISTS OF WORD "INSOMNIA" WITH DECK OF PLAYING CARDS CLUB SYMBOL ON BOTH SIDES, UNDERNEATH IS TAGLINE "CADDIES COULDN'T FIND CLUBS THIS EASY!"

FOR ON-LINE BUSINESS DIRECTORIES FEATURING ENTERTAINMENT CLUBS (U.S. CLS. 100, 101 AND 102).
ALEXANDER L. POWERS, EXAMINING ATTORNEY

CLASS 35—(Continued).

SN 77-887,258. INFINITIVE FEDERAL, DULLES, VA. FILED 12-7-2009.

Optimize Your Mission

THE MARK CONSISTS OF STANDARD CHARACTERS WITHOUT CLAIM TO ANY PARTICULAR FONT, STYLE, SIZE, OR COLOR.

FOR BUSINESS CONSULTING SERVICES RELATING TO THE INTEGRATION OF THE AREAS OF BUSINESS PROCESS TECHNOLOGY, ORGANIZATIONAL LEARNING, CHANGE MANAGEMENT, AND OPERATIONAL SUSTAINABILITY (U.S. CLS. 100, 101 AND 102).

FIRST USE 11-15-2009; IN COMMERCE 11-15-2009.
KELLEY WELLS, EXAMINING ATTORNEY

SN 77-887,280. SEXTON, RICHARD, NEW YORK, NY. FILED 12-7-2009.

Captain's Knock

THE MARK CONSISTS OF STANDARD CHARACTERS WITHOUT CLAIM TO ANY PARTICULAR FONT, STYLE, SIZE, OR COLOR.

FOR BUSINESS NETWORKING (U.S. CLS. 100, 101 AND 102).

FIRST USE 12-3-2009; IN COMMERCE 12-3-2009.
ELLEN B. AWRICH, EXAMINING ATTORNEY

SN 77-887,283. D.A.W., INC., HOLLISTON, MA. FILED 12-7-2009.



The logo for Eaton Apothecary features the word "Eaton" in a large, stylized, cursive font. Below it, the word "Apothecary" is written in a smaller, sans-serif font, enclosed within a horizontal rectangular border.

NO CLAIM IS MADE TO THE EXCLUSIVE RIGHT TO USE "APOTHECARY", APART FROM THE MARK AS SHOWN.

FOR RETAIL DRUG STORE SERVICES (U.S. CLS. 100, 101 AND 102).

FIRST USE 0-0-1985; IN COMMERCE 0-0-1985.
REBECCA POVARCHUK, EXAMINING ATTORNEY

CLASS 35—(Continued).

SN 77-887,327. SECOND LICENSE APPLICATION CORPORATION, DFW AIRPORT, TX. FILED 12-7-2009.



The logo for superTradeExchange features the word "super" in a lowercase, bold, sans-serif font, followed by "TradeExchange" in a larger, bold, sans-serif font. A shield-shaped graphic is positioned behind the letters "UPE" in "TradeExchange".

OWNER OF U.S. REG. NO. 3,674,783.

NO CLAIM IS MADE TO THE EXCLUSIVE RIGHT TO USE "SUPER TRADE EXCHANGE", APART FROM THE MARK AS SHOWN.

THE MARK CONSISTS OF THE WORD "SUPERTRADEEXCHANGE" WITH A SHIELD DESIGN BEHIND THE LETTERS "UPE".

FOR EXCHANGE SERVICES, NAMELY, AN INTERACTIVE WEB SITE FOR USERS TO BUY AND SELL GOODS AND SERVICES (U.S. CLS. 100, 101 AND 102).
MIDGE BUTLER, EXAMINING ATTORNEY

SN 77-887,434. NORTH AMERICAN DIAMOND BROKERS, POTTSBORO, TX. FILED 12-7-2009.



NO CLAIM IS MADE TO THE EXCLUSIVE RIGHT TO USE "NORTH AMERICAN DIAMOND BROKERS", APART FROM THE MARK AS SHOWN.

THE STIPPLING IS FOR SHADING PURPOSES ONLY.
THE MARK CONSISTS OF A ROUND CUT DIAMOND WITH THE SHADOW OF A COMPASS NEEDLE OVERLAYS ON TOP. THE STYLIZED TEXT "NORTH AMERICAN DIAMOND BROKERS" APPEARS AROUND.

FOR ON-LINE RETAIL STORE SERVICES FEATURING DIAMONDS (U.S. CLS. 100, 101 AND 102).

TAMARA FRAZIER, EXAMINING ATTORNEY

CLASS 35—(Continued).

SN 77-887,449. LANGWORTHY, DAVID S., LAKE PLACID, FL. FILED 12-7-2009.

COMBATHLETE

THE MARK CONSISTS OF STANDARD CHARACTERS WITHOUT CLAIM TO ANY PARTICULAR FONT, STYLE, SIZE, OR COLOR.

FOR ADVERTISING AND BUSINESS SERVICES, NAMELY, PROVIDING AN ONLINE WEBSITE WHERE ADVERTISERS, MARKETERS, AND CONTENT PROVIDERS CAN INTERACT WITH USERS FOR ADVERTISING, BRANDING, AND PROMOTING KNOWLEDGE, PRODUCTS, AND SERVICES, AND TRADESHOWS, ON BEHALF OF THEMSELVES AND OTHERS, AND FOR EVALUATING AND RATING THE SAME, ALL THE FOREGOING RELEVANT TO HUMAN ACTIVITIES AFFECTING CLIMATE CHANGE AND RELATED FIELDS (U.S. CLS. 100, 101 AND 102).

YAT SYE, LEE, EXAMINING ATTORNEY

SN 77-887,473. LOGONATION, INC., MOORESVILLE, NC. FILED 12-7-2009.

DEALTOWN

THE MARK CONSISTS OF STANDARD CHARACTERS WITHOUT CLAIM TO ANY PARTICULAR FONT, STYLE, SIZE, OR COLOR.

FOR PROMOTING THE GOODS AND SERVICES OF OTHERS BY PROVIDING A WEB SITE OR OTHER ELECTRONIC OR PRINT MEDIA FEATURING MERCHANT INFORMATION AND SALES PROMOTIONS THAT ALLOWS A USER TO SEARCH, RECEIVE OR ACCESS THIS INFORMATION BASED ON SELECTED BIOGRAPHICAL CRITERIA (U.S. CLS. 100, 101 AND 102).

JASON BLAIR, EXAMINING ATTORNEY

SN 77-887,519. CAMERA READY KIDS, TALENT MANAGEMENT, INC., SILVER SPRING, MD. FILED 12-7-2009.

Camera Ready Kids

THE MARK CONSISTS OF STANDARD CHARACTERS WITHOUT CLAIM TO ANY PARTICULAR FONT, STYLE, SIZE, OR COLOR.

FOR TALENT AGENCIES (U.S. CLS. 100, 101 AND 102).

FIRST USE 8-4-1988; IN COMMERCE 8-4-1988.

ANNE E. GUSTASON, EXAMINING ATTORNEY

CLASS 35—(Continued).

SN 77-887,527. BURLINGTON COAT FACTORY WAREHOUSE CORPORATION, BURLINGTON, NJ. FILED 12-7-2009.



OWNER OF U.S. REG. NO. 3,323,985.

THE MARK CONSISTS OF THE LETTER "B" STYLIZED IN A HEART-SHAPED DESIGN.

FOR ONLINE RETAIL STORE SERVICES AND RETAIL STORE SERVICES FEATURING CLOTHING, NAMELY, COATS, OUTERWEAR, WOMEN'S SPORTSWEAR, MEN'S WEAR, CHILDREN'S AND INFANT'S WEAR, FOOTWEAR, SOCKS AND HOSIERY, AND CLOTHING ACCESSORIES FOR ADULTS, CHILDREN AND INFANTS; FURNITURE, TOYS, AND RELATED MERCHANDISE AND ACCESSORIES FOR INFANTS AND CHILDREN, NAMELY, BOUNCER SEATS, JUMPERS, PLAY YARDS, PLAYMATES, GYMS, STATIONARY ENTERTAINERS AND WALKERS, SWINGS, BATH ACCESSORIES, POTTY AND DIAPERING ACCESSORIES, BOOKS, MUSIC, VIDEOS, FEEDING ACCESSORIES, SAFETY AND HEALTH ACCESSORIES, HOUSEWARES, BED AND BATH LINENS, WINDOW TREATMENTS, FURNITURE ACCESSORIES, AND DECORATIVE ACCESSORIES; LUGGAGE, BOOKBAGS, TOTE BAGS AND VALISES FOR ADULTS, CHILDREN AND INFANTS; AND MISCELLANEOUS GIFTWARES (U.S. CLS. 100, 101 AND 102).

FIRST USE 11-9-2009; IN COMMERCE 11-9-2009.

ALEXANDER L. POWERS, EXAMINING ATTORNEY

CLASS 35—(Continued).

SN 77-887,534. FRONT DOOR FABRICS, LLC, CHARLOTTE, NC. FILED 12-7-2009.



NO CLAIM IS MADE TO THE EXCLUSIVE RIGHT TO USE "FABRICS", APART FROM THE MARK AS SHOWN. THE MARK CONSISTS OF A STYLIZED FLEUR-DE-LIS DESIGN.

FOR RETAIL STORES FEATURING FABRICS FOR HOME DECORATING, CUSTOMER FURNITURE, TRIM, AND WALLPAPER (U.S. CLS. 100, 101 AND 102). FIRST USE 9-17-2007; IN COMMERCE 9-17-2007. ALEXANDER L. POWERS, EXAMINING ATTORNEY

SN 77-887,574. WHITE, JIM, COLUMBIA, SC. FILED 12-7-2009.

DMV4U

THE MARK CONSISTS OF STANDARD CHARACTERS WITHOUT CLAIM TO ANY PARTICULAR FONT, STYLE, SIZE, OR COLOR.

FOR STATE VEHICULAR REGISTRATION AND TITLE TRANSFER (U.S. CLS. 100, 101 AND 102). FIRST USE 3-2-2005; IN COMMERCE 3-2-2005. SUE LAWRENCE, EXAMINING ATTORNEY

CLASS 35—(Continued).

SN 77-887,623. NATIONAL COUNCIL ON FAMILY VIOLENCE, AUSTIN, TX. FILED 12-7-2009.

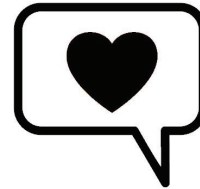

THE MARK CONSISTS OF A SPEECH BALLOON WITH A HEART CONTAINED WITHIN IT.

FOR REFERRALS IN THE FIELD OF SUSPECTED CASES OF TEENAGE DATING VIOLENCE AND ABUSE TO APPROPRIATE AGENCIES; PROMOTING PUBLIC AWARENESS OF THE NEED FOR INTERVENTION IN SUSPECTED CASES OF TEENAGE DATING VIOLENCE AND ABUSE BY PROVIDING INFORMATION ABOUT TEENAGE DATING VIOLENCE AND ABUSE; PUBLIC INFORMATION CAMPAIGN SERVICES TO PROMOTE PUBLIC AWARENESS OF TEENAGE DATING VIOLENCE AND ABUSE, ITS SYMPTOMS AND ITS IMPACT ON CHILDREN AND THEIR FAMILIES (U.S. CLS. 100, 101 AND 102).

FIRST USE 1-0-2007; IN COMMERCE 1-0-2007. STEPHANIE ALI, EXAMINING ATTORNEY

SN 77-887,655. ALLEN, RICHARD L., MONONA, WI. FILED 12-7-2009.

Reptile Rapture

THE MARK CONSISTS OF STANDARD CHARACTERS WITHOUT CLAIM TO ANY PARTICULAR FONT, STYLE, SIZE, OR COLOR.

NO CLAIM IS MADE TO THE EXCLUSIVE RIGHT TO USE "REPTILE", APART FROM THE MARK AS SHOWN.

FOR RETAIL AND ONLINE RETAIL PET STORE SERVICES FEATURING REPTILES, SNAKES, LIZARDS, GECKOS, TURTLES, TORTOISES, AMPHIBIANS, FROGS, TOADS, SALAMANDERS, RODENTS, AND RELATED PET FOODS, LIGHTS, AND PLANTS (U.S. CLS. 100, 101 AND 102).

FIRST USE 11-1-2007; IN COMMERCE 11-1-2007. JENNIFER MARTIN, EXAMINING ATTORNEY

CLASS 35—(Continued).

SN 77-887,671. SPORTSCASTOR MARKETING, INC., PHOENIX, AZ. FILED 12-7-2009.

SPORTSCASTOR

THE MARK CONSISTS OF STANDARD CHARACTERS WITHOUT CLAIM TO ANY PARTICULAR FONT, STYLE, SIZE, OR COLOR.

FOR ADVERTISING AND MARKETING; ADVERTISING AND MARKETING SERVICES, NAMELY, PROMOTING THE GOODS AND SERVICES OF OTHERS; SHOPPING BY RESEARCHERS WHO POSE AS CUSTOMERS TO EVALUATE THE QUALITY OF SERVICE DELIVERED (U.S. CLS. 100, 101 AND 102).

FIRST USE 8-0-2002; IN COMMERCE 8-0-2009.
KELLY BOULTON, EXAMINING ATTORNEY

SN 77-887,793. EPOCRATES, INC., SAN MATEO, CA. FILED 12-7-2009.

EPOCRATES LEADER

THE MARK CONSISTS OF STANDARD CHARACTERS WITHOUT CLAIM TO ANY PARTICULAR FONT, STYLE, SIZE, OR COLOR.

FOR BUSINESS ADVISORY SERVICES, CONSULTANCY AND INFORMATION; MARKET ANALYSIS AND RESEARCH SERVICES (U.S. CLS. 100, 101 AND 102).

PAULA MAHONEY, EXAMINING ATTORNEY

SN 77-887,815. GENESIS PHYSICIANS GROUP, INC., DALLAS, TX. FILED 12-7-2009.

INDEPENDENT, YET NOT ALONE

THE MARK CONSISTS OF STANDARD CHARACTERS WITHOUT CLAIM TO ANY PARTICULAR FONT, STYLE, SIZE, OR COLOR.

FOR CONSULTING SERVICES IN THE FIELD OF PHYSICIAN PRACTICE MANAGEMENT (U.S. CLS. 100, 101 AND 102).

TRACY CROSS, EXAMINING ATTORNEY

CLASS 35—(Continued).

SN 77-887,817. HAVAS S.A., 92281 SURESNES CEDEX, FRANCE, FILED 12-7-2009.

Consumer²

THE MARK CONSISTS OF THE WORD "CONSUMER" AND THE NUMBER TWO WRITTEN IN SUPERScript.

FOR ADVERTISING, MARKETING, PROMOTION AND PUBLICITY SERVICES; PUBLIC RELATIONS SERVICES; ADVERTISING CONSULTATION; MARKETING CONSULTATION; PUBLIC RELATIONS CONSULTATION; ADVERTISING AGENCY SERVICES; BUSINESS MARKETING SERVICES; BUSINESS MARKETING CONSULTING SERVICES; DEVELOPING AND IMPLEMENTING PROMOTIONAL CAMPAIGNS FOR BUSINESS; MARKET RESEARCH CONSULTATION; MARKET RESEARCH SERVICES (U.S. CLS. 100, 101 AND 102).

TRACY CROSS, EXAMINING ATTORNEY

SN 77-887,843. IVY HEART, LLC, SAINT CHARLES, IL. FILED 12-7-2009.

LANDSCAPE MAGIC

THE MARK CONSISTS OF STANDARD CHARACTERS WITHOUT CLAIM TO ANY PARTICULAR FONT, STYLE, SIZE, OR COLOR.

NO CLAIM IS MADE TO THE EXCLUSIVE RIGHT TO USE "LANDSCAPE", APART FROM THE MARK AS SHOWN.

FOR PROMOTING THE SERVICES OF OTHERS AND PROVIDING BUSINESS REFERRALS IN THE FIELD OF LANDSCAPING (U.S. CLS. 100, 101 AND 102).

FIRST USE 11-21-2009; IN COMMERCE 11-21-2009.
TRACY CROSS, EXAMINING ATTORNEY

SN 77-887,859. PRIMENET DIRECT MARKETING SOLUTIONS, LLC, CLEARWATER, FL. FILED 12-7-2009.

123MARKETING

THE MARK CONSISTS OF STANDARD CHARACTERS WITHOUT CLAIM TO ANY PARTICULAR FONT, STYLE, SIZE, OR COLOR.

OWNER OF U.S. REG. NO. 3,721,919.
FOR DIRECT MARKETING AND DIRECT MAIL ADVERTISING SERVICES (U.S. CLS. 100, 101 AND 102).

ESTHER BELENKER, EXAMINING ATTORNEY

CLASS 35—(Continued).

SN 77-887,947. FRANFINDERS, LLC, DULUTH, GA. FILED 12-7-2009.

FRANFINDERS

THE MARK CONSISTS OF STANDARD CHARACTERS WITHOUT CLAIM TO ANY PARTICULAR FONT, STYLE, SIZE, OR COLOR.

FOR FRANCHISING, NAMELY, CONSULTATION AND ASSISTANCE IN BUSINESS MANAGEMENT, ORGANIZATION AND PROMOTION (U.S. CLS. 100, 101 AND 102).

FIRST USE 5-6-2008; IN COMMERCE 5-6-2008.
MARILYN IZZI, EXAMINING ATTORNEY

CLASS 35—(Continued).

SN 77-887,987. MONTAVO, INC., BELLEVUE, WA. FILED 12-7-2009.

MMAP

THE MARK CONSISTS OF STANDARD CHARACTERS WITHOUT CLAIM TO ANY PARTICULAR FONT, STYLE, SIZE, OR COLOR.

FOR PROMOTING THE GOODS AND SERVICES OF OTHERS BY MEANS OF DISTRIBUTING ADVERTISING ON THE INTERNET (U.S. CLS. 100, 101 AND 102).

MICHAEL WEBSTER, EXAMINING ATTORNEY

SN 77-887,976. PUENTE BAGELS, INC., SAN FRANCISCO, CA. FILED 12-7-2009.

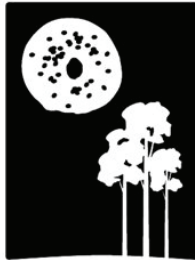
**MARIN BAGEL
COMPANY**

NO CLAIM IS MADE TO THE EXCLUSIVE RIGHT TO USE "MARIN BAGEL COMPANY", APART FROM THE MARK AS SHOWN.

THE MARK CONSISTS OF THE WORDS "MARIN BAGEL COMPANY" STYLIZED, BELOW AN IMAGE OF A HALF BAGEL ABOVE A TREE, WITH A BLACK BACKGROUND.

FOR WHOLESALE DISTRIBUTORSHIPS FEATURING BAKERY GOODS (U.S. CLS. 100, 101 AND 102).

FIRST USE 7-15-2009; IN COMMERCE 12-7-2009.
ANGELA M. MICHELI, EXAMINING ATTORNEY

SN 77-888,050. SUPERFEET WORLDWIDE, INC., FERNDALE, WA. FILED 12-7-2009.

SUPERFEET

THE MARK CONSISTS OF STANDARD CHARACTERS WITHOUT CLAIM TO ANY PARTICULAR FONT, STYLE, SIZE, OR COLOR.

OWNER OF U.S. REG. NOS. 1,430,999, 1,543,393 AND 1,901,654.

FOR ONLINE RETAIL STORE SERVICES FEATURING ORTHOTIC INSERTS FOR FOOTWEAR, FOOTWEAR INSERTS AND FOOTWEAR (U.S. CLS. 100, 101 AND 102).

FIRST USE 12-0-2006; IN COMMERCE 12-0-2006.
KELLY CHOE, EXAMINING ATTORNEY

SN 77-887,978. SAI INVESTMENTS, LLC., KETCHIKAN, AK. FILED 12-7-2009.

'Romance the Gem'

NO CLAIM IS MADE TO THE EXCLUSIVE RIGHT TO USE "GEM", APART FROM THE MARK AS SHOWN.

FOR RETAIL JEWELRY STORES (U.S. CLS. 100, 101 AND 102).

FIRST USE 5-15-2000; IN COMMERCE 5-15-2000.
ANGELA M. MICHELI, EXAMINING ATTORNEY

SN 77-888,057. SUPERFEET WORLDWIDE, INC., FERNDALE, WA. FILED 12-7-2009.

EVERY SHOE. EVERY DAY.

THE MARK CONSISTS OF STANDARD CHARACTERS WITHOUT CLAIM TO ANY PARTICULAR FONT, STYLE, SIZE, OR COLOR.

OWNER OF U.S. REG. NO. 3,355,746.

FOR ONLINE RETAIL STORE SERVICES FEATURING ORTHOTIC INSERTS FOR FOOTWEAR, FOOTWEAR INSERTS AND FOOTWEAR (U.S. CLS. 100, 101 AND 102).

KELLY CHOE, EXAMINING ATTORNEY

CLASS 35—(Continued).

SN 77-888,069. WESTERN STATES FRICTION GROUP, INC., SALT LAKE CITY, UT. FILED 12-7-2009.

CLASS 35—(Continued).

SN 77-888,192. WILLIAMS, JAMES D, SAN FRANCISCO, CA. FILED 12-8-2009.

**STATES FRICTION SELECT
BRAKE**



THE MARK CONSISTS OF STANDARD CHARACTERS WITHOUT CLAIM TO ANY PARTICULAR FONT, STYLE, SIZE, OR COLOR.

OWNER OF U.S. REG. NOS. 3,614,670 AND 3,614,672.

NO CLAIM IS MADE TO THE EXCLUSIVE RIGHT TO USE "FRICTION SELECT BRAKE", APART FROM THE MARK AS SHOWN.

FOR WHOLESALE DISTRIBUTORSHIPS FEATURING BRAKES AND BRAKE PARTS (U.S. CLS. 100, 101 AND 102).

DAVID MILLER, EXAMINING ATTORNEY

THE MARK CONSISTS OF THE STYLIZED TERMS "U1" WITHIN A CIRCLE, WITH THE WORDING "UNITY ONE" LOCATED BELOW THE FOREGOING, WITH A CURVED BAND TO THE LEFT OF ALL OF THE FOREGOING.

FOR BUSINESS MANAGEMENT AND CONSULTATION; VENDOR MANAGEMENT SERVICES FOR HEALTHCARE FACILITIES (U.S. CLS. 100, 101 AND 102).

REBECCA SMITH, EXAMINING ATTORNEY

SN 77-888,119. JOHN O. SPARKS AND ASSOCIATES, INC., CINCINNATI, OH. FILED 12-7-2009.

SN 77-888,260. FINE WINE CELLARS, LLC, SCARSDALE, NY. FILED 12-8-2009.

CHEMSAVE

SATURN WINE IMPORTS

THE MARK CONSISTS OF STANDARD CHARACTERS WITHOUT CLAIM TO ANY PARTICULAR FONT, STYLE, SIZE, OR COLOR.

FOR MANUFACTURER REPRESENTATIVES IN THE FIELD OF ENVIRONMENTALLY PREFERABLE, POLLUTION PREVENTION PRODUCTS, PROCESSES, AND SERVICES (U.S. CLS. 100, 101 AND 102).

FIRST USE 4-15-2002; IN COMMERCE 9-11-2003.
JASON TURNER, EXAMINING ATTORNEY

THE MARK CONSISTS OF STANDARD CHARACTERS WITHOUT CLAIM TO ANY PARTICULAR FONT, STYLE, SIZE, OR COLOR.

NO CLAIM IS MADE TO THE EXCLUSIVE RIGHT TO USE "WINE IMPORTS", APART FROM THE MARK AS SHOWN.

FOR WHOLESALE WINE IMPORT AGENCY AND DISTRIBUTORSHIP SERVICES (U.S. CLS. 100, 101 AND 102).

JUDITH HELFMAN, EXAMINING ATTORNEY

CLASS 35—(Continued).

SN 77-888,436. GREISIGER, MARK, GLADWYNE, PA. FILED 12-8-2009.

BREACH COACH

THE MARK CONSISTS OF STANDARD CHARACTERS WITHOUT CLAIM TO ANY PARTICULAR FONT, STYLE, SIZE, OR COLOR.

NO CLAIM IS MADE TO THE EXCLUSIVE RIGHT TO USE "BREACH", APART FROM THE MARK AS SHOWN.

FOR BUSINESS CONSULTING SERVICES RELATING TO THE ACCIDENTAL OR INTENTIONAL/MALICIOUS EVENTS INVOLVING THE RELEASE OR LEAK OF PRIVATE INFORMATION AND/OR COMPUTER DATA (U.S. CLS. 100, 101 AND 102).

FIRST USE 10-0-2009; IN COMMERCE 10-0-2009.
KARANENDRA S. CHHINA, EXAMINING ATTORNEY

CLASS 35—(Continued).

SN 77-888,497. EVERY BODY NEEDS A POSITIVE ATTITUDE, INC., MUTTONTOWN, NY. FILED 12-8-2009.



POSITIVE ATTITUDE

OWNER OF U.S. REG. NO. 1,530,965.

THE MARK CONSISTS OF LETTER "A" WITH A STYLIZED SWIRL THAT CROSSES IT AND FORMS A HIGHLY STYLIZED LETTER "P", BENEATH WHICH APPEAR THE WORDS "POSITIVE ATTITUDE".

FOR RETAIL STORE AND ON-LINE RETAIL STORE SERVICES FEATURING FOOTWEAR, WEARING APPAREL, LUGGAGE, HANDBAGS, SMALL LEATHER GOODS, BUSINESS CASES, EYEWEAR, JEWELRY AND WATCHES, BELTS, SCARVES AND NECKWEAR, FRAGRANCES, GIFTS AND SUNDRIES, SPORTING GOODS, TOYS, SNACKS AND DRINKS, COSMETICS, NON-MEDICATED TOILETRIES, OFFICE SUPPLIES, LINEN PRODUCTS, HOUSEWARE AND HOME FURNISHINGS (U.S. CLS. 100, 101 AND 102).

NAPOLEON SHARMA, EXAMINING ATTORNEY

SN 77-888,480. VERITY FARMS, LLC, SIOUX FALLS, SD. FILED 12-8-2009.

VERITY

THE MARK CONSISTS OF STANDARD CHARACTERS WITHOUT CLAIM TO ANY PARTICULAR FONT, STYLE, SIZE, OR COLOR.

OWNER OF U.S. REG. NOS. 2,834,630, 3,145,454 AND 3,306,958.

FOR BUSINESS CONSULTATION IN THE FIELD OF CROP AND SOIL MANAGEMENT, AGRICULTURE, AND LIVESTOCK (U.S. CLS. 100, 101 AND 102).

FIRST USE 9-0-2004; IN COMMERCE 9-0-2004.
KEVIN CORWIN, EXAMINING ATTORNEY

SN 77-888,681. PIANO LIFESTYLES, INC., JOHNSON, VT. FILED 12-8-2009.

PERFECTLY GRAND

THE MARK CONSISTS OF STANDARD CHARACTERS WITHOUT CLAIM TO ANY PARTICULAR FONT, STYLE, SIZE, OR COLOR.

OWNER OF U.S. REG. NO. 2,280,709.

FOR ONLINE RETAIL STORE SERVICES FEATURING MUSICAL INSTRUMENTS, PARTS AND ACCESSORIES FOR MUSICAL INSTRUMENTS, MUSIC STANDS, BENCHES, STOOLS, LAMPS, SHEET MUSIC CABINETS, MUSIC THEMED FURNITURE, SHEET MUSIC, DVDS, CDS, BOOKS, PIANO CLEANING SUPPLIES, METRONOMES, PIANO BENCH CUSHIONS, PIANO COVERS, PIANO TRANSPORTERS, PIANO DOLLIES, CASTER CUPS, PAPERWEIGHTS (U.S. CLS. 100, 101 AND 102).

FIRST USE 6-23-1997; IN COMMERCE 6-23-1997.
TASNEEM HUSSAIN, EXAMINING ATTORNEY

CLASS 35—(Continued).

SN 77-888,712. JOHNSON, KELI, SAN CLEMENTE, CA.
FILED 12-8-2009.



NO CLAIM IS MADE TO THE EXCLUSIVE RIGHT TO USE "OC TYKES" AND "OCTYKES.COM", APART FROM THE MARK AS SHOWN.

THE COLOR(S) ORANGE, GREEN, BROWN AND WHITE IS/ARE CLAIMED AS A FEATURE OF THE MARK.

THE MARK CONSISTS OF THE LETTERS "OC" IN WHITE APPEARING IN AN ORANGE SQUARE, THE LETTERS "TYKES" IN GREEN, THE LETTERS "OCTYKES.COM" AND THE DESIGN OF THE STROLLER IN BROWN. THE REMAINING COLOR WHITE APPEARING IN THE MARK REPRESENTS THE BACKGROUND OF THE MARK.

FOR RETAIL STORE AND ON-LINE RETAIL STORE SERVICES FEATURING BABY AND CHILDREN'S EQUIPMENT, NAMELY, STROLLERS, HIGH CHAIRS, CAR SEATS, SHOES, EATING UTENSILS, BABY CARRIERS, AND BABY SLINGS (U.S. CLS. 100, 101 AND 102).

FIRST USE 8-1-2007; IN COMMERCE 8-1-2007.
SUSAN RICHARDS, EXAMINING ATTORNEY

CLASS 35—(Continued).

SN 77-888,732. BABY BOOMERS GENERATION NETWORK, INC., HENDERSON, NV. FILED 12-8-2009.



NO CLAIM IS MADE TO THE EXCLUSIVE RIGHT TO USE "BABY BOOMERS GENERATION NETWORK, INC.", APART FROM THE MARK AS SHOWN.

THE MARK CONSISTS OF A SMILING BABY FACE INSIDE THE INNER CIRCLE. ON THE OUTER CIRCLE THERE IS THE STYLIZED TEXT "BABY BOOMERS GENERATION NETWORK, INC." WITH A DOT ON THE RIGHT AND LEFT IN THE CIRCLE.

FOR PROMOTING THE GOODS AND SERVICES OF OTHERS BY PROVIDING A WEB SITE FEATURING COUPONS, REBATES, PRICE-COMPARISON INFORMATION, PRODUCT REVIEWS, LINKS TO THE RETAIL WEB SITES OF OTHERS, AND DISCOUNT INFORMATION (U.S. CLS. 100, 101 AND 102).

CARYN GLASSER, EXAMINING ATTORNEY

SN 77-888,718. VISIBLE HOMES, LLC, ANN ARBOR, MI.
FILED 12-8-2009.

Visible Homes

THE MARK CONSISTS OF STANDARD CHARACTERS WITHOUT CLAIM TO ANY PARTICULAR FONT, STYLE, SIZE, OR COLOR.

NO CLAIM IS MADE TO THE EXCLUSIVE RIGHT TO USE "HOMES", APART FROM THE MARK AS SHOWN.

FOR ADVERTISING OF COMMERCIAL OR RESIDENTIAL REAL ESTATE; REAL ESTATE MARKETING ANALYSIS; REAL ESTATE MARKETING SERVICES IN THE FIELD OF CONDOMINIUMS, LUXURY HOMES, HOMES, FARMS; REAL ESTATE MARKETING SERVICES, NAMELY, ON-LINE SERVICES FEATURING TOURS OF RESIDENTIAL AND COMMERCIAL REAL ESTATE (U.S. CLS. 100, 101 AND 102).

FIRST USE 8-19-2009; IN COMMERCE 11-9-2009.
SUSAN RICHARDS, EXAMINING ATTORNEY

SN 77-888,816. BLUE SUN LLC, NEW ALBANY, IN. FILED 12-8-2009.



THE COLOR(S) BLACK AND BLUE IS/ARE CLAIMED AS A FEATURE OF THE MARK.

THE MARK CONSISTS OF A HALF CIRCLE IN THE COLOR BLUE, WITH A LIGHTENING OF THE SHADE OF BLUE TOWARDS THE BOTTOM OF THE HALF CIRCLE, ON TOP OF AN ARC IN THE COLOR BLUE, WHICH TAPERS SLIGHTLY AT THE RIGHT END, ALL ON TOP OF THE TWO WORDS "BLUE SUN" IN TYPED BLACK LETTERS WITH A STRAIGHT BLUE LINE UNDERNEATH.

FOR REAL ESTATE MARKETING SERVICES IN THE FIELD OF COMMERCIAL REAL ESTATE (U.S. CLS. 100, 101 AND 102).

JANET LEE, EXAMINING ATTORNEY

CLASS 35—(Continued).

SN 77-888,820. A. B. CLOSING CORPORATION, DBA KAVALIRO INC., ORLANDO, FL. FILED 12-8-2009.

Kavaliro

THE MARK CONSISTS OF STANDARD CHARACTERS WITHOUT CLAIM TO ANY PARTICULAR FONT, STYLE, SIZE, OR COLOR.

FOR BUSINESS CONSULTING SERVICES RELATING TO THE INTEGRATION OF THE AREAS OF BUSINESS PROCESS TECHNOLOGY, ORGANIZATIONAL LEARNING, CHANGE MANAGEMENT, AND OPERATIONAL SUSTAINABILITY; BUSINESS MANAGEMENT CONSULTING WITH RELATION TO STRATEGY, FINANCING, MARKETING, PRODUCTION, PERSONNEL AND SALE MATTERS FOR COMPANIES INVOLVED WITH THIN FILM AND NANO TECHNOLOGIES AND PLASMA PROCESSES; EMPLOYMENT AGENCY SERVICES, NAMELY, FILLING THE TEMPORARY AND PERMANENT STAFFING NEEDS OF BUSINESSES; EMPLOYMENT HIRING, RECRUITING, PLACEMENT, STAFFING AND CAREER NETWORKING SERVICES; EMPLOYMENT STAFFING CONSULTATION SERVICES; EMPLOYMENT STAFFING IN THE FIELD OF TECHNOLOGY; PROFESSIONAL STAFFING AND RECRUITING SERVICES; STRATEGIC SOURCING, NAMELY, STAFFING IN THE FIELD OF ENGINEERING (U.S. CLS. 100, 101 AND 102).

ELISSA GARBER KON, EXAMINING ATTORNEY

SN 77-888,882. RACETRAC PETROLEUM, INC., ATLANTA, GA. FILED 12-8-2009.

TRAC FANATIC

THE MARK CONSISTS OF STANDARD CHARACTERS WITHOUT CLAIM TO ANY PARTICULAR FONT, STYLE, SIZE, OR COLOR.

FOR CUSTOMER LOYALTY SERVICES FOR COMMERCIAL, PROMOTIONAL AND/OR ADVERTISING PURPOSES (U.S. CLS. 100, 101 AND 102).

KAPIL BHANOT, EXAMINING ATTORNEY

CLASS 35—(Continued).

SN 77-888,883. WARNATH, STEPHEN, WASHINGTON, DC. FILED 12-8-2009.

NEXUS INSTITUTE

THE MARK CONSISTS OF STANDARD CHARACTERS WITHOUT CLAIM TO ANY PARTICULAR FONT, STYLE, SIZE, OR COLOR.

NO CLAIM IS MADE TO THE EXCLUSIVE RIGHT TO USE "INSTITUTE", APART FROM THE MARK AS SHOWN, FOR PUBLIC POLICY RESEARCH INFORMATION AND ADVISORY SERVICES (U.S. CLS. 100, 101 AND 102).

FIRST USE 12-1-2003; IN COMMERCE 3-1-2004.

KAPIL BHANOT, EXAMINING ATTORNEY

SN 77-888,892. PHYSERVE PHYSICIAN SERVICES, INC., DALLAS, TX. FILED 12-8-2009.

PhyServe

THE MARK CONSISTS OF STANDARD CHARACTERS WITHOUT CLAIM TO ANY PARTICULAR FONT, STYLE, SIZE, OR COLOR.

FOR BUSINESS CONSULTING SERVICES TO THE MEDICAL PROFESSION (U.S. CLS. 100, 101 AND 102).

FIRST USE 11-1-2009; IN COMMERCE 11-1-2009.

ODESSA BIBBINS, EXAMINING ATTORNEY

SN 77-888,902. ERT SALES OF HAWAII, INC., PEARL CITY, HI. FILED 12-8-2009.

PRICE BUSTERS

THE MARK CONSISTS OF STANDARD CHARACTERS WITHOUT CLAIM TO ANY PARTICULAR FONT, STYLE, SIZE, OR COLOR.

NO CLAIM IS MADE TO THE EXCLUSIVE RIGHT TO USE "PRICE", APART FROM THE MARK AS SHOWN.

FOR RETAIL STORE SERVICES FEATURING SEASONAL MERCHANDISE FOR VALENTINE'S DAY, EASTER, HALLOWEEN AND CHRISTMAS (U.S. CLS. 100, 101 AND 102).

FIRST USE 12-1-2004; IN COMMERCE 12-1-2004.

KAPIL BHANOT, EXAMINING ATTORNEY

CLASS 35—(Continued).

SN 77-888,916. CANDICE BENNETT & ASSOCIATES, INC.,
LORTON, VA. FILED 12-8-2009.

SNiQR

THE MARK CONSISTS OF STANDARD CHARACTERS
WITHOUT CLAIM TO ANY PARTICULAR FONT, STYLE,
SIZE, OR COLOR.

FOR MARKET RESEARCH AND MARKET INTELLI-
GENCE SERVICES (U.S. CLS. 100, 101 AND 102).
MICHAEL WIENER, EXAMINING ATTORNEY

SN 77-888,938. FARM COUNTRY TRADER, INC., INWOOD,
IA. FILED 12-8-2009.

FRASSIFIEDS.COM

THE MARK CONSISTS OF STANDARD CHARACTERS
WITHOUT CLAIM TO ANY PARTICULAR FONT, STYLE,
SIZE, OR COLOR.

FOR ADVERTISING AND MARKETING SERVICES,
NAMELY, PROMOTING THE GOODS AND SERVICES
OF OTHERS (U.S. CLS. 100, 101 AND 102).
MICHAEL WIENER, EXAMINING ATTORNEY

SN 77-889,094. GREEN LAB DESIGN STUDIO, LTD., HOL-
LYWOOD, CA. FILED 12-8-2009.

greenLAB

THE MARK CONSISTS OF THE WORD "GREEN" AND
"LAB" COMBINED TO FORM "GREENLAB" IN A STY-
LIZED FORMAT; THE WORD "GREEN" IS IN LOWER
CASE, THE WORD "LAB" IS CAPITALIZED IN A CUSTOM
FONT.

FOR ADVERTISING AGENCY SPECIALIZING IN THE
DESIGN AND EXECUTION OF WORD OF MOUTH,
VIRAL, BUZZ AND EXPERIENTIAL MARKETING PRO-
GRAMS (U.S. CLS. 100, 101 AND 102).

FIRST USE 7-1-2008; IN COMMERCE 7-1-2008.
SHAILA SETTLES, EXAMINING ATTORNEY

CLASS 35—(Continued).

SN 77-889,103. HELLER, ADAM S., ALBUQUERQUE, NM,
AND MESLER, LARRY M., CARMEL VALLEY, CA.
FILED 12-8-2009.

DRYVE DRY

THE MARK CONSISTS OF STANDARD CHARACTERS
WITHOUT CLAIM TO ANY PARTICULAR FONT, STYLE,
SIZE, OR COLOR.

FOR ADMINISTRATION OF A DISCOUNT PROGRAM
FOR ENABLING PARTICIPANTS TO OBTAIN DIS-
COUNTS ON THE COST OF SERVICES OR RECEIVE
IMPROVED SERVICES THROUGH USE OF A MEMBER-
SHIP CARD (U.S. CLS. 100, 101 AND 102).

JANICE L. MCMORROW, EXAMINING ATTORNEY

SN 77-889,206. ATLARGE, INC., SARASOTA, FL. FILED 12-9-
2009.

ATLARGE

THE MARK CONSISTS OF STANDARD CHARACTERS
WITHOUT CLAIM TO ANY PARTICULAR FONT, STYLE,
SIZE, OR COLOR.

FOR BUSINESS MONITORING AND CONSULTING
SERVICES, NAMELY, TRACKING WEB SITES AND
APPLICATIONS OF OTHERS TO PROVIDE STRATEGY,
INSIGHT, MARKETING, SALES, OPERATION, PRO-
DUCT DESIGN, PARTICULARLY SPECIALIZING IN
THE USE OF ANALYTIC AND STATISTIC MODELS
FOR THE UNDERSTANDING AND PREDICTING OF
CONSUMERS, BUSINESSES, AND MARKET TRENDS
AND ACTIONS; BUSINESS MONITORING SERVICES,
NAMELY, TRACKING WEB SITES OF OTHERS TO
PROVIDE DETAILS ABOUT USER CLICK TRAFFIC
OR VISITS TO THE WEB SITE (U.S. CLS. 100, 101 AND
102).

FIRST USE 6-0-2001; IN COMMERCE 6-0-2004.
TRACY CROSS, EXAMINING ATTORNEY

SN 77-889,293. KLASSMAN, LISA, WILMINGTON, DE.
FILED 12-9-2009.

SUGAR POSH

THE MARK CONSISTS OF STANDARD CHARACTERS
WITHOUT CLAIM TO ANY PARTICULAR FONT, STYLE,
SIZE, OR COLOR.

FOR RETAIL STORE SERVICES FEATURING TOYS,
CANDY, ARTS AND CRAFTS FOR GIRLS, CLOTHING,
JEWELRY, ACCESSORIES, STATIONERY, GLASSWARE,
BOOKS, COSMETICS, PACKAGED BAKED GOODS, ICE
CREAM AND PERFUMES (U.S. CLS. 100, 101 AND 102).

JEFF DEFORD, EXAMINING ATTORNEY

CLASS 35—(Continued).

SN 77-889,777. GATEWAY AREA FOUNDATION, CLINTON, IA. FILED 12-9-2009.



NO CLAIM IS MADE TO THE EXCLUSIVE RIGHT TO USE "CLINTON IOWA CONVENTION & VISITORS BUREAU" AND "CLINTON" "CAMANCHE" "FULTON", APART FROM THE MARK AS SHOWN.

THE MARK CONSISTS OF THE TEXT "CLINTON IOWA" FOLLOWED BY A CARTOON PICTURE OF THE SUN AND A LIGHT HOUSE FOLLOWED BY THE TEXT "CONVENTION & VISITORS BUREAU CLINTON . CAMANCHE . FULTON" STACK WRITTEN IN THREE LINES. UNDER ALL THIS, ARE TWO LINE DESIGNS WITH THE TEXT "THINGS TO DO ... WITH A RIVER VIEW!" UNDER IT.

FOR CONVENTION AND VISITORS BUREAU SERVICES, NAMELY, PROMOTING CONVENTIONS AND TOURISM IN THE CLINTON, IOWA AREA (U.S. CLS. 100, 101 AND 102).

FIRST USE 12-1-1999; IN COMMERCE 12-1-1999.
REBECCA SMITH, EXAMINING ATTORNEY

SN 77-889,782. ELEMENT 52 LLC, HANKSVILLE, UT. FILED 12-9-2009.

Element 52

THE MARK CONSISTS OF STANDARD CHARACTERS WITHOUT CLAIM TO ANY PARTICULAR FONT, STYLE, SIZE, OR COLOR.

FOR REAL ESTATE MARKETING SERVICES IN THE FIELD OF CONDOMINIUMS (U.S. CLS. 100, 101 AND 102).

GEORGE LORENZO, EXAMINING ATTORNEY

SN 77-889,821. LEE, BONNIE, DBA SYMMETRY BUSINESS SERVICES, BOYES HOT SPRINGS, CA. FILED 12-9-2009.

TAXPERTISE

THE MARK CONSISTS OF STANDARD CHARACTERS WITHOUT CLAIM TO ANY PARTICULAR FONT, STYLE, SIZE, OR COLOR.

FOR TAX ADVISORY SERVICES; TAX CONSULTATION; TAX FILING SERVICES; TAX PREPARATION (U.S. CLS. 100, 101 AND 102).

MARLENE BELL, EXAMINING ATTORNEY

CLASS 35—(Continued).

SN 77-889,999. THE COLLECTIVE EXPERIENCE LLC, BOISE, ID. FILED 12-9-2009.

The Collective Experience

THE MARK CONSISTS OF STANDARD CHARACTERS WITHOUT CLAIM TO ANY PARTICULAR FONT, STYLE, SIZE, OR COLOR.

FOR BUSINESS CONSULTING SERVICES, NAMELY, PROVIDING ASSISTANCE IN DEVELOPMENT OF BUSINESS STRATEGIES AND CREATIVE IDEATION (U.S. CLS. 100, 101 AND 102).

YAT SYE, LEE, EXAMINING ATTORNEY

SN 77-890,029. LITKOS, WEST HARTFORD, CT. FILED 12-9-2009.

WEB.YOU.O

THE MARK CONSISTS OF STANDARD CHARACTERS WITHOUT CLAIM TO ANY PARTICULAR FONT, STYLE, SIZE, OR COLOR.

FOR ON-LINE BUSINESS NETWORKING SERVICES (U.S. CLS. 100, 101 AND 102).

SUE LAWRENCE, EXAMINING ATTORNEY

SN 77-890,053. RICK KEPPLER, MANHATTAN BEACH, CA. FILED 12-9-2009.

BRANDVIL

THE MARK CONSISTS OF STANDARD CHARACTERS WITHOUT CLAIM TO ANY PARTICULAR FONT, STYLE, SIZE, OR COLOR.

FOR ADVERTISING, MARKETING AND PROMOTION SERVICES; MARKETING CONSULTING; ON-LINE ADVERTISING AND MARKETING SERVICES; PROMOTION AND MARKETING SERVICES AND RELATED CONSULTING; PROMOTION, ADVERTISING AND MARKETING OF ON-LINE WEBSITES; PROVIDING A SEARCHABLE WEBSITE FEATURING THE GOODS AND SERVICES OF OTHER VENDORS; PROVIDING BUSINESS MARKETING INFORMATION; PROVIDING CONSULTING SERVICES IN THE FIELD OF FACILITATING THE PLANNING, BUYING, AND SELLING OF MEDIA; PROVIDING CONSUMER INFORMATION SERVICES AND MAKING REFERRALS IN THE FIELD OF ENTERTAINMENT SERVICES FOR PRODUCTS, SERVICES, EVENTS, ACTIVITIES, FACILITIES AND LOCATIONS; PROVIDING INFORMATION IN THE FIELD OF MARKETING AND ON-LINE MARKETING MEDIA VIA THE INTERNET (U.S. CLS. 100, 101 AND 102).

FIRST USE 12-1-2009; IN COMMERCE 12-1-2009.
LYDIA BELZER, EXAMINING ATTORNEY

CLASS 35—(Continued).

SN 77-890,129. COVINGTON PARTNERS LLC, SILVER SPRING, MD. FILED 12-10-2009.

JASMERE

THE MARK CONSISTS OF STANDARD CHARACTERS WITHOUT CLAIM TO ANY PARTICULAR FONT, STYLE, SIZE, OR COLOR.

THE WORDING "JASMERE" HAS NO MEANING IN A FOREIGN LANGUAGE.

FOR PROVIDING A WEBSITE THAT PROMOTES THE GOODS OF OTHERS, NAMELY, PROVIDING INFORMATION REGARDING DISCOUNTS, COUPONS, REBATES, VOUCHERS AND SPECIAL OFFERS FOR THE GOODS OF OTHERS (U.S. CLS. 100, 101 AND 102).

FIRST USE 10-0-2009; IN COMMERCE 12-7-2009.
ROBIN CHOSID, EXAMINING ATTORNEY

SN 77-890,142. JUST CAUSE MARKETING, INC., NEW RICHMOND, OH. FILED 12-10-2009.

K.O.I. ~ Kapitalizing On Investment

THE MARK CONSISTS OF STANDARD CHARACTERS WITHOUT CLAIM TO ANY PARTICULAR FONT, STYLE, SIZE, OR COLOR.

FOR ADVERTISING, MARKETING AND PROMOTION SERVICES (U.S. CLS. 100, 101 AND 102).

FIRST USE 12-9-2009; IN COMMERCE 12-9-2009.
NICHOLAS ALTREE, EXAMINING ATTORNEY

SN 77-890,191. ISAAC DANIEL GROUP, INC., MIRAMAR, FL. FILED 12-10-2009.

GENIE

THE MARK CONSISTS OF STANDARD CHARACTERS WITHOUT CLAIM TO ANY PARTICULAR FONT, STYLE, SIZE, OR COLOR.

FOR PROVIDING A WEBSITE FOR WHICH ADVERTISERS AND MARKETERS CAN OFFER DISCOUNTS AND REBATES FOR THE COST OF GOODS AND SERVICES (U.S. CLS. 100, 101 AND 102).

KARANENDRA S. CHHINA, EXAMINING ATTORNEY

CLASS 35—(Continued).

SN 77-890,226. CAREERBUILDER LLC, CHICAGO, IL. FILED 12-10-2009.

CBSALARY

THE MARK CONSISTS OF STANDARD CHARACTERS WITHOUT CLAIM TO ANY PARTICULAR FONT, STYLE, SIZE, OR COLOR.

FOR PROVIDING AN INTERNET WEBSITE FEATURING EMPLOYMENT INFORMATION PERTAINING TO EMPLOYEE COMPENSATION, SALARY, BONUSES, BENEFITS, JOB DESCRIPTIONS AND NEGOTIATION OF RAISES AND PROMOTIONS (U.S. CLS. 100, 101 AND 102).

MICHAEL WIENER, EXAMINING ATTORNEY

SN 77-890,262. NATIONAL VOLUNTARY ORGANIZATIONS ACTIVE IN DISASTER, INC., AKA NATIONAL VOAD; NVOAD, ARLINGTON, VA. FILED 12-10-2009.

VOAD

THE MARK CONSISTS OF STANDARD CHARACTERS WITHOUT CLAIM TO ANY PARTICULAR FONT, STYLE, SIZE, OR COLOR.

FOR ASSOCIATION SERVICES, NAMELY, PROMOTING COMMUNICATION, COORDINATION, COOPERATION AND COLLABORATION AMONG DISASTER RESPONSE ORGANIZATIONS (U.S. CLS. 100, 101 AND 102).

FIRST USE 1-31-1970; IN COMMERCE 1-31-1970.
ESTHER BELENKER, EXAMINING ATTORNEY

SN 77-890,266. MARSH INC., NEW YORK, NY. FILED 12-10-2009.

GREENRETURN

THE MARK CONSISTS OF STANDARD CHARACTERS WITHOUT CLAIM TO ANY PARTICULAR FONT, STYLE, SIZE, OR COLOR.

FOR PROVIDING BUSINESS ANALYSIS IN THE FIELD OF GREEN CONSTRUCTION, NAMELY, ANALYZING AND EVALUATING COSTS AND BENEFITS OF GREEN CONSTRUCTION AND ESTIMATING THE RETURN ON INVESTMENT (U.S. CLS. 100, 101 AND 102).

FIRST USE 10-15-2009; IN COMMERCE 10-15-2009.
TRACY FLETCHER, EXAMINING ATTORNEY

CLASS 35—(Continued).

SN 77-890,276. ACCORDION PARTNERS LLC, NEW YORK, NY. FILED 12-10-2009.



THE MARK CONSISTS OF THREE STYLIZED AND DIFFERING DIAMOND SHAPES, HALF OF EACH DIAMOND SHAPE SHADED LIGHTER THAN THE OTHER HALF, TOUCHING IN THE MIDDLE, AND EXTENDING OUTWARD IN DIFFERENT DIRECTIONS.

FOR BUSINESS CONSULTING AND INFORMATION SERVICES; PERSONNEL PLACEMENT AND RECRUITMENT (U.S. CLS. 100, 101 AND 102).

FIRST USE 1-31-2009; IN COMMERCE 1-31-2009.
KEVIN CORWIN, EXAMINING ATTORNEY

CLASS 35—(Continued).

SN 77-890,351. ENEWORLDJOBS.COM LLC, JACKSON CENTER, OH. FILED 12-10-2009.

ENEWWORLDJOBS

THE MARK CONSISTS OF STANDARD CHARACTERS WITHOUT CLAIM TO ANY PARTICULAR FONT, STYLE, SIZE, OR COLOR.

FOR BUSINESS MANAGEMENT CONSULTANCY IN THE FIELD OF INSOURCING, NAMELY, ASSISTING BUSINESSES IN THE DEVELOPMENT OF PROCESSES FOR THE ANALYSIS AND THE IMPLEMENTATION OF THE DELEGATION OF OPERATIONS OR JOBS FROM PRODUCTION WITHIN A BUSINESS TO AN INTERNAL ENTITY THAT SPECIALIZES IN THAT OPERATION; JOB AND PERSONNEL PLACEMENT; JOB PLACEMENT; PROVIDING A JOB-READINESS AND CAREER-DEVELOPMENT WEBSITE FEATURING INFORMATION FOR COLLEGIATE ATHLETES THAT HAVE GRADUATED OR WHO ARE GRADUATING; PROVIDING DEMAND CREATION AND LEAD GENERATION ACTIVITIES AND SERVICES; PROVIDING EMPLOYMENT COUNSELING INFORMATION ON HOW TO SUCCESSFULLY TRANSITION JOBS FOR MATURE WORKERS; PROVIDING INFORMATION ON THE TOPIC OF DETERMINING JOB SATISFACTION (U.S. CLS. 100, 101 AND 102).

TRACY WHITTAKER-BROWN, EXAMINING ATTORNEY

SN 77-890,322. TYCO VALVES & CONTROLS, INC., HOUSTON, TX. FILED 12-10-2009.

VITAL WORLD

THE MARK CONSISTS OF STANDARD CHARACTERS WITHOUT CLAIM TO ANY PARTICULAR FONT, STYLE, SIZE, OR COLOR.

FOR PROMOTING ENVIRONMENTALLY CONSCIOUS AND GREEN INNOVATIONS FOR USE BY BUSINESS (U.S. CLS. 100, 101 AND 102).

COLLEEN KEARNEY, EXAMINING ATTORNEY

SN 77-890,449. CHEVON HICKS, LOS ANGELES, CA. FILED 12-10-2009.

HEAVENSPOT

THE MARK CONSISTS OF STANDARD CHARACTERS WITHOUT CLAIM TO ANY PARTICULAR FONT, STYLE, SIZE, OR COLOR.

FOR CREATIVE MARKETING DESIGN SERVICES (U.S. CLS. 100, 101 AND 102).

FIRST USE 5-6-1997; IN COMMERCE 10-12-1997.
GEORGE LORENZO, EXAMINING ATTORNEY

CLASS 35—(Continued).

SN 77-890,469. MATTRESS INN, INC., NASHVILLE, TN.
FILED 12-10-2009.

MATTRESS INN RESORT

THE MARK CONSISTS OF STANDARD CHARACTERS WITHOUT CLAIM TO ANY PARTICULAR FONT, STYLE, SIZE, OR COLOR.

OWNER OF U.S. REG. NO. 3,608,612.

NO CLAIM IS MADE TO THE EXCLUSIVE RIGHT TO USE "MATTRESS", APART FROM THE MARK AS SHOWN.

FOR RETAIL SHOPS FEATURING MATTRESSES THAT CUSTOMERS CAN TRY BEFORE PURCHASING (U.S. CLS. 100, 101 AND 102).

ANGELA DUONG, EXAMINING ATTORNEY

SN 77-890,496. NEUROFOCUS, INC., BERKELEY, CA. FILED
12-10-2009.



OWNER OF U.S. REG. NOS. 3,421,532 AND 3,655,177.

THE MARK CONSISTS OF STYLIZED CHARACTERS SPELLING "NEUROFOCUS".

FOR ADVERTISING AND MARKETING; ADVERTISING SERVICES, NAMELY, PROMOTING AND MARKETING THE GOODS AND SERVICES OF OTHERS THROUGH ALL PUBLIC COMMUNICATION MEANS; ADVERTISING SERVICES, PUBLIC RELATIONS AND MARKETING SERVICES, NAMELY, PROMOTING AND MARKETING THE GOODS AND SERVICES OF OTHERS THROUGH ALL PUBLIC COMMUNICATION MEANS; ADVERTISING, MARKETING AND PROMOTION SERVICES; ADVICE CONCERNING CHEMICAL PRODUCT MARKETING; ADVICE IN THE FIELD OF BUSINESS MANAGEMENT AND MARKETING; ANALYZING AND COMPILING DATA FOR MEASURING THE PERFORMANCE OF FINANCIAL MARKETS; ARRANGING AND CONDUCTING MARKETING PROMOTIONAL EVENTS FOR OTHERS; BUSINESS ADVICE AND ANALYSIS OF MARKETS; BUSINESS CONSULTATION AND MANAGEMENT REGARDING MARKETING ACTIVITIES AND LAUNCHING OF NEW PRODUCTS; BUSINESS MANAGEMENT CONSULTING WITH RELATION TO STRATEGY, MARKETING, PRODUCTION, PERSONNEL AND RETAIL SALE MATTERS; BUSINESS MARKETING AND DIRECT MAIL CONSULTING SERVICES; BUSINESS MARKETING CONSULTING SERVICES; BUSINESS MARKETING CONSULTING SERVICES TO CHILDCARE ORGANIZATIONS; BUSINESS MARKETING SERVICES; COMMERCIAL INFORMATION AGENCIES; CONDUCTING BUSINESS AND MARKET RESEARCH SURVEYS; CONDUCTING MARKETING STUDIES; COOPERATIVE ADVERTISING AND MARKETING; COOPERATIVE ADVERTISING AND MARKETING SERVICES BY WAY OF SOLICITATION, CUSTOMER SERVICE AND PROVIDING MARKETING INFORMATION VIA WEBSITES ON A GLOBAL COMPUTER NETWORK; CREATION OF MARKETING TOOLS DESIGNED TO INCREASE A CLIENT COMPANY'S KNOWLEDGE OF CUSTOMER NEEDS, AND ITS COMPETITORS' PRODUCTS AND SERVICES, PRICING, ADVERTISING STRATEGY AND SALES STRATEGY; CREATIVE MARKETING DESIGN SERVICES; CUSTOM WRITING SERVICES COMPRISING PUBLIC RELATIONS AND MARKETING MATERIALS FOR THE AUDIO, VIDEO AND TECHNOLOGY INDUSTRIES; DEVELOPMENT OF MARKETING STRATEGIES AND CONCEPTS; DIRECT MARKETING ADVERTISING FOR OTHERS; DIRECT MARKETING SERVICES; ENTERTAINMENT MARKETING SERVICES, NAMELY, MARKETING, PROMOTION AND ADVERTISING FOR INDEPENDENT RECORDING ARTISTS; FLEA MAR-

CLASS 35—(Continued).

KETS; GENERAL BUSINESS MERCHANDISING SERVICES, NAMELY, MARKETING; GRAIN MARKET ANALYSIS; IMPLEMENTATION AND FOLLOW-UP OF ADVICE IN THE FIELDS OF MARKETING; INFORMATION OR ENQUIRIES ON BUSINESS AND MARKETING; MARKET ANALYSIS; MARKET MANIPULATION, RESEARCH AND ANALYSIS, WHETHER OR NOT VIA THE INTERNET; MARKET OPINION POLLING STUDIES; MARKET REPORTS AND STUDIES; MARKET RESEARCH; MARKET RESEARCH CONSULTATION; MARKET RESEARCH SERVICES; MARKET RESEARCH STUDIES; MARKET SEGMENTATION CONSULTATION; MARKET STUDY AND ANALYSIS OF MARKET STUDIES; MARKETING CONSULTATION IN THE FIELD OF NEW OR EXISTING PRODUCTS AND SERVICES; MARKETING CONSULTING; MARKETING PLAN DEVELOPMENT; MARKETING SERVICES, NAMELY, PROVIDING INFORMATIONAL WEB PAGES DESIGNED TO GENERATE SALES TRAFFIC VIA HYPERLINKS TO OTHER WEB SITES; MEDIA PLANNING, NAMELY, ADVISING THE CLIENT ON THE CORRECT TIMES AND STATIONS TO ADVERTISE BASED ON MEDIA ANALYSIS OF THE MARKET FOR THAT MEDIA; MULTI-LEVEL MARKETING BUSINESS SERVICES; ON-LINE ADVERTISING AND MARKETING SERVICES; PROMOTING, ADVERTISING AND MARKETING OF THE ON-LINE WEBSITES OF OTHERS; PROMOTION AND MARKETING SERVICES AND RELATED CONSULTING; PROMOTION, ADVERTISING AND MARKETING OF ON-LINE WEBSITES; PROVIDING ADVERTISING, MARKETING AND PROMOTIONAL SERVICES FOR THE PHARMACEUTICAL AND MEDICAL PRODUCTS OF OTHERS; PROVIDING ADVERTISING, MARKETING AND PROMOTIONAL SERVICES, NAMELY, DEVELOPMENT OF ADVERTISING CAMPAIGNS FOR COMMUNICATION VIA TELEVISION, RADIO, WEB, PRINT, SIGNAGE, POINT-OF-PURCHASE AND AUDIOVISUAL DISPLAYS, BILLBOARDS AND VIDEO GAMES; PROVIDING BUSINESS MARKETING INFORMATION; PROVIDING FINANCIAL INDICES OF SELECT BONDS TO ENABLE CONSUMERS TO EVALUATE INVESTMENTS AND MARKET TRENDS IN THE BOND MARKET; PROVIDING INFORMATION IN THE FIELD OF MARKETING AND ON-LINE MARKETING MEDIA VIA THE INTERNET; PROVIDING MARKETING AND PROMOTION OF SPECIAL EVENTS; PROVIDING PROMOTIONAL MARKETING SERVICES TO BUSINESSES IN THE BROADBAND AND MEDIA INDUSTRIES; REAL ESTATE MARKETING SERVICES IN THE FIELD OF COMMERCIAL AND RESIDENTIAL PROPERTY DEVELOPMENTS; REAL ESTATE MARKETING SERVICES, NAMELY, ON-LINE SERVICES FEATURING TOURS OF RESIDENTIAL AND COMMERCIAL REAL ESTATE; RENTAL OF ALL PUBLICITY AND MARKETING PRESENTATION MATERIALS; STATISTICAL EVALUATIONS OF MARKETING DATA; COLLECTION AND/OR ANALYSIS OF NEUROLOGICAL, NEUROPHYSIOLOGICAL AND/OR EFFECTOR RESPONSES COLLECTED BY MEDICAL IMAGING, SUCH AS EEG AND/OR OTHER MODALITIES FROM SUBJECTS EXPOSED TO STIMULUS, FOR USE IN MARKET RESEARCH, BRAND ANALYSIS, PRODUCT IMPACT, ADVERTISING EFFECTIVENESS AND/OR MEDIA CONSULTATION; COLLECTION AND/OR ANALYSIS OF NEUROLOGICAL, NEUROPHYSIOLOGICAL AND/OR EFFECTOR RESPONSES COLLECTED BY MEDICAL IMAGING, SUCH AS EEG AND/OR OTHER MODALITIES FROM SUBJECTS EXPOSED TO STIMULUS, FOR USE IN MARKET RESEARCH, BRAND ANALYSIS, PRODUCT IMPACT, ADVERTISING EFFECTIVENESS AND/OR MEDIA CONSULTATION FEATUR-

CLASS 35—(Continued).

ING A NEUROINFORMATICS REPOSITORY INCLUDING NEURORESPONSE DATA FOR USE IN MARKET RESEARCH, BRAND ANALYSIS, PRODUCT IMPACT, ADVERTISING EFFECTIVENESS AND/OR MEDIA CONSULTATION; MEDICAL IMAGING, NAMELY, NEUROIMAGING FOR USE IN MARKET RESEARCH, BRAND ANALYSIS, PRODUCT IMPACT, ADVERTISING EFFECTIVENESS AND/OR MEDIA CONSULTATION; BUSINESS SERVICES, NAMELY, ANALYSIS OF ADVERTISING EFFECTIVENESS, BRANDS, IMAGES, PRODUCT IMPACT, PRODUCT PRICING, AND MEDIA (U.S. CLS. 100, 101 AND 102).

FIRST USE 12-1-2009; IN COMMERCE 12-1-2009.
ANNE E. GUSTASON, EXAMINING ATTORNEY

SN 77-890,498. MENZA, ANTHONY C., DBA BLACK LIGHT WORLD, CUB RUN, KY. FILED 12-10-2009.

BLACK LIGHT WORLD

THE MARK CONSISTS OF STANDARD CHARACTERS WITHOUT CLAIM TO ANY PARTICULAR FONT, STYLE, SIZE, OR COLOR.

NO CLAIM IS MADE TO THE EXCLUSIVE RIGHT TO USE "BLACK LIGHT", APART FROM THE MARK AS SHOWN.

FOR ON-LINE RETAIL STORE SERVICES FEATURING BLACK LIGHTS, GLOW PAINTS AND POWDERS, INKS, INVISIBLE INKS, STAMP PADS AND STAMPING KITS, UV DYES, MARKING PENS, COUNTERFEIT CURRENCY DETECTION KITS, INVISIBLE INK MARKING PENS, PET STAIN AND ODOR REMOVAL SUPPLIES, AND UV PROTECTIVE GLASSES (U.S. CLS. 100, 101 AND 102).

FIRST USE 0-0-2002; IN COMMERCE 0-0-2002.
FRED CARL, EXAMINING ATTORNEY

SN 77-890,507. CHEVON HICKS, LOS ANGELES, CA. FILED 12-10-2009.



THE MARK CONSISTS OF A CHILD'S ANIMATED FACE SCREAMING ON A BULL'S-EYE BACKGROUND.

FOR CREATIVE MARKETING DESIGN SERVICES (U.S. CLS. 100, 101 AND 102).

FIRST USE 5-6-1997; IN COMMERCE 10-12-1997.
GEORGE LORENZO, EXAMINING ATTORNEY

CLASS 35—(Continued).

SN 77-890,556. GENDER ACTION, WASHINGTON, DC. FILED 12-10-2009.

GENDER ACTION

THE MARK CONSISTS OF STANDARD CHARACTERS WITHOUT CLAIM TO ANY PARTICULAR FONT, STYLE, SIZE, OR COLOR.

OWNER OF U.S. REG. NO. 2,897,986.

NO CLAIM IS MADE TO THE EXCLUSIVE RIGHT TO USE "GENDER", APART FROM THE MARK AS SHOWN.

FOR PUBLIC ADVOCACY TO PROMOTE AWARENESS OF GENDER EQUALITY AND GENDER JUSTICE (U.S. CLS. 100, 101 AND 102).

FIRST USE 5-13-2002; IN COMMERCE 5-13-2002.

BERNICE MIDDLETON, EXAMINING ATTORNEY

SN 77-890,630. SIMPLEREGISTRY, INC, WILMINGTON, DE. FILED 12-10-2009.

SimpleRegistry

THE MARK CONSISTS OF STANDARD CHARACTERS WITHOUT CLAIM TO ANY PARTICULAR FONT, STYLE, SIZE, OR COLOR.

FOR GIFT REGISTRY SERVICES (U.S. CLS. 100, 101 AND 102).

ANTHONY RINKER, EXAMINING ATTORNEY

SN 77-890,631. NATIONAL VOLUNTARY ORGANIZATIONS ACTIVE IN DISASTER, INC., AKA NATIONAL VOAD; NVOAD, ARLINGTON, VA. FILED 12-10-2009.

National VOAD

THE MARK CONSISTS OF STANDARD CHARACTERS WITHOUT CLAIM TO ANY PARTICULAR FONT, STYLE, SIZE, OR COLOR.

NO CLAIM IS MADE TO THE EXCLUSIVE RIGHT TO USE "NATIONAL", APART FROM THE MARK AS SHOWN.

FOR ASSOCIATION SERVICES, NAMELY, PROMOTING COMMUNICATION, COORDINATION, COOPERATION AND COLLABORATION AMONG DISASTER RESPONSE ORGANIZATIONS (U.S. CLS. 100, 101 AND 102).

FIRST USE 12-31-1991; IN COMMERCE 12-31-1991.

ESTHER BELENKER, EXAMINING ATTORNEY

CLASS 35—(Continued).

SN 77-890,664. HOMESWEETHOMEBRANDS FRANCHISE CORPORATION, ARCADIA, CA. FILED 12-10-2009.

love being the boss

THE MARK CONSISTS OF STANDARD CHARACTERS WITHOUT CLAIM TO ANY PARTICULAR FONT, STYLE, SIZE, OR COLOR.

FOR FRANCHISING, NAMELY, CONSULTATION AND ASSISTANCE IN BUSINESS MANAGEMENT, ORGANIZATION AND PROMOTION (U.S. CLS. 100, 101 AND 102).

FIRST USE 6-2-2009; IN COMMERCE 6-2-2009.
JUSTINE D. PARKER, EXAMINING ATTORNEY

CLASS 35—(Continued).

SN 77-890,763. PERSIAN MIRROR, LLC, NEW YORK, NY. FILED 12-10-2009.

PERSIANMIRROR

THE MARK CONSISTS OF STANDARD CHARACTERS WITHOUT CLAIM TO ANY PARTICULAR FONT, STYLE, SIZE, OR COLOR.

FOR ON-LINE RETAIL STORE SERVICES FEATURING BOOKS, GAMES, DVDS, TOYS, AND CLOTHING (U.S. CLS. 100, 101 AND 102).

JACLYN KIDWELL WALKER, EXAMINING ATTORNEY

SN 77-890,676. IMMERSION ACTIVE, FREDERICK, MD. FILED 12-10-2009.

INSPIRE INFLUENCE

THE MARK CONSISTS OF STANDARD CHARACTERS WITHOUT CLAIM TO ANY PARTICULAR FONT, STYLE, SIZE, OR COLOR.

FOR ADVERTISING AND MARKETING; CONSULTING SERVICES IN THE FIELD OF INTERNET MARKETING; DEVELOPING PROMOTIONAL CAMPAIGNS FOR BUSINESS; PROVIDING BUSINESS MANAGEMENT INFORMATION IN CONNECTION WITH CONSULTING AND ADVISORY SERVICES IN THE FIELD OF STRATEGIC PLANNING (U.S. CLS. 100, 101 AND 102).

FIRST USE 3-1-2009; IN COMMERCE 9-1-2009.
TINA MAI, EXAMINING ATTORNEY

SN 77-890,945. NETWORKMEDIA.COM INC., AVILA BEACH, CA. FILED 12-10-2009.

NETWORKMEDIA

THE MARK CONSISTS OF STANDARD CHARACTERS WITHOUT CLAIM TO ANY PARTICULAR FONT, STYLE, SIZE, OR COLOR.

FOR ADVERTISING AND MARKETING SERVICES (U.S. CLS. 100, 101 AND 102).

FIRST USE 5-1-2009; IN COMMERCE 5-1-2009.
GRETTA YAO, EXAMINING ATTORNEY

SN 77-890,755. SMITH MOUNTAIN INDUSTRIES, INC., FOREST, VA. FILED 12-10-2009.

MIKA

THE MARK CONSISTS OF STANDARD CHARACTERS WITHOUT CLAIM TO ANY PARTICULAR FONT, STYLE, SIZE, OR COLOR.

FOR ONLINE RETAIL STORE AND RETAIL STORE SERVICES, ALL IN THE FIELDS OF CANDLES, CANDLE ACCESSORIES, ELECTRIC ROOM FRAGRANCE DISPENSERS, SCENTED OILS, REED DIFFUSERS AND HOME FRAGRANCE PRODUCTS (U.S. CLS. 100, 101 AND 102).

IRA J. GOODSaid, EXAMINING ATTORNEY

SN 77-890,999. STUB MEDIA LLC, NEWARK, DE. FILED 12-10-2009.

GAMESTUB

THE MARK CONSISTS OF STANDARD CHARACTERS WITHOUT CLAIM TO ANY PARTICULAR FONT, STYLE, SIZE, OR COLOR.

FOR OPERATING AN ON-LINE MARKETPLACE FOR SELLERS AND BUYERS OF TICKETS FOR SPORTING EVENTS, CONCERTS, THEATER, SHOWS, AND OTHER ENTERTAINMENT EVENTS (U.S. CLS. 100, 101 AND 102).

FIRST USE 12-1-2009; IN COMMERCE 12-1-2009.
TAMARA FRAZIER, EXAMINING ATTORNEY

CLASS 35—(Continued).

SN 77-891,041. REALCME, INC., NEW YORK, NY. FILED 12-10-2009.

RealIndex

THE MARK CONSISTS OF STANDARD CHARACTERS WITHOUT CLAIM TO ANY PARTICULAR FONT, STYLE, SIZE, OR COLOR.

FOR ANALYZING AND COMPILING DATA FOR MEASURING THE PERFORMANCE OF MEDICAL EDUCATION ACTIVITIES AND CURRICULUM (U.S. CLS. 100, 101 AND 102).

FIRST USE 11-18-2009; IN COMMERCE 11-18-2009.
KAELE KUNG, EXAMINING ATTORNEY

SN 77-891,055. XTRAC LLC, BOSTON, MA. FILED 12-10-2009.

XTRAC

THE MARK CONSISTS OF STANDARD CHARACTERS WITHOUT CLAIM TO ANY PARTICULAR FONT, STYLE, SIZE, OR COLOR.

FOR BUSINESS PROCESS MANAGEMENT CONSULTING AND ADVISORY SERVICES (U.S. CLS. 100, 101 AND 102).

TINA L. SNAPP, EXAMINING ATTORNEY

SN 77-891,087. HEARTS OF GOLD, INC., NEW YORK, NY. FILED 12-11-2009.

THE THRIFTY HOG

THE MARK CONSISTS OF STANDARD CHARACTERS WITHOUT CLAIM TO ANY PARTICULAR FONT, STYLE, SIZE, OR COLOR.

FOR RETAIL THRIFT SHOP FEATURING CLOTHING, FURNITURE, HOUSEWARES, AND GENERAL MERCHANDISE (U.S. CLS. 100, 101 AND 102).

JUDITH HELFMAN, EXAMINING ATTORNEY

CLASS 35—(Continued).

SN 77-891,103. TYCO VALVES & CONTROLS, INC, HOUSTON, TX. FILED 12-11-2009.

VITAL JOURNEY

THE MARK CONSISTS OF STANDARD CHARACTERS WITHOUT CLAIM TO ANY PARTICULAR FONT, STYLE, SIZE, OR COLOR.

FOR PROMOTING ENVIRONMENTALLY CONSCIOUS AND GREEN INNOVATIONS FOR USE BY BUSINESSES (U.S. CLS. 100, 101 AND 102).

COLLEEN KEARNEY, EXAMINING ATTORNEY

SN 77-891,300. GIVE PROPS, INC., LA JOLLA, CA. FILED 12-11-2009.

POSITIVEFEED

THE MARK CONSISTS OF STANDARD CHARACTERS WITHOUT CLAIM TO ANY PARTICULAR FONT, STYLE, SIZE, OR COLOR.

FOR ADVERTISING AND MARKETING SERVICES FOR OTHERS, NAMELY, PREPARING ELECTRONIC AND PRINT ADVERTISEMENTS OF A PERSONAL NATURE (U.S. CLS. 100, 101 AND 102).

TARAH HARDY, EXAMINING ATTORNEY

SN 77-891,577. MVL RIGHTS LLC, MANHATTAN BEACH, CA. FILED 12-11-2009.

HALL OF ARMOR

THE MARK CONSISTS OF STANDARD CHARACTERS WITHOUT CLAIM TO ANY PARTICULAR FONT, STYLE, SIZE, OR COLOR.

FOR ADVERTISING AND MARKETING SERVICES, NAMELY, PROMOTING THE GOODS AND SERVICES OF OTHERS; ON-LINE RETAIL GIFT SHOPS; ON-LINE RETAIL STORE SERVICES FEATURING A WIDE VARIETY OF CONSUMER GOODS OF OTHERS; RETAIL GIFT SHOPS; RETAIL STORE AND ON-LINE RETAIL STORE SERVICES FEATURING TOYS, GAMES, PLAYTHINGS, STATIONERY, T-SHIRTS, BACKPACKS AND OTHER PRODUCTS FEATURING LICENSED FICTIONAL CHARACTERS; RETAIL STORE SERVICES FEATURING A WIDE VARIETY OF CONSUMER GOODS OF OTHERS (U.S. CLS. 100, 101 AND 102).

FLORENTINA BLANDU, EXAMINING ATTORNEY

CLASS 35—(Continued).

SN 77-891,935. PROFESSIONAL STAFFING SOLUTIONS INTERNATIONAL, LLC, TEWKSBURY, MA. FILED 12-11-2009.



strategic talent

NO CLAIM IS MADE TO THE EXCLUSIVE RIGHT TO USE "STRATEGICTALENT", APART FROM THE MARK AS SHOWN.

THE MARK CONSISTS OF THE WORDING "STRATEGICTALENT" WITH A SHADED CIRCLE OVER THE LETTER "C" IN "STRATEGIC" AND A SHADED CIRCLE OVER THE LETTER "A" IN "TALENT".

FOR PROFESSIONAL STAFFING AND RECRUITING SERVICES; PROVIDING AN EMPLOYER WITH CANDIDATES OR POTENTIAL EMPLOYEES TO FILL TEMPORARY, CONTRACT AND PERMANENT POSITIONS (U.S. CLS. 100, 101 AND 102).

KATHERINE STOIDES, EXAMINING ATTORNEY

CLASS 35—(Continued).

SN 77-892,085. TORO MONTOYA, DIEGO FERNANDO, TA I PROTECTED, CHARLOTTE, NC. FILED 12-12-2009.



TodoRemates

THE MARK CONSISTS OF STANDARD CHARACTERS WITHOUT CLAIM TO ANY PARTICULAR FONT, STYLE, SIZE, OR COLOR.

FOR AUCTION MANAGEMENT SERVICES PROVIDED TO OTHERS OVER AN ON-LINE WEB SITE ACCESSED THROUGH A GLOBAL COMPUTER NETWORK (U.S. CLS. 100, 101 AND 102).

JILL PRATER, EXAMINING ATTORNEY

SN 77-892,185. DIGI-RESOURCE LLC, BLOOMFIELD HILLS, MI. FILED 12-13-2009.



Digi-Rights

THE MARK CONSISTS OF STANDARD CHARACTERS WITHOUT CLAIM TO ANY PARTICULAR FONT, STYLE, SIZE, OR COLOR.

FOR BUSINESS ADVISORY SERVICES, CONSULTANCY AND INFORMATION; BUSINESS PROCESS OUTSOURCING SERVICES IN THE FIELD OF RIGHTS AND PERMISSIONS ACQUISITION, COPYRIGHTS AND LICENSING; BUSINESS SERVICES, NAMELY, FORMULATION OF BEST PRACTICES FOR PROJECT MANAGEMENT, RESEARCHING, PERMISSIONS, RIGHTS NEGOTIATING, RIGHTS CODING AND PROCESSING, CREDIT LINE ACKNOWLEDGEMENTS, AND MANAGEMENT BUDGETING, CONTROL AND REPORTING; MANAGEMENT AND BUSINESS CONSULTING SERVICES IN THE FIELD OF DIGITAL RIGHTS MANAGEMENT; PROVIDING AN ON-LINE DIRECTORY INFORMATION SERVICE FEATURING INFORMATION REGARDING GLOBAL SOURCE REGISTRY OF RIGHTS HOLDERS, LICENSEES AND LICENSORS (U.S. CLS. 100, 101 AND 102).

FIRST USE 9-1-2007; IN COMMERCE 9-1-2007.

TRACY FLETCHER, EXAMINING ATTORNEY

SN 77-892,031. DRAFTUS.COM LLC, FRISCO, TX. FILED 12-11-2009.



THE COLOR(S) BLACK, BLUE, YELLOW, AND WHITE IS/ARE CLAIMED AS A FEATURE OF THE MARK.

THE MARK CONSISTS OF THE WORDING "DRAFTUS" APPEARING IN THE COLOR BLACK, THE WORDING "US" IN THE COLOR BLUE, THE WORDING "IT'S YOUR TURN" IN THE COLOR BLACK, AND THE DESIGN OF A HIGHLY STYLIZED PERSON WEARING A GRADUATION CAP. THE PERSON IS BLUE WITH DARKER BLUE SHADINGS AND A WHITE EYE; THE GRADUATION CAP IS BLUE WITH A YELLOW TASSEL.

FOR EMPLOYMENT COUNSELING AND RECRUITING; EMPLOYMENT HIRING, RECRUITING, PLACEMENT, STAFFING AND CAREER NETWORKING SERVICES; VIDEO PRODUCTION SERVICES IN THE FIELD OF EMPLOYMENT RECRUITING (U.S. CLS. 100, 101 AND 102).

JEAN IM, EXAMINING ATTORNEY

CLASS 35—(Continued).

SN 77-892,186. DIGI-RESOURCE LLC, BLOOMFIELD HILLS, MI. FILED 12-13-2009.

Digi-Resource

THE MARK CONSISTS OF STANDARD CHARACTERS WITHOUT CLAIM TO ANY PARTICULAR FONT, STYLE, SIZE, OR COLOR.

FOR BUSINESS CONSULTATION SERVICES, NAMELY, BUSINESS PROCESS IMPROVEMENT AND ENTERPRISE ARCHITECTURE DESIGN; BUSINESS CONSULTING SERVICES RELATING TO THE INTEGRATION OF THE AREAS OF BUSINESS PROCESS TECHNOLOGY, ORGANIZATIONAL LEARNING, CHANGE MANAGEMENT, AND OPERATIONAL SUSTAINABILITY; BUSINESS PROCESS OUTSOURCING SERVICES IN THE FIELD OF RIGHTS AND PERMISSIONS ACQUISITION, COPYRIGHTS AND LICENSING; DATA PROCESSING SERVICES; OUTSOURCING IN THE FIELD OF BEST PRACTICES FOR PROJECT MANAGEMENT, RESEARCHING, PERMISSIONS, RIGHTS NEGOTIATING, RIGHTS CODING AND PROCESSING, CREDIT LINE ACKNOWLEDGEMENTS, AND MANAGEMENT BUDGETING, CONTROL AND REPORTING (U.S. CLS. 100, 101 AND 102).

FIRST USE 9-1-2007; IN COMMERCE 9-1-2007.
TRACY FLETCHER, EXAMINING ATTORNEY

SN 77-892,210. SAFE PASSAGE, YARMOUTH, ME. FILED 12-13-2009.



Safe Passage
Camino Seguro

THE MARK CONSISTS OF A DESIGN OF A TUNNEL AND THE WORDS "SAFE PASSAGE" AND "CAMINO SEGURO".

THE ENGLISH TRANSLATION OF "CAMINO SEGURO" IN THE MARK IS SAFE PASSAGE.

FOR CHARITABLE SERVICES, NAMELY, ORGANIZING AND DEVELOPING PROJECTS THAT AIM TO IMPROVE THE LIVES OF UNDERPRIVILEGED AND IMPOVERISHED PEOPLE (U.S. CLS. 100, 101 AND 102).

FIRST USE 11-30-2009; IN COMMERCE 11-30-2009.
LAURIE KAUFMAN, EXAMINING ATTORNEY

CLASS 35—(Continued).

SN 77-892,458. BUSINESS JOURNALS, INC., NORWALK, CT. FILED 12-14-2009.

VANGUARD

THE MARK CONSISTS OF STANDARD CHARACTERS WITHOUT CLAIM TO ANY PARTICULAR FONT, STYLE, SIZE, OR COLOR.

FOR ARRANGING AND CONDUCTING TRADE SHOW EXHIBITIONS IN THE FIELD OF MEN'S CLOTHING (U.S. CLS. 100, 101 AND 102).

FIRST USE 1-18-2010; IN COMMERCE 1-18-2010.
SOPHIA S. KIM, EXAMINING ATTORNEY

SN 77-892,553. KELLY, MARK, MERCERSBURG, PA. FILED 12-14-2009.



THE MARK CONSISTS OF THE LITERAL ELEMENT "AFRIKAN REPUBLIC", REPRESENTED IN STYLIZED FONT, AND A DESIGN ELEMENT CONSISTING OF FOUR LINES EACH BEARING A SERIES OF TRIANGULAR SHAPES, THE FOUR LINES FORMING A RECTANGULAR-SHAPED BORDER WITH GAPS AT EACH OF ITS CORNERS, WHEREIN THE BORDER SIMULATES A FRAME SURROUNDING THE LITERAL ELEMENT.

FOR RETAIL STORE AND ON-LINE RETAIL STORE SERVICES FEATURING SKIN AND HAIR CARE PRODUCTS; WHOLESALE STORES FEATURING SKIN AND HAIR CARE PRODUCTS (U.S. CLS. 100, 101 AND 102).

FIRST USE 7-1-2003; IN COMMERCE 7-1-2003.
RONALD DELGIZZI, EXAMINING ATTORNEY

SN 77-892,562. HORWITZ, JERE V, ZIONSVILLE, IN. FILED 12-14-2009.

invoice4me

THE MARK CONSISTS OF STANDARD CHARACTERS WITHOUT CLAIM TO ANY PARTICULAR FONT, STYLE, SIZE, OR COLOR.

FOR BILLING (U.S. CLS. 100, 101 AND 102).
FIRST USE 11-9-2009; IN COMMERCE 11-9-2009.

WILLIAM BRECKENFELD, EXAMINING ATTORNEY

CLASS 35—(Continued).

SN 77-892,606. TRANSFORM TECHNOLOGIES LLC, LAWRENCEVILLE, GA. FILED 12-14-2009.

ORTHOMAIL

THE MARK CONSISTS OF STANDARD CHARACTERS WITHOUT CLAIM TO ANY PARTICULAR FONT, STYLE, SIZE, OR COLOR.
FOR DIRECT MAIL ADVERTISING FOR ORTHODONTISTS (U.S. CLS. 100, 101 AND 102).
FIRST USE 4-3-2009; IN COMMERCE 5-5-2009.
LYDIA BELZER, EXAMINING ATTORNEY

CLASS 35—(Continued).

SN 77-893,116. GLOBAL DNS LLC, MERCER ISLAND, WA. FILED 12-14-2009.

ALTMLS

THE MARK CONSISTS OF STANDARD CHARACTERS WITHOUT CLAIM TO ANY PARTICULAR FONT, STYLE, SIZE, OR COLOR.
FOR MAINTAINING AN ONLINE REGISTRY OF LISTINGS OF REAL ESTATE OFFERED FOR SALE, RENTAL, OR USE (U.S. CLS. 100, 101 AND 102).
NAAKWAMA ANKRAH, EXAMINING ATTORNEY

SN 77-892,707. WATCHPOINT, COLORADO SPRINGS, CO. FILED 12-14-2009.

WATCHPOINT

THE MARK CONSISTS OF THE UNDERLINED TEXT "WATCHPOINT" WITH AN IMAGE OF AN EYE IN THE "O" OF "POINT".
FOR DISTRIBUTORSHIP SERVICES IN THE FIELD OF HIGH QUALITY SECURITY CAMERAS, DVRS, AND OTHER SECURITY AND/OR SURVEILLANCE RELATED EQUIPMENT (U.S. CLS. 100, 101 AND 102).
FIRST USE 3-0-2009; IN COMMERCE 3-0-2009.
MICHAEL WEBSTER, EXAMINING ATTORNEY

SN 77-893,194. BYNAMITE, INC., SAN FRANCISCO, CA. FILED 12-14-2009.

Bynamite

THE MARK CONSISTS OF STANDARD CHARACTERS WITHOUT CLAIM TO ANY PARTICULAR FONT, STYLE, SIZE, OR COLOR.
FOR ADVERTISING AND COMMERCIAL INFORMATION SERVICES, VIA THE INTERNET (U.S. CLS. 100, 101 AND 102).
KEVIN DINALLO, EXAMINING ATTORNEY

SN 77-892,708. PARADIGM PRECISION SAMPLE, PORT WASHINGTON, NY. FILED 12-14-2009.

VeraProof

THE MARK CONSISTS OF STANDARD CHARACTERS WITHOUT CLAIM TO ANY PARTICULAR FONT, STYLE, SIZE, OR COLOR.
FOR ANALYSIS OF MARKET RESEARCH DATA AND STATISTICS (U.S. CLS. 100, 101 AND 102).
MICHAEL WEBSTER, EXAMINING ATTORNEY

SN 77-893,234. FLIKPIX LLC, BURLINGAME, CA. FILED 12-14-2009.

**LaughandCryMovieGuide.com***Comedy and Drama That Entertain and Enrich*

THE MARK CONSISTS OF A FILM STRIP WITH A LAUGHING ICON IN A SQUARE BOX AND A CRYING ICON IN A SQUARE BOX AS WELL. TO THE RIGHT THERE IS THE STYLIZED TEXT "LAUGHANDCRYMOVIEGUIDE.COM COMEDY AND DRAMA THAT ENTERTAIN AND ENRICH".
FOR ONLINE RETAIL STORE SERVICES FEATURING BOOKS ABOUT MOVIES (U.S. CLS. 100, 101 AND 102).
FIRST USE 10-25-2008; IN COMMERCE 10-25-2008.
JENNIFER HETU, EXAMINING ATTORNEY

CLASS 35—(Continued).

SN 77-893,342. POWERPACT HOLDINGS LLC, MID-LOTHIAN, VA. FILED 12-14-2009.

VOOT

THE MARK CONSISTS OF STANDARD CHARACTERS WITHOUT CLAIM TO ANY PARTICULAR FONT, STYLE, SIZE, OR COLOR.

FOR CONDUCTING MARKETING, ADVERTISING, MEDIA USAGE, RATING, MONITORING AND RESEARCH SERVICES, NAMELY, ANALYZING AND PREPARING REPORTS RELATED TO SOCIAL MEDIA WEBSITES, CONTENT AND AUDIENCE ENGAGEMENT FACTORS (U.S. CLS. 100, 101 AND 102).

MARGERY A. TIERNEY, EXAMINING ATTORNEY

SN 77-893,603. LUMINIX NETWORK LLC, CHICAGO, IL. FILED 12-15-2009.

LUMINIX

THE MARK CONSISTS OF STANDARD CHARACTERS WITHOUT CLAIM TO ANY PARTICULAR FONT, STYLE, SIZE, OR COLOR.

FOR CONSULTING IN THE FIELD OF ENERGY USAGE MANAGEMENT AND ENERGY EFFICIENCY (U.S. CLS. 100, 101 AND 102).

SUSAN RICHARDS, EXAMINING ATTORNEY

SN 77-893,837. TIME'S UP, INC., NEW YORK, NY. FILED 12-15-2009.



THE MARK CONSISTS OF A RECTANGULAR BOX BEARING THE CAPITAL LETTER "X" NEXT TO AN UPWARDLY DIRECTED ARROW. BELOW ARE THE WORDS "TIME'S UP".

FOR PROMOTING PUBLIC AWARENESS OF ENVIRONMENTAL ISSUES AND INITIATIVES IN ORDER TO PROMOTE, FOSTER AND ENCOURAGE INTEREST AND SUPPORT FOR THE ENVIRONMENT AND CAUSES RELATED TO ENVIRONMENTAL ISSUES (U.S. CLS. 100, 101 AND 102).

FIRST USE 1-1-1989; IN COMMERCE 1-1-1989.

MARILYN IZZI, EXAMINING ATTORNEY

CLASS 35—(Continued).

SN 77-893,931. TALISMAN LBS, LLC, HONOLULU, HI. FILED 12-15-2009.

TALISMAN

THE MARK CONSISTS OF STANDARD CHARACTERS WITHOUT CLAIM TO ANY PARTICULAR FONT, STYLE, SIZE, OR COLOR.

OWNER OF U.S. REG. NO. 3,544,685.

FOR DISSEMINATION OF ADVERTISING FOR OTHERS VIA PUBLIC AND PRIVATE WIRELESS NETWORKS FOR DISPLAY ON MOBILE DEVICES; MARKETING AND CONSULTING SERVICES IN THE FIELD OF PROMOTING AND TRACKING THE GOODS, SERVICES, AND BRANDS OF OTHERS THROUGH ALL PUBLIC COMMUNICATION MEANS, PARTICULARLY SPECIALIZING IN THE USE OF MOBILE, SOCIAL, AND PRINT MEDIA TO DRIVE CONSUMER INTEREST, ENGAGEMENT AND ACTION; MARKETING, PROMOTIONAL AND ADVERTISING SERVICES PROVIDED BY MOBILE TELEPHONE CONNECTIONS; PROVIDING ADVERTISING SERVICE TO DISTRIBUTE ADVERTISEMENTS FOR DISPLAY ON INTERNET, NAMELY, IN WEBSITES, SOCIAL CONVERSATIONS OVER THE INTERNET, EMAILS, MICROBLOGS, BLOGS, ELECTRONIC MESSAGES, INSTANT MESSAGES, TEXT MESSAGES, MULTIMEDIA MESSAGES, SOCIAL NETWORKS, STATUS UPDATES, FORUMS, ELECTRONIC BULLETIN BOARDS (U.S. CLS. 100, 101 AND 102).

FIRST USE 6-17-2008; IN COMMERCE 8-8-2008.

KEVIN CORWIN, EXAMINING ATTORNEY

SN 77-894,001. SELLING SOURCE LLC, LAS VEGAS, NV. FILED 12-15-2009.

IMPEERIAN

THE MARK CONSISTS OF STANDARD CHARACTERS WITHOUT CLAIM TO ANY PARTICULAR FONT, STYLE, SIZE, OR COLOR.

FOR INSURANCE LEAD COLLECTION AND MATCHING SERVICES, NAMELY, MATCHING CONSUMER REQUESTS FOR INSURANCE POLICY QUOTES COLLECTED OVER THE INTERNET TO PRE-QUALIFIED INSURANCE BROKERS, AGENTS AND AGENCIES INTERESTED IN THOSE REQUESTS; PROMOTION OF FINANCIAL AND INSURANCE SERVICES, ON BEHALF OF THIRD PARTIES (U.S. CLS. 100, 101 AND 102).

DAVID I, EXAMINING ATTORNEY

CLASS 35—(Continued).

SN 77-894,090. BRAND AFFINITY TECHNOLOGIES, INC., IRVINE, CA. FILED 12-15-2009.



NO CLAIM IS MADE TO THE EXCLUSIVE RIGHT TO USE "BRAND AFFINITY TECHNOLOGIES", APART FROM THE MARK AS SHOWN.

THE MARK CONSISTS OF THE LETTERS "B", "A", AND "T", EACH SURROUNDED BY A ROUNDED SQUARE ELEMENT WITH THE WORDS "BRAND AFFINITY TECHNOLOGIES" UNDERNEATH.

FOR MARKETING AND MEDIA SERVICES, NAMELY, PROVIDING INFORMATION IN THE FIELD OF MARKETING AND ONLINE MARKETING MEDIA VIA THE INTERNET (U.S. CLS. 100, 101 AND 102).

FIRST USE 4-1-2009; IN COMMERCE 4-1-2009.
LINDSEY RUBIN, EXAMINING ATTORNEY

SN 77-894,096. BRAND AFFINITY TECHNOLOGIES, INC., IRVINE, CA. FILED 12-15-2009.



THE MARK CONSISTS OF THE LETTERS "B", "A", AND "T", EACH SURROUNDED BY A ROUNDED SQUARE ELEMENT.

FOR MARKETING AND MEDIA SERVICES, NAMELY, PROVIDING INFORMATION IN THE FIELD OF MARKETING AND ONLINE MARKETING MEDIA VIA THE INTERNET (U.S. CLS. 100, 101 AND 102).

FIRST USE 4-1-2009; IN COMMERCE 4-1-2009.
LINDSEY RUBIN, EXAMINING ATTORNEY

SN 77-894,151. STUCKERT, JOHN, ROCKLIN, CA. FILED 12-15-2009.

FUNOMICS

THE MARK CONSISTS OF STANDARD CHARACTERS WITHOUT CLAIM TO ANY PARTICULAR FONT, STYLE, SIZE, OR COLOR.

FOR PROVIDING INFORMATION AND ANALYSIS IN THE FIELDS OF ECONOMICS AND BUSINESS (U.S. CLS. 100, 101 AND 102).

NAKIA HENRY, EXAMINING ATTORNEY

CLASS 35—(Continued).

SN 77-894,540. SECOND LICENSE APPLICATION CORPORATION, DFW AIRPORT, TX. FILED 12-16-2009.

SUPERSHIELD

THE MARK CONSISTS OF STANDARD CHARACTERS WITHOUT CLAIM TO ANY PARTICULAR FONT, STYLE, SIZE, OR COLOR.

FOR ADVERTISING AND PROMOTING THE SERVICES OF OTHERS THROUGH A PROGRAM ASSURING SATISFACTORY PERFORMANCE OF ADVERTISED SERVICES (U.S. CLS. 100, 101 AND 102).

MIDGE BUTLER, EXAMINING ATTORNEY

SN 77-895,470. DSW SHOE WAREHOUSE, INC., COLUMBUS, OH. FILED 12-17-2009.

DESIGNER SHOES. WAREHOUSE PRICES.

THE MARK CONSISTS OF STANDARD CHARACTERS WITHOUT CLAIM TO ANY PARTICULAR FONT, STYLE, SIZE, OR COLOR.

FOR RETAIL STORE AND ON-LINE RETAIL STORE SERVICES FEATURING FOOTWEAR, HOSIERY AND CLOTHING ACCESSORIES (U.S. CLS. 100, 101 AND 102).

FIRST USE 10-1-2009; IN COMMERCE 10-1-2009.
WILLIAM ROSSMAN, EXAMINING ATTORNEY

CLASS 35—(Continued).

SN 77-895,686. NATIONAL CHILDREN'S ORAL HEALTH FOUNDATION, CHARLOTTE, NC. FILED 12-17-2009.

AMERICA'S TOOTHPAIRY

THE MARK CONSISTS OF STANDARD CHARACTERS WITHOUT CLAIM TO ANY PARTICULAR FONT, STYLE, SIZE, OR COLOR.

OWNER OF U.S. REG. NO. 3,753,071.

NO CLAIM IS MADE TO THE EXCLUSIVE RIGHT TO USE "AMERICA'S", APART FROM THE MARK AS SHOWN.

FOR CHARITABLE SERVICES, NAMELY, ORGANIZING AND ADMINISTERING A HEALTH SERVICES PROGRAM TO PROVIDE ORAL HEALTH SERVICES, ORAL HEALTH CARE SERVICES, ORAL HYGIENE SERVICES, ORAL HYGIENE CARE SERVICES, DENTISTRY SERVICES, DENTAL CARE SERVICES, PREVENTIVE DENTAL CARE SERVICES, DENTAL SCREENING SERVICES, DENTAL EXAMINATION SERVICES, DENTAL TREATMENT SERVICES, DENTAL DISEASE TREATMENT SERVICES, PREVENTIVE DENTAL TREATMENT SERVICES TO NEEDY PERSONS AND UNDESERVED GROUPS; CHARITABLE SERVICES, NAMELY, ORGANIZING AND CONDUCTING VOLUNTEER PROGRAMS AND COMMUNITY SERVICE PROJECTS IN THE FIELDS OF ORAL HEALTH SERVICES, ORAL HEALTH CARE SERVICES, ORAL HYGIENE SERVICES, ORAL HYGIENE CARE SERVICES, DENTISTRY SERVICES, DENTAL CARE SERVICES, PREVENTIVE DENTAL CARE SERVICES, DENTAL SCREENING SERVICES, DENTAL EXAMINATION SERVICES, DENTAL TREATMENT SERVICES, DENTAL DISEASE TREATMENT SERVICES, PREVENTIVE DENTAL TREATMENT SERVICES; AND ORGANIZING AND ADMINISTERING NETWORKS OF DENTIST AND ORAL HEALTH AND DENTAL CARE PROVIDERS AND SPECIALISTS (U.S. CLS. 100, 101 AND 102).

FIRST USE 5-0-2009; IN COMMERCE 5-0-2009.

ROBERT C. CLARK JR., EXAMINING ATTORNEY

SN 77-896,092. PRINT MANAGEMENT PARTNERS, DES PLAINES, IL. FILED 12-17-2009.

eRivalry

THE MARK CONSISTS OF STANDARD CHARACTERS WITHOUT CLAIM TO ANY PARTICULAR FONT, STYLE, SIZE, OR COLOR.

FOR PROMOTING THE DONATION OF BLOOD AND VOLUNTEER SERVICES AND FINANCIAL RESOURCES IN THE FIELD OF BLOOD DONATIONS BY MEANS OF ARRANGING AND CONDUCTING INCENTIVE REWARD PROGRAMS (U.S. CLS. 100, 101 AND 102).

FIRST USE 11-30-2009; IN COMMERCE 11-30-2009.

JAMES MACFARLANE, EXAMINING ATTORNEY

CLASS 35—(Continued).

SN 77-896,284. GLOBAL DISCOUNTS CARD, LLC, LAS VEGAS, NV. FILED 12-17-2009.

GDC

THE MARK CONSISTS OF STANDARD CHARACTERS WITHOUT CLAIM TO ANY PARTICULAR FONT, STYLE, SIZE, OR COLOR.

FOR ADMINISTRATION OF A DISCOUNT PROGRAM FOR ENABLING PARTICIPANTS TO OBTAIN DISCOUNTS ON GOODS AND SERVICES THROUGH USE OF A DISCOUNT MEMBERSHIP CARD; PROMOTING THE GOODS AND SERVICES OF OTHERS THROUGH THE DISTRIBUTION OF DISCOUNT CARDS (U.S. CLS. 100, 101 AND 102).

FIRST USE 7-27-2009; IN COMMERCE 7-27-2009.

GISELLE AGOSTO, EXAMINING ATTORNEY

SN 77-896,548. SEARS BRANDS, LLC, HOFFMAN ESTATES, IL. FILED 12-18-2009.

UNDECK THE HALLS

THE MARK CONSISTS OF STANDARD CHARACTERS WITHOUT CLAIM TO ANY PARTICULAR FONT, STYLE, SIZE, OR COLOR.

FOR RETAIL DEPARTMENT STORE SERVICES; ONLINE RETAIL DEPARTMENT STORE SERVICES (U.S. CLS. 100, 101 AND 102).

STEVEN R. FINE, EXAMINING ATTORNEY

CLASS 35—(Continued).

SN 77-896,685. SUGAR RUSH, INC., DENVER, CO. FILED 12-18-2009.



THE COLOR(S) BROWN AND PINK IS/ARE CLAIMED AS A FEATURE OF THE MARK.

THE MARK CONSISTS OF THE STYLIZED WORDING "LOLA'S SUGAR RUSH" WITH THE LOWER CIRCLE SPIRAL BEING FORMED BY THE LOWER PORTION OF THE LETTER "G" IN THE WORDING "SUGAR". THE COLOR BROWN APPEARS IN THE STYLIZED WORDING AND IN THE SPIRAL DESIGN. THE COLOR PINK APPEARS IN THE CIRCULAR BACKGROUND OF THE SPIRAL DESIGN.

FOR RETAIL CANDY STORES; RETAIL STORE AND ON-LINE RETAIL STORE SERVICES FEATURING CANDIES AND CONFECTIONERIES (U.S. CLS. 100, 101 AND 102).

FIRST USE 5-20-2009; IN COMMERCE 5-20-2009.
VERNA BETH RIRIE, EXAMINING ATTORNEY

SN 77-896,747. 2J'S NATURAL FOODS, INC., GREAT FALLS, MT. FILED 12-18-2009.



OWNER OF U.S. REG. NO. 3,553,863.

THE MARK CONSISTS OF A SOLID, FILLED-IN OVAL, WITH THE LITERAL ELEMENT "2J'S" WRITTEN OVER THE FRONT OF THE OVAL IN STYLIZED LETTERING; THE LITERAL ELEMENT IS BLANK SO THAT IT APPEARS IN CONTRAST WITH THE OVAL; THERE IS A STYLIZED LEAF THAT IS ALSO BLANK, AND WHICH STEMS FROM THE LOWER RIGHT SIDE OF THE OVAL PERIMETER INWARD, AND OVERLAPS THE LETTER "J".

FOR RETAIL GROCERY STORES (U.S. CLS. 100, 101 AND 102).

FIRST USE 5-1-2008; IN COMMERCE 5-1-2008.
SUSAN RICHARDS, EXAMINING ATTORNEY

CLASS 35—(Continued).

SN 77-899,343. ENERCOM, INC., DENVER, CO. FILED 12-22-2009.

OIL & GAS 360

THE MARK CONSISTS OF STANDARD CHARACTERS WITHOUT CLAIM TO ANY PARTICULAR FONT, STYLE, SIZE, OR COLOR.

NO CLAIM IS MADE TO THE EXCLUSIVE RIGHT TO USE "OIL & GAS", APART FROM THE MARK AS SHOWN.

FOR PROVIDING AN ONLINE WEBSITE AND DATABASE FEATURING INFORMATION REGARDING BUSINESS CONFERENCES AND TRADE EVENTS IN THE ENERGY, NATURAL RESOURCES, AND OIL AND GAS INDUSTRY; PROVIDING BUSINESS INFORMATION REGARDING NEWS, REPORTS AND DATA RELATING TO THE ENERGY, NATURAL RESOURCES, AND OIL AND GAS INDUSTRY; BUSINESS CONSULTING SERVICES IN THE ENERGY, NATURAL RESOURCES AND OIL AND GAS INDUSTRY (U.S. CLS. 100, 101 AND 102).
ESTHER BELENKER, EXAMINING ATTORNEY

SN 77-900,992. SMITH, RICHARD A., LONG LAKE, MN. FILED 12-25-2009.

Live Eco-Logically

THE MARK CONSISTS OF STANDARD CHARACTERS WITHOUT CLAIM TO ANY PARTICULAR FONT, STYLE, SIZE, OR COLOR.

FOR PROMOTING HEALTH AND ENVIRONMENTAL AWARENESS WITHIN PEOPLE SO THAT THEY CAN LEAD A CLEAN AND HEALTHY LIFE (U.S. CLS. 100, 101 AND 102).

MARIAM MAHMOUDI, EXAMINING ATTORNEY

SN 77-901,249. WAKEFERN FOOD CORP., KEASBEY, NJ. FILED 12-28-2009.

ONE PLACE. YOUR PLACE.

THE MARK CONSISTS OF STANDARD CHARACTERS WITHOUT CLAIM TO ANY PARTICULAR FONT, STYLE, SIZE, OR COLOR.

FOR RETAIL GROCERY STORES (U.S. CLS. 100, 101 AND 102).

FIRST USE 3-30-2008; IN COMMERCE 3-30-2008.
THOMAS MANOR, EXAMINING ATTORNEY

CLASS 35—(Continued).

SN 77-902,567. CRYSTAL ROCK LLC, WATERTOWN, CT.
FILED 12-30-2009.



THE MARK CONSISTS OF A DEPICTION OF A COFFEE BEAN MARKED WITH THE LETTER "B" ENCIRCLING THE LETTER "C".

FOR RETAIL STORE AND MAIL ORDER SERVICES IN THE FIELD OF COFFEE (U.S. CLS. 100, 101 AND 102).
AARON BRODSKY, EXAMINING ATTORNEY

SN 77-902,714. GSENSE INC., BRIARCLIFF MANOR, NY.
FILED 12-30-2009.

You Are The Card

THE MARK CONSISTS OF STANDARD CHARACTERS WITHOUT CLAIM TO ANY PARTICULAR FONT, STYLE, SIZE, OR COLOR.

FOR ADVERTISEMENT AND PUBLICITY SERVICES BY TELEVISION, RADIO, MAIL; ADVERTISEMENT HOARDING RENTAL; ADVERTISING AGENCIES; ADVERTISING AGENCIES PROVIDING THE STRATEGY, DESIGN AND EXECUTION OF PROGRAMS TO PROMOTE BUSINESSES IN THE FOOD AND FOODSERVICE INDUSTRIES; ADVERTISING AGENCIES, NAMELY, PROMOTING THE GOODS AND SERVICES OF OTHERS; ADVERTISING AGENCIES, NAMELY, PROMOTING THE SERVICES OF PAYMENT SYSTEMS THROUGH THE DISTRIBUTION OF PRINTED AND AUDIO PROMOTIONAL MATERIALS AND BY RENDERING SALES PROMOTION ADVICE; ADVERTISING AGENCY SPECIALIZING IN THE DESIGN AND EXECUTION OF WORD OF MOUTH, VIRAL, BUZZ AND EXPERIENTIAL MARKETING PROGRAMS; ADVERTISING AND ADVERTISEMENT SERVICES; ADVERTISING AND BUSINESS ADVICE RELATING TO TELEMATICS' SERVICES; ADVERTISING AND BUSINESS MANAGEMENT CONSULTANCY; ADVERTISING AND BUSINESS SERVICES, NAMELY, PROVIDING AN ONLINE WEBSITE WHERE ADVERTISERS, MARKETERS, AND CONTENT PROVIDERS CAN INTERACT WITH USERS FOR ADVERTISING, BRANDING, AND PROMOTING KNOWLEDGE, PRODUCTS, AND SERVICES, AND TRADESHOWS, ON BEHALF OF THEMSELVES AND OTHERS, AND FOR EVALUATING AND RATING THE SAME, ALL THE FOREGOING RELEVANT TO HUMAN ACTIVITIES AFFECTING CLIMATE CHANGE AND RELATED FIELDS; ADVERTISING AND BUSINESS SERVICES, NAMELY, SECURING AIRTIME ON ALL FORMS OF MEDIA COMMUNICATIONS STATIONS, SYSTEMS, NETWORKS, AND SERVICES FOR THE PURPOSE OF PROMOTING THE GOODS AND SERVICES OF OTHERS; ADVERTISING AND COMMERCIAL INFORMATION SERVICES, VIA THE INTERNET; ADVERTISING AND DIRECTORY SERVICES, NAMELY, PROMOTING THE SERVICES OF OTHERS BY PROVIDING A WEB PAGE FEATURING LINKS TO THE WEBSITES OF OTHERS; ADVERTISING AND MARKETING; ADVERTISING AND MARKETING SERVICES, NAMELY, PROMOTING THE GOODS AND SERVICES OF OTHERS; ADVERTISING AND PROMOT-

CLASS 35—(Continued).

ING THE GOODS AND SERVICES OF A VISUAL ARTIST; ADVERTISING AND PROMOTION SERVICES AND RELATED CONSULTING; ADVERTISING AND PROMOTIONAL SERVICES; ADVERTISING AND PUBLICITY SERVICES; ADVERTISING AND PUBLICITY SERVICES, NAMELY, PROMOTING THE GOODS, SERVICES, BRAND IDENTITY AND COMMERCIAL INFORMATION AND NEWS OF THIRD PARTIES THROUGH PRINT, AUDIO, VIDEO, DIGITAL AND ON-LINE MEDIUM; ADVERTISING BUSINESS ESPECIALLY IN THE FIELD OF TELEMATIC AND TELEPHONE NETWORKS; ADVERTISING BY TRANSMISSION OF ON-LINE PUBLICITY FOR THIRD PARTIES THROUGH ELECTRONIC COMMUNICATIONS NETWORKS; ADVERTISING CONSULTATION; ADVERTISING FLYER DISTRIBUTION; ADVERTISING IN PERIODICALS, BROCHURES AND NEWSPAPERS; ADVERTISING OF COMMERCIAL OR RESIDENTIAL REAL ESTATE; ADVERTISING OF THE PUBLISHED TEXTS OF OTHERS; ADVERTISING ON THE INTERNET FOR OTHERS; ADVERTISING PARTICULARLY SERVICES FOR THE PROMOTION OF GOODS; ADVERTISING RELATING TO PHARMACEUTICAL PRODUCTS AND IN-VIVO IMAGING PRODUCTS; ADVERTISING SERVICES; ADVERTISING SERVICES FOR PROMOTING THE BROKERAGE OF STOCKS AND OTHER SECURITIES; ADVERTISING SERVICES OF A RADIO AND TELEVISION ADVERTISING AGENCY; ADVERTISING SERVICES RELATING TO SANDWICHES; ADVERTISING SERVICES, FOR THIRD PARTIES, IN CONNECTION WITH THE COMMERCIALIZATION AND SALE OF PERFUMERY AND COSMETIC ARTICLES, PRODUCTS FOR HOUSEHOLD PURPOSES, OPTICAL PRODUCTS, CLOCKS AND TIMEPIECES, JEWELLERY, FURNISHING ARTICLES; ADVERTISING SERVICES, NAMELY, COST-PER-ACTION ON-LINE ADVERTISING; ADVERTISING SERVICES, NAMELY, CREATING CORPORATE AND BRAND IDENTITY FOR OTHERS; ADVERTISING SERVICES, NAMELY, CREATING CORPORATE LOGOS FOR OTHERS; ADVERTISING SERVICES, NAMELY, PRODUCTION OF SPECIAL EFFECTS INCLUDING MODEL-MAKING SERVICES, COMPUTER-GENERATED IMAGERY AND COMPUTER-GENERATED GRAPHICS FOR THE PRODUCTION OF COMMERCIALS; ADVERTISING SERVICES, NAMELY, PROMOTING AND MARKETING THE GOODS AND SERVICES OF OTHERS IN THE FIELD OF UPSCALE CHOICES SUCH AS CULTURAL EVENTS, RESTAURANTS, SHOPPING, AND TRAVEL VIA PRINT AND ELECTRONIC MEDIA; ADVERTISING SERVICES, NAMELY, PROMOTING AND MARKETING THE GOODS AND SERVICES OF OTHERS THROUGH ALL PUBLIC COMMUNICATION MEANS; ADVERTISING SERVICES, NAMELY, PROMOTING CAR DEALERSHIPS OF OTHERS; ADVERTISING SERVICES, NAMELY, PROMOTING PROPERTIES FOR SALE BY OWNER VIA THE INTERNET; ADVERTISING SERVICES, NAMELY, PROMOTING THE BOOKS OF OTHERS IN THE FIELD OF LAW BY MEANS OF NEWS AND REVIEWS REGARDING SAME; ADVERTISING SERVICES, NAMELY, PROMOTING THE BRANDS, GOODS AND SERVICES OF OTHERS; ADVERTISING SERVICES, NAMELY, PROMOTING THE FOOD AND WINE OF OTHERS; ADVERTISING SERVICES, NAMELY, PROMOTING THE GIFT CARDS OF OTHERS; ADVERTISING SERVICES, NAMELY, PROMOTING THE SANDWICHES OF OTHERS; ADVERTISING SERVICES, NAMELY, PROVIDING A WEBSITE FOR THE PROMOTION OF THE BOOKS OF OTHERS IN THE FIELD OF LAW, INCLUDING NEWS AND REVIEWS REGARDING SAME; ADVERTISING SERVICES, NAMELY, PROVIDING ADVERTISING SPACE IN A PERIODICAL; ADVERTISING SERVICES, NAMELY, PROVIDING INFORMATION AS TO THE AVAILABILITY OF PAYMENT SERVICES FOR RENT OR PURCHASE; ADVERTISING SERVICES, PUBLIC RELATIONS AND MARKETING SERVICES, NAMELY, PROMOTING AND MARKETING THE GOODS AND SERVICES OF OTHERS THROUGH ALL PUBLIC COMMUNICATION MEANS; ADVERTISING TEXT PUBLICATION SERVICES; ADVERTISING THROUGH ALL PUBLIC COMMUNICATION MEANS; ADVERTISING VIA ELECTRONIC MEDIA AND SPECIFICALLY THE INTERNET; ADVERTISING, INCLUDING ON-LINE ADVERTISING ON A COMPUTER NETWORK; ADVERTISING, INCLUDING PROMOTION OF PRODUCTS AND SERVICES OF THIRD PARTIES THROUGH SPONSORING ARRANGEMENTS AND LICENCE AGREEMENTS

CLASS 35—(Continued).

RELATING TO INTERNATIONAL SPORTS' EVENTS; ADVERTISING, INCLUDING PROMOTION RELATING TO THE SALE OF ARTICLES AND SERVICES FOR THIRD PARTIES BY THE TRANSMISSION OF ADVERTISING MATERIAL AND THE DISSEMINATION OF ADVERTISING MESSAGES ON COMPUTER NETWORKS; ADVERTISING, MARKETING AND PROMOTING THE GOODS AND SERVICES OF OTHERS USING KIOSKS; ADVERTISING, MARKETING AND PROMOTION SERVICES; ADVERTISING, MARKETING AND PROMOTIONAL SERVICES FOR AUTOMOTIVE DEALERSHIPS; ADVERTISING, MARKETING AND PROMOTIONAL SERVICES FOR LIGHT AND HEAVY EQUIPMENT DEALERSHIPS; ADVERTISING, MARKETING AND PROMOTIONAL SERVICES FOR THE DONATION OF HUMAN BLOOD THAT EXACTLY MATCHES THE BLOOD TYPE OF INDIVIDUALS NEEDING TRANSFUSIONS; ADVERTISING, MARKETING AND PROMOTIONAL SERVICES RELATED TO ALL INDUSTRIES FOR THE PURPOSE OF FACILITATING NETWORKING AND SOCIALIZING OPPORTUNITIES FOR BUSINESS PURPOSES; ADVERTISING, PROMOTION AND MARKETING SERVICES IN THE NATURE OF E-MAIL BLAST CAMPAIGNS FOR OTHERS; AGENCIES FOR ADVERTISING TIME AND SPACE; ANALYSIS OF ADVERTISING RESPONSE; ARRANGING AND CONDUCTING OF FAIRS AND EXHIBITIONS FOR BUSINESS AND ADVERTISING PURPOSES; BUSINESS MANAGEMENT AND CONSULTING SERVICES FOR THE HEALTH CARE INDUSTRY, NAMELY, CUSTOMER SERVICE, ACCOUNTING SERVICES, AND WEB-BASED ADVERTISING AND MARKETING SERVICES; BUSINESS SERVICES, NAMELY, TRACKING AND MONITORING OF CALLS FOR OTHERS IN RESPONSE TO ADVERTISING ADS; CINEMA ADVERTISING; CLASSIFIED ADVERTISING SERVICES; COMPILATION OF ADVERTISEMENTS FOR USE AS WEB PAGES ON THE INTERNET; CONDUCTING, ARRANGING AND ORGANIZING TRADE SHOWS AND TRADE FAIRS FOR COMMERCIAL AND ADVERTISING PURPOSES; CONSUMER LOYALTY SERVICES FOR COMMERCIAL, PROMOTIONAL, AND/OR ADVERTISING PURPOSES, NAMELY, ADMINISTRATION OF FREQUENT FLYER PROGRAM THAT ALLOWS MEMBERS TO REDEEM MILES FOR POINTS OR AWARDS OFFERED BY OTHER LOYALTY PROGRAMS; COOPERATIVE ADVERTISING AND MARKETING; COOPERATIVE ADVERTISING AND MARKETING SERVICES BY WAY OF SOLICITATION, CUSTOMER SERVICE AND PROVIDING MARKETING INFORMATION VIA WEB SITES ON A GLOBAL COMPUTER NETWORK; COOPERATIVE ADVERTISING AND MARKETING SERVICES, NAMELY, OFFERING DISCOUNTS TO CLIENTS THROUGH THE JOINT PARTICIPATION OF MEMBER BEAUTY SALONS.; CREATING AND UPDATING ADVERTISING MATERIAL; CREATION OF MARKETING TOOLS DESIGNED TO INCREASE A CLIENT COMPANY'S KNOWLEDGE OF CUSTOMER NEEDS, AND ITS COMPETITORS' PRODUCTS AND SERVICES, PRICING, ADVERTISING STRATEGY AND SALES STRATEGY; CUSTOMER LOYALTY SERVICES AND CUSTOMER CLUB SERVICES, FOR COMMERCIAL, PROMOTIONAL AND/OR ADVERTISING PURPOSES; DESIGN OF ADVERTISING BROCHURES FOR OTHERS; DESIGN OF ADVERTISING FLYERS FOR OTHERS; DESIGN OF ADVERTISING MATERIALS FOR OTHERS; DESIGN OF INTERNET ADVERTISING; DEVELOPING ADVERTISING CAMPAIGNS FOR OTHERS GEARED TOWARD ENVIRONMENTAL ISSUES; DEVELOPMENT, OPERATION AND ADMINISTRATION OF DIGITAL SIGNAGE SYSTEMS AND DIGITAL ADVERTISING SYSTEMS FOR OTHERS, NAMELY, PROVIDING ADVERTISING SPACE BY ELECTRONIC MEANS AND GLOBAL COMPUTER INFORMATION NETWORKS; DIRECT MAIL ADVERTISING; DIRECT MARKETING ADVERTISING FOR OTHERS; DISPLAYING ADVERTISEMENTS FOR OTHERS; DISSEMINATION OF ADVERTISEMENTS; DISSEMINATION OF ADVERTISEMENTS AND OF ADVERTISING MATERIAL; DISSEMINATION OF ADVERTISING FOR OTHERS VIA AN ON-LINE COMMUNICATIONS NETWORK ON THE INTERNET; DISSEMINATION OF ADVERTISING FOR OTHERS VIA PUBLIC AND PRIVATE WIRELESS NETWORKS FOR DISPLAY ON MOBILE DEVICES; DISSEMINATION OF ADVERTISING FOR OTHERS VIA THE INTERNET; DISSEMINATION OF ADVERTISING MATERIAL; DISSEMINATION OF ADVERTISING MATTER; DISSEMI-

CLASS 35—(Continued).

NATION OF ADVERTISING, SCHEDULING AND MANAGING OF TRAINING COURSES AND PROGRAMS FOR OTHERS VIA A GLOBAL COMPUTER NETWORK; DISSEMINATION SERVICES OF ADVERTISEMENT MATTER; DISTRIBUTION AND DISSEMINATION OF ADVERTISING MATERIALS; DISTRIBUTION OF ADVERTISEMENTS AND COMMERCIAL ANNOUNCEMENTS; DISTRIBUTION OF ADVERTISING MAIL AND OF ADVERTISING SUPPLEMENTS ATTACHED TO REGULAR EDITIONS; DISTRIBUTION OF ADVERTISING MATERIALS; DISTRIBUTION OF PRODUCTS FOR ADVERTISING PURPOSES; ELECTRONIC BILLBOARD ADVERTISING; ELECTRONIC COMMERCE SERVICES, NAMELY, PROVIDING INFORMATION ABOUT PRODUCTS VIA TELECOMMUNICATION NETWORKS FOR ADVERTISING AND SALES PURPOSES; ENTERTAINMENT MARKETING SERVICES, NAMELY, MARKETING, PROMOTION AND ADVERTISING FOR INDEPENDENT RECORDING ARTISTS; INTERNET ADVERTISING SERVICES; ISSUING AND UPDATING OF ADVERTISING TEXTS; LAY-OUT SERVICES FOR ADVERTISING PURPOSES; MANAGEMENT OF ADVERTISING THROUGH A COMMAND AND CONTROL CENTER FOR BOTH MOVIE THEATRE ON-SCREEN ADVERTISING AND OVER THE INTERNET; MARKETING AND ADVERTISING SERVICES FOR AUTOMOBILE DEALERSHIPS; MARKETING, ADVERTISING AND PROMOTING THE GOODS AND SERVICES OF OTHERS IN THE FIELD OF TRAVEL AND TOURISM, NAMELY, PROVIDING INFORMATION VIA MAIL AND ELECTRONIC MAIL; MARKETING, ADVERTISING, AND PROMOTING THE RETAIL GOODS AND SERVICES OF OTHERS TO WIRELESS ELECTRONIC DEVICES; MARKETING, PROMOTIONAL AND ADVERTISING SERVICES PROVIDED BY MOBILE TELEPHONE CONNECTIONS; MEDIA BUYING ADVICE, NAMELY, ADVISING THE CLIENT HOW MUCH MEDIA TIME, AND AT WHAT TIMES THE CLIENT SHOULD BE PURCHASING ADVERTISING; MEDIA PLANNING, NAMELY, ADVISING THE CLIENT ON THE CORRECT TIMES AND STATIONS TO ADVERTISE BASED ON MEDIA ANALYSIS OF THE MARKET FOR THAT MEDIA; MEDIA PRODUCTION LOCATION SCOUTING SERVICES FOR ADVERTISING PURPOSES; MEDIATION OF ADVERTISING; MODELING FOR ADVERTISING OR SALES PROMOTION; MODELING SERVICES FOR ADVERTISING OR SALES PROMOTION; MUSIC SELECTION SERVICES FOR USE IN ADVERTISING; ON-LINE ADVERTISING AND MARKETING SERVICES; ON-LINE ADVERTISING ON COMPUTER COMMUNICATION NETWORKS; ON-LINE ADVERTISING ON COMPUTER NETWORKS; ON-LINE ADVERTISING SERVICES FOR OTHERS; ONLINE ADVERTISING VIA A COMPUTER COMMUNICATIONS NETWORK.; ORGANISATION AND HOLDING OF FAIRS FOR COMMERCIAL OR ADVERTISING PURPOSES; ORGANISATION OF EXHIBITIONS FOR COMMERCIAL OR ADVERTISING PURPOSES; ORGANISING EXHIBITIONS FOR COMMERCIAL OR ADVERTISING PURPOSES; ORGANIZATION OF EVENTS, EXHIBITIONS, FAIRS AND SHOWS FOR COMMERCIAL, PROMOTIONAL AND ADVERTISING PURPOSES; ORGANIZATION OF EXHIBITIONS FOR COMMERCIAL OR ADVERTISING PURPOSES; ORGANIZATION OF FAIRS AND EXHIBITIONS FOR COMMERCIAL AND ADVERTISING PURPOSES; ORGANIZATION OF FAIRS FOR COMMERCIAL AND ADVERTISING PURPOSES; ORGANIZING BUSINESS EXPOSITIONS FOR PAYMENT SERVICES; ORGANIZING EXHIBITIONS FOR COMMERCIAL OR ADVERTISING PURPOSES; ORGANIZING EXHIBITIONS FOR PAYMENT SERVICES; OUT-OF-HOME ADVERTISING SERVICES, NAMELY, RENTAL OF ADVERTISING SPACE, AND PREPARING AND PLACING ADVERTISEMENTS FOR OTHERS; PAY PER CLICK (PPC) ADVERTISING MANAGEMENT SERVICES; PLACING ADVERTISEMENTS FOR OTHERS; PLANNING AND CONDUCTING OF TRADE FAIRS, EXHIBITIONS AND PRESENTATIONS FOR ECONOMIC OR ADVERTISING PURPOSES; PREPARATION AND REALIZATION OF MEDIA AND ADVERTISING PLANS AND CONCEPTS; PREPARATION OF CUSTOM ADVERTISEMENTS FOR OTHERS; PREPARATION OF CUSTOM OR NON-CUSTOM ADVERTISING FOR BUSINESSES FOR DISSEMINATION VIA THE WEB, CD OR DVD FOR OPTIONAL UPLOAD OR DOWNLOAD TO A COMPUTER; PREPARING ADVERTISEMENTS FOR OTHERS; PREPARING

CLASS 35—(Continued).

AND PLACING ADVERTISEMENTS FOR OTHERS; PREPARING AND PLACING OF ADVERTISEMENTS; PREPARING AND PLACING OUTDOOR ADVERTISEMENTS FOR OTHERS; PREPARING AUDIOVISUAL DISPLAYS IN THE FIELD OF PAYMENT SYSTEMS; PREPARING AUDIOVISUAL PRESENTATIONS FOR USE IN ADVERTISING; PREPARING SPEECHES AND ORAL PRESENTATIONS FOR OTHERS FOR USE IN ADVERTISING; PROCESSING TELEPHONE INQUIRIES REGARDING ADVERTISED GOODS AND SERVICES; PRODUCTION OF ADVERTISING MATTER AND COMMERCIALS; PRODUCTION OF FILM AND TELEVISION ADVERTISING; PROMOTING THE GOODS AND SERVICES OF OTHERS BY DISTRIBUTING ADVERTISING MATERIALS THROUGH A VARIETY OF METHODS; PROMOTING THE GOODS AND SERVICES OF OTHERS BY MEANS OF DISTRIBUTING ADVERTISING ON THE INTERNET; PROMOTING THE GOODS AND SERVICES OF OTHERS BY PREPARING AND PLACING ADVERTISEMENTS IN AN ELECTRONIC MAGAZINE ACCESSED THROUGH A GLOBAL COMPUTER NETWORK; PROMOTING, ADVERTISING AND MARKETING OF THE ON-LINE WEB SITES OF OTHERS; PROMOTING, ADVERTISING AND MARKETING THE ON-LINE DATABASES AND ELECTRONIC PUBLICATIONS OF OTHERS; PROMOTION, ADVERTISING AND MARKETING OF ON-LINE WEBSITES; PROMOTIONAL SERVICES, NAMELY, DISTRIBUTION OF ADVERTISING FLYERS, COUPONS, CATALOGS AND PROMOTIONAL ITEMS OF OTHERS; PROVIDING A SEARCHABLE ON-LINE ADVERTISING WEBSITE AND GUIDE FEATURING THE GOODS AND SERVICES OF OTHER VENDORS VIA THE INTERNET; PROVIDING A SEARCHABLE ONLINE ADVERTISING GUIDE FEATURING THE GOODS AND SERVICES OF ONLINE VENDORS; PROVIDING A SEARCHABLE ONLINE ADVERTISING GUIDE FEATURING THE GOODS AND SERVICES OF OTHER ON-LINE VENDORS ON THE INTERNET; PROVIDING A SEARCHABLE ONLINE ADVERTISING WEBSITE AND INFORMATIONAL GUIDE FEATURING THE GOODS AND SERVICES OF OTHER VENDORS VIA THE INTERNET IN THE FIELD OF PAYMENT SERVICES; PROVIDING A WEB SITE AT WHICH FITNESS PROFESSIONALS AND FACILITIES CAN POST PROMOTIONAL PROFILES AND RESPOND TO ADVERTISEMENTS FOR THEIR SERVICES; PROVIDING A WEB SITE WHERE USERS CAN POST ITEMS FOR SALE THROUGH ON-LINE CLASSIFIED ADVERTISEMENTS; PROVIDING A WEB SITE WHICH FEATURES ADVERTISEMENTS FOR THE GOODS AND SERVICES OF OTHERS ON A GLOBAL COMPUTER NETWORK; PROVIDING ADVERTISING AND ADVERTISEMENT SERVICES; PROVIDING ADVERTISING SERVICE TO DISTRIBUTE ADVERTISEMENTS FOR DISPLAY ON INTERNET, NAMELY, IN WEBSITES, SOCIAL CONVERSATIONS OVER THE INTERNET, EMAILS, MICROBLOGS, BLOGS, ELECTRONIC MESSAGES, INSTANT MESSAGES, TEXT MESSAGES, MULTIMEDIA MESSAGES, SOCIAL NETWORKS, STATUS UPDATES, FORUMS, ELECTRONIC BULLETIN BOARDS.; PROVIDING ADVERTISING SERVICES; PROVIDING ADVERTISING SERVICES USING 3D AND ANIMATION DESIGNS; PROVIDING ADVERTISING SPACE IN PERIODICALS, NEWSPAPERS AND MAGAZINES; PROVIDING ADVERTISING SPACE ON BILLBOARDS AND IN KIOSKS; PROVIDING ADVERTISING SPACE ON FREE-STANDING VISUAL ADVERTISING SYSTEMS FEATURING THE GOODS AND SERVICES OF OTHERS; PROVIDING ADVERTISING, MARKETING AND PROMOTIONAL SERVICES FOR THE PHARMACEUTICAL AND MEDICAL INDUSTRY; PROVIDING ADVERTISING, MARKETING AND PROMOTIONAL SERVICES FOR THE PHARMACEUTICAL AND MEDICAL PRODUCTS OF OTHERS; PROVIDING ADVERTISING, MARKETING AND PROMOTIONAL SERVICES, NAMELY, DEVELOPMENT OF ADVERTISING CAMPAIGNS FOR PAYMENT SERVICES; PROVIDING ADVERTISING, MARKETING AND PROMOTIONAL SERVICES, NAMELY, DEVELOPMENT OF ADVERTISING CAMPAIGNS PROVIDED THROUGH CABLE TELEVISION BROADCAST, WEB CASTS, RADIO BROADCASTS, NEWSPAPERS, MAGAZINES, ONLINE BANNERS, OUTDOOR BILLBOARDS, WILD POSTINGS, BUS AND SUBWAY ADS; PROVIDING AN INTERNET WEB SITE FOR CLASSIFIED ADVERTISING TO BUY AND SELL UKRAINIAN RELATED WARES, ART, ANTIQUES, BOOKS, EMBROIDERY, COSTUMES, COL-

CLASS 35—(Continued).

LECTIBLES, INSTRUMENTS, MEMORABILIA AND OTHER ONE-OF-A-KIND ITEMS; PROVIDING AN INTERNET WEB SITE TO ADVERTISE SERVICES OF INTEREST TO THE UKRAINIAN COMMUNITY IN THE UNITED STATES OF AMERICA AND CANADA AND TO ADVERTISE SERVICES PROVIDED BY INDIVIDUALS OF UKRAINIAN ORIGIN; PROVIDING AN ONLINE DIRECTORY INFORMATION SERVICE FEATURING INFORMATION REGARDING VEHICLES IN THE NATURE OF CLASSIFIED ADVERTISEMENTS; PROVIDING AND RENTAL OF ADVERTISING SPACE ON THE INTERNET; PROVIDING SPACE AT A WEB SITE FOR THE ADVERTISEMENT OF THE GOODS AND SERVICES OF OTHERS; PROVIDING TELEVISION ADVERTISING FOR OTHERS; PROVISION OF ADVERTISING SPACE BY ELECTRONIC MEANS AND GLOBAL INFORMATION NETWORKS; PROVISION OF SPACE ON WEBSITES FOR ADVERTISING GOODS AND SERVICES; PUBLIC RELATIONS, ADVERTISING AND MARKETING SERVICES FOR THE TOURISM AND CONVENTION INDUSTRY, NAMELY, ORGANIZING AND HOSTING SITE INSPECTIONS AND FAMILIARIZATION TOURS FOR WHOLESALERS, TOUR OPERATORS, TRAVEL AGENTS, MEETING AND INCENTIVE TRAVEL PLANNERS AND TRAVEL MEDIA; PUBLISHING OF ADVERTISING TEXTS; REAL ESTATE ADVERTISING SERVICES; RECRUITMENT ADVERTISEMENT SERVICES, NAMELY, POSTING OF CLINICAL TRIAL NOTICES FOR THE PURPOSE OF RECRUITING PATIENTS FOR PARTICIPATION IN CLINICAL TRIALS FOR THE TESTING OF DRUGS; RENTAL OF ADVERTISEMENT SPACE AND ADVERTISING MATERIAL; RENTAL OF ADVERTISING SPACE; RENTAL OF ADVERTISING SPACE ON WEB SITES; RENTAL OF SIGNS FOR ADVERTISING PURPOSES; RENTING OF ADVERTISING SPACES; SERVICES OF ADVERTISING AGENCIES; SERVICES TO DETERMINE THE AUDIENCE AFFECTED BY ADVERTISEMENTS; SPECIALTY MERCHANDISING SERVICES, NAMELY, PROMOTING THE GOODS AND SERVICES OF OTHERS THROUGH THE DISTRIBUTION OF CUSTOMIZED ADVERTISING MATERIALS, NAMELY, CD'S, DIGITAL MEDIA, PENS, BROCHURES; TELEVISION ADVERTISING AGENCIES; VENDOR-ON-PREMISE SERVICES, NAMELY, THE ADMINISTRATION OF THE EMPLOYMENT PROCESS ON-SITE, INCLUDING RESUME REVIEW AND CHECKING, EMPLOYMENT APPLICATION ACQUISITION, ADVERTISING FOR RECRUITMENT, CONDUCT OF INTERVIEWS, AND REFERENCE CHECKING (U.S. CLS. 100, 101 AND 102).

FIRST USE 8-15-2009; IN COMMERCE 8-15-2009.
JILL PRATER, EXAMINING ATTORNEY

SN 77-902,732. GSENSE INC., BRIARCLIFF MANOR, NY.
FILED 12-30-2009.

Human Key

THE MARK CONSISTS OF STANDARD CHARACTERS WITHOUT CLAIM TO ANY PARTICULAR FONT, STYLE, SIZE, OR COLOR.

FOR ADVERTISEMENT AND PUBLICITY SERVICES BY TELEVISION, RADIO, MAIL; ADVERTISEMENT HOARDING RENTAL; ADVERTISING AGENCIES; ADVERTISING AGENCIES PROVIDING THE STRATEGY, DESIGN AND EXECUTION OF PROGRAMS TO PROMOTE BUSINESSES IN THE FOOD AND FOODSERVICE INDUSTRIES; ADVERTISING AGENCIES, NAMELY, PROMOTING THE GOODS AND SERVICES OF OTHERS; ADVERTISING AGENCIES, NAMELY, PROMOTING THE SERVICES OF PROTECTION THROUGH THE DISTRIBUTION OF PRINTED AND AUDIO PROMOTIONAL MATERIALS AND BY RENDERING SALES PROMOTION ADVICE; ADVERTISING AGENCY SPECIALIZING IN THE DESIGN AND EXECUTION OF

CLASS 35—(Continued).

WORD OF MOUTH, VIRAL, BUZZ AND EXPERIENTIAL MARKETING PROGRAMS; ADVERTISING AND ADVERTISEMENT SERVICES; ADVERTISING AND BUSINESS ADVICE RELATING TO TELEMATICS' SERVICES; ADVERTISING AND BUSINESS MANAGEMENT CONSULTANCY; ADVERTISING AND BUSINESS SERVICES, NAMELY, PROVIDING AN ONLINE WEBSITE WHERE ADVERTISERS, MARKETERS, AND CONTENT PROVIDERS CAN INTERACT WITH USERS FOR ADVERTISING, BRANDING, AND PROMOTING KNOWLEDGE, PRODUCTS, AND SERVICES, AND TRADESHOWS, ON BEHALF OF THEMSELVES AND OTHERS, AND FOR EVALUATING AND RATING THE SAME, ALL THE FOREGOING RELEVANT TO HUMAN ACTIVITIES AFFECTING CLIMATE CHANGE AND RELATED FIELDS; ADVERTISING AND BUSINESS SERVICES, NAMELY, SECURING AIRTIME ON ALL FORMS OF MEDIA COMMUNICATIONS STATIONS, SYSTEMS, NETWORKS, AND SERVICES FOR THE PURPOSE OF PROMOTING THE GOODS AND SERVICES OF OTHERS; ADVERTISING AND COMMERCIAL INFORMATION SERVICES, VIA THE INTERNET; ADVERTISING AND DIRECTORY SERVICES, NAMELY, PROMOTING THE SERVICES OF OTHERS BY PROVIDING A WEB PAGE FEATURING LINKS TO THE WEBSITES OF OTHERS; ADVERTISING AND MARKETING; ADVERTISING AND MARKETING SERVICES, NAMELY, PROMOTING THE GOODS AND SERVICES OF OTHERS; ADVERTISING AND PROMOTING THE GOODS AND SERVICES OF A VISUAL ARTIST; ADVERTISING AND PROMOTION SERVICES AND RELATED CONSULTING; ADVERTISING AND PROMOTIONAL SERVICES; ADVERTISING AND PUBLICITY SERVICES; ADVERTISING AND PUBLICITY SERVICES, NAMELY, PROMOTING THE GOODS, SERVICES, BRAND IDENTITY AND COMMERCIAL INFORMATION AND NEWS OF THIRD PARTIES THROUGH PRINT, AUDIO, VIDEO, DIGITAL AND ON-LINE MEDIUM; ADVERTISING BUSINESS ESPECIALLY IN THE FIELD OF TELEMATIC AND TELEPHONE NETWORKS; ADVERTISING BY TRANSMISSION OF ON-LINE PUBLICITY FOR THIRD PARTIES THROUGH ELECTRONIC COMMUNICATIONS NETWORKS; ADVERTISING CONSULTATION; ADVERTISING FLYER DISTRIBUTION; ADVERTISING IN PERIODICALS, BROCHURES AND NEWSPAPERS; ADVERTISING OF COMMERCIAL OR RESIDENTIAL REAL ESTATE; ADVERTISING OF THE PUBLISHED TEXTS OF OTHERS; ADVERTISING ON THE INTERNET FOR OTHERS; ADVERTISING PARTICULARLY SERVICES FOR THE PROMOTION OF GOODS; ADVERTISING RELATING TO PHARMACEUTICAL PRODUCTS AND IN-VIVO IMAGING PRODUCTS; ADVERTISING SERVICES; ADVERTISING SERVICES FOR PROMOTING THE BROKERAGE OF STOCKS AND OTHER SECURITIES; ADVERTISING SERVICES OF A RADIO AND TELEVISION ADVERTISING AGENCY; ADVERTISING SERVICES RELATING TO SANDWICHES; ADVERTISING SERVICES, FOR THIRD PARTIES, IN CONNECTION WITH THE COMMERCIALIZATION AND SALE OF PERFUMERY AND COSMETIC ARTICLES, PRODUCTS FOR HOUSEHOLD PURPOSES, OPTICAL PRODUCTS, CLOCKS AND TIMEPIECES, JEWELLERY, FURNISHING ARTICLES; ADVERTISING SERVICES, NAMELY, COST-PER-ACTION ON-LINE ADVERTISING; ADVERTISING SERVICES, NAMELY, CREATING CORPORATE AND BRAND IDENTITY FOR OTHERS; ADVERTISING SERVICES, NAMELY, CREATING CORPORATE LOGOS FOR OTHERS; ADVERTISING SERVICES, NAMELY, PRODUCTION OF SPECIAL EFFECTS INCLUDING MODEL-MAKING SERVICES, COMPUTER-GENERATED IMAGERY AND COMPUTER-GENERATED GRAPHICS FOR THE PRODUCTION OF COMMERCIALS; ADVERTISING SERVICES, NAMELY, PROMOTING AND MARKETING THE GOODS AND SERVICES OF OTHERS IN THE FIELD OF UPSCALE CHOICES SUCH AS CULTURAL EVENTS, RESTAURANTS, SHOPPING, AND TRAVEL VIA PRINT AND ELECTRONIC MEDIA; ADVERTISING SERVICES, NAMELY, PROMOTING AND MARKETING THE GOODS AND SERVICES OF OTHERS THROUGH ALL PUBLIC COMMUNICATION MEANS; ADVERTISING SERVICES, NAMELY, PROMOTING CAR DEALERSHIPS OF OTHERS; ADVERTISING SERVICES, NAMELY, PROMOTING PROPERTIES FOR SALE BY OWNER VIA THE INTERNET; ADVERTISING SERVICES, NAMELY, PROMOTING THE BOOKS OF OTHERS IN THE FIELD OF LAW BY MEANS

CLASS 35—(Continued).

OF NEWS AND REVIEWS REGARDING SAME; ADVERTISING SERVICES, NAMELY, PROMOTING THE BRANDS, GOODS AND SERVICES OF OTHERS; ADVERTISING SERVICES, NAMELY, PROMOTING THE FOOD AND WINE OF OTHERS; ADVERTISING SERVICES, NAMELY, PROMOTING THE GIFT CARDS OF OTHERS; ADVERTISING SERVICES, NAMELY, PROMOTING THE SANDWICHES OF OTHERS; ADVERTISING SERVICES, NAMELY, PROVIDING A WEBSITE FOR THE PROMOTION OF THE BOOKS OF OTHERS IN THE FIELD OF LAW, INCLUDING NEWS AND REVIEWS REGARDING SAME; ADVERTISING SERVICES, NAMELY, PROVIDING ADVERTISING SPACE IN A PERIODICAL; ADVERTISING SERVICES, NAMELY, PROVIDING INFORMATION AS TO THE AVAILABILITY OF PROTECTION SERVICES FOR RENT OR PURCHASE; ADVERTISING SERVICES, PUBLIC RELATIONS AND MARKETING SERVICES, NAMELY, PROMOTING AND MARKETING THE GOODS AND SERVICES OF OTHERS THROUGH ALL PUBLIC COMMUNICATION MEANS; ADVERTISING TEXT PUBLICATION SERVICES; ADVERTISING THROUGH ALL PUBLIC COMMUNICATION MEANS; ADVERTISING VIA ELECTRONIC MEDIA AND SPECIFICALLY THE INTERNET; ADVERTISING, INCLUDING ON-LINE ADVERTISING ON A COMPUTER NETWORK; ADVERTISING, INCLUDING PROMOTION OF PRODUCTS AND SERVICES OF THIRD PARTIES THROUGH SPONSORING ARRANGEMENTS AND LICENCE AGREEMENTS RELATING TO INTERNATIONAL SPORTS' EVENTS; ADVERTISING, INCLUDING PROMOTION RELATING TO THE SALE OF ARTICLES AND SERVICES FOR THIRD PARTIES BY THE TRANSMISSION OF ADVERTISING MATERIAL AND THE DISSEMINATION OF ADVERTISING MESSAGES ON COMPUTER NETWORKS; ADVERTISING, MARKETING AND PROMOTING THE GOODS AND SERVICES OF OTHERS USING KIOSKS; ADVERTISING, MARKETING AND PROMOTION SERVICES; ADVERTISING, MARKETING AND PROMOTIONAL SERVICES FOR AUTOMOTIVE DEALERSHIPS; ADVERTISING, MARKETING AND PROMOTIONAL SERVICES FOR LIGHT AND HEAVY EQUIPMENT DEALERSHIPS; ADVERTISING, MARKETING AND PROMOTIONAL SERVICES FOR THE DONATION OF HUMAN BLOOD THAT EXACTLY MATCHES THE BLOOD TYPE OF INDIVIDUALS NEEDING TRANSFUSIONS; ADVERTISING, MARKETING AND PROMOTIONAL SERVICES RELATED TO ALL INDUSTRIES FOR THE PURPOSE OF FACILITATING NETWORKING AND SOCIALIZING OPPORTUNITIES FOR BUSINESS PURPOSES; ADVERTISING, PROMOTION AND MARKETING SERVICES IN THE NATURE OF E-MAIL BLAST CAMPAIGNS FOR OTHERS; AGENCIES FOR ADVERTISING TIME AND SPACE; ANALYSIS OF ADVERTISING RESPONSE; ARRANGING AND CONDUCTING OF FAIRS AND EXHIBITIONS FOR BUSINESS AND ADVERTISING PURPOSES; BUSINESS MANAGEMENT AND CONSULTING SERVICES FOR THE HEALTH CARE INDUSTRY, NAMELY, CUSTOMER SERVICE, ACCOUNTING SERVICES, AND WEB-BASED ADVERTISING AND MARKETING SERVICES; BUSINESS SERVICES, NAMELY, TRACKING AND MONITORING OF CALLS FOR OTHERS IN RESPONSE TO ADVERTISING ADS; CINEMA ADVERTISING; CLASSIFIED ADVERTISING SERVICES; COMPILATION OF ADVERTISEMENTS FOR USE AS WEB PAGES ON THE INTERNET; CONDUCTING, ARRANGING AND ORGANIZING TRADE SHOWS AND TRADE FAIRS FOR COMMERCIAL AND ADVERTISING PURPOSES; CONSUMER LOYALTY SERVICES FOR COMMERCIAL, PROMOTIONAL, AND/OR ADVERTISING PURPOSES, NAMELY, ADMINISTRATION OF FREQUENT FLYER PROGRAM THAT ALLOWS MEMBERS TO REDEEM MILES FOR POINTS OR AWARDS OFFERED BY OTHER LOYALTY PROGRAMS; COOPERATIVE ADVERTISING AND MARKETING; COOPERATIVE ADVERTISING AND MARKETING SERVICES BY WAY OF SOLICITATION, CUSTOMER SERVICE AND PROVIDING MARKETING INFORMATION VIA WEB SITES ON A GLOBAL COMPUTER NETWORK; COOPERATIVE ADVERTISING AND MARKETING SERVICES, NAMELY, OFFERING DISCOUNTS TO CLIENTS THROUGH THE JOINT PARTICIPATION OF MEMBER BEAUTY SALONS.; CREATING AND UPDATING ADVERTISING MATERIAL; CREATION OF MARKETING TOOLS DESIGNED TO INCREASE A CLIENT COMPANY'S KNOWLEDGE OF

CLASS 35—(Continued).

CUSTOMER NEEDS, AND ITS COMPETITORS' PRODUCTS AND SERVICES, PRICING, ADVERTISING STRATEGY AND SALES STRATEGY; CUSTOMER LOYALTY SERVICES AND CUSTOMER CLUB SERVICES, FOR COMMERCIAL, PROMOTIONAL AND/OR ADVERTISING PURPOSES; DESIGN OF ADVERTISING BROCHURES FOR OTHERS; DESIGN OF ADVERTISING FLYERS FOR OTHERS; DESIGN OF ADVERTISING MATERIALS FOR OTHERS; DESIGN OF INTERNET ADVERTISING; DEVELOPING ADVERTISING CAMPAIGNS FOR OTHERS GEARED TOWARD ENVIRONMENTAL ISSUES; DEVELOPMENT, OPERATION AND ADMINISTRATION OF DIGITAL SIGNAGE SYSTEMS AND DIGITAL ADVERTISING SYSTEMS FOR OTHERS, NAMELY, PROVIDING ADVERTISING SPACE BY ELECTRONIC MEANS AND GLOBAL COMPUTER INFORMATION NETWORKS; DIRECT MAIL ADVERTISING; DIRECT MARKETING ADVERTISING FOR OTHERS; DISPLAYING ADVERTISEMENTS FOR OTHERS; DISSEMINATION OF ADVERTISEMENTS; DISSEMINATION OF ADVERTISEMENTS AND OF ADVERTISING MATERIAL; DISSEMINATION OF ADVERTISING FOR OTHERS VIA AN ON-LINE COMMUNICATIONS NETWORK ON THE INTERNET; DISSEMINATION OF ADVERTISING FOR OTHERS VIA PUBLIC AND PRIVATE WIRELESS NETWORKS FOR DISPLAY ON MOBILE DEVICES; DISSEMINATION OF ADVERTISING FOR OTHERS VIA THE INTERNET; DISSEMINATION OF ADVERTISING MATERIAL; DISSEMINATION OF ADVERTISING MATTER; DISSEMINATION OF ADVERTISING, SCHEDULING AND MANAGING OF TRAINING COURSES AND PROGRAMS FOR OTHERS VIA A GLOBAL COMPUTER NETWORK; DISSEMINATION SERVICES OF ADVERTISEMENT MATTER; DISTRIBUTION AND DISSEMINATION OF ADVERTISING MATERIALS; DISTRIBUTION OF ADVERTISEMENTS AND COMMERCIAL ANNOUNCEMENTS; DISTRIBUTION OF ADVERTISING MAIL AND OF ADVERTISING SUPPLEMENTS ATTACHED TO REGULAR EDITIONS; DISTRIBUTION OF ADVERTISING MATERIALS; DISTRIBUTION OF PRODUCTS FOR ADVERTISING PURPOSES; ELECTRONIC BILLBOARD ADVERTISING; ELECTRONIC COMMERCE SERVICES, NAMELY, PROVIDING INFORMATION ABOUT PRODUCTS VIA TELECOMMUNICATION NETWORKS FOR ADVERTISING AND SALES PURPOSES; ENTERTAINMENT MARKETING SERVICES, NAMELY, MARKETING, PROMOTION AND ADVERTISING FOR INDEPENDENT RECORDING ARTISTS; INTERNET ADVERTISING SERVICES; ISSUING AND UPDATING OF ADVERTISING TEXTS; LAYOUT SERVICES FOR ADVERTISING PURPOSES; MANAGEMENT OF ADVERTISING THROUGH A COMMAND AND CONTROL CENTER FOR BOTH MOVIE THEATRE ON-SCREEN ADVERTISING AND OVER THE INTERNET; MARKETING AND ADVERTISING SERVICES FOR AUTOMOBILE DEALERSHIPS; MARKETING, ADVERTISING AND PROMOTING THE GOODS AND SERVICES OF OTHERS IN THE FIELD OF TRAVEL AND TOURISM, NAMELY, PROVIDING INFORMATION VIA MAIL AND ELECTRONIC MAIL; MARKETING, ADVERTISING, AND PROMOTING THE RETAIL GOODS AND SERVICES OF OTHERS TO WIRELESS ELECTRONIC DEVICES; MARKETING, PROMOTIONAL AND ADVERTISING SERVICES PROVIDED BY MOBILE TELEPHONE CONNECTIONS; MEDIA BUYING ADVICE, NAMELY, ADVISING THE CLIENT HOW MUCH MEDIA TIME, AND AT WHAT TIMES THE CLIENT SHOULD BE PURCHASING ADVERTISING; MEDIA PLANNING, NAMELY, ADVISING THE CLIENT ON THE CORRECT TIMES AND STATIONS TO ADVERTISE BASED ON MEDIA ANALYSIS OF THE MARKET FOR THAT MEDIA; MEDIA PRODUCTION LOCATION SCOUTING SERVICES FOR ADVERTISING PURPOSES; MEDIATION OF ADVERTISING; MODELING FOR ADVERTISING OR SALES PROMOTION; MODELING SERVICES FOR ADVERTISING OR SALES PROMOTION; MUSIC SELECTION SERVICES FOR USE IN ADVERTISING; ON-LINE ADVERTISING AND MARKETING SERVICES; ON-LINE ADVERTISING ON COMPUTER COMMUNICATION NETWORKS; ON-LINE ADVERTISING ON COMPUTER NETWORKS; ON-LINE ADVERTISING SERVICES FOR OTHERS; ONLINE ADVERTISING VIA A COMPUTER COMMUNICATIONS NETWORK.; ORGANISATION AND HOLDING OF FAIRS FOR COMMERCIAL OR ADVERTISING PURPOSES; ORGANISATION OF EXHIBITIONS FOR COMMERCIAL OR ADVERTISING PURPOSES; ORGANISING EXHIBITIONS FOR COMMERCIAL OR ADVERTISING PURPOSES; ORGANIZATION OF EVENTS, EXHIBITIONS, FAIRS AND SHOWS FOR COMMERCIAL, PROMOTIONAL AND ADVERTISING PURPOSES; ORGANIZATION OF EXHIBITIONS FOR COMMERCIAL OR ADVERTISING PURPOSES; ORGANIZATION OF FAIRS AND EXHIBITIONS FOR COMMERCIAL AND ADVERTISING PURPOSES; ORGANIZATION OF FAIRS FOR COMMERCIAL AND ADVERTISING PURPOSES; ORGANIZING BUSINESS EXPOSITIONS FOR PROTECTION SERVICES; ORGANIZING EXHIBITIONS FOR COMMERCIAL OR ADVERTISING PURPOSES; ORGANIZING EXHIBITIONS FOR PROTECTION SERVICES; OUT-OF-HOME ADVERTISING SERVICES, NAMELY, RENTAL OF ADVERTISING SPACE, AND PREPARING AND PLACING ADVERTISEMENTS FOR OTHERS; PAY PER CLICK (PPC) ADVERTISING MANAGEMENT SERVICES; PLACING ADVERTISEMENTS FOR OTHERS; PLANNING AND CONDUCTING OF TRADE FAIRS, EXHIBITIONS AND PRESENTATIONS FOR ECONOMIC OR ADVERTISING PURPOSES; PREPARATION AND REALIZATION OF MEDIA AND ADVERTISING PLANS AND CONCEPTS; PREPARATION OF CUSTOM ADVERTISEMENTS FOR OTHERS; PREPARATION OF CUSTOM OR NON-CUSTOM ADVERTISING FOR BUSINESSES FOR DISSEMINATION VIA THE WEB, CD OR DVD FOR OPTIONAL UPLOAD OR DOWNLOAD TO A COMPUTER; PREPARING ADVERTISEMENTS FOR OTHERS; PREPARING AND PLACING ADVERTISEMENTS FOR OTHERS; PREPARING AND PLACING OF ADVERTISEMENTS; PREPARING AND PLACING OUTDOOR ADVERTISEMENTS FOR OTHERS; PREPARING AUDIOVISUAL DISPLAYS IN THE FIELD OF PROTECTION SERVICES; PREPARING AUDIOVISUAL PRESENTATIONS FOR USE IN ADVERTISING; PREPARING SPEECHES AND ORAL PRESENTATIONS FOR OTHERS FOR USE IN ADVERTISING; PROCESSING TELEPHONE INQUIRIES REGARDING ADVERTISED GOODS AND SERVICES; PRODUCTION OF ADVERTISING MATTER AND COMMERCIALS; PRODUCTION OF FILM AND TELEVISION ADVERTISING; PROMOTING THE GOODS AND SERVICES OF OTHERS BY DISTRIBUTING ADVERTISING MATERIALS THROUGH A VARIETY OF METHODS; PROMOTING THE GOODS AND SERVICES OF OTHERS BY MEANS OF DISTRIBUTING ADVERTISING ON THE INTERNET; PROMOTING THE GOODS AND SERVICES OF OTHERS BY PREPARING AND PLACING ADVERTISEMENTS IN AN ELECTRONIC MAGAZINE ACCESSED THROUGH A GLOBAL COMPUTER NETWORK; PROMOTING, ADVERTISING AND MARKETING OF THE ON-LINE WEB SITES OF OTHERS; PROMOTING, ADVERTISING AND MARKETING THE ON-LINE DATABASES AND ELECTRONIC PUBLICATIONS OF OTHERS; PROMOTION, ADVERTISING AND MARKETING OF ON-LINE WEBSITES; PROMOTIONAL SERVICES, NAMELY, DISTRIBUTION OF ADVERTISING FLYERS, COUPONS, CATALOGS AND PROMOTIONAL ITEMS OF OTHERS; PROVIDING A SEARCHABLE ON-LINE ADVERTISING WEBSITE AND GUIDE FEATURING THE GOODS AND SERVICES OF OTHER VENDORS VIA THE INTERNET; PROVIDING A SEARCHABLE ONLINE ADVERTISING GUIDE FEATURING THE GOODS AND SERVICES OF ONLINE VENDORS; PROVIDING A SEARCHABLE ONLINE ADVERTISING GUIDE FEATURING THE GOODS AND SERVICES OF OTHER ON-LINE VENDORS ON THE INTERNET; PROVIDING A SEARCHABLE ONLINE ADVERTISING WEBSITE AND INFORMATIONAL GUIDE FEATURING THE GOODS AND SERVICES OF OTHER VENDORS VIA THE INTERNET IN THE FIELD OF PROTECTION SERVICES; PROVIDING A WEB SITE AT WHICH FITNESS PROFESSIONALS AND FACILITIES CAN POST PROMOTIONAL PROFILES AND RESPOND TO ADVERTISEMENTS FOR THEIR SERVICES; PROVIDING A WEB SITE WHERE USERS CAN POST ITEMS FOR SALE THROUGH ON-LINE CLASSIFIED ADVERTISEMENTS; PROVIDING A WEB SITE WHICH FEATURES ADVERTISEMENTS FOR THE GOODS AND SERVICES OF OTHERS ON A GLOBAL COMPUTER NETWORK; PROVIDING ADVERTISING AND ADVERTISEMENT SERVICES; PROVIDING ADVERTISING SERVICE TO DISTRIBUTE ADVERTISEMENTS FOR DISPLAY ON INTERNET, NAMELY, IN WEBSITES, SOCIAL CONVERSATIONS OVER THE INTERNET, EMAILS, MICROBLOGS, BLOGS, ELECTRO-

CLASS 35—(Continued).

BITIONS FOR COMMERCIAL OR ADVERTISING PURPOSES; ORGANISING EXHIBITIONS FOR COMMERCIAL OR ADVERTISING PURPOSES; ORGANIZATION OF EVENTS, EXHIBITIONS, FAIRS AND SHOWS FOR COMMERCIAL, PROMOTIONAL AND ADVERTISING PURPOSES; ORGANIZATION OF EXHIBITIONS FOR COMMERCIAL OR ADVERTISING PURPOSES; ORGANIZATION OF FAIRS AND EXHIBITIONS FOR COMMERCIAL AND ADVERTISING PURPOSES; ORGANIZATION OF FAIRS FOR COMMERCIAL AND ADVERTISING PURPOSES; ORGANIZING BUSINESS EXPOSITIONS FOR PROTECTION SERVICES; ORGANIZING EXHIBITIONS FOR COMMERCIAL OR ADVERTISING PURPOSES; ORGANIZING EXHIBITIONS FOR PROTECTION SERVICES; OUT-OF-HOME ADVERTISING SERVICES, NAMELY, RENTAL OF ADVERTISING SPACE, AND PREPARING AND PLACING ADVERTISEMENTS FOR OTHERS; PAY PER CLICK (PPC) ADVERTISING MANAGEMENT SERVICES; PLACING ADVERTISEMENTS FOR OTHERS; PLANNING AND CONDUCTING OF TRADE FAIRS, EXHIBITIONS AND PRESENTATIONS FOR ECONOMIC OR ADVERTISING PURPOSES; PREPARATION AND REALIZATION OF MEDIA AND ADVERTISING PLANS AND CONCEPTS; PREPARATION OF CUSTOM ADVERTISEMENTS FOR OTHERS; PREPARATION OF CUSTOM OR NON-CUSTOM ADVERTISING FOR BUSINESSES FOR DISSEMINATION VIA THE WEB, CD OR DVD FOR OPTIONAL UPLOAD OR DOWNLOAD TO A COMPUTER; PREPARING ADVERTISEMENTS FOR OTHERS; PREPARING AND PLACING ADVERTISEMENTS FOR OTHERS; PREPARING AND PLACING OF ADVERTISEMENTS; PREPARING AND PLACING OUTDOOR ADVERTISEMENTS FOR OTHERS; PREPARING AUDIOVISUAL DISPLAYS IN THE FIELD OF PROTECTION SERVICES; PREPARING AUDIOVISUAL PRESENTATIONS FOR USE IN ADVERTISING; PREPARING SPEECHES AND ORAL PRESENTATIONS FOR OTHERS FOR USE IN ADVERTISING; PROCESSING TELEPHONE INQUIRIES REGARDING ADVERTISED GOODS AND SERVICES; PRODUCTION OF ADVERTISING MATTER AND COMMERCIALS; PRODUCTION OF FILM AND TELEVISION ADVERTISING; PROMOTING THE GOODS AND SERVICES OF OTHERS BY DISTRIBUTING ADVERTISING MATERIALS THROUGH A VARIETY OF METHODS; PROMOTING THE GOODS AND SERVICES OF OTHERS BY MEANS OF DISTRIBUTING ADVERTISING ON THE INTERNET; PROMOTING THE GOODS AND SERVICES OF OTHERS BY PREPARING AND PLACING ADVERTISEMENTS IN AN ELECTRONIC MAGAZINE ACCESSED THROUGH A GLOBAL COMPUTER NETWORK; PROMOTING, ADVERTISING AND MARKETING OF THE ON-LINE WEB SITES OF OTHERS; PROMOTING, ADVERTISING AND MARKETING THE ON-LINE DATABASES AND ELECTRONIC PUBLICATIONS OF OTHERS; PROMOTION, ADVERTISING AND MARKETING OF ON-LINE WEBSITES; PROMOTIONAL SERVICES, NAMELY, DISTRIBUTION OF ADVERTISING FLYERS, COUPONS, CATALOGS AND PROMOTIONAL ITEMS OF OTHERS; PROVIDING A SEARCHABLE ON-LINE ADVERTISING WEBSITE AND GUIDE FEATURING THE GOODS AND SERVICES OF OTHER VENDORS VIA THE INTERNET; PROVIDING A SEARCHABLE ONLINE ADVERTISING GUIDE FEATURING THE GOODS AND SERVICES OF ONLINE VENDORS; PROVIDING A SEARCHABLE ONLINE ADVERTISING GUIDE FEATURING THE GOODS AND SERVICES OF OTHER ON-LINE VENDORS ON THE INTERNET; PROVIDING A SEARCHABLE ONLINE ADVERTISING WEBSITE AND INFORMATIONAL GUIDE FEATURING THE GOODS AND SERVICES OF OTHER VENDORS VIA THE INTERNET IN THE FIELD OF PROTECTION SERVICES; PROVIDING A WEB SITE AT WHICH FITNESS PROFESSIONALS AND FACILITIES CAN POST PROMOTIONAL PROFILES AND RESPOND TO ADVERTISEMENTS FOR THEIR SERVICES; PROVIDING A WEB SITE WHERE USERS CAN POST ITEMS FOR SALE THROUGH ON-LINE CLASSIFIED ADVERTISEMENTS; PROVIDING A WEB SITE WHICH FEATURES ADVERTISEMENTS FOR THE GOODS AND SERVICES OF OTHERS ON A GLOBAL COMPUTER NETWORK; PROVIDING ADVERTISING AND ADVERTISEMENT SERVICES; PROVIDING ADVERTISING SERVICE TO DISTRIBUTE ADVERTISEMENTS FOR DISPLAY ON INTERNET, NAMELY, IN WEBSITES, SOCIAL CONVERSATIONS OVER THE INTERNET, EMAILS, MICROBLOGS, BLOGS, ELECTRO-

CLASS 35—(Continued).

NIC MESSAGES, INSTANT MESSAGES, TEXT MESSAGES, MULTIMEDIA MESSAGES, SOCIAL NETWORKS, STATUS UPDATES, FORUMS, ELECTRONIC BULLETIN BOARDS.; PROVIDING ADVERTISING SERVICES; PROVIDING ADVERTISING SERVICES USING 3D AND ANIMATION DESIGNS; PROVIDING ADVERTISING SPACE IN PERIODICALS, NEWSPAPERS AND MAGAZINES; PROVIDING ADVERTISING SPACE ON BILLBOARDS AND IN KIOSKS; PROVIDING ADVERTISING SPACE ON FREE-STANDING VISUAL ADVERTISING SYSTEMS FEATURING THE GOODS AND SERVICES OF OTHERS; PROVIDING ADVERTISING, MARKETING AND PROMOTIONAL SERVICES FOR THE PHARMACEUTICAL AND MEDICAL INDUSTRY; PROVIDING ADVERTISING, MARKETING AND PROMOTIONAL SERVICES FOR THE PHARMACEUTICAL AND MEDICAL PRODUCTS OF OTHERS; PROVIDING ADVERTISING, MARKETING AND PROMOTIONAL SERVICES, NAMELY, DEVELOPMENT OF ADVERTISING CAMPAIGNS FOR PROTECTION SERVICES; PROVIDING ADVERTISING, MARKETING AND PROMOTIONAL SERVICES, NAMELY, DEVELOPMENT OF ADVERTISING CAMPAIGNS PROVIDED THROUGH CABLE TELEVISION BROADCAST, WEB CASTS, RADIO BROADCASTS, NEWSPAPERS, MAGAZINES, ONLINE BANNERS, OUTDOOR BILLBOARDS, WILD POSTINGS, BUS AND SUBWAY ADS; PROVIDING AN INTERNET WEB SITE FOR CLASSIFIED ADVERTISING TO BUY AND SELL UKRAINIAN RELATED WARES, ART, ANTIQUES, BOOKS, EMBROIDERY, COSTUMES, COLLECTIBLES, INSTRUMENTS, MEMORABILIA AND OTHER ONE-OF-A-KIND ITEMS; PROVIDING AN INTERNET WEB SITE TO ADVERTISE SERVICES OF INTEREST TO THE UKRAINIAN COMMUNITY IN THE UNITED STATES OF AMERICA AND CANADA AND TO ADVERTISE SERVICES PROVIDED BY INDIVIDUALS OF UKRAINIAN ORIGIN; PROVIDING AN ONLINE DIRECTORY INFORMATION SERVICE FEATURING INFORMATION REGARDING VEHICLES IN THE NATURE OF CLASSIFIED ADVERTISEMENTS; PROVIDING AND RENTAL OF ADVERTISING SPACE ON THE INTERNET; PROVIDING SPACE AT A WEB SITE FOR THE ADVERTISEMENT OF THE GOODS AND SERVICES OF OTHERS; PROVIDING TELEVISION ADVERTISING FOR OTHERS; PROVISION OF ADVERTISING SPACE BY ELECTRONIC MEANS AND GLOBAL INFORMATION NETWORKS; PROVISION OF SPACE ON WEBSITES FOR ADVERTISING GOODS AND SERVICES; PUBLIC RELATIONS, ADVERTISING AND MARKETING SERVICES FOR THE TOURISM AND CONVENTION INDUSTRY, NAMELY, ORGANIZING AND HOSTING SITE INSPECTIONS AND FAMILIARIZATION TOURS FOR WHOLESALERS, TOUR OPERATORS, TRAVEL AGENTS, MEETING AND INCENTIVE TRAVEL PLANNERS AND TRAVEL MEDIA; PUBLISHING OF ADVERTISING TEXTS; REAL ESTATE ADVERTISING SERVICES; RECRUITMENT ADVERTISEMENT SERVICES, NAMELY, POSTING OF CLINICAL TRIAL NOTICES FOR THE PURPOSE OF RECRUITING PATIENTS FOR PARTICIPATION IN CLINICAL TRIALS FOR THE TESTING OF DRUGS; RENTAL OF ADVERTISEMENT SPACE AND ADVERTISING MATERIAL; RENTAL OF ADVERTISING SPACE; RENTAL OF ADVERTISING SPACE ON WEB SITES; RENTAL OF SIGNS FOR ADVERTISING PURPOSES; RENTING OF ADVERTISING SPACES; SERVICES OF ADVERTISING AGENCIES; SERVICES TO DETERMINE THE AUDIENCE AFFECTED BY ADVERTISEMENTS; SPECIALTY MERCHANDISING SERVICES, NAMELY, PROMOTING THE GOODS AND SERVICES OF OTHERS THROUGH THE DISTRIBUTION OF CUSTOMIZED ADVERTISING MATERIALS, NAMELY, DIGITAL MEDIA, BROCHURES; TELEVISION ADVERTISING AGENCIES; VENDOR-ON-PREMISE SERVICES, NAMELY, THE ADMINISTRATION OF THE EMPLOYMENT PROCESS ON-SITE, INCLUDING RESUME REVIEW AND CHECKING, EMPLOYMENT APPLICATION ACQUISITION, ADVERTISING FOR RECRUITMENT, CONDUCT OF INTERVIEWS, AND REFERENCE CHECKING (U.S. CLS. 100, 101 AND 102).

FIRST USE 8-15-2009; IN COMMERCE 8-15-2009.

JILL PRATER, EXAMINING ATTORNEY

CLASS 35—(Continued).

SN 77-905,882. HANKY PANKY, LTD., NEW YORK, NY. FILED 1-6-2010.

HANKY PANKY

THE MARK CONSISTS OF STANDARD CHARACTERS WITHOUT CLAIM TO ANY PARTICULAR FONT, STYLE, SIZE, OR COLOR.

OWNER OF U.S. REG. NOS. 2,847,981, 3,196,011 AND 3,405,101.

FOR RETAIL STORE SERVICES IN THE FIELDS OF CLOTHING, NAMELY, LINGERIE, SHIRTS, SLEEPWEAR, UNDERSHIRTS, UNDERWEAR, AND GARTER BELTS (U.S. CLS. 100, 101 AND 102).

FIRST USE 11-20-2009; IN COMMERCE 11-20-2009.

ANGELA DUONG, EXAMINING ATTORNEY

SN 77-907,689. SARASOTA CONVENTION AND VISITORS BUREAU, INC., SARASOTA, FL. FILED 1-8-2010.

SARASOTA
— AND HER ISLANDS —

OWNER OF U.S. REG. NO. 3,530,768.

NO CLAIM IS MADE TO THE EXCLUSIVE RIGHT TO USE "SARASOTA", APART FROM THE MARK AS SHOWN.

THE MARK CONSISTS OF THE WORD "SARASOTA" WITH A STYLIZED LETTER "O" CONTAINING STYLIZED WAVES. THE WORD "SARASOTA" IS PLACED OVER THE WORDS "AND HER ISLANDS" WHICH ARE CENTERED BETWEEN TWO LINES.

FOR CONVENTION AND VISITORS BUREAU SERVICES, NAMELY, PROMOTING TOURISM, BUSINESS AND CONVENTIONS IN AND AROUND THE SARASOTA COUNTY, FLORIDA AREA (U.S. CLS. 100, 101 AND 102).

FIRST USE 11-30-2007; IN COMMERCE 11-30-2007.

MARIAM MAHMOUDI, EXAMINING ATTORNEY

SN 77-909,269. ARMY AND AIR FORCE EXCHANGE SERVICE, DALLAS, TX. FILED 1-11-2010.

You save, we give back.

THE MARK CONSISTS OF STANDARD CHARACTERS WITHOUT CLAIM TO ANY PARTICULAR FONT, STYLE, SIZE, OR COLOR.

FOR RETAIL DISCOUNT STORE SERVICES IN THE FIELD OF GENERAL CONSUMER MERCHANDISE (U.S. CLS. 100, 101 AND 102).

NICHOLAS COLEMAN, EXAMINING ATTORNEY

CLASS 35—(Continued).

SN 77-909,292. SUPERMEDIA LLC, DFW AIRPORT, TX. FILED 1-11-2010.

SUPEREXPOSURE

THE MARK CONSISTS OF STANDARD CHARACTERS WITHOUT CLAIM TO ANY PARTICULAR FONT, STYLE, SIZE, OR COLOR.

FOR DISSEMINATION OF ADVERTISING FOR OTHERS VIA THE INTERNET; ADVERTISING SERVICES, NAMELY, PROMOTING THE GOODS AND SERVICES OF OTHERS VIA THE INTERNET (U.S. CLS. 100, 101 AND 102).

MARC LEIPZIG, EXAMINING ATTORNEY

SN 77-910,768. PERSIAN MIRROR, LLC, NEW YORK, NY. FILED 1-13-2010.



THE MARK CONSISTS OF THE WORD "PERSIANMIRROR" IN STYLIZED FONT.

FOR ON-LINE RETAIL STORE SERVICES FEATURING BOOKS, GAMES, DVDS, TOYS, AND CLOTHING (U.S. CLS. 100, 101 AND 102).

JACLYN KIDWELL WALKER, EXAMINING ATTORNEY

SN 77-912,662. WILNER, ELI, NEW YORK, NY. FILED 1-15-2010.

ELI WILNER

THE MARK CONSISTS OF STANDARD CHARACTERS WITHOUT CLAIM TO ANY PARTICULAR FONT, STYLE, SIZE, OR COLOR.

THE NAME(S), PORTRAIT(S), AND/OR SIGNATURE(S) SHOWN IN THE MARK IDENTIFIES "ELI WILNER", WHOSE CONSENT(S) TO REGISTER IS MADE OF RECORD.

FOR RETAIL STORE SERVICES FEATURING FRAMES (U.S. CLS. 100, 101 AND 102).

VIVIAN MICZNIK FIRST, EXAMINING ATTORNEY

CLASS 35—(Continued).

SN 77-915,563. UNITED STATES GYPSUM COMPANY, CHICAGO, IL. FILED 1-20-2010.

ECOBLUEPRINT

THE MARK CONSISTS OF STANDARD CHARACTERS WITHOUT CLAIM TO ANY PARTICULAR FONT, STYLE, SIZE, OR COLOR.

FOR PROVIDING CONSUMER PRODUCT INFORMATION IN THE FIELD OF CONSTRUCTION VIA THE INTERNET (U.S. CLS. 100, 101 AND 102).

FIRST USE 12-30-2009; IN COMMERCE 12-30-2009. CIMMERIAN COLEMAN, EXAMINING ATTORNEY

SN 77-915,721. MANHEIM, INC., ATLANTA, GA. FILED 1-20-2010.



OWNER OF U.S. REG. NOS. 1,699,332, 3,229,428 AND OTHERS.

NO CLAIM IS MADE TO THE EXCLUSIVE RIGHT TO USE "SPECIALTY AUCTIONS", APART FROM THE MARK AS SHOWN.

THE COLOR(S) GOLD, BROWN, BLUE AND WHITE IS/ ARE CLAIMED AS A FEATURE OF THE MARK.

THE MARK CONSISTS OF A GOLD "M" OVER A BLUE CIRCULAR BACKGROUND AND WITHIN TWO GOLD OUTER RINGS. THE COLOR BROWN OUTLINES THE MARK. TO THE RIGHT OF THE "M" ARE THE WORDS "MANHEIM SPECIALTY AUCTIONS". THE WORDS "MANHEIM" AND "AUCTIONS" ARE IN THE COLOR WHITE, THE WORD "SPECIALTY" IS IN THE COLOR GOLD, ALL ON A BLUE BACKGROUND.

FOR AUTOMOBILE AUCTION SERVICES; AUTOMOBILE AUCTION SERVICES PROVIDED VIA THE INTERNET (U.S. CLS. 100, 101 AND 102).

FIRST USE 1-20-2010; IN COMMERCE 1-20-2010. WILLIAM ROSSMAN, EXAMINING ATTORNEY

CLASS 35—(Continued).

SN 77-917,102. ACE HARDWARE CORPORATION, OAK BROOK, IL. FILED 1-21-2010.

MENOS TIEMPO DANDO
VUELTAS, MAS TIEMPO PARA
LO IMPORTANTE

THE MARK CONSISTS OF STANDARD CHARACTERS WITHOUT CLAIM TO ANY PARTICULAR FONT, STYLE, SIZE, OR COLOR.

THE ENGLISH TRANSLATION OF "MENOS TIEMPO DANDO VUELTAS, MAS TIEMPO PARA LO IMPORTANTE" IN THE MARK IS LESS TIME RUNNING IN CIRCLES, MORE TIME FOR WHAT IS IMPORTANT.

FOR RETAIL HARDWARE STORE SERVICES (U.S. CLS. 100, 101 AND 102).

MICHAEL WIENER, EXAMINING ATTORNEY

SN 77-917,606. UNITED STATES GYPSUM COMPANY, CHICAGO, IL. FILED 1-22-2010.

ECOBBLUEPRINT
|.|.|.|.|.|.|.|.|.|.|.|.|.

THE COLOR(S) GREEN, BOLDED BLUE, AND LIGHT BLUE IS/ARE CLAIMED AS A FEATURE OF THE MARK.

THE MARK CONSISTS OF LONG AND SHORT VERTICAL GREEN LINES UNDER THE WORD "ECO" IN BOLDED BLUE FOLLOWED BY THE WORD "BLUEPRINT" IN LIGHT BLUE.

FOR PROVIDING CONSUMER PRODUCT INFORMATION IN THE FIELD OF CONSTRUCTION VIA THE INTERNET (U.S. CLS. 100, 101 AND 102).

FIRST USE 12-30-2009; IN COMMERCE 12-30-2009.
CIMMERIAN COLEMAN, EXAMINING ATTORNEY

SN 77-918,981. WINFIELD SOLUTIONS, LLC, SHOREVIEW, MN. FILED 1-25-2010.

CONNECT3

THE MARK CONSISTS OF STANDARD CHARACTERS WITHOUT CLAIM TO ANY PARTICULAR FONT, STYLE, SIZE, OR COLOR.

FOR PROVIDING A WEBSITE USED TO PLACE ON-LINE COMMERCIAL ORDERS IN THE FIELD OF AGRICULTURAL SEED AND CROP PROTECTION PRODUCTS (U.S. CLS. 100, 101 AND 102).

COLLEEN DOMBROW, EXAMINING ATTORNEY

CLASS 35—(Continued).

SN 77-923,764. OAKLEY, INC., FOOTHILL RANCH, CA. FILED 1-29-2010.

OAKLEY VAULT

THE MARK CONSISTS OF STANDARD CHARACTERS WITHOUT CLAIM TO ANY PARTICULAR FONT, STYLE, SIZE, OR COLOR.

OWNER OF U.S. REG. NOS. 1,356,297, 1,519,596 AND 1,968,365.

FOR RETAIL STORE SERVICES AND ON-LINE RETAIL STORE SERVICES FEATURING EYEWEAR, REPLACEMENT LENSES, EYEWEAR NOSEPIECE KITS, CLOTHING, HEADWEAR, FOOTWEAR, WATCHES, DECALS, POSTERS, ATHLETIC BAGS, BACKPACKS, AND KNAPSACKS (U.S. CLS. 100, 101 AND 102).

FIRST USE 3-30-2001; IN COMMERCE 3-30-2001.
EMILY CARLSEN, EXAMINING ATTORNEY

SN 77-924,605. VITAL IMAGES, INC., MINNETONKA, MN. FILED 2-1-2010.

VITAL

THE MARK CONSISTS OF STANDARD CHARACTERS WITHOUT CLAIM TO ANY PARTICULAR FONT, STYLE, SIZE, OR COLOR.

OWNER OF U.S. REG. NOS. 3,036,769, 3,180,821 AND 3,416,864.

FOR PROVIDING CUSTOMER SERVICE IN THE FIELD OF COMPUTER SOFTWARE; ARRANGING AND CONDUCTING TRADE SHOW EXHIBITIONS IN THE FIELD OF MEDICAL TECHNOLOGY; DEMONSTRATION OF PRODUCTS; DISSEMINATION OF ADVERTISEMENTS AND OF ADVERTISING MATERIAL; PROVIDING AN ON-LINE COMPUTER DATABASE FEATURING TRADE INFORMATION IN THE FIELD OF MEDICAL TECHNOLOGY; PROVIDING ON-LINE DIRECTORY INFORMATION SERVICES ALSO FEATURING HYPERLINKS TO OTHER WEB SITES; PROCESSING TELEPHONE INQUIRIES REGARDING ADVERTISED GOODS AND SERVICES; AND PROVIDING ON-LINE REGISTRATION SERVICES FOR COMPUTER SOFTWARE EDUCATION PROGRAMS (U.S. CLS. 100, 101 AND 102).

FIRST USE 11-0-2003; IN COMMERCE 11-0-2003.
RICHARD WHITE, EXAMINING ATTORNEY

CLASS 35—(Continued).

SN 77-931,238. GALEN ADVISORS, LLC, ATLANTA, GA.
FILED 2-9-2010.

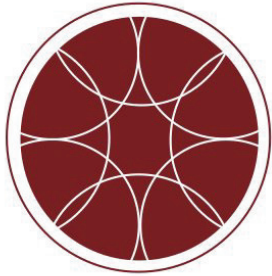

THE COLOR(S) RED AND WHITE IS/ARE CLAIMED AS A FEATURE OF THE MARK.

THE MARK CONSISTS OF THE COLORS RED AND WHITE, WITH A RED DISC CIRCUMSCRIBED BY AN OUTER RED CIRCLE DEFINING A WHITE RING BETWEEN THE OUTER RED CIRCLE AND THE RED DISC, WITH A WHITE ORBITING SPIRAL HAVING FOUR TERMINAL ENDS AND FOUR LOOPS TRAVERSING THE RED DISC.

FOR BUSINESS MANAGEMENT AND CONSULTATION FOR THE HEALTH CARE INDUSTRY, NAMELY, BILLING SERVICES AND PRACTICE ORGANIZATION AND MANAGEMENT; BUSINESS MANAGEMENT AND BUSINESS MANAGEMENT CONSULTATION SERVICES FOR ESTABLISHING NEW AMBULATORY SURGERY CENTERS (U.S. CLS. 100, 101 AND 102).

FIRST USE 1-29-2010; IN COMMERCE 1-29-2010.
GINA FINK, EXAMINING ATTORNEY

SN 78-525,894. WALSH, KATHLEEN MIGNINI, BEL AIR, MD. FILED 12-2-2004.



NO CLAIM IS MADE TO THE EXCLUSIVE RIGHT TO USE "MARKETING SOLUTIONS", APART FROM THE MARK AS SHOWN.

FOR BUSINESS MARKETING SERVICES (U.S. CLS. 100, 101 AND 102).

KRISTINA MORRIS, EXAMINING ATTORNEY

CLASS 35—(Continued).

SN 79-070,307. OVERTURE SOFTWARE, LDA, PORTUGAL,
FILED 8-13-2008.

WEEZZI

THE MARK CONSISTS OF STANDARD CHARACTERS WITHOUT CLAIM TO ANY PARTICULAR FONT, STYLE, SIZE, OR COLOR.

OWNER OF INTERNATIONAL REGISTRATION 0924448 DATED 2-19-2007, EXPIRES 2-19-2017.

FOR ADVERTISING AND BUSINESS INFORMATION ON THE INTERNET, BUSINESS MANAGEMENT AND ADMINISTRATION ON THE INTERNET, BUSINESS MANAGEMENT OF THE PRICES OF GOODS AND SERVICES ON ONLINE COMMERCIAL SITES (U.S. CLS. 100, 101 AND 102).

CHRISIE B. KING, EXAMINING ATTORNEY

SN 79-071,339. GIANNI VERSACE S.P.A., ITALY, FILED 3-24-2009.

VJC

THE MARK CONSISTS OF STANDARD CHARACTERS WITHOUT CLAIM TO ANY PARTICULAR FONT, STYLE, SIZE, OR COLOR.

PRIORITY DATE OF 3-18-2009 IS CLAIMED.

OWNER OF INTERNATIONAL REGISTRATION 1008836 DATED 3-24-2009, EXPIRES 3-24-2019.

OWNER OF U.S. REG. NO. 2,759,881.

FOR ADVERTISING; BUSINESS MANAGEMENT; BUSINESS ADMINISTRATION; OFFICE FUNCTIONS; DISSEMINATION OF ADVERTISEMENTS; DISSEMINATION OF ADVERTISING MATTER; RENTAL OF ADVERTISING SPACES; COMMERCIAL OR INDUSTRIAL BUSINESS MANAGEMENT CONSULTANCY AND ASSISTANCE; PROFESSIONAL BUSINESS CONSULTANCY; MODELING FOR ADVERTISING OR BUSINESS PROMOTION; FRANCHISING, SERVICES PROVIDED BY A FRANCHISOR, NAMELY, ASSISTANCE IN THE RUNNING, MANAGEMENT, AND DEVELOPMENT OF COMMERCIAL ENTERPRISES FOR THIRD PARTIES; INFORMATION IN THE FIELD OF FASHION; THE BRINGING TOGETHER FOR THE BENEFIT OF OTHERS, OF A VARIETY OF GOODS, ALLOWING THE CONSUMER TO VIEW AND BUY THE AFORESAID GOODS IN THE FIELD OF CLOTHING, JEWELRY, APPLIANCES, FRAGRANCES, COSMETICS, SUNGLASSES, SPECTACLE FRAMES, LUGGAGE, BELTS, PAPER GOODS, STATIONERY, PLAYING CARDS, FURNITURE, MIRRORS, PICTURE FRAMES, HOUSEHOLD AND TOILET UTENSILS, GLASSWARE, CARPETS, GAMES, PLAYTHING, SPORTING ARTICLES AND ACCESSORIES RELATING TO THE AFORESAID GOODS; BUSINESS MANAGEMENT SERVICES; HOTEL MANAGEMENT SERVICES (U.S. CLS. 100, 101 AND 102).

CHARISMA HAMPTON, EXAMINING ATTORNEY

CLASS 35—(Continued).

SN 79-071,705. AVENCORE, PARIS, FRANCE, FILED 5-27-2009.

AVENCORE

THE MARK CONSISTS OF STANDARD CHARACTERS WITHOUT CLAIM TO ANY PARTICULAR FONT, STYLE, SIZE, OR COLOR.

PRIORITY DATE OF 11-27-2008 IS CLAIMED.

OWNER OF INTERNATIONAL REGISTRATION 1009827 DATED 5-27-2009, EXPIRES 5-27-2019.

FOR BUSINESS CONSULTATION AND MANAGEMENT REGARDING MARKETING AND LAUNCHING OF NEW PRODUCTS (U.S. CLS. 100, 101 AND 102).

JESSICA FATHY, EXAMINING ATTORNEY

SN 79-071,790. DAEMS CHRISTIAN, BUGGENHOUT, BELGIUM, AND BLOMMAERT KARINE, BUGGENHOUT, BELGIUM, FILED 3-12-2009.



PRIORITY DATE OF 2-13-2009 IS CLAIMED.

OWNER OF INTERNATIONAL REGISTRATION 1010130 DATED 3-12-2009, EXPIRES 3-12-2019.

THE COLOR(S) BLACK, WHITE AND BLUE IS/ARE CLAIMED AS A FEATURE OF THE MARK.

THE MARK CONSISTS OF A BLACK BACKGROUND ON WHICH IS AN ARRAY OF BLUE DOTS FORMING A SQUARE WITH THE EXCEPTION OF ONE DOT MISSING IN THE UPPER RIGHT CORNER, WITH THE WORDING "JOB CORNER" APPEARING BELOW THE ARRAY WITH THE WORDING "JOB" IN WHITE AND THE WORDING "CORNER" IN BLUE WITH THE "C" FACING BACKWARDS.

FOR EMPLOYMENT AND CONSULTANCY AGENCIES FOR STAFFING AND PERSONNEL MANAGEMENT ISSUES; PLACEMENT OF TEMPORARY PERSONNEL; ADVERTISING AND PROMOTIONAL SERVICES; DISSEMINATION OF ADVERTISING ARTICLES, ADVERTISING MESSAGES AND PROMOTIONAL MATERIAL, NAMELY, VIA THE INTERNET; BUSINESS INFORMATION; BUSINESS MANAGEMENT; BUSINESS ADMINISTRATION; ADMINISTRATIVE SERVICES IN THE NATURE OF ADMINISTRATIVE ACCOUNTING; MEDIATION OF ADVERTISING; COMPILING OF STATISTICS; AUCTIONS AND PUBLIC SALES, NAMELY, ARRANGING OF AUCTIONS AND PUBLIC SALES, PROVIDING ON-LINE SERVICES, PROMOTIONAL MARKETING AND REPRESENTATION SERVICES FOR SALES TO THE PUBLIC SECTOR; MARKET STUDIES, MARKET RESEARCH AND ANALYSIS OF MARKET STUDIES; ADVISORY SERVICES FOR BUSINESS ORGANIZATION AND MANAGEMENT; MARKETING; PUBLIC RELATIONS; PROMOTIONAL ACTIVITIES AND ADVERTISING COMPETITIONS IN ORDER TO AWARD AN ANNUAL PRIZE FOR WEBSITES AND RELATED CAMPAIGNS (U.S. CLS. 100, 101 AND 102).

SUZANNE BLANE, EXAMINING ATTORNEY

CLASS 36—INSURANCE AND FINANCIAL

SN 76-691,928. COYOTE CENTER DEVELOPMENT, LLC, PHOENIX, AZ. FILED 8-8-2008.

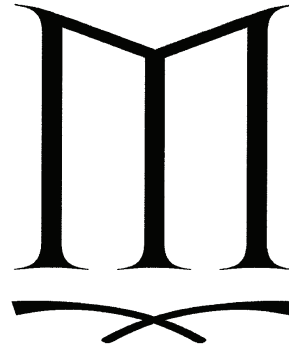

THE MARK CONSISTS OF A STYLIZED "M" UNDERLINED WITH TWO CURVED LINES THAT INTERSECT IN THE MIDDLE OF THE "M".

FOR RESIDENTIAL REAL ESTATE MANAGEMENT SERVICES (U.S. CLS. 100, 101 AND 102).

FIRST USE 2-2-2008; IN COMMERCE 2-2-2008.

SKYE YOUNG, EXAMINING ATTORNEY

SN 76-697,800. CAPITAL REAL ESTATE ADVISORS, LLC, OAKBROOK TERRACE, IL. FILED 6-8-2009.

CAPITAL REAL ESTATE ADVISORS

THE MARK CONSISTS OF STANDARD CHARACTERS WITHOUT CLAIM TO ANY PARTICULAR FONT, STYLE, SIZE, OR COLOR.

NO CLAIM IS MADE TO THE EXCLUSIVE RIGHT TO USE "REAL ESTATE ADVISORS", APART FROM THE MARK AS SHOWN.

FOR REAL ESTATE CONSULTATION (U.S. CLS. 100, 101 AND 102).

CIMMERIAN COLEMAN, EXAMINING ATTORNEY

CLASS 36—(Continued).

SN 76-697,898. HSBC FINANCE CORPORATION, METTAWA, IL. FILED 6-15-2009.

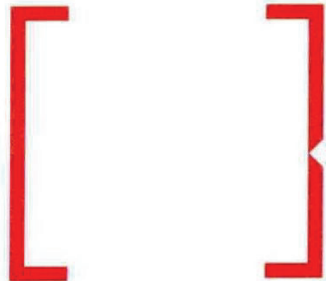

THE COLOR(S) RED IS/ARE CLAIMED AS A FEATURE OF THE MARK.

THE MARK CONSISTS OF RED BRACKETS WITH A NOTCH FEATURED ON THE OUTSIDE, CENTER POINT OF THE RIGHT-HAND BRACKET.

FOR INSURANCE SERVICES, NAMELY, UNDERWRITING, ISSUING AND ADMINISTRATION OF LIFE INSURANCE (U.S. CLS. 100, 101 AND 102).

AMY ALFIERI, EXAMINING ATTORNEY

SN 76-699,146. CHODOSH, TERRY, RANCHO PALOS VERDES, CA. FILED 8-24-2009.

SILVER GUARDIAN

THE MARK CONSISTS OF STANDARD CHARACTERS WITHOUT CLAIM TO ANY PARTICULAR FONT, STYLE, SIZE, OR COLOR.

FOR INSURANCE SERVICES, NAMELY INSURANCE COVERAGE AND INSURANCE ADMINISTRATION IN THE FIELD OF SELF DEFENSE INSURANCE FOR RETIRED LAW ENFORCEMENT (U.S. CLS. 100, 101 AND 102).

FIRST USE 7-18-2008; IN COMMERCE 7-18-2008.

THOMAS MANOR, EXAMINING ATTORNEY

SN 77-220,219. MOORE, CHARLES A., COLUMBUS, GA. FILED 7-2-2007.

iportfolio

THE MARK CONSISTS OF STANDARD CHARACTERS WITHOUT CLAIM TO ANY PARTICULAR FONT, STYLE, SIZE, OR COLOR.

FOR FINANCIAL PLANNING AND INVESTMENT ADVISORY SERVICES (U.S. CLS. 100, 101 AND 102).

MATTHEW MCDOWELL, EXAMINING ATTORNEY

CLASS 36—(Continued).

SN 77-564,337. PEEL & HOLLAND, INC., BENTON, KY. FILED 9-8-2008.

SOLUTIONPRO

THE MARK CONSISTS OF STANDARD CHARACTERS WITHOUT CLAIM TO ANY PARTICULAR FONT, STYLE, SIZE, OR COLOR.

FOR INSURANCE RISK CONSULTING IN THE FIELD OF LIABILITY, PROPERTY, EMPLOYEE BENEFITS, SURETY BONDING, WORKERS' COMPENSATION, AND UNINSURABLE RISKS; INSURANCE RISK MANAGEMENT IN THE FIELD OF REDUCING LIABILITY RISKS AND REDUCING FUTURE INSURANCE PREMIUMS; INSURANCE SERVICES, NAMELY, INSURANCE ADMINISTRATION (U.S. CLS. 100, 101 AND 102).

ANDREW RHIM, EXAMINING ATTORNEY

SN 77-570,578. MILLION, MARK G., GOODYEAR, AZ. FILED 9-16-2008.

MILLION REALTY

THE MARK CONSISTS OF STANDARD CHARACTERS WITHOUT CLAIM TO ANY PARTICULAR FONT, STYLE, SIZE, OR COLOR.

NO CLAIM IS MADE TO THE EXCLUSIVE RIGHT TO USE "REALTY", APART FROM THE MARK AS SHOWN.

FOR REAL ESTATE BROKERAGE (U.S. CLS. 100, 101 AND 102).

FIRST USE 12-3-2007; IN COMMERCE 8-1-2008.

TRACY CROSS, EXAMINING ATTORNEY

SN 77-576,996. ENSERVIO, INC., NATICK, MA. FILED 9-23-2008.



OWNER OF U.S. REG. NOS. 3,350,120 AND 3,540,022.

NO CLAIM IS MADE TO THE EXCLUSIVE RIGHT TO USE "SELECT" AND "CONTENTS", APART FROM THE MARK AS SHOWN.

THE COLOR(S) GOLD, BLACK, AND WHITE IS/ARE CLAIMED AS A FEATURE OF THE MARK.

THE MARK CONSISTS OF THE WORD "ENSERVIO" IN BLACK IN THE UPPER LEFT-HAND CORNER OF A RECTANGULAR AREA. THE WORD "SELECT" APPEARS IN GOLD SCRIPT FONT BELOW THE WORD "ENSERVIO" AND FILLS MOST OF THE RECTANGULAR AREA. THE WORDING "THE CONTENTS CONCIERGE" APPEARS IN GOLD IN THE LOWER HORIZONTAL BORDER OF THE RECTANGULAR AREA.

FOR APPRAISAL SERVICES FOR TANGIBLE PROPERTY (U.S. CLS. 100, 101 AND 102).

FIRST USE 5-19-2008; IN COMMERCE 5-19-2008.

SUZANNE BLANE, EXAMINING ATTORNEY

CLASS 36—(Continued).

SN 77-622,985. LINDA NELSON HOMSEY, DBA FREYA FINANCIAL SERVICES, WINCHESTER, MA. FILED 11-27-2008.

CLASS 36—(Continued).

SN 77-664,707. BERMAN CAPITAL MANAGEMENT LP, NEW YORK, NY. FILED 2-6-2009.

See The Future ... Make It Yours

THE CONSTANTIVITY THEORY

THE MARK CONSISTS OF STANDARD CHARACTERS WITHOUT CLAIM TO ANY PARTICULAR FONT, STYLE, SIZE, OR COLOR.
FOR FINANCIAL PLANNING AND INVESTMENT ADVISORY SERVICES (U.S. CLS. 100, 101 AND 102).
FIRST USE 1-15-2009; IN COMMERCE 1-15-2009.
ODESSA BIBBINS, EXAMINING ATTORNEY

THE MARK CONSISTS OF STANDARD CHARACTERS WITHOUT CLAIM TO ANY PARTICULAR FONT, STYLE, SIZE, OR COLOR.
NO CLAIM IS MADE TO THE EXCLUSIVE RIGHT TO USE "THEORY", APART FROM THE MARK AS SHOWN.
FOR INVESTMENT MANAGEMENT SERVICES AND INVESTMENT ADVISORY SERVICES (U.S. CLS. 100, 101 AND 102).
FIRST USE 8-1-2001; IN COMMERCE 8-1-2001.
ELIZABETH HUGHITT, EXAMINING ATTORNEY

SN 77-625,878. WHITE CLOUD CAPITAL MANAGEMENT LIMITED, PORT LOUIS, MAURITIUS, FILED 12-3-2008.

WHITE CLOUD CAPITAL

SN 77-664,709. BERMAN CAPITAL MANAGEMENT LP, NEW YORK, NY. FILED 2-6-2009.

THE MARK CONSISTS OF STANDARD CHARACTERS WITHOUT CLAIM TO ANY PARTICULAR FONT, STYLE, SIZE, OR COLOR.
NO CLAIM IS MADE TO THE EXCLUSIVE RIGHT TO USE "CAPITAL", APART FROM THE MARK AS SHOWN.
FOR FINANCIAL AND INVESTMENT SERVICES, NAMELY, MANAGEMENT OF PRIVATE EQUITY FUNDS, PRIVATE EQUITY FUND INVESTMENT SERVICES (U.S. CLS. 100, 101 AND 102).
ALLISON HOLTZ, EXAMINING ATTORNEY

THE CROCODILE APPROACH

SN 77-625,880. WHITE CLOUD CAPITAL MANAGEMENT LIMITED, PORT LOUIS, MAURITIUS, FILED 12-3-2008.

WHITE CLOUD

THE MARK CONSISTS OF STANDARD CHARACTERS WITHOUT CLAIM TO ANY PARTICULAR FONT, STYLE, SIZE, OR COLOR.
NO CLAIM IS MADE TO THE EXCLUSIVE RIGHT TO USE "APPROACH", APART FROM THE MARK AS SHOWN.
FOR INVESTMENT MANAGEMENT SERVICES AND INVESTMENT ADVISORY SERVICES (U.S. CLS. 100, 101 AND 102).
FIRST USE 8-1-2001; IN COMMERCE 8-1-2001.
ELIZABETH HUGHITT, EXAMINING ATTORNEY

THE MARK CONSISTS OF STANDARD CHARACTERS WITHOUT CLAIM TO ANY PARTICULAR FONT, STYLE, SIZE, OR COLOR.
FOR FINANCIAL AND INVESTMENT SERVICES, NAMELY, MANAGEMENT OF PRIVATE EQUITY FUNDS, PRIVATE EQUITY FUND INVESTMENT SERVICES (U.S. CLS. 100, 101 AND 102).
ALLISON HOLTZ, EXAMINING ATTORNEY

CLASS 36—(Continued).

SN 77-683,743. G-XCHANGE, INC., MANDALUYONG CITY, PHILIPPINES, FILED 3-4-2009.

G-XCHANGE

THE MARK CONSISTS OF STANDARD CHARACTERS WITHOUT CLAIM TO ANY PARTICULAR FONT, STYLE, SIZE, OR COLOR.

PRIORITY CLAIMED UNDER SEC. 44(D) ON PHILIPPINES APPLICATION NO. 42008012533, FILED 10-15-2008, REG. NO. 42008012533, DATED 3-9-2009, EXPIRES 3-9-2019.

FOR FINANCIAL SERVICES, NAMELY, FINANCIAL SPONSORSHIP OF SPORTS COMPETITIONS, TOURNAMENTS, CULTURAL AND EDUCATIONAL EVENTS, ENVIRONMENTAL PROJECTS, SCIENTIFIC RESEARCH; MONETARY SERVICES, NAMELY, SERVICES RELATING TO THE TRANSFER OF FUNDS FROM ACCOUNTS, NAMELY, MONEY TRANSFER, AND DIRECT DEBIT SERVICES; AND REMITTANCE SERVICES, NAMELY, ELECTRONIC FOREIGN EXCHANGE PAYMENT PROCESSING, AND SERVICES RELATING TO THE REMITTANCE AND PAYMENT OF MONEY IN THE NATURE OF PROVIDING ELECTRONIC PROCESSING, ELECTRONIC FUNDS TRANSFER; PROVIDING ELECTRONIC PROCESSING OF CREDIT CARD TRANSACTIONS AND ELECTRONIC PAYMENTS VIA A GLOBAL COMPUTER NETWORK (U.S. CLS. 100, 101 AND 102).

MICHAEL KEATING, EXAMINING ATTORNEY

SN 77-685,540. BONNEVILLE ENVIRONMENTAL FOUNDATION, PORTLAND, OR. FILED 3-6-2009.

**WATER RESTORATION
CERTIFICATES**

THE MARK CONSISTS OF STANDARD CHARACTERS WITHOUT CLAIM TO ANY PARTICULAR FONT, STYLE, SIZE, OR COLOR.

NO CLAIM IS MADE TO THE EXCLUSIVE RIGHT TO USE "WATER" AND "CERTIFICATES", APART FROM THE MARK AS SHOWN.

FOR BROKERAGE OF EXCESS WATER RIGHTS (U.S. CLS. 100, 101 AND 102).

SUZANNE BLANE, EXAMINING ATTORNEY

SN 77-692,749. INTEGRATED ASSET SERVICES, LLC, DENVER, CO. FILED 3-17-2009.

Integrated Valuation Solutions

NO CLAIM IS MADE TO THE EXCLUSIVE RIGHT TO USE "VALUATION", APART FROM THE MARK AS SHOWN.

THE COLOR(S) TEAL IS/ARE CLAIMED AS A FEATURE OF THE MARK.

THE MARK CONSISTS OF THE COLOR TEAL IN THE WORDING "INTEGRATED VALUATION SOLUTIONS".

FOR FINANCIAL DUE DILIGENCE SERVICES IN THE FIELD OF REAL ESTATE; REAL ESTATE APPRAISAL AND VALUATION (U.S. CLS. 100, 101 AND 102).

FIRST USE 3-16-2009; IN COMMERCE 3-16-2009.

FRED CARL, EXAMINING ATTORNEY

CLASS 36—(Continued).

SN 77-707,303. THE HCO EXCHANGE, LLC, BALTIMORE, MD. FILED 4-6-2009.

Equity FLIRT

THE MARK CONSISTS OF STANDARD CHARACTERS WITHOUT CLAIM TO ANY PARTICULAR FONT, STYLE, SIZE, OR COLOR.

NO CLAIM IS MADE TO THE EXCLUSIVE RIGHT TO USE "EQUITY", APART FROM THE MARK AS SHOWN.

FOR FINANCIAL RISK MANAGEMENT SERVICES FOR THE STRUCTURING, NEGOTIATION AND TRADING OF DERIVATIVE CONTRACTS RELATED TO LINE ITEM VARIABILITY IN AUDITED FINANCIAL REPORTS TO INDIVIDUAL OR INSTITUTIONAL INVESTORS (U.S. CLS. 100, 101 AND 102).

BARBARA A. GOLD, EXAMINING ATTORNEY

SN 77-724,874. NATIONAL PARK TRUST INC., ROCKVILLE, MD. FILED 4-29-2009.

BUDDY BISON

THE MARK CONSISTS OF STANDARD CHARACTERS WITHOUT CLAIM TO ANY PARTICULAR FONT, STYLE, SIZE, OR COLOR.

FOR CHARITABLE FUNDRAISING SERVICES (U.S. CLS. 100, 101 AND 102).

JAMES STEIN, EXAMINING ATTORNEY

SN 77-731,641. HARDERSEN, DARREN, DBA TDHG HARDERSEN GROUP, INC., JUPITER, FL. FILED 5-7-2009.



NO CLAIM IS MADE TO THE EXCLUSIVE RIGHT TO USE "GROUP, INC.", APART FROM THE MARK AS SHOWN.

THE MARK CONSISTS OF THE STYLIZED TEXT "HG HARDERSEN GROUP, INC.".

FOR FINANCIAL ADVISORY SERVICES; INSURANCE BROKERAGE IN THE FIELD OF LIFE INSURANCE, ANNUITIES, LONG TERM CARE, DISABILITY (U.S. CLS. 100, 101 AND 102).

FIRST USE 1-1-2009; IN COMMERCE 1-1-2009.

ALLISON HOLTZ, EXAMINING ATTORNEY

CLASS 36—(Continued).

SN 77-735,807. ISLAMIC RELIEF WORLDWIDE, BIRMINGHAM, UNITED KINGDOM, FILED 5-13-2009.

ISLAMIC RELIEF WORLDWIDE

THE MARK CONSISTS OF STANDARD CHARACTERS WITHOUT CLAIM TO ANY PARTICULAR FONT, STYLE, SIZE, OR COLOR.

OWNER OF ERPN CMNTY TM OFC REG. NO. 005806062, DATED 4-24-2008, EXPIRES 4-2-2017.

OWNER OF U.S. REG. NOS. 3,302,215, 3,492,704 AND OTHERS.

NO CLAIM IS MADE TO THE EXCLUSIVE RIGHT TO USE "WORLDWIDE", APART FROM THE MARK AS SHOWN.

SEC. 2(F) AS TO "ISLAMIC RELIEF".

FOR (BASED ON USE IN COMMERCE AND 44(E)) CHARITABLE FUNDRAISING SERVICES; CHARITABLE FUNDRAISING SERVICES FOR LOAN FINANCING AND GRANTS TO INDIVIDUALS IN DEVELOPING COUNTRIES FOR MICRO-ECONOMIC DEVELOPMENT; FINANCIAL ADMINISTRATION OF PROGRAMS PROVIDING LOAN FINANCING AND GRANTS TO INDIVIDUALS IN DEVELOPING COUNTRIES FOR MICRO-ECONOMIC DEVELOPMENT; AND ACCEPTING AND ADMINISTERING MONETARY CHARITABLE CONTRIBUTIONS; (BASED ON USE IN COMMERCE) LOAN FINANCING, NAMELY, PROVIDING FINANCIAL ASSISTANCE TO FAMILIES TO ESTABLISH AND DEVELOP SMALL BUSINESSES AND TO FOSTER HOMELESS AND ORPHANED CHILDREN; FINANCING SERVICES, NAMELY, PROVIDING LOANS AND GRANTS TO INDIVIDUALS IN DEVELOPING COUNTRIES FOR MICROECONOMIC DEVELOPMENT (U.S. CLS. 100, 101 AND 102).

FIRST USE 1-1-2007; IN COMMERCE 1-1-2007.

MELISSA VALLILLO, EXAMINING ATTORNEY

SN 77-741,262. HALE PUBLISHING GROUP, INC., LAS VEGAS, NV. FILED 5-20-2009.

Terry Hale

THE MARK CONSISTS OF STANDARD CHARACTERS WITHOUT CLAIM TO ANY PARTICULAR FONT, STYLE, SIZE, OR COLOR.

THE NAME(S), PORTRAIT(S), AND/OR SIGNATURE(S) SHOWN IN THE MARK IDENTIFIES "TERRY HALE", WHOSE CONSENT(S) TO REGISTER IS MADE OF RECORD.

FOR PROVIDING INFORMATION IN THE FIELD OF REAL ESTATE VIA THE INTERNET; PROVIDING REAL ESTATE LISTINGS AND REAL ESTATE INFORMATION VIA THE INTERNET; REAL ESTATE CONSULTATION; REAL ESTATE MANAGEMENT CONSULTATION (U.S. CLS. 100, 101 AND 102).

FIRST USE 2-20-2006; IN COMMERCE 2-20-2006.

LESLEY LAMOTHE, EXAMINING ATTORNEY

CLASS 36—(Continued).

SN 77-742,212. ONEWEST BANK, F.S.B., PASADENA, CA. FILED 5-21-2009.



OWNER OF U.S. REG. NOS. 3,196,326, 3,735,171 AND 3,735,172.

NO CLAIM IS MADE TO THE EXCLUSIVE RIGHT TO USE "THE NEW YORK MORTGAGE COMPANY" AND "A DIVISION OF" AND "BANK", APART FROM THE MARK AS SHOWN.

THE MARK CONSIST OF THE LITERAL ELEMENT "NYMC THE NEW YORK MORTGAGE COMPANY A DIVISION OF ONEWEST BANK" INSIDE A SQUARE OR RECTANGULAR BORDER. AT THE TOP AND CENTER OF THE BORDER ARE THE LETTERS "NYMC" IN THE LARGEST FONT SIZE. IMMEDIATELY BELOW THE "NYMC" ELEMENT ARE THE WORDS "THE " "NEW YORK" "MORTGAGE "AND "COMPANY", ALL CENTERED WITHIN SEPARATE SHADED RECTANGLES THAT ARE "STACKED" ONE ON TOP OF THE OTHER. THE WORDING "A DIVISION OF" IS PLACED IMMEDIATELY BELOW THE BOTTOM "STACKED BOX" ELEMENT AND IMMEDIATELY ABOVE THE WORDING "ONEWEST BANK".

FOR FINANCIAL SERVICES, NAMELY, BANKING SERVICES; MORTGAGE LENDING SERVICES; MORTGAGE BANKING SERVICES, NAMELY, MORTGAGE LOAN ORIGINATION SERVICES; FINANCIAL SERVICES, NAMELY, LOAN ORIGINATION SERVICES; BROKERAGE AND SERVICING OF MORTGAGES AND FINANCIAL LOANS; BROKERAGE OF MORTGAGE LOANS, NAMELY, PRIVATE AND PUBLIC BROKERAGE OF LOANS AND MORTGAGES IN THE SECOND MARKET (U.S. CLS. 100, 101 AND 102).

KALIE KUNG, EXAMINING ATTORNEY

SN 77-743,124. WORLD STEEL EXCHANGE MARKETING, LLC, ENGLEWOOD CLIFFS, NJ. FILED 5-22-2009.

WSEM

THE MARK CONSISTS OF STANDARD CHARACTERS WITHOUT CLAIM TO ANY PARTICULAR FONT, STYLE, SIZE, OR COLOR.

FOR PROVIDING FINANCIAL AND INVESTMENT INFORMATION SERVICES; PROVIDING INFORMATION ABOUT FUTURES EXCHANGE SERVICES IN THE FIELD OF STEEL AND OTHER METAL FUTURES, OPTIONS AND OTHER DERIVATIVES; PROVIDING FINANCIAL INFORMATION AND FINANCIAL ANALYSIS SERVICES IN CONNECTION WITH STEEL AND METALS TRADING (U.S. CLS. 100, 101 AND 102).

ALLISON HOLTZ, EXAMINING ATTORNEY

CLASS 36—(Continued).

SN 77-750,039. AMERICAN DIABETES ASSOCIATION, INC., ALEXANDRIA, VA. FILED 6-2-2009.

STEP OUT WALK TO FIGHT DIABETES

THE MARK CONSISTS OF STANDARD CHARACTERS WITHOUT CLAIM TO ANY PARTICULAR FONT, STYLE, SIZE, OR COLOR.

OWNER OF U.S. REG. NOS. 3,395,464 AND 3,483,135.
NO CLAIM IS MADE TO THE EXCLUSIVE RIGHT TO USE "WALK TO FIGHT DIABETES", APART FROM THE MARK AS SHOWN.

FOR CHARITABLE FUND RAISING SERVICES (U.S. CLS. 100, 101 AND 102).

FIRST USE 1-31-2008; IN COMMERCE 1-31-2008.
DOMINIC J. FERRAIUOLO, EXAMINING ATTORNEY

SN 77-751,996. RIZZI, RON, DBA CARS AND COFFEE, INC., BALL GROUND, GA. FILED 6-4-2009.

Motorcycles And Coffee

THE MARK CONSISTS OF STANDARD CHARACTERS WITHOUT CLAIM TO ANY PARTICULAR FONT, STYLE, SIZE, OR COLOR.

OWNER OF U.S. REG. NOS. 3,536,536, 3,546,282 AND OTHERS.

FOR CHARITABLE FUNDRAISING SERVICES, NAMELY, RAISING MONEY FOR CHARITY BY CONDUCTING MOTORCYCLE SHOWS (U.S. CLS. 100, 101 AND 102).

MARIA-VICTORIA SUAREZ, EXAMINING ATTORNEY

SN 77-755,204. TUITIONFUND, LLC, NASHVILLE, TN. FILED 6-9-2009.

TUITIONFUND

THE MARK CONSISTS OF STANDARD CHARACTERS WITHOUT CLAIM TO ANY PARTICULAR FONT, STYLE, SIZE, OR COLOR.

OWNER OF U.S. REG. NO. 3,536,271.
SEC. 2(F).
FOR CREDIT AND DEBIT CARD REBATE PROGRAMS (U.S. CLS. 100, 101 AND 102).

FIRST USE 9-4-2000; IN COMMERCE 9-4-2000.
TRACY CROSS, EXAMINING ATTORNEY

CLASS 36—(Continued).

SN 77-757,390. THE MEGA LIFE AND HEALTH INSURANCE COMPANY, NORTH RICHLAND HILLS, TX. FILED 6-11-2009.

PROTECTFIT

THE MARK CONSISTS OF STANDARD CHARACTERS WITHOUT CLAIM TO ANY PARTICULAR FONT, STYLE, SIZE, OR COLOR.

FOR INSURANCE SERVICES, NAMELY, INSURANCE CLAIMS ADMINISTRATION AND INSURANCE ADMINISTRATION FEATURING PAYING CASH BENEFITS FOR EXPENSES ASSOCIATED WITH ACCIDENTAL INJURIES (U.S. CLS. 100, 101 AND 102).

JAY BESCH, EXAMINING ATTORNEY

SN 77-759,838. MONUMENTAL LIFE INSURANCE COMPANY, BALTIMORE, MD. FILED 6-15-2009.



OWNER OF U.S. REG. NO. 2,323,318.
THE MARK CONSISTS OF STYLIZED LETTER "M" SET WITHIN A SOLID PARALLELOGRAM

FOR INSURANCE AGENCIES IN THE FIELD OF LIFE, ACCIDENT AND HEALTH INSURANCE; INSURANCE SERVICES, NAMELY, UNDERWRITING LIFE, ACCIDENT AND HEALTH INSURANCE; INSURANCE ADMINISTRATION IN THE FIELD OF LIFE, ACCIDENT AND HEALTH INSURANCE (U.S. CLS. 100, 101 AND 102).

FIRST USE 0-0-1995; IN COMMERCE 0-0-1995.
STEVEN PEREZ, EXAMINING ATTORNEY

CLASS 36—(Continued).

SN 77-759,870. MONUMENTAL LIFE INSURANCE COMPANY, BALTIMORE, MD. FILED 6-15-2009.



OWNER OF U.S. REG. NOS. 2,323,318, 2,516,167 AND OTHERS.

NO CLAIM IS MADE TO THE EXCLUSIVE RIGHT TO USE "LIFE INSURANCE COMPANY", APART FROM THE MARK AS SHOWN.

THE MARK CONSISTS OF A STYLIZED LETTER "M" SET WITHIN A SOLID PARALLELOGRAM TO THE LEFT OF THE WORDING "MONUMENTAL LIFE INSURANCE COMPANY" IN STYLIZED FONT.

FOR INSURANCE AGENCIES IN THE FIELD OF LIFE, ACCIDENT AND HEALTH INSURANCE; INSURANCE SERVICES, NAMELY, UNDERWRITING LIFE, ACCIDENT AND HEALTH INSURANCE; INSURANCE ADMINISTRATION IN THE FIELD OF LIFE, ACCIDENT AND HEALTH INSURANCE (U.S. CLS. 100, 101 AND 102).

FIRST USE 0-0-1995; IN COMMERCE 0-0-1995.
STEVEN PEREZ, EXAMINING ATTORNEY

SN 77-759,893. MONUMENTAL LIFE INSURANCE COMPANY, BALTIMORE, MD. FILED 6-15-2009.



OWNER OF U.S. REG. NOS. 2,323,318, 2,516,167 AND OTHERS.

NO CLAIM IS MADE TO THE EXCLUSIVE RIGHT TO USE "LIFE INSURANCE COMPANY", APART FROM THE MARK AS SHOWN.

THE COLOR(S) BLUE, BLACK AND WHITE IS/ARE CLAIMED AS A FEATURE OF THE MARK.

THE MARK CONSISTS OF A STYLIZED LETTER "M" IN WHITE SET WITHIN A SLANTED BLUE RECTANGLE TO THE LEFT OF THE WORDING "MONUMENTAL LIFE INSURANCE COMPANY" IN BLACK STYLIZED FONT.

FOR INSURANCE AGENCIES IN THE FIELD OF LIFE, ACCIDENT AND HEALTH INSURANCE; INSURANCE SERVICES, NAMELY, UNDERWRITING LIFE, ACCIDENT AND HEALTH INSURANCE; INSURANCE ADMINISTRATION IN THE FIELD OF LIFE, ACCIDENT AND HEALTH INSURANCE (U.S. CLS. 100, 101 AND 102).

FIRST USE 0-0-1995; IN COMMERCE 0-0-1995.
STEVEN PEREZ, EXAMINING ATTORNEY

CLASS 36—(Continued).

SN 77-762,763. ICAP SERVICES NORTH AMERICA, LLC, JERSEY CITY, NJ. FILED 6-18-2009.

TICONDEROGA

THE MARK CONSISTS OF STANDARD CHARACTERS WITHOUT CLAIM TO ANY PARTICULAR FONT, STYLE, SIZE, OR COLOR.

FOR FINANCIAL SERVICES, NAMELY, BROKER/DEALER OF A WIDE RANGE OF SECURITIES PRODUCTS TO THE INSTITUTIONAL MARKET, NAMELY, US TREASURY PRODUCTS, GSE AGENCIES, US MORTGAGES, MONEY MARKET INSTRUMENTS, EURO-GOVERNMENT BONDS, EUROZONE AND US REPURCHASE AGREEMENTS, CREDIT DERIVATIVES, INTEREST RATE DERIVATIVES AND OTHER OTC DERIVATIVE INSTRUMENTS, SECURITIES, EQUITY INSTRUMENTS, PROVIDING FINANCIAL INFORMATION IN THE FIELD OF FINANCIAL DERIVATIVES AND EQUITIES; PRIVATE PLACEMENTS OF DERIVATIVES AND EQUITY FUNDS FOR OTHERS; CONDUCTING A SECURITIES AND DERIVATIVES EXCHANGE; TRADING OF FINANCIAL INSTRUMENTS AND OTHER DERIVATIVE PRODUCTS, AND ENERGY PRODUCTS INCLUSIVE OF OIL, POWER, NATURAL GAS AND COAL; LOAN DEFAULT MITIGATION SERVICES; ASSUMING FINANCIAL RISK OF OTHERS BY ENTERING INTO CREDIT SWAPS; CREDIT RECOVERY, REPAIR AND RESTORATION SERVICES; FOREIGN CURRENCY EXCHANGE TRANSACTIONS, MONEY TRANSFER SERVICES AND EXCHANGE SERVICES; FINANCIAL GUARANTEES; INTER-DEALER BROKERAGE RELATING TO INTEREST RATE SWAPS AND INTEREST RATE OPTIONS; EQUITY DERIVATIVES AND COMMODITY TRADING FOR OTHERS; BROKERAGE FOR TRADING OF FINANCIAL INSTRUMENTS, FINANCIAL PRODUCTS AND DERIVATIVES; DEBT TRADING SERVICES; FINANCIAL EVALUATIONS; FISCAL ASSESSMENTS AND VALUATIONS; FINANCIAL ADVISORY SERVICES; ON-LINE BANKING SERVICES; PROVIDING ONLINE FINANCIAL INFORMATION IN THE NATURE OF TRADE SUPPORT INFORMATION, FINANCIAL MARKET REPORTS, FINANCIAL CONSULTATION, CONSULTANCY AND ADVISORY SERVICES, HISTORICAL FINANCIAL TRANSACTION AND HISTORICAL FINANCIAL VALUES DATA (U.S. CLS. 100, 101 AND 102).

GISELLE AGOSTO, EXAMINING ATTORNEY

SN 77-763,090. THE MEGA LIFE AND HEALTH INSURANCE COMPANY, NORTH RICHLAND HILLS, TX. FILED 6-18-2009.

CARECHOICE PLUS PLAN

THE MARK CONSISTS OF STANDARD CHARACTERS WITHOUT CLAIM TO ANY PARTICULAR FONT, STYLE, SIZE, OR COLOR.

NO CLAIM IS MADE TO THE EXCLUSIVE RIGHT TO USE "PLAN", APART FROM THE MARK AS SHOWN.

FOR UNDERWRITING AND ADMINISTERING OF HEALTH INSURANCE SERVICES (U.S. CLS. 100, 101 AND 102).

FIRST USE 2-4-2008; IN COMMERCE 2-4-2008.
JAY BESCH, EXAMINING ATTORNEY

CLASS 36—(Continued).

SN 77-763,212. THE MEGA LIFE AND HEALTH INSURANCE COMPANY, NORTH RICHLAND HILLS, TX. FILED 6-18-2009.

CARECHOICE PLAN

THE MARK CONSISTS OF STANDARD CHARACTERS WITHOUT CLAIM TO ANY PARTICULAR FONT, STYLE, SIZE, OR COLOR.

NO CLAIM IS MADE TO THE EXCLUSIVE RIGHT TO USE "PLAN", APART FROM THE MARK AS SHOWN.

FOR UNDERWRITING AND ADMINISTERING OF HEALTH INSURANCE SERVICES (U.S. CLS. 100, 101 AND 102).

FIRST USE 2-4-2008; IN COMMERCE 2-4-2008.
JAY BESCH, EXAMINING ATTORNEY

CLASS 36—(Continued).

SN 77-767,238. NEW MEXICO EDUCATORS FEDERAL CREDIT UNION, ALBUQUERQUE, NM. FILED 6-24-2009.

ANYWHERE ACCESS MOBILE

THE MARK CONSISTS OF STANDARD CHARACTERS WITHOUT CLAIM TO ANY PARTICULAR FONT, STYLE, SIZE, OR COLOR.

NO CLAIM IS MADE TO THE EXCLUSIVE RIGHT TO USE "ACCESS MOBILE", APART FROM THE MARK AS SHOWN.

FOR CREDIT UNION SERVICES; BILL PAYMENT SERVICES, ELECTRONIC FUNDS TRANSFER SERVICES (U.S. CLS. 100, 101 AND 102).

FIRST USE 10-15-2008; IN COMMERCE 10-15-2008.
SANJEEV VOHRA, EXAMINING ATTORNEY

SN 77-766,286. BANKRATE, INC., NORTH PALM BEACH, FL. FILED 6-23-2009.

STAR RATINGS

THE MARK CONSISTS OF STANDARD CHARACTERS WITHOUT CLAIM TO ANY PARTICULAR FONT, STYLE, SIZE, OR COLOR.

NO CLAIM IS MADE TO THE EXCLUSIVE RIGHT TO USE "RATINGS", APART FROM THE MARK AS SHOWN.

FOR FINANCIAL INFORMATION SERVICES IN THE NATURE OF PROVIDING AN ONLINE COMPUTER DATABASE OF FINANCIAL INSTITUTIONS AND THEIR CORRESPONDING RATINGS (U.S. CLS. 100, 101 AND 102).

FIRST USE 10-31-2007; IN COMMERCE 10-31-2007.
JULIE GUTTADAURO, EXAMINING ATTORNEY

SN 77-767,263. NEW MEXICO EDUCATORS FEDERAL CREDIT UNION, ALBUQUERQUE, NM. FILED 6-24-2009.

ANYWHERE ADVISORS

THE MARK CONSISTS OF STANDARD CHARACTERS WITHOUT CLAIM TO ANY PARTICULAR FONT, STYLE, SIZE, OR COLOR.

NO CLAIM IS MADE TO THE EXCLUSIVE RIGHT TO USE "ADVISORS", APART FROM THE MARK AS SHOWN.

FOR CREDIT UNION SERVICES; ELECTRONIC FUNDS TRANSFER SERVICES (U.S. CLS. 100, 101 AND 102).

FIRST USE 1-9-2009; IN COMMERCE 1-9-2009.
SANJEEV VOHRA, EXAMINING ATTORNEY

SN 77-767,204. NEW MEXICO EDUCATORS FEDERAL CREDIT UNION, ALBUQUERQUE, NM. FILED 6-24-2009.

ANYWHERE ACCESS TEXT

THE MARK CONSISTS OF STANDARD CHARACTERS WITHOUT CLAIM TO ANY PARTICULAR FONT, STYLE, SIZE, OR COLOR.

NO CLAIM IS MADE TO THE EXCLUSIVE RIGHT TO USE "ACCESS TEXT", APART FROM THE MARK AS SHOWN.

FOR CREDIT UNION SERVICES (U.S. CLS. 100, 101 AND 102).

FIRST USE 10-15-2008; IN COMMERCE 10-15-2008.
SANJEEV VOHRA, EXAMINING ATTORNEY

SN 77-767,287. NEW MEXICO EDUCATORS FEDERAL CREDIT UNION, ALBUQUERQUE, NM. FILED 6-24-2009.

ANYWHERE ACCESS INTERNET BANKING

THE MARK CONSISTS OF STANDARD CHARACTERS WITHOUT CLAIM TO ANY PARTICULAR FONT, STYLE, SIZE, OR COLOR.

NO CLAIM IS MADE TO THE EXCLUSIVE RIGHT TO USE "ACCESS INTERNET BANKING", APART FROM THE MARK AS SHOWN.

FOR CREDIT UNION SERVICES; BILL PAYMENT SERVICES, ELECTRONIC FUNDS TRANSFER SERVICES (U.S. CLS. 100, 101 AND 102).

FIRST USE 12-17-2008; IN COMMERCE 12-17-2008.
SANJEEV VOHRA, EXAMINING ATTORNEY

CLASS 36—(Continued).

SN 77-767,305. NEW MEXICO EDUCATORS FEDERAL CREDIT UNION, ALBUQUERQUE, NM. FILED 6-24-2009.

ANYWHERE ACCESS

THE MARK CONSISTS OF STANDARD CHARACTERS WITHOUT CLAIM TO ANY PARTICULAR FONT, STYLE, SIZE, OR COLOR.

NO CLAIM IS MADE TO THE EXCLUSIVE RIGHT TO USE "ACCESS", APART FROM THE MARK AS SHOWN.

FOR CREDIT UNION SERVICES; BILL PAYMENT SERVICES; ELECTRONIC FUNDS TRANSFER SERVICES (U.S. CLS. 100, 101 AND 102).

FIRST USE 10-15-2008; IN COMMERCE 10-15-2008.
SANJEEV VOHRA, EXAMINING ATTORNEY

SN 77-770,129. DONALD C. SAVOY, INC., FLORHAM PARK, NJ. FILED 6-29-2009.

einsurancepeople

THE MARK CONSISTS OF STANDARD CHARACTERS WITHOUT CLAIM TO ANY PARTICULAR FONT, STYLE, SIZE, OR COLOR.

FOR GENERAL AGENCY AND BROKERAGE SERVICES FOR GROUP HEALTH INSURANCE, GROUP DENTAL INSURANCE, AND GROUP ANCILLIAR INSURANCE, NAMELY, GROUP LIFE AND GROUP DISABILITY, AND INDIVIDUAL HEALTH INSURANCE (U.S. CLS. 100, 101 AND 102).

FIRST USE 3-8-2006; IN COMMERCE 3-8-2006.
TAMARA FRAZIER, EXAMINING ATTORNEY

SN 77-775,175. MALAYKA INTERNATIONAL, FORMERLY DEAR ANGEL MINISTRIES, HARRISON TOWNSHIP, MI. FILED 7-6-2009.

Malayka International

THE MARK CONSISTS OF STANDARD CHARACTERS WITHOUT CLAIM TO ANY PARTICULAR FONT, STYLE, SIZE, OR COLOR.

NO CLAIM IS MADE TO THE EXCLUSIVE RIGHT TO USE "INTERNATIONAL", APART FROM THE MARK AS SHOWN.

THE NAME(S), PORTRAIT(S), AND/OR SIGNATURE(S) SHOWN IN THE MARK DOES NOT IDENTIFY A PARTICULAR LIVING INDIVIDUAL.

FOR CHARITABLE FUNDRAISING SERVICES (U.S. CLS. 100, 101 AND 102).

FIRST USE 7-1-2009; IN COMMERCE 7-6-2009.
GENE MACIOL, EXAMINING ATTORNEY

CLASS 36—(Continued).

SN 77-776,981. BOGART PEDIATRIC CANCER RESEARCH PROGRAM, LOS ANGELES, CA. FILED 7-8-2009.



The Bogart Pediatric Cancer Research Program

NO CLAIM IS MADE TO THE EXCLUSIVE RIGHT TO USE "PEDIATRIC CANCER RESEARCH PROGRAM", APART FROM THE MARK AS SHOWN.

THE MARK CONSISTS OF A STAR, A BEAKER AND A HEART, SIDE BY SIDE; THE STAR, BEAKER, AND HEART ARE EACH OUTLINED; UNDERNEATH THE STAR, BEAKER AND HEART ARE THE WORDS "THE BOGART PEDIATRIC CANCER RESEARCH PROGRAM".

FOR CHARITABLE FUNDRAISING SERVICES (U.S. CLS. 100, 101 AND 102).

FIRST USE 0-0-1982; IN COMMERCE 0-0-1982.
LINDA M. KING, EXAMINING ATTORNEY

SN 77-779,693. KINGSTONE INSURANCE COMPANY, FORMERLY COMMERCIAL MUTUAL INSURANCE COMPANY, KINGSTON, NY. FILED 7-13-2009.



NO CLAIM IS MADE TO THE EXCLUSIVE RIGHT TO USE "EST. 1886", APART FROM THE MARK AS SHOWN.

THE MARK CONSISTS OF A DEPICTION OF A CROWN ATOP THE LETTER "K" WITH THE TERM "KINGSTONE" ABOVE THE CROWN AND THE TERM "EST. 1886" BELOW THE LETTER "K", ALL PLACED WITHIN A DOUBLED-LINED BOX.

FOR INSURANCE SERVICES, NAMELY, UNDERWRITING, ISSUING AND ADMINISTRATION OF PROPERTY AND CASUALTY INSURANCE (U.S. CLS. 100, 101 AND 102).

FIRST USE 7-1-2009; IN COMMERCE 7-1-2009.
MARTHA FROMM, EXAMINING ATTORNEY

CLASS 36—(Continued).

SN 77-780,467. MARRIOTT INTERNATIONAL, INC.,
BETHESDA, MD. FILED 7-14-2009.

WILLOW RIDGE LODGE

THE MARK CONSISTS OF STANDARD CHARACTERS
WITHOUT CLAIM TO ANY PARTICULAR FONT, STYLE,
SIZE, OR COLOR.

NO CLAIM IS MADE TO THE EXCLUSIVE RIGHT TO
USE "LODGE", APART FROM THE MARK AS SHOWN.

FOR REAL ESTATE SERVICES, NAMELY, MANAGE-
MENT, FINANCING, BROKERAGE, LEASING AND
REAL ESTATE AGENCY SERVICES IN THE FIELD OF
TIMESHARE PROPERTIES; VACATION REAL ESTATE
TIMESHARE EXCHANGE SERVICES (U.S. CLS. 100, 101
AND 102).

AMY KERTGATE, EXAMINING ATTORNEY

SN 77-781,273. IT'S THE JOURNEY, INC., ATLANTA, GA.
FILED 7-15-2009.

DO THE 2

THE MARK CONSISTS OF STANDARD CHARACTERS
WITHOUT CLAIM TO ANY PARTICULAR FONT, STYLE,
SIZE, OR COLOR.

FOR CHARITABLE FUND RAISING SERVICES,
NAMELY, ORGANIZING AND CONDUCTING FUND
RAISING EVENTS FOR THE BENEFIT OF BREAST
CANCER RESEARCH AND CAUSES (U.S. CLS. 100, 101
AND 102).

FIRST USE 12-9-2008; IN COMMERCE 12-9-2008.
JULIE WATSON, EXAMINING ATTORNEY

SN 77-788,010. AMERICAN SPECIALTY INSURANCE &
RISK SERVICES, INC., TAMPA, FL. FILED 7-23-2009.

**THINK SPEED. THINK
CONVENIENCE. THINK FASTCOV.**

THE MARK CONSISTS OF STANDARD CHARACTERS
WITHOUT CLAIM TO ANY PARTICULAR FONT, STYLE,
SIZE, OR COLOR.

FOR INSURANCE BROKERAGE; INSURANCE AD-
MINISTRATION; AND RISK MANAGEMENT SERVICES
IN THE FIELD OF PROPERTY AND CASUALTY IN-
SURANCE (U.S. CLS. 100, 101 AND 102).

FIRST USE 6-0-2007; IN COMMERCE 6-0-2007.
LESLIE RICHARDS, EXAMINING ATTORNEY

CLASS 36—(Continued).

SN 77-790,062. KALINOWSKY, JANE, SIMI VALLEY, CA.
FILED 7-27-2009.

Home Sales For A CURE

THE MARK CONSISTS OF STANDARD CHARACTERS
WITHOUT CLAIM TO ANY PARTICULAR FONT, STYLE,
SIZE, OR COLOR.

NO CLAIM IS MADE TO THE EXCLUSIVE RIGHT TO
USE "HOME SALES", APART FROM THE MARK AS
SHOWN.

FOR CHARITABLE FUND RAISING SERVICES,
NAMELY, PROVIDING INDIVIDUALS WITH THE IN-
FORMATION AND OPPORTUNITY TO MAKE MONE-
TARY DONATIONS TO CHARITIES INVOLVED WITH
CYSTIC FIBROSIS; CHARITABLE FUND-RAISING SER-
VICES BY MEANS OF RAISING FUNDS FROM COM-
MISSIONS FROM REAL ESTATE SERVICES AND
DONATING FUNDS TO CHARITIES INVOLVED WITH
CYSTIC FIBROSIS; FINANCIAL VALUATION OF PER-
SONAL PROPERTY AND REAL ESTATE; PROVIDING A
DATABASE OF INFORMATION ABOUT RESIDENTIAL
REAL ESTATE LISTINGS IN DIFFERENT NEIGHBOR-
HOODS AND COMMUNITIES; PROVIDING A DATA-
BASE OF RESIDENTIAL REAL ESTATE LISTINGS
WITHIN NEIGHBORHOODS AND COMMUNITIES SPE-
CIFICALLY IDENTIFIED BY USERS; PROVIDING IN-
FORMATION IN THE FIELD OF REAL ESTATE VIA
THE INTERNET; PROVIDING INFORMATION IN THE
FIELD OF REAL ESTATE BY MEANS OF LINKING THE
WEB SITE TO OTHER WEB SITES FEATURING REAL
ESTATE INFORMATION; PROVIDING REAL ESTATE
LISTINGS AND REAL ESTATE INFORMATION VIA
THE INTERNET; REAL ESTATE CONSULTATION;
REAL ESTATE LISTING SERVICES FOR HOUSING
RENTALS AND APARTMENT RENTALS; REAL ES-
TATE MANAGEMENT SERVICES; REAL ESTATE SER-
VICES IN THE FORM OF PROVIDING PHYSICAL
ACCESS TO AVAILABLE PROPERTIES VIA A REMOTE
CALL-IN LOCKING DEVICE; REAL ESTATE SERVICES,
NAMELY, PROVIDING AN ONLINE QUESTIONNAIRE
TO HELP USERS DETERMINE THE BEST NEIGHBOR-
HOODS AND COMMUNITIES SUITED TO THEIR IN-
DIVIDUAL NEEDS AND PREFERENCES, AND A
PORTION OF ANY OF THE PROCEEDS DEEMED
CHARITABLE PROCEEDS RAISED FROM ANY OF
THE FOREGOING TO BE DONATED TO CHARITIES
INVOLVED WITH CYSTIC FIBROSIS (U.S. CLS. 100, 101
AND 102).

FIRST USE 7-0-2009; IN COMMERCE 7-0-2009.
KATHLEEN M. VANSTON, EXAMINING ATTORNEY

CLASS 36—(Continued).

SN 77-797,433. TRADING CROSS CONNECTS LIMITED, LONDON, UNITED KINGDOM, FILED 8-5-2009.

BAY HEAD CI

THE MARK CONSISTS OF STANDARD CHARACTERS WITHOUT CLAIM TO ANY PARTICULAR FONT, STYLE, SIZE, OR COLOR.

NO CLAIM IS MADE TO THE EXCLUSIVE RIGHT TO USE "CI", APART FROM THE MARK AS SHOWN.

FOR PROVIDING WORKING CAPITAL, VENTURE CAPITAL SERVICES, NAMELY, PROVIDING FINANCING TO EMERGING START-UP COMPANIES; PROVISION OF LOANS SECURED BY COMMERCIAL PAPER; FINANCIAL GUARANTEES; SECURITIES TRADING SERVICES, NAMELY, THE ESTABLISHMENT OF SECURITIES TRADING LINES WITH PRIME BROKERS; FINANCIAL RISK MANAGEMENT SERVICES; PROVISION OF FINANCIAL INFORMATION AND ADVISORY SERVICES; FINANCIAL CONSULTANCY SERVICES; VENTURE CAPITAL ADVISORY SERVICES (U.S. CLS. 100, 101 AND 102).

FIRST USE 11-23-2009; IN COMMERCE 11-23-2009.
GISELLE AGOSTO, EXAMINING ATTORNEY

CLASS 36—(Continued).

SN 77-805,156. TC LOAN SERVICE, LLC, FORT WORTH, TX, FILED 8-14-2009.

ThinkCash

OWNER OF U.S. REG. NO. 3,521,141.

THE MARK CONSISTS OF THE WORDING "THINK-CASH" WITH A STYLIZED DESIGN IN PLACE OF THE "I". THE DESIGN IS A STYLIZED DOLLAR BILL WITH A DOT OVER IT AND STRETCHED CORNERS THAT MAKE IT RESEMBLE OF STICK FIGURE PERSON.

FOR FINANCIAL SERVICES, NAMELY, PROVIDING SHORT TERM INSTALLMENT LOANS VIA THE INTERNET (U.S. CLS. 100, 101 AND 102).

FIRST USE 9-1-2006; IN COMMERCE 1-2-2007.
CORY BOONE, EXAMINING ATTORNEY

SN 77-815,303. ALTERNATIVE MERCHANT PROCESSING, INC., BOCA RATON, FL. FILED 8-28-2009.



NO CLAIM IS MADE TO THE EXCLUSIVE RIGHT TO USE "MERCHANT PROCESSING", APART FROM THE MARK AS SHOWN.

THE COLOR(S) BLUE, WHITE, AND BLACK IS/ARE CLAIMED AS A FEATURE OF THE MARK.

THE MARK CONSISTS OF A DISTINCTIVE DESIGN COMPRISING A LIGHT BLUE RECTANGULAR BOX CONTAINING THE TEXTUAL WORD "ALTERNATIVE" IN THE COLOR WHITE AND CENTERED WITHIN THE BOX WITH THE TAILS OF THE LETTERS "A" "N" AND "E" INTERSECTING TO THE BORDERS OF THE RECTANGLE. DIRECTLY UNDER THE BLUE RECTANGULAR BOX AND CENTERED THEREWITH ARE THE TEXTUAL WORDS "MERCHANT PROCESSING" IN THE COLOR BLACK.

FOR FINANCIAL SERVICES RELATED TO CREDIT CARDS AND PAYMENT CARDS, NAMELY, CREDIT CARD AND DEBIT CARD SERVICES; MERCHANT BANKING SERVICES; CHARGE CARD AND PREPAID CARD TRANSACTION PROCESSING SERVICES, NAMELY, ELECTRONIC TRANSACTION AUTHORIZATION AND SETTLEMENT SERVICES, ELECTRONIC PAYMENTS SERVICES IN THE NATURE OF CREDIT CARD PAYMENT PROCESSING SERVICES, PROCESSING ELECTRONIC PAYMENTS MADE THROUGH DEBIT CARDS, ELECTRONIC FUNDS TRANSFER AND CURRENCY TRANSFER SERVICES, AND CASH DISBURSEMENT SERVICES, NAMELY, CASH REPLACEMENT RENDERED BY CREDIT OR DEBIT CARD THAT UTILIZES A DEVICE TO ALLOW PAYMENT TO BE CHARGED TO A PREVIOUSLY SPECIFIED PAYMENT MEDIUM, SUCH AS A DEBIT CARD OR CREDIT CARD; CHECK VERIFICATION SERVICES; AND ADVISORY AND CONSULTING SERVICES RELATING TO ALL THE AFORESAID SERVICES (U.S. CLS. 100, 101 AND 102).

FIRST USE 10-6-2005; IN COMMERCE 10-30-2005.
JENNIFER HETU, EXAMINING ATTORNEY

SN 77-802,048. LONGEVITY ASSET MANAGEMENT LLC, NEW YORK, NY. FILED 8-11-2009.



NO CLAIM IS MADE TO THE EXCLUSIVE RIGHT TO USE "LONGEVITY ASSET MANAGEMENT", APART FROM THE MARK AS SHOWN.

THE COLOR(S) AQUA AND DARK BLUE IS/ARE CLAIMED AS A FEATURE OF THE MARK.

THE MARK CONSISTS OF A STYLIZED RECTANGULAR LOGO COMPOSED OF AN INVERTED AQUA COLORED LETTER "L" AND AN INVERTED DARK BLUE COLORED LETTER "L" TO THE LEFT OF THE "LONGEVITY" WHICH IS COLORED AQUA AND WHICH IS ABOVE THE WORDS "ASSET MANAGEMENT" COLORED DARK BLUE. THE COLOR WHITE REPRESENTS TRANSPARENT AREAS AND IS NOT A PART OF THE MARK.

FOR FINANCIAL ASSET MANAGEMENT (U.S. CLS. 100, 101 AND 102).

FIRST USE 7-15-2009; IN COMMERCE 8-7-2009.
KATHERINE M. DUBRAY, EXAMINING ATTORNEY

CLASS 36—(Continued).

SN 77-815,532. PACIFIC LIFE INSURANCE COMPANY, NEWPORT BEACH, CA. FILED 8-28-2009.

PACIFIC FUSION

THE MARK CONSISTS OF STANDARD CHARACTERS WITHOUT CLAIM TO ANY PARTICULAR FONT, STYLE, SIZE, OR COLOR.

OWNER OF U.S. REG. NOS. 2,168,494, 2,411,140 AND OTHERS.

NO CLAIM IS MADE TO THE EXCLUSIVE RIGHT TO USE "FUSION", APART FROM THE MARK AS SHOWN.

FOR ANNUITY SERVICES, NAMELY, ACCOUNT AND INVESTMENT ADMINISTRATION, INVESTMENT, AND DISTRIBUTION OF ANNUITIES (U.S. CLS. 100, 101 AND 102).

JUDITH HELFMAN, EXAMINING ATTORNEY

SN 77-818,136. FCOA, LLC, CALEDONIA, MI. FILED 9-2-2009.

FOREMOST OUTDOORS

THE MARK CONSISTS OF STANDARD CHARACTERS WITHOUT CLAIM TO ANY PARTICULAR FONT, STYLE, SIZE, OR COLOR.

OWNER OF U.S. REG. NOS. 929,339 AND 3,401,596.

NO CLAIM IS MADE TO THE EXCLUSIVE RIGHT TO USE "OUTDOORS", APART FROM THE MARK AS SHOWN.

FOR INSURANCE SERVICES, NAMELY, UNDERWRITING IN THE FIELD OF PROPERTY AND CASUALTY, INSURANCE ADMINISTRATION, INSURANCE CLAIMS ADMINISTRATION, AND INSURANCE AGENCIES; PROVIDING INSURANCE INFORMATION (U.S. CLS. 100, 101 AND 102).

FIRST USE 8-14-2009; IN COMMERCE 8-14-2009.

KIM SAITO, EXAMINING ATTORNEY

SN 77-822,988. INTELLECTUAL PROPERTY EXCHANGE INTERNATIONAL, INC., CHICAGO, IL. FILED 9-9-2009.

PVI

THE MARK CONSISTS OF STANDARD CHARACTERS WITHOUT CLAIM TO ANY PARTICULAR FONT, STYLE, SIZE, OR COLOR.

FOR FINANCIAL INVESTMENT SERVICES, NAMELY, PROVIDING AND ADMINISTERING INVESTMENT CONTRACTS (U.S. CLS. 100, 101 AND 102).

STEVEN R. FINE, EXAMINING ATTORNEY

CLASS 36—(Continued).

SN 77-823,003. INTELLECTUAL PROPERTY EXCHANGE INTERNATIONAL, INC., CHICAGO, IL. FILED 9-9-2009.

EMI

THE MARK CONSISTS OF STANDARD CHARACTERS WITHOUT CLAIM TO ANY PARTICULAR FONT, STYLE, SIZE, OR COLOR.

FOR FINANCIAL INVESTMENT SERVICES, NAMELY, PROVIDING AND ADMINISTERING INVESTMENT CONTRACTS (U.S. CLS. 100, 101 AND 102).

STEVEN R. FINE, EXAMINING ATTORNEY

SN 77-829,665. TRUE VALUE COMPANY, CHICAGO, IL. FILED 9-18-2009.



OWNER OF U.S. REG. NOS. 3,592,690, 3,607,183 AND OTHERS.

NO CLAIM IS MADE TO THE EXCLUSIVE RIGHT TO USE "FOUNDATION", APART FROM THE MARK AS SHOWN.

THE MARK CONSISTS OF THE WORDS "PAINTING A BRIGHTER FUTURE TRUE VALUE FOUNDATION" WITH TWO FIGURES WITH OUTSTRETCHED HANDS AND A SUN IN THE BACKGROUND.

FOR CHARITABLE SERVICES IN THE NATURE OF GRANTS OF MONEY FOR EDUCATIONAL, SOCIAL AND ATHLETIC IMPROVEMENTS TO LOCAL SCHOOLS (U.S. CLS. 100, 101 AND 102).

SKYE YOUNG, EXAMINING ATTORNEY

CLASS 36—(Continued).

SN 77-834,583. STRUCTURE PROPERTY MANAGEMENT GROUP, INC., IRVINE, CA. FILED 9-24-2009.



NO CLAIM IS MADE TO THE EXCLUSIVE RIGHT TO USE "PROPERTY MANAGEMENT GROUP", APART FROM THE MARK AS SHOWN.

THE COLOR(S) GREEN, BLUE, AND GRAY IS/ARE CLAIMED AS A FEATURE OF THE MARK.

THE MARK CONSISTS OF A STYLIZED GRAPHIC DEPICTING BUILDINGS IN ALTERNATING COLORS OF BLUE, GREEN, AND GRAY ON A HORIZON. UNDERNEATH THAT ARE THE STYLIZED WORDS "STRUCTURE PMG PROPERTY MANAGEMENT GROUP", WHERE THE WORD "STRUCTURE" IS IN GREEN, "PMG" IS IN GRAY, AND "PROPERTY MANAGEMENT GROUP" IS IN BLUE.

FOR REAL ESTATE SERVICES, NAMELY, RENTAL PROPERTY MANAGEMENT; REAL ESTATE CONSULTATION (U.S. CLS. 100, 101 AND 102).

FIRST USE 2-23-2009; IN COMMERCE 2-23-2009.

ALYSSA STEEL, EXAMINING ATTORNEY

SN 77-836,103. LANGVA, MARC D., PLYMOUTH, MN. FILED 9-28-2009.

Work Optional Lifestyle

THE MARK CONSISTS OF STANDARD CHARACTERS WITHOUT CLAIM TO ANY PARTICULAR FONT, STYLE, SIZE, OR COLOR.

FOR FINANCIAL ADVICE AND CONSULTANCY SERVICES (U.S. CLS. 100, 101 AND 102).

FIRST USE 9-1-2009; IN COMMERCE 9-1-2009.

SAIMA MAKHDOOM, EXAMINING ATTORNEY

SN 77-836,555. JAMES E. FRAZIER, EVANSVILLE, IN. FILED 9-28-2009.

E-ME-RECEIPT

THE MARK CONSISTS OF STANDARD CHARACTERS WITHOUT CLAIM TO ANY PARTICULAR FONT, STYLE, SIZE, OR COLOR.

FOR PROVIDING AN ON-LINE COMPUTER DATABASE IN THE FIELD OF FINANCIAL INFORMATION, NAMELY, THE ORGANIZING OF SALES RECEIPTS RESULTING FROM COMMERCIAL SALES TRANSACTIONS (U.S. CLS. 100, 101 AND 102).

SUNG IN, EXAMINING ATTORNEY

CLASS 36—(Continued).

SN 77-838,222. D&M INSURANCE SERVICES, DBA DON BULLARD INSURANCE, WILMINGTON, NC. FILED 9-30-2009.



NO CLAIM IS MADE TO THE EXCLUSIVE RIGHT TO USE "AUTO HOME BUSINESS LIFE INSURANCE", APART FROM THE MARK AS SHOWN.

THE NAME "DON BULLARD" IDENTIFIES A LIVING INDIVIDUAL WHOSE CONSENT IS OF RECORD.

THE MARK CONSISTS OF A CIRCLE CONTAINING A PARTIALLY EXPOSED SUNBURST; A BANNER WITH THE WORDING "DON BULLARD INSURANCE" SITS ATOP THE SUNBURST, AND AROUND THE INNER EDGE OF THE CIRCLE ARE THE WORDS "AUTO HOME BUSINESS LIFE" AT THE TOP AND "YOUR NEIGHBORHOOD AGENT" AT THE BOTTOM.

FOR INSURANCE AGENCIES IN THE FIELD OF HOME INSURANCE, LIFE INSURANCE, AUTOMOBILE INSURANCE, AND BUSINESS INSURANCE; INSURANCE BROKERAGE IN THE FIELD OF HOME INSURANCE, LIFE INSURANCE, AUTOMOBILE INSURANCE, AND BUSINESS INSURANCE (U.S. CLS. 100, 101 AND 102).

FIRST USE 7-15-2009; IN COMMERCE 7-15-2009.

LINDA MICKLEBURGH, EXAMINING ATTORNEY

SN 77-838,502. APARTMENT FRENZY, LLC, HOUSTON, TX. FILED 9-30-2009.



THE COLOR(S) ORANGE, BLUE, AND BLACK IS/ARE CLAIMED AS A FEATURE OF THE MARK.

THE MARK CONSISTS OF A BLACK RECTANGLE CONTAINING THE WORDING "APARTMENT" AND ".COM" IN ORANGE AND THE WORDING "FRENZY" IN BLUE.

FOR APARTMENT AND OFFICE RENTALS; APARTMENT LOCATING SERVICES FOR OTHERS; CLASSIFIED REAL ESTATE LISTINGS OF APARTMENT RENTALS AND HOUSING RENTALS; LEASING OF APARTMENTS; MANAGEMENT OF APARTMENTS; REAL ESTATE LISTING SERVICES FOR HOUSING RENTALS AND APARTMENT RENTALS; REAL ESTATE SERVICES, NAMELY, LEASING AND MANAGEMENT FOR OTHERS OF RESIDENTIAL CONDOMINIUMS LOCATED WITHIN HOTEL DEVELOPMENTS; REAL ESTATE SERVICES, NAMELY, RENTAL OF SHORT-TERM FURNISHED APARTMENTS; RENTAL OF APARTMENTS; RENTAL OF APARTMENTS AND OFFICES; RENTAL OF APARTMENTS IN AN APARTMENT COMMUNITY; RENTING OF APARTMENTS (U.S. CLS. 100, 101 AND 102).

SUSAN RICHARDS, EXAMINING ATTORNEY

CLASS 36—(Continued).

SN 77-839,026. BURNS, WALTER, HOBOKEN, NJ. FILED 10-1-2009.



NO CLAIM IS MADE TO THE EXCLUSIVE RIGHT TO USE "LIVING ON THE HUDSON", APART FROM THE MARK AS SHOWN.

THE MARK CONSISTS OF A STYLIZED LETTER "H" ABOVE A WAVY LINE INSIDE A CIRCLE. TO THE RIGHT OF THE CIRCLE THERE IS THE STYLIZED TEXT "LIVING ON THE HUDSON".

FOR PROVIDING INFORMATION AND NEWS IN THE FIELD OF REAL ESTATE VIA THE INTERNET (U.S. CLS. 100, 101 AND 102).

FIRST USE 4-22-2009; IN COMMERCE 4-22-2009.
GINA FINK, EXAMINING ATTORNEY

SN 77-839,036. BRIGHT PINK, CHICAGO, IL. FILED 10-1-2009.

VIPink

THE MARK CONSISTS OF STANDARD CHARACTERS WITHOUT CLAIM TO ANY PARTICULAR FONT, STYLE, SIZE, OR COLOR.

FOR ORGANIZING AND CONDUCTING SPECIAL EVENTS FOR CHARITABLE FUNDRAISING PURPOSES (U.S. CLS. 100, 101 AND 102).

JUDITH HELFMAN, EXAMINING ATTORNEY

SN 77-841,631. AMICA MUTUAL INSURANCE COMPANY, PROVIDENCE, RI. FILED 10-5-2009.



OWNER OF U.S. REG. NO. 2,125,216.
NO CLAIM IS MADE TO THE EXCLUSIVE RIGHT TO USE "CHOICE AUTO", APART FROM THE MARK AS SHOWN.

THE MARK CONSISTS OF A SILHOUETTE OF A CAR POSITIONED OVER THE WORDS "PLATINUM CHOICE AUTO".

FOR INSURANCE SERVICES, NAMELY, UNDERWRITING AUTOMOBILE INSURANCE (U.S. CLS. 100, 101 AND 102).

FIRST USE 10-1-2009; IN COMMERCE 10-1-2009.
NAAKWAMA ANKRAH, EXAMINING ATTORNEY

CLASS 36—(Continued).

SN 77-844,680. CITY-WIDE TAX ASSISTANCE PROGRAM, CHICAGO, IL. FILED 10-8-2009.

LIFT LIFE IMPROVING FINANCIAL TOOLS

THE MARK CONSISTS OF STANDARD CHARACTERS WITHOUT CLAIM TO ANY PARTICULAR FONT, STYLE, SIZE, OR COLOR.

NO CLAIM IS MADE TO THE EXCLUSIVE RIGHT TO USE "FINANCIAL TOOLS", APART FROM THE MARK AS SHOWN.

FOR CHARITABLE SERVICES FOR INDIVIDUALS IN NEED, NAMELY, PROVIDING ADVICE REGARDING PROCUREMENT OF FINANCIAL AID FOR EDUCATION, MANAGEMENT OF PERSONAL FINANCES, AND PROCURING AND USING BANKING SERVICES (U.S. CLS. 100, 101 AND 102).

FIRST USE 1-0-2009; IN COMMERCE 1-0-2009.
KIMBERLY FRYE, EXAMINING ATTORNEY

SN 77-846,378. COOPER RIVER FINANCIAL LLC, MEDFORD, NJ. FILED 10-12-2009.

COOPER RIVER FINANCIAL

THE MARK CONSISTS OF STANDARD CHARACTERS WITHOUT CLAIM TO ANY PARTICULAR FONT, STYLE, SIZE, OR COLOR.

NO CLAIM IS MADE TO THE EXCLUSIVE RIGHT TO USE "FINANCIAL", APART FROM THE MARK AS SHOWN.

FOR FINANCIAL SERVICES, NAMELY, CAPITAL MARKETS FINANCIAL CONSULTING FEATURING RESIDENTIAL MORTGAGE VALUATION, MODELING AND HEDGING ANALYSIS FOR THIRD PARTY FINANCIAL INTERMEDIARIES; INTEREST RATE FINANCIAL RISK MANAGEMENT FOR MORTGAGE PIPELINE AND MORTGAGE SERVICING PORTFOLIOS FOR MORTGAGE CAPITAL MARKETS PARTICIPANTS TO HELP MANAGE BALANCE SHEET EXPOSURE; LOAN DELIVERY STRATEGIES, NAMELY, BEST EXECUTION PRICING ANALYSIS FOR RESIDENTIAL MORTGAGE LOANS SOLD TO GOVERNMENT SPONSORED ENTITIES (GSES) AND/OR MAJOR PRIVATE MORTGAGE CONDUITS; WAREHOUSE LENDING SERVICES; FINANCIAL PACKAGING, NAMELY, PROVIDING PACKAGED SERVICES FOR NON-DEPOSITORY MORTGAGE BANKING COMPANIES COMPRISING BOTH WAREHOUSE LENDING LINES OF CREDIT AND FINANCING OF MORTGAGE LOAN SERVICING RIGHTS; ELECTRONIC MORTGAGE LOAN DOCUMENT PROCESSING; FINANCIAL MANAGEMENT; ASSISTING OTHERS IN FINANCIAL FORECASTING; ASSISTING OTHERS IN CASH MANAGEMENT, AND DEVELOPING CASH FLOW ANALYSIS AND MANAGEMENT MODELS RELATIVE TO ORIGINATED, SOLD, OR RETAINED RESIDENTIAL MORTGAGE ASSETS (U.S. CLS. 100, 101 AND 102).

RONALD DELGIZZI, EXAMINING ATTORNEY

CLASS 36—(Continued).

SN 77-846,382. COOPER RIVER FINANCIAL LLC, MED-FORD, NJ. FILED 10-12-2009.



NO CLAIM IS MADE TO THE EXCLUSIVE RIGHT TO USE "FINANCIAL LLC", APART FROM THE MARK AS SHOWN.

THE MARK CONSISTS OF THE WORDS "COOPER RIVER FINANCIAL, LLC" BELOW A DEPICTION OF SCULL-TYPE BOAT WITH A FOUR-PERSON CREW.

FOR FINANCIAL SERVICES, NAMELY, CAPITAL MARKETS FINANCIAL CONSULTING FEATURING RESIDENTIAL MORTGAGE VALUATION, MODELING AND HEDGING ANALYSIS FOR THIRD PARTY FINANCIAL INTERMEDIARIES; INTEREST RATE FINANCIAL RISK MANAGEMENT FOR MORTGAGE PIPELINE AND MORTGAGE SERVICING PORTFOLIOS FOR MORTGAGE CAPITAL MARKETS PARTICIPANTS TO HELP MANAGE BALANCE SHEET EXPOSURE; LOAN DELIVERY STRATEGIES, NAMELY, BEST EXECUTION PRICING ANALYSIS FOR RESIDENTIAL MORTGAGE LOANS SOLD TO GOVERNMENT SPONSORED ENTITIES (GSES) AND/OR MAJOR PRIVATE MORTGAGE CONDUITS; WAREHOUSE LENDING SERVICES; FINANCIAL PACKAGING, NAMELY, PROVIDING PACKAGED SERVICES FOR NON-DEPOSITORY MORTGAGE BANKING COMPANIES COMPRISING BOTH WAREHOUSE LENDING LINES OF CREDIT AND FINANCING OF MORTGAGE LOAN SERVICING RIGHTS; ELECTRONIC MORTGAGE LOAN DOCUMENT PROCESSING; FINANCIAL MANAGEMENT; ASSISTING OTHERS IN FINANCIAL FORECASTING; ASSISTING OTHERS IN CASH MANAGEMENT, AND DEVELOPING CASH FLOW ANALYSIS AND MANAGEMENT MODELS RELATIVE TO ORIGINATED, SOLD, OR RETAINED RESIDENTIAL MORTGAGE ASSETS (U.S. CLS. 100, 101 AND 102).

RONALD DELGIZZI, EXAMINING ATTORNEY

SN 77-847,639. TRANSPARENT USA, LLC, ATLANTA, GA. FILED 10-13-2009.

Transparent USA

THE MARK CONSISTS OF STANDARD CHARACTERS WITHOUT CLAIM TO ANY PARTICULAR FONT, STYLE, SIZE, OR COLOR.

NO CLAIM IS MADE TO THE EXCLUSIVE RIGHT TO USE "USA", APART FROM THE MARK AS SHOWN.

FOR FINANCIAL ANALYSES; FINANCIAL CONSULTATION IN THE FIELD OF ACCOUNTS PAYABLE; FINANCIAL INFORMATION AND EVALUATIONS (U.S. CLS. 100, 101 AND 102).

FIRST USE 9-28-2009; IN COMMERCE 9-28-2009.

KAPIL BHANOT, EXAMINING ATTORNEY

CLASS 36—(Continued).

SN 77-847,700. EPSTEIN, CHARLES D., HOLYOKE, MA. FILED 10-13-2009.

THE BEAR MARKET MANAGER

THE MARK CONSISTS OF STANDARD CHARACTERS WITHOUT CLAIM TO ANY PARTICULAR FONT, STYLE, SIZE, OR COLOR.

NO CLAIM IS MADE TO THE EXCLUSIVE RIGHT TO USE "MANAGER", APART FROM THE MARK AS SHOWN.

FOR FINANCIAL SERVICES, NAMELY, PROVIDING FINANCIAL ADVICE AND ASSISTANCE TO INDIVIDUALS TO HELP OVERCOME THE EMOTIONAL IMPACT OF MARKET VOLATILITY AND GETTING BACK ON TRACK TO CREATING FINANCIAL INDEPENDENCE WITH REDUCED FINANCIAL ANXIETY (U.S. CLS. 100, 101 AND 102).

JOHN WILKE, EXAMINING ATTORNEY

SN 77-849,535. LMGH, LLC, TAMPA, FL. FILED 10-15-2009.

CAPITAL BA6

THE MARK CONSISTS OF STANDARD CHARACTERS WITHOUT CLAIM TO ANY PARTICULAR FONT, STYLE, SIZE, OR COLOR.

NO CLAIM IS MADE TO THE EXCLUSIVE RIGHT TO USE "CAPITAL", APART FROM THE MARK AS SHOWN.

FOR OFFERING LEASE-WITH-OPTION-TO-PURCHASE CONTRACTS AND SERVICES TO CUSTOMERS OF THIRD PARTY SELLERS OF RETAIL GOODS, NAMELY, LEASE-PURCHASE FINANCING (U.S. CLS. 100, 101 AND 102).

ROBERT STRUCK, EXAMINING ATTORNEY

SN 77-851,071. GIRLING, DAVID W., DBA GIRLING REAL ESTATE INVESTMENT GROUP, NEWPORT BEACH, CA. FILED 10-17-2009.

Newport Beach Price Index ("NBPI")

THE MARK CONSISTS OF STANDARD CHARACTERS WITHOUT CLAIM TO ANY PARTICULAR FONT, STYLE, SIZE, OR COLOR.

NO CLAIM IS MADE TO THE EXCLUSIVE RIGHT TO USE "NEWPORT BEACH PRICE INDEX", APART FROM THE MARK AS SHOWN.

FOR FINANCIAL VALUATION OF PERSONAL PROPERTY AND REAL ESTATE; PROVIDING A DATABASE OF INFORMATION ABOUT RESIDENTIAL REAL ESTATE LISTINGS IN DIFFERENT NEIGHBORHOODS AND COMMUNITIES; REAL ESTATE INVESTMENT SERVICES IN THE NATURE OF PURCHASING AND SELLING OF REAL ESTATE FOR OTHERS (U.S. CLS. 100, 101 AND 102).

DAWN HAN, EXAMINING ATTORNEY

CLASS 36—(Continued).

SN 77-857,022. THE FILLIES, INC., LOUISVILLE, KY. FILED 10-26-2009.

CLASS 36—(Continued).

SN 77-867,901. COLLINGS, BRYAN ALEXANDER COPPIN, DBA HEXAM CAPITAL LLC, LONDON, UNITED KINGDOM, FILED 11-9-2009.

DERBY PRINCESSES

THE MARK CONSISTS OF STANDARD CHARACTERS WITHOUT CLAIM TO ANY PARTICULAR FONT, STYLE, SIZE, OR COLOR.

FOR CHARITABLE FUND-RAISING SERVICES, NAMELY, ORGANIZING AND CONDUCTING PAGEANTS, PARADES, DANCES, BALLROOM DANCES, AND FESTIVALS (U.S. CLS. 100, 101 AND 102).
TARAH HARDY, EXAMINING ATTORNEY

SN 77-861,607. CUNA MUTUAL INSURANCE SOCIETY, MADISON, WI. FILED 10-30-2009.

**MEDICARE SUITE**

THE MARK CONSISTS OF STANDARD CHARACTERS WITHOUT CLAIM TO ANY PARTICULAR FONT, STYLE, SIZE, OR COLOR.

NO CLAIM IS MADE TO THE EXCLUSIVE RIGHT TO USE "MEDICARE", APART FROM THE MARK AS SHOWN.
FOR INSURANCE SERVICES, NAMELY, BROKERAGE IN THE FIELD OF SUPPLEMENTAL MEDICARE INSURANCE (U.S. CLS. 100, 101 AND 102).
FIRST USE 6-22-2009; IN COMMERCE 6-22-2009.
PAUL E. FAHRENKOPF, EXAMINING ATTORNEY

SN 77-862,543. DELTA MEDIA GROUP, INC., CANTON, OH. FILED 11-2-2009.



THE MARK CONSISTS OF THE WORD "PROPERTY" OFFSET TO THE LEFT AND ABOVE THE WORD "PURSUIT", WHERE THE LETTER "O" IS FORMED AS A MAGNIFYING GLASS HAVING A HOUSE ICON CENTERED WITHIN.

FOR PROVIDING WEBSITES FEATURING INFORMATION IN THE FIELD OF REAL ESTATE, NAMELY, PROVIDING SEARCHABLE ONLINE REAL ESTATE DATABASES (U.S. CLS. 100, 101 AND 102).
FIRST USE 9-0-1996; IN COMMERCE 9-0-1996.
AARON BRODSKY, EXAMINING ATTORNEY

NO CLAIM IS MADE TO THE EXCLUSIVE RIGHT TO USE "CAPITAL", APART FROM THE MARK AS SHOWN.

THE COLOR(S) RED AND GOLD IS/ARE CLAIMED AS A FEATURE OF THE MARK.

THE MARK CONSISTS OF THE WORD "HEXAM" IN RED ABOVE THE WORD "CAPITAL" IN SMALLER RED LETTERS, AND A BACKGROUND DESIGN OF A GOLD HEXAGON.

FOR ADVICE RELATING TO INVESTMENTS; COMMODITY INVESTMENT ADVICE; EQUITY CAPITAL INVESTMENT; FINANCIAL AND INVESTMENT SERVICES, NAMELY, MANAGEMENT AND BROKERAGE IN THE FIELDS OF STOCKS, BONDS, OPTIONS, COMMODITIES, FUTURES, AND OTHER SECURITIES, AND THE INVESTMENT OF FUNDS OF OTHERS; FINANCIAL ASSET MANAGEMENT; FINANCIAL PORTFOLIO MANAGEMENT; FINANCIAL SERVICES, NAMELY, COORDINATION, WITHIN A SINGLE ACCOUNT, OF AN INVESTMENT PORTFOLIO'S MAINTENANCE, TRADING, REBALANCING, AND TAX MANAGEMENT NEEDS; FINANCIAL SERVICES, NAMELY, INVESTMENT ADVICE, INVESTMENT MANAGEMENT, INVESTMENT CONSULTATION, AND INVESTMENT OF FUNDS FOR OTHERS, INCLUDING PRIVATE AND PUBLIC EQUITY AND DEBT INVESTMENT SERVICES; INVESTMENT MANAGEMENT; MANAGEMENT OF A CAPITAL INVESTMENT FUND; MANAGEMENT OF PORTFOLIOS COMPRISING SECURITIES; MANAGEMENT OF PORTFOLIOS OF TRANSFERABLE SECURITIES; MANAGEMENT OF PRIVATE EQUITY FUNDS; PUBLIC EQUITY INVESTMENT MANAGEMENT; TRUST MANAGEMENT ACCOUNTS (U.S. CLS. 100, 101 AND 102).
CORY BOONE, EXAMINING ATTORNEY

CLASS 36—(Continued).

SN 77-868,404. GOEL ENTERPRISE, BALTIMORE, MD.
FILED 11-9-2009.



NO CLAIM IS MADE TO THE EXCLUSIVE RIGHT TO USE "ENTERPRISE", APART FROM THE MARK AS SHOWN.

THE COLOR(S) BLUE, WHITE AND SILVER IS/ARE CLAIMED AS A FEATURE OF THE MARK.

THE MARK CONSISTS OF A STYLIZED LETTER "G" IN WHITE INSIDE A CIRCLE SHADED BY BANDS OF BLUE, OUTLINED BY A RING OF WHITE WITH A SILVER OUTER BORDER, AND THE WORD "GOEL" IN BLUE ABOVE THE WORD "ENTERPRISE" IN SILVER.

FOR VENTURE CAPITAL FUNDING SERVICES TO EMERGING AND START-UP COMPANIES (U.S. CLS. 100, 101 AND 102).

NICHOLAS ALTREE, EXAMINING ATTORNEY

SN 77-869,360. MURRAY, SCHOEN AND HOMER INC.,
NEW ROCHELLE, NY. FILED 11-10-2009.

We'll help you protect
what is important in your
life

THE MARK CONSISTS OF STANDARD CHARACTERS WITHOUT CLAIM TO ANY PARTICULAR FONT, STYLE, SIZE, OR COLOR.

FOR INSURANCE AGENCY AND FINANCIAL ADVICE (U.S. CLS. 100, 101 AND 102).

VIVIAN MICZNIK FIRST, EXAMINING ATTORNEY

CLASS 36—(Continued).

SN 77-869,363. DELTA DENTAL OF IOWA, ANKENY, IA.
FILED 11-10-2009.

VERATRUS

THE MARK CONSISTS OF STANDARD CHARACTERS WITHOUT CLAIM TO ANY PARTICULAR FONT, STYLE, SIZE, OR COLOR.

FOR ADMINISTRATION OF VISION HEALTH INSURANCE INDEMNITY AND BENEFIT PROGRAMS FOR BOTH INDIVIDUALS AND GROUPS (U.S. CLS. 100, 101 AND 102).

TRACY WHITTAKER-BROWN, EXAMINING ATTORNEY

SN 77-869,885. PENNSYLVANIA MANUFACTURERS' ASSOCIATION INSURANCE COMPANY, BLUE BELL, PA.
FILED 11-11-2009.

PMA Webservice

THE MARK CONSISTS OF STANDARD CHARACTERS WITHOUT CLAIM TO ANY PARTICULAR FONT, STYLE, SIZE, OR COLOR.

OWNER OF U.S. REG. NOS. 1,293,238, 3,148,247 AND 3,150,804.

NO CLAIM IS MADE TO THE EXCLUSIVE RIGHT TO USE "WEBSOURCE", APART FROM THE MARK AS SHOWN.

FOR INSURANCE SERVICES IN THE NATURE OF LOSS CONTROL MANAGEMENT FOR OTHERS (U.S. CLS. 100, 101 AND 102).

FIRST USE 11-10-2009; IN COMMERCE 11-10-2009.

ODESSA BIBBINS, EXAMINING ATTORNEY

SN 77-877,254. RECOM GLOBAL, LLC, PHOENIX, AZ.
FILED 11-20-2009.

NO CLAIM IS MADE TO THE EXCLUSIVE RIGHT TO USE "GLOBAL", APART FROM THE MARK AS SHOWN.

THE COLOR(S) BLUE, GREEN AND WHITE IS/ARE CLAIMED AS A FEATURE OF THE MARK.

THE MARK CONSISTS OF THE WORDING "RECOM GLOBAL" IN BLUE EXCEPT FOR BOTH INSTANCES OF THE LETTER "O" WHICH ARE COMPRISED OF GREEN AND WHITE LINES.

FOR ASSESSMENT AND MANAGEMENT OF REAL ESTATE (U.S. CLS. 100, 101 AND 102).

HAI-LY LAM, EXAMINING ATTORNEY

CLASS 36—(Continued).

SN 77-878,489. INSPHERE INSURANCE SOLUTIONS, INC., NORTH RICHLAND HILLS, TX. FILED 11-23-2009.



THE MARK CONSISTS OF A PLANET ECLIPSING THE SUN APPEARING WITHIN A SQUARE WITH THE LETTERS "IN" IN THE SQUARE AND OVERLAPPING THE SUN AND THE LETTERS "SPHERE" APPEARING TO THE RIGHT OF THE SQUARE ALL OF WHICH ARE OVER THE WORD "INSITE".

FOR PROVIDING ON-LINE INFORMATION TO INSURANCE AGENTS REGARDING INSURANCE POLICIES, ADMINISTRATION, AND UNDERWRITING (U.S. CLS. 100, 101 AND 102).

KHANH LE, EXAMINING ATTORNEY

SN 77-880,500. MANASOTA MOON, LLC, RICHLAND CENTER, WI. FILED 11-25-2009.

MANASOTA MOON

THE MARK CONSISTS OF STANDARD CHARACTERS WITHOUT CLAIM TO ANY PARTICULAR FONT, STYLE, SIZE, OR COLOR.

NO CLAIM IS MADE TO THE EXCLUSIVE RIGHT TO USE "MANASOTA", APART FROM THE MARK AS SHOWN.

FOR VACATION REAL ESTATE TIME-SHARING (U.S. CLS. 100, 101 AND 102).

MIDGE BUTLER, EXAMINING ATTORNEY

SN 77-880,538. INSPHERE INSURANCE SOLUTIONS, INC., NORTH RICHLAND HILLS, TX. FILED 11-23-2009.



Life | Health | Retirement | Long-Term Care

NO CLAIM IS MADE TO THE EXCLUSIVE RIGHT TO USE "INSURANCE SOLUTIONS" AND "LIFE, HEALTH, RETIREMENT, LONG-TERM CARE", APART FROM THE MARK AS SHOWN.

THE MARK CONSISTS OF A PLANET ECLIPSING THE SUN APPEARING WITHIN A SQUARE WITH THE LETTERS "IN" IN THE SQUARE AND OVERLAPPING THE SUN AND THE LETTERS "SPHERE" APPEARING TO THE RIGHT OF THE SQUARE ALL OF WHICH ARE OVER THE WORDS "INSURANCE SOLUTIONS" ALL OF WHICH ARE OVER THE WORDS "LIFE HEALTH RETIREMENT LONG-TERM CARE" WITH VERTICAL LINES APPEARING BETWEEN THOSE WORDS.

FOR INSURANCE AGENCY SERVICES (U.S. CLS. 100, 101 AND 102).

KHANH LE, EXAMINING ATTORNEY

CLASS 36—(Continued).

SN 77-881,494. THE PEOPLE'S ADJUSTER LLC, LOXAHATCHEE, FL. FILED 11-27-2009.

THE PEOPLE'S ADJUSTER

THE MARK CONSISTS OF STANDARD CHARACTERS WITHOUT CLAIM TO ANY PARTICULAR FONT, STYLE, SIZE, OR COLOR.

NO CLAIM IS MADE TO THE EXCLUSIVE RIGHT TO USE "ADJUSTER", APART FROM THE MARK AS SHOWN. FOR CLAIMS ADJUSTMENT IN THE FIELD OF INSURANCE (U.S. CLS. 100, 101 AND 102).

FIRST USE 11-23-2009; IN COMMERCE 11-23-2009.

MARY CRAWFORD, EXAMINING ATTORNEY

SN 77-881,805. GATEWAY OPPORTUNITIES, LLC, DBA GATEWAY ASSETS, SAN DIEGO, CA. FILED 11-29-2009.

Gateway Assets

THE MARK CONSISTS OF STANDARD CHARACTERS WITHOUT CLAIM TO ANY PARTICULAR FONT, STYLE, SIZE, OR COLOR.

NO CLAIM IS MADE TO THE EXCLUSIVE RIGHT TO USE "ASSETS", APART FROM THE MARK AS SHOWN.

FOR FINANCIAL DUE DILIGENCE SERVICES IN THE FIELD OF REAL ESTATE; FINANCIAL INVESTMENT IN THE FIELD OF REAL ESTATE; REAL ESTATE ACQUISITION SERVICES; REAL ESTATE CONSULTANCY; REAL ESTATE EQUITY SHARING, NAMELY, MANAGING AND ARRANGING FOR CO-OWNERSHIP OF REAL ESTATE; REAL ESTATE INVESTMENT SERVICES IN THE NATURE OF PURCHASING AND SELLING OF REAL ESTATE FOR OTHERS; REAL ESTATE SYNDICATION (U.S. CLS. 100, 101 AND 102).

FIRST USE 5-14-2009; IN COMMERCE 5-14-2009.

ELLEN B. AWRICH, EXAMINING ATTORNEY

CLASS 36—(Continued).

SN 77-882,283. CRIO, INC., WEST PALM BEACH, CA. FILED 11-30-2009.

Crio Flood Advantage

THE MARK CONSISTS OF STANDARD CHARACTERS WITHOUT CLAIM TO ANY PARTICULAR FONT, STYLE, SIZE, OR COLOR.

OWNER OF U.S. REG. NO. 3,698,872.

NO CLAIM IS MADE TO THE EXCLUSIVE RIGHT TO USE "FLOOD", APART FROM THE MARK AS SHOWN.

FOR BROKERAGE IN THE FIELD OF FLOOD INSURANCE; INSURANCE AGENCIES; INSURANCE AGENCIES IN THE FIELD OF FLOOD INSURANCE; INSURANCE BROKERAGE; INSURANCE BROKERAGE IN THE FIELD OF FLOOD INSURANCE; INSURANCE CONSULTATION; INSURANCE SERVICES IN THE NATURE OF LOSS CONTROL MANAGEMENT FOR OTHERS (U.S. CLS. 100, 101 AND 102).

FIRST USE 9-15-2009; IN COMMERCE 9-17-2009.

ELLEN BURNS, EXAMINING ATTORNEY

CLASS 36—(Continued).

SN 77-882,316. BUYBOOK TECHNOLOGIES, INC., MANHEIM, PA. FILED 11-30-2009.

BUYBOOK TECHNOLOGIES

THE MARK CONSISTS OF STANDARD CHARACTERS WITHOUT CLAIM TO ANY PARTICULAR FONT, STYLE, SIZE, OR COLOR.

NO CLAIM IS MADE TO THE EXCLUSIVE RIGHT TO USE "TECHNOLOGIES", APART FROM THE MARK AS SHOWN.

FOR VEHICLE VALUATION SERVICES; PROVIDING AUTOMOTIVE VALUATION OF VEHICLES INFORMATION VIA A GLOBAL COMPUTER NETWORK FOR VEHICLES FOR SALE; PROVIDING FINANCIAL TRADE IN INFORMATION IN THE FIELD OF VEHICLE VALUATION (U.S. CLS. 100, 101 AND 102).

FIRST USE 9-0-2009; IN COMMERCE 9-0-2009.

JASON TURNER, EXAMINING ATTORNEY

SN 77-882,467. MERIDIAN HOME MORTGAGE CORPORATION, HAMPSTEAD, MD. FILED 11-30-2009.

Smart Senior Finance

THE MARK CONSISTS OF STANDARD CHARACTERS WITHOUT CLAIM TO ANY PARTICULAR FONT, STYLE, SIZE, OR COLOR.

NO CLAIM IS MADE TO THE EXCLUSIVE RIGHT TO USE "SENIOR FINANCE", APART FROM THE MARK AS SHOWN.

FOR MORTGAGE BROKERAGE (U.S. CLS. 100, 101 AND 102).

KYLE PEETE, EXAMINING ATTORNEY

SN 77-882,312. PENNSYLVANIA MANUFACTURERS' ASSOCIATION INSURANCE COMPANY, BLUE BELL, PA. FILED 11-30-2009.

PMA Companies

THE MARK CONSISTS OF STANDARD CHARACTERS WITHOUT CLAIM TO ANY PARTICULAR FONT, STYLE, SIZE, OR COLOR.

OWNER OF U.S. REG. NOS. 1,293,238, 3,148,247 AND 3,150,804.

NO CLAIM IS MADE TO THE EXCLUSIVE RIGHT TO USE "COMPANIES", APART FROM THE MARK AS SHOWN.

FOR INSURANCE SERVICES, NAMELY, WRITING PROPERTY AND CASUALTY INSURANCE (U.S. CLS. 100, 101 AND 102).

FIRST USE 9-1-2008; IN COMMERCE 9-1-2008.

ODESSA BIBBINS, EXAMINING ATTORNEY

SN 77-883,010. FREISCHMIDT, BENJAMIN, CAMMERAY, NSW, AUSTRALIA, FILED 12-1-2009.

METRIC MONITOR

THE MARK CONSISTS OF STANDARD CHARACTERS WITHOUT CLAIM TO ANY PARTICULAR FONT, STYLE, SIZE, OR COLOR.

OWNER OF SINGAPORE REG. NO. T0904888D, DATED 9-3-2009, EXPIRES 5-2-2019.

FOR FINANCIAL ANALYSIS AND INFORMATION SERVICES, INCLUDING THE PROVISION OF THESE SERVICES VIA THE INTERNET OR COMPUTER DATABASE (U.S. CLS. 100, 101 AND 102).

PAULA MAHONEY, EXAMINING ATTORNEY

CLASS 36—(Continued).

SN 77-884,023. ADVANCED TRADING METHODS, LLC,
LITTLE ROCK, AR. FILED 12-2-2009.

Heat Bars

THE MARK CONSISTS OF STANDARD CHARACTERS WITHOUT CLAIM TO ANY PARTICULAR FONT, STYLE, SIZE, OR COLOR.

FOR FINANCIAL ANALYSES; FINANCIAL ANALYSIS AND CONSULTATION; FINANCIAL ANALYSIS AND RESEARCH SERVICES (U.S. CLS. 100, 101 AND 102).
KATHERINE STOIDES, EXAMINING ATTORNEY

SN 77-884,028. ADVANCED TRADING METHODS, LLC,
LITTLE ROCK, AR. FILED 12-2-2009.

Trade Velocity

THE MARK CONSISTS OF STANDARD CHARACTERS WITHOUT CLAIM TO ANY PARTICULAR FONT, STYLE, SIZE, OR COLOR.

NO CLAIM IS MADE TO THE EXCLUSIVE RIGHT TO USE "TRADE", APART FROM THE MARK AS SHOWN.

FOR FINANCIAL ANALYSES; FINANCIAL ANALYSIS AND CONSULTATION; FINANCIAL ANALYSIS AND RESEARCH SERVICES (U.S. CLS. 100, 101 AND 102).
KATHERINE STOIDES, EXAMINING ATTORNEY

SN 77-884,078. TRANSAMERICA CORPORATION, CEDAR
RAPIDS, IA. FILED 12-2-2009.

RETIREMENT INCOME CHOICE

THE MARK CONSISTS OF STANDARD CHARACTERS WITHOUT CLAIM TO ANY PARTICULAR FONT, STYLE, SIZE, OR COLOR.

NO CLAIM IS MADE TO THE EXCLUSIVE RIGHT TO USE "RETIREMENT INCOME", APART FROM THE MARK AS SHOWN.

FOR FINANCIAL SERVICES, NAMELY, INSURANCE UNDERWRITING IN THE FIELD OF ANNUITIES AND RIDERS THEREFOR, ISSUANCE AND ADMINISTRATION OF ANNUITIES, INSURANCE CLAIMS ADJUSTMENT, INVESTMENT MANAGEMENT, INSURANCE CLAIMS PROCESSING AND BROKERAGE IN THE FIELD OF ANNUITIES AND RIDERS THEREFOR (U.S. CLS. 100, 101 AND 102).

FIRST USE 1-31-2008; IN COMMERCE 1-31-2008.
KATHERINE STOIDES, EXAMINING ATTORNEY

CLASS 36—(Continued).

SN 77-884,090. TRANSAMERICA CORPORATION, CEDAR
RAPIDS, IA. FILED 12-2-2009.

INCOME LINK

THE MARK CONSISTS OF STANDARD CHARACTERS WITHOUT CLAIM TO ANY PARTICULAR FONT, STYLE, SIZE, OR COLOR.

NO CLAIM IS MADE TO THE EXCLUSIVE RIGHT TO USE "INCOME", APART FROM THE MARK AS SHOWN.

FOR FINANCIAL SERVICES, NAMELY, INSURANCE UNDERWRITING IN THE FIELD OF ANNUITIES AND RIDERS THEREFOR, ISSUANCE AND ADMINISTRATION OF ANNUITIES, INSURANCE CLAIMS ADJUSTMENT, INVESTMENT MANAGEMENT, INSURANCE CLAIMS PROCESSING AND BROKERAGE IN THE FIELD OF ANNUITIES AND RIDERS THEREFOR (U.S. CLS. 100, 101 AND 102).

KATHERINE STOIDES, EXAMINING ATTORNEY

SN 77-884,247. GRAY MATTERS, INCORPORATED, DBA
WENDY J. PIERSON FOUNDATION FOR BRAIN CANCER RESEARCH, HINESBURG, VT. FILED 12-2-2009.

Gray Matters!

THE MARK CONSISTS OF STANDARD CHARACTERS WITHOUT CLAIM TO ANY PARTICULAR FONT, STYLE, SIZE, OR COLOR.

FOR FUND RAISING SERVICES, NAMELY, ORGANIZING, ARRANGING AND CONDUCTING FUND RAISING PROGRAMS FOR THE BENEFIT OF SCHOOLS AND NON-PROFIT ORGANIZATIONS (U.S. CLS. 100, 101 AND 102).

MARY ROSSMAN, EXAMINING ATTORNEY

SN 77-884,921. MATTHEW MORRISON O'CONNOR, CHEVY
CHASE, MD. AND MATTHEW ROBERTS HOVAL SMITH,
KENSINGTON, MD. AND CHRISTOPHER SEAN BURDEN,
ROCKVILLE, MD. FILED 12-2-2009.

Footprint Free

THE MARK CONSISTS OF STANDARD CHARACTERS WITHOUT CLAIM TO ANY PARTICULAR FONT, STYLE, SIZE, OR COLOR.

FOR BROKERAGE OF CARBON DIOXIDE AND OTHER GREENHOUSE GAS EMISSION CREDITS, ALLOWANCES OR OFFSETS ON BEHALF OF OFFSET PRODUCERS (U.S. CLS. 100, 101 AND 102).

ANNE FARRELL, EXAMINING ATTORNEY

CLASS 36—(Continued).

SN 77-885,273. APERTOR HOSPITALITY, LLC, HENDERSON, NV. FILED 12-3-2009.

APERTOR HOSPITALITY

THE MARK CONSISTS OF STANDARD CHARACTERS WITHOUT CLAIM TO ANY PARTICULAR FONT, STYLE, SIZE, OR COLOR.

NO CLAIM IS MADE TO THE EXCLUSIVE RIGHT TO USE "HOSPITALITY", APART FROM THE MARK AS SHOWN.

FOR FINANCIAL ADVISORY AND CONSULTANCY SERVICES; FINANCIAL ASSET MANAGEMENT; ADVISORY SERVICES RELATING TO CREDIT AND DEBIT CONTROL, INVESTMENT AND FINANCING OF LOANS; FINANCIAL DUE DILIGENCE; AND FINANCIAL RESTRUCTURING SERVICES (U.S. CLS. 100, 101 AND 102).

PATRICIA EVANKO, EXAMINING ATTORNEY

SN 77-885,297. APERTOR HOSPITALITY, LLC, HENDERSON, NV. FILED 12-3-2009.



NO CLAIM IS MADE TO THE EXCLUSIVE RIGHT TO USE "HOSPITALITY", APART FROM THE MARK AS SHOWN.

THE MARK CONSISTS OF FOUR LINES FORMING "AH" AND THE STYLIZED WORDING "APERTOR HOSPITALITY".

FOR FINANCIAL ADVISORY AND CONSULTANCY SERVICES; FINANCIAL ASSET MANAGEMENT; ADVISORY SERVICES RELATING TO CREDIT AND DEBIT CONTROL, INVESTMENT AND FINANCING OF LOANS; FINANCIAL DUE DILIGENCE; AND FINANCIAL RESTRUCTURING SERVICES (U.S. CLS. 100, 101 AND 102).

PATRICIA EVANKO, EXAMINING ATTORNEY

CLASS 36—(Continued).

SN 77-885,475. GRANGE MUTUAL CASUALTY COMPANY, COLUMBUS, OH. FILED 12-3-2009.

GRANGE INSURANCE

THE MARK CONSISTS OF STANDARD CHARACTERS WITHOUT CLAIM TO ANY PARTICULAR FONT, STYLE, SIZE, OR COLOR.

OWNER OF U.S. REG. NOS. 1,535,724, 1,636,326 AND 1,663,622.

NO CLAIM IS MADE TO THE EXCLUSIVE RIGHT TO USE "INSURANCE", APART FROM THE MARK AS SHOWN.

FOR INSURANCE SERVICES, NAMELY, INSURANCE UNDERWRITING IN THE FIELD OF AUTO, HOME, FARM, BUSINESS, LIFE, PROPERTY, CASUALTY, ACCIDENT, HEALTH, DISABILITY, ANNUITIES (U.S. CLS. 100, 101 AND 102).

FIRST USE 12-0-1987; IN COMMERCE 12-0-1987.

MARIA-VICTORIA SUAREZ, EXAMINING ATTORNEY

SN 77-885,479. GRANGE MUTUAL CASUALTY COMPANY, COLUMBUS, OH. FILED 12-3-2009.

GRANGE LIFE INSURANCE

THE MARK CONSISTS OF STANDARD CHARACTERS WITHOUT CLAIM TO ANY PARTICULAR FONT, STYLE, SIZE, OR COLOR.

OWNER OF U.S. REG. NOS. 1,535,724, 1,636,326 AND 1,663,622.

NO CLAIM IS MADE TO THE EXCLUSIVE RIGHT TO USE "LIFE INSURANCE", APART FROM THE MARK AS SHOWN.

FOR INSURANCE SERVICES, NAMELY, LIFE INSURANCE AND ANNUITY UNDERWRITING (U.S. CLS. 100, 101 AND 102).

FIRST USE 0-0-1968; IN COMMERCE 0-0-1972.

MARIA-VICTORIA SUAREZ, EXAMINING ATTORNEY

SN 77-885,632. SILVER LAKE MANAGEMENT, L.L.C., MENLO PARK, CA. FILED 12-3-2009.

SLP

THE MARK CONSISTS OF STANDARD CHARACTERS WITHOUT CLAIM TO ANY PARTICULAR FONT, STYLE, SIZE, OR COLOR.

FOR FINANCIAL SERVICES, NAMELY, INVESTMENT ADVISORY AND PRIVATE EQUITY FUND SERVICES; FINANCIAL MANAGEMENT, CONSULTATION AND INVESTMENT ADVICE (U.S. CLS. 100, 101 AND 102).

FIRST USE 1-0-2000; IN COMMERCE 1-0-2000.

SANI KHOURI, EXAMINING ATTORNEY

CLASS 36—(Continued).

SN 77-885,778. REAL ESTATE SERVICES OF NEVADA, LTD, DBA RENOWN REAL ESTATE SERVICES, RENO, NV. FILED 12-3-2009.

RENOWN

THE MARK CONSISTS OF STANDARD CHARACTERS WITHOUT CLAIM TO ANY PARTICULAR FONT, STYLE, SIZE, OR COLOR.

FOR COMMERCIAL AND RESIDENTIAL REAL ESTATE AGENCY SERVICES (U.S. CLS. 100, 101 AND 102). FIRST USE 10-28-2009; IN COMMERCE 10-28-2009. KIMBERLY PERRY, EXAMINING ATTORNEY

CLASS 36—(Continued).

SN 77-886,046. BROADARCH CAPITAL, LLC, NEW YORK, NY. FILED 12-4-2009.

BROADARCH CAPITAL

THE MARK CONSISTS OF STANDARD CHARACTERS WITHOUT CLAIM TO ANY PARTICULAR FONT, STYLE, SIZE, OR COLOR.

NO CLAIM IS MADE TO THE EXCLUSIVE RIGHT TO USE "CAPITAL", APART FROM THE MARK AS SHOWN.

FOR FINANCIAL ASSET MANAGEMENT; HEDGE FUND INVESTMENT SERVICES (U.S. CLS. 100, 101 AND 102).

SANJEEV VOHRA, EXAMINING ATTORNEY

SN 77-886,590. MISSOURI DOCTORS MUTUAL INSURANCE COMPANY, ST. JOSEPH, MO. FILED 12-4-2009.

MoDocs

THE MARK CONSISTS OF STANDARD CHARACTERS WITHOUT CLAIM TO ANY PARTICULAR FONT, STYLE, SIZE, OR COLOR.

OWNER OF U.S. REG. NOS. 3,022,663, 3,033,738 AND 3,190,658.

FOR INSURANCE UNDERWRITING SERVICES, NAMELY, INSURING HEALTH CARE PROFESSIONALS AGAINST MALPRACTICE CLAIMS (U.S. CLS. 100, 101 AND 102).

FIRST USE 10-1-2004; IN COMMERCE 10-1-2004. ELI HELLMAN, EXAMINING ATTORNEY

SN 77-885,823. CURIUM CAPITAL ADVISORS, LLC, BOSTON, MA. FILED 12-3-2009.



CURIUM CAPITAL ADVISORS, LLC

NO CLAIM IS MADE TO THE EXCLUSIVE RIGHT TO USE "CAPITAL ADVISORS, LLC", APART FROM THE MARK AS SHOWN.

THE MARK CONSISTS OF A CHEVRON, WITH THE LEFT SIDE LONGER AND LOWER THAN THE RIGHT SIDE AND EACH SIDES ENDING IN A POINT. TWO SWIRLS ORBIT THE CHEVRON AT AN APPROXIMATELY FORTY-FIVE DEGREE ANGLE FROM THE LEFT SIDE, BISECTING THE CHEVRON'S LEFT SIDE BELOW ITS MIDPOINT. A SEGMENT OF EACH SWIRL "DISAPPEARS" BEHIND THE CHEVRON AND THUS IS IMPLIED TO BE THERE THOUGH NOT VISIBLE. BENEATH THE CHEVRON AND THE SWIRLS APPEAR THE WORDS "CURIUM CAPITAL ADVISORS, LLC", ALL IN CAPITAL LETTERS. THE "C" IN "CURIUM", THE "C" IN "CAPITAL", AND THE "A" IN "ADVISORS" ARE SLIGHTLY BIGGER THAN THE OTHER LETTERS IN THOSE WORDS.

FOR COMMODITY INVESTMENT ADVICE; FINANCIAL FORECASTING; FINANCIAL PORTFOLIO ANALYSIS SERVICES; FINANCIAL RISK MANAGEMENT CONSULTATION; GLOBAL INVESTMENT RESEARCH SERVICES; INVESTMENT ADVISORY SERVICES; PROVIDING AN ON-LINE COMPUTER DATABASE IN THE FIELD OF STOCK/SECURITIES MARKET INFORMATION; PROVIDING INFORMATION AND RESEARCH IN THE FIELD OF FINANCE AND FINANCIAL INVESTMENTS (U.S. CLS. 100, 101 AND 102).

FIRST USE 10-22-2008; IN COMMERCE 10-30-2008. B. PARADEWELAI, EXAMINING ATTORNEY

SN 77-886,611. DEALER SERVICES CORPORATION, CARMEL, IN. FILED 12-4-2009.

DSC LEASE ADVANTAGE

THE MARK CONSISTS OF STANDARD CHARACTERS WITHOUT CLAIM TO ANY PARTICULAR FONT, STYLE, SIZE, OR COLOR.

NO CLAIM IS MADE TO THE EXCLUSIVE RIGHT TO USE "LEASE", APART FROM THE MARK AS SHOWN.

FOR AUTOMOBILE LEASE FINANCING (U.S. CLS. 100, 101 AND 102).

CAROL SPILS, EXAMINING ATTORNEY

CLASS 36—(Continued).

SN 77-886,619. MISSOURI DOCTORS MUTUAL INSURANCE COMPANY, ST. JOSEPH, MO. FILED 12-4-2009.

FREEDOM TAIL

THE MARK CONSISTS OF STANDARD CHARACTERS WITHOUT CLAIM TO ANY PARTICULAR FONT, STYLE, SIZE, OR COLOR.

NO CLAIM IS MADE TO THE EXCLUSIVE RIGHT TO USE "TAIL", APART FROM THE MARK AS SHOWN.

FOR INSURANCE UNDERWRITING SERVICES, NAMELY, INSURING HEALTH CARE PROFESSIONALS AGAINST MALPRACTICE CLAIMS (U.S. CLS. 100, 101 AND 102).

FIRST USE 11-9-2009; IN COMMERCE 11-9-2009.
ELI HELLMAN, EXAMINING ATTORNEY

SN 77-886,624. DEALER SERVICES CORPORATION, CARMEL, IN. FILED 12-4-2009.

DSC LENDER ACCESS NETWORK

THE MARK CONSISTS OF STANDARD CHARACTERS WITHOUT CLAIM TO ANY PARTICULAR FONT, STYLE, SIZE, OR COLOR.

NO CLAIM IS MADE TO THE EXCLUSIVE RIGHT TO USE "LENDER ACCESS NETWORK", APART FROM THE MARK AS SHOWN.

FOR AUTOMOBILE LEASE FINANCING (U.S. CLS. 100, 101 AND 102).

CAROL SPILS, EXAMINING ATTORNEY

SN 77-886,630. DEALER SERVICES CORPORATION, CARMEL, IN. FILED 12-4-2009.

DSC

THE MARK CONSISTS OF STANDARD CHARACTERS WITHOUT CLAIM TO ANY PARTICULAR FONT, STYLE, SIZE, OR COLOR.

FOR FINANCING SERVICES (U.S. CLS. 100, 101 AND 102).

FIRST USE 7-7-2005; IN COMMERCE 7-7-2005.
CAROL SPILS, EXAMINING ATTORNEY

CLASS 36—(Continued).

SN 77-886,652. MISSOURI DOCTORS MUTUAL INSURANCE COMPANY, ST. JOSEPH, MO. FILED 12-4-2009.



NO CLAIM IS MADE TO THE EXCLUSIVE RIGHT TO USE "TAIL", APART FROM THE MARK AS SHOWN.

THE MARK CONSISTS OF THE WORDS "FREEDOM" AND "TAIL" IN A STYLIZED FONT WITH THE WORD "FREEDOM" PLACED ABOVE THE WORD "TAIL".

FOR INSURANCE UNDERWRITING SERVICES, NAMELY, INSURING HEALTH CARE PROFESSIONALS AGAINST MALPRACTICE CLAIMS (U.S. CLS. 100, 101 AND 102).

FIRST USE 11-9-2009; IN COMMERCE 11-9-2009.
ELI HELLMAN, EXAMINING ATTORNEY

SN 77-887,005. ANZAR ENTERPRISES INC., SAN YSIDRO, CA. FILED 12-5-2009.

MONTE DE ORO

THE MARK CONSISTS OF STANDARD CHARACTERS WITHOUT CLAIM TO ANY PARTICULAR FONT, STYLE, SIZE, OR COLOR.

THE ENGLISH TRANSLATION OF "MONTE DE ORO" IN THE MARK IS "MOUNTAIN OF GOLD".

FOR PAWN BROKER SERVICES, NAMELY, MONEY LENDING (U.S. CLS. 100, 101 AND 102).

CAROLYN CATALDO, EXAMINING ATTORNEY

SN 77-887,259. MEADOW CAPITAL MANAGEMENT, LP, NEW YORK, NY. FILED S.R. 12-7-2009; AM. P.R. 3-11-2010.



NO CLAIM IS MADE TO THE EXCLUSIVE RIGHT TO USE "PARTNERS", APART FROM THE MARK AS SHOWN.

THE COLOR(S) GREEN AND GRAY IS/ARE CLAIMED AS A FEATURE OF THE MARK.

THE MARK CONSISTS OF TWO WORDS: "MEADOW" AND "PARTNERS". BOTH WORDS ARE CAPITALIZED, AND "MEADOW" IS GREEN AND ON TOP. "PARTNERS" IS GRAY AND DIRECTLY BELOW "MEADOW" IN A SMALLER FONT. THE WIDTH OF BOTH WORDS IS EXACTLY THE SAME. ABOVE THE WORDING, THE DESIGN OF BLADES OF GRASS APPEARS WITH ONE BLADE IN GRAY AND THREE BLADES IN GREEN.

FOR FINANCIAL INVESTMENT IN THE FIELD OF REAL ESTATE (U.S. CLS. 100, 101 AND 102).

FIRST USE 2-1-2009; IN COMMERCE 3-1-2009.

LEIGH CAROLINE CASE, EXAMINING ATTORNEY

CLASS 36—(Continued).

SN 77-887,287. SECOND LICENSE APPLICATION CORPORATION, DFW AIRPORT, TX. FILED 12-7-2009.

SUPERGUARANTEE

THE MARK CONSISTS OF STANDARD CHARACTERS WITHOUT CLAIM TO ANY PARTICULAR FONT, STYLE, SIZE, OR COLOR.

OWNER OF U.S. REG. NO. 3,723,656.
FOR PROVIDING LIMITED WARRANTIES TO PURCHASERS OF THIRD PARTY VEHICLES (U.S. CLS. 100, 101 AND 102).

MIDGE BUTLER, EXAMINING ATTORNEY

SN 77-887,467. CHARLES AND LUCILLE KING FAMILY FOUNDATION, NEW YORK, NY. FILED 12-7-2009.



THE MARK CONSISTS OF A STYLIZED CAPITAL LETTER "K" IN WHICH THE LEFT SIDE OF THE LETTER IS MODELED AFTER A STRIP OF FILM WITH SPROCKETS.

FOR PHILANTHROPIC SERVICES CONCERNING MONETARY DONATIONS IN THE FORM OF GRANTS TO SUPPORT FILM STUDENTS AND STUDENT PROJECTS IN THE AREA OF FILM AND TELEVISION (U.S. CLS. 100, 101 AND 102).

FIRST USE 12-1-1997; IN COMMERCE 12-1-1997.
JESSICA FATHY, EXAMINING ATTORNEY

SN 77-887,689. CITY ON A HILL CAPITAL LP, NEW YORK, NY. FILED 12-7-2009.

CITY ON A HILL

THE MARK CONSISTS OF STANDARD CHARACTERS WITHOUT CLAIM TO ANY PARTICULAR FONT, STYLE, SIZE, OR COLOR.

FOR FINANCIAL SERVICES, NAMELY, INVESTMENT ADVISORY SERVICES, INVESTMENT MANAGEMENT SERVICES AND ASSET MANAGEMENT SERVICES (U.S. CLS. 100, 101 AND 102).

KELLY BOULTON, EXAMINING ATTORNEY

CLASS 36—(Continued).

SN 77-887,691. CITY ON A HILL CAPITAL LP, NEW YORK, NY. FILED 12-7-2009.



THE COLOR(S) BLUE AND GOLD IS/ARE CLAIMED AS A FEATURE OF THE MARK.

THE MARK CONSISTS OF A BLUE SILHOUETTE OF A CITY SKYLINE ABOVE A GOLD CURVED HILL WITH GOLD SUNRAYS BEHIND THE SKYLINE, AND THE WORDS "CITY ON A HILL" BENEATH THE CURVED HILL, WHERE THE WORDS "CITY" AND "HILL" ARE IN BLUE AND THE WORDS "ON" AND "A" ARE IN GOLD.

FOR FINANCIAL SERVICES, NAMELY, INVESTMENT ADVISORY SERVICES, INVESTMENT MANAGEMENT SERVICES AND ASSET MANAGEMENT SERVICES (U.S. CLS. 100, 101 AND 102).

KELLY BOULTON, EXAMINING ATTORNEY

SN 77-887,730. MARATHON MANAGEMENT SERVICES LLC, INDEPENDENCE, OH. FILED 12-7-2009.

CSBB

THE MARK CONSISTS OF STANDARD CHARACTERS WITHOUT CLAIM TO ANY PARTICULAR FONT, STYLE, SIZE, OR COLOR.

FOR BUSINESS BROKERAGE (U.S. CLS. 100, 101 AND 102).

GINA HAYES, EXAMINING ATTORNEY

SN 77-887,745. AMERICAN FIDELITY INTERNATIONAL (BERMUDA), LTD., HAMILTON, BERMUDA, FILED 12-7-2009.

AFIBL.COM

THE MARK CONSISTS OF STANDARD CHARACTERS WITHOUT CLAIM TO ANY PARTICULAR FONT, STYLE, SIZE, OR COLOR.

FOR UNDERWRITING AND BROKERAGE OF INSURANCE PRODUCTS, NAMELY, LIFE, HEALTH AND DISABILITY INSURANCE (U.S. CLS. 100, 101 AND 102).

STEPHANIE ALI, EXAMINING ATTORNEY

CLASS 36—(Continued).

SN 77-887,928. SA LYND DEVELOPMENT PARTNERS, LP,
SAN ANTONIO, TX. FILED 12-7-2009.



THE MARK CONSISTS OF THE LETTERS "E" AND "N" IN A SEMI-HORIZONTAL POSITION AND THE LETTER "V" IN A VERTICAL POSITION.

FOR REAL ESTATE SERVICES, NAMELY, REAL ESTATE BROKERAGE, LEASING AND MANAGEMENT SERVICES; AND RENTAL OF MULTI-USE PROPERTIES, RESIDENTIAL PROPERTIES, AND COMMERCIAL PROPERTIES; ALL OF THE AFOREMENTIONED RELATING TO THE EDGIEST HIGH-END, BOUTIQUE RENTAL PROPERTY (U.S. CLS. 100, 101 AND 102).

SUSAN RICHARDS, EXAMINING ATTORNEY

SN 77-888,239. LABRECQUE, LEON, TROY, MI. FILED 12-8-2009.

REDUCING UNCERTAINTY

THE MARK CONSISTS OF STANDARD CHARACTERS WITHOUT CLAIM TO ANY PARTICULAR FONT, STYLE, SIZE, OR COLOR.

FOR WEALTH MANAGEMENT SERVICES (U.S. CLS. 100, 101 AND 102).

NATALIE POLZER, EXAMINING ATTORNEY

SN 77-888,474. HOMEFREE-USA, HYATTSVILLE, MD. FILED 12-8-2009.

PROJECT RESTORE

THE MARK CONSISTS OF STANDARD CHARACTERS WITHOUT CLAIM TO ANY PARTICULAR FONT, STYLE, SIZE, OR COLOR.

NO CLAIM IS MADE TO THE EXCLUSIVE RIGHT TO USE "PROJECT", APART FROM THE MARK AS SHOWN.

FOR FINANCIAL COUNSELING SERVICES, NAMELY, HELPING OTHERS BUILD A BETTER WORKING RELATIONSHIP WITH THEIR MONEY (U.S. CLS. 100, 101 AND 102).

ESTHER BELENKER, EXAMINING ATTORNEY

CLASS 36—(Continued).

SN 77-888,551. WEPAY, INC., SAN JOSE, CA. FILED 12-8-2009.



THE COLOR(S) BLUE, WHITE, GREEN IS/ARE CLAIMED AS A FEATURE OF THE MARK.

THE MARK CONSISTS OF BLUE CIRCLE, THE LETTERS "WE" ARE UPPER CASE "W", LOWER CASE "E", BOTH LETTERS ARE WHITE AND WITHIN THE BLUE CIRCLE, AND THE LETTERS "PAY" ARE ALL UPPERCASE, AND THEY ARE ALL OUTSIDE OF THE CIRCLE AND TO THE RIGHT OF THE CIRCLE AND ARE THE COLOR GREEN.

FOR BILL PAYMENT AND MONEY MANAGEMENT SERVICES FOR GROUPS PROVIDED THROUGH A WEBSITE (U.S. CLS. 100, 101 AND 102).

FIRST USE 8-1-2008; IN COMMERCE 8-1-2008.

SUE LAWRENCE, EXAMINING ATTORNEY

SN 77-888,631. RIDEAU, EARL, CANYON LAKE, CA. FILED 12-8-2009.

DON'T LOSE YOUR SHORTS

THE MARK CONSISTS OF STANDARD CHARACTERS WITHOUT CLAIM TO ANY PARTICULAR FONT, STYLE, SIZE, OR COLOR.

FOR FINANCIAL INVESTMENT IN THE FIELD OF STOCKS, BONDS, MUTUAL FUNDS, AND ETFs; INSURANCE BROKERAGE IN THE FIELD OF LIFE INSURANCE AND ANNUITIES (U.S. CLS. 100, 101 AND 102).

TASNEEM HUSSAIN, EXAMINING ATTORNEY

CLASS 36—(Continued).

SN 77-888,660. EDGEWATER BEACH RESORT MANAGEMENT, INC., PANAMA CITY BEACH, FL. FILED 12-8-2009.

THE RESORT COLLECTION OF PANAMA CITY BEACH

THE MARK CONSISTS OF STANDARD CHARACTERS WITHOUT CLAIM TO ANY PARTICULAR FONT, STYLE, SIZE, OR COLOR.

NO CLAIM IS MADE TO THE EXCLUSIVE RIGHT TO USE "RESORT", APART FROM THE MARK AS SHOWN. SEC. 2(F).

FOR REAL ESTATE MANAGEMENT OF VACATION HOMES; REAL ESTATE SERVICES, NAMELY, CONDOMINIUM MANAGEMENT SERVICES; REAL ESTATE SERVICES, NAMELY, LEASING AND MANAGEMENT FOR OTHERS OF RESIDENTIAL CONDOMINIUMS LOCATED WITHIN HOTEL DEVELOPMENTS; REAL ESTATE SERVICES, NAMELY, RENTAL OF SHORT-TERM FURNISHED APARTMENTS; REAL ESTATE SERVICES, NAMELY, RENTAL OF VACATION HOMES, CONDOMINIUMS, CABINS, AND VILLAS USING PAY PER CLICK ADVERTISING ON A GLOBAL COMPUTER NETWORK; REAL ESTATE SERVICES, NAMELY, RENTAL, BROKERAGE, LEASING AND MANAGEMENT OF COMMERCIAL PROPERTY, OFFICES AND OFFICE SPACE; REAL ESTATE SERVICES, NAMELY, VACATION HOME RENTAL MANAGEMENT SERVICES (U.S. CLS. 100, 101 AND 102).

FIRST USE 1-2-2005; IN COMMERCE 1-2-2005.
ANGELA DUONG, EXAMINING ATTORNEY

SN 77-888,691. KRIM, TODD, LOS ANGELES, CA. FILED 12-8-2009.

REALITY CARES

THE MARK CONSISTS OF STANDARD CHARACTERS WITHOUT CLAIM TO ANY PARTICULAR FONT, STYLE, SIZE, OR COLOR.

FOR CHARITABLE FUNDRAISING (U.S. CLS. 100, 101 AND 102).

FIRST USE 1-20-2004; IN COMMERCE 1-20-2004.
FRED MANDIR, EXAMINING ATTORNEY

SN 77-888,751. NORTH POINT GROUP, INC., ATLANTA, GA. FILED 12-8-2009.

POINTENORTH

THE MARK CONSISTS OF STANDARD CHARACTERS WITHOUT CLAIM TO ANY PARTICULAR FONT, STYLE, SIZE, OR COLOR.

FOR INSURANCE AGENCIES; INSURANCE AGENCY AND BROKERAGE (U.S. CLS. 100, 101 AND 102).
GEORGE LORENZO, EXAMINING ATTORNEY

CLASS 36—(Continued).

SN 77-889,056. JOURNALISM ONLINE, LLC, NEW YORK, NY. FILED 12-8-2009.

PRESS PLUS

THE MARK CONSISTS OF STANDARD CHARACTERS WITHOUT CLAIM TO ANY PARTICULAR FONT, STYLE, SIZE, OR COLOR.

FOR FINANCIAL SERVICES, NAMELY, PROVIDING ONLINE PAYMENT SERVICES AND FUNDED ACCOUNTS USED TO PURCHASE ACCESS TO CONTENT VIA THE GLOBAL COMPUTER NETWORK (U.S. CLS. 100, 101 AND 102).

DAWN FELDMAN, EXAMINING ATTORNEY

SN 77-889,065. LOLO VENTURES LLC, WILMINGTON, DE. FILED 12-8-2009.

LŌLŌ VENTURES

THE MARK CONSISTS OF STANDARD CHARACTERS WITHOUT CLAIM TO ANY PARTICULAR FONT, STYLE, SIZE, OR COLOR.

NO CLAIM IS MADE TO THE EXCLUSIVE RIGHT TO USE "VENTURES", APART FROM THE MARK AS SHOWN.

FOR FINANCIAL SERVICES IN THE NATURE OF VENTURE CAPITAL INVESTMENT SERVICES; VENTURE CAPITAL SERVICES, NAMELY, PROVIDING FINANCING TO EMERGING AND START-UP COMPANIES (U.S. CLS. 100, 101 AND 102).

LAURA HAMMEL, EXAMINING ATTORNEY

SN 77-889,070. JOURNALISM ONLINE, LLC, NEW YORK, NY. FILED 12-8-2009.

PRESS+

THE MARK CONSISTS OF THE WORD "PRESS," FOLLOWED BY A PLUS SIGN INSIDE A DARKENED SQUARE.

FOR FINANCIAL SERVICES, NAMELY, PROVIDING ONLINE PAYMENT SERVICES AND FUNDED ACCOUNTS USED TO PURCHASE ACCESS TO CONTENT VIA THE GLOBAL COMPUTER NETWORK (U.S. CLS. 100, 101 AND 102).

DAWN FELDMAN, EXAMINING ATTORNEY

CLASS 36—(Continued).

SN 77-889,084. LOLO VENTURES LLC, WILMINGTON, DE. FILED 12-8-2009.



NO CLAIM IS MADE TO THE EXCLUSIVE RIGHT TO USE "VENTURES", APART FROM THE MARK AS SHOWN. THE MARK CONSISTS OF THE FIRST WORD "LOLO" (WITH OVERBAR OVER EACH LETTER "O") AT TOP, THE SECOND WORD "VENTURES" AT BOTTOM, AND BETWEEN THE FIRST AND SECOND WORDS APPEARS A LOGO INCLUDING THE FOLLOWING: A SMALL LETTER "O" WITH OVERBAR, FOLLOWED AT RIGHT BY A SYMBOL FORMED BY JOINING OF A REVERSED CAPITAL LETTER "L" AND A CAPITAL LETTER "L" SHARING A COMMON VERTICAL PORTION, FOLLOWED AT RIGHT BY A SMALL LETTER "O" WITH OVERBAR.

FOR FINANCIAL SERVICES IN THE NATURE OF VENTURE CAPITAL INVESTMENT SERVICES; VENTURE CAPITAL SERVICES, NAMELY, PROVIDING FINANCING TO EMERGING AND START-UP COMPANIES (U.S. CLS. 100, 101 AND 102).

LAURA HAMMEL, EXAMINING ATTORNEY

SN 77-889,228. SOUTHERN EYE PHYSICIAN'S CENTER, LLC, AKA SOUTHERN EYE CENTER, HATTIESBURG, MS. FILED 12-9-2009.

WaveBlend

THE MARK CONSISTS OF STANDARD CHARACTERS WITHOUT CLAIM TO ANY PARTICULAR FONT, STYLE, SIZE, OR COLOR.

FOR HEALTHCARE INSURANCE SERVICES FOR LASIK SURGERY (U.S. CLS. 100, 101 AND 102).

RUDY R. SINGLETON, EXAMINING ATTORNEY

CLASS 36—(Continued).

SN 77-889,774. CAIS GROUP LLC, NEW YORK, NY. FILED 12-9-2009.

CAISFUNDS

THE MARK CONSISTS OF STANDARD CHARACTERS WITHOUT CLAIM TO ANY PARTICULAR FONT, STYLE, SIZE, OR COLOR.

FOR FINANCIAL SERVICES, NAMELY, INVESTMENT MANAGEMENT SERVICES IN THE FIELD OF ALTERNATIVE INVESTMENT FUNDS (U.S. CLS. 100, 101 AND 102).

BARNEY CHARLON, EXAMINING ATTORNEY

SN 77-889,785. MILLER, DAVID, LUBBOCK, TX. FILED 12-9-2009.



NO CLAIM IS MADE TO THE EXCLUSIVE RIGHT TO USE "FINANCIAL SERVICES", APART FROM THE MARK AS SHOWN.

THE COLOR(S) BLACK, RED, GREEN, BLUE, AND WHITE IS/ARE CLAIMED AS A FEATURE OF THE MARK. THE MARK CONSISTS OF A RECTANGLE INCLUDING A HORIZONTAL BLUE BAR OVER TWO VERTICAL BARS OF GREEN AND RED WITH A WHITE ARC PASSING THROUGH THE GREEN AND BLUE BARS, ACCOMPANIED BY THE WORDS "RFS FINANCIAL SERVICES" IN BLACK.

FOR PROVIDING FINANCIAL INFORMATION (U.S. CLS. 100, 101 AND 102).

FIRST USE 5-1-2008; IN COMMERCE 5-1-2008.

REBECCA POVARCHUK, EXAMINING ATTORNEY

SN 77-889,793. UNITED RETIREMENT ADVISORS GROUP INC., WAYNE, PA. FILED 12-9-2009.

ROTHMYIRA

THE MARK CONSISTS OF STANDARD CHARACTERS WITHOUT CLAIM TO ANY PARTICULAR FONT, STYLE, SIZE, OR COLOR.

FOR INVESTMENT ADVISORY SERVICES (U.S. CLS. 100, 101 AND 102).

FIRST USE 8-0-2009; IN COMMERCE 8-0-2009.

ANNE E. GUSTASON, EXAMINING ATTORNEY

CLASS 36—(Continued).

SN 77-889,982. HOLST, JEFF, AUSTIN, TX. FILED 12-9-2009.

Our cause is helping yours

THE MARK CONSISTS OF STANDARD CHARACTERS WITHOUT CLAIM TO ANY PARTICULAR FONT, STYLE, SIZE, OR COLOR.

FOR CHARITABLE FUNDRAISING SERVICES (U.S. CLS. 100, 101 AND 102).
ALEX KEAM, EXAMINING ATTORNEY

SN 77-889,994. WRC INDUSTRIES, LLC, PHOENIX, AZ. FILED 12-9-2009.

SWAPSMART

THE MARK CONSISTS OF STANDARD CHARACTERS WITHOUT CLAIM TO ANY PARTICULAR FONT, STYLE, SIZE, OR COLOR.

FOR LEASING OF SHOPPING MALL SPACE; REAL ESTATE SERVICE, NAMELY, RENTAL PROPERTY MANAGEMENT (U.S. CLS. 100, 101 AND 102).
FIRST USE 4-1-2009; IN COMMERCE 4-1-2009.
SUSAN RICHARDS, EXAMINING ATTORNEY

SN 77-889,995. WRC INDUSTRIES, LLC, PHOENIX, AZ. FILED 12-9-2009.

SWAP\$MART

THE COLOR(S) GREEN, BLACK AND WHITE IS/ARE CLAIMED AS A FEATURE OF THE MARK.

THE MARK CONSISTS OF A WHITE BACKGROUND, THE WORDING "SWAPSMART" IN STYLIZED FONT, ALL CAPITAL LETTERS AND IN THE COLOR BLACK WITH GREEN BORDERING, THE SECOND S IN THE WORDING "SWAPSMART" APPEARS AS A GREEN DOLLAR SYMBOL.

FOR LEASING OF SHOPPING MALL SPACE; REAL ESTATE SERVICE, NAMELY, RENTAL PROPERTY MANAGEMENT (U.S. CLS. 100, 101 AND 102).
FIRST USE 4-1-2009; IN COMMERCE 4-1-2009.
SUSAN RICHARDS, EXAMINING ATTORNEY

CLASS 36—(Continued).

SN 77-890,018. QUADRANT INFORMATION SERVICES, INC., RENO, NV. FILED 12-9-2009.

MAPSIGHT

THE MARK CONSISTS OF STANDARD CHARACTERS WITHOUT CLAIM TO ANY PARTICULAR FONT, STYLE, SIZE, OR COLOR.

FOR INSURANCE INFORMATION (U.S. CLS. 100, 101 AND 102).
PAM WILLIS, EXAMINING ATTORNEY

SN 77-890,106. COASTWISE CAPITAL GROUP, LLC, LA JOLLA, CA. FILED 12-10-2009.

YOUR GREATEST INVESTMENT
IS YOU

THE MARK CONSISTS OF STANDARD CHARACTERS WITHOUT CLAIM TO ANY PARTICULAR FONT, STYLE, SIZE, OR COLOR.

FOR PROVIDING EDUCATIONAL SCHOLARSHIPS (U.S. CLS. 100, 101 AND 102).
FIRST USE 8-21-2009; IN COMMERCE 8-21-2009.
KAELIE KUNG, EXAMINING ATTORNEY

SN 77-890,108. COASTWISE CAPITAL GROUP, LLC, LA JOLLA, CA. FILED 12-10-2009.

A LIFE WELL INVESTED

THE MARK CONSISTS OF STANDARD CHARACTERS WITHOUT CLAIM TO ANY PARTICULAR FONT, STYLE, SIZE, OR COLOR.

FOR PROVIDING EDUCATIONAL SCHOLARSHIPS (U.S. CLS. 100, 101 AND 102).
FIRST USE 8-21-2009; IN COMMERCE 8-21-2009.
KAELIE KUNG, EXAMINING ATTORNEY

CLASS 36—(Continued).

SN 77-890,144. ZYSKOWSKI, JOHN A, GRAND RAPIDS, MI. FILED 12-10-2009.

DriveLightly

THE MARK CONSISTS OF STANDARD CHARACTERS WITHOUT CLAIM TO ANY PARTICULAR FONT, STYLE, SIZE, OR COLOR.

FOR BROKERAGE OF CARBON DIOXIDE AND OTHER GREENHOUSE GAS EMISSION CREDITS, ALLOWANCES OR OFFSETS ON BEHALF OF OFFSET PRODUCERS (U.S. CLS. 100, 101 AND 102).

ADA HAN, EXAMINING ATTORNEY

SN 77-890,297. INTELLIREAL LLC, DENVER, CO. FILED 12-10-2009.

IntelliReal

THE COLOR(S) BLUE AND BLACK IS/ARE CLAIMED AS A FEATURE OF THE MARK.

THE MARK CONSISTS OF BLUE "INTELLI" AND BLACK "REAL".

FOR FINANCIAL DUE DILIGENCE SERVICES IN THE FIELD OF REAL ESTATE; PROVIDING A DATABASE OF INFORMATION ABOUT RESIDENTIAL REAL ESTATE LISTINGS IN DIFFERENT NEIGHBORHOODS AND COMMUNITIES; PROVIDING A DATABASE OF RESIDENTIAL REAL ESTATE LISTINGS WITHIN NEIGHBORHOODS AND COMMUNITIES SPECIFICALLY IDENTIFIED BY USERS; PROVIDING INFORMATION IN THE FIELD OF REAL ESTATE VIA THE INTERNET; REAL ESTATE VALUATIONS; VALUATIONS IN REAL ESTATE MATTERS (U.S. CLS. 100, 101 AND 102).

FIRST USE 1-1-2006; IN COMMERCE 1-1-2006.
MICHAEL WIENER, EXAMINING ATTORNEY

SN 77-890,299. INTELLIREAL LLC, DENVER, CO. FILED 12-10-2009.

iAVM

THE COLOR(S) BLACK AND BLUE IS/ARE CLAIMED AS A FEATURE OF THE MARK.

THE MARK CONSISTS OF BLACK "I" AND BLUE "AVM".

FOR REAL ESTATE VALUATIONS (U.S. CLS. 100, 101 AND 102).

FIRST USE 5-3-2006; IN COMMERCE 5-3-2006.
MICHAEL WIENER, EXAMINING ATTORNEY

CLASS 36—(Continued).

SN 77-890,350. COMMUNITY CRUSADE FOR CHILDREN, INC., NEW HAVEN, CT. FILED 12-10-2009.

Kiducation

THE MARK CONSISTS OF STANDARD CHARACTERS WITHOUT CLAIM TO ANY PARTICULAR FONT, STYLE, SIZE, OR COLOR.

OWNER OF U.S. REG. NO. 2,623,678.

FOR CHARITABLE FUND RAISING SERVICES BY MEANS OF COLLECTING AND REDEEMING RECYCLABLES FOR DONATION OF REDEMPTION PROCEEDS TO CHARITABLE ORGANIZATIONS; CHARITABLE FUNDRAISING (U.S. CLS. 100, 101 AND 102).

FIRST USE 6-22-2000; IN COMMERCE 6-22-2000.
DOMINIC FATHY, EXAMINING ATTORNEY

SN 77-890,432. BUCHANAN TIMBER & FORESTRY, LLC, SELMA, AL. FILED 12-10-2009.

SOUTHROCK FOREST INVESTMENTS

THE MARK CONSISTS OF STANDARD CHARACTERS WITHOUT CLAIM TO ANY PARTICULAR FONT, STYLE, SIZE, OR COLOR.

NO CLAIM IS MADE TO THE EXCLUSIVE RIGHT TO USE "FOREST INVESTMENTS", APART FROM THE MARK AS SHOWN.

FOR REAL ESTATE INVESTMENT SERVICES, INVESTMENT ADVISORY SERVICES, REAL ESTATE CONSULTATION SERVICES, FINANCIAL ASSET MANAGEMENT, REAL ESTATE MANAGEMENT, LAND ACQUISITION SERVICES, LAND LEASING SERVICES, LAND VALUATION SERVICES, FINANCIAL AND REAL ESTATE ADVISORY SERVICES FOR TIMBERLAND OWNERS AND INVESTORS IN THE FIELD OF AGRICULTURE, HORTICULTURE AND FORESTRY (U.S. CLS. 100, 101 AND 102).

DOMINIC FATHY, EXAMINING ATTORNEY

CLASS 36—(Continued).

SN 77-890,534. MCGEE INSURANCE AND FINANCIAL SERVICES, LLC, SANFORD, FL. FILED 12-10-2009.



“Stay Connected”

NO CLAIM IS MADE TO THE EXCLUSIVE RIGHT TO USE "I&FS" OR "INSURANCE & FINANCIAL SERVICES", APART FROM THE MARK AS SHOWN.

THE COLOR(S) RED, BLACK, GOLD IS/ARE CLAIMED AS A FEATURE OF THE MARK.

THE MARK CONSISTS OF A LARGE, RED LETTER "M" WITH A SMALLER, GOLD LETTER "C" IN BETWEEN THE LETTER "M". UNDER THE LETTERS "M" AND "C" IS THE LETTERING "I&FS" IN BLACK, WHICH IS ABOVE THE WORDING "MCGEE INSURANCE & FINANCIAL SERVICES" ALSO IN BLACK. BENEATH ALL OF THIS LETTERING AND WORDING IS THE WORDING ""STAY CONNECTED"" IN RED. THE COLOR GRAY APPEARING IN THE MARK REPRESENTS BACKGROUND, OUTLINING, SHADING AND/OR TRANSPARENT AREAS AND IS NOT PART OF THE MARK.

FOR INSURANCE AGENCIES IN THE FIELD OF AUTOMOBILE, MOTORCYCLE, HOMEOWNERS, RENTAL, LIFE, WORKERS COMPENSATION, CLASSICAL AND CUSTOMIZED AUTOMOBILE, COMMERCIAL CARGO, COMMERCIAL BUILDING, COMMERCIAL LIABILITY, COMMERCIAL AVIATION, COMMERCIAL AUTOMOBILE, COMMERCIAL INLAND MARINE, FLOOD, GOLF CART, BOAT, ACCIDENTAL DEATH AND DISABILITY, CANCER, IDENTITY THEFT, HEALTH, DENTAL, UMBRELLA POLICIES, ALL TERRAIN VEHICLES (ATVS), JEWELRY POLICIES, TOWING, RECREATIONAL VEHICLES (RVS) AND TRAILERS, MOTOR HOMES, AND LONG TERM CARE; ISSUANCE AND ADMINISTRATION OF VARIABLE ANNUITIES; FINANCIAL INVESTMENT SERVICES IN THE FIELD OF CERTIFICATES OF DEPOSIT (CDS); MUTUAL FUND DISTRIBUTION; MUTUAL FUND INVESTMENT; INVESTMENT OF FUNDS FOR OTHERS IN THE FIELD OF 529 EDUCATION SAVINGS PLANS; AGENCIES IN THE FIELD OF BONDS; FINANCIAL PLANNING FOR RETIREMENT; FINANCIAL ADMINISTRATION OF RETIREMENT PLANS (U.S. CLS. 100, 101 AND 102).

FIRST USE 12-7-2009; IN COMMERCE 12-7-2009.

JAMES MACFARLANE, EXAMINING ATTORNEY

CLASS 36—(Continued).

SN 77-890,593. LEND-A-HAND INDIA, NEW YORK, NY. FILED 12-10-2009.



THE MARK CONSISTS OF PEOPLE HOLDING HANDS ON STAIRS WITH THE SUN IN THE BACKGROUND.

FOR CHARITABLE FUNDRAISING SERVICES (U.S. CLS. 100, 101 AND 102).

FIRST USE 12-1-2004; IN COMMERCE 5-12-2005.

HELENE LIWINSKI, EXAMINING ATTORNEY

SN 77-890,618. AMERICAN INTERNATIONAL GROUP, INC., NEW YORK, NY. FILED 12-10-2009.

I'VE GOT A CLIENT

THE MARK CONSISTS OF STANDARD CHARACTERS WITHOUT CLAIM TO ANY PARTICULAR FONT, STYLE, SIZE, OR COLOR.

FOR INSURANCE UNDERWRITING IN THE FIELD OF ACCIDENT AND HEALTH, LIFE INSURANCE AND ANNUITIES (U.S. CLS. 100, 101 AND 102).

LAURA KOVALSKY, EXAMINING ATTORNEY

CLASS 36—(Continued).

SN 77-890,692. AMERICAN INTERNATIONAL GROUP, INC., NEW YORK, NY. FILED 12-10-2009.

INCOME ADVANTAGE SUITE

THE MARK CONSISTS OF STANDARD CHARACTERS WITHOUT CLAIM TO ANY PARTICULAR FONT, STYLE, SIZE, OR COLOR.

OWNER OF U.S. REG. NOS. 3,511,136, 3,620,733 AND 3,707,960.

NO CLAIM IS MADE TO THE EXCLUSIVE RIGHT TO USE "INCOME" AND "SUITE", APART FROM THE MARK AS SHOWN.

FOR ANNUITY UNDERWRITING; INVESTMENT MANAGEMENT OF AND DISTRIBUTION OF ANNUITIES; ISSUANCE AND ADMINISTRATION OF ANNUITIES; LIFE INSURANCE UNDERWRITING (U.S. CLS. 100, 101 AND 102).

FIRST USE 8-31-2009; IN COMMERCE 8-31-2009. LAURA KOVALSKY, EXAMINING ATTORNEY

SN 77-891,008. THEORIEM LLC, PHILADELPHIA, PA. FILED 12-10-2009.

theoriem

FOR FINANCIAL SERVICES, NAMELY, SECURITIES TRADING BROKERAGE (U.S. CLS. 100, 101 AND 102). JUDITH HELFMAN, EXAMINING ATTORNEY

SN 77-891,150. MARRIOTT INTERNATIONAL, INC., BETHESDA, MD. FILED 12-11-2009.



THE MARK CONSISTS OF TWO INTERLOCKING CIRCLES.

FOR REAL ESTATE SERVICES, NAMELY, LEASING, RENTAL AND MANAGEMENT OF SERVICED APARTMENTS (U.S. CLS. 100, 101 AND 102).

KEVIN CORWIN, EXAMINING ATTORNEY

CLASS 36—(Continued).

SN 77-891,225. SECOND LICENSE APPLICATION CORPORATION, DFW AIRPORT, TX. FILED 12-11-2009.



OWNER OF U.S. REG. NO. 3,723,688. THE MARK CONSISTS OF A SHIELD DESIGN HAVING A SQUARE IN THE MIDDLE WITH A CHECK MARK.

FOR PROVIDING LIMITED WARRANTIES TO PURCHASERS OF THIRD PARTY VEHICLES (U.S. CLS. 100, 101 AND 102).

MIDGE BUTLER, EXAMINING ATTORNEY

SN 77-891,233. SECOND LICENSE APPLICATION CORPORATION, DFW AIRPORT, TX. FILED 12-11-2009.



OWNER OF U.S. REG. NO. 3,723,688. THE COLOR(S) YELLOW, ORANGE, GRAY AND BLACK IS/ARE CLAIMED AS A FEATURE OF THE MARK.

THE MARK CONSISTS OF A SHIELD DESIGN WITH A SQUARE AND CHECK MARK INSIDE OF THE SHIELD. THE SHIELD IS OUTLINED IN GRAY. THE LEFT HAND INTERIOR SIDE OF THE SHIELD IS DEGREES OF ORANGE TO YELLOW AND THE RIGHT HAND INTERIOR SIDE OF THE SHIELD IS SHADES OF ORANGE. THE BOX INSIDE THE SHIELD IS OUTLINED IN BLACK WITH A YELLOW INTERIOR. THE CHECKMARK IS BLACK.

FOR PROVIDING LIMITED WARRANTIES TO PURCHASERS OF THIRD PARTY VEHICLES (U.S. CLS. 100, 101 AND 102).

MIDGE BUTLER, EXAMINING ATTORNEY

CLASS 36—(Continued).

SN 77-891,328. CHARTWELL PROPERTIES, INC., LOS ANGELES, CA. FILED 12-11-2009.



**THE SHOPS
ON EL PASEO**

NO CLAIM IS MADE TO THE EXCLUSIVE RIGHT TO USE "THE SHOPS ON EL PASEO", APART FROM THE MARK AS SHOWN.

THE MARK CONSISTS OF THE STYLIZED LETTERS "E" AND "P" INTERTWINED, WITH A VERTICAL LINE TO THE RIGHT OF THE "E" AND "P", AND THE WORDS "THE SHOPS ON EL PASEO" TO THE RIGHT OF THE VERTICAL LINE.

FOR LEASING OF SHOPPING MALL SPACE (U.S. CLS. 100, 101 AND 102).

TARAH HARDY, EXAMINING ATTORNEY

CLASS 36—(Continued).

SN 77-893,078. TOWNEBANK, PORTSMOUTH, VA. FILED 12-14-2009.

TOWNE MORTGAGE

THE MARK CONSISTS OF STANDARD CHARACTERS WITHOUT CLAIM TO ANY PARTICULAR FONT, STYLE, SIZE, OR COLOR.

OWNER OF U.S. REG. NO. 3,483,269.

NO CLAIM IS MADE TO THE EXCLUSIVE RIGHT TO USE "MORTGAGE", APART FROM THE MARK AS SHOWN.

FOR MORTGAGE LENDING SERVICES (U.S. CLS. 100, 101 AND 102).

FIRST USE 10-1-2000; IN COMMERCE 10-1-2000.

MORGAN WYNNE, EXAMINING ATTORNEY

SN 77-891,903. GLOBAL CASH ACCESS, INC., LAS VEGAS, NV. FILED 12-11-2009.

CARDXCHANGE

THE MARK CONSISTS OF STANDARD CHARACTERS WITHOUT CLAIM TO ANY PARTICULAR FONT, STYLE, SIZE, OR COLOR.

FOR PROVIDING DEBIT AND STORED VALUE CARD SERVICES FOR CUSTOMERS IN THE CASINO INDUSTRY; DEBIT ACCOUNT SERVICES FEATURING COMPUTER READABLE CARDS FOR USE BY CUSTOMERS IN THE CASINO INDUSTRY (U.S. CLS. 100, 101 AND 102).

ALEXANDER L. POWERS, EXAMINING ATTORNEY

SN 77-893,125. GLOBAL DNS LLC, MERCER ISLAND, WA. FILED 12-14-2009.

ALTMLS

THE MARK CONSISTS OF STANDARD CHARACTERS WITHOUT CLAIM TO ANY PARTICULAR FONT, STYLE, SIZE, OR COLOR.

FOR PROVIDING, VIA THE INTERNET, LISTINGS OF REAL ESTATE OFFERED FOR SALE, RENTAL, OR USE (U.S. CLS. 100, 101 AND 102).

NAAKWAMA ANKRAH, EXAMINING ATTORNEY

SN 77-892,625. PROGRESSIVE CASUALTY INSURANCE COMPANY, MAYFIELD VILLAGE, OH. FILED 12-14-2009.

PROGRESSIVE SIGNATURE AGENT

THE MARK CONSISTS OF STANDARD CHARACTERS WITHOUT CLAIM TO ANY PARTICULAR FONT, STYLE, SIZE, OR COLOR.

OWNER OF U.S. REG. NOS. 1,844,695, 3,099,096 AND OTHERS.

NO CLAIM IS MADE TO THE EXCLUSIVE RIGHT TO USE "AGENT", APART FROM THE MARK AS SHOWN.

FOR ADMINISTERING INCENTIVE PROGRAMS FOR INSURANCE AGENTS IN ORDER TO PROMOTE SALES OF PROPERTY AND CASUALTY INSURANCE PRODUCTS (U.S. CLS. 100, 101 AND 102).

FIRST USE 12-14-2009; IN COMMERCE 12-14-2009.

CAROLYN CATALDO, EXAMINING ATTORNEY

SN 77-893,148. FSULEASING.COM. LLC, TALLAHASSEE, FL. FILED 12-14-2009.

FSULeasing.com

THE MARK CONSISTS OF STANDARD CHARACTERS WITHOUT CLAIM TO ANY PARTICULAR FONT, STYLE, SIZE, OR COLOR.

FOR LEASING OF APARTMENTS; LEASING OF REAL PROPERTY (U.S. CLS. 100, 101 AND 102).

FIRST USE 11-19-2007; IN COMMERCE 11-19-2007.

CHARISMA HAMPTON, EXAMINING ATTORNEY

CLASS 36—(Continued).

SN 77-893,448. THE ZIEGLER COMPANIES, INC., CHICAGO, IL. FILED 12-15-2009.

TEMPS-75

THE MARK CONSISTS OF STANDARD CHARACTERS WITHOUT CLAIM TO ANY PARTICULAR FONT, STYLE, SIZE, OR COLOR.

FOR FINANCIAL SERVICES IN THE NATURE OF AN INVESTMENT SECURITY (U.S. CLS. 100, 101 AND 102).
KARANENDRA S. CHHINA, EXAMINING ATTORNEY

SN 77-893,453. THE ZIEGLER COMPANIES, INC., CHICAGO, IL. FILED 12-15-2009.

TEMPS-65

THE MARK CONSISTS OF STANDARD CHARACTERS WITHOUT CLAIM TO ANY PARTICULAR FONT, STYLE, SIZE, OR COLOR.

FOR FINANCIAL SERVICES IN THE NATURE OF AN INVESTMENT SECURITY (U.S. CLS. 100, 101 AND 102).
KARANENDRA S. CHHINA, EXAMINING ATTORNEY

SN 77-895,518. AMERICAN INTERNATIONAL GROUP, INC., NEW YORK, NY. FILED 12-17-2009.

AMERICAN GENERAL WORKSITE

THE MARK CONSISTS OF STANDARD CHARACTERS WITHOUT CLAIM TO ANY PARTICULAR FONT, STYLE, SIZE, OR COLOR.

OWNER OF U.S. REG. NOS. 803,239, 1,173,600 AND OTHERS.

NO CLAIM IS MADE TO THE EXCLUSIVE RIGHT TO USE "WORKSITE", APART FROM THE MARK AS SHOWN.

FOR INSURANCE UNDERWRITING IN THE FIELD OF LIFE, DISABILITY, ACCIDENT AND HEALTH, CANCER CARE AND CRITICAL ILLNESS (U.S. CLS. 100, 101 AND 102).

FIRST USE 11-20-2009; IN COMMERCE 11-20-2009.
LAURA KOVALSKY, EXAMINING ATTORNEY

CLASS 36—(Continued).

SN 77-897,723. LINT, JAMES R, ABERDEEN, MD. FILED 12-20-2009.

Lint Center for National Security Studies, Inc.

THE MARK CONSISTS OF STANDARD CHARACTERS WITHOUT CLAIM TO ANY PARTICULAR FONT, STYLE, SIZE, OR COLOR.

NO CLAIM IS MADE TO THE EXCLUSIVE RIGHT TO USE "CENTER FOR NATIONAL SECURITY STUDIES, INC.", APART FROM THE MARK AS SHOWN.

SEC. 2(F).
FOR CHARITABLE FOUNDATION SERVICES, NAMELY, PROVIDING FUND RAISING ACTIVITIES, SUPPLEMENTAL FUNDING, CAPITAL IMPROVEMENT FUNDING, SCHOLARSHIPS AND FINANCIAL ASSISTANCE FOR PROGRAMS AND SERVICES OF OTHERS; PROVIDING EDUCATIONAL SCHOLARSHIPS (U.S. CLS. 100, 101 AND 102).

FIRST USE 7-15-2009; IN COMMERCE 8-1-2009.
HEATHER THOMPSON, EXAMINING ATTORNEY

SN 77-898,800. SECOND LICENSE APPLICATION CORPORATION, DFW AIRPORT, TX. FILED 12-22-2009.

SUPERGUARANTEE AUTOS

THE MARK CONSISTS OF STANDARD CHARACTERS WITHOUT CLAIM TO ANY PARTICULAR FONT, STYLE, SIZE, OR COLOR.

OWNER OF U.S. REG. NO. 3,723,656.
NO CLAIM IS MADE TO THE EXCLUSIVE RIGHT TO USE "AUTOS", APART FROM THE MARK AS SHOWN.

FOR PROVIDING LIMITED WARRANTIES TO PURCHASERS OF THIRD PARTY VEHICLES (U.S. CLS. 100, 101 AND 102).

MIDGE BUTLER, EXAMINING ATTORNEY

CLASS 36—(Continued).

SN 77-899,873. IRONSHORE, INC., GEORGE TOWN, CAYMAN ISLANDS, FILED 12-23-2009.

**DEPTH IN LEADERSHIP.
TRUSTED PARTNERSHIP.**

THE MARK CONSISTS OF STANDARD CHARACTERS WITHOUT CLAIM TO ANY PARTICULAR FONT, STYLE, SIZE, OR COLOR.

FOR ACCIDENT INSURANCE UNDERWRITING; FIRE INSURANCE UNDERWRITING; INSURANCE CARRIER SERVICES; INSURANCE CLAIMS ADMINISTRATION; INSURANCE CLAIMS PROCESSING; INSURANCE PREMIUM RATE COMPUTING; INSURANCE SERVICES, NAMELY, WRITING PROPERTY AND CASUALTY INSURANCE; INSURANCE SUBROGATION AND SALVAGE; INSURANCE UNDERWRITING IN THE FIELDS OF ACCIDENT, CONSTRUCTION, MARINE, MEDICAL, HEALTHCARE, PRODUCT LIABILITY, PROPERTY, SPECIALTY CASUALTY, PROFESSIONAL LIABILITY, ENERGY, ENVIRONMENTAL LIABILITY, ENVIRONMENTAL POLLUTION, ENVIRONMENTAL CASUALTY, AND CASUALTY; REINSURANCE UNDERWRITING; INSURANCE UNDERWRITING SERVICES FOR ALL TYPES OF INSURANCE (U.S. CLS. 100, 101 AND 102).

JULIE VEPPUMTHARA, EXAMINING ATTORNEY

SN 77-899,878. IRONSHORE, INC., GEORGE TOWN, CAYMAN ISLANDS, FILED 12-23-2009.

Depth in Leadership. Trusted Partnership.

IRONSHORE
your safe harbour

OWNER OF U.S. REG. NOS. 3,328,886, 3,340,749 AND OTHERS.

THE MARK CONSISTS OF THE WORDS "DEPTH IN LEADERSHIP. TRUSTED PARTNERSHIP." ABOVE THE DESIGN OF A SCALLOPED SHELL WITH A CROWN ON TOP TO THE RIGHT OF WHICH IS THE WORD "IRONSHORE" IN ALL CAPITAL LETTERS WITH THE WORDS "YOUR SAFE HARBOUR" DIRECTLY BELOW AND TO THE RIGHT OF THE WORD "IRONSHORE".

FOR ACCIDENT INSURANCE UNDERWRITING; FIRE INSURANCE UNDERWRITING; INSURANCE CARRIER SERVICES; INSURANCE CLAIMS ADMINISTRATION; INSURANCE CLAIMS PROCESSING; INSURANCE PREMIUM RATE COMPUTING; INSURANCE SERVICES, NAMELY, WRITING PROPERTY AND CASUALTY INSURANCE; INSURANCE SUBROGATION AND SALVAGE; INSURANCE UNDERWRITING IN THE FIELD OF ACCIDENT, CONSTRUCTION, MARINE, MEDICAL, PROPERTY AND CASUALTY; INSURANCE UNDERWRITING SERVICES FOR ALL TYPES OF INSURANCE; MARINE INSURANCE UNDERWRITING; MEDICAL INSURANCE UNDERWRITING (U.S. CLS. 100, 101 AND 102).

JULIE VEPPUMTHARA, EXAMINING ATTORNEY

CLASS 36—(Continued).

SN 77-899,884. IRONSHORE, INC., GEORGE TOWN, CAYMAN ISLANDS, FILED 12-23-2009.

Depth in Leadership. Trusted Partnership.

IRONSHORE
your safe harbour

OWNER OF U.S. REG. NOS. 3,328,886, 3,340,749 AND OTHERS.

THE COLOR(S) BLUE, ORANGE, AND BLACK IS/ARE CLAIMED AS A FEATURE OF THE MARK.

THE MARK CONSISTS OF THE WORDS "DEPTH IN LEADERSHIP. TRUSTED PARTNERSHIP." IN THE COLOR BLUE ABOVE THE DESIGN OF A SCALLOPED SHELL IN THE COLOR BLUE WITH A CROWN ON TOP IN THE COLOR ORANGE, TO THE RIGHT OF WHICH IS THE WORD "IRONSHORE" IN ALL CAPITAL LETTERS WITH THE WORD "IRON" IN THE COLOR ORANGE AND THE WORD "SHORE" IN THE COLOR BLUE, WITH THE WORDS "YOUR SAFE HARBOUR" IN LOWER CASE IN BLACK, DIRECTLY BELOW AND TO THE RIGHT OF THE WORD "IRONSHORE".

FOR ACCIDENT INSURANCE UNDERWRITING; FIRE INSURANCE UNDERWRITING; INSURANCE CARRIER SERVICES; INSURANCE CLAIMS ADMINISTRATION; INSURANCE CLAIMS PROCESSING; INSURANCE PREMIUM RATE COMPUTING; INSURANCE SERVICES, NAMELY, WRITING PROPERTY AND CASUALTY INSURANCE; INSURANCE SUBROGATION AND SALVAGE; INSURANCE UNDERWRITING IN THE FIELDS OF ACCIDENT, CONSTRUCTION, MARINE, MEDICAL, HEALTHCARE, PRODUCT LIABILITY, PROPERTY, SPECIALTY CASUALTY, PROFESSIONAL LIABILITY, ENERGY, ENVIRONMENTAL LIABILITY, ENVIRONMENTAL POLLUTION, ENVIRONMENTAL CASUALTY, AND CASUALTY; REINSURANCE UNDERWRITING; INSURANCE UNDERWRITING SERVICES FOR ALL TYPES OF INSURANCE (U.S. CLS. 100, 101 AND 102).

JULIE VEPPUMTHARA, EXAMINING ATTORNEY

SN 77-900,995. SMITH, BENJAMIN CK, BETHESDA, MD. FILED 12-25-2009.

301-DOLLAR-1

THE MARK CONSISTS OF STANDARD CHARACTERS WITHOUT CLAIM TO ANY PARTICULAR FONT, STYLE, SIZE, OR COLOR.

FOR COMMERCIAL LENDING SERVICES; CONSUMER LENDING SERVICES; FINANCIAL LOAN CONSULTATION; FINANCIAL SERVICES, NAMELY, MONEY LENDING; FINANCIAL SERVICES, NAMELY, MORTGAGE PLANNING; FINANCIAL SERVICES, NAMELY, MORTGAGE REFINANCING; FINANCIAL SERVICES, NAMELY, RAISING DEBT AND EQUITY CAPITAL FOR OTHERS; LENDING CONSULTANT SERVICES; MORTGAGE LENDING; REAL ESTATE LENDING SERVICES; WHOLESAL E LENDING SERVICES (U.S. CLS. 100, 101 AND 102).

FIRST USE 7-1-1994; IN COMMERCE 7-1-1994.

JASON LOTT, EXAMINING ATTORNEY

CLASS 36—(Continued).

SN 77-903,085. HEIFER INTERNATIONAL FOUNDATION, INC., LITTLE ROCK, AR. FILED 12-30-2009.



THE COLOR(S) BLUE, GREEN, AND BROWN IS/ARE CLAIMED AS A FEATURE OF THE MARK.

THE MARK CONSISTS OF AN ARRANGEMENT OF THREE LEAVES HAVING A BLUE LEAF, A GREEN LEAF, AND A BROWN LEAF.

FOR CHARITABLE FUNDRAISING SERVICES (U.S. CLS. 100, 101 AND 102).

FIRST USE 10-30-2005; IN COMMERCE 10-30-2005.
KAREN K. BUSH, EXAMINING ATTORNEY

CLASS 36—(Continued).

SN 77-905,442. UNIVERSITY OF UTAH RESEARCH FOUNDATION, SALT LAKE CITY, UT. FILED 1-5-2010.

Kickstart Seed Fund

THE MARK CONSISTS OF STANDARD CHARACTERS WITHOUT CLAIM TO ANY PARTICULAR FONT, STYLE, SIZE, OR COLOR.

OWNER OF U.S. REG. NO. 3,746,641.

NO CLAIM IS MADE TO THE EXCLUSIVE RIGHT TO USE "SEED FUND", APART FROM THE MARK AS SHOWN.

FOR FINANCIAL INVESTMENT IN THE FIELD OF SEED FUNDS (U.S. CLS. 100, 101 AND 102).

FIRST USE 3-31-2008; IN COMMERCE 3-31-2008.
TAMARA FRAZIER, EXAMINING ATTORNEY

SN 77-907,105. AKITA, INC., WILMINGTON, DE. FILED 1-7-2010.

CARBONCOVER

THE MARK CONSISTS OF STANDARD CHARACTERS WITHOUT CLAIM TO ANY PARTICULAR FONT, STYLE, SIZE, OR COLOR.

FOR INSURANCE UNDERWRITING IN THE FIELD OF PROFESSIONAL LIABILITY (U.S. CLS. 100, 101 AND 102).

FIRST USE 1-6-2010; IN COMMERCE 1-6-2010.
JASON TURNER, EXAMINING ATTORNEY

SN 77-903,404. STATE FARM MUTUAL AUTOMOBILE INSURANCE COMPANY, BLOOMINGTON, IL. FILED 12-31-2009.

State Farm Crystal Rewards

THE MARK CONSISTS OF STANDARD CHARACTERS WITHOUT CLAIM TO ANY PARTICULAR FONT, STYLE, SIZE, OR COLOR.

OWNER OF U.S. REG. NOS. 1,125,010, 2,319,867 AND OTHERS.

NO CLAIM IS MADE TO THE EXCLUSIVE RIGHT TO USE "REWARDS", APART FROM THE MARK AS SHOWN.

FOR CHARGE CARD AND CREDIT CARD SERVICES (U.S. CLS. 100, 101 AND 102).

SAIMA MAKHDOOM, EXAMINING ATTORNEY

SN 77-907,676. UNITED AMERICAN INSURANCE COMPANY, MCKINNEY, TX. FILED 1-8-2010.

UNITED INVESTORS LIFE INSURANCE COMPANY

THE MARK CONSISTS OF STANDARD CHARACTERS WITHOUT CLAIM TO ANY PARTICULAR FONT, STYLE, SIZE, OR COLOR.

NO CLAIM IS MADE TO THE EXCLUSIVE RIGHT TO USE "LIFE INSURANCE COMPANY", APART FROM THE MARK AS SHOWN.

FOR UNDERWRITING HEALTH INSURANCE (U.S. CLS. 100, 101 AND 102).

FIRST USE 0-0-1961; IN COMMERCE 0-0-1961.
NAKIA HENRY, EXAMINING ATTORNEY

CLASS 36—(Continued).

SN 77-907,732. MUSCULAR DYSTROPHY ASSOCIATION, INC., TUCSON, AZ. FILED 1-8-2010.

THE BASH FOR AUGIE'S QUEST

THE MARK CONSISTS OF STANDARD CHARACTERS WITHOUT CLAIM TO ANY PARTICULAR FONT, STYLE, SIZE, OR COLOR.

OWNER OF U.S. REG. NOS. 3,244,343, 3,253,364 AND 3,434,587.

NO CLAIM IS MADE TO THE EXCLUSIVE RIGHT TO USE "BASH", APART FROM THE MARK AS SHOWN.

THE NAME(S), PORTRAIT(S), AND/OR SIGNATURE(S) SHOWN IN THE MARK IDENTIFIES A LIVING INDIVIDUAL, WHOSE CONSENT(S) TO REGISTER IS MADE OF RECORD.

FOR CHARITABLE FUNDRAISING SERVICES FOR BASIC AND APPLIED RESEARCH INTO AMYOTROPHIC LATERAL SCLEROSIS AND FOR FUNDING SERVICES TO PERSONS AFFECTED BY SUCH DISORDERS (U.S. CLS. 100, 101 AND 102).

FIRST USE 3-0-2006; IN COMMERCE 3-0-2006.
JUDITH HELFMAN, EXAMINING ATTORNEY

SN 77-908,996. 2M REALTY ADVISORS, LLC, DBA 2M REALTY, PORTER, TX. FILED 1-11-2010.



NO CLAIM IS MADE TO THE EXCLUSIVE RIGHT TO USE "LIST", APART FROM THE MARK AS SHOWN.

THE MARK CONSISTS OF STYLIZED VERSION OF THE WORD "FLEXLIST" IN COMBINATION WITH A STICK FIGURE MAN AND A HOUSE COMPRISED OF PUZZLE PIECES.

FOR PROVIDING REAL ESTATE LISTINGS AND REAL ESTATE INFORMATION VIA THE INTERNET; REAL ESTATE BROKERAGE; REAL ESTATE LISTING (U.S. CLS. 100, 101 AND 102).

FIRST USE 12-1-2009; IN COMMERCE 12-1-2009.
KEVON CHISOLM, EXAMINING ATTORNEY

CLASS 36—(Continued).

SN 77-909,021. INSPHERE INSURANCE SOLUTIONS, INC., NORTH RICHLAND HILLS, TX. FILED 1-11-2010.



NO CLAIM IS MADE TO THE EXCLUSIVE RIGHT TO USE "INVEST", APART FROM THE MARK AS SHOWN.

THE MARK CONSISTS OF A PLANET ECLIPSING THE SUN WITH THE LETTERS "IN" IN THE WORD "INVEST" OVERLAPPING THE PLANET AND THE WORD "INSPHERE" APPEARING OVER THE LETTERS "NVEST".

FOR INVESTMENT OF FUNDS FOR INDEPENDENT INSURANCE AGENTS IN STOCK PURCHASE PLANS (U.S. CLS. 100, 101 AND 102).

KHANH LE, EXAMINING ATTORNEY

SN 77-909,725. THE NEW YORK TIMES COMPANY, NEW YORK, NY. FILED 1-12-2010.

DEALBOOK

THE MARK CONSISTS OF STANDARD CHARACTERS WITHOUT CLAIM TO ANY PARTICULAR FONT, STYLE, SIZE, OR COLOR.

OWNER OF U.S. REG. NOS. 3,322,023 AND 3,378,767.
FOR PROVIDING NEWS AND INFORMATION IN THE FIELD OF REAL ESTATE; PROVIDING ONLINE DATABASES IN THE FIELD OF REAL ESTATE; PROVIDING A WEBSITE FEATURING NEWS AND INFORMATION IN THE FIELD OF REAL ESTATE (U.S. CLS. 100, 101 AND 102).

FIRST USE 3-0-2006; IN COMMERCE 3-0-2006.
ANDREA BUTLER, EXAMINING ATTORNEY

SN 77-910,806. AMERICAN INTERNATIONAL GROUP, INC., NEW YORK, NY. FILED 1-13-2010.

AG DISABILITYCARE

THE MARK CONSISTS OF STANDARD CHARACTERS WITHOUT CLAIM TO ANY PARTICULAR FONT, STYLE, SIZE, OR COLOR.

OWNER OF U.S. REG. NOS. 2,996,097, 3,722,175 AND OTHERS.

NO CLAIM IS MADE TO THE EXCLUSIVE RIGHT TO USE "DISABILITYCARE", APART FROM THE MARK AS SHOWN.

FOR INSURANCE UNDERWRITING IN THE FIELD OF DISABILITY INSURANCE AND INCOME PROTECTION (U.S. CLS. 100, 101 AND 102).

FIRST USE 12-7-2009; IN COMMERCE 12-7-2009.
LAURA KOVALSKY, EXAMINING ATTORNEY

CLASS 36—(Continued).

SN 77-910,936. AMERICAN INTERNATIONAL GROUP, INC., NEW YORK, NY. FILED 1-13-2010.

AG TERM MVP

THE MARK CONSISTS OF STANDARD CHARACTERS WITHOUT CLAIM TO ANY PARTICULAR FONT, STYLE, SIZE, OR COLOR.

OWNER OF U.S. REG. NOS. 2,920,118, 3,339,213 AND OTHERS.

NO CLAIM IS MADE TO THE EXCLUSIVE RIGHT TO USE "TERM", APART FROM THE MARK AS SHOWN.

FOR LIFE INSURANCE UNDERWRITING (U.S. CLS. 100, 101 AND 102).

FIRST USE 12-7-2009; IN COMMERCE 12-7-2009.
LAURA KOVALSKY, EXAMINING ATTORNEY

SN 77-910,973. AMERICAN INTERNATIONAL GROUP, INC., NEW YORK, NY. FILED 1-13-2010.

AG EMERGENCYCARE

THE MARK CONSISTS OF STANDARD CHARACTERS WITHOUT CLAIM TO ANY PARTICULAR FONT, STYLE, SIZE, OR COLOR.

OWNER OF U.S. REG. NOS. 3,351,908, 3,722,175 AND OTHERS.

NO CLAIM IS MADE TO THE EXCLUSIVE RIGHT TO USE "EMERGENCYCARE", APART FROM THE MARK AS SHOWN.

FOR INSURANCE UNDERWRITING IN THE FIELD OF SUPPLEMENTAL ACCIDENT AND HEALTH EXPENSES (U.S. CLS. 100, 101 AND 102).

FIRST USE 12-7-2009; IN COMMERCE 12-7-2009.
LAURA KOVALSKY, EXAMINING ATTORNEY

SN 77-911,098. AMERICAN INTERNATIONAL GROUP, INC., NEW YORK, NY. FILED 1-13-2010.

AG CRITICALCARE

THE MARK CONSISTS OF STANDARD CHARACTERS WITHOUT CLAIM TO ANY PARTICULAR FONT, STYLE, SIZE, OR COLOR.

OWNER OF U.S. REG. NOS. 2,974,291, 3,722,175 AND OTHERS.

NO CLAIM IS MADE TO THE EXCLUSIVE RIGHT TO USE "CRITICALCARE", APART FROM THE MARK AS SHOWN.

FOR INSURANCE UNDERWRITING IN THE FIELD OF SUPPLEMENTAL CRITICAL ILLNESS EXPENSES (U.S. CLS. 100, 101 AND 102).

FIRST USE 12-7-2009; IN COMMERCE 12-7-2009.
LAURA KOVALSKY, EXAMINING ATTORNEY

CLASS 36—(Continued).

SN 77-912,912. MANHEIM, INC., ATLANTA, GA. FILED 1-15-2010.



OWNER OF U.S. REG. NOS. 3,229,428 AND 3,476,531.
NO CLAIM IS MADE TO THE EXCLUSIVE RIGHT TO USE "FINANCIAL SERVICES", APART FROM THE MARK AS SHOWN.

THE COLOR(S) GOLD, BROWN, BLUE AND WHITE IS/ ARE CLAIMED AS A FEATURE OF THE MARK.

THE MARK CONSISTS OF A GOLD "M" OVER A BLUE CIRCULAR BACKGROUND AND WITHIN TWO GOLD OUTER RINGS. THE COLOR BROWN OUTLINES THE MARK. TO THE RIGHT OF THE "M" ARE STYLIZED LETTERS "MAFS" IN THE COLOR WHITE. CENTERED UNDERNEATH THE "M" AND "MAFS" ARE THE STYLIZED WORDS "MANHEIM FINANCIAL SERVICES" IN THE COLOR WHITE AND ALL ON A BLUE BACKGROUND.

FOR AUTOMOBILE FINANCING SERVICES (U.S. CLS. 100, 101 AND 102).

FIRST USE 1-20-2010; IN COMMERCE 1-20-2010.
WILLIAM ROSSMAN, EXAMINING ATTORNEY

SN 77-914,035. ZURICH INSURANCE COMPANY LTD, ZURICH, SWITZERLAND, FILED 1-18-2010.

Collateral-eZe

THE MARK CONSISTS OF STANDARD CHARACTERS WITHOUT CLAIM TO ANY PARTICULAR FONT, STYLE, SIZE, OR COLOR.

FOR INSURANCE UNDERWRITING SERVICES IN THE FIELD OF PROPERTY AND CASUALTY (U.S. CLS. 100, 101 AND 102).

BRENDAN MCCAULEY, EXAMINING ATTORNEY

CLASS 36—(Continued).

SN 77-914,367. TRANSAMERICA CORPORATION, CEDAR RAPIDS, IA. FILED 1-19-2010.

CLASS 36—(Continued).

SN 79-070,856. UNION ASSET MANAGEMENT HOLDING AG, FED REP GERMANY, FILED 4-6-2009.

TRANSSECURITY

THE MARK CONSISTS OF STANDARD CHARACTERS WITHOUT CLAIM TO ANY PARTICULAR FONT, STYLE, SIZE, OR COLOR.

OWNER OF U.S. REG. NOS. 718,353, 831,626 AND OTHERS.

FOR FINANCIAL PLANNING AND LIFE INSURANCE UNDERWRITING; PROVIDING INFORMATION AND ADVICE TO FINANCIAL PLANNERS AND LIFE INSURANCE PROFESSIONALS RELATING TO THE ESTABLISHMENT OF TRUSTS FUNDED BY OR OTHERWISE USING LIFE INSURANCE (U.S. CLS. 100, 101 AND 102).

KATHERINE STOIDES, EXAMINING ATTORNEY

QUONIAM

THE MARK CONSISTS OF STANDARD CHARACTERS WITHOUT CLAIM TO ANY PARTICULAR FONT, STYLE, SIZE, OR COLOR.

PRIORITY DATE OF 10-24-2008 IS CLAIMED.

OWNER OF INTERNATIONAL REGISTRATION 1007545 DATED 4-6-2009, EXPIRES 4-6-2019.

FOR SERVICES OF AN INVESTMENT COMPANY, NAMELY, INVESTMENT ADVICE, INVESTMENT MANAGEMENT, INVESTMENT CONSULTATION, INVESTMENT OF FUNDS FOR OTHERS, MUTUAL AND SPECIAL FUND INVESTMENT, MUTUAL AND SPECIAL FUND BROKERAGE, AND SAFEKEEPING AND MANAGEMENT OF FUND UNITS; ADMINISTRATION AND DISTRIBUTION OF MUTUAL AND SPECIAL FUNDS; FINANCIAL CONSULTANCY IN THE FIELD OF FUNDS, FUNDS ANALYSIS, SHARE ANALYSIS, BOND ANALYSIS AND ASSET MANAGEMENT; INVESTMENT CONSULTANCY; CAPITAL INVESTMENTS SERVICES; CAPITAL INVESTMENT BROKERAGE; SECURITIES BROKERAGE; EXECUTION OF TRADE IN SECURITIES; FINANCIAL AFFAIRS, MONETARY AFFAIRS, FINANCIAL SERVICES, NAMELY, ESTABLISHING MUTUAL AND SPECIAL FUNDS FOR THIRD PARTIES AS WELL AS MUTUAL AND SPECIAL FUNDS IN THE FORM OF STOCKS AND SHARES FOR THIRD PARTIES, FINANCIAL PORTFOLIO MANAGEMENT, FINANCIAL RISK MANAGEMENT, FINANCIAL RISK MANAGEMENT CONSULTATION, FINANCIAL PORTFOLIO ANALYSIS SERVICES AND FINANCIAL RESEARCH, AND DISCRETIONARY MANAGEMENT OF SEGREGATED INDIVIDUAL POOLS OF ASSETS WHICH ARE INVESTED IN FINANCIAL INSTRUMENTS; PROVIDING OF FINANCIAL INFORMATION; FINANCIAL EVALUATION; BANKING; FINANCIAL ANALYSIS AND FINANCIAL CONSULTANCY; INSURANCE AGENCY AND BROKERAGE; INSURANCE BROKERAGE; REAL ESTATE AFFAIRS, NAMELY, REAL ESTATE INVESTMENT SERVICES, REAL ESTATE MANAGEMENT SERVICES AND REAL ESTATE FINANCING SERVICES; REAL ESTATE BROKERAGE; LEASING AND APPRAISAL OF REAL ESTATE; DEPOSITS OF VALUABLES IN THE NATURE OF SAFE DEPOSIT BOX SERVICES; HIRE-PURCHASING FINANCING SERVICES (U.S. CLS. 100, 101 AND 102).

JACLYN KIDWELL WALKER, EXAMINING ATTORNEY

SN 77-921,290. BANK OF AMERICA CORPORATION, CHARLOTTE, NC. FILED 1-27-2010.

MERRILL EDGE

THE MARK CONSISTS OF STANDARD CHARACTERS WITHOUT CLAIM TO ANY PARTICULAR FONT, STYLE, SIZE, OR COLOR.

OWNER OF U.S. REG. NOS. 1,280,908, 3,490,012 AND OTHERS.

FOR FINANCIAL PLANNING AND INVESTMENT ADVISORY SERVICES (U.S. CLS. 100, 101 AND 102).

JULIE WATSON, EXAMINING ATTORNEY

CLASS 37—CONSTRUCTION AND REPAIR

SN 77-389,677. TATA SONS LIMITED, MUMBAI, INDIA,
FILED 2-6-2008.



OWNER OF INDIA REG. NO. 1247047, DATED 10-31-2003,
EXPIRES 10-31-2013.

OWNER OF U.S. REG. NOS. 2,814,916, 2,824,913 AND
2,929,070.

THE MARK CONSISTS OF "TATA" AND STYLIZED
LETTER "T" IN OVAL DESIGN.

FOR CONSTRUCTION AND INSTALLATION OF FI-
BER OPTIC TELECOMMUNICATIONS NETWORKS,
TECHNICAL FACILITIES AND TERRESTRIAL AND
SUB-SEA COMMUNICATIONS NETWORKS; AND
HARDWARE MAINTENANCE OF FIBER OPTIC TELE-
COMMUNICATIONS NETWORKS, TECHNICAL FACIL-
ITIES AND TERRESTRIAL AND SUB-SEA
COMMUNICATIONS NETWORKS (U.S. CLS. 100, 103
AND 106).

STEVEN JACKSON, EXAMINING ATTORNEY

SN 77-472,555. THE JEREMIAH PROJECT, INC., WILLIAMS-
BURG, VA. FILED 5-12-2008.



NO CLAIM IS MADE TO THE EXCLUSIVE RIGHT TO
USE "PROJECT", APART FROM THE MARK AS SHOWN.

THE MARK CONSISTS OF THE LETTERS "JP" WITH A
NEGATIVE IMAGE OF THE CROSS IN THE CENTER AND
A NEGATIVE IMAGE OF A HAMMER INCORPORATED IN
THE "P" AND THE WORDING "JEREMIAH PROJECT"
BENEATH THE DESIGN.

FOR CHARITABLE SERVICES, NAMELY, PROVIDING
MAINTAINANCE AND REPAIRS ON THE HOMES
OF THOSE IN NEED (U.S. CLS. 100, 103 AND 106).

FIRST USE 4-0-2008; IN COMMERCE 4-0-2008.

WILLIAM BRECKENFELD, EXAMINING ATTORNEY

CLASS 37—(Continued).

SN 77-631,202. HAYWARD BAKER INC., ODENTON, MD.
FILED 12-11-2008.



NO CLAIM IS MADE TO THE EXCLUSIVE RIGHT TO
USE "GROUTING", APART FROM THE MARK AS SHOWN.
THE MARK CONSISTS OF THE WORD "DENVER"
ABOVE THE WORD "GROUTING" WITH MOUNTAINS
PLACED ON THEIR LEFT.

SEC. 2(F).

FOR SUBSURFACE GEOTECHNICAL CONSTRU-
TION SERVICES, NAMELY, COMPACTION AND CE-
MENT GROUTING, COMMERCIAL AND RESIDENTIAL
FOUNDATION REMEDIATION, SHORING, SLOPE AND
LANDSLIDE STABILIZATION, JET GROUTING, SOIL
NAILING, DRILLING AND BLASTING, AND MINING
SERVICES NAMELY MINE REHABILITATION AND
SPECIALIZED DRILLING SERVICES (U.S. CLS. 100, 103
AND 106).

FIRST USE 5-31-1981; IN COMMERCE 5-31-1981.

DORITT L. CARROLL, EXAMINING ATTORNEY

SN 77-682,358. BUCKNOR, KIRK D, FORT PIERCE, FL.
FILED 3-3-2009.



NO CLAIM IS MADE TO THE EXCLUSIVE RIGHT TO
USE "BLINDS" AND "INC", APART FROM THE MARK AS
SHOWN.

THE COLOR(S) RED, YELLOW, BLUE, WHITE IS/ARE
CLAIMED AS A FEATURE OF THE MARK.

THE MARK CONSISTS OF THE STYLIZED WORD
"BLINDS" WITH THE WORD ELEMENTS SHOWCASE
INC. APPEARING DIRECTLY BELOW IN BLUE ON A
YELLOW BACKGROUND. THE LETTER "B", APPEARS
WITH VERTICAL BANDS OF BLUE SEPARATED BY
YELLOW WITH ONE RED BAND, THE LETTER "D"
APPEARS WITH HORIZONTAL BANDS OF BLUE SEPA-
RATED BY YELLOW WITH TWO RED BANDS AND THE
LETTER "S" APPEARS IN SOLID BLUE. THE LETTER "L"
APPEARS AS A HIGH RISE WITH DIAGONAL YELLOW
LINES, THE LETTER "I" APPEARS AS A CONDOMINIUM
WITH A RED FACADE, YELLOW WINDOWS AND A BLUE
ROOF AND THE LETTER "N" APPEARS AS A SINGLE
FAMILY HOME WITH A BLUE FACADE AND A LARGE
SINGLE WINDOW TREATMENT IN YELLOW WITH BLUE
OUTLINING.

FOR INSTALLATION AND REPAIR OF BLINDS (U.S.
CLS. 100, 103 AND 106).

FIRST USE 7-25-2006; IN COMMERCE 7-25-2006.

JEFF DEFORD, EXAMINING ATTORNEY

CLASS 37—(Continued).

SN 77-690,315. HAIL HOUSE CALL, LLC, PHILLIPSBURG, KS. FILED 3-13-2009.



NO CLAIM IS MADE TO THE EXCLUSIVE RIGHT TO USE "HAIL" AND "HOUSE CALL", APART FROM THE MARK AS SHOWN.

THE MARK CONSISTS OF A ROOF LINE OF A HOUSE WITH A CHIMNEY, STYLIZED LARGE LETTERS "HHC" UNDER THE ROOF LINE, THE WORD "HAIL" EMBEDDED IN THE FIRST LARGE LETTER "H", THE WORD "HOUSE" EMBEDDED IN THE SECOND LARGE LETTER "H", AND THE WORD "CALL" EMBEDDED IN THE LARGE LETTER "C".

FOR REPAIR OF VINYL SIDING; REPAIR OF VINYL WINDOW TRIM; AND REPAIR OF VINYL FENCE (U.S. CLS. 100, 103 AND 106).

FIRST USE 1-31-2007; IN COMMERCE 1-31-2007.
MICHAEL WEBSTER, EXAMINING ATTORNEY

CLASS 37—(Continued).

CHAMP COMPLETE AUTO SERVICE" IN A STYLIZED FONT IN THE COLORS BLACK AND WHITE AND A DESIGN CONSISTING OF FIVE BLACK STARS ABOVE A BLACK AND WHITE STEERING WHEEL PARTIALLY ENCIRCLED BY BLACK CIRCLES AND THE WORDS "AUTO CHAMP" ATOP THREE LINES IN WHITE AND FIVE INTERLOCKING WHITE CIRCLES, WITH THREE BLACK HORIZONTAL LINES, ALL ENCLOSED WITHIN A YELLOW RECTANGULAR CARRIER OUTLINED IN BLACK.

FOR VEHICLE REPAIR AND MAINTENANCE SERVICE (U.S. CLS. 100, 103 AND 106).

RENEE MCCRAY, EXAMINING ATTORNEY

SN 77-693,846. GGG ENTERPRISES INC., DBA CONCOURS BODY SHOP, RENO, NV. FILED 3-18-2009.

SN 77-747,203. TYCO VALVES & CONTROLS INC., HOUSTON, TX. FILED 5-29-2009.

It's your car, It's your choice, Choose Concours!

THE MARK CONSISTS OF STANDARD CHARACTERS WITHOUT CLAIM TO ANY PARTICULAR FONT, STYLE, SIZE, OR COLOR.

FOR VEHICLE REPAIR (U.S. CLS. 100, 103 AND 106).
FIRST USE 7-5-1985; IN COMMERCE 7-5-1985.
LINDA ORNDORFF, EXAMINING ATTORNEY

PRESSURE MANAGEMENT CENTER

SN 77-730,636. AUTO CHECK FRANCHISING SYSTEMS, INC., HOUSTON, TX. FILED 5-6-2009.



NO CLAIM IS MADE TO THE EXCLUSIVE RIGHT TO USE "AUTO" AND "COMPLETE AUTO SERVICE", APART FROM THE MARK AS SHOWN.

THE COLOR(S) BLACK, WHITE, AND YELLOW IS/ARE CLAIMED AS A FEATURE OF THE MARK.

THE MARK CONSISTS OF THE WORDING "AUTO

THE MARK CONSISTS OF STANDARD CHARACTERS WITHOUT CLAIM TO ANY PARTICULAR FONT, STYLE, SIZE, OR COLOR.

NO CLAIM IS MADE TO THE EXCLUSIVE RIGHT TO USE "MANAGEMENT CENTER", APART FROM THE MARK AS SHOWN.

FOR INSTALLATION, MAINTENANCE AND REPAIR OF METAL VALVES, ACTUATORS, CONTROLLERS, INSTRUMENTATION, AND PARTS AND FITTINGS THEREFORE (U.S. CLS. 100, 103 AND 106).

FIRST USE 12-31-1996; IN COMMERCE 12-31-1996.
ROBERT STRUCK, EXAMINING ATTORNEY

CLASS 37—(Continued).

SN 77-755,627. KELLY-MOORE PAINT COMPANY, INC.,
SAN CARLOS, CA. FILED 6-9-2009.

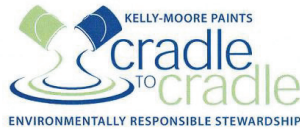

OWNER OF U.S. REG. NOS. 1,244,936, 2,711,280 AND OTHERS.

NO CLAIM IS MADE TO THE EXCLUSIVE RIGHT TO USE "PAINTS" AND "CRADLE TO CRADLE" AND "ENVIRONMENTALLY RESPONSIBLE STEWARDSHIP", APART FROM THE MARK AS SHOWN.

THE COLOR(S) BLUE AND GREEN IS/ARE CLAIMED AS A FEATURE OF THE MARK.

THE MARK CONSISTS OF THE NAME "KELLY MOORE PAINTS" IN BLUE; THE WORDS "CRADLE TO CRADLE" IN BLUE AND THE SECOND "CRADLE" IN GREEN; THE NAME "ENVIRONMENTALLY RESPONSIBLE STEWARDSHIP" IN BLUE; AND TWO STYLIZED TILTED PAINT CANS SPILLING PAINT INTO A COMMON POOL WITH THE PAINT CAN ON THE LEFT AND ITS STREAM IN GREEN AND THE PAINT CAN ON THE RIGHT AND ITS STREAM IN BLUE.

FOR PROVIDING A WEBSITE AND ONLINE INFORMATION IN THE FIELDS OF PAINTING TECHNIQUES, NAMELY, PROVIDING INFORMATION IN THE FIELD OF PAINTING VIA THE INTERNET; AND CONSULTING IN THE FIELD OF PAINTING AND SURFACE PREPARATION TECHNIQUES, NAMELY, CONSULTATION RELATING TO PAINTING OF BUILDINGS (U.S. CLS. 100, 103 AND 106).

BENJAMIN OKEKE, EXAMINING ATTORNEY

SN 77-755,637. SCURTO CEMENT CONSTRUCTION, LTD.,
GILBERTS, IL. FILED 6-9-2009.

DUCTILCRETE

THE MARK CONSISTS OF STANDARD CHARACTERS WITHOUT CLAIM TO ANY PARTICULAR FONT, STYLE, SIZE, OR COLOR.

FOR BUILDING CONSTRUCTION, NAMELY CONSTRUCTION OF CONCRETE STRUCTURES AND SURFACES (U.S. CLS. 100, 103 AND 106).

DAVID I, EXAMINING ATTORNEY

CLASS 37—(Continued).

SN 77-757,324. SCURTO CEMENT CONSTRUCTION, LTD.,
GILBERTS, IL. FILED 6-11-2009.

SCURTO JOINT-LESS CONCRETE

THE MARK CONSISTS OF STANDARD CHARACTERS WITHOUT CLAIM TO ANY PARTICULAR FONT, STYLE, SIZE, OR COLOR.

NO CLAIM IS MADE TO THE EXCLUSIVE RIGHT TO USE "JOINT-LESS CONCRETE", APART FROM THE MARK AS SHOWN.

FOR BUILDING CONSTRUCTION SERVICES, NAMELY, CONSTRUCTION OF CONCRETE FLOORS (U.S. CLS. 100, 103 AND 106).

DAVID I, EXAMINING ATTORNEY

SN 77-758,811. HOME TO-DO'S, INC., DBA HOME TO-DO'S,
CARDIFF BY THE SEA, CA. FILED 6-12-2009.



NO CLAIM IS MADE TO THE EXCLUSIVE RIGHT TO USE "HOME", APART FROM THE MARK AS SHOWN.

THE STIPPLING IS FOR SHADING PURPOSES.

THE COLOR(S) NAVY BLUE, RED, AND ORANGE IS/ARE CLAIMED AS A FEATURE OF THE MARK.

THE MARK CONSISTS OF THE FOLLOWING: THE WORDS "HOME TO-DO'S" WHERE "HOME" IS IN THE COLOR BLUE AND "TO DO'S" IS IN THE COLOR RED WITH A BLUE CHECK MARK TAKING THE PLACE OF THE APOSTROPHE ON "DO'S", A DRAWING OF A CARTOON LIKE MAN IN THE COLOR DARK AND LIGHT ORANGE RUNNING WITH A TOOL BOX IN ONE HAND AND A BLUE HAMMER IN THE OTHER PLACED OVER THE WORD "HOME".

FOR BUILDING CONSTRUCTION, REMODELING AND REPAIR; BUILDING MAINTENANCE AND REPAIR (U.S. CLS. 100, 103 AND 106).

FIRST USE 2-13-2005; IN COMMERCE 3-1-2005.

LINDA ESTRADA, EXAMINING ATTORNEY

CLASS 37—(Continued).

SN 77-760,206. OLISO INCORPORATED, SAN FRANCISCO, CA. FILED 6-15-2009.

Smart Iron

THE MARK CONSISTS OF STANDARD CHARACTERS WITHOUT CLAIM TO ANY PARTICULAR FONT, STYLE, SIZE, OR COLOR.

NO CLAIM IS MADE TO THE EXCLUSIVE RIGHT TO USE "IRON", APART FROM THE MARK AS SHOWN.

FOR CLOTHING IRONING (U.S. CLS. 100, 103 AND 106).

BARBARA BROWN, EXAMINING ATTORNEY

CLASS 37—(Continued).

SN 77-769,423. ABM INDUSTRIES INCORPORATED, NEW YORK, NY. FILED 6-26-2009.

ABM ONEPASS

THE MARK CONSISTS OF STANDARD CHARACTERS WITHOUT CLAIM TO ANY PARTICULAR FONT, STYLE, SIZE, OR COLOR.

OWNER OF U.S. REG. NOS. 659,936, 3,070,896 AND OTHERS.

FOR COMMERCIAL JANITORIAL SERVICES; COMMERCIAL HOUSEKEEPING SERVICES, NAMELY, CLEANING SERVICES FOR COMMERCIAL BUILDINGS, OFFICES AND COMMERCIAL FACILITIES (U.S. CLS. 100, 103 AND 106).

FIRST USE 4-6-2009; IN COMMERCE 4-6-2009.

DEIRDRE ROBERTSON, EXAMINING ATTORNEY

SN 77-764,978. SHENANDOAH VALLEY INDUSTRIES, WAYNESBORO, VA. FILED 6-22-2009.



NO CLAIM IS MADE TO THE EXCLUSIVE RIGHT TO USE "POWDER COATING SOLUTIONS", APART FROM THE MARK AS SHOWN.

THE COLOR(S) RED, ORANGE, YELLOW, GREEN, BLUE, INDIGO, VIOLET, GREY, AND CREAM IS/ARE CLAIMED AS A FEATURE OF THE MARK.

THE MARK CONSISTS OF THE WORDS "POWDER COATING" WHICH APPEAR IN RAINBOW COLORS OF RED, ORANGE, YELLOW, GREEN, BLUE, INDIGO AND VIOLET AND THE WORD "SOLUTIONS" APPEARS IN RED BELOW, WITH A 10 POINT CREAM STAR OUTLINED IN GREY BEHIND THE WORDS.

FOR APPLYING DECORATIVE COATINGS TO METAL COMMERCIAL REFRIGERATORS AND FREEZERS; APPLYING PROTECTIVE COATINGS TO METAL COMMERCIAL REFRIGERATORS AND FREEZERS (U.S. CLS. 100, 103 AND 106).

FIRST USE 1-1-2005; IN COMMERCE 1-1-2005.

ROBERT C. CLARK JR., EXAMINING ATTORNEY

SN 77-793,696. WORLD MARKET CENTER VENTURE, LLC, LAS VEGAS, NV. FILED 7-30-2009.



NO CLAIM IS MADE TO THE EXCLUSIVE RIGHT TO USE "LAS VEGAS", APART FROM THE MARK AS SHOWN. THE COLOR(S) DARK GREEN, LIGHT GREEN, BLUE AND WHITE IS/ARE CLAIMED AS A FEATURE OF THE MARK.

THE MARK CONSISTS OF A STYLIZED SPHERE IN DARK GREEN AND LIGHT GREEN, HAVING TWO CURVED WHITE LINES AND A CURVED BLUE LINE IN THE LOWER CENTER OF THE SPHERE. ONE OF THE CURVED WHITE LINES DIVIDES THE SPHERE AND THE OTHER CURVED WHITE LINE RUNS THROUGH BOTH HALVES AND A CURVED BLUE LINE IS IN THE MIDDLE. TO THE RIGHT OF THE DESIGN OF THE SPHERE ARE THE STYLIZED WORDS, "ONE GOOD WORLD LAS VEGAS" IN A STACKED FORMATION WITH UNDERLINES UNDER "ONE", "GOOD", AND "WORLD". THE WORD "ONE" IS IN DARK GREEN AND HAS A LIGHT GREEN LINE UNDERNEATH. THE WORD "GOOD" IS IN LIGHT GREEN AND HAS A LIGHT GREEN LINE UNDERNEATH. THE WORD "WORLD" IS IN BLUE AND HAS A LIGHT GREEN LINE UNDERNEATH. THE WORDS "LAS VEGAS" ARE IN LIGHT GREEN.

FOR REAL ESTATE DEVELOPMENT, NAMELY, SITE SELECTION, CONSTRUCTION PLANNING, CONSTRUCTION MANAGEMENT AND SUPERVISION, AND CONSTRUCTION SERVICES, NAMELY, PLANNING, LAYING OUT AND CONSTRUCTION OF TRADE AND RETAIL SHOWROOM FACILITIES, CONFERENCE FACILITIES, EXHIBITION FACILITIES, MEETING FACILITIES AND FACILITIES ANCILLARY TO THE FOREGOING (U.S. CLS. 100, 103 AND 106).

JAY BESCH, EXAMINING ATTORNEY

CLASS 37—(Continued).

SN 77-800,586. ASSOCIATED AIR CENTER, L.P., TEMPE, AZ. FILED 8-10-2009.

ASSOCIATED AIRCENTER

THE MARK CONSISTS OF STANDARD CHARACTERS WITHOUT CLAIM TO ANY PARTICULAR FONT, STYLE, SIZE, OR COLOR.

NO CLAIM IS MADE TO THE EXCLUSIVE RIGHT TO USE "AIR CENTER", APART FROM THE MARK AS SHOWN.

SEC. 2(F) AS TO "ASSOCIATED".

FOR REFURBISHMENT OF AIRCRAFT (U.S. CLS. 100, 103 AND 106).

FIRST USE 0-0-1984; IN COMMERCE 0-0-1984.

GEOFFREY FOSDICK, EXAMINING ATTORNEY

SN 77-803,891. MR. MINIBLIND, INC., LAKEWOOD, CA. FILED 8-13-2009.



NO CLAIM IS MADE TO THE EXCLUSIVE RIGHT TO USE "ORIGINAL" AND "MINIBLIND", APART FROM THE MARK AS SHOWN.

THE MARK CONSISTS OF AN IMAGE OF A SMALL CARTOON MAN BETWEEN "MR." AND "MINIBLIND", WITH THE WORDS "THE ORIGINAL" IN SMALLER FONT ABOVE.

FOR WINDOW BLIND INSTALLATION AND REPAIR (U.S. CLS. 100, 103 AND 106).

FIRST USE 12-28-2007; IN COMMERCE 12-28-2007.

EUGENIA MARTIN, EXAMINING ATTORNEY

SN 77-818,352. GREENOVATE, LLC, COLUMBUS, OH. FILED 9-2-2009.

Greenovate

THE MARK CONSISTS OF STANDARD CHARACTERS WITHOUT CLAIM TO ANY PARTICULAR FONT, STYLE, SIZE, OR COLOR.

FOR CONSULTING IN THE FIELD OF BUILDING CONSTRUCTION (U.S. CLS. 100, 103 AND 106).

FIRST USE 9-1-2006; IN COMMERCE 9-1-2006.

REGINA DRUMMOND, EXAMINING ATTORNEY

CLASS 37—(Continued).

SN 77-844,215. ELEMENT ELECTRIC INC., DIXON, CA. FILED 10-8-2009.

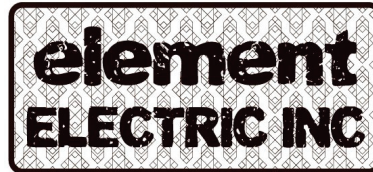

NO CLAIM IS MADE TO THE EXCLUSIVE RIGHT TO USE "ELECTRIC INC", APART FROM THE MARK AS SHOWN.

THE STIPPLING IS FOR SHADING PURPOSES ONLY.

THE MARK CONSISTS OF A STYLIZED RECTANGLE WITH ROUNDED EDGES, AND THE TEXT "ELEMENT ELECTRIC INC" WRITTEN IN IT.

FOR ELECTRICAL CONTRACTOR SERVICES; ELECTRICAL REPAIRS, MAINTENANCE, AND INSTALLATION OF ELECTRICAL WIRING, OUTLETS, LIGHT FIXTURES, AND ELECTRICAL PANELS; INSTALLATION, MAINTENANCE AND REPAIR OF ELECTRICAL SYSTEMS AND SOLAR POWER UNITS (U.S. CLS. 100, 103 AND 106).

FIRST USE 9-1-2005; IN COMMERCE 1-20-2006.

KIMBERLY FRYE, EXAMINING ATTORNEY

SN 77-856,674. AB INSTALLATIONS, INC., SYKESVILLE, MD. FILED 10-24-2009.

ALLSTAR BRANDING

THE MARK CONSISTS OF STANDARD CHARACTERS WITHOUT CLAIM TO ANY PARTICULAR FONT, STYLE, SIZE, OR COLOR.

OWNER OF U.S. REG. NO. 3,361,555.

NO CLAIM IS MADE TO THE EXCLUSIVE RIGHT TO USE "BRANDING", APART FROM THE MARK AS SHOWN.

FOR VINYL APPLICATION OF GRAPHIC DESIGNS ON VEHICLES AND STRUCTURES (U.S. CLS. 100, 103 AND 106).

FIRST USE 8-23-2007; IN COMMERCE 8-23-2007.

AISHA CLARKE, EXAMINING ATTORNEY

CLASS 37—(Continued).

SN 77-867,779. RESTORATION 1, LLC, POMPANO BEACH, FL. FILED 11-8-2009.



NO CLAIM IS MADE TO THE EXCLUSIVE RIGHT TO USE "RESTORATION" AND "WATER DAMAGE EXPERTS", APART FROM THE MARK AS SHOWN.

THE COLOR(S) ORANGE, BLUE, AND BLACK IS/ARE CLAIMED AS A FEATURE OF THE MARK.

THE MARK CONSISTS OF THE STYLIZED WORD "RESTORATION" IN ORANGE FOLLOWED BY THE ARTISTIC RENDERING OF WAVES OF WATER IN BLUE WITH A STYLIZED NUMBER "1" IN ORANGE IN THE MIDDLE OF THE ARTISTIC RENDERING OF THE WAVES. BELOW THE STYLIZED WORD "RESTORATION" ARE THE STYLIZED WORDS "WATER DAMAGE EXPERTS" IN BLACK.

FOR RESTORATION IN THE FIELD OF REPAIRING HOMES AND BUILDINGS FROM WATER, FIRE, SMOKE, AND MOLD (U.S. CLS. 100, 103 AND 106).

FIRST USE 12-1-2008; IN COMMERCE 12-1-2008.
ARETHA SOMERVILLE, EXAMINING ATTORNEY

CLASS 37—(Continued).

SILHOUETTE OF A WRENCH. THE THIRD CIRCLE HAS THE SILHOUETTE OF A HOUSE WITH TWO WINDOWS ON THE TOP, AND ONE DOOR BELOW. TO THE LEFT OF THE HOUSE IS THE SILHOUETTE OF A TREE. THE RIGHT CIRCLE HAS THE SILHOUETTE OF A PAINT BRUSH. ABOVE AND BELOW THESE IMAGES ARE TWO SOLID LINES. BELOW THE IMAGES AND THE LINES IS THE WORDING "THE CONTEMPORARY CRAFTSMEN" IN COPPERPLATE GOTHIC BOLD. BELOW THE WORDING IS A SINGLE LINE.

FOR AIR CONDITIONING CONTRACTOR SERVICES; BUILDING CONSTRUCTION, REMODELING AND REPAIR; CARPENTRY CONTRACTOR SERVICES; CONSTRUCTION AND RENOVATION OF BUILDINGS; CONSTRUCTION, MAINTENANCE AND RENOVATION OF PROPERTY; CONSULTATION SERVICES IN THE FIELD OF YACHT AND BOAT BUILDING, CONVERSION, RENOVATION, REFIT AND REPAIR; CUSTOM CONSTRUCTION AND BUILDING RENOVATION; DRYWALL AND PAINTING CONTRACTOR SERVICES; DRYWALL CONTRACTOR SERVICES; ELECTRICAL CONTRACTOR SERVICES; FOUNDATION CONTRACTOR SERVICES; FRAMING CONTRACTOR SERVICES; GENERAL BUILDING CONTRACTOR SERVICES; HEATING CONTRACTOR SERVICES; HOME ENERGY ASSESSMENT SERVICES FOR THE PURPOSE OF DETERMINING HOME IMPROVEMENTS NEEDED TO IMPROVE ENERGY USE AND EFFICIENCY; HVAC CONTRACTOR SERVICES; MECHANICAL CONTRACTOR SERVICES; PAINTING CONTRACTOR SERVICES; PAVING CONTRACTOR SERVICES; PLASTERING CONTRACTOR SERVICES; PLUMBING CONTRACTOR SERVICES; RENOVATION AND RESTORATION OF BUILDINGS (U.S. CLS. 100, 103 AND 106).

FIRST USE 3-1-2008; IN COMMERCE 3-1-2008.
KIMBERLY FRYE, EXAMINING ATTORNEY

SN 77-884,209. ATLROOF.COM AND CONSTRUCTION INC., SHARPSBURG, GA. FILED 12-2-2009.



NO CLAIM IS MADE TO THE EXCLUSIVE RIGHT TO USE "ATLROOF.COM", APART FROM THE MARK AS SHOWN.

THE COLOR(S) BLACK AND BLUE IS/ARE CLAIMED AS A FEATURE OF THE MARK.

THE MARK CONSISTS OF BLACK BOLDED TEXT CAPITAL LETTERS FOR THE LETTERS "ATL", FOLLOWED WITHOUT SPACE BY BLACK STANDARD TEXT LOWERCASE LETTERS FOR THE LETTERS "ROOF", FOLLOWED WITHOUT SPACE BY BLACK STANDARD TEXT LOWERCASE LETTERS FOR THE SYMBOL AND LETTERS ".COM". THE LITERAL ELEMENT "ATLROOF.COM" IS BENEATH A BLUE LINE WHICH COVERS IT FROM END TO END. THE BLUE LINE RUNS HORIZONTALLY AND FORMS THE OUTLINE OF THE ROOFLINES OF THREE NEIGHBORING HOUSES.

FOR BUILDING CONSTRUCTION AND REPAIR; GENERAL BUILDING CONTRACTOR SERVICES; RESIDENTIAL AND COMMERCIAL BUILDING CONSTRUCTION; ROOFING CONSULTATION; ROOFING CONTRACTING; ROOFING INSTALLATION; ROOFING REPAIR; ROOFING SERVICES (U.S. CLS. 100, 103 AND 106).

FIRST USE 5-1-1998; IN COMMERCE 5-1-1998.
NAPOLEON SHARMA, EXAMINING ATTORNEY

SN 77-879,208. THE CONTEMPORARY CRAFTSMEN LLC, DBA THE CONTEMPORARY CRAFTSMEN, BURKE, VA. FILED 11-23-2009.



NO CLAIM IS MADE TO THE EXCLUSIVE RIGHT TO USE "CRAFTSMEN", APART FROM THE MARK AS SHOWN.

THE MARK CONSISTS OF FOUR CIRCLES OF THE SAME SIZE IN LINE WITH EACH OTHER. THE LEFT MOST CIRCLE HAS THE IMAGE OF A CLAW HAMMER WITHIN IT, THE SECOND CIRCLE FROM THE LEFT HAS A

CLASS 37—(Continued).

SN 77-884,317. AETNA BUILDING MAINTENANCE, INC., COLUMBUS, OH. FILED 12-2-2009.



THE COLOR(S) GREEN AND BLUE IS/ARE CLAIMED AS A FEATURE OF THE MARK.

THE MARK CONSISTS OF A TWO COLOR GREEN TO BLUE BOX WITH A GREEN AND BLUE "A" WITH A ELM LEAF AS PART OF THE "A".

FOR CLEANING OF BUILDINGS; CLEANING OF INDUSTRIAL PREMISES; JANITORIAL SERVICES (U.S. CLS. 100, 103 AND 106).

FIRST USE 10-16-2009; IN COMMERCE 10-16-2009.

JOHN DALIER, EXAMINING ATTORNEY

CLASS 37—(Continued).

SN 77-884,725. DFW COMFORT EXPERTS, INC., DBA STARK SERVICE CO, HURST, TX. FILED 12-2-2009.

Stark Service Co

THE MARK CONSISTS OF STANDARD CHARACTERS WITHOUT CLAIM TO ANY PARTICULAR FONT, STYLE, SIZE, OR COLOR.

NO CLAIM IS MADE TO THE EXCLUSIVE RIGHT TO USE "SERVICE CO", APART FROM THE MARK AS SHOWN.

FOR PLUMBING CONTRACTOR SERVICES (U.S. CLS. 100, 103 AND 106).

FIRST USE 2-1-2006; IN COMMERCE 2-1-2006.

JANICE KIM, EXAMINING ATTORNEY

SN 77-884,358. AETNA BUILDING MAINTENANCE, INC., COLUMBUS, OH. FILED 12-2-2009.

Think Green Think Aetna

THE MARK CONSISTS OF STANDARD CHARACTERS WITHOUT CLAIM TO ANY PARTICULAR FONT, STYLE, SIZE, OR COLOR.

FOR CLEANING OF BUILDINGS; CLEANING OF INDUSTRIAL PREMISES; JANITORIAL SERVICES (U.S. CLS. 100, 103 AND 106).

FIRST USE 10-16-2009; IN COMMERCE 10-16-2009.

JOHN DALIER, EXAMINING ATTORNEY

SN 77-884,832. DFW COMFORT EXPERTS, INC, DBA STARK AIR, HURST, TX. FILED 12-2-2009.



SN 77-884,708. DFW COMFORT EXPERTS, INC, DBA STARK AIR, HURST, TX. FILED 12-2-2009.

Stark Air

THE MARK CONSISTS OF STANDARD CHARACTERS WITHOUT CLAIM TO ANY PARTICULAR FONT, STYLE, SIZE, OR COLOR.

NO CLAIM IS MADE TO THE EXCLUSIVE RIGHT TO USE "AIR", APART FROM THE MARK AS SHOWN.

FOR HVAC CONTRACTOR SERVICES (U.S. CLS. 100, 103 AND 106).

FIRST USE 1-2-2000; IN COMMERCE 1-2-2000.

LEIGH CAROLINE CASE, EXAMINING ATTORNEY

THE COLOR(S) GREEN, RED, WHITE AND BLUE IS/ARE CLAIMED AS A FEATURE OF THE MARK.

THE MARK CONSISTS OF A CIRCLE WITH OUTER GREEN EDGE FILLED WITH VARYING SHADE OF RED FROM DARK TO LIGHT TOWARD THE CENTER. A LARGE WHITE CHECK MARK IS INSIDE THE CIRCLE WITH WORDING "STARK SEAL OF SAFETY" IN WHITE LETTERS OUTLINED IN BLUE.

FOR HVAC CONTRACTOR SERVICES (U.S. CLS. 100, 103 AND 106).

FIRST USE 2-1-2007; IN COMMERCE 2-1-2007.

LEIGH CAROLINE CASE, EXAMINING ATTORNEY

CLASS 37—(Continued).

SN 77-885,346. TECH GURU, LLC, MINNEAPOLIS, MN. FILED 12-3-2009.

enlightened IT for business

THE MARK CONSISTS OF STANDARD CHARACTERS WITHOUT CLAIM TO ANY PARTICULAR FONT, STYLE, SIZE, OR COLOR.

NO CLAIM IS MADE TO THE EXCLUSIVE RIGHT TO USE "IT FOR BUSINESS", APART FROM THE MARK AS SHOWN.

FOR COMPUTER INSTALLATION AND REPAIR (U.S. CLS. 100, 103 AND 106).

FIRST USE 7-17-2007; IN COMMERCE 7-17-2007.

DAVID HOFFMAN, EXAMINING ATTORNEY

SN 77-885,808. PACIFIC RENOVATIONS INC., SAN JOSE, CA. FILED 12-3-2009.



NO CLAIM IS MADE TO THE EXCLUSIVE RIGHT TO USE "RENOVATIONS", APART FROM THE MARK AS SHOWN.

THE MARK CONSISTS OF STYLIZED HOUSE WITH A CURVED ROOF, MULTIPLE WINDOWS AND TWO DOORS AND A CURVED LINE UNDER THE WORDS "PACIFIC RENOVATIONS."

FOR BUILDING CONSTRUCTION; BUILDING CONSTRUCTION, REMODELING AND REPAIR; GENERAL CONSTRUCTION CONTRACTING (U.S. CLS. 100, 103 AND 106).

FIRST USE 8-17-2005; IN COMMERCE 8-17-2005.

EDWARD NELSON, EXAMINING ATTORNEY

CLASS 37—(Continued).

SN 77-886,212. WALTON FACILITIES MANAGEMENT, INC., CALABASAS, CA. FILED 12-4-2009.



THE COLOR(S) CHARTREUSE, LIGHT BLUE, WHITE AND DARK GRAY IS/ARE CLAIMED AS A FEATURE OF THE MARK.

THE MARK CONSISTS OF TWO TRIANGLES, ONE OF WHICH IS CHARTREUSE AND THE OTHER LIGHT BLUE, WITHIN A WHITE BOX-SHAPED BACKGROUND WITH SHAVED OFF EDGES, SURROUNDED BY DARK GRAY SHADOWING.

FOR INSTALLATION AND REPLACEMENT SERVICE FOR HEATING, VENTILATING AND AIR CONDITIONING SYSTEMS; JANITORIAL SERVICES; REPAIR OR MAINTENANCE OF AIR-CONDITIONING APPARATUS (U.S. CLS. 100, 103 AND 106).

FIRST USE 11-16-2009; IN COMMERCE 11-16-2009.

GEORGE LORENZO, EXAMINING ATTORNEY

SN 77-886,951. FINDLAY AUTOMOTIVE, INC., LAS VEGAS, NV. FILED 12-5-2009.



THE COLOR(S) ORANGE AND WHITE IS/ARE CLAIMED AS A FEATURE OF THE MARK.

THE MARK CONSISTS OF THE STYLIZED WORDING "ZM" IN ORANGE, LOCATED WITHIN A MISCELLANEOUS ORANGE CIRCULAR DESIGN.

FOR AUTOMOTIVE MAINTENANCE AND REPAIR; AUTOMOTIVE MAINTENANCE SERVICES, NAMELY, AUTOMOTIVE UPGRADING (U.S. CLS. 100, 103 AND 106).

FIRST USE 10-1-2009; IN COMMERCE 10-1-2009.

CHERYL CLAYTON, EXAMINING ATTORNEY

CLASS 37—(Continued).

SN 77-887,119. POOL SERVICES TECHNOLOGIES, INC., ESCONDIDO, CA. FILED 12-6-2009.

PURIPOOL

THE MARK CONSISTS OF STANDARD CHARACTERS WITHOUT CLAIM TO ANY PARTICULAR FONT, STYLE, SIZE, OR COLOR.

FOR SWIMMING POOL CLEANING SERVICES; SWIMMING POOL MAINTENANCE (U.S. CLS. 100, 103 AND 106).

BRENDAN MCCAULEY, EXAMINING ATTORNEY



SN 77-887,285. HVAC OF LEXINGTON, INC., LEXINGTON, KY. FILED 12-7-2009.

CALL THE COMFORT MAN

THE MARK CONSISTS OF STANDARD CHARACTERS WITHOUT CLAIM TO ANY PARTICULAR FONT, STYLE, SIZE, OR COLOR.

FOR INSTALLATION, MAINTENANCE AND REPAIR OF RESIDENTIAL AND COMMERCIAL HEATING, VENTILATION AND AIR CONDITIONING SYSTEMS (U.S. CLS. 100, 103 AND 106).

APRIL ROACH, EXAMINING ATTORNEY



SN 77-888,016. DUST BUNNIES, HOLLYWOOD, SC. FILED 12-7-2009.

DUST BUNNIES

THE MARK CONSISTS OF STANDARD CHARACTERS WITHOUT CLAIM TO ANY PARTICULAR FONT, STYLE, SIZE, OR COLOR.

FOR CLEANING OF RESIDENTIAL HOUSES; CLEANING OF COMMERCIAL OFFICES AND BUSINESSES (U.S. CLS. 100, 103 AND 106).

FIRST USE 2-1-2009; IN COMMERCE 2-1-2009.
MICHAEL WEBSTER, EXAMINING ATTORNEY

CLASS 37—(Continued).

SN 77-888,721. MAINLINE SUBSTATION CONSTRUCTION & SERVICE INC., BRANDON, SD. FILED 12-8-2009.

MAINLINE SUBSTATION CONSTRUCTION & SERVICE INC.

THE MARK CONSISTS OF STANDARD CHARACTERS WITHOUT CLAIM TO ANY PARTICULAR FONT, STYLE, SIZE, OR COLOR.

NO CLAIM IS MADE TO THE EXCLUSIVE RIGHT TO USE "SUBSTATION CONSTRUCTION & SERVICE INC.", APART FROM THE MARK AS SHOWN.

FOR CONSTRUCTION OF BUILDINGS AND FACILITIES, NAMELY, BUILDING OF SUBSTATIONS FOR UTILITY COMPANIES AND WIND FARMS (U.S. CLS. 100, 103 AND 106).

SUSAN RICHARDS, EXAMINING ATTORNEY



SN 77-888,931. RING, FRANKLIN DOUGLAS JR., BRENTWOOD, CA. FILED 12-8-2009.

HUSBANDS 2 GO

THE MARK CONSISTS OF STANDARD CHARACTERS WITHOUT CLAIM TO ANY PARTICULAR FONT, STYLE, SIZE, OR COLOR.

OWNER OF U.S. REG. NO. 3,150,055.

FOR BUILDING CONSTRUCTION AND REPAIR; ELECTRICAL REPAIRS, MAINTENANCE, AND INSTALLATION OF ELECTRICAL WIRING, OUTLETS, LIGHT FIXTURES, AND ELECTRICAL PANELS; GENERAL CONTRACTOR SERVICES, NAMELY, PLUMBING, HEATING AND AIR CONDITIONING, CARPENTRY, DRYWALL, PAINTING, ELECTRICAL, BUILDING AND FRAMING CONTRACTOR SERVICES; HANDYMAN SERVICE, NAMELY, BUILDING REPAIR AND MAINTENANCE; HOUSE PAINTING; MAINTENANCE AND/OR REPAIR OF FURNITURE; PLUMBING SERVICES; PRESSURE WASHING SERVICES; REAL ESTATE PROPERTY CLEANING, REPAIR AND MAINTENANCE SERVICES (U.S. CLS. 100, 103 AND 106).

FIRST USE 1-1-2005; IN COMMERCE 1-1-2005.
MICHELE SWAIN, EXAMINING ATTORNEY

CLASS 37—(Continued).

SN 77-889,638. BLAKE-ALI, INC., DALLAS, TX. FILED 12-9-2009.

LEGENDS ROOFING

THE MARK CONSISTS OF STANDARD CHARACTERS WITHOUT CLAIM TO ANY PARTICULAR FONT, STYLE, SIZE, OR COLOR.

NO CLAIM IS MADE TO THE EXCLUSIVE RIGHT TO USE "ROOFING", APART FROM THE MARK AS SHOWN. FOR ROOFING SERVICES (U.S. CLS. 100, 103 AND 106).

FIRST USE 7-2-2003; IN COMMERCE 9-0-2004.
KEVON CHISOLM, EXAMINING ATTORNEY

CLASS 37—(Continued).

SN 77-890,606. THE KLINGLER GROUP, L.L.C., CHANDLER, AZ. FILED 12-10-2009.

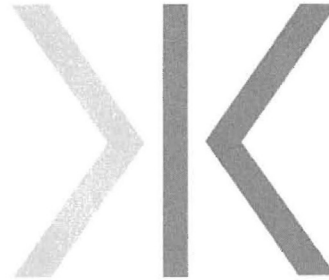

OWNER OF U.S. REG. NO. 3,687,836.

THE MARK CONSISTS OF A HORIZONTAL MIRROR IMAGE OF THE LETTER "K", WITH THE BACKWARDS "K" ON THE LEFT SHARING THE VERTICAL BACKBONE FOR THE RIGHT-FACING "K". THE LEFT MOST SIDE OF THE IMAGE IS LIGHTER. THE RIGHT-FACING "K", INCLUDING THE VERTICAL BACKBONE, IS A DARKER SHADE.

FOR CONSULTING IN THE FIELD OF BUILDING CONSTRUCTION (U.S. CLS. 100, 103 AND 106).

FIRST USE 12-5-2009; IN COMMERCE 12-7-2009.
RICHARD WHITE, EXAMINING ATTORNEY

SN 77-890,030. CLEAN DIESEL SPECIALISTS INC, ANAHEIM, CA. FILED 12-9-2009.



NO CLAIM IS MADE TO THE EXCLUSIVE RIGHT TO USE "CLEAN DIESEL SPECIALISTS", APART FROM THE MARK AS SHOWN.

THE MARK CONSISTS OF A CIRCLE WITH 5-6 SIDED CELLS INSIDE, "CDS" LETTERS EXTENDING FROM LOWER RIGHT SIDE OF THE CIRCLE, AND "CLEAN DIESEL SPECIALISTS" PRINTED UNDER AND TO THE RIGHT.

FOR INSTALLATION, MAINTENANCE AND REPAIR OF DIESEL EMISSION COMPLIANCE SYSTEMS (U.S. CLS. 100, 103 AND 106).

LINDSEY RUBIN, EXAMINING ATTORNEY

SN 77-890,694. HVAC OF LEXINGTON, INC., LEXINGTON, KY. FILED 12-10-2009.



NO CLAIM IS MADE TO THE EXCLUSIVE RIGHT TO USE "HEATING & AIR CONDITIONING", APART FROM THE MARK AS SHOWN.

FOR INSTALLATION, MAINTENANCE AND REPAIR OF RESIDENTIAL AND COMMERCIAL HEATING, VENTILATION AND AIR CONDITIONING SYSTEMS (U.S. CLS. 100, 103 AND 106).

APRIL ROACH, EXAMINING ATTORNEY

CLASS 37—(Continued).

SN 77-890,719. THE KLINGLER GROUP, L.L.C., CHANDLER, AZ. FILED 12-10-2009.



OWNER OF U.S. REG. NO. 3,687,836.
NO CLAIM IS MADE TO THE EXCLUSIVE RIGHT TO USE "GROUP", APART FROM THE MARK AS SHOWN.
THE MARK CONSISTS OF THE NAME "THE KLINGLER GROUP" WITH A HORIZONTAL MIRROR IMAGE OF THE LETTER "K", WITH THE BACKWARDS "K" ON THE LEFT SHARING THE VERTICAL BACKBONE FOR THE RIGHT-FACING "K". THE LEFT MOST SIDE OF THE IMAGE IS LIGHTER. THE RIGHT-FACING "K", INCLUDING THE VERTICAL BACKBONE, IS A DARKER SHADE.
FOR CONSULTING IN THE FIELD OF BUILDING CONSTRUCTION (U.S. CLS. 100, 103 AND 106).
FIRST USE 12-5-2009; IN COMMERCE 12-7-2009.
RICHARD WHITE, EXAMINING ATTORNEY

SN 77-890,768. KB PLUMBING, HEATING & COOLING, INC., DBA KB COMPLETE PLUMBING HEATING & COOLING, SHAWNEE, KS. FILED 12-10-2009.

A COMPANY YOU CAN REFER TO
A FRIEND

THE MARK CONSISTS OF STANDARD CHARACTERS WITHOUT CLAIM TO ANY PARTICULAR FONT, STYLE, SIZE, OR COLOR.
FOR HEATING, VENTILATION, AIR CONDITIONING, AND PLUMBING CONTRACTOR SERVICES (U.S. CLS. 100, 103 AND 106).
FIRST USE 0-0-2007; IN COMMERCE 0-0-2007.
EUGENIA MARTIN, EXAMINING ATTORNEY

CLASS 37—(Continued).

SN 77-891,312. VFC FRANCHISE CORPORATION, DBA VINYL FENCE & PATIO COVER COMPANY, SANTA ANA, CA. FILED 12-11-2009.



NO CLAIM IS MADE TO THE EXCLUSIVE RIGHT TO USE "VINYL FENCE & PATIO COVER COMPANY", APART FROM THE MARK AS SHOWN.

THE COLOR(S) BLUE, RED, GREY AND WHITE IS/ARE CLAIMED AS A FEATURE OF THE MARK.

THE MARK CONSISTS OF THE WORDS "VINYL" AND "FENCE" IN BLUE, WITH A RED CIRCLE OUTLINED IN GREY AND WHITE CONTAINING A WHITE DEPICTION OF A FENCE WITHIN SAID CIRCLE, BETWEEN THOSE WORDS, AND THE WORDS "PATIO" AND "COVER" IN BLUE, PRECEDED BY A GREY AMPERSAND, WITH THE WORD "COMPANY" IN GREY, UNDERNEATH THE WORD "COVER."

FOR INSTALLATION AND MAINTENANCE OF VINYL FENCING AND PATIO SURFACES, ALONG WITH PATIO COVERS (U.S. CLS. 100, 103 AND 106).

FIRST USE 8-26-2009; IN COMMERCE 8-26-2009.
JASON LOTT, EXAMINING ATTORNEY

SN 77-891,366. CHOY, JEFFREY, WINCHESTER, VA. FILED 12-11-2009.

Make Every Drop Count

THE MARK CONSISTS OF STANDARD CHARACTERS WITHOUT CLAIM TO ANY PARTICULAR FONT, STYLE, SIZE, OR COLOR.

FOR UNUSED OIL COLLECTION FOR RECYCLING (U.S. CLS. 100, 103 AND 106).
CIMMERIAN COLEMAN, EXAMINING ATTORNEY

SN 77-891,589. FIRESTONE BUILDING PRODUCTS COMPANY, LLC, INDIANAPOLIS, IN. FILED 12-11-2009.

TOTALGARD

THE MARK CONSISTS OF STANDARD CHARACTERS WITHOUT CLAIM TO ANY PARTICULAR FONT, STYLE, SIZE, OR COLOR.

FOR BUILDING MAINTENANCE AND REPAIR; BUILDING INSPECTION SERVICES, NAMELY, INSPECTION OF BUILDING ROOF SYSTEMS; CONSTRUCTION PROJECT MANAGEMENT SERVICES IN THE FIELD OF BUILDING CONSTRUCTION AND THE INSTALLATION, REPAIR AND REPLACEMENT OF ROOF SYSTEMS (U.S. CLS. 100, 103 AND 106).

FLORENTINA BLANDU, EXAMINING ATTORNEY

CLASS 37—(Continued).

SN 77-893,262. THE 4TH BIN, INC., NEW YORK, NY. FILED 12-14-2009.

THE 4TH BIN

THE MARK CONSISTS OF STANDARD CHARACTERS WITHOUT CLAIM TO ANY PARTICULAR FONT, STYLE, SIZE, OR COLOR.

FOR RECYCLING SERVICES, NAMELY, COLLECTION OF UNUSED ELECTRONIC EQUIPMENT FOR RESALE TO CONSUMERS OR FOR PROCESSING (U.S. CLS. 100, 103 AND 106).

FIRST USE 3-15-2009; IN COMMERCE 9-15-2009.
ALICIA COLLINS, EXAMINING ATTORNEY

SN 77-900,098. MELECCA TECH, INC., DBA PURE FILL SOLUTIONS, ST. PAUL, MN. FILED 12-23-2009.

PURE FILL

THE MARK CONSISTS OF STANDARD CHARACTERS WITHOUT CLAIM TO ANY PARTICULAR FONT, STYLE, SIZE, OR COLOR.

FOR INSTALLATION AND MAINTENANCE OF RESTAURANT AND BAKERY COOKING OIL HANDLING SYSTEMS (U.S. CLS. 100, 103 AND 106).

JENNIFER MARTIN, EXAMINING ATTORNEY

SN 77-912,669. WILNER, ELI, NEW YORK, NY. FILED 1-15-2010.

ELI WILNER

THE MARK CONSISTS OF STANDARD CHARACTERS WITHOUT CLAIM TO ANY PARTICULAR FONT, STYLE, SIZE, OR COLOR.

THE NAME(S), PORTRAIT(S), AND/OR SIGNATURE(S) SHOWN IN THE MARK IDENTIFIES "ELI WILNER", WHOSE CONSENT(S) TO REGISTER IS MADE OF RECORD.

FOR RESTORATION IN THE FIELD OF FRAMES (U.S. CLS. 100, 103 AND 106).

VIVIAN MICZNIK FIRST, EXAMINING ATTORNEY

CLASS 37—(Continued).

SN 77-914,321. DORNIER, CONRADO, 82547 BEUERBERG, FED REP GERMANY, FILED 1-19-2010.

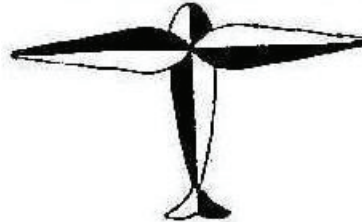

THE MARK CONSISTS OF A STYLIZED AIRPLANE. FOR SERVICES RELATED TO VEHICLES, APPARATUS FOR LOCOMOTION BY LAND, AIR OR WATER, NAMELY, MAINTENANCE AND REPAIR SERVICES FOR SEAPLANES, AIRPLANES, BOATS (U.S. CLS. 100, 103 AND 106).

JENNIFER HETU, EXAMINING ATTORNEY

SN 77-941,518. TAVARES, TULLY M, DBA FAIR DOLLAR PLUMBING AND DRAIN SERVICES, ASHBURN, VA. FILED 2-22-2010.

FAIR DOLLAR PLUMBING AND DRAIN CLEANING

THE MARK CONSISTS OF STANDARD CHARACTERS WITHOUT CLAIM TO ANY PARTICULAR FONT, STYLE, SIZE, OR COLOR.

OWNER OF U.S. REG. NOS. 2,749,372 AND 3,745,639. NO CLAIM IS MADE TO THE EXCLUSIVE RIGHT TO USE "PLUMBING AND DRAIN CLEANING", APART FROM THE MARK AS SHOWN.

FOR PLUMBING AND DRAIN CLEANING AND REPAIR SERVICES, INSTALLATION AND REPAIR OF HOT WATER HEATERS, PIPES, FAUCETS, TUBS, SHOWERS, TOILETS AND OTHER PLUMBING FIXTURES; DRAIN CLEANING SERVICES. FIRST USE: 19970103. FIRST USE IN COMMERCE: 19970114 (U.S. CLS. 100, 103 AND 106).

FIRST USE 1-3-1997; IN COMMERCE 1-14-1997.
SHANNON TWOHIG, EXAMINING ATTORNEY

CLASS 38—COMMUNICATION

SN 76-698,508. L-3 COMMUNICATIONS CORPORATION, NEW YORK, NY. FILED 7-20-2009.



OWNER OF U.S. REG. NO. 3,499,697.
NO CLAIM IS MADE TO THE EXCLUSIVE RIGHT TO USE "COMMUNICATIONS", APART FROM THE MARK AS SHOWN.
FOR TELECOMMUNICATIONS GATEWAY SERVICES, TELECOMMUNICATIONS SERVICES, NAMELY, PERSONAL COMMUNICATIONS SERVICES (U.S. CLS. 100, 101 AND 104).
FIRST USE 5-1-1997; IN COMMERCE 5-1-1997.
RON FAIRBANKS, EXAMINING ATTORNEY

CLASS 38—(Continued).

SN 76-700,747. D&M ENTERPRISE GROUP, LLC, HOLMDEL, NJ. FILED 12-9-2009.



NO CLAIM IS MADE TO THE EXCLUSIVE RIGHT TO USE "ENTERPRISE GROUP", APART FROM THE MARK AS SHOWN.
THE COLOR(S) GOLD AND GREEN IS/ARE CLAIMED AS A FEATURE OF THE MARK.
THE MARK CONSISTS OF TWO GOLD INTERSECTING OVALS WITH THE WORDING "D&M ENTERPRISE GROUP" APPEARING IN THE COLOR GREEN IN THE CENTER OF THE DESIGN.
FOR TELECOMMUNICATION SERVICES, NAMELY, PROVIDING LOCAL AND LONG DISTANCE TRANSMISSION OF VOICE, DATA, GRAPHICS BY MEANS OF TELEPHONE, TELEGRAPHIC, CABLE, AND SATELLITE TRANSMISSIONS (U.S. CLS. 100, 101 AND 104).
FIRST USE 6-1-2004; IN COMMERCE 6-1-2004.
COLLEEN KEARNEY, EXAMINING ATTORNEY

SN 76-699,560. CBS RADIO INC., NEW YORK, NY. FILED 9-21-2009.

FRESH

THE MARK CONSISTS OF STANDARD CHARACTERS WITHOUT CLAIM TO ANY PARTICULAR FONT, STYLE, SIZE, OR COLOR.
OWNER OF U.S. REG. NOS. 3,308,589, 3,521,272 AND OTHERS.
FOR RADIO BROADCASTING SERVICES AND BROADCASTING SERVICES, NAMELY, STREAMING OF AUDIO MATERIAL VIA THE GLOBAL COMMUNICATION NETWORK (U.S. CLS. 100, 101 AND 104).
FIRST USE 1-2-2007; IN COMMERCE 1-2-2007.
MYRIAH HABEEB, EXAMINING ATTORNEY

SN 76-700,850. CREATIVE MANAGER, INC., OAKHURST, NJ. FILED 12-14-2009.

GROUPAMAJIG

THE MARK CONSISTS OF STANDARD CHARACTERS WITHOUT CLAIM TO ANY PARTICULAR FONT, STYLE, SIZE, OR COLOR.
OWNER OF U.S. REG. NO. 3,512,958.
FOR PROVIDING AN ON-LINE DISCUSSION FORUM FOR TRANSMISSION OF MESSAGES AMONG COMPUTER USERS CONCERNING BUSINESS MANAGEMENT STRATEGY AND WORKFLOW, AS WELL AS BUSINESS MANAGEMENT SOFTWARE (U.S. CLS. 100, 101 AND 104).
FIRST USE 5-0-2008; IN COMMERCE 5-0-2008.
MICHAEL WIENER, EXAMINING ATTORNEY

CLASS 38—(Continued).

SN 77-374,075. JOÃO BATISTA DA CRUZ NETO, AVEN-
TURA, FL. FILED 1-17-2008.

CLASS 38—(Continued).

SN 77-655,475. DEUTSCHE TELEKOM A.G., BONN, FED
REP GERMANY, FILED 1-23-2009.



NO CLAIM IS MADE TO THE EXCLUSIVE RIGHT TO USE "VIDEO", APART FROM THE MARK AS SHOWN.

THE MARK CONSISTS OF THE LETTERS "Y" & "V" IN STYLIZED FORM WITHIN A CIRCLE. "YVIDEOO" TO THE RIGHT.

THE WORD "YVIDEOO" HAS NO FOREIGN MEANING IN A FOREIGN LANGUAGE.

FOR AUDIO AND VIDEO BROADCASTING SERVICES OVER THE INTERNET OR ELECTRONIC COMMUNICATIONS NETWORK, NAMELY, PROVIDING A WEBSITE FEATURING TECHNOLOGY THAT ENABLES USERS TO SHARE VIDEOS ON A WIDE VARIETY OF TOPICS AND SUBJECTS; PROVIDING ONLINE FORUMS AND CHAT ROOMS FOR TRANSMISSION OF MESSAGES AMONG COMPUTER USERS IN THE FIELD OF GENERAL INTEREST OVER THE INTERNET; AND TRANSMISSION OF INFORMATION AND VIDEO CLIPS BY ELECTRONIC COMMUNICATIONS NETWORKS, NAMELY, A COMPUTER SYSTEM (U.S. CLS. 100, 101 AND 104).

FIRST USE 12-13-2007; IN COMMERCE 12-13-2007.

NAKIA HENRY, EXAMINING ATTORNEY

PRIORITY CLAIMED UNDER SEC. 44(D) ON ERPN CMNTY TM OFC APPLICATION NO. 007517881, FILED 1-13-2009, REG. NO. 007517881, DATED 10-28-2009, EXPIRES 1-13-2019.

PRIORITY CLAIMED UNDER SEC. 44(D) ON FED REP GERMANY APPLICATION NO. 302008047717, FILED 7-24-2008, REG. NO. 302008047717, DATED 7-24-2008, EXPIRES 7-24-2018.

THE MARK CONSISTS OF THE PHRASE "STREET GIGS" IN CAPITAL LETTERS OUTLINED BY A THIN LINE, ALL AGAINST A DECORATIVE BACKGROUND.

FOR TELECOMMUNICATIONS SERVICES, NAMELY, WIRELESS PHONE SERVICES AND PERSONAL COMMUNICATION SERVICES; ELECTRIC, DIGITAL, CELLULAR AND WIRELESS TRANSMISSION OF VOICE, DATA, INFORMATION, IMAGES, SIGNALS, AND MESSAGES VIA TELEPHONE, TELEVISION AND GLOBAL COMMUNICATIONS NETWORKS; PROVIDING TELECOMMUNICATIONS CONNECTIONS OVER A GLOBAL COMMUNICATIONS NETWORK; ELECTRONIC MAIL SERVICES; VOICE MAIL AND MESSAGING SERVICES, NAMELY, THE RECORDING AND STORAGE AND SUBSEQUENT TRANSMISSION OF VOICE MESSAGES BY TELEPHONE; AUDIO AND VIDEO TELECONFERENCING; RENTAL OF EQUIPMENT FOR TELECOMMUNICATIONS, NAMELY, EQUIPMENT FOR TRANSMITTING, RECEIVING, RECORDING, MONITORING, OPERATING AND ACCESSING TELECOMMUNICATIONS SYSTEMS; PAGING SERVICES; PROVIDING MULTIPLE-USER ACCESS TO A GLOBAL COMMUNICATIONS NETWORK; MOBILE MEDIA SERVICES IN THE NATURE OF ELECTRONIC TRANSMISSION OF ENTERTAINMENT MEDIA CONTENT; AUDIO AND VIDEO BROADCASTING FEATURING ENTERTAINMENT IN THE NATURE OF LIVE VISUAL AND AUDIO PERFORMANCES OF MUSICAL, VARIETY, NEWS AND COMEDY SHOWS; PROVIDING ON-LINE FORUMS FOR TRANSMISSION OF MESSAGES AMONG COMPUTER USERS CONCERNING ENTERTAINMENT IN THE NATURE OF LIVE VISUAL AND AUDIO PERFORMANCES OF MUSICAL, VARIETY, NEWS AND COMEDY SHOWS (U.S. CLS. 100, 101 AND 104).

SHAILA SETTLES, EXAMINING ATTORNEY

CLASS 38—(Continued).

SN 77-735,380. SMEAK, INC., SARATOGA, CA. FILED 5-12-2009.

SMEAK

THE MARK CONSISTS OF STANDARD CHARACTERS WITHOUT CLAIM TO ANY PARTICULAR FONT, STYLE, SIZE, OR COLOR.

FOR TELECOMMUNICATION ACCESS SERVICES, NAMELY, PROVIDING ONLINE AND TELECOMMUNICATION FACILITIES FOR REALTIME INTERACTION BETWEEN AND AMONG USERS OF COMPUTERS, MOBILE AND HANDHELD COMPUTERS, WIRED AND WIRELESS COMMUNICATION DEVICES, AND AUTONOMOUS CENTRAL SERVERS, ENABLING INDIVIDUALS TO SEND AND RECEIVE MESSAGES VIA EMAIL AND INSTANT MESSAGING OR BY AN INTERACTIVE WEBSITE; PROVIDING ON-LINE CHAT ROOMS AND ELECTRONIC BULLETIN BOARDS FOR TRANSMISSION OF MESSAGES AMONG USERS IN THE FIELD OF GENERAL INTEREST; PROVIDING AN ONLINE COMMUNITY FORUM FOR USERS TO SHARE INFORMATION, PHOTOS, AUDIO AND VIDEO CONTENT ABOUT THEMSELVES, THEIR LIKES AND DISLIKES AND DAILY ACTIVITIES, TO GET FEEDBACK FROM THEIR PEERS (U.S. CLS. 100, 101 AND 104).

TIMOTHY FINNEGAN, EXAMINING ATTORNEY

SN 77-738,876. SYSTEMS TECHNOLOGY FORUM, LTD., FREDERICKSBURG, VA. FILED 5-17-2009.



NO CLAIM IS MADE TO THE EXCLUSIVE RIGHT TO USE "SYSTEMS TECHNOLOGY", APART FROM THE MARK AS SHOWN.

THE MARK CONSISTS OF AN UNIFORM OVAL INCLUDING THE WORDING "STF" AND "SYSTEMS TECHNOLOGY FORUM" AND CONTAINING A CRESCENT SHAPE BORDERING THE "STF" WORDING.

FOR ELECTRONIC COMMERCE SERVICES, NAMELY, ELECTRONIC TRANSMISSION AND RECEPTION OF DATA, DOCUMENTS, AND INFORMATION VIA COMPUTER; ELECTRONIC DATA INTERCHANGE NETWORK SERVICES (U.S. CLS. 100, 101 AND 104).

FIRST USE 1-0-2004; IN COMMERCE 1-0-2004.
DAVID HOFFMAN, EXAMINING ATTORNEY

CLASS 38—(Continued).

SN 77-738,884. SYSTEMS TECHNOLOGY FORUM, LTD., FREDERICKSBURG, VA. FILED 5-17-2009.

SYSTEMS TECHNOLOGY FORUM

THE MARK CONSISTS OF STANDARD CHARACTERS WITHOUT CLAIM TO ANY PARTICULAR FONT, STYLE, SIZE, OR COLOR.

NO CLAIM IS MADE TO THE EXCLUSIVE RIGHT TO USE "SYSTEMS TECHNOLOGY", APART FROM THE MARK AS SHOWN.

FOR ELECTRONIC COMMERCE SERVICES, NAMELY, ELECTRONIC TRANSMISSION AND RECEPTION OF DATA, DOCUMENTS, AND INFORMATION VIA COMPUTER; ELECTRONIC DATA INTERCHANGE NETWORK SERVICES (U.S. CLS. 100, 101 AND 104).

FIRST USE 4-17-2003; IN COMMERCE 4-17-2003.
DAVID HOFFMAN, EXAMINING ATTORNEY

SN 77-747,151. CLARENDON FOUNDATION, INC., LAS VEGAS, NV. FILED 5-28-2009.

VUSION

THE MARK CONSISTS OF STANDARD CHARACTERS WITHOUT CLAIM TO ANY PARTICULAR FONT, STYLE, SIZE, OR COLOR.

FOR STREAMING OF VIDEO MATERIAL ON THE INTERNET (U.S. CLS. 100, 101 AND 104).

MARC LEIPZIG, EXAMINING ATTORNEY

SN 77-750,644. BANDWIDTH.COM, INC., CARY, NC. FILED 6-3-2009.

BANDWIDTH.COM

THE MARK CONSISTS OF STANDARD CHARACTERS WITHOUT CLAIM TO ANY PARTICULAR FONT, STYLE, SIZE, OR COLOR.

OWNER OF U.S. REG. NO. 2,664,707.

SEC. 2(F).

FOR COMMUNICATION SERVICES, NAMELY, TRANSMISSION OF VOICE, AUDIO, VISUAL IMAGES AND DATA BY TELECOMMUNICATIONS NETWORKS, WIRELESS COMMUNICATION NETWORKS, THE INTERNET, INFORMATION SERVICES NETWORKS AND DATA NETWORKS; PROVIDING TELECOMMUNICATION CONNECTIONS TO THE INTERNET OR DATABASES; PROVIDING TELEPHONE CONFERENCING SERVICES; WEB CONFERENCING SERVICES (U.S. CLS. 100, 101 AND 104).

FIRST USE 0-0-1999; IN COMMERCE 0-0-1999.

KATHERINE M. DUBRAY, EXAMINING ATTORNEY

CLASS 38—(Continued).

SN 77-753,479. UBTA-UBET COMMUNICATIONS, INC., ROOSEVELT, UT. FILED 6-5-2009.

UBTA-UBET

THE MARK CONSISTS OF STANDARD CHARACTERS WITHOUT CLAIM TO ANY PARTICULAR FONT, STYLE, SIZE, OR COLOR.

OWNER OF U.S. REG. NOS. 2,195,914 AND 2,198,432.

FOR TELECOMMUNICATIONS SERVICES, NAMELY, CELLULAR TELEPHONE AND PAGING SERVICES, SATELLITE TRANSMISSION SERVICES, SATELLITE TELEVISION BROADCASTING SERVICES, PROVIDING MULTIPLE-USER ACCESS TO A GLOBAL COMPUTER INFORMATION NETWORK, TELEPHONE SERVICES (U.S. CLS. 100, 101 AND 104).

RUSS HERMAN, EXAMINING ATTORNEY

SN 77-753,487. UBTA-UBET COMMUNICATIONS, INC., ROOSEVELT, UT. FILED 6-5-2009.



OWNER OF U.S. REG. NOS. 2,195,914 AND 2,198,432.
NO CLAIM IS MADE TO THE EXCLUSIVE RIGHT TO USE "COMMUNICATIONS", APART FROM THE MARK AS SHOWN.

THE MARK CONSISTS OF THE WORDING "UBTA-UBET" UNDERLINED, WITH THE WORDING "COMMUNICATIONS" UNDERLINED BENEATH.

FOR TELECOMMUNICATIONS SERVICES, NAMELY, CELLULAR TELEPHONE AND PAGING SERVICES, SATELLITE TRANSMISSION SERVICES, SATELLITE TELEVISION BROADCASTING SERVICES, PROVIDING MULTIPLE-USER ACCESS TO A GLOBAL COMPUTER INFORMATION NETWORK, TELEPHONE SERVICES (U.S. CLS. 100, 101 AND 104).

RUSS HERMAN, EXAMINING ATTORNEY

CLASS 38—(Continued).

SN 77-766,172. FIBERTOWER CORPORATION, SAN FRANCISCO, CA. FILED 6-23-2009.

BROADBAND FUELED

THE MARK CONSISTS OF STANDARD CHARACTERS WITHOUT CLAIM TO ANY PARTICULAR FONT, STYLE, SIZE, OR COLOR.

NO CLAIM IS MADE TO THE EXCLUSIVE RIGHT TO USE "BROADBAND", APART FROM THE MARK AS SHOWN.

FOR COMMUNICATION VIA FIBRE OPTICAL NETWORKS; PROVIDING ELECTRONIC TELECOMMUNICATION CONNECTIONS; PROVIDING THIRD PARTY USERS WITH ACCESS TO TELECOMMUNICATION INFRASTRUCTURE; WIRELESS BROADBAND COMMUNICATION SERVICES; WIRELESS ELECTRONIC TRANSMISSION OF VOICE SIGNALS, DATA, FACSIMILES, IMAGES AND INFORMATIONS (U.S. CLS. 100, 101 AND 104).

LAURA KOVALSKY, EXAMINING ATTORNEY

SN 77-767,331. OWN LLC, WESTLAKE VILLAGE, CA. FILED 6-24-2009.



THE MARK CONSISTS OF THE ACRONYM "OWN" IN STYLIZED LETTERS.

FOR COMMUNICATIONS SERVICES, NAMELY, TRANSMITTING STREAMED SOUND AND AUDIO-VISUAL RECORDINGS VIA THE INTERNET, CABLE NETWORKS, WIRELESS NETWORKS, SATELLITE, OR INTERACTIVE MULTIMEDIA NETWORKS; AUDIO AND VIDEO BROADCASTING SERVICES OVER THE INTERNET; TRANSMISSION OF INFORMATION IN THE AUDIO-VISUAL FIELD; TELEVISION BROADCASTING SERVICES; CABLE TELEVISION BROADCASTING; SATELLITE TELEVISION BROADCASTING; MOBILE MEDIA SERVICES IN THE NATURE OF ELECTRONIC TRANSMISSION OF ENTERTAINMENT MEDIA CONTENT; PODCASTING SERVICES; WEBCASTING SERVICES; VIDEO-ON-DEMAND TRANSMISSION SERVICES; PROVIDING ON-LINE CHAT ROOMS AND ELECTRONIC BULLETIN BOARDS FOR TRANSMISSION OF MESSAGES AMONG USERS IN THE FIELD OF GENERAL INTEREST (U.S. CLS. 100, 101 AND 104).

LINDA M. KING, EXAMINING ATTORNEY

CLASS 38—(Continued).

SN 77-801,756. JASWANT TECHNOLOGIES, INC., IRVING, TX. FILED 8-11-2009.

Just BugMe

THE MARK CONSISTS OF STANDARD CHARACTERS WITHOUT CLAIM TO ANY PARTICULAR FONT, STYLE, SIZE, OR COLOR.

FOR ELECTRONIC MESSAGE SENDING; ELECTRONIC MESSAGING SYSTEM, NAMELY, ELECTRONIC QUEUING SERVICES; ELECTRONIC STORE-AND-FORWARD MESSAGING; INSTANT MESSAGING SERVICES; INTERNET BASED PAGING AND ALERTING SERVICES, NAMELY, PROVIDING A WEB SITE AT WHICH USERS CAN SEND MESSAGES TO ELECTRONIC PAGING DEVICES; MESSAGE SENDING AND RECEIVING SERVICES; MESSAGE SENDING, RECEIVING AND FORWARDING; ON-LINE SERVICES, NAMELY, MESSAGE SENDING; PROVIDING E-MAIL AND INSTANT MESSAGING SERVICES; PROVIDING ON-LINE ELECTRONIC BULLETIN BOARDS FOR TRANSMISSION OF MESSAGES AMONG COMPUTER USERS CONCERNING CALENDARS AND REMINDER ITEMS; PROVIDING ON-LINE FORUMS FOR TRANSMISSION OF MESSAGES AMONG COMPUTER USERS; VIRTUAL CHATROOMS ESTABLISHED VIA TEXT MESSAGING; WEB MESSAGING (U.S. CLS. 100, 101 AND 104).

FIRST USE 8-9-2009; IN COMMERCE 8-9-2009.
ADA HAN, EXAMINING ATTORNEY

SN 77-808,912. TREMOR MEDIA, INC., NEW YORK, NY. FILED 8-20-2009.

VCHOICE

THE MARK CONSISTS OF STANDARD CHARACTERS WITHOUT CLAIM TO ANY PARTICULAR FONT, STYLE, SIZE, OR COLOR.

FOR BROADCASTING AND STREAMING OF AUDIO, VISUAL AND AUDIOVISUAL MATERIAL IN THE FIELD OF ADVERTISING VIA THE INTERNET; DELIVERY OF INTERACTIVE AUDIO AND VIDEO OVER DIGITAL NETWORKS (U.S. CLS. 100, 101 AND 104).
MARLENE BELL, EXAMINING ATTORNEY

CLASS 38—(Continued).

SN 77-814,550. STEELE, DONALD R, ETOBICOKE, ONTARIO, CANADA, FILED 8-27-2009.

Authors Audio

THE MARK CONSISTS OF STANDARD CHARACTERS WITHOUT CLAIM TO ANY PARTICULAR FONT, STYLE, SIZE, OR COLOR.

SEC. 2(F).
FOR INTERNET BROADCASTING SERVICES (U.S. CLS. 100, 101 AND 104).
FIRST USE 12-20-2004; IN COMMERCE 12-20-2004.
ESTHER A. BORSUK, EXAMINING ATTORNEY

SN 77-819,913. MYFAB HONG KONG CORPORATION LIMITED, HONG KONG, HONG KONG, FILED 9-3-2009.

myfab

THE MARK CONSISTS OF STANDARD CHARACTERS WITHOUT CLAIM TO ANY PARTICULAR FONT, STYLE, SIZE, OR COLOR.

FOR ELECTRONIC TRANSMISSION OF DATA AND INFORMATION (U.S. CLS. 100, 101 AND 104).
CARYN GLASSER, EXAMINING ATTORNEY

SN 77-821,176. CANDICE C SMITH, OLD BROOKVILE, NY. FILED 9-6-2009.

SHOUT FRAUD

THE MARK CONSISTS OF STANDARD CHARACTERS WITHOUT CLAIM TO ANY PARTICULAR FONT, STYLE, SIZE, OR COLOR.

FOR COMMUNICATION SERVICES, NAMELY, TRANSMISSION OF VOICE, AUDIO, VISUAL IMAGES AND DATA BY TELECOMMUNICATIONS NETWORKS, WIRELESS COMMUNICATION NETWORKS, THE INTERNET, INFORMATION SERVICES NETWORKS AND DATA NETWORKS; DATA TRANSMISSION AND RECEPTION SERVICES VIA TELECOMMUNICATION MEANS; ELECTRONIC EXCHANGE OF DATA STORED IN DATABASES ACCESSIBLE VIA TELECOMMUNICATION NETWORKS; PROVIDING TELECOMMUNICATION CONNECTIONS TO THE INTERNET OR DATABASES; PROVIDING TELECOMMUNICATIONS CONNECTIONS TO A GLOBAL COMPUTER NETWORK; PROVIDING TELECOMMUNICATIONS CONNECTIONS TO THE INTERNET OR DATABASES; TELECOMMUNICATION SERVICES, NAMELY, TRANSMISSION OF

CLASS 38—(Continued).

PODCASTS; TELECOMMUNICATION SERVICES, NAMELY, TRANSMISSION OF VOICE, DATA AND DOCUMENTS, IN THE FIELD OF ENVIRONMENTAL PROTECTION; TELECOMMUNICATION SERVICES, NAMELY, TRANSMISSION OF VOICE, DATA, GRAPHICS, IMAGES, AUDIO AND VIDEO BY MEANS OF TELECOMMUNICATIONS NETWORKS, WIRELESS COMMUNICATION NETWORKS, AND THE INTERNET; TELECOMMUNICATION SERVICES, NAMELY, TRANSMISSION OF VOICE, DATA, GRAPHICS, SOUND AND VIDEO BY MEANS OF BROADBAND POWER LINE OR WIRELESS NETWORKS; TELECOMMUNICATION SERVICES, NAMELY, TRANSMISSION OF WEBCASTS; TELECOMMUNICATIONS BY E-MAIL; TELECOMMUNICATIONS CONSULTATION; TRANSFER OF DATA BY TELECOMMUNICATION; TRANSFER OF DATA BY TELECOMMUNICATIONS; TRANSMISSION AND RECEPTION OF DATABASE INFORMATION VIA THE TELECOMMUNICATION NETWORK; TRANSMISSION OF DATABASE INFORMATION VIA TELECOMMUNICATIONS NETWORKS (U.S. CLS. 100, 101 AND 104).
SKYE YOUNG, EXAMINING ATTORNEY

SN 77-822,175. UBER ENTERTAINMENT INC., KIRKLAND, WA. FILED 9-8-2009.

UBER NATION

THE MARK CONSISTS OF STANDARD CHARACTERS WITHOUT CLAIM TO ANY PARTICULAR FONT, STYLE, SIZE, OR COLOR.

THE ENGLISH TRANSLATION OF "UBER" IN THE MARK IS OVER.

FOR PROVIDING ONLINE CHAT ROOMS, FORUMS, AND BULLETIN BOARDS FOR THE TRANSMISSION OF MESSAGES IN THE FIELD OF VIDEO GAMES, SOFTWARE DEVELOPMENT, AND GENERAL INTEREST (U.S. CLS. 100, 101 AND 104).

FIRST USE 2-11-2009; IN COMMERCE 2-11-2009.
MARC LEIPZIG, EXAMINING ATTORNEY

SN 77-833,634. DONSKY, ERIC, DBA CHATMETV, INC., LAGUNA BEACH, CA. FILED 9-23-2009.

ChatMeTV

THE MARK CONSISTS OF STANDARD CHARACTERS WITHOUT CLAIM TO ANY PARTICULAR FONT, STYLE, SIZE, OR COLOR.

FOR TELECOMMUNICATIONS SERVICES FOR PROVIDING MULTIPLE-USER ACCESS TO A GLOBAL COMPUTER NETWORK (U.S. CLS. 100, 101 AND 104).

GEOFFREY FOSDICK, EXAMINING ATTORNEY

CLASS 38—(Continued).

SN 77-839,241. MOODY BIBLE INSTITUTE OF CHICAGO, CHICAGO, IL. FILED 10-1-2009.

SOUNDFILE

THE MARK CONSISTS OF STANDARD CHARACTERS WITHOUT CLAIM TO ANY PARTICULAR FONT, STYLE, SIZE, OR COLOR.

FOR RADIO PROGRAM BROADCASTING (U.S. CLS. 100, 101 AND 104).

FIRST USE 1-24-2009; IN COMMERCE 1-24-2009.
CAROLYN CATALDO, EXAMINING ATTORNEY

SN 77-843,156. PAUL A BRIA, DBA TRACKALERT.COM, GRAPEVINE, TX. FILED 10-7-2009.

TrackAlert

THE MARK CONSISTS OF STANDARD CHARACTERS WITHOUT CLAIM TO ANY PARTICULAR FONT, STYLE, SIZE, OR COLOR.

FOR COMPUTER-AIDED TRANSMISSION OF MESSAGES; DELIVERY OF MESSAGES BY ELECTRONIC TRANSMISSION; ELECTRONIC MAIL AND MESSAGING SERVICES; ELECTRONIC MESSAGE SENDING; ELECTRONIC MESSAGE TRANSMISSION; ELECTRONIC MESSAGING SYSTEM, NAMELY, ELECTRONIC QUEUING SERVICES; ELECTRONIC STORE-AND-FORWARD MESSAGING; ELECTRONIC TRANSMISSION OF MAIL AND MESSAGES; ELECTRONIC TRANSMISSION OF MESSAGES; ELECTRONIC TRANSMISSION OF MESSAGES AND DATA; ELECTRONIC, ELECTRIC, AND DIGITAL TRANSMISSION OF VOICE, DATA, IMAGES, SIGNALS, AND MESSAGES; INSTANT MESSAGING SERVICES; INTERNET BASED PAGING AND ALERTING SERVICES, NAMELY, PROVIDING A WEB SITE AT WHICH USERS CAN SEND MESSAGES TO ELECTRONIC PAGING DEVICES; MESSAGE COLLECTION AND TRANSMISSION; MESSAGE SENDING AND RECEIVING SERVICES; MESSAGE SENDING, RECEIVING AND FORWARDING; ON-LINE SERVICES, NAMELY, MESSAGE SENDING; PROVIDING E-MAIL AND INSTANT MESSAGING SERVICES; PROVIDING ON-LINE CHAT ROOMS AND ELECTRONIC BULLETIN BOARDS FOR TRANSMISSION OF MESSAGES AMONG USERS IN THE FIELD OF GENERAL INTEREST; PROVIDING ON-LINE CHAT ROOMS FOR TRANSMISSION OF MESSAGES AMONG COMPUTER USERS CONCERNING SAFETY AND SURVIVAL; PROVIDING ON-LINE ELECTRONIC BULLETIN BOARDS FOR TRANSMISSION OF MESSAGES AMONG COMPUTER USERS CONCERNING SAFETY AND SURVIVAL; PROVIDING ON-LINE FORUMS FOR TRANSMISSION OF MESSAGES AMONG COMPUTER USERS; TEXT AND NUMERIC WIRELESS DIGITAL MESSAGING SERVICES; TRANSMISSION OF MESSAGES; TRANSMISSION OF MESSAGES OVER ELECTRONIC MEDIA; TRANSMISSION OF SHORT MESSAGES; WEB MESSAGING; WORLDWIDE SWITCHED TEXT AND MESSAGE TRANSMISSION SERVICES (U.S. CLS. 100, 101 AND 104).

FIRST USE 6-30-2009; IN COMMERCE 8-1-2009.
LAURIE MAYES, EXAMINING ATTORNEY

CLASS 38—(Continued).

SN 77-877,558. S4 CONSULTING, INC., COLUMBUS, OH.
FILED 11-20-2009.



THE COLOR(S) YELLOW BLUE RED AND GREEN IS/
ARE CLAIMED AS A FEATURE OF THE MARK.

THE MARK CONSISTS OF FOUR PUZZLE PIECES WITH
THE TOP LEFT PIECE BEING YELLOW IN COLOR, THE
TOP RIGHT PIECE BEING BLUE IN COLOR, THE BOTTOM
LEFT PIECE BEING RED IN COLOR AND THE BOTTOM
RIGHT PIECE IS DETACHED FROM THE OTHERS BEING
GREEN IN COLOR.

FOR PROVIDING AN ONLINE COMMUNITY WEB-
SITE FEATURING MESSAGE BOARDS, BLOGS AND
DISCUSSION GROUPS FOR SHARING INFORMATION
ON HOW TO PROTECT, GROW AND RECOVER BUSI-
NESS RELATIONSHIPS (U.S. CLS. 100, 101 AND 104).

FIRST USE 5-12-2009; IN COMMERCE 5-12-2009.

REGINA DRUMMOND, EXAMINING ATTORNEY

SN 77-877,983. WORKING ASSETS FUNDING SERVICE,
INC., SAN FRANCISCO, CA. FILED 11-20-2009.

Not Just Green, Real Green

THE MARK CONSISTS OF STANDARD CHARACTERS
WITHOUT CLAIM TO ANY PARTICULAR FONT, STYLE,
SIZE, OR COLOR.

FOR REDUCED ENVIRONMENTAL IMPACT TELE-
COMMUNICATIONS SERVICES, NAMELY, WIRELESS
AND CELLULAR TELEPHONE SERVICES, LONG DIS-
TANCE TELEPHONE SERVICES, TELEPHONE VOICE
MESSAGING, PERSONAL COMMUNICATIONS SER-
VICES, ELECTRONIC MAIL SERVICES, ELECTRONIC
TRANSMISSION OF VOICE AND DATA, FACSIMILE
TRANSMISSION SERVICES AND PROVIDING ACCESS
TO GLOBAL COMPUTER NETWORKS (U.S. CLS. 100,
101 AND 104).

FIRST USE 11-12-2009; IN COMMERCE 11-12-2009.

DAVID H. STINE, EXAMINING ATTORNEY

CLASS 38—(Continued).

SN 77-883,384. TAILORED TECHNOLOGY, INC, SAN FRAN-
CISCO, CA. FILED 12-1-2009.

BANDWIDTH ENVY

THE MARK CONSISTS OF STANDARD CHARACTERS
WITHOUT CLAIM TO ANY PARTICULAR FONT, STYLE,
SIZE, OR COLOR.

NO CLAIM IS MADE TO THE EXCLUSIVE RIGHT TO
USE "BANDWIDTH", APART FROM THE MARK AS
SHOWN.

FOR COMMUNICATION SERVICES, NAMELY,
TRANSMISSION OF VOICE, AUDIO, VISUAL IMAGES
AND DATA BY TELECOMMUNICATIONS NETWORKS,
WIRELESS COMMUNICATION NETWORKS, THE IN-
TERNET, INFORMATION SERVICES NETWORKS AND
DATA NETWORKS; DIGITAL NETWORK TELECOM-
MUNICATIONS SERVICES; PROVIDING ACCESS TO
TELECOMMUNICATION NETWORKS; PROVIDING
TELECOMMUNICATION CONNECTIONS TO THE IN-
TERNET OR DATABASES; PROVIDING TELECOMMU-
NICATIONS CONNECTIONS TO THE INTERNET OR
DATABASES; TELECOMMUNICATIONS RESELLER
SERVICES FOR BUSINESSES, NAMELY, PROVIDING
LONG DISTANCE TELECOMMUNICATION SERVICES,
VOICE TELECOMMUNICATION SERVICES, LOCAL
TELEPHONE SERVICE, AND INTERNET ACCESS SER-
VICES; TELECOMMUNICATIONS SERVICES, NAMELY,
PROVIDING FIBER OPTIC NETWORK SERVICES;
WIRELESS TELEPHONE TELECOMMUNICATIONS
SERVICES, NAMELY, WIRELESS MOBILE TELEPHONE
CALLING PLANS (U.S. CLS. 100, 101 AND 104).

MARK T. MULLEN, EXAMINING ATTORNEY

SN 77-884,792. FOUNDATION TO SUPPORT ANIMAL PRO-
TECTION, NORFOLK, VA. FILED 12-2-2009.

ANIMAL RIGHTS TELEVISION

THE MARK CONSISTS OF STANDARD CHARACTERS
WITHOUT CLAIM TO ANY PARTICULAR FONT, STYLE,
SIZE, OR COLOR.

OWNER OF U.S. REG. NO. 2,793,234.

NO CLAIM IS MADE TO THE EXCLUSIVE RIGHT TO
USE "TELEVISION", APART FROM THE MARK AS
SHOWN.

SEC. 2(F).

FOR WEBCASTING SERVICES (U.S. CLS. 100, 101
AND 104).

FIRST USE 8-14-2001; IN COMMERCE 8-22-2001.

JOHN DWYER, EXAMINING ATTORNEY

CLASS 38—(Continued).

SN 77-886,042. COOKIE JAR ENTERTAINMENT, INC., TORONTO, ONTARIO, CANADA, FILED 12-4-2009.



NO CLAIM IS MADE TO THE EXCLUSIVE RIGHT TO USE "TV", APART FROM THE MARK AS SHOWN.

THE MARK CONSISTS OF THE STYLIZED WORDING "@CADEMYTV", WITH THE "@" SYMBOL IN PLACE OF THE FIRST LETTER "A", A HAPPY FACE FORMED BY PERIODS IN THE ADJACENT LETTERS "AD", AND A CURVED LINE BENEATH THEM FORMING A SMILE.

FOR TELEVISION AND RADIO BROADCASTING SERVICES VIA CABLE, SATELLITE AND OTHER MEANS; WEBCASTING; PODCASTING; TRANSMISSION OF SOUND, VIDEO AND INFORMATION TO HANDHELD AND WIRELESS DEVICES (U.S. CLS. 100, 101 AND 104).

IRA J. GOODSAD, EXAMINING ATTORNEY

SN 77-886,364. EMBARQ HOLDINGS COMPANY LLC, OVERLAND PARK, KS. FILED 12-4-2009.

**We're all stronger
connected**

THE MARK CONSISTS OF STANDARD CHARACTERS WITHOUT CLAIM TO ANY PARTICULAR FONT, STYLE, SIZE, OR COLOR.

FOR CONSULTING IN THE FIELD OF TELECOMMUNICATIONS IN THE NATURE OF TECHNICAL CONSULTING IN THE FIELD OF AUDIO, TEXT AND DATA TRANSMISSION AND COMMUNICATION; TELEPHONE COMMUNICATION SERVICES, ELECTRONIC TRANSMISSION OF MESSAGES AND DATA, TELEPHONE VOICE MESSAGING SERVICE; TELECOMMUNICATION AND INFORMATION TECHNOLOGY SERVICES, NAMELY, ELECTRONIC, DIGITAL, WIRELESS TRANSMISSION OF VOICE, DATA, INFORMATION, IMAGES, SIGNALS AND MESSAGES; AND ELECTRONIC TRANSMISSION OF VOICE, DATA, IMAGES, AUDIO, VIDEO AND INFORMATION VIA TELEPHONE, TELEVISION AND GLOBAL COMMUNICATION NETWORKS; PROVIDING TELECOMMUNICATIONS CONNECTIONS TO A GLOBAL COMMUNICATIONS NETWORK, ELECTRONIC STORE-AND-FORWARD MESSAGING; RENTAL OF TELECOMMUNICATIONS EQUIPMENT, NAMELY, EQUIPMENT FOR ELECTRONIC ACCESS TO GLOBAL TELECOMMUNICATIONS NETWORK, EQUIPMENT FOR TRANSMITTING, RECEIVING, RECORDING AND MONITORING VOICE, DATA, INFORMATION IMAGES, SIGNALS, MESSAGES COMPRISED OF DATA AND WORD PROCESSORS, AND TELECOMMUNICATIONS HARDWARE COMPONENTS AND PERIPHERALS THEREOF FOR USE IN THE TELECOMMUNICATIONS INDUSTRY, AND EQUIPMENT FOR TRANSMITTING, RECEIVING, RECORDING AND MONITORING COMPUTER PROGRAMS FOR USE IN OPERATING AND ACCESSING TELECOMMUNICATIONS SYSTEMS; AUDIO AND VIDEO BROADCASTING; PROVIDING MULTIPLE-USER DIAL-UP AND DEDICATED ACCESS TO THE INTERNET; PERSONAL COMMUNICATIONS SERVICES; TRANSMISSION AND BROADCAST OF AUDIO AND VIDEO PROGRAMMING; LEASING OF TELECOMMUNICATIONS EQUIPMENT, COMPONENTS

CLASS 38—(Continued).

AND SYSTEMS; PROVIDING INFORMATION VIA THE TELEPHONE AND THE GLOBAL COMMUNICATION NETWORKS IN THE FIELD OF TELECOMMUNICATIONS; TRANSMISSION, RECEPTION AND PROCESSING OF CODED AND EMERGENCY SIGNALS; INTERNET TELEPHONY SERVICE; TELECOMMUNICATION SERVICES, NAMELY, LOCAL AND LONG DISTANCE TRANSMISSION OF VOICE, DATA, GRAPHICS BY MEANS OF TELEPHONE, CABLE, AND SATELLITE TRANSMISSIONS; BROADCASTING SERVICES AND PROVISION OF TELECOMMUNICATION ACCESS TO VIDEO AND AUDIO CONTENT PROVIDED VIA A VIDEO-ON-DEMAND SERVICE VIA THE INTERNET; CALL FORWARDING SERVICES; ELECTRONIC MAIL SERVICES; PREPAID LONG DISTANCE TELEPHONE SERVICES; PROVIDING REMOTE INTERNET ACCESS; SATELLITE, CABLE, NETWORK TRANSMISSION OF SOUNDS, IMAGES, SIGNALS AND DATA; SECURE E-MAIL SERVICES; INTEGRATION AND ENABLING OF E-COMMERCE, NAMELY, PROVIDING MULTIPLE-USER ACCESS TO A GLOBAL COMPUTER INFORMATION NETWORK; BROADBAND TELEVISION BROADCASTING AND BROADBAND TELEVISION TRANSMISSION SERVICES FOR THE INTERNET; VIDEO ON DEMAND TRANSMISSION SERVICES; TELECOMMUNICATIONS SERVICES, NAMELY, PROVIDING A PHONE AND COMMUNICATIONS SERVICE CAPABLE OF SWITCHING BETWEEN A WIRELESS AND WIRELINE CONNECTION; PROVIDING MULTIPLE USER ACCESS TO WIRELESS AND WIRELINE LOCAL AREA COMPUTER NETWORKS; HIGH SPEED TRANSMISSION OF VOICE, DATA, IMAGES, VIDEO, AUDIO AND INFORMATION VIA A GLOBAL COMPUTER NETWORK, COMPUTERS AND WIRELESS DEVICES; PROVIDING ACCESS FOR OTHERS TO A GLOBAL COMPUTER NETWORK FOR THE TRANSFER AND DISSEMINATION OF INFORMATION IN A WIDE VARIETY OF FIELDS; AUDIO TELECONFERENCING SERVICES; VIDEO TELECONFERENCING, ELECTRONIC MAIL, VOICE-MAIL AND ELECTRONIC DATA TRANSMISSION; TELEPHONE COMMUNICATIONS SERVICES; ELECTRONIC, ELECTRIC, AND DIGITAL TRANSMISSION OF VOICE, DATA, IMAGES, SIGNALS, AND MESSAGES; VOICE MESSAGE, RECEIVING, RECORDING AND TRANSMISSION SERVICES (U.S. CLS. 100, 101 AND 104).

NELSON SNYDER, EXAMINING ATTORNEY

CLASS 38—(Continued).

SN 77-887,168. SOLATINA, LLC, REVERE, MA. FILED 12-6-2009.

SoLatina

THE MARK CONSISTS OF STANDARD CHARACTERS WITHOUT CLAIM TO ANY PARTICULAR FONT, STYLE, SIZE, OR COLOR.

THE ENGLISH TRANSLATION OF LATINA IN THE MARK IS A WOMAN OF LATIN-AMERICAN OR SPANISH-SPEAKING DESCENT.

FOR CHAT ROOM SERVICES FOR SOCIAL NETWORKING; PEER-TO-PEER NETWORK COMPUTER SERVICES, NAMELY, ELECTRONIC TRANSMISSION OF AUDIO, VIDEO AND OTHER DATA AND DOCUMENTS AMONG COMPUTERS; PROVIDING E-MAIL AND INSTANT MESSAGING SERVICES; PROVIDING ON-LINE CHAT ROOMS AND ELECTRONIC BULLETIN BOARDS FOR TRANSMISSION OF MESSAGES AMONG USERS IN THE FIELD OF GENERAL INTEREST; PROVIDING ON-LINE CHAT ROOMS FOR TRANSMISSION OF MESSAGES AMONG COMPUTER USERS CONCERNING USER-DEFINED CONTENT; PROVIDING ON-LINE FORUMS FOR TRANSMISSION OF MESSAGES AMONG COMPUTER USERS (U.S. CLS. 100, 101 AND 104).

MORGAN WYNNE, EXAMINING ATTORNEY

SN 77-887,667. PALMER, JEFFERY A., FORT LAUDERDALE, FL. FILED 12-7-2009.

SATCOLLECT

THE MARK CONSISTS OF STANDARD CHARACTERS WITHOUT CLAIM TO ANY PARTICULAR FONT, STYLE, SIZE, OR COLOR.

FOR FIXED AND MOBILE TELEPHONE SERVICES; TELECOMMUNICATION SERVICES, NAMELY, LOCAL AND LONG DISTANCE TRANSMISSION OF VOICE, DATA, GRAPHICS BY MEANS OF TELEPHONE, TELEGRAPHIC, CABLE, AND SATELLITE TRANSMISSIONS (U.S. CLS. 100, 101 AND 104).

FIRST USE 6-5-2005; IN COMMERCE 11-8-2005.
MARC LEIPZIG, EXAMINING ATTORNEY

CLASS 38—(Continued).

SN 77-887,669. TOP RANK INC., LAS VEGAS, NV. FILED 12-7-2009.

THIS IS BOXING

THE MARK CONSISTS OF STANDARD CHARACTERS WITHOUT CLAIM TO ANY PARTICULAR FONT, STYLE, SIZE, OR COLOR.

NO CLAIM IS MADE TO THE EXCLUSIVE RIGHT TO USE "BOXING", APART FROM THE MARK AS SHOWN.

FOR AUDIO AND VIDEO BROADCASTING SERVICES AND TELECASTS OVER THE INTERNET CONCERNING BOXING EVENTS AND BOXING HISTORY (U.S. CLS. 100, 101 AND 104).

BRIAN NEVILLE, EXAMINING ATTORNEY

SN 77-887,811. AUGUSTA NATIONAL, INC., AUGUSTA, GA. FILED 12-7-2009.

iMASTERS

THE MARK CONSISTS OF STANDARD CHARACTERS WITHOUT CLAIM TO ANY PARTICULAR FONT, STYLE, SIZE, OR COLOR.

OWNER OF U.S. REG. NOS. 361,678, 1,470,536 AND OTHERS.

FOR COMPUTER-AIDED ELECTRONIC TRANSMISSION AND ELECTRONIC DELIVERY OF VOICE, DATA, IMAGES, MESSAGES IN THE FIELD OF GOLF TOURNAMENT AND GOLF RELATED SPORTS ENTERTAINMENT, VIA COMPUTER NETWORKS, INTERACTIVE TELEVISION AND THE INTERNET (U.S. CLS. 100, 101 AND 104).

ANGELA M. MICHELI, EXAMINING ATTORNEY

SN 77-887,873. AUGUSTA NATIONAL, INC., AUGUSTA, GA. FILED 12-7-2009.

eMASTERS

THE MARK CONSISTS OF STANDARD CHARACTERS WITHOUT CLAIM TO ANY PARTICULAR FONT, STYLE, SIZE, OR COLOR.

OWNER OF U.S. REG. NOS. 361,678, 1,470,536 AND OTHERS.

FOR COMPUTER-AIDED ELECTRONIC TRANSMISSION AND ELECTRONIC DELIVERY OF VOICE, DATA, IMAGES, MESSAGES IN THE FIELD OF GOLF TOURNAMENT AND GOLF RELATED SPORTS ENTERTAINMENT, VIA COMPUTER NETWORKS, INTERACTIVE TELEVISION AND THE INTERNET (U.S. CLS. 100, 101 AND 104).

ANGELA M. MICHELI, EXAMINING ATTORNEY

CLASS 38—(Continued).

SN 77-887,934. BAGRAT, SARGSYAN, ENCINO, CA. FILED 12-7-2009.



NO CLAIM IS MADE TO THE EXCLUSIVE RIGHT TO USE "RUSSIA TV WORLDWIDE RUSSIAN TELEVISION", APART FROM THE MARK AS SHOWN.

THE COLOR(S) RED, WHITE AND BLUE IS/ARE CLAIMED AS A FEATURE OF THE MARK.

THE MARK CONSISTS OF THE WORDS "RUSSIA TV" IN BLUE WITH THREE DROPS IN RED, BLUE, WHITE AND THE WORDS "WORLDWIDE RUSSIAN TELEVISION" IN RED.

FOR BROADCAST OF CABLE TELEVISION PROGRAMS; BROADCASTING OF RADIO AND TELEVISION PROGRAMS; BROADCASTING OF TELEVISION PROGRAMS; BROADCASTING PROGRAMS VIA A GLOBAL COMPUTER NETWORK; SATELLITE TELEVISION BROADCASTING; SATELLITE TRANSMISSION SERVICES; TELEVISION AND RADIO BROADCASTING SERVICES; SUBSCRIPTION TELEVISION BROADCASTING; TELEVISION AND RADIO BROADCASTING SERVICES; TELEVISION BROADCASTING; TELEVISION PROGRAM BROADCASTING; TELEVISION PROGRAM BROADCASTING VIA CABLE; VIDEO BROADCASTING; VIDEO BROADCASTING SERVICES VIA THE INTERNET (U.S. CLS. 100, 101 AND 104).

FIRST USE 11-0-2009; IN COMMERCE 11-0-2009.
CYNTHIA SLOAN, EXAMINING ATTORNEY

SN 77-887,939. BAGRAT, SARGSYAN, ENCINO, CA. FILED 12-7-2009.



NO CLAIM IS MADE TO THE EXCLUSIVE RIGHT TO USE "US RUSSIA", APART FROM THE MARK AS SHOWN.

THE COLOR(S) RED, WHITE, BLUE AND GRAY IS/ARE CLAIMED AS A FEATURE OF THE MARK.

THE MARK CONSISTS OF THE LETTERS "U" IN BLUE WITH WHITE STARS AND RED AND WHITE STRIPES, THE LETTER "S" IN RED AND WHITE STRIPES AND THE LETTERS "RUSS" IN GRAY, BLUE AND RED STRIPES AND THE LETTERS "IA" IN GRAY AND BLUE STRIPES AND FIVE RED STARS IN AN ARCH STARTING ABOVE THE "U" TO THE "I".

FOR BROADCAST OF CABLE TELEVISION PROGRAMS; BROADCASTING OF RADIO AND TELEVISION PROGRAMS; BROADCASTING OF TELEVISION PROGRAMS; BROADCASTING PROGRAMS VIA A GLOBAL COMPUTER NETWORK; SATELLITE TELEVISION BROADCASTING; SATELLITE TRANSMISSION SERVICES; TELEVISION AND RADIO BROADCASTING SERVICES; SUBSCRIPTION TELEVISION BROADCASTING; TELEVISION AND RADIO BROADCASTING SERVICES; TELEVISION BROADCASTING; TELEVISION PROGRAM BROADCASTING; TELEVISION PROGRAM BROADCASTING VIA CABLE; VIDEO BROADCASTING; VIDEO BROADCASTING SERVICES VIA THE INTERNET (U.S. CLS. 100, 101 AND 104).

FIRST USE 11-0-2009; IN COMMERCE 11-0-2009.
CYNTHIA SLOAN, EXAMINING ATTORNEY

CLASS 38—(Continued).

SN 77-887,945. BAGRAT, SARGSYAN, ENCINO, CA. FILED 12-7-2009.



OWNER OF U.S. REG. NOS. 3,562,819 AND 3,562,820.
NO CLAIM IS MADE TO THE EXCLUSIVE RIGHT TO USE "USA TV", APART FROM THE MARK AS SHOWN.

THE COLOR(S) BLUE, RED, BLACK AND WHITE IS/ARE CLAIMED AS A FEATURE OF THE MARK.

THE MARK CONSISTS OF THE LETTERS "USA" IN BLUE WITH THE OUTLINE OF STARS IN WHITE, A REPRESENTATION OF THE EARTH IN THE COLORS RED AND BLACK AND THE LETTERS "TV" IN RED WHITE AND BLUE DESIGN.

FOR BROADCAST OF CABLE TELEVISION PROGRAMS; BROADCASTING OF RADIO AND TELEVISION PROGRAMS; BROADCASTING OF TELEVISION PROGRAMS; BROADCASTING PROGRAMS VIA A GLOBAL COMPUTER NETWORK; SATELLITE TELEVISION BROADCASTING; SATELLITE TRANSMISSION SERVICES; TELEVISION AND RADIO BROADCASTING SERVICES; SUBSCRIPTION TELEVISION BROADCASTING; TELEVISION AND RADIO BROADCASTING SERVICES; TELEVISION BROADCASTING; TELEVISION PROGRAM BROADCASTING; TELEVISION PROGRAM BROADCASTING VIA CABLE; VIDEO BROADCASTING; VIDEO BROADCASTING SERVICES VIA THE INTERNET (U.S. CLS. 100, 101 AND 104).

FIRST USE 4-0-2008; IN COMMERCE 4-0-2008.
CYNTHIA SLOAN, EXAMINING ATTORNEY

SN 77-888,610. TIVO BRANDS LLC, ALVISO, CA. FILED 12-8-2009.

TIVO

THE MARK CONSISTS OF STANDARD CHARACTERS WITHOUT CLAIM TO ANY PARTICULAR FONT, STYLE, SIZE, OR COLOR.

FOR TELEVISION BROADCASTING SERVICES; TRANSMISSION OF NETWORK AND SATELLITE TELEVISION PROGRAMMING; DIGITAL AND ELECTRONIC TRANSMISSION OF VOICE, DATA, SOUND, MUSIC, GRAPHICS, IMAGES, AUDIO, VIDEO, INFORMATION, AND MESSAGES (U.S. CLS. 100, 101 AND 104).

FIRST USE 3-0-1999; IN COMMERCE 3-0-1999.
BRENDAN MCCAULEY, EXAMINING ATTORNEY

CLASS 38—(Continued).

SN 77-888,929. N-1 COMMUNICATIONS, LLC, CHESTERFIELD, MO. FILED 12-8-2009.

HIBEAM

THE MARK CONSISTS OF STANDARD CHARACTERS WITHOUT CLAIM TO ANY PARTICULAR FONT, STYLE, SIZE, OR COLOR.

FOR INTERNET ACCESS PROVIDER SERVICES; TELECOMMUNICATION SERVICES, NAMELY, LOCAL AND LONG DISTANCE TRANSMISSION OF VOICE, DATA, GRAPHICS BY MEANS OF TELEPHONE, TELEGRAPHIC, CABLE, AND SATELLITE TRANSMISSIONS; TELECOMMUNICATION SERVICES, NAMELY, PROVIDING INTERNET ACCESS VIA BROADBAND OPTICAL OR WIRELESS NETWORKS (U.S. CLS. 100, 101 AND 104).

FIRST USE 11-20-2009; IN COMMERCE 11-20-2009.
ELI HELLMAN, EXAMINING ATTORNEY

CLASS 38—(Continued).

SN 77-890,789. LOWE PROFILE PRODUCTIONS, INC., BEVERLY HILLS, CA. FILED 12-10-2009.



THE MARK CONSISTS OF THE STYLIZED LETTERS "TBP" INSIDE OF AN OVAL SHAPE DESIGN.

FOR RADIO BROADCASTING SERVICES, NAMELY, WEBCASTING SERVICES (U.S. CLS. 100, 101 AND 104).
TINA MAI, EXAMINING ATTORNEY

SN 77-889,805. ELECTRA, LTD., BETHESDA, MD. FILED 12-9-2009.

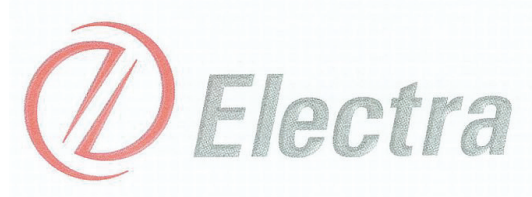

OWNER OF U.S. REG. NO. 2,755,206.
THE COLOR(S) RED AND LIGHT GRAY IS/ARE CLAIMED AS A FEATURE OF THE MARK.

THE MARK CONSISTS OF TWO RED LOWER CASE "E" S ON A TILT, FACING EACH OTHER, INTERLOCKING LOOSELY AND FORMING A CIRCULAR SHAPE NEXT TO THE WORD "ELECTRA" IN LIGHT GRAY, ITALIC LETTERS, WITH THE "E" CAPITALIZED AND THE "LECTRA" IN LOWER CASE.

FOR PROVIDING TELECOMMUNICATIONS CONNECTIONS TO A GLOBAL COMPUTER NETWORK; TELECOMMUNICATIONS CONSULTATION; TELECOMMUNICATIONS ROUTING AND JUNCTION SERVICES (U.S. CLS. 100, 101 AND 104).

FIRST USE 1-1-1990; IN COMMERCE 1-1-1990.
FRED MANDIR, EXAMINING ATTORNEY

SN 77-891,275. MORGAN, ELLIOTT, BRIDPORT, VT. FILED 12-11-2009.

FARM FRESH RADIO

THE MARK CONSISTS OF STANDARD CHARACTERS WITHOUT CLAIM TO ANY PARTICULAR FONT, STYLE, SIZE, OR COLOR.

NO CLAIM IS MADE TO THE EXCLUSIVE RIGHT TO USE "RADIO", APART FROM THE MARK AS SHOWN.

FOR INTERACTIVE DELIVERY OF VIDEO OVER DIGITAL NETWORKS; RADIO BROADCASTING; RADIO PROGRAMME BROADCASTING (U.S. CLS. 100, 101 AND 104).

FIRST USE 11-30-2003; IN COMMERCE 11-30-2003.
KATHLEEN M. VANSTON, EXAMINING ATTORNEY

CLASS 38—(Continued).

SN 77-891,276. RENTERPRISE PROPERTY NETWORK, LLC, DBA CAMPUSLIST.COM, NEW HAVEN, CT. FILED 12-11-2009.

CAMPUSLIST

THE MARK CONSISTS OF STANDARD CHARACTERS WITHOUT CLAIM TO ANY PARTICULAR FONT, STYLE, SIZE, OR COLOR.

FOR PROVIDING ONLINE INTERACTIVE BULLETIN BOARDS FOR TRANSMISSION OF MESSAGES AMONG USERS OF PERSONAL COMPUTERS AND WIRELESS HANDHELD DEVICES CONCERNING CLASSIFIED AD LISTINGS AND LISTINGS FOR ANNOUNCEMENTS, NEWS, EVENTS, CLASSES, MEETINGS, DATING, STUDENT LOANS, ACTIVITIES, HOUSING, REAL ESTATE, ROOMMATES, RENTALS, FOR SALE ADVERTISEMENTS, WANT ADS, EMPLOYMENT, RESUMES, VOLUNTEERISM, SERVICES, COMMUNITY, PERSONALS, POLITICS, FAMILY, ARTS AND INFORMATION ON A WIDE VARIETY OF TOPICS OF GENERAL INTEREST TO THE PUBLIC; PROVIDING ON-LINE FORUMS AND DISCUSSION GROUPS FOR TRANSMISSION OF MESSAGES AMONG USERS OF PERSONAL COMPUTERS AND WIRELESS HANDHELD DEVICES CONCERNING HIGHER LEARNING, CIVIL RIGHTS, HEALTH, FAMILY, ARTS, POLITICS, LEISURE, ROMANCE, WORK, AND INFORMATION ON A WIDE VARIETY OF TOPICS OF GENERAL INTEREST TO THE PUBLIC; AND ELECTRONIC TRANSMISSION OF MESSAGES, DATA AND IMAGES (U.S. CLS. 100, 101 AND 104).

FIRST USE 10-21-2009; IN COMMERCE 10-21-2009.
KAREN K. BUSH, EXAMINING ATTORNEY

CLASS 38—(Continued).

SN 77-892,136. BODYLASTICS INTERNATIONAL INC., BOCA RATON, FL. FILED 12-12-2009.

CHISELED

THE MARK CONSISTS OF STANDARD CHARACTERS WITHOUT CLAIM TO ANY PARTICULAR FONT, STYLE, SIZE, OR COLOR.

FOR ON-LINE BROADCASTING OF A FITNESS SHOW VIA THE INTERNET (U.S. CLS. 100, 101 AND 104).

DAVID MURRAY, EXAMINING ATTORNEY

SN 77-894,031. BAGRAT, SARGSYAN, ENCINO, CA. FILED 12-15-2009.



SN 77-891,561. ZONE MEDIA LTD., DOUGLAS, ISLE OF MAN, FILED 12-11-2009.

PLUSTV

THE MARK CONSISTS OF STANDARD CHARACTERS WITHOUT CLAIM TO ANY PARTICULAR FONT, STYLE, SIZE, OR COLOR.

FOR STREAMING OF AUDIO, VIDEO AND AUDIO-VISUAL MATERIAL ON THE INTERNET; INTERNET PROTOCOL TELEVISION TRANSMISSION SERVICES; AND ONLINE TELEVISION BROADCASTING SERVICES (U.S. CLS. 100, 101 AND 104).

ALICIA COLLINS, EXAMINING ATTORNEY

NO CLAIM IS MADE TO THE EXCLUSIVE RIGHT TO USE "US ARMENIA", APART FROM THE MARK AS SHOWN.

THE COLOR(S) RED, BLUE AND ORANGE IS/ARE CLAIMED AS A FEATURE OF THE MARK.

THE MARK CONSISTS OF LETTERS "US" IN BLUE, "ARMENIA" IN ORANGE WITH FIVE RED STARS IN AN ARCH ABOVE THE LETTERS "RMENI" AND A CURVED STRIPE THROUGH THE LETTERS "SARMENIA". THE COLOR WHITE IN THE CURVED STRIPE REPRESENTS BACKGROUND AND IS NOT A PART OF THE MARK.

FOR BROADCAST OF CABLE TELEVISION PROGRAMS; BROADCASTING OF RADIO AND TELEVISION PROGRAMS; BROADCASTING OF TELEVISION PROGRAMS; BROADCASTING PROGRAMS VIA A GLOBAL COMPUTER NETWORK; SATELLITE TELEVISION BROADCASTING; SATELLITE TRANSMISSION SERVICES; TELEVISION AND RADIO BROADCASTING SERVICES; SUBSCRIPTION TELEVISION BROADCASTING; TELEVISION AND RADIO BROADCASTING SERVICES; TELEVISION BROADCASTING; TELEVISION PROGRAM BROADCASTING; TELEVISION PROGRAM BROADCASTING VIA CABLE; VIDEO BROADCASTING; VIDEO BROADCASTING SERVICES VIA THE INTERNET (U.S. CLS. 100, 101 AND 104).

FIRST USE 4-0-2008; IN COMMERCE 4-0-2008.
CYNTHIA SLOAN, EXAMINING ATTORNEY

CLASS 38—(Continued).

SN 77-894,062. AT&T INTELLECTUAL PROPERTY II, L.P., RENO, NV. FILED 12-15-2009.

RETHINK POSSIBLE

THE MARK CONSISTS OF STANDARD CHARACTERS WITHOUT CLAIM TO ANY PARTICULAR FONT, STYLE, SIZE, OR COLOR.

FOR TELECOMMUNICATIONS SERVICES, NAMELY, PROVIDING TELEPHONE COMMUNICATION AND INTERNET TELEPHONY SERVICES; PROVIDING TELEPHONE COMMUNICATIONS SERVICES THAT PROVIDE A GROUP OF SPECIALIZED TELEPHONE SERVICES WITH CUSTOM CALLING FEATURES AND TELEPHONE CALLING PLANS; ELECTRONIC VOICE MESSAGING, NAMELY, THE RECORDING AND SUBSEQUENT TRANSMISSION OF VOICE MESSAGES BY TELEPHONE; PROVIDING MULTIPLE USER DIAL-UP, HIGH-SPEED AND DEDICATED ACCESS TO THE INTERNET; ELECTRONIC TRANSMISSION OF MESSAGES, DATA, IMAGES, VIDEO AND INFORMATION VIA THE INTERNET; WIRELESS TRANSMISSION OF VOICE, MESSAGES, DATA AND INFORMATION; HIGH-SPEED ACCESS SERVICES AND WIRELESS ACCESS SERVICES TO THE INTERNET; TELEVISION TRANSMISSION SERVICES; TELECOMMUNICATIONS SERVICES IN THE NATURE OF PROVIDING VOICE AND DATA NETWORKING SERVICES, NAMELY, PROVIDING DIGITAL AND ANALOG NETWORKING SERVICES TO TRANSMIT DATA AND VOICE; TELECONFERENCING, VIDEOCONFERENCING AND WEB CONFERENCING SERVICES; CELLULAR AND MOBILE TELEPHONE COMMUNICATIONS; TELECOMMUNICATIONS CONSULTATION; VOICE OVER INTERNET PROTOCOL (VOIP) SERVICES; TELECOMMUNICATIONS CONSULTATION IN THE FIELD OF DATA, VOICE AND VIDEO COMMUNICATIONS NETWORKS (U.S. CLS. 100, 101 AND 104).

GILBERT SWIFT, EXAMINING ATTORNEY

CLASS 39—TRANSPORTATION AND STORAGE

SN 77-496,037. AMERICAN ELECTRIC POWER COMPANY, INC., COLUMBUS, OH. FILED 6-11-2008.

**gridSMART from American
Electric Power**

THE MARK CONSISTS OF STANDARD CHARACTERS WITHOUT CLAIM TO ANY PARTICULAR FONT, STYLE, SIZE, OR COLOR.

OWNER OF U.S. REG. NOS. 1,486,484 AND 2,215,802.

NO CLAIM IS MADE TO THE EXCLUSIVE RIGHT TO USE "AMERICAN ELECTRIC POWER", APART FROM THE MARK AS SHOWN.

FOR PUBLIC UTILITY SERVICES IN THE NATURE OF ELECTRICITY DISTRIBUTION; UTILITY SERVICES, NAMELY, TRANSMISSION OF ELECTRICITY (U.S. CLS. 100 AND 105).

JORDAN BAKER, EXAMINING ATTORNEY

CLASS 39—(Continued).

SN 77-505,188. JONVIEW CANADA INC., TORONTO, CANADA, FILED 6-23-2008.



OWNER OF CANADA REG. NO. TMA756520, DATED 1-6-2010, EXPIRES 1-6-2025.

NO CLAIM IS MADE TO THE EXCLUSIVE RIGHT TO USE "CANADA", APART FROM THE MARK AS SHOWN.

THE NAME(S), PORTRAIT(S), AND/OR SIGNATURE(S) SHOWN IN THE MARK DOES NOT IDENTIFY A PARTICULAR LIVING INDIVIDUAL.

THE MARK CONSISTS OF THE TERMS "JONVIEW CANADA" AND A REPRESENTATION OF A MAPLE LEAF.

FOR TRAVEL SERVICES, NAMELY, TRANSPORTATION SERVICES FOR INDIVIDUALS OR GOODS BY AIR; TOUR OPERATING SERVICES; WHOLESALE AND RETAIL TRAVEL AGENCY SERVICES PROVIDED THROUGH CONVENTIONAL MARKETING CHANNELS AND VIA THE INTERNET, NAMELY, TRAVEL ORGANIZATION SERVICES, TRAVEL PLANNING SERVICES, TRAVEL INFORMATION SERVICES, RENTAL OF TOURIST AND TRANSPORT VEHICLES; TRAVEL SERVICES, NAMELY, PROVIDING, ARRANGING AND COORDINATING TRAVEL ARRANGEMENTS FOR INDIVIDUALS AND GROUPS, NAMELY, ALL-INCLUSIVE TRAVEL PACKAGE VACATIONS, TRAVEL TOUR PACKAGES, CRUISES AND HOLIDAY DESTINATION STAYS AND VACATIONS; ORGANIZATION, BOOKING AND ARRANGEMENT OF EXCURSIONS, DAY TRIPS, SIGHTSEEING TOURS, HOLIDAYS, TOURS AND TRAVEL (U.S. CLS. 100 AND 105).

MARY ROSSMAN, EXAMINING ATTORNEY

SN 77-736,289. SHUTTER TOURS LLC, SAMMAMISH, WA. FILED 5-13-2009.

Shutter Tours

THE MARK CONSISTS OF STANDARD CHARACTERS WITHOUT CLAIM TO ANY PARTICULAR FONT, STYLE, SIZE, OR COLOR.

FOR TOUR OPERATING (U.S. CLS. 100 AND 105).

FIRST USE 4-1-2009; IN COMMERCE 5-1-2009.

BRENDAN MCCAULEY, EXAMINING ATTORNEY

CLASS 39—(Continued).

SN 77-747,872. URDIALES, JOSE MARIANO LOPEZ, BARCELONA, SPAIN, FILED 5-29-2009.



PRIORITY CLAIMED UNDER SEC. 44(D) ON ERP N CMNTY TM OFC APPLICATION NO. 008250813, FILED 4-28-2009, REG. NO. 008250813, DATED 11-14-2009, EXPIRES 4-28-2019.

THE COLOR(S) GREEN, LIGHT BLUE, DARK BLUE, BLACK, GREY IS/ARE CLAIMED AS A FEATURE OF THE MARK.

THE MARK CONSISTS OF THE WORDS "ZERO 2 INFINITY" IN BLACK WITH NUMERAL "0" IN GREEN AND TWO BARS IN LIGHT BLUE AND DARK BLUE WITH THE INFINITY SYMBOL IN BLACK ALL WITH GREY HIGHLIGHTS.

FOR TRAVEL ARRANGEMENT; BOOKING OF SEATS FOR TRAVEL; ESCORTING OF TRAVELERS; AIR FREIGHT SHIPPING SERVICES; TRANSPORTATION OF PASSENGERS AND GOODS BY AIR; CARGO LOADING SERVICES; PROVIDING INFORMATION REGARDING THE TRANSPORT OF MERCHANDISE; TRANSPORT INFORMATION; SIGHTSEEING ARRANGEMENT SERVICE; LAUNCHING OF SPACE VEHICLES; PILOTING (U.S. CLS. 100 AND 105).

DEBRA LEE, EXAMINING ATTORNEY

CLASS 39—(Continued).

SN 77-748,528. PLUFFMUDDERS LLC, DBA ECOSENSE GLOBAL, MT. PLEASANT, SC. FILED 5-31-2009.



NO CLAIM IS MADE TO THE EXCLUSIVE RIGHT TO USE "RENTALS", APART FROM THE MARK AS SHOWN.

THE COLOR(S) GREEN, BLUE, BLACK, YELLOW AND WHITE IS/ARE CLAIMED AS A FEATURE OF THE MARK.

THE MARK CONSISTS OF THE WORDING "ECOSENSE GLOBAL RENTALS" IN THE COLOR BLACK OVERLAYING A DESIGN ELEMENT OF A GLOBE WITH DETAILED LEAF MAPPING IN VARYING SHADES OF BLUE AND GREEN, ENCIRCLED IN WHITE OUTLINE. GREEN LEAVES ENCIRCLE THE GLOBE AND A YELLOW SUN IS BEHIND THE CIRCLE.

FOR (BASED ON USE IN COMMERCE) CAR RENTAL; RENTAL OF CARS; RENTAL OF ELECTRIC CARS; RENTAL OF GPS-EQUIPPED VEHICLES, NAMELY, SCOOTERS, ELECTRIC CARS AND BICYCLES; RENTAL OF VEHICLES; VEHICLE RENTAL; (BASED ON INTENT TO USE) BICYCLE RENTAL; MOTORCYCLE RENTAL; PUSH-CHAIR RENTAL; RENTAL AND LEASING OF PASSENGER VANS; RENTAL OF BABY STROLLERS; RENTAL OF BICYCLES; RENTAL OF BOATS; RENTAL OF SCOOTERS FOR TRANSPORTATION PURPOSES (U.S. CLS. 100 AND 105).

FIRST USE 1-14-2009; IN COMMERCE 1-14-2009.

WENDY JUN, EXAMINING ATTORNEY

SN 77-752,390. US AIRWAYS, INC., TEMPE, AZ. FILED 6-4-2009.

US AIRWAYS BENOTIFIED

THE MARK CONSISTS OF STANDARD CHARACTERS WITHOUT CLAIM TO ANY PARTICULAR FONT, STYLE, SIZE, OR COLOR.

OWNER OF U.S. REG. NOS. 2,261,360, 2,931,571 AND OTHERS.

SEC. 2(F) AS TO "US AIRWAYS".

FOR TRAVEL INFORMATION SERVICES, NAMELY, PROVIDING FLIGHT STATUS AND DELAY NOTIFICATION SERVICES, AND PROVIDING TRANSPORTATION AND OTHER TRAVEL INFORMATION SERVICES; COMPUTERIZED AIR TRAVEL RESERVATION SERVICES AND PROVIDING TICKETING SERVICES FOR AIR TRAVELERS (U.S. CLS. 100 AND 105).

TINA L. SNAPP, EXAMINING ATTORNEY

CLASS 39—(Continued).

SN 77-764,471. CATALINA CHANNEL EXPRESS, INC., SAN PEDRO, CA. FILED 6-19-2009.

CLASS 39—(Continued).

SN 77-816,535. FAIRTRAN, LLC, OKLAHOMA CITY, OK. FILED 8-31-2009.

CATALINA EXPRESS

FairTran

THE MARK CONSISTS OF STANDARD CHARACTERS WITHOUT CLAIM TO ANY PARTICULAR FONT, STYLE, SIZE, OR COLOR.

SEC. 2(F).
FOR WATER TRANSPORTATION OF PASSENGERS IN THE NATURE OF CONDUCTING SIGHT-SEEING TOURS, BOAT CHARTER AND FERRY SERVICES (U.S. CLS. 100 AND 105).

FIRST USE 1-1-1981; IN COMMERCE 7-15-1981.
JULIE GUTTADAURO, EXAMINING ATTORNEY

THE MARK CONSISTS OF STANDARD CHARACTERS WITHOUT CLAIM TO ANY PARTICULAR FONT, STYLE, SIZE, OR COLOR.

FOR TRANSPORTATION SERVICES PROVIDED TO THE TRUCKING INDUSTRY IN THE NATURE OF CALCULATING COST PER MILE RATE ESTIMATES FOR THE PURPOSE OF CALCULATING REASONABLE AND FAIR PRICING IN THE TRUCKING INDUSTRY, AND PROVIDING INFORMATION IN THE NATURE OF LANE POSTING, DAILY UPDATES, TRUCK STOP FUEL PRICING SEARCHES, HISTORICAL FUEL SURCHARGES, AND OTHER RELATED INFORMATION VIA TELEPHONE, MOBILE COMMUNICATION DEVICES, AND GLOBAL COMPUTER NETWORK (U.S. CLS. 100 AND 105).

FIRST USE 11-19-2009; IN COMMERCE 11-19-2009.
DARRYL SPRUILL, EXAMINING ATTORNEY

SN 77-792,481. UNITED PARCEL SERVICE OF AMERICA, INC., ATLANTA, GA. FILED 7-29-2009.

SN 77-832,560. WELLER, CHARLOTTE, HOUSTON, TX. FILED 9-22-2009.

UPS IMPORT CONTROL

RING OF FIRE EXPEDITIONS

THE MARK CONSISTS OF STANDARD CHARACTERS WITHOUT CLAIM TO ANY PARTICULAR FONT, STYLE, SIZE, OR COLOR.

OWNER OF U.S. REG. NOS. 735,064, 3,538,859 AND OTHERS.

NO CLAIM IS MADE TO THE EXCLUSIVE RIGHT TO USE "IMPORT CONTROL", APART FROM THE MARK AS SHOWN.

FOR TRANSPORTATION, SHIPPING AND DELIVERY OF PERSONAL PROPERTY BY AIR, RAIL, BOAT AND MOTOR VEHICLE; WAREHOUSING, PACKAGING, STORAGE AND RETURNS WITH RESPECT TO THE TRANSPORTATION AND DELIVERY OF PERSONAL PROPERTY; FREIGHT FORWARDING; ELECTRONIC STORAGE OF TRACKING, PERFORMANCE, CLAIMS, BILLING AND BROKERAGE SHIPMENT DATA (U.S. CLS. 100 AND 105).

PRISCILLA MILTON, EXAMINING ATTORNEY

THE MARK CONSISTS OF STANDARD CHARACTERS WITHOUT CLAIM TO ANY PARTICULAR FONT, STYLE, SIZE, OR COLOR.

NO CLAIM IS MADE TO THE EXCLUSIVE RIGHT TO USE "EXPEDITIONS", APART FROM THE MARK AS SHOWN.

FOR ARRANGING AND CONDUCTING TRAVELING TOURS AND EXPEDITIONS TO OBSERVE ASTRONOMICAL EVENTS (U.S. CLS. 100 AND 105).

FIRST USE 2-1-1991; IN COMMERCE 2-1-1991.
AMY C. KEAN, EXAMINING ATTORNEY

CLASS 39—(Continued).

SN 77-850,823. LAACO, LTD, LOS ANGELES, CA. FILED 10-16-2009.

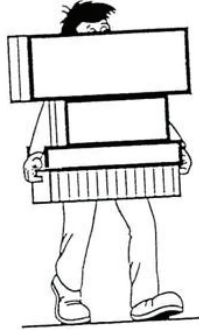

THE LINING IS A FEATURE OF THE MARK.
THE MARK CONSISTS OF A MAN CARRYING FOUR BOXES OF VARIOUS SIZES.
FOR SELF-STORAGE WAREHOUSE SERVICES (U.S. CLS. 100 AND 105).
KELLY CHOE, EXAMINING ATTORNEY

SN 77-864,733. MOVING SOLUTIONS, INC., FORT SMITH, AR. FILED 11-4-2009.



THE MARK CONSISTS OF THE WORDING "MOVE-BUILDER" TO THE RIGHT OF A SQUARE DESIGN THAT ENCOMPASSES SIX SMALLER SQUARES.
FOR MOVING COMPANY SERVICES FOR HOUSEHOLD AND COMMERCIAL PURPOSES; TRANSPORTATION SERVICES, NAMELY, FREIGHT FORWARDING THE GOODS OF OTHERS BY TRUCK AND SHIP (U.S. CLS. 100 AND 105).
FIRST USE 11-24-2009; IN COMMERCE 11-24-2009.
DAWN HAN, EXAMINING ATTORNEY

SN 77-874,136. SHUTTLE HUB LLC, ATLANTA, GA. FILED 11-17-2009.



THE MARK CONSISTS OF A BUS VAN WITH THE STYLIZED TEXT "SHUTTLEHUB".
FOR BOOKING OF SEATS FOR TRAVEL, NAMELY, GROUND TRANSPORTATION (U.S. CLS. 100 AND 105).
TIMOTHY FINNEGAN, EXAMINING ATTORNEY

CLASS 39—(Continued).

SN 77-875,316. POWELL PROFESSIONAL SERVICES, LLC, COLUMBUS, TX. FILED 11-18-2009.



NO CLAIM IS MADE TO THE EXCLUSIVE RIGHT TO USE "EMS", APART FROM THE MARK AS SHOWN.
THE COLOR(S) BLUE AND GRAY IS/ARE CLAIMED AS A FEATURE OF THE MARK.
THE MARK CONSISTS OF THE COLOR(S) BLUE AND GRAY, WITH THE COLOR BLUE APPEARING IN THE WORDING "GUARDIAN EMS RESPONDING AT THE SPEED OF LIFE!" AND THE DESIGN OF THE WINGS, LINES AND CURVES IN THE MEDICAL SYMBOL, AND THE COLOR GRAY APPEARING IN THE TRIANGLE OF THE MEDICAL SYMBOL.
FOR AMBULANCE TRANSPORT (U.S. CLS. 100 AND 105).
FIRST USE 5-0-2000; IN COMMERCE 5-0-2000.
SOPHIA S. KIM, EXAMINING ATTORNEY

SN 77-883,751. N.S.T. HOLDINGS LLC, BLUE SPRINGS, MO. FILED 12-1-2009.

Aardvark Moving Company

THE MARK CONSISTS OF STANDARD CHARACTERS WITHOUT CLAIM TO ANY PARTICULAR FONT, STYLE, SIZE, OR COLOR.
NO CLAIM IS MADE TO THE EXCLUSIVE RIGHT TO USE "MOVING COMPANY", APART FROM THE MARK AS SHOWN.
FOR MOVING SERVICES, NAMELY, MOVING OF COMMERCIAL AND HOUSEHOLD GOODS FOR OTHERS (U.S. CLS. 100 AND 105).
FIRST USE 1-0-1999; IN COMMERCE 1-0-1999.
RONALD DELGIZZI, EXAMINING ATTORNEY

SN 77-885,914. BRILLIANT TRANSPORTATION, LTD, NEW YORK, NY. FILED 12-4-2009.



THE MARK CONSISTS OF A STYLIZED WORD "BRILLIANT" IN LOWER CASE LETTERS UNDER A STYLIZED WING DESIGN.
FOR CHAUFFEURED PRIVATE GROUND TRANSPORTATION (U.S. CLS. 100 AND 105).
FIRST USE 12-3-2009; IN COMMERCE 12-3-2009.
LAKEISHA LEWIS, EXAMINING ATTORNEY

CLASS 39—(Continued).

SN 77-887,229. RENAISSANCE POWER, INC., BATON ROUGE, LA. FILED 12-7-2009.

ALL AMERICAN

THE MARK CONSISTS OF STANDARD CHARACTERS WITHOUT CLAIM TO ANY PARTICULAR FONT, STYLE, SIZE, OR COLOR.
FOR PUBLIC UTILITY SERVICES IN THE NATURE OF ELECTRICITY DISTRIBUTION (U.S. CLS. 100 AND 105).
ALYSSA STEEL, EXAMINING ATTORNEY

SN 77-887,230. RENAISSANCE POWER INC., BATON ROUGE, LA. FILED 12-7-2009.

POWERFUL SAVINGS

THE MARK CONSISTS OF STANDARD CHARACTERS WITHOUT CLAIM TO ANY PARTICULAR FONT, STYLE, SIZE, OR COLOR.
OWNER OF U.S. REG. NO. 2,464,030.
FOR PUBLIC UTILITY SERVICES IN THE NATURE OF ELECTRICITY DISTRIBUTION (U.S. CLS. 100 AND 105).
LEIGH CAROLINE CASE, EXAMINING ATTORNEY

SN 77-888,727. STEVENSON, SUSANNE, DEL MAR, CA. FILED 12-8-2009.

THE LAST QUIET PLACES

THE MARK CONSISTS OF STANDARD CHARACTERS WITHOUT CLAIM TO ANY PARTICULAR FONT, STYLE, SIZE, OR COLOR.
FOR ARRANGING TRAVEL TOURS (U.S. CLS. 100 AND 105).
CHERYL CLAYTON, EXAMINING ATTORNEY

CLASS 39—(Continued).

SN 77-889,770. BLACK BALL TRANSPORT, INC., SEATTLE, WA. FILED 12-9-2009.

BLACK BALL

THE MARK CONSISTS OF STANDARD CHARACTERS WITHOUT CLAIM TO ANY PARTICULAR FONT, STYLE, SIZE, OR COLOR.
FOR TRANSPORT BY FERRY-BOAT (U.S. CLS. 100 AND 105).
FIRST USE 11-20-2008; IN COMMERCE 11-20-2008.
ADA HAN, EXAMINING ATTORNEY

SN 77-892,075. SHELLBACK CRUISES, LLC, DBA SHELLBACK CRUISES, CHARLESTON, SC. FILED 12-12-2009.



THE COLOR(S) THE COLORS GREEN, GRAY, WHITE, YELLOW, BEIGE, SEA-BLUE, LIGHT BLUE IS/ARE CLAIMED AS A FEATURE OF THE MARK.
THE MARK CONSISTS OF GREEN, GRAY AND WHITE TURTLE WEARING A WHITE AND BLUE CAPTAIN'S HAT WITH A YELLOW ANCHOR, RECLINING ON A WHITE ADIRONDACK CHAIR WITH A GREEN DRINK GLASS CONTAINING A YELLOW UMBRELLA ON THE ARM OF THE CHAIR. THE RECLINING TURTLE IS ON A BEIGE BEACH WITH A BACKDROP OF GREEN PALM TREES, SEA-BLUE OCEAN, LIGHT BLUE SKY AND A WHITE CRUISE SHIP ON THE HORIZON.
FOR ARRANGING OF CRUISES; ARRANGING OF TOURS AND CRUISES; TRAVEL, EXCURSION AND CRUISE ARRANGEMENT (U.S. CLS. 100 AND 105).
FIRST USE 12-11-2009; IN COMMERCE 12-11-2009.
GEOFFREY FOSDICK, EXAMINING ATTORNEY

CLASS 39—(Continued).

SN 77-893,197. KENNIHAN, JEROME, VALENCIA, PA. FILED 12-14-2009.



NO CLAIM IS MADE TO THE EXCLUSIVE RIGHT TO USE "TRAVEL", APART FROM THE MARK AS SHOWN.

THE MARK CONSISTS OF THE STYLIZED TEXT "INTELLIGENT TRAVEL 360" ON A PANEL WITH A GLOBE ON THE RIGHT.

FOR AIR CHARTER SERVICES (U.S. CLS. 100 AND 105).

FIRST USE 7-1-2009; IN COMMERCE 7-1-2009.

LAURIE KAUFMAN, EXAMINING ATTORNEY

SN 77-893,884. VIP SCHOOL BUS, METAIRIE, LA. FILED 12-15-2009.

LUXURY MEETS FUN

THE MARK CONSISTS OF STANDARD CHARACTERS WITHOUT CLAIM TO ANY PARTICULAR FONT, STYLE, SIZE, OR COLOR.

FOR LIMOUSINE SERVICES (U.S. CLS. 100 AND 105).

FIRST USE 8-0-2009; IN COMMERCE 8-0-2009.

KEVIN CORWIN, EXAMINING ATTORNEY

SN 77-893,891. VIP SCHOOL BUS, METAIRIE, LA. FILED 12-15-2009.

RIDING THE BUS HAS NEVER BEEN THIS MUCH FUN

THE MARK CONSISTS OF STANDARD CHARACTERS WITHOUT CLAIM TO ANY PARTICULAR FONT, STYLE, SIZE, OR COLOR.

FOR LIMOUSINE SERVICES (U.S. CLS. 100 AND 105).

FIRST USE 8-0-2009; IN COMMERCE 8-0-2009.

KEVIN CORWIN, EXAMINING ATTORNEY

CLASS 39—(Continued).

SN 77-895,482. CELEBRITY CRUISES INC., MIAMI, FL. FILED 12-17-2009.

CELEBRITY SILHOUETTE

THE MARK CONSISTS OF STANDARD CHARACTERS WITHOUT CLAIM TO ANY PARTICULAR FONT, STYLE, SIZE, OR COLOR.

OWNER OF U.S. REG. NOS. 1,677,067, 2,478,526 AND 2,743,297.

FOR CRUISE SHIP SERVICES, ARRANGING AND CONDUCTING CRUISES FOR OTHERS, AND TRANSPORTATION OF PASSENGERS BY SHIP (U.S. CLS. 100 AND 105).

BARNEY CHARLON, EXAMINING ATTORNEY

SN 77-902,137. PROPARK, INC., HARTFORD, CT. FILED 12-29-2009.

BLUE SKY

THE MARK CONSISTS OF STANDARD CHARACTERS WITHOUT CLAIM TO ANY PARTICULAR FONT, STYLE, SIZE, OR COLOR.

FOR PARKING GARAGE SERVICES (U.S. CLS. 100 AND 105).

JACQUELINE A. LAVINE, EXAMINING ATTORNEY

SN 77-905,290. FEDERAL EXPRESS CORPORATION, MEMPHIS, TN. FILED 1-5-2010.

WE UNDERSTAND. IT'S A GLOBAL GAME.

THE MARK CONSISTS OF STANDARD CHARACTERS WITHOUT CLAIM TO ANY PARTICULAR FONT, STYLE, SIZE, OR COLOR.

FOR PICK-UP, TRANSPORTATION, STORAGE AND DELIVERY OF DOCUMENTS, PACKAGES AND FREIGHT BY LAND AND AIR (U.S. CLS. 100 AND 105).

BARBARA A. GOLD, EXAMINING ATTORNEY

CLASS 39—(Continued).

SN 77-905,424. DALLAS AREA RAPID TRANSIT, DALLAS, TX. FILED 1-5-2010.



OWNER OF U.S. REG. NOS. 2,683,454, 3,718,204 AND OTHERS.

THE MARK CONSISTS OF A DIAMOND SHAPED SIGN CONTAINING THE WORD "DART" IN THE TOP PORTION OF THE DIAMOND. BEHIND THE WORD "DART" IS A CHEVRON POINTING TO THE RIGHT. BENEATH THE WORD "DART", BETWEEN TWO LINES APPEARS THE WORD "SAFELY" IN ALL CAPITAL LETTERS. BENEATH THE WORD "SAFELY" IS A DRAWING OF GEOMETRICAL SHAPES THAT APPEAR TO BE AN ADULT AND CHILD CONNECTED THROUGH SHARING AN OBLONG, CURVED SHAPE THAT FORMS THE ARMS AND TORSO OF THE FIGURES.

FOR TRANSPORTATION SERVICES, NAMELY, MASS TRANSIT FOR THE GENERAL PUBLIC (U.S. CLS. 100 AND 105).

FIRST USE 11-0-2007; IN COMMERCE 11-0-2007.
ROBIN MITTLER, EXAMINING ATTORNEY

SN 77-908,063. MICROSTAR LOGISTICS, LLC, GREENWOOD VILLAGE, CO. FILED 1-8-2010.



NO CLAIM IS MADE TO THE EXCLUSIVE RIGHT TO USE "KEG MANAGEMENT", APART FROM THE MARK AS SHOWN.

THE MARK CONSISTS OF THE WORD "MICROSTAR" ABOVE A LINE WITH A "STAR" OVER THE "I" IN "MICROSTAR" AND THE WORD "KEG MANAGEMENT" BELOW THE LINE.

FOR LEASING AND TRANSPORTING SERVICES, NAMELY, LEASING AND TRANSPORTING BEVERAGE AND CHEMICAL CONTAINERS FOR OTHERS (U.S. CLS. 100 AND 105).

FIRST USE 0-0-1997; IN COMMERCE 0-0-1997.
SUSAN RICHARDS, EXAMINING ATTORNEY

CLASS 39—(Continued).

SN 77-908,073. MICROSTAR LOGISTICS, LLC, GREENWOOD VILLAGE, CO. FILED 1-8-2010.



NO CLAIM IS MADE TO THE EXCLUSIVE RIGHT TO USE "LOGISTICS", APART FROM THE MARK AS SHOWN. THE MARK CONSISTS OF THE WORD "MICROSTAR" ABOVE A LINE WITH A "STAR" OVER THE "I" IN "MICROSTAR" AND THE WORD "LOGISTICS" BELOW THE LINE TO THE FAR LEFT.

FOR LEASING AND TRANSPORTING SERVICES, NAMELY, LEASING AND TRANSPORTING BEVERAGE AND CHEMICAL CONTAINERS FOR OTHERS (U.S. CLS. 100 AND 105).

FIRST USE 0-0-2008; IN COMMERCE 0-0-2008.
SUSAN RICHARDS, EXAMINING ATTORNEY

SN 77-928,775. TRAILERLOGIC, DBA MORTUARY RESPONSE SOLUTIONS, BELTON, SC. FILED 2-5-2010.

THINKING OUTSIDE THE CHALK

THE MARK CONSISTS OF STANDARD CHARACTERS WITHOUT CLAIM TO ANY PARTICULAR FONT, STYLE, SIZE, OR COLOR.

FOR DISASTER RESPONSE SERVICES, NAMELY, PROVIDING FACILITIES, STORAGE UNITS, AND COOLING TRAILERS, BAGS, PACKS, AND REFRIGERATORS FOR HOUSING FATALITIES (U.S. CLS. 100 AND 105).

MARY ROSSMAN, EXAMINING ATTORNEY

CLASS 39—(Continued).

SN 79-073,490. HANATOUR SERVICE INC., SEOUL 110-160, REPUBLIC OF KOREA, FILED 7-13-2009.



OWNER OF INTERNATIONAL REGISTRATION 1014922 DATED 7-13-2009, EXPIRES 7-13-2019.

NO CLAIM IS MADE TO THE EXCLUSIVE RIGHT TO USE THE NON-LATIN CHARACTERS THAT TRANSLITERATE TO "YEO HAENG", APART FROM THE MARK AS SHOWN.

THE MARK CONSISTS OF THE WORDING "POPCORN-TOUR.COM" FOLLOWED BY THE WORDING "POP CORN" ARRANGED TO LOOK LIKE THE FACE OF AN ANIMAL, A DESIGN OF A PAIR OF ANIMAL EARS ON TOP AND UNDERNEATH ARE THE KOREAN CHARACTERS THAT TRANSLITERATE TO "TOK TOK TWI NEUN YEO HAENG PAP KON".

THE NON-LATIN CHARACTERS IN THE MARK TRANSLITERATE TO "TOK TOK TWI NEUN YEO HAENG PAP KON" IN WHICH "TOK TOK" IS AN ONOMATOPOEIA THAT REFERS TO THE SOUND OF POPCORN POPPING AND THIS HAS NO MEANING IN A FOREIGN LANGUAGE, AND "TWI NEUN," "YEO HAENG" AND "PAP KON" MEANS "POPPING," "TRAVEL" AND "POPCORN" RESPECTIVELY IN ENGLISH.

FOR TRAVEL RESERVATIONS, NAMELY, TRAVEL BOOKING AGENCIES, TRAVEL AND TOUR TICKET RESERVATION SERVICES, ONLINE TRIP AND TRAVEL RESERVATION SERVICES, COORDINATING TRAVEL ARRANGEMENTS FOR INDIVIDUALS AND FOR GROUPS; BOOKING OF SEATS FOR TRAVEL; ESCORTING OF TRAVELERS; TOURIST OFFICE SERVICES, EXCEPT FOR HOTEL RESERVATION; ARRANGING OF TOURS; TOUR GUIDE SERVICES (U.S. CLS. 100 AND 105).

HAI-LY LAM, EXAMINING ATTORNEY

CLASS 40—MATERIAL TREATMENT

SN 76-680,783. PURITY SOURCE, LLC, CLAYTON, MO. FILED 8-17-2007.



NO CLAIM IS MADE TO THE EXCLUSIVE RIGHT TO USE "PURE WATER SOLUTIONS", APART FROM THE MARK AS SHOWN.

FOR DISTRIBUTION OF WATER PURIFICATION SYSTEMS IN THE NATURE OF RENTAL OF WATER PURIFYING APPARATUS, WHERE THE PURIFICATION SYSTEMS AFFORD REVERSE OSMOSIS FILTRATION PROVIDED BY THE ACTIVATED OXYGEN SANITATION PROCESS (U.S. CLS. 100, 103 AND 106).
ADA HAN, EXAMINING ATTORNEY

SN 76-696,704. ACCESS TCA, INC., WHITINSVILLE, MA. FILED 4-6-2009.

ACCESS

THE MARK CONSISTS OF STANDARD CHARACTERS WITHOUT CLAIM TO ANY PARTICULAR FONT, STYLE, SIZE, OR COLOR.

FOR CUSTOM MANUFACTURE OF TRADE SHOW EXHIBITS IN THE FIELDS OF SPORTS AND RECREATIONAL ACTIVITIES (U.S. CLS. 100, 103 AND 106).

FIRST USE 5-1-1985; IN COMMERCE 5-1-1985.

DAWN HAN, EXAMINING ATTORNEY

SN 76-700,891. ESSILOR OF AMERICA, INC., DALLAS, TX. FILED 12-17-2009.

W.A.V.E. TECHNOLOGY 2

THE MARK CONSISTS OF STANDARD CHARACTERS WITHOUT CLAIM TO ANY PARTICULAR FONT, STYLE, SIZE, OR COLOR.

OWNER OF U.S. REG. NOS. 3,403,964 AND 3,403,969.

NO CLAIM IS MADE TO THE EXCLUSIVE RIGHT TO USE "TECHNOLOGY", APART FROM THE MARK AS SHOWN.

FOR OPHTHALMIC SERVICES IN THE NATURE OF CUSTOM MANUFACTURING AND REFINING OF OPHTHALMIC LENSES WHICH REDUCE DISTORTIONS AND ABERRATIONS AND INCREASE VISUAL ACUITY (U.S. CLS. 100, 103 AND 106).

SANI KHOURI, EXAMINING ATTORNEY

CLASS 40—(Continued).

SN 77-295,436. FOOT RELIEF INSOLES LLC, MODESTO, CA. FILED 10-3-2007.



NO CLAIM IS MADE TO THE EXCLUSIVE RIGHT TO USE "FOOT RELIEF" AND "INSOLES", APART FROM THE MARK AS SHOWN.

THE MARK CONSISTS OF THE WORDS "FOOT RELIEF" IN A STYLIZED FORMAT, OVER A REPRESENTATION OF THE SILHOUETTE OF A FOOT, ALL OVER A BOX CONTAINING THE STYLIZED WORD "INSOLES", WHICH IS OVER THE STYLIZED WORDING "ALL DAY FOOT MESSAGE".

FOR CUSTOM MANUFACTURER OF GLYCERIN FILLED SHOE INSOLES (U.S. CLS. 100, 103 AND 106).

FIRST USE 9-7-2007; IN COMMERCE 9-7-2007.

KHANH LE, EXAMINING ATTORNEY

SN 77-623,454. REEL EFX, INC., NORTH HOLLYWOOD, CA. FILED 12-1-2008.

REEL SNOW

THE MARK CONSISTS OF STANDARD CHARACTERS WITHOUT CLAIM TO ANY PARTICULAR FONT, STYLE, SIZE, OR COLOR.

NO CLAIM IS MADE TO THE EXCLUSIVE RIGHT TO USE "SNOW", APART FROM THE MARK AS SHOWN.

FOR CUSTOM FABRICATION OF MODELS, SETS AND PROPS IN THE FORM OF SNOW, ARTIFICIAL SNOW, SNOW EFFECTS, SNOW DRESSING, BLIZZARDS AND SNOW CONDITIONS FOR PHOTOGRAPHIC, CINEMAGRAPHIC, MOTION PICTURE, ENTERTAINMENT AND AMUSEMENT SERVICES (U.S. CLS. 100, 103 AND 106).

SKYE YOUNG, EXAMINING ATTORNEY

CLASS 40—(Continued).

SN 77-652,044. PETREE, RUSTY, HOUSTON, TX. FILED 1-19-2009.

Drilformance

THE MARK CONSISTS OF STANDARD CHARACTERS WITHOUT CLAIM TO ANY PARTICULAR FONT, STYLE, SIZE, OR COLOR.

FOR CUSTOM MANUFACTURE OF DRILLING PRODUCTS AND EQUIPMENT FOR THE OIL, GAS, AND MINERAL INDUSTRY (U.S. CLS. 100, 103 AND 106).

FIRST USE 11-3-2008; IN COMMERCE 11-3-2008.

TRACY CROSS, EXAMINING ATTORNEY

SN 77-675,994. NPI SOLUTIONS, INC., SAN JOSE, CA. FILED 2-23-2009.



NO CLAIM IS MADE TO THE EXCLUSIVE RIGHT TO USE "INC." AND "NEW PRODUCT INTEGRATION", APART FROM THE MARK AS SHOWN.

THE COLOR(S) GREEN AND GRAY IS/ARE CLAIMED AS A FEATURE OF THE MARK.

THE MARK CONSISTS OF A GREEN SQUARE, CIRCLE AND TRIANGLE FLANKED BY GRAY HORIZONTAL LINES, NEXT TO THE LOGO IN GREEN TYPE "NPI SOLUTIONS, INC." (IN ITALIC) FOLLOWED ALSO IN GREEN TYPE "NEW PRODUCT INTEGRATION".

FOR CONTRACT MANUFACTURING IN THE FIELD OF PRODUCT INTEGRATION (U.S. CLS. 100, 103 AND 106).

FIRST USE 3-3-2006; IN COMMERCE 3-3-2006.

PRISCILLA MILTON, EXAMINING ATTORNEY

SN 77-733,312. RECYCLE4U, LLC, HOUSTON, TX. FILED 5-10-2009.



NO CLAIM IS MADE TO THE EXCLUSIVE RIGHT TO USE "RECYCLE" AND THE UNIVERSAL RECYCLING SYMBOL, APART FROM THE MARK AS SHOWN.

THE COLOR(S) GREEN IS/ARE CLAIMED AS A FEATURE OF THE MARK.

THE MARK CONSISTS OF THE WORDING "RECYCLE 4U" WITH "4U" WITHIN THE UNIVERSAL RECYCLING SYMBOL, ALL IN GREEN.

FOR RECYCLING (U.S. CLS. 100, 103 AND 106).

FIRST USE 1-23-2009; IN COMMERCE 1-31-2009.

MELISSA VALLILLO, EXAMINING ATTORNEY

CLASS 40—(Continued).

SN 77-756,756. INFINITE ENERGY MANUFACTURING, LLC, CLEVELAND, OH. FILED 6-10-2009.

Infinite Energy

THE MARK CONSISTS OF STANDARD CHARACTERS WITHOUT CLAIM TO ANY PARTICULAR FONT, STYLE, SIZE, OR COLOR.

NO CLAIM IS MADE TO THE EXCLUSIVE RIGHT TO USE "ENERGY", APART FROM THE MARK AS SHOWN.

FOR CUSTOM MANUFACTURE OF POWER GENERATION AND POLLUTION CONTROL COMPONENTS USED IN THE ENERGY INDUSTRY; CUSTOM STEEL ROLLING AND FABRICATION TO THE ORDER AND SPECIFICATION OF OTHERS; MACHINE SHOP SERVICES, NAMELY, MACHINING PARTS FOR OTHERS; MANUFACTURE OF GENERAL PRODUCT LINES IN THE FIELD OF POWER GENERATION AND POLLUTION CONTROL COMPONENTS USED IN THE ENERGY INDUSTRY TO THE ORDER AND SPECIFICATION OF OTHERS; MANUFACTURE OF POWER GENERATION AND POLLUTION CONTROL COMPONENTS USED IN THE ENERGY INDUSTRY TO ORDER AND/OR SPECIFICATION OF OTHERS; MANUFACTURING SERVICES FOR OTHERS IN THE FIELD OF ENERGY INDUSTRY; METAL FABRICATION AND FINISHING SERVICES (U.S. CLS. 100, 103 AND 106).

NELSON SNYDER, EXAMINING ATTORNEY



SN 77-760,192. SOLIX BIOFUELS, INC., FORT COLLINS, CO. FILED 6-15-2009.

AGS

THE MARK CONSISTS OF STANDARD CHARACTERS WITHOUT CLAIM TO ANY PARTICULAR FONT, STYLE, SIZE, OR COLOR.

FOR HAZARDOUS WASTE EMISSION MANAGEMENT SERVICES FOR INDUSTRY, POWER PLANTS, AND PUBLIC UTILITIES INTENDED TO MITIGATE ENVIRONMENTAL POLLUTION, CARBON DIOXIDE, NITROUS OXIDE, HEAVY METALS, AND TRACE COMPOUNDS (U.S. CLS. 100, 103 AND 106).

COLLEEN DOMBROW, EXAMINING ATTORNEY

CLASS 40—(Continued).

SN 77-761,089. TECHMETALS, INC., DAYTON, OH. FILED 6-16-2009.

MEDADIZE

THE MARK CONSISTS OF STANDARD CHARACTERS WITHOUT CLAIM TO ANY PARTICULAR FONT, STYLE, SIZE, OR COLOR.

FOR METAL TREATMENT SERVICES (U.S. CLS. 100, 103 AND 106).

FIRST USE 1-0-2009; IN COMMERCE 1-0-2009.
LAURIE MAYES, EXAMINING ATTORNEY



SN 77-828,961. SEABOARD ENVELOPE COMPANY, INC., IRWINDALE, CA. FILED 9-17-2009.

peel to seal

THE MARK CONSISTS OF STANDARD CHARACTERS WITHOUT CLAIM TO ANY PARTICULAR FONT, STYLE, SIZE, OR COLOR.

FOR CONVERTING PAPER INTO MAILING ENVELOPES AND OTHER MAILERS (U.S. CLS. 100, 103 AND 106).

CIMMERIAN COLEMAN, EXAMINING ATTORNEY



SN 77-836,556. BONA DENT, INC, SENECA FALLS, NY. FILED 9-28-2009.



NO CLAIM IS MADE TO THE EXCLUSIVE RIGHT TO USE "DENTAL LABORATORY", APART FROM THE MARK AS SHOWN.

THE MARK CONSISTS OF A CRESCENT WITH THE WORDS "DANAREN DENTAL LABORATORY" ENVELOPED BY THE CRESCENT.

FOR DENTAL LABORATORIES (U.S. CLS. 100, 103 AND 106).

FIRST USE 12-1-2004; IN COMMERCE 12-1-2004.
EUGENIA MARTIN, EXAMINING ATTORNEY

CLASS 40—(Continued).

SN 77-883,504. 300 BELOW, INC., DECATUR, IL. FILED 12-1-2009.



NO CLAIM IS MADE TO THE EXCLUSIVE RIGHT TO USE "CRYO ACCURIZING", APART FROM THE MARK AS SHOWN.

THE MARK CONSISTS OF CROSS HAIRS CENTERING IN THE CAPITAL "C". THE RIGHT SIDE OF THE HORIZONTAL COMPONENT EXTENDS TO THE RIGHT INTERSECTING THE "R", "Y" AND "O" AND ENDING WITH A BULLET SHAPE WITHIN THE RIGHT SIDE OF THE "O". THE WORD "ACCURIZING" APPEARS BELOW THE WORD "CRYO".

FOR CRYOGENIC TEMPERING OF FIREARMS AND FIREARMS COMPONENTS (U.S. CLS. 100, 103 AND 106). FIRST USE 12-15-1994; IN COMMERCE 12-15-1994. TRICIA SONNEBORN, EXAMINING ATTORNEY

SN 77-883,665. M2H INVESTMENTS, INC., DBA DILLANOS COFFEE ROASTERS, SUMNER, WA. FILED 12-1-2009.

CAFFEINE NATION

THE MARK CONSISTS OF STANDARD CHARACTERS WITHOUT CLAIM TO ANY PARTICULAR FONT, STYLE, SIZE, OR COLOR.

NO CLAIM IS MADE TO THE EXCLUSIVE RIGHT TO USE "CAFFEINE", APART FROM THE MARK AS SHOWN.

FOR PROVIDING INFORMATION ABOUT COFFEE ROASTING AND PROCESSING AND RELATED NEWS AND COMMENTARY VIA THE INTERNET (U.S. CLS. 100, 103 AND 106).

TOBY BULLOFF, EXAMINING ATTORNEY

SN 77-887,362. WASTE-AWAY GROUP, LTD., ELKHART, IN. FILED 12-7-2009.

INTEGRA

THE MARK CONSISTS OF STANDARD CHARACTERS WITHOUT CLAIM TO ANY PARTICULAR FONT, STYLE, SIZE, OR COLOR.

FOR DOCUMENT DESTRUCTION SERVICES (U.S. CLS. 100, 103 AND 106).

FIRST USE 4-0-2007; IN COMMERCE 4-0-2007. B. PARADEWELAI, EXAMINING ATTORNEY

CLASS 40—(Continued).

SN 77-887,455. PEACE, LOVE AND POTTERY, SUWANEE, GA. FILED 12-7-2009.

Peace, Love and Pottery

THE MARK CONSISTS OF STANDARD CHARACTERS WITHOUT CLAIM TO ANY PARTICULAR FONT, STYLE, SIZE, OR COLOR.

NO CLAIM IS MADE TO THE EXCLUSIVE RIGHT TO USE "POTTERY", APART FROM THE MARK AS SHOWN.

FOR POTTERY FIRING (U.S. CLS. 100, 103 AND 106). FIRST USE 4-20-2009; IN COMMERCE 4-21-2009.

JASON TURNER, EXAMINING ATTORNEY

SN 77-887,898. SHWEIKI MEDIA, INC., SAN ANTONIO, TX. FILED 12-7-2009.

MAGGOO

THE MARK CONSISTS OF STANDARD CHARACTERS WITHOUT CLAIM TO ANY PARTICULAR FONT, STYLE, SIZE, OR COLOR.

FOR PRINTING SERVICES; PRINTING OF BOOKS FOR OTHERS; PRINTING OF ADVERTISING MATERIALS FOR OTHERS; PRINTING OF PAPERS FOR OTHERS (U.S. CLS. 100, 103 AND 106).

BRENDAN MCCAULEY, EXAMINING ATTORNEY

SN 77-887,902. P&D PARTNERSHIP, DBA THE GRAYS MATTER, NATICK, MA. FILED 12-7-2009.

THE GRAYS MATTER

THE MARK CONSISTS OF STANDARD CHARACTERS WITHOUT CLAIM TO ANY PARTICULAR FONT, STYLE, SIZE, OR COLOR.

FOR IMPRINTING MESSAGES ON WEARING APPAREL, ACCESSORIES AND MUGS (U.S. CLS. 100, 103 AND 106).

KEVIN CORWIN, EXAMINING ATTORNEY

CLASS 40—(Continued).

SN 77-888,818. CONTROLLED THERMAL TECHNOLOGY, PHOENIX, AZ. FILED 12-8-2009.

Nitridox Pro

THE MARK CONSISTS OF STANDARD CHARACTERS WITHOUT CLAIM TO ANY PARTICULAR FONT, STYLE, SIZE, OR COLOR.

NO CLAIM IS MADE TO THE EXCLUSIVE RIGHT TO USE "PRO", APART FROM THE MARK AS SHOWN.

FOR METAL HEAT TREATING SERVICES BY MEANS OF THERMO-CHEMICAL DIFFUSION; METAL TREATING; METAL TREATMENT; TREATMENT OF METAL (U.S. CLS. 100, 103 AND 106).

LINDA LAVACHE, EXAMINING ATTORNEY

SN 77-888,971. FRED WEBER, INC., MARYLAND HEIGHTS, MO. FILED 12-8-2009.



THE MARK CONSISTS OF STYLIZED COMPACT FLUORESCENT LIGHT BULB INSIDE OF TWO CIRCLES. THE OUTER CIRCLE HAS AN INCOMPLETE OUTER BORDER AND A CHANGING WIDTH. FOUR GROUPS OF LEAVES APPEAR ON THE LIGHT BULB. THE WORDS "METHANE TO MEGAWATTS" APPEAR TO THE RIGHT OF THE LIGHT BULB. IN ALL CAPITAL LETTERS.

FOR GENERATION OF ELECTRICITY FROM METHANE (U.S. CLS. 100, 103 AND 106).

FIRST USE 9-10-2009; IN COMMERCE 9-10-2009.
BARNEY CHARLON, EXAMINING ATTORNEY

SN 77-891,173. UNCOMMON, LLC, CHICAGO, IL. FILED 12-11-2009.

TATT

THE MARK CONSISTS OF STANDARD CHARACTERS WITHOUT CLAIM TO ANY PARTICULAR FONT, STYLE, SIZE, OR COLOR.

FOR APPLICATION OF HEAT TRANSFERRED ADHESIVES FOR COMMERCIAL USE (U.S. CLS. 100, 103 AND 106).

LINDA E. BLOHM, EXAMINING ATTORNEY

CLASS 40—(Continued).

SN 77-892,585. DIRADO, HUGO A, SAN CLEMENTE, CA. FILED 12-14-2009.

Karatclad

THE MARK CONSISTS OF STANDARD CHARACTERS WITHOUT CLAIM TO ANY PARTICULAR FONT, STYLE, SIZE, OR COLOR.

FOR JEWELRY ELECTROPLATING SERVICES (U.S. CLS. 100, 103 AND 106).

LINDA E. BLOHM, EXAMINING ATTORNEY

SN 77-900,777. BRIAN CZECHOWSKI, DBA CODE-3 GRAPHICS, ALAMEDA, CA. FILED 12-24-2009.

Code-3 Graphics

THE MARK CONSISTS OF STANDARD CHARACTERS WITHOUT CLAIM TO ANY PARTICULAR FONT, STYLE, SIZE, OR COLOR.

NO CLAIM IS MADE TO THE EXCLUSIVE RIGHT TO USE "GRAPHICS", APART FROM THE MARK AS SHOWN.

FOR CUSTOM MANUFACTURE OF VEHICLE WRAPS AND FLEET GRAPHICS (U.S. CLS. 100, 103 AND 106).

FIRST USE 10-0-2009; IN COMMERCE 10-0-2009.

KATINA MISTER, EXAMINING ATTORNEY

SN 77-912,678. WILNER, ELI, NEW YORK, NY. FILED 1-15-2010.

ELI WILNER

THE MARK CONSISTS OF STANDARD CHARACTERS WITHOUT CLAIM TO ANY PARTICULAR FONT, STYLE, SIZE, OR COLOR.

THE NAME(S), PORTRAIT(S), AND/OR SIGNATURE(S) SHOWN IN THE MARK IDENTIFIES "ELI WILNER", WHOSE CONSENT(S) TO REGISTER IS MADE OF RECORD.

FOR FRAMING OF WORKS OF ART; PROVIDING WORKSHOP FACILITIES FOR BUILDING, WOODWORKING OR FRAMING PURPOSES (U.S. CLS. 100, 103 AND 106).

VIVIAN MICZNIK FIRST, EXAMINING ATTORNEY

CLASS 40—(Continued).

SN 79-068,538. MGG GROUP B.V., NETHERLANDS, FILED 4-22-2009.

LPSC

THE MARK CONSISTS OF STANDARD CHARACTERS WITHOUT CLAIM TO ANY PARTICULAR FONT, STYLE, SIZE, OR COLOR.

PRIORITY DATE OF 11-13-2008 IS CLAIMED.

OWNER OF INTERNATIONAL REGISTRATION 1002009 DATED 4-22-2009, EXPIRES 4-22-2019.

FOR TREATMENT OF MATERIALS, NAMELY, ALUMINIUM SAND CASTING; SERVICES OF A FOUNDRY, NAMELY, MACHINING OF ALUMINIUM; CUSTOM FABRICATION FOR OTHER OF METAL PARTS FOR THE TRUCK, CAR, AND BOILER INDUSTRIES (U.S. CLS. 100, 103 AND 106).

JASON BLAIR, EXAMINING ATTORNEY

CLASS 41—(Continued).

SN 76-696,437. WILMOT MOUNTAIN, INC., WILMOT, WI. FILED 3-23-2009.



NO CLAIM IS MADE TO THE EXCLUSIVE RIGHT TO USE "WILMOT MOUNTAIN", APART FROM THE MARK AS SHOWN.

THE MARK CONSISTS OF THE REPRESENTATION OF THREE SNOW COVERED MOUNTAIN PEAKS THE WORDS WILMOT MOUNTAIN IN A STYLIZED FONT.

FOR SKI RESORTS (U.S. CLS. 100, 101 AND 107).

DEBRA LEE, EXAMINING ATTORNEY

CLASS 41—EDUCATION AND ENTERTAINMENT

SN 76-691,925. COYOTE CENTER DEVELOPMENT, LLC, PHOENIX, AZ. FILED 8-8-2008.



NO CLAIM IS MADE TO THE EXCLUSIVE RIGHT TO USE "CLUB", APART FROM THE MARK AS SHOWN.

THE MARK CONSISTS OF THE STYLIZED LETTERING "CM" OVER THE WORDS "CLUB MAJESTIC"; TWO CURVED BARS, ONE CROSSED OVER THE OTHER, APPEARS AT THE CENTER OF THE MARK.

FOR SOCIAL CLUB SERVICES, NAMELY, ARRANGING ORGANIZING AND HOSTING SOCIAL EVENTS, GET-TOGETHERS, AND PARTIES AT WESTGATE CITY CENTER AS WELL AS AT OTHER LOCATIONS (U.S. CLS. 100, 101 AND 107).

SKYE YOUNG, EXAMINING ATTORNEY

SN 76-697,671. FRIENDS OF SCOTLAND, INC., SARATOGA, CA. FILED 6-1-2009.

DRESSED TO KILT

THE MARK CONSISTS OF STANDARD CHARACTERS WITHOUT CLAIM TO ANY PARTICULAR FONT, STYLE, SIZE, OR COLOR.

OWNER OF U.S. REG. NOS. 3,289,405, 3,289,406 AND 3,708,995.

FOR ENTERTAINMENT IN THE NATURE OF ON-GOING VARIETY, NEWS, MUSIC OR COMEDY SHOWS FEATURING SCOTTISH THEMES BROADCAST OVER TELEVISION, SATELLITE, AUDIO, RADIO, CABLE TELEVISION, CABLE, WEBCASTS, INTERNET AND VIDEO MEDIA; ENTERTAINMENT IN THE NATURE OF ON-GOING NEWS, COMEDY, MUSIC AND VARIETY TELEVISION PROGRAMS HAVING SCOTTISH THEMES; PRODUCTION OF RADIO AND TELEVISION PROGRAMS; TELEVISION SHOW PRODUCTION (U.S. CLS. 100, 101 AND 107).

SHAILA SETTLES, EXAMINING ATTORNEY

CLASS 41—(Continued).

SN 76-698,048. PFP HOLDING COMPANY, LLC, CHESTERFIELD, MO. FILED 6-23-2009.



NO CLAIM IS MADE TO THE EXCLUSIVE RIGHT TO USE "PHEASANTS", APART FROM THE MARK AS SHOWN.

FOR ORGANIZING AND CONDUCTING HUNTS FOR UPLAND GAME BIRDS (U.S. CLS. 100, 101 AND 107).
FIRST USE 0-0-1952; IN COMMERCE 0-0-1952.
MORGAN WYNNE, EXAMINING ATTORNEY

SN 76-698,451. WHAT'S ON YOUR DASH, L.L.C., ROCHESTER HILLS, MI. FILED 7-16-2009.



NO CLAIM IS MADE TO THE EXCLUSIVE RIGHT TO USE "COACH", APART FROM THE MARK AS SHOWN.

FOR PERSONAL AND PROFESSIONAL LIFE COACHING SERVICES IN THE FIELD OF PERSONAL DEVELOPMENT AND LEADERSHIP (U.S. CLS. 100, 101 AND 107).

SHAILA SETTLES, EXAMINING ATTORNEY

CLASS 41—(Continued).

SN 76-700,750. BRAIN POTENTIAL INSTITUTE, INC., MONTGOMERY, TX. FILED 12-9-2009.

BRAIN POTENTIAL

THE MARK CONSISTS OF STANDARD CHARACTERS WITHOUT CLAIM TO ANY PARTICULAR FONT, STYLE, SIZE, OR COLOR.

FOR EDUCATIONAL SERVICES, NAMELY, PROVIDING TRAINING TO INDIVIDUALS IN ORDER TO IMPROVE THEIR COGNITIVE SKILLS (U.S. CLS. 100, 101 AND 107).

LESLIE RICHARDS, EXAMINING ATTORNEY

SN 76-700,757. THREE DOG NIGHT, LAS VEGAS, NV. FILED 12-9-2009.

THREE DOG NIGHT

THE MARK CONSISTS OF STANDARD CHARACTERS WITHOUT CLAIM TO ANY PARTICULAR FONT, STYLE, SIZE, OR COLOR.

FOR ENTERTAINMENT SERVICES, NAMELY, LIVE CONCERTS AND PERFORMANCES BY A MUSICAL BAND (U.S. CLS. 100, 101 AND 107).

FIRST USE 9-1-1968; IN COMMERCE 9-1-1968.

TASNEEM HUSSAIN, EXAMINING ATTORNEY

SN 76-700,814. DR GREGORY BEROZA, NEW YORK, NY. FILED 12-11-2009.

TALKING HORSES

THE MARK CONSISTS OF STANDARD CHARACTERS WITHOUT CLAIM TO ANY PARTICULAR FONT, STYLE, SIZE, OR COLOR.

NO CLAIM IS MADE TO THE EXCLUSIVE RIGHT TO USE "HORSES", APART FROM THE MARK AS SHOWN.

FOR ENTERTAINMENT SERVICES, NAMELY, PROVIDING VIDEO PODCASTS IN THE FIELD OF HORSES DISTRIBUTED OVER THE INTERNET (U.S. CLS. 100, 101 AND 107).

FIRST USE 6-0-2008; IN COMMERCE 6-0-2008.

AMY KERTGATE, EXAMINING ATTORNEY

CLASS 41—(Continued).

SN 77-204,513. INNER CIRCLE WRESTLING ACADEMY, LLC, CANTON, GA. FILED 6-12-2007.

Because there is no off-season...

THE MARK CONSISTS OF STANDARD CHARACTERS WITHOUT CLAIM TO ANY PARTICULAR FONT, STYLE, SIZE, OR COLOR.

FOR WRESTLING INSTRUCTION (U.S. CLS. 100, 101 AND 107).

FIRST USE 3-3-2007; IN COMMERCE 3-3-2007.

MARTHA SANTOMARTINO, EXAMINING ATTORNEY

SN 77-386,811. PASCUA YAQUI TRIBE, TUCSON, AZ. FILED 2-1-2008.

CASINO SUN

THE MARK CONSISTS OF STANDARD CHARACTERS WITHOUT CLAIM TO ANY PARTICULAR FONT, STYLE, SIZE, OR COLOR.

OWNER OF U.S. REG. NOS. 2,211,185, 2,213,042 AND OTHERS.

NO CLAIM IS MADE TO THE EXCLUSIVE RIGHT TO USE "CASINO", APART FROM THE MARK AS SHOWN.

FOR PROVIDING CASINO FACILITIES AND SERVICES (U.S. CLS. 100, 101 AND 107).

FIRST USE 6-0-1993; IN COMMERCE 6-0-1993.

JOHN E. MICHOS, EXAMINING ATTORNEY

SN 77-406,384. UTNE, NINA ROTHSCHILD, MINNEAPOLIS, MN. FILED 2-26-2008.

FUTUREFIT

THE MARK CONSISTS OF STANDARD CHARACTERS WITHOUT CLAIM TO ANY PARTICULAR FONT, STYLE, SIZE, OR COLOR.

FOR EDUCATIONAL SERVICES, NAMELY, PROVIDING RADIO PROGRAMS AND ON-LINE JOURNALS AND CONDUCTING SEMINARS, WORKSHOPS, CLASSES AND LIVE SPEAKING PERFORMANCES IN THE FIELDS OF HEALTH, NUTRITION, LIFESTYLE WELLNESS, ENERGY EFFICIENCY, RENEWABLE RESOURCES AND PUBLIC POLICY TO IMPROVE HEALTH AND LESSEN ADVERSE EFFECTS ON THE ENVIRONMENT (U.S. CLS. 100, 101 AND 107).

KAREN K. BUSH, EXAMINING ATTORNEY

CLASS 41—(Continued).

SN 77-460,446. GILL ACTION FUND, DENVER, CO. FILED 4-29-2008.

POLITICAL OUTGIVING

THE MARK CONSISTS OF STANDARD CHARACTERS WITHOUT CLAIM TO ANY PARTICULAR FONT, STYLE, SIZE, OR COLOR.

NO CLAIM IS MADE TO THE EXCLUSIVE RIGHT TO USE "POLITICAL", APART FROM THE MARK AS SHOWN.

FOR EDUCATIONAL SERVICES, NAMELY, TRAINING VIA WORKSHOPS AND MEETINGS IN THE FIELD OF USE OF POLITICAL CONTRIBUTIONS AS A MEANS TO ACHIEVE CIVIL RIGHTS FOR GAY, LESBIAN, TRANSGENDER, AND BISEXUAL PERSONS (U.S. CLS. 100, 101 AND 107).

ELIZABETH HUGHITT, EXAMINING ATTORNEY

SN 77-551,253. ABRAHAM, THOMAS G., MIAMI, FL. FILED 8-20-2008.

IGATE 3D

THE MARK CONSISTS OF STANDARD CHARACTERS WITHOUT CLAIM TO ANY PARTICULAR FONT, STYLE, SIZE, OR COLOR.

NO CLAIM IS MADE TO THE EXCLUSIVE RIGHT TO USE "3D", APART FROM THE MARK AS SHOWN.

FOR DIGITAL IMAGING SERVICES, NAMELY, NON-MEDICAL THREE-DIMENSIONAL DIGITAL IMAGING OF THE HUMAN BODY FOR OTHERS; PHOTOGRAPHY SERVICES FOR OTHERS; PHOTOGRAPHIC COMPUTER IMAGING FOR OTHERS, NAMELY, NON-MEDICAL THREE-DIMENSIONAL IMAGING FOR OTHERS; THREE-DIMENSIONAL DIGITAL PHOTOGRAPHY SERVICES FOR OTHERS (U.S. CLS. 100, 101 AND 107).

KAREN SEVERSON, EXAMINING ATTORNEY

SN 77-578,787. TELEVISION FOOD NETWORK, G.P., NEW YORK, NY. FILED 9-25-2008.

SECRETS OF A RESTAURANT CHEF

THE MARK CONSISTS OF STANDARD CHARACTERS WITHOUT CLAIM TO ANY PARTICULAR FONT, STYLE, SIZE, OR COLOR.

NO CLAIM IS MADE TO THE EXCLUSIVE RIGHT TO USE "RESTAURANT CHEF", APART FROM THE MARK AS SHOWN.

FOR EDUCATIONAL AND ENTERTAINMENT SERVICES, NAMELY, A CONTINUING PROGRAM ABOUT FOOD AND COOKING, ACCESSIBLE BY RADIO, TELEVISION, CABLE, FIBER OPTIC NETWORKS, WIRELESS NETWORKS, SATELLITE, AUDIO VIDEO, AND COMPUTER NETWORKS (U.S. CLS. 100, 101 AND 107).

ASMAT KHAN, EXAMINING ATTORNEY

CLASS 41—(Continued).

SN 77-651,530. LEADERSHIP PRESS AVENUE, LLC, MINNEAPOLIS, MN. FILED 1-16-2009.

Kick-Butt Kick-Off

THE MARK CONSISTS OF STANDARD CHARACTERS WITHOUT CLAIM TO ANY PARTICULAR FONT, STYLE, SIZE, OR COLOR.

FOR EDUCATIONAL SERVICES, NAMELY, PROVIDING MOTIVATIONAL SPEAKERS, TRAINING SERVICES AND CONDUCTING CONFERENCES, CLASSES, SEMINARS, WORKSHOPS AND MEETINGS IN THE FIELD OF MARKETING, SALES, MOTIVATING EMPLOYEES AND ORGANIZATIONS, AND BUSINESS AND ORGANIZATIONAL DEVELOPMENT (U.S. CLS. 100, 101 AND 107).

FIRST USE 12-8-2006; IN COMMERCE 12-8-2006.
MARC LEIPZIG, EXAMINING ATTORNEY

SN 77-663,713. ROBERT JOHN, DBA ROBERT JOHN PHOTOGRAPHY, PALMDALE, CA. FILED 2-4-2009.

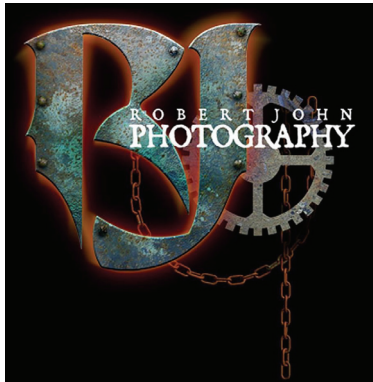

NO CLAIM IS MADE TO THE EXCLUSIVE RIGHT TO USE "PHOTOGRAPHY", APART FROM THE MARK AS SHOWN.

THE NAME ROBERT JOHN IDENTIFIES A LIVING INDIVIDUAL WHOSE CONSENT IS OF RECORD.

THE COLOR(S) ORANGE, GREY, WHITE, TEAL, RUST BROWN, RUST GREEN IS/ARE CLAIMED AS A FEATURE OF THE MARK.

THE MARK CONSISTS OF THE LETTERS "RJ" IN RUST GREEN, WITH ORANGE AND TEAL COLORED RIVETS, AND AN ORANGE OUTLINE AROUND THE LETTERS; A GREY COLORED GEAR AND RUST BROWN CHAIN APPEAR BEHIND THE LETTERS; THE WORDS "ROBERT JOHN PHOTOGRAPHY", IN WHITE LETTERS, APPEAR IN FRONT OF THE LETTERS "RJ". THE COLOR BLACK IS USED AS A BACKGROUND, AND IS NOT CLAIMED AS A FEATURE OF THE MARK.

FOR PHOTOGRAPHY; PHOTOGRAPHY SERVICES; PORTRAIT PHOTOGRAPHY; PROVIDING FACILITIES FOR PRODUCING VIDEO, CINEMA AND PHOTOGRAPHY PRODUCTIONS; VIDEOGRAPHY SERVICES (U.S. CLS. 100, 101 AND 107).

FIRST USE 1-1-1982; IN COMMERCE 1-1-1982.
HENRY S. ZAK, EXAMINING ATTORNEY

CLASS 41—(Continued).

SN 77-666,191. MEZYDLO, VALERIE, CRESTWOOD, IL. FILED 2-9-2009.

DJ VAL

THE MARK CONSISTS OF STANDARD CHARACTERS WITHOUT CLAIM TO ANY PARTICULAR FONT, STYLE, SIZE, OR COLOR.

NO CLAIM IS MADE TO THE EXCLUSIVE RIGHT TO USE "DJ", APART FROM THE MARK AS SHOWN.

THE NAME IN THE MARK IDENTIFIES A LIVING INDIVIDUAL WHOSE CONSENT IS OF RECORD.

FOR ENTERTAINMENT SERVICES IN THE NATURE OF LIVE PERFORMANCES BY DISC JOCKEYS; REMIXING SERVICES IN THE NATURE OF MUSIC PRODUCTION SERVICES PERFORMED BY DISC JOCKEYS (U.S. CLS. 100, 101 AND 107).

KAREN K. BUSH, EXAMINING ATTORNEY

SN 77-673,213. TEXAS SKI RANCH, L.P., NEW BRAUNFELS, TX. FILED 2-18-2009.



THE COLOR(S) BLACK AND WHITE IS/ARE CLAIMED AS A FEATURE OF THE MARK.

THE MARK CONSISTS OF A BLACK, HORIZONTAL OVAL OUTLINE IN A WAKEBOARD SHAPE WITH WHITE BACKGROUND, HORIZONTAL BLACK SWIRL DESIGN IN CENTER, AND BLACK HALF-ELLIPTICAL SHAPES ON EITHER SIDE OF THE CENTER DESIGN.

FOR PROVIDING FACILITIES FOR RECREATION ACTIVITIES (U.S. CLS. 100, 101 AND 107).

FIRST USE 9-28-2000; IN COMMERCE 9-28-2000.
BARBARA RUTLAND, EXAMINING ATTORNEY

SN 77-686,835. BARRETT, KAREEM, QUEENS, NY. AND REID, WILLIAM, QUEENS, NY. FILED 3-9-2009.

Frontline Gunnas Records

THE MARK CONSISTS OF STANDARD CHARACTERS WITHOUT CLAIM TO ANY PARTICULAR FONT, STYLE, SIZE, OR COLOR.

NO CLAIM IS MADE TO THE EXCLUSIVE RIGHT TO USE "RECORDS", APART FROM THE MARK AS SHOWN.

FOR AUDIO RECORDING AND PRODUCTION; EDITING OR RECORDING OF SOUNDS AND IMAGES; MULTIMEDIA ENTERTAINMENT SERVICES IN THE NATURE OF RECORDING, PRODUCTION AND POST-PRODUCTION SERVICES IN THE FIELDS OF MUSIC, VIDEO, AND FILMS; MUSIC PRODUCTION SERVICES; PRODUCTION OF SOUND RECORDINGS (U.S. CLS. 100, 101 AND 107).

ALLISON HOLTZ, EXAMINING ATTORNEY

CLASS 41—(Continued).

SN 77-697,172. INSPIRED AUTHORS, LLC, BROOKLYN, NY. FILED 3-23-2009.

PERFECT WOMAN

THE MARK CONSISTS OF STANDARD CHARACTERS WITHOUT CLAIM TO ANY PARTICULAR FONT, STYLE, SIZE, OR COLOR.

NO CLAIM IS MADE TO THE EXCLUSIVE RIGHT TO USE "WOMAN", APART FROM THE MARK AS SHOWN.

FOR EDUCATIONAL SERVICES, NAMELY, PROVIDING DEVELOPING, ARRANGING, AND CONDUCTING EDUCATIONAL CONFERENCES AND PROGRAMS AND PROVIDING COURSES OF INSTRUCTION IN THE FIELDS OF MOTIVATION, SPIRITUAL, INSPIRATION AND PERSONAL GROWTH; INSTRUCTION IN THE FIELD OF MOTIVATION, SPIRITUAL, INSPIRATION AND PERSONAL GROWTH; ORGANIZING EXHIBITIONS FOR MOTIVATION, SPIRITUAL, INSPIRATION AND PERSONAL GROWTH; PROVIDING EDUCATIONAL MENTORING SERVICES AND PROGRAMS IN THE FIELD OF MOTIVATION, SPIRITUAL, INSPIRATION AND PERSONAL GROWTH; PUBLICATION OF PRINTED MATTER; PUBLICATION OF TEXTS, BOOKS, JOURNALS; PUBLICATION OF TEXTS, BOOKS, MAGAZINES AND OTHER PRINTED MATTER; PUBLISHING OF BOOKS, MAGAZINES; PUBLISHING OF ELECTRONIC PUBLICATIONS; WORKSHOPS AND SEMINARS IN THE FIELD OF MOTIVATION, SPIRITUAL, INSPIRATION AND PERSONAL GROWTH; WRITING OF TEXTS (U.S. CLS. 100, 101 AND 107).

BRIAN CALLAGHAN, EXAMINING ATTORNEY

SN 77-702,013. COOL MUSIC NETWORK, LLC, LAWRENCE, KS. FILED 3-30-2009.

THECOOLTV

THE MARK CONSISTS OF THE THREE WORDS "THE COOL TV" COMBINED AS ONE. THE WORDS "THE-COOLTV" ARE IN ALL CAPS AND RUN TOGETHER WITHOUT SPACES IN BETWEEN. THE WORDS "COOLTV" ARE DARKER AND APPEAR MORE BOLD THAN THE WORD "THE". ALL THE LETTERS ARE BLACK.

FOR ENTERTAINMENT IN THE NATURE OF ONGOING TELEVISION PROGRAMS IN THE FIELD OF MUSIC AND LIVE MUSIC BROADCAST OVER TELEVISION, THE INTERNET, AND OTHER MOBILE DEVICES (U.S. CLS. 100, 101 AND 107).

FIRST USE 9-1-2008; IN COMMERCE 9-1-2008.
JILL PRATER, EXAMINING ATTORNEY

CLASS 41—(Continued).

SN 77-712,880. PRG MEDIA, INC., NEW YORK, NY. FILED 4-13-2009.

POWDER ROOM GRAFFITI

THE MARK CONSISTS OF STANDARD CHARACTERS WITHOUT CLAIM TO ANY PARTICULAR FONT, STYLE, SIZE, OR COLOR.

FOR ONLINE SERVICES, NAMELY, PROVIDING A WEBSITE FEATURING ENTERTAINMENT INFORMATION REGARDING ISSUES OF INTEREST AND CONCERN TO WOMEN, NAMELY, ENTERTAINMENT INFORMATION REGARDING MUSIC, MOVIES, BOOKS, TELEVISION, FINE ARTS, SPORTS, CELEBRITIES, WEDDING PARTY PLANNING, RELATIONSHIPS SUCH INFORMATION BEING FOR ENTERTAINMENT PURPOSES ONLY, POPULAR CULTURE AND ENTERTAINMENT TOPICS OF GENERAL INTEREST (U.S. CLS. 100, 101 AND 107).

RUDY R. SINGLETON, EXAMINING ATTORNEY

SN 77-720,348. LRP PUBLICATIONS, INC., PALM BEACH GARDENS, FL. FILED 4-23-2009.



NO CLAIM IS MADE TO THE EXCLUSIVE RIGHT TO USE "FEDERAL DISPUTE RESOLUTION CONFERENCE", APART FROM THE MARK AS SHOWN.

THE COLOR(S) RED, WHITE, AND BLUE IS/ARE CLAIMED AS A FEATURE OF THE MARK.

THE MARK CONSISTS OF LARGE, BLUE, STYLIZED HORIZONTAL LETTERS "FDR", WITH A WHITE STAR SITUATED IN THE LETTER "R", FOLLOWED BY A 5-STRIPE RED AND WHITE WAVING FLAG IMAGE, UNDER WHICH EXISTS THE HORIZONTAL WORDS "FEDERAL DISPUTE RESOLUTION" IN WHITE INSIDE A RED RECTANGULAR STRIPE, FOLLOWED BY THE WORD "CONFERENCE" IN BLUE LETTERS. THE BACKGROUND OF THE ENTIRE MARK IS WHITE.

FOR ARRANGING AND CONDUCTING EDUCATIONAL CONFERENCES; EDUCATION SERVICES, NAMELY, PROVIDING TUTORIAL SESSIONS AND WORKSHOPS IN THE FIELD OF FEDERAL CIVILIAN EMPLOYMENT (U.S. CLS. 100, 101 AND 107).

FIRST USE 8-1-2008; IN COMMERCE 8-1-2008.
JIM RINGLE, EXAMINING ATTORNEY

CLASS 41—(Continued).

SN 77-721,662. MARTHA STEWART LIVING OMNIMEDIA, INC., NEW YORK, NY. FILED 4-24-2009.

CLASS 41—(Continued).

SN 77-725,187. INDEPENDENT COMMUNITY BANKERS OF AMERICA, WASHINGTON, DC. FILED 4-29-2009.

ICBA NATIONAL CONVENTION &
TECHWORLD

MAD HUNGRY

THE MARK CONSISTS OF STANDARD CHARACTERS WITHOUT CLAIM TO ANY PARTICULAR FONT, STYLE, SIZE, OR COLOR.

OWNER OF U.S. REG. NOS. 2,476,487, 2,747,286 AND OTHERS.

NO CLAIM IS MADE TO THE EXCLUSIVE RIGHT TO USE "NATIONAL CONVENTION", APART FROM THE MARK AS SHOWN.

FOR ORGANIZATION OF SEMINARS, WORKING GROUPS, RESEARCH GROUPS AND CONVENTIONS, IN THE FIELD OF BANKING (U.S. CLS. 100, 101 AND 107).

FIRST USE 3-31-1988; IN COMMERCE 3-31-1988.
DORITT L. CARROLL, EXAMINING ATTORNEY

THE MARK CONSISTS OF STANDARD CHARACTERS WITHOUT CLAIM TO ANY PARTICULAR FONT, STYLE, SIZE, OR COLOR.

FOR PROVIDING ONLINE PUBLICATIONS IN THE NATURE OF MAGAZINES, COLUMNS, MAGAZINE FEATURES, MAGAZINE SECTIONS, RECIPE CARDS, ARTICLES, NEWSLETTERS, AND JOURNALS ALL IN THE FIELDS OF FOOD, COOKING AND ENTERTAINING; ENTERTAINMENT SERVICES IN THE NATURE OF RADIO PROGRAMS AND TELEVISION PROGRAMS IN THE FIELDS OF FOOD, COOKING AND ENTERTAINING; PRODUCTION OF TELEVISION AND RADIO PROGRAMS; ENTERTAINMENT SERVICES IN THE NATURE OF ONGOING PROGRAMMING IN THE FIELDS OF FOOD, COOKING AND ENTERTAINING BROADCAST OVER TELEVISION, RADIO, AND SATELLITE; ENTERTAINMENT SERVICES IN THE NATURE OF ONGOING AUDIO AND VIDEO PROGRAMMING IN THE FIELDS OF FOOD, COOKING AND ENTERTAINING BROADCAST OVER THE INTERNET; PROVIDING PODCASTS, WEBCASTS, AND BLOGS IN THE FIELDS OF FOOD, COOKING AND ENTERTAINING; PROVIDING ONLINE INFORMATION IN THE FIELDS OF ENTERTAINING, NAMELY, PARTY PLANNING AND ARRANGING, ORGANIZING, CONDUCTING, AND HOSTING SOCIAL ENTERTAINMENT EVENTS; ENTERTAINMENT SERVICES, NAMELY, PROVIDING NON-DOWNLOADABLE AUDIO OR AUDIO VISUAL IMAGES, NAMELY, PHOTOS AND PICTURES IN THE FIELDS OF FOOD, COOKING AND ENTERTAINING PRESENTED TO MOBILE COMMUNICATION DEVICES VIA A GLOBAL COMPUTER NETWORK AND WIRELESS NETWORKS; ENTERTAINMENT SERVICES IN THE NATURE OF A SERIES OF SHORT SHOWS AND WEBSISODES FEATURING FOOD, COOKING AND ENTERTAINING DISTRIBUTED TO MOBILE COMMUNICATION DEVICES VIA A GLOBAL COMPUTER NETWORK AND WIRELESS NETWORKS, WHICH MAY INCLUDE VIDEO, TEXT, PHOTOS, ILLUSTRATIONS OR HYPERTEXT; EDUCATIONAL DEMONSTRATIONS IN THE FIELD OF COOKING; FOOD TASTINGS (U.S. CLS. 100, 101 AND 107).

SUSAN STIGLITZ, EXAMINING ATTORNEY

SN 77-728,582. YOUTH CANADA ASSOCIATION, OTTAWA, ONTARIO, CANADA, FILED 5-4-2009.

YOU CAN

THE MARK CONSISTS OF STANDARD CHARACTERS WITHOUT CLAIM TO ANY PARTICULAR FONT, STYLE, SIZE, OR COLOR.

OWNER OF CANADA REG. NO. TMA662,582, DATED 4-12-2006, EXPIRES 4-12-2021.

FOR EDUCATIONAL SERVICES, NAMELY, WORKSHOPS, SEMINARS, COURSES, PROGRAMS, FORUMS, CONFERENCES, DISCUSSION GROUPS AND LECTURES, IN THE FIELDS OF COMMUNITY CONFLICT RESOLUTION, PEACE BUILDING AND DISPUTE RESOLUTION (U.S. CLS. 100, 101 AND 107).

ALYSSA STEEL, EXAMINING ATTORNEY

CLASS 41—(Continued).

SN 77-730,753. JOSEPH BARTLETT, HARRISONBURG, VA.
FILED 5-6-2009.

KEYNOC

THE MARK CONSISTS OF STANDARD CHARACTERS WITHOUT CLAIM TO ANY PARTICULAR FONT, STYLE, SIZE, OR COLOR.

FOR ENTERTAINMENT SERVICES, NAMELY, AUDIO RECORDING AND PRODUCTION; MUSIC PRODUCTION SERVICES; RECORD PRODUCTION; SOUND RECORDING STUDIO; ENTERTAINMENT, NAMELY, LIVE PERFORMANCES BY A MUSICAL ARTIST; ENTERTAINMENT, NAMELY, LIVE MUSIC CONCERTS; ENTERTAINMENT SERVICES, NAMELY, PROVIDING NONDOWNLOADABLE PRERECORDED MUSIC AND INFORMATION IN THE FIELD OF MUSIC, ALL ON-LINE VIA A GLOBAL COMPUTER NETWORK; ENTERTAINMENT SERVICES, NAMELY, PROVIDING A WEB SITE FEATURING NONDOWNLOADABLE MUSICAL PERFORMANCES, MUSICAL VIDEOS, RELATED FILM CLIPS, PHOTOGRAPHS, AND OTHER MULTIMEDIA MATERIALS FEATURING MUSIC AND MUSICAL PERFORMANCES (U.S. CLS. 100, 101 AND 107).

HAI-LY LAM, EXAMINING ATTORNEY

SN 77-730,761. BARTLETT, JOSEPH, HARRISONBURG, VA.
FILED 5-6-2009.

FIRESLEEVE PRODUCTIONS

THE MARK CONSISTS OF STANDARD CHARACTERS WITHOUT CLAIM TO ANY PARTICULAR FONT, STYLE, SIZE, OR COLOR.

NO CLAIM IS MADE TO THE EXCLUSIVE RIGHT TO USE "PRODUCTIONS", APART FROM THE MARK AS SHOWN.

FOR ENTERTAINMENT SERVICES, NAMELY, AUDIO RECORDING AND PRODUCTION; MUSIC PRODUCTION SERVICES; PRODUCTION OF SOUND RECORDINGS; SOUND RECORDING STUDIO; ENTERTAINMENT, NAMELY, LIVE PERFORMANCES BY A MUSICAL ARTIST; ENTERTAINMENT SERVICES, NAMELY, PROVIDING NONDOWNLOADABLE PRERECORDED MUSIC ON-LINE VIA A GLOBAL COMPUTER NETWORK; ENTERTAINMENT SERVICES, NAMELY, PROVIDING NONDOWNLOADABLE PRERECORDED MUSIC AND INFORMATION IN THE FIELD OF MUSIC, ALL ON-LINE VIA A GLOBAL COMPUTER NETWORK; ENTERTAINMENT SERVICES, NAMELY, PROVIDING A WEB SITE FEATURING NONDOWNLOADABLE MUSICAL PERFORMANCES, MUSICAL VIDEOS, RELATED FILM CLIPS, PHOTOGRAPHS, AND OTHER MULTIMEDIA MATERIALS FEATURING MUSIC AND MUSICAL PERFORMANCES; MUSIC PUBLISHING SERVICES (U.S. CLS. 100, 101 AND 107).

HAI-LY LAM, EXAMINING ATTORNEY

CLASS 41—(Continued).

SN 77-732,983. MARY C. BROCKERT, PASADENA, CA. AND
ALIA R. BROCKERT, PASADENA, CA. FILED 5-8-2009.

ROSE LE BEAU

THE MARK CONSISTS OF STANDARD CHARACTERS WITHOUT CLAIM TO ANY PARTICULAR FONT, STYLE, SIZE, OR COLOR.

FOR ENTERTAINMENT SERVICES IN THE NATURE OF LIVE MUSICAL PERFORMANCES; ENTERTAINMENT SERVICES, NAMELY, PROVIDING NONDOWNLOADABLE PRERECORDED MUSIC, INFORMATION IN THE FIELD OF MUSIC, AND COMMENTARY AND ARTICLES ABOUT MUSIC, ALL ON-LINE VIA A GLOBAL COMPUTER NETWORK; MULTIMEDIA ENTERTAINMENT SERVICES IN THE NATURE OF RECORDING, PRODUCTION AND POST-PRODUCTION SERVICES IN THE FIELDS OF MUSIC, VIDEO, AND FILMS (U.S. CLS. 100, 101 AND 107).

JAMES GRIFFIN, EXAMINING ATTORNEY

SN 77-734,261. WESTWARD PRODUCTIONS LLC, UNIVERSAL CITY, CA. FILED 5-11-2009.

BILLY ELLIOT THE MUSICAL

THE MARK CONSISTS OF STANDARD CHARACTERS WITHOUT CLAIM TO ANY PARTICULAR FONT, STYLE, SIZE, OR COLOR.

NO CLAIM IS MADE TO THE EXCLUSIVE RIGHT TO USE "THE MUSICAL", APART FROM THE MARK AS SHOWN.

"BILLY ELLIOT" DOES NOT IDENTIFY A LIVING INDIVIDUAL.

FOR ENTERTAINMENT SERVICES, NAMELY, A WEBSITE FEATURING INFORMATION RELATING TO A LIVE THEATRICAL PRODUCTION (U.S. CLS. 100, 101 AND 107).

FIRST USE 10-1-2008; IN COMMERCE 10-1-2008.

ELIZABETH HUGHITT, EXAMINING ATTORNEY

CLASS 41—(Continued).

SN 77-734,668. CITY VISITOR, INC., INDEPENDENCE, OH.
FILED 5-12-2009.

VISITOR
VALUE PASS
SEE MORE PAY LESS

THE MARK CONSISTS OF STANDARD CHARACTERS WITHOUT CLAIM TO ANY PARTICULAR FONT, STYLE, SIZE, OR COLOR.

NO CLAIM IS MADE TO THE EXCLUSIVE RIGHT TO USE "VISITOR VALUE PASS", APART FROM THE MARK AS SHOWN.

FOR PUBLICATION OF TEXTS, BOOKS, MAGAZINES AND OTHER PRINTED MATTER (U.S. CLS. 100, 101 AND 107).

FIRST USE 3-16-2009; IN COMMERCE 3-16-2009.

REGINA DRUMMOND, EXAMINING ATTORNEY

CLASS 41—(Continued).

SN 77-735,887. ISLAMIC RELIEF WORLDWIDE, BIRMINGHAM, UNITED KINGDOM, FILED 5-13-2009.

ISLAMIC RELIEF WORLDWIDE

THE MARK CONSISTS OF STANDARD CHARACTERS WITHOUT CLAIM TO ANY PARTICULAR FONT, STYLE, SIZE, OR COLOR.

OWNER OF ERPN CMNTY TM OFC REG. NO. 005806062, DATED 4-24-2008, EXPIRES 4-2-2017.

OWNER OF U.S. REG. NOS. 3,302,215, 3,302,270 AND OTHERS.

NO CLAIM IS MADE TO THE EXCLUSIVE RIGHT TO USE "WORLDWIDE", APART FROM THE MARK AS SHOWN.

SEC. 2(F) AS TO "ISLAMIC RELIEF".

FOR (BASED ON USE IN COMMERCE AND 44(E)) EDUCATIONAL SERVICES, NAMELY, ARRANGING AND ORGANIZING EDUCATIONAL CONFERENCES, SEMINARS, WORKSHOPS, LEARNING FORUMS, TRAINING LECTURES, COURSES, SYMPOSIA, AND COMMUNITY CULTURAL EVENTS FOR ADHERENTS OF ISLAM AND THE GENERAL PUBLIC, ALL OF THE FOREGOING IN THE FIELDS OF ISLAM, HUMANITARIAN AID AND DEVELOPMENT SERVICES, EMERGENCY AID, FINANCIAL SERVICES, AND PROVISION OF FOOD, HEALTH CARE, HOUSING, EDUCATION, JOBS, CLEAN WATER AND MEDICAL ASSISTANCE TO REFUGEES AND NEEDY PERSONS, AND DISTRIBUTION OF EDUCATIONAL MATERIALS IN CONNECTION THEREWITH; (BASED ON USE IN COMMERCE) PROVIDING A WEBSITE FEATURING NON-DOWNLOADABLE AUDIO AND VIDEO RECORDINGS, ALL IN THE FIELDS OF ISLAM, HUMANITARIAN AID AND DEVELOPMENT SERVICES, EMERGENCY AID, FINANCIAL SERVICES, AND PROVISION OF FOOD, HEALTH CARE, HOUSING, EDUCATION, JOBS, CLEAN WATER AND MEDICAL ASSISTANCE TO REFUGEES AND NEEDY PERSONS; PROVIDING VOCATIONAL EDUCATION TO NEEDY PERSONS IN THE FIELDS OF AGRICULTURE, TAILORING, COMPUTER SKILLS, CRAFT-MAKING, AND MICROENTERPRISES (U.S. CLS. 100, 101 AND 107).

FIRST USE 1-1-2007; IN COMMERCE 1-1-2007.

MELISSA VALLILLO, EXAMINING ATTORNEY

SN 77-735,180. OXFORD CLUB, LLC, BALTIMORE, MD.
FILED 5-12-2009.

CHAIRMAN'S CIRCLE

THE MARK CONSISTS OF STANDARD CHARACTERS WITHOUT CLAIM TO ANY PARTICULAR FONT, STYLE, SIZE, OR COLOR.

FOR PUBLISHING OF BOOKS, NEWSLETTERS AND ELECTRONIC PUBLICATIONS FEATURING INVESTMENT, TRAVEL, RETIREMENT AND ASSET PROTECTION INFORMATION; AND ARRANGING AND CONDUCTING EDUCATIONAL CONFERENCES IN THE FIELD OF INVESTMENT, TRAVEL, RETIREMENT AND ASSET PROTECTION; AND ARRANGING AND CONDUCTING SPECIAL EVENTS IN THE FIELD OF INVESTMENT, TRAVEL, RETIREMENT AND ASSET PROTECTION (U.S. CLS. 100, 101 AND 107).

FIRST USE 4-30-1998; IN COMMERCE 4-30-1998.

AISHA SALEM, EXAMINING ATTORNEY

CLASS 41—(Continued).

SN 77-738,877. SYSTEMS TECHNOLOGY FORUM, LTD., FREDERICKSBURG, VA. FILED 5-17-2009.



NO CLAIM IS MADE TO THE EXCLUSIVE RIGHT TO USE "SYSTEMS TECHNOLOGY FORUM", APART FROM THE MARK AS SHOWN.

THE MARK CONSISTS OF AN UNIFORM OVAL INCLUDING THE WORDING "STF" AND "SYSTEMS TECHNOLOGY FORUM" AND CONTAINING A CRESCENT SHAPE BORDERING THE "STF" WORDING.

FOR EDUCATIONAL SERVICES, NAMELY, TRAINING SERVICES IN THE FIELD OF COMPUTER SOFTWARE INTEGRATION; EDUCATIONAL SERVICES, NAMELY, TRAINING SERVICES IN THE FIELD OF MATERIAL SCIENCE AND ENGINEERING; EDUCATIONAL SERVICES, NAMELY, TRAINING SERVICES IN THE USE AND MAINTENANCE OF SHIPS, AIRCRAFT, NAVAL AND AERONAUTICAL SYSTEMS AND VEHICLES, MISSILE SYSTEMS; TRAINING SERVICES IN THE USE AND MAINTENANCE OF ELECTRONIC SYSTEMS, COMPUTER SYSTEMS AND NETWORKS, COMMUNICATIONS SYSTEMS AND NETWORKS (U.S. CLS. 100, 101 AND 107).

FIRST USE 1-0-2004; IN COMMERCE 1-0-2004.
DAVID HOFFMAN, EXAMINING ATTORNEY

CLASS 41—(Continued).

SN 77-743,552. GEOPAGE, INC., REDMOND, WA. FILED 5-22-2009.

GEOBLOG

THE MARK CONSISTS OF STANDARD CHARACTERS WITHOUT CLAIM TO ANY PARTICULAR FONT, STYLE, SIZE, OR COLOR.

FOR ONLINE JOURNALS, NAMELY, A BLOG FEATURING USER-GENERATED AND ACCESSIBLE INFORMATION ABOUT LOCAL BUSINESS AND ENTERTAINMENT VENUES AND RECREATION AND LEISURE ACTIVITIES IN PARTICULAR GEOGRAPHIC AREAS (U.S. CLS. 100, 101 AND 107).

MICHAEL KEATING, EXAMINING ATTORNEY

SN 77-744,174. ELVIS PRESLEY ENTERPRISES, INC., MEMPHIS, TN. FILED 5-26-2009.

FOREVER ELVIS

SN 77-740,789. INTERNATIONAL BRAZILIAN JIU-JITSU FEDERATION, RIO DE JANEIRO, BRAZIL, FILED 5-19-2009.

INTERNATIONAL BRAZILIAN JIU-JITSU FEDERATION

THE MARK CONSISTS OF STANDARD CHARACTERS WITHOUT CLAIM TO ANY PARTICULAR FONT, STYLE, SIZE, OR COLOR.

NO CLAIM IS MADE TO THE EXCLUSIVE RIGHT TO USE "BRAZILIAN JIU-JITSU FEDERATION", APART FROM THE MARK AS SHOWN.
SEC. 2(F).

FOR ENTERTAINMENT IN THE NATURE OF MARTIAL ARTS TOURNAMENTS; ORGANIZING SPORTING EVENTS, NAMELY, JIU-JITSU TOURNAMENTS (U.S. CLS. 100, 101 AND 107).

FIRST USE 0-0-1995; IN COMMERCE 0-0-1995.
ELLEN BURNS, EXAMINING ATTORNEY

THE MARK CONSISTS OF STANDARD CHARACTERS WITHOUT CLAIM TO ANY PARTICULAR FONT, STYLE, SIZE, OR COLOR.

OWNER OF U.S. REG. NOS. 1,265,579, 2,241,437 AND OTHERS.

THE NAME(S), PORTRAIT(S), AND/OR SIGNATURE(S) SHOWN IN THE MARK DOES NOT IDENTIFY A PARTICULAR LIVING INDIVIDUAL.

FOR ENTERTAINMENT SERVICES, NAMELY, PRODUCTION OF MUSICAL AUDIO AND VIDEO RECORDINGS; RECORD PRODUCTION; MUSICAL CONCERT BOOKING AND LIVE MUSIC CONCERTS; CONCEPTION, CREATION, PRODUCTION, AND PRESENTATION OF THEATRICAL PERFORMANCES FEATURING ARTISTIC ACTS, COMICAL ACTS, CHOREOGRAPHY AND/OR DANCE ACTS, SET TO MUSIC AND/OR SONG; ONLINE INFORMATION SERVICES IN THE FIELD OF ENTERTAINMENT; TICKET BOOKING AND TICKET RESERVATION SERVICES FOR THEATRICAL SHOWS FEATURING ARTISTIC ACTS, COMICAL ACTS, CHOREOGRAPHY AND DANCE ACTS SET TO MUSIC AND SONG; PRODUCTION OF RECORDED THEATRICAL PERFORMANCES IN THE FORM OF MULTIMEDIA RECORDED ON CD-ROM, IN THE NATURE OF A VIDEO, AKIN TO A VIDEOTAPE, TO BE VIEWED ON A COMPUTER IN CD-ROM FORMAT (U.S. CLS. 100, 101 AND 107).

ALLISON SCHRODY, EXAMINING ATTORNEY

CLASS 41—(Continued).

SN 77-744,191. ELVIS PRESLEY ENTERPRISES, INC., MEMPHIS, TN. FILED 5-26-2009.

TRULY ELVIS

THE MARK CONSISTS OF STANDARD CHARACTERS WITHOUT CLAIM TO ANY PARTICULAR FONT, STYLE, SIZE, OR COLOR.

OWNER OF U.S. REG. NOS. 1,265,579, 2,241,437 AND OTHERS.

THE NAME(S), PORTRAIT(S), AND/OR SIGNATURE(S) SHOWN IN THE MARK DOES NOT IDENTIFY A PARTICULAR LIVING INDIVIDUAL.

FOR ENTERTAINMENT SERVICES, NAMELY, PRODUCTION OF MUSICAL AUDIO AND VIDEO RECORDINGS; RECORD PRODUCTION; MUSICAL CONCERT BOOKING AND LIVE MUSIC CONCERTS; CONCEPTION, CREATION, PRODUCTION, AND PRESENTATION OF THEATRICAL PERFORMANCES FEATURING ARTISTIC ACTS, COMICAL ACTS, CHOREOGRAPHY AND/OR DANCE ACTS, SET TO MUSIC AND/OR SONG; ONLINE INFORMATION SERVICES IN THE FIELD OF ENTERTAINMENT; TICKET BOOKING AND TICKET RESERVATION SERVICES FOR THEATRICAL SHOWS FEATURING ARTISTIC ACTS, COMICAL ACTS, CHOREOGRAPHY AND DANCE ACTS SET TO MUSIC AND SONG; PRODUCTION OF RECORDED THEATRICAL PERFORMANCES IN THE FORM OF MULTIMEDIA RECORDED ON CD-ROM, IN THE NATURE OF A VIDEO, AKIN TO A VIDEOTAPE, TO BE VIEWED ON A COMPUTER IN CD-ROM FORMAT (U.S. CLS. 100, 101 AND 107).

ALLISON SCHRODY, EXAMINING ATTORNEY

SN 77-747,198. UBISOFT ENTERTAINMENT, RENNES, FRANCE, FILED 5-29-2009.

R.U.S.E

THE MARK CONSISTS OF STANDARD CHARACTERS WITHOUT CLAIM TO ANY PARTICULAR FONT, STYLE, SIZE, OR COLOR.

FOR ENTERTAINMENT SERVICES, NAMELY, PROVIDING AN ON-LINE COMPUTER GAME FOR OTHERS OVER GLOBAL AND LOCAL AREA COMPUTER NETWORKS AND PROVIDING INFORMATION ON-LINE RELATING TO COMPUTER GAMES, VIDEO GAMES AND COMPUTER AND VIDEO GAMES RELATED PRODUCTS (U.S. CLS. 100, 101 AND 107).

SHAILA SETTLES, EXAMINING ATTORNEY

CLASS 41—(Continued).

SN 77-749,277. INTERNETMEDIABRANDS.COM LLC, LAS VEGAS, NV. FILED 6-1-2009.

World of Poker

THE MARK CONSISTS OF STANDARD CHARACTERS WITHOUT CLAIM TO ANY PARTICULAR FONT, STYLE, SIZE, OR COLOR.

NO CLAIM IS MADE TO THE EXCLUSIVE RIGHT TO USE "POKER", APART FROM THE MARK AS SHOWN.

FOR PROVIDING ON-LINE POKER GAMES (U.S. CLS. 100, 101 AND 107).

JAMES LOVELACE, EXAMINING ATTORNEY

SN 77-750,045. BANUSZEWICZ, OLIVIA, NEW YORK, NY, AND GOLDSTEIN, DEBRA, NEW YORK, NY. FILED 6-2-2009.

FLIRTEXTING

THE MARK CONSISTS OF STANDARD CHARACTERS WITHOUT CLAIM TO ANY PARTICULAR FONT, STYLE, SIZE, OR COLOR.

FOR ENTERTAINMENT IN THE NATURE OF ONGOING TELEVISION PROGRAMS IN THE FIELDS OF DATING, RELATIONSHIPS AND SOCIAL NETWORKING (U.S. CLS. 100, 101 AND 107).

DOMINIC J. FERRAIUOLO, EXAMINING ATTORNEY

SN 77-750,107. GIRLS IN THE GAME, CHICAGO, IL. FILED 6-2-2009.

SPRING TRAINING

THE MARK CONSISTS OF STANDARD CHARACTERS WITHOUT CLAIM TO ANY PARTICULAR FONT, STYLE, SIZE, OR COLOR.

FOR EDUCATIONAL SERVICES, NAMELY, A TRAINING PROGRAM FOR TEACHERS, YOUTH PROVIDERS AND COACHES, INCLUDING CURRICULUM IN CONNECTION THEREWITH, AND AN ON-GOING SUPPORT PROGRAM TO ENHANCE THE PHYSICAL WELL-BEING, HEALTH AND LEADERSHIP DEVELOPMENT OF YOUNG GIRLS (U.S. CLS. 100, 101 AND 107).

REGINA DRUMMOND, EXAMINING ATTORNEY

CLASS 41—(Continued).

SN 77-753,030. FRIENDLY FAMILY PRODUCTIONS, LLC,
LOS ANGELES, CA. FILED 6-5-2009.

**BY THE SHORES OF SILVER
LAKE**

THE MARK CONSISTS OF STANDARD CHARACTERS WITHOUT CLAIM TO ANY PARTICULAR FONT, STYLE, SIZE, OR COLOR.

FOR ENTERTAINMENT SERVICES, NAMELY, AN ON-GOING TELEVISION SERIES FEATURING DRAMA OR DOCUMENTARIES; PRODUCTION AND DISTRIBUTION OF MOTION PICTURES AND TELEVISION PROGRAMS; ONLINE ENTERTAINMENT, NAMELY, PROVIDING ONLINE VIDEO GAMES AND COMPUTER GAMES; PROVIDING ONLINE ENTERTAINMENT INFORMATION; PRODUCTION AND DISTRIBUTION OF MULTIMEDIA AND PRE-RECORDED MEDIA, NAMELY, VIDEO GAMES AND COMPUTER GAMES; PRODUCING AND PRESENTING MUSICAL CONCERTS AND LIVE SHOW PERFORMANCES; AMUSEMENT PARK AND THEME PARK SERVICES (U.S. CLS. 100, 101 AND 107).

RENEE MCCRAY, EXAMINING ATTORNEY

CLASS 41—(Continued).

SN 77-753,532. FREEMAN, BLAKE, LOS ANGELES, CA.
FILED 6-5-2009.

WUNDERKIND PICTURES

THE MARK CONSISTS OF STANDARD CHARACTERS WITHOUT CLAIM TO ANY PARTICULAR FONT, STYLE, SIZE, OR COLOR.

NO CLAIM IS MADE TO THE EXCLUSIVE RIGHT TO USE "PICTURES", APART FROM THE MARK AS SHOWN.

THE ENGLISH TRANSLATION OF "WUNDERKIND" IN THE MARK IS CHILD PRODIGY.

FOR FILM AND VIDEO PRODUCTION; FILM PRODUCTION; MEDIA PRODUCTION SERVICES, NAMELY, VIDEO AND FILM PRODUCTION; PRODUCTION OF TELEVISION PROGRAMS; TELEVISION SHOW PRODUCTION (U.S. CLS. 100, 101 AND 107).

FIRST USE 5-5-2009; IN COMMERCE 5-5-2009.

HOWARD SMIGA, EXAMINING ATTORNEY

SN 77-753,821. CELEBRATING YOU, LLC, MISSOURI CITY,
TX. FILED 6-6-2009.



SN 77-753,142. FRIENDLY FAMILY PRODUCTIONS, LLC,
LOS ANGELES, CA. FILED 6-5-2009.

**LITTLE HOUSE IN THE BIG
WOODS**

THE MARK CONSISTS OF STANDARD CHARACTERS WITHOUT CLAIM TO ANY PARTICULAR FONT, STYLE, SIZE, OR COLOR.

FOR ENTERTAINMENT SERVICES, NAMELY, AN ON-GOING TELEVISION SERIES FEATURING DRAMA OR DOCUMENTARIES; PRODUCTION AND DISTRIBUTION OF MOTION PICTURES AND TELEVISION PROGRAMS; ONLINE ENTERTAINMENT, NAMELY, PROVIDING ONLINE VIDEO GAMES AND COMPUTER GAMES; PROVIDING ONLINE ENTERTAINMENT INFORMATION; PRODUCTION AND DISTRIBUTION OF MULTIMEDIA AND PRE-RECORDED MEDIA, NAMELY, VIDEO GAMES AND COMPUTER GAMES; PRODUCING AND PRESENTING MUSICAL CONCERTS AND LIVE SHOW PERFORMANCES; AMUSEMENT PARK AND THEME PARK SERVICES (U.S. CLS. 100, 101 AND 107).

RENEE MCCRAY, EXAMINING ATTORNEY

THE COLOR(S) PINK, GRAY AND BLACK IS/ARE CLAIMED AS A FEATURE OF THE MARK.

THE MARK CONSISTS OF TWO INTERLOCKING CROWNS COLORED BLACK, WITH GRAY AND PINK BACKGROUND IN THE CROWN ON THE RIGHT. BEHIND THE CROWNS ARE VINES WITH LEAVES BLEEDING FROM GRAY TO PINK. THE WORD "CELEBRATING" STARTS OUT PINK AND THEN BLEEDS OUT TO GRAYS. THE WORD "YOU" IS BLACK.

FOR EDUCATIONAL SERVICES, NAMELY, DEVELOPING AND CONDUCTING TRAINING COURSES AND DISTRIBUTION OF TRAINING MATERIALS IN CONNECTION THEREWITH FOR SUBJECT MATTERS AS REQUESTED BY CUSTOMERS (U.S. CLS. 100, 101 AND 107).

FIRST USE 7-0-2008; IN COMMERCE 4-0-2009.

DAWN FELDMAN, EXAMINING ATTORNEY

CLASS 41—(Continued).

SN 77-754,869. WORLD RINGSLINGER FEDERATION LLC, KAPOLEI, HI. FILED 6-8-2009.

WORLD RINGSLINGER FEDERATION

THE MARK CONSISTS OF STANDARD CHARACTERS WITHOUT CLAIM TO ANY PARTICULAR FONT, STYLE, SIZE, OR COLOR.

NO CLAIM IS MADE TO THE EXCLUSIVE RIGHT TO USE "WORLD" AND "FEDERATION", APART FROM THE MARK AS SHOWN.

FOR ARRANGING AND CONDUCTING ATHLETIC COMPETITIONS; ARRANGING OF CONTESTS; BOOKING OF SEATS FOR SHOWS AND SPORTS EVENTS; ENCOURAGING AMATEUR SPORTS AND PHYSICAL EDUCATION BY ORGANIZING, SANCTIONING, CONDUCTING, REGULATING AND GOVERNING AMATEUR ATHLETIC PROGRAMS AND ACTIVITIES; ENTERTAINMENT IN THE NATURE OF COMPETITIONS IN THE FIELD OF ATHLETICS; ENTERTAINMENT IN THE NATURE OF ACTION SKILL GAMES; ENTERTAINMENT SERVICES, NAMELY, ARRANGING AND CONDUCTING OF COMPETITIONS FOR GAMES; ENTERTAINMENT SERVICES, NAMELY, CONDUCTING CONTESTS; ENTERTAINMENT SERVICES, NAMELY, PARTICIPATION IN ACTION SKILL GAME EVENTS; OFFICIATING AT SPORTS CONTESTS; OPERATION OF SPORTS CAMPS; ORGANISATION OF SPORTS COMPETITIONS; ORGANIZING SPORTING EVENTS, NAMELY, ACTION SKILL GAME COMPETITION; PROVIDING A WEB SITE FEATURING SPORTING INFORMATION; PROVIDING A WEBSITE FEATURING ONLINE SPORTS TRAINING AND TRAINING ADVICE AND THE RECORDING OF TRAINING AND WORKOUTS; PROVIDING CURRENT EVENT NEWS AND INFORMATION VIA A GLOBAL COMPUTER NETWORK; PROVIDING FACILITIES FOR SPORTS TOURNAMENTS; PROVIDING FACILITIES FOR THE SPORT OF SPINNING RING SLINGING TOURNAMENTS; PROVIDING NEWS AND INFORMATION IN THE FIELD OF SPORTS; SPORTS REFEREEING AND OFFICIATING; SPORTS TRAINING SERVICES (U.S. CLS. 100, 101 AND 107).

SUSAN RICHARDS, EXAMINING ATTORNEY

SN 77-754,894. WORLD RINGSLINGER FEDERATION LLC, KAPOLEI, HI. FILED 6-8-2009.

SLING IT!

THE MARK CONSISTS OF STANDARD CHARACTERS WITHOUT CLAIM TO ANY PARTICULAR FONT, STYLE, SIZE, OR COLOR.

FOR ENCOURAGING AMATEUR SPORTS AND PHYSICAL EDUCATION BY ORGANIZING, SANCTIONING, CONDUCTING, REGULATING AND GOVERNING AMATEUR ATHLETIC PROGRAMS AND ACTIVITIES; ENTERTAINMENT IN THE NATURE OF SPINNING RING SLINGING GAMES (U.S. CLS. 100, 101 AND 107).

SUSAN RICHARDS, EXAMINING ATTORNEY

CLASS 41—(Continued).

SN 77-755,650. NEW ORLEANS OUTREACH, NEW ORLEANS, LA. FILED 6-9-2009.

Power Ties

THE MARK CONSISTS OF STANDARD CHARACTERS WITHOUT CLAIM TO ANY PARTICULAR FONT, STYLE, SIZE, OR COLOR.

FOR EDUCATION SERVICES IN THE NATURE OF EARLY CHILDHOOD INSTRUCTION; EDUCATION SERVICES, NAMELY, MENTORING IN THE FIELD OF LIFE SKILLS AND HEALTHY HABITS; EDUCATION SERVICES, NAMELY, ONE-ON-ONE MENTORING IN THE FIELDS OF LIFE SKILLS AND HEALTHY HABITS; EDUCATION SERVICES, NAMELY, PROVIDING TUTORIAL SESSIONS IN THE FIELDS OF ELEMENTARY AND HIGH SCHOOL CORE ACADEMIC SUBJECTS; EDUCATION SERVICES, NAMELY, PROVIDING TUTORING IN THE FIELDS OF ELEMENTARY AND HIGH SCHOOL CORE ACADEMIC SUBJECTS; EDUCATIONAL SERVICES, NAMELY, PROVIDING WORKSHOPS IN THE FIELDS OF CAREER AWARENESS AND JOB READINESS (U.S. CLS. 100, 101 AND 107).

FIRST USE 10-11-1994; IN COMMERCE 10-11-1994.

DAVID TAYLOR, EXAMINING ATTORNEY

SN 77-756,285. EMPOWER, LLC, DBA BABES IN THE BACKCOUNTRY, BRECKENRIDGE, CO. FILED 6-10-2009.

Babes in the Backcountry

THE MARK CONSISTS OF STANDARD CHARACTERS WITHOUT CLAIM TO ANY PARTICULAR FONT, STYLE, SIZE, OR COLOR.

FOR PHYSICAL EDUCATION (U.S. CLS. 100, 101 AND 107).

FIRST USE 8-1-2004; IN COMMERCE 8-1-2004.

JENNY PARK, EXAMINING ATTORNEY

CLASS 41—(Continued).

SN 77-758,854. BRAD PAISLEY, ATLANTA, GA. FILED 6-12-2009.

BRAD PAISLEY

THE MARK CONSISTS OF STANDARD CHARACTERS WITHOUT CLAIM TO ANY PARTICULAR FONT, STYLE, SIZE, OR COLOR.

THE NAME "BRAD PAISLEY" IDENTIFIES A LIVING INDIVIDUAL WHOSE CONSENT IS OF RECORD.

FOR ENTERTAINMENT SERVICES, NAMELY, LIVE MUSICAL AND VOCAL PERFORMANCES BY A SOLO RECORDING ARTIST; PROVIDING A WEB SITE FEATURING PRE-RECORDED MUSICAL AUDIO AND AUDIO-VISUAL CLIPS, PHOTOGRAPHS, NEWS, REVIEWS AND OTHER MULTIMEDIA ARTICLES IN CONNECTION WITH A SOLO RECORDING ARTIST; AND FAN CLUB SERVICES (U.S. CLS. 100, 101 AND 107).

SANDRA BUJA, EXAMINING ATTORNEY

CLASS 41—(Continued).

SN 77-758,914. THE COURAGE TO SPEAK FOUNDATION, INC., NORWALK, CT. FILED 6-12-2009.

COURAGEOUS PARENTING 101

THE MARK CONSISTS OF STANDARD CHARACTERS WITHOUT CLAIM TO ANY PARTICULAR FONT, STYLE, SIZE, OR COLOR.

NO CLAIM IS MADE TO THE EXCLUSIVE RIGHT TO USE "PARENTING", APART FROM THE MARK AS SHOWN.

FOR PROVIDING EDUCATIONAL SERVICES ASSOCIATED WITH DRUG- AND ALCOHOL-ABUSE PREVENTION, NAMELY, CONDUCTING WORKSHOPS AND COURSES ASSOCIATED WITH DRUG- AND ALCOHOL-ABUSE PREVENTION, OPENING LINES OF COMMUNICATION BETWEEN YOUTH AND ADULTS TO PREVENT DRUG AND ALCOHOL ABUSE, BOLSTER SELF-ESTEEM AND CHARACTER BUILDING, PARENTING SKILLS AND YOUTH LEADERSHIP AND DEVELOPMENT ALL DIRECTED TO PARENTS; AND DISTRIBUTING COURSE MATERIALS IN CONJUNCTION THEREWITH IN THE NATURE OF PAMPHLETS, BROCHURES, JOURNALS, VIDEO TAPES, AND COMPACT DISCS (U.S. CLS. 100, 101 AND 107).

FIRST USE 1-10-2008; IN COMMERCE 1-10-2008.
TAMARA FRAZIER, EXAMINING ATTORNEY

SN 77-758,862. OWEN, JOSHUA R., ATLANTA, GA. FILED 6-12-2009.

JAKE OWEN

THE MARK CONSISTS OF STANDARD CHARACTERS WITHOUT CLAIM TO ANY PARTICULAR FONT, STYLE, SIZE, OR COLOR.

THE NAME(S), PORTRAIT(S), AND/OR SIGNATURE(S) SHOWN IN THE MARK IDENTIFIES THE PROFESSIONAL NAME OF JOSHUA R. OWEN, WHOSE CONSENT(S) TO REGISTER IS MADE OF RECORD.

FOR ENTERTAINMENT SERVICES, NAMELY, LIVE MUSICAL AND VOCAL PERFORMANCES BY A SOLO RECORDING ARTIST; PROVIDING A WEB SITE FEATURING PRE-RECORDED MUSICAL AUDIO AND AUDIO-VISUAL CLIPS, PHOTOGRAPHS, NEWS, REVIEWS AND OTHER MULTIMEDIA ARTICLES IN CONNECTION WITH A SOLO RECORDING ARTIST; AND FAN CLUB SERVICES (U.S. CLS. 100, 101 AND 107).

ROBIN CHOSID, EXAMINING ATTORNEY

SN 77-759,136. SHAAIM FAMILY LLC, BROOKLYN, NY. FILED 6-14-2009.

The Living Classroom Institute

NO CLAIM IS MADE TO THE EXCLUSIVE RIGHT TO USE "CLASSROOM INSTITUTE", APART FROM THE MARK AS SHOWN.

THE MARK CONSISTS OF THE WORDING "THE LIVING CLASSROOM INSTITUTE" TO THE LEFT OF THE ANCIENT EGYPTIAN HIEROGLYPH FOR THE PRINCIPLE OF AMEN, NU, WATER AND INFINITE TRANSFORMATION.

FOR EDUCATIONAL SERVICES, NAMELY, PROVIDING CLASSES, WORKSHOPS AND SEMINARS IN THE FIELDS OF VOCATIONAL TRAINING IN THE FIELD OF MANUFACTURE, INSTALLATION AND MAINTENANCE OF PHOTOVOLTAIC, SOLAR THERMAL, SOLAR THERMAL HEATING, SOLAR LIGHTING AND SOLAR COOKING ALTERNATIVE ENERGY SYSTEMS (U.S. CLS. 100, 101 AND 107).

FIRST USE 4-18-2009; IN COMMERCE 4-18-2009.
SUZANNE BLANE, EXAMINING ATTORNEY

CLASS 41—(Continued).

SN 77-759,502. SUPIT, EDWIN J., DBA MELODIES OF PRAYER, TAMUNING, GUAM, FILED 6-15-2009.

Melodies Of Prayer

THE MARK CONSISTS OF STANDARD CHARACTERS WITHOUT CLAIM TO ANY PARTICULAR FONT, STYLE, SIZE, OR COLOR.

FOR PROVIDING ON-LINE RELIGIOUS INSTRUCTION PROMOTING CHRISTIAN AND FAMILY VALUES (U.S. CLS. 100, 101 AND 107).

FIRST USE 7-14-2005; IN COMMERCE 7-14-2005.
SARA THOMAS, EXAMINING ATTORNEY

CLASS 41—(Continued).

SN 77-759,829. PENTON MEDIA, INC., NEW YORK, NY. FILED 6-15-2009.

Natural Products Expo West

THE MARK CONSISTS OF STANDARD CHARACTERS WITHOUT CLAIM TO ANY PARTICULAR FONT, STYLE, SIZE, OR COLOR.

NO CLAIM IS MADE TO THE EXCLUSIVE RIGHT TO USE "EXPO", APART FROM THE MARK AS SHOWN. SEC. 2(F).

FOR EDUCATIONAL SERVICES, NAMELY, CONDUCTING CONFERENCES, SEMINARS, AND WORKSHOPS IN THE FIELD OF THE NATURAL, ORGANIC LIFESTYLE AND HEALTHY PRODUCTS INDUSTRY AND MARKET AND DISTRIBUTION OF COURSE MATERIAL IN CONNECTION THEREWITH; EDUCATIONAL SERVICES, NAMELY, CONDUCTING EDUCATIONAL EXHIBITIONS AND EXPOSITIONS IN THE FIELD OF THE NATURAL, ORGANIC LIFESTYLE AND HEALTHY PRODUCTS INDUSTRY AND MARKET (U.S. CLS. 100, 101 AND 107).

FIRST USE 0-0-1981; IN COMMERCE 0-0-1981.
MARGARET POWER, EXAMINING ATTORNEY

SN 77-759,827. PENTON MEDIA, INC., NEW YORK, NY. FILED 6-15-2009.

SN 77-759,883. ONE ECONOMY CORPORATION, WASHINGTON, DC. FILED 6-15-2009.

Natural Products Expo East

DIARY OF A SINGLE MOM

THE MARK CONSISTS OF STANDARD CHARACTERS WITHOUT CLAIM TO ANY PARTICULAR FONT, STYLE, SIZE, OR COLOR.

NO CLAIM IS MADE TO THE EXCLUSIVE RIGHT TO USE "EXPO", APART FROM THE MARK AS SHOWN. SEC. 2(F).

FOR EDUCATIONAL SERVICES, NAMELY, CONDUCTING CONFERENCES, SEMINARS, AND WORKSHOPS IN THE FIELD OF THE NATURAL, ORGANIC LIFESTYLE AND HEALTHY PRODUCTS INDUSTRY AND MARKET AND DISTRIBUTION OF COURSE MATERIAL IN CONNECTION THEREWITH; EDUCATIONAL SERVICES, NAMELY, CONDUCTING EDUCATIONAL EXHIBITIONS AND EXPOSITIONS IN THE FIELD OF THE NATURAL, ORGANIC LIFESTYLE AND HEALTHY PRODUCTS INDUSTRY AND MARKET (U.S. CLS. 100, 101 AND 107).

FIRST USE 0-0-1985; IN COMMERCE 0-0-1985.
MARGARET POWER, EXAMINING ATTORNEY

THE MARK CONSISTS OF STANDARD CHARACTERS WITHOUT CLAIM TO ANY PARTICULAR FONT, STYLE, SIZE, OR COLOR.

FOR EDUCATIONAL AND ENTERTAINMENT SERVICES, NAMELY, A CONTINUING ONLINE PROGRAM ABOUT SINGLE MOTHERS ACCESSIBLE BY COMPUTER NETWORKS; ENTERTAINMENT SERVICES, NAMELY PROVIDING A WEBSITE FEATURING AUDIO AND VIDEO PRESENTATIONS IN THE NATURE OF VIDEO CLIPS AND WEBISODES FEATURING STORIES ABOUT SINGLE MOTHERS (U.S. CLS. 100, 101 AND 107).

FIRST USE 11-3-2008; IN COMMERCE 11-3-2008.
ROBIN MITTLER, EXAMINING ATTORNEY

CLASS 41—(Continued).

SN 77-760,019. FINE LIVING NETWORK, LLC, KNOXVILLE, TN. FILED 6-15-2009.

YOU'RE A TOOL

THE MARK CONSISTS OF STANDARD CHARACTERS WITHOUT CLAIM TO ANY PARTICULAR FONT, STYLE, SIZE, OR COLOR.

FOR EDUCATIONAL AND ENTERTAINMENT SERVICES, NAMELY, AN ONGOING TELEVISION PROGRAM IN THE FIELD OF FAMILY MANAGEMENT AND RELATIONSHIPS ACCESSIBLE BY RADIO, TELEVISION, CABLE, FIBER OPTIC NETWORKS, WIRELESS NETWORKS, SATELLITE, AUDIO VIDEO, AND COMPUTER NETWORKS (U.S. CLS. 100, 101 AND 107).
JENNIFER MARTIN, EXAMINING ATTORNEY

SN 77-760,088. EDUCATIONAL TESTING SERVICE, AKA ETS, PRINCETON, NJ. FILED 6-15-2009.



OWNER OF U.S. REG. NOS. 558,879, 1,166,461 AND 2,363,333.

NO CLAIM IS MADE TO THE EXCLUSIVE RIGHT TO USE "PREFERRED ASSOCIATE", APART FROM THE MARK AS SHOWN.

THE MARK CONSISTS OF "EPA" IN WHITE STYLIZED LETTERS WITHIN A BLACK SQUARE SHAPE WITH THE WORDS "ETS PREFERRED ASSOCIATE" TO THE RIGHT OF THE SHAPE IN STYLIZED LETTERS.

FOR TEST ADMINISTRATION SERVICES, NAMELY, ADMINISTRATION OF A STANDARDIZED EDUCATIONAL TEST; TEST SCORING SERVICES AND TEST SCORE REPORTING SERVICES (U.S. CLS. 100, 101 AND 107).

ALLISON SCHRODY, EXAMINING ATTORNEY

SN 77-763,181. RUFSKIN, LLC, SAN DIEGO, CA. FILED 6-18-2009.

G-LIST AWARDS

THE MARK CONSISTS OF STANDARD CHARACTERS WITHOUT CLAIM TO ANY PARTICULAR FONT, STYLE, SIZE, OR COLOR.

NO CLAIM IS MADE TO THE EXCLUSIVE RIGHT TO USE "AWARDS", APART FROM THE MARK AS SHOWN.

FOR ENTERTAINMENT SERVICES, NAMELY, HOLDING A REGULAR EVENT FOR THE PRESENTATION OF AWARDS IN RECOGNITION OF ACHIEVEMENT IN THE LESBIAN, GAY, BISEXUAL, AND TRANSGENDER COMMUNITY (U.S. CLS. 100, 101 AND 107).

ALLISON SCHRODY, EXAMINING ATTORNEY

CLASS 41—(Continued).

SN 77-764,325. CONCORDIA COLLEGE, MOORHEAD, MN. FILED 6-19-2009.

LeadNow

THE MARK CONSISTS OF STANDARD CHARACTERS WITHOUT CLAIM TO ANY PARTICULAR FONT, STYLE, SIZE, OR COLOR.

FOR EDUCATIONAL SERVICES, NAMELY, CONDUCTING PROGRAMS IN THE FIELD OF LEADERSHIP DEVELOPMENT (U.S. CLS. 100, 101 AND 107).
FIRST USE 2-1-2006; IN COMMERCE 5-1-2006.
ELISSA GARBER KON, EXAMINING ATTORNEY

SN 77-767,356. OWN LLC, WESTLAKE VILLAGE, CA. FILED 6-24-2009.



THE MARK CONSISTS OF THE ACRONYM "OWN" IN STYLIZED LETTERS.

FOR ENTERTAINMENT SERVICES, NAMELY, MULTIMEDIA PROGRAMS IN THE FIELD OF GENERAL HUMAN INTEREST, DISTRIBUTED VIA VARIOUS PLATFORMS ACROSS MULTIPLE FORMS OF TRANSMISSION MEDIA; PROVIDING ENTERTAINMENT INFORMATION REGARDING ONGOING TELEVISION PROGRAMS VIA A GLOBAL COMPUTER NETWORK; PRODUCTION OF TELEVISION PROGRAMS; PRODUCTION OF MULTIMEDIA PROGRAMS (U.S. CLS. 100, 101 AND 107).

LINDA M. KING, EXAMINING ATTORNEY

SN 77-767,539. DREAMSLAUGHTER, AKA MICHAEL KEYES, LOS ANGELES, CA. FILED 6-24-2009.

dreamslaughter

THE MARK CONSISTS OF STANDARD CHARACTERS WITHOUT CLAIM TO ANY PARTICULAR FONT, STYLE, SIZE, OR COLOR.

THE NAME "DREAMSLAUGHTER" IDENTIFIES A LIVING INDIVIDUAL, "MICHAEL KEYES", WHOSE CONSENT IS OF RECORD.

FOR ENTERTAINMENT SERVICES, NAMELY, PERSONAL APPEARANCES BY A CELEBRITY (U.S. CLS. 100, 101 AND 107).

FIRST USE 3-10-1998; IN COMMERCE 12-9-2009.

JANICE KIM, EXAMINING ATTORNEY

CLASS 41—(Continued).

SN 77-767,720. ATHENS, RYAN, RIVERSIDE, CA. FILED 6-24-2009.

BETCADDIE

THE MARK CONSISTS OF STANDARD CHARACTERS WITHOUT CLAIM TO ANY PARTICULAR FONT, STYLE, SIZE, OR COLOR.

FOR PROVIDING GAMING, BETTING, AND CONTEST INFORMATION VIA THE INTERNET; PROVIDING ON-LINE NEWS AND INFORMATION IN THE FIELDS OF GAMING, BETTING AND CONTESTS (U.S. CLS. 100, 101 AND 107).

FIRST USE 1-1-2009; IN COMMERCE 1-1-2009.

JESSICA FATHY, EXAMINING ATTORNEY

SN 77-769,968. NBA DEVELOPMENT LEAGUE, LLC, SECAUCUS, NJ. FILED 6-29-2009.



NO CLAIM IS MADE TO THE EXCLUSIVE RIGHT TO USE "SPRINGFIELD", APART FROM THE MARK AS SHOWN.

THE MARK CONSISTS OF THE DEPICTION OF AN ARMORED KNIGHT HOLDING A BASKETBALL STANDING IN FRONT OF A SHIELD WITH THE WORDS "SPRINGFIELD ARMOR".

FOR ENTERTAINMENT AND EDUCATIONAL SERVICES IN THE NATURE OF ONGOING TELEVISION AND RADIO PROGRAMS IN THE FIELD OF BASKETBALL AND RENDERING LIVE BASKETBALL GAMES AND BASKETBALL EXHIBITIONS; THE PRODUCTION AND DISTRIBUTION OF RADIO AND TELEVISION SHOWS FEATURING BASKETBALL GAMES, BASKETBALL EVENTS AND PROGRAMS IN THE FIELD OF BASKETBALL; CONDUCTING AND ARRANGING BASKETBALL CLINICS AND CAMPS, COACHES CLINICS AND CAMPS, DANCE TEAM CLINICS AND CAMPS AND BASKETBALL GAMES; ENTERTAINMENT SERVICES IN THE NATURE OF PERSONAL APPEARANCES BY A COSTUMED MASCOT OR DANCE TEAM AT BASKETBALL GAMES AND EXHIBITIONS, CLINICS, CAMPS, PROMOTIONS, AND OTHER BASKETBALL-RELATED EVENTS, SPECIAL EVENTS AND PARTIES; FAN CLUB SERVICES; ENTERTAINMENT SERVICES, NAMELY, PROVIDING A WEBSITE FEATURING MULTIMEDIA MATERIAL IN THE NATURE OF TELEVISION HIGHLIGHTS, INTERACTIVE TELEVISION HIGHLIGHTS, VIDEO RECORDINGS, VIDEO STREAM

CLASS 41—(Continued).

RECORDINGS, INTERACTIVE VIDEO HIGHLIGHT SELECTIONS, RADIO PROGRAMS, RADIO HIGHLIGHTS, AND AUDIO RECORDINGS IN THE FIELD OF BASKETBALL; PROVIDING NEWS AND INFORMATION IN THE NATURE OF STATISTICS AND TRIVIA IN THE FIELD OF BASKETBALL; ON-LINE NON-DOWNLOADABLE GAMES, NAMELY, COMPUTER GAMES, VIDEO GAMES, INTERACTIVE VIDEO GAMES, ACTION SKILL GAMES, ARCADE GAMES, ADULTS' AND CHILDREN'S PARTY GAMES, BOARD GAMES, PUZZLES, AND TRIVIA GAMES; ELECTRONIC PUBLISHING SERVICES, NAMELY, PUBLICATION OF MAGAZINES, GUIDES, NEWSLETTERS, COLORING BOOKS, AND GAME SCHEDULES OF OTHERS ON-LINE THROUGH THE INTERNET, ALL IN THE FIELD OF BASKETBALL; PROVIDING AN ONLINE COMPUTER DATABASE IN THE FIELD OF BASKETBALL; ALL OF THE FOREGOING TO BE USED TO PROMOTE THE SPORT OF BASKETBALL IN CONNECTION WITH THE TRADEMARK OWNER'S PROFESSIONAL BASKETBALL TEAM (U.S. CLS. 100, 101 AND 107).

SHARON MEIER, EXAMINING ATTORNEY

SN 77-771,253. TELEVISA S.A. DE C. V., COLONIA ZEDEC SANTA FE, MEXICO, FILED 6-30-2009.

MI PECADO

THE MARK CONSISTS OF STANDARD CHARACTERS WITHOUT CLAIM TO ANY PARTICULAR FONT, STYLE, SIZE, OR COLOR.

PRIORITY CLAIMED UNDER SEC. 44(D) ON MEXICO APPLICATION NO. 992200, FILED 2-26-2009, REG. NO. 1093656, DATED 4-8-2009, EXPIRES 2-26-2019.

THE ENGLISH TRANSLATION OF "MI PECADO" IN THE MARK IS MY SIN.

FOR ENTERTAINMENT SERVICES IN THE NATURE OF AN ONGOING DRAMATIC TELEVISION PROGRAM (U.S. CLS. 100, 101 AND 107).

LAURA KOVALSKY, EXAMINING ATTORNEY

CLASS 41—(Continued).

SN 77-772,440. FLORIDA SMOOTH JAZZ FOUNDATION, INC., COCOA BEACH, FL. FILED 7-1-2009.



NO CLAIM IS MADE TO THE EXCLUSIVE RIGHT TO USE THE PICTORIAL REPRESENTATION OF THE STATE OF FLORIDA, APART FROM THE MARK AS SHOWN.

THE MARK CONSISTS OF A REPRESENTATION OF THE STATE OF FLORIDA AND A SAXOPHONE WITH FIVE WAVY LINES INDICATING SOUND EXTENDING FROM THE BELL, WITH THE SAXOPHONE PLACED ON TOP OF THE FLORIDA REPRESENTATION.

FOR ENTERTAINMENT SERVICES IN THE NATURE OF ORGANIZING AND CONDUCTING MUSIC CONCERTS, MUSIC FESTIVALS AND PARTIES; ENTERTAINMENT SERVICES IN THE NATURE OF LIVE PERFORMANCES FEATURING JAZZ AND ELECTRONIC INFLUENCED MUSICAL GROUPS (U.S. CLS. 100, 101 AND 107).

FIRST USE 2-13-2009; IN COMMERCE 2-13-2009.
ALLISON HOLTZ, EXAMINING ATTORNEY

SN 77-773,908. RADIO SYNDICATE, INC., LOS ANGELES, CA. FILED 7-2-2009.

POCOS PERO LOCOS

THE MARK CONSISTS OF STANDARD CHARACTERS WITHOUT CLAIM TO ANY PARTICULAR FONT, STYLE, SIZE, OR COLOR.

THE ENGLISH TRANSLATION OF "POCOS PERO LOCOS" IN THE MARK IS FEW BUT CRAZY.

FOR ENTERTAINMENT SERVICES, NAMELY, PROVIDING AN ON-GOING RADIO PROGRAM IN THE FIELD OF LATIN POP AND HIP-HOP MUSIC (U.S. CLS. 100, 101 AND 107).

FIRST USE 8-1-1999; IN COMMERCE 8-1-1999.
EUGENIA MARTIN, EXAMINING ATTORNEY

CLASS 41—(Continued).

SN 77-776,476. LMG, INC., ORLANDO, FL. FILED 7-8-2009.

TOURCATT

THE MARK CONSISTS OF STANDARD CHARACTERS WITHOUT CLAIM TO ANY PARTICULAR FONT, STYLE, SIZE, OR COLOR.

FOR PRODUCTION OF SOUND AND IMAGE RECORDINGS ON SOUND AND IMAGE CARRIERS; PRODUCTION OF SOUND AND MUSIC VIDEO RECORDINGS (U.S. CLS. 100, 101 AND 107).

JAY FLOWERS, EXAMINING ATTORNEY

SN 77-785,905. VANTAGE SOLUTIONS, LLC, CHICAGO, IL. FILED 7-21-2009.



OWNER OF U.S. REG. NOS. 2,794,064 AND 2,796,925.

NO CLAIM IS MADE TO THE EXCLUSIVE RIGHT TO USE "SOLUTIONS LLC", APART FROM THE MARK AS SHOWN.

THE COLOR(S) RED, ORANGE AND BLACK IS/ARE CLAIMED AS A FEATURE OF THE MARK.

THE MARK CONSISTS OF THE WORDING, "VANTAGE", WHEREIN THE "V" PORTION OF THE MARK IS DEPICTED AS A STYLIZED PERSON WITH OUTSTRETCHED ARMS IN THE COLOR RED AND ORANGE, AND THE REST OF THE WORD APPEARS IN THE COLOR BLACK, AND APPEARING BELOW IS THE WORDING, "SOLUTIONS LLC" IN THE COLOR ORANGE; THE COLOR WHITE IS NOT A FEATURE OF THE MARK BUT MERELY REPRESENTS A TRANSPARENT BACKGROUND.

FOR TRAINING SERVICES IN THE FIELD OF HUMAN RESOURCES (U.S. CLS. 100, 101 AND 107).

FIRST USE 5-15-1999; IN COMMERCE 5-15-1999.
KELLY CHOE, EXAMINING ATTORNEY

CLASS 41—(Continued).

SN 77-786,076. HUALAPAI TRIBE, PEACH SPRINGS, AZ.
FILED 7-21-2009.

GRAND CANYON WEST

THE MARK CONSISTS OF STANDARD CHARACTERS WITHOUT CLAIM TO ANY PARTICULAR FONT, STYLE, SIZE, OR COLOR.

SEC. 2(F).

FOR ENTERTAINMENT SERVICES IN THE NATURE OF OPERATING AN ATTRACTION AT A TOURIST DESTINATION, NAMELY, OPERATING A VIEWING PLATFORM AT THE TOURIST DESTINATION; GUIDED TOURS OF NATURAL LANDSCAPES AND AREAS FEATURING NATIVE AMERICAN LIFESTYLE AND CULTURE; ENTERTAINMENT SERVICES, NAMELY, HELICOPTER RIDES AND TOURS (U.S. CLS. 100, 101 AND 107).

FIRST USE 2-14-1988; IN COMMERCE 2-14-1988.

KATHLEEN M. VANSTON, EXAMINING ATTORNEY

SN 77-786,578. UBISOFT ENTERTAINMENT, RENNES, FRANCE, FILED 7-22-2009.

ASSASSIN'S CREED LINEAGE

THE MARK CONSISTS OF STANDARD CHARACTERS WITHOUT CLAIM TO ANY PARTICULAR FONT, STYLE, SIZE, OR COLOR.

FOR ENTERTAINMENT SERVICES, NAMELY, TELEVISION ACTION SERIES AND THE PRODUCTION OF MOTION PICTURES (U.S. CLS. 100, 101 AND 107).

SAMUEL E. SHARPER JR., EXAMINING ATTORNEY

SN 77-786,599. PENNWELL CORPORATION, TULSA, OK.
FILED 7-22-2009.



NO CLAIM IS MADE TO THE EXCLUSIVE RIGHT TO USE "DENTAL ASSISTING DIGEST", APART FROM THE MARK AS SHOWN.

THE MARK CONSISTS OF THE WORDS "DENTAL ASSISTING DIGEST" WITH THE LETTER "A" DEPICTED AS A STYLIZED TOOTH.

FOR PROVIDING ONLINE NEWSLETTERS RELATING TO THE PRACTICE OF DENTISTRY (U.S. CLS. 100, 101 AND 107).

FIRST USE 1-1-2008; IN COMMERCE 1-1-2008.

MARK SPARACINO, EXAMINING ATTORNEY

CLASS 41—(Continued).

SN 77-786,606. PENNWELL CORPORATION, TULSA, OK.
FILED 7-22-2009.

LIGHTWAVE

THE MARK CONSISTS OF STANDARD CHARACTERS WITHOUT CLAIM TO ANY PARTICULAR FONT, STYLE, SIZE, OR COLOR.

OWNER OF U.S. REG. NOS. 1,743,097, 2,752,337 AND 2,874,004.

SEC. 2(F).

FOR PROVIDING ONLINE NEWSLETTERS IN THE FIELD OF FIBER OPTICS (U.S. CLS. 100, 101 AND 107).
FIRST USE 9-1-2003; IN COMMERCE 9-1-2003.

MARK SPARACINO, EXAMINING ATTORNEY

SN 77-787,099. CREATOR PICTURES, LLC, JAMAICA, NY.
FILED 7-22-2009.



NO CLAIM IS MADE TO THE EXCLUSIVE RIGHT TO USE "AFRO LATINO", "SERIE DOCUMENTAL" AND THE DESIGN OF THE MAP OF MEXICO, CARIBBEAN ISLANDS, CENTRAL AND SOUTH AMERICA, APART FROM THE MARK AS SHOWN.

THE MARK CONSISTS OF STYLIZED LETTERS OF "AFRO LATINOS" OVER A MAP OF MEXICO, CARIBBEAN ISLANDS, CENTRAL AND SOUTH AMERICA; THE LETTER "O" IN "LATINOS" HAS TWO CIRCLES RADIATING FROM IT; A BANNER THAT SAYS "LA HISTORIA QUE NUNCA NOS CONTRARON" AND THE PHRASE "SERIE DOCUMENTAL" IN A TRAPEZOID-SHAPED BOX.

THE ENGLISH TRANSLATION OF "LA HISTORIA QUE NUNCA NOS CONTRARON; SERIE DOCUMENTAL" IN THE MARK IS THE UNTAUGHT STORY; DOCUMENTARY SERIES.

FOR ENTERTAINMENT IN THE NATURE OF VISUAL AND AUDIO PERFORMANCES, AND MUSICAL VARIETY AND NEWS SHOWS; ENTERTAINMENT, NAMELY, A CONTINUING TELEVISION SERIES TRANSMITTED OVER TELEVISION, SATELLITE, AUDIO AND VIDEO MEDIA (U.S. CLS. 100, 101 AND 107).

FIRST USE 1-1-2009; IN COMMERCE 1-1-2009.

SUZANNE BLANE, EXAMINING ATTORNEY

CLASS 41—(Continued).

SN 77-787,667. THE CHILDREN'S MUSEUM OF HOUSTON, HOUSTON, TX. FILED 7-23-2009.

Invention Convention

THE MARK CONSISTS OF STANDARD CHARACTERS WITHOUT CLAIM TO ANY PARTICULAR FONT, STYLE, SIZE, OR COLOR.

FOR EDUCATIONAL AND ENTERTAINMENT SERVICES IN THE NATURE OF A CHILDREN'S MUSEUM FEATURING CULTURAL EXHIBITS, HANDS-ON PLAY AND LEARNING ACTIVITIES; EDUCATIONAL SERVICES, NAMELY, PROVIDING CLASSES, EXHIBITS, HANDS-ON LEARNING PROGRAMS AND SEMINARS, AND PUBLISHING OF BOOKS AND PROVIDING ELECTRONIC NEWSLETTERS VIA E-MAIL, ALL PERTAINING TO CHILDREN'S EDUCATION, ALL IN THE SUBJECTS OF INVENTING AND CREATIVE PROBLEM SOLVING (U.S. CLS. 100, 101 AND 107).

FIRST USE 4-0-2004; IN COMMERCE 1-0-2005.
RONALD DELGIZZI, EXAMINING ATTORNEY

SN 77-787,724. PENNWELL CORPORATION, TULSA, OK. FILED 7-23-2009.

CABLING INSTALLATION & MAINTENANCE

THE MARK CONSISTS OF STANDARD CHARACTERS WITHOUT CLAIM TO ANY PARTICULAR FONT, STYLE, SIZE, OR COLOR.

OWNER OF U.S. REG. NO. 2,298,008. SEC. 2(F).
FOR PROVIDING ONLINE NEWSLETTERS IN THE FIELD OF INSTALLATION AND MAINTENANCE OF COMMUNICATIONS CABLING (U.S. CLS. 100, 101 AND 107).

FIRST USE 1-1-2004; IN COMMERCE 1-1-2004.
MARK SPARACINO, EXAMINING ATTORNEY

SN 77-788,060. PENNWELL CORPORATION, TULSA, OK. FILED 7-23-2009.

HYDROWORLD weekly

NO CLAIM IS MADE TO THE EXCLUSIVE RIGHT TO USE "WEEKLY", APART FROM THE MARK AS SHOWN.

THE MARK CONSISTS OF THE WORDS "HYDROWORLD WEEKLY" WITH A HORIZONTAL LINE UNDERNEATH THE WORDS.

FOR PROVIDING ONLINE NEWSLETTERS IN THE FIELD OF HYDROELECTRIC POWER (U.S. CLS. 100, 101 AND 107).

FIRST USE 6-16-2009; IN COMMERCE 6-16-2009.
MARK SPARACINO, EXAMINING ATTORNEY

CLASS 41—(Continued).

SN 77-790,061. ARPAIA, DONATELLA, NEW YORK, NY. FILED 7-27-2009.

DONATELLA

THE MARK CONSISTS OF STANDARD CHARACTERS WITHOUT CLAIM TO ANY PARTICULAR FONT, STYLE, SIZE, OR COLOR.

"DONATELLA" IDENTIFIES A LIVING INDIVIDUAL WHOSE CONSENT IS OF RECORD.

FOR ENTERTAINMENT SERVICES IN THE NATURE OF AN ONGOING TELEVISION PROGRAM IN THE FIELDS OF COOKING AND CULINARY ARTS (U.S. CLS. 100, 101 AND 107).

KATHLEEN M. VANSTON, EXAMINING ATTORNEY

SN 77-793,535. DICKINSON OF SAN ANTONIO, INC., SAN ANTONIO, TX. FILED 7-30-2009.

River City College

THE MARK CONSISTS OF STANDARD CHARACTERS WITHOUT CLAIM TO ANY PARTICULAR FONT, STYLE, SIZE, OR COLOR.

NO CLAIM IS MADE TO THE EXCLUSIVE RIGHT TO USE "COLLEGE", APART FROM THE MARK AS SHOWN.

FOR PROVIDING COURSES OF INSTRUCTION AT THE COLLEGE LEVEL (U.S. CLS. 100, 101 AND 107).

SANI KHOURI, EXAMINING ATTORNEY

SN 77-795,715. MARTINEZ III, I. RICARDO, NEW ORLEANS, LA. FILED 8-3-2009.

★ III ★

THE MARK CONSISTS OF ROMAN NUMERAL 3 ("III") WITH TWO FIVE-POINTED STARS.

FOR MULTIMEDIA ENTERTAINMENT SERVICES IN THE NATURE OF RECORDING, PRODUCTION AND POST-PRODUCTION SERVICES IN THE FIELDS OF MUSIC, VIDEO, AND FILMS (U.S. CLS. 100, 101 AND 107).

FIRST USE 8-31-2007; IN COMMERCE 8-31-2007.
KIM MONINGHOFF, EXAMINING ATTORNEY

CLASS 41—(Continued).

SN 77-797,179. INSTITUTE FOR MINDFULNESS STUDIES, INC., MIAMI BEACH, FL. FILED 8-5-2009.

The Mindful Lawyer

THE MARK CONSISTS OF STANDARD CHARACTERS WITHOUT CLAIM TO ANY PARTICULAR FONT, STYLE, SIZE, OR COLOR.

NO CLAIM IS MADE TO THE EXCLUSIVE RIGHT TO USE "LAWYER", APART FROM THE MARK AS SHOWN.

FOR PROFESSIONAL COACHING SERVICES IN THE FIELD OF LAW AND CONTEMPLATIVE PRACTICES (U.S. CLS. 100, 101 AND 107).

FIRST USE 12-12-2003; IN COMMERCE 12-12-2003.
WENDY JUN, EXAMINING ATTORNEY

CLASS 41—(Continued).

SN 77-802,116. KALEIDOSCOPE MEDIA GROUP, DBA BUSINESS MASTERY INTERNATIONAL, LOS ANGELES, CA. FILED 8-11-2009.

Ultimate Business Success

THE MARK CONSISTS OF STANDARD CHARACTERS WITHOUT CLAIM TO ANY PARTICULAR FONT, STYLE, SIZE, OR COLOR.

NO CLAIM IS MADE TO THE EXCLUSIVE RIGHT TO USE "BUSINESS", APART FROM THE MARK AS SHOWN.

FOR EDUCATION SERVICES, NAMELY, PROVIDING CLASSES, SEMINARS AND WORKSHOPS IN THE FIELD OF INCREASING SALES AND MARKETING TECHNIQUES AND DISTRIBUTING COURSE MATERIALS IN CONNECTION THEREWITH; COACHING AND INSTRUCTION SERVICES IN THE FIELD OF INCREASING SALES AND MARKETING TECHNIQUES AND DISTRIBUTING COURSE MATERIALS IN CONNECTION THEREWITH (U.S. CLS. 100, 101 AND 107).

JOHN WILKE, EXAMINING ATTORNEY

SN 77-801,914. WIRE JEWELRY BOOTCAMP LLC, SAINT JOSEPH, MO. FILED 8-11-2009.



THE MARK CONSISTS OF A MAN WITH MAGNIFYING EYEGASSES HOLDING WIRE CUTTERS AND A BALL OF WIRE.

FOR PROVIDING TRAINING SERVICES IN THE FIELD OF JEWELRY MAKING VIA A WEBSITE ACCESSIBLE BY MEMBERS FEATURING TUTORIALS, NON-DOWNLOADABLE INSTRUCTIONAL VIDEOS, SEMINARS, WEBINARS AND ON-LINE COURSES (U.S. CLS. 100, 101 AND 107).

FIRST USE 8-1-2009; IN COMMERCE 8-1-2009.
MARK SHINER, EXAMINING ATTORNEY

SN 77-803,326. ENLASO CORPORATION, BOISE, ID. FILED 8-12-2009.

RHONIX

THE MARK CONSISTS OF STANDARD CHARACTERS WITHOUT CLAIM TO ANY PARTICULAR FONT, STYLE, SIZE, OR COLOR.

FOR PROVIDING ON-LINE JOURNALS, NAMELY, BLOGS IN THE FIELD OF LANGUAGE LOCALIZATION AND TRANSLATION SERVICES FOR THE MEDICAL INDUSTRY; PROVIDING A WEBSITE IN THE FIELDS OF LANGUAGE TRANSLATION AND LANGUAGE LOCALIZATION IN THE NATURE OF LANGUAGE INTERPRETATION FOR THE MEDICAL INDUSTRY FEATURING EDUCATIONAL MATERIALS AND USER-GENERATED CONTENT (U.S. CLS. 100, 101 AND 107).

CHARLOTTE CORWIN, EXAMINING ATTORNEY

CLASS 41—(Continued).

SN 77-804,227. DOUEK, SAMUEL, MEXICO CITY, MEXICO,
FILED 8-13-2009.



OWNER OF U.S. REG. NO. 3,509,348.

NO CLAIM IS MADE TO THE EXCLUSIVE RIGHT TO USE "MEXICO FILM FESTIVAL", APART FROM THE MARK AS SHOWN.

THE MARK CONSISTS OF THE WORDS "HOLA MEXICO FILM FESTIVAL" IN STYLIZED FORM; THE WORD "HOLA" IS ON THE TOP WITH FANCIFUL SWIRLS ON BOTH SIDES, THE WORD "MEXICO" IS IN THE MIDDLE WITH A FLOWER ON BOTH SIDES, AND THE WORDS "FILM FESTIVAL" ARE AT THE BOTTOM, WITH A FANCIFUL BANNER UNDERNEATH THE WORDS, WITH A FILM REEL IN THE MIDDLE OF THE BANNER.

THE ENGLISH TRANSLATION OF "HOLA" IN THE MARK IS HELLO.

FOR CONDUCTING ENTERTAINMENT EXHIBITIONS IN THE NATURE OF FILM FESTIVALS (U.S. CLS. 100, 101 AND 107).

FIRST USE 7-23-2008; IN COMMERCE 7-23-2008.
JOHN GARTNER, EXAMINING ATTORNEY

SN 77-813,534. SEGALL, STUART C., SAN DIEGO, CA.
FILED 8-26-2009.

THE NEXT GENERATION

THE MARK CONSISTS OF STANDARD CHARACTERS WITHOUT CLAIM TO ANY PARTICULAR FONT, STYLE, SIZE, OR COLOR.

FOR EDUCATIONAL SERVICES, NAMELY, PROVIDING TRAINING IN THE NATURE OF SCENARIOS IN SITUATIONAL ENVIRONMENTS TO PREPARE MILITARY, PARA-MILITARY, AND LAW-ENFORCEMENT PERSONNEL FOR DEFENSE AND SECURITY MISSIONS, AND CONSULTATION ON THE EMPLOYMENT AND USE OF TRAINING AIDES FOR CREATION OF REALISTIC TRAINING ENVIRONMENTS (U.S. CLS. 100, 101 AND 107).

FIRST USE 12-1-2002; IN COMMERCE 12-1-2002.
DOMINIC J. FERRAIUOLO, EXAMINING ATTORNEY

CLASS 41—(Continued).

SN 77-816,704. LISKEY, MARK E., DBA THE MESSAGE INSTITUTE, BERWYN, PA. FILED 8-31-2009.

pressure perfect

THE MARK CONSISTS OF STANDARD CHARACTERS WITHOUT CLAIM TO ANY PARTICULAR FONT, STYLE, SIZE, OR COLOR.

FOR EDUCATIONAL SERVICES, NAMELY, PROVIDING SEMINARS, CLASSES, WORKSHOPS, LEARNING FORUMS, WEBINARS AND ONLINE E-LEARNING COURSES IN THE FIELD OF RELAXATION MASSAGE (U.S. CLS. 100, 101 AND 107).

FIRST USE 8-0-2008; IN COMMERCE 3-0-2009.
ANTHONY RINKER, EXAMINING ATTORNEY

SN 77-817,473. STEAMDONKEY LLC, TIERRA VERDE, FL.
FILED 9-1-2009.



NO CLAIM IS MADE TO THE EXCLUSIVE RIGHT TO USE "TILT", APART FROM THE MARK AS SHOWN.

THE MARK CONSISTS OF THE WORDS "TILT BREAKER" AND A DESIGN OF A CIRCLE WITH A STYLIZED DESIGN OF A DONKEY HEAD PROTRUDING FROM THE CIRCLE AND TWO SMOKE PUFFS WITH DOLLAR SIGNS COMING FROM THE DONKEY'S NOSTRILS.

FOR PROVIDING INSTRUCTIONAL INFORMATION ON POKER (U.S. CLS. 100, 101 AND 107).

SUSAN RICHARDS, EXAMINING ATTORNEY

SN 77-817,934. L.A. OFFICE, THE, LOS ANGELES, CA.
FILED 9-1-2009.

L.A. OFFICE ROADSHOW

THE MARK CONSISTS OF STANDARD CHARACTERS WITHOUT CLAIM TO ANY PARTICULAR FONT, STYLE, SIZE, OR COLOR.

OWNER OF U.S. REG. NO. 2,573,920.

SEC. 2(F).

FOR EDUCATION SERVICES, NAMELY, PROVIDING MENTORING, TUTORING, CLASSES, SEMINARS AND WORKSHOPS IN THE FIELD OF MARKETING AND PROMOTIONS OPPORTUNITIES AND IMPLEMENTATION TO CLIENTS IN ALL CATEGORIES OF INDUSTRIES (U.S. CLS. 100, 101 AND 107).

FIRST USE 12-1-1997; IN COMMERCE 1-2-1998.

DAVID TAYLOR, EXAMINING ATTORNEY

CLASS 41—(Continued).

SN 77-817,956. BECKERMAN, TONY, VISTA, CA. FILED 9-1-2009.

HAIR UNITED

THE MARK CONSISTS OF STANDARD CHARACTERS WITHOUT CLAIM TO ANY PARTICULAR FONT, STYLE, SIZE, OR COLOR.

NO CLAIM IS MADE TO THE EXCLUSIVE RIGHT TO USE "HAIR", APART FROM THE MARK AS SHOWN.

FOR EDUCATION SERVICES, NAMELY, PROVIDING CLASSES, SEMINARS, AND WORKSHOPS IN THE FIELD OF HAIR (U.S. CLS. 100, 101 AND 107).

JERI J. FICKES, EXAMINING ATTORNEY

SN 77-818,873. TWENTIETH CENTURY FOX FILM CORPORATION, LOS ANGELES, CA. FILED 9-2-2009.

GLEEK

THE MARK CONSISTS OF STANDARD CHARACTERS WITHOUT CLAIM TO ANY PARTICULAR FONT, STYLE, SIZE, OR COLOR.

FOR PROVIDING ON-LINE INFORMATION IN THE FIELD OF TELEVISION AND VIDEO ENTERTAINMENT FEATURING COMEDY AND MUSIC VIA THE INTERNET; ENTERTAINMENT SERVICES IN THE NATURE OF NON-DOWNLOADABLE VIDEOS AND IMAGES FEATURING TELEVISION AND ENTERTAINMENT TRANSMITTED VIA THE INTERNET AND WIRELESS COMMUNICATION NETWORKS; ON-LINE JOURNALS, NAMELY, BLOGS FEATURING PERSONAL OPINIONS IN THE FIELD OF GENERAL INTEREST, COMEDY AND MUSIC; FAN CLUBS; PUBLICATION OF TEXTS, JOURNALS, BOOKS AND MAGAZINES; PROVIDING NON-DOWNLOADABLE ONLINE PUBLICATIONS IN THE NATURE OF NEWSLETTERS AND MAGAZINES IN THE FIELD OF TELEVISION AND VIDEO ENTERTAINMENT FEATURING COMEDY AND MUSIC (U.S. CLS. 100, 101 AND 107).

KATHERINE STOIDES, EXAMINING ATTORNEY

CLASS 41—(Continued).

SN 77-819,557. BASTAS, JULIA, DBA BOOTY VORTEX, SOMERVILLE, MA. FILED 9-3-2009.

Booty Vortex

THE MARK CONSISTS OF STANDARD CHARACTERS WITHOUT CLAIM TO ANY PARTICULAR FONT, STYLE, SIZE, OR COLOR.

FOR ENTERTAINMENT IN THE NATURE OF VISUAL AND AUDIO PERFORMANCES, NAMELY, MUSICAL BAND, ROCK GROUP, GYMNASTIC, DANCE, AND BALLET PERFORMANCES; ENTERTAINMENT, NAMELY, LIVE PERFORMANCES BY A MUSICAL BAND (U.S. CLS. 100, 101 AND 107).

FIRST USE 12-1-2004; IN COMMERCE 12-1-2004.

GINA HAYES, EXAMINING ATTORNEY

SN 77-822,599. MILLER, SEAN, MESA, AZ. FILED 9-9-2009.

CRYSTAL HAZE

THE MARK CONSISTS OF STANDARD CHARACTERS WITHOUT CLAIM TO ANY PARTICULAR FONT, STYLE, SIZE, OR COLOR.

THE NAME "CRYSTAL HAZE" DOES NOT IDENTIFY A LIVING INDIVIDUAL.

FOR ENTERTAINMENT, NAMELY, LIVE PERFORMANCES BY A MUSICAL BAND (U.S. CLS. 100, 101 AND 107).

CHARISMA HAMPTON, EXAMINING ATTORNEY

SN 77-824,222. PRODIGY DESIGN LIMITED, WELLINGTON, NEW ZEALAND, FILED 9-10-2009.

THE KINGDOM

THE MARK CONSISTS OF STANDARD CHARACTERS WITHOUT CLAIM TO ANY PARTICULAR FONT, STYLE, SIZE, OR COLOR.

PRIORITY CLAIMED UNDER SEC. 44(D) ON NEW ZEALAND APPLICATION NO. 803485, FILED 3-10-2009, REG. NO. 803485, DATED 3-10-2009, EXPIRES 3-10-2019.

FOR PUBLISHING OF GAMING SOFTWARE INCLUDING DOWNLOADABLE GAMING SOFTWARE; PUBLISHING OF VIDEO GAMES SOFTWARE AND DOWNLOADABLE VIDEO GAMES SOFTWARE (U.S. CLS. 100, 101 AND 107).

TINA MAI, EXAMINING ATTORNEY

CLASS 41—(Continued).

SN 77-824,391. ETERNAL PRESERVATION ASSOCIATES, LLC, BOCA RATON, FL. FILED 9-11-2009.

ACCIDENTAL MUMMIES

THE MARK CONSISTS OF STANDARD CHARACTERS WITHOUT CLAIM TO ANY PARTICULAR FONT, STYLE, SIZE, OR COLOR.

NO CLAIM IS MADE TO THE EXCLUSIVE RIGHT TO USE "MUMMIES", APART FROM THE MARK AS SHOWN.

FOR CONDUCTING CULTURAL AND EDUCATIONAL EXHIBITIONS IN THE NATURE OF ARCHAEOLOGY, ANTHROPOLOGY AND FORENSIC SCIENCE; EDUCATIONAL SERVICES, NAMELY, WORKSHOPS, PANEL DISCUSSIONS, LIVE PRESENTATIONS IN THE FIELD OF ARCHAEOLOGY, ANTHROPOLOGY AND FORENSIC SCIENCE, AND DISTRIBUTION OF PRINTED AND ELECTRONICALLY TRANSMITTED COURSE MATERIALS IN CONNECTION THEREWITH (U.S. CLS. 100, 101 AND 107).

PAM WILLIS, EXAMINING ATTORNEY

SN 77-829,868. RAMSELL HOLDING CORPORATION, OAKLAND, CA. FILED 9-18-2009.

DON'T TURN YOUR BACK ON AIDS

THE MARK CONSISTS OF STANDARD CHARACTERS WITHOUT CLAIM TO ANY PARTICULAR FONT, STYLE, SIZE, OR COLOR.

NO CLAIM IS MADE TO THE EXCLUSIVE RIGHT TO USE "AIDS", APART FROM THE MARK AS SHOWN.

FOR EDUCATIONAL SERVICES, NAMELY, CONDUCTING PROGRAMS IN THE FIELD OF HIV AND AIDS AWARENESS (U.S. CLS. 100, 101 AND 107).

FIRST USE 12-2-2006; IN COMMERCE 12-2-2006.
TRACY CROSS, EXAMINING ATTORNEY

SN 77-832,141. TUPELO MUSIC HALL LLC, EAST DERRY, NH. FILED 9-22-2009.

TUPELO MUSIC HALL

THE MARK CONSISTS OF STANDARD CHARACTERS WITHOUT CLAIM TO ANY PARTICULAR FONT, STYLE, SIZE, OR COLOR.

NO CLAIM IS MADE TO THE EXCLUSIVE RIGHT TO USE "MUSIC HALL", APART FROM THE MARK AS SHOWN.

FOR PROVIDING FACILITIES FOR CONCERTS AND COMEDY PERFORMANCES; PRODUCTION OF MUSIC AND COMEDY PERFORMANCES (U.S. CLS. 100, 101 AND 107).

FIRST USE 8-1-2004; IN COMMERCE 8-1-2004.
ANGELA DUONG, EXAMINING ATTORNEY

CLASS 41—(Continued).

SN 77-833,799. UNITED STATES OF AMERICA AS REPRESENTED BY THE SECRETARY OF THE NAVY, DBA NAVAL AIR WARFARE CENTER TRAINING SYSTEMS DIVISION, ORLANDO, FL. FILED 9-24-2009.



NO CLAIM IS MADE TO THE EXCLUSIVE RIGHT TO USE "TEAM", "TRAINING", "INFORMATION EXCHANGE", "COMMUNICATION", "SUPPORTING BEHAVIOR" AND "LEADERSHIP", APART FROM THE MARK AS SHOWN.

THE COLOR(S) YELLOW, BLUE, ORANGE, WHITE AND GRAY IS/ARE CLAIMED AS A FEATURE OF THE MARK.

THE MARK CONSISTS OF A TWO DIMENSIONAL FIGURE HAVING CURVED ENDS AND PARALLEL SIDES ENCLOSING SHADES OF YELLOW AT THE UPPER END AND TRANSITIONING TO SHADES OF BLUE AT THE LOWER END WITH ORANGE IN BETWEEN AND WITH THE LETTER "TDT" IN WHITE WITH BLUE OUTLINE AT THE TOP OVER THE WORDING "TEAM DIMENSIONAL TRAINING" IN BLUE, AND FOUR SWORDS ON THE BOTTOM POINTING UP AT THE WORDING WITH EACH SWORD HAVING AN ORANGE HANDLE AND A GRAY AND WHITE BLADE, ON WHICH THE FOLLOWING WORDING APPEARS IN BLUE "INFORMATION EXCHANGE", "COMMUNICATION", "SUPPORTING BEHAVIOR" AND "LEADERSHIP" RESPECTIVELY ON THE BLADE OF EACH SWORD.

FOR EDUCATIONAL SERVICES, NAMELY, CONDUCTING CLASSES, SEMINARS, CONFERENCES, WORKSHOPS, SIMULATOR TRAINING IN THE FIELD OF GROUP PERFORMANCE AND DISTRIBUTION OF COURSE MATERIAL IN CONNECTION THEREWITH (U.S. CLS. 100, 101 AND 107).

FIRST USE 5-0-2001; IN COMMERCE 5-0-2001.
BARBARA BROWN, EXAMINING ATTORNEY

SN 77-839,378. TEACHING HOUSE, NEW YORK, NY. FILED 10-1-2009.



NO CLAIM IS MADE TO THE EXCLUSIVE RIGHT TO USE "TEACHING" AND "NEW YORK", APART FROM THE MARK AS SHOWN.

THE MARK CONSISTS OF THE LETTERS "T","H" ARE IN

CLASS 41—(Continued).

CAPITAL LETTERS WITH A BOLD FONT STYLE FOLLOWED BY THE LETTERS "N","Y" IN CAPITAL LETTERS WITH A SMALLER FONT SIZE. THE LETTERS "T","H","N","Y" ARE ENCLOSED IN A RECTANGULAR SHAPE WITH A BOLD OUTLINE. THE RECTANGLE IS LOCATED TO THE LEFT OF THE WORDS "TEACHING HOUSE" IN ALL CAPITAL LETTERS WITH A BOLD FONT STYLE. THE WORDS "NEW YORK" IN CAPITAL LETTERS ARE CENTERED UNDER THE WORDS TEACHING HOUSE IN A SMALLER FONT SIZE.

FOR EDUCATIONAL SERVICES, NAMELY, PROVIDING CLASSES AND INSTRUCTION IN THE FIELDS OF TEACHER TRAINING SKILLS AND INSTRUCTION IN ENGLISH AS A FOREIGN LANGUAGE (U.S. CLS. 100, 101 AND 107).

FIRST USE 3-0-2008; IN COMMERCE 3-0-2008.
SUSAN RICHARDS, EXAMINING ATTORNEY

SN 77-839,536. CAMP CRANIUM, MILTON, PA. FILED 10-1-2009.



NO CLAIM IS MADE TO THE EXCLUSIVE RIGHT TO USE "CAMP", APART FROM THE MARK AS SHOWN. THE COLOR(S) BROWN AND GREEN IS/ARE CLAIMED AS A FEATURE OF THE MARK.

THE MARK CONSISTS OF THE WORDS "CAMP CRANIUM" IN GREEN PLACED TO THE RIGHT OF A TREE LOGO COMPRISED OF A BROWN TREE TRUNK AND A GREEN STYLIZED HUMAN BRAIN WITH GREEN LEAVES IN PLACE OF THE LEAF CROWN.

FOR OPERATION OF A SUMMER CAMP FOR BRAIN INJURED CHILDREN, CHARITABLE SERVICES, NAMELY, SENDING BRAIN INJURED CHILDREN TO SUMMER CAMP (U.S. CLS. 100, 101 AND 107).

FIRST USE 6-8-2008; IN COMMERCE 6-8-2008.
DOMINIC J. FERRAIUOLO, EXAMINING ATTORNEY

SN 77-839,668. PERKINS, JACK G., DBA POP-CULT, SAN FRANCISCO, CA. FILED 10-1-2009.

Pop-Cult

THE MARK CONSISTS OF STANDARD CHARACTERS WITHOUT CLAIM TO ANY PARTICULAR FONT, STYLE, SIZE, OR COLOR.

OWNER OF U.S. REG. NO. 2,305,157.
SEC. 2(F).

FOR PUBLICATION OF TEXTS, BOOKS, MAGAZINES AND OTHER PRINTED MATTER; PUBLISHING OF BOOKS, E-BOOKS, AUDIO BOOKS, MUSIC AND ILLUSTRATIONS (U.S. CLS. 100, 101 AND 107).

FIRST USE 6-1-1983; IN COMMERCE 1-1-1984.
MAYUR VAGHANI, EXAMINING ATTORNEY

CLASS 41—(Continued).

SN 77-839,729. METROPOLIS PRODUCTIONS, LLC, ORLANDO, FL. FILED 10-1-2009.



NO CLAIM IS MADE TO THE EXCLUSIVE RIGHT TO USE "KARAOKE LIVE", APART FROM THE MARK AS SHOWN.

THE STIPPLING IS FOR SHADING PURPOSES ONLY. THE MARK CONSISTS OF THE STYLIZED WORDING "KARAOKE LIVE" APPEARING ON A RECTANGULAR BACKGROUND, WITH THE OUTLINE OF THAT RECTANGLE DEPICTED AS A JAGGED LINE, AND THE INTERIOR OF THE RECTANGLE IS DIVIDED INTO THREE VERTICAL SECTIONS, WITH THE OUTER TWO SECTIONS SHADED. ON THE LOWER PORTION OF THE RECTANGLE APPEAR SILHOUETTES OF FIVE INDIVIDUALS, TWO OF WHICH ARE SINGING WITH MICROPHONES, TWO OF WHICH ARE DEPICTED PLAYING GUITARS, AND ONE INDIVIDUAL IS SEATED BEHIND A DRUM SET. THE WORDING "LIVE" APPEARS WITHIN A SERIES OF FOUR RECTANGLES, WITH EACH LETTER APPEARING AS A CUTOFF OF THE RECTANGLES.

FOR ENTERTAINMENT IN THE NATURE OF LIVE MUSICAL PERFORMANCES OF SINGERS FROM THE AUDIENCE BACKED BY AND PERFORMING WITH A LIVE BAND WITH THE VISUAL ASSISTANCE FROM A VIDEO MONITOR DISPLAYING LYRICS FROM THE SONG; ENTERTAINMENT SERVICES, NAMELY, LIVE MUSICAL PERFORMANCES CONSISTING OF PARTICIPATION IN KARAOKE WITH A LIVE BAND WHEREBY SINGERS FROM THE AUDIENCE ARE BACKED BY AND PERFORM WITH A LIVE BAND WITH THE VISUAL ASSISTANCE FROM A VIDEO MONITOR DISPLAYING LYRICS FROM THE SONG; ENTERTAINMENT, NAMELY, LIVE PERFORMANCES BY A MUSICAL BAND; ENTERTAINMENT, NAMELY, LIVE MUSIC CONCERTS; ENTERTAINMENT, NAMELY, LIVE PERFORMANCES BY LIVE MUSICIANS OR MUSICAL GROUPS (U.S. CLS. 100, 101 AND 107).

FIRST USE 1-0-2008; IN COMMERCE 1-0-2008.
MARK PILARO, EXAMINING ATTORNEY

CLASS 41—(Continued).

SN 77-839,997. US PUBLISHERS, INC., NEWARK, DE. FILED 10-2-2009.

US IMMIGRATION SUPPORT

THE MARK CONSISTS OF STANDARD CHARACTERS WITHOUT CLAIM TO ANY PARTICULAR FONT, STYLE, SIZE, OR COLOR.

SEC. 2(F).
FOR ONLINE ELECTRONIC PUBLISHING OF BOOKS AND PERIODICALS; PUBLISHING OF ELECTRONIC PUBLICATIONS (U.S. CLS. 100, 101 AND 107).
FIRST USE 1-12-2004; IN COMMERCE 1-12-2004.
NANCY CLARKE, EXAMINING ATTORNEY

CLASS 41—(Continued).

SN 77-842,464. SERAPHIM RANCH, LLC, CINCINNATI, OH. FILED 10-6-2009.



NO CLAIM IS MADE TO THE EXCLUSIVE RIGHT TO USE "RANCH", APART FROM THE MARK AS SHOWN.

THE MARK CONSISTS OF THE WORD "SERAPHIM" WITH AN ARROW FORMING PART OF THE WORD, IMPOSED OVER A DEER SKULL, WITH THE WORD "RANCH" TO THE LOWER RIGHT.

FOR RECREATIONAL SERVICES, NAMELY, PROVIDING HUNTING PRESERVES AND OTHER OUTDOOR ACTIVITIES, NAMELY, FISHING AND HUNTING GUIDE SERVICES; PROVIDING FACILITIES FOR RECREATION AND OUTDOOR ACTIVITIES, NAMELY, FISHING, HUNTING AND HUNTING GUIDE SERVICES (U.S. CLS. 100, 101 AND 107).

FIRST USE 6-1-2009; IN COMMERCE 6-1-2009.
JENNIFER VASQUEZ, EXAMINING ATTORNEY

SN 77-840,932. KIN, JEFFERY J., SARASOTA, FL. FILED 10-4-2009.

Got A Minute?

THE MARK CONSISTS OF STANDARD CHARACTERS WITHOUT CLAIM TO ANY PARTICULAR FONT, STYLE, SIZE, OR COLOR.

NO CLAIM IS MADE TO THE EXCLUSIVE RIGHT TO USE "MINUTE", APART FROM THE MARK AS SHOWN.

FOR PRESENTATION OF LIVE SHOW PERFORMANCES IN THE NATURE OF SHORT PLAYS, SKITS OR RELATED MUSICAL MATERIAL OF ONE MINUTE OR MORE IN DURATION (U.S. CLS. 100, 101 AND 107).
FIRST USE 9-14-2006; IN COMMERCE 9-14-2006.
KATHERINE STOIDES, EXAMINING ATTORNEY

SN 77-842,486. SERAPHIM RANCH, LLC, CINCINNATI, OH. FILED 10-6-2009.

SERAPHIM RANCH

THE MARK CONSISTS OF STANDARD CHARACTERS WITHOUT CLAIM TO ANY PARTICULAR FONT, STYLE, SIZE, OR COLOR.

NO CLAIM IS MADE TO THE EXCLUSIVE RIGHT TO USE "RANCH", APART FROM THE MARK AS SHOWN.

FOR RECREATIONAL SERVICES, NAMELY, PROVIDING HUNTING PRESERVES AND OTHER OUTDOOR ACTIVITIES, NAMELY, FISHING AND HUNTING GUIDE SERVICES; PROVIDING FACILITIES FOR RECREATION AND OUTDOOR ACTIVITIES, NAMELY, FISHING, HUNTING AND HUNTING GUIDE SERVICES (U.S. CLS. 100, 101 AND 107).

FIRST USE 6-1-2009; IN COMMERCE 6-1-2009.
JENNIFER VASQUEZ, EXAMINING ATTORNEY

CLASS 41—(Continued).

SN 77-844,249. SCHANDOR, MARIA, NORTH CONWAY, NH. FILED 10-8-2009.

ÜberBlast

THE MARK CONSISTS OF STANDARD CHARACTERS WITHOUT CLAIM TO ANY PARTICULAR FONT, STYLE, SIZE, OR COLOR.

FOR CHILDREN'S ENTERTAINMENT AND AMUSEMENT CENTERS, NAMELY, INTERACTIVE PLAY AREAS (U.S. CLS. 100, 101 AND 107).

FIRST USE 9-3-2009; IN COMMERCE 9-25-2009.
TARAH HARDY, EXAMINING ATTORNEY

SN 77-844,458. AZTECA INTERNATIONAL CORPORATION, GLENDALE, CA. FILED 10-8-2009.

NOTICIERO NACIONAL AZTECA
AMERICA

THE MARK CONSISTS OF STANDARD CHARACTERS WITHOUT CLAIM TO ANY PARTICULAR FONT, STYLE, SIZE, OR COLOR.

OWNER OF U.S. REG. NOS. 3,025,238 AND 3,145,906.
NO CLAIM IS MADE TO THE EXCLUSIVE RIGHT TO USE "NOTICIERO NACIONAL" AND "AMERICA", APART FROM THE MARK AS SHOWN.

THE ENGLISH TRANSLATION OF "NOTICIERO NACIONAL AZTECA AMERICA" IN THE MARK IS "NATIONAL NEWS AZTECA AMERICA".

FOR ONGOING TELEVISION NEWS PROGRAM (U.S. CLS. 100, 101 AND 107).

FIRST USE 2-9-2009; IN COMMERCE 2-9-2009.
MARC LEIPZIG, EXAMINING ATTORNEY

SN 77-847,069. SCRITCHFIELD, REBECCA, WASHINGTON, DC. FILED 10-12-2009.



THE MARK CONSISTS OF GROWING PLANT WITH A STEM, THREE LEAVES, AND SOIL. TO THE RIGHT THERE IS THE STYLIZED TEXT "NURTURE PRINCIPLES FIND WELLNESS WITHIN".

FOR EDUCATIONAL AND ENTERTAINMENT SERVICES, NAMELY, KEYNOTE SPEAKING, WORKSHOPS AND PRESENTATIONS FEATURING CONTENT ON WELLNESS, NUTRITION AND EXERCISE TOPICS (U.S. CLS. 100, 101 AND 107).

FIRST USE 4-20-2009; IN COMMERCE 4-25-2009.
KRISTIN CARLSON, EXAMINING ATTORNEY

CLASS 41—(Continued).

SN 77-847,331. MYRTLE BEACH MARATHON, INC., MYRTLE BEACH, SC. FILED 10-13-2009.

MYRTLE BEACH MARATHON

THE MARK CONSISTS OF STANDARD CHARACTERS WITHOUT CLAIM TO ANY PARTICULAR FONT, STYLE, SIZE, OR COLOR.

NO CLAIM IS MADE TO THE EXCLUSIVE RIGHT TO USE "MARATHON", APART FROM THE MARK AS SHOWN.

SEC. 2(F).

FOR ATHLETIC AND SPORTS EVENT SERVICES, NAMELY, ARRANGING, ORGANIZING, OPERATING AND CONDUCTING MARATHON RACES (U.S. CLS. 100, 101 AND 107).

FIRST USE 2-1-1998; IN COMMERCE 2-1-1998.
DAVID H. STINE, EXAMINING ATTORNEY

SN 77-847,382. MYRTLE BEACH MARATHON, INC., MYRTLE BEACH, SC. FILED 10-13-2009.

MYRTLE BEACH HALF MARATHON

THE MARK CONSISTS OF STANDARD CHARACTERS WITHOUT CLAIM TO ANY PARTICULAR FONT, STYLE, SIZE, OR COLOR.

NO CLAIM IS MADE TO THE EXCLUSIVE RIGHT TO USE "HALF MARATHON", APART FROM THE MARK AS SHOWN.

SEC. 2(F).

FOR ATHLETIC AND SPORTS EVENT SERVICES, NAMELY, ARRANGING, ORGANIZING, OPERATING AND CONDUCTING MARATHON RACES (U.S. CLS. 100, 101 AND 107).

FIRST USE 2-1-2000; IN COMMERCE 2-1-2000.
DAVID H. STINE, EXAMINING ATTORNEY

CLASS 41—(Continued).

SN 77-848,134. SENIOR LIVING UNIVERSITY, LLC, HER-SHEY, PA. FILED 10-14-2009.

CLASS 41—(Continued).

SN 77-848,999. CAPITAL ALUMNI NETWORK, ARLING-TON, VA. FILED 10-14-2009.

SENIOR LIVING UNIVERSITY

Capital Alumni Network

THE MARK CONSISTS OF STANDARD CHARACTERS WITHOUT CLAIM TO ANY PARTICULAR FONT, STYLE, SIZE, OR COLOR.

NO CLAIM IS MADE TO THE EXCLUSIVE RIGHT TO USE "SENIOR LIVING", APART FROM THE MARK AS SHOWN.

FOR PROVIDING NEWSLETTERS IN THE FIELD OF CARE GIVING AND ASSISTED LIVING VIA E-MAIL; EDUCATIONAL SERVICES, NAMELY, DEVELOPING TRAINING COURSES AND CERTIFICATION PRO-GRAMS FOR OTHERS IN THE FIELD OF CARE GIV-ING AND ASSISTED LIVING, FOR USE IN TRAINING PERSONNEL IN THE CARE GIVING AND ASSISTED LIVING INDUSTRY, AND DISTRIBUTION OF TRAIN-ING MATERIALS IN CONNECTION THEREWITH (U.S. CLS. 100, 101 AND 107).

FIRST USE 1-0-2007; IN COMMERCE 1-0-2007.
EVELYN BRADLEY, EXAMINING ATTORNEY

THE MARK CONSISTS OF STANDARD CHARACTERS WITHOUT CLAIM TO ANY PARTICULAR FONT, STYLE, SIZE, OR COLOR.

NO CLAIM IS MADE TO THE EXCLUSIVE RIGHT TO USE "ALUMNI NETWORK", APART FROM THE MARK AS SHOWN.

FOR ORGANIZING SOCIAL ENTERTAINMENT EVENTS AND SPORTS COMPETITIONS FOR COLLEGE AND UNIVERSITY ALUMNI IN THE GREATER WA-SHINGTON, DC AREA; SOCIAL CLUB SERVICES, NAMELY, ARRANGING, ORGANIZING AND HOSTING SOCIAL EVENTS, GET-TOGETHERS AND PARTIES FOR COLLEGE AND UNIVERSITY ALUMNI IN THE GREATER WASHINGTON, DC AREA; ORGANIZING SPORTING EVENTS, NAMELY, CO-ED BASKETBALL, FLAG FOOTBALL, GOLF, SOCCER, SOFTBALL AND VOLLEYBALL LEAGUES AND TOURNAMENTS FOR COLLEGE AND UNIVERSITY ALUMNI IN THE GREATER WASHINGTON, DC AREA (U.S. CLS. 100, 101 AND 107).

FIRST USE 7-15-1998; IN COMMERCE 7-15-1998.
NELSON SNYDER, EXAMINING ATTORNEY

SN 77-848,783. READY FOR THE WORLD INC., DBA READY FOR THE WORLD, ATLANTA, GA. FILED 10-14-2009.

SN 77-849,052. YOU VOTED INC., NASHVILLE, TN. FILED 10-14-2009.

Ready For The World

YOU VOTED!

THE MARK CONSISTS OF STANDARD CHARACTERS WITHOUT CLAIM TO ANY PARTICULAR FONT, STYLE, SIZE, OR COLOR.

FOR ENTERTAINMENT, NAMELY, LIVE PERFORM-ANCES BY A MUSICAL BAND (U.S. CLS. 100, 101 AND 107).

FIRST USE 2-1-1984; IN COMMERCE 2-1-1984.
JENNIFER VASQUEZ, EXAMINING ATTORNEY

THE MARK CONSISTS OF STANDARD CHARACTERS WITHOUT CLAIM TO ANY PARTICULAR FONT, STYLE, SIZE, OR COLOR.

FOR LIVE EVENTS, NAMELY, CONCERTS AND GOLF, BASEBALL, BASKETBALL, FOOTBALL AND SOCCER SPORTING EVENTS; ORGANIZING LIVE EVENTS FOR OTHERS, NAMELY, ARRANGING MEET-INGS (U.S. CLS. 100, 101 AND 107).

JAMES GRIFFIN, EXAMINING ATTORNEY

CLASS 41—(Continued).

SN 77-850,544. ST. PATRICK CENTER, ST. LOUIS, MO. FILED 10-16-2009.

GO! NETWORK

THE MARK CONSISTS OF STANDARD CHARACTERS WITHOUT CLAIM TO ANY PARTICULAR FONT, STYLE, SIZE, OR COLOR.

FOR CHARITABLE SERVICES, NAMELY, ARRANGING AND CONDUCTING SEMINARS IN THE FIELD OF EMPLOYMENT COUNSELING, RESUME PREPARATION, JOB INTERVIEWING, FINANCIAL PLANNING, ENTREPRENEURSHIP TRAINING, PROFESSIONAL IMAGE DEVELOPMENT, BUSINESS NETWORKING, SOCIAL MEDIA TRAINING, AND COMPLETING AND EVALUATING SELF ASSESSMENTS (U.S. CLS. 100, 101 AND 107).

FIRST USE 1-3-2009; IN COMMERCE 2-3-2009.
CHERYL CLAYTON, EXAMINING ATTORNEY

SN 77-854,126. THE SKATEPARK OF TAMPA, INC., TAMPA, FL. FILED 10-21-2009.



THE MARK CONSISTS OF A FIVE-POINT STAR PARTIALLY OVERLAPPING A SKYLINE.

FOR PROVIDING FACILITIES FOR RECREATION ACTIVITIES, NAMELY, SKATE PARKS (U.S. CLS. 100, 101 AND 107).

FIRST USE 12-31-1999; IN COMMERCE 12-31-1999.
TINA MAI, EXAMINING ATTORNEY

CLASS 41—(Continued).

SN 77-854,138. THE SKATEPARK OF TAMPA, INC., TAMPA, FL. FILED 10-21-2009.



NO CLAIM IS MADE TO THE EXCLUSIVE RIGHT TO USE "SKATEPARK OF TAMPA ESTABLISHED 1993", APART FROM THE MARK AS SHOWN.

THE MARK CONSISTS OF A FIVE-POINT STAR PARTIALLY OVERLAPPING A SKYLINE; BOTH THE STAR AND SKYLINE ENCLOSED IN A CIRCULAR BORDER; THE CIRCULAR BORDER CONTAINING TWO FIVE-POINT STARS, THE STARS BEING BETWEEN THE WORDS "SKATEPARK OF TAMPA" LOCATED ON THE TOP HALF OF THE CIRCLE AND THE WORDS "ESTABLISHED 1993" LOCATED ON THE BOTTOM HALF OF THE CIRCLE.

FOR PROVIDING FACILITIES FOR RECREATION ACTIVITIES, NAMELY, SKATE PARKS (U.S. CLS. 100, 101 AND 107).

FIRST USE 12-31-1999; IN COMMERCE 12-31-1999.
TINA MAI, EXAMINING ATTORNEY

SN 77-854,673. DIAGEO NORTH AMERICA, INC., NORWALK, CT. FILED 10-22-2009.

CÎROC ENTERTAINMENT

THE MARK CONSISTS OF STANDARD CHARACTERS WITHOUT CLAIM TO ANY PARTICULAR FONT, STYLE, SIZE, OR COLOR.

OWNER OF U.S. REG. NOS. 2,854,986 AND 3,643,409. NO CLAIM IS MADE TO THE EXCLUSIVE RIGHT TO USE "ENTERTAINMENT", APART FROM THE MARK AS SHOWN.

FOR PRODUCTION OF MUSICAL VIDEO RECORDINGS (U.S. CLS. 100, 101 AND 107).

FIRST USE 8-31-2009; IN COMMERCE 8-31-2009.
DEBRA LEE, EXAMINING ATTORNEY

CLASS 41—(Continued).

SN 77-854,792. SCONCE, GREGORY, DBA INFOSTAR, FAIR OAKS, CA. FILED 10-22-2009.



THE COLOR(S) RED AND BLACK IS/ARE CLAIMED AS A FEATURE OF THE MARK.

THE MARK CONSISTS OF THE WORD "INFOSTAR" IN RED STYLIZED FONT OUTLINED IN BLACK.

FOR MULTIMEDIA PUBLISHING SERVICES, NAMELY, DIGITAL VIDEO AND AUDIO; EDUCATION SERVICES, NAMELY, CLASSES, SEMINARS, WORKSHOPS AND MULTIMEDIA PRESENTATIONS ABOUT DENTAL PROCEDURES FOR PATIENTS EXPECTED TO UNDERGO THE PROCEDURE; RECORDING, PRODUCTION, AND POST-PRODUCTION OF AUDIOVISUAL PRESENTATIONS FOR USE IN EDUCATING DENTAL PATIENTS IN THE FIELD OF DENTAL PROCEDURES; PRODUCTION OF DVDS, VIDEOTAPES AND PRESENTATIONS FOR WEBSITES FEATURING MATERIAL ON DENTAL PROCEDURES DESIGNED TO EDUCATE THE PATIENT ABOUT PROCEDURES THEY ANTICIPATE UNDERGOING (U.S. CLS. 100, 101 AND 107).

FIRST USE 4-0-1993; IN COMMERCE 4-0-1993.
ALLISON SCHRODY, EXAMINING ATTORNEY

CLASS 41—(Continued).

SN 77-856,115. UNDER ARMOUR, INC., BALTIMORE, MD. AND IMG ACADEMIES, LLP, BRADENTON, FL. FILED 10-23-2009.

C180

SN 77-856,099. UNDER ARMOUR, INC., BALTIMORE, MD. AND IMG ACADEMIES, LLP, BRADENTON, FL. FILED 10-23-2009.

C90

THE MARK CONSISTS OF STANDARD CHARACTERS WITHOUT CLAIM TO ANY PARTICULAR FONT, STYLE, SIZE, OR COLOR.

FOR ATHLETIC TESTING SERVICES, NAMELY, TESTING THE PHYSICAL PERFORMANCE OF ATHLETES FOR THE PURPOSE OF SPORTS TRAINING AND ASSESSMENT OF ATHLETIC ABILITY, POTENTIAL, AND PERFORMANCE; ATHLETIC MEASUREMENT SERVICES IN THE NATURE OF TESTING THE PHYSICAL PERFORMANCE OF ATHLETES FOR THE PURPOSE OF SPORTS TRAINING AND ASSESSMENT OF ATHLETIC ABILITY, POTENTIAL, AND PERFORMANCE; ATHLETIC ANALYZATION SERVICES, NAMELY, ANALYZING ATHLETE'S PHYSICAL PERFORMANCE TEST SCORES AND DATA FOR OTHERS; ATHLETIC SCORING SERVICES, NAMELY, ANALYZING ATHLETE'S PHYSICAL PERFORMANCE TEST SCORES AND DATA FOR OTHERS AND ASSIGNING NUMERIC MEASURE TO THE RESULTS; ATHLETIC RATING SERVICES, NAMELY, RATING THE ATHLETIC PERFORMANCE OF OTHERS BY ASSIGNING NUMERIC MEASURE; ATHLETIC TRAINING AND INSTRUCTION IN THE FIELD OF SPORTS; EDUCATIONAL SERVICES, NAMELY, TRAINING OTHERS IN TESTING, MEASURING, ANALYZING, SCORING, RATING, AND PROVIDING TRAINING AND INSTRUCTION IN THE FIELD OF SPORTS (U.S. CLS. 100, 101 AND 107).
ANDREW RHIM, EXAMINING ATTORNEY

THE MARK CONSISTS OF STANDARD CHARACTERS WITHOUT CLAIM TO ANY PARTICULAR FONT, STYLE, SIZE, OR COLOR.

FOR ATHLETIC TESTING SERVICES, NAMELY, TESTING THE PHYSICAL PERFORMANCE OF ATHLETES FOR THE PURPOSE OF SPORTS TRAINING AND ASSESSMENT OF ATHLETIC ABILITY, POTENTIAL, AND PERFORMANCE; ATHLETIC MEASUREMENT SERVICES IN THE NATURE OF TESTING THE PHYSICAL PERFORMANCE OF ATHLETES FOR THE PURPOSE OF SPORTS TRAINING AND ASSESSMENT OF ATHLETIC ABILITY, POTENTIAL, AND PERFORMANCE; ATHLETIC ANALYZATION SERVICES, NAMELY, ANALYZING ATHLETE'S PHYSICAL PERFORMANCE TEST SCORES AND DATA FOR OTHERS; ATHLETIC SCORING SERVICES, NAMELY, ANALYZING ATHLETE'S PHYSICAL PERFORMANCE TEST SCORES AND DATA FOR OTHERS AND ASSIGNING NUMERIC MEASURE TO THE RESULTS; ATHLETIC RATING SERVICES, NAMELY, RATING THE ATHLETIC PERFORMANCE OF OTHERS BY ASSIGNING NUMERIC MEASURE; ATHLETIC TRAINING AND INSTRUCTION IN THE FIELD OF SPORTS; EDUCATIONAL SERVICES, NAMELY, TRAINING OTHERS IN TESTING, MEASURING, ANALYZING, SCORING, RATING, AND PROVIDING TRAINING AND INSTRUCTION IN THE FIELD OF SPORTS (U.S. CLS. 100, 101 AND 107).
ANDREW RHIM, EXAMINING ATTORNEY

CLASS 41—(Continued).

SN 77-856,125. UNDER ARMOUR, INC., BALTIMORE, MD. AND IMG ACADEMIES, LLP, BRADENTON, FL. FILED 10-23-2009.

C360

THE MARK CONSISTS OF STANDARD CHARACTERS WITHOUT CLAIM TO ANY PARTICULAR FONT, STYLE, SIZE, OR COLOR.

FOR ATHLETIC TESTING SERVICES, NAMELY, TESTING THE PHYSICAL PERFORMANCE OF ATHLETES FOR THE PURPOSE OF SPORTS TRAINING AND ASSESSMENT OF ATHLETIC ABILITY, POTENTIAL, AND PERFORMANCE; ATHLETIC MEASUREMENT SERVICES IN THE NATURE OF TESTING THE PHYSICAL PERFORMANCE OF ATHLETES FOR THE PURPOSE OF SPORTS TRAINING AND ASSESSMENT OF ATHLETIC ABILITY, POTENTIAL, AND PERFORMANCE; ATHLETIC ANALYZATION SERVICES, NAMELY, ANALYZING ATHLETE'S PHYSICAL PERFORMANCE TEST SCORES AND DATA FOR OTHERS; ATHLETIC SCORING SERVICES, NAMELY, ANALYZING ATHLETE'S PHYSICAL PERFORMANCE TEST SCORES AND DATA FOR OTHERS AND ASSIGNING NUMERIC MEASURE TO THE RESULTS; ATHLETIC RATING SERVICES, NAMELY, RATING THE ATHLETIC PERFORMANCE OF OTHERS BY ASSIGNING NUMERIC MEASURE; ATHLETIC TRAINING AND INSTRUCTION IN THE FIELD OF SPORTS; EDUCATIONAL SERVICES, NAMELY, TRAINING OTHERS IN TESTING, MEASURING, ANALYZING, SCORING, RATING, AND PROVIDING TRAINING AND INSTRUCTION IN THE FIELD OF SPORTS (U.S. CLS. 100, 101 AND 107).
ANDREW RHIM, EXAMINING ATTORNEY

SN 77-856,729. HEMAKOM, ROSANA, SILVER SPRING, MD. FILED 10-24-2009.

Chronicles of Momnia

THE MARK CONSISTS OF STANDARD CHARACTERS WITHOUT CLAIM TO ANY PARTICULAR FONT, STYLE, SIZE, OR COLOR.

NO CLAIM IS MADE TO THE EXCLUSIVE RIGHT TO USE "CHRONICLES", APART FROM THE MARK AS SHOWN.

FOR ON-LINE JOURNALS, NAMELY, BLOGS FEATURING PARENTING, FAMILY RELATIONSHIP, MOTHERHOOD, MARRIAGE, FOOD, TRAVEL AND CONSUMER PRODUCT INFORMATION AND COMEDY (U.S. CLS. 100, 101 AND 107).

FIRST USE 11-8-2008; IN COMMERCE 8-1-2009.
TARA PATE, EXAMINING ATTORNEY

CLASS 41—(Continued).

SN 77-857,244. SHREM, ANDREA J., HOBOKEN, NJ. FILED 10-26-2009.



NO CLAIM IS MADE TO THE EXCLUSIVE RIGHT TO USE "STRIP", APART FROM THE MARK AS SHOWN.

THE MARK CONSISTS OF LARGE ITALICIZED STYLIZED TEXT READING "POWER STRIP" AND BETWEEN THOSE TWO WORDS IS AN OUTLINE OF A NAKED FEMALE FORM TILTING A FEDORA ON HER HEAD, UNDERNEATH THE LARGE WORDING IS "MOVEMENT THAT EMPOWERS YOUR FEMININE SPIRIT!".

FOR EXOTIC DANCE INSTRUCTION (U.S. CLS. 100, 101 AND 107).

FIRST USE 9-1-2007; IN COMMERCE 9-1-2007.
ADA HAN, EXAMINING ATTORNEY

SN 77-857,637. THE TRUSTEES OF THE ANDY KAUFMAN MEMORIAL TRUST, A NEW YORK TRUST, THE TRUSTEES COMPRISING MICHAEL KAUFMAN, A UNITED STATES CITIZEN, STANLEY KAUFMAN, A UNITED STATES CITIZEN, AND CAROL L. KERMAN, A UNITED STATES CITIZEN, LINCOLN PARK, NJ. FILED S.R. 10-26-2009; AM. P.R. 2-12-2010.

The Andy Kaufman Award

THE MARK CONSISTS OF STANDARD CHARACTERS WITHOUT CLAIM TO ANY PARTICULAR FONT, STYLE, SIZE, OR COLOR.

NO CLAIM IS MADE TO THE EXCLUSIVE RIGHT TO USE "AWARD", APART FROM THE MARK AS SHOWN.

"ANDY KAUFMAN" DOES NOT IDENTIFY A LIVING INDIVIDUAL.

FOR PROVIDING RECOGNITION AND INCENTIVES BY THE WAY OF AWARDS AND CONTESTS TO DEMONSTRATE EXCELLENCE IN THE FIELD OF COMEDIC ENTERTAINMENT INCLUDING, BUT NOT LIMITED TO, PRODUCING, WRITING, PERFORMING, AND DEVELOPING COMEDY IN ALL FORMATS INCLUDING, BUT NOT LIMITED TO, THEATRE, STAND-UP, TELEVISION, FILM, AND INTERNET (U.S. CLS. 100, 101 AND 107).

FIRST USE 1-1-2004; IN COMMERCE 1-1-2004.
MEGHAN REINHART, EXAMINING ATTORNEY

CLASS 41—(Continued).

SN 77-857,815. FREEMAN, JERAMY, EAST SYRACUSE, NY. FILED 10-26-2009.

PROJECT 42

THE MARK CONSISTS OF STANDARD CHARACTERS WITHOUT CLAIM TO ANY PARTICULAR FONT, STYLE, SIZE, OR COLOR.

NO CLAIM IS MADE TO THE EXCLUSIVE RIGHT TO USE "42", APART FROM THE MARK AS SHOWN.

FOR PHYSICAL FITNESS INSTRUCTION; PHYSICAL FITNESS CONDITIONING CLASSES; PROVIDING ASSISTANCE, PERSONAL TRAINING AND PHYSICAL FITNESS CONSULTATION TO INDIVIDUALS TO HELP THEM MAKE PHYSICAL FITNESS, STRENGTH, CONDITIONING, AND EXERCISE IMPROVEMENT IN THEIR DAILY LIVING (U.S. CLS. 100, 101 AND 107).

FIRST USE 1-1-2006; IN COMMERCE 1-1-2006.
CYNTHIA TRIPI, EXAMINING ATTORNEY

SN 77-857,880. GZEBB, RANDALL J., DBA WICKED MERCIES, SAN FRANCISCO, CA. AND LUCAS, JAMES B., DBA WICKED MERCIES, SAN FRANCISCO, CA. FILED 10-26-2009.

WICKED MERCIES

THE MARK CONSISTS OF STANDARD CHARACTERS WITHOUT CLAIM TO ANY PARTICULAR FONT, STYLE, SIZE, OR COLOR.

FOR COMPOSITION OF MUSIC FOR OTHERS; ENTERTAINMENT AND EDUCATION SERVICES IN THE NATURE OF LIVE DANCE AND MUSICAL PERFORMANCES; ENTERTAINMENT IN THE NATURE OF LIVE PERFORMANCES BY A MUSICAL GROUP; ENTERTAINMENT IN THE NATURE OF VISUAL AND AUDIO PERFORMANCES, NAMELY, MUSICAL BAND, ROCK GROUP, GYMNASTIC, DANCE, AND BALLET PERFORMANCES; ENTERTAINMENT IN THE NATURE OF LIVE MUSIC CONCERTS; ENTERTAINMENT SERVICES IN THE NATURE OF LIVE MUSICAL PERFORMANCES; ENTERTAINMENT, NAMELY, LIVE MUSIC CONCERTS; ENTERTAINMENT, NAMELY, LIVE PERFORMANCES BY A MUSICAL BAND; PRESENTATION OF MUSICAL PERFORMANCE; PRODUCTION OF MUSICAL SOUND RECORDING; PRODUCTION OF SOUND AND MUSIC VIDEO RECORDINGS (U.S. CLS. 100, 101 AND 107).

FIRST USE 7-1-2008; IN COMMERCE 12-19-2008.
KIMBERLY FRYE, EXAMINING ATTORNEY

CLASS 41—(Continued).

SN 77-858,252. ICNA, JAMAICA, NY. FILED 10-27-2009.



NO CLAIM IS MADE TO THE EXCLUSIVE RIGHT TO USE "ISLAMIC" AND "NORTH AMERICA", APART FROM THE MARK AS SHOWN.

THE COLOR(S) GOLD AND GREEN IS/ARE CLAIMED AS A FEATURE OF THE MARK.

THE MARK CONSISTS OF AN ARABIC PHRASE ALLAH AKBAR WRITTEN IN ARABIC CALLIGRAPHY IN THE SHAPE OF A FLAME TORCH OR LAMP IN GREEN WITH A GOLD CURVED BASE. TO THE LEFT OF THE DESIGN IS THE ACRONYM "ICNA" IN GREEN AND THE WORDING "ISLAMIC CIRCLE OF NORTH AMERICA" IN GREEN JUST BELOW THE ACRONYM WITH THE ACRONYM AND WORDING SEPARATED BY A GOLD HORIZONTAL LINE. THE COLOR WHITE IS NOT A FEATURE OF THE MARK AND REPRESENTS THE TRANSPARENT AREAS OF THE MARK.

THE NON-LATIN CHARACTERS IN THE MARK TRANSLITERATE TO "ALLAH AKBAR" AND THIS MEANS "GOD IS GREAT" IN ENGLISH.

FOR EDUCATION SERVICES, NAMELY, PROVIDING CLASSES, SEMINARS, PUBLIC DISCUSSIONS, WORKSHOPS AND CONFERENCES IN THE FIELD OF RELIGION; EDUCATION SERVICES, NAMELY, PROVIDING CLASSES, SEMINARS, PUBLIC DISCUSSIONS, WORKSHOPS AND CONFERENCES IN THE FIELDS ISLAM AND THE MUSLIM RELIGIOUS FAITH (U.S. CLS. 100, 101 AND 107).

FIRST USE 12-6-1988; IN COMMERCE 12-6-1988.
DEIRDRE ROBERTSON, EXAMINING ATTORNEY

SN 77-858,595. BIRD DOG MEDIA, INC., DBA PURPLE YOGA, FULLERTON, CA. FILED 10-27-2009.

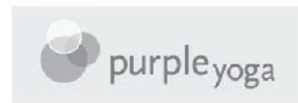

NO CLAIM IS MADE TO THE EXCLUSIVE RIGHT TO USE "YOGA", APART FROM THE MARK AS SHOWN.

THE MARK CONSISTS OF THREE CIRCLES THAT INTERSECT ALL TO THE LEFT OF THE WORDING "PURPLE YOGA" ALL IN A RECTANGULAR BACKGROUND.

FOR YOGA INSTRUCTION (U.S. CLS. 100, 101 AND 107).

FIRST USE 4-1-2009; IN COMMERCE 9-1-2009.
DOMINIC J. FERRAIUOLO, EXAMINING ATTORNEY

CLASS 41—(Continued).

SN 77-859,765. 24-7 STAR, L.L.C., PLANO, TX. FILED 10-28-2009.

SHOPPING IS MY CARDIO

THE MARK CONSISTS OF STANDARD CHARACTERS WITHOUT CLAIM TO ANY PARTICULAR FONT, STYLE, SIZE, OR COLOR.

FOR ENTERTAINMENT SERVICES, NAMELY, THE PROVISION OF CONTINUING SHOWS FEATURING INFORMATION FOR RETAIL SHOPPING CONSUMERS DELIVERED BY TELEVISION AND INTERNET (U.S. CLS. 100, 101 AND 107).

FIRST USE 8-8-2009; IN COMMERCE 8-8-2009.

THEODORE MCBRIDE, EXAMINING ATTORNEY

CLASS 41—(Continued).

SN 77-862,069. JORDAN WIRSZ INTERNATIONAL, INC., LAS VEGAS, NV. FILED 10-31-2009.

BECOME INCREDIBLE

THE MARK CONSISTS OF STANDARD CHARACTERS WITHOUT CLAIM TO ANY PARTICULAR FONT, STYLE, SIZE, OR COLOR.

FOR EDUCATIONAL SERVICES, NAMELY, CONDUCTING LIVE AND ON-LINE CLASSES, SEMINARS, CONFERENCES, AND WORKSHOPS IN THE FIELDS OF PERSONAL DEVELOPMENT, SUCCESS AND ACHIEVEMENT AND DISTRIBUTION OF COURSE MATERIAL IN CONNECTION THEREWITH; LIFE COACHING SERVICES IN THE FIELDS OF WEIGHT LOSS, ADDICTION, PERSONAL CRISES, HEALTH AND FITNESS, DIET AND EXERCISE, LIFESTYLE EDUCATION, AND PERSONAL DEVELOPMENT, SUCCESS AND ACHIEVEMENT; PERSONAL COACHING SERVICES IN THE FIELDS OF WEIGHT LOSS, ADDICTION, PERSONAL CRISES, HEALTH AND FITNESS, DIET AND EXERCISE, LIFESTYLE EDUCATION, AND PERSONAL DEVELOPMENT, SUCCESS AND ACHIEVEMENT; BUSINESS COACHING SERVICES IN THE NATURE OF LIFE COACHING SERVICES IN THE FIELD OF PERSONAL DEVELOPMENT, SUCCESS AND ACHIEVEMENT (U.S. CLS. 100, 101 AND 107).

FIRST USE 1-0-2009; IN COMMERCE 1-0-2009.

NAPOLEON SHARMA, EXAMINING ATTORNEY

SN 77-861,917. GOLD, RANDY, CALABASAS, CA. FILED 10-30-2009.

JACUZZI JOURNALS

THE MARK CONSISTS OF STANDARD CHARACTERS WITHOUT CLAIM TO ANY PARTICULAR FONT, STYLE, SIZE, OR COLOR.

NO CLAIM IS MADE TO THE EXCLUSIVE RIGHT TO USE "JOURNALS", APART FROM THE MARK AS SHOWN.

FOR MULTIMEDIA PUBLISHING OF BOOKS, MAGAZINES, JOURNALS, SOFTWARE, GAMES, MUSIC, AND ELECTRONIC PUBLICATIONS (U.S. CLS. 100, 101 AND 107).

HAI-LY LAM, EXAMINING ATTORNEY

SN 77-862,090. CORTI BROTHERS MARKET, INC., SACRAMENTO, CA. FILED 10-31-2009.

Inside the Vines

THE MARK CONSISTS OF STANDARD CHARACTERS WITHOUT CLAIM TO ANY PARTICULAR FONT, STYLE, SIZE, OR COLOR.

FOR EDUCATIONAL AND ENTERTAINMENT SERVICES, NAMELY, A CONTINUING PROGRAM ABOUT GLOBAL WINE, VINEYARDS, WINERIES, WINE HISTORY, WINE INDUSTRY, AND CULINARY ACCESSIBLE BY RADIO, TELEVISION, SATELLITE, AUDIO, VIDEO AND COMPUTER NETWORKS; PRODUCTION OF CABLE TELEVISION PROGRAMS; PRODUCTION OF TELEVISION PROGRAMS (U.S. CLS. 100, 101 AND 107).

SHAUNIA CARLYLE, EXAMINING ATTORNEY

CLASS 41—(Continued).

SN 77-863,537. FATHER'S DAY/MOTHER'S DAY COUNCIL, INC., NEW YORK, NY. FILED 11-3-2009.

OUTSTANDING MOTHER AWARDS

THE MARK CONSISTS OF STANDARD CHARACTERS WITHOUT CLAIM TO ANY PARTICULAR FONT, STYLE, SIZE, OR COLOR.

NO CLAIM IS MADE TO THE EXCLUSIVE RIGHT TO USE "AWARDS", APART FROM THE MARK AS SHOWN. SEC. 2(F).

FOR ENTERTAINMENT SERVICES, NAMELY, PRESENTATION OF AN AWARD TO HONOR A MOTHER FOR EXCELLENCE IN THE FIELD OF MOTHERHOOD (U.S. CLS. 100, 101 AND 107).

FIRST USE 4-17-1979; IN COMMERCE 4-17-1979.
ALICE BENMAMAN, EXAMINING ATTORNEY

SN 77-864,087. JUDY CRANE, OCKLAWAHA, FL. FILED 11-3-2009.

SPIRIT2SPIRIT TRAUMA
HEALING

THE MARK CONSISTS OF STANDARD CHARACTERS WITHOUT CLAIM TO ANY PARTICULAR FONT, STYLE, SIZE, OR COLOR.

NO CLAIM IS MADE TO THE EXCLUSIVE RIGHT TO USE "TRAUMA HEALING", APART FROM THE MARK AS SHOWN.

FOR EDUCATIONAL SERVICES, NAMELY, ARRANGING AND CONDUCTING TRAINING AND CERTIFICATION COURSES AND WORKSHOPS IN FIELD OF TRAUMA ADDICTION FOR MENTAL HEALTH PROFESSIONALS (U.S. CLS. 100, 101 AND 107).

GINA FINK, EXAMINING ATTORNEY

SN 77-867,492. MUSIC OF WORDS, WILMINGTON, DE. FILED 11-6-2009.

D^wREAM

THE MARK CONSISTS OF THE WORD "DWREAM" WITH A STYLIZED SUPERScript "W" AND STYLIZED "M" WITH A SWEEP AND CURLED TAIL.

FOR PUBLISHING OF BOOKS, E-BOOKS, AUDIO BOOKS, MUSIC AND ILLUSTRATIONS (U.S. CLS. 100, 101 AND 107).

ALYSSA STEEL, EXAMINING ATTORNEY

CLASS 41—(Continued).

SN 77-867,646. ALADDIN HOLDINGS LLC, DAVISBURG, MI. FILED 11-7-2009.

The Lottery Genie

THE MARK CONSISTS OF STANDARD CHARACTERS WITHOUT CLAIM TO ANY PARTICULAR FONT, STYLE, SIZE, OR COLOR.

NO CLAIM IS MADE TO THE EXCLUSIVE RIGHT TO USE "LOTTERY", APART FROM THE MARK AS SHOWN.

FOR PROVIDING A WEBSITE FOR THE PURPOSE OF PROVIDING INFORMATION ON PROVIDING LOTTERY SERVICES, ON PLAYING LOTTERIES AND ON CONDUCTING LOTTERIES FOR OTHERS; PROVIDING A WEBSITE FOR THE PURPOSE OF PROVIDING STATISTICAL INFORMATION REGARDING THE CHANCES OF WINNING A LOTTERY, NOT FOR BUSINESS OR COMMERCIAL PURPOSES (U.S. CLS. 100, 101 AND 107).

MAUREEN DALL, EXAMINING ATTORNEY

SN 77-868,053. JEFFREY RICHTER, OSSINING, NY. FILED 11-9-2009.

Little Jammers

THE MARK CONSISTS OF STANDARD CHARACTERS WITHOUT CLAIM TO ANY PARTICULAR FONT, STYLE, SIZE, OR COLOR.

FOR ENTERTAINMENT AND EDUCATION SERVICES IN THE NATURE OF LIVE DANCE AND MUSICAL PERFORMANCES; ENTERTAINMENT IN THE NATURE OF VISUAL AND AUDIO PERFORMANCES, NAMELY, MUSICAL BAND, ROCK GROUP, GYMNAS-TIC, DANCE, AND BALLET PERFORMANCES; ENTERTAINMENT SERVICES IN THE NATURE OF LIVE MUSICAL PERFORMANCES; ENTERTAINMENT, NAMELY, LIVE MUSIC CONCERTS; ENTERTAINMENT, NAMELY, LIVE PERFORMANCES BY A MUSICAL BAND; ENTERTAINMENT, NAMELY, LIVE PERFORMANCES BY MUSICAL BANDS; ENTERTAINMENT, NAMELY, PRODUCTION OF CHILDREN'S MUSICAL PERFORMANCES; MUSIC PRODUCTION SERVICES; MUSIC VIDEO PRODUCTION; PRESENTATION OF MUSICAL PERFORMANCE; PRODUCTION OF SOUND AND MUSIC VIDEO RECORDINGS; PROVIDING ADVICE AND INFORMATION IN THE FIELD OF EDUCATIONAL AND ENTERTAINMENT ACTIVITIES AND EVENTS FOR CHILDREN; EDUCATION SERVICES, NAMELY, PROVIDING LIVE AND ON-LINE CLASSES FEATURING INSTRUCTION AND PERFORMANCES IN THE FIELD OF MUSIC; EDUCATION SERVICES, NAMELY, PROVIDING CLASSES FEATURING INSTRUCTION AND PERFORMANCES IN THE FIELD OF MUSIC; EDUCATIONAL SERVICES, NAMELY, PROVIDING CLASSES FEATURING INSTRUCTION AND PERFORMANCES IN THE FIELDS OF MUSIC; ENTERTAINMENT SERVICES, NAMELY, PROVIDING A WEB SITE FEATURING NON-DOWNLOADABLE MUSICAL PERFORMANCES, MUSICAL VIDEOS, RELATED FILM CLIPS, PHOTOGRAPHS, AND OTHER MULTIMEDIA MATERIALS FEATURING CHILDREN'S MUSICAL PERFORMANCES (U.S. CLS. 100, 101 AND 107).

DAVID MURRAY, EXAMINING ATTORNEY

CLASS 41—(Continued).

SN 77-868,722. ALWAYS IN MOTION, HUNTINGTON BEACH, CA. FILED 11-9-2009.



THE COLOR(S) GREEN AND BLACK IS/ARE CLAIMED AS A FEATURE OF THE MARK.

THE MARK CONSISTS OF 21 SQUARES FORMING A STAIRCASE ON THE LEFT HALF OF THE MARK. THE FIRST TWO COLUMNS ON THE LEFT SIDE ARE DARK GREEN (CONSISTING OF THREE SQUARES). THE NEXT COLUMN IN SUCCESSION IS GREEN (CONSISTING OF THREE SQUARES). THE REMAINING COLUMNS ARE LIGHT GREEN (CONSISTING OF 15 SQUARES). THE RIGHT HALF OF THE MARK HAS THE WORDS "ALWAYS IN MOTION" HORIZONTALLY STACKED (THREE ROWS) IN BLACK LETTERING.

FOR PROVIDING ASSISTANCE, PERSONAL TRAINING AND PHYSICAL FITNESS CONSULTATION TO INDIVIDUALS TO HELP THEM MAKE PHYSICAL FITNESS, STRENGTH, CONDITIONING, AND EXERCISE IMPROVEMENT IN THEIR DAILY LIVING (U.S. CLS. 100, 101 AND 107).

MEGHAN REINHART, EXAMINING ATTORNEY

CLASS 41—(Continued).

SN 77-872,691. S & K UNIVERSAL, LLC, DBA MASTAN PRODUCTIONS, OXNARD, CA. FILED 11-13-2009.

MASTAN PRODUCTIONS

THE MARK CONSISTS OF STANDARD CHARACTERS WITHOUT CLAIM TO ANY PARTICULAR FONT, STYLE, SIZE, OR COLOR.

NO CLAIM IS MADE TO THE EXCLUSIVE RIGHT TO USE "PRODUCTIONS", APART FROM THE MARK AS SHOWN.

THE ENGLISH TRANSLATION OF "MASTAN" IN THE MARK IS "INTOXICATED".

FOR ENTERTAINMENT SERVICES IN THE NATURE OF LIVE MUSICAL PERFORMANCES; ENTERTAINMENT, NAMELY, LIVE MUSIC CONCERTS; ENTERTAINMENT, NAMELY, LIVE PERFORMANCES BY A MUSICAL BAND; MUSIC COMPOSITION AND TRANSCRIPTION FOR OTHERS; MUSIC COMPOSITION FOR OTHERS; MUSIC PRODUCTION SERVICES; MUSIC VIDEO PRODUCTION; PRESENTATION OF MUSICAL PERFORMANCE; PRODUCTION OF MUSICAL SOUND RECORDING; PRODUCTION OF SOUND AND MUSIC VIDEO RECORDINGS; PROVIDING AN INTERNET WEBSITE PORTAL FEATURING LINKS TO MUSICAL ARTIST WEBSITES AND MUSIC PERFORMANCE TICKET INFORMATION; PROVIDING AN INTERNET WEBSITE PORTAL IN THE FIELD OF MUSIC (U.S. CLS. 100, 101 AND 107).

FIRST USE 8-4-2009; IN COMMERCE 8-4-2009.

JORDAN BAKER, EXAMINING ATTORNEY

SN 77-871,762. THE TRAINING AUTHORITIES, LLC, BILLINGS, MT. FILED S.R. 11-12-2009; AM. P.R. 2-24-2010.



NO CLAIM IS MADE TO THE EXCLUSIVE RIGHT TO USE "HEO ACADEMY", APART FROM THE MARK AS SHOWN.

THE MARK CONSISTS OF LETTERS "HEO" IN A SHIELD WITH THE WORD "ACADEMY" TO THE RIGHT.

FOR ONLINE TRAINING FOR TRAINING HEAVY EQUIPMENT OPERATORS HOW TO OPERATE HEAVY EQUIPMENT (U.S. CLS. 100, 101 AND 107).

FIRST USE 2-22-2009; IN COMMERCE 2-22-2009.

LAURIE MAYES, EXAMINING ATTORNEY

SN 77-872,694. S & K UNIVERSAL, LLC, DBA MASTAN PRODUCTIONS, OXNARD, CA. FILED 11-14-2009.



Homay & The Mastan Ensemble

NO CLAIM IS MADE TO THE EXCLUSIVE RIGHT TO USE "ENSEMBLE", APART FROM THE MARK AS SHOWN.

THE MARK CONSISTS OF THE LETTER "H" WITH A CIRCULAR DESIGN BISECTING THE MIDDLE AND LOWER PORTION OF THE LETTER "H"; ABOVE THE WORDS, "HOMAY & THE MASTAN ENSEMBLE".

THE ENGLISH TRANSLATION OF "HOMAY" IN THE MARK IS "BIRD", AND THE ENGLISH TRANSLATION OF "MASTAN" IN THE MARK IS "INTOXICATED".

FOR ENTERTAINMENT SERVICES IN THE NATURE OF LIVE MUSICAL PERFORMANCES; ENTERTAINMENT SERVICES, NAMELY, PROVIDING A WEB SITE FEATURING MUSICAL PERFORMANCES, MUSICAL VIDEOS, RELATED FILM CLIPS, PHOTOGRAPHS, AND OTHER MULTIMEDIA MATERIALS FEATURING MUSIC; MUSIC COMPOSITION FOR OTHERS; PRODUCTION OF MUSICAL SOUND RECORDING; PRODUCTION OF SOUND AND MUSIC VIDEO RECORDINGS (U.S. CLS. 100, 101 AND 107).

FIRST USE 1-1-2005; IN COMMERCE 1-1-2005.

JORDAN BAKER, EXAMINING ATTORNEY

CLASS 41—(Continued).

SN 77-872,942. INFINITY MARTIAL ARTS, INC., MIDDLETON, WI. FILED 11-15-2009.



NO CLAIM IS MADE TO THE EXCLUSIVE RIGHT TO USE "MARTIAL ARTS", APART FROM THE MARK AS SHOWN.

THE COLOR(S) BLACK, WHITE, AND GREEN IS/ARE CLAIMED AS A FEATURE OF THE MARK.

THE MARK CONSISTS OF A GREEN ABSTRACT FIGURE PERFORMING MARTIAL ARTS APPEARING AGAINST A BLACK BACKGROUND IN THE TOP HALF OF THE MARK. IN THE BOTTOM HALF OF THE MARK, THE COLORS WHITE AND GREEN APPEAR IN THE WORDING "INFINITY MARTIAL ARTS" WITH A STYLIZED FONT AGAINST A BLACK BACKGROUND. A DIAGONAL GREEN LINE APPEARS FROM THE TOP LEFT CORNER OF THE MARK, AND ENDING THROUGH THE "N" IN THE WORD "INFINITY". A GREEN TRIANGLE APPEARS BETWEEN THE WORDS "MARTIAL" AND "ARTS". A GREEN HORIZONTAL LINE APPEARS UNDER THE WORD "INFINITY".

FOR MARTIAL ARTS INSTRUCTION (U.S. CLS. 100, 101 AND 107).

FIRST USE 4-1-2007; IN COMMERCE 4-1-2007.
ANDREA HACK, EXAMINING ATTORNEY

SN 77-873,526. IMAGE ASSETS, LLC, ALPHARETTA, GA. FILED 11-16-2009.

Style YOUiversity

THE MARK CONSISTS OF STANDARD CHARACTERS WITHOUT CLAIM TO ANY PARTICULAR FONT, STYLE, SIZE, OR COLOR.

NO CLAIM IS MADE TO THE EXCLUSIVE RIGHT TO USE "STYLE", APART FROM THE MARK AS SHOWN.

FOR EDUCATION SERVICES, NAMELY, ONE-ON-ONE MENTORING IN THE FIELDS OF COLOR AND STYLE; EDUCATION SERVICES, NAMELY, PROVIDING LIVE AND ON-LINE SEMINARS AND WORKSHOPS IN THE FIELD OF IMAGE AND STYLE; EDUCATION SERVICES, NAMELY, PROVIDING MENTORING, TUTORING, CLASSES, SEMINARS AND WORKSHOPS IN THE FIELD OF WARDROBE MANAGEMENT (U.S. CLS. 100, 101 AND 107).

ALYSSA STEEL, EXAMINING ATTORNEY

CLASS 41—(Continued).

SN 77-873,850. BAR225 LTD., SEDONA, AZ. FILED 11-16-2009.

ARIZONA'S LITTLE HOLLYWOOD

THE MARK CONSISTS OF STANDARD CHARACTERS WITHOUT CLAIM TO ANY PARTICULAR FONT, STYLE, SIZE, OR COLOR.

NO CLAIM IS MADE TO THE EXCLUSIVE RIGHT TO USE "ARIZONA'S" AND "HOLLYWOOD", APART FROM THE MARK AS SHOWN.

FOR MUSEUMS (U.S. CLS. 100, 101 AND 107).
B. PARADEWELAI, EXAMINING ATTORNEY

SN 77-874,333. BLOCKBOSS ENTERTAINMENT, LLC, OAKLAND, CA. FILED 11-17-2009.



NO CLAIM IS MADE TO THE EXCLUSIVE RIGHT TO USE "ENTERTAINMENT", APART FROM THE MARK AS SHOWN.

THE MARK CONSISTS OF THE WORDS "BLOCK BOSS" IN STYLIZED FONT CENTERED ABOVE THE WORD "ENTERTAINMENT" IN LOWERCASE STYLIZED FONT. ABOVE THE WORDS IS A DRAWING CONSISTING OF TWO LETTER "B'S, ONE REVERSED, CENTERED BELOW A CROWN.

FOR RECORD LABEL SERVICES, NAMELY, AUDIO RECORDING AND RECORD PRODUCTION (U.S. CLS. 100, 101 AND 107).

FIRST USE 10-0-2009; IN COMMERCE 10-0-2009.
BRIAN NEVILLE, EXAMINING ATTORNEY

CLASS 41—(Continued).

SN 77-874,696. COMPETITOR GROUP, INC., SAN DIEGO, CA. FILED 11-17-2009.



OWNER OF U.S. REG. NOS. 2,131,333, 2,530,120 AND 3,422,420.

NO CLAIM IS MADE TO THE EXCLUSIVE RIGHT TO USE "ARIZONA MARATHON & 1/2", APART FROM THE MARK AS SHOWN.

THE MARK CONSISTS OF THE WORDS "ROCK 'N' ROLL ARIZONA MARATHON & 1/2" AND OTHER DESIGNS BEING IN THE SHAPES OF A CACTUS AND STRINGED INSTRUMENT, ALL SURROUNDED BY A RECTANGULAR BORDER.

FOR ENTERTAINMENT IN THE NATURE OF ORGANIZING A SPORTING EVENT IN THE NATURE OF A RUNNING RACE AND RELATED SPORTING AND ENTERTAINMENT EVENTS, NAMELY, ORGANIZING COMMUNITY FAIRS FEATURING VENDOR BOOTHS OF FOOD AND RACE RELATED SPORTING GOODS, AND PLANNING PARTIES AND DINNERS (U.S. CLS. 100, 101 AND 107).

BRENDAN REGAN, EXAMINING ATTORNEY

SN 77-874,890. 3 PEAKS VENTURES, LLC, RENTON, WA. FILED 11-17-2009.



NO CLAIM IS MADE TO THE EXCLUSIVE RIGHT TO USE "DRUNK.COM", APART FROM THE MARK AS SHOWN.

THE MARK CONSISTS OF THE WORDING "OFFICIALLY" IN A STYLIZED MANNER, "DRUNK" FORMATTED AFTER THE COLLEGE LETTERMAN LOOK, AND ".COM" DEPICTED NEXT TO THE WORD "DRUNK". THE MARK DEPICTS AN INDIVIDUAL LYING ON THE GROUND WITH A SPILLED CUP OF LIQUID TO THE LEFT HAND SIDE OF THE INDIVIDUAL.

FOR ENTERTAINMENT AND EDUCATIONAL SERVICES, NAMELY, PROVIDING A WEBSITE FEATURING ALCOHOL-RELATED INSTRUCTIONAL ARTICLES AND NON-DOWNLOADABLE ALCOHOL-RELATED INSTRUCTIONAL VIDEOS (U.S. CLS. 100, 101 AND 107).

JENNY PARK, EXAMINING ATTORNEY

CLASS 41—(Continued).

SN 77-874,995. SLIM & FIT FRANCHISE, LLC, CONCORD, OH. FILED 11-18-2009.



NO CLAIM IS MADE TO THE EXCLUSIVE RIGHT TO USE "SLIM & FIT" AND "PERSONAL WEIGHT LOSS & FITNESS", APART FROM THE MARK AS SHOWN.

THE NAME "JAIME BRENKUS" IDENTIFIES A LIVING INDIVIDUAL WHOSE CONSENT IS OF RECORD.

THE COLOR(S) RED, WHITE AND BLUE IS/ARE CLAIMED AS A FEATURE OF THE MARK.

THE MARK CONSISTS OF "JAIME BRENKUS" IN BLUE LETTERS FOLLOWED UNDERNEATH IN LARGER RED LETTERS "SLIM" FOLLOWED BY "&" IN BLUE, FOLLOWED BY "FIT" IN RED LETTERS. BELOW IS A RECTANGLE BLUE BOX WITH "PERSONAL WEIGHT LOSS & FITNESS" IN WHITE LETTERS.

FOR PROVIDING ASSISTANCE, PERSONAL TRAINING AND PHYSICAL FITNESS CONSULTATION TO INDIVIDUALS TO HELP THEM MAKE PHYSICAL FITNESS, STRENGTH, CONDITIONING, AND EXERCISE IMPROVEMENT IN THEIR DAILY LIVING (U.S. CLS. 100, 101 AND 107).

FIRST USE 9-2-2006; IN COMMERCE 9-2-2006.
MARC LEIPZIG, EXAMINING ATTORNEY

SN 77-875,299. SONSHIP HOSPITALITY, INC., MYRTLE BEACH, SC. FILED 11-18-2009.

RADICAL ROPES

THE MARK CONSISTS OF STANDARD CHARACTERS WITHOUT CLAIM TO ANY PARTICULAR FONT, STYLE, SIZE, OR COLOR.

NO CLAIM IS MADE TO THE EXCLUSIVE RIGHT TO USE "ROPES", APART FROM THE MARK AS SHOWN.

FOR PROVIDING AMUSEMENT PARKS; ENTERTAINMENT SERVICES IN THE NATURE OF AN AMUSEMENT PARK ATTRACTION, NAMELY, HIGH ROPES COURSES, CANOPY TOURS, ZIPLINES AND CLIMBING WALLS (U.S. CLS. 100, 101 AND 107).

SOPHIA S. KIM, EXAMINING ATTORNEY

CLASS 41—(Continued).

SN 77-875,403. MANHATTAN SHORT FILM FESTIVAL, DBA MANHATTAN SHORT FILM FESTIVAL, NEW YORK CITY, NY. FILED 11-18-2009.



NO CLAIM IS MADE TO THE EXCLUSIVE RIGHT TO USE "MANHATTAN SHORT", APART FROM THE MARK AS SHOWN.

THE MARK CONSISTS OF TWO RINGS WITH THE WORDS "MANHATTAN SHORT" ON TOP AND "ONE WORLD ONE WEEK ONE FESTIVAL" BELOW. INSIDE THE RINGS ARE THREE FILMS STRIPS. TWO ON TOP AND ONE ON THE BOTTOM.

FOR DISTRIBUTION OF MOTION PICTURE FILMS ABOUT GLOBAL ISSUES TO CINEMAS IN SIX CONTINENTS DURING ONE WEEK (U.S. CLS. 100, 101 AND 107).

FIRST USE 1-1-2007; IN COMMERCE 1-1-2007.
DEBRA LEE, EXAMINING ATTORNEY

CLASS 41—(Continued).

SN 77-876,892. WALDMAN, BONNIE, LA JOLLA, CA. FILED 11-19-2009.

THE LANGUAGE DIET

THE MARK CONSISTS OF STANDARD CHARACTERS WITHOUT CLAIM TO ANY PARTICULAR FONT, STYLE, SIZE, OR COLOR.

NO CLAIM IS MADE TO THE EXCLUSIVE RIGHT TO USE "LANGUAGE", APART FROM THE MARK AS SHOWN.

FOR EDUCATIONAL SERVICES, NAMELY, CONDUCTING PROGRAMS, CLASSES, WORKSHOPS, TUTORING AND SEMINARS IN THE FIELD OF IMPROVING COMMUNICATION OF INDIVIDUALS WITH SPECIAL NEEDS AND DISTRIBUTION OF TRAINING MATERIAL IN CONNECTION THEREWITH (U.S. CLS. 100, 101 AND 107).

KELLY CHOE, EXAMINING ATTORNEY

SN 77-876,423. CHRISTOPHER J. MACDONALD, SAN CLEMENTE, CA. AND DEE M. MACDONALD, SAN CLEMENTE, CA. FILED 11-19-2009.

WORLD SUPER OPEN

THE MARK CONSISTS OF STANDARD CHARACTERS WITHOUT CLAIM TO ANY PARTICULAR FONT, STYLE, SIZE, OR COLOR.

NO CLAIM IS MADE TO THE EXCLUSIVE RIGHT TO USE "OPEN", APART FROM THE MARK AS SHOWN.

FOR ENTERTAINMENT IN THE NATURE OF GOLF TOURNAMENTS; FITTING OF GOLF CLUBS TO INDIVIDUAL USERS; GOLF CADDIE SERVICES; GOLF INSTRUCTION; ORGANISATION OF GOLF TOURNAMENTS; PROVIDING A WEB SITE THROUGH WHICH GOLFERS LOCATE INFORMATION ABOUT GOLF COURSES AND GOLF TOURNAMENTS; PROVIDING NEWS AND INFORMATION ON THE SPORT OF GOLF (U.S. CLS. 100, 101 AND 107).

FRED CARL, EXAMINING ATTORNEY

SN 77-876,910. HORACE PORTER, BROOKLYN, NY. FILED 11-19-2009.

KLA-SICK

THE MARK CONSISTS OF STANDARD CHARACTERS WITHOUT CLAIM TO ANY PARTICULAR FONT, STYLE, SIZE, OR COLOR.

FOR ENTERTAINMENT SERVICES IN THE NATURE OF LIVE MUSICAL PERFORMANCES BY A PERFORMER OR GROUP (U.S. CLS. 100, 101 AND 107).

AARON BRODSKY, EXAMINING ATTORNEY

CLASS 41—(Continued).

SN 77-877,012. DIGIUSEPPE, JULIETTE, LOS ANGELES, CA. FILED 11-19-2009.



THE MARK CONSISTS OF A STYLIZED WOLF FACE SPLIT IN HALF, A SEMI-CIRCLE AND THE WORDING "DANSEWOLF", ALL WITHIN A SHADED SQUARE.

FOR ENTERTAINMENT, NAMELY, LIVE MUSIC CONCERTS; ENTERTAINMENT, NAMELY, LIVE PERFORMANCES BY A MUSICAL BAND (U.S. CLS. 100, 101 AND 107).

FIRST USE 8-1-2008; IN COMMERCE 8-1-2008.
MELISSA VALLILLO, EXAMINING ATTORNEY

SN 77-877,571. FREMANTLE MEDIA NORTH AMERICA, INC., BURBANK, CA. FILED 11-20-2009.

IDOL GIVES BACK

THE MARK CONSISTS OF STANDARD CHARACTERS WITHOUT CLAIM TO ANY PARTICULAR FONT, STYLE, SIZE, OR COLOR.

OWNER OF U.S. REG. NO. 3,352,837.

FOR ENTERTAINMENT SERVICES IN THE NATURE OF ONGOING TELEVISION PROGRAMS FEATURING MUSICAL PERFORMANCES TO RAISE FUNDS FOR CHARITIES; PROVIDING DIGITIZED PRINT AND VISUAL EDUCATIONAL AND ENTERTAINMENT INFORMATION ABOUT A TELEVISION PROGRAM SERIES VIA A GLOBAL COMPUTER NETWORK; EDUCATION SERVICES, NAMELY, PROVIDING A WEBSITE FEATURING EDUCATIONAL AND ENTERTAINMENT INFORMATION ABOUT A TELEVISION PROGRAM FEATURING A WIDE VARIETY OF GLOBAL ISSUES IN NEED OF CHARITABLE FUNDING, AND PROVIDING AN ONLINE MAGAZINE IN THE FIELD OF A WIDE VARIETY OF GLOBAL ISSUES IN NEED OF CHARITABLE FUNDING (U.S. CLS. 100, 101 AND 107).

FIRST USE 4-25-2007; IN COMMERCE 4-25-2007.
CAROL SPILS, EXAMINING ATTORNEY

CLASS 41—(Continued).

SN 77-877,609. COX, BRIAN, LAS CRUCES, NM. FILED 11-20-2009.



NO CLAIM IS MADE TO THE EXCLUSIVE RIGHT TO USE "TALK SHOW", APART FROM THE MARK AS SHOWN.

THE MARK CONSISTS OF THE STYLIZED WORDS "TITLE TOWN TALK SHOW".

FOR ENTERTAINMENT, NAMELY, A CONTINUING TALK SHOW BROADCAST OVER TELEVISION, RADIO (U.S. CLS. 100, 101 AND 107).

FIRST USE 7-25-2009; IN COMMERCE 7-25-2009.
TASNEEM HUSSAIN, EXAMINING ATTORNEY

SN 77-878,156. SPHEREQUEST, INC., MIAMI, FL. FILED 11-21-2009.

CELEBREEL

THE MARK CONSISTS OF STANDARD CHARACTERS WITHOUT CLAIM TO ANY PARTICULAR FONT, STYLE, SIZE, OR COLOR.

FOR ENTERTAINMENT SERVICES, NAMELY, PROVIDING INFORMATION IN THE FIELD OF ENTERTAINMENT REGARDING NEWS, TV SHOWS, MOVIES, MOVIE TICKETS, ACTORS, SHOW TIMES AND MERCHANDISE; PROVIDING VIRTUAL ENVIRONMENTS IN WHICH USERS CAN INTERACT BY EXCHANGING INFORMATION, PROVIDING FEEDBACK, AND GIVING OPINIONS, REVIEWS, FEEDBACK AND RATINGS ABOUT NEWS, SHOWS, AND MOVIES IN THE FIELD OF ENTERTAINMENT, WHICH CAN BE INTEGRATED WITH ONLINE SOCIAL MEDIA NETWORKS AND DELIVERED VIA GLOBAL COMMUNICATION AND WIRELESS NETWORKS TO MOBILE DEVICES FOR ENTERTAINMENT PURPOSES (U.S. CLS. 100, 101 AND 107).

FIRST USE 1-21-2010; IN COMMERCE 1-21-2010.
COLLEEN KEARNEY, EXAMINING ATTORNEY

CLASS 41—(Continued).

SN 77-878,693. SPOTLIGHT PUBLICATIONS LLC, WILMINGTON, DE. FILED 11-23-2009.

(914) Inc.

THE MARK CONSISTS OF STANDARD CHARACTERS WITHOUT CLAIM TO ANY PARTICULAR FONT, STYLE, SIZE, OR COLOR.

OWNER OF U.S. REG. NO. 3,545,474.

NO CLAIM IS MADE TO THE EXCLUSIVE RIGHT TO USE "INC.", APART FROM THE MARK AS SHOWN.

FOR MAGAZINE PUBLISHING; PUBLICATION OF ELECTRONIC MAGAZINES; PUBLICATION OF MAGAZINES; PUBLISHING OF WEB MAGAZINES (U.S. CLS. 100, 101 AND 107).

HAI-LY LAM, EXAMINING ATTORNEY

SN 77-878,835. BREWERS ASSOCIATION, INC., BOULDER, CO. FILED 11-23-2009.

GREAT AMERICAN BEER
FESTIVAL

THE MARK CONSISTS OF STANDARD CHARACTERS WITHOUT CLAIM TO ANY PARTICULAR FONT, STYLE, SIZE, OR COLOR.

OWNER OF U.S. REG. NO. 1,854,900.

NO CLAIM IS MADE TO THE EXCLUSIVE RIGHT TO USE "BEER FESTIVAL", APART FROM THE MARK AS SHOWN.

FOR ORGANIZING, ARRANGING AND CONDUCTING A BEER FESTIVAL (U.S. CLS. 100, 101 AND 107).

FIRST USE 3-0-1982; IN COMMERCE 3-0-1982.

ESTHER BELENKER, EXAMINING ATTORNEY

SN 77-879,252. CHARLES DUM, DBA SILVERMOON DESIGNS, SALEM, OR. FILED 11-23-2009.

SILVERMOON
DESIGNS

NO CLAIM IS MADE TO THE EXCLUSIVE RIGHT TO USE "DESIGNS", APART FROM THE MARK AS SHOWN.

THE MARK CONSISTS OF THE WORD "SILVERMOON" ABOVE THE WORD "DESIGNS", BOTH IN STYLIZED FONT. THE "S" IN "SILVERMOON" IS LARGER AND INTERSECTS THE WORD "DESIGNS" BETWEEN THE "D" AND "E".

FOR PHOTOGRAPHY (U.S. CLS. 100, 101 AND 107).

FIRST USE 6-0-2007; IN COMMERCE 6-0-2007.

GINA FINK, EXAMINING ATTORNEY

CLASS 41—(Continued).

SN 77-880,629. BOARD OF TRUSTEES OF SOUTHERN ILLINOIS UNIVERSITY, CARBONDALE, IL. FILED 11-25-2009.

SIU

THE MARK CONSISTS OF STANDARD CHARACTERS WITHOUT CLAIM TO ANY PARTICULAR FONT, STYLE, SIZE, OR COLOR.

FOR EDUCATIONAL SERVICES IN THE NATURE OF COURSES AND DEGREE PROGRAMS AT THE UNIVERSITY LEVEL; ORGANIZING EDUCATIONAL, CULTURAL, SPORTING, AND ENTERTAINMENT EVENTS (U.S. CLS. 100, 101 AND 107).

FIRST USE 1-1-1980; IN COMMERCE 1-1-1980.

DAVID ELTON, EXAMINING ATTORNEY

SN 77-881,003. ABSOLUTE & DOWSE LLC, LONDON, UNITED KINGDOM, FILED 11-25-2009.

2 STRANGERS & A WEDDING

THE MARK CONSISTS OF STANDARD CHARACTERS WITHOUT CLAIM TO ANY PARTICULAR FONT, STYLE, SIZE, OR COLOR.

OWNER OF U.S. REG. NO. 3,581,718.

FOR DISTRIBUTION AND PRODUCTION OF MOTION PICTURE FILMS AND TELEVISION PROGRAMS; FILM AND TELEVISION SHOW ENTERTAINMENT PRODUCTION; ENTERTAINMENT IN THE NATURE OF AN ON-GOING REALITY BASED TELEVISION PROGRAM; PROVIDING INFORMATION IN THE FIELD OF ENTERTAINMENT BY MEANS OF A GLOBAL COMPUTER NETWORK (U.S. CLS. 100, 101 AND 107).

WARREN L. OLANDRIA, EXAMINING ATTORNEY

CLASS 41—(Continued).

SN 77-881,539. 17 BLACK, LLC, CEDAR GROVE, NJ. FILED 11-27-2009.



NO CLAIM IS MADE TO THE EXCLUSIVE RIGHT TO USE "EST. 1987", APART FROM THE MARK AS SHOWN.

THE MARK CONSISTS OF THE STYLIZED LETTERS "RB" ON A SHIELD DESIGN BELOW A CROWN WITH THE WORDING "AMBER" AND "EST. 1987" THEREON, SURROUNDED BY LAUREL LEAVES WITH ONE STYLIZED INDIVIDUAL PLAYING THE HORN ON EACH SIDE OF THE SHIELD.

FOR PHOTOGRAPHY (U.S. CLS. 100, 101 AND 107).
PATRICIA EVANKO, EXAMINING ATTORNEY

CLASS 41—(Continued).

SN 77-881,684. NETINETIMEDIA LLC, SEBASTOPOL, CA. FILED 11-28-2009.

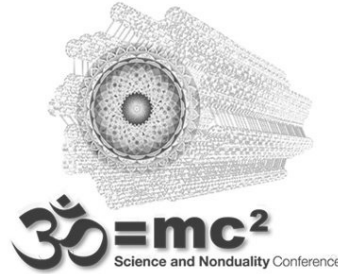

NO CLAIM IS MADE TO THE EXCLUSIVE RIGHT TO USE "SCIENCE AND NONDUALITY CONFERENCE", APART FROM THE MARK AS SHOWN.

THE MARK CONSISTS OF A MISCELLANEOUS CIRCULAR DESIGN, WITH THE WORDING "OM = MC2 SCIENCE AND NONDUALITY CONFERENCE", WITH THE "OM" BEING IN SANSKRIT.

THE NON-LATIN CHARACTERS IN THE MARK TRANSLITERATE TO "OM" AND THIS MEANS "OM" IN ENGLISH.

FOR ARRANGING AND CONDUCTING EDUCATIONAL CONFERENCES; EDUCATION SERVICES, NAMELY, PROVIDING FILM PRESENTATIONS AND PODCASTS IN THE FIELD OF CONNECTING SPIRITUALITY WITH SCIENCE; EDUCATIONAL SERVICES, NAMELY, CONDUCTING CONFERENCES, SEMINARS, WORKSHOPS, FESTIVALS AND LECTURE EVENTS IN THE FIELD OF CONNECTING SPIRITUALITY WITH SCIENCE (U.S. CLS. 100, 101 AND 107).

FIRST USE 11-0-2008; IN COMMERCE 11-0-2008.
KHANH LE, EXAMINING ATTORNEY

SN 77-881,670. DENNIS CARROLL'S PREMIER PERSONAL TRAINING INC., WEST CHESTER, PA. FILED 11-28-2009.



NO CLAIM IS MADE TO THE EXCLUSIVE RIGHT TO USE "FITNESS BOOT CAMPS", APART FROM THE MARK AS SHOWN.

THE MARK CONSISTS OF FIVE SOLDIERS WITH A FLAG IN THE BACKGROUND THAT RESEMBLES A HIGHLY STYLIZED VERSION OF THE AMERICAN FLAG HAVING THE STARS REPLACED BY SEVERAL IRREGULARLY SHAPED DOTS IN PLACE OF THE STAR FIELD, WITH THE WORDING "ADOPT A PLATOON FITNESS BOOT CAMPS HELP YOURSELF - HELP A SOLDIER" LOCATED BELOW THE FOREGOING WITHIN A RECTANGLE.

FOR CONSULTING SERVICES IN THE FIELDS OF FITNESS AND EXERCISE; COUNSELING SERVICES IN THE FIELD OF PHYSICAL FITNESS; PERSONAL TRAINER SERVICES; PERSONAL TRAINING SERVICES, NAMELY, STRENGTH AND CONDITIONING TRAINING; PHYSICAL FITNESS CONDITIONING CLASSES; PHYSICAL FITNESS CONSULTATION; PHYSICAL FITNESS INSTRUCTION; PHYSICAL FITNESS TRAINING SERVICES; PROVIDING ASSISTANCE, PERSONAL TRAINING AND PHYSICAL FITNESS CONSULTATION TO INDIVIDUALS TO HELP THEM MAKE PHYSICAL FITNESS, STRENGTH, CONDITIONING, AND EXERCISE IMPROVEMENT IN THEIR DAILY LIVING (U.S. CLS. 100, 101 AND 107).

APRIL ROACH, EXAMINING ATTORNEY

SN 77-882,129. AMERICAN PUBLIC UNIVERSITY SYSTEM, INC., CHARLES TOWN, WV. FILED 11-30-2009.

UNIVERSITY OF HEROES

THE MARK CONSISTS OF STANDARD CHARACTERS WITHOUT CLAIM TO ANY PARTICULAR FONT, STYLE, SIZE, OR COLOR.

NO CLAIM IS MADE TO THE EXCLUSIVE RIGHT TO USE "UNIVERSITY", APART FROM THE MARK AS SHOWN.

FOR EDUCATIONAL SERVICES, NAMELY, PROVIDING COURSES OF INSTRUCTION AT THE UNDERGRADUATE AND GRADUATE LEVEL (U.S. CLS. 100, 101 AND 107).

AMY C. KEAN, EXAMINING ATTORNEY

CLASS 41—(Continued).

SN 77-882,190. TOSH AVIATION, INC., CHATTANOOGA, TN. FILED 11-30-2009.



THE MARK CONSISTS OF THE LETTER "E" FOLLOWED BY A TRIANGLE FOLLOWED BY THE WORD "GIRLS".
FOR ENTERTAINMENT SERVICES, NAMELY, PROVIDING A WEB SITE FEATURING MUSICAL PERFORMANCES, MUSICAL VIDEOS, RELATED FILM CLIPS, PHOTOGRAPHS, AND OTHER MULTIMEDIA MATERIALS FEATURING MUSICAL PERFORMANCES, MUSICAL VIDEOS, RELATED FILM CLIPS, AND PHOTOGRAPHS OF AN ENTERTAINMENT NATURE (U.S. CLS. 100, 101 AND 107).

Laura KOVALSKY, EXAMINING ATTORNEY

CLASS 41—(Continued).

SN 77-882,374. SHEPHERDS THEOLOGICAL SEMINARY, INC., CARY, NC. FILED 11-30-2009.

SHEPHERDS THEOLOGICAL
SEMINARY

THE MARK CONSISTS OF STANDARD CHARACTERS WITHOUT CLAIM TO ANY PARTICULAR FONT, STYLE, SIZE, OR COLOR.

NO CLAIM IS MADE TO THE EXCLUSIVE RIGHT TO USE "THEOLOGICAL SEMINARY", APART FROM THE MARK AS SHOWN.

FOR EDUCATIONAL SERVICES, NAMELY, PROVIDING GRADUATE DEGREE, UNDERGRADUATE DEGREE, ASSOCIATE, CERTIFICATE, AND CONTINUING EDUCATION PROGRAMS IN THEOLOGY, MINISTRY, EDUCATION, BIBLICAL STUDIES, CHURCH HISTORY, BIBLICAL COUNSELING, PREACHING, PASTORAL PRACTICES, BIBLICAL LANGUAGES, BIBLICAL LITERATURE AND WORLD RELIGIONS; RELIGIOUS INSTRUCTION SERVICES FOCUSED ON THEOLOGY, MINISTRY, EDUCATION, BIBLICAL STUDIES, CHURCH HISTORY, BIBLICAL COUNSELING, PREACHING, PASTORAL PRACTICES, BIBLICAL LANGUAGES, BIBLICAL LITERATURE AND WORLD RELIGIONS (U.S. CLS. 100, 101 AND 107).

FIRST USE 6-12-2002; IN COMMERCE 1-13-2003.

LYDIA BELZER, EXAMINING ATTORNEY

SN 77-882,193. DASILVA, AGUINALDO, PEMBROKE PINES, FL. FILED 11-30-2009.



THE MARK CONSISTS OF THE WORDING, "YOURLIFE" AND "NEVER LIVED BEFORE", SEPARATED BY A CIRCLE SHELL DESIGN THAT INCREASES IN SIZE FROM SMALL AT THE BOTTOM TO LARGE AT THE TOP.

FOR PROVIDING ON-LINE TRAINING COURSES, SEMINARS, WORKSHOPS IN THE FIELD OF SELF DEVELOPMENT (U.S. CLS. 100, 101 AND 107).

KELLY CHOE, EXAMINING ATTORNEY

SN 77-882,994. NORTH DAKOTA STATE COLLEGE OF SCIENCE, WAHPETON, ND. FILED 12-1-2009.

NDSCS The Science of
Success

THE MARK CONSISTS OF STANDARD CHARACTERS WITHOUT CLAIM TO ANY PARTICULAR FONT, STYLE, SIZE, OR COLOR.

FOR EDUCATIONAL SERVICES, NAMELY, PROVIDING COURSES OF INSTRUCTION AT THE COLLEGE LEVEL (U.S. CLS. 100, 101 AND 107).

FIRST USE 11-5-2009; IN COMMERCE 11-5-2009.

PAULA MAHONEY, EXAMINING ATTORNEY

CLASS 41—(Continued).

SN 77-883,009. SIX GALLERY, LLC, AKA SIX GALLERY, COLUMBUS, OH. FILED 12-1-2009.

Six Gallery

THE MARK CONSISTS OF STANDARD CHARACTERS WITHOUT CLAIM TO ANY PARTICULAR FONT, STYLE, SIZE, OR COLOR.

FOR ENTERTAINMENT, NAMELY, LIVE PERFORMANCES BY A MUSICAL BAND; PRODUCTION OF FILMS AND TELEVISION PROGRAMS FEATURING PERFORMANCES BY A MUSICAL BAND; ENTERTAINMENT, NAMELY, PROVIDING NONDOWNLOADABLE PRERECORDED MUSICAL PERFORMANCES ON-LINE VIA A GLOBAL COMPUTER NETWORK (U.S. CLS. 100, 101 AND 107).

FIRST USE 4-12-2006; IN COMMERCE 4-12-2006.
PAULA MAHONEY, EXAMINING ATTORNEY

CLASS 41—(Continued).

SN 77-883,503. ARTE GRAFICO EDITORIAL ARGENTINO S.A., BUENOS AIRES, ARGENTINA, FILED 12-1-2009.

CLARIN.COM

THE MARK CONSISTS OF STANDARD CHARACTERS WITHOUT CLAIM TO ANY PARTICULAR FONT, STYLE, SIZE, OR COLOR.

OWNER OF U.S. REG. NOS. 2,130,172, 2,130,173 AND 2,130,175.

THE ENGLISH TRANSLATION OF "CLARIN" IN THE MARK IS "BUGLE."

FOR PROVIDING ON-LINE NON-DOWNLOADABLE NEWSPAPERS; PUBLICATION OF ELECTRONIC NEWSPAPERS ACCESSIBLE VIA A GLOBAL COMPUTER NETWORK; PROVIDING ONLINE NEWS IN THE NATURE OF CURRENT EVENTS REPORTING; PROVIDING INFORMATION IN THE FIELD OF NEWS IN THE NATURE OF CURRENT EVENTS REPORTING BY LINKING USERS TO OTHER WEBSITES CONTAINING INFORMATION IN THE FIELD OF NEWS IN THE NATURE OF CURRENT EVENTS REPORTING (U.S. CLS. 100, 101 AND 107).

FIRST USE 3-16-1996; IN COMMERCE 3-16-1996.
TRICIA SONNEBORN, EXAMINING ATTORNEY

SN 77-883,479. ARTE GRAFICO EDITORIAL ARGENTINO S.A., BUENOS AIRES, ARGENTINA, FILED 12-1-2009.



OWNER OF U.S. REG. NOS. 2,130,172, 2,130,173 AND 2,130,175.

THE COLOR(S) RED IS/ARE CLAIMED AS A FEATURE OF THE MARK.

THE MARK CONSISTS OF THE WORDS "CLARIN.COM" IN STYLIZED RED LETTERS FOLLOWED BY THE SILHOUETTE OF MAN PLAYING THE BUGLE.

THE ENGLISH TRANSLATION OF "CLARIN" IN THE MARK IS "BUGLE."

FOR PROVIDING ON-LINE NON-DOWNLOADABLE NEWSPAPERS; PUBLICATION OF ELECTRONIC NEWSPAPERS ACCESSIBLE VIA A GLOBAL COMPUTER NETWORK; PROVIDING ONLINE NEWS IN THE NATURE OF CURRENT EVENTS REPORTING; PROVIDING INFORMATION IN THE FIELD OF NEWS IN THE NATURE OF CURRENT EVENTS REPORTING BY LINKING USERS TO OTHER WEBSITES CONTAINING INFORMATION IN THE FIELD OF NEWS IN THE NATURE OF CURRENT EVENTS REPORTING (U.S. CLS. 100, 101 AND 107).

FIRST USE 3-16-1996; IN COMMERCE 3-16-1996.
TRICIA SONNEBORN, EXAMINING ATTORNEY

SN 77-883,570. ELYSE C. BEC, INC., CHICAGO, IL. FILED 12-1-2009.



FEAR NO ART

NO CLAIM IS MADE TO THE EXCLUSIVE RIGHT TO USE "ART", APART FROM THE MARK AS SHOWN.

THE COLOR BLACK SHOWN IN THE MARK REPRESENTS BACKGROUND ONLY.

FOR ENTERTAINMENT SERVICES, NAMELY, AN ON-GOING SERIES FEATURING ART AND ARTISTS PROVIDED THROUGH TV, INTERNET, RADIO, CABLE TV, FILM (U.S. CLS. 100, 101 AND 107).

FIRST USE 1-1-2009; IN COMMERCE 1-1-2009.
SUSAN RICHARDS, EXAMINING ATTORNEY

CLASS 41—(Continued).

SN 77-883,648. LINKING HUMAN SYSTEMS, LLC,
BOULDER, CO. FILED 12-1-2009.

ARISE

THE MARK CONSISTS OF STANDARD CHARACTERS WITHOUT CLAIM TO ANY PARTICULAR FONT, STYLE, SIZE, OR COLOR.

FOR EDUCATIONAL SERVICES, NAMELY, CONDUCTING CLASSES, SEMINARS AND WORKSHOPS IN THE FIELD OF FAMILY COUNSELING AND SUBSTANCE ABUSE AND DISTRIBUTION OF COURSE MATERIALS, NAMELY, BOOKS AND WORKBOOKS ASSOCIATED THEREWITH (U.S. CLS. 100, 101 AND 107).

FIRST USE 12-31-1996; IN COMMERCE 12-31-1996.
SIMON TENG, EXAMINING ATTORNEY

SN 77-883,657. HARRELL, RICHARD, TAMPA, FL. FILED
12-1-2009.



The logo for Richard Harrell Photography features the name "Richard Harrell" in a serif font, with a camera lens icon integrated into the letter "a". Below the name, the word "Photography" is written in a smaller, sans-serif font, with a decorative flourish underneath.

NO CLAIM IS MADE TO THE EXCLUSIVE RIGHT TO USE "PHOTOGRAPHY", APART FROM THE MARK AS SHOWN.

THE NAME "RICHARD HARRELL" IDENTIFIES A LIVING INDIVIDUAL WHOSE CONSENT IS OF RECORD.

FOR PHOTOGRAPHY; PHOTOGRAPHY SERVICES; PORTRAIT PHOTOGRAPHY (U.S. CLS. 100, 101 AND 107).

FIRST USE 9-0-2008; IN COMMERCE 9-0-2008.
SIMON TENG, EXAMINING ATTORNEY

SN 77-883,787. MINDBRIDGE FOUNDATION, IOWA CITY,
IA. FILED 12-1-2009.



The logo for Anime Iowa features the word "Anime" in a bold, sans-serif font, with "Iowa" written below it in a similar font. The letters are filled with a stippled pattern, and there is a large, stylized letter "A" to the left of the word "Anime".

NO CLAIM IS MADE TO THE EXCLUSIVE RIGHT TO USE "ANIME IOWA", APART FROM THE MARK AS SHOWN.

THE STIPPLING IS FOR SHADING PURPOSES ONLY.

THE MARK CONSISTS OF A STYLIZED VERSION OF THE WORD "ANIME" IN WHICH THE WORD "IOWA" IS INCLUDED BELOW IT USING THE SECOND STROKE OF THE "A" AS THE "I" FOR "IOWA".

FOR ORGANIZATION AND ARRANGING OF AN ANNUAL EDUCATIONAL CONVENTION AND CONFERENCE FOCUSING ON JAPANESE ANIMATION AND CULTURE (U.S. CLS. 100, 101 AND 107).

FIRST USE 6-14-1999; IN COMMERCE 6-14-1999.
SOPHIA S. KIM, EXAMINING ATTORNEY

CLASS 41—(Continued).

SN 77-883,827. KNIGHT, LEIA M., DBA KNIGHT VISIONS
PHOTOGRAPHY, VANCOUVER, WA. FILED 12-1-2009.

Knight Visions Photography

THE MARK CONSISTS OF STANDARD CHARACTERS WITHOUT CLAIM TO ANY PARTICULAR FONT, STYLE, SIZE, OR COLOR.

NO CLAIM IS MADE TO THE EXCLUSIVE RIGHT TO USE "PHOTOGRAPHY", APART FROM THE MARK AS SHOWN.

FOR PHOTOGRAPHIC AND VIDEO SERVICES, NAMELY, PHOTOGRAPHIC AND VIDEO CAPTURE; PHOTOGRAPHIC COMPOSITION FOR OTHERS; PHOTOGRAPHIC COMPUTER IMAGING; PHOTOGRAPHIC REPORTING; PHOTOGRAPHY; PHOTOGRAPHY SERVICES; PORTRAIT PHOTOGRAPHY (U.S. CLS. 100, 101 AND 107).

FIRST USE 1-1-2005; IN COMMERCE 1-1-2005.
JUSTINE D. PARKER, EXAMINING ATTORNEY

SN 77-883,831. BONHAM, ROBERT, RUTHERFORD, NJ.
FILED 12-1-2009.

MR. AMERICA

THE MARK CONSISTS OF STANDARD CHARACTERS WITHOUT CLAIM TO ANY PARTICULAR FONT, STYLE, SIZE, OR COLOR.

NO CLAIM IS MADE TO THE EXCLUSIVE RIGHT TO USE "AMERICA", APART FROM THE MARK AS SHOWN.

FOR ENTERTAINMENT IN THE NATURE OF HOSTING, CONDUCTING AND ARRANGING FITNESS AND BODYBUILDING SHOWS AND EVENTS (U.S. CLS. 100, 101 AND 107).

KHANH LE, EXAMINING ATTORNEY

CLASS 41—(Continued).

SN 77-884,035. HINES, LINDSEY M, DBA LINDSEY M. HINES AUSTINTAGEOUS EVENTS, CEDAR PARK, TX. FILED 12-2-2009.

Austintageous Events

THE MARK CONSISTS OF STANDARD CHARACTERS WITHOUT CLAIM TO ANY PARTICULAR FONT, STYLE, SIZE, OR COLOR.

NO CLAIM IS MADE TO THE EXCLUSIVE RIGHT TO USE "EVENTS", APART FROM THE MARK AS SHOWN.

FOR PROVIDING INFORMATION IN THE FIELD OF WEDDING PARTY PLANNING; PROVIDING INFORMATION REGARDING WEDDING PLANNING FOR WEDDING PARTIES; SPECIAL EVENT, PARTY AND WEDDING PLANNING AND COORDINATION SERVICES; SPECIAL EVENT, PARTY AND WEDDING PLANNING CONSULTATION SERVICES; SPECIAL EVENT, PARTY AND WEDDING PLANNING, COORDINATION AND CONSULTATION SERVICES; WEDDING PLANNING AND COORDINATION SERVICES (U.S. CLS. 100, 101 AND 107).

FIRST USE 10-1-2009; IN COMMERCE 10-1-2009.
KATHERINE STOIDES, EXAMINING ATTORNEY

CLASS 41—(Continued).

SN 77-884,118. CIRCLES OF GRACE, PINEHURST, TX. FILED 12-2-2009.

CIRCLES OF GRACE

THE MARK CONSISTS OF STANDARD CHARACTERS WITHOUT CLAIM TO ANY PARTICULAR FONT, STYLE, SIZE, OR COLOR.

FOR TRAINING SERVICES IN THE FIELD OF ALTERNATIVE DISPUTE RESOLUTION; TRAINING SERVICES IN THE FIELD OF CONFLICT PREVENTION, CONFLICT MANAGEMENT, CONFLICT RESOLUTION, PEACE-BUILDING AND GOOD GOVERNANCE TECHNIQUES (U.S. CLS. 100, 101 AND 107).

FIRST USE 11-30-2009; IN COMMERCE 11-30-2009.
GILBERT SWIFT, EXAMINING ATTORNEY

SN 77-884,167. AMERICAN READING COMPANY, KING OF PRUSSIA, PA. FILED 12-2-2009.

SN 77-884,109. AMERICAN READING COMPANY, KING OF PRUSSIA, PA. FILED 12-2-2009.

ACTION 100 RTI ACCOUNTABILITY SYSTEM

ACTION 100

THE MARK CONSISTS OF STANDARD CHARACTERS WITHOUT CLAIM TO ANY PARTICULAR FONT, STYLE, SIZE, OR COLOR.

FOR EDUCATIONAL SERVICES, NAMELY, A READING PROGRAM FOR PRE-KINDERGARTEN THROUGH SECONDARY SCHOOL STUDENTS AND DISTRIBUTION OF PRINTED MATERIALS AND BOOKS IN CONNECTION THEREWITH; A PROGRAM FOR ASSESSING THE LEVEL OF DIFFICULTY OF BOOKS AS PART OF A READING PROGRAM (U.S. CLS. 100, 101 AND 107).

FIRST USE 8-26-2009; IN COMMERCE 9-14-2009.
BARBARA GAYNOR, EXAMINING ATTORNEY

THE MARK CONSISTS OF STANDARD CHARACTERS WITHOUT CLAIM TO ANY PARTICULAR FONT, STYLE, SIZE, OR COLOR.

NO CLAIM IS MADE TO THE EXCLUSIVE RIGHT TO USE "RTI ACCOUNTABILITY SYSTEM", APART FROM THE MARK AS SHOWN.

FOR EDUCATIONAL SERVICES, NAMELY, A READING PROGRAM FOR PRE-KINDERGARTEN THROUGH SECONDARY SCHOOL STUDENTS AND DISTRIBUTION OF PRINTED MATERIALS AND BOOKS IN CONNECTION THEREWITH; A PROGRAM FOR ASSESSING THE LEVEL OF DIFFICULTY OF BOOKS AS PART OF A READING PROGRAM (U.S. CLS. 100, 101 AND 107).

FIRST USE 8-26-2009; IN COMMERCE 9-14-2009.
BARBARA GAYNOR, EXAMINING ATTORNEY

CLASS 41—(Continued).

SN 77-884,272. UGC MEDIA, LLC, DENVER, CO. FILED 12-2-2009.



NO CLAIM IS MADE TO THE EXCLUSIVE RIGHT TO USE "TALENT AWARDS", APART FROM THE MARK AS SHOWN.

THE MARK CONSISTS OF A STAR SURROUNDED BY THE WORDS "USER GEN R 8 ED TALENT AWARDS" WRITTEN IN THE SHAPE OF A CIRCLE, WITH THE WORDING "USER GEN R 8 ED" APPEARING WITHIN A SHADED ARCH DESIGN.

FOR ENTERTAINMENT SERVICES, NAMELY, PROVIDING A WEBSITE FEATURING MULTIMEDIA CLIPS AND VIDEOS FEATURING SINGING, DANCING, ACTING, STANDUP COMEDY, MUSICAL ACTS, ANIMATION, HUMOR, ART AND GENERAL TALENT PERFORMANCES; PROVIDING A WEBSITE FEATURING AN ONLINE TALENT COMPETITION JUDGED BY PROFESSIONAL AND CELEBRITY JUDGES; ENTERTAINMENT SERVICES IN THE NATURE OF LIVE TALENT COMPETITIONS; ENTERTAINMENT SERVICES IN THE NATURE OF A CONTINUING TELEVISION PROGRAM FEATURING A TALENT COMPETITION (U.S. CLS. 100, 101 AND 107).

DAVID ELTON, EXAMINING ATTORNEY

SN 77-884,451. JOHNSTON, NANCY, BLOOMFIELD TOWNSHIP, MI. FILED 12-2-2009.

Sleeping Bear Films

THE MARK CONSISTS OF STANDARD CHARACTERS WITHOUT CLAIM TO ANY PARTICULAR FONT, STYLE, SIZE, OR COLOR.

NO CLAIM IS MADE TO THE EXCLUSIVE RIGHT TO USE "FILMS", APART FROM THE MARK AS SHOWN.

FOR MEDIA PRODUCTION SERVICES, NAMELY, VIDEO AND FILM PRODUCTION (U.S. CLS. 100, 101 AND 107).

PAULA MAHONEY, EXAMINING ATTORNEY

CLASS 41—(Continued).

SN 77-884,522. MDP WORLDWIDE, INC., DBA ACT, NORTH POTOMAC, MD. FILED 12-2-2009.



THE MARK CONSISTS OF THE TERM "ACT" IN STYLIZED SHINY AND REFLECTIVE LETTERING.

FOR EDUCATIONAL SERVICES, NAMELY, CONDUCTING A NONACADEMIC, AVOCATIONAL PROGRAM FOR CHILDREN AND TEENS IN THE NATURE OF CONFERENCES, SEMINARS AND WORKSHOPS DESIGNED TO HELP ENROLLEES UNDERSTAND AND MASTER THE CRITICAL ARTISTIC AND BUSINESS SKILLS NEEDED FOR THE ENTERTAINMENT INDUSTRY, CONSISTING PRIMARILY OF ON-CAMERA PERFORMANCE SKILLS, SELF-DEVELOPMENT AND CONFIDENCE BUILDING, AND INTERVIEW TECHNIQUES (U.S. CLS. 100, 101 AND 107).

FIRST USE 8-1-2009; IN COMMERCE 8-1-2009.

SUE LAWRENCE, EXAMINING ATTORNEY

SN 77-884,527. LOVE PER SECOND, LLC, MASSAPEQUA, NY. FILED 12-2-2009.

Love per Second

THE MARK CONSISTS OF STANDARD CHARACTERS WITHOUT CLAIM TO ANY PARTICULAR FONT, STYLE, SIZE, OR COLOR.

FOR ENTERTAINMENT SERVICES, NAMELY, CONDUCTING PARTIES FOR THE PURPOSE OF DATING AND SOCIAL INTRODUCTION FOR ADULTS (U.S. CLS. 100, 101 AND 107).

FIRST USE 10-4-2009; IN COMMERCE 10-4-2009.

CHERYL CLAYTON, EXAMINING ATTORNEY

SN 77-884,621. FOUNDATIONS, INC., MOORESTOWN, NJ. FILED 12-2-2009.

TECHNOLOGY IS POWER

THE MARK CONSISTS OF STANDARD CHARACTERS WITHOUT CLAIM TO ANY PARTICULAR FONT, STYLE, SIZE, OR COLOR.

FOR EDUCATIONAL SERVICES, NAMELY, TEACHING AND TRAINING IN COMPUTER SKILLS (U.S. CLS. 100, 101 AND 107).

FIRST USE 6-30-2009; IN COMMERCE 6-30-2009.

DOMINIC FATHY, EXAMINING ATTORNEY

CLASS 41—(Continued).

SN 77-884,632. FOUNDATIONS, INC., MOORESTOWN, NJ.
FILED 12-2-2009.

TEENS-GO-GREEN

THE MARK CONSISTS OF STANDARD CHARACTERS WITHOUT CLAIM TO ANY PARTICULAR FONT, STYLE, SIZE, OR COLOR.

FOR EDUCATIONAL SERVICES, NAMELY, PROVIDING EDUCATIONAL PROGRAMS USING A LANDSCAPING BUSINESS MODEL TO TEACH SUSTAINABILITY AND ENTREPRENEURSHIP (U.S. CLS. 100, 101 AND 107).

FIRST USE 7-1-2009; IN COMMERCE 7-1-2009.
DOMINIC FATHY, EXAMINING ATTORNEY

SN 77-884,712. W2W ENTERTAINMENT, LLC, AKA W2W RECORDS, HENDERSON, NV. FILED 12-2-2009.



THE COLOR(S) BLACK, RED & WHITE IS/ARE CLAIMED AS A FEATURE OF THE MARK.

THE MARK CONSISTS OF TWO SIDE-BY-SIDE BLACK "W"'S IN CAPITAL LETTERS, BOTH HAVING WHITE OUTLINING, AND A STYLIZED RED NUMBER "2" HAVING A WHITE OUTLINE AND WHITE SPLOTCHES IMPOSED BETWEEN THE "W"'S. THE BACKGROUND OF THE MARK IS TRANSPARENT.

FOR PRODUCTION OF SOUND AND MUSIC VIDEO RECORDINGS (U.S. CLS. 100, 101 AND 107).

ANDREA HACK, EXAMINING ATTORNEY

SN 77-884,748. MCINTYRE, DOUGLAS JOHN, CALABASAS, CA. FILED 12-2-2009.

Red Eye Radio

THE MARK CONSISTS OF STANDARD CHARACTERS WITHOUT CLAIM TO ANY PARTICULAR FONT, STYLE, SIZE, OR COLOR.

NO CLAIM IS MADE TO THE EXCLUSIVE RIGHT TO USE "RADIO", APART FROM THE MARK AS SHOWN.

FOR ENTERTAINMENT IN THE NATURE OF LIVE RADIO PERSONALITY PERFORMANCES (U.S. CLS. 100, 101 AND 107).

FRED MANDIR, EXAMINING ATTORNEY

CLASS 41—(Continued).

SN 77-884,784. COMPETITOR GROUP, INC., SAN DIEGO, CA. FILED 12-2-2009.



OWNER OF U.S. REG. NOS. 2,131,333, 3,422,420 AND OTHERS.

NO CLAIM IS MADE TO THE EXCLUSIVE RIGHT TO USE "SAN DIEGO MARATHON & 1/2", APART FROM THE MARK AS SHOWN.

THE MARK CONSISTS OF THE WORDS "ROCK 'N' ROLL SAN DIEGO MARATHON & 1/2" AND OTHER DESIGNS SURROUNDED BY A RECTANGULAR BORDER. A STYLIZED OCEAN WAVE AND PALM TREE ARE LOCATED IN FRONT OF A SETTING SUN WITHIN A SQUARE BORDER.

FOR ENTERTAINMENT IN THE NATURE OF ORGANIZING A SPORTING EVENT IN THE NATURE OF A RUNNING RACE AND RELATED SPORTING AND ENTERTAINMENT EVENTS, NAMELY, ORGANIZING COMMUNITY FAIRS FEATURING VENDOR BOOTHS OF FOOD AND RACE RELATED SPORTING GOODS, AND PLANNING PARTIES AND DINNERS (U.S. CLS. 100, 101 AND 107).

BRENDAN REGAN, EXAMINING ATTORNEY

SN 77-884,822. TUTOR CORPS, SAN FRANCISCO, CA. FILED 12-2-2009.

Tutor Corps

THE MARK CONSISTS OF STANDARD CHARACTERS WITHOUT CLAIM TO ANY PARTICULAR FONT, STYLE, SIZE, OR COLOR.

NO CLAIM IS MADE TO THE EXCLUSIVE RIGHT TO USE "TUTOR", APART FROM THE MARK AS SHOWN.

FOR EDUCATION SERVICES, NAMELY, PROVIDING TUTORING IN THE FIELDS OF ALL ACADEMIC SUBJECTS (U.S. CLS. 100, 101 AND 107).

FIRST USE 0-0-2004; IN COMMERCE 0-0-2004.

ALLISON SCHRODY, EXAMINING ATTORNEY

SN 77-884,851. TUTOR CORPS, SAN FRANCISCO, CA. FILED 12-2-2009.

We take learning personally

THE MARK CONSISTS OF STANDARD CHARACTERS WITHOUT CLAIM TO ANY PARTICULAR FONT, STYLE, SIZE, OR COLOR.

FOR EDUCATION SERVICES, NAMELY, PROVIDING TUTORING IN THE FIELDS OF ALL ACADEMIC SUBJECTS (U.S. CLS. 100, 101 AND 107).

FIRST USE 8-0-2009; IN COMMERCE 8-0-2009.

ALLISON SCHRODY, EXAMINING ATTORNEY

CLASS 41—(Continued).

SN 77-884,853. CHRISTIAN, NIGEL, REMBERT, SC. FILED 12-2-2009.

KURISU

THE MARK CONSISTS OF STANDARD CHARACTERS WITHOUT CLAIM TO ANY PARTICULAR FONT, STYLE, SIZE, OR COLOR.

FOR ENTERTAINMENT, NAMELY, LIVE PERFORMANCES BY A MUSICAL PERFORMER (U.S. CLS. 100, 101 AND 107).

KIM SAITO, EXAMINING ATTORNEY

SN 77-885,177. YENIAR ENTERTAINMENT, LLC, CORONA, NY. FILED 12-3-2009.

DJ FACEMAN

THE MARK CONSISTS OF STANDARD CHARACTERS WITHOUT CLAIM TO ANY PARTICULAR FONT, STYLE, SIZE, OR COLOR.

NO CLAIM IS MADE TO THE EXCLUSIVE RIGHT TO USE "DJ", APART FROM THE MARK AS SHOWN.

"DJ FACEMAN" IDENTIFIES THE STAGE NAME OF TERRANCE RAINEY, A LIVING INDIVIDUAL WHOSE CONSENT IS OF RECORD.

FOR DISC JOCKEYS FOR RADIO BROADCASTS, PARTIES AND SPECIAL EVENTS (U.S. CLS. 100, 101 AND 107).

FIRST USE 10-16-2007; IN COMMERCE 10-16-2007.
LINDA ESTRADA, EXAMINING ATTORNEY

SN 77-885,223. INFANTE, JUAN ANTONIO, CHICAGO, IL. FILED 12-3-2009.

SIMBOLO NORTENO

THE MARK CONSISTS OF STANDARD CHARACTERS WITHOUT CLAIM TO ANY PARTICULAR FONT, STYLE, SIZE, OR COLOR.

THE ENGLISH TRANSLATION OF SIMBOLO NORTENO IN THE MARK IS NORTHERN SYMBOL.

FOR ENTERTAINMENT, NAMELY, LIVE PERFORMANCES BY A MUSICAL BAND (U.S. CLS. 100, 101 AND 107).

FIRST USE 11-1-2007; IN COMMERCE 1-13-2008.
JACQUELINE A. LAVINE, EXAMINING ATTORNEY

CLASS 41—(Continued).

SN 77-885,459. 745 LLC, BOSTON, MA. FILED 12-3-2009.

SEVEN45 STUDIOS

THE MARK CONSISTS OF STANDARD CHARACTERS WITHOUT CLAIM TO ANY PARTICULAR FONT, STYLE, SIZE, OR COLOR.

NO CLAIM IS MADE TO THE EXCLUSIVE RIGHT TO USE "STUDIOS", APART FROM THE MARK AS SHOWN.

FOR ENTERTAINMENT SERVICES, NAMELY, PRODUCTION OF COMPUTER AND VIDEO GAME SOFTWARE; PROVIDING ONLINE VIDEO GAMES ACCESSIBLE OVER A NETWORK BY ONE OR MORE PLAYERS (U.S. CLS. 100, 101 AND 107).

SAMUEL E. SHARPER JR., EXAMINING ATTORNEY

SN 77-885,592. THE MOREY ORGANIZATION, INC., WILDWOOD, NJ. FILED 12-3-2009.

GHOST SHIP

THE MARK CONSISTS OF STANDARD CHARACTERS WITHOUT CLAIM TO ANY PARTICULAR FONT, STYLE, SIZE, OR COLOR.

NO CLAIM IS MADE TO THE EXCLUSIVE RIGHT TO USE "SHIP", APART FROM THE MARK AS SHOWN.

FOR ENTERTAINMENT SERVICES IN THE NATURE OF AN AMUSEMENT PARK RIDE (U.S. CLS. 100, 101 AND 107).

HANNO RITTNER, EXAMINING ATTORNEY

SN 77-885,799. LANPHEER ENTERPRISES, INC., SAN DIEGO, CA. FILED 12-3-2009.

GOTRAILING.COM

THE MARK CONSISTS OF STANDARD CHARACTERS WITHOUT CLAIM TO ANY PARTICULAR FONT, STYLE, SIZE, OR COLOR.

FOR RECREATIONAL SERVICES, NAMELY, PROVIDING INFORMATION ON TRAILS VIA A WEBSITE (U.S. CLS. 100, 101 AND 107).

AMY HELLA, EXAMINING ATTORNEY

CLASS 41—(Continued).

SN 77-886,104. CRANIUM, INC., PAWTUCKET, RI. FILED 12-4-2009.

CRANIUM

THE MARK CONSISTS OF STANDARD CHARACTERS WITHOUT CLAIM TO ANY PARTICULAR FONT, STYLE, SIZE, OR COLOR.

OWNER OF U.S. REG. NOS. 2,267,778, 2,898,339 AND 3,437,955.

FOR ENTERTAINMENT SERVICES, NAMELY, AN ON-GOING TELEVISION GAME SHOW (U.S. CLS. 100, 101 AND 107).

WILLIAM BRECKENFELD, EXAMINING ATTORNEY

SN 77-886,179. AWANA CLUBS INTERNATIONAL, STREAMWOOD, IL. FILED 12-4-2009.

T&T Ultimate Adventure

THE MARK CONSISTS OF STANDARD CHARACTERS WITHOUT CLAIM TO ANY PARTICULAR FONT, STYLE, SIZE, OR COLOR.

FOR EDUCATIONAL SERVICES, NAMELY, PROVIDING AN EDUCATIONAL CHILDREN'S MINISTRY PROGRAM FOR CHRISTIAN CHURCHES AND DISTRIBUTION OF COURSE MATERIAL IN CONNECTION THEREWITH (U.S. CLS. 100, 101 AND 107).

MICHELE SWAIN, EXAMINING ATTORNEY

SN 77-886,213. AWANA CLUBS INTERNATIONAL, STREAMWOOD, IL. FILED 12-4-2009.

T&T Ultimate Challenge

THE MARK CONSISTS OF STANDARD CHARACTERS WITHOUT CLAIM TO ANY PARTICULAR FONT, STYLE, SIZE, OR COLOR.

FOR EDUCATIONAL SERVICES, NAMELY, PROVIDING AN EDUCATIONAL CHILDREN'S MINISTRY PROGRAM FOR CHRISTIAN CHURCHES AND DISTRIBUTION OF COURSE MATERIAL IN CONNECTION THEREWITH (U.S. CLS. 100, 101 AND 107).

MICHELE SWAIN, EXAMINING ATTORNEY

CLASS 41—(Continued).

SN 77-886,247. WHIZZBANG STUDIOS, LLC, NIWOT, CO. FILED 12-4-2009.

Whizzbang Studios

THE MARK CONSISTS OF STANDARD CHARACTERS WITHOUT CLAIM TO ANY PARTICULAR FONT, STYLE, SIZE, OR COLOR.

NO CLAIM IS MADE TO THE EXCLUSIVE RIGHT TO USE "STUDIOS", APART FROM THE MARK AS SHOWN.

FOR VIDEO PRODUCTION SERVICES (U.S. CLS. 100, 101 AND 107).

FIRST USE 5-8-2004; IN COMMERCE 7-27-2004.

LAURA HAMMEL, EXAMINING ATTORNEY

SN 77-886,500. ANTHROPOTENTIALS, INC., CHICAGO, IL. FILED 12-4-2009.

Anthropotentials

THE MARK CONSISTS OF STANDARD CHARACTERS WITHOUT CLAIM TO ANY PARTICULAR FONT, STYLE, SIZE, OR COLOR.

FOR PROFESSIONAL COACHING SERVICES IN THE FIELD OF PERSONAL LEADERSHIP AND SPIRITUAL GROWTH (U.S. CLS. 100, 101 AND 107).

ANNE FARRELL, EXAMINING ATTORNEY

SN 77-886,583. ID-RELEASE, LLC, DBA WIN-INITIATIVE, NEW YORK, NY. FILED 12-4-2009.



THE MARK CONSISTS OF THREE LINES OF STYLIZED TEXT SPELLING "10 BEST 10"; THE NUMBER "10" FOLLOWED BY THE WORD "BEST", FOLLOWED BY THE NUMBER "10".

FOR ENTERTAINMENT SERVICES IN THE NATURE OF INTERNATIONAL PHOTOGRAPHY COMPETITIONS (U.S. CLS. 100, 101 AND 107).

FIRST USE 7-0-2009; IN COMMERCE 7-0-2009.

KIM SAITO, EXAMINING ATTORNEY

CLASS 41—(Continued).

SN 77-886,728. BIG BAD BOO PRODUCTIONS, INC., NEW YORK, NY. FILED 12-4-2009.

1001 NIGHTS

THE MARK CONSISTS OF STANDARD CHARACTERS WITHOUT CLAIM TO ANY PARTICULAR FONT, STYLE, SIZE, OR COLOR.

FOR ENTERTAINMENT AND EDUCATION SERVICES, NAMELY, THE PRODUCTION, PUBLICATION AND DISTRIBUTION OF ONGOING TELEVISION PROGRAMS, MOVIES AND MUSICAL PROGRAMS FEATURING ANIMATED, CARTOON AND/OR COMIC BOOK CHARACTERS; PROVIDING NON-DOWNLOADABLE ONLINE GAMES FEATURING ANIMATED, CARTOON AND/OR COMIC BOOK CHARACTERS; PROVIDING A WEBSITE DISPLAYING INFORMATION REGARDING TELEVISION PROGRAMS, MOVIES, MUSIC AND BOOKS FEATURING ANIMATED, CARTOON AND/OR COMIC BOOK CHARACTERS (U.S. CLS. 100, 101 AND 107).

FIRST USE 10-5-2009; IN COMMERCE 10-5-2009.
JOHN WILKE, EXAMINING ATTORNEY

SN 77-886,753. BIG BAD BOO PRODUCTIONS, INC., NEW YORK, NY. FILED 12-4-2009.



THE MARK CONSISTS OF THE STYLIZED WORDS "1001 NIGHTS" WITH CURVED LINES BENEATH "1001" AND "HTS", ONE DIAMOND BEFORE "1001", ONE DIAMOND AFTER "NIGHTS" AND TWO DIAMONDS OVER THE "G".

FOR ENTERTAINMENT AND EDUCATION SERVICES, NAMELY, THE PRODUCTION, PUBLICATION AND DISTRIBUTION OF ONGOING TELEVISION PROGRAMS, MOVIES AND MUSICAL PROGRAMS FEATURING ANIMATED, CARTOON AND/OR COMIC BOOK CHARACTERS; PROVIDING NON-DOWNLOADABLE ONLINE GAMES FEATURING ANIMATED, CARTOON AND/OR COMIC BOOK CHARACTERS; PROVIDING A WEBSITE DISPLAYING INFORMATION REGARDING TELEVISION PROGRAMS, MOVIES, MUSIC AND BOOKS FEATURING ANIMATED, CARTOON AND/OR COMIC BOOK CHARACTERS (U.S. CLS. 100, 101 AND 107).

FIRST USE 10-5-2009; IN COMMERCE 10-5-2009.
JOHN WILKE, EXAMINING ATTORNEY

CLASS 41—(Continued).

SN 77-886,908. SMALL DOG ELECTRONICS, INC., WAITS-FIELD, VT. FILED 12-4-2009.

DEAL RETRIEVER

THE MARK CONSISTS OF STANDARD CHARACTERS WITHOUT CLAIM TO ANY PARTICULAR FONT, STYLE, SIZE, OR COLOR.

FOR ON-LINE ELECTRONIC NEWSLETTERS DELIVERED BY EMAIL IN THE FIELD OF AUDIO AND VIDEO PRODUCTS, COMPUTER COMPONENTS, COMPUTER PARTS, COMPUTERS, COMPUTER SERVICES, ELECTRONIC PARTS, ELECTRONIC ACCESSORIES, ELECTRONICS, NETWORKING; PROVIDING NEWSLETTERS IN THE FIELD OF AUDIO AND VIDEO PRODUCTS, COMPUTER COMPONENTS, COMPUTER PARTS, COMPUTERS, COMPUTER SERVICES, ELECTRONIC PARTS, ELECTRONIC ACCESSORIES, ELECTRONICS, NETWORKING VIA E-MAIL; PROVIDING ON-LINE NEWSLETTERS IN THE FIELD OF AUDIO AND VIDEO PRODUCTS, COMPUTER COMPONENTS, COMPUTER PARTS, COMPUTERS, COMPUTER SERVICES, ELECTRONIC PARTS, ELECTRONIC ACCESSORIES, ELECTRONICS, NETWORKING (U.S. CLS. 100, 101 AND 107).

FIRST USE 11-23-2009; IN COMMERCE 11-23-2009.
REBECCA EISINGER, EXAMINING ATTORNEY

SN 77-887,036. BRIAN O'TOOLE, DBA CAMBRIAN CREATIVE, HOBOKEN, NJ. FILED 12-5-2009.



THE COLOR(S) BLUE, TURQUOISE, WHITE, BLACK IS/ ARE CLAIMED AS A FEATURE OF THE MARK.

THE MARK CONSISTS OF A REPRESENTATION OF A PREHISTORIC FOSSILIZED CREATURE IN TURQUOISE WITH THE LITERAL ELEMENT "CAMBRIAN CREATIVE" APPEARING ACROSS THE CENTER IN WHITE WITH A LIGHT SOURCE IN WHITE EMANATING FROM THE CENTER OF THE SECOND "A" IN "CAMBRIAN," ALL APPEARING ON A BLUE, WHITE AND TURQUOISE RECTANGULAR BACKGROUND WITH SMALL SPECS APPEARING AND BLACK AROUND THE UPPER RIGHT AND LEFT CORNERS OF THE MARK'S RECTANGULAR BACKGROUND.

FOR PRODUCTION OF TELEVISION PROGRAMS (U.S. CLS. 100, 101 AND 107).

THOMAS MANOR, EXAMINING ATTORNEY

CLASS 41—(Continued).

SN 77-887,182. MARIE, SYLVIA, SEBASTOPOL, CA. FILED 12-6-2009.



NO CLAIM IS MADE TO THE EXCLUSIVE RIGHT TO USE "HARMONY", APART FROM THE MARK AS SHOWN. THE COLOR(S) GOLD, GREEN, PURPLE, RED, PINK AND MAGENTA IS/ARE CLAIMED AS A FEATURE OF THE MARK.

THE MARK CONSISTS OF A PINK AND RED HEART, WITH A GREEN BORDER, A GOLD SUN ABOVE THE HEART, 3 CONNECTED GREEN CURVED LINES BELOW THE HEART, AND 2 PURPLE CURVED LINES EXTENDING ABOVE, BELOW AND THROUGH THE HEART, ALL TO THE LEFT OF STYLIZED WORDING "EARTHLIGHT HARMONY" IN MAGENTA.

FOR EDUCATIONAL SERVICES, NAMELY, CONDUCTING WORKSHOPS, SEMINARS, AND RETREATS IN THE FIELD OF LIVING IN HARMONY WITH ONESELF AND NATURE AND DISTRIBUTION OF TRAINING MATERIAL IN CONNECTION THEREWITH (U.S. CLS. 100, 101 AND 107).

FIRST USE 9-19-2007; IN COMMERCE 9-19-2007.
NICHOLAS COLEMAN, EXAMINING ATTORNEY

SN 77-887,299. HUNTER'S POINT GOLF CLUB, LLC, NAMPA, ID. FILED 12-7-2009.



HUNTER'S POINT

THE MARK CONSISTS OF A DRAWING OF AN ELK STANDING IN FRONT OF A GOLF COURSE.

FOR GOLF CLUB SERVICES, GOLF COURSES (U.S. CLS. 100, 101 AND 107).

FIRST USE 6-30-2006; IN COMMERCE 6-30-2006.
CHRIS WELLS, EXAMINING ATTORNEY

CLASS 41—(Continued).

SN 77-887,311. HIT ENTERTAINMENT LIMITED, LONDON, UNITED KINGDOM, FILED 12-7-2009.



OWNER OF U.S. REG. NO. 3,667,928.

NO CLAIM IS MADE TO THE EXCLUSIVE RIGHT TO USE "CLUB", APART FROM THE MARK AS SHOWN.

THE COLOR(S) RED, YELLOW, BLUE, WHITE, AND LIGHT BLUE IS/ARE CLAIMED AS A FEATURE OF THE MARK.

THE MARK CONSISTS OF THE DESIGN OF A THREE DIMENSIONAL BLOCK WITH THE LETTERS "H", "I" AND "T" ON DIFFERENT FACES OF THE BLOCK THE TOP FACE OF THE BLOCK IS RED WITH A WHITE "H," THE LEFT FACE IS YELLOW WITH A BLUE "I," AND THE RIGHT FACE IS BLUE WITH A WHITE "T." TO THE RIGHT OF THE BLOCK IS A YELLOW RECTANGULAR FRAME, AND INSIDE THE FRAME IS PREDOMINANTLY THE COLOR LIGHT BLUE WITH A COLOR GRADIENT FROM DARK BLUE TO WHITE. THE WORD "THE" IS IN WHITE, THE WORD "LITTLE" IS IN BLUE, THE WORD "BIG" IS IN RED, WITH THE DOT OF THE "I" FORMED BY A DESIGN OF A YELLOW SUN, AND THE WORD "CLUB" IS IN BLUE.

FOR ENTERTAINMENT SERVICES, NAMELY, THEME PARK SERVICES; PRESENTATION OF LIVE SHOW PERFORMANCES FOR LIVE AUDIENCES, AND PERSONAL APPEARANCES BY COSTUMED CHARACTERS; AN ONGOING SERIES OF TELEVISION PROGRAMS FOR CHILDREN FEATURING CHILDREN'S ENTERTAINMENT; PROVISION OF EDUCATION AND ENTERTAINMENT FOR CHILDREN BY MEANS OF THE INTERNET, NAMELY, PROVIDING A WEBSITE FEATURING EDUCATIONAL GAMES IN THE FIELDS OF LANGUAGE, ALPHABET, NUMBERS, COLORS, SPATIAL RELATIONSHIPS, MANNERS, VOCABULARY, AND/OR MATH, AND INFORMATION ABOUT CHILDREN'S TELEVISION PROGRAMS; FAN CLUBS (U.S. CLS. 100, 101 AND 107).

KRISTIN CARLSON, EXAMINING ATTORNEY

SN 77-887,358. MATYUSHENKO, VLADIMIR, EL SEGUNDO, CA. FILED 12-7-2009.

THE JANITOR

THE MARK CONSISTS OF STANDARD CHARACTERS WITHOUT CLAIM TO ANY PARTICULAR FONT, STYLE, SIZE, OR COLOR.

FOR ENTERTAINMENT SERVICES, NAMELY, PARTICIPATION IN FIGHTING COMPETITIONS (U.S. CLS. 100, 101 AND 107).

FIRST USE 9-5-1997; IN COMMERCE 9-5-1997.
JOHN E. MICHOS, EXAMINING ATTORNEY

CLASS 41—(Continued).

SN 77-887,368. TIMOTHY P. HOLMES, SARANAC LAKE, NY. FILED 12-7-2009.

Adirondack Innovation Network

THE MARK CONSISTS OF STANDARD CHARACTERS WITHOUT CLAIM TO ANY PARTICULAR FONT, STYLE, SIZE, OR COLOR.

NO CLAIM IS MADE TO THE EXCLUSIVE RIGHT TO USE "ADIRONDACK", APART FROM THE MARK AS SHOWN.

FOR EDUCATIONAL SERVICES, NAMELY, PROVIDING TRAINING AND COURSES OF INSTRUCTION IN THE FIELD OF ENTREPRENEURIAL LEADERSHIP, MOTIVATION AND BRAINSTORMING (U.S. CLS. 100, 101 AND 107).

JOHN WILKE, EXAMINING ATTORNEY

SN 77-887,412. LOPEZ, MANUEL, BROOKLYN, NY. FILED 12-7-2009.

THE PEACOCK'S TAIL

THE MARK CONSISTS OF STANDARD CHARACTERS WITHOUT CLAIM TO ANY PARTICULAR FONT, STYLE, SIZE, OR COLOR.

FOR ENTERTAINMENT IN THE NATURE OF LIVE PERFORMANCES BY A MUSIC BAND (U.S. CLS. 100, 101 AND 107).

ALYSSA STEEL, EXAMINING ATTORNEY

CLASS 41—(Continued).

SN 77-887,418. GUINAN, TIM, GERMANTOWN, MD. FILED 12-7-2009.



THE MARK CONSISTS OF A BOX SURROUNDING A STYLIZED FIGURE OF A SQUATTING MAN PULLING A CHAIN, WITH THE WORD "RESULTS" BELOW THE MAN AND TO THE LEFT OF THE STYLIZED UPRIGHT WORD "UNLEASHED".

FOR PROVIDING ASSISTANCE, PERSONAL TRAINING AND PHYSICAL FITNESS CONSULTATION TO CORPORATE CLIENTS TO HELP THEIR EMPLOYEES MAKE PHYSICAL FITNESS, STRENGTH, CONDITIONING, AND EXERCISE ALTERATIONS IN THEIR DAILY LIVING; PROVIDING ASSISTANCE, PERSONAL TRAINING AND PHYSICAL FITNESS CONSULTATION TO INDIVIDUALS TO HELP THEM MAKE PHYSICAL FITNESS, STRENGTH, CONDITIONING, AND EXERCISE IMPROVEMENT IN THEIR DAILY LIVING (U.S. CLS. 100, 101 AND 107).

MARC LEIPZIG, EXAMINING ATTORNEY

SN 77-887,437. HOBBY, AUSTIN, PANAMA CITY BEACH, FL. FILED 12-7-2009.

FANATTIC

THE MARK CONSISTS OF STANDARD CHARACTERS WITHOUT CLAIM TO ANY PARTICULAR FONT, STYLE, SIZE, OR COLOR.

FOR ENTERTAINMENT SERVICES IN THE NATURE OF LIVE MUSICAL PERFORMANCES; ENTERTAINMENT SERVICES, NAMELY, LIVE, TELEVISED AND MOVIE APPEARANCES BY A PROFESSIONAL ENTERTAINER (U.S. CLS. 100, 101 AND 107).

TAMARA FRAZIER, EXAMINING ATTORNEY

CLASS 41—(Continued).

SN 77-887,464. JEWISH VOCATIONAL SERVICE OF METROWEST, INC., EAST ORANGE, NJ. FILED 12-7-2009.



NO CLAIM IS MADE TO THE EXCLUSIVE RIGHT TO USE "EXPO", APART FROM THE MARK AS SHOWN.

THE MARK CONSISTS OF THE WORDS "JVS", "CREATIVE", "MATURITY", AND "EXPO" IN ARROWS ON A SIGN POST.

FOR EDUCATIONAL SERVICES DIRECTED TO MATURE ADULTS, NAMELY, DEVELOPING, ARRANGING AND CONDUCTING SEMINARS, EDUCATIONAL SESSIONS, CONFERENCES, WORKSHOPS, EDUCATIONAL EXPOSITIONS, AND EDUCATIONAL PROGRAMS IN THE FIELDS OF RETIREMENT PLANNING, LIFESTYLE, PERSONAL FINANCE, HEALTH, NUTRITION, WELLNESS, VOLUNTEERISM, CAREER DEVELOPMENT, VOCATIONAL TRAINING, NAMELY, JOB SEEKING SKILLS TRAINING, LEISURE ACTIVITIES AND HOBBIES, RELATIONSHIPS, EXERCISE, AND OTHER AREAS OF CONCERN TO MATURE ADULTS AND DISTRIBUTION OF PROGRAM MATERIAL IN CONNECTION THEREWITH; PROVIDING VOCATIONAL GUIDANCE, VOCATIONAL TRAINING, NAMELY, JOB SEEKING SKILLS TRAINING, AND CAREER COUNSELING TO MATURE ADULTS (U.S. CLS. 100, 101 AND 107).

FIRST USE 10-0-2007; IN COMMERCE 10-0-2007.
LINDA ESTRADA, EXAMINING ATTORNEY

SN 77-887,544. THE CORPORATION FOR THE DISSEMINATION OF TEACHINGS OF VALUE, LAFAYETTE, CO. FILED 12-7-2009.

OES

THE MARK CONSISTS OF STANDARD CHARACTERS WITHOUT CLAIM TO ANY PARTICULAR FONT, STYLE, SIZE, OR COLOR.

FOR EDUCATION SERVICES, NAMELY, PROVIDING CLASSES, SEMINARS, AND WORKSHOPS IN THE FIELD OF WHOLISTIC HEALING, THERAPY AND PERSONAL-DEVELOPMENT (U.S. CLS. 100, 101 AND 107).

FIRST USE 10-15-2009; IN COMMERCE 10-15-2009.
ERIN FALK, EXAMINING ATTORNEY

CLASS 41—(Continued).

SN 77-887,585. DONMAR WAREHOUSE PROJECTS LIMITED, LONDON, UNITED KINGDOM, FILED 12-7-2009.

DONMAR

THE MARK CONSISTS OF STANDARD CHARACTERS WITHOUT CLAIM TO ANY PARTICULAR FONT, STYLE, SIZE, OR COLOR.

FOR ENTERTAINMENT SERVICES, NAMELY, PRESENTING LIVE THEATER PERFORMANCES (U.S. CLS. 100, 101 AND 107).

FIRST USE 12-1-1998; IN COMMERCE 12-1-1998.
ERIN FALK, EXAMINING ATTORNEY

SN 77-887,686. SHE SEZ HOLDINGS, LOGANVILLE, GA. FILED 12-7-2009.

Righting Wrongs

THE MARK CONSISTS OF STANDARD CHARACTERS WITHOUT CLAIM TO ANY PARTICULAR FONT, STYLE, SIZE, OR COLOR.

FOR EDUCATIONAL AND ENTERTAINMENT SERVICES, NAMELY, A CONTINUING PROGRAM ABOUT FORGIVENESS ACCESSIBLE BY RADIO, TELEVISION, SATELLITE, AUDIO, VIDEO AND COMPUTER NETWORKS (U.S. CLS. 100, 101 AND 107).

WENDY GOODMAN, EXAMINING ATTORNEY

SN 77-887,749. BRIAN WILLIS, PHOENIX, AZ. FILED 12-7-2009.

Gofetch & Barkalott

THE MARK CONSISTS OF STANDARD CHARACTERS WITHOUT CLAIM TO ANY PARTICULAR FONT, STYLE, SIZE, OR COLOR.

FOR PROVIDING ANIMAL EXERCISE SERVICES; PROVIDING INFORMATION AND ADVICE IN THE FIELD OF PET TRAINING (U.S. CLS. 100, 101 AND 107).

FIRST USE 10-31-2007; IN COMMERCE 10-31-2007.
C. DIONNE CLYBURN, EXAMINING ATTORNEY

CLASS 41—(Continued).

SN 77-887,932. PEARSON EDUCATION, INC., UPPER SADDLE RIVER, NJ. FILED 12-7-2009.



OWNER OF U.S. REG. NOS. 3,660,289, 3,665,997 AND OTHERS.

THE MARK CONSISTS OF THE WORDS "MASTERINGA&P" WITH TWO ARROWS ROTATING IN A CLOCKWISE MOTION CONNECTING THE WORDS "MASTERING" AND "A&P".

FOR EDUCATIONAL SERVICES, NAMELY, DEVELOPMENT AND DISSEMINATION OF EDUCATIONAL MATERIALS OF OTHERS IN THE FIELD OF ANATOMY AND PHYSIOLOGY TO TEACHERS, PROFESSORS, AND THEIR STUDENTS VIA THE INTERNET, NAMELY, DIGITAL TEXTBOOKS, INSTRUCTORS MANUALS, SUPPLEMENTARY READING MATERIALS, INSTRUCTIONAL MATERIALS IN THE NATURE OF SELF-ASSESSMENT AND STUDY TOOLS FOR STUDENTS, HOMEWORK ASSIGNMENTS, COURSE ASSESSMENT AND COURSE MANAGEMENT MATERIALS AS WELL AS DIAGNOSTIC MATERIALS FOR USE IN CONNECTION WITH THE STUDY OF ANATOMY AND PHYSIOLOGY (U.S. CLS. 100, 101 AND 107).

SUSAN RICHARDS, EXAMINING ATTORNEY

SN 77-887,983. COMPETITOR GROUP, INC., SAN DIEGO, CA. FILED 12-7-2009.



OWNER OF U.S. REG. NO. 3,698,614.
THE MARK CONSISTS OF A STYLIZED GUITAR SURROUNDED BY AN INCOMPLETE CIRCLE.

FOR ENTERTAINMENT IN THE NATURE OF ORGANIZING A SPORTING EVENT IN THE NATURE OF A RUNNING RACE AND RELATED SPORTING AND ENTERTAINMENT EVENTS, NAMELY, ORGANIZING COMMUNITY FAIRS FEATURING VENDOR BOOTHS OF FOOD AND RACE RELATED SPORTING GOODS, AND PLANNING PARTIES AND DINNERS (U.S. CLS. 100, 101 AND 107).

FIRST USE 4-1-2009; IN COMMERCE 4-1-2009.
BRENDAN REGAN, EXAMINING ATTORNEY

CLASS 41—(Continued).

SN 77-888,012. DOMINICAN KING INC, GREENSBORO, NC. FILED 12-7-2009.



THE MARK CONSISTS OF THE STYLIZED TEXT "DS".
FOR ENTERTAINMENT SERVICES IN THE NATURE OF LIVE MUSICAL PERFORMANCES (U.S. CLS. 100, 101 AND 107).

MICHAEL WEBSTER, EXAMINING ATTORNEY

SN 77-888,047. USP LLC, FORMERLY USP, INC., OCEANSIDE, CA, CA. FILED 12-7-2009.

HAIRDRESSER POWER

THE MARK CONSISTS OF STANDARD CHARACTERS WITHOUT CLAIM TO ANY PARTICULAR FONT, STYLE, SIZE, OR COLOR.

OWNER OF U.S. REG. NO. 2,958,656.

NO CLAIM IS MADE TO THE EXCLUSIVE RIGHT TO USE "HAIRDRESSER", APART FROM THE MARK AS SHOWN.

FOR EDUCATIONAL SERVICES, NAMELY, TRAINING BEAUTICIANS IN THE ART OF HAIR CUTS, HAIR STYLES, PERMS AND COLOR, CONDUCTING WORKSHOPS AND SEMINARS IN THE FIELD OF COSMETOLOGY; PROVIDING ONLINE INFORMATION IN THE FIELD OF TRAINING FOR COSMETOLOGISTS; PUBLICATION OF BOOKS AND MANUALS IN THE FIELD OF BUSINESS AND COSMETOLOGY; CONDUCTING IN-SALON CLASSES IN THE FIELD OF COSMETOLOGY (U.S. CLS. 100, 101 AND 107).

KEVIN DINALLO, EXAMINING ATTORNEY

SN 77-888,089. LINZAC, LLC, SCOTTSDALE, AZ. FILED 12-7-2009.

YOUR LOVE REMEMBERED

THE MARK CONSISTS OF STANDARD CHARACTERS WITHOUT CLAIM TO ANY PARTICULAR FONT, STYLE, SIZE, OR COLOR.

FOR AUDIO AND VIDEO RECORDING SERVICES; MULTIMEDIA ENTERTAINMENT SERVICES IN THE NATURE OF DEVELOPMENT, PRODUCTION AND POST-PRODUCTION SERVICES IN THE FIELDS OF VIDEO AND FILMS; VIDEO EDITING; VIDEO PRODUCTION SERVICES; VIDEO TAPE RECORDING FOR OTHERS (U.S. CLS. 100, 101 AND 107).

FIRST USE 8-0-2009; IN COMMERCE 11-6-2009.

KATHERINE M. DUBRAY, EXAMINING ATTORNEY

CLASS 41—(Continued).

SN 77-888,105. PQR2, MONTICELLO, MN. FILED 12-7-2009.

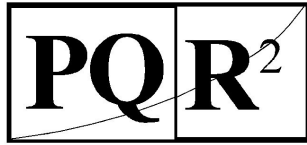

THE MARK CONSISTS OF A RECTANGLE AND A SQUARE NEXT TO EACH OTHER. ON THE RECTANGLE THERE IS THE STYLIZED TEXT "PQ" AND ON THE SQUARE THERE IS THE STYLIZED TEXT "R2". A LINE CROSSES FROM ONE CORNER OF THE RECTANGLE AND THE OTHER CORNER OF THE SQUARE.

FOR EDUCATIONAL SERVICES, NAMELY, CONDUCTING CLASSES, SEMINARS, CONFERENCES AND WORKSHOPS IN THE FIELD OF SALES PROCESS METHODOLOGY AND DISTRIBUTION OF COURSE MATERIAL IN CONNECTION THEREWITH (U.S. CLS. 100, 101 AND 107).

FIRST USE 1-1-2009; IN COMMERCE 1-1-2009.
MARIAM MAHMOUDI, EXAMINING ATTORNEY

SN 77-888,195. FLUID MEDIA INC., PEACHTREE CITY, GA.
FILED 12-8-2009.

Baseballisms

THE MARK CONSISTS OF STANDARD CHARACTERS WITHOUT CLAIM TO ANY PARTICULAR FONT, STYLE, SIZE, OR COLOR.

FOR ON-LINE JOURNALS, NAMELY, BLOGS FEATURING BASEBALL (U.S. CLS. 100, 101 AND 107).

FIRST USE 1-8-2008; IN COMMERCE 3-2-2008.
LEIGH CAROLINE CASE, EXAMINING ATTORNEY

SN 77-888,408. THE CULINARY INSTITUTE OF AMERICA,
HYDE PARK, NY. FILED 12-8-2009.

FOOD IS LIFE

THE MARK CONSISTS OF STANDARD CHARACTERS WITHOUT CLAIM TO ANY PARTICULAR FONT, STYLE, SIZE, OR COLOR.

FOR EDUCATIONAL SERVICES, NAMELY, PROVIDING COURSES OF INSTRUCTION AT THE COLLEGE LEVEL WHICH OFFER BACHELOR'S AND ASSOCIATES DEGREES IN CULINARY ARTS, BAKING AND PASTRY ARTS (U.S. CLS. 100, 101 AND 107).

JENNIFER HETU, EXAMINING ATTORNEY

CLASS 41—(Continued).

SN 77-888,420. TERGAR INTERNATIONAL, AKA RIME FOUNDATION, HOPKINS, MN. FILED 12-8-2009.

Joy of Living

THE MARK CONSISTS OF STANDARD CHARACTERS WITHOUT CLAIM TO ANY PARTICULAR FONT, STYLE, SIZE, OR COLOR.

FOR MEDITATION TRAINING (U.S. CLS. 100, 101 AND 107).

FIRST USE 9-30-2009; IN COMMERCE 9-30-2009.
JOHN DWYER, EXAMINING ATTORNEY

SN 77-888,421. THE CULINARY INSTITUTE OF AMERICA,
HYDE PARK, NY. FILED 12-8-2009.

FOOD IS LIFE CREATE AND SAVOR YOURS

THE MARK CONSISTS OF STANDARD CHARACTERS WITHOUT CLAIM TO ANY PARTICULAR FONT, STYLE, SIZE, OR COLOR.

FOR EDUCATIONAL SERVICES, NAMELY, PROVIDING COURSES OF INSTRUCTION AT THE COLLEGE LEVEL WHICH OFFER BACHELOR'S AND ASSOCIATES DEGREES IN CULINARY ARTS, BAKING AND PASTRY ARTS (U.S. CLS. 100, 101 AND 107).

JENNIFER HETU, EXAMINING ATTORNEY

SN 77-888,422. LATIN RHYTHMS DANCE, LTD., CHICAGO,
IL. FILED 12-8-2009.

LIVE LOVE DANCE

THE MARK CONSISTS OF STANDARD CHARACTERS WITHOUT CLAIM TO ANY PARTICULAR FONT, STYLE, SIZE, OR COLOR.

NO CLAIM IS MADE TO THE EXCLUSIVE RIGHT TO USE "DANCE", APART FROM THE MARK AS SHOWN.

FOR DANCE INSTRUCTION, ENTERTAINMENT SERVICES IN THE NATURE OF DANCE PERFORMANCES, DANCE STUDIOS (U.S. CLS. 100, 101 AND 107).

JENNIFER HETU, EXAMINING ATTORNEY

CLASS 41—(Continued).

SN 77-888,628. PEARSON EDUCATION, INC., UPPER SADDLE RIVER, NJ. FILED 12-8-2009.

Mastering  MICROBIOLOGY

OWNER OF U.S. REG. NOS. 3,660,289, 3,665,997 AND OTHERS.

THE MARK CONSISTS OF THE WORDS "MASTERING-MICROBIOLOGY" WITH TWO ARROWS ROTATING IN A CLOCK-WISE MOTION CONNECTING THE WORDS "MASTERING" AND "MICROBIOLOGY".

FOR EDUCATIONAL SERVICES, NAMELY, DEVELOPMENT AND DISSEMINATION OF EDUCATIONAL MATERIALS OF OTHERS IN THE FIELD OF MICROBIOLOGY TO TEACHERS, PROFESSORS, AND THEIR STUDENTS VIA THE INTERNET, NAMELY, DIGITAL TEXTBOOKS, INSTRUCTORS MANUALS, SUPPLEMENTARY READING MATERIALS, INSTRUCTIONAL MATERIALS IN THE NATURE OF SELF-ASSESSMENT AND STUDY TOOLS FOR STUDENTS, HOMEWORK ASSIGNMENTS, COURSE ASSESSMENT AND COURSE MANAGEMENT MATERIALS AS WELL AS DIAGNOSTIC MATERIALS FOR USE IN CONNECTION WITH THE STUDY OF MICROBIOLOGY (U.S. CLS. 100, 101 AND 107).

SUSAN RICHARDS, EXAMINING ATTORNEY

SN 77-888,723. MUNCY, JEFF, VAN NUYS, CA. AND TORRES, MICHAEL, VAN NUYS, CA. AND JAMES, MARY, VAN NUYS, CA. FILED 12-8-2009.

GRANOLA ROAD

THE MARK CONSISTS OF STANDARD CHARACTERS WITHOUT CLAIM TO ANY PARTICULAR FONT, STYLE, SIZE, OR COLOR.

FOR ENTERTAINMENT SERVICES IN THE NATURE OF ON-GOING TELEVISION PROGRAMS IN THE FIELD OF CHILDREN'S ENTERTAINMENT (U.S. CLS. 100, 101 AND 107).

CHERYL CLAYTON, EXAMINING ATTORNEY

CLASS 41—(Continued).

SN 77-888,730. EIDOS EDUCATION, HIGHLANDS, NJ. FILED 12-8-2009.

SENSE 

THE MARK CONSISTS OF THE STYLIZED TEXT "SENSE IT" WITH "IT" INSIDE A CIRCLE WITH TWO CONCENTRIC SEMI-CIRCLES RADIATING OUT OF IT.

FOR EDUCATION SERVICES, NAMELY, PROVIDING LIVE AND ON-LINE CLASSES, SEMINARS, WORKSHOPS IN THE FIELD OF SCIENCE, TECHNOLOGY, ENGINEERING AND MATHEMATICS; EDUCATIONAL SERVICES, NAMELY, DEVELOPING CURRICULUM FOR OTHERS IN THE FIELD OF SCIENCE, TECHNOLOGY, ENGINEERING AND MATHEMATICS (U.S. CLS. 100, 101 AND 107).

CHERYL CLAYTON, EXAMINING ATTORNEY

SN 77-888,795. FUSIONGROOVIN, LLC, BEDFORD, NY. FILED 12-8-2009.

**It's smokin' fusion, with
a groove!**

THE MARK CONSISTS OF STANDARD CHARACTERS WITHOUT CLAIM TO ANY PARTICULAR FONT, STYLE, SIZE, OR COLOR.

FOR ENTERTAINMENT SERVICES, NAMELY, PROVIDING NONDOWNLOADABLE PRERECORDED MUSIC, INFORMATION IN THE FIELD OF MUSIC, AND COMMENTARY AND ARTICLES ABOUT MUSIC, ALL ON-LINE VIA A GLOBAL COMPUTER NETWORK (U.S. CLS. 100, 101 AND 107).

FIRST USE 3-15-2002; IN COMMERCE 3-15-2002.
WENDY GOODMAN, EXAMINING ATTORNEY

SN 77-888,798. EDUCATIONAL INFORMATION CORPORATION, DBA WCPE RADIO, WAKE FOREST, NC. FILED 12-8-2009.

Sleepers, Awake!

THE MARK CONSISTS OF STANDARD CHARACTERS WITHOUT CLAIM TO ANY PARTICULAR FONT, STYLE, SIZE, OR COLOR.

FOR ENTERTAINMENT SERVICES, NAMELY, PROVIDING A CONTINUING RADIO PROGRAM FEATURING PRIMARILY MUSIC, WITH COMMENTARY AND NEWS, DELIVERED BY CABLECAST, SATELLITE TRANSMISSION, AND A GLOBAL COMPUTER NETWORK (U.S. CLS. 100, 101 AND 107).

FIRST USE 0-0-1982; IN COMMERCE 0-0-1985.
CARYN GLASSER, EXAMINING ATTORNEY

CLASS 41—(Continued).

SN 77-888,826. HEAVEN & EARTH PRODUCTIONS, MANHATTAN BEACH, CA. FILED 12-8-2009.



NO CLAIM IS MADE TO THE EXCLUSIVE RIGHT TO USE "PRODUCTIONS", APART FROM THE MARK AS SHOWN.

THE COLOR(S) BLACK, WHITE, BLUE IS/ARE CLAIMED AS A FEATURE OF THE MARK.

THE MARK CONSISTS OF LITERAL ELEMENT "HEAVEN & EARTH PRODUCTIONS" IN FONT OF TIMES NEW ROMAN, BOLD, BLACK, WITHIN BLACK AND WHITE FILMSTRIP BORDER OVER BACKGROUND OF BLUE SKY WITH WHITE CLOUDS.

FOR AUDIO AND VIDEO RECORDING SERVICES; FILM AND VIDEO FILM PRODUCTION; FILM AND VIDEO PRODUCTION CONSULTING SERVICES; MEDIA PRODUCTION SERVICES, NAMELY, VIDEO AND FILM PRODUCTION; PHOTOGRAPHIC AND VIDEO SERVICES, NAMELY, PHOTOGRAPHIC AND VIDEO CAPTURE (U.S. CLS. 100, 101 AND 107).

H. M. FISHER, EXAMINING ATTORNEY

CLASS 41—(Continued).

SN 77-889,089. STARLIGHT CHILDREN'S FOUNDATION, LOS ANGELES, CA. FILED 12-8-2009.

STARLITE SITE

THE MARK CONSISTS OF STANDARD CHARACTERS WITHOUT CLAIM TO ANY PARTICULAR FONT, STYLE, SIZE, OR COLOR.

OWNER OF U.S. REG. NOS. 3,231,708, 3,235,404 AND OTHERS.

NO CLAIM IS MADE TO THE EXCLUSIVE RIGHT TO USE "SITE", APART FROM THE MARK AS SHOWN.

FOR PROVIDING FACILITIES FOR RECREATIONAL ACTIVITIES, NAMELY, PROVIDING ROOMS AND OTHER ENVIRONMENTS FOR SERIOUSLY ILL CHILDREN AND THEIR FAMILIES AT HOSPITALS AND OUT-PATIENT MEDICAL FACILITIES FOR RELAXATION AND ENTERTAINMENT (U.S. CLS. 100, 101 AND 107).

FIRST USE 1-1-2000; IN COMMERCE 1-1-2000.
STEPHEN AQUILA, EXAMINING ATTORNEY

SN 77-889,108. T2 TRAINING, INC., VIRGINIA BEACH, VA. FILED 12-8-2009.



THE MARK CONSISTS OF THE LETTER "T" FOLLOWED BY THE NUMBER "2" IN SUPERSCRIPIT AT TOP RIGHT CORNER, AS IN "T SQUARED." THE "T" IS FULLY ENCOMPASSED BY A CIRCLE, BUT THE CIRCLE IS BROKEN BY THE "2" WHICH LAYS PARTIALLY INSIDE AND PARTIALLY OUTSIDE THE CIRCLE.

FOR EDUCATIONAL SERVICES, NAMELY, CONDUCTING SEMINARS AND WORKSHOPS FEATURING GAMES, DRILLS, AND EXERCISES IN THE FIELD OF OPERATIONAL SERVICES TO THE MILITARY, DEPARTMENT OF DEFENSE, AND CIVILIAN CORPORATIONS, IN SUPPORT OF FIGHTING THE WAR ON TERRORISM AND DISTRIBUTION OF TRAINING MATERIAL IN CONNECTION THEREWITH; TRAINING SERVICES IN THE FIELD OF THREAT ASSESSMENT, READINESS EXERCISES, CYBER TERRORISM AND MARITIME SECURITY (U.S. CLS. 100, 101 AND 107).

FIRST USE 2-0-2009; IN COMMERCE 2-0-2009.
TRACY WHITTAKER-BROWN, EXAMINING ATTORNEY

SN 77-888,850. NOROOZ PRODUCTIONS, LLC, NEW YORK, NY. FILED 12-8-2009.



OWNER OF U.S. REG. NO. 3,583,755.
THE MARK CONSISTS OF THE STYLIZED WORDS "MIXED NUTZ".

FOR ENTERTAINMENT SERVICES IN THE NATURE OF ON-GOING TELEVISION PROGRAMS IN THE FIELD OF CHILDREN'S ENTERTAINMENT; PRODUCTION OF DVDS, VIDEOTAPES AND TELEVISION PROGRAMS FEATURING CARTOON AND COMIC BOOK CHARACTERS (U.S. CLS. 100, 101 AND 107).

FIRST USE 10-5-2009; IN COMMERCE 10-5-2009.
CAROLINE WOOD, EXAMINING ATTORNEY

CLASS 41—(Continued).

SN 77-889,291. JALBERT IV, JOSPEH JAY, DBA JALBERT ENTERPRISES, HUNTINGTON, NY. FILED 12-9-2009.

Kinetic TV

THE MARK CONSISTS OF STANDARD CHARACTERS WITHOUT CLAIM TO ANY PARTICULAR FONT, STYLE, SIZE, OR COLOR.

NO CLAIM IS MADE TO THE EXCLUSIVE RIGHT TO USE "TV", APART FROM THE MARK AS SHOWN.

FOR ENTERTAINMENT SERVICES, NAMELY, AN ON-GOING SERIES FEATURING SPORTS PROVIDED THROUGH TELEVISION (U.S. CLS. 100, 101 AND 107).

FIRST USE 10-1-2004; IN COMMERCE 10-1-2004.

JEFF DEFORD, EXAMINING ATTORNEY

SN 77-889,387. LEADER OF THE PACK CANINE INSTITUTE LLC, SCHNECKSVILLE, PA. FILED 12-9-2009.



NO CLAIM IS MADE TO THE EXCLUSIVE RIGHT TO USE "CANINE INSTITUTE", APART FROM THE MARK AS SHOWN.

THE MARK CONSISTS OF A HUMAN HAND AND DOG PAW INSIDE A SHIELD WITH THE STYLIZED TEXT "LEADER OF THE PACK CANINE INSTITUTE" TO THE RIGHT. BELOW THERE IS THE STYLIZED TEXT "CREATING HAPPY AND BALANCED DOGS, ONE LEADER AT A TIME."

FOR DOG TRAINING (U.S. CLS. 100, 101 AND 107).

FIRST USE 10-1-2009; IN COMMERCE 10-1-2009.

B. PARADEWELAI, EXAMINING ATTORNEY

SN 77-889,411. LE, SHEREE, LOS ANGELES, CA. FILED 12-9-2009.

AI CHERIE

THE MARK CONSISTS OF STANDARD CHARACTERS WITHOUT CLAIM TO ANY PARTICULAR FONT, STYLE, SIZE, OR COLOR.

THE NAME "AI CHERIE" IN THE MARK IS THE STAGE NAME OF THE OWNER WHOSE CONSENT IS OF RECORD.

FOR ENTERTAINMENT SERVICES IN THE NATURE OF LIVE MUSICAL PERFORMANCES; ENTERTAINMENT SERVICES, NAMELY, LIVE, TELEVISED AND MOVIE APPEARANCES BY A PROFESSIONAL ENTERTAINER (U.S. CLS. 100, 101 AND 107).

FIRST USE 12-0-2007; IN COMMERCE 12-0-2008.

LINDA POWELL, EXAMINING ATTORNEY

CLASS 41—(Continued).

SN 77-889,575. JESSEMMMA PRODUCTIONS, LLC, LONG BEACH, NY. FILED 12-9-2009.

THE SILLY DILLY BAND

THE MARK CONSISTS OF STANDARD CHARACTERS WITHOUT CLAIM TO ANY PARTICULAR FONT, STYLE, SIZE, OR COLOR.

NO CLAIM IS MADE TO THE EXCLUSIVE RIGHT TO USE "BAND", APART FROM THE MARK AS SHOWN.

FOR ENTERTAINMENT SERVICES IN THE NATURE OF LIVE MUSICAL PERFORMANCES (U.S. CLS. 100, 101 AND 107).

FIRST USE 8-14-2008; IN COMMERCE 8-14-2008.

ANTHONY RINKER, EXAMINING ATTORNEY

SN 77-889,687. UNION CHAPEL MISSIONARY BAPTIST CHURCH, HUNTSVILLE, AL. FILED 12-9-2009.



NO CLAIM IS MADE TO THE EXCLUSIVE RIGHT TO USE "CHRISTIAN ACADEMY", APART FROM THE MARK AS SHOWN.

THE COLOR(S) DARK RED, WHITE, GREEN IS/ARE CLAIMED AS A FEATURE OF THE MARK.

THE MARK CONSISTS OF A DARK RED SHIELD WITH A WHITE CROSS ON THE SHIELD, THE TERM "UNION CHAPEL" IN LARGE DARK RED LETTERS OUTLINED IN WHITE ON THE SHIELD, WITH THE TERM "CHRISTIAN ACADEMY" BENEATH IN WHITE LETTERS OUTLINED IN RED; AN OPEN BIBLE IN WHITE OUTLINED IN DARK RED BENEATH ON THE SHIELD; A DARK RED RIBBON BENEATH THE BIBLE WITH THE WORD "AMBASSADORS" ON IT IN WHITE LETTERS; GREEN LEAVES EXTENDING UPWARDLY FROM BOTH ENDS OF THE RIBBON ALONG THE SIDES OF THE SHIELD.

FOR EDUCATIONAL SERVICES, NAMELY, PROVIDING COURSES OF INSTRUCTION FOR KINDERGARTEN THROUGH GRADE 8 AND DISTRIBUTING COURSE MATERIAL IN CONNECTION THEREWITH (U.S. CLS. 100, 101 AND 107).

FIRST USE 4-30-2007; IN COMMERCE 4-30-2007.

RICHARD WHITE, EXAMINING ATTORNEY

CLASS 41—(Continued).

SN 77-889,690. IMPERIAL CIRCUS CORPORATION, DBA IMPERIAL CIRCUS CORPORATION, ORLANDO, FL. FILED 12-9-2009.

CIRCUS VENUS

THE MARK CONSISTS OF STANDARD CHARACTERS WITHOUT CLAIM TO ANY PARTICULAR FONT, STYLE, SIZE, OR COLOR.

NO CLAIM IS MADE TO THE EXCLUSIVE RIGHT TO USE "CIRCUS", APART FROM THE MARK AS SHOWN.

FOR ENTERTAINMENT IN THE NATURE OF CIRCUSES (U.S. CLS. 100, 101 AND 107).

FIRST USE 11-18-2009; IN COMMERCE 11-18-2009.
ARETHA SOMERVILLE, EXAMINING ATTORNEY

SN 77-889,752. VAN SYCKLE, RICHARD, WHITE BLUFF, TN. FILED 12-9-2009.

TRIALS OF THE UNKNOWN

THE MARK CONSISTS OF STANDARD CHARACTERS WITHOUT CLAIM TO ANY PARTICULAR FONT, STYLE, SIZE, OR COLOR.

FOR ENTERTAINMENT, NAMELY, A CONTINUING REALITY SHOW ABOUT THE PARANORMAL BROADCAST OVER TELEVISION AND ON THE INTERNET (U.S. CLS. 100, 101 AND 107).

PATRICIA EVANKO, EXAMINING ATTORNEY

SN 77-889,760. SALESBASIX, HOWELL, MI. FILED 12-9-2009.



NO CLAIM IS MADE TO THE EXCLUSIVE RIGHT TO USE "SALES & MARKETING E-LEARNING", APART FROM THE MARK AS SHOWN.

THE MARK CONSISTS OF A CIRCLE WITH THREE STRIPES AND THE STYLIZED TEXT "SALESBASIX SALES & MARKETING E-LEARNING".

FOR EDUCATION SERVICES, NAMELY, PROVIDING ON-LINE COURSES IN THE FIELD OF SALES, MARKETING, SOCIAL MEDIA, PUBLIC RELATIONS; TRAINING SERVICES IN THE FIELD OF SALES, MARKETING SOCIAL MEDIA, PUBLIC RELATIONS (U.S. CLS. 100, 101 AND 107).

DAVID H. STINE, EXAMINING ATTORNEY

CLASS 41—(Continued).

SN 77-889,779. LEXTYLE, LLC, LAS VEGAS, NV. FILED 12-9-2009.



THE MARK CONSISTS OF THE STYLIZED WORD "RELENTLESS" WITH A STYLIZED IMAGE OF A STAR TO THE LEFT.

FOR EDUCATION SERVICES, NAMELY, PROVIDING MENTORING, TUTORING, CLASSES, SEMINARS AND WORKSHOPS IN THE FIELD OF SPORTS; PERSONAL TRAINING SERVICES, NAMELY, STRENGTH AND CONDITIONING TRAINING; PHYSICAL FITNESS TRAINING SERVICES (U.S. CLS. 100, 101 AND 107).

FIRST USE 11-16-2008; IN COMMERCE 2-1-2009.
REBECCA EISINGER, EXAMINING ATTORNEY

SN 77-889,911. MCMOORE, MIQUEL J., GOLDEN VALLEY, MN. FILED 12-9-2009.

Opportunity Calling

THE MARK CONSISTS OF STANDARD CHARACTERS WITHOUT CLAIM TO ANY PARTICULAR FONT, STYLE, SIZE, OR COLOR.

FOR ENTERTAINMENT AND EDUCATIONAL SERVICES, NAMELY, THE PRESENTATION OF SEMINARS, LECTURES, WORKSHOPS AND PANEL DISCUSSIONS, AND ONGOING TELEVISION AND RADIO TALK SHOWS ALL IN THE FIELD OF PUBLIC INTEREST CONCERNING CAREER AND JOB OPPORTUNITIES (U.S. CLS. 100, 101 AND 107).

CARYN GLASSER, EXAMINING ATTORNEY

SN 77-890,086. FUNZIO, INC., DBA FUNZIO, SAN FRANCISCO, CA. FILED 12-10-2009.

CRIMEVILLE

THE MARK CONSISTS OF STANDARD CHARACTERS WITHOUT CLAIM TO ANY PARTICULAR FONT, STYLE, SIZE, OR COLOR.

FOR ENTERTAINMENT SERVICES, NAMELY, PROVIDING ON-LINE COMPUTER GAMES (U.S. CLS. 100, 101 AND 107).

ADA HAN, EXAMINING ATTORNEY

CLASS 41—(Continued).

SN 77-890,301. PALAWIND, LLC, STATE ROAD, NC. FILED 12-10-2009.



THE MARK CONSISTS OF THREE LEAVES WITH THE STYLIZED TEXT "PALAWIND ADVENTURE TO OUR WORLD" AND A LINE IN THE MIDDLE.

FOR ENTERTAINMENT SERVICES, NAMELY, PROVIDING ON-LINE, NON-DOWNLOADABLE VIRTUAL ITEMS, USER ACCOUNT UPGRADES, FORUM UPGRADES AND ON-SITE UPGRADES FOR USE IN VIRTUAL ENVIRONMENTS CREATED FOR ENTERTAINMENT PURPOSES (U.S. CLS. 100, 101 AND 107).

FIRST USE 5-15-2009; IN COMMERCE 12-9-2009.
MORGAN WYNNE, EXAMINING ATTORNEY

SN 77-890,327. MOORPARK SOCCER CLUB, MOORPARK, CA. FILED 12-10-2009.



THE MARK CONSISTS OF A SHIELD WITH A SOCCER BALL ON THE TOP PART. ON THE BOTTOM PART THERE IS THE STYLIZED TEXT "MSC" IN THE MIDDLE AND STRIPES AROUND IT.

FOR ORGANIZING SPORTING EVENTS, NAMELY, SOCCER (U.S. CLS. 100, 101 AND 107).

FIRST USE 6-1-1985; IN COMMERCE 6-1-1985.
MICHAEL WIENER, EXAMINING ATTORNEY

CLASS 41—(Continued).

SN 77-890,486. UNIVERSITY OF NORTHWESTERN OHIO, LIMA, OH. FILED 12-10-2009.



NO CLAIM IS MADE TO THE EXCLUSIVE RIGHT TO USE "MOTORSPORTS", APART FROM THE MARK AS SHOWN.

THE COLOR(S) RED, BLACK AND WHITE IS/ARE CLAIMED AS A FEATURE OF THE MARK.

THE MARK CONSISTS OF A RED LARGE "U" OUTLINED IN BLACK AND WHITE WITH THE STYLIZED WORDING "MOTORSPORTS" ARCHED ACROSS MIDDLE IN WHITE LETTERS WITH RED, BLACK, AND WHITE OUTLINING AND THE STYLIZED WORDING "UNOH" IN BLACK AND RED OUTLINED IN WHITE ACROSS THE BOTTOM OF THE "U".

FOR EDUCATION SERVICES IN THE NATURE OF COURSES AT THE UNIVERSITY LEVEL; ENTERTAINMENT SERVICES IN THE NATURE OF AUTOMOBILE RACING AND EXHIBITIONS; ENTERTAINMENT SERVICES, NAMELY, PARTICIPATION IN CAR RACES; ENTERTAINMENT, NAMELY, A CONTINUING REALITY SHOW BROADCAST OVER TELEVISION, CABLE OR IPTV (INTERNET PROTOCOL TELEVISION) (U.S. CLS. 100, 101 AND 107).

FIRST USE 10-4-2009; IN COMMERCE 10-4-2009.
LIEF MARTIN, EXAMINING ATTORNEY

SN 77-890,579. LOMBARDO, DAVID A., SHOREWOOD, IL. FILED 12-10-2009.

SAFER USA

THE MARK CONSISTS OF STANDARD CHARACTERS WITHOUT CLAIM TO ANY PARTICULAR FONT, STYLE, SIZE, OR COLOR.

NO CLAIM IS MADE TO THE EXCLUSIVE RIGHT TO USE "USA", APART FROM THE MARK AS SHOWN.

FOR TRAINING SERVICES, NAMELY, PROVIDING COURSES IN THE FIELD OF RESPONSIBLE FIREARM OWNERSHIP AND USE (U.S. CLS. 100, 101 AND 107).

FIRST USE 1-1-2005; IN COMMERCE 1-1-2005.
JOHN SCHUYLER YARD, EXAMINING ATTORNEY

CLASS 41—(Continued).

SN 77-890,638. CBS RADIO STATIONS INC., NEW YORK, NY. FILED 12-10-2009.

RIB ROUNDUP

THE MARK CONSISTS OF STANDARD CHARACTERS WITHOUT CLAIM TO ANY PARTICULAR FONT, STYLE, SIZE, OR COLOR.

NO CLAIM IS MADE TO THE EXCLUSIVE RIGHT TO USE "RIB", APART FROM THE MARK AS SHOWN.

FOR ENTERTAINMENT SERVICES, NAMELY, A LIVE CONCERT EVENT AND A RIB COOK-OFF CONTEST (U.S. CLS. 100, 101 AND 107).

DOUGLAS LEE, EXAMINING ATTORNEY

CLASS 41—(Continued).

SN 77-890,748. KLASSMAN, LISA, WILMINGTON, DE. FILED 12-10-2009.

SUGAR POSH

THE MARK CONSISTS OF STANDARD CHARACTERS WITHOUT CLAIM TO ANY PARTICULAR FONT, STYLE, SIZE, OR COLOR.

FOR ENTERTAINMENT SERVICES, NAMELY, CONDUCTING PARTIES FOR GIRLS; ENTERTAINMENT SERVICES, NAMELY, CONDUCTING GLAMOUR, FASHION AND SALON-THEMED PARTIES; PARTY PLANNING; PARTY PLANNING CONSULTATION (U.S. CLS. 100, 101 AND 107).

FIRST USE 2-0-2007; IN COMMERCE 2-0-2007.
JEFF DEFORD, EXAMINING ATTORNEY

SN 77-890,657. WHATADOG LLC, PLAINWELL, MI. FILED 12-10-2009.

UNLEASH YOUR DOG'S INTELLIGENCE

THE MARK CONSISTS OF STANDARD CHARACTERS WITHOUT CLAIM TO ANY PARTICULAR FONT, STYLE, SIZE, OR COLOR.

NO CLAIM IS MADE TO THE EXCLUSIVE RIGHT TO USE "DOG'S", APART FROM THE MARK AS SHOWN.

FOR DOG TRAINING (U.S. CLS. 100, 101 AND 107).
ALEXANDER L. POWERS, EXAMINING ATTORNEY

SN 77-890,929. INTERNATIONAL MARKETING CONSULTANTS LLC, WOODLAND HILLS, CA. FILED 12-10-2009.

NAME THAT WINNER

THE MARK CONSISTS OF STANDARD CHARACTERS WITHOUT CLAIM TO ANY PARTICULAR FONT, STYLE, SIZE, OR COLOR.

FOR ENTERTAINMENT SERVICES, NAMELY, PRODUCTION AND DISTRIBUTION OF A GAME SHOW; ENTERTAINMENT SERVICES, NAMELY, PROVIDING GAMES OF CHANCE VIA THE INTERNET; PROVIDING A WEB-BASED SYSTEM AND ON-LINE PORTAL FOR CUSTOMERS TO PARTICIPATE IN ON-LINE GAMING, OPERATION AND COORDINATION OF GAME TOURNAMENTS, LEAGUES AND TOURS (U.S. CLS. 100, 101 AND 107).

GEORGE LORENZO, EXAMINING ATTORNEY

SN 77-890,700. PERSIAN MIRROR, LLC, NEW YORK, NY. FILED 12-10-2009.

PERSIANMIRROR

THE MARK CONSISTS OF STANDARD CHARACTERS WITHOUT CLAIM TO ANY PARTICULAR FONT, STYLE, SIZE, OR COLOR.

FOR PROVIDING ON-LINE MAGAZINE IN THE FIELD OF CULTURE, CUISINE AND COMMUNITY (U.S. CLS. 100, 101 AND 107).

FIRST USE 2-16-2004; IN COMMERCE 2-16-2004.
JACLYN KIDWELL WALKER, EXAMINING ATTORNEY

SN 77-891,071. NUT FIT, BRIGHTON, MA. FILED 12-11-2009.

Nutfit

THE MARK CONSISTS OF STANDARD CHARACTERS WITHOUT CLAIM TO ANY PARTICULAR FONT, STYLE, SIZE, OR COLOR.

OWNER OF U.S. REG. NO. 3,729,462.
FOR PERSONAL TRAINING SERVICES, NAMELY, STRENGTH AND CONDITIONING TRAINING AND SPEED TRAINING (U.S. CLS. 100, 101 AND 107).

FIRST USE 5-28-2009; IN COMMERCE 11-23-2009.
MICHAEL LITZAU, EXAMINING ATTORNEY

CLASS 41—(Continued).

SN 77-891,092. NATIONAL ASSOCIATION FOR STOCK CAR AUTO RACING, INC., DAYTONA BEACH, FL. FILED 12-11-2009.

WHERE THE RACE LIVES ON.

THE MARK CONSISTS OF STANDARD CHARACTERS WITHOUT CLAIM TO ANY PARTICULAR FONT, STYLE, SIZE, OR COLOR.

FOR EDUCATION AND ENTERTAINMENT SERVICES, NAMELY, PROVIDING A MUSEUM GALLERY AREA DISPLAYING HISTORICAL ARTIFACTS AND MEMORABILIA RELATING TO AUTOMOBILE RACING; AND CONDUCTING A RECOGNITION CEREMONY IN CONNECTION WITH EXTRAORDINARY CONTRIBUTORS IN THE AUTOMOBILE RACING FIELD (U.S. CLS. 100, 101 AND 107).

JUDITH HELFMAN, EXAMINING ATTORNEY

CLASS 41—(Continued).

SN 77-891,318. MORRELL, GERALD, STRATFORD, WI. FILED 12-11-2009.

Miss Nude Midwest

THE MARK CONSISTS OF STANDARD CHARACTERS WITHOUT CLAIM TO ANY PARTICULAR FONT, STYLE, SIZE, OR COLOR.

OWNER OF U.S. REG. NO. 3,523,986.

NO CLAIM IS MADE TO THE EXCLUSIVE RIGHT TO USE "NUDE MIDWEST", APART FROM THE MARK AS SHOWN.

FOR ENTERTAINMENT IN THE NATURE OF BEAUTY PAGEANTS (U.S. CLS. 100, 101 AND 107).

FIRST USE 12-3-2009; IN COMMERCE 12-3-2009.

MICHELE SWAIN, EXAMINING ATTORNEY

SN 77-891,146. AMERICAN CITY BUSINESS JOURNALS INC., CHARLOTTE, NC. FILED 12-11-2009.

LACROSSE POWERBALL
TOURNAMENT

THE MARK CONSISTS OF STANDARD CHARACTERS WITHOUT CLAIM TO ANY PARTICULAR FONT, STYLE, SIZE, OR COLOR.

NO CLAIM IS MADE TO THE EXCLUSIVE RIGHT TO USE "LACROSSE" OR "TOURNAMENT", APART FROM THE MARK AS SHOWN.

FOR ORGANIZING SPORTING EVENTS, NAMELY, LACROSSE GAMES, TOURNAMENTS AND COMPETITIONS (U.S. CLS. 100, 101 AND 107).

KATHRYN COWARD, EXAMINING ATTORNEY

SN 77-891,512. CENTRAL AMUSEMENT INTERNATIONAL, LLC, BOONTON, NJ. FILED 12-11-2009.

Scream Zone

THE MARK CONSISTS OF STANDARD CHARACTERS WITHOUT CLAIM TO ANY PARTICULAR FONT, STYLE, SIZE, OR COLOR.

FOR AMUSEMENT PARKS (U.S. CLS. 100, 101 AND 107).

KYLE PEETE, EXAMINING ATTORNEY

SN 77-891,290. THE YOUTH LEADERSHIP TRAINING ACADEMY (YLTA), LAYTONSVILLE, MD. FILED 12-11-2009.

YLTA The Youth Leadership
Training Academy Today's
Teens Tomorrow's Leaders

THE MARK CONSISTS OF STANDARD CHARACTERS WITHOUT CLAIM TO ANY PARTICULAR FONT, STYLE, SIZE, OR COLOR.

NO CLAIM IS MADE TO THE EXCLUSIVE RIGHT TO USE "YOUTH LEADERSHIP TRAINING ACADEMY", APART FROM THE MARK AS SHOWN.

FOR PROVIDING AFTER SCHOOL EDUCATIONAL PROGRAMS FOR CHILDREN IN MIDDLE SCHOOL AND HIGH SCHOOL (U.S. CLS. 100, 101 AND 107).

KATHLEEN M. VANSTON, EXAMINING ATTORNEY

SN 77-891,520. KAVYATA GROUP, LLC, ANN ARBOR, MI. FILED 12-11-2009.

Kavyata

THE MARK CONSISTS OF STANDARD CHARACTERS WITHOUT CLAIM TO ANY PARTICULAR FONT, STYLE, SIZE, OR COLOR.

THE WORDING "KAVYATA" HAS NO MEANING IN A FOREIGN LANGUAGE.

FOR PUBLISHING OF BOOKS, E-BOOKS, AUDIO BOOKS, MUSIC AND ILLUSTRATIONS (U.S. CLS. 100, 101 AND 107).

FIRST USE 10-31-2005; IN COMMERCE 10-31-2005.

ESTHER BELENKER, EXAMINING ATTORNEY

CLASS 41—(Continued).

SN 77-891,727. JAAP, KATHLEEN, BACLIFF, TX. FILED 12-11-2009.

**The P3 Advantage*
Prosperity ~ Profits ~
Peace of Mind**

THE MARK CONSISTS OF STANDARD CHARACTERS WITHOUT CLAIM TO ANY PARTICULAR FONT, STYLE, SIZE, OR COLOR.

FOR LIFE COACHING SERVICES IN THE FIELD OF VALUES-BASED INTEGRITY (U.S. CLS. 100, 101 AND 107).

FIRST USE 5-9-2008; IN COMMERCE 5-9-2008.
NANCY CLARKE, EXAMINING ATTORNEY

SN 77-891,821. CARE COMMUNICATIONS, INC., CHICAGO, IL. FILED 12-11-2009.

CARE COMMUNICATIONS PRESS

THE MARK CONSISTS OF STANDARD CHARACTERS WITHOUT CLAIM TO ANY PARTICULAR FONT, STYLE, SIZE, OR COLOR.

OWNER OF U.S. REG. NOS. 2,788,067 AND 2,864,063.
NO CLAIM IS MADE TO THE EXCLUSIVE RIGHT TO USE "PRESS", APART FROM THE MARK AS SHOWN.
FOR BOOK PUBLISHING (U.S. CLS. 100, 101 AND 107).
SUSAN RICHARDS, EXAMINING ATTORNEY

SN 77-891,896. ANGELTRITION INSTITUTE, EAGLE POINT, OR. FILED 12-11-2009.

ANGELtrition

THE MARK CONSISTS OF STANDARD CHARACTERS WITHOUT CLAIM TO ANY PARTICULAR FONT, STYLE, SIZE, OR COLOR.

FOR EDUCATIONAL RESEARCH (U.S. CLS. 100, 101 AND 107).
SEAN CROWLEY, EXAMINING ATTORNEY

CLASS 41—(Continued).

SN 77-891,901. ANGELTRITION INSTITUTE, EAGLE POINT, OR. FILED 12-11-2009.

**Putting Compassion into
Action**

THE MARK CONSISTS OF STANDARD CHARACTERS WITHOUT CLAIM TO ANY PARTICULAR FONT, STYLE, SIZE, OR COLOR.

FOR EDUCATIONAL RESEARCH (U.S. CLS. 100, 101 AND 107).
SEAN CROWLEY, EXAMINING ATTORNEY

SN 77-891,985. SHORTSTOP, LLC, PORTLAND, OR. FILED 12-11-2009.

PORTLAND TIMBERS

THE MARK CONSISTS OF STANDARD CHARACTERS WITHOUT CLAIM TO ANY PARTICULAR FONT, STYLE, SIZE, OR COLOR.

OWNER OF U.S. REG. NO. 3,212,294.
SEC. 2(F) AS TO "PORTLAND".
FOR ENTERTAINMENT SERVICES IN THE NATURE OF SOCCER GAMES AND EXHIBITIONS (U.S. CLS. 100, 101 AND 107).

FIRST USE 4-28-2001; IN COMMERCE 4-28-2001.
DAVID COLLIER, EXAMINING ATTORNEY

SN 77-891,999. STRANGE MUSIC, INC., BLUE SPRINGS, MO. FILED 12-11-2009.



OWNER OF U.S. REG. NOS. 3,721,933 AND 3,721,951.
THE MARK CONSISTS OF THE DESIGN OF A STYLIZED SNAKE AND BAT FORMING THE LETTERS "SM".

FOR ENTERTAINMENT SERVICES IN THE NATURE OF LIVE MUSICAL PERFORMANCES; ENTERTAINMENT, NAMELY, LIVE PERFORMANCES BY MUSICAL BANDS (U.S. CLS. 100, 101 AND 107).

FIRST USE 2-28-2001; IN COMMERCE 2-28-2001.
ANNE E. GUSTASON, EXAMINING ATTORNEY

CLASS 41—(Continued).

SN 77-892,048. THOMAS N. MCGAFFEY, DALLAS, TX.
FILED 12-11-2009.

CLASS 41—(Continued).

SN 77-892,211. MIND THE GAP, LLC, MCKINNEY, TX.
FILED 12-13-2009.

HUMAN POWER³

Mind the Gap

THE MARK CONSISTS OF THE LETTERS "HUMAN POWER 3 (SUPERSCRIPT)" AS SHOWN IN THE DRAWINGS.

FOR EDUCATIONAL SERVICES, NAMELY, CONDUCTING SEMINARS IN THE FIELD OF APPLIED PRAGMATIC LINGUISTICS AND DISTRIBUTION OF COURSE MATERIAL IN CONNECTION THEREWITH (U.S. CLS. 100, 101 AND 107).

FIRST USE 7-31-2009; IN COMMERCE 7-31-2009.
ROBERT C. CLARK JR., EXAMINING ATTORNEY

THE MARK CONSISTS OF STANDARD CHARACTERS WITHOUT CLAIM TO ANY PARTICULAR FONT, STYLE, SIZE, OR COLOR.

FOR PROFESSIONAL COACHING SERVICES IN THE FIELD OF MANAGEMENT AND LEADERSHIP DEVELOPMENT; PROVIDING GROUP COACHING AND LEARNING FORUMS IN THE FIELD OF LEADERSHIP DEVELOPMENT (U.S. CLS. 100, 101 AND 107).

FIRST USE 5-15-2008; IN COMMERCE 8-8-2008.
LAURIE KAUFMAN, EXAMINING ATTORNEY

SN 77-892,178. T2 TRAINING, INC., VIRGINIA BEACH, VA.
FILED 12-12-2009.

SN 77-892,337. T2 TRAINING, INC., VIRGINIA BEACH, VA.
FILED 12-13-2009.

T2 Trauma Training

T2 Tactical Training

THE MARK CONSISTS OF STANDARD CHARACTERS WITHOUT CLAIM TO ANY PARTICULAR FONT, STYLE, SIZE, OR COLOR.

NO CLAIM IS MADE TO THE EXCLUSIVE RIGHT TO USE "TRAUMA TRAINING", APART FROM THE MARK AS SHOWN.

FOR EDUCATIONAL SERVICES, NAMELY, CONDUCTING PRACTICAL, HANDS-ON TRAINING AND LIFELIKE EXPERIENCES IN THE FIELD OF EMERGENCY MEDICAL AND TRAUMA RESPONSE AND DISTRIBUTION OF TRAINING MATERIAL IN CONNECTION THEREWITH; TRAINING SERVICES IN THE FIELD OF TACTICAL COMBAT CASUALTY CARE (U.S. CLS. 100, 101 AND 107).

FIRST USE 2-0-2009; IN COMMERCE 2-0-2009.
TRACY WHITTAKER-BROWN, EXAMINING ATTORNEY

THE MARK CONSISTS OF STANDARD CHARACTERS WITHOUT CLAIM TO ANY PARTICULAR FONT, STYLE, SIZE, OR COLOR.

NO CLAIM IS MADE TO THE EXCLUSIVE RIGHT TO USE "TACTICAL TRAINING", APART FROM THE MARK AS SHOWN.

FOR EDUCATIONAL SERVICES, NAMELY, CONDUCTING SEMINARS AND WORKSHOPS FEATURING GAMES, DRILLS, AND EXERCISES IN THE FIELD OF OPERATIONAL SERVICES TO THE MILITARY, DEPARTMENT OF DEFENSE, AND CIVILIAN CORPORATIONS, IN SUPPORT OF FIGHTING THE WAR ON TERRORISM AND DISTRIBUTION OF TRAINING MATERIAL IN CONNECTION THEREWITH; TACTICAL TRAINING SERVICES IN THE FIELD OF THREAT ASSESSMENT, READINESS EXERCISES, CYBER TERRORISM AND MARITIME SECURITY (U.S. CLS. 100, 101 AND 107).

TRACY WHITTAKER-BROWN, EXAMINING ATTORNEY

CLASS 41—(Continued).

SN 77-892,346. GRIGGS (IV), BARNEY FRANK, LEBANON, NH. FILED 12-14-2009.

omg blog

THE MARK CONSISTS OF STANDARD CHARACTERS WITHOUT CLAIM TO ANY PARTICULAR FONT, STYLE, SIZE, OR COLOR.

NO CLAIM IS MADE TO THE EXCLUSIVE RIGHT TO USE "BLOG", APART FROM THE MARK AS SHOWN.

FOR ON-LINE JOURNALS, NAMELY, BLOGS FEATURING ENTERTAINMENT, MUSIC, MOVIES, TELEVISION, CELEBRITIES, FASHION, NEWS, AND CULTURE; PROVIDING INFORMATION, NEWS AND COMMENTARY IN THE FIELD OF CURRENT EVENTS RELATING TO THE GAY COMMUNITY; PROVIDING INFORMATION, NEWS AND COMMENTARY IN THE FIELD OF ENTERTAINMENT; PROVIDING INFORMATION, NEWS AND COMMENTARY IN THE FIELD OF ENTERTAINMENT RELATING TO THE GAY COMMUNITY; PROVIDING NEWS IN THE NATURE OF CURRENT EVENT REPORTING (U.S. CLS. 100, 101 AND 107).

FIRST USE 7-21-2003; IN COMMERCE 7-21-2003.

LINDA MICKLEBURGH, EXAMINING ATTORNEY

CLASS 41—(Continued).

SN 77-892,557. DOUGLAS, CHRISTOPHER, BOZEMAN, MT. FILED 12-14-2009.

Roughstock2Roping

THE MARK CONSISTS OF STANDARD CHARACTERS WITHOUT CLAIM TO ANY PARTICULAR FONT, STYLE, SIZE, OR COLOR.

FOR ENTERTAINMENT IN THE NATURE OF RODEOS AND TEAM ROPING (U.S. CLS. 100, 101 AND 107).

FIRST USE 8-1-2008; IN COMMERCE 9-18-2008.

WILLIAM BRECKENFELD, EXAMINING ATTORNEY

SN 77-892,552. NISTOR, AMANDA, DBA RUFFLED, NEW YORK, NY. FILED 12-14-2009.

Ruffled

THE MARK CONSISTS OF STANDARD CHARACTERS WITHOUT CLAIM TO ANY PARTICULAR FONT, STYLE, SIZE, OR COLOR.

FOR ON-LINE JOURNALS, NAMELY, BLOGS FEATURING WEDDINGS (U.S. CLS. 100, 101 AND 107).

FIRST USE 10-12-2009; IN COMMERCE 10-12-2009.

STEVEN PEREZ, EXAMINING ATTORNEY

SN 77-892,672. ABYSSINIAN DEVELOPMENT CORPORATION, NEW YORK, NY. FILED 12-14-2009.



SN 77-892,555. HAWK'S NEST PUBLISHING, LLC, MYSTIC, CT. FILED 12-14-2009.

Hawk's Nest

THE MARK CONSISTS OF STANDARD CHARACTERS WITHOUT CLAIM TO ANY PARTICULAR FONT, STYLE, SIZE, OR COLOR.

FOR BOOK PUBLISHING (U.S. CLS. 100, 101 AND 107).

FIRST USE 5-1-2006; IN COMMERCE 8-1-2007.

JASON LOTT, EXAMINING ATTORNEY

NO CLAIM IS MADE TO THE EXCLUSIVE RIGHT TO USE "HARLEM! A SALON SERIES", APART FROM THE MARK AS SHOWN.

THE COLOR(S) RED, BLACK, AND WHITE IS/ARE CLAIMED AS A FEATURE OF THE MARK.

THE MARK CONSISTS OF A STYLIZED WALL DESIGN FEATURING THE STYLIZED WORDS "HARLEM! A SALON SERIES". THE COLOR RED APPEARS IN THE "HARLEM!" WORDING, THE COLOR BLACK APPEARS IN THE "A SALON SERIES" WORDING AND IN THE BACKGROUND, AND THE COLOR WHITE APPEARS IN THE WALL DESIGN.

FOR ORGANIZING COMMUNITY CULTURAL EVENTS (U.S. CLS. 100, 101 AND 107).

FIRST USE 11-20-2009; IN COMMERCE 11-20-2009.

JASON LOTT, EXAMINING ATTORNEY

CLASS 41—(Continued).

SN 77-892,676. ROBINSON BRADSHAW & HINSON P.A., CHARLOTTE, NC. FILED 12-14-2009.

GLR

THE MARK CONSISTS OF STANDARD CHARACTERS WITHOUT CLAIM TO ANY PARTICULAR FONT, STYLE, SIZE, OR COLOR.

FOR ON-LINE JOURNAL, NAMELY, BLOG FEATURING NEWS AND COMMENTARY IN THE FIELDS OF GENOMICS-ORIENTED AND PERSONALIZED MEDICINE BUSINESSES DEVELOPMENTS, RESEARCH DEVELOPMENTS, AND LAW (U.S. CLS. 100, 101 AND 107). FIRST USE 6-4-2009; IN COMMERCE 6-4-2009. JESSICA FATHY, EXAMINING ATTORNEY

SN 77-892,702. THE YOUTH LEADERSHIP TRAINING ACADEMY (YLTA), LAYTONSVILLE, MD. FILED 12-14-2009.

Financial Fitne\$\$ For Teens

THE MARK CONSISTS OF STANDARD CHARACTERS WITHOUT CLAIM TO ANY PARTICULAR FONT, STYLE, SIZE, OR COLOR.

NO CLAIM IS MADE TO THE EXCLUSIVE RIGHT TO USE "FINANCIAL" AND "TEENS", APART FROM THE MARK AS SHOWN.

FOR PROVIDING AFTER SCHOOL EDUCATIONAL PROGRAMS FOR CHILDREN IN MIDDLE SCHOOL AND HIGH SCHOOL (U.S. CLS. 100, 101 AND 107). KATHLEEN M. VANSTON, EXAMINING ATTORNEY

CLASS 41—(Continued).

SN 77-892,793. FITNESS 4 LESS HOLDINGS LLC, BOWIE, MD. FILED 12-14-2009.

**Fitness Meets
Affordability!**

THE MARK CONSISTS OF STANDARD CHARACTERS WITHOUT CLAIM TO ANY PARTICULAR FONT, STYLE, SIZE, OR COLOR.

FOR CONSULTING SERVICES IN THE FIELDS OF FITNESS AND EXERCISE; COUNSELING SERVICES IN THE FIELD OF PHYSICAL FITNESS; EDUCATIONAL SERVICES, NAMELY, DEVELOPING AND CONDUCTING WORKOUTS, WORKSHOPS, PRESENTATIONS, RETREATS, AND PERSONAL TRAINING IN RIGHT-BRAIN FITNESS; HEALTH CLUB SERVICES, NAMELY, PROVIDING INSTRUCTION AND EQUIPMENT IN THE FIELD OF PHYSICAL EXERCISE; PHYSICAL FITNESS CONDITIONING CLASSES; PHYSICAL FITNESS CONSULTATION; PHYSICAL FITNESS INSTRUCTION; PHYSICAL FITNESS TRAINING SERVICES; PROVIDING ASSISTANCE, PERSONAL TRAINING AND PHYSICAL FITNESS CONSULTATION TO CORPORATE CLIENTS TO HELP THEIR EMPLOYEES MAKE PHYSICAL FITNESS, STRENGTH, CONDITIONING, AND EXERCISE ALTERATIONS IN THEIR DAILY LIVING; PROVIDING ASSISTANCE, PERSONAL TRAINING AND PHYSICAL FITNESS CONSULTATION TO INDIVIDUALS TO HELP THEM MAKE PHYSICAL FITNESS, STRENGTH, CONDITIONING, AND EXERCISE IMPROVEMENT IN THEIR DAILY LIVING; PROVIDING FITNESS AND EXERCISE FACILITIES (U.S. CLS. 100, 101 AND 107).

FIRST USE 11-1-2009; IN COMMERCE 11-1-2009. ELISSA GARBER KON, EXAMINING ATTORNEY

SN 77-893,187. NANCY BARDACKE, OAKLAND, CA. FILED 12-14-2009.

**MINDFULNESS-BASED
CHILDBIRTH AND PARENTING**

THE MARK CONSISTS OF STANDARD CHARACTERS WITHOUT CLAIM TO ANY PARTICULAR FONT, STYLE, SIZE, OR COLOR.

NO CLAIM IS MADE TO THE EXCLUSIVE RIGHT TO USE "CHILDBIRTH AND PARENTING", APART FROM THE MARK AS SHOWN.

SEC. 2(F). FOR EDUCATIONAL SERVICES AND EDUCATOR TRAINING SERVICES, NAMELY, PROVIDING WORKSHOPS, SEMINARS, LECTURES, PRESENTATIONS AND CLASSES IN THE FIELDS OF CHILDBIRTH AND PARENTING, AND DISTRIBUTING COURSE MATERIALS IN CONNECTION THEREWITH (U.S. CLS. 100, 101 AND 107).

FIRST USE 3-9-1998; IN COMMERCE 3-9-1998. MELISSA VALLILLO, EXAMINING ATTORNEY

CLASS 41—(Continued).

SN 77-893,567. STAGE ONE PRODUCTIONS. NATIONAL DANCE COMPETITION, INC., NORMAN, OK. FILED 12-15-2009.

STAGE ONE

THE MARK CONSISTS OF STANDARD CHARACTERS WITHOUT CLAIM TO ANY PARTICULAR FONT, STYLE, SIZE, OR COLOR.

FOR ENTERTAINMENT SERVICES, NAMELY, ARRANGING AND CONDUCTING OF DANCE COMPETITIONS (U.S. CLS. 100, 101 AND 107).

FIRST USE 1-12-1997; IN COMMERCE 1-12-1997.
CHARLOTTE CORWIN, EXAMINING ATTORNEY

SN 77-894,102. KASS, DANIEL, MONTECITO, CA. FILED 12-15-2009.

21 DAY RUNT PROGRAM

THE MARK CONSISTS OF STANDARD CHARACTERS WITHOUT CLAIM TO ANY PARTICULAR FONT, STYLE, SIZE, OR COLOR.

NO CLAIM IS MADE TO THE EXCLUSIVE RIGHT TO USE "21 DAY" AND "PROGRAM", APART FROM THE MARK AS SHOWN.

FOR EDUCATIONAL SERVICES, NAMELY, CONDUCTING SEMINARS AND WORKSHOPS IN THE FIELD OF SELF- AND PERSONAL IMPROVEMENT; EDUCATIONAL AND ENTERTAINMENT SERVICES, NAMELY, PROVIDING MOTIVATIONAL SPEAKERS (U.S. CLS. 100, 101 AND 107).

FIRST USE 1-14-2009; IN COMMERCE 1-14-2009.
DAVID YONTEF, EXAMINING ATTORNEY

SN 77-894,190. CHAPMAN, WILLIAM DONALD, MESA, AZ. FILED 12-15-2009.

"CATCH EM' UP"

THE MARK CONSISTS OF STANDARD CHARACTERS WITHOUT CLAIM TO ANY PARTICULAR FONT, STYLE, SIZE, OR COLOR.

FOR ENTERTAINMENT IN THE NATURE OF ON-GOING TELEVISION PROGRAMS IN THE FIELD OF SHOWING FUNNY FISHING CLIPS; ENTERTAINMENT SERVICES, NAMELY, PROVIDING ON-GOING TELEVISION PROGRAMS IN THE FIELD OF FUNNY FISHING CLIPS VIA A GLOBAL COMPUTER NETWORK; VIDEO PRODUCTION SERVICES (U.S. CLS. 100, 101 AND 107).

FIRST USE 9-15-2009; IN COMMERCE 9-15-2009.
DOMINIC J. FERRAIUOLO, EXAMINING ATTORNEY

CLASS 41—(Continued).

SN 77-894,783. TWENTIETH CENTURY FOX FILM CORPORATION, LOS ANGELES, CA. FILED 12-16-2009.

THE DEEP END

THE MARK CONSISTS OF STANDARD CHARACTERS WITHOUT CLAIM TO ANY PARTICULAR FONT, STYLE, SIZE, OR COLOR.

FOR ENTERTAINMENT SERVICES IN THE NATURE OF A TELEVISION SERIES FEATURING DRAMA; PROVIDING ON-LINE INFORMATION IN THE FIELD OF TELEVISION AND VIDEO ENTERTAINMENT FEATURING DRAMA VIA THE INTERNET; ENTERTAINMENT SERVICES IN THE NATURE OF NON-DOWNLOADABLE VIDEOS AND IMAGES FEATURING TELEVISION SHOWS AND ENTERTAINMENT TRANSMITTED VIA THE INTERNET AND WIRELESS COMMUNICATION NETWORKS (U.S. CLS. 100, 101 AND 107).

FIRST USE 1-21-2010; IN COMMERCE 1-21-2010.
JAY FLOWERS, EXAMINING ATTORNEY

SN 77-895,595. CALVIN, FRANK L., WARREN, OH. FILED 12-17-2009.

The Rubberband Gym

THE MARK CONSISTS OF STANDARD CHARACTERS WITHOUT CLAIM TO ANY PARTICULAR FONT, STYLE, SIZE, OR COLOR.

NO CLAIM IS MADE TO THE EXCLUSIVE RIGHT TO USE "GYM", APART FROM THE MARK AS SHOWN.

FOR PHYSICAL FITNESS INSTRUCTION; PHYSICAL FITNESS TRAINING SERVICES; PROVIDING ASSISTANCE, PERSONAL TRAINING AND PHYSICAL FITNESS CONSULTATION TO INDIVIDUALS TO HELP THEM MAKE PHYSICAL FITNESS, STRENGTH, CONDITIONING, AND EXERCISE IMPROVEMENT IN THEIR DAILY LIVING; PROVIDING FITNESS AND EXERCISE FACILITIES (U.S. CLS. 100, 101 AND 107).

FIRST USE 11-1-2008; IN COMMERCE 6-1-2009.
SHAUNIA CARLYLE, EXAMINING ATTORNEY

SN 77-897,628. FUNZIO, INC., DBA FUNZIO, SAN FRANCISCO, CA. FILED 12-19-2009.

Happy City

THE MARK CONSISTS OF STANDARD CHARACTERS WITHOUT CLAIM TO ANY PARTICULAR FONT, STYLE, SIZE, OR COLOR.

FOR ENTERTAINMENT SERVICES, NAMELY, PROVIDING ON-LINE COMPUTER GAMES (U.S. CLS. 100, 101 AND 107).

ADA HAN, EXAMINING ATTORNEY

CLASS 41—(Continued).

SN 77-898,999. 745 LLC, BOSTON, MA. FILED 12-22-2009.

SEVEN45
STUDIOS

NO CLAIM IS MADE TO THE EXCLUSIVE RIGHT TO USE "STUDIOS", APART FROM THE MARK AS SHOWN.

THE MARK CONSISTS OF THE STYLIZED WORD "SEVEN" WITH THE LOWER RIGHT STEM OF THE LETTER "N" IN THE WORD CUT AT AN ANGLE NEXT TO THE NUMBER "45" WITH THE WORDING "STUDIOS" APPEARING BELOW THE STYLIZED WORD "SEVEN".

FOR ENTERTAINMENT SERVICES, NAMELY, PRODUCTION OF COMPUTER AND VIDEO GAME SOFTWARE; PROVIDING ONLINE VIDEO GAMES ACCESSIBLE OVER A NETWORK BY ONE OR MORE PLAYERS (U.S. CLS. 100, 101 AND 107).

FIRST USE 4-1-2009; IN COMMERCE 4-1-2009.

SAMUEL E. SHARPER JR., EXAMINING ATTORNEY

SN 77-900,628. ROBERT REPKO, BROOKLYN, NY. FILED 12-23-2009.

Glammy Awards

THE MARK CONSISTS OF STANDARD CHARACTERS WITHOUT CLAIM TO ANY PARTICULAR FONT, STYLE, SIZE, OR COLOR.

NO CLAIM IS MADE TO THE EXCLUSIVE RIGHT TO USE "AWARDS", APART FROM THE MARK AS SHOWN.

FOR PROVIDING RECOGNITION AND INCENTIVES BY THE WAY OF AWARDS TO DEMONSTRATE EXCELLENCE IN THE FIELD OF ARTS AND ENTERTAINMENT (U.S. CLS. 100, 101 AND 107).

FIRST USE 12-7-1997; IN COMMERCE 12-7-1997.

TASNEEM HUSSAIN, EXAMINING ATTORNEY

SN 77-901,611. ONLINECHIROCREDITS, INC., BRIDGE-TON, NJ. FILED 12-28-2009.

OnlineChiroCredits.com

THE MARK CONSISTS OF STANDARD CHARACTERS WITHOUT CLAIM TO ANY PARTICULAR FONT, STYLE, SIZE, OR COLOR.

SEC. 2(F).

FOR CONTINUING EDUCATION SERVICES, NAMELY, PROVIDING LIVE AND ON-LINE CONTINUING PROFESSIONAL EDUCATION SEMINARS IN THE FIELD OF CHIROPRACTIC (U.S. CLS. 100, 101 AND 107).

FIRST USE 9-1-2003; IN COMMERCE 9-1-2003.

ADA HAN, EXAMINING ATTORNEY

CLASS 41—(Continued).

SN 77-901,735. MONTANO, JOHNNY, MERCED, CA. FILED 12-28-2009.

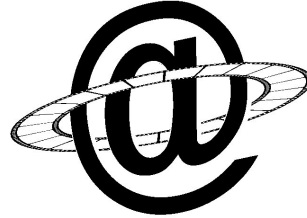

THE MARK CONSISTS OF THE STYLIZED TEXT "@" WITH A FILM STRIP ROTATING AROUND IT.

FOR MOTION PICTURE EQUIPMENT RENTALS AND PRODUCTION (U.S. CLS. 100, 101 AND 107).

DOMINIC J. FERRAIUOLO, EXAMINING ATTORNEY

SN 77-902,277. PITCHFORK HOLDING CO., CHICAGO, IL. FILED 12-29-2009.

PITCHFORK

THE MARK CONSISTS OF STANDARD CHARACTERS WITHOUT CLAIM TO ANY PARTICULAR FONT, STYLE, SIZE, OR COLOR.

OWNER OF U.S. REG. NO. 3,243,740.

FOR PRESENTATION OF MUSICAL PERFORMANCES (U.S. CLS. 100, 101 AND 107).

FIRST USE 4-1-2006; IN COMMERCE 4-1-2006.

ROBIN CHOSID, EXAMINING ATTORNEY

SN 77-906,063. UNIVERSAL CITY STUDIOS LLLP, UNIVERSAL CITY, CA. FILED 1-6-2010.

FESTIVAL OF THE DEAD

THE MARK CONSISTS OF STANDARD CHARACTERS WITHOUT CLAIM TO ANY PARTICULAR FONT, STYLE, SIZE, OR COLOR.

OWNER OF U.S. REG. NO. 2,312,330.

FOR ENTERTAINMENT SERVICES IN THE NATURE OF AN AMUSEMENT PARK ATTRACTION, NAMELY, A THEMED AREA (U.S. CLS. 100, 101 AND 107).

JUDITH HELFMAN, EXAMINING ATTORNEY

CLASS 41—(Continued).

SN 77-906,191. FOSS SWIM SCHOOL, INC., EDEN PRAIRIE, MN. FILED 1-6-2010.



OWNER OF U.S. REG. NO. 2,856,043.

NO CLAIM IS MADE TO THE EXCLUSIVE RIGHT TO USE "SWIMMERS" AND "SWIM SCHOOL", APART FROM THE MARK AS SHOWN.

THE MARK CONSISTS OF A CIRCLE WITH THE WORDING "SWIMMERS" APPEARING IN AN ARC WITHIN THE TOP BORDER OF THE CIRCLE AND THE WORD "GUARANTEED" APPEARING IN AN ARC WITHIN THE BOTTOM BORDER OF THE CIRCLE. AN ARCED LINE APPEARS UNDER "SWIMMERS" AND ABOVE "GUARANTEED". THE WORD "FOSS" APPEARS IN STYLIZED TEXT WITHIN A SHADED AND BORDERED OVAL WITH THREE HORIZONTAL WING-LIKE STRIPES CROPPED INWARD AT A DIAGONAL ANGLE APPEARING ON EACH SIDE OF THE OVAL. THE STYLIZED WORDING "SWIM SCHOOL" APPEARS BELOW THE OVAL.

FOR SWIMMING INSTRUCTION (U.S. CLS. 100, 101 AND 107).

FIRST USE 7-15-2009; IN COMMERCE 7-15-2009.

AMY KERTGATE, EXAMINING ATTORNEY

SN 77-906,333. NATIONAL VOLUNTARY ORGANIZATIONS ACTIVE IN DISASTER, INC., AKA NATIONAL VOAD; NVOAD, ARLINGTON, VA. FILED 1-6-2010.

National Voluntary Organizations Active in Disaster

THE MARK CONSISTS OF STANDARD CHARACTERS WITHOUT CLAIM TO ANY PARTICULAR FONT, STYLE, SIZE, OR COLOR.

NO CLAIM IS MADE TO THE EXCLUSIVE RIGHT TO USE "ORGANIZATIONS", APART FROM THE MARK AS SHOWN.

SEC. 2(F).

FOR EDUCATIONAL SERVICES, NAMELY, PROVIDING EDUCATIONAL SPEAKERS, SEMINARS, EXHIBITIONS, AND RECEPTIONS, AND DISTRIBUTING RELATED TRAINING MATERIALS, ALL TO SHARE KNOWLEDGE AND RESOURCES IN THE AREAS OF DISASTER PREPARATION, RESPONSE AND RECOVERY (U.S. CLS. 100, 101 AND 107).

FIRST USE 1-14-1985; IN COMMERCE 1-14-1985.

ESTHER BELENKER, EXAMINING ATTORNEY

CLASS 41—(Continued).

SN 77-906,442. WENDY DUBIT, NEW YORK, NY. FILED 1-6-2010.

UNDERWOMAN

THE MARK CONSISTS OF STANDARD CHARACTERS WITHOUT CLAIM TO ANY PARTICULAR FONT, STYLE, SIZE, OR COLOR.

FOR ON-LINE JOURNALS, NAMELY, BLOGS FEATURING HUMOR AND ENTERTAINMENT (U.S. CLS. 100, 101 AND 107).

FIRST USE 1-31-2009; IN COMMERCE 1-31-2009.

KRISTINA MORRIS, EXAMINING ATTORNEY

SN 77-907,683. UNIVERSITY OF UTAH RESEARCH FOUNDATION, SALT LAKE CITY, UT. FILED 1-8-2010.



Bringing **U** Innovative Learning and Discovery

THE COLOR(S) RED, BLACK IS/ARE CLAIMED AS A FEATURE OF THE MARK.

THE MARK CONSISTS OF "BUILD" IN ALL CAPITAL LETTERS, WITH A BLACK "B", RED BLOCK "U", FOLLOWED BY "ILD" IN BLACK. THE PHRASE "BRINGING U INNOVATIVE LEARNING AND DISCOVERY" APPEARS BENEATH "BUILD" IN BLACK WITH THE BLOCK "U" IN RED.

FOR EDUCATION INFORMATION; EDUCATION SERVICES IN THE NATURE OF COURSES AT THE UNIVERSITY LEVEL; EDUCATION SERVICES, NAMELY, PROVIDING PRESENTATIONS, EVENTS, CLASSES, AND MATERIALS IN THE FIELD OF INNOVATIVE TECHNOLOGY AND ENTREPRENEURIAL PROGRAMS; EDUCATIONAL SERVICES, NAMELY, PROVIDING COURSES OF INSTRUCTION AT THE UNIVERSITY LEVEL AND DISTRIBUTION OF COURSE MATERIAL IN CONNECTION THEREWITH; EDUCATIONAL SERVICES, NAMELY, PROVIDING DISPLAYS AND EXHIBITS IN THE FIELD OF INNOVATIVE TECHNOLOGY AND ENTREPRENEURIAL PROGRAMS (U.S. CLS. 100, 101 AND 107).

TAMARA FRAZIER, EXAMINING ATTORNEY

SN 77-908,768. ZIKER CLEANERS, INC., SOUTH BEND, IN. FILED 1-11-2010.

RIGHTEOUS RIDE

THE MARK CONSISTS OF STANDARD CHARACTERS WITHOUT CLAIM TO ANY PARTICULAR FONT, STYLE, SIZE, OR COLOR.

FOR CONDUCTING PRIZE CONTESTS RELATING TO VEHICLES (U.S. CLS. 100, 101 AND 107).

FIRST USE 7-0-2009; IN COMMERCE 7-0-2009.

LINDA LAVACHE, EXAMINING ATTORNEY

CLASS 41—(Continued).

SN 77-910,777. PERSIAN MIRROR, LLC, NEW YORK, NY.
FILED 1-13-2010.



THE MARK CONSISTS OF THE WORD "PERSIANMIRROR" IN STYLIZED FONT.

FOR PROVIDING ON-LINE MAGAZINE IN THE FIELD OF CULTURE, CUISINE AND COMMUNITY (U.S. CLS. 100, 101 AND 107).

FIRST USE 2-16-2004; IN COMMERCE 2-16-2004.
JACLYN KIDWELL WALKER, EXAMINING ATTORNEY

SN 77-911,401. FESTIVAL FUN PARKS, LLC, NEWPORT BEACH, CA. FILED 1-13-2010.

THE BERMUDA TRIANGLE

THE MARK CONSISTS OF STANDARD CHARACTERS WITHOUT CLAIM TO ANY PARTICULAR FONT, STYLE, SIZE, OR COLOR.

FOR ENTERTAINMENT SERVICES IN THE NATURE OF AN AMUSEMENT PARK RIDE (U.S. CLS. 100, 101 AND 107).

FIRST USE 4-12-1989; IN COMMERCE 4-12-1989.
NICHOLAS COLEMAN, EXAMINING ATTORNEY

SN 77-914,464. THE CORPORATION FOR THE DISSEMINATION OF TEACHINGS OF VALUE, LAFAYETTE, CO. FILED 1-19-2010.

HARMONIZING

THE MARK CONSISTS OF STANDARD CHARACTERS WITHOUT CLAIM TO ANY PARTICULAR FONT, STYLE, SIZE, OR COLOR.

FOR EDUCATION SERVICES, NAMELY, PROVIDING CLASSES, SEMINARS, AND WORKSHOPS FOR GROUPS AND IN ONE TO ONE SETTINGS IN THE FIELD OF HOLISTIC HEALING AND THERAPY, AND PERSONAL DEVELOPMENT (U.S. CLS. 100, 101 AND 107).

FIRST USE 1-18-2010; IN COMMERCE 1-18-2010.
ERIN FALK, EXAMINING ATTORNEY

CLASS 41—(Continued).

SN 77-914,951. COMPETITOR GROUP, INC., SAN DIEGO, CA. FILED 1-19-2010.



OWNER OF U.S. REG. NOS. 2,131,333, 2,530,120 AND 3,660,153.

NO CLAIM IS MADE TO THE EXCLUSIVE RIGHT TO USE "PHILADELPHIA 1/2 MARATHON", APART FROM THE MARK AS SHOWN.

THE MARK CONSISTS OF THE STYLIZED WORDS "ROCK 'N' ROLL PHILADELPHIA 1/2 MARATHON" IN THREE SEPARATE RECTANGLES AND A SEPARATE RECTANGLE CONTAINING A DESIGN, ALL SURROUNDED BY A RECTANGULAR BORDER. THE DESIGN COMPRISES A BELL SURROUNDED BY STARS.

FOR ENTERTAINMENT IN THE NATURE OF ORGANIZING A SPORTING EVENT IN THE NATURE OF A RUNNING RACE AND RELATED SPORTING AND ENTERTAINMENT EVENTS, NAMELY, ORGANIZING COMMUNITY FAIRS FEATURING VENDOR BOOTHS OF FOOD AND RACE RELATED SPORTING GOODS, AND PLANNING PARTIES AND DINNERS (U.S. CLS. 100, 101 AND 107).

BRENDAN REGAN, EXAMINING ATTORNEY

SN 77-914,957. COMPETITOR GROUP, INC., SAN DIEGO, CA. FILED 1-19-2010.

ROCK 'N' ROLL PHILADELPHIA

THE MARK CONSISTS OF STANDARD CHARACTERS WITHOUT CLAIM TO ANY PARTICULAR FONT, STYLE, SIZE, OR COLOR.

OWNER OF U.S. REG. NOS. 2,131,333, 3,660,153 AND OTHERS.

NO CLAIM IS MADE TO THE EXCLUSIVE RIGHT TO USE "PHILADELPHIA", APART FROM THE MARK AS SHOWN.

FOR ENTERTAINMENT IN THE NATURE OF ORGANIZING A SPORTING EVENT IN THE NATURE OF A RUNNING RACE AND RELATED SPORTING AND ENTERTAINMENT EVENTS, NAMELY, ORGANIZING COMMUNITY FAIRS FEATURING VENDOR BOOTHS OF FOOD AND RACE RELATED SPORTING GOODS, AND PLANNING PARTIES AND DINNERS (U.S. CLS. 100, 101 AND 107).

BRENDAN REGAN, EXAMINING ATTORNEY

CLASS 41—(Continued).

SN 77-918,576. WORLD WRESTLING ENTERTAINMENT, INC., STAMFORD, CT. FILED 1-22-2010.

NXT

THE MARK CONSISTS OF STANDARD CHARACTERS WITHOUT CLAIM TO ANY PARTICULAR FONT, STYLE, SIZE, OR COLOR.

FOR ENTERTAINMENT SERVICES, NAMELY, THE PRODUCTION AND EXHIBITION OF PROFESSIONAL WRESTLING EVENTS RENDERED LIVE AND THROUGH THE MEDIA OF TELEVISION; PROVIDING WRESTLING NEWS AND INFORMATION VIA A GLOBAL COMPUTER NETWORK (U.S. CLS. 100, 101 AND 107).

NATALIE POLZER, EXAMINING ATTORNEY

CLASS 41—(Continued).

SN 77-922,093. NATIONAL VOLUNTARY ORGANIZATIONS ACTIVE IN DISASTER, INC., AKA NATIONAL VOAD; NVOAD, ARLINGTON, VA. FILED 1-28-2010.



THE MARK CONSISTS OF A STYLIZED TREE. FOR EDUCATIONAL SERVICES, NAMELY, PROVIDING EDUCATIONAL SPEAKERS, SEMINARS, EXHIBITIONS, AND RECEPTIONS, AND DISTRIBUTING RELATED TRAINING MATERIALS, ALL TO SHARE KNOWLEDGE AND RESOURCES IN THE AREAS OF DISASTER PREPARATION, RESPONSE AND RECOVERY (U.S. CLS. 100, 101 AND 107).

FIRST USE 1-28-1980; IN COMMERCE 1-28-1980.
ESTHER BELENKER, EXAMINING ATTORNEY

SN 77-924,109. CREATIVE MARKETING ASSOCIATES, INC., KANSAS CITY, MO. FILED 1-29-2010.

ADDITUP

THE MARK CONSISTS OF STANDARD CHARACTERS WITHOUT CLAIM TO ANY PARTICULAR FONT, STYLE, SIZE, OR COLOR.

FOR ENTERTAINMENT SERVICES IN THE NATURE OF AN INTERACTIVE CONTEST BY TELEPHONE OR INTERNET UTILIZING SYNTHESIZED VOICE EQUIPMENT (U.S. CLS. 100, 101 AND 107).

FIRST USE 1-20-2010; IN COMMERCE 1-20-2010.
TRACY WHITTAKER-BROWN, EXAMINING ATTORNEY

SN 77-920,477. ELECTRONIC ARTS INC., REDWOOD CITY, CA. FILED 1-26-2010.

MySims SkyHeroes

THE MARK CONSISTS OF STANDARD CHARACTERS WITHOUT CLAIM TO ANY PARTICULAR FONT, STYLE, SIZE, OR COLOR.

OWNER OF U.S. REG. NO. 3,554,643.

FOR ENTERTAINMENT SERVICES, NAMELY, PROVIDING AN ON-LINE COMPUTER GAME; PROVISION OF INFORMATION RELATING TO ELECTRONIC COMPUTER GAMES PROVIDED VIA THE INTERNET (U.S. CLS. 100, 101 AND 107).

CARYN GLASSER, EXAMINING ATTORNEY

SN 77-926,445. FARKAS, GLENN R., CARROLLTON, TX. FILED 2-2-2010.

The Complete Package

THE MARK CONSISTS OF STANDARD CHARACTERS WITHOUT CLAIM TO ANY PARTICULAR FONT, STYLE, SIZE, OR COLOR.

FOR ENTERTAINMENT IN THE NATURE OF ONGOING TELEVISION PROGRAMS IN THE FIELD OF A CONTINUING TELEVISION TALENT SHOW (U.S. CLS. 100, 101 AND 107).

HOWARD B. LEVINE, EXAMINING ATTORNEY

CLASS 41—(Continued).

SN 77-939,084. UPRIGHT CITIZENS BRIGADE, NEW YORK, NY. FILED 2-18-2010.

UCB

THE MARK CONSISTS OF STANDARD CHARACTERS WITHOUT CLAIM TO ANY PARTICULAR FONT, STYLE, SIZE, OR COLOR.

FOR EDUCATION SERVICES, NAMELY, PROVIDING CLASSES, WORKSHOPS, SEMINARS, PROGRAMS, MEETINGS AND CONFERENCES IN THE FIELDS OF THEATRICAL SKILLS AND IMPROVISATIONAL COMEDY; ENTERTAINMENT IN THE NATURE OF LIVE STAND-UP COMEDY, IMPROVISATIONAL COMEDY AND GROUP SKETCH COMEDY (U.S. CLS. 100, 101 AND 107).

FIRST USE 8-0-1993; IN COMMERCE 8-0-1993.
JAMES MACFARLANE, EXAMINING ATTORNEY

SN 77-949,390. PEARSON EDUCATION, INC., UPPER SADDLE RIVER, NJ. FILED 3-3-2010.

MYHUMANSERVICESLAB

THE MARK CONSISTS OF STANDARD CHARACTERS WITHOUT CLAIM TO ANY PARTICULAR FONT, STYLE, SIZE, OR COLOR.

OWNER OF U.S. REG. NOS. 2,554,037, 3,752,159 AND OTHERS.

FOR EDUCATIONAL SERVICES, NAMELY, DEVELOPMENT AND DISSEMINATION OF EDUCATIONAL TOOLS, CONTENT, AND MATERIALS OF OTHERS TO UNIVERSITY PROFESSORS AND THEIR STUDENTS VIA THE INTERNET, NAMELY, DIGITAL TEXTBOOKS, INSTRUCTORS MANUALS, SUPPLEMENTARY READING MATERIALS, INSTRUCTIONAL MATERIALS IN THE NATURE OF SELF-ASSESSMENT AND STUDY TOOLS FOR STUDENTS, HOMEWORK ASSIGNMENTS, COURSE ASSESSMENT AND COURSE MANAGEMENT MATERIALS IN THE FIELDS OF HEALTH, WELL-BEING, MEDICINE, LAW AND SOCIAL PROGRAMS (U.S. CLS. 100, 101 AND 107).

SUSAN RICHARDS, EXAMINING ATTORNEY

CLASS 41—(Continued).

SN 79-070,521. OPEROSA EOOD, BG-1463 SOFIA, BULGARIA, FILED 4-15-2009.



OPEROSA

OWNER OF INTERNATIONAL REGISTRATION 0921692 DATED 3-21-2007, EXPIRES 3-21-2017.

THE MARK CONSISTS OF THE DESIGN OF A CIRCLE. WITHIN THE CIRCLE IS A SPIRAL WITH A SMALL STAR AT THE END OF THE SPIRAL. EMERGING FROM THE CIRCLE IS THE SILHOUETTE OF A WOMAN WITH HER ARMS OPEN AND HAIR FLOWING BEHIND HER. BELOW THE DESIGN IS THE WORDING "OPEROSA" IN STYLIZED FORM.

THE WORDING "OPEROSA" HAS NO MEANING IN A FOREIGN LANGUAGE.

FOR EDUCATION SERVICES IN THE NATURE OF MASTER CLASSES IN PERFORMING CLASSICAL MUSIC, SEMINARS ON CLASSICAL MUSIC AND THE CLASSICAL MUSIC INDUSTRY, AND SEMINARS WITH LECTURES AND FORUMS ABOUT OPERA, DANCE, THEATER, AND ART; ENTERTAINMENT SERVICES IN THE NATURE OF LIVE CLASSICAL MUSIC PERFORMANCES (U.S. CLS. 100, 101 AND 107).

MARILYN IZZI, EXAMINING ATTORNEY

SN 79-071,122. SOCIETE TECHNIQUE POUR L'ENERGIE; ATOMIQUE TECHNICATOME, FRANCE, FILED 4-24-2009.

Z Plant

THE MARK CONSISTS OF STANDARD CHARACTERS WITHOUT CLAIM TO ANY PARTICULAR FONT, STYLE, SIZE, OR COLOR.

PRIORITY DATE OF 11-14-2008 IS CLAIMED.

OWNER OF INTERNATIONAL REGISTRATION 1008244 DATED 4-24-2009, EXPIRES 4-24-2019.

FOR PROVIDING TRAINING COURSES IN THE FORM OF THEORETICAL CLASSROOM INSTRUCTION, HANDS-ON EXERCISES AND PRACTICES CONCERNING PROJECT MANAGEMENT IN THE FIELD OF NUCLEAR SAFETY (U.S. CLS. 100, 101 AND 107).

KRISTINA MORRIS, EXAMINING ATTORNEY

CLASS 41—(Continued).

SN 79-073,943. ZHANG DA GUANG, CHINA, FILED 8-20-2009.



OWNER OF INTERNATIONAL REGISTRATION 1016105 DATED 8-20-2009, EXPIRES 8-20-2019.

NO CLAIM IS MADE TO THE EXCLUSIVE RIGHT TO USE "PHOTOGRAPHIC ORGANIZATION" OR THE NON-LATIN CHARACTERS THAT TRANSLITERATE TO "SHE YING JI GOU", APART FROM THE MARK AS SHOWN.

THE MARK CONSISTS OF THE STYLIZED WORDING "2 VISION PHOTOGRAPHIC ORGANIZATION", WITH THE NUMBER "2" OVERLAPPING THE LETTER "V", THE LETTER "V" HAVING A WING OF A BIRD. THE WORDING "PHOTOGRAPHIC ORGANIZATION" ABOVE THE LETTERS "ISION" AND CHINESE CHARACTERS APPEARING ABOVE THE WORDING "PHOTOGRAPHIC ORGANIZATION".

THE NON-LATIN CHARACTERS IN THE MARK TRANSLITERATE TO "SHI JUE SHE YING JI GOU" AND THIS MEANS "VISION PHOTOGRAPHIC ORGANIZATION" IN ENGLISH.

FOR EDUCATIONAL ACADEMIES, NAMELY, BOARDING SCHOOLS, EDUCATION IN THE NATURE OF PHOTOGRAPHY SCHOOLS; ORGANIZATION OF EXHIBITION FOR CULTURAL OR EDUCATIONAL PURPOSES; PHOTOGRAPHY; PUBLICATION OF BOOKS; DISTRIBUTION OF VIDEO CASSETTES, NAMELY, DISTRIBUTION OF MOTION PICTURE FILMS; PRESENTATION OF LIVE PERFORMANCES, NAMELY, LIVE MUSICAL PERFORMANCES, LIVE SHOW PERFORMANCES; SPORT CAMP SERVICES; MODELLING FOR ARTISTS (U.S. CLS. 100, 101 AND 107).

LEIGH LOWRY, EXAMINING ATTORNEY

CLASS 42—SCIENTIFIC AND COMPUTER SERVICES

SN 77-011,718. FUTURE MEDIA ARCHITECTS, INC., ROAD TOWN, BR. VIRGIN ISLANDS, FILED 10-2-2006.

OXIDE.MOBI

THE MARK CONSISTS OF STANDARD CHARACTERS WITHOUT CLAIM TO ANY PARTICULAR FONT, STYLE, SIZE, OR COLOR.

OWNER OF U.S. REG. NO. 2,879,220.

FOR COMPUTER SERVICES, NAMELY, PROVIDING SEARCH ENGINE AND ONLINE WEB LINK SERVICES TO OTHER WEBSITES TO OBTAIN DATA ON A GLOBAL COMPUTER NETWORK; DOMAIN NAME REGISTRATION SERVICES ON A GLOBAL COMPUTER NETWORK; HOSTING THE DATA, IMAGES, AUDIO AND VIDEO CONTENT OF OTHERS ON A GLOBAL COMPUTER NETWORK (U.S. CLS. 100 AND 101).

NAKIA HENRY, EXAMINING ATTORNEY

CLASS 42—(Continued).

SN 77-119,608. TRANSWORLD TRADING & TECHNOLOGY, LLC, PHOENIX, AZ. FILED 3-1-2007.

GOOD.NET

THE MARK CONSISTS OF STANDARD CHARACTERS WITHOUT CLAIM TO ANY PARTICULAR FONT, STYLE, SIZE, OR COLOR.

FOR HOSTING OF DIGITAL CONTENT, NAMELY, AUDIO CLIPS, VIDEO CLIPS, MUSICAL PERFORMANCES, MUSICAL VIDEOS, FILM CLIPS, PHOTOGRAPHS, AND OTHER MULTIMEDIA MATERIALS, ON THE INTERNET (U.S. CLS. 100 AND 101).

KATHERINE CHANG, EXAMINING ATTORNEY

SN 77-447,772. PORSCIA FASHION INC., VANCOUVER, CANADA, FILED 4-14-2008.

PORSCIA

THE MARK CONSISTS OF STANDARD CHARACTERS WITHOUT CLAIM TO ANY PARTICULAR FONT, STYLE, SIZE, OR COLOR.

FOR DESIGN FOR OTHERS IN THE FIELD OF FASHION APPAREL ACCESSORIES FOR MEN, WOMEN AND CHILDREN (U.S. CLS. 100 AND 101).

SALLY SHIH, EXAMINING ATTORNEY

SN 77-509,509. NEDDERMAN, SCOTT A., CHARLOTTE, NC. FILED 6-27-2008.

Netphase

THE MARK CONSISTS OF STANDARD CHARACTERS WITHOUT CLAIM TO ANY PARTICULAR FONT, STYLE, SIZE, OR COLOR.

FOR DESIGN, CREATION, HOSTING AND MAINTENANCE OF INTERNET SITES FOR THIRD PARTIES (U.S. CLS. 100 AND 101).

FIRST USE 2-5-1997; IN COMMERCE 2-5-1997.

MICHAEL LITZAU, EXAMINING ATTORNEY

CLASS 42—(Continued).

SN 77-608,756. DECHO CORPORATION, PLEASANT GROVE, UT. FILED 11-6-2008.

DECHO

THE MARK CONSISTS OF STANDARD CHARACTERS WITHOUT CLAIM TO ANY PARTICULAR FONT, STYLE, SIZE, OR COLOR.

THE WORDING "DECHO" HAS NO MEANING IN A FOREIGN LANGUAGE.

FOR PROVIDING TEMPORARY USE OF ON-LINE NON-DOWNLOADABLE SOFTWARE DEVELOPMENT TOOLS FOR THE COLLECTION, EDITING, ORGANIZING, MODIFYING, BOOK MARKING, TRANSMISSION, STORAGE AND SHARING OF DATA AND INFORMATION; PROVIDING TEMPORARY USE OF ON-LINE NON-DOWNLOADABLE SOFTWARE DEVELOPMENT TOOLS FOR MANAGEMENT OF STORED COMPUTER DATA, NAMELY, SOFTWARE FOR DATA BACKUP AND RECOVERY MANAGEMENT, SOFTWARE FOR DATA ARCHIVING AND STORAGE MANAGEMENT, COMPUTER SOFTWARE FOR SYNCHRONIZATION AND AGGREGATION OF STORED DATA; PROVIDING TEMPORARY USE OF ON-LINE NON-DOWNLOADABLE SOFTWARE DEVELOPMENT TOOLS FOR PROVIDING AND MANAGING REMOTE ACCESS TO STORED DATA OVER COMPUTER NETWORKS; PROVIDING TEMPORARY USE OF ON-LINE NON-DOWNLOADABLE SOFTWARE DEVELOPMENT TOOLS FOR VIEWING AND ANALYZING EMAIL MESSAGES; APPLICATION SERVICE PROVIDER, NAMELY, PROVIDING, HOSTING, MANAGING, DEVELOPING, AND MAINTAINING APPLICATIONS AND SOFTWARE OF OTHERS IN THE FIELDS OF DATA INDEXING, DATA BACKUP, DATA RECOVERY, DATA ARCHIVAL, DATA PRESERVATION, ONLINE DATA STORAGE, REMOTE DATA ACCESS, COLLABORATION, DATA SYNCHRONIZATION, DATA SYNDICATION, DATA AGGREGATION, DATA ORGANIZATION, AND DATA EDITING; APPLICATION SERVICE PROVIDER, NAMELY, HOSTING COMPUTER SOFTWARE APPLICATIONS OF OTHERS (U.S. CLS. 100 AND 101).

STEVEN PEREZ, EXAMINING ATTORNEY

CLASS 42—(Continued).

SN 77-622,474. SHARETHIS, INC., CINCINNATI, OH. FILED 11-26-2008.

SHAREBOX

THE MARK CONSISTS OF STANDARD CHARACTERS WITHOUT CLAIM TO ANY PARTICULAR FONT, STYLE, SIZE, OR COLOR.

FOR COMPUTER SERVICES, NAMELY, PROVIDING TEMPORARY USE OF ON-LINE NON-DOWNLOADABLE SOFTWARE FOR EXCHANGING MULTIMEDIA FILES, ARTWORK, TEXT, AUDIO, VIDEO, AND INTERNET WEB URLS (U.S. CLS. 100 AND 101).

FIRST USE 6-0-2006; IN COMMERCE 6-0-2006.

COLLEEN DOMBROW, EXAMINING ATTORNEY

SN 77-631,994. CAYUGA MEDICAL CENTER AT ITHACA, INC., ITHACA, NY. FILED 12-12-2008.

THE CENTER IS YOU

SN 77-617,454. MAJESCOMASTEK, INC., EDISON, NJ. FILED 11-19-2008.



OWNER OF U.S. REG. NO. 3,299,318.

THE COLOR(S) GRAY, YELLOW, RED AND BLUE IS/ARE CLAIMED AS A FEATURE OF THE MARK.

THE MARK CONSISTS OF "MAJESCOMASTEK" IN BLUE, UNDERNEATH A GRAY RIBBON PASSING THROUGH A STYLIZED GRAY TRIANGLE AND TRANSFORMING INTO RED, BLUE AND YELLOW RIBBONS.

FOR CONSULTING IN THE FIELD OF INFORMATION TECHNOLOGY (U.S. CLS. 100 AND 101).

FIRST USE 8-8-2008; IN COMMERCE 8-8-2008.

VIVIAN MICZNIK FIRST, EXAMINING ATTORNEY

THE MARK CONSISTS OF STANDARD CHARACTERS WITHOUT CLAIM TO ANY PARTICULAR FONT, STYLE, SIZE, OR COLOR.

SUBJECT TO CONCURRENT USE PROCEEDING WITH REGISTRATION NO. 3372321. APPLICANT CLAIMS THE EXCLUSIVE RIGHT TO USE THE MARK IN THE AREA COMPRISING NEW YORK, PENNSYLVANIA, NEW JERSEY, RHODE ISLAND, CONNECTICUT, VERMONT, MASSACHUSETTS, NEW HAMPSHIRE, AND MAINE.

FOR PROVIDING TEMPORARY USE OF ONLINE NON-DOWNLOADABLE SOFTWARE FOR USE IN THE MANAGEMENT OF PERSONAL HEALTH INFORMATION (U.S. CLS. 100 AND 101).

AMY ALFIERI, EXAMINING ATTORNEY

CLASS 42—(Continued).

SN 77-633,381. DUBMENOW, INC., VIENNA, VA. FILED 12-15-2008.



THE MARK CONSISTS OF THE WORDING "DUB ME NOW" IN STYLIZED FONT FOLLOWED BY THREE SMALL DOTS.

FOR APPLICATION SERVICE PROVIDER, NAMELY, PROVIDING, HOSTING, MANAGING, DEVELOPING, AND MAINTAINING APPLICATIONS, SOFTWARE, AND DATABASES IN THE FIELDS OF WIRELESS COMMUNICATION, MOBILE INFORMATION ACCESS, CONTACT INFORMATION EXCHANGE, NETWORKING, CREATION OF BACKUPS OF MOBILE ADDRESS BOOKS, DATA SYNCHRONIZATION WITH MULTIPLE CUSTOMER RELATIONSHIP MANAGEMENT (CRM) SYSTEMS AND APPLICATIONS, MOBILE AND DESKTOP ADDRESS BOOK APPLICATIONS AND DATABASES, AND REMOTE DATA MANAGEMENT FOR WIRELESS DELIVERY OF CONTENT TO MOBILE ELECTRONIC DEVICES (U.S. CLS. 100 AND 101).

FIRST USE 3-1-2008; IN COMMERCE 11-19-2008.

NATALIE POLZER, EXAMINING ATTORNEY

CLASS 42—(Continued).

SN 77-638,132. CELLCAST TECHNOLOGIES, LLC, ST. CHARLES, MO. FILED 12-22-2008.

EAGLE

SN 77-636,402. AFFERENT SECURITY LABS, LLC, LENEXA, KS. FILED 12-18-2008.

Cyber-Risktools

THE MARK CONSISTS OF STANDARD CHARACTERS WITHOUT CLAIM TO ANY PARTICULAR FONT, STYLE, SIZE, OR COLOR.

FOR APPLICATION SERVICE PROVIDER FEATURING SOFTWARE USED TO PREVENT UNAUTHORIZED ACCESS OR THEFT OF ELECTRONICALLY PROTECTED PERSONALLY IDENTIFIABLE INFORMATION AND OTHER SENSITIVE INFORMATION (U.S. CLS. 100 AND 101).

FIRST USE 2-1-2005; IN COMMERCE 4-1-2005.

DAVID C. REIHNER, EXAMINING ATTORNEY

THE MARK CONSISTS OF STANDARD CHARACTERS WITHOUT CLAIM TO ANY PARTICULAR FONT, STYLE, SIZE, OR COLOR.

FOR COMPUTER SERVICES IN THE NATURE OF MANAGEMENT OF ELECTRONIC EMERGENCY ALERTING AND PUBLIC SERVICE MESSAGES FOR GOVERNMENT, COMMUNITY, PUBLIC SERVICE AND SECURITY ENTITIES, NAMELY, RECEIVING, QUEUING, AGGREGATING, VERIFYING ELECTRONICALLY, AND DELIVERING MESSAGES FOR THE CLIENT ENTITIES AND SELECTING AND DELIVERING THE MESSAGES TO THIRD-PARTY TELECOMMUNICATION COMPANIES FOR PROVIDING THIRD-PARTY DELIVERY OF THE MESSAGES TO MESSAGE RECIPIENTS OVER THEIR CELLULAR AND WIRELESS SHORT MESSAGING SERVICES (SMS) AND CELL BROADCAST (CB) MESSAGING SERVICES, AND THEIR EMAIL, INTERNET, AND WIRELINE TELECOMMUNICATIONS SERVICES, ALL OF THE FOREGOING EXCLUDING TELECOMMUNICATIONS SERVICES, NAMELY, AIR TIME BROKERAGE, GATEWAY, AUDIOTEXT, AUTOMATIC CALL DISTRIBUTION, ONLINE CHAT ROOM, MESSAGING, VOIP, IP PBX WIRELESS, CALL RECORDING, INTERACTIVE VOICE RESPONSE, ISDN, TELEPHONE COMMUNICATION, TELECONFERENCING AND MULTIPLE-USER INFORMATION NETWORK ACCESS SERVICES (U.S. CLS. 100 AND 101).

FIRST USE 11-19-2008; IN COMMERCE 11-19-2008.

TINA MAI, EXAMINING ATTORNEY

CLASS 42—(Continued).

SN 77-638,143. CELLCAST TECHNOLOGIES, LLC, ST. CHARLES, MO. FILED 12-22-2008.

EAGLE ALERTS

THE MARK CONSISTS OF STANDARD CHARACTERS WITHOUT CLAIM TO ANY PARTICULAR FONT, STYLE, SIZE, OR COLOR.

NO CLAIM IS MADE TO THE EXCLUSIVE RIGHT TO USE "ALERTS", APART FROM THE MARK AS SHOWN.

FOR COMPUTER SERVICES IN THE NATURE OF MANAGEMENT OF ELECTRONIC EMERGENCY ALERTING AND PUBLIC SERVICE MESSAGES FOR GOVERNMENT, COMMUNITY, PUBLIC SERVICE AND SECURITY ENTITIES, NAMELY, RECEIVING, QUEUING, AGGREGATING, VERIFYING ELECTRONICALLY, AND DELIVERING MESSAGES FOR THE CLIENT ENTITIES AND SELECTING AND DELIVERING THE MESSAGES TO THIRD-PARTY TELECOMMUNICATION COMPANIES FOR PROVIDING THIRD-PARTY DELIVERY OF THE MESSAGES TO MESSAGE RECIPIENTS OVER THEIR CELLULAR AND WIRELESS SHORT MESSAGING SERVICES (SMS) AND CELL BROADCAST (CB) MESSAGING SERVICES, AND THEIR EMAIL, INTERNET, AND WIRE LINE TELECOMMUNICATIONS SERVICES, ALL OF THE FOREGOING EXCLUDING TELECOMMUNICATIONS SERVICES, NAMELY, AIR TIME BROKERAGE, GATEWAY, AUDIO TEXT, AUTOMATIC CALL DISTRIBUTION, ON-LINE CHAT ROOM, MESSAGING, VOIP, IP PBX WIRELESS, CALL RECORDING, INTERACTIVE VOICE RESPONSE, ISDN, TELEPHONE COMMUNICATION, TELECONFERENCING AND MULTIPLE-USER INFORMATION NETWORK ACCESS SERVICES (U.S. CLS. 100 AND 101).

TINA MAI, EXAMINING ATTORNEY

SN 77-638,937. SHARETHIS, INC., CINCINNATI, OH. FILED 12-23-2008.

ONE CLICK SHARING

THE MARK CONSISTS OF STANDARD CHARACTERS WITHOUT CLAIM TO ANY PARTICULAR FONT, STYLE, SIZE, OR COLOR.

NO CLAIM IS MADE TO THE EXCLUSIVE RIGHT TO USE "SHARING", APART FROM THE MARK AS SHOWN.

FOR COMPUTER SERVICES, NAMELY, PROVIDING TEMPORARY USE OF ON-LINE NON-DOWNLOADABLE SOFTWARE FOR EXCHANGING MULTIMEDIA FILES, ARTWORK, TEXT, AUDIO, VIDEO, AND INTERNET WEB URLS (U.S. CLS. 100 AND 101).

COLLEEN DOMBROW, EXAMINING ATTORNEY

CLASS 42—(Continued).

SN 77-638,983. SHARETHIS, INC., CINCINNATI, OH. FILED 12-23-2008.

SHARING MADE SIMPLE

THE MARK CONSISTS OF STANDARD CHARACTERS WITHOUT CLAIM TO ANY PARTICULAR FONT, STYLE, SIZE, OR COLOR.

NO CLAIM IS MADE TO THE EXCLUSIVE RIGHT TO USE "SHARING", APART FROM THE MARK AS SHOWN.

FOR COMPUTER SERVICES, NAMELY, PROVIDING TEMPORARY USE OF ON-LINE NON-DOWNLOADABLE SOFTWARE FOR EXCHANGING MULTIMEDIA FILES, ARTWORK, TEXT, AUDIO, VIDEO, AND INTERNET WEB URLS (U.S. CLS. 100 AND 101).

COLLEEN DOMBROW, EXAMINING ATTORNEY

SN 77-680,812. CHASEVISION360, CHARLOTTE, NC. FILED 2-28-2009.

ChaseVision360
take a good look around

NO CLAIM IS MADE TO THE EXCLUSIVE RIGHT TO USE "360", APART FROM THE MARK AS SHOWN.

THE COLOR(S) GRAY, MAROON (DARK RED) AND RED IS/ARE CLAIMED AS A FEATURE OF THE MARK.

THE MARK CONSISTS OF A GRAY CAPITAL LETTER "C" FOLLOWED BY GRAY LOWER CASE "H-A-S-E" THEN A GRAY CAPITAL LETTER "V" FOLLOWED BY GRAY LOWER CASE "I-S-I-O-N". THE LETTERS ARE FOLLOWED WITHOUT A SPACE BY MAROON NUMBERS "360". A MAROON DEGREE SYMBOL IS LOCATED AT THE END OF THE NUMBER "360" TO INDICATE THE CONCEPT OF A CIRCLE THE DEGREE SYMBOL IS CONNECTED TO THE NUMBER "3" VIA A MAROON BELT OR HALF CIRCLE THAT STARTS AT THE BOTTOM OR TOE OF THE "3" AND "SWOOPS" UNDER THE "360" TO CONNECT TO THE DEGREE SYMBOL. THE NUMBER "360" IS REFLECTED OR MIRRORED IN RED BELOW. THIS FEATURE FADES AWAY AS AN IMAGE WOULD WHEN REFLECTED ON A POND. NOTE THAT ONLY THE NUMBER IS REFLECTED. THE MAROON WORDING "TAKE A GOOD LOOK AROUND" IS POSITIONED UNDER THE WORD "CHASEVISION".

FOR DISPLAYING THE IMAGES OF OTHERS ON A COMPUTER SERVER, NAMELY, DISPLAYING 360-DEGREE PANORAMIC OR SPHERICAL IMAGES OF PARTICULAR SITES, LOCATIONS, BUILDINGS, COMPLEXES, ROOMS, OBJECTS, OR EVENTS TYPICALLY IN CONNECTION WITH A SITE AUDIT, INSPECTION OR ASSESSMENT; HOSTING DIGITAL CONTENT FOR OTHERS, NAMELY, HOSTING OF 360-DEGREE PANORAMIC OR SPHERICAL IMAGES OR VIDEOS OF PARTICULAR SITES, LOCATIONS, BUILDINGS, COMPLEXES, ROOMS, OBJECTS, OR EVENTS (U.S. CLS. 100 AND 101).

FIRST USE 12-9-2008; IN COMMERCE 12-15-2008.

KIMBERLY FRYE, EXAMINING ATTORNEY

CLASS 42—(Continued).

SN 77-708,984. HIROOKA, RYUJI, SCOTTSDALE, AZ. FILED 4-7-2009.



NO CLAIM IS MADE TO THE EXCLUSIVE RIGHT TO USE "AMERICAN INSTITUTE OF EASTERN MEDICINE" AND THE NON-LATIN CHARACTERS THAT MEAN "PHILANTHROPY" AND "AMERICAN INSTITUTE OF EASTERN MEDICINE", APART FROM THE MARK AS SHOWN. THE COLOR(S) RED, WHITE AND GOLD IS/ARE CLAIMED AS A FEATURE OF THE MARK.

THE MARK CONSISTS OF LATIN CHARACTERS FORMING THE WORDS "AMERICAN INSTITUTE OF EASTERN MEDICINE" IN WHITE SET BENEATH NON-LATIN CHARACTERS IN WHITE WHICH, ROUGHLY TRANSLATED, MEAN "PHILANTHROPY" ACCORDING TO THE CHINESE LANGUAGE. THE LATIN AND NON-LATIN CHARACTERS ARE SEPARATED BY A SMALL OVAL CONTAINING ADDITIONAL THE LATIN CHARACTERS "WXI" WHICH ARE WRITTEN IN RED AND SET WITHIN A GOLD BACKGROUND. THE LATIN AND NON-LATIN CHARACTERS, TOGETHER WITH THE OVAL SEPARATOR, ARE SET WITHIN A RED RECTANGULAR BACKGROUND. THE RED RECTANGULAR BACKGROUND IS SURROUNDED BY A SOLID GOLD BORDER WHICH IS SLIGHTLY SET APART FROM THE RED BACKGROUND AND BROKEN ON EITHER SIDE SO AS NOT TO OVERLAP THE TWO INWARD-FACING DRAGONS OF THE SAME SHADE AND COLOR PLACED ON THE EASTERN AND WESTERN BORDER THEREOF. APPEARING BELOW THE SOUTHERN SOLID GOLD BORDER ARE EIGHT NON-LATIN CHARACTERS DRAWN IN RED WHICH MEAN "AMERICAN INSTITUTE OF EASTERN MEDICINE" ACCORDING TO THE CHINESE LANGUAGE.

THE ENGLISH TRANSLATION OF "AI BO" AND "MEI GUO DONG FANG YI XUE XIE HUI" IN THE MARK IS "PHILANTHROPY" AND "AMERICAN INSTITUTE OF EASTERN MEDICINE".

FOR MEDICAL AND SCIENTIFIC RESEARCH IN THE FIELD OF DIET, NUTRITION AND EXERCISE; MEDICAL AND SCIENTIFIC RESEARCH INFORMATION IN THE FIELD OF DIET, NUTRITION AND EXERCISE; PHARMACEUTICAL RESEARCH AND DEVELOPMENT; PROVIDING MEDICAL AND SCIENTIFIC RESEARCH INFORMATION IN THE FIELD OF PHARMACEUTICALS AND CLINICAL TRIALS; SCIENTIFIC AND TECHNICAL CONSULTING AND RESEARCH SERVICES RELATING TO FOODS AND DIETARY SUPPLEMENTS; SCIENTIFIC RESEARCH; SCIENTIFIC RESEARCH AND DEVELOPMENT (U.S. CLS. 100 AND 101).

FIRST USE 2-1-2007; IN COMMERCE 2-1-2007.
SKYE YOUNG, EXAMINING ATTORNEY

CLASS 42—(Continued).

SN 77-726,431. COGNETICS CORPORATION, PRINCETON JUNCTION, NJ. FILED 4-30-2009.

MindPops

THE MARK CONSISTS OF STANDARD CHARACTERS WITHOUT CLAIM TO ANY PARTICULAR FONT, STYLE, SIZE, OR COLOR.

FOR PROVIDING TEMPORARY USE OF ON-LINE, NONDOWNLOADABLE, INTERACTIVE MULTIMEDIA COMPUTER PROGRAMS FEATURING TEXT, AUDIO AND VIDEO, FOR TRAINING AND ASSESSMENT IN THE FIELDS OF CRITICAL THINKING, TECHNOLOGY, COMMUNICATION, BUSINESS ACUMEN, PROBLEM SOLVING, COLLABORATION, AND GLOBAL AWARENESS, WHICH SOFTWARE IS INTENDED FOR VARIOUS USERS DEPENDING UPON THE SUBJECT MATTER OF THE INDIVIDUAL SOFTWARE (U.S. CLS. 100 AND 101).

FIRST USE 3-1-2009; IN COMMERCE 3-1-2009.
KIMBERLY FRYE, EXAMINING ATTORNEY

SN 77-729,536. STI TECHNOLOGIES, INC., ROCHESTER, NY. FILED 5-5-2009.

SIMUTECH SUPPORT

THE MARK CONSISTS OF STANDARD CHARACTERS WITHOUT CLAIM TO ANY PARTICULAR FONT, STYLE, SIZE, OR COLOR.

OWNER OF U.S. REG. NO. 3,655,473.

NO CLAIM IS MADE TO THE EXCLUSIVE RIGHT TO USE "SUPPORT", APART FROM THE MARK AS SHOWN.

FOR TECHNICAL SUPPORT SERVICES, NAMELY, TROUBLESHOOTING OF COMPUTER SOFTWARE PROBLEMS FOR COMPUTER SIMULATION SOFTWARE FOR ENGINEERING ANALYSIS (U.S. CLS. 100 AND 101).

JIM RINGLE, EXAMINING ATTORNEY

SN 77-733,622. CANDELARIA DESIGN ASSOCIATES, LLC, PHOENIX, AZ. FILED 5-11-2009.

CANDELARIA

THE MARK CONSISTS OF STANDARD CHARACTERS WITHOUT CLAIM TO ANY PARTICULAR FONT, STYLE, SIZE, OR COLOR.

FOR ARCHITECTURAL DESIGN SERVICES; ARCHITECTURAL RESEARCH SERVICES; LANDSCAPE ARCHITECTURAL DESIGN (U.S. CLS. 100 AND 101).

FIRST USE 4-0-2007; IN COMMERCE 4-0-2007.
GENE MACIOL, EXAMINING ATTORNEY

CLASS 42—(Continued).

SN 77-734,785. ALEXANDER STREET PRESS LLC, ALEXANDRIA, VA. FILED 5-12-2009.

CRITICAL LEARNING EDITIONS

THE MARK CONSISTS OF STANDARD CHARACTERS WITHOUT CLAIM TO ANY PARTICULAR FONT, STYLE, SIZE, OR COLOR.

NO CLAIM IS MADE TO THE EXCLUSIVE RIGHT TO USE "EDITIONS", APART FROM THE MARK AS SHOWN. FOR PROVIDING A WEBSITE FEATURING A MEDIA AGGREGATOR AND SEARCH ENGINE FOR VIDEO, AUDIO, PICTORIAL AND TEXTUAL CONTENT (U.S. CLS. 100 AND 101).

SHAILA SETTLES, EXAMINING ATTORNEY

SN 77-735,070. ALEXANDER STREET PRESS LLC, ALEXANDRIA, VA. FILED 5-12-2009.

CRITICAL VIDEO EDITIONS

THE MARK CONSISTS OF STANDARD CHARACTERS WITHOUT CLAIM TO ANY PARTICULAR FONT, STYLE, SIZE, OR COLOR.

NO CLAIM IS MADE TO THE EXCLUSIVE RIGHT TO USE "VIDEO EDITIONS", APART FROM THE MARK AS SHOWN.

FOR PROVIDING A WEBSITE FEATURING A MEDIA AGGREGATOR AND SEARCH ENGINE FOR VIDEO CONTENT (U.S. CLS. 100 AND 101).

FIRST USE 1-0-2008; IN COMMERCE 1-0-2008.
SHAILA SETTLES, EXAMINING ATTORNEY

SN 77-735,356. DOUBLE DIVISION INC., SAN RAMON, CA. FILED 5-12-2009.

SIPREMA SOLUTIONS

THE MARK CONSISTS OF STANDARD CHARACTERS WITHOUT CLAIM TO ANY PARTICULAR FONT, STYLE, SIZE, OR COLOR.

NO CLAIM IS MADE TO THE EXCLUSIVE RIGHT TO USE "SOLUTIONS", APART FROM THE MARK AS SHOWN.

FOR APPLICATION SERVICE PROVIDER (ASP) FEATURING SOFTWARE FOR USE IN THE FIELD OF COMMERCIAL PROPERTY MANAGEMENT AND ADMINISTRATION (U.S. CLS. 100 AND 101).

YAT SYE, LEE, EXAMINING ATTORNEY

CLASS 42—(Continued).

SN 77-735,557. SHAIKH, JEFFREY W, DBA DIGITAL CANVAS, ANTIOCH, CA. FILED 5-13-2009.

Digital Canvas

THE MARK CONSISTS OF STANDARD CHARACTERS WITHOUT CLAIM TO ANY PARTICULAR FONT, STYLE, SIZE, OR COLOR.

NO CLAIM IS MADE TO THE EXCLUSIVE RIGHT TO USE "DIGITAL", APART FROM THE MARK AS SHOWN.

FOR COMPUTER SERVICES, NAMELY, INTERACTIVE HOSTING SERVICES WHICH ALLOW THE USER TO PUBLISH AND SHARE THEIR OWN CONTENT AND IMAGES ON-LINE; DESIGN OF HOMEPAGES AND WEBSITES; WEB SITE HOSTING SERVICES (U.S. CLS. 100 AND 101).

FIRST USE 0-0-1998; IN COMMERCE 0-0-1998.
SHAILA SETTLES, EXAMINING ATTORNEY

SN 77-738,867. SYSTEMS TECHNOLOGY FORUM, LTD., FREDERICKSBURG, VA. FILED 5-17-2009.



NO CLAIM IS MADE TO THE EXCLUSIVE RIGHT TO USE "SYSTEMS TECHNOLOGY", APART FROM THE MARK AS SHOWN.

THE MARK CONSISTS OF AN UNIFORM OVAL INCLUDING THE WORDING "STF" AND "SYSTEMS TECHNOLOGY FORUM" AND CONTAINING A CRESCENT SHAPE BORDERING THE "STF" WORDING.

FOR TECHNICAL AND ENGINEERING CONSULTING SERVICES IN THE FIELDS OF NAVAL OPERATIONS AND AERONAUTICS AND AVIATION, NAMELY, COMMAND, CONTROL, COMMUNICATIONS AND COMPUTER CONSULTING, TECHNICAL ENGINEERING CONSULTING, TECHNICAL ACQUISITION CONSULTING AND PROGRAMMATIC ACQUISITION CONSULTING; RESEARCH AND TESTING ON MACHINES, APPARATUS AND INSTRUMENTS; MATERIALS TESTING AND EVALUATION; NEW PRODUCT RESEARCH AND DEVELOPMENT FOR OTHERS, DESIGN AND TESTING FOR NEW PRODUCT DEVELOPMENT FOR OTHERS, ALL RELATING TO NAVAL OPERATIONS AND AERONAUTICS AND AVIATION, NAVAL AND AERONAUTICS SYSTEMS AND VEHICLES, ELECTRONIC SYSTEMS, INFORMATION SYSTEMS, ENERGY SYSTEMS, AND MATERIALS TECHNOLOGY; CONSULTING SERVICES IN THE FIELD OF DESIGN, SELECTION, IMPLEMENTATION AND USE OF COMPUTER HARDWARE AND SOFTWARE SYSTEMS FOR OTHERS; COMPUTER CONSULTING SERVICES FOR PLANNING, DESIGN, AND ANALYSIS OF INFORMATION PROCESSES, SYSTEMS, AND BUSINESS REENGINEERING; COMPUTER SERVICES, NAMELY, COMPUTER SYSTEM DESIGN AND DEVELOPMENT; COMPUTER HARDWARE AND SOFTWARE INTEGRATION FOR COMPUTER SYSTEMS; COMPUTER PROGRAMMING SERVICES; COMPUTER SOFTWARE DESIGN SERVICES; COMPUTER SYSTEMS ANALYSIS; COMPUTER SYSTEMS DESIGN SERVICES; SOFTWARE DEVELOPMENT; PROVIDING TEMPORARY USE OF NON DOWNLOADABLE COMPUTER

CLASS 42—(Continued).

SOFTWARE FOR COMPUTER SYSTEMS ANALYSIS; COMPUTER SYSTEMS DEVELOPMENT; NETWORK MANAGEMENT SERVICES; DATABASE DEVELOPMENT; ANALYSIS AND DESIGN OF COMPUTER SYSTEMS, SOFTWARE AND INFORMATION SYSTEMS FOR OTHERS; DESIGN FOR OTHERS OF WEB SITES AND SOFTWARE APPLICATIONS THEREFORE ON LOCAL AND INTERNAL COMPUTER NETWORKS AND THE INTERNET; PROVIDING DESIGN, DEVELOPMENT AND HOST SERVICES FOR OTHERS' INTERNET WEB SITES AND COMPUTER NETWORKS; MAINTENANCE OF SOFTWARE, SOFTWARE SYSTEMS AND INTERNET WEB SITES; INFORMATION TECHNOLOGY CONSULTATION SERVICES; COMPUTER CONSULTATION ON THE COMPUTER-RELATED ASPECTS OF INFORMATION TECHNOLOGY SECURITY AND E-COMMERCE; PROVIDING INFORMATION OVER LOCAL AND INTERNAL COMPUTER NETWORKS AND THE INTERNET ON THE SUBJECTS OF COMPUTER ANALYSIS, COMPUTER SYSTEMS DESIGN SERVICES, AND SOFTWARE AND SOFTWARE DEVELOPMENT; INTEGRATION OF COMPUTER SYSTEMS AND NETWORKS (U.S. CLS. 100 AND 101).

FIRST USE 1-0-2004; IN COMMERCE 1-0-2004.
DAVID HOFFMAN, EXAMINING ATTORNEY

CLASS 42—(Continued).

MANAGEMENT SERVICES; DATABASE DEVELOPMENT; ANALYSIS AND DESIGN OF COMPUTER SYSTEMS, SOFTWARE AND INFORMATION SYSTEMS FOR OTHERS; DESIGN FOR OTHERS OF WEB SITES AND SOFTWARE APPLICATIONS THEREFORE ON LOCAL AND INTERNAL COMPUTER NETWORKS AND THE INTERNET; PROVIDING DESIGN, DEVELOPMENT AND HOST SERVICES FOR OTHERS' INTERNET WEB SITES AND COMPUTER NETWORKS; MAINTENANCE OF SOFTWARE, SOFTWARE SYSTEMS AND INTERNET WEB SITES; INFORMATION TECHNOLOGY CONSULTATION SERVICES; COMPUTER CONSULTATION ON THE COMPUTER-RELATED ASPECTS OF INFORMATION TECHNOLOGY SECURITY AND E-COMMERCE; PROVIDING INFORMATION OVER LOCAL AND INTERNAL COMPUTER NETWORKS AND THE INTERNET ON THE SUBJECTS OF COMPUTER ANALYSIS, COMPUTER SYSTEMS DESIGN SERVICES, AND SOFTWARE AND SOFTWARE DEVELOPMENT; INTEGRATION OF COMPUTER SYSTEMS AND NETWORKS (U.S. CLS. 100 AND 101).

FIRST USE 4-17-2003; IN COMMERCE 4-17-2003.
DAVID HOFFMAN, EXAMINING ATTORNEY

SN 77-738,880. SYSTEMS TECHNOLOGY FORUM, LTD., FREDERICKSBURG, VA. FILED 5-17-2009.

SN 77-738,899. SYSTEMS TECHNOLOGY FORUM, LTD., FREDERICKSBURG, VA. FILED 5-17-2009.

SYSTEMS TECHNOLOGY FORUM

THE MARK CONSISTS OF STANDARD CHARACTERS WITHOUT CLAIM TO ANY PARTICULAR FONT, STYLE, SIZE, OR COLOR.

NO CLAIM IS MADE TO THE EXCLUSIVE RIGHT TO USE "SYSTEMS TECHNOLOGY", APART FROM THE MARK AS SHOWN.

FOR TECHNICAL AND ENGINEERING CONSULTING SERVICES IN THE FIELDS OF NAVAL OPERATIONS AND AERONAUTICS AND AVIATION, NAMELY, COMMAND, CONTROL, COMMUNICATIONS AND COMPUTER CONSULTING, TECHNICAL ENGINEERING CONSULTING, TECHNICAL ACQUISITION CONSULTING AND PROGRAMMATIC ACQUISITION CONSULTING; RESEARCH AND TESTING ON MACHINES, APPARATUS AND INSTRUMENTS; MATERIALS TESTING AND EVALUATION; NEW PRODUCT RESEARCH AND DEVELOPMENT FOR OTHERS, DESIGN AND TESTING FOR NEW PRODUCT DEVELOPMENT FOR OTHERS, ALL RELATING TO NAVAL OPERATIONS AND AERONAUTICS AND AVIATION, NAVAL AND AERONAUTICS SYSTEMS AND VEHICLES, ELECTRONIC SYSTEMS, INFORMATION SYSTEMS, ENERGY SYSTEMS, AND MATERIALS TECHNOLOGY; CONSULTING SERVICES IN THE FIELD OF DESIGN, SELECTION, IMPLEMENTATION AND USE OF COMPUTER HARDWARE AND SOFTWARE SYSTEMS FOR OTHERS; COMPUTER CONSULTING SERVICES FOR PLANNING, DESIGN, AND ANALYSIS OF INFORMATION PROCESSES, SYSTEMS, AND BUSINESS REENGINEERING; COMPUTER SERVICES, NAMELY, COMPUTER SYSTEM DESIGN AND DEVELOPMENT; COMPUTER HARDWARE AND SOFTWARE INTEGRATION FOR COMPUTER SYSTEMS; COMPUTER PROGRAMMING SERVICES; COMPUTER SOFTWARE DESIGN SERVICES; COMPUTER SYSTEMS ANALYSIS; COMPUTER SYSTEMS DESIGN SERVICES; SOFTWARE DEVELOPMENT; PROVIDING TEMPORARY USE OF NON DOWNLOADABLE COMPUTER SOFTWARE FOR COMPUTER SYSTEMS ANALYSIS; COMPUTER SYSTEMS DEVELOPMENT; NETWORK

**OBJECTIVE. PASSIONATE.
PERFORMANCE.**

THE MARK CONSISTS OF STANDARD CHARACTERS WITHOUT CLAIM TO ANY PARTICULAR FONT, STYLE, SIZE, OR COLOR.

FOR TECHNICAL AND ENGINEERING CONSULTING SERVICES IN THE FIELDS OF NAVAL OPERATIONS AND AERONAUTICS AND AVIATION, NAMELY, COMMAND, CONTROL, COMMUNICATIONS AND COMPUTER CONSULTING, TECHNICAL ENGINEERING CONSULTING, TECHNICAL ACQUISITION CONSULTING AND PROGRAMMATIC ACQUISITION CONSULTING; RESEARCH AND TESTING ON MACHINES, APPARATUS AND INSTRUMENTS; MATERIALS TESTING AND EVALUATION; NEW PRODUCT RESEARCH AND DEVELOPMENT FOR OTHERS, DESIGN AND TESTING FOR NEW PRODUCT DEVELOPMENT FOR OTHERS, ALL RELATING TO NAVAL OPERATIONS AND AERONAUTICS AND AVIATION, NAVAL AND AERONAUTICS SYSTEMS AND VEHICLES, ELECTRONIC SYSTEMS, INFORMATION SYSTEMS, ENERGY SYSTEMS, AND MATERIALS TECHNOLOGY; CONSULTING SERVICES IN THE FIELD OF DESIGN, SELECTION, IMPLEMENTATION AND USE OF COMPUTER HARDWARE AND SOFTWARE SYSTEMS FOR OTHERS; COMPUTER CONSULTING SERVICES FOR PLANNING, DESIGN, AND ANALYSIS OF INFORMATION PROCESSES, SYSTEMS, AND BUSINESS REENGINEERING; COMPUTER SERVICES, NAMELY, COMPUTER SYSTEM DESIGN AND DEVELOPMENT; COMPUTER HARDWARE AND SOFTWARE INTEGRATION FOR COMPUTER SYSTEMS; COMPUTER PROGRAMMING SERVICES; COMPUTER SOFTWARE DESIGN SERVICES; COMPUTER SYSTEMS ANALYSIS; COMPUTER SYSTEMS DESIGN SERVICES; SOFTWARE DEVELOPMENT; PROVIDING TEMPORARY USE OF NON DOWNLOADABLE COMPUTER SOFTWARE FOR COMPUTER SYSTEMS ANALYSIS; COMPUTER SYSTEMS DEVELOPMENT; NETWORK

CLASS 42—(Continued).

MANAGEMENT SERVICES; DATABASE DEVELOPMENT; ANALYSIS AND DESIGN OF COMPUTER SYSTEMS, SOFTWARE AND INFORMATION SYSTEMS FOR OTHERS; DESIGN FOR OTHERS OF WEB SITES AND SOFTWARE APPLICATIONS THEREFORE ON LOCAL AND INTERNAL COMPUTER NETWORKS AND THE INTERNET; PROVIDING DESIGN, DEVELOPMENT AND HOST SERVICES FOR OTHERS' INTERNET WEB SITES AND COMPUTER NETWORKS; MAINTENANCE OF SOFTWARE, SOFTWARE SYSTEMS AND INTERNET WEB SITES; INFORMATION TECHNOLOGY CONSULTATION SERVICES; COMPUTER CONSULTATION ON THE COMPUTER-RELATED ASPECTS OF INFORMATION TECHNOLOGY SECURITY AND E-COMMERCE; PROVIDING INFORMATION OVER LOCAL AND INTERNAL COMPUTER NETWORKS AND THE INTERNET ON THE SUBJECTS OF COMPUTER ANALYSIS, COMPUTER SYSTEMS DESIGN SERVICES, AND SOFTWARE AND SOFTWARE DEVELOPMENT; INTEGRATION OF COMPUTER SYSTEMS AND NETWORKS (U.S. CLS. 100 AND 101).

FIRST USE 5-0-2008; IN COMMERCE 5-0-2008.
DAVID HOFFMAN, EXAMINING ATTORNEY

SN 77-738,908. SYSTEMS TECHNOLOGY FORUM, LTD., FREDERICKSBURG, VA. FILED 5-17-2009.

STF

THE MARK CONSISTS OF STANDARD CHARACTERS WITHOUT CLAIM TO ANY PARTICULAR FONT, STYLE, SIZE, OR COLOR.

FOR TECHNICAL AND ENGINEERING CONSULTING SERVICES IN THE FIELDS OF NAVAL OPERATIONS AND AERONAUTICS AND AVIATION, NAMELY, COMMAND, CONTROL, COMMUNICATIONS AND COMPUTER CONSULTING, TECHNICAL ENGINEERING CONSULTING, TECHNICAL ACQUISITION CONSULTING AND PROGRAMMATIC ACQUISITION CONSULTING; RESEARCH AND TESTING ON MACHINES, APPARATUS AND INSTRUMENTS; MATERIALS TESTING AND EVALUATION; NEW PRODUCT RESEARCH AND DEVELOPMENT FOR OTHERS, DESIGN AND TESTING FOR NEW PRODUCT DEVELOPMENT FOR OTHERS, ALL RELATING TO NAVAL OPERATIONS AND AERONAUTICS AND AVIATION, NAVAL AND AERONAUTICS SYSTEMS AND VEHICLES, ELECTRONIC SYSTEMS, INFORMATION SYSTEMS, ENERGY SYSTEMS, AND MATERIALS TECHNOLOGY; CONSULTING SERVICES IN THE FIELD OF DESIGN, SELECTION, IMPLEMENTATION AND USE OF COMPUTER HARDWARE AND SOFTWARE SYSTEMS FOR OTHERS; COMPUTER CONSULTING SERVICES FOR PLANNING, DESIGN, AND ANALYSIS OF INFORMATION PROCESSES, SYSTEMS, AND BUSINESS REENGINEERING; COMPUTER SERVICES, NAMELY, COMPUTER SYSTEM DESIGN AND DEVELOPMENT; COMPUTER HARDWARE AND SOFTWARE INTEGRATION FOR COMPUTER SYSTEMS; COMPUTER PROGRAMMING SERVICES; COMPUTER SOFTWARE DESIGN SERVICES; COMPUTER SYSTEMS ANALYSIS; COMPUTER SYSTEMS DESIGN SERVICES; SOFTWARE DEVELOPMENT; PROVIDING TEMPORARY USE OF NON DOWNLOADABLE COMPUTER SOFTWARE FOR COMPUTER SYSTEMS ANALYSIS; COMPUTER SYSTEMS DEVELOPMENT; NETWORK

CLASS 42—(Continued).

MANAGEMENT SERVICES; DATABASE DEVELOPMENT; ANALYSIS AND DESIGN OF COMPUTER SYSTEMS, SOFTWARE AND INFORMATION SYSTEMS FOR OTHERS; DESIGN FOR OTHERS OF WEB SITES AND SOFTWARE APPLICATIONS THEREFORE ON LOCAL AND INTERNAL COMPUTER NETWORKS AND THE INTERNET; PROVIDING DESIGN, DEVELOPMENT AND HOST SERVICES FOR OTHERS' INTERNET WEB SITES AND COMPUTER NETWORKS; MAINTENANCE OF SOFTWARE, SOFTWARE SYSTEMS AND INTERNET WEB SITES; INFORMATION TECHNOLOGY CONSULTATION SERVICES; COMPUTER CONSULTATION ON THE COMPUTER-RELATED ASPECTS OF INFORMATION TECHNOLOGY SECURITY AND E-COMMERCE; PROVIDING INFORMATION OVER LOCAL AND INTERNAL COMPUTER NETWORKS AND THE INTERNET ON THE SUBJECTS OF COMPUTER ANALYSIS, COMPUTER SYSTEMS DESIGN SERVICES, AND SOFTWARE AND SOFTWARE DEVELOPMENT; INTEGRATION OF COMPUTER SYSTEMS AND NETWORKS (U.S. CLS. 100 AND 101).

FIRST USE 4-17-2003; IN COMMERCE 4-17-2003.
DAVID HOFFMAN, EXAMINING ATTORNEY

SN 77-748,575. TIPOLOGY, LLC, KEMPTON, PA. FILED 6-1-2009.

X:

THE MARK CONSISTS OF STANDARD CHARACTERS WITHOUT CLAIM TO ANY PARTICULAR FONT, STYLE, SIZE, OR COLOR.

FOR INTEGRATED INTERNET APPLICATIONS, NAMELY, APPLICATION SERVICE PROVIDER FEATURING SOFTWARE FOR USE IN PROVIDING AND DEVELOPING SEARCH ENGINES, USER-DEFINED SEARCH METHODOLOGIES, WEB BROWSERS, WEB BROWSER PLUG-INS, SYNDICATION FEEDS, CONTENT SHARING, CONTENT MANAGEMENT AND REPUBLICATION SYSTEMS, AND DEVELOPMENT TOOLS FEATURING VOCABULARIES, THESAURI, TAXONOMIES, ONTOLOGIES, AND META-MODELS (U.S. CLS. 100 AND 101).

MARIAM MAHMOUDI, EXAMINING ATTORNEY

SN 77-750,647. BANDWIDTH.COM, INC., CARY, NC. FILED 6-3-2009.

BANDWIDTH.COM

THE MARK CONSISTS OF STANDARD CHARACTERS WITHOUT CLAIM TO ANY PARTICULAR FONT, STYLE, SIZE, OR COLOR.

OWNER OF U.S. REG. NO. 2,664,707.

SEC. 2(F).

FOR PLANNING AND DEVELOPMENT OF ELECTRONIC COMMUNICATIONS NETWORKS; TECHNICAL SUPPORT, NAMELY, MONITORING OF NETWORK SYSTEMS; TECHNICAL SUPPORT SERVICES, NAMELY, TROUBLESHOOTING IN THE NATURE OF DIAGNOSING PROBLEMS WITH ELECTRONIC COMMUNICATIONS NETWORKS (U.S. CLS. 100 AND 101).

FIRST USE 9-0-2002; IN COMMERCE 9-0-2002.

KATHERINE M. DUBRAY, EXAMINING ATTORNEY

CLASS 42—(Continued).

SN 77-753,132. HOME-PROBE, INC., ATLANTA, GA. FILED 6-5-2009.

Home Probe

THE MARK CONSISTS OF STANDARD CHARACTERS WITHOUT CLAIM TO ANY PARTICULAR FONT, STYLE, SIZE, OR COLOR.

SEC. 2(F).
FOR INSPECTIONS OF HOUSES (U.S. CLS. 100 AND 101).

FIRST USE 12-1-2001; IN COMMERCE 6-7-2002.
BRENDAN REGAN, EXAMINING ATTORNEY

SN 77-754,867. MODERANDI INC., FORMERLY EVOLVE REVENUE, INC., SCOTTSDALE, AZ. FILED 6-8-2009.

GROWTHPANEL

THE MARK CONSISTS OF STANDARD CHARACTERS WITHOUT CLAIM TO ANY PARTICULAR FONT, STYLE, SIZE, OR COLOR.

FOR SOFTWARE AS A SERVICE (SAAS) SERVICES FEATURING ONLINE NON-DOWNLOADABLE SOFTWARE FOR MARKETING PROJECT MANAGEMENT, MARKETING PLAN CREATION, COLLABORATION, DOCUMENT ACCESS AND DOCUMENT STORAGE (U.S. CLS. 100 AND 101).

FIRST USE 5-5-2009; IN COMMERCE 5-5-2009.
BARBARA RUTLAND, EXAMINING ATTORNEY

SN 77-755,005. HUBCENTRIX, INC., ST. PETERSBURG, FL. FILED 6-9-2009.

HUBCENTRIX

THE MARK CONSISTS OF STANDARD CHARACTERS WITHOUT CLAIM TO ANY PARTICULAR FONT, STYLE, SIZE, OR COLOR.

FOR SOFTWARE AS A SERVICE (SAAS) SERVICES FEATURING SOFTWARE FOR USE IN DIGITAL ASSET MANAGEMENT, MEDIA ASSET MANAGEMENT, VIDEO ASSET MANAGEMENT, BRAND MANAGEMENT, MANAGEMENT OF WEB CONTENT AND OTHER ELECTRONIC CONTENT, AND FOR USE IN MANAGING THE STORAGE OF THE AFORESAID CONTENT (U.S. CLS. 100 AND 101).

JEFFERY COWARD, EXAMINING ATTORNEY

CLASS 42—(Continued).

SN 77-755,519. INTRIGUE SOFTWARE, INC., FORT WORTH, TX. FILED 6-9-2009.

INTRIG

THE MARK CONSISTS OF STANDARD CHARACTERS WITHOUT CLAIM TO ANY PARTICULAR FONT, STYLE, SIZE, OR COLOR.

FOR COMPUTER HARDWARE AND SOFTWARE CONSULTING SERVICES; COMPUTER PROGRAMMING AND SOFTWARE DESIGN; COMPUTER SOFTWARE CONSULTING; COMPUTER SOFTWARE DESIGN; COMPUTER SOFTWARE DESIGN FOR OTHERS; COMPUTER SOFTWARE DESIGN, COMPUTER PROGRAMMING, OR MAINTENANCE OF COMPUTER SOFTWARE; COMPUTER SOFTWARE DEVELOPMENT; COMPUTER SOFTWARE DEVELOPMENT AND COMPUTER PROGRAMMING DEVELOPMENT FOR OTHERS; CONSULTANCY IN THE FIELD OF SOFTWARE DESIGN; CUSTOMIZED SOFTWARE DEVELOPMENT SERVICES; DESIGN AND DEVELOPMENT OF COMPUTER SOFTWARE; DESIGN AND DEVELOPMENT OF SOFTWARE AND HARDWARE FOR DATA AND MULTIMEDIA CONTENT CONVERSION FROM AND TO DIFFERENT PROTOCOLS; DESIGN, DEVELOPMENT AND IMPLEMENTATION OF SOFTWARE; DEVELOPING COMPUTER SOFTWARE; SOFTWARE DESIGN AND DEVELOPMENT (U.S. CLS. 100 AND 101).

SHAUNIA CARLYLE, EXAMINING ATTORNEY

SN 77-755,576. INTRIGUE SOFTWARE, INC., FORT WORTH, TX. FILED 6-9-2009.



THE MARK CONSISTS OF TWO INTERLOCKED TRIANGLES NEXT TO THE STYLIZED WORD "INTRIG".

FOR COMPUTER HARDWARE AND SOFTWARE CONSULTING SERVICES; COMPUTER PROGRAMMING AND SOFTWARE DESIGN; COMPUTER SOFTWARE CONSULTING; COMPUTER SOFTWARE DESIGN; COMPUTER SOFTWARE DESIGN FOR OTHERS; COMPUTER SOFTWARE DESIGN, COMPUTER PROGRAMMING, OR MAINTENANCE OF COMPUTER SOFTWARE; COMPUTER SOFTWARE DEVELOPMENT; COMPUTER SOFTWARE DEVELOPMENT AND COMPUTER PROGRAMMING DEVELOPMENT FOR OTHERS; CONSULTANCY IN THE FIELD OF SOFTWARE DESIGN; CUSTOMIZED SOFTWARE DEVELOPMENT SERVICES; DESIGN AND DEVELOPMENT OF COMPUTER SOFTWARE; DESIGN AND DEVELOPMENT OF SOFTWARE AND HARDWARE FOR DATA AND MULTIMEDIA CONTENT CONVERSION FROM AND TO DIFFERENT PROTOCOLS; DESIGN, DEVELOPMENT AND IMPLEMENTATION OF SOFTWARE; DEVELOPING COMPUTER SOFTWARE; SOFTWARE DESIGN AND DEVELOPMENT (U.S. CLS. 100 AND 101).

SHAUNIA CARLYLE, EXAMINING ATTORNEY

CLASS 42—(Continued).

SN 77-757,397. TIPOLOGY, LLC, KEMPTON, PA. FILED 6-11-2009.



THE MARK CONSISTS OF THE LETTER "X" FOLLOWED BY A COLON AND ENCOMPASSED BY A CIRCLE.

FOR INTEGRATED INTERNET APPLICATIONS, NAMELY, APPLICATION SERVICE PROVIDER FEATURING SOFTWARE FOR USE IN PROVIDING AND DEVELOPING SEARCH ENGINES, USER-DEFINED SEARCH METHODOLOGIES, WEB BROWSERS, WEB BROWSER PLUG-INS, SYNDICATION FEEDS, CONTENT SHARING, CONTENT MANAGEMENT AND REPUBLICATION SYSTEMS, AND DEVELOPMENT TOOLS FEATURING VOCABULARIES, THESAURI, TAXONOMIES, ONTOLOGIES, AND META-MODELS (U.S. CLS. 100 AND 101).

MARIAM MAHMOUDI, EXAMINING ATTORNEY

SN 77-759,565. THE LOUIS BERGER GROUP, INC., FORMERLY LOUIS BERGER INTERNATIONAL, INC., MORRISTOWN, NJ. FILED 6-15-2009.



THE COLOR(S) RED, WHITE, BLUE, GREEN, YELLOW, GOLD, BLACK AND TAN IS/ARE CLAIMED AS A FEATURE OF THE MARK.

THE MARK CONSISTS OF THE LETTERS, "LB" IN WHITE IN THE CENTER OF A SHADED RED RECTANGLE WHICH IS AT THE INTERSECTION OF A STRAIGHT AND A VERTICAL LINE IN RED, WRAPPED AS A RIBBON AROUND THE DESIGN OF A GLOBE WITH BLUE WATER, AND THE CONTINENTS SHOWN IN GREEN, YELLOW, GOLD, TAN, BLACK AND WHITE.

FOR ARCHITECTURAL AND ENGINEERING SERVICES (U.S. CLS. 100 AND 101).

FIRST USE 10-13-2003; IN COMMERCE 10-13-2003.
BARBARA A. GOLD, EXAMINING ATTORNEY

CLASS 42—(Continued).

SN 77-759,717. BERGER GROUP HOLDINGS, INC., MORRISTOWN, NJ. FILED 6-15-2009.



THE COLOR(S) RED, WHITE, BLUE, GREEN, YELLOW, GOLD, BLACK AND TAN IS/ARE CLAIMED AS A FEATURE OF THE MARK.

THE MARK CONSISTS OF THE LETTERS, "BGH" IN WHITE IN THE CENTER OF A SHADED RED RECTANGLE WHICH IS AT THE INTERSECTION OF A STRAIGHT AND A VERTICAL LINE IN RED, WRAPPED AS A RIBBON AROUND THE DESIGN OF A GLOBE WITH BLUE WATER, AND THE CONTINENTS SHOWN IN GREEN, YELLOW, GOLD, TAN, BLACK AND WHITE.

FOR ARCHITECTURAL AND ENGINEERING SERVICES (U.S. CLS. 100 AND 101).

FIRST USE 2-25-2004; IN COMMERCE 2-25-2004.
BARBARA A. GOLD, EXAMINING ATTORNEY

SN 77-759,864. GRIFFITHS, ANDREW, SANTA ROSA, CA. FILED 6-15-2009.

INPRODUCT NAVIGATION

THE MARK CONSISTS OF STANDARD CHARACTERS WITHOUT CLAIM TO ANY PARTICULAR FONT, STYLE, SIZE, OR COLOR.

FOR COMPUTER SERVICE, NAMELY, ACTING AS AN APPLICATION SERVICE PROVIDER IN THE FIELD OF KNOWLEDGE MANAGEMENT TO HOST COMPUTER APPLICATION SOFTWARE FOR CREATING SEARCHABLE DATABASES OF INFORMATION AND DATA (U.S. CLS. 100 AND 101).

SUSAN RICHARDS, EXAMINING ATTORNEY

CLASS 42—(Continued).

SN 77-760,167. SPEECHPATHOLOGY.COM, LLC, SAN ANTONIO, TX. FILED 6-15-2009.

SIMUCASE

THE MARK CONSISTS OF STANDARD CHARACTERS WITHOUT CLAIM TO ANY PARTICULAR FONT, STYLE, SIZE, OR COLOR.

FOR PROVIDING ON-LINE NON-DOWNLOADABLE SOFTWARE FOR VIRTUAL SIMULATION TRAINING FOR SPEECH-LANGUAGE PATHOLOGISTS, AUDIOLOGISTS, PHYSICAL AND OCCUPATIONAL THERAPISTS, K-12 SPECIAL EDUCATORS, HEALTH PROFESSIONALS AND UNIVERSITY FACULTY AND STUDENTS IN THE AFOREMENTIONED FIELDS, TARGETING CLINICAL DECISION MAKING, DIAGNOSIS, AND PROGNOSIS EVALUATION IN THE FIELDS OF COMMUNICATION SCIENCES AND DISORDERS (U.S. CLS. 100 AND 101).

JILL C. ALT, EXAMINING ATTORNEY

SN 77-760,824. TWIST CREATIVE, INC., CLEVELAND, OH. FILED 6-16-2009.

TWIST

THE MARK CONSISTS OF THE LETTERS "TWIST" (ALL UPPER CASE) IN A DISTINCT SANS SERIF FONT.

FOR GRAPHIC DESIGN (U.S. CLS. 100 AND 101).

FIRST USE 1-1-2000; IN COMMERCE 1-1-2000.

FLORENTINA BLANDU, EXAMINING ATTORNEY

SN 77-760,988. TWIST CREATIVE, INC., CLEVELAND, OH. FILED 6-16-2009.

Twist Creative

THE MARK CONSISTS OF STANDARD CHARACTERS WITHOUT CLAIM TO ANY PARTICULAR FONT, STYLE, SIZE, OR COLOR.

FOR GRAPHIC DESIGN (U.S. CLS. 100 AND 101).

FIRST USE 1-1-2000; IN COMMERCE 1-1-2000.

FLORENTINA BLANDU, EXAMINING ATTORNEY

CLASS 42—(Continued).

SN 77-761,442. DIRECTIVES ENTERPRISES PTY. LTD. AS TRUSTEE FOR DIRECTIVES TRUST, BEACONSFIELD, VICTORIA, AUSTRALIA, FILED 6-16-2009.

wannado

THE MARK CONSISTS OF STANDARD CHARACTERS WITHOUT CLAIM TO ANY PARTICULAR FONT, STYLE, SIZE, OR COLOR.

FOR PROVIDING COMPUTER SERVICES FOR HOSTING ONLINE WEB FACILITIES FOR OTHERS FOR ORGANISING, PROMOTING, BOOKING AND CONDUCTING SCHEDULABLE ACTIVITIES AND RESOURCES; PROVIDING USE OF SOFTWARE APPLICATIONS THROUGH A WEBSITE, NAMELY, PROVIDING TEMPORARY USE OF A WEB-BASED APPLICATION FOR ORGANISING, PROMOTING, BOOKING AND CONDUCTING SCHEDULABLE ACTIVITIES AND RESOURCES (U.S. CLS. 100 AND 101).

BRENDAN MCCAULEY, EXAMINING ATTORNEY

SN 77-761,610. BRANDWISE, INC., LAKEWOOD, CO. FILED 6-17-2009.

OWNER OF U.S. REG. NO. 2,574,197.

THE COLOR(S) MAROON AND BURNT ORANGE IS/ARE CLAIMED AS A FEATURE OF THE MARK.

THE MARK CONSISTS OF THE WORD "BRANDWISE" IN LOWER CASE WITH "BRAND" IN THE COLOR MAROON AND "WISE" IN THE COLOR BURNT ORANGE. THERE ARE TWO PARTIAL CIRCULAR DESIGNS ABOVE THE "I" OF BRANDWISE. THE LEFT CIRCULAR DESIGN IS IN THE COLOR BURNT ORANGE AND THE RIGHT CIRCULAR DESIGN IS IN THE COLOR MAROON. THERE IS A STRAIGHT LINE UNDER THE WORD "BRANDWISE" IN THE COLOR MAROON.

FOR APPLICATION SERVICE PROVIDER (ASP) DELIVERING HOSTED SOFTWARE SOLUTIONS TO MANUFACTURERS AND THEIR SALES CHANNELS WITHIN TARGETED INDUSTRIES AND THIS SOFTWARE SUITE INTEGRATES A SERIES OF INDUSTRY-SPECIFIC TOOLS THAT HELP MANUFACTURERS AND SALES REPRESENTATIVES SELL MORE PRODUCTS TO THEIR CUSTOMERS, COMBINING SALES FORCE AUTOMATION TECHNOLOGY, DECISION SUPPORT, CUSTOMER RELATIONSHIP MANAGEMENT (CRM), AND E-COMMERCE TO ENHANCE THE COORDINATION AND COMMUNICATION OF INFORMATION BETWEEN MANUFACTURERS AND THEIR SALES CHANNEL (U.S. CLS. 100 AND 101).

FIRST USE 11-1-1999; IN COMMERCE 11-1-1999.

REGINA DRUMMOND, EXAMINING ATTORNEY

CLASS 42—(Continued).

SN 77-762,746. DURAMOBILE, INC., NEWARK, DE. FILED 6-18-2009.

DURAMOBILE

THE MARK CONSISTS OF STANDARD CHARACTERS WITHOUT CLAIM TO ANY PARTICULAR FONT, STYLE, SIZE, OR COLOR.

FOR COMPUTER SOFTWARE DEVELOPMENT IN THE FIELD OF MOBILE APPLICATIONS; DESIGN OF COMPUTER NETWORKS AND SOFTWARE FOR OTHERS FOR THE MOBILE INTERNET INDUSTRY; DESIGN OF HOME PAGES, COMPUTER SOFTWARE AND WEB SITES; DESIGN OF MOBILE TELEPHONES (U.S. CLS. 100 AND 101).

FIRST USE 1-1-2002; IN COMMERCE 2-1-2003.
BARBARA A. GOLD, EXAMINING ATTORNEY

CLASS 42—(Continued).

SN 77-767,359. FERGUS, JOSEPH E, CHANTILLY, VA. FILED 6-24-2009.

NEXGREEN

THE MARK CONSISTS OF STANDARD CHARACTERS WITHOUT CLAIM TO ANY PARTICULAR FONT, STYLE, SIZE, OR COLOR.

FOR PRODUCT DEVELOPMENT AND ENGINEERING SERVICES FOR OTHERS, NAMELY, DEVELOPMENT OF NEW TECHNOLOGY FOR OTHERS IN THE FIELD OF ENVIRONMENTALLY-CONSCIOUS AND GREEN INNOVATIONS; PROVIDING TECHNOLOGICAL INFORMATION ABOUT ENVIRONMENTALLY-CONSCIOUS AND GREEN INNOVATIONS (U.S. CLS. 100 AND 101).

STEVEN PEREZ, EXAMINING ATTORNEY

SN 77-767,440. FERGUS, JOSEPH E, CHANTILLY, VA. FILED 6-24-2009.

NEXGRĒN

THE MARK CONSISTS OF THE TERM "NEXGREN" IN STYLIZED FONT WITH A MACRON MARK ABOVE THE SECOND LETTER "E".

FOR PRODUCT DEVELOPMENT AND ENGINEERING SERVICES FOR OTHERS, NAMELY, DEVELOPMENT OF NEW TECHNOLOGY FOR OTHERS IN THE FIELD OF ENVIRONMENTALLY-CONSCIOUS AND GREEN INNOVATIONS; PROVIDING TECHNOLOGICAL INFORMATION ABOUT ENVIRONMENTALLY-CONSCIOUS AND GREEN INNOVATIONS (U.S. CLS. 100 AND 101).

STEVEN PEREZ, EXAMINING ATTORNEY

SN 77-772,099. ACTIVE8MEDIA, LLC, ATLANTA, GA. FILED 7-1-2009.

TANGELO

THE MARK CONSISTS OF STANDARD CHARACTERS WITHOUT CLAIM TO ANY PARTICULAR FONT, STYLE, SIZE, OR COLOR.

FOR PROVIDING A WEBSITE FEATURING ON-LINE NON-DOWNLOADABLE SOFTWARE TOOLS FOR PUBLISHING IMAGES; APPLICATION SERVICE PROVIDER FEATURING SOFTWARE FOR USE IN CREATING, SHARING, TAGGING, PUBLISHING AND EXPLORING INTERACTIVE IMAGES; AND COMPUTER SERVICES, NAMELY, INTERACTIVE HOSTING SERVICES WHICH ALLOW THE USER TO PUBLISH AND SHARE THEIR OWN CONTENT AND IMAGES ON-LINE (U.S. CLS. 100 AND 101).

MICHAEL ENGEL, EXAMINING ATTORNEY

SN 77-764,602. FACEPLANT MEDIA SOLUTIONS, INC., MAHOPAC, NY. FILED 6-20-2009.

FACEPLANT

THE MARK CONSISTS OF STANDARD CHARACTERS WITHOUT CLAIM TO ANY PARTICULAR FONT, STYLE, SIZE, OR COLOR.

FOR APPLICATION SERVICE PROVIDER (ASP) FEATURING SOFTWARE FOR USE BY CONTENT CREATORS OF WEB BASED EDUCATIONAL LESSONS TO ENABLE SUBSCRIBERS TO VIEW AND/OR DOWNLOAD WEB BASED EDUCATIONAL MATERIAL; APPLICATION SERVICE PROVIDER (ASP), NAMELY, HOSTING COMPUTER SOFTWARE APPLICATIONS OF OTHERS; APPLICATION SERVICE PROVIDER FEATURING SOFTWARE FOR PROVIDING AN ON-LINE DATABASE IN THE FIELD OF TRANSACTION PROCESSING TO UPLOAD TRANSACTIONAL DATA, PROVIDE STATISTICAL ANALYSIS, AND PRODUCE NOTIFICATIONS AND REPORTS; APPLICATION SERVICE PROVIDER, NAMELY, PROVIDING, HOSTING, MANAGING, DEVELOPING, AND MAINTAINING APPLICATIONS, SOFTWARE, WEB SITES, AND DATABASES IN THE FIELDS OF PERSONAL PRODUCTIVITY, WIRELESS COMMUNICATION, MOBILE INFORMATION ACCESS, AND REMOTE DATA MANAGEMENT FOR WIRELESS DELIVERY OF CONTENT TO HANDHELD COMPUTERS, LAPTOPS AND MOBILE ELECTRONIC DEVICES; COMPUTER SERVICE, NAMELY, ACTING AS AN APPLICATION SERVICE PROVIDER IN THE FIELD OF KNOWLEDGE MANAGEMENT TO HOST COMPUTER APPLICATION SOFTWARE FOR SEARCHING AND RETRIEVING INFORMATION FROM DATABASES AND COMPUTER NETWORKS (U.S. CLS. 100 AND 101).

SHAUNIA CARLYLE, EXAMINING ATTORNEY

CLASS 42—(Continued).

SN 77-775,889. SWAS, INC., LACEYVILLE, PA. FILED 7-7-2009.

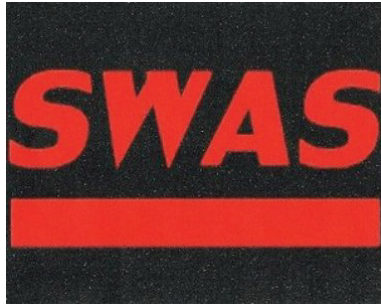

THE COLOR(S) RED AND BLACK IS/ARE CLAIMED AS A FEATURE OF THE MARK.

THE MARK CONSISTS OF THE LETTERS "SWAS" APPEARING IN RED AND UNDERLINED IN RED, ALL AGAINST A BLACK BACKGROUND.

FOR WEATHER REPORTING, NAMELY, PROVIDING METEOROLOGICAL REPORTS, WARNINGS, AND ALERT INFORMATION TO OTHERS THROUGH ELECTRONIC, TELEPHONE, CELLULAR, NETWORK, AND WIRELESS COMMUNICATIONS MEDIA (U.S. CLS. 100 AND 101).

FIRST USE 4-15-2009; IN COMMERCE 4-15-2009.
MATTHEW KLINE, EXAMINING ATTORNEY

CLASS 42—(Continued).

SN 77-776,256. LMG, INC., ORLANDO, FL. FILED 7-8-2009.



NO CLAIM IS MADE TO THE EXCLUSIVE RIGHT TO USE "SHOW TECHNOLOGY", APART FROM THE MARK AS SHOWN.

THE COLOR(S) BLUE, WHITE, GREY AND BLACK IS/ARE CLAIMED AS A FEATURE OF THE MARK.

THE MARK CONSISTS OF THE ACRONYM MARK "LMG" IN A STYLIZED FORMAT WITHIN A BLUE RECTANGULAR DESIGN WITH THE WORDING "SHOW TECHNOLOGY" SET FORTH BELOW WITHIN A GREY RECTANGULAR DESIGN THAT OVERLAPS THE BLUE DESIGN TO FORM AN ELLIPTICAL DARK BLUE SHADOW. THE RECTANGULAR DESIGN IS BLUE. THE ELLIPTICAL SHADOW DESIGN IS DARK BLUE. THE WORDING "LMG" IS OUTLINED IN WHITE. THE WORDING "SHOW TECHNOLOGY" IS BLACK. THE RECTANGULAR DESIGN ENCOMPASSING THE WORDING "SHOW TECHNOLOGY" IS GREY.

FOR CREATION AND DESIGN OF AUDIOVISUAL AND LIGHTING SYSTEMS FOR LIVE EVENTS (U.S. CLS. 100 AND 101).

FIRST USE 0-0-2003; IN COMMERCE 0-0-2003.
JAY FLOWERS, EXAMINING ATTORNEY

SN 77-776,237. LMG, INC., ORLANDO, FL. FILED 7-8-2009.



THE COLOR(S) BLUE AND WHITE IS/ARE CLAIMED AS A FEATURE OF THE MARK.

THE MARK CONSISTS OF THE ACRONYM MARK "LMG" IN A STYLIZED FORMAT WITHIN A RECTANGULAR DESIGN. THE RECTANGULAR DESIGN IS BLUE. THE WORDING "LMG" IS WHITE.

FOR CREATION AND DESIGN OF AUDIOVISUAL AND LIGHTING SYSTEMS FOR LIVE EVENTS AND MOBILE PRODUCTIONS; CREATION AND DESIGN OF CUSTOMIZED PRESENTATION TECHNOLOGY, NAMELY, AUDIOVISUAL, VIDEO, TELECONFERENCING, MULTIMEDIA AND LIGHTING SYSTEMS FOR EVENTS, INSTITUTIONS, BUSINESSES, HOUSES OF WORSHIP, EDUCATIONAL FACILITIES AND PERMANENT FACILITIES (U.S. CLS. 100 AND 101).

FIRST USE 2-0-2009; IN COMMERCE 2-0-2009.
JAY FLOWERS, EXAMINING ATTORNEY

SN 77-776,304. LMG, INC., ORLANDO, FL. FILED 7-8-2009.



NO CLAIM IS MADE TO THE EXCLUSIVE RIGHT TO USE "TOURING", APART FROM THE MARK AS SHOWN.

THE COLOR(S) RED, BLACK AND WHITE IS/ARE CLAIMED AS A FEATURE OF THE MARK.

THE MARK CONSISTS OF THE WORDING "LMG" APPEARING IN RED IN A STYLIZED FORMAT WITH WHITE LINING INSIDE THE LETTERS ABOVE THE WORDING "TOURING" WHICH APPEARS IN BLACK IN A STYLIZED FORMAT WITH A HORIZONTAL LINE DESIGN EXTENDING FROM BOTH SIDES THEREFROM, ALSO IN THE COLOR BLACK.

FOR CREATION AND DESIGN OF AUDIOVISUAL AND LIGHTING SYSTEMS FOR LIVE EVENTS (U.S. CLS. 100 AND 101).

FIRST USE 2-0-2009; IN COMMERCE 2-0-2009.
JAY FLOWERS, EXAMINING ATTORNEY

CLASS 42—(Continued).

SN 77-776,341. LMG, INC., ORLANDO, FL. FILED 7-8-2009.



NO CLAIM IS MADE TO THE EXCLUSIVE RIGHT TO USE "SYSTEMS INTEGRATION", APART FROM THE MARK AS SHOWN.

THE COLOR(S) GREEN, WHITE, GREY AND BLACK IS/ ARE CLAIMED AS A FEATURE OF THE MARK.

THE MARK CONSISTS OF THE ACRONYM MARK "LMG" IN A STYLIZED FORMAT WITHIN A GREEN RECTANGULAR DESIGN WITH THE WORDING "SYSTEMS INTEGRATION" SET FORTH BELOW WITHIN A GREY RECTANGULAR DESIGN THAT OVERLAPS THE GREEN DESIGN TO FORM AN ELLIPTICAL DARK GREEN SHADOW. THE RECTANGULAR DESIGN IS GREEN. THE ELLIPTICAL SHADOW DESIGN IS DARK GREEN. THE WORDING "LMG" IS OUTLINED IN WHITE. THE WORDING "SYSTEMS INTEGRATION" IS BLACK. THE RECTANGULAR DESIGN ENCOMPASSING THE WORDING "SYSTEMS INTEGRATION" IS GREY.

FOR CREATION AND DESIGN OF CUSTOMIZED PRESENTATION TECHNOLOGY, NAMELY, AUDIOVISUAL, VIDEO, TELECONFERENCING, MULTIMEDIA AND LIGHTING SYSTEMS FOR EVENTS, INSTITUTIONS, BUSINESSES, HOUSES OF WORSHIP, EDUCATIONAL FACILITIES AND PERMANENT FACILITIES (U.S. CLS. 100 AND 101).

FIRST USE 2-0-2009; IN COMMERCE 2-0-2009.

JAY FLOWERS, EXAMINING ATTORNEY

SN 77-776,526. LMG, INC., ORLANDO, FL. FILED 7-8-2009.

BEYOND TECHNOLOGY

THE MARK CONSISTS OF STANDARD CHARACTERS WITHOUT CLAIM TO ANY PARTICULAR FONT, STYLE, SIZE, OR COLOR.

NO CLAIM IS MADE TO THE EXCLUSIVE RIGHT TO USE "TECHNOLOGY", APART FROM THE MARK AS SHOWN.

FOR CREATION AND DESIGN OF AUDIOVISUAL AND LIGHTING SYSTEMS FOR LIVE EVENTS AND MOBILE PRODUCTIONS; CREATION AND DESIGN OF CUSTOMIZED PRESENTATION TECHNOLOGY, NAMELY, AUDIOVISUAL, VIDEO, TELECONFERENCING, MULTIMEDIA AND LIGHTING SYSTEMS FOR EVENTS, INSTITUTIONS, BUSINESSES, HOUSES OF WORSHIP, EDUCATIONAL FACILITIES AND PERMANENT FACILITIES (U.S. CLS. 100 AND 101).

FIRST USE 2-0-2009; IN COMMERCE 2-0-2009.

JAY FLOWERS, EXAMINING ATTORNEY

CLASS 42—(Continued).

SN 77-782,717. SUNGARD AVAILABILITY SERVICES LP, WAYNE, PA. FILED 7-16-2009.

SECURE2DISK

THE MARK CONSISTS OF STANDARD CHARACTERS WITHOUT CLAIM TO ANY PARTICULAR FONT, STYLE, SIZE, OR COLOR.

FOR COMPUTER SERVICES, NAMELY, PROVIDING REMOTE COMPUTER BACKUP SERVICES FOR OTHERS VIA THE INTERNET (U.S. CLS. 100 AND 101).

FIRST USE 5-31-2009; IN COMMERCE 5-31-2009.

RONALD MCMORROW, EXAMINING ATTORNEY

SN 77-792,832. APPLIED MATERIALS, INC., SANTA CLARA, CA. FILED 7-29-2009.

SUNFARM

THE MARK CONSISTS OF STANDARD CHARACTERS WITHOUT CLAIM TO ANY PARTICULAR FONT, STYLE, SIZE, OR COLOR.

FOR ENGINEERING SERVICES, NAMELY, ENGINEERING, DESIGN AND SIMULATION OF SOFTWARE APPLICATION USED FOR THE CONSTRUCTION AND MANAGEMENT OF SOLAR MANUFACTURING FACILITIES, EQUIPMENT, SOLAR MATERIALS, AND THE SALE OF SOLAR PRODUCTS, SERVICES, AND DEVICES, THE SOLAR PRODUCTS HAVING CAPABILITY FOR THE GENERATION AND TRANSFORMATION OF ELECTRICITY FROM SOLAR ENERGY (U.S. CLS. 100 AND 101).

MORGAN WYNNE, EXAMINING ATTORNEY

SN 77-793,726. WORLD MARKET CENTER VENTURE, LLC, LAS VEGAS, NV. FILED 7-30-2009.



NO CLAIM IS MADE TO THE EXCLUSIVE RIGHT TO USE "LAS VEGAS", APART FROM THE MARK AS SHOWN.

THE COLOR(S) DARK GREEN, LIGHT GREEN, BLUE AND WHITE IS/ARE CLAIMED AS A FEATURE OF THE MARK.

THE MARK CONSISTS OF A STYLIZED SPHERE IN DARK GREEN AND LIGHT GREEN, HAVING TWO CURVED WHITE LINES AND A CURVED BLUE LINE IN THE LOWER CENTER OF THE SPHERE. ONE OF THE CURVED WHITE LINES DIVIDES THE SPHERE AND THE OTHER CURVED WHITE LINE RUNS THROUGH BOTH HALVES AND A CURVED BLUE LINE IS IN THE MIDDLE.

CLASS 42—(Continued).

TO THE RIGHT OF THE DESIGN OF THE SPHERE ARE THE STYLIZED WORDS, "ONE GOOD WORLD LAS VEGAS" IN A STACKED FORMATION WITH UNDERLINES UNDER "ONE", "GOOD", AND "WORLD". THE WORD "ONE" IS IN DARK GREEN AND HAS A LIGHT GREEN LINE UNDERNEATH. THE WORD "GOOD" IS IN LIGHT GREEN AND HAS A LIGHT GREEN LINE UNDERNEATH. THE WORD "WORLD" IS IN BLUE AND HAS A LIGHT GREEN LINE UNDERNEATH. THE WORDS "LAS VEGAS" ARE IN LIGHT GREEN.

FOR INTERIOR DESIGN SERVICES (U.S. CLS. 100 AND 101).
JAY BESCH, EXAMINING ATTORNEY

SN 77-798,317. SOLLINK INC., TAOYUAN COUNTY 325, TAIWAN, FILED 8-6-2009.



THE MARK CONSISTS OF THE STYLIZED TERM "SOLLINK" WHEREBY THE "O" IS A SQUARE WITH ROUNDED EDGES HAVING A BUTTERFLY DESIGN HAVING LINES GOING FROM THE WINGS TOWARDS THE RIGHT SIDE OF THE SQUARE.

FOR NEW MANUFACTURED PRODUCT DESIGN SERVICES; INDUSTRIAL DESIGN SERVICES (U.S. CLS. 100 AND 101).
TARAH HARDY, EXAMINING ATTORNEY

SN 77-800,762. NAPOLI, ROSE, DBA STYLISH SPACES REDECORATING, HOBOKEN, NJ. FILED 8-10-2009.



NO CLAIM IS MADE TO THE EXCLUSIVE RIGHT TO USE "REDECORATING", APART FROM THE MARK AS SHOWN.

THE COLOR(S) MAGENTA AND BLACK IS/ARE CLAIMED AS A FEATURE OF THE MARK.

THE MARK CONSISTS OF THE WORDS "STYLISH SPACES" IN BLACK IN TITLE CASE WITH A BLACK ROSE STEM SEPARATING THE WORDS "STYLISH" AND "SPACES". THE ROSE HEAD IS PLACED ABOVE THE STEM IN A SIMPLE LINE DRAWING CONSISTING OF ONE VERTICAL LINE THAT SPIRALS WITH INDENTATIONS, IN THE COLOR MAGENTA, TO FORM A ROSE OUTLINE. THE WORD "REDECORATING" IS PLACED BELOW THE TWO OTHER WORDS IN ALL CAPS, IN THE COLOR MAGENTA AND CENTERED BETWEEN THE "L" IN STYLISH AND THE "A" IN SPACES.

FOR INTERIOR DECORATING (U.S. CLS. 100 AND 101).
FIRST USE 5-15-2009; IN COMMERCE 5-15-2009.
RICHARD WHITE, EXAMINING ATTORNEY

CLASS 42—(Continued).

SN 77-806,763. FRANK T. MCMURTREY JR., DBA GSI GLOBAL SYSTEMS INTEGRATION, TOKYO, JAPAN, FILED 8-18-2009.

GSI Global Systems Integration

THE MARK CONSISTS OF STANDARD CHARACTERS WITHOUT CLAIM TO ANY PARTICULAR FONT, STYLE, SIZE, OR COLOR.

NO CLAIM IS MADE TO THE EXCLUSIVE RIGHT TO USE "GLOBAL SYSTEMS INTEGRATION", APART FROM THE MARK AS SHOWN.

FOR COMPUTER PROGRAMMING AND COMPUTER SYSTEM ANALYSIS; COMPUTER SERVICES, NAMELY, COMPUTER SYSTEM ADMINISTRATION FOR OTHERS; COMPUTER SERVICES, NAMELY, PROVIDING A WEB-BASED SYSTEM AND ONLINE PORTAL FOR CUSTOMERS TO REMOTELY MANAGE, ADMINISTER, MODIFY AND CONTROL THEIR END USER COMPUTER DEVICES, DATA AND SOFTWARE APPLICATIONS; COMPUTER SERVICES, NAMELY, REMOTE AND ON-SITE MANAGEMENT OF THE INFORMATION TECHNOLOGY (IT) SYSTEMS OF OTHERS; COMPUTER SYSTEM DESIGN SERVICES; COMPUTER SYSTEMS ANALYSIS; COMPUTER SYSTEMS INTEGRATION SERVICES; CONSULTATION SERVICES IN THE FIELDS OF SELECTION, IMPLEMENTATION AND USE OF COMPUTER HARDWARE AND SOFTWARE SYSTEMS FOR OTHERS; CONSULTING SERVICES IN THE FIELD OF COMPUTER-BASED INFORMATION SYSTEMS FOR BUSINESSES; CONSULTING SERVICES IN THE FIELD OF DESIGN, SELECTION, IMPLEMENTATION AND USE OF COMPUTER HARDWARE AND SOFTWARE SYSTEMS FOR OTHERS; CONSULTING SERVICES IN THE FIELD OF IDENTIFICATION, SUPPORT, AND IMPLEMENTATION OF COMPUTER-BASED INFORMATION SYSTEMS FOR BUSINESSES; DESIGN AND DEVELOPMENT OF ON-LINE COMPUTER SOFTWARE SYSTEMS; INTEGRATION OF COMPUTER SYSTEMS AND NETWORKS; TECHNICAL CONSULTING AND ASSISTANCE WITH COMPUTER-BASED INFORMATION SYSTEMS AND COMPONENTS (U.S. CLS. 100 AND 101).

FIRST USE 1-1-2009; IN COMMERCE 8-18-2009.
KATHERINE M. DUBRAY, EXAMINING ATTORNEY

SN 77-808,149. OPEN AIR INNOVATION, BROOMFIELD, CO. FILED 8-19-2009.



THE COLOR(S) BLACK, WHITE AND ORANGE IS/ARE CLAIMED AS A FEATURE OF THE MARK.

THE MARK CONSISTS OF RECTANGLE BOX WITH "GRAPEVINE" IN BLACK. THE RECTANGLE IS ORANGE BACKGROUND WITH BLACK CORNERS. THE WORDING "THE ART OF CONVERSATION" IS IN WHITE LETTERS.

FOR APPLICATION SERVICE PROVIDER (ASP) FEATURING SOFTWARE FOR USE FOR COLLABORATION, BUSINESS MANAGEMENT, TIME MANAGEMENT, INFORMATION MANAGEMENT, ORGANIZATION, ON-LINE VOICE, REAL-TIME AUDIO, CONTENT MANAGEMENT, OR INTERNET AUDIO (U.S. CLS. 100 AND 101).

FIRST USE 1-1-2009; IN COMMERCE 8-1-2009.
DAWN FELDMAN, EXAMINING ATTORNEY

CLASS 42—(Continued).

SN 77-808,918. TREMOR MEDIA, INC., NEW YORK, NY. FILED 8-20-2009.

VCHOICE

THE MARK CONSISTS OF STANDARD CHARACTERS WITHOUT CLAIM TO ANY PARTICULAR FONT, STYLE, SIZE, OR COLOR.

FOR APPLICATION SERVICE PROVIDER FEATURING SOFTWARE FOR USE IN CONNECTION WITH A MONETIZATION PLATFORM FOR INTERNET ADVERTISING FOR OTHERS; PROVIDING TEMPORARY USE OF ONLINE, NON-DOWNLOADABLE SOFTWARE APPLICATIONS FOR THE MANAGEMENT OF AUDIO, VIDEO AND OTHER MEDIA CONTENT IN THE FIELD OF ADVERTISING; PROVIDING TEMPORARY USE OF AN ON-LINE NON-DOWNLOADABLE SOFTWARE PLATFORM FOR USE BY ADVERTISERS AND AUDIO AND VIDEO CONTENT PUBLISHERS FOR THE PURPOSE OF ADVERTISING, MARKETING AND PROMOTIONAL SERVICES; PROVIDING COMPUTER PROGRAMMING SERVICES TO CUSTOMERS THAT ENABLES THEM TO PROVIDE INTERACTIVE AUDIO AND VIDEO ADVERTISING ON WEB SITES (U.S. CLS. 100 AND 101).

MARLENE BELL, EXAMINING ATTORNEY

SN 77-814,375. BENETECH, INC., WYNANTSKILL, NY. FILED 8-27-2009.

MEDCLAIM USA

THE MARK CONSISTS OF STANDARD CHARACTERS WITHOUT CLAIM TO ANY PARTICULAR FONT, STYLE, SIZE, OR COLOR.

OWNER OF U.S. REG. NO. 3,699,251.

NO CLAIM IS MADE TO THE EXCLUSIVE RIGHT TO USE "USA", APART FROM THE MARK AS SHOWN.

FOR APPLICATION SERVICE PROVIDER (ASP) FEATURING SOFTWARE IN THE FIELD OF INSURANCE CLAIMS ADMINISTRATION AND TECHNICAL SUPPORT SERVICES RELATED THERETO, NAMELY, TROUBLESHOOTING OF SOFTWARE PROBLEMS (U.S. CLS. 100 AND 101).

FIRST USE 8-26-2009; IN COMMERCE 8-26-2009.

EMILY CARLSEN, EXAMINING ATTORNEY

CLASS 42—(Continued).

SN 77-817,108. INTERNATIONAL DOI FOUNDATION, OXFORD OX2 8HY, UNITED KINGDOM, FILED 9-1-2009.

short DOI

THE MARK CONSISTS OF STANDARD CHARACTERS WITHOUT CLAIM TO ANY PARTICULAR FONT, STYLE, SIZE, OR COLOR.

OWNER OF U.S. REG. NOS. 2,360,526, 2,360,527 AND 3,557,609.

NO CLAIM IS MADE TO THE EXCLUSIVE RIGHT TO USE "SHORT", APART FROM THE MARK AS SHOWN.

SEC. 2(F) AS TO "DOI".

FOR PROVIDING IDENTIFIERS FOR DIGITAL OBJECTS AND OTHER RESOURCES IN DISTRIBUTED COMPUTER SYSTEMS AND ENSURING THAT SUCH IDENTIFIERS ARE UNIQUE OVER LONG TIME PERIODS (U.S. CLS. 100 AND 101).

DAVID COLLIER, EXAMINING ATTORNEY

SN 77-821,151. BICKART, JOHN, OCEAN, NJ. FILED 9-6-2009.

reMember Mate

THE MARK CONSISTS OF STANDARD CHARACTERS WITHOUT CLAIM TO ANY PARTICULAR FONT, STYLE, SIZE, OR COLOR.

FOR INTERACTIVE MULTIMEDIA COMPUTER PROGRAM, NAMELY, PROVIDING TEMPORARY USE OF NON-DOWNLOADABLE INTERACTIVE MULTIMEDIA COMPUTER SOFTWARE FOR WRITING QUIZZES FOR EDUCATIONAL AND ENTERTAINMENT USE (U.S. CLS. 100 AND 101).

FIRST USE 1-1-2005; IN COMMERCE 5-1-2007.

TARA PATE, EXAMINING ATTORNEY

SN 77-822,055. EUREKA GENOMICS CORPORATION, HERCULES, CA. FILED 9-8-2009.

EGAP

THE MARK CONSISTS OF STANDARD CHARACTERS WITHOUT CLAIM TO ANY PARTICULAR FONT, STYLE, SIZE, OR COLOR.

FOR BIOTECHNOLOGY RESEARCH AND DEVELOPMENT SERVICES FOR OTHERS, NAMELY, GENOME SEQUENCING, GENOME MAPPING, GENOME ANALYSIS AND SCIENTIFIC RESEARCH AND ANALYSIS IN THE FIELDS OF GENETICS AND BIOINFORMATICS (U.S. CLS. 100 AND 101).

DEZMONA MIZELLE, EXAMINING ATTORNEY

CLASS 42—(Continued).

SN 77-824,393. ETERNAL PRESERVATION ASSOCIATES, LLC, BOCA RATON, FL. FILED 9-11-2009.

ACCIDENTAL MUMMIES

THE MARK CONSISTS OF STANDARD CHARACTERS WITHOUT CLAIM TO ANY PARTICULAR FONT, STYLE, SIZE, OR COLOR.

NO CLAIM IS MADE TO THE EXCLUSIVE RIGHT TO USE "MUMMIES", APART FROM THE MARK AS SHOWN. FOR PROVIDING INFORMATION ABOUT ARCHAEOLOGY, ANTHROPOLOGY AND FORENSIC SCIENCE VIA THE INTERNET (U.S. CLS. 100 AND 101).

PAM WILLIS, EXAMINING ATTORNEY

SN 77-826,582. MACHADO, RICARDO A. O., DALLAS, TX. FILED 9-15-2009.

PLANT YOUR TREE

THE MARK CONSISTS OF STANDARD CHARACTERS WITHOUT CLAIM TO ANY PARTICULAR FONT, STYLE, SIZE, OR COLOR.

NO CLAIM IS MADE TO THE EXCLUSIVE RIGHT TO USE "TREE", APART FROM THE MARK AS SHOWN.

FOR HABITAT DEVELOPMENT AND PRESERVATION SERVICES, NAMELY, MONITORING, TESTING AND ANALYZING ECOLOGICAL SUCCESS IN THE FIELD OF ENVIRONMENTALLY SENSITIVE HABITAT, NAMELY, MONITORING, TESTING AND ANALYZING THE CONSERVATION AND PRESERVATION OF NATIVE PLANTS AND WILDLIFE (U.S. CLS. 100 AND 101).

ALLISON HOLTZ, EXAMINING ATTORNEY

SN 77-827,758. ALBECK GERKEN, INC., DBA NAZTEC ITS, TAMPA, FL. FILED 9-16-2009.

WE MAKE GREEN HAPPEN

THE MARK CONSISTS OF STANDARD CHARACTERS WITHOUT CLAIM TO ANY PARTICULAR FONT, STYLE, SIZE, OR COLOR.

FOR TRANSPORTATION ENGINEERING SERVICES (U.S. CLS. 100 AND 101).

FIRST USE 1-15-2010; IN COMMERCE 1-15-2010.

B. PARADEWELAI, EXAMINING ATTORNEY

CLASS 42—(Continued).

SN 77-827,972. HOANG, NAMANH VU, SANTA ANA, CA. FILED 9-16-2009.

BADUKU

THE MARK CONSISTS OF STANDARD CHARACTERS WITHOUT CLAIM TO ANY PARTICULAR FONT, STYLE, SIZE, OR COLOR.

THE WORDING "BADUKU" HAS NO MEANING IN A FOREIGN LANGUAGE.

FOR COMPUTER SERVICES, NAMELY, CREATING AN ON-LINE COMMUNITY FOR REGISTERED USERS TO PARTICIPATE IN DISCUSSIONS, GET FEEDBACK FROM THEIR PEERS, FORM VIRTUAL COMMUNITIES, AND ENGAGE IN SOCIAL NETWORKING, ALL CONCERNING RANKINGS, RATINGS, REVIEWS, REFERRALS AND RECOMMENDATIONS IN ANY FIELD OF KNOWLEDGE (U.S. CLS. 100 AND 101).

NELSON SNYDER, EXAMINING ATTORNEY

SN 77-835,904. BOUNCEBACK, LLC, RALEIGH, NC. FILED 9-27-2009.



THE COLOR(S) YELLOW/GREEN, LIGHT GREEN, AND GRAY IS/ARE CLAIMED AS A FEATURE OF THE MARK.

THE MARK CONSISTS OF A BALL THAT IS YELLOW/GREEN ON TOP AND LIGHT GREEN ON THE BOTTOM WITH A DOTTED GRAY LINE OVER THE BALL THAT FORMS THE TOP HALF OF A LOWERCASE "B". UNDER THE BALL THERE IS A SMALL ROUND GRAY SHADOW SO THE BALL APPEARS TO BE "BOUNCING". BELOW THE BALL IS THE WORD "BOUNCEBACK" IN ALL LOWER-CASE LETTERS WITH A SLIGHTLY RAISED "O" AND WITH "BOUNCE" IN GRAY AND "BACK" IN YELLOW/GREEN.

FOR HOSTING AN ONLINE COMMUNITY WEBSITE FEATURING SHARED COMMUNICATIONS BETWEEN MEMBERS CONCERNING SUCCEEDING AFTER A DIVORCE OR BREAKUP, RECOMMENDATIONS FOR DIVORCE LAWYERS, THERAPISTS, PSYCHIATRISTS, FINANCIAL ADVISORS, CHILD CARE PROVIDERS, REALTORS, HEALTH CLUBS, PILATES AND YOGA STUDIOS, SALONS AND SPAS, RESTAURANTS, BARS, RETAIL SHOPPING, AND RECOMMENDATIONS ON BOOKS, MOVIES AND MUSIC (U.S. CLS. 100 AND 101).

JOHN WILKE, EXAMINING ATTORNEY

CLASS 42—(Continued).

SN 77-836,750. SIMULAT, INC., BERKELEY, CA. FILED 9-28-2009.

Collaborative WarRoom

THE MARK CONSISTS OF STANDARD CHARACTERS WITHOUT CLAIM TO ANY PARTICULAR FONT, STYLE, SIZE, OR COLOR.

NO CLAIM IS MADE TO THE EXCLUSIVE RIGHT TO USE "COLLABORATIVE", APART FROM THE MARK AS SHOWN.

FOR NON-DOWNLOADABLE COMPUTER SOFTWARE ON A NETWORK FOR SYNCHRONOUS AND ASYNCHRONOUS COLLABORATION WITH DATA PERSISTENCE USED FOR WEB CONFERENCING, DOCUMENT MANAGEMENT, WIKI, AND INSTANT MESSAGING (U.S. CLS. 100 AND 101).

FIRST USE 9-14-2009; IN COMMERCE 9-14-2009.
NAKIA HENRY, EXAMINING ATTORNEY

SN 77-839,925. COURTLAND SOFTWARE SERVICES, INC., DBA COURTLAND CONSULTING, EAST LANSING, MI. FILED 10-2-2009.



THE MARK CONSISTS OF THE WORD "STRUDELL" WITH A UMLAUT OVER THE "U".

FOR PROVIDING AN ONLINE ELECTRONIC DATABASE ON THE INTERNET IN THE FIELD OF WEB DESIGN (U.S. CLS. 100 AND 101).

FIRST USE 2-27-2009; IN COMMERCE 2-27-2009.
ANTHONY RINKER, EXAMINING ATTORNEY

SN 77-841,457. DOW AGROSCIENCES LLC, INDIANAPOLIS, IN. FILED 10-5-2009.



NO CLAIM IS MADE TO THE EXCLUSIVE RIGHT TO USE "PRECISION TRAITS", APART FROM THE MARK AS SHOWN.

THE MARK CONSISTS OF THE WORDS "EXZACT PRECISION TRAITS" WITH DESIGN OF TWO ARCS COMING OFF THE X AND MEETING AT A POINT.

FOR SCIENTIFIC RESEARCH AND DEVELOPMENT SERVICES IN THE NATURE OF GENE INJECTION SERVICES (U.S. CLS. 100 AND 101).

STEPHEN AQUILA, EXAMINING ATTORNEY

CLASS 42—(Continued).

SN 77-844,740. FPX, LLC, MANKATO, MN. FILED 10-8-2009.



OWNER OF U.S. REG. NO. 3,720,363.

THE COLOR(S) GRAY AND WHITE IS/ARE CLAIMED AS A FEATURE OF THE MARK.

THE MARK CONSISTS OF THE STYLIZED LETTERS "FPX" APPEARING IN THE COLOR WHITE WITHIN A GRAY RECTANGLE. ARROWS EXTEND FROM THE STEM OF THE "F" AND THE UPPER-RIGHT PORTION OF THE "X". THE UPPER PORTION OF THE ARROW EXTENDING FROM THE "X" IS SHOWN IN GRAY.

FOR PROVIDING ON-LINE NON-DOWNLOADABLE SOFTWARE FOR CONFIGURATION OF ORDERS FOR PRODUCTS AND SERVICES, FOR PRICING OF PRODUCTS AND SERVICES AND FOR GENERATING PRICE QUOTATIONS FOR PRODUCTS AND SERVICES (U.S. CLS. 100 AND 101).

FIRST USE 6-15-2009; IN COMMERCE 6-15-2009.
ROBERT LAVACHE, EXAMINING ATTORNEY

SN 77-847,834. YOUNG, ASHLEY J, DBA PC4MOBILE, PLEASANTON, CA. FILED 10-13-2009.



NO CLAIM IS MADE TO THE EXCLUSIVE RIGHT TO USE "PC" AND "MOBILE", APART FROM THE MARK AS SHOWN.

THE COLOR(S) LIGHT BLUE, GREY, AND PURPLE IS/ARE CLAIMED AS A FEATURE OF THE MARK.

THE MARK CONSISTS OF LIGHT BLUE BACKGROUND WITH LARGE "PC" IN GREY AND "4 MOBILE" IN PURPLE.

FOR COMPUTER SERVICES, NAMELY, HOSTING THE SOFTWARE, WEBSITES, AND OTHER COMPUTER APPLICATIONS OF OTHERS ON A VIRTUAL PRIVATE SERVER THAT USERS MAY ACCESS USING MOBILE DEVICES AND REMOTE COMPUTERS (U.S. CLS. 100 AND 101).

FIRST USE 9-16-2009; IN COMMERCE 9-16-2009.
KIM MONINGHOFF, EXAMINING ATTORNEY

CLASS 42—(Continued).

SN 77-849,140. SERVCORP LIMITED, SYDNEY, AUSTRALIA, FILED 10-15-2009.

CLASS 42—(Continued).

SN 77-851,123. LOCATEMYCARCOM, LLC, AURORA, IL, FILED 10-17-2009.

SERVCORP SMART OFFICE

THE MARK CONSISTS OF STANDARD CHARACTERS WITHOUT CLAIM TO ANY PARTICULAR FONT, STYLE, SIZE, OR COLOR.

NO CLAIM IS MADE TO THE EXCLUSIVE RIGHT TO USE "SMART OFFICE", APART FROM THE MARK AS SHOWN.

FOR APPLICATION SERVICE PROVIDER (ASP) SERVICES FEATURING SOFTWARE FOR CONNECTING COMPUTER NETWORK USERS AND GLOBAL COMPUTER NETWORKS, PERFORMING ELECTRONIC BUSINESS TRANSACTIONS VIA A GLOBAL COMPUTER NETWORK, SEARCHING INCORPORATION DETAILS OF COMPANIES, PROCESSING AND VIEWING ACCOUNTS FOR USE OF OFFICE AND TELEPHONE AND GLOBAL COMPUTER NETWORK FACILITIES, DATABASE MANAGEMENT, SENDING AND RECEIVING E-MAIL, SENDING AND RECEIVING FACSIMILE TRANSMISSION FROM COMPUTERS, SENDING AND RECEIVING TEXT MESSAGES, WORD PROCESSING, TRANSLATION OF TEXT, ELECTRONIC BOOKING OF TRANSLATION SERVICES, COMPUTER SEARCH ENGINES, ELECTRONIC BOOKING OF TICKETS FOR TRAVEL AND TRAVEL SERVICES, ELECTRONIC ORDERING OF OFFICE SUPPLIES, MANAGING ELECTRONIC BOOKINGS FOR OFFICES AND MEETING ROOM FACILITIES, MANAGING ELECTRONIC BOOKINGS FOR OFFICE EQUIPMENT AND SECRETARIAL SERVICES, CONTACT MANAGEMENT, CALL CENTRE MANAGEMENT, TELEPHONE CALL FORWARDING, OFFICE MANAGEMENT, VIDEO-CONFERENCING, ELECTRONIC FILE TRANSFER AND STORAGE, INTEGRATING ACCESS TO MULTIPLE ACCOUNTS FOR ONE USER, COMPUTER SOFTWARE THAT FUNCTIONS TO INTEGRATE MULTIPLE SOFTWARE APPLICATIONS, PROVIDING INTERNET AND TELECOMMUNICATIONS PORTAL ACCESS TO MULTIPLE SOFTWARE APPLICATIONS, OPERATION OF NETWORK ACCESS SERVERS, CALCULATION OF CURRENCY CONVERSION AND FOR COMPUTER TELEPHONY SOFTWARE, SOFTWARE FOR FILE AND CONTENT MANAGEMENT, SOFTWARE FOR MANAGEMENT OF TEXT, AUDIO, VIDEO AND DATA; RENTAL OF COMPUTER HARDWARE AND SOFTWARE; DESIGN AND DEVELOPMENT OF COMPUTER HARDWARE AND SOFTWARE FOR ENHANCED TRANSMISSION OF VOICE BY MEANS OF BROADBAND OR WIRELESS NETWORKS (U.S. CLS. 100 AND 101).

JOHN DWYER, EXAMINING ATTORNEY

LocateMyCar

THE MARK CONSISTS OF STANDARD CHARACTERS WITHOUT CLAIM TO ANY PARTICULAR FONT, STYLE, SIZE, OR COLOR.

FOR COMPUTER SERVICE, NAMELY, ACTING AS AN APPLICATION SERVICE PROVIDER IN THE FIELD OF KNOWLEDGE MANAGEMENT TO HOST COMPUTER APPLICATION SOFTWARE FOR SEARCHING AND RETRIEVING INFORMATION FROM DATABASES AND COMPUTER NETWORKS; COMPUTER SERVICES, NAMELY, PROVIDING SEARCH ENGINES FOR OBTAINING DATA FROM JOURNALS AND OTHER PUBLICATIONS ON A GLOBAL COMPUTER NETWORK; COMPUTER SERVICES, NAMELY, PROVIDING SEARCH ENGINES FOR OBTAINING DATA ON A GLOBAL COMPUTER NETWORK; COMPUTER SERVICES, NAMELY, PROVIDING SEARCH PLATFORMS TO ALLOW USERS TO REQUEST CONTENT FROM AND RECEIVE CONTENT TO A MOBILE DEVICE; COMPUTER SERVICES, NAMELY, SEARCH ENGINE OPTIMIZATION; CONSULTATION SERVICES IN THE FIELD OF SEARCH ENGINE OPTIMIZATION; PROVIDING A WEBSITE THAT GIVES COMPUTER USERS THE ABILITY TO SUBSCRIBE TO ONLINE PUBLICATIONS PERMITTING SEARCHES OF BUILDING CODES AND STANDARDS; PROVIDING CUSTOMIZED ON-LINE WEB PAGES FEATURING USER-DEFINED INFORMATION, WHICH INCLUDES SEARCH ENGINES AND ON-LINE WEB LINKS TO OTHER WEB SITES; SEARCHING AND RETRIEVING INFORMATION, SITES, AND OTHER RESOURCES AVAILABLE ON COMPUTER NETWORKS FOR OTHERS (U.S. CLS. 100 AND 101).

FIRST USE 1-1-2008; IN COMMERCE 1-1-2008.

ROBERT STRUCK, EXAMINING ATTORNEY

CLASS 42—(Continued).

SN 77-851,591. MICRON SYSTEMS INC., GLEN ROCK, NJ.
FILED 10-19-2009.

MICRON

THE MARK CONSISTS OF STANDARD CHARACTERS WITHOUT CLAIM TO ANY PARTICULAR FONT, STYLE, SIZE, OR COLOR.

OWNER OF U.S. REG. NO. 3,103,106.
FOR PROVIDING ON-LINE NON-DOWNLOADABLE SOFTWARE FOR USE BY LAW FIRMS, CORPORATE LEGAL RECRUITMENT AND PROFESSIONAL DEVELOPMENT DEPARTMENTS FOR USE IN RECRUITMENT AND APPLICANT TRACKING, CONTINUING EDUCATION, HUMAN RESOURCES, ELECTRONIC MAIL INTEGRATION, TRACKING OF EMPLOYEES AND EMPLOYEE CANDIDATES, SCHEDULING EMPLOYEE CANDIDATE INTERVIEWS, COMPILING EMPLOYEE CANDIDATE INFORMATION, PROJECT PERFORMANCE EVALUATIONS, AND PRODUCING REAL-TIME, ON-DEMAND CUSTOMIZABLE REPORTS; PROVIDING ON-LINE NON-DOWNLOADABLE SOFTWARE FOR TRACKING AND EVALUATING EDUCATION AND CONTINUING EDUCATION ASSIGNMENTS, ATTENDANCE, CREDITS, COSTS, DEGREES AND PROGRAM TITLES, AND FOR TRACKING AND EVALUATING EMPLOYEE SKILL AND COMPETENCY REQUIREMENTS, PROVIDING DISTANT LEARNING OPPORTUNITIES THROUGH VIDEO/AUDIO UPLOAD AND FACILITATING LEARNING TO CLOSE ANY SKILL REQUIREMENT; PROVIDING ON-LINE NON-DOWNLOADABLE SOFTWARE FOR TRACKING AND PROCESSING STUDENT AND EMPLOYER DATA AND TO MONITOR AND RECONCILE INTERVIEW SCHEDULES; ON-LINE NON-DOWNLOADABLE SOFTWARE USED TO TRACK RECRUITING BY LAW FIRMS; PROVIDING ON-LINE NON-DOWNLOADABLE SOFTWARE FOR EMPLOYEE AND PROJECT PERFORMANCE EVALUATIONS, SURVEYS, CANDIDATE TESTING AND SCREENING, AND OTHER HUMAN RESOURCE FUNCTIONS, NAMELY, TRACKING ATTENDANCE, HOURS, BILLING AND EMPLOYMENT STATISTICS, MAINTAINING JOB LISTINGS AND GENERATING REPORTS ON ALL OF THE FOREGOING (U.S. CLS. 100 AND 101).

FIRST USE 4-23-2004; IN COMMERCE 4-23-2004.
MARK SHINER, EXAMINING ATTORNEY

SN 77-852,280. WHITE, DAVID, MANHATTAN BEACH, CA.
FILED 10-19-2009.

CENTRIC INDUSTRIES

THE MARK CONSISTS OF STANDARD CHARACTERS WITHOUT CLAIM TO ANY PARTICULAR FONT, STYLE, SIZE, OR COLOR.

NO CLAIM IS MADE TO THE EXCLUSIVE RIGHT TO USE "INDUSTRIES", APART FROM THE MARK AS SHOWN.

FOR PRODUCT DEVELOPMENT (U.S. CLS. 100 AND 101).

FIRST USE 10-1-2009; IN COMMERCE 10-1-2009.
FRANK LATTUCA, EXAMINING ATTORNEY

CLASS 42—(Continued).

SN 77-853,694. FOREIGN CURRENCY EXCHANGE CORP.,
ORLANDO, FL. FILED 10-21-2009.

FX2GO

THE MARK CONSISTS OF STANDARD CHARACTERS WITHOUT CLAIM TO ANY PARTICULAR FONT, STYLE, SIZE, OR COLOR.

FOR HOSTING AN ONLINE WEBSITE THAT GIVES USERS THE ABILITY TO PURCHASE FOREIGN CURRENCY ON-LINE AND SHIPPED DIRECTLY TO THE CLIENT'S HOME/BUSINESS ADDRESS (U.S. CLS. 100 AND 101).

LAKEISHA LEWIS, EXAMINING ATTORNEY

SN 77-859,203. SCANSCOUT, INC., BOSTON, MA. FILED 10-28-2009.

SCANSCOUT

THE MARK CONSISTS OF STANDARD CHARACTERS WITHOUT CLAIM TO ANY PARTICULAR FONT, STYLE, SIZE, OR COLOR.

FOR APPLICATION SERVICE PROVIDER (ASP) FEATURING SOFTWARE FOR USE IN DESIGNING AND MANAGING ONLINE VIDEO ADVERTISING AND MARKETING CAMPAIGNS (U.S. CLS. 100 AND 101).

FIRST USE 11-0-2006; IN COMMERCE 11-0-2006.
MARIAM MAHMOUDI, EXAMINING ATTORNEY

CLASS 42—(Continued).

SN 77-860,798. PUZZLE LOGIC INC., TAIPEI CITY, TAIWAN, FILED 10-29-2009.

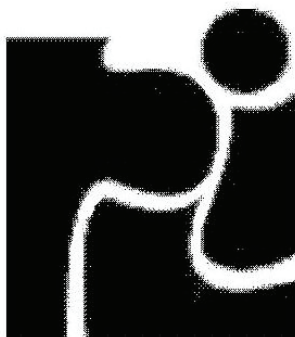

THE MARK CONSISTS OF A DESIGN COMPRISED OF A STYLIZED DEPICTION OF PUZZLE PIECES THAT ARE ARRANGED TO FORM A HIGHLY STYLIZED REPRESENTATION OF A HUMAN BEING.

FOR DESIGN FOR OTHERS OF SEMICONDUCTOR CHIPS; DESIGN FOR OTHERS OF INTEGRATED CIRCUITS FOR USE IN COMPUTER SYSTEMS; COMPUTER ANIMATION DESIGN FOR OTHERS; COMPUTER GRAPHICS SERVICE; COMPUTER PROGRAMMING FOR OTHERS; COMPUTER SOFTWARE DESIGN FOR OTHERS; DEVELOPMENT OF DATA PROCESSING PROGRAMS BY ORDER OF THIRD PARTIES; COMPUTER SYSTEM ANALYSIS; COMPUTER SOFTWARE CONSULTATION; COMPUTER SOFTWARE DEVELOPMENT; COMPUTER SERVICES, NAMELY, DESIGNING AND IMPLEMENTING WEB PAGES FOR OTHERS (U.S. CLS. 100 AND 101).

ROBERT LAVACHE, EXAMINING ATTORNEY

SN 77-860,801. PUZZLE LOGIC INC., TAIPEI CITY, TAIWAN, FILED 10-29-2009.

PUZZLE LOGIC

NO CLAIM IS MADE TO THE EXCLUSIVE RIGHT TO USE "LOGIC", APART FROM THE MARK AS SHOWN.

FOR DESIGN FOR OTHERS OF SEMICONDUCTOR CHIPS; DESIGN FOR OTHERS OF INTEGRATED CIRCUITS FOR USE IN COMPUTER SYSTEMS; COMPUTER ANIMATION DESIGN FOR OTHERS; COMPUTER GRAPHICS SERVICE; COMPUTER PROGRAMMING FOR OTHERS; COMPUTER SOFTWARE DESIGN FOR OTHERS; DEVELOPMENT OF DATA PROCESSING PROGRAMS BY ORDER OF THIRD PARTIES; COMPUTER SYSTEM ANALYSIS; COMPUTER SOFTWARE CONSULTATION; COMPUTER SOFTWARE DEVELOPMENT; COMPUTER SERVICES, NAMELY, DESIGNING AND IMPLEMENTING WEB PAGES FOR OTHERS (U.S. CLS. 100 AND 101).

ROBERT LAVACHE, EXAMINING ATTORNEY

CLASS 42—(Continued).

SN 77-861,010. SCOTT T. BURR, OXFORD, MI. FILED 10-29-2009.

Accelerated Research Solutions at the Speed of Opportunity

THE MARK CONSISTS OF STANDARD CHARACTERS WITHOUT CLAIM TO ANY PARTICULAR FONT, STYLE, SIZE, OR COLOR.

NO CLAIM IS MADE TO THE EXCLUSIVE RIGHT TO USE "RESEARCH SOLUTIONS", APART FROM THE MARK AS SHOWN.

FOR TECHNOLOGY CONSULTATION AND RESEARCH IN THE FIELD OF MECHANICAL ENGINEERING AND MATERIAL SCIENCE (U.S. CLS. 100 AND 101).

EMILY CARLSEN, EXAMINING ATTORNEY

SN 77-862,067. SIX ESTATE COMMUNICATIONS LLC, NEW YORK, NY. FILED 10-31-2009.

SixEstate Communications

THE MARK CONSISTS OF STANDARD CHARACTERS WITHOUT CLAIM TO ANY PARTICULAR FONT, STYLE, SIZE, OR COLOR.

NO CLAIM IS MADE TO THE EXCLUSIVE RIGHT TO USE "COMMUNICATIONS", APART FROM THE MARK AS SHOWN.

FOR CREATING AND MAINTAINING BLOGS FOR OTHERS (U.S. CLS. 100 AND 101).

TINA MAI, EXAMINING ATTORNEY

SN 77-863,502. CONCORDIA PUBLISHING HOUSE, ST. LOUIS, MO. FILED 11-3-2009.

CHURCH 360

THE MARK CONSISTS OF STANDARD CHARACTERS WITHOUT CLAIM TO ANY PARTICULAR FONT, STYLE, SIZE, OR COLOR.

NO CLAIM IS MADE TO THE EXCLUSIVE RIGHT TO USE "CHURCH", APART FROM THE MARK AS SHOWN.

FOR PROVIDING TEMPORARY USE OF ON-LINE NON-DOWNLOADABLE SOFTWARE FOR USE IN CHURCH ADMINISTRATION, MANAGEMENT AND COMMUNICATION (U.S. CLS. 100 AND 101).

LURIE KAUFMAN, EXAMINING ATTORNEY

CLASS 42—(Continued).

SN 77-864,486. WORKGLOW, LLC, SAN MARCOS, TX.
FILED 11-4-2009.

WORKGLOW

THE MARK CONSISTS OF STANDARD CHARACTERS WITHOUT CLAIM TO ANY PARTICULAR FONT, STYLE, SIZE, OR COLOR.

FOR PROVIDING A WEB-BASED SOFTWARE APPLICATION FOR USE IN TIMEKEEPING, LABOR JOB COST ACCOUNTING, TRACKING AND ANALYZING EMPLOYEE ATTENDANCE, EMPLOYEE PERFORMANCE, EMPLOYEE SCHEDULING, LABOR COSTS, AND PAYROLL; PROVIDING ON-LINE NON-DOWNLOADABLE SOFTWARE TO STORE, MANAGE, TRACK, ANALYZE, AND REPORT DATA IN THE FIELDS OF HUMAN RESOURCES, WORKFORCE AND LABOR MANAGEMENT (U.S. CLS. 100 AND 101).

ALICIA COLLINS, EXAMINING ATTORNEY

SN 77-867,477. YOBEL SCM COSTUME JEWELRY S.A.,
JESUS MARIA, PERU, FILED 11-6-2009.

jewelry tales
A Design Experience.

OWNER OF PERU REG. NO. 58887, DATED 10-7-2009,
EXPIRES 10-7-2018.

NO CLAIM IS MADE TO THE EXCLUSIVE RIGHT TO USE "JEWELRY" AND "DESIGN", APART FROM THE MARK AS SHOWN.

THE MARK CONSISTS OF THE WORDS "JEWELRY TALES" IN STYLIZED FONT. THE PHRASE "A DESIGN EXPERIENCE" IS PLACED BELOW THE WORD "TALES" IN A DIFFERENT STYLIZED FONT.

FOR JEWELRY DESIGN SERVICES (U.S. CLS. 100 AND 101).

CHARLES L. JENKINS, EXAMINING ATTORNEY

CLASS 42—(Continued).

SN 77-868,768. IRVINE, CHRISTOPHER, LOS ALTOS, CA.
FILED 11-9-2009.



greenii
A SUSTAINABLE FUTURE FOR ALL

THE MARK CONSISTS OF AN OVERHEAD VIEW OF A BUMBLE BEE BENEATH WHICH APPEARS THE WORDING "GREENNII" AND "A SUSTAINABLE FUTURE FOR ALL".

FOR CONSULTING SERVICES IN THE FIELD OF ENVIRONMENTAL ASSESSMENT, COMPLIANCE AND PLANNING; PROVIDING A WEB SITE FEATURING TECHNOLOGY THAT ENABLES USERS TO SHARE, BOOKMARK, INDEX, STORE, COLLECT AND SHOW-CASE CONTENT, ARTICLES, IMAGES, CALENDARS, PRODUCTS, PROJECTS, AND OTHER INFORMATION RESOURCES IN ELECTRONIC FORM IN THE NATURE AND FIELD OF CLIMATE CHANGE AND GLOBAL WARMING AND ASSOCIATED RELATED FIELDS INCLUDING GREEN BUILDING, PLANNING, RENEWABLE ENERGY, SUSTAINABLE COMMUNITIES, CONSERVATION, AND OTHER HUMAN ACTIVITIES AFFECTING CARBON USE AND ITS IMPACTS ON THE WORLD AND THE ENVIRONMENT (U.S. CLS. 100 AND 101).

MARTHA FROMM, EXAMINING ATTORNEY

SN 77-873,208. D3I TECHNOLOGIES LLC, CHICAGO, IL.
FILED 11-16-2009.

FIRSTLOOK NAVIGATOR

THE MARK CONSISTS OF STANDARD CHARACTERS WITHOUT CLAIM TO ANY PARTICULAR FONT, STYLE, SIZE, OR COLOR.

OWNER OF U.S. REG. NOS. 2,948,525, 3,041,549 AND OTHERS.

NO CLAIM IS MADE TO THE EXCLUSIVE RIGHT TO USE "NAVIGATOR", APART FROM THE MARK AS SHOWN.

FOR COMPUTER SERVICES, NAMELY, ACTING AS AN APPLICATION SERVICE PROVIDER IN THE FIELD OF KNOWLEDGE MANAGEMENT TO HOST COMPUTER APPLICATIONS SOFTWARE FOR SEARCHING AND RETRIEVING INFORMATION FROM DATABASES AND COMPUTER NETWORKS AND PROVIDING COMPUTERIZED ANALYTICAL PROCESSING AND DATA ANALYSIS SERVICES THAT USE PREDICTIVE MODELING TO FACILITATE MANAGEMENT OF INFORMATION IN THE FIELD OF AUTOMOTIVE RETAIL SALES PERFORMANCE (U.S. CLS. 100 AND 101).

ANDREA BUTLER, EXAMINING ATTORNEY

CLASS 42—(Continued).

SN 77-874,342. FIBROCELL TECHNOLOGIES, INC., EXTON, PA. FILED 11-17-2009.

FIBROCELL PROCESS

THE MARK CONSISTS OF STANDARD CHARACTERS WITHOUT CLAIM TO ANY PARTICULAR FONT, STYLE, SIZE, OR COLOR.

NO CLAIM IS MADE TO THE EXCLUSIVE RIGHT TO USE "PROCESS", APART FROM THE MARK AS SHOWN.

FOR SCIENTIFIC RESEARCH AND DEVELOPMENT, NAMELY, COSMETIC RESEARCH AND DEVELOPMENT OF PERSONALIZED HISTOCOMPATIBLE FIBROBLAST CELLS FOR USE IN REGENERATIVE MEDICAL, DENTAL AND COSMETIC TREATMENT PROCEDURES TAILORED TO AN INDIVIDUAL (U.S. CLS. 100 AND 101).

MARC LEIPZIG, EXAMINING ATTORNEY

SN 77-874,378. FIBROCELL TECHNOLOGIES, INC., EXTON, PA. FILED 11-17-2009.

FIBROCELL THERAPY

THE MARK CONSISTS OF STANDARD CHARACTERS WITHOUT CLAIM TO ANY PARTICULAR FONT, STYLE, SIZE, OR COLOR.

NO CLAIM IS MADE TO THE EXCLUSIVE RIGHT TO USE "THERAPY", APART FROM THE MARK AS SHOWN.

FOR SCIENTIFIC RESEARCH AND DEVELOPMENT, NAMELY, COSMETIC RESEARCH AND DEVELOPMENT OF PERSONALIZED HISTOCOMPATIBLE FIBROBLAST CELLS FOR USE IN REGENERATIVE MEDICAL, DENTAL AND COSMETIC TREATMENT PROCEDURES TAILORED TO AN INDIVIDUAL (U.S. CLS. 100 AND 101).

FIRST USE 12-1-2009; IN COMMERCE 12-1-2009.
MARC LEIPZIG, EXAMINING ATTORNEY

CLASS 42—(Continued).

SN 77-874,876. DVD YOUR MEMORIES INC., SAN DIEGO, CA. FILED 11-17-2009.



NO CLAIM IS MADE TO THE EXCLUSIVE RIGHT TO USE "THE LEADER IN FAMILY MEDIA TRANSFER", APART FROM THE MARK AS SHOWN.

THE MARK CONSISTS OF THE WORDING "DVDYOUR-MEMORIES THE LEADER IN FAMILY MEDIA TRANSFER" AND A DESIGN THAT LOOKS LIKE A HUMAN MADE OUT OF FILM.

FOR DIGITAL TRANSFER SERVICES FOR TRANSFERRING HOME VIDEOS AND FILM TO DVD AND THE INTERNET; MEDIA TRANSFER SERVICES, NAMELY, TRANSFERRING ANALOG TO DIGITAL MEDIA, TRANSFERRING PHOTOS, TRANSFERRING SLIDES, TRANSFERRING NEGATIVES, AND ANALOG MEDIA TO A HARD DRIVE SPACE (U.S. CLS. 100 AND 101).

FIRST USE 3-1-2007; IN COMMERCE 3-1-2007.
ALICIA COLLINS, EXAMINING ATTORNEY

SN 77-876,295. PRODUCTIONS 1000 LLC, WASHINGTON, DC. FILED 11-19-2009.

ENERGY HEROES

THE MARK CONSISTS OF STANDARD CHARACTERS WITHOUT CLAIM TO ANY PARTICULAR FONT, STYLE, SIZE, OR COLOR.

NO CLAIM IS MADE TO THE EXCLUSIVE RIGHT TO USE "ENERGY", APART FROM THE MARK AS SHOWN.

FOR PROVIDING A WEBSITE FEATURING INFORMATION AND CONTENT IN THE FIELD OF ENVIRONMENTAL AWARENESS AND ENERGY AWARENESS CONSERVATION, NAMELY, CLIMATE CHANGE AND GLOBAL WARMING AND ASSOCIATED RELATED FIELDS INCLUDING GREEN BUILDING, PLANNING, RENEWABLE ENERGY, SUSTAINABLE COMMUNITIES, CONSERVATION, AND OTHER HUMAN ACTIVITIES AFFECTING CARBON USE AND ITS IMPACTS ON THE WORLD; COMPUTER SERVICES, NAMELY, CREATING AN ON-LINE COMMUNITY FOR REGISTERED USERS TO ENGAGE IN INTERACTIVE SOCIAL NETWORKING IN THE FIELD OF ENVIRONMENTAL AWARENESS AND ENERGY AWARENESS AND CONSERVATION; PROVIDING INFORMATION FEATURING ANIMATION IN THE FIELD OF ENVIRONMENTAL AWARENESS AND ENERGY AWARENESS CONSERVATION, NAMELY, CLIMATE CHANGE AND GLOBAL WARMING AND ASSOCIATED RELATED FIELDS INCLUDING GREEN BUILDING, PLANNING, RENEWABLE ENERGY, SUSTAINABLE COMMUNITIES, CONSERVATION, AND OTHER HUMAN ACTIVITIES AFFECTING CARBON USE AND ITS IMPACTS ON THE WORLD (U.S. CLS. 100 AND 101).

KATHY DE JONGE, EXAMINING ATTORNEY

CLASS 42—(Continued).

SN 77-876,400. AMBRY GENETICS, ALISO VIEJO, CA. FILED 11-19-2009.

STEMARRAY

THE MARK CONSISTS OF STANDARD CHARACTERS WITHOUT CLAIM TO ANY PARTICULAR FONT, STYLE, SIZE, OR COLOR.

FOR SCIENTIFIC RESEARCH SERVICES, NAMELY, ANALYZING BIOLOGICAL SAMPLES INCLUDING CELLS AND CELL EXTRACTS FOR THE PRESENCE, ABSENCE OR ABUNDANCE OF NUCLEIC ACID, POLYPEPTIDE OR MOLECULAR MARKERS ASSOCIATED WITH CELL IDENTITY OR DIFFERENTIATION, AND IDENTIFYING CELL STAGE BY DETECTING OR MEASURING CELL DIFFERENTIATION MARKERS (U.S. CLS. 100 AND 101).

FRED CARL, EXAMINING ATTORNEY

CLASS 42—(Continued).

SN 77-877,976. INGENIX, INC., EDEN PRAIRIE, MN. FILED 11-20-2009.

INGENIX INSITE

THE MARK CONSISTS OF STANDARD CHARACTERS WITHOUT CLAIM TO ANY PARTICULAR FONT, STYLE, SIZE, OR COLOR.

OWNER OF U.S. REG. NOS. 2,390,360, 3,344,189 AND OTHERS.

FOR PROVIDING TEMPORARY USE OF AN INTERACTIVE WEB-BASED NON-DOWNLOADABLE SOFTWARE APPLICATION USED FOR DATA MANAGEMENT AND DATA ASSESSMENT, DECISION-MAKING AND AS A REPORTING TOOL IN THE FIELDS OF HEALTH CARE AND HEALTH CARE CLAIMS REIMBURSEMENT (U.S. CLS. 100 AND 101).

FIRST USE 11-0-2008; IN COMMERCE 11-0-2008.
MELISSA VALLILLO, EXAMINING ATTORNEY

SN 77-878,226. WARD, CASEY B., ISSAQUAH, WA. FILED 11-21-2009.

FUTUREWORKS

THE MARK CONSISTS OF STANDARD CHARACTERS WITHOUT CLAIM TO ANY PARTICULAR FONT, STYLE, SIZE, OR COLOR.

FOR CONSULTING SERVICES IN THE FIELD OF DESIGN, SELECTION, IMPLEMENTATION AND USE OF COMPUTER HARDWARE AND SOFTWARE SYSTEMS FOR OTHERS; CONSULTING SERVICES IN THE FIELD OF HOSTING COMPUTER SOFTWARE APPLICATIONS; CONSULTING SERVICES IN THE FIELD OF PROVIDING ONLINE, NON-DOWNLOADABLE SOFTWARE AND APPLICATIONS; CREATING, MAINTAINING, AND MODERNIZING COMPUTER SOFTWARE; CUSTOMIZED SOFTWARE DEVELOPMENT SERVICES; DEBUGGING COMPUTER SOFTWARE FOR OTHERS; DESIGN AND DEVELOPMENT OF COMPUTER SOFTWARE; DESIGN OF HOME PAGES, COMPUTER SOFTWARE AND WEB SITES; DESIGN, MAINTENANCE, DEVELOPMENT AND UPDATING OF COMPUTER SOFTWARE; SOFTWARE AS A SERVICE (SAAS) SERVICES FEATURING SOFTWARE IN THE FIELD OF BUSINESS SALES, LEGAL, FINANCE AND OPERATIONS, AND IN THE FIELD OF CONSUMER NUTRITION AND WELLNESS (U.S. CLS. 100 AND 101).

FIRST USE 1-1-1994; IN COMMERCE 1-1-1994.
FRED CARL, EXAMINING ATTORNEY

SN 77-876,427. AMBRY GENETICS, ALISO VIEJO, CA. FILED 11-19-2009.

AMBRY STEMARRAY

THE MARK CONSISTS OF STANDARD CHARACTERS WITHOUT CLAIM TO ANY PARTICULAR FONT, STYLE, SIZE, OR COLOR.

OWNER OF U.S. REG. NOS. 2,674,217 AND 3,069,616.
FOR SCIENTIFIC RESEARCH SERVICES, NAMELY, ANALYZING BIOLOGICAL SAMPLES INCLUDING CELLS AND CELL EXTRACTS FOR THE PRESENCE, ABSENCE OR ABUNDANCE OF NUCLEIC ACID, POLYPEPTIDE OR MOLECULAR MARKERS ASSOCIATED WITH CELL IDENTITY OR DIFFERENTIATION, AND IDENTIFYING CELL STAGE BY DETECTING OR MEASURING CELL DIFFERENTIATION MARKERS (U.S. CLS. 100 AND 101).

FRED CARL, EXAMINING ATTORNEY

CLASS 42—(Continued).

SN 77-878,359. DYNAMIC ANSWERS, INC., LILBURN, GA.
FILED 11-22-2009.



THE COLOR(S) RED AND BLUE IS/ARE CLAIMED AS A FEATURE OF THE MARK.

THE MARK CONSISTS OF THE STYLIZED WORDING "SITEMAST" TO THE RIGHT OF A CIRCLE WITH THE DESIGN OF A SAILBOAT ATOP WAVES THEREIN. PORTIONS OF THE SAILBOAT EXTEND BEYOND THE CIRCLE'S EDGES. THE COLOR BLUE APPEARS IN THE WAVES AND IN THE BACKGROUND OF THE CIRCLE, EXCEPT FOR THE CENTER RIGHT PORTION OF THE CIRCLE. THE COLOR BLUE ALSO APPEARS IN THE WORD "SITE" IN THE MARK. THE COLOR RED APPEARS IN THE SAILBOAT AND IN THE WORD "MAST." THE WHITE IN THE DRAWING REPRESENTS BACKGROUND AND TRANSPARENT AREAS AND IS NOT PART OF THE MARK.

FOR WEB SITE HOSTING SERVICES; WEBSITE DESIGN AND DEVELOPMENT FOR OTHERS (U.S. CLS. 100 AND 101).

FIRST USE 10-16-2009; IN COMMERCE 10-16-2009.
MAUREEN DALL, EXAMINING ATTORNEY

SN 77-879,774. POWERMOD CORPORATION, MIAMI LAKES, FL. FILED 11-24-2009.

Powermod

THE MARK CONSISTS OF STANDARD CHARACTERS WITHOUT CLAIM TO ANY PARTICULAR FONT, STYLE, SIZE, OR COLOR.

FOR SOFTWARE DESIGN AND DEVELOPMENT (U.S. CLS. 100 AND 101).

FIRST USE 11-6-2009; IN COMMERCE 11-6-2009.
DEZMONA MIZELLE, EXAMINING ATTORNEY

SN 77-880,405. PIXYBEAR, INC., NEWPORT BEACH, CA.
FILED 11-24-2009.

PIXYKIDS

THE MARK CONSISTS OF STANDARD CHARACTERS WITHOUT CLAIM TO ANY PARTICULAR FONT, STYLE, SIZE, OR COLOR.

FOR COMPUTER SERVICES, NAMELY, PROVIDING AN INTERACTIVE WEB SITE THAT ALLOWS USERS TO CREATE THEIR OWN BOOKS (U.S. CLS. 100 AND 101).

IRA J. GOODSaid, EXAMINING ATTORNEY

CLASS 42—(Continued).

SN 77-881,352. FRIENDSCENTS, LLC, ATLANTA, GA.
FILED 11-26-2009.

FRIENDSCENTS

THE MARK CONSISTS OF STANDARD CHARACTERS WITHOUT CLAIM TO ANY PARTICULAR FONT, STYLE, SIZE, OR COLOR.

FOR COMPUTER SERVICES, NAMELY, HOSTING ONLINE WEB FACILITIES FOR TWEEN GIRLS, TEEN GIRLS, AND OTHERS FOR ORGANIZING AND CONDUCTING ONLINE MEETINGS, GATHERINGS, AND INTERACTIVE DISCUSSIONS; AND COMPUTER SERVICES IN THE NATURE OF CUSTOMIZED WEB PAGES FEATURING USER-DEFINED INFORMATION, PERSONAL PROFILES AND INFORMATION; PROVIDING ONLINE COMPUTER DATABASES AND ON-LINE SEARCHABLE DATABASES IN THE FIELD OF VIRTUAL COMMUNITY; COMPUTER SOFTWARE DEVELOPMENT; APPLICATION SERVICE PROVIDER (ASP) FEATURING SOFTWARE TO ENABLE UPLOADING, POSTING, SHOWING, DISPLAYING, TAGGING, BLOGGING, SHARING, OR OTHERWISE PROVIDING ELECTRONIC MEDIA OR INFORMATION OVER THE INTERNET OR OTHER COMMUNICATIONS NETWORK; PROVIDING TEMPORARY USE OF NON-DOWNLOADABLE SOFTWARE APPLICATIONS FOR VIRTUAL COMMUNITY, SOCIAL NETWORKING, PHOTO SHARING, VIDEO SHARING, AND TRANSMISSION OF PHOTOGRAPHIC IMAGES (U.S. CLS. 100 AND 101).

FIRST USE 3-1-2009; IN COMMERCE 4-20-2009.
ELLEN BURNS, EXAMINING ATTORNEY

SN 77-882,048. THE BRENNAN GROUP, INC., HALIFAX, CANADA, FILED 11-30-2009.

TalentSeeker

THE MARK CONSISTS OF STANDARD CHARACTERS WITHOUT CLAIM TO ANY PARTICULAR FONT, STYLE, SIZE, OR COLOR.

OWNER OF CANADA REG. NO. TMA714892, DATED 5-22-2008, EXPIRES 5-22-2023.

FOR PROVIDING A WEB SITE FEATURING TECHNOLOGY THAT ENABLES RECRUITERS AND HIRING MANAGERS TO MANAGE THE ENTIRE CANDIDATE ATTRACTION AND SELECTION PROCESS, INCLUDING ADMINISTRATION OF BACKGROUND CHECKS, ASSESSMENTS AND SKILLS TESTS; AS WELL AS COMPILING DATA THAT FACILITATES THE CONTINUOUS IMPROVEMENT OF THE PROCESS (U.S. CLS. 100 AND 101).

SANI KHOURI, EXAMINING ATTORNEY

CLASS 42—(Continued).

SN 77-882,059. ACTIVITYRAZZLE, HARRISBURG, PA. FILED 11-30-2009.



NO CLAIM IS MADE TO THE EXCLUSIVE RIGHT TO USE "ACTIVITY", APART FROM THE MARK AS SHOWN. THE MARK CONSISTS OF THE STYLIZED TEXT "ACTIVITY RAZZLE" WITH A LINE IN THE MIDDLE AND THREE ARROW HEADS ON THE LEFT SIDE OF THE TEXT.

FOR COMPUTER SERVICES, NAMELY, PROVIDING A WEB-BASED SYSTEM AND ONLINE PORTAL FEATURING ON-LINE NON-DOWNLOADABLE SOFTWARE FOR USERS TO COLLECT, ORGANIZE, DOCUMENT, AND STORE ACTIVITY DATA AND INFORMATION RELATED TO ACTIVITY PROGRAMS IN SENIOR LIVING COMMUNITIES, FACILITIES, AND SENIOR CENTERS; PROVIDING TEMPORARY USE OF WEB-BASED SOFTWARE FOR REGULATORY DOCUMENTATION SUPPORT IN NURSING HOMES AND ASSISTED LIVING; COMPUTER SOFTWARE TECHNOLOGY CONSULTING RELATED TO ACTIVITY SOFTWARE SET UP (U.S. CLS. 100 AND 101).

CHERYL CLAYTON, EXAMINING ATTORNEY

SN 77-882,496. IO DATA CENTERS, LLC, PHOENIX, AZ. FILED 11-30-2009.

SCALE MATTERS

THE MARK CONSISTS OF STANDARD CHARACTERS WITHOUT CLAIM TO ANY PARTICULAR FONT, STYLE, SIZE, OR COLOR.

FOR COMPUTER COLOCATION SERVICES, NAMELY, PROVIDING FACILITIES FOR THE LOCATION OF COMPUTER SERVERS WITH THE EQUIPMENT OF OTHERS (U.S. CLS. 100 AND 101).

JULIE VEPPUMTHARA, EXAMINING ATTORNEY

SN 77-882,508. PIXYBEAR, INC., NEWPORT BEACH, CA. FILED 11-30-2009.

PixySite

THE MARK CONSISTS OF STANDARD CHARACTERS WITHOUT CLAIM TO ANY PARTICULAR FONT, STYLE, SIZE, OR COLOR.

FOR COMPUTER SERVICES, NAMELY, PROVIDING AN INTERACTIVE WEB SITE THAT ALLOWS USERS TO CREATE THEIR OWN BOOKS (U.S. CLS. 100 AND 101).

IRA J. GOODSID, EXAMINING ATTORNEY

CLASS 42—(Continued).

SN 77-883,603. STOEVER, THEODORE, RENO, NV. FILED 12-1-2009.

MyTag

THE MARK CONSISTS OF STANDARD CHARACTERS WITHOUT CLAIM TO ANY PARTICULAR FONT, STYLE, SIZE, OR COLOR.

FOR PROVIDING A WEB SITE ENABLING USERS TO CREATE THEIR OWN PERSONAL BRAND OR LOGO, FOR PERSONAL PROMOTION, TO BE SHARED WITH OTHERS VIA DIGITAL MEDIUMS AND/OR CUSTOMIZABLE MERCHANDISE (U.S. CLS. 100 AND 101).

BENJAMIN OKEKE, EXAMINING ATTORNEY

SN 77-884,026. MICRONEIL RESEARCH CORPORATION, DBA MICRONEIL RESEARCH, LEESBURG, VA. FILED 12-2-2009.



NO CLAIM IS MADE TO THE EXCLUSIVE RIGHT TO USE "RESEARCH", APART FROM THE MARK AS SHOWN. THE NAME "MICRONEIL" DOES NOT IDENTIFY A LIVING INDIVIDUAL.

THE MARK CONSISTS OF THE WORD "MICRONEIL" OVER A CHARACTER THAT RESEMBLES A BACKWARD, LOWERCASE "U" WITH AN EXTENDED END, ANGLED TO THE RIGHT AND SURROUNDED BY AN OVAL THAT RESEMBLES AN ATOM ORBITING AROUND THE "U-SHAPED" CHARACTER, ALL ABOVE THE WORD "RESEARCH" IN SMALLER-SIZED PLAIN FONT.

THE WORDING "MICRONEIL" HAS NO MEANING IN A FOREIGN LANGUAGE.

FOR COMPUTER HARDWARE AND SOFTWARE CONSULTING SERVICES; CONSULTING IN THE FIELD OF INFORMATION TECHNOLOGY; ELECTRONIC AND ELECTRICAL SYSTEMS DESIGN SERVICES (U.S. CLS. 100 AND 101).

FIRST USE 11-14-2005; IN COMMERCE 11-14-2005.

TARA PATE, EXAMINING ATTORNEY

CLASS 42—(Continued).

SN 77-884,282. FLEXBUDGET, LLC, SHOREWOOD, MN. FILED 12-2-2009.

ProfitSee

THE MARK CONSISTS OF STANDARD CHARACTERS WITHOUT CLAIM TO ANY PARTICULAR FONT, STYLE, SIZE, OR COLOR.

FOR PROVIDING TEMPORARY USE OF ON-LINE NON-DOWNLOADABLE SOFTWARE FOR FISCAL AND ASSET MANAGEMENT OF COMPANIES (U.S. CLS. 100 AND 101).

FIRST USE 9-5-2009; IN COMMERCE 9-5-2009.
LAURA HAMMEL, EXAMINING ATTORNEY

SN 77-884,309. MICRONEIL RESEARCH CORPORATION, DBA MICRONEIL, LEESBURG, VA. FILED 12-2-2009.

MicroNeil

THE MARK CONSISTS OF STANDARD CHARACTERS WITHOUT CLAIM TO ANY PARTICULAR FONT, STYLE, SIZE, OR COLOR.

THE NAME(S), PORTRAIT(S), AND/OR SIGNATURE(S) SHOWN IN THE MARK DOES NOT IDENTIFY A PARTICULAR LIVING INDIVIDUAL.

THE WORDING "MICRONEIL" HAS NO MEANING IN A FOREIGN LANGUAGE.

FOR COMPUTER HARDWARE AND SOFTWARE CONSULTING SERVICES; CONSULTING IN THE FIELD OF INFORMATION TECHNOLOGY; ELECTRONIC AND ELECTRICAL SYSTEMS DESIGN SERVICES (U.S. CLS. 100 AND 101).

FIRST USE 11-14-2005; IN COMMERCE 11-14-2005.
TARA PATE, EXAMINING ATTORNEY

SN 77-884,623. MEDSYM, INC., BIRMINGHAM, AL. FILED 12-2-2009.

MEDSYM

THE MARK CONSISTS OF STANDARD CHARACTERS WITHOUT CLAIM TO ANY PARTICULAR FONT, STYLE, SIZE, OR COLOR.

FOR APPLICATION SERVICE PROVIDER (ASP), NAMELY, HOSTING COMPUTER SOFTWARE APPLICATIONS OF OTHERS; COMPUTER TECHNOLOGY SUPPORT SERVICES, NAMELY, HELP DESK SERVICES; DEVELOPING COMPUTER SOFTWARE; INSTALLATION AND MAINTENANCE OF COMPUTER SOFTWARE; IT INTEGRATION SERVICES (U.S. CLS. 100 AND 101).

FIRST USE 3-31-2009; IN COMMERCE 3-31-2009.
BENJAMIN OKEKE, EXAMINING ATTORNEY

CLASS 42—(Continued).

SN 77-884,935. RETENSA, LLC, NEW YORK, NY. FILED 12-2-2009.

EXITPRO

THE MARK CONSISTS OF STANDARD CHARACTERS WITHOUT CLAIM TO ANY PARTICULAR FONT, STYLE, SIZE, OR COLOR.

FOR APPLICATION SERVICE PROVIDER (ASP) FEATURING SOFTWARE FOR USE IN EMPLOYEE TURNOVER MANAGEMENT, AND FOR EXIT INTERVIEW AND SEPARATION MANAGEMENT; CLOUD COMPUTING FEATURING SOFTWARE FOR USE IN EMPLOYEE TURNOVER MANAGEMENT, AND FOR EXIT INTERVIEW AND SEPARATION MANAGEMENT; PROVIDING ON-LINE NON-DOWNLOADABLE SOFTWARE FOR EMPLOYEE TURNOVER MANAGEMENT, AND FOR EXIT INTERVIEW AND SEPARATION MANAGEMENT; PROVIDING TEMPORARY USE OF A WEB-BASED SOFTWARE APPLICATION FOR EMPLOYEE TURNOVER MANAGEMENT, AND FOR EXIT INTERVIEW AND SEPARATION MANAGEMENT; PROVIDING TEMPORARY USE OF ON-LINE NON-DOWNLOADABLE SOFTWARE FOR EMPLOYEE TURNOVER MANAGEMENT, AND FOR EXIT INTERVIEW AND SEPARATION MANAGEMENT (U.S. CLS. 100 AND 101).

FIRST USE 8-0-2003; IN COMMERCE 8-0-2003.
HEATHER BIDDULPH, EXAMINING ATTORNEY

SN 77-884,937. CRANIAC, INC., AUSTIN, TX. FILED 12-2-2009.

CRANIAC

THE MARK CONSISTS OF STANDARD CHARACTERS WITHOUT CLAIM TO ANY PARTICULAR FONT, STYLE, SIZE, OR COLOR.

FOR COMPUTER HARDWARE AND SOFTWARE CONSULTING SERVICES; COMPUTER SOFTWARE CONSULTANCY; COMPUTER SOFTWARE CONSULTATION; COMPUTER SOFTWARE CONSULTING; COMPUTER SOFTWARE DEVELOPMENT AND COMPUTER PROGRAMMING DEVELOPMENT FOR OTHERS; CONSULTING SERVICES IN THE FIELD OF DESIGN, SELECTION, IMPLEMENTATION AND USE OF COMPUTER HARDWARE AND SOFTWARE SYSTEMS FOR OTHERS; CONSULTING SERVICES IN THE FIELD OF THEME PARK ATTRACTION DESIGN; DESIGN AND DEVELOPMENT OF COMPUTER GAME SOFTWARE AND VIRTUAL REALITY SOFTWARE; DESIGN AND DEVELOPMENT OF COMPUTER SOFTWARE; DESIGN FOR OTHERS IN THE FIELD OF INTERACTIVE ENTERTAINMENT TECHNOLOGY AND GAME CONTROL ENGINEERING; ENGINEERING SERVICES, NAMELY, ENGINEERING FOR THE DESIGN OF INTERACTIVE ENTERTAINMENT TECHNOLOGY; TECHNOLOGY CONSULTATION AND RESEARCH IN THE FIELD OF INTERACTIVE ENTERTAINMENT (U.S. CLS. 100 AND 101).

FIRST USE 8-1-1993; IN COMMERCE 8-1-1993.
ELLEN PERKINS, EXAMINING ATTORNEY

CLASS 42—(Continued).

SN 77-884,943. CRANIAC, INC., AUSTIN, TX. FILED 12-2-2009.



THE MARK CONSISTS OF A STYLIZED, PIZZA-PIECE-SHAPED (TRIANGULAR-WEDGE) HUMAN FACE.

FOR COMPUTER HARDWARE AND SOFTWARE CONSULTING SERVICES; COMPUTER SOFTWARE CONSULTANCY; COMPUTER SOFTWARE CONSULTATION; COMPUTER SOFTWARE CONSULTING; COMPUTER SOFTWARE DEVELOPMENT AND COMPUTER PROGRAMMING DEVELOPMENT FOR OTHERS; CONSULTING SERVICES IN THE FIELD OF DESIGN, SELECTION, IMPLEMENTATION AND USE OF COMPUTER HARDWARE AND SOFTWARE SYSTEMS FOR OTHERS; CONSULTING SERVICES IN THE FIELD OF THEME PARK ATTRACTION DESIGN; DESIGN AND DEVELOPMENT OF COMPUTER GAME SOFTWARE AND VIRTUAL REALITY SOFTWARE; DESIGN AND DEVELOPMENT OF COMPUTER SOFTWARE; DESIGN FOR OTHERS IN THE FIELD OF INTERACTIVE ENTERTAINMENT TECHNOLOGY AND GAME CONTROL ENGINEERING; ENGINEERING SERVICES, NAMELY, ENGINEERING FOR THE DESIGN OF INTERACTIVE ENTERTAINMENT TECHNOLOGY; TECHNOLOGY CONSULTATION AND RESEARCH IN THE FIELD OF INTERACTIVE ENTERTAINMENT (U.S. CLS. 100 AND 101).

FIRST USE 8-1-1993; IN COMMERCE 8-1-1993.
ELLEN PERKINS, EXAMINING ATTORNEY

SN 77-884,994. APPRISS INC., LOUISVILLE, KY. FILED 12-3-2009.

VINE PROTECTIVE ORDER

THE MARK CONSISTS OF STANDARD CHARACTERS WITHOUT CLAIM TO ANY PARTICULAR FONT, STYLE, SIZE, OR COLOR.

OWNER OF U.S. REG. NO. 3,131,240.

NO CLAIM IS MADE TO THE EXCLUSIVE RIGHT TO USE "PROTECTIVE ORDER", APART FROM THE MARK AS SHOWN.

FOR APPLICATION SERVICE PROVIDER (ASP) FEATURING SOFTWARE FOR USE IN THE FIELD OF CRIMINAL JUSTICE FOR CREATING, MANAGING, AND PROVIDING ACCESS TO JUDICIAL ORDERS (U.S. CLS. 100 AND 101).

FIRST USE 4-0-2009; IN COMMERCE 4-0-2009.
INGA ERVIN, EXAMINING ATTORNEY

CLASS 42—(Continued).

SN 77-885,058. SOLUTION SPACE TECHNOLOGIES, LLC, CAROL STREAM, IL. FILED 12-3-2009.

Solution Space Technologies

THE MARK CONSISTS OF STANDARD CHARACTERS WITHOUT CLAIM TO ANY PARTICULAR FONT, STYLE, SIZE, OR COLOR.

NO CLAIM IS MADE TO THE EXCLUSIVE RIGHT TO USE "TECHNOLOGIES", APART FROM THE MARK AS SHOWN.

FOR COMPUTER HARDWARE AND SOFTWARE CONSULTING SERVICES; COMPUTER SOFTWARE CONSULTATION; COMPUTER SOFTWARE CONSULTING; CONSULTANCY WITH REGARD TO WEBPAGE DESIGN; CONSULTATION SERVICES IN THE FIELD OF SEARCH ENGINE OPTIMIZATION; CONSULTATION SERVICES IN THE FIELDS OF SELECTION, IMPLEMENTATION AND USE OF COMPUTER HARDWARE AND SOFTWARE SYSTEMS FOR OTHERS; CONSULTING IN THE FIELD OF INFORMATION TECHNOLOGY; CONSULTING IN THE FIELD OF IT PROJECT MANAGEMENT; CONSULTING SERVICES IN THE FIELD OF COMPUTER-BASED INFORMATION SYSTEMS FOR BUSINESSES; CONSULTING SERVICES IN THE FIELD OF DESIGN, SELECTION, IMPLEMENTATION AND USE OF COMPUTER HARDWARE AND SOFTWARE SYSTEMS FOR OTHERS; CONSULTING SERVICES IN THE FIELD OF IDENTIFICATION, SUPPORT, AND IMPLEMENTATION OF COMPUTER-BASED INFORMATION SYSTEMS FOR BUSINESSES; CONSULTING SERVICES IN THE FIELD OF OFFICE AND WORKPLACE AUTOMATION; IT CONSULTING SERVICES (U.S. CLS. 100 AND 101).

JERI J. FICKES, EXAMINING ATTORNEY

SN 77-885,247. IDV SOLUTIONS, LLC, LANSING, MI. FILED 12-3-2009.

SpatialWiki

THE MARK CONSISTS OF STANDARD CHARACTERS WITHOUT CLAIM TO ANY PARTICULAR FONT, STYLE, SIZE, OR COLOR.

FOR PROVIDING ONLINE NONDOWNLOADABLE SOFTWARE THAT ALLOWS USERS TO VISUALLY CREATE, ANNOTATE, AND MODIFY A GROWING LIBRARY OF USER-CONTRIBUTED GEOGRAPHIC SHAPES (U.S. CLS. 100 AND 101).

FIRST USE 6-6-2008; IN COMMERCE 10-8-2008.

KATHERINE STOIDES, EXAMINING ATTORNEY

CLASS 42—(Continued).

SN 77-885,488. RATIONAL RETENTION LLC, ALBANY, NY.
FILED 12-3-2009.

RATIONAL RETENTION

THE MARK CONSISTS OF STANDARD CHARACTERS WITHOUT CLAIM TO ANY PARTICULAR FONT, STYLE, SIZE, OR COLOR.

NO CLAIM IS MADE TO THE EXCLUSIVE RIGHT TO USE "RETENTION", APART FROM THE MARK AS SHOWN.

FOR PROVISION OF ONLINE ACCESS TO AND USE OF HOSTED ONLINE, NON-DOWNLOADABLE COMPUTER SOFTWARE FOR USE IN INFORMATION LIFE-CYCLE MANAGEMENT, INCLUDING RECORD AND DOCUMENT RETENTION, ELECTRONIC DISCOVERY AND LEGAL COMPLIANCE (U.S. CLS. 100 AND 101).

TINA BROWN, EXAMINING ATTORNEY

SN 77-886,105. MUSCLESPOON.COM, LLC., BOISE, ID.
FILED 12-4-2009.

BODYBOOK

THE MARK CONSISTS OF STANDARD CHARACTERS WITHOUT CLAIM TO ANY PARTICULAR FONT, STYLE, SIZE, OR COLOR.

FOR COMPUTER SERVICES, NAMELY, CREATING AN ON-LINE COMMUNITY FOR REGISTERED USERS TO PARTICIPATE IN DISCUSSIONS, GET FEEDBACK FROM THEIR PEERS, FORM VIRTUAL COMMUNITIES, AND ENGAGE IN SOCIAL NETWORKING FEATURING BODYBUILDING, HEALTH, SUPPLEMENTS AND FITNESS (U.S. CLS. 100 AND 101).

FIRST USE 11-2-2009; IN COMMERCE 12-3-2009.

WILLIAM BRECKENFELD, EXAMINING ATTORNEY

SN 77-886,391. NATIONAL ALLIANCE OF WOUND CARE,
GLENDALE, WI. FILED 12-4-2009.

NATIONAL ALLIANCE OF WOUND CARE

THE MARK CONSISTS OF STANDARD CHARACTERS WITHOUT CLAIM TO ANY PARTICULAR FONT, STYLE, SIZE, OR COLOR.

OWNER OF U.S. REG. NO. 3,140,727.

NO CLAIM IS MADE TO THE EXCLUSIVE RIGHT TO USE "WOUND CARE", APART FROM THE MARK AS SHOWN.

SEC. 2(F).

FOR TESTING, ANALYSIS AND EVALUATION OF THE SERVICES OF OTHERS FOR THE PURPOSE OF CERTIFICATION IN THE FIELD OF WOUND CARE (U.S. CLS. 100 AND 101).

FIRST USE 12-18-2002; IN COMMERCE 12-18-2002.

KATHLEEN M. VANSTON, EXAMINING ATTORNEY

CLASS 42—(Continued).

SN 77-886,885. SICOIR COMPUTER TECHNOLOGIES,
HAYS, KS. FILED 12-4-2009.

Sicoir

THE MARK CONSISTS OF STANDARD CHARACTERS WITHOUT CLAIM TO ANY PARTICULAR FONT, STYLE, SIZE, OR COLOR.

THE WORDING "SICOIR" HAS NO MEANING IN A FOREIGN LANGUAGE.

FOR COMPUTER SERVICES, NAMELY, REMOTE AND ON-SITE MANAGEMENT OF THE INFORMATION TECHNOLOGY (IT) SYSTEMS OF OTHERS; WEB SITE DEVELOPMENT FOR OTHERS; COMPUTER DIAGNOSTIC SERVICES; COMPUTER HARDWARE AND SOFTWARE CONSULTING SERVICES; COMPUTER FORENSIC SERVICES; COMPUTER MONITORING SERVICE WHICH TRACKS HARDWARE PERFORMANCE AND PROCESSES AND SENDS OUT HISTORICAL REPORTS AND ALERTS; COMPUTER NETWORK DESIGN FOR OTHERS; COMPUTER SECURITY CONSULTANCY IN THE FIELD OF SCANNING AND PENETRATION TESTING OF COMPUTERS AND NETWORKS TO ASSESS INFORMATION SECURITY VULNERABILITY; COMPUTER SERVICE, NAMELY, ACTING AS AN APPLICATION SERVICE PROVIDER IN THE FIELD OF KNOWLEDGE MANAGEMENT TO HOST COMPUTER APPLICATION SOFTWARE FOR THE COLLECTION, EDITING, ORGANIZING, MODIFYING, BOOK MARKING, TRANSMISSION, STORAGE AND SHARING OF DATA AND INFORMATION; COMPUTER SERVICES, NAMELY, CREATING AND MAINTAINING WEB SITES FOR OTHERS; COMPUTER SERVICES, NAMELY, COMPUTER SYSTEM ADMINISTRATION FOR OTHERS; COMPUTER TECHNOLOGY SUPPORT SERVICES, NAMELY, HELP DESK SERVICES; COMPUTER CONSULTATION (U.S. CLS. 100 AND 101).

FIRST USE 3-1-2003; IN COMMERCE 3-1-2003.

JAMES LOVELACE, EXAMINING ATTORNEY

SN 77-887,244. TRANSFORMING ARCHITECTURE, LLC,
DBA TRANSFORMING ARCHITECTURE, HIGHLAND,
MD. FILED 12-7-2009.



NO CLAIM IS MADE TO THE EXCLUSIVE RIGHT TO USE "ARCHITECTURE" AND "CUSTOM DESIGNS" AND "FLAT FEES", APART FROM THE MARK AS SHOWN.

THE MARK CONSISTS OF THE WORDS "TRANSFORMING ARCHITECTURE" ABOVE THE WORDS "CUSTOM DESIGNS. FLAT FEES." WITH A SERIES OF TEN (10) ARCHITECTURAL DRAWINGS BEGINNING BELOW THE "C" IN "ARCHITECTURE" AND PROGRESSING CLOCKWISE AROUND THE WORDS, ENDING ABOVE THE "N" IN "TRANSFORMING".

FOR ARCHITECTURAL AND ENGINEERING SERVICES; ARCHITECTURAL CONSULTATION; ARCHITECTURAL DESIGN; CONSULTING SERVICES IN THE FIELD OF ARCHITECTURAL DESIGN (U.S. CLS. 100 AND 101).

FIRST USE 10-1-2009; IN COMMERCE 10-1-2009.

LEIGH CAROLINE CASE, EXAMINING ATTORNEY

CLASS 42—(Continued).

SN 77-887,323. DIGITAL DENTAL STRATEGIES, INC., AKA DDS.COM, BEVERLY HILLS, CA. FILED 12-7-2009.

We Know SEO

THE MARK CONSISTS OF STANDARD CHARACTERS WITHOUT CLAIM TO ANY PARTICULAR FONT, STYLE, SIZE, OR COLOR.

NO CLAIM IS MADE TO THE EXCLUSIVE RIGHT TO USE "SEO", APART FROM THE MARK AS SHOWN.

FOR COMPUTER SERVICES, NAMELY, SEARCH ENGINE OPTIMIZATION (U.S. CLS. 100 AND 101).

FIRST USE 12-7-2009; IN COMMERCE 12-7-2009.

AMY KERTGATE, EXAMINING ATTORNEY

SN 77-887,339. AFFINITY AUTOMATION, LLC, CORNELIUS, NC. FILED 12-7-2009.

Utilitrend

THE MARK CONSISTS OF THE TERM "UTILITREND" IN STYLIZED FONT.

FOR APPLICATION SERVICE PROVIDER (ASP) FEATURING SOFTWARE FOR USE IN DATABASE MANAGEMENT, CHARTING AND REPORTING FOR ENERGY TRACKING (U.S. CLS. 100 AND 101).

FIRST USE 5-3-2007; IN COMMERCE 1-28-2008.

HELENE LIWINSKI, EXAMINING ATTORNEY

SN 77-887,438. EMOXIE DATA SOLUTIONS, INC., FALLSTON, MD. FILED 12-7-2009.

EMOXIE

THE MARK CONSISTS OF STANDARD CHARACTERS WITHOUT CLAIM TO ANY PARTICULAR FONT, STYLE, SIZE, OR COLOR.

FOR BUILDING AND MAINTAINING WEBSITES; CHARITABLE SERVICES, NAMELY, PROVIDING A WEBSITE THAT ENABLES CHILDREN OF A SCHOOL DISTRICT TO COMMUNICATE WITH A CHARITY OF THEIR CHOICE; COMPUTER SERVICES, NAMELY, CONTINUAL MONITORING AND UPDATING OF A CUSTOMER'S ENGLISH WEBSITE FOR CHANGES AND EDITING AND MAKING THESE CHANGES TO THE CUSTOMER'S MULTILINGUAL WEBSITE(S) WITHOUT INVOLVEMENT FROM THE CUSTOMER'S INTERNAL IT RESOURCES; DESIGN OF HOMEPAGES AND WEBSITES; DESIGN, CREATION, HOSTING, MAINTENANCE OF WEBSITES FOR OTHERS; DESIGNING WEBSITES FOR ADVERTISING PURPOSES; HOSTING AN ONLINE COMMUNITY WEBSITE FEATURING SHARED COMMUNICATIONS BETWEEN COMMUNITY MEMBERS INTERESTED IN PERSONAL AND SMALL BUSINESS COMPUTER INFORMATION SECURITY; HOSTING AN ONLINE WEBSITE FEATURING ADVERTISING; HOSTING THE SOFTWARE, WEBSITES AND OTHER COMPUTER APPLICATIONS OF OTHERS ON A VIRTUAL PRIVATE SERVER; MAINTENANCE OF WEBSITES AND HOSTING ON-LINE WEB FACILITIES FOR OTHERS; PROVIDING A SECURED-ACCESS WEBSITE THAT GIVES REGISTERED INTERNET NETWORKED INSTITUTIONS THE ABILITY TO UPLOAD, VIEW, COPY, PRINT, DOWNLOAD AND SHARE DOCUMENTS AND IMAGES FOR THE PURPOSES OF CONDUCTING CONSUMER-DRIVEN TRANSACTIONS; PROVIDING A WEBSITE ALLOWING USERS TO UPLOAD AND DOWNLOAD MUSIC; PROVIDING A WEBSITE FEATURING A MEDIA AGGREGATOR AND SEARCH ENGINE FOR INTERNET CONTENT; PROVIDING A WEBSITE FEATURING A SEARCHABLE ON-LINE QUALITY EVALUATION OF RARITIES FOR THE PURPOSE OF MEASURING THE SCARCITY OF RARE COLLECTIBLE OBJECTS; PROVIDING A WEBSITE FEATURING ENVIRONMENTAL INFORMATION ABOUT CLIMATE CHANGE AND BIO-DIVERSITY; PROVIDING A WEBSITE FEATURING INFORMATION ABOUT GREEN ARCHITECTURE, INTERIOR DESIGN, SUSTAINABLE COMMUNITY PLANNING AND INFRASTRUCTURE DEVELOPMENT; PROVIDING A WEBSITE FEATURING INFORMATION ABOUT INVESTIGATIONAL MEDICAL DEVICES, DIAGNOSTIC AND DRUGS; PROVIDING A WEBSITE FEATURING INFORMATION IN THE FIELD OF INTERIOR DESIGN AND ARCHITECTURE FOR USE BY INTERIOR DESIGNERS AND ARCHITECTS; PROVIDING A WEBSITE FEATURING NON-DOWNLOADABLE VIDEOS FEATURING SCIENTIFIC INFORMATION IN THE FIELD OF CLIMATE CHANGE; PROVIDING A WEBSITE FEATURING ON-LINE NON-DOWNLOADABLE SOFTWARE THAT ENABLES USERS TO CREATE AUDIO DRAMA SERIES AND EPISODES, WRITE SCRIPTS, AUDITION AND ASSIGN TALENT, RECORD AND MIX AUDIO, PUBLISH PRODUCED AUDIO DRAMAS, TRACK AND ANALYZE AUDIO DRAMA STATISTICS, ADVERTISE AND MARKET AUDIO DRAMAS, AND STREAM AND/OR DOWNLOAD AUDIO DRAMAS; PROVIDING A WEBSITE FEATURING ON-LINE NON-DOWNLOADABLE SOFTWARE TOOLS FOR IMAGE EDITING; PROVIDING A WEBSITE THAT ENABLES USERS TO SUBSCRIBE TO COACHING, MENTORING, AND/OR EDUCATIONAL SERVICES AND TO ENABLE USERS TO AUTHOR AND PUBLISH INSTRUCTIONAL CONTENT FOR OTHERS; PROVIDING A WEBSITE THAT FEATURES TECHNOLOGY THAT ENABLES THE SECURE EXCHANGE OF INFORMATION BY USERS; PROVIDING A WEBSITE THAT GIVES COMPUTER USERS THE ABILITY TO SUBSCRIBE TO ONLINE PUBLICATIONS PERMITTING SEARCHES OF BUILDING CODES AND STANDARDS; PROVIDING A WEBSITE THAT GIVES USERS THE ABILITY TO CREATE CUSTOMIZED WEB PAGES FEATURING USER-DEFINED INFORMATION; PROVIDING A WEBSITE THAT GIVES USERS THE ABILITY TO CREATE CUSTOMIZED WEB PAGES FEATURING USER-DEFINED PROFILES; PROVIDING A WEBSITE THAT GIVES USERS THE ABILITY TO PURCHASE DOWNLOADABLE MUSIC; PROVIDING A WEBSITE THAT GIVES USERS THE ABILITY TO VOTE FOR THEIR FAVORITE MUSICAL ARTISTS; PROVIDING AN ONLINE WEBSITE FOR CREATING AND HOSTING MICRO WEBSITES FOR BUSINESSES; PROVIDING COMPUTER PROGRAMMING SERVICES TO CUSTOMERS THAT ENABLES THE CUSTOMER'S WEBSITE TO PROCESS NATURAL LANGUAGE QUERIES; PROVIDING PERIODIC UPDATES TO SUBSCRIBERS OF WEB FEEDS PULLED FROM WEBSITES SELECTED BY THE SUBSCRIBER BY MEANS OF ELECTRONIC MAIL; UPDATING WEBSITES FOR OTHERS; WEBSITE DESIGN AND DEVELOPMENT FOR OTHERS; WEBSITE DEVELOPMENT FOR OTHERS; WEBSITE USABILITY TESTING SERVICES (U.S. CLS. 100 AND 101).

CLASS 42—(Continued).

FIRST USE 2-1-2003; IN COMMERCE 2-1-2003.

TAMARA FRAZIER, EXAMINING ATTORNEY

CLASS 42—(Continued).

SN 77-887,539. FIRST DATA CORPORATION, GREENWOOD VILLAGE, CO. FILED 12-7-2009.

TRANSARMOR

THE MARK CONSISTS OF STANDARD CHARACTERS WITHOUT CLAIM TO ANY PARTICULAR FONT, STYLE, SIZE, OR COLOR.

FOR SECURE PAYMENT TRANSACTION SERVICES, NAMELY, PROVIDING ENCRYPTION, DECRYPTION AND TOKENIZATION SERVICES OF PAYMENT CARD DATA (U.S. CLS. 100 AND 101).

BRIAN NEVILLE, EXAMINING ATTORNEY

SN 77-887,556. AMERICAN HORIZON SOFTWARE LLC, PLAINVIEW, NY. FILED 12-7-2009.

INDIQUEST

THE MARK CONSISTS OF STANDARD CHARACTERS WITHOUT CLAIM TO ANY PARTICULAR FONT, STYLE, SIZE, OR COLOR.

FOR PROVIDING ON-LINE NON-DOWNLOADABLE SOFTWARE FOR INSURANCE POLICY AND INSURANCE CLAIMS MANAGEMENT (U.S. CLS. 100 AND 101).

TIMOTHY FINNEGAN, EXAMINING ATTORNEY

SN 77-887,647. BAKER HUGHES INCORPORATED, HOUSTON, TX. FILED 12-7-2009.

RDS

THE MARK CONSISTS OF STANDARD CHARACTERS WITHOUT CLAIM TO ANY PARTICULAR FONT, STYLE, SIZE, OR COLOR.

FOR CONSULTING SERVICES FOR OTHERS IN THE FIELD OF DESIGN, PLANNING, AND IMPLEMENTATION PROJECT MANAGEMENT OF WELLS, GEOMECHANICS, GEOPHYSICS, RESERVOIR PERFORMANCE, AND PRODUCTION CHEMISTRY AND TECHNOLOGY; PERFORMING OIL WELL DIAGNOSTICS; TECHNOLOGY CONSULTATION AND RESEARCH IN THE FIELD OF WELLS, GEOMECHANICS, GEOPHYSICS, RESERVOIR PERFORMANCE, AND PRODUCTION CHEMISTRY AND TECHNOLOGY (U.S. CLS. 100 AND 101).

FIRST USE 9-15-2009; IN COMMERCE 10-0-2009.

HEATHER THOMPSON, EXAMINING ATTORNEY

CLASS 42—(Continued).

SN 77-887,651. SCHUELLER, STEFAN, DBA TECHDROID, CARLISLE, MA. FILED 12-7-2009.

Techdroid

THE MARK CONSISTS OF STANDARD CHARACTERS WITHOUT CLAIM TO ANY PARTICULAR FONT, STYLE, SIZE, OR COLOR.

FOR IT CONSULTING SERVICES (U.S. CLS. 100 AND 101).

FIRST USE 1-1-1998; IN COMMERCE 1-1-1998.

ELLEN B. AWRICH, EXAMINING ATTORNEY

SN 77-887,670. BAKER HUGHES INCORPORATED, HOUSTON, TX. FILED 12-7-2009.

BAKER RDS

THE MARK CONSISTS OF STANDARD CHARACTERS WITHOUT CLAIM TO ANY PARTICULAR FONT, STYLE, SIZE, OR COLOR.

OWNER OF U.S. REG. NOS. 596,717, 3,034,180 AND OTHERS.

FOR CONSULTING SERVICES FOR OTHERS IN THE FIELD OF DESIGN, PLANNING, AND IMPLEMENTATION PROJECT MANAGEMENT OF WELLS, GEOMECHANICS, GEOPHYSICS, RESERVOIR PERFORMANCE, AND PRODUCTION CHEMISTRY AND TECHNOLOGY; PERFORMING OIL WELL DIAGNOSTICS; TECHNOLOGY CONSULTATION AND RESEARCH IN THE FIELD OF WELLS, GEOMECHANICS, GEOPHYSICS, RESERVOIR PERFORMANCE, AND PRODUCTION CHEMISTRY AND TECHNOLOGY (U.S. CLS. 100 AND 101).

FIRST USE 9-15-2009; IN COMMERCE 10-0-2009.

HEATHER THOMPSON, EXAMINING ATTORNEY

CLASS 42—(Continued).

SN 77-887,717. SHEET DYNAMICS LTD, CINCINNATI, OH. FILED 12-7-2009.

ETEGENT

THE MARK CONSISTS OF STANDARD CHARACTERS WITHOUT CLAIM TO ANY PARTICULAR FONT, STYLE, SIZE, OR COLOR.

FOR ENGINEERING RESEARCH AND DEVELOPMENT, ENGINEERING PROFESSIONAL SERVICES AND SOFTWARE DEVELOPMENT IN THE AREAS OF SIGNAL PROCESSING, IMAGE PROCESSING, PARALLEL PROCESSING IMPLEMENTATION OF COMPUTER ALGORITHMS, NON-DESTRUCTIVE INSPECTION DATA MANAGEMENT, AUTOMATIC TARGET RECOGNITION, FIBER OPTIC SENSING SYSTEMS, HEALTH MONITORING OF AIRCRAFT ENGINES AND OTHER MACHINERY, DEVELOPMENT OF PRESSURE, VIBRATION, TEMPERATURE AND STRAIN SENSORS (U.S. CLS. 100 AND 101).

KELLY BOULTON, EXAMINING ATTORNEY

SN 77-887,800. BAKER HUGHES INCORPORATED, HOUSTON, TX. FILED 12-7-2009.



OWNER OF U.S. REG. NOS. 596,717, 3,034,180 AND OTHERS.

NO CLAIM IS MADE TO THE EXCLUSIVE RIGHT TO USE "COMPANY", APART FROM THE MARK AS SHOWN.

THE COLOR(S) AQUA AND GOLD IS/ARE CLAIMED AS A FEATURE OF THE MARK.

THE MARK CONSISTS OF THE AQUA LETTERS "RDS" OVER THE WORDING "A BAKER HUGHES COMPANY" OVER A GOLD HORIZONTAL LINE HAVING A DOWNWARD FACING POINT UNDER THE WORD "BAKER".

FOR CONSULTING SERVICES FOR OTHERS IN THE FIELD OF DESIGN, PLANNING, AND IMPLEMENTATION PROJECT MANAGEMENT OF WELLS, GEOMECHANICS, GEOPHYSICS, RESERVOIR PERFORMANCE, AND PRODUCTION CHEMISTRY AND TECHNOLOGY; PERFORMING OIL WELL DIAGNOSTICS; TECHNOLOGY CONSULTATION AND RESEARCH IN THE FIELD OF WELLS, GEOMECHANICS, GEOPHYSICS, RESERVOIR PERFORMANCE, AND PRODUCTION CHEMISTRY AND TECHNOLOGY (U.S. CLS. 100 AND 101).

FIRST USE 9-15-2009; IN COMMERCE 10-0-2009.

HEATHER THOMPSON, EXAMINING ATTORNEY

CLASS 42—(Continued).

SN 77-887,903. MICROBIZWIZ LLC, HANCOCK, NY. FILED 12-7-2009.

MicroBizWiz

THE MARK CONSISTS OF STANDARD CHARACTERS WITHOUT CLAIM TO ANY PARTICULAR FONT, STYLE, SIZE, OR COLOR.

FOR APPLICATION SERVICE PROVIDER, NAMELY, PROVIDING, HOSTING, MANAGING, DEVELOPING, RESEARCHING, TRACKING, ANALYZING, REPORTING, AND MAINTAINING APPLICATIONS, SOFTWARE, WEB SITES, AND DATABASES OF OTHERS IN THE FIELDS OF ADVERTISING AND MARKETING (U.S. CLS. 100 AND 101).

FIRST USE 12-1-2009; IN COMMERCE 12-1-2009.

KEVIN CORWIN, EXAMINING ATTORNEY

SN 77-887,999. CREE, INC., DURHAM, NC. FILED 12-7-2009.

EasyWhite

THE MARK CONSISTS OF STANDARD CHARACTERS WITHOUT CLAIM TO ANY PARTICULAR FONT, STYLE, SIZE, OR COLOR.

FOR DESIGN OF CUSTOM LIGHT EMITTING DIODES (LEDS) FOR OTHERS (U.S. CLS. 100 AND 101).

SUSAN RICHARDS, EXAMINING ATTORNEY

CLASS 42—(Continued).

SN 77-888,384. TOKARA SOLUTIONS, INC., COLLEYVILLE, TX. FILED 12-8-2009.

TOKARA

THE MARK CONSISTS OF STANDARD CHARACTERS WITHOUT CLAIM TO ANY PARTICULAR FONT, STYLE, SIZE, OR COLOR.

FOR COMPUTER SOFTWARE CONSULTANCY; COMPUTER SOFTWARE CONSULTATION; COMPUTER SOFTWARE CONSULTING; COMPUTER SOFTWARE DESIGN AND UPDATING; COMPUTER SOFTWARE DESIGN FOR OTHERS; COMPUTER SOFTWARE DEVELOPMENT AND COMPUTER PROGRAMMING DEVELOPMENT FOR OTHERS; CONSULTANCY IN THE FIELD OF SOFTWARE DESIGN; CONSULTING IN THE FIELD OF INFORMATION TECHNOLOGY; CONSULTING IN THE FIELD OF IT PROJECT MANAGEMENT; CONSULTING SERVICES IN THE FIELD OF DESIGN, SELECTION, IMPLEMENTATION AND USE OF COMPUTER HARDWARE AND SOFTWARE SYSTEMS FOR OTHERS; CUSTOMIZATION OF COMPUTER HARDWARE AND SOFTWARE; DESIGN, DEVELOPMENT, INSTALLATION AND MAINTENANCE OF COMPUTER SOFTWARE; IT CONSULTING SERVICES; PROGRAMMING OF COMPUTER SOFTWARE FOR OTHERS (U.S. CLS. 100 AND 101).

NICHOLAS COLEMAN, EXAMINING ATTORNEY

CLASS 42—(Continued).

SN 77-888,459. HEALTHFUSION, INC., SOLANA BEACH, CA. FILED 12-8-2009.

MEDITOUCH EHR

THE MARK CONSISTS OF STANDARD CHARACTERS WITHOUT CLAIM TO ANY PARTICULAR FONT, STYLE, SIZE, OR COLOR.

NO CLAIM IS MADE TO THE EXCLUSIVE RIGHT TO USE "EHR", APART FROM THE MARK AS SHOWN.

FOR PROVIDING TEMPORARY USE OF ONLINE NON DOWNLOADABLE SOFTWARE FOR USE TO AID IN THE DETERMINATION OF PATIENT ELIGIBILITY FOR MEDICAL BENEFITS AND IN THE COORDINATION OF PATIENT REFERRALS AND PROVIDER CLAIMS, AND TO PROVIDE INFORMATION RELATING TO PROVIDERS, LABORATORY AND PHARMACY DATA, ELECTRONIC HEALTH RECORDS, MEDICAL AND OPTICAL SUPPLIES AND INVENTORY, AND MEDICAL QUALITY MAINTENANCE, AND FOR USE IN A PHYSICIAN PRACTICE MANAGEMENT SYSTEM, SPECIFICALLY, FOR USE IN ONLINE DATABASE MANAGEMENT OF HEALTHCARE PRACTICES THROUGH USE OF SOFTWARE FOR USE IN PATIENT BILLING, INSURANCE BILLING, ELECTRONIC CLAIMS PROCESSING, ACCOUNTS RECEIVABLE TRAILING, PATIENT SCHEDULING, CREATING AND MAINTAINING PATIENT DEMOGRAPHICS AND MEDICAL HISTORY RECORDS, CREATING AND MAINTAINING PATIENT INSURANCE RECORDS, BUT NOT FOR WRITING PHARMACEUTICAL PRESCRIPTIONS (U.S. CLS. 100 AND 101).

FIRST USE 12-8-2009; IN COMMERCE 2-12-2010.
ASMAT KHAN, EXAMINING ATTORNEY

SN 77-888,425. SPARTAN INNOVATIONS, LLC, DBA DR7 INNOVATIONS, LLC, GOSHEN, KY. FILED 12-8-2009.

dr7 innovations

THE MARK CONSISTS OF STANDARD CHARACTERS WITHOUT CLAIM TO ANY PARTICULAR FONT, STYLE, SIZE, OR COLOR.

FOR DESIGN AND DEVELOPMENT OF MEDICAL DEVICES (U.S. CLS. 100 AND 101).

JENNIFER HETU, EXAMINING ATTORNEY

SN 77-888,564. DYNAVOX SYSTEMS LLC, PITTSBURGH, PA. FILED 12-8-2009.

AdaptedLearning.com

THE MARK CONSISTS OF STANDARD CHARACTERS WITHOUT CLAIM TO ANY PARTICULAR FONT, STYLE, SIZE, OR COLOR.

FOR HOSTING AN ONLINE WEBSITE FEATURING THE SHARING OF EDUCATIONAL MATERIALS AND INFORMATION FOR TEACHERS (U.S. CLS. 100 AND 101).

FIRST USE 10-31-2008; IN COMMERCE 10-31-2008.
ELIZABETH KAJUBI, EXAMINING ATTORNEY

CLASS 42—(Continued).

SN 77-888,624. MYFILLIN, LLC, EVANS, GA. FILED 12-8-2009.



THE COLOR(S) BLUE, WHITE IS/ARE CLAIMED AS A FEATURE OF THE MARK.

THE MARK CONSISTS OF THE PHRASE "MYFILLIN" BLUE IN COLOR, WITH A STYLIZED "I" WHITE IN COLOR CONTAINED WITHIN A TALKING BUBBLE SHAPED DESIGN, FOLLOWED BY AN "N", BLUE IN COLOR.

FOR SOFTWARE AS A SERVICE (SAAS) SERVICES FEATURING SOFTWARE IN THE FIELD OF EMPLOYMENT AGENCY SERVICES, NAMELY, THAT ONLINE CONNECTS EMPLOYERS WITH POTENTIAL EMPLOYEES TO FILL THE TEMPORARY STAFFING NEEDS OF BUSINESSES (U.S. CLS. 100 AND 101).

KARANENDRA S. CHHINA, EXAMINING ATTORNEY

SN 77-888,668. SILVER STONE INVESTMENTS, LLC, ROYAL PALM BEACH, FL. FILED 12-8-2009.

MYPETSONALITY.COM

THE MARK CONSISTS OF STANDARD CHARACTERS WITHOUT CLAIM TO ANY PARTICULAR FONT, STYLE, SIZE, OR COLOR.

FOR PROVIDING TEMPORARY USE OF NON-DOWNLOADABLE SOFTWARE APPLICATIONS FOR CLASSIFIEDS, VIRTUAL COMMUNITY, SOCIAL NETWORKING, TEXT, PHOTO AND VIDEO SHARING, ALL FOR PET ENTHUSIASTS (U.S. CLS. 100 AND 101).

ROBIN MITTLER, EXAMINING ATTORNEY

CLASS 42—(Continued).

SN 77-889,043. ISIS HOLDINGS, LLC, RICHMOND, VA. FILED 12-8-2009.



PRAETORIAN
G · U · A · R · D

THE MARK CONSISTS OF A ROMAN HELMET IN A CIRCLE SURROUNDED BY A WREATH OF OLIVE LEAVES. BENEATH THE LOGO IS "PRAETORIAN G.U.A.R.D.", WITH EACH LETTER IN "G.U.A.R.D" SEPARATED BY DOTS.

FOR SOFTWARE AS A SERVICE (SAAS) SERVICES, NAMELY, HOSTING SOFTWARE FOR USE BY OTHERS FOR USE IN NETWORK MONITORING, NETWORK ADMINISTRATION, NETWORK SECURITY, NETWORK MANAGEMENT, HARDWARE AND SOFTWARE MONITORING, USER AUDITING AND MONITORING, DISASTER RECOVERY, NETWORK REPORTING, AND SERVER ADMINISTRATION (U.S. CLS. 100 AND 101).

FIRST USE 4-1-2009; IN COMMERCE 11-11-2009.
ANTHONY RINKER, EXAMINING ATTORNEY

SN 77-889,123. REINALDO ALVARENGA BERGAMASCHI EPP, TARRYTOWN, NY. FILED 12-8-2009.

ODYSCI

THE MARK CONSISTS OF STANDARD CHARACTERS WITHOUT CLAIM TO ANY PARTICULAR FONT, STYLE, SIZE, OR COLOR.

FOR COMPUTER SERVICE, NAMELY, ACTING AS AN APPLICATION SERVICE PROVIDER IN THE FIELD OF KNOWLEDGE MANAGEMENT TO HOST COMPUTER APPLICATION SOFTWARE FOR SEARCHING AND RETRIEVING INFORMATION FROM DATABASES AND COMPUTER NETWORKS (U.S. CLS. 100 AND 101).

CYNTHIA SLOAN, EXAMINING ATTORNEY

SN 77-889,209. ATLARGE, INC., SARASOTA, FL. FILED 12-9-2009.

ATLARGE

THE MARK CONSISTS OF STANDARD CHARACTERS WITHOUT CLAIM TO ANY PARTICULAR FONT, STYLE, SIZE, OR COLOR.

FOR CONSULTATION SERVICES IN THE FIELD OF SEARCH ENGINE OPTIMIZATION; CREATING, DESIGNING AND MAINTAINING WEB SITES; MAINTENANCE OF WEBSITES AND HOSTING ON-LINE WEB FACILITIES FOR OTHERS (U.S. CLS. 100 AND 101).

FIRST USE 6-0-2001; IN COMMERCE 6-0-2004.
TRACY CROSS, EXAMINING ATTORNEY

CLASS 42—(Continued).

SN 77-889,325. MERGEONE, WEST CHESTER, PA. FILED 12-9-2009.

MergeOne

THE MARK CONSISTS OF STANDARD CHARACTERS WITHOUT CLAIM TO ANY PARTICULAR FONT, STYLE, SIZE, OR COLOR.

FOR APPLICATION SERVICE PROVIDER (ASP) FEATURING SOFTWARE FOR USE FINANCIAL SERVICES; APPLICATION SERVICE PROVIDER (ASP), NAMELY, HOSTING COMPUTER SOFTWARE APPLICATIONS OF OTHERS; APPLICATION SERVICE PROVIDER FEATURING APPLICATION PROGRAMMING INTERFACE (API) SOFTWARE FOR ALLOWING DATA RETRIEVAL, UPLOAD, ACCESS AND MANAGEMENT; APPLICATION SERVICE PROVIDER FEATURING APPLICATION PROGRAMMING INTERFACE (API) SOFTWARE FOR USE IN BUILDING SOFTWARE APPLICATIONS; APPLICATION SERVICE PROVIDER FEATURING SOFTWARE FOR PROVIDING AN ON-LINE DATABASE IN THE FIELD OF TRANSACTION PROCESSING TO UPLOAD TRANSACTIONAL DATA, PROVIDE STATISTICAL ANALYSIS, AND PRODUCE NOTIFICATIONS AND REPORTS; COMPUTER PROGRAMMING AND SOFTWARE DESIGN; COMPUTER SERVICE, NAMELY, ACTING AS AN APPLICATION SERVICE PROVIDER IN THE FIELD OF INFORMATION MANAGEMENT TO HOST COMPUTER APPLICATION SOFTWARE FOR THE PURPOSE OF FINANCIAL DATA; COMPUTER SERVICE, NAMELY, ACTING AS AN APPLICATION SERVICE PROVIDER IN THE FIELD OF KNOWLEDGE MANAGEMENT TO HOST COMPUTER APPLICATION SOFTWARE FOR CREATING SEARCHABLE DATABASES OF INFORMATION AND DATA; COMPUTER SERVICE, NAMELY, ACTING AS AN APPLICATION SERVICE PROVIDER IN THE FIELD OF KNOWLEDGE MANAGEMENT TO HOST COMPUTER APPLICATION SOFTWARE FOR SEARCHING AND RETRIEVING INFORMATION FROM DATABASES AND COMPUTER NETWORKS; COMPUTER SERVICE, NAMELY, ACTING AS AN APPLICATION SERVICE PROVIDER IN THE FIELD OF KNOWLEDGE MANAGEMENT TO HOST COMPUTER APPLICATION SOFTWARE FOR THE COLLECTION, EDITING, ORGANIZING, MODIFYING, BOOK MARKING, TRANSMISSION, STORAGE AND SHARING OF DATA AND INFORMATION; COMPUTER SERVICES, NAMELY, PROVIDING A WEB-BASED SYSTEM AND ONLINE PORTAL FEATURING ON-LINE NON-DOWNLOADABLE SOFTWARE THAT ENABLES USERS TO ACCESS TRAINING, EDUCATION, TESTING AND CERTIFICATION MATERIALS IN THE FIELD OF FINANCIAL SERVICES; COMPUTER SOFTWARE CONSULTING; COMPUTER SOFTWARE DESIGN; COMPUTER SOFTWARE DESIGN AND UPDATING; COMPUTER SOFTWARE DEVELOPMENT IN THE FIELD OF MOBILE APPLICATIONS; COMPUTER SOFTWARE RENTAL; CONSULTANCY IN THE FIELD OF SOFTWARE DESIGN; CONSULTING SERVICES IN THE FIELD OF PROVIDING ONLINE, NON-DOWNLOADABLE SOFTWARE AND APPLICATIONS; DESIGN AND DEVELOPMENT OF COMPUTER SOFTWARE; DESIGN AND DEVELOPMENT OF ON-LINE COMPUTER SOFTWARE SYSTEMS; DESIGN AND IMPLEMENTATION OF SOFTWARE AND TECHNOLOGY SOLUTIONS FOR THE PURPOSE OF PRODUCT AND DOCUMENT AUTHENTICATION AND TRACKING, AND BRAND MONITORING AND PROTECTION, TO PROTECT AGAINST COUNTERFEITING, TAMPERING, AND DIVERSION, AND TO ENSURE THE INTEGRITY OF GENUINE PRODUCTS AND DOCUMENTS; DESIGN, DEVELOPMENT AND IMPLEMENTATION OF SOFTWARE; DE-

CLASS 42—(Continued).

SIGN, DEVELOPMENT, INSTALLATION AND MAINTENANCE OF COMPUTER SOFTWARE; DEVELOPING AND UPDATING COMPUTER SOFTWARE; DEVELOPING COMPUTER SOFTWARE; DEVELOPMENT, UPDATING AND MAINTENANCE OF SOFTWARE AND DATA BASES; INSTALLATION AND MAINTENANCE OF INTERNET ACCESS SOFTWARE; PROVIDING ON-LINE NON-DOWNLOADABLE SOFTWARE FOR ORGANIZING FINANCIAL DATA; RENTAL OF COMPUTER SOFTWARE AND PROGRAMS; UPDATING AND DESIGN OF COMPUTER SOFTWARE (U.S. CLS. 100 AND 101).

REBECCA POVARCHUK, EXAMINING ATTORNEY

SN 77-889,355. SUNFLOWER IN THE CITY DESIGN LLC, FLORHAM PARK, NJ. FILED 12-9-2009.

Sunflower In The City Design

THE MARK CONSISTS OF STANDARD CHARACTERS WITHOUT CLAIM TO ANY PARTICULAR FONT, STYLE, SIZE, OR COLOR.

NO CLAIM IS MADE TO THE EXCLUSIVE RIGHT TO USE "DESIGN", APART FROM THE MARK AS SHOWN.

FOR GRAPHIC DESIGN SERVICES; CREATION AND MAINTENANCE OF WEBSITES FOR OTHERS (U.S. CLS. 100 AND 101).

FIRST USE 8-24-2009; IN COMMERCE 8-24-2009.
BARBARA A. GOLD, EXAMINING ATTORNEY

SN 77-889,510. WUNDERLICH SECURITIES, INC., MEMPHIS, TN. FILED 12-9-2009.

WUNTRADE

THE MARK CONSISTS OF STANDARD CHARACTERS WITHOUT CLAIM TO ANY PARTICULAR FONT, STYLE, SIZE, OR COLOR.

FOR PROVIDING TEMPORARY USE OF NON-DOWNLOADABLE COMPUTER SOFTWARE, NAMELY, AN ELECTRONIC TRADING PLATFORM IN THE FIELD OF BOND AND FIXED INCOME TRADING (U.S. CLS. 100 AND 101).

FRED MANDIR, EXAMINING ATTORNEY

CLASS 42—(Continued).

SN 77-889,556. INFORMATION CONSULTING GROUP, LLC, CHICAGO, IL. FILED 12-9-2009.

CLASS 42—(Continued).

SN 77-890,229. GLORI OIL LIMITED, HOUSTON, TX. FILED 12-10-2009.

4060

THE MARK CONSISTS OF STANDARD CHARACTERS WITHOUT CLAIM TO ANY PARTICULAR FONT, STYLE, SIZE, OR COLOR.
FOR IT CONSULTING SERVICES (U.S. CLS. 100 AND 101).
JILL PRATER, EXAMINING ATTORNEY

SN 77-889,573. 344 DESIGN, LLC, PASADENA, CA. FILED 12-9-2009.

344 LOVES YOU

THE MARK CONSISTS OF STANDARD CHARACTERS WITHOUT CLAIM TO ANY PARTICULAR FONT, STYLE, SIZE, OR COLOR.
FOR GRAPHIC DESIGN SERVICES; GRAPHIC ILLUSTRATION SERVICES FOR OTHERS (U.S. CLS. 100 AND 101).
FIRST USE 4-0-2003; IN COMMERCE 4-0-2003.
ANTHONY RINKER, EXAMINING ATTORNEY

SN 77-890,054. SPERIDIAN TECHNOLOGIES, LLC, ALBUQUERQUE, NM. FILED 12-9-2009.

Speridian

THE MARK CONSISTS OF STANDARD CHARACTERS WITHOUT CLAIM TO ANY PARTICULAR FONT, STYLE, SIZE, OR COLOR.
FOR COMPUTER SERVICES, NAMELY, REMOTE AND ON-SITE MANAGEMENT OF THE INFORMATION TECHNOLOGY (IT) SYSTEMS OF OTHERS; IT CONSULTING SERVICES; IT INTEGRATION SERVICES (U.S. CLS. 100 AND 101).
FIRST USE 12-1-2006; IN COMMERCE 12-1-2006.
EVELYN BRADLEY, EXAMINING ATTORNEY

BEOR

THE MARK CONSISTS OF STANDARD CHARACTERS WITHOUT CLAIM TO ANY PARTICULAR FONT, STYLE, SIZE, OR COLOR.
FOR DEVELOPMENT OF NEW BIOTECHNOLOGY TECHNOLOGY FOR OTHERS USED TO ENHANCE PRODUCTION FROM OIL WELLS. ENGINEERING SERVICES IN THE FIELD OF IMPROVING RECOVERY OF OIL FROM OIL RESERVOIRS MOLECULAR BIOLOGICAL RESEARCH IN THE FIELD OF IMPROVING RECOVERY OF OIL FROM OIL RESERVOIRS (U.S. CLS. 100 AND 101).
FIRST USE 12-15-2007; IN COMMERCE 3-5-2008.
FRED MANDIR, EXAMINING ATTORNEY

SN 77-890,409. HALL, VICTORIA L., DBA HALL ENTERPRISES, NAPA, CA. FILED 12-10-2009.

Helping Your Team Work

THE MARK CONSISTS OF STANDARD CHARACTERS WITHOUT CLAIM TO ANY PARTICULAR FONT, STYLE, SIZE, OR COLOR.
FOR COMPUTER SOFTWARE CONSULTING; PRODUCT DEVELOPMENT CONSULTATION (U.S. CLS. 100 AND 101).
FIRST USE 5-1-2009; IN COMMERCE 5-1-2009.
STEPHEN AQUILA, EXAMINING ATTORNEY

SN 77-890,566. KORE WIRELESS GROUP INC., ALPHARETTA, GA. FILED 12-10-2009.

KORE PRISMPRO

THE MARK CONSISTS OF STANDARD CHARACTERS WITHOUT CLAIM TO ANY PARTICULAR FONT, STYLE, SIZE, OR COLOR.
OWNER OF U.S. REG. NO. 3,486,469.
FOR COMPUTER SERVICES, NAMELY, PROVIDING A WEB-BASED SYSTEM AND ONLINE PORTAL FOR CUSTOMERS TO REMOTELY MANAGE, ADMINISTER, MODIFY, AND CONTROL END-USER DEVICES, DATA, AND SOFTWARE APPLICATIONS ON COMMERCIAL WIRELESS COMMUNICATIONS NETWORKS (U.S. CLS. 100 AND 101).
JOHN SCHUYLER YARD, EXAMINING ATTORNEY

CLASS 42—(Continued).

SN 77-890,576. KORE WIRELESS GROUP INC., ALPHARETTA, GA. FILED 12-10-2009.

PRISM^{Pro}

THE MARK CONSISTS OF "PRISMPRO" IN STYLIZED FORM.

FOR COMPUTER SERVICES, NAMELY, PROVIDING A WEB-BASED SYSTEM AND ONLINE PORTAL FOR CUSTOMERS TO REMOTELY MANAGE, ADMINISTER, MODIFY, AND CONTROL END-USER DEVICES, DATA, AND SOFTWARE APPLICATIONS ON COMMERCIAL WIRELESS COMMUNICATIONS NETWORKS (U.S. CLS. 100 AND 101).

JOHN SCHÜYLER YARD, EXAMINING ATTORNEY

SN 77-890,744. BIO-VED PHARMACEUTICALS, INC., SAN JOSE, CA. FILED 12-10-2009.

N/Rx

THE MARK CONSISTS OF STANDARD CHARACTERS WITHOUT CLAIM TO ANY PARTICULAR FONT, STYLE, SIZE, OR COLOR.

FOR PHARMACEUTICAL RESEARCH AND DEVELOPMENT (U.S. CLS. 100 AND 101).

LAURA HAMMEL, EXAMINING ATTORNEY

SN 77-891,052. XTRAC LLC, BOSTON, MA. FILED 12-10-2009.

XTRAC

THE MARK CONSISTS OF STANDARD CHARACTERS WITHOUT CLAIM TO ANY PARTICULAR FONT, STYLE, SIZE, OR COLOR.

FOR PROVIDING TEMPORARY USE OF NON-DOWNLOADABLE COMPUTER PROGRAMS FOR USE IN MODELLING, IMPLEMENTING, AUTOMATING, OPTIMIZING, AND MONITORING BUSINESS PROCESSES (U.S. CLS. 100 AND 101).

FIRST USE 7-1-1995; IN COMMERCE 7-1-1995.

TINA L. SNAPP, EXAMINING ATTORNEY

CLASS 42—(Continued).

SN 77-891,053. MURPHY, SCOTT, HUNTINGTON BEACH, CA. FILED 12-10-2009.

PEOPLEPEDIA

THE MARK CONSISTS OF STANDARD CHARACTERS WITHOUT CLAIM TO ANY PARTICULAR FONT, STYLE, SIZE, OR COLOR.

FOR COMPUTER SERVICES, NAMELY, CREATING AN ON-LINE COMMUNITY FOR REGISTERED USERS TO PARTICIPATE IN DISCUSSIONS, GET FEEDBACK FROM THEIR PEERS, FORM VIRTUAL COMMUNITIES, AND ENGAGE IN SOCIAL NETWORKING FEATURING PEOPLE SEARCHES, FAMILY TREES, AND GENEALOGY; COMPUTER SERVICES, NAMELY, HOSTING AN INTERACTIVE WEB SITE THAT ALLOWS FAMILIES TO RECORD AND DISPLAY FAMILY PROFILES, RELATIONSHIPS, INTERESTS, AUDIO AND VIDEO CONTENT; GENEALOGY RESEARCH (U.S. CLS. 100 AND 101).

TINA L. SNAPP, EXAMINING ATTORNEY

SN 77-891,522. STUDIO NORTH, INC., NORTH CHICAGO, IL. FILED 12-11-2009.

9ALIGN

THE MARK CONSISTS OF STANDARD CHARACTERS WITHOUT CLAIM TO ANY PARTICULAR FONT, STYLE, SIZE, OR COLOR.

FOR SOFTWARE AS A SERVICE (SAAS) SERVICE, NAMELY, SOFTWARE FOR USE BY OTHERS TO DEVELOP A PLATFORM OF MARKETING, ADVERTISING, BRANDING, PUBLIC ADDRESS, PUBLIC RELATIONS, AND CRISIS MANAGEMENT MESSAGES (U.S. CLS. 100 AND 101).

ALLISON HOLTZ, EXAMINING ATTORNEY

CLASS 42—(Continued).

SN 77-891,537. MYCA HEALTH, INC., QUEBEC, CANADA,
FILED 12-11-2009.

MYCA

THE MARK CONSISTS OF STANDARD CHARACTERS WITHOUT CLAIM TO ANY PARTICULAR FONT, STYLE, SIZE, OR COLOR.

FOR APPLICATION SERVICE PROVIDER (ASP) FEATURING SOFTWARE FOR USE IN ALLOWING HEALTHCARE PROFESSIONALS TO COMMUNICATE DIRECTLY WITH PATIENTS IN REAL TIME VIA THE INTERNET AND MOBILE VIDEO CONFERENCING, SCHEDULE AND MANAGE MEDICAL APPOINTMENTS, STORE, RETRIEVE, AND SEND HEALTH AND MEDICAL INFORMATION, AND SHARE HEALTH AND MEDICAL KNOWLEDGE AND INFORMATION (U.S. CLS. 100 AND 101).

FIRST USE 9-30-2007; IN COMMERCE 9-30-2007.
ANGELA DUONG, EXAMINING ATTORNEY

SN 77-891,543. NTM ENGINEERING, INC., DILLSBURG, PA.
FILED 12-11-2009.

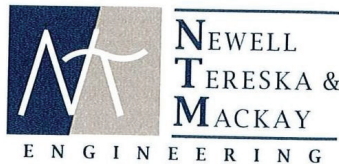

NO CLAIM IS MADE TO THE EXCLUSIVE RIGHT TO USE "ENGINEERING", APART FROM THE MARK AS SHOWN.

THE COLOR(S) DARK BLUE, GRAY AND WHITE IS/ARE CLAIMED AS A FEATURE OF THE MARK.

THE MARK CONSISTS OF A SQUARE THAT IS SPLIT DIAGONALLY FROM THE TOP RIGHT OF CENTER TO THE BOTTOM LEFT OF CENTER; THE LEFT PORTION OF THE SQUARE IS DARK BLUE AND THE RIGHT PORTION OF THE SQUARE IS GRAY; IN THE DARK BLUE PORTION OF THE SQUARE IS A "N" IN WHITE, THAT IS SLANTED TO THE RIGHT; IN THE GRAY PORTION OF THE SQUARE IS A "T" IN WHITE, THAT IS SLANTED TO THE LEFT AND HAS A WAVY TOP; THE TOP OF THE "T" CROSSES THE RIGHT SIDE OF THE "N" AND CREATES AN "M"; NEXT TO THE TOP OF THE SQUARE IS A SOLID DARK BLUE

CLASS 42—(Continued).

LINE; BELOW THE SOLID DARK BLUE LINE IS THE WORD "NEWELL" IN DARK BLUE CAPITAL LETTERS WITH A BOLDED "N"; BELOW THAT ARE THE WORDS "TERESKA &" IN DARK BLUE CAPITAL LETTERS WITH A BOLDED "T"; BELOW THAT IS THE WORD "MACKAY" IN DARK BLUE CAPITAL LETTERS WITH A BOLDED "M"; BELOW THAT IS ANOTHER SOLID DARK BLUE LINE; BELOW THE SQUARE AND THE BOTTOM SOLID DARK BLUE LINE IS THE WORD "ENGINEERING" IN DARK BLUE CAPITAL LETTERS.

FOR CIVIL ENGINEERING; CIVIL ENGINEERING FOR THE DESIGN OF BRIDGES, BRIDGE INSPECTION, STORMWATER, EROSION AND SEDIMENTATION, AND COURSE DEVELOPMENT AND TRAINING; CIVIL ENGINEERING RELATING TO WATER IRRIGATION; ENGINEERING AND HYDROLOGICAL DESIGN OF RESTORATION OF STREAM CHANNELS, MARSHES, ESTUARIES, AND WETLANDS; HYDRAULIC ENGINEERING AND DESIGN; HYDROLOGIC AND ENGINEERING MODELING AND DESIGN OF MEASURES TO PROTECT AREAS LIKELY TO BE INUNDATED BY STORM-WATER AND FLOOD-WATERS (U.S. CLS. 100 AND 101).

FIRST USE 12-11-2006; IN COMMERCE 12-11-2006.
ANGELA DUONG, EXAMINING ATTORNEY

SN 77-891,544. MYCA HEALTH, INC., QUEBEC, CANADA,
FILED 12-11-2009.



THE MARK CONSISTS OF THE WORD "MYCA" AND A CURVING DESIGN ABOVE THE LETTERS "C" AND "A".

FOR APPLICATION SERVICE PROVIDER (ASP) FEATURING SOFTWARE FOR USE IN ALLOWING HEALTHCARE PROFESSIONALS TO COMMUNICATE DIRECTLY WITH PATIENTS IN REAL TIME VIA THE INTERNET AND MOBILE VIDEO CONFERENCING, SCHEDULE AND MANAGE MEDICAL APPOINTMENTS, STORE, RETRIEVE, AND SEND HEALTH AND MEDICAL INFORMATION, AND SHARE HEALTH AND MEDICAL KNOWLEDGE AND INFORMATION (U.S. CLS. 100 AND 101).

FIRST USE 9-30-2007; IN COMMERCE 9-30-2007.
ANGELA DUONG, EXAMINING ATTORNEY

SN 77-891,551. GRESHAM, SMITH AND PARTNERS, NASHVILLE, TN. FILED 12-11-2009.

GS&P

THE MARK CONSISTS OF STANDARD CHARACTERS WITHOUT CLAIM TO ANY PARTICULAR FONT, STYLE, SIZE, OR COLOR.

FOR ARCHITECTURE, ENGINEERING, INTERIOR DESIGN, LAND SURVEYING AND LANDSCAPE ARCHITECTURE SERVICES (U.S. CLS. 100 AND 101).

FIRST USE 12-11-1997; IN COMMERCE 12-11-1997.
GEORGE LORENZO, EXAMINING ATTORNEY

CLASS 42—(Continued).

SN 77-892,022. HEALTH INFORMATION TECHNOLOGY CARE, LLC, PETALUMA, CA. FILED 12-11-2009.

HITCare

THE MARK CONSISTS OF STANDARD CHARACTERS WITHOUT CLAIM TO ANY PARTICULAR FONT, STYLE, SIZE, OR COLOR.

FOR IT CONSULTING SERVICES (U.S. CLS. 100 AND 101).

FIRST USE 3-1-2008; IN COMMERCE 4-17-2008.
NICHOLAS ALTREE, EXAMINING ATTORNEY

SN 77-892,080. PACIFIC PARTNERS MANAGEMENT SERVICES, INC., FOSTER CITY, CA. FILED 12-12-2009.

HEALTH ACCESS SOLUTIONS

THE MARK CONSISTS OF STANDARD CHARACTERS WITHOUT CLAIM TO ANY PARTICULAR FONT, STYLE, SIZE, OR COLOR.

NO CLAIM IS MADE TO THE EXCLUSIVE RIGHT TO USE "HEALTH", APART FROM THE MARK AS SHOWN. SEC. 2(F).

FOR SOFTWARE AS A SERVICE (SAAS) SERVICES, NAMELY, HOSTING SOFTWARE FOR USE BY OTHERS FOR USE BY MEDICAL PRACTITIONERS, HEALTHCARE PROVIDERS, MANAGED HEALTHCARE ORGANIZATIONS, AND HEALTH PLAN PROVIDERS THAT ALLOWS USER TO COMMUNICATE BY MEANS OF SECURE MESSAGING, EXCHANGE RELEVANT CLINICAL INFORMATION, COORDINATE CARE OF PATIENTS, SUPPORT CLINICAL DECISIONS BASED ON PROVEN BEST PRACTICES, VIEW CLINICAL BUSINESS ANALYTICS THAT ALLOW DEVELOPMENT OF OUTCOMES METRICS AND REPORTS, AUTOMATE AUTHORIZATIONS FOR REFERRALS AND PROCEDURES TO MEET PRE-DEFINED CARE STANDARDS, SEND REMINDERS TO BOTH CARE PROFESSIONALS AND PATIENTS FOR ROUTINE CHECK-UPS, MANAGE THE WELLNESS OF THE SUBSCRIBER POPULATION THEREBY REDUCING EMERGENCY PROCEDURES AND MEDICAL COSTS (U.S. CLS. 100 AND 101).

FIRST USE 4-30-2004; IN COMMERCE 11-4-2004.
JILL PRATER, EXAMINING ATTORNEY

CLASS 42—(Continued).

SN 77-892,115. EVOLUTE GMBH, 2380 PERCHTOLDSORF, AUSTRIA, FILED 12-12-2009.

Evolute

THE MARK CONSISTS OF STANDARD CHARACTERS WITHOUT CLAIM TO ANY PARTICULAR FONT, STYLE, SIZE, OR COLOR.

OWNER OF ERPN CMNTY TM OFC REG. NO. 006896971, DATED 10-21-2008, EXPIRES 5-8-2018.

FOR SCIENTIFIC AND TECHNOLOGICAL SERVICES AND RESEARCH IN THE FIELD OF GEOMETRY FOR ARCHITECTURAL AND MANUFACTURING APPLICATIONS; TECHNICAL ANALYSIS AND CONSULTING SERVICES IN THE FIELD OF GEOMETRY FOR ARCHITECTURAL AND MANUFACTURING APPLICATIONS; DESIGN AND DEVELOPMENT OF COMPUTER SOFTWARE (U.S. CLS. 100 AND 101).

HELENE LIWINSKI, EXAMINING ATTORNEY

SN 77-892,737. IDEANODE, INC., DENVER, CO. FILED 12-14-2009.

GIGBOT

THE MARK CONSISTS OF STANDARD CHARACTERS WITHOUT CLAIM TO ANY PARTICULAR FONT, STYLE, SIZE, OR COLOR.

FOR COMPUTER SERVICES, NAMELY, HOSTING ON-LINE WEB FACILITIES FOR OTHERS TO SHOWCASE LIVE MUSICAL PERFORMANCES AND ARTISTS, FOR CONDUCTING ONLINE SEARCHES FOR LIVE MUSICAL PERFORMANCES, FOR FACILITATING INTERACTIVE DISCUSSIONS ABOUT LIVE MUSICAL PERFORMANCES AND ARTISTS, AND FOR FACILITATING CONNECTIONS AMONG FANS OF LIVE MUSICAL PERFORMANCES AND ARTISTS (U.S. CLS. 100 AND 101).

FIRST USE 8-11-2007; IN COMMERCE 8-11-2007.
LYDIA BELZER, EXAMINING ATTORNEY

SN 77-893,346. POWERPACT HOLDINGS LLC, MIDLOTHIAN, VA. FILED 12-14-2009.

VOOT

THE MARK CONSISTS OF STANDARD CHARACTERS WITHOUT CLAIM TO ANY PARTICULAR FONT, STYLE, SIZE, OR COLOR.

FOR COMPUTER SERVICES, NAMELY, PROVIDING INTERNET SEARCH ENGINES (U.S. CLS. 100 AND 101).
MARGERY A. TIERNEY, EXAMINING ATTORNEY

CLASS 42—(Continued).

SN 77-893,844. EXPORT WOOD PACKING INSPECTION LLC, SALIDA, CO. FILED 12-15-2009.



FOR INSPECTION, QUANTITY AND QUALITY CONTROL, SUPERVISION AND VERIFICATION OF THE QUALITY AND QUANTITY OF RAW MATERIALS, COMMODITIES, MANUFACTURED, SEMI-MANUFACTURED AND TRANSFORMED GOODS OR GOODS OF ANY OTHER NATURE AND THEIR CONFORMITY WITH NATIONAL AND INTERNATIONAL NORMS, LAWS, RULES, PRACTICE AND STANDARDS AND WITH CLIENTS' CONTRACTUAL REQUIREMENTS (U.S. CLS. 100 AND 101).

FIRST USE 2-25-2010; IN COMMERCE 2-25-2010.
STEPHEN AQUILA, EXAMINING ATTORNEY

CLASS 42—(Continued).

SN 77-899,489. UMBRA DATA, INC., SAN JOSE, CA. FILED 12-22-2009.

Dark Side Intelligence

THE MARK CONSISTS OF STANDARD CHARACTERS WITHOUT CLAIM TO ANY PARTICULAR FONT, STYLE, SIZE, OR COLOR.

FOR COMPUTER SECURITY CONSULTANCY (U.S. CLS. 100 AND 101).
GISELLE AGOSTO, EXAMINING ATTORNEY

SN 77-899,521. MITEM CORPORATION, MENLO PARK, CA. FILED 12-22-2009.

SN 77-894,467. MEDNET SOLUTIONS, MINNETONKA, MN. FILED 12-16-2009.

EMPOWER
a MedNet Solution

OWNER OF U.S. REG. NO. 3,711,695.
THE COLOR(S) BLUE AND RED IS/ARE CLAIMED AS A FEATURE OF THE MARK.

THE MARK CONSISTS OF A RED CHEVRON, "EMPOWER" IN AN ITALICIZED BLUE FONT, AND "A MEDNET SOLUTION" IN A NON-ITALICIZED RED FONT.

FOR PROVIDING TEMPORARY USE OF ON-LINE NON-DOWNLOADABLE SOFTWARE FOR MANAGING INVESTIGATOR INITIATED TRIALS (IITS), FOR USE IN THE MEDICAL DEVICE, PHARMACEUTICAL AND BIOTECHNOLOGY INDUSTRIES (U.S. CLS. 100 AND 101).

FIRST USE 12-1-2009; IN COMMERCE 12-1-2009.
JENNIFER HETU, EXAMINING ATTORNEY

BLUE IRIS ELABORATE

THE MARK CONSISTS OF STANDARD CHARACTERS WITHOUT CLAIM TO ANY PARTICULAR FONT, STYLE, SIZE, OR COLOR.

FOR PROVIDING TEMPORARY USE OF ONLINE NON-DOWNLOADABLE COMPUTER SOFTWARE IN THE FIELDS OF MEDICAL AND HEALTHCARE RECORDS CREATION AND PROCESSING, NAMELY, PROVIDING RECORD GENERATING CAPACITY, AND PROVIDING INTERCONNECTIVITY AND INTEGRATION OF ELECTRONIC MEDICAL RECORDS, CLINICAL LABORATORY RECORDS, RADIOLOGICAL RECORDS, EPIDEMIOLOGICAL RECORDS, PHARMACOLOGICAL RECORDS, HOSPITALS' RECORDS, PHYSICIANS' RECORDS, PHARMACIES' RECORDS, HEALTHCARE PROVIDERS' RECORDS, INSURANCE PROVIDERS' RECORDS, AND BILLING AND PAYMENT RECORDS OF HEALTHCARE PROVIDERS (U.S. CLS. 100 AND 101).

MICHAEL ENGEL, EXAMINING ATTORNEY

CLASS 42—(Continued).

SN 77-901,461. HEALTHFUSION, INC., SOLANA BEACH, CA. FILED 12-28-2009.

STIMULUS READY

THE MARK CONSISTS OF STANDARD CHARACTERS WITHOUT CLAIM TO ANY PARTICULAR FONT, STYLE, SIZE, OR COLOR.

FOR PROVIDING TEMPORARY USE OF ONLINE NON DOWNLOADABLE SOFTWARE FOR USE TO AID IN THE DETERMINATION OF PATIENT ELIGIBILITY FOR MEDICAL BENEFITS AND IN THE COORDINATION OF PATIENT REFERRALS AND PROVIDER CLAIMS, AND TO PROVIDE INFORMATION RELATING TO PROVIDERS, LABORATORY AND PHARMACY DATA, ELECTRONIC HEALTH RECORDS, MEDICAL AND OPTICAL SUPPLIES AND INVENTORY, AND MEDICAL QUALITY MAINTENANCE, AND FOR USE IN A PHYSICIAN PRACTICE MANAGEMENT SYSTEM, SPECIFICALLY, FOR USE IN ONLINE DATABASE MANAGEMENT OF HEALTHCARE PRACTICES THROUGH USE OF SOFTWARE FOR USE IN PATIENT BILLING, INSURANCE BILLING, ELECTRONIC CLAIMS PROCESSING, ACCOUNTS RECEIVABLE TRAILING, PATIENT SCHEDULING, CREATING AND MAINTAINING PATIENT DEMOGRAPHICS AND MEDICAL HISTORY RECORDS, CREATING AND MAINTAINING PATIENT INSURANCE RECORDS, BUT NOT FOR WRITING PHARMACEUTICAL PRESCRIPTIONS (U.S. CLS. 100 AND 101).

ASMAT KHAN, EXAMINING ATTORNEY

CLASS 42—(Continued).

SN 77-901,474. PACIFIC PARTNERS MANAGEMENT SERVICES, INC., FOSTER CITY, CA. FILED 12-28-2009.

Health Access SOLUTIONS



NO CLAIM IS MADE TO THE EXCLUSIVE RIGHT TO USE "HEALTH", APART FROM THE MARK AS SHOWN.

THE MARK CONSISTS OF THE WORDING "HEALTH ACCESS" APPEARING IN STYLIZED FONT, BELOW THE "HEALTH ACCESS" WORDING APPEARS THE WORDING "SOLUTIONS", THE WORDING "SOLUTIONS" APPEARS IN STYLIZED FONT AND ALL CAPITAL LETTERS, BELOW THE "SOLUTIONS" WORDING APPEARS TWO BOLD LINES CROSSING.

SEC. 2(F).

FOR SOFTWARE AS A SERVICE (SAAS) SERVICES, NAMELY, HOSTING SOFTWARE FOR USE BY OTHERS FOR USE BY MEDICAL PRACTITIONERS, HEALTHCARE PROVIDERS, MANAGED HEALTHCARE ORGANIZATIONS, AND HEALTH PLAN PROVIDERS THAT ALLOWS USER TO COMMUNICATE BY MEANS OF SECURE MESSAGING, EXCHANGE RELEVANT CLINICAL INFORMATION, COORDINATE CARE OF PATIENTS, SUPPORT CLINICAL DECISIONS BASED ON PROVEN BEST PRACTICES, VIEW CLINICAL BUSINESS ANALYTICS THAT ALLOW DEVELOPMENT OF OUTCOMES METRICS AND REPORTS, AUTOMATE AUTHORIZATIONS FOR REFERRALS AND PROCEDURES TO MEET PRE-DEFINED CARE STANDARDS, SEND REMINDERS TO BOTH CARE PROFESSIONALS AND PATIENTS FOR ROUTINE CHECK-UPS, MANAGE THE WELLNESS OF THE SUBSCRIBER POPULATION THEREBY REDUCING EMERGENCY PROCEDURES AND MEDICAL COSTS (U.S. CLS. 100 AND 101).

FIRST USE 4-30-2004; IN COMMERCE 11-4-2004.

JILL PRATER, EXAMINING ATTORNEY

SN 77-902,270. HEALTHFUSION, INC., SOLANA BEACH, CA. FILED 12-29-2009.

THE EHR THAT THINKS LIKE A DOCTOR

THE MARK CONSISTS OF STANDARD CHARACTERS WITHOUT CLAIM TO ANY PARTICULAR FONT, STYLE, SIZE, OR COLOR.

FOR PROVIDING TEMPORARY USE OF ONLINE NON DOWNLOADABLE SOFTWARE FOR USE TO AID IN THE DETERMINATION OF PATIENT ELIGIBILITY FOR MEDICAL BENEFITS AND IN THE COORDINATION OF PATIENT REFERRALS AND PROVIDER CLAIMS, AND TO PROVIDE INFORMATION RELATING TO PROVIDERS, LABORATORY AND PHARMACY DATA, ELECTRONIC HEALTH RECORDS, MEDICAL AND OPTICAL SUPPLIES AND INVENTORY, AND MEDICAL QUALITY MAINTENANCE, AND FOR USE IN A PHYSICIAN PRACTICE MANAGEMENT SYSTEM, SPECIFICALLY, FOR USE IN ONLINE DATABASE MANAGEMENT OF HEALTHCARE PRACTICES THROUGH USE OF SOFTWARE FOR USE IN PATIENT BILLING, INSURANCE BILLING, ELECTRONIC CLAIMS PROCESSING, ACCOUNTS RECEIVABLE TRAILING, PATIENT SCHEDULING, CREATING AND MAINTAINING PATIENT DEMOGRAPHICS AND MEDICAL HISTORY RECORDS, CREATING AND MAINTAINING PATIENT INSURANCE RECORDS (U.S. CLS. 100 AND 101).

ASMAT KHAN, EXAMINING ATTORNEY

CLASS 42—(Continued).

SN 77-902,438. PACIFIC PARTNERS MANAGEMENT SERVICES, INC., FOSTER CITY, CA. FILED 12-29-2009.

CLASS 43—HOTEL AND RESTAURANT SERVICES

SN 76-700,090. BRYAN, JOSEPH L., BROOKLYN, NY. FILED 10-28-2009.

**HEALTH ACCESS SOLUTIONS
THE CLINICAL GROUPWARE
COMPANY**

THE MARK CONSISTS OF STANDARD CHARACTERS WITHOUT CLAIM TO ANY PARTICULAR FONT, STYLE, SIZE, OR COLOR.

NO CLAIM IS MADE TO THE EXCLUSIVE RIGHT TO USE "HEALTH" AND "CLINICAL GROUPWARE COMPANY", APART FROM THE MARK AS SHOWN.

FOR SOFTWARE AS A SERVICE (SAAS) SERVICES, NAMELY, HOSTING SOFTWARE FOR USE BY OTHERS FOR USE BY MEDICAL PRACTITIONERS, HEALTHCARE PROVIDERS, MANAGED HEALTHCARE ORGANIZATIONS, AND HEALTH PLAN PROVIDERS THAT ALLOWS USER TO COMMUNICATE BY MEANS OF SECURE MESSAGING, EXCHANGE RELEVANT CLINICAL INFORMATION, COORDINATE CARE OF PATIENTS, SUPPORT CLINICAL DECISIONS BASED ON PROVEN BEST PRACTICES, VIEW CLINICAL BUSINESS ANALYTICS THAT ALLOW DEVELOPMENT OF OUTCOMES METRICS AND REPORTS, AUTOMATE AUTHORIZATIONS FOR REFERRALS AND PROCEDURES TO MEET PRE-DEFINED CARE STANDARDS, SEND REMINDERS TO BOTH CARE PROFESSIONALS AND PATIENTS FOR ROUTINE CHECK-UPS, MANAGE THE WELLNESS OF THE SUBSCRIBER POPULATION THEREBY REDUCING EMERGENCY PROCEDURES AND MEDICAL COSTS (U.S. CLS. 100 AND 101).

FIRST USE 11-30-2009; IN COMMERCE 12-28-2009.
JILL PRATER, EXAMINING ATTORNEY



**CARIBBEAN SPICE
JAMAICAN/AMERICAN CUISINE**

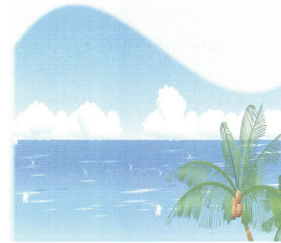

SN 77-924,376. FIRST BOSTON FINANCIAL, LLC, KENTFIELD, CA. FILED 1-31-2010.

servicetattler.com

THE MARK CONSISTS OF STANDARD CHARACTERS WITHOUT CLAIM TO ANY PARTICULAR FONT, STYLE, SIZE, OR COLOR.

FOR PROVIDING AN ONLINE NETWORK SERVICE THAT ENABLES USERS TO SHARE DATA IN THE FIELD OF RESTAURANTS AND OTHER RETAIL ESTABLISHMENTS (U.S. CLS. 100 AND 101).

SCOTT BIBB, EXAMINING ATTORNEY

NO CLAIM IS MADE TO THE EXCLUSIVE RIGHT TO USE "CARIBBEAN SPICE JAMAICAN/AMERICAN CUISINE", APART FROM THE MARK AS SHOWN.

THE COLOR(S) BLACK, WHITE, BLUE, PINK, PEACH, BROWN, GRAY, GREEN AND ORANGE IS/ARE CLAIMED AS A FEATURE OF THE MARK.

THE MARK CONSISTS OF THE BLACK WORDING "CARIBBEAN SPICE JAMAICAN/AMERICAN CUISINE" COMBINED WITH A BEACH SCENE AND A DESIGN OF A BAKER NEXT TO A TABLE. THE COLOR WHITE APPEARS IN THE BAKER'S HAT, TEETH, AND APRON AND IN THE TABLECLOTH. THE COLOR BROWN APPEARS IN THE BAKER'S HAIR, IN FOOD ON THE TABLE, AND IN FOOD BEING FLIPPED BY THE BAKER. THE COLOR PINK APPEARS IN THE BAKER'S FACE AND ARMS. THE COLOR PEACH APPEARS IN THE BAKER'S SHIRT. THE COLOR GRAY APPEARS IN THE BAKER'S PANTS, THE FRYING PAN IN THE BAKER'S HAND, AND IN THE DISH ON THE TABLE. THE COLOR BLACK APPEARS AS OUTLINING FOR THE BAKER, TABLE AND OTHER ITEMS IN THIS DESIGN. THE BEACH SCENE CONSISTS OF BLUE MOUNTAINS, BLUE AND WHITE CLOUDS, BLUE WATER WITH WHITE WAVES AND WHITE HIGHLIGHTING, WHITE PEOPLE, AND A PALM TREE WITH A DARK AND LIGHT BROWN TRUNK, ORANGE COCONUTS, AND GREEN FRONDS. THE MARK APPEARS ON A WHITE BACKGROUND.

FOR RESTAURANT (U.S. CLS. 100 AND 101),
KIM MONINGHOFF, EXAMINING ATTORNEY

CLASS 43—(Continued).

SN 77-590,766. GOLDEN GAMING, INC., LAS VEGAS, NV. FILED 10-10-2008.



OWNER OF U.S. REG. NOS. 2,973,734, 3,218,537 AND OTHERS.

NO CLAIM IS MADE TO THE EXCLUSIVE RIGHT TO USE "LAS VEGAS HENDERSON RENO N. LAS VEGAS" AND "TAVERN", APART FROM THE MARK AS SHOWN.

THE COLOR(S) GOLD, BLACK AND RED IS/ARE CLAIMED AS A FEATURE OF THE MARK.

THE MARK CONSISTS OF FOUR GOLD ANGLES REPRESENTING MOUNTAINS SUPERIMPOSED OVER THE GOLD AND BLACK STYLIZED WORDS "SIERRA GOLD A NEVADA STYLE TAVERN" WITH A NARROW BLACK BORDER AROUND IT, WITH A RED PAINTED STYLIZED LINE, OVER THE RED STYLIZED WORDS "LAS VEGAS", "HENDERSON", "RENO" SEPARATED BY A RED DOT OVER THE RED STYLIZED WORDS "N. LAS VEGAS".

SEC. 2(F) AS TO "A NEVADA STYLE TAVERN". FOR COCKTAIL LOUNGES; PROVIDING BANQUET AND SOCIAL FUNCTION FACILITIES FOR SPECIAL OCCASIONS; PROVISION OF CONFERENCE FACILITIES; RESTAURANT AND BAR SERVICES (U.S. CLS. 100 AND 101).

FIRST USE 9-15-2004; IN COMMERCE 9-15-2004. CAROLYN CATALDO, EXAMINING ATTORNEY

SN 77-632,470. TAYLOR, CASSANDRA L., DBA JUST FOR KIDS, LLC, CHICAGO, IL. FILED 12-12-2008.



NO CLAIM IS MADE TO THE EXCLUSIVE RIGHT TO USE "JUST FOR KIDS, LLC", APART FROM THE MARK AS SHOWN.

THE COLOR(S) RED, ORANGE, YELLOW, GREEN, BLUE, BROWN, BEIGE, TAN, WHITE, BLACK, PINK, PURPLE IS/ARE CLAIMED AS A FEATURE OF THE MARK.

THE MARK CONSISTS OF FOUR CHILDREN UNDER A COMBINED THINKING CLOUD WITH THE COMPANY NAME, JUST FOR KIDS, LLC, WRITTEN WITH BUBBLE LETTERING IN THE CLOUD. THE CLOUD IS WHITE. IN "JUST FOR KIDS, LLC," THE "J" IS RED, BLUE "U", YELLOW "S", PURPLE "T", ORANGE "F", GREEN "O", RED "R", BLUE "K", YELLOW "I", PURPLE "D", ORANGE

CLASS 43—(Continued).

"S", RED "L", BLUE "L", YELLOW "C", AND GREEN EXCLAMATION POINT. THE FOUR CHILDREN STARTING FROM THE LEFT: ASIAN MALE WITH BEIGE SKIN, BLACK EYES, AND BLACK HAIR; AFRICAN AMERICAN FEMALE WITH TAN SKIN, GREEN EYES, AND BROWN HAIR WITH PINK HAIR BANDS; CAUCASIAN FEMALE WITH LIGHT BROWN HAIR, BLUE EYES, AND BEIGE SKIN WITH FRECKLES, AFRICAN AMERICAN MALE WITH BROWN SKIN, DARK BROWN HAIR, BROWN EYES, AND PINK TONGUE.

FOR CHILD CARE CENTERS; CHILD CARE SERVICES (U.S. CLS. 100 AND 101).

FIRST USE 1-1-2003; IN COMMERCE 1-1-2003. FLORENTINA BLANDU, EXAMINING ATTORNEY

SN 77-647,289. PODZILNI, DOUG, SHOREWOOD, WI. FILED 1-12-2009.

SMOOTHIE NATION

THE MARK CONSISTS OF STANDARD CHARACTERS WITHOUT CLAIM TO ANY PARTICULAR FONT, STYLE, SIZE, OR COLOR.

NO CLAIM IS MADE TO THE EXCLUSIVE RIGHT TO USE "SMOOTHIE", APART FROM THE MARK AS SHOWN.

FOR RESTAURANT, CAFE, SNACK BAR AND JUICE BAR SERVICES (U.S. CLS. 100 AND 101). SARA THOMAS, EXAMINING ATTORNEY

SN 77-700,492. COHEN, BOYD, HUNTINGTON BEACH, CA. FILED 3-26-2009.



NO CLAIM IS MADE TO THE EXCLUSIVE RIGHT TO USE "CREAMERY", APART FROM THE MARK AS SHOWN.

THE MARK CONSISTS OF THE WORDS "AUTO CREAMERY" IN SCRIPT ACROSS A CONCENTRIC OVAL DESIGN AND FOUR STARS ABOVE THE WORDS "SERVING UP LATE MODELS & CLASSICS".

FOR SERVING FOOD AND DRINKS, NAMELY, ICE CREAM, GELATO, AND FROZEN CONFECTIONS (U.S. CLS. 100 AND 101).

TRACY CROSS, EXAMINING ATTORNEY

CLASS 43—(Continued).

SN 77-712,823. ROBSON, DOUGLAS J., PHOENIX, AZ. FILED 4-13-2009.



NO CLAIM IS MADE TO THE EXCLUSIVE RIGHT TO USE "CAFÉ BAR", APART FROM THE MARK AS SHOWN. THE ENGLISH TRANSLATION OF "GALLO BLANCO" IN THE MARK IS WHITE ROOSTER.

FOR BAR AND RESTAURANT SERVICES (U.S. CLS. 100 AND 101).

FIRST USE 4-1-2009; IN COMMERCE 4-1-2009.
SUSAN RICHARDS, EXAMINING ATTORNEY

SN 77-713,876. BTO SELF SERVE YOGURT LLC, TUCSON, AZ. FILED 4-14-2009.

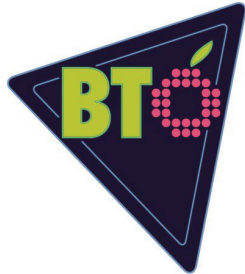

THE COLOR(S) GREEN, BLUE AND PINK IS/ARE CLAIMED AS A FEATURE OF THE MARK.

THE MARK CONSISTS OF THE STYLIZED LETTERS "BTO", INSIDE A TRIANGULAR SHAPED DESIGN; THE LETTERS "BT" ARE IN A LIGHT GREEN COLOR WITH A MEDIUM GREEN OUTLINE. THE LETTER "O" IS FORMED BY 28 PINK DOTS, THE TRIANGULAR SHAPED DESIGN IS DARK BLUE OUTLINED IN LIGHTER BLUE AND THE LIGHTER BLUE LINE IS REPEATED AGAIN SLIGHTLY INSIDE THE TRIANGLE DESIGN, THERE IS AN ADDITIONAL OVAL-LIKE DESIGN ABOVE THE LETTER "O" THAT IS LIGHT GREEN WITH A MEDIUM GREEN OUTLINE.

FOR SELF-SERVICE RESTAURANT SERVICES, NAMELY, SELF SERVE, CAFETERIA STYLE SERVICES FEATURING YOGURT AND TOPPINGS FOR YOGURT (U.S. CLS. 100 AND 101).

TRICIA SONNEBORN, EXAMINING ATTORNEY

CLASS 43—(Continued).

SN 77-719,712. DANIEL JOHNS, MANITOWISH WATERS, WI. FILED 4-22-2009.

Little Bohemia Lodge

THE MARK CONSISTS OF STANDARD CHARACTERS WITHOUT CLAIM TO ANY PARTICULAR FONT, STYLE, SIZE, OR COLOR.

NO CLAIM IS MADE TO THE EXCLUSIVE RIGHT TO USE "LODGE", APART FROM THE MARK AS SHOWN.

FOR BAR AND RESTAURANT SERVICES; CAFE AND RESTAURANT SERVICES; CAFE-RESTAURANTS; CAFETERIA AND RESTAURANT SERVICES; CARRY-OUT RESTAURANTS; CONSULTATION SERVICES IN THE FIELD OF RESTAURANT MENU DEVELOPMENT; DELICATESSENS; FAST FOOD AND NON-STOP RESTAURANT SERVICES; FAST-FOOD RESTAURANTS; HOTEL AND RESTAURANT RESERVATION SERVICES; HOTEL AND RESTAURANT SERVICES; HOTEL, BAR AND RESTAURANT SERVICES; HOTEL, RESTAURANT AND BAR SERVICES; PROVIDING ADVICE TO TOURISTS AND BUSINESS TRAVELERS ON HOTEL AND RESTAURANT DESTINATIONS; PROVISION OF FOOD AND DRINK IN RESTAURANTS; RESTAURANT; RESTAURANT AND BAR SERVICES; RESTAURANT AND CAFE SERVICES; RESTAURANT AND CATERING SERVICES; RESTAURANT AND HOTEL SERVICES; RESTAURANT SERVICES; RESTAURANT SERVICES FEATURING SANDWICHES; RESTAURANT SERVICES, INCLUDING SIT-DOWN SERVICE OF FOOD AND TAKE-OUT RESTAURANT SERVICES; RESTAURANT SERVICES, NAMELY, PROVIDING OF FOOD AND BEVERAGES FOR CONSUMPTION ON AND OFF THE PREMISES; RESTAURANT, BAR AND CATERING SERVICES; RESTAURANTS (U.S. CLS. 100 AND 101).

FIRST USE 1-1-1934; IN COMMERCE 1-1-1934.
AMY ALFIERI, EXAMINING ATTORNEY

SN 77-735,989. ISLAMIC RELIEF WORLDWIDE, BIRMINGHAM, UNITED KINGDOM, FILED 5-13-2009.

ISLAMIC RELIEF WORLDWIDE

THE MARK CONSISTS OF STANDARD CHARACTERS WITHOUT CLAIM TO ANY PARTICULAR FONT, STYLE, SIZE, OR COLOR.

OWNER OF ERPN CMNTY TM OFC REG. NO. 005806062, DATED 4-24-2008, EXPIRES 4-2-2017.

OWNER OF U.S. REG. NOS. 3,302,215, 3,302,270 AND OTHERS.

NO CLAIM IS MADE TO THE EXCLUSIVE RIGHT TO USE "WORLDWIDE", APART FROM THE MARK AS SHOWN.

SEC. 2(F) AS TO "ISLAMIC RELIEF".

FOR CHARITABLE SERVICES, NAMELY, PROVIDING FOOD AND DRINK TO NEEDY PERSONS; EMERGENCY SHELTER SERVICES, NAMELY, PROVIDING TEMPORARY HOUSING TO NEEDY PERSONS; PROVIDING INFORMATION VIA A GLOBAL COMMUNICATIONS NETWORK ON PROVIDING FOOD, TEMPORARY ACCOMMODATIONS, AND TEMPORARY EMERGENCY HOUSING TO NEEDY PERSONS (U.S. CLS. 100 AND 101).

FIRST USE 1-1-2007; IN COMMERCE 1-1-2007.

MELISSA VALLILLO, EXAMINING ATTORNEY

CLASS 43—(Continued).

SN 77-743,382. SCHMID, PETER F., FORT MYERS, FL. FILED 5-22-2009.

PURE

THE MARK CONSISTS OF STANDARD CHARACTERS WITHOUT CLAIM TO ANY PARTICULAR FONT, STYLE, SIZE, OR COLOR.

FOR RESTAURANT AND BAR SERVICES (U.S. CLS. 100 AND 101).

VIVIAN MICZNIK FIRST, EXAMINING ATTORNEY

SN 77-750,166. MIRKO FRANCHISING, LLC, BISHOP, GA. FILED 6-2-2009.



OWNER OF U.S. REG. NO. 3,578,689.

NO CLAIM IS MADE TO THE EXCLUSIVE RIGHT TO USE "PASTA", APART FROM THE MARK AS SHOWN.

THE COLOR(S) RED, YELLOW AND BLACK IS/ARE CLAIMED AS A FEATURE OF THE MARK.

THE MARK CONSISTS OF A GEOMETRIC SHAPE DESIGN OF A LARGE RECTANGLE THAT IS CONSTRUCTED OF A RED UPPER ELONGATED RECTANGLE IN THE UPPER LEFT CORNER, A RED LOWER ELONGATED RECTANGLE IN THE LOWER LEFT CORNER CENTERED VERTICALLY BENEATH THE UPPER RED ELONGATED RECTANGLE, A YELLOW UPPER ELONGATED RECTANGLE ON THE SAME HORIZONTAL PLANE AS THE RED UPPER ELONGATED RECTANGLE AND POSITIONED IN THE UPPER RIGHT HAND CORNER OF THE LARGER RECTANGLE, A YELLOW LOWER ELONGATED RECTANGLE CENTERED VERTICALLY BENEATH AND THE YELLOW UPPER ELONGATED RECTANGLE. THE ELONGATED RECTANGLES INCLUDING A SPACE BETWEEN THE UPPER ELONGATED RECTANGLES AND THE LOWER ELONGATED RECTANGLES WITH THE LETTERS "M I R K O" IN BLACK POSITIONED IN THE SPACE, A YELLOW OVAL IS POSITIONED IN THE CENTER OF THE O, THE WORD "PASTA" APPEARS IN BLACK CENTERED IN THE YELLOW LOWER ELONGATED RECTANGLE.

FOR BAR AND RESTAURANT SERVICES; CAFE AND RESTAURANT SERVICES; CARRY-OUT RESTAURANTS; RESTAURANT; RESTAURANT AND BAR SERVICES; RESTAURANT SERVICES; RESTAURANT SERVICES FEATURING SANDWICHES; RESTAURANT SERVICES FEATURING PASTA, ITALIAN CUISINE, SALAD, SANDWICHES; RESTAURANT SERVICES, INCLUDING SIT-DOWN SERVICE OF FOOD AND TAKE-OUT RESTAURANT SERVICES; RESTAURANT SERVICES, NAMELY, PROVIDING OF FOOD AND BEVERAGES FOR CONSUMPTION ON AND OFF THE PREMISES; RESTAURANTS; TAKE-OUT RESTAURANT SERVICES (U.S. CLS. 100 AND 101).

FIRST USE 9-27-2007; IN COMMERCE 9-27-2007.

TRACY CROSS, EXAMINING ATTORNEY

CLASS 43—(Continued).

SN 77-754,954. GRILLED CHEESE & CO. LLC, WESTMINSTER, MD. FILED 6-9-2009.



NO CLAIM IS MADE TO THE EXCLUSIVE RIGHT TO USE "GRILLED CHEESE & CO.", APART FROM THE MARK AS SHOWN.

THE MARK CONSISTS OF THE WORDS "GRILLED CHEESE & CO" CONTAINED WITHIN THE BORDERS OF TWO CONCENTRIC CIRCLES, THE INNER CIRCLE OF WHICH CONTAINS THE DEPICTION OF TWO CHUNKS OF SWISS CHEESE, ONE LYING ON ITS SIDE AND THE OTHER UPENDED, THE CONCENTRIC CIRCLES ARE JOINED AT THE MIDLINE BY TWO SHORT HORIZONTAL LINES.

FOR CATERING (U.S. CLS. 100 AND 101).
FIRST USE 4-23-2005; IN COMMERCE 4-23-2005.
BENJAMIN OKEKE, EXAMINING ATTORNEY

SN 77-755,972. DORROS HOLDINGS, LLC, WILSON, WY. FILED 6-10-2009.



OWNER OF U.S. REG. NOS. 3,674,058 AND 3,674,059.

NO CLAIM IS MADE TO THE EXCLUSIVE RIGHT TO USE "FOOD COMPANY", APART FROM THE MARK AS SHOWN.

THE MARK CONSISTS OF THE STYLIZED WORDS "E.LEAVEN FOOD COMPANY" WHERE THE "L" IN "LEAVEN" IS DEPICTED AS A STALK OF GRAIN AND THE PERIOD BETWEEN "E" AND "LEAVEN" IS DEPICTED AS A GRAIN.

FOR RESTAURANT AND CATERING SERVICES (U.S. CLS. 100 AND 101).

FIRST USE 5-0-2008; IN COMMERCE 5-0-2008.

SARA THOMAS, EXAMINING ATTORNEY

CLASS 43—(Continued).

SN 77-765,769. CASPER & GAMBINI'S (WORLDWIDE) LTD., ROAD TWON, TORTOLA, BR.VIRGIN ISLANDS, FILED 6-23-2009.



**Casper &
Gambini's**

OWNER OF LEBANON REG. NO. 115155, DATED 2-28-2008, EXPIRES 2-28-2023.

OWNER OF U.S. REG. NO. 2,703,861.
THE MARK CONSISTS OF THE WORDING "CASPER & GAMBINI'S" WRITTEN IN STYLIZED LATIN LETTERS. FOR PROVIDING OF FOOD AND DRINK (U.S. CLS. 100 AND 101).
STEVEN PEREZ, EXAMINING ATTORNEY

SN 77-766,689. ADALBERTOS MEXICAN FOOD, INC., DBA ADALBERTOS MEXICAN FOOD, SAN DIEGO, CA. FILED 6-23-2009.



NO CLAIM IS MADE TO THE EXCLUSIVE RIGHT TO USE "MEXICAN FOOD", APART FROM THE MARK AS SHOWN.

THE MARK CONSISTS OF AN OUTLINE OF THE STATE OF CALIFORNIA WITH TWO STARS DEPICTING THE CITIES OF SAN DIEGO AND SACRAMENTO AND A JALAPENO CHILE POSITIONED OVER THE MIDDLE OF THE CALIFORNIA OUTLINE; THE WORD "ADALBERTO'S" IS WRITTEN NEAR THE TOP OF THE STATE AND THE WORDS "MEXICAN FOOD" ARE WRITTEN BELOW THE STATE.

FOR CARRY-OUT RESTAURANTS; FAST-FOOD RESTAURANTS; RESTAURANTS (U.S. CLS. 100 AND 101).
FIRST USE 5-28-1982; IN COMMERCE 5-28-1982.
LINDA M. KING, EXAMINING ATTORNEY

CLASS 43—(Continued).

SN 77-767,581. CARLSBAD INN, LLC, CARLSBAD, CA. FILED 6-24-2009.

CARLSBAD INN

THE MARK CONSISTS OF STANDARD CHARACTERS WITHOUT CLAIM TO ANY PARTICULAR FONT, STYLE, SIZE, OR COLOR.

NO CLAIM IS MADE TO THE EXCLUSIVE RIGHT TO USE "INN", APART FROM THE MARK AS SHOWN.

SEC. 2(F).
FOR RESORT LODGING SERVICES (U.S. CLS. 100 AND 101).

FIRST USE 3-31-1985; IN COMMERCE 3-31-1985.
BRIAN CALLAGHAN, EXAMINING ATTORNEY

SN 77-767,615. CARLSBAD INN, LLC, CARLSBAD, CA. FILED 6-24-2009.

CARLSBAD INN BEACH RESORT

THE MARK CONSISTS OF STANDARD CHARACTERS WITHOUT CLAIM TO ANY PARTICULAR FONT, STYLE, SIZE, OR COLOR.

NO CLAIM IS MADE TO THE EXCLUSIVE RIGHT TO USE "INN BEACH RESORT", APART FROM THE MARK AS SHOWN.

SEC. 2(F).
FOR RESORT LODGING SERVICES (U.S. CLS. 100 AND 101).

FIRST USE 3-31-1985; IN COMMERCE 3-31-1985.
BRIAN CALLAGHAN, EXAMINING ATTORNEY

SN 77-771,344. BARCELÓ CORPORACIÓN EMPRESARIAL, S.A., (BALEARES), SPAIN, FILED 6-30-2009.

IMAGINE ALL

THE MARK CONSISTS OF STANDARD CHARACTERS WITHOUT CLAIM TO ANY PARTICULAR FONT, STYLE, SIZE, OR COLOR.

PRIORITY CLAIMED UNDER SEC. 44(D) ON ERP N CMNTY TM OFC APPLICATION NO. 8384885, FILED 6-24-2009, REG. NO. 008384885, DATED 12-3-2009, EXPIRES 6-24-2019.

FOR SERVICES FOR THE RESERVATION OF HOTEL ROOMS AND ROOMS; PROVIDING HOTEL ACCOMMODATIONS; RESERVATION OF CAMPGROUND ACCOMMODATIONS; CATERING; PROVISION OF FOOD AND DRINK IN RESTAURANTS (U.S. CLS. 100 AND 101).

BRENDAN REGAN, EXAMINING ATTORNEY

CLASS 43—(Continued).

SN 77-772,506. MAND BEAS INC., CINCINNATI, OH. FILED 7-1-2009.

BABA INDIA

THE MARK CONSISTS OF STANDARD CHARACTERS WITHOUT CLAIM TO ANY PARTICULAR FONT, STYLE, SIZE, OR COLOR.

NO CLAIM IS MADE TO THE EXCLUSIVE RIGHT TO USE "INDIA", APART FROM THE MARK AS SHOWN.

THE ENGLISH TRANSLATION OF "BABA" IN THE MARK IS GRANDFATHER, A SAINT, A LEARNED ONE, AND A SCHOLAR.

FOR RESTAURANT SERVICES (U.S. CLS. 100 AND 101).

FIRST USE 8-13-2003; IN COMMERCE 8-13-2003.

RUDY R. SINGLETON, EXAMINING ATTORNEY

SN 77-772,705. MARY BROWN'S INC., MARKHAM, ONTARIO, CANADA, FILED 7-1-2009.

MARY BROWN'S

THE MARK CONSISTS OF STANDARD CHARACTERS WITHOUT CLAIM TO ANY PARTICULAR FONT, STYLE, SIZE, OR COLOR.

OWNER OF CANADA REG. NO. TMA543085, DATED 3-26-2001, EXPIRES 3-26-2016.

THE NAME(S), PORTRAIT(S), AND/OR SIGNATURE(S) SHOWN IN THE MARK DOES NOT IDENTIFY A PARTICULAR LIVING INDIVIDUAL.

FOR RESTAURANT SERVICES AND TAKE-OUT RESTAURANT SERVICES (U.S. CLS. 100 AND 101).

TINA L. SNAPP, EXAMINING ATTORNEY

SN 77-786,706. ANVIL NY, LLC, NEW YORK, NY. FILED 7-22-2009.

LANDMARC TRIBECA

THE MARK CONSISTS OF STANDARD CHARACTERS WITHOUT CLAIM TO ANY PARTICULAR FONT, STYLE, SIZE, OR COLOR.

NO CLAIM IS MADE TO THE EXCLUSIVE RIGHT TO USE "TRIBECA", APART FROM THE MARK AS SHOWN.

FOR RESTAURANT AND BAR SERVICES (U.S. CLS. 100 AND 101).

VERNA BETH RIRIE, EXAMINING ATTORNEY

CLASS 43—(Continued).

SN 77-793,740. WORLD MARKET CENTER VENTURE, LLC, LAS VEGAS, NV. FILED 7-30-2009.



NO CLAIM IS MADE TO THE EXCLUSIVE RIGHT TO USE "LAS VEGAS", APART FROM THE MARK AS SHOWN.

THE COLOR(S) DARK GREEN, LIGHT GREEN, BLUE, AND WHITE IS/ARE CLAIMED AS A FEATURE OF THE MARK.

THE MARK CONSISTS OF A STYLIZED SPHERE IN DARK GREEN AND LIGHT GREEN, HAVING TWO CURVED WHITE LINES AND A CURVED BLUE LINE IN THE LOWER CENTER OF THE SPHERE. ONE OF THE CURVED WHITE LINES DIVIDES THE SPHERE AND THE OTHER CURVED WHITE LINE RUNS THROUGH BOTH HALVES AND A CURVED BLUE LINE IS IN THE MIDDLE. TO THE RIGHT OF THE DESIGN OF THE SPHERE ARE THE STYLIZED WORDS, "ONE GOOD WORLD LAS VEGAS" IN A STACKED FORMATION WITH UNDERLINES UNDER "ONE", "GOOD", AND "WORLD". THE WORD "ONE" IS IN DARK GREEN AND HAS A LIGHT GREEN LINE UNDERNEATH. THE WORD "GOOD" IS IN LIGHT GREEN AND HAS A LIGHT GREEN LINE UNDERNEATH. THE WORD "WORLD" IS IN BLUE AND HAS A LIGHT GREEN LINE UNDERNEATH. THE WORDS "LAS VEGAS" ARE IN LIGHT GREEN.

FOR PROVIDING SHOWROOM, CONFERENCE, EXHIBITION AND MEETING FACILITIES (U.S. CLS. 100 AND 101).

JAY BESCH, EXAMINING ATTORNEY

SN 77-793,872. WORLD MARKET CENTER VENTURE, LLC, LAS VEGAS, NV. FILED 7-30-2009.

ONE GOOD WORLD LAS VEGAS

THE MARK CONSISTS OF STANDARD CHARACTERS WITHOUT CLAIM TO ANY PARTICULAR FONT, STYLE, SIZE, OR COLOR.

NO CLAIM IS MADE TO THE EXCLUSIVE RIGHT TO USE "LAS VEGAS", APART FROM THE MARK AS SHOWN.

FOR PROVIDING SHOWROOM, CONFERENCE, EXHIBITION AND MEETING FACILITIES (U.S. CLS. 100 AND 101).

JAY BESCH, EXAMINING ATTORNEY

CLASS 43—(Continued).

SN 77-797,480. HYATT CORPORATION, CHICAGO, IL.
FILED 8-5-2009.



HYATT SUMMERFIELD SUITES

OWNER OF U.S. REG. NOS. 827,330, 945,384 AND 982,652.
NO CLAIM IS MADE TO THE EXCLUSIVE RIGHT TO
USE "SUITES", APART FROM THE MARK AS SHOWN.

THE MARK CONSISTS OF FOUR BOXES WITH SWIRL
DESIGN ABOVE THE WORD "HYATT SUMMERFIELD
SUITES".

FOR HOTEL AND RESORT SERVICES; HOTELS;
RESTAURANT, BAR AND COCKTAIL LOUNGE SER-
VICES; PROVIDING CONFERENCE, EXHIBITION AND
MEETING FACILITIES; PROVIDING BANQUET AND
SOCIAL FUNCTION FACILITIES FOR SPECIAL OCCA-
SIONS; CATERING FOR THE PROVISION OF FOOD
AND BEVERAGES (U.S. CLS. 100 AND 101).

FIRST USE 6-0-2006; IN COMMERCE 6-0-2006.
TARAH HARDY, EXAMINING ATTORNEY

CLASS 43—(Continued).

SN 77-800,128. SAC ADULT DAY CARE, INC., DETROIT, MI.
FILED 8-7-2009.



NO CLAIM IS MADE TO THE EXCLUSIVE RIGHT TO
USE "SAC ADULT DAY CARE, INC.", APART FROM THE
MARK AS SHOWN.

THE STIPPLING IS FOR SHADING PURPOSES ONLY.
THE MARK CONSISTS OF A VERY LARGE LETTER "S",
SMALLER LETTERS "AC" NEXT TO EACH OTHER, THE
WORDS "ADULT DAY CARE, INC." CENTERED TO THE
RIGHT OF WITH A HORIZONTAL BAR/LINE UNDER-
NEATH, AND AN ORCHID FACING THE LETTERS "SAC";
THE CENTER OF THE ORCHID FACES THE LETTER "A"
OF "SAC".

FOR PROVIDING ELDER CARE (U.S. CLS. 100 AND
101).

FIRST USE 8-22-2008; IN COMMERCE 9-30-2008.
SUE LAWRENCE, EXAMINING ATTORNEY

SN 77-798,009. SHORELINE RESTAURANT CORPORATION,
MCKINNEY, TX. FILED 8-5-2009.



OWNER OF U.S. REG. NO. 1,968,553.
NO CLAIM IS MADE TO THE EXCLUSIVE RIGHT TO
USE "STEAK HOUSE", APART FROM THE MARK AS
SHOWN.

THE MARK CONSISTS OF THE WORD "CULPEPPER"
ABOVE AN ILLUSTRATION OF A STAR AND THE WORDS
"STEAK" AND "HOUSE".

SEC. 2(F).
FOR RESTAURANT AND CATERING SERVICES (U.S.
CLS. 100 AND 101).

FIRST USE 5-0-1982; IN COMMERCE 5-0-1982.
ALICE BENMAMAN, EXAMINING ATTORNEY

SN 77-818,866. MOOSE, INC., DBA MOOSE RESTAURANT
GROUP, HONOLULU, HI. FILED 9-2-2009.

TACO LICIOUS

THE MARK CONSISTS OF STANDARD CHARACTERS
WITHOUT CLAIM TO ANY PARTICULAR FONT, STYLE,
SIZE, OR COLOR.

NO CLAIM IS MADE TO THE EXCLUSIVE RIGHT TO
USE "TACO", APART FROM THE MARK AS SHOWN.

FOR RESTAURANT AND BAR SERVICES (U.S. CLS.
100 AND 101).

FIRST USE 0-0-1994; IN COMMERCE 0-0-1994.
AMY C. KEAN, EXAMINING ATTORNEY

CLASS 43—(Continued).

SN 77-821,245. YOGO CAFE, INC, RYE, NY. FILED 9-7-2009.



THE COLOR(S) WHITE, GREEN, AND ORANGE IS/ARE CLAIMED AS A FEATURE OF THE MARK.

THE MARK CONSISTS OF "YOGO JOY" IN WHITE AND "YOGO YOUR WAY." IN GREEN. THE "O" IN "JOY" IS REPRESENTED BY A LIGHT AND MEDIUM ORANGE-COLOR ORANGE WITH TWO GREEN LEAVES. THE MARK APPEARS ON A LIGHT GREEN BACKGROUND.

FOR SELF-SERVICE RESTAURANTS FEATURING FROZEN YOGURT WITH VARIOUS FRUIT AND DRY TOPPINGS (U.S. CLS. 100 AND 101).

FIRST USE 8-1-2009; IN COMMERCE 8-1-2009.

KIM MONINGHOFF, EXAMINING ATTORNEY

CLASS 43—(Continued).

SN 77-832,382. PASCUA YAQUI TRIBE, TUCSON, AZ. FILED 9-22-2009.

CASINO DEL SOL

THE MARK CONSISTS OF STANDARD CHARACTERS WITHOUT CLAIM TO ANY PARTICULAR FONT, STYLE, SIZE, OR COLOR.

OWNER OF U.S. REG. NOS. 2,213,038, 2,965,247 AND OTHERS.

THE ENGLISH TRANSLATION OF "DEL SOL" IN THE MARK IS "OF THE SUN".

FOR HOTEL SERVICES (U.S. CLS. 100 AND 101).

KATHLEEN M. VANSTON, EXAMINING ATTORNEY

SN 77-821,365. VISMO, LLC, LAS VEGAS, NV. FILED 9-8-2009.

tokyobite

THE MARK CONSISTS OF STANDARD CHARACTERS WITHOUT CLAIM TO ANY PARTICULAR FONT, STYLE, SIZE, OR COLOR.

FOR CAFE SERVICES FEATURING BEVERAGES, NAMELY, SPARKLING WATERS, JUICES, COFFEES AND TEAS (U.S. CLS. 100 AND 101).

CHARISMA HAMPTON, EXAMINING ATTORNEY

SN 77-836,466. EINSTEIN'S WORKSHOP INC., DBA EINSTEIN'S WORKSHOP, SUGAR LAND, TX. FILED 9-28-2009.



SN 77-821,408. BLACK SHEEP COAL FIRED PIZZA, LLC, MINNEAPOLIS, MN. FILED 9-8-2009.

BLACK SHEEP COAL FIRED PIZZA

THE MARK CONSISTS OF STANDARD CHARACTERS WITHOUT CLAIM TO ANY PARTICULAR FONT, STYLE, SIZE, OR COLOR.

NO CLAIM IS MADE TO THE EXCLUSIVE RIGHT TO USE "COAL FIRED PIZZA", APART FROM THE MARK AS SHOWN.

FOR RESTAURANT SERVICES (U.S. CLS. 100 AND 101).

FIRST USE 10-20-2008; IN COMMERCE 10-20-2008.

KAELIE KUNG, EXAMINING ATTORNEY

NO CLAIM IS MADE TO THE EXCLUSIVE RIGHT TO USE "LEARNING", APART FROM THE MARK AS SHOWN.

THE COLOR(S) LIGHT BLUE, DARK BLUE, PINK, PURPLE, YELLOW, TAN, BROWN, BLACK AND WHITE IS/ARE CLAIMED AS A FEATURE OF THE MARK.

THE MARK CONSISTS OF A CARICATURE OF EINSTEIN'S TWO TONED TAN FACE WITH WHITE HAIR OVERLAYING A LIGHT BLUE GEAR SPROCKET ALL OUTLINED IN BLACK; THE WORD "EINSTEIN'S" IS IN PURPLE WITH THE SECOND "I" APPEARING INVERTED; THE WORD "WORKSHOP" IS DARK BLUE WITH THE FACES OF TWO SMALL CHILDREN IN TAN WITH BROWN HAIR APPEARING IN PLACE OF THE LETTERS "O" IN THE WORD "WORKSHOP"; 3 WAVY RAINBOW LINES IN THE COLORS YELLOW, PINK AND LIGHT BLUE APPEAR BELOW THE WORD "WORKSHOP", WITH THE WORDS "ENJOYABLE LEARNING" IN PINK ABOVE THE RAINBOW LINES.

FOR PRESCHOOLER AND INFANT CARE AT DAY-CARE CENTERS (U.S. CLS. 100 AND 101).

ELLEN BURNS, EXAMINING ATTORNEY

CLASS 43—(Continued).

SN 77-843,336. BOGHOSSIAN, HRATCH, POMPANO BEACH, FL. FILED 10-7-2009.

LE DESSERT FACTORY

THE MARK CONSISTS OF STANDARD CHARACTERS WITHOUT CLAIM TO ANY PARTICULAR FONT, STYLE, SIZE, OR COLOR.

NO CLAIM IS MADE TO THE EXCLUSIVE RIGHT TO USE "LE DESSERT", APART FROM THE MARK AS SHOWN.

FOR COFFEE SHOP, COFFEE AND JUICE BAR SERVICES, RESTAURANT AND CAFE SERVICES, CAFE, COFFEE AND TEA BARS, FAST FOOD RESTAURANTS, ICE CREAM SHOP SERVICES IN THE NATURE OF A RESTAURANT, ICE CREAM SHOP, JUICE BAR SERVICES, TEA BARS, TEA ROOMS, WINE BARS, CATERING, CARRY-OUT RESTAURANTS, BAR AND COCKTAIL LOUNGE SERVICES, CAFES, COFFEE BARS, PROVIDING OF FOOD AND DRINK, TAKE-OUT RESTAURANT SERVICES, PROVIDING NEWS IN THE FIELD OF DRINKS, CAFE-RESTAURANTS, CAFE AND RESTAURANT SERVICES, SERVING OF FOOD AND DRINK BEVERAGES, RESTAURANT AND BAR SERVICES (U.S. CLS. 100 AND 101).

FIRST USE 10-7-2009; IN COMMERCE 10-7-2009.
TINA MAI, EXAMINING ATTORNEY

SN 77-846,262. FAROOQ S. ALI, UNION, NJ. FILED 10-11-2009.

ROOQ'S STEAKHOUSE

THE MARK CONSISTS OF STANDARD CHARACTERS WITHOUT CLAIM TO ANY PARTICULAR FONT, STYLE, SIZE, OR COLOR.

NO CLAIM IS MADE TO THE EXCLUSIVE RIGHT TO USE "STEAKHOUSE", APART FROM THE MARK AS SHOWN.

THE NAME(S), PORTRAIT(S), AND/OR SIGNATURE(S) SHOWN IN THE MARK IDENTIFIES FAROOQ ALI, WHOSE CONSENT(S) TO REGISTER IS MADE OF RECORD.

FOR RESTAURANT (U.S. CLS. 100 AND 101).
ODESSA BIBBINS, EXAMINING ATTORNEY

CLASS 43—(Continued).

SN 77-848,550. MR. PICKLE'S INC., AUBURN, CA. FILED 10-14-2009.

MR. PICKLE'S
SANDWICH SHOP

OWNER OF U.S. REG. NO. 2,766,768.

NO CLAIM IS MADE TO THE EXCLUSIVE RIGHT TO USE "SANDWICH SHOP", APART FROM THE MARK AS SHOWN.

THE MARK CONSISTS OF THE WORDS "MR. PICKLE'S" IN CAPITAL LETTERS SHADED AND CENTERED OVER "SANDWICH SHOP" IN SMALLER, SHADED CAPITAL LETTERS ENCLOSED IN A RECTANGULAR BOX WITH A BORDER COMPRISED OF TWO LINES, THE OUTSIDE LINE BEING THICKER THAN THE INSIDE LINE.

FOR RESTAURANT; RESTAURANT AND CATERING SERVICES; RESTAURANT SERVICES; RESTAURANT SERVICES FEATURING SANDWICHES; RESTAURANT SERVICES, INCLUDING SIT-DOWN SERVICE OF FOOD AND TAKE-OUT RESTAURANT SERVICES; RESTAURANTS (U.S. CLS. 100 AND 101).

FIRST USE 8-10-2009; IN COMMERCE 10-14-2009.
SUZANNE BLANE, EXAMINING ATTORNEY

SN 77-849,848. TERRY ENTERPRISES, LLC, AUSTIN, TX. FILED 10-15-2009.

P.TERRY'S

THE COLOR(S) RED, WHITE, AND BLACK IS/ARE CLAIMED AS A FEATURE OF THE MARK.

THE MARK CONSISTS OF THE FOLLOWING: THE TERMS "P.TERRY'S" IN RED, WITH A WHITE OUTLINE AND BLACK SHADOWING.

FOR CAFE-RESTAURANTS; CARRY-OUT RESTAURANTS; ICE CREAM SHOP SERVICES IN THE NATURE OF A RESTAURANT; RESTAURANT; RESTAURANT AND CATERING SERVICES; RESTAURANTS (U.S. CLS. 100 AND 101).

FIRST USE 3-15-2005; IN COMMERCE 7-15-2005.
SUNG IN, EXAMINING ATTORNEY

CLASS 43—(Continued).

SN 77-851,393. OTG MANAGEMENT, INC., PHILADELPHIA, PA. FILED 10-19-2009.

Tagliare

THE MARK CONSISTS OF STANDARD CHARACTERS WITHOUT CLAIM TO ANY PARTICULAR FONT, STYLE, SIZE, OR COLOR.

THE ENGLISH TRANSLATION OF "TAGLIARE" IN THE MARK IS TO CUT, TO SLICE, OR TO CUT UP.

FOR RESTAURANT AND BAR SERVICES (U.S. CLS. 100 AND 101).

DAVID TAYLOR, EXAMINING ATTORNEY

SN 77-851,990. RAY'S RESTAURANTS, LLC, MARIETTA, GA. FILED 10-19-2009.

RAY'S ON THE RIVER

THE MARK CONSISTS OF STANDARD CHARACTERS WITHOUT CLAIM TO ANY PARTICULAR FONT, STYLE, SIZE, OR COLOR.

THE NAME(S), PORTRAIT(S), AND/OR SIGNATURE(S) SHOWN IN THE MARK IDENTIFIES "RAY" SCHOENBAUM, WHOSE CONSENT(S) TO REGISTER IS MADE OF RECORD.

FOR RESTAURANT SERVICES (U.S. CLS. 100 AND 101).

FIRST USE 3-4-1985; IN COMMERCE 3-4-1985.

DOMINIC J. FERRAIUOLO, EXAMINING ATTORNEY

SN 77-859,166. SBAFO ITALIA SRL, BERGAMO, ITALY, FILED 10-28-2009.



SBAFO
TUTTALAPIZZACHEVUOI

THE COLOR(S) ORANGE AND BLACK IS/ARE CLAIMED AS A FEATURE OF THE MARK.

THE MARK CONSISTS OF THE WORD "SBAFO" AND A DESIGN ELEMENT ABOVE THAT WORD, WHICH BOTH APPEAR IN THE COLOR ORANGE. THE WORDING "TUTTALAPIZZACHEVUOI" APPEARS BELOW THE WORD "SBAFO" IN THE COLOR BLACK, WITH THE "TUTTA" PORTION OF THE WORDING UNDERLINED IN ORANGE.

THE ENGLISH TRANSLATION OF "TUTTALAPIZZACHEVUOI" IN THE MARK IS ALL THE PIZZA YOU WANT. THE ENGLISH TRANSLATION OF "SBAFO" IN THE MARK IS "TO EAT VIVIDLY."

FOR RESTAURANT SERVICES (U.S. CLS. 100 AND 101).

JANICE KIM, EXAMINING ATTORNEY

CLASS 43—(Continued).

SN 77-861,709. CRAWFORTH BROTHERS 2, LLC, DBA PIE HOLE, BOISE, ID. FILED 10-30-2009.

pie hole

THE MARK CONSISTS OF STANDARD CHARACTERS WITHOUT CLAIM TO ANY PARTICULAR FONT, STYLE, SIZE, OR COLOR.

NO CLAIM IS MADE TO THE EXCLUSIVE RIGHT TO USE "PIE", APART FROM THE MARK AS SHOWN.

FOR RESTAURANT AND BAR SERVICES FEATURING PIZZA; TAKE-OUT RESTAURANT SERVICES FEATURING PIZZA (U.S. CLS. 100 AND 101).

FIRST USE 9-1-2005; IN COMMERCE 9-1-2005.

CYNTHIA SLOAN, EXAMINING ATTORNEY

SN 77-863,158. HARBOR VIEW GRILL, LLC, SAUSALITO, CA. FILED 11-2-2009.

FLYNN'S LANDING

THE MARK CONSISTS OF STANDARD CHARACTERS WITHOUT CLAIM TO ANY PARTICULAR FONT, STYLE, SIZE, OR COLOR.

FOR BAR AND RESTAURANT SERVICES (U.S. CLS. 100 AND 101).

EDWARD FENNESSY, EXAMINING ATTORNEY

SN 77-868,995. BAREBURGER, INC., ASTORIA, NY. FILED 11-10-2009.



NO CLAIM IS MADE TO THE EXCLUSIVE RIGHT TO USE "ORGANIC", APART FROM THE MARK AS SHOWN.

THE COLOR(S) GREEN, YELLOW, GOLD, BROWN, BLACK, GRAY, WHITE, RED AND TAN IS/ARE CLAIMED AS A FEATURE OF THE MARK.

THE MARK CONSISTS OF A BROWN BEAR WITH A TAN FACE ON A BLACK AND GRAY OLD FASHION BICYCLE; THE BEAR IS HOLDING A WHITE PLATE; A BROWN BURGER WITH A TAN BUN, GREEN LETTUCE, GOLD

CLASS 43—(Continued).

CHEESE, RED TOMATO AND GOLD FRIES ARE ON THE PLATE; SOME OF THE FRIES ARE FALLING OFF OF THE PLATE; THE BEAR'S OTHER PAW IS HOLDING A GOLD BEVERAGE IN A STEIN; THE BEAR IS SURROUNDED BY GREEN VINES; THE WORD "BAREBURGER" APPEARS IN STYLIZED YELLOW LETTERS ABOVE THE BEAR; THE WORD "ORGANIC" APPEARS IN GREEN LETTERS BELOW THE BEAR; A SMALL BROWN SQUIRREL WITH A BROWN HORN APPEARS STANDING ON A VINE TO THE RIGHT OF THE BEAR.

FOR CAFE AND RESTAURANT SERVICES (U.S. CLS. 100 AND 101).

FIRST USE 6-1-2009; IN COMMERCE 6-1-2009.

RONALD MCMORROW, EXAMINING ATTORNEY

SN 77-871,152. HAMATY, CHARBEL, WAKE FOREST, NC. FILED 11-12-2009.

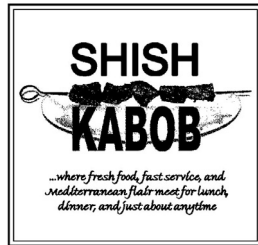

NO CLAIM IS MADE TO THE EXCLUSIVE RIGHT TO USE "SHISH KABOB", APART FROM THE MARK AS SHOWN.

THE MARK CONSISTS OF A SHISH KABOB ON A PLATE AND THE TEXT "SHISH KABOB ...WHERE FRESH FOOD, FAST SERVICE, AND MEDITERRANEAN FLAIR MEET FOR LUNCH, DINNER, AND JUST ABOUT ANYTIME".

FOR RESTAURANT SERVICES (U.S. CLS. 100 AND 101).

FIRST USE 6-2-2008; IN COMMERCE 6-2-2008.

ROBERT STRUCK, EXAMINING ATTORNEY

SN 77-876,952. TRACY BORKUM, SAN DIEGO, CA. FILED 11-19-2009.

Urban Kitchen

THE MARK CONSISTS OF STANDARD CHARACTERS WITHOUT CLAIM TO ANY PARTICULAR FONT, STYLE, SIZE, OR COLOR.

NO CLAIM IS MADE TO THE EXCLUSIVE RIGHT TO USE "KITCHEN", APART FROM THE MARK AS SHOWN.

FOR CATERING; CATERING FOR THE PROVISION OF FOOD AND BEVERAGES (U.S. CLS. 100 AND 101).

FIRST USE 1-1-2004; IN COMMERCE 1-1-2004.

PRISCILLA MILTON, EXAMINING ATTORNEY

CLASS 43—(Continued).

SN 77-880,511. FSC FRANCHISE CO., LLC, TAMPA, FL. FILED 11-25-2009.

OWNER OF U.S. REG. NOS. 1,897,862, 3,316,038 AND OTHERS.

THE MARK CONSISTS OF THE WORDING "BEEF 'O' BRADY'S" IN STYLIZED FONT WITH DESIGNS OF SHAMROCKS ON EACH SIDE OF THE WORDING.

FOR RESTAURANT AND BAR SERVICES; TAKE-OUT RESTAURANT SERVICES (U.S. CLS. 100 AND 101).

FIRST USE 12-8-2008; IN COMMERCE 12-8-2008.

CORY BOONE, EXAMINING ATTORNEY

SN 77-881,246. ROUX 66 LLC, OAKLAND, CA. FILED 11-25-2009.

ROUX 66

THE MARK CONSISTS OF STANDARD CHARACTERS WITHOUT CLAIM TO ANY PARTICULAR FONT, STYLE, SIZE, OR COLOR.

FOR RESTAURANT AND BAR SERVICES (U.S. CLS. 100 AND 101).

JUSTINE D. PARKER, EXAMINING ATTORNEY

SN 77-881,588. OTG MANAGEMENT, INC., PHILADELPHIA, PA. FILED 11-27-2009.

BAR BRACE

THE MARK CONSISTS OF STANDARD CHARACTERS WITHOUT CLAIM TO ANY PARTICULAR FONT, STYLE, SIZE, OR COLOR.

NO CLAIM IS MADE TO THE EXCLUSIVE RIGHT TO USE "BAR", APART FROM THE MARK AS SHOWN.

FOR RESTAURANT AND BAR SERVICES (U.S. CLS. 100 AND 101).

STEVEN JACKSON, EXAMINING ATTORNEY

CLASS 43—(Continued).

SN 77-883,335. A & K FOOD SERVICE, INC., WALNUT, CA. FILED 12-1-2009.

PERIS RESTAURANT

THE MARK CONSISTS OF STANDARD CHARACTERS WITHOUT CLAIM TO ANY PARTICULAR FONT, STYLE, SIZE, OR COLOR.

NO CLAIM IS MADE TO THE EXCLUSIVE RIGHT TO USE "RESTAURANT", APART FROM THE MARK AS SHOWN.

FOR BAR AND RESTAURANT SERVICES; CAFE AND RESTAURANT SERVICES; CAFE-RESTAURANTS; CAFETERIA AND RESTAURANT SERVICES; CARRY-OUT RESTAURANTS; CONSULTATION SERVICES IN THE FIELD OF RESTAURANT MENU DEVELOPMENT; DELICATESSENS; FAST FOOD AND NON-STOP RESTAURANT SERVICES; FAST-FOOD RESTAURANTS; FAST-FOOD RESTAURANTS AND SNACKBARS; RESTAURANT; RESTAURANT AND BAR SERVICES; RESTAURANT AND CAFE SERVICES; RESTAURANT AND CATERING SERVICES; RESTAURANT SERVICES; RESTAURANT SERVICES, INCLUDING SIT-DOWN SERVICE OF FOOD AND TAKE-OUT RESTAURANT SERVICES; RESTAURANT SERVICES, NAMELY, PROVIDING OF FOOD AND BEVERAGES FOR CONSUMPTION ON AND OFF THE PREMISES; RESTAURANT, BAR AND CATERING SERVICES; TAKE-OUT RESTAURANT SERVICES (U.S. CLS. 100 AND 101).
ROBIN CHOSID, EXAMINING ATTORNEY

SN 77-883,829. JAW RESTAURANT MANAGEMENT, LLC, CULVER CITY, CA. FILED 12-1-2009.

The Counter MINI

THE MARK CONSISTS OF STANDARD CHARACTERS WITHOUT CLAIM TO ANY PARTICULAR FONT, STYLE, SIZE, OR COLOR.

OWNER OF U.S. REG. NO. 3,115,678.
FOR RESTAURANT SERVICES, NOT FEATURING VEGETARIAN CUISINE (U.S. CLS. 100 AND 101).
JOHN WILKE, EXAMINING ATTORNEY

CLASS 43—(Continued).

SN 77-883,883. SETH BRANITZ, NEW PALTZ, NY. AND JENNIFER BRANITZ, NEW PALTZ, NY. FILED 12-2-2009.

**Karma Road
Organic Café**

NO CLAIM IS MADE TO THE EXCLUSIVE RIGHT TO USE "ORGANIC CAFE" AND "HEALTHY DELICIOUS FOOD", APART FROM THE MARK AS SHOWN.

THE MARK CONSISTS OF THE WORDS "KARMA ROAD ORGANIC CAFE HEALTHY DELICIOUS FOOD FOR EVERYONE" AND A DEPICTION OF A ROAD LEADING TO A HEART-SHAPED SUN ON THE HORIZON.

FOR CAFE, RESTAURANT, CATERING, SIT-DOWN AND TAKE-OUT RESTAURANT SERVICES, ALL FEATURING ORGANIC AND VEGETARIAN FOOD (U.S. CLS. 100 AND 101).

FIRST USE 2-1-2007; IN COMMERCE 2-2-2007.
JERI J. FICKES, EXAMINING ATTORNEY

SN 77-884,079. FUZION FOOD GROUP USA, INC., SIOUX FALLS, SD. FILED 12-2-2009.

Joey Pagoda's

THE MARK CONSISTS OF STANDARD CHARACTERS WITHOUT CLAIM TO ANY PARTICULAR FONT, STYLE, SIZE, OR COLOR.

THE NAME IN THE MARK DOES NOT IDENTIFY A PARTICULAR LIVING INDIVIDUAL.

FOR RESTAURANT AND BAR SERVICES (U.S. CLS. 100 AND 101).

KATHERINE STOIDES, EXAMINING ATTORNEY

CLASS 43—(Continued).

SN 77-884,825. RESTAURANTE E PIZZARIA A ESPERANÇA LTDA, SÃO PAULO - SP, BRAZIL, FILED 12-2-2009.



NO CLAIM IS MADE TO THE EXCLUSIVE RIGHT TO USE "PIZZERIA", "RISTORANTE" AND "50 YEARS", APART FROM THE MARK AS SHOWN.

THE COLOR(S) WHITE, GREEN AND SALMON IS/ARE CLAIMED AS A FEATURE OF THE MARK.

THE MARK CONSISTS OF THE WORD "PIZZERIA" IN WHITE, BELOW WHICH IS A SERIES OF SMALL GREEN SQUARES, BELOW WHICH ARE THE WORDS "LA SPERANZA" IN WHITE, BELOW WHICH IS A SERIES OF SMALL GREEN SQUARES, BELOW WHICH IS THE WORD "RISTORANTE" IN WHITE, BELOW WHICH IS THE NUMBER "50" IN SALMON, BELOW WHICH IS THE WORD "YEARS" IN GREEN. "50 YEARS" APPEARS AGAINST A WHITE BACKGROUND AND IS CONTAINED WITHIN A SALMON CIRCLE. THE REST OF THE MARK IS SET AGAINST A SALMON BACKGROUND IN A FANCIFUL SHAPE, SURROUNDED BY AN INNER WHITE BORDER AND AN OUTER GREEN BORDER.

THE ENGLISH TRANSLATION OF "LA SPERANZA" AND "RISTORANTE" IN THE MARK IS "THE HOPE" AND "RESTAURANT."

FOR RESTAURANT, BAR AND CATERING SERVICES (U.S. CLS. 100 AND 101).

DEBRA LEE, EXAMINING ATTORNEY

SN 77-885,172. REYNOLDS, CHARLES H., SAN JOSE, CA. FILED 12-3-2009.

A free order of fun with
every meal

THE MARK CONSISTS OF STANDARD CHARACTERS WITHOUT CLAIM TO ANY PARTICULAR FONT, STYLE, SIZE, OR COLOR.

FOR RESTAURANT SERVICES (U.S. CLS. 100 AND 101).

FIRST USE 12-1-2009; IN COMMERCE 12-1-2009.
PAUL CROWLEY, EXAMINING ATTORNEY

CLASS 43—(Continued).

SN 77-885,773. SMIRK, LLC, SAN JOSE, CA. FILED 12-3-2009.

O' JOE'S

THE MARK CONSISTS OF STANDARD CHARACTERS WITHOUT CLAIM TO ANY PARTICULAR FONT, STYLE, SIZE, OR COLOR.

FOR BAR AND COCKTAIL LOUNGE SERVICES; RESTAURANT AND CAFE SERVICES (U.S. CLS. 100 AND 101).

KIMBERLY PERRY, EXAMINING ATTORNEY

SN 77-886,156. SOCCER SENORITAS, LLC, KNOXVILLE, TN. FILED 12-4-2009.

SOCCER TACO

THE MARK CONSISTS OF STANDARD CHARACTERS WITHOUT CLAIM TO ANY PARTICULAR FONT, STYLE, SIZE, OR COLOR.

NO CLAIM IS MADE TO THE EXCLUSIVE RIGHT TO USE "TACO", APART FROM THE MARK AS SHOWN.

FOR RESTAURANT SERVICES (U.S. CLS. 100 AND 101).

FIRST USE 10-30-2007; IN COMMERCE 10-30-2007.
CHARLES L. JENKINS, EXAMINING ATTORNEY

SN 77-886,406. SOCCER SENORITAS, LLC, KNOXVILLE, TN. FILED 12-4-2009.



NO CLAIM IS MADE TO THE EXCLUSIVE RIGHT TO USE "MEXICAN SPORTS BAR" AND "TACOS", APART FROM THE MARK AS SHOWN.

THE MARK CONSISTS OF THE WORDS "SOCCER TACO" AND "MEXICAN SPORTS BAR AND TACOS" AND A FANCIFUL DESIGN OF A BASEBALL, A FOOTBALL, A SOCCER BALL, A BASKETBALL AND A TENNIS BALL ABOVE TWO CHECKERED FLAGS.

FOR RESTAURANT SERVICES (U.S. CLS. 100 AND 101).

FIRST USE 10-30-2007; IN COMMERCE 10-30-2007.
CHARLES L. JENKINS, EXAMINING ATTORNEY

CLASS 43—(Continued).

SN 77-886,866. JAW RESTAURANT MANAGEMENT, LLC,
CULVER CITY, CA. FILED 12-4-2009.



OWNER OF U.S. REG. NO. 3,115,678.
NO CLAIM IS MADE TO THE EXCLUSIVE RIGHT TO
USE "BURGERS", APART FROM THE MARK AS SHOWN.
THE COLOR(S) GRAY, BLUE IS/ARE CLAIMED AS A
FEATURE OF THE MARK.
THE MARK CONSISTS OF GRAY LETTERS SPELLING
"THE COUNTER" AND A GRAY DIAMOND-SHAPED DE-
SIGN CONTAINING A STYLIZED LETTER "C", OVER
BLUE LETTERS SPELLING "MINI", OVER GRAY LETTERS
SPELLING "CUSTOM BUILT BURGERS".
FOR RESTAURANT SERVICES, NOT FEATURING
VEGETARIAN CUISINE (U.S. CLS. 100 AND 101).
JOHN WILKE, EXAMINING ATTORNEY

SN 77-887,278. ATALLAH, IHAB, FT. LAUDERDALE, FL.
FILED 12-7-2009.

OFF THE HOOKAH

THE MARK CONSISTS OF STANDARD CHARACTERS
WITHOUT CLAIM TO ANY PARTICULAR FONT, STYLE,
SIZE, OR COLOR.
FOR BAR, CAFE, AND COCKTAIL LOUNGE SER-
VICES (U.S. CLS. 100 AND 101).
FIRST USE 2-0-2007; IN COMMERCE 2-0-2007.
MICHAEL WIENER, EXAMINING ATTORNEY

CLASS 43—(Continued).

SN 77-887,555. CAPITAL DEVELOPMENT ASSOCIATES,
INC., TA WOODY'S CRAB HOUSE, NORTH EAST, MD.
FILED 12-7-2009.

Woody's Crab House

THE MARK CONSISTS OF STANDARD CHARACTERS
WITHOUT CLAIM TO ANY PARTICULAR FONT, STYLE,
SIZE, OR COLOR.

NO CLAIM IS MADE TO THE EXCLUSIVE RIGHT TO
USE "CRAB HOUSE", APART FROM THE MARK AS
SHOWN.

THE NAME(S), PORTRAIT(S), AND/OR SIGNATURE(S)
SHOWN IN THE MARK DOES NOT IDENTIFY A PARTI-
CULAR LIVING INDIVIDUAL.

FOR RESTAURANT AND BAR SERVICES (U.S. CLS.
100 AND 101).

FIRST USE 3-24-1993; IN COMMERCE 3-24-1993.

TIMOTHY FINNEGAN, EXAMINING ATTORNEY

SN 77-887,638. ZOOTIST HOSPITALITY, LLC, BOZEMAN,
MT. FILED 12-7-2009.

NORTHERN HOTEL

THE MARK CONSISTS OF STANDARD CHARACTERS
WITHOUT CLAIM TO ANY PARTICULAR FONT, STYLE,
SIZE, OR COLOR.

NO CLAIM IS MADE TO THE EXCLUSIVE RIGHT TO
USE "HOTEL", APART FROM THE MARK AS SHOWN.

FOR BAR AND RESTAURANT SERVICES; HOTEL
SERVICES (U.S. CLS. 100 AND 101).

APRIL ROACH, EXAMINING ATTORNEY

CLASS 43—(Continued).

SN 77-887,963. NOMBE RESTAURANT, LLC, SAN FRANCISCO, CA. FILED 12-7-2009.



NO CLAIM IS MADE TO THE EXCLUSIVE RIGHT TO USE THE NON-LATIN CHARACTERS THAT TRANSLITERATE TO "SAKE", APART FROM THE MARK AS SHOWN.

THE NAME(S), PORTRAIT(S), AND/OR SIGNATURE(S) SHOWN IN THE MARK DOES NOT IDENTIFY A PARTICULAR LIVING INDIVIDUAL.

THE MARK CONSISTS OF THE WORD "NOMBE" IN STYLIZED FONT CENTERED BELOW A DRAWING OF A MAN SITTING CROSS LEGGED HOLDING A FISHING POLE WITH A FISH IN THE RIGHT HAND, AND A BOTTLE IN THE LEFT HAND. ASIAN CHARACTERS APPEAR ON THE BOTTLE.

THE WORDING "NOMBE" HAS NO MEANING IN A FOREIGN LANGUAGE.

THE NON-LATIN CHARACTERS IN THE MARK TRANSLITERATE TO SAKE (SOCKEY) AND THIS MEANS SAKE (ALCOHOLIC BEVERAGE) IN ENGLISH.

FOR RESTAURANT SERVICES FEATURING JAPANESE FOOD (U.S. CLS. 100 AND 101).

FIRST USE 11-0-2009; IN COMMERCE 11-0-2009.

ELISSA GARBER KON, EXAMINING ATTORNEY

SN 77-888,558. JOE & VINO'S, LLC, MIDLAND, MI. FILED 12-8-2009.

JOE & VINO'S

THE MARK CONSISTS OF STANDARD CHARACTERS WITHOUT CLAIM TO ANY PARTICULAR FONT, STYLE, SIZE, OR COLOR.

FOR RESTAURANT SERVICES FEATURING COFFEE, WINE AND DESSERTS (U.S. CLS. 100 AND 101).

BILL DAWE, EXAMINING ATTORNEY

CLASS 43—(Continued).

SN 77-889,066. ROYAL YORK HOTEL LP, MISSISSAUGA, ONTARIO, CANADA, FILED 12-8-2009.

ROYAL YORK

THE MARK CONSISTS OF STANDARD CHARACTERS WITHOUT CLAIM TO ANY PARTICULAR FONT, STYLE, SIZE, OR COLOR.

OWNER OF CANADA REG. NO. TMA495121, DATED 5-22-1998, EXPIRES 5-22-2013.

FOR TRAVEL AND ACCOMMODATION SERVICES, NAMELY, MAKING AND TAKING HOTEL RESERVATIONS FOR OTHERS (U.S. CLS. 100 AND 101).

AMEEN IMAM, EXAMINING ATTORNEY

SN 77-889,106. R&J ENTERPRISES, DOVER, DE. FILED 12-8-2009.

ESTASI CATERING

THE MARK CONSISTS OF STANDARD CHARACTERS WITHOUT CLAIM TO ANY PARTICULAR FONT, STYLE, SIZE, OR COLOR.

NO CLAIM IS MADE TO THE EXCLUSIVE RIGHT TO USE "CATERING", APART FROM THE MARK AS SHOWN.

THE ENGLISH TRANSLATION OF "ESTASI" IS ECSTASY.

FOR CATERING; CATERING OF FOOD AND DRINKS (U.S. CLS. 100 AND 101).

NICHOLAS ALTREE, EXAMINING ATTORNEY

SN 77-889,267. NORTH STAR CORPORATE HOUSING, L.L.C., MELBOURNE BEACH, FL. FILED 12-9-2009.

NO CLAIM IS MADE TO THE EXCLUSIVE RIGHT TO USE "CORPORATE HOUSING", APART FROM THE MARK AS SHOWN.

THE MARK CONSISTS OF "NORTH STAR" IN SCRIPT OVER THE WORDS "CORPORATE HOUSING" WITH A STAR TO THE LEFT OF THE "N".

FOR ARRANGING TEMPORARY HOUSING ACCOMMODATIONS (U.S. CLS. 100 AND 101).

FIRST USE 4-8-2009; IN COMMERCE 4-8-2009.

ALEXANDER L. POWERS, EXAMINING ATTORNEY

CLASS 43—(Continued).

SN 77-889,906. SIXTEENFIFTY HOLDINGS, INC., LA JOLLA, CA. FILED 12-9-2009.

Simple Hotels

THE MARK CONSISTS OF STANDARD CHARACTERS WITHOUT CLAIM TO ANY PARTICULAR FONT, STYLE, SIZE, OR COLOR.

NO CLAIM IS MADE TO THE EXCLUSIVE RIGHT TO USE "HOTELS", APART FROM THE MARK AS SHOWN. FOR HOTEL SERVICES; HOTELS (U.S. CLS. 100 AND 101).

VIVIAN MICZNIK FIRST, EXAMINING ATTORNEY

SN 77-889,912. SIXTEENFIFTY HOLDINGS, INC., LA JOLLA, CA. FILED 12-9-2009.

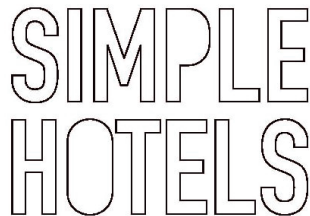

NO CLAIM IS MADE TO THE EXCLUSIVE RIGHT TO USE "HOTELS", APART FROM THE MARK AS SHOWN.

THE MARK CONSISTS OF THE LITERAL ELEMENT "SIMPLE HOTELS" IN A UNIQUE BLOCK FONT, AND IN CAPITAL LETTERS, WITH "SIMPLE" BEING PLACED DIRECTLY ABOVE "HOTELS".

FOR HOTEL SERVICES; HOTELS (U.S. CLS. 100 AND 101).

VIVIAN MICZNIK FIRST, EXAMINING ATTORNEY

SN 77-890,841. LOWE PROFILE PRODUCTIONS, INC., BEVERLY HILLS, CA. FILED 12-10-2009.



THE MARK CONSISTS OF THE STYLIZED LETTERS "TBP" INSIDE OF AN OVAL SHAPE DESIGN.

FOR RESTAURANT; BAR AND COCKTAIL LOUNGE SERVICES; HOTEL ACCOMMODATION SERVICES (U.S. CLS. 100 AND 101).

TINA MAI, EXAMINING ATTORNEY

CLASS 43—(Continued).

SN 77-891,154. MARRIOTT INTERNATIONAL, INC., BETHESDA, MD. FILED 12-11-2009.



THE MARK CONSISTS OF TWO INTERLOCKING CIRCLES.

FOR HOTEL SERVICES; RESTAURANT, BAR AND COCKTAIL LOUNGE SERVICES; RESORT LODGING SERVICES; PROVISION OF GENERAL-PURPOSE FACILITIES FOR MEETINGS, CONFERENCES AND EXHIBITIONS; PROVISION OF BANQUET AND SOCIAL FUNCTION FACILITIES FOR SPECIAL OCCASIONS; AND RESERVATIONS SERVICES FOR HOTEL ACCOMMODATIONS FOR OTHERS (U.S. CLS. 100 AND 101).

KEVIN CORWIN, EXAMINING ATTORNEY

SN 77-891,273. BRIGHT STAR ACADEMY CEDAR PARK, LLC, DELAWARE, OH. FILED 12-11-2009.

Live green, grow bright...one little star at a time!

THE MARK CONSISTS OF STANDARD CHARACTERS WITHOUT CLAIM TO ANY PARTICULAR FONT, STYLE, SIZE, OR COLOR.

FOR PRESCHOOLER AND INFANT CARE AT DAY-CARE CENTERS (U.S. CLS. 100 AND 101).

FIRST USE 11-1-2009; IN COMMERCE 11-1-2009.

JOHN E. MICHOS, EXAMINING ATTORNEY

SN 77-891,888. IFTUSO TWO, L.P., MESA, AZ. FILED 12-11-2009.

BEAUREGARD FOOD CO.

THE MARK CONSISTS OF STANDARD CHARACTERS WITHOUT CLAIM TO ANY PARTICULAR FONT, STYLE, SIZE, OR COLOR.

NO CLAIM IS MADE TO THE EXCLUSIVE RIGHT TO USE "FOOD CO.", APART FROM THE MARK AS SHOWN. FOR RESTAURANT SERVICES (U.S. CLS. 100 AND 101).

FIRST USE 1-22-2010; IN COMMERCE 1-22-2010. COLLEEN KEARNEY, EXAMINING ATTORNEY

CLASS 43—(Continued).

SN 77-892,181. REX DUVAL CATERERS, INC., NEW YORK, NY. FILED 12-12-2009.

EXTRA PLATE

THE MARK CONSISTS OF STANDARD CHARACTERS WITHOUT CLAIM TO ANY PARTICULAR FONT, STYLE, SIZE, OR COLOR.

FOR CHARITABLE SERVICES, NAMELY, PROVIDING FOOD TO NEEDY PERSONS (U.S. CLS. 100 AND 101).

FIRST USE 12-5-2009; IN COMMERCE 12-5-2009.
TASNEEM HUSSAIN, EXAMINING ATTORNEY

CLASS 43—(Continued).

SN 77-899,208. 3903427 CANADA INC., QUEBEC, CANADA, FILED 12-22-2009.

MILOS LV

THE MARK CONSISTS OF STANDARD CHARACTERS WITHOUT CLAIM TO ANY PARTICULAR FONT, STYLE, SIZE, OR COLOR.

NO CLAIM IS MADE TO THE EXCLUSIVE RIGHT TO USE "LV", APART FROM THE MARK AS SHOWN.
FOR RESTAURANT SERVICES (U.S. CLS. 100 AND 101).

COLLEEN KEARNEY, EXAMINING ATTORNEY

SN 77-893,154. SILENT VALLEY CLUB, INC., DBA SILENT VALLEY CLUB, BANNING, CA. FILED 12-14-2009.

Silent Valley

THE MARK CONSISTS OF STANDARD CHARACTERS WITHOUT CLAIM TO ANY PARTICULAR FONT, STYLE, SIZE, OR COLOR.

FOR BOOKING OF CAMPGROUND ACCOMMODATION; PROVIDING CAMPGROUND FACILITIES (U.S. CLS. 100 AND 101).

FIRST USE 5-15-1974; IN COMMERCE 5-15-1974.
SEAN CROWLEY, EXAMINING ATTORNEY

SN 77-900,023. MARRIOTT INTERNATIONAL, INC., BETHESDA, MD. FILED 12-23-2009.

THRIVE ON LONG STAYS

THE MARK CONSISTS OF STANDARD CHARACTERS WITHOUT CLAIM TO ANY PARTICULAR FONT, STYLE, SIZE, OR COLOR.

FOR HOTEL SERVICES; RESTAURANT SERVICES; PROVISION OF GENERAL PURPOSE FACILITIES FOR MEETINGS, CONFERENCES AND EXHIBITIONS; PROVISION OF BANQUET AND SOCIAL FUNCTION FACILITIES FOR SPECIAL OCCASIONS; AND RESERVATION SERVICES FOR HOTEL ACCOMMODATIONS FOR OTHERS (U.S. CLS. 100 AND 101).

FIRST USE 7-0-2007; IN COMMERCE 7-0-2007.
KEVIN CORWIN, EXAMINING ATTORNEY

SN 77-896,690. WIMPY'S LLC., OLIVE BRANCH, MS. FILED 12-18-2009.

Wimpy's Burgers and Fries

THE MARK CONSISTS OF STANDARD CHARACTERS WITHOUT CLAIM TO ANY PARTICULAR FONT, STYLE, SIZE, OR COLOR.

NO CLAIM IS MADE TO THE EXCLUSIVE RIGHT TO USE "BURGERS AND FRIES", APART FROM THE MARK AS SHOWN.

FOR FAST-FOOD RESTAURANTS (U.S. CLS. 100 AND 101).

JACQUELINE A. LAVINE, EXAMINING ATTORNEY

SN 77-900,092. ALLRECIPES.COM, INC., SEATTLE, WA. FILED 12-23-2009.

MAN TESTED RECIPES

THE MARK CONSISTS OF STANDARD CHARACTERS WITHOUT CLAIM TO ANY PARTICULAR FONT, STYLE, SIZE, OR COLOR.

NO CLAIM IS MADE TO THE EXCLUSIVE RIGHT TO USE "RECIPES", APART FROM THE MARK AS SHOWN.

FOR PROVIDING RECIPES VIA A WEBSITE ON A GLOBAL COMPUTER NETWORK (U.S. CLS. 100 AND 101).

LINDA LAVACHE, EXAMINING ATTORNEY

CLASS 43—(Continued).

SN 77-900,623. JLM UNLIMITED ENTERPRISES, LLC, TOLEDO, OH. FILED 12-23-2009.



NO CLAIM IS MADE TO THE EXCLUSIVE RIGHT TO USE "SUBS WINGS", APART FROM THE MARK AS SHOWN.

THE MARK CONSISTS OF THE STYLIZED WORDING "THE BEAR'S SUBS WINGS WORLD" WITH THE DESIGN OF A TEDDY BEAR WHOSE TONGUE IS HANGING OUT AND WHO IS HOLDING A SANDWICH.

FOR RESTAURANT SERVICES (U.S. CLS. 100 AND 101).
MAUREEN DALL, EXAMINING ATTORNEY

SN 77-900,884. JLM UNLIMITED ENTERPRISES, L.L.C., TOLEDO, OH. FILED 12-24-2009.

**JLM Unlimited Enterprises,
L.L.C.**

THE MARK CONSISTS OF STANDARD CHARACTERS WITHOUT CLAIM TO ANY PARTICULAR FONT, STYLE, SIZE, OR COLOR.

NO CLAIM IS MADE TO THE EXCLUSIVE RIGHT TO USE "ENTERPRISES, L.L.C.", APART FROM THE MARK AS SHOWN.

FOR RESTAURANT SERVICES (U.S. CLS. 100 AND 101).
MAUREEN DALL, EXAMINING ATTORNEY

SN 77-902,199. IFTUSO TWO, L.P., MESA, AZ. FILED 12-29-2009.

IT'S A SOUTHERN THING

THE MARK CONSISTS OF STANDARD CHARACTERS WITHOUT CLAIM TO ANY PARTICULAR FONT, STYLE, SIZE, OR COLOR.

FOR RESTAURANT SERVICES (U.S. CLS. 100 AND 101).
FIRST USE 1-22-2010; IN COMMERCE 1-22-2010.
COLLEEN KEARNEY, EXAMINING ATTORNEY

CLASS 43—(Continued).

SN 77-902,205. IFTUSO TWO, L.P., MESA, AZ. FILED 12-29-2009.

IT'S A MEXICAN THING

THE MARK CONSISTS OF STANDARD CHARACTERS WITHOUT CLAIM TO ANY PARTICULAR FONT, STYLE, SIZE, OR COLOR.

FOR RESTAURANT SERVICES (U.S. CLS. 100 AND 101).
COLLEEN KEARNEY, EXAMINING ATTORNEY

SN 77-902,206. IFTUSO TWO, L.P., MESA, AZ. FILED 12-29-2009.

IT'S A BREAKFAST THING

THE MARK CONSISTS OF STANDARD CHARACTERS WITHOUT CLAIM TO ANY PARTICULAR FONT, STYLE, SIZE, OR COLOR.

FOR RESTAURANT SERVICES (U.S. CLS. 100 AND 101).
COLLEEN KEARNEY, EXAMINING ATTORNEY

SN 77-902,214. IFTUSO TWO, L.P., MESA, AZ. FILED 12-29-2009.

IT'S AN ITALIAN THING

THE MARK CONSISTS OF STANDARD CHARACTERS WITHOUT CLAIM TO ANY PARTICULAR FONT, STYLE, SIZE, OR COLOR.

FOR RESTAURANT SERVICES (U.S. CLS. 100 AND 101).
COLLEEN KEARNEY, EXAMINING ATTORNEY

CLASS 43—(Continued).

SN 77-902,216. IFTUSO TWO, L.P., MESA, AZ. FILED 12-29-2009.

IT'S A SOUL FOOD THING

THE MARK CONSISTS OF STANDARD CHARACTERS WITHOUT CLAIM TO ANY PARTICULAR FONT, STYLE, SIZE, OR COLOR.
FOR RESTAURANT SERVICES (U.S. CLS. 100 AND 101).

COLLEEN KEARNEY, EXAMINING ATTORNEY

SN 77-903,338. ALVAREZ, GEORGE, CORAL GABLES, FL. FILED 12-31-2009.

ExcellenceRivieraMaya.com

THE MARK CONSISTS OF STANDARD CHARACTERS WITHOUT CLAIM TO ANY PARTICULAR FONT, STYLE, SIZE, OR COLOR.

FOR TRAVEL SERVICES, NAMELY, MAKING RESERVATIONS AND BOOKINGS FOR TEMPORARY LODGING; MAKING HOTEL AND LODGING RESERVATIONS FOR INDIVIDUALS AND GROUPS VIA A GLOBAL COMPUTER NETWORK (U.S. CLS. 100 AND 101).

FIRST USE 4-29-2006; IN COMMERCE 4-29-2006.
LAURIE KAUFMAN, EXAMINING ATTORNEY

CLASS 43—(Continued).

SN 77-912,191. ARMY AND AIR FORCE EXCHANGE SERVICE, DALLAS, TX. FILED 1-14-2010.



FOOD COURT

NO CLAIM IS MADE TO THE EXCLUSIVE RIGHT TO USE "FOOD COURT", APART FROM THE MARK AS SHOWN.

THE COLOR(S) DARK RED, MEDIUM RED, MEDIUM BLUE, DARK BLUE, AND BLACK IS/ARE CLAIMED AS A FEATURE OF THE MARK.

THE MARK CONSISTS OF INTERSECTING CHEVRONS FORMING A STYLIZED "X", IN WHICH THE TOP LEFT BAR OF THE "X" IS A DARK RED, THE BOTTOM LEFT BAR OF THE "X" IS A MEDIUM RED, THE TOP RIGHT BAR OF THE "X" IS A MEDIUM BLUE AND THE BOTTOM RIGHT BAR OF THE "X" IS A DARK BLUE, OVER THE WORD "FOOD COURT" IN STYLIZED CAPITAL LETTERS IN A BLACK FONT .

FOR CAFETERIA AND RESTAURANT SERVICES; CATERING IN FAST-FOOD CAFETERIAS (U.S. CLS. 100 AND 101).

NICHOLAS COLEMAN, EXAMINING ATTORNEY

SN 78-520,259. PANCER, JEFFREY, DBA COMEDY HALL OF FAME, BROOKVILLE, NY. FILED 11-19-2004.

Comedy Hall of
Fame

THE MARK CONSISTS OF STANDARD CHARACTERS WITHOUT CLAIM TO ANY PARTICULAR FONT, STYLE, SIZE, OR COLOR.

NO CLAIM IS MADE TO THE EXCLUSIVE RIGHT TO USE "COMEDY", APART FROM THE MARK AS SHOWN.

FOR RESTAURANT SERVICES FEATURING A VENUE FOR COMEDY PERFORMANCES (U.S. CLS. 100 AND 101).

HENRY S. ZAK, EXAMINING ATTORNEY

CLASS 44—MEDICAL, BEAUTY AND AGRICULTURAL SERVICES

SN 76-674,220. CHOPPERS, INC., AMELIA, OH. FILED 3-19-2007.

CHOPPERS

THE MARK CONSISTS OF STANDARD CHARACTERS WITHOUT CLAIM TO ANY PARTICULAR FONT, STYLE, SIZE, OR COLOR.

FOR HAIR CARE SERVICES, NAMELY, HAIR STYLING; HAIR CUTTING SERVICES (U.S. CLS. 100 AND 101).

FIRST USE 3-1-2007; IN COMMERCE 8-9-2007.
COLLEEN DOMBROW, EXAMINING ATTORNEY

SN 76-700,665. ALL SMILES DENTAL CENTERS, INC., DALLAS, TX. FILED 12-4-2009.

SONRIELE A LA VIDA

THE MARK CONSISTS OF STANDARD CHARACTERS WITHOUT CLAIM TO ANY PARTICULAR FONT, STYLE, SIZE, OR COLOR.

THE ENGLISH TRANSLATION OF "SONRIELE A LA VIDA" IS SMILE AT LIFE.

FOR DENTAL AND ORTHODONTIC SERVICES (U.S. CLS. 100 AND 101).

FIRST USE 11-23-2009; IN COMMERCE 11-23-2009.
HENRY S. ZAK, EXAMINING ATTORNEY

SN 77-433,833. BENZEEVI, YORAI, VISALIA, CA. FILED 3-27-2008.

PROVIDER IS TRIAGE

THE MARK CONSISTS OF STANDARD CHARACTERS WITHOUT CLAIM TO ANY PARTICULAR FONT, STYLE, SIZE, OR COLOR.

NO CLAIM IS MADE TO THE EXCLUSIVE RIGHT TO USE "TRIAGE", APART FROM THE MARK AS SHOWN.

FOR HOSPITAL ADMINISTRATION SERVICES, NAMELY, TRANSFERRING PATIENTS FROM THE HOSPITAL INTAKE AREA TO THE EMERGENCY DEPARTMENT (U.S. CLS. 100 AND 101).

FIRST USE 1-0-2003; IN COMMERCE 11-1-2005.
SHAUNIA CARLYLE, EXAMINING ATTORNEY

CLASS 44—(Continued).

SN 77-499,441. INVERSIONES EN RECREACION, DEPORTE Y SALUD, SA INVERDESA SA, BOGATA, COLOMBIA, FILED 6-16-2008.



PRIORITY CLAIMED UNDER SEC. 44(D) ON PANAMA APPLICATION NO. 170453-01, FILED 4-17-2008.

THE COLOR(S) ORANGE AND BLUE IS/ARE CLAIMED AS A FEATURE OF THE MARK.

THE MARK CONSISTS OF AN ORANGE BOOMERANG WITH A BLUE SPHERE ABOVE IT.

FOR MEDICAL SERVICES; SPORTS MEDICINE AND AESTHETIC SERVICES; MASSAGE SERVICES; ENDERMOTHERAPY, NAMELY, LYMPHATIC DRAINAGE MASSAGE, SOFT TISSUE MOBILIZATION AND SOFTENING SCAR TISSUE TREATMENT; CRYOTHERAPY AND, IN GENERAL, ALL TYPE OF SERVICES FOR THE CARE, HYGIENE, IMPROVEMENT AND BEAUTIFICATION OF BODY AND SKIN, NAMELY, PROVIDING TURKISH BATH FACILITIES, SAUNA SERVICES, OPERATION OF SAUNA FACILITIES, RELAXATION THERAPY IN THE NATURE OF AUTOGENOUS TRAINING, MASSAGE, HEALTH SPA SERVICES, NAMELY, BODY WRAPS, MUD TREATMENTS, SEAWEED TREATMENTS, HYDROTHERAPY BATHS, AND BODY SCRUBS, RENTAL OF HYDROTHERAPY-BASED EQUIPMENT FOR MEDICAL, THERAPEUTIC AND PERSONAL RELAXATION PURPOSES; VETERINARIAN SERVICES; HYGIENE AND BEAUTY SERVICES FOR PERSONS AND ANIMALS; AGRICULTURAL ADVICE, HORTICULTURAL, AND SILVICULTURAL SERVICES (U.S. CLS. 100 AND 101).

TRACY CROSS, EXAMINING ATTORNEY

SN 77-561,871. PERRY, KIA, DBA KIA NICOL, DETROIT, MI. FILED S.R. 9-3-2008; AM. P.R. 12-15-2008.

kia nicol

Letting your image fit your Lifestyle

THE NAME(S), PORTRAIT(S), AND/OR SIGNATURE(S) SHOWN IN THE MARK IDENTIFIES KIA PERRY, WHOSE CONSENT(S) TO REGISTER IS MADE OF RECORD.

FOR COSMETOLOGY SERVICES (U.S. CLS. 100 AND 101).

FIRST USE 8-19-2006; IN COMMERCE 8-19-2006.
KATHERINE E. HALMEN, EXAMINING ATTORNEY

CLASS 44—(Continued).

SN 77-614,054. SENTISOMA THERAPIES, LLC, DENVER, CO. FILED 11-13-2008.

SentiSoma Therapies

THE MARK CONSISTS OF STANDARD CHARACTERS WITHOUT CLAIM TO ANY PARTICULAR FONT, STYLE, SIZE, OR COLOR.

NO CLAIM IS MADE TO THE EXCLUSIVE RIGHT TO USE "THERAPIES", APART FROM THE MARK AS SHOWN. THE ENGLISH TRANSLATION OF "SENTISOMA" IN THE MARK IS TO FEEL BURDEN.

FOR BODYWORK THERAPY (U.S. CLS. 100 AND 101).
GRETCHEN ULRICH, EXAMINING ATTORNEY

SN 77-723,863. JASMINE M. GORTON DMD INC., SAN RAFAEL, CA. FILED 4-28-2009.

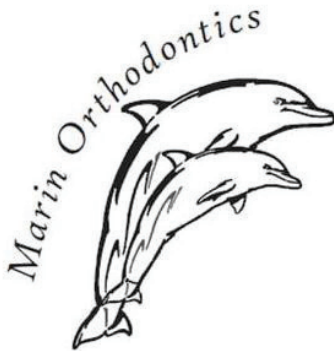

NO CLAIM IS MADE TO THE EXCLUSIVE RIGHT TO USE "MARIN ORTHODONTICS", APART FROM THE MARK AS SHOWN.

THE MARK CONSISTS OF THE WORDS "MARIN ORTHODONTICS" ADJACENT TO TWO DOLPHIN DESIGNS.

FOR ORTHODONTIC SERVICES (U.S. CLS. 100 AND 101).

FIRST USE 4-24-2009; IN COMMERCE 4-24-2009.
SUZANNE BLANE, EXAMINING ATTORNEY

CLASS 44—(Continued).

SN 77-733,918. HUMANA INC., LOUISVILLE, KY. FILED 5-11-2009.

HUMANA CARES

THE MARK CONSISTS OF STANDARD CHARACTERS WITHOUT CLAIM TO ANY PARTICULAR FONT, STYLE, SIZE, OR COLOR.

OWNER OF U.S. REG. NOS. 1,305,479, 3,116,497 AND OTHERS.

FOR DISEASE MANAGEMENT SERVICES, NAMELY, PROVIDING INFORMATION ON ACUTE AND CHRONIC HEALTH CONDITIONS, PROVIDING INFORMATION ON TREATMENTS AND PATIENT CARE SERVICES FOR ACUTE AND CHRONIC HEALTH CONDITIONS; PROVIDING HEALTH CARE INFORMATION OFFERED BY NURSES THROUGH TELECOMMUNICATIONS NETWORKS AND THE INTERNET; PROVIDING MEDICAL SERVICES OFFERED BY CARE MANAGEMENT NURSES VIA THE INTERNET OR TELECOMMUNICATIONS NETWORKS; DISEASE MANAGEMENT SERVICES FOR INSURANCE AND HEALTH MAINTENANCE ORGANIZATION PLAN MEMBERS WITH CHRONIC AND HIGH-RISK CONDITIONS; MEDICARE PRESCRIPTION DRUG COVERAGE PLAN SERVICES, NAMELY, COMPLEX CASE DISEASE MANAGEMENT AND DISEASE MANAGEMENT; MEDICARE PRESCRIPTION COVERAGE PLAN SERVICES, NAMELY, DISEASE MANAGEMENT PROGRAMS, AND COMPLEX CASE MANAGEMENT SERVICES IN THE NATURE OF PROVIDING CONSULTATION SERVICES TO PATIENTS WITH CHRONIC CONDITIONS REGARDING MEDICATION COMPLIANCE, AND PROVIDING INFORMATION REGARDING HEALTH AND SAFETY ISSUES REGARDING CHRONIC CONDITIONS; PATIENT HEALTHCARE MANAGEMENT PROGRAMS, NAMELY, PROVIDING EVALUATION SERVICES TO FORMULATE DISEASE-SPECIFIC PATIENT TREATMENT PLANS, THERAPY OPTIMIZATION PLANS FOR THE TREATMENT OF CHRONIC DISEASES AND PATIENT CARE PROGRAMS IN THE NATURE OF MONITORING EFFECTIVENESS OF MEDICAL TREATMENTS AND PLANNING MEDICAL TREATMENT INTERVENTIONS; PROVIDING HEALTHCARE, NURSING CARE, AND MEDICAL SERVICES; PHYSICAL THERAPY; MEDICAL COUNSELING; CONSULTATION IN THE FIELD OF HOME HEALTH TREATMENT PROGRAMS ADAPTED TO INDIVIDUAL PATIENT NEEDS, NAMELY, FACILITATING PATIENT'S TRANSITION FROM HOSPITAL TO HOME, ASSESSING THE HOME ENVIRONMENT AND THE PATIENT CONDITION, MONITORING A PATIENT'S CONDITION AND REPORTING SAME TO OTHERS TO FACILITATE THEIR PROVISION OF HOME HEALTHCARE SERVICES PROVIDED, AND PHARMACEUTICALS AND EQUIPMENT UTILIZED TO TREAT THE PATIENT; CLINICAL TESTING FOR OTHERS IN THE HEALTHCARE FIELD; PROVIDING MEDICAL THERAPY AND INFORMATION SERVICES TO INDIVIDUALS AFFECTED BY CERTAIN CHRONIC DISORDER; NEUROLOGICAL REHABILITATION SERVICES; REGENERATIVE PHYSICAL THERAPY; HEALTHCARE SERVICES, NAMELY, WELLNESS PROGRAMS, DISEASE MANAGEMENT PROGRAMS AND CARE SUPPORT PROGRAMS; HEALTHCARE SERVICES IN THE NATURE OF HEALTH MAINTENANCE AND PREFERRED PROVIDER ORGANIZATIONS, DISPENSING OF PHARMACEUTICALS, AND HEALTH MANAGEMENT ORGANIZATIONS; BEHAVIORAL HEALTH DISEASE MANAGEMENT PROGRAMS, NAMELY, MEDICAL COUNSELING AND MEDICAL SERVICES IN THE FIELD OF BEHAVIORAL HEALTH AND DISEASE MANAGEMENT; MEDICAL ADVISORY SERVICES VIA TELEPHONE (U.S. CLS. 100 AND 101).

HEATHER BIDDULPH, EXAMINING ATTORNEY

CLASS 44—(Continued).

SN 77-736,019. ISLAMIC RELIEF WORLDWIDE, BIRMINGHAM, UNITED KINGDOM, FILED 5-13-2009.

ISLAMIC RELIEF WORLDWIDE

THE MARK CONSISTS OF STANDARD CHARACTERS WITHOUT CLAIM TO ANY PARTICULAR FONT, STYLE, SIZE, OR COLOR.

OWNER OF ERPN CMNTY TM OFC REG. NO. 005806062, DATED 4-24-2008, EXPIRES 4-2-2017.

OWNER OF U.S. REG. NOS. 3,302,215, 3,302,270 AND OTHERS.

NO CLAIM IS MADE TO THE EXCLUSIVE RIGHT TO USE "WORLDWIDE", APART FROM THE MARK AS SHOWN.

SEC. 2(F) AS TO "ISLAMIC RELIEF".

FOR CHARITABLE SERVICES, NAMELY, PROVIDING MEDICAL SERVICES, HEALTH CARE, AND EMERGENCY MEDICAL ASSISTANCE TO NEEDY PERSONS; CHARITABLE SERVICES, NAMELY, PROVIDING AGRICULTURAL ADVICE, EQUIPMENT, AND SEEDS TO NEEDY PERSONS; PROVIDING INFORMATION VIA A GLOBAL COMMUNICATIONS NETWORK ON PROVIDING MEDICAL SERVICES, HEALTH CARE, AND EMERGENCY MEDICAL ASSISTANCE TO NEEDY PERSONS (U.S. CLS. 100 AND 101).

FIRST USE 1-1-2007; IN COMMERCE 1-1-2007.

MELISSA VALLILLO, EXAMINING ATTORNEY

SN 77-738,127. SYNERON CANADA CORPORATION, RICHMOND HILL, CANADA, FILED 5-15-2009.

SUBLATE

THE MARK CONSISTS OF STANDARD CHARACTERS WITHOUT CLAIM TO ANY PARTICULAR FONT, STYLE, SIZE, OR COLOR.

FOR AESTHETIC SKIN PROCEDURES USING RADIO-FREQUENCY, LIGHT AND ULTRASOUND ENERGY (U.S. CLS. 100 AND 101).

KATINA MISTER, EXAMINING ATTORNEY

SN 77-738,143. SYNERON CANADA CORPORATION, RICHMOND HILL, CANADA, FILED 5-15-2009.

SUBABLATION

THE MARK CONSISTS OF STANDARD CHARACTERS WITHOUT CLAIM TO ANY PARTICULAR FONT, STYLE, SIZE, OR COLOR.

FOR AESTHETIC SKIN PROCEDURES USING RADIO-FREQUENCY, LIGHT AND ULTRASOUND ENERGY (U.S. CLS. 100 AND 101).

KATINA MISTER, EXAMINING ATTORNEY

CLASS 44—(Continued).

SN 77-746,398. DONOR NETWORK ALLIANCE, LLC, NORTHBROOK, IL. FILED 5-28-2009.

DNA

THE MARK CONSISTS OF STANDARD CHARACTERS WITHOUT CLAIM TO ANY PARTICULAR FONT, STYLE, SIZE, OR COLOR.

FOR PROVIDING INFORMATION VIA THE INTERNET CONCERNING THE AVAILABILITY OF HUMAN EGGS OR DONORS FOR ACHIEVING PREGNANCY (U.S. CLS. 100 AND 101).

FIRST USE 2-0-2009; IN COMMERCE 2-0-2009.

TIMOTHY FINNEGAN, EXAMINING ATTORNEY

SN 77-746,432. DONOR NETWORK ALLIANCE, LLC, NORTHBROOK, IL. FILED 5-28-2009.



THE MARK CONSISTS OF THREE CIRCLES OF ALTERNATING DARK AND LIGHT SHADING INTERSECTING IN A VERTICAL ARRAY.

FOR PROVIDING INFORMATION VIA THE INTERNET CONCERNING THE AVAILABILITY OF HUMAN EGGS OR DONORS FOR ACHIEVING PREGNANCY (U.S. CLS. 100 AND 101).

FIRST USE 2-0-2009; IN COMMERCE 2-0-2009.

TIMOTHY FINNEGAN, EXAMINING ATTORNEY

SN 77-752,178. SHIRLEY'S SOLUTIONS, COPPELL, TX. FILED 6-4-2009.

UnderWraps

THE MARK CONSISTS OF STANDARD CHARACTERS WITHOUT CLAIM TO ANY PARTICULAR FONT, STYLE, SIZE, OR COLOR.

FOR COSMETIC BODY CARE SERVICES IN THE NATURE OF BODY WRAPS UTILIZING EXFOLIATION, CREAM, PROTECTIVE SLEEVE AND WOVEN FIBER WRAPS TO MOISTURIZE AND REPAIR DRY SKIN AND HAIR (U.S. CLS. 100 AND 101).

SEAN CROWLEY, EXAMINING ATTORNEY

CLASS 44—(Continued).

SN 77-752,670. COASTAL RANGE VINEYARDS, INC., DBA COASTAL RANGE VINEYARDS, SANTA CRUZ, CA. FILED 6-4-2009.

Coastal Range Vineyards

THE MARK CONSISTS OF STANDARD CHARACTERS WITHOUT CLAIM TO ANY PARTICULAR FONT, STYLE, SIZE, OR COLOR.

NO CLAIM IS MADE TO THE EXCLUSIVE RIGHT TO USE "VINEYARDS", APART FROM THE MARK AS SHOWN.

FOR VINEYARD AND WINERY SERVICES, NAMELY, THE CULTIVATION OF GRAPES FOR OTHERS (U.S. CLS. 100 AND 101).

FIRST USE 1-1-2008; IN COMMERCE 1-1-2008.
MICHAEL KEATING, EXAMINING ATTORNEY

CLASS 44—(Continued).

SN 77-767,493. NAVIGATING ADHD, CENTERVILLE, MA. FILED 6-24-2009.

Navigating ADHD

A Practical Path from Chaos to Calm

NO CLAIM IS MADE TO THE EXCLUSIVE RIGHT TO USE "ADHD", APART FROM THE MARK AS SHOWN.

THE MARK CONSISTS OF "NAVIGATING ADHD A PRACTICAL PATH FROM CHAOS TO CALM".

FOR CONSULTING SERVICES IN THE FIELD OF MENTAL HEALTH AND WELLNESS (U.S. CLS. 100 AND 101).

FIRST USE 3-1-2009; IN COMMERCE 3-1-2009.
MORGAN WYNNE, EXAMINING ATTORNEY

SN 77-754,058. SKIN LASER REJUVENATION LLC, NEW YORK, NY. FILED 6-8-2009.



THE MARK CONSISTS OF THE CHARACTERS "SLR" WITH THE "S" SITTING IN THE MIDDLE AND TO THE LEFT OF THE CHARACTER "L" AND THE BACK BRIDGE OF THE "R" ANCHORED ON THE SAME PLAIN AS THE "L" AND THE CHARACTERS "L" AND "R" IN SLIGHTLY LARGER LETTERING THAN THE "S".

FOR MEDICAL SERVICES, NAMELY, LASER HAIR REMOVAL; HEALTH SPA SERVICES, NAMELY, LASER TREATMENTS FOR ACNE, REJUVENATION, SCARS, TATTOO REMOVAL AND FOR FACIALS; COSMETIC ELECTROLYSIS; PERMANENT HAIR REMOVAL AND REDUCTION; AND HEALTH SPA SERVICES, NAMELY, COSMETIC BODY CARE SERVICES (U.S. CLS. 100 AND 101).

FIRST USE 4-16-2008; IN COMMERCE 4-16-2008.
KATHERINE STOIDES, EXAMINING ATTORNEY

SN 77-773,840. PARSONS, JERRY, SAN ANTONIO, TX. FILED 7-2-2009.

PLANTANSWERS

THE MARK CONSISTS OF STANDARD CHARACTERS WITHOUT CLAIM TO ANY PARTICULAR FONT, STYLE, SIZE, OR COLOR.

SEC. 2(F).

FOR PROVIDING A WEB SITE FEATURING ANSWERS TO QUESTIONS ABOUT PLANTS, NAMELY, PROVIDING GARDENING INFORMATION ABOUT LIVE PLANTS AND PLANT RECOMMENDATIONS FOR ALL CLIMATE AREAS, NOT FOR BUSINESS OR ADVERTISING PURPOSES (U.S. CLS. 100 AND 101).

FIRST USE 4-4-1999; IN COMMERCE 4-4-1999.
ANDREW LEASER, EXAMINING ATTORNEY

CLASS 44—(Continued).

SN 77-785,319. LEVIN & MILLER CORPORATIONS, DBA POSTUREWORKS, SAN FRANCISCO, CA. FILED 7-20-2009.



THE COLOR(S) GREEN, GREY, AND WHITE IS/ARE CLAIMED AS A FEATURE OF THE MARK.

THE MARK CONSISTS OF (FROM LEFT TO RIGHT) 2 MALE SILHOUETTES ARE GREY, THIRD MALE SILHOUETTE IS WHITE, THE BOXES SURROUNDING THE SILHOUETTES ARE LIME GREEN, THE WORD "POSTURE" IS LIME GREEN, THE WORD "WORKS" IS GREY, THE TWO WORDS "POSTUREWORKS" ARE SEEN AS ONE WORD.

FOR CHIROPRACTIC SERVICES; PROVIDING ASSISTANCE, FITNESS EVALUATION AND CONSULTATION TO INDIVIDUALS TO HELP THEM MAKE HEALTH, WELLNESS AND NUTRITIONAL CHANGES IN THEIR DAILY LIVING TO IMPROVE HEALTH; PROVIDING HEALTHY LIFESTYLE AND NUTRITION SERVICES, NAMELY, PERSONAL ASSESSMENTS, PERSONALIZED ROUTINES, MAINTENANCE SCHEDULES, AND COUNSELING (U.S. CLS. 100 AND 101).

FIRST USE 3-1-2009; IN COMMERCE 3-1-2009.
MICHAEL SOUDERS, EXAMINING ATTORNEY

SN 77-802,175. HEART SOLUTIONS OF OKLAHOMA, PC, OKLAHOMA CITY, OK. FILED 8-11-2009.



NO CLAIM IS MADE TO THE EXCLUSIVE RIGHT TO USE "HEART SOLUTIONS OF OKLAHOMA", APART FROM THE MARK AS SHOWN.

THE STIPPLING IS FOR SHADING PURPOSES ONLY.
THE COLOR(S) RED, PINK AND BLACK IS/ARE CLAIMED AS A FEATURE OF THE MARK.

THE MARK CONSISTS OF DESIGN FEATURING TWO SEEMINGLY OVERLAPPING HEARTS WITH DOUBLE RED OUTLINING, PINK WITHIN THE DOUBLE OUTLINES AND PINK SHADOWS, ALL OVER THE BLACK STYLIZED WORDING "HEART SOLUTIONS OF OKLAHOMA". THE INTERIOR OF THE HEARTS CONSISTS OF NEGATIVE SPACE THAT WILL BE THE COLOR OF THE ITEM UPON WHICH THE MARK IS PLACED.

FOR PHYSICIAN SERVICES (U.S. CLS. 100 AND 101).
FIRST USE 2-1-2004; IN COMMERCE 2-1-2004.
TRACY WHITTAKER-BROWN, EXAMINING ATTORNEY

CLASS 44—(Continued).

SN 77-819,096. OPTIONS FOR LIVING, INC., SILVER SPRING, MD. FILED 9-3-2009.

OPTIONS FOR LIVING INC.

THE MARK CONSISTS OF STANDARD CHARACTERS WITHOUT CLAIM TO ANY PARTICULAR FONT, STYLE, SIZE, OR COLOR.

NO CLAIM IS MADE TO THE EXCLUSIVE RIGHT TO USE "INC.", APART FROM THE MARK AS SHOWN.

FOR PSYCHOLOGICAL TESTING AND CONSULTATION RENDERED IN CONNECTION THEREWITH; GERONTOLOGICAL MEDICAL AND PSYCHOLOGICAL TESTING AND CONSULTATION RENDERED IN CONNECTION THEREWITH (U.S. CLS. 100 AND 101).

KATHLEEN M. VANSTON, EXAMINING ATTORNEY

SN 77-835,410. ERGO SOLUTIONS, LLC, BOWIE, MD. FILED 9-25-2009.



NO CLAIM IS MADE TO THE EXCLUSIVE RIGHT TO USE "SOLUTIONS", APART FROM THE MARK AS SHOWN.

THE COLOR(S) RED, PINK, WHITE, AND BLACK IS/ARE CLAIMED AS A FEATURE OF THE MARK.

THE MARK CONSISTS OF THE WORDING "E ERGO SOLUTIONS" WITH THE LARGE STYLIZED "E" IN RED, PINK, BLACK AND WHITE, TO THE RIGHT OF WHICH IS THE WORDING "ERGO" IN BLACK, WITH THE WORDING "SOLUTIONS" IN BLACK BELOW THE WORDING "E ERGO".

FOR OCCUPATIONAL THERAPY SERVICES; PHYSICAL THERAPY EVALUATION, IDENTIFICATION, AND MANAGEMENT OF MOVEMENT DYSFUNCTION TO RESTORE, MAINTAIN, AND PROMOTE OPTIMAL PHYSICAL FUNCTION PREVENTING THE ONSET, SYMPTOMS AND PROGRESSION OF IMPAIRMENTS, FUNCTIONAL LIMITATIONS, AND DISABILITIES RESULTING FROM DISEASE, DISORDERS, CONDITIONS, OR INJURIES; SPEECH PATHOLOGY THERAPY SERVICES (U.S. CLS. 100 AND 101).

FIRST USE 1-1-2004; IN COMMERCE 1-1-2004.
SUZANNE BLANE, EXAMINING ATTORNEY

CLASS 44—(Continued).

SN 77-844,522. ST. LUKE'S EPISCOPAL-PRESBYTERIAN HOSPITALS, CHESTERFIELD, MO. FILED 10-8-2009.

**ALBERT PUJOLS WELLNESS
CENTER FOR ADULTS WITH
DOWN SYNDROME**

THE MARK CONSISTS OF STANDARD CHARACTERS WITHOUT CLAIM TO ANY PARTICULAR FONT, STYLE, SIZE, OR COLOR.

NO CLAIM IS MADE TO THE EXCLUSIVE RIGHT TO USE "WELLNESS CENTER FOR ADULTS WITH DOWN SYNDROME", APART FROM THE MARK AS SHOWN.

THE NAME(S), PORTRAIT(S), AND/OR SIGNATURE(S) SHOWN IN THE MARK IDENTIFIES "ALBERT PUJOLS", WHOSE CONSENT(S) TO REGISTER IS MADE OF RECORD.

FOR MEDICAL CARE SERVICES; PSYCHOLOGICAL ASSESSMENT SERVICES; COUNSELING SERVICES IN THE FIELDS OF HEALTH AND NUTRITION; MENTAL HEALTH COUNSELING AS IT RELATES TO BUILDING RELATIONSHIPS (U.S. CLS. 100 AND 101).

ROBIN CHOSID, EXAMINING ATTORNEY

SN 77-850,434. ALFRED SOFER, FAIRFIELD, CT. FILED 10-16-2009.

**YOUR LOOK, YOUR CHOICE,
YOUR CONFIDENCE**

THE MARK CONSISTS OF STANDARD CHARACTERS WITHOUT CLAIM TO ANY PARTICULAR FONT, STYLE, SIZE, OR COLOR.

FOR PLASTIC, COSMETIC AND RECONSTRUCTIVE SURGERY (U.S. CLS. 100 AND 101).

FIRST USE 9-15-2009; IN COMMERCE 9-15-2009.
ALLISON HOLTZ, EXAMINING ATTORNEY

SN 77-860,947. FUSION SLEEP, SUWANEE, GA. FILED 10-29-2009.

Sleep4Safety

THE MARK CONSISTS OF STANDARD CHARACTERS WITHOUT CLAIM TO ANY PARTICULAR FONT, STYLE, SIZE, OR COLOR.

FOR MEDICAL SERVICES, NAMELY, PROVISION OF EVALUATION, TESTING, AND TREATMENT SERVICES FOR PATIENTS SUFFERING FROM SLEEP DISORDERS; SERVICE IS FOCUSED ON COMPANIES WITH SAFETY CRITICAL OPERATIONS, AND SUGGESTS THE IMPORTANT OF HEALTHY SLEEP FOR A SAFE OPERATOR IN INDUSTRIES SUCH AS TRUCKING, AVIATION, RAIL AND LOGISTICS (U.S. CLS. 100 AND 101).

FIRST USE 8-1-2009; IN COMMERCE 10-15-2009.
KIMBERLY PERRY, EXAMINING ATTORNEY

CLASS 44—(Continued).

SN 77-870,496. UNIVERSITY OF UTAH RESEARCH FOUNDATION, SALT LAKE CITY, UT. FILED 11-11-2009.

7 DOMAINS OF WOMEN'S HEALTH

THE MARK CONSISTS OF STANDARD CHARACTERS WITHOUT CLAIM TO ANY PARTICULAR FONT, STYLE, SIZE, OR COLOR.

NO CLAIM IS MADE TO THE EXCLUSIVE RIGHT TO USE "WOMEN'S HEALTH", APART FROM THE MARK AS SHOWN.

FOR CONSULTING SERVICES IN THE FIELD OF WOMEN'S HEALTH; HEALTH CARE SERVICES, NAMELY, WELLNESS PROGRAMS (U.S. CLS. 100 AND 101).

TAMARA FRAZIER, EXAMINING ATTORNEY

SN 77-873,582. VISIONMAKERS, DAYTON, OH. FILED 11-16-2009.



THE MARK CONSISTS OF STYLIZED ABSTRACT DRAWING CONSISTING OF OUTLINE OF EYE WITH EYEBALL. THERE IS AN INCOMPLETE TRIANGLE IN THE BACKGROUND. DIRECTLY INSIDE THE EYE AND CONTINUING TO THE RIGHT OF THE EYE, IS THE WORD "VISIONMAKERS". THE EYEBALL TAKES THE PLACE OF THE LETTER "O" IN THE WORD "VISIONMAKERS".

FOR OPTICIAN SERVICES (U.S. CLS. 100 AND 101).
FIRST USE 6-3-1992; IN COMMERCE 6-3-1992.
ADA HAN, EXAMINING ATTORNEY

CLASS 44—(Continued).

SN 77-876,854. WARNER OB/GYN ASSOCIATES PC, WASHINGTON, DC. FILED 11-19-2009.



NO CLAIM IS MADE TO THE EXCLUSIVE RIGHT TO USE "GREEN PREGNANCY", APART FROM THE MARK AS SHOWN.

THE MARK CONSISTS OF "GREENPREGNANCY" IN STYLIZED LETTERS, ABOVE WHICH APPEARS A SHADED CIRCLE CONTAINING THREE CURVED LINES. FOR COUNSELING SERVICES IN THE FIELDS OF HEALTH, NUTRITION AND LIFESTYLE WELLNESS; MEDICAL SERVICES (U.S. CLS. 100 AND 101).

JOHN SCHUYLER YARD, EXAMINING ATTORNEY

SN 77-877,755. COLE, STEVEN A, HUNTINGTON, NY. FILED 11-20-2009.

UB-PAP

THE MARK CONSISTS OF STANDARD CHARACTERS WITHOUT CLAIM TO ANY PARTICULAR FONT, STYLE, SIZE, OR COLOR.

FOR COUNSELING SERVICES IN THE FIELDS OF HEALTH, NUTRITION AND LIFESTYLE WELLNESS (U.S. CLS. 100 AND 101).

LAKEISHA LEWIS, EXAMINING ATTORNEY

SN 77-877,781. COLE, STEVEN A, HUNTINGTON, NY. FILED 11-20-2009.

CMI

THE MARK CONSISTS OF STANDARD CHARACTERS WITHOUT CLAIM TO ANY PARTICULAR FONT, STYLE, SIZE, OR COLOR.

FOR COUNSELING SERVICES IN THE FIELDS OF HEALTH, NUTRITION AND LIFESTYLE WELLNESS (U.S. CLS. 100 AND 101).

LAKEISHA LEWIS, EXAMINING ATTORNEY

CLASS 44—(Continued).

SN 77-878,733. WESTMONT LIVING, INC., SAN DIEGO, CA. FILED 11-23-2009.

COMPASS ROSE

THE MARK CONSISTS OF STANDARD CHARACTERS WITHOUT CLAIM TO ANY PARTICULAR FONT, STYLE, SIZE, OR COLOR.

FOR PROVIDING MEDICAL AND NURSING SERVICES IN THE FIELDS OF DEMENTIA CARE AND ALZHEIMER'S CARE FOR SENIOR CITIZENS (U.S. CLS. 100 AND 101).

DAVID COLLIER, EXAMINING ATTORNEY

SN 77-878,750. WESTMONT LIVING, INC., SAN DIEGO, CA. FILED 11-23-2009.

NAVIGATING THE ALZHEIMER'S JOURNEY

THE MARK CONSISTS OF STANDARD CHARACTERS WITHOUT CLAIM TO ANY PARTICULAR FONT, STYLE, SIZE, OR COLOR.

FOR PROVIDING MEDICAL AND NURSING SERVICES IN THE FIELDS OF DEMENTIA CARE AND ALZHEIMER'S CARE FOR SENIOR CITIZENS (U.S. CLS. 100 AND 101).

DAVID COLLIER, EXAMINING ATTORNEY

SN 77-881,021. FRANKLIN C. BAER, AKA SANRU, HARRISONBURG, VA. FILED 11-25-2009.

SANRU

THE MARK CONSISTS OF STANDARD CHARACTERS WITHOUT CLAIM TO ANY PARTICULAR FONT, STYLE, SIZE, OR COLOR.

FOR CHARITABLE SERVICES, NAMELY, PROVIDING HEALTH CARE EQUIPMENT; CONSULTING SERVICES TO HEALTH CARE PROVIDERS IN THE FIELD OF TREATING LIFE-CHANGING OR LIFE-THREATENING DISEASES; HEALTH CARE SERVICES, NAMELY, DISEASE MANAGEMENT PROGRAMS; HEALTH CARE SERVICES, NAMELY, WELLNESS PROGRAMS; HEALTHCARE SERVICES, NAMELY, INTEGRATED HEALTHCARE SERVICES WITH A NETWORK OF INTERNATIONAL HEALTHCARE PROVIDERS (U.S. CLS. 100 AND 101).

FIRST USE 3-15-1983; IN COMMERCE 6-22-1992.

MATTHEW PAPPAS, EXAMINING ATTORNEY

CLASS 44—(Continued).

SN 77-881,178. AMERICAN FERTILITY INSTITUTE, DBA FERTILITY MIRACLES, BEVERLY HILLS, CA. FILED 11-25-2009.

Fertility Miracles

THE MARK CONSISTS OF STANDARD CHARACTERS WITHOUT CLAIM TO ANY PARTICULAR FONT, STYLE, SIZE, OR COLOR.

NO CLAIM IS MADE TO THE EXCLUSIVE RIGHT TO USE "FERTILITY", APART FROM THE MARK AS SHOWN.

FOR HUMAN EGG DONATION SERVICES; MATERNAL SURROGACY SERVICES; MEDICAL SERVICES, NAMELY, IN VITRO FERTILIZATION; MEDICAL SERVICES, NAMELY, FERTILITY SERVICES (U.S. CLS. 100 AND 101).

FIRST USE 6-1-2007; IN COMMERCE 6-1-2007.
CHARISMA HAMPTON, EXAMINING ATTORNEY

SN 77-881,365. LINDER, BRETT T, ANCHORAGE, AK. FILED 11-26-2009.



THE COLOR(S) FOREST GREEN, SUMMER GREEN, AND WHITE IS/ARE CLAIMED AS A FEATURE OF THE MARK.

THE MARK CONSISTS OF A FOREST GREEN IMAGE OF THE BODY SPRAWLED OUT OVER SUMMER GREEN RADIANT CIRCLES UPON A WHITE BACKGROUND.

FOR BODYWORK THERAPY; BODYWORK THERAPY SERVICES, NAMELY, STRUCTURAL INTEGRATION THERAPY AND MOVEMENT THERAPY; PHYSICAL THERAPY (U.S. CLS. 100 AND 101).

FIRST USE 10-24-2009; IN COMMERCE 10-24-2009.
TINA L. SNAPP, EXAMINING ATTORNEY

CLASS 44—(Continued).

SN 77-881,784. TOOLEY JR., DUNCAN S., DBA TOOLEY TRANSFORMATION TRAINING, RANCHO PALOS VERDES, CA. FILED 11-29-2009.

Mental Lap Band

THE MARK CONSISTS OF STANDARD CHARACTERS WITHOUT CLAIM TO ANY PARTICULAR FONT, STYLE, SIZE, OR COLOR.

NO CLAIM IS MADE TO THE EXCLUSIVE RIGHT TO USE "MENTAL", APART FROM THE MARK AS SHOWN.

FOR HYPNOSIS SERVICES (U.S. CLS. 100 AND 101).

FIRST USE 10-24-2009; IN COMMERCE 11-6-2009.

ELI HELLMAN, EXAMINING ATTORNEY

SN 77-882,476. BULLARO-ANDERER, DEANNA LYNN, D.O., LLC, MESA, AZ. FILED 11-30-2009.

Baby Whisperer

THE MARK CONSISTS OF STANDARD CHARACTERS WITHOUT CLAIM TO ANY PARTICULAR FONT, STYLE, SIZE, OR COLOR.

NO CLAIM IS MADE TO THE EXCLUSIVE RIGHT TO USE "BABY", APART FROM THE MARK AS SHOWN.

FOR OBSTETRIC AND GYNECOLOGY SERVICES (U.S. CLS. 100 AND 101).

ANNE FARRELL, EXAMINING ATTORNEY

SN 77-883,179. BEN ATKINS CONSULTING, LLC, DUNEDIN, FL. FILED 12-1-2009.

Come Here, Get Well, Go Home

THE MARK CONSISTS OF STANDARD CHARACTERS WITHOUT CLAIM TO ANY PARTICULAR FONT, STYLE, SIZE, OR COLOR.

SEC. 2(F).

FOR CONVALESCENCE HOMES; CONVALESCENT HOMES; HOME NURSING AID SERVICES; MEDICAL EVALUATION SERVICES, NAMELY, FUNCTIONAL ASSESSMENT PROGRAM FOR PATIENTS RECEIVING MEDICAL REHABILITATION SERVICES FOR PURPOSES OF GUIDING TREATMENT AND ASSESSING PROGRAM EFFECTIVENESS; MEDICAL, PHYSICAL REHABILITATION AND PHYSICAL THERAPY SERVICES; NURSING CARE; NURSING HOMES; NURSING SERVICES; PHYSICAL REHABILITATION; PROVIDING MENTAL REHABILITATION FACILITIES; PROVIDING PHYSICAL REHABILITATION FACILITIES; REHABILITATION PATIENT CARE SERVICES; REHABILITATION PATIENT CARE SERVICES WHICH INCLUDES INPATIENT AND OUTPATIENT CARE; REST HOMES (U.S. CLS. 100 AND 101).

FIRST USE 4-1-2008; IN COMMERCE 4-1-2008.

CHARISMA HAMPTON, EXAMINING ATTORNEY

CLASS 44—(Continued).

SN 77-884,161. PALMER, SAMUEL E., KATHLEEN, GA. FILED 12-2-2009.



NO CLAIM IS MADE TO THE EXCLUSIVE RIGHT TO USE "WEIGHT LOSS PROGRAM", APART FROM THE MARK AS SHOWN.

THE COLOR(S) GREEN, PURPLE AND BLACK IS/ARE CLAIMED AS A FEATURE OF THE MARK.

THE MARK CONSISTS OF THE WORDING "SHAPE UP WEIGHT LOSS PROGRAM YOUR BODY YOUR HEALTH YOUR LIFE". THE LETTER "S" IN THE WORD "SHAPE" IS PURPLE STYLIZED LETTER S WITH ONE PURPLE STROKE TO THE LEFT UPPER CURVATURE OF THE LETTER S AND A GREEN OVAL BETWEEN THE STROKE AND THE UPPER CURVATURE OF THE LETTER S; THE LETTERS "HAPE" ARE IN PURPLE. THE WORD "UP" IS IN GREEN. THE WORDS "WEIGHT LOSS PROGRAM" ARE IN PURPLE. THE WORDS "YOUR BODY YOUR HEALTH YOUR LIFE" ARE IN BLACK.

FOR PROVIDING WEIGHT LOSS PROGRAM SERVICES (U.S. CLS. 100 AND 101).

FIRST USE 1-1-2009; IN COMMERCE 1-1-2009.
MATTHEW KLINE, EXAMINING ATTORNEY

SN 77-884,768. LE, VU, FOOTHILL RANCH, CA. FILED 12-2-2009.

THESIMPLETOOTH

THE MARK CONSISTS OF STANDARD CHARACTERS WITHOUT CLAIM TO ANY PARTICULAR FONT, STYLE, SIZE, OR COLOR.

FOR DENTISTRY (U.S. CLS. 100 AND 101).

FIRST USE 1-5-2005; IN COMMERCE 10-5-2005.

CHARISMA HAMPTON, EXAMINING ATTORNEY

CLASS 44—(Continued).

SN 77-885,375. QUALTEX LABORATORIES, SAN ANTONIO, TX. FILED 12-3-2009.

**Your Testing Service
Solution**

THE MARK CONSISTS OF STANDARD CHARACTERS WITHOUT CLAIM TO ANY PARTICULAR FONT, STYLE, SIZE, OR COLOR.

NO CLAIM IS MADE TO THE EXCLUSIVE RIGHT TO USE "TESTING SERVICE", APART FROM THE MARK AS SHOWN.

FOR MEDICAL TESTING; INFECTIOUS DISEASE TESTING; AND MEDICAL TESTING IN THE NATURE OF GENETIC TESTING (U.S. CLS. 100 AND 101).

FIRST USE 1-1-2009; IN COMMERCE 1-1-2009.
HANNO RITTNER, EXAMINING ATTORNEY

SN 77-886,027. NEFF, KRIS L., WESTERVILLE, OH. AND BLANKENBECKLER, JEFFREY A., WESTERVILLE, OH. FILED 12-4-2009.

WE CREATE SMILES

THE MARK CONSISTS OF STANDARD CHARACTERS WITHOUT CLAIM TO ANY PARTICULAR FONT, STYLE, SIZE, OR COLOR.

FOR DENTIST SERVICES (U.S. CLS. 100 AND 101).

FIRST USE 5-2-2009; IN COMMERCE 5-2-2009.
KRISTINA MORRIS, EXAMINING ATTORNEY

SN 77-886,393. SABHARWAL, HARINDER, SUNNYVALE, CA. AND SABHARWAL, ANSHU SETH, SUNNYVALE, CA. FILED 12-4-2009.

Temple of Health

THE MARK CONSISTS OF STANDARD CHARACTERS WITHOUT CLAIM TO ANY PARTICULAR FONT, STYLE, SIZE, OR COLOR.

NO CLAIM IS MADE TO THE EXCLUSIVE RIGHT TO USE "HEALTH", APART FROM THE MARK AS SHOWN.

FOR CONSULTING SERVICES IN THE FIELD OF HEALTH; COUNSELING SERVICES IN THE FIELDS OF HEALTH, NUTRITION AND LIFESTYLE WELLNESS; PROVIDING HEALTH INFORMATION (U.S. CLS. 100 AND 101).

KATHLEEN M. VANSTON, EXAMINING ATTORNEY

CLASS 44—(Continued).

SN 77-886,944. KELLY, NANCY, JEAN, CENTENNIAL, CO. FILED 12-4-2009.

Medicine Fat

THE MARK CONSISTS OF STANDARD CHARACTERS WITHOUT CLAIM TO ANY PARTICULAR FONT, STYLE, SIZE, OR COLOR.

NO CLAIM IS MADE TO THE EXCLUSIVE RIGHT TO USE "MEDICINE", APART FROM THE MARK AS SHOWN. FOR ALTERNATIVE MEDICINE SERVICES (U.S. CLS. 100 AND 101).
SARA THOMAS, EXAMINING ATTORNEY

CLASS 44—(Continued).

SN 77-888,017. SOUTHWEST GENERAL HEALTH CENTER, CLEVELAND, OH. FILED 12-7-2009.

OAKVIEW

THE MARK CONSISTS OF STANDARD CHARACTERS WITHOUT CLAIM TO ANY PARTICULAR FONT, STYLE, SIZE, OR COLOR.

FOR BEHAVIORAL HEALTH SERVICES, NAMELY, CHEMICAL DEPENDENCY TREATMENT, ADDICTIVE DISEASE TREATMENT, AND ALCOHOLISM TREATMENT (U.S. CLS. 100 AND 101).
FIRST USE 9-1-1985; IN COMMERCE 9-1-1985.
GISELLE AGOSTO, EXAMINING ATTORNEY

SN 77-888,284. HOSPITAL CLINICAL SERVICES GROUP, INC., NASHVILLE, TN. FILED 12-8-2009.

SN 77-887,313. SLEEP MORE MEDICAL, INC., DBA SLEEP-MORE, OVERLAND PARK, KS. FILED 12-7-2009.

SleepMore

THE MARK CONSISTS OF STANDARD CHARACTERS WITHOUT CLAIM TO ANY PARTICULAR FONT, STYLE, SIZE, OR COLOR.

FOR HEALTH ASSESSMENT SERVICES, NAMELY, PROVIDING A DATABASE IN THE FIELD OF SLEEP APNEA AND HOME SLEEP TESTING DIAGNOSTIC INFORMATION BASED ON COLLECTED DATA AND INFORMATION ALL FOR TREATMENT AND DIAGNOSTIC PURPOSES; HEALTHCARE SERVICES, NAMELY, TREATMENT OF PATIENTS WITH SNORING AND SLEEP APNEA DISORDERS; PROVIDING AN INTERNET WEB SITE FOR MEDICAL PROFESSIONALS AND MEDICAL PATIENTS RELATING TO SLEEP APNEA AND RELATED DIAGNOSTIC DATA INPUT FROM REMOTE LOCATIONS USING ELECTRONIC PATIENT MONITORING DEVICES THAT FEED INFORMATION TO THE WEB SITE FOR USE BY MEDICAL PROFESSIONALS FOR PURPOSES OF MONITORING AND DIAGNOSING MEDICAL CONDITIONS; PROVIDING INFORMATION IN THE FIELD OF SLEEP APNEA AND RELATED SLEEP DISORDERS FOR DOCTORS AND PATIENTS (U.S. CLS. 100 AND 101).
MICHAEL WIENER, EXAMINING ATTORNEY

HCSG

THE MARK CONSISTS OF STANDARD CHARACTERS WITHOUT CLAIM TO ANY PARTICULAR FONT, STYLE, SIZE, OR COLOR.

FOR MEDICAL SERVICES PROVIDED ON AN OUT-SOURCING BASIS (U.S. CLS. 100 AND 101).
FIRST USE 5-0-2007; IN COMMERCE 5-0-2007.
SHANNON TWOHIG, EXAMINING ATTORNEY

SN 77-888,287. HOSPITAL CLINICAL SERVICES GROUP, INC., NASHVILLE, TN. FILED 12-8-2009.



THE MARK CONSISTS OF A RIBBON SHAPE WITH THE CAPITAL LETTERS "HC" ON IT AND THE CAPITAL LETTERS "SG" BELOW IT.

FOR MEDICAL SERVICES PROVIDED ON AN OUT-SOURCING BASIS (U.S. CLS. 100 AND 101).
FIRST USE 5-0-2007; IN COMMERCE 5-0-2007.
SHANNON TWOHIG, EXAMINING ATTORNEY

CLASS 44—(Continued).

SN 77-888,383. INKSHOPS, INC., BARTLETT, IL. FILED 12-8-2009.

HIGH STAKES TATTOO

THE MARK CONSISTS OF STANDARD CHARACTERS WITHOUT CLAIM TO ANY PARTICULAR FONT, STYLE, SIZE, OR COLOR.

NO CLAIM IS MADE TO THE EXCLUSIVE RIGHT TO USE "TATTOO", APART FROM THE MARK AS SHOWN. FOR TATTOOING SERVICES (U.S. CLS. 100 AND 101).
NICHOLAS COLEMAN, EXAMINING ATTORNEY

SN 77-888,733. THE MCLEAN HOSPITAL CORPORATION, BELMONT, MA. FILED 12-8-2009.

MCLEAN

THE MARK CONSISTS OF STANDARD CHARACTERS WITHOUT CLAIM TO ANY PARTICULAR FONT, STYLE, SIZE, OR COLOR.

OWNER OF U.S. REG. NOS. 1,150,076 AND 2,549,637. SEC. 2(F).
FOR HEALTH CARE; HOSPITALS; MENTAL HEALTH SERVICES; PROVIDING HEALTH INFORMATION; PSYCHIATRIC SERVICES; PSYCHOLOGICAL COUNSELING (U.S. CLS. 100 AND 101).
FIRST USE 6-0-1826; IN COMMERCE 6-0-1826.
TASNEEM HUSSAIN, EXAMINING ATTORNEY

SN 77-888,793. VACCINATION STATION, INC., DBA OPERATION VACCINATION, DALLAS, TX. FILED 12-8-2009.

OPERATION VACCINATION

THE MARK CONSISTS OF STANDARD CHARACTERS WITHOUT CLAIM TO ANY PARTICULAR FONT, STYLE, SIZE, OR COLOR.

NO CLAIM IS MADE TO THE EXCLUSIVE RIGHT TO USE "VACCINATION", APART FROM THE MARK AS SHOWN.
FOR VETERINARY SERVICES (U.S. CLS. 100 AND 101).
FIRST USE 4-23-1980; IN COMMERCE 4-23-1980.
WENDY GOODMAN, EXAMINING ATTORNEY

CLASS 44—(Continued).

SN 77-888,800. YOUSSEF, AMIR, MIAMI, FL. FILED 12-8-2009.

PRIVATE LOVE DESIGN

THE MARK CONSISTS OF STANDARD CHARACTERS WITHOUT CLAIM TO ANY PARTICULAR FONT, STYLE, SIZE, OR COLOR.

NO CLAIM IS MADE TO THE EXCLUSIVE RIGHT TO USE "DESIGN", APART FROM THE MARK AS SHOWN. FOR BODY WAXING SERVICES (U.S. CLS. 100 AND 101).
MAUREEN DALL, EXAMINING ATTORNEY

SN 77-888,810. YOUSSEF, AMIR, MIAMI, FL. FILED 12-8-2009.

PLD

THE MARK CONSISTS OF STANDARD CHARACTERS WITHOUT CLAIM TO ANY PARTICULAR FONT, STYLE, SIZE, OR COLOR.

FOR BODY WAXING SERVICES (U.S. CLS. 100 AND 101).
MAUREEN DALL, EXAMINING ATTORNEY

SN 77-889,266. JENNIFER SMITH FOX, DBA THE SVELTE GOURMET, MEGGETT, SC. FILED 12-9-2009.

THE SVELTE GOURMET

THE MARK CONSISTS OF STANDARD CHARACTERS WITHOUT CLAIM TO ANY PARTICULAR FONT, STYLE, SIZE, OR COLOR.

NO CLAIM IS MADE TO THE EXCLUSIVE RIGHT TO USE "GOURMET", APART FROM THE MARK AS SHOWN. FOR PROVIDING INFORMATION ON MAINTAINING A HEALTHY LIFESTYLE AND LOSING WEIGHT (U.S. CLS. 100 AND 101).
FIRST USE 10-6-2009; IN COMMERCE 10-6-2009.
ALEXANDER L. POWERS, EXAMINING ATTORNEY

CLASS 44—(Continued).

SN 77-890,154. HAFKIN, BETSY, NEW YORK, NY. FILED 12-10-2009.

I listen with my hands

THE MARK CONSISTS OF STANDARD CHARACTERS WITHOUT CLAIM TO ANY PARTICULAR FONT, STYLE, SIZE, OR COLOR.

FOR MASSAGE; MASSAGE AND THERAPEUTIC SHIATSU MASSAGE; MASSAGE THERAPY SERVICES; MESSAGES (U.S. CLS. 100 AND 101).

FIRST USE 12-1-2008; IN COMMERCE 12-1-2008.
ALICIA COLLINS, EXAMINING ATTORNEY

SN 77-891,120. FORBESS, BILLY A., LEXINGTON, KY. FILED 12-11-2009.



THE COLOR(S) BLACK, WHITE AND RED IS/ARE CLAIMED AS A FEATURE OF THE MARK.

THE MARK CONSISTS OF A WHITE KANGAROO, OUTLINED IN BLACK, WEARING A RED AND WHITE CHECK DRESS WITH WHITE APRON, AND A RED BOW ON THE TAIL AND RED SHOES, CARRYING A RED TOOTHBRUSH, AND A WHITE BABY KANGAROO OUTLINED IN BLACK IS IN THE POUCH ON THE FRONT OF THE APRON.

FOR DENTIST SERVICES (U.S. CLS. 100 AND 101).
FIRST USE 9-1-1980; IN COMMERCE 9-1-1980.
SANDRA BUJA, EXAMINING ATTORNEY

SN 77-891,189. RESPOND SYSTEMS, INC., BRANFORD, CT. FILED 12-11-2009.

The Power of Cool

THE MARK CONSISTS OF STANDARD CHARACTERS WITHOUT CLAIM TO ANY PARTICULAR FONT, STYLE, SIZE, OR COLOR.

FOR PROVIDING LASER THERAPY FOR TREATING MEDICAL CONDITIONS (U.S. CLS. 100 AND 101).

SUSAN STIGLITZ, EXAMINING ATTORNEY

CLASS 44—(Continued).

SN 77-891,190. THE NATIONAL MAGAZINE COMPANY LIMITED, LONDON, UNITED KINGDOM, FILED 12-11-2009.

NETDOCTOR

THE MARK CONSISTS OF STANDARD CHARACTERS WITHOUT CLAIM TO ANY PARTICULAR FONT, STYLE, SIZE, OR COLOR.

FOR HEALTHCARE; MEDICAL ASSISTANCE SERVICES; MEDICAL COUNSELING; PROVIDING A WEB SITE FEATURING INFORMATION ON HEALTH AND NUTRITION; PROVIDING A WEB SITE FEATURING MEDICAL INFORMATION; PSYCHOLOGICAL TESTING (U.S. CLS. 100 AND 101).

FIRST USE 3-1-2000; IN COMMERCE 3-1-2000.
JEFF DEFORD, EXAMINING ATTORNEY

SN 77-891,974. BRAINSTORMS, INC., SANTA FE, NM. FILED 12-11-2009.

SUPERMIND

THE MARK CONSISTS OF STANDARD CHARACTERS WITHOUT CLAIM TO ANY PARTICULAR FONT, STYLE, SIZE, OR COLOR.

FOR PROVIDING INFORMATION IN THE FIELDS OF HEALTH, FITNESS, DIET, NUTRITION, WEIGHT MANAGEMENT, AND LIFESTYLE WELLNESS VIA THE INTERNET (U.S. CLS. 100 AND 101).

EVELYN BRADLEY, EXAMINING ATTORNEY

SN 77-892,007. EXISTENCE GENETICS, LOS ANGELES, CA. FILED 12-11-2009.

NEXUS

THE MARK CONSISTS OF STANDARD CHARACTERS WITHOUT CLAIM TO ANY PARTICULAR FONT, STYLE, SIZE, OR COLOR.

FOR GENETIC TESTING FOR MEDICAL PURPOSES (U.S. CLS. 100 AND 101).

FLORENTINA BLANDU, EXAMINING ATTORNEY

CLASS 44—(Continued).

SN 77-892,410. JOHNSON & JOHNSON, NEW BRUNSWICK, NJ. FILED 12-14-2009.

MY WAY WITH MIGRAINES

THE MARK CONSISTS OF STANDARD CHARACTERS WITHOUT CLAIM TO ANY PARTICULAR FONT, STYLE, SIZE, OR COLOR.

NO CLAIM IS MADE TO THE EXCLUSIVE RIGHT TO USE "MIGRAINES", APART FROM THE MARK AS SHOWN.

FOR PROVIDING A WEBSITE FEATURING INFORMATION ON THE TREATMENT AND PREVENTION OF MIGRAINES (U.S. CLS. 100 AND 101).

FIRST USE 4-13-2006; IN COMMERCE 4-13-2006.
SANJEEV VOHRA, EXAMINING ATTORNEY

SN 77-892,420. JOHNSON & JOHNSON, NEW BRUNSWICK, NJ. FILED 12-14-2009.

DIABETICONS

THE MARK CONSISTS OF STANDARD CHARACTERS WITHOUT CLAIM TO ANY PARTICULAR FONT, STYLE, SIZE, OR COLOR.

FOR PROVIDING INFORMATION TO PATIENTS ABOUT DIABETES VIA THE INTERNET (U.S. CLS. 100 AND 101).

SANJEEV VOHRA, EXAMINING ATTORNEY

SN 77-892,525. MICHAEL FOLEY, CHICAGO, IL. FILED 12-14-2009.

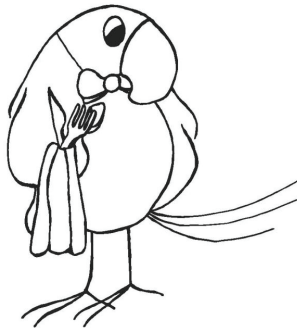

THE MARK CONSISTS OF AN IMAGE OF A BIRD HOLDING A NAPKIN AND UTENSILS.

FOR CONSULTING SERVICES IN THE FIELDS OF HEALTH AND NUTRITION (U.S. CLS. 100 AND 101).

KHANH LE, EXAMINING ATTORNEY

CLASS 44—(Continued).

SN 77-892,680. SHAWNEE MISSION MEDICAL CENTER, INC., SHAWNEE MISSION, KS. FILED 12-14-2009.



THE MARK CONSISTS OF A STYLIZED LETTER "S" WITH A PARTIAL STARBURST CUT OUT OF IT.

FOR HEALTH CARE; HOME HEALTH CARE SERVICES; MASSAGE THERAPY SERVICES; MEDICAL CLINICS; MEDICAL RADIOLOGY SERVICES; MEDICAL SERVICES; MEDICAL TESTING; MENTAL HEALTH SERVICES; NUTRITION COUNSELING; PERFORMING DIAGNOSIS OF DISEASES; PHYSICAL REHABILITATION; PHYSICAL THERAPY; PHYSICIAN SERVICES; PROVIDING A WEB SITE FEATURING MEDICAL INFORMATION; PROVIDING HEALTH INFORMATION; PROVIDING HEALTHY LIFESTYLE AND NUTRITION SERVICES, NAMELY, PERSONAL ASSESSMENTS, PERSONALIZED ROUTINES, MAINTENANCE SCHEDULES, AND COUNSELING; PROVIDING INFORMATION IN THE FIELD OF SURGICAL WEIGHT LOSS; PROVIDING MEDICAL INFORMATION; PROVIDING MEDICAL INFORMATION, CONSULTANCY AND ADVISORY SERVICES; PROVIDING WEIGHT LOSS PROGRAM SERVICES; SURGERY (U.S. CLS. 100 AND 101).

FIRST USE 2-10-2003; IN COMMERCE 2-10-2003.
ELISSA GARBER KON, EXAMINING ATTORNEY

SN 77-892,751. ESOTERIX, INC., AUSTIN, TX. FILED 12-14-2009.

HPVDET_X

THE MARK CONSISTS OF STANDARD CHARACTERS WITHOUT CLAIM TO ANY PARTICULAR FONT, STYLE, SIZE, OR COLOR.

FOR MEDICAL TESTING (U.S. CLS. 100 AND 101).

FIRST USE 1-1-2002; IN COMMERCE 1-1-2002.

JOHN DWYER, EXAMINING ATTORNEY

CLASS 44—(Continued).

SN 77-893,134. SUN STREET CENTERS, SALINAS, CA.
FILED 12-14-2009.

Sun Street Centers

THE MARK CONSISTS OF STANDARD CHARACTERS WITHOUT CLAIM TO ANY PARTICULAR FONT, STYLE, SIZE, OR COLOR.

NO CLAIM IS MADE TO THE EXCLUSIVE RIGHT TO USE "CENTERS", APART FROM THE MARK AS SHOWN. SEC. 2(F).

FOR ADDICTION TREATMENT SERVICES; INFORMATION ABOUT PARENTING TOPICS, NAMELY, DRUG AND ALCOHOL AWARENESS; PROVIDING HEALTHY LIFESTYLE AND NUTRITION SERVICES, NAMELY, PERSONAL ASSESSMENTS, PERSONALIZED ROUTINES, MAINTENANCE SCHEDULES, AND COUNSELING; REHABILITATION OF ALCOHOL ADDICTED PATIENTS (U.S. CLS. 100 AND 101).

FIRST USE 1-24-1966; IN COMMERCE 1-24-1966.
GISELLE AGOSTO, EXAMINING ATTORNEY

SN 77-893,675. FAZIO MEDIA CONSULTING, LLC, ROCHESTER, NY. FILED 12-15-2009.

Put your hand in my hand

THE MARK CONSISTS OF STANDARD CHARACTERS WITHOUT CLAIM TO ANY PARTICULAR FONT, STYLE, SIZE, OR COLOR.

FOR MEDICAL SERVICES (U.S. CLS. 100 AND 101).
ARETHA SOMERVILLE, EXAMINING ATTORNEY

SN 77-894,077. AMEDISYS, INC., BATON ROUGE, LA.
FILED 12-15-2009.

C₄M

THE MARK CONSISTS OF THE LETTER "C", THE NUMBER "4" SUBSCRIPTED, AND THE LETTER "M".

FOR HEALTH CARE SERVICES AND HEALTH CARE INFORMATION SERVICES, NAMELY, PROVIDING INFORMATION TO OTHERS ABOUT EVIDENCE-BASED COORDINATED CARE FOR CHRONICALLY ILL PATIENTS AND PROVIDING HEALTH CARE TO CHRONICALLY ILL PATIENTS (U.S. CLS. 100 AND 101).

FIRST USE 5-4-2009; IN COMMERCE 5-4-2009.
LIEF MARTIN, EXAMINING ATTORNEY

CLASS 44—(Continued).

SN 77-894,109. AMEDISYS, INC., BATON ROUGE, LA.
FILED 12-15-2009.

CCCCM

THE MARK CONSISTS OF STANDARD CHARACTERS WITHOUT CLAIM TO ANY PARTICULAR FONT, STYLE, SIZE, OR COLOR.

FOR HEALTH CARE SERVICES AND HEALTH CARE INFORMATION SERVICES, NAMELY, PROVIDING INFORMATION TO OTHERS ABOUT EVIDENCE-BASED COORDINATED CARE FOR CHRONICALLY ILL PATIENTS AND PROVIDING HEALTH CARE TO CHRONICALLY ILL PATIENTS (U.S. CLS. 100 AND 101).

LIEF MARTIN, EXAMINING ATTORNEY

SN 77-896,183. WILFORD, GLENN P, RIALTO, CA. FILED 12-17-2009.

hairfanatics

THE MARK CONSISTS OF STANDARD CHARACTERS WITHOUT CLAIM TO ANY PARTICULAR FONT, STYLE, SIZE, OR COLOR.

FOR HAIR SALON SERVICES, NAMELY, HAIR CUTTING, STYLING, COLORING, AND HAIR EXTENSION SERVICES (U.S. CLS. 100 AND 101).

FIRST USE 12-24-2007; IN COMMERCE 12-24-2007.
DAWN FELDMAN, EXAMINING ATTORNEY

SN 77-897,236. ORA STUDIOS, LTD., CHICAGO, IL. FILED 12-18-2009.

NATURALLY BEAUTIFUL

THE MARK CONSISTS OF STANDARD CHARACTERS WITHOUT CLAIM TO ANY PARTICULAR FONT, STYLE, SIZE, OR COLOR.

FOR DENTISTRY; GENERAL, SPECIALTY, AND COSMETIC DENTAL SERVICES; DENTAL SERVICES IN THE FIELD OF ORAL SURGERY, TOOTH WHITENING, DENTAL CARE, HYGIENE, AND TREATMENT; COUNSELING PERTAINING TO DENTISTRY, DENTAL SERVICES, TOOTH WHITENING, ORAL SURGERY, AND ORAL HYGIENE; TOOTH WHITENING SERVICES; DENTAL SERVICES CENTERS FEATURING TOOTH WHITENING SERVICES; ORAL SURGERY SERVICES; SPA SERVICES, NAMELY, PROVIDING COSMETIC DENTAL CARE (U.S. CLS. 100 AND 101).

FIRST USE 10-1-2008; IN COMMERCE 10-1-2008.
JASON LOTT, EXAMINING ATTORNEY

CLASS 44—(Continued).

SN 77-911,823. BRAINSTORMS, INC., SANTA FE, NM.
FILED 1-14-2010.



THE MARK CONSISTS OF THE WORDING "MY HEALING KITCHEN MEALS THAT HEAL", WITH A DESIGN OF A SPOON AND FORK FORMING THE LETTERS "RX", ALL THE WORDING APPEARING IS A SHADED RECTANGLE. FOR PROVIDING INFORMATION IN THE FIELDS OF HEALTH, DIET, NUTRITION, WEIGHT MANAGEMENT, AND LIFESTYLE WELLNESS VIA THE INTERNET (U.S. CLS. 100 AND 101).

FIRST USE 10-30-2009; IN COMMERCE 10-30-2009.
EVELYN BRADLEY, EXAMINING ATTORNEY

CLASS 44—(Continued).

SN 77-924,739. INKSHOPS, INC., BARTLETT, IL. FILED 2-1-2010.

High Stakes Ink

THE MARK CONSISTS OF STANDARD CHARACTERS WITHOUT CLAIM TO ANY PARTICULAR FONT, STYLE, SIZE, OR COLOR.

NO CLAIM IS MADE TO THE EXCLUSIVE RIGHT TO USE "INK", APART FROM THE MARK AS SHOWN.

FOR BODY PIERCING SERVICES; TATTOOING SERVICES (U.S. CLS. 100 AND 101).

NICHOLAS COLEMAN, EXAMINING ATTORNEY

SN 77-924,616. HOSPITAL CLINICAL SERVICES GROUP, INC., NASHVILLE, TN. FILED 2-1-2010.



NO CLAIM IS MADE TO THE EXCLUSIVE RIGHT TO USE "SPECIALTYCARE", APART FROM THE MARK AS SHOWN.

THE MARK CONSISTS OF THE WORDS "SPECIALTYCARE" APPEARING BELOW A RIBBON-LIKE DESIGN INCORPORATING THE LETTERS "SC".

FOR MEDICAL SERVICES PROVIDED ON AN OUTSOURCING BASIS (U.S. CLS. 100 AND 101).

SHANNON TWOHIG, EXAMINING ATTORNEY

CLASS 45—PERSONAL AND LEGAL SERVICES

SN 77-184,729. WICKFORD EQUITIES, LLC, MINDEN, NV.
FILED 5-18-2007.

SuccessDNA

THE MARK CONSISTS OF STANDARD CHARACTERS WITHOUT CLAIM TO ANY PARTICULAR FONT, STYLE, SIZE, OR COLOR.

FOR ONLINE SOCIAL NETWORKING SERVICES (U.S. CLS. 100 AND 101).

FIRST USE 12-28-2007; IN COMMERCE 12-28-2007.
SUZANNE BLANE, EXAMINING ATTORNEY

SN 77-924,630. HOSPITAL CLINICAL SERVICES GROUP, INC., NASHVILLE, TN. FILED 2-1-2010.



THE MARK CONSISTS OF A RIBBON-LIKE DESIGN INCORPORATING THE LETTERS "SC".

FOR MEDICAL SERVICES PROVIDED ON AN OUTSOURCING BASIS (U.S. CLS. 100 AND 101).

SHANNON TWOHIG, EXAMINING ATTORNEY

SN 77-563,083. ALARM SPECIALIST CORPORATION, DBA ALL AMERICAN MONITORING, SARASOTA, FL. FILED 9-5-2008.

ALL AMERICAN MONITORING

NO CLAIM IS MADE TO THE EXCLUSIVE RIGHT TO USE "MONITORING", APART FROM THE MARK AS SHOWN.

FOR ALARM MONITORING (U.S. CLS. 100 AND 101).
MARK PILARO, EXAMINING ATTORNEY

CLASS 45—(Continued).

SN 77-622,418. SOURCECORP, INCORPORATED, DALLAS, TX. FILED 11-26-2008.

KINSELLA MEDIA

THE MARK CONSISTS OF STANDARD CHARACTERS WITHOUT CLAIM TO ANY PARTICULAR FONT, STYLE, SIZE, OR COLOR.

NO CLAIM IS MADE TO THE EXCLUSIVE RIGHT TO USE "MEDIA", APART FROM THE MARK AS SHOWN.

SEC. 2(F) AS TO "KINSELLA".
FOR LITIGATION SUPPORT SERVICES, NAMELY, DESIGNING AND IMPLEMENTING NOTIFICATION PROGRAMS (U.S. CLS. 100 AND 101).

FIRST USE 2-2-2009; IN COMMERCE 2-2-2009.
KELLY BOULTON, EXAMINING ATTORNEY

CLASS 45—(Continued).

SN 77-736,106. ISLAMIC RELIEF WORLDWIDE, BIRMINGHAM, UNITED KINGDOM, FILED 5-13-2009.

ISLAMIC RELIEF WORLDWIDE

THE MARK CONSISTS OF STANDARD CHARACTERS WITHOUT CLAIM TO ANY PARTICULAR FONT, STYLE, SIZE, OR COLOR.

OWNER OF U.S. REG. NOS. 3,302,215, 3,302,270 AND OTHERS.

NO CLAIM IS MADE TO THE EXCLUSIVE RIGHT TO USE "WORLDWIDE", APART FROM THE MARK AS SHOWN.

SEC. 2(F) AS TO "ISLAMIC RELIEF".
FOR CHARITABLE SERVICES, NAMELY, PROVIDING CLOTHING TO NEEDY PERSONS; ISLAMIC MINISTERIAL SERVICES; PROVIDING INFORMATION VIA A GLOBAL COMMUNICATIONS NETWORK ON ISLAM AND ON CHARITABLE INFORMATION FOR PROVIDING CLOTHING TO NEEDY PERSONS (U.S. CLS. 100 AND 101).

FIRST USE 1-1-2009; IN COMMERCE 1-1-2009.
MELISSA VALLILLO, EXAMINING ATTORNEY

SN 77-744,040. TRUSTWAVE HOLDINGS, INC., ANNAPOLIS, MD. FILED 5-26-2009.

**The ELEMENTS of compliance
and data security**

THE MARK CONSISTS OF STANDARD CHARACTERS WITHOUT CLAIM TO ANY PARTICULAR FONT, STYLE, SIZE, OR COLOR.

NO CLAIM IS MADE TO THE EXCLUSIVE RIGHT TO USE "COMPLIANCE AND DATA SECURITY", APART FROM THE MARK AS SHOWN.

FOR REVIEWING STANDARDS AND PRACTICES TO ASSURE COMPLIANCE WITH PAYMENT CARD INDUSTRY SECURITY STANDARDS COUNCIL LAWS AND REGULATIONS (U.S. CLS. 100 AND 101).

FIRST USE 3-1-2009; IN COMMERCE 3-1-2009.
FONG HSU, EXAMINING ATTORNEY

FOOK

SN 77-689,173. NG FOOK FUNERAL SERVICES LLC, NEW YORK, NY. FILED 3-12-2009.

THE MARK CONSISTS OF STANDARD CHARACTERS WITHOUT CLAIM TO ANY PARTICULAR FONT, STYLE, SIZE, OR COLOR.

THE ENGLISH TRANSLATION OF "FOOK" IN THE MARK IS "BLESSING".

FOR FUNERARY SERVICES, NAMELY, CONSULTATION AND PLANNING FOR FUNERALS AND MEMORIALS; ARRANGING AND CONDUCTING CEREMONIES FOR FUNERALS AND MEMORIALS; ARRANGING AND COORDINATING VIEWINGS, TRANSPORTATION, RECEPTIONS, FLOWERS, CASKETS, VAULTS, URNS, CEREMONIAL ACCOUTERMENTS, INTERMENT, AND NOTICES (U.S. CLS. 100 AND 101).

FIRST USE 10-31-1976; IN COMMERCE 10-31-1976.
DAVID ELTON, EXAMINING ATTORNEY

SN 77-748,064. EPISCOPAL DIOCESE OF FORT WORTH, FORT WORTH, TX. FILED 5-29-2009.

**The Episcopal Diocese of
Fort Worth**

THE MARK CONSISTS OF STANDARD CHARACTERS WITHOUT CLAIM TO ANY PARTICULAR FONT, STYLE, SIZE, OR COLOR.

SEC. 2(F).
FOR RELIGIOUS SERVICES, NAMELY, MINISTERIAL, EVANGELICAL AND MISSIONARY SERVICES (U.S. CLS. 100 AND 101).

FIRST USE 6-1-1983; IN COMMERCE 6-1-1983.
HAI-LY LAM, EXAMINING ATTORNEY

CLASS 45—(Continued).

SN 77-753,608. EMPOWUR, LLC, BERKELEY, CA. FILED 6-5-2009.



THE COLOR(S) GREEN, RED, BLUE AND YELLOW IS/ARE CLAIMED AS A FEATURE OF THE MARK.

THE MARK CONSISTS OF A SEMI-CIRCLE OF GREEN, RED AND BLUE THAT GRADUALLY FADES, OVER THREE BLUE SILHOUETTES OF HUMAN FIGURES IN A YELLOW BACKGROUND.

FOR PROVIDING INFORMATION ABOUT PERSONAL GROWTH AND SELF IMPROVEMENT IN AN ONLINE, INTERACTIVE FORMAT SO PARTICIPANTS CAN TRACK THEIR PERSONAL GROWTH AND SELF IMPROVEMENT (U.S. CLS. 100 AND 101).

MARY BOAGNI, EXAMINING ATTORNEY

CLASS 45—(Continued).

SN 77-777,519. LIONZ GATE SECURITY SERVICES TRAINING CENTER LLC, MIAMI, FL. FILED 7-9-2009.



NO CLAIM IS MADE TO THE EXCLUSIVE RIGHT TO USE "SECURITY SERVICES", APART FROM THE MARK AS SHOWN.

THE COLOR(S) BLACK, WHITE, RED, GRAY, IS/ARE CLAIMED AS A FEATURE OF THE MARK.

THE MARK CONSISTS OF A RED SHIELD WITH A GRAY AND WHITE BORDER, A GRAY AND WHITE LION HEAD INSIDE OF SHIELD BACKED BY A HALF CIRCLE IN THE COLOR BLACK, A BLACK HORIZONTAL LINE AT BOTTOM OF THE LION'S HEAD. THE LETTERS "LG" ARE IN RED AT THE BOTTOM OF THE SHIELD WHICH IS BORDERED IN GRAY. UNDER THE SHIELD ARE THE WORDS "LIONZ GATE SECURITY SERVICES" IN THE COLORS BLACK AND WHITE.

FOR SECURITY GUARD SERVICES (U.S. CLS. 100 AND 101).

JUSTINE D. PARKER, EXAMINING ATTORNEY

SN 77-760,576. VITA-MIX CORPORATION, CLEVELAND, OH. FILED 6-16-2009.

VITA-VILLAGE

THE MARK CONSISTS OF STANDARD CHARACTERS WITHOUT CLAIM TO ANY PARTICULAR FONT, STYLE, SIZE, OR COLOR.

FOR ONLINE SOCIAL NETWORKING SERVICES (U.S. CLS. 100 AND 101).

FIRST USE 8-0-2008; IN COMMERCE 8-0-2008.

TARA PATE, EXAMINING ATTORNEY

SN 77-784,622. BB ONLINE UK LIMITED, TA BB-ONLINE, LONGFIELD DA3 7JF, UNITED KINGDOM, FILED S.R. 7-20-2009; AM. P.R. 3-16-2010.

bb-online

THE MARK CONSISTS OF STANDARD CHARACTERS WITHOUT CLAIM TO ANY PARTICULAR FONT, STYLE, SIZE, OR COLOR.

FOR DOMAIN NAME REGISTRATION SERVICES (U.S. CLS. 100 AND 101).

FIRST USE 1-30-1997; IN COMMERCE 1-30-1997.

MAYUR VAGHANI, EXAMINING ATTORNEY

CLASS 45—(Continued).

SN 77-796,424. PLATTFORM VDW, INC., DBA PLATTFORM ADVERTISING, NEW YORK, NY. FILED 8-4-2009.



THE MARK CONSISTS OF SIX BOXES WITH THE LETTER "S" IN THE SECOND BOX, THE LETTER "G" IN THE THIRD BOX, THE LETTER "E" IN THE FOURTH BOX, A PARTIAL SPROCKET IN THE FIFTH BOX WITH A VINE WITH TWO LEAVES INTERSECTING THE TOP RIGHT OF THE FIFTH BOX AND THE WORDS "SELF-GROWTHENGINE.COM" BELOW THE SIX BOXES.

FOR PROVIDING A RESOURCE WEBSITE PROVIDING INFORMATION IN THE FIELD OF PERSONAL DEVELOPMENT (U.S. CLS. 100 AND 101).

KRISTINA MORRIS, EXAMINING ATTORNEY



SN 77-813,536. DAVIS POLK & WARDWELL LLP, NEW YORK, NY. FILED 8-26-2009.

DAVIS POLK

THE MARK CONSISTS OF STANDARD CHARACTERS WITHOUT CLAIM TO ANY PARTICULAR FONT, STYLE, SIZE, OR COLOR.

OWNER OF U.S. REG. NO. 2,321,090.

THE NAME(S), PORTRAIT(S), AND/OR SIGNATURE(S) SHOWN IN THE MARK DOES NOT IDENTIFY A PARTICULAR LIVING INDIVIDUAL.

FOR LEGAL SERVICES (U.S. CLS. 100 AND 101).

FIRST USE 6-22-2009; IN COMMERCE 6-22-2009.

LAKEISHA LEWIS, EXAMINING ATTORNEY



SN 77-814,680. HAYES, GORDON H, MORRIS PLAINS, NJ. FILED 8-27-2009.

MARRIAGE MINDED SINGLES

THE MARK CONSISTS OF STANDARD CHARACTERS WITHOUT CLAIM TO ANY PARTICULAR FONT, STYLE, SIZE, OR COLOR.

NO CLAIM IS MADE TO THE EXCLUSIVE RIGHT TO USE "SINGLES", APART FROM THE MARK AS SHOWN.

FOR COMPUTER DATING SERVICES; DATING SERVICES; INTERNET-BASED DATING, SOCIAL INTRODUCTION AND SOCIAL NETWORKING SERVICES (U.S. CLS. 100 AND 101).

RAMONA ORTIGA, EXAMINING ATTORNEY

CLASS 45—(Continued).

SN 77-826,157. BOYD, TRACY, ROCHESTER, MI. FILED 9-14-2009.

Pastor Tracy Boyd

THE MARK CONSISTS OF STANDARD CHARACTERS WITHOUT CLAIM TO ANY PARTICULAR FONT, STYLE, SIZE, OR COLOR.

NO CLAIM IS MADE TO THE EXCLUSIVE RIGHT TO USE "PASTOR", APART FROM THE MARK AS SHOWN.

THE NAME "PASTOR TRACY BOYD" IDENTIFIES A LIVING INDIVIDUAL WHOSE CONSENT IS OF RECORD.

FOR CHRISTIAN MINISTRY SERVICES (U.S. CLS. 100 AND 101).

AMY C. KEAN, EXAMINING ATTORNEY



SN 77-839,998. US PUBLISHERS, INC., NEWARK, DE. FILED 10-2-2009.

USIMMIGRATIONSUPPORT.ORG

THE MARK CONSISTS OF STANDARD CHARACTERS WITHOUT CLAIM TO ANY PARTICULAR FONT, STYLE, SIZE, OR COLOR.

SEC. 2(F).

FOR PROVIDING A WEBSITE FEATURING INFORMATION ABOUT THE LEGAL ASPECTS OF IMMIGRATION (U.S. CLS. 100 AND 101).

FIRST USE 1-12-2004; IN COMMERCE 1-12-2004.

NANCY CLARKE, EXAMINING ATTORNEY

CLASS 45—(Continued).

SN 77-843,992. SMITH AND HOUNDS INC., BROOKLYN, NY. FILED 10-7-2009.



THE COLOR(S) BLACK, BLUE AND WHITE IS/ARE CLAIMED AS A FEATURE OF THE MARK.

THE MARK CONSISTS OF A STYLIZED DESIGN OF THE LETTERS "CXC" AS ONE DESIGN WITH THE COLOR BLENDING FROM BLACK TO BLUE AND BACK TO BLACK GOING FROM LEFT TO RIGHT; THE BLUE LETTER "X" HAS WHITE HIGHLIGHTS; BELOW THIS DESIGN IS THE WORDING CLASS "X" CHANGE WITH THE BLACK "X" HAVING EXTENDED ENDS ENCOMPASSING THE TOP AND THE BOTTOM OF THE BLUE WORDS.

FOR PROVIDING ON-LINE COMPUTER DATABASES AND ON-LINE SEARCHABLE DATABASES IN THE FIELD OF SOCIAL NETWORKING (U.S. CLS. 100 AND 101).

FIRST USE 9-16-2009; IN COMMERCE 9-16-2009.
LINDA MICKLEBURGH, EXAMINING ATTORNEY

CLASS 45—(Continued).

SN 77-857,843. BIOHOLOGRAPH, INC., MODESTO, CA. FILED 10-26-2009.

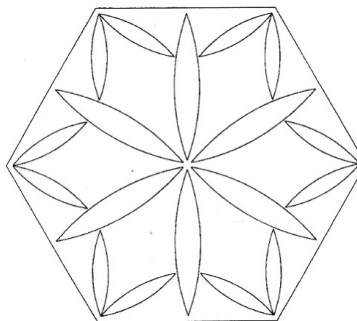

THE MARK CONSISTS OF A HEXAGON THAT INCLUDES SIX MODIFIED ELLIPTICAL SHAPES RADIATING OUT FROM THE CENTER TO THE FLAT SIDES OF THE HEXAGON, AND TWELVE PAIRS OF SMALLER MODIFIED ELLIPTICAL SHAPES, TWO IN EACH CORNER OF THE HEXAGON.

FOR PROVIDING CONSULTATION TO INDIVIDUALS IN THE FIELD OF METAPHYSICAL ENHANCEMENTS AND IMPROVEMENTS (U.S. CLS. 100 AND 101).

KATHLEEN LORENZO, EXAMINING ATTORNEY

SN 77-855,083. MPEG LA, LLC, GREENWOOD VILLAGE, CO. FILED 10-22-2009.

TAGIVAN

THE MARK CONSISTS OF STANDARD CHARACTERS WITHOUT CLAIM TO ANY PARTICULAR FONT, STYLE, SIZE, OR COLOR.

THE WORDING "TAGIVAN" HAS NO MEANING IN A FOREIGN LANGUAGE.

FOR MANAGEMENT OF INTELLECTUAL PROPERTY, NAMELY, LICENSING OF INTELLECTUAL PROPERTY TO OTHERS; INTELLECTUAL PROPERTY CONSULTATION AND PROVIDING INFORMATION ABOUT INTELLECTUAL PROPERTY AND INDUSTRIAL PROPERTY RIGHTS (U.S. CLS. 100 AND 101).

LINDA MICKLEBURGH, EXAMINING ATTORNEY

SN 77-865,021. THE ORGANIZING SORT LLC, ST. LOUIS, MO. FILED 11-4-2009.

The Organizing Sort

THE MARK CONSISTS OF STANDARD CHARACTERS WITHOUT CLAIM TO ANY PARTICULAR FONT, STYLE, SIZE, OR COLOR.

FOR ORGANIZATIONAL SERVICES FOR HOME OR PERSONAL PURPOSES, NAMELY, ORGANIZING ATTICS, BASEMENTS, KITCHENS, PLAYROOMS, BEDROOMS, GARAGES, CLOSETS, HOME OFFICES, COLLECTIBLES, MEMORABILIA, PHOTOS, STORAGE SPACES AND WAREHOUSES; PREPARING AND MANAGING HOME AND PERSONAL ITEMS FOR GARAGE SALES (U.S. CLS. 100 AND 101).

MICHAEL KEATING, EXAMINING ATTORNEY

CLASS 45—(Continued).

SN 77-868,417. ETHOS BUSINESS LAW, LLC, MINNEAPOLIS, MN. FILED 11-9-2009.

Ethos Business Law

THE MARK CONSISTS OF STANDARD CHARACTERS WITHOUT CLAIM TO ANY PARTICULAR FONT, STYLE, SIZE, OR COLOR.

NO CLAIM IS MADE TO THE EXCLUSIVE RIGHT TO USE "BUSINESS LAW", APART FROM THE MARK AS SHOWN.

FOR LEGAL SERVICES (U.S. CLS. 100 AND 101).
FIRST USE 2-1-2009; IN COMMERCE 2-1-2009.
BARBARA A. GOLD, EXAMINING ATTORNEY

SN 77-871,165. FULL SAIL MINISTRIES, VISALIA, CA. FILED 11-12-2009.



NO CLAIM IS MADE TO THE EXCLUSIVE RIGHT TO USE "MINISTRIES", APART FROM THE MARK AS SHOWN.

THE STIPPLING IS FOR SHADING PURPOSES ONLY.
THE MARK CONSISTS OF SEMI-CIRCULAR SHAPE, LIKE A SUNSET, WITH THE SHAPE OF A SAIL IN THE MIDDLE. BELOW THERE IS THE STYLIZED TEXT "FULL SAIL MINISTRIES".

FOR MINISTERIAL SERVICES (U.S. CLS. 100 AND 101).
FIRST USE 7-1-1999; IN COMMERCE 7-1-1999.
BENJAMIN OKEKE, EXAMINING ATTORNEY

CLASS 45—(Continued).

SN 77-876,361. MOMS OF AMERICA, LLC, FAIRFAX, VA. FILED 11-19-2009.



NO CLAIM IS MADE TO THE EXCLUSIVE RIGHT TO USE "MOMS OF AMERICA", APART FROM THE MARK AS SHOWN.

FOR ON-LINE SOCIAL NETWORKING SERVICES; PROVIDING AN ONLINE SOCIAL NETWORKING WEBSITE FOR SUPPORTING AND REWARDING PARENTS (U.S. CLS. 100 AND 101).

FIRST USE 10-21-2009; IN COMMERCE 10-21-2009.
SIMON TENG, EXAMINING ATTORNEY

SN 77-881,776. NORTH AMERICAN INVESTIGATIONS INC., MINEOLA, NY. FILED 11-29-2009.



NORTH AMERICAN INVESTIGATIONS

NO CLAIM IS MADE TO THE EXCLUSIVE RIGHT TO USE "INVESTIGATIONS", APART FROM THE MARK AS SHOWN.

THE MARK CONSISTS OF THE STYLIZED WORDING "NAI NORTH AMERICAN INVESTIGATIONS", WITH THE "NAI" APPEARING AS IF UNDER A MAGNIFYING GLASS. SEC. 2(F) AS TO "NORTH AMERICAN INVESTIGATIONS".

FOR BACKGROUND INVESTIGATION AND RESEARCH SERVICES; DETECTIVE INVESTIGATIONS; FAMILY LAW INVESTIGATION SERVICES; INFIDELITY INVESTIGATION SERVICES IN THE FIELD OF PERSONAL RELATIONSHIPS; MISSING PERSONS INVESTIGATION; PERSONAL BACKGROUND INVESTIGATIONS; PRIVATE INVESTIGATION (U.S. CLS. 100 AND 101).

FIRST USE 8-0-1992; IN COMMERCE 8-0-1992.
KAREN BRACEY, EXAMINING ATTORNEY

CLASS 45—(Continued).

SN 77-882,034. ROCKET21 ENTERPRISES, LLC, FAIRFIELD, CT. FILED 11-30-2009.

ROCKET21

THE MARK CONSISTS OF STANDARD CHARACTERS WITHOUT CLAIM TO ANY PARTICULAR FONT, STYLE, SIZE, OR COLOR.

FOR PROVIDING A SOCIAL NETWORKING WEBSITE FEATURING INFORMATION IN THE FIELD OF PERSONAL AND PROFESSIONAL DEVELOPMENT, INDUSTRIES AND CAREERS, AND ASSISTANCE WITH HOMEWORK ASSIGNMENTS, ALL FOR STUDENTS (U.S. CLS. 100 AND 101).

RENEE MCCRAY, EXAMINING ATTORNEY

SN 77-882,206. THE FELLOWSHIP AT CINCO RANCH, INC., KATY, TX. FILED 11-30-2009.

KOSMOS

THE MARK CONSISTS OF STANDARD CHARACTERS WITHOUT CLAIM TO ANY PARTICULAR FONT, STYLE, SIZE, OR COLOR.

FOR CHRISTIAN MINISTRY SERVICES PROVIDED AT A CHRISTIAN FELLOWSHIP CENTER (U.S. CLS. 100 AND 101).

FIRST USE 8-15-2009; IN COMMERCE 8-15-2009.

DAVID ELTON, EXAMINING ATTORNEY

SN 77-882,529. DUBOIS, SHAWN KELLY, WIMBERLEY, TX. FILED 11-30-2009.



THE MARK CONSISTS OF THE IMAGE OF A DOGHOUSE, A LEASH AND A DOG COLLAR, WITH THE WORDING "THE DOGHOUSE".

FOR CONSULTING IN THE FIELD OF PERSONAL RELATIONSHIPS; PREPARATION OF CUSTOMIZED GIFT SETS (U.S. CLS. 100 AND 101).

TARA PATE, EXAMINING ATTORNEY

CLASS 45—(Continued).

SN 77-883,185. ALEXANDRIA INTELLECTUAL PROPERTY, LLC, ALEXANDRIA, VA. FILED 12-1-2009.

Alex-IP

THE MARK CONSISTS OF STANDARD CHARACTERS WITHOUT CLAIM TO ANY PARTICULAR FONT, STYLE, SIZE, OR COLOR.

FOR LEGAL SERVICES IN THE NATURE OF MANAGING THE PROSECUTION OF INTELLECTUAL PROPERTY APPLICATIONS AND PORTFOLIOS (U.S. CLS. 100 AND 101).

MYRIAH HABEEB, EXAMINING ATTORNEY

SN 77-884,757. MARK BARRON BOWEN, LOS ANGELES, CA. FILED 12-2-2009.

SEEKINGSECURITY

THE MARK CONSISTS OF STANDARD CHARACTERS WITHOUT CLAIM TO ANY PARTICULAR FONT, STYLE, SIZE, OR COLOR.

FOR COMPUTER DATING SERVICES; ONLINE INTERNET DATING; ONLINE SOCIAL NETWORKING SERVICE; SOCIAL INTRODUCTION AGENCIES; MATCHMAKING SERVICES (U.S. CLS. 100 AND 101).

WILLIAM ROSSMAN, EXAMINING ATTORNEY

SN 77-884,920. RAYMOND KIM, SAN DIEGO, CA. AND CRAIG GOEBEL, LA JOLLA, CA. AND SCOTT NORLAND, SAN DIEGO, CA. AND ALEXENDER GENOV, SANTEE, CA. FILED 12-2-2009.

myTrailmap

THE MARK CONSISTS OF STANDARD CHARACTERS WITHOUT CLAIM TO ANY PARTICULAR FONT, STYLE, SIZE, OR COLOR.

FOR ONLINE SOCIAL NETWORKING SERVICES PROVIDED THROUGH A SPORTS COMMUNITY WEBSITE (U.S. CLS. 100 AND 101).

FIRST USE 8-1-2007; IN COMMERCE 8-1-2009.

ANNE FARRELL, EXAMINING ATTORNEY

CLASS 45—(Continued).

SN 77-887,333. NEW LEAF LEGAL, LLC, BOSTON, MA. FILED 12-7-2009.

New Leaf

THE MARK CONSISTS OF STANDARD CHARACTERS WITHOUT CLAIM TO ANY PARTICULAR FONT, STYLE, SIZE, OR COLOR.

FOR LEGAL RESEARCH; LEGAL SERVICES; LICENSING OF INTELLECTUAL PROPERTY (U.S. CLS. 100 AND 101).

FIRST USE 11-15-2009; IN COMMERCE 12-1-2009.
DOUGLAS LEE, EXAMINING ATTORNEY

SN 77-887,454. SERVICO, INC., ALBANY, NY. FILED 12-7-2009.

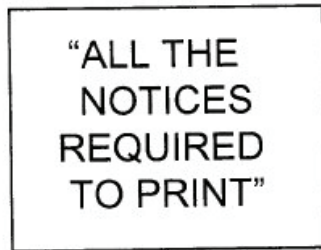

THE MARK CONSISTS OF THE TEXT, "ALL THE NOTICES REQUIRED TO PRINT" WITHIN A BORDER. SEC. 2(F) AS TO "ALL THE NOTICES REQUIRED TO PRINT".

FOR LEGAL SERVICES, NAMELY, PREPARING LEGAL NOTICES FOR PUBLICATION (U.S. CLS. 100 AND 101).

FIRST USE 2-1-2001; IN COMMERCE 2-1-2001.
MARILYN IZZI, EXAMINING ATTORNEY

SN 77-887,551. GO PRETTY LLC, NEW YORK, NY. FILED 12-7-2009.

GO PRETTY

THE MARK CONSISTS OF STANDARD CHARACTERS WITHOUT CLAIM TO ANY PARTICULAR FONT, STYLE, SIZE, OR COLOR.

FOR PERSONAL FASHION CONSULTING SERVICES; PROVIDING A WEB SITE THROUGH WHICH CUSTOMERS MAY BOOK APPOINTMENTS FOR ON-SITE PERSONAL FASHION CONSULTING SERVICES (U.S. CLS. 100 AND 101).

SANI KHOURI, EXAMINING ATTORNEY

CLASS 45—(Continued).

SN 77-887,590. PAWN ALERT, BENTON, KS. FILED 12-7-2009.

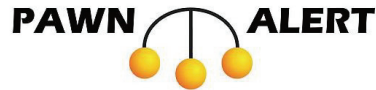

THE COLOR(S) YELLOW, BLACK IS/ARE CLAIMED AS A FEATURE OF THE MARK.

THE MARK CONSISTS OF "PAWN ALERT" ELEMENT IN BLACK, IN BETWEEN "PAWN" AND "ALERT" IS THREE GOLD BALLS CONNECTED BY BLACK LINES.

FOR STOLEN PROPERTY RECOVERY SERVICES; OPERATING A WEB SITE IN THE FIELD OF STOLEN PROPERTY RECOVERY SERVICES (U.S. CLS. 100 AND 101).

SHAUNIA CARLYLE, EXAMINING ATTORNEY

SN 77-887,644. NATIONAL COUNCIL ON FAMILY VIOLENCE, AUSTIN, TX. FILED 12-7-2009.

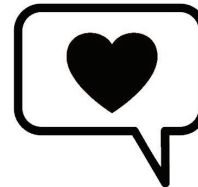

THE MARK CONSISTS OF A SPEECH BALLOON WITH A HEART CONTAINED WITHIN IT.

FOR TELEPHONIC AND INTERNET-BASED HOT-LINE SERVICES, NAMELY, OFFERING ADVICE REGARDING TEENAGE DATING VIOLENCE AND ABUSE (U.S. CLS. 100 AND 101).

FIRST USE 1-0-2007; IN COMMERCE 1-0-2007.
STEPHANIE ALI, EXAMINING ATTORNEY

SN 77-888,189. MILLER, DANIEL, LEWISVILLE, TX. AND KANELIS, NATHAN, DALLAS, TX. FILED 12-8-2009.

AllMyHomies

THE MARK CONSISTS OF STANDARD CHARACTERS WITHOUT CLAIM TO ANY PARTICULAR FONT, STYLE, SIZE, OR COLOR.

FOR ON-LINE SOCIAL NETWORKING SERVICES (U.S. CLS. 100 AND 101).

FIRST USE 4-12-2000; IN COMMERCE 4-12-2000.
ANNE E. GUSTASON, EXAMINING ATTORNEY

CLASS 45—(Continued).

SN 77-888,273. SAVASENIORCARE ADMINISTRATIVE SERVICES, LLC, ATLANTA, GA. FILED 12-8-2009.

MVP MANAGEMENT VALIDATION
PROCESS

THE MARK CONSISTS OF STANDARD CHARACTERS WITHOUT CLAIM TO ANY PARTICULAR FONT, STYLE, SIZE, OR COLOR.

NO CLAIM IS MADE TO THE EXCLUSIVE RIGHT TO USE "PROCESS", APART FROM THE MARK AS SHOWN.

FOR QUALITATIVE PRE-EMPLOYMENT BACKGROUND SCREENING SERVICE FOR HEALTH CARE PROVIDERS (U.S. CLS. 100 AND 101).

KATHERINE CHANG, EXAMINING ATTORNEY

SN 77-888,997. PALLADIUM EDUCATION, INC., PASADENA, CA. FILED 12-8-2009.

Compassionate Containment

THE MARK CONSISTS OF STANDARD CHARACTERS WITHOUT CLAIM TO ANY PARTICULAR FONT, STYLE, SIZE, OR COLOR.

FOR PROVIDING INFORMATION IN THE FIELD OF SELF-DEFENSE (U.S. CLS. 100 AND 101).

FIRST USE 9-17-2009; IN COMMERCE 10-13-2009.

SUE LAWRENCE, EXAMINING ATTORNEY

SN 77-889,796. THE NEW 2 DO.COM LLC, RYE BROOK, NY. FILED 12-9-2009.

THE NEW 2 DO

THE MARK CONSISTS OF STANDARD CHARACTERS WITHOUT CLAIM TO ANY PARTICULAR FONT, STYLE, SIZE, OR COLOR.

FOR ON-LINE SOCIAL NETWORKING SERVICES; INTERNET-BASED DATING, SOCIAL INTRODUCTION AND SOCIAL NETWORKING SERVICES; PROVIDING ON-LINE COMPUTER DATABASES AND ON-LINE SEARCHABLE DATABASES IN THE FIELD OF SOCIAL NETWORKING (U.S. CLS. 100 AND 101).

JASON LOTT, EXAMINING ATTORNEY

CLASS 45—(Continued).

SN 77-890,009. THE TODD LAW FIRM, PLLC, AUSTIN, TX. FILED 12-9-2009.



THE TODD LAW FIRM

NO CLAIM IS MADE TO THE EXCLUSIVE RIGHT TO USE "LAW FIRM", APART FROM THE MARK AS SHOWN.

THE MARK CONSISTS OF A CIRCLE WITH A GAVEL, AND THE STYLIZED TEXT "THE TODD LAW FIRM" TO THE RIGHT.

FOR LEGAL SERVICES (U.S. CLS. 100 AND 101).

FIRST USE 10-7-2009; IN COMMERCE 10-7-2009.

SUE LAWRENCE, EXAMINING ATTORNEY

SN 77-890,084. THIEM, CURT G, LOS ALTOS, CA. FILED 12-10-2009.

stupid sushi

THE MARK CONSISTS OF STANDARD CHARACTERS WITHOUT CLAIM TO ANY PARTICULAR FONT, STYLE, SIZE, OR COLOR.

FOR PROVIDING A SOCIAL NETWORKING WEBSITE FOR ENTERTAINMENT PURPOSES (U.S. CLS. 100 AND 101).

FIRST USE 12-9-2009; IN COMMERCE 12-9-2009.

JUDITH HELFMAN, EXAMINING ATTORNEY

SN 77-890,235. UNVELOPE.COM LLC, POUND RIDGE, NY. FILED 12-10-2009.

UNVELOPE

THE MARK CONSISTS OF STANDARD CHARACTERS WITHOUT CLAIM TO ANY PARTICULAR FONT, STYLE, SIZE, OR COLOR.

FOR PROVIDING A SELECTION OF ON-LINE ELECTRONIC GREETING CARDS (U.S. CLS. 100 AND 101).

ANTHONY RINKER, EXAMINING ATTORNEY

CLASS 45—(Continued).

SN 77-890,317. LARSON, LAURA, ALISO VIEJO, CA. FILED 12-10-2009.

Faith Telegraph

THE MARK CONSISTS OF STANDARD CHARACTERS WITHOUT CLAIM TO ANY PARTICULAR FONT, STYLE, SIZE, OR COLOR.

NO CLAIM IS MADE TO THE EXCLUSIVE RIGHT TO USE "FAITH", APART FROM THE MARK AS SHOWN. FOR PROVIDING INFORMATION AND NEWS VIA A WEBSITE IN THE FIELD OF CHRISTIANITY (U.S. CLS. 100 AND 101).

FIRST USE 1-8-2009; IN COMMERCE 1-8-2009.
CAROL SPILS, EXAMINING ATTORNEY

CLASS 45—(Continued).

SN 77-890,840. POWELL, JAY H, DBA AUCET TECHNOLOGIES, APACHE JUNCTION, AZ. FILED 12-10-2009.

Rescue Text

THE MARK CONSISTS OF STANDARD CHARACTERS WITHOUT CLAIM TO ANY PARTICULAR FONT, STYLE, SIZE, OR COLOR.

NO CLAIM IS MADE TO THE EXCLUSIVE RIGHT TO USE "TEXT", APART FROM THE MARK AS SHOWN.

FOR SECURITY SERVICES, NAMELY, PROVIDING ELECTRONIC ALERTS NOTIFYING OF A CHANGED STATUS OR CONDITION OF A SENSING DEVICE VIA THE INTERNET (U.S. CLS. 100 AND 101).

GRETTA YAO, EXAMINING ATTORNEY

SN 77-890,636. UNDERWOOD, CARLOS, BROADLANDS, VA. FILED 12-10-2009.



NO CLAIM IS MADE TO THE EXCLUSIVE RIGHT TO USE "CHRIST", APART FROM THE MARK AS SHOWN. THE MARK CONSISTS OF THE STYLIZED TEXT "WALKING IN CHRIST".

FOR MINISTERIAL SERVICES (U.S. CLS. 100 AND 101).

DORITT L. CARROLL, EXAMINING ATTORNEY

SN 77-890,974. LAW OFFICES OF MARLO VAN OORSCHOT, APLC, LOS ANGELES, CA. FILED 12-10-2009.

STRATEGY. GUIDANCE. TEAMWORK.

THE MARK CONSISTS OF STANDARD CHARACTERS WITHOUT CLAIM TO ANY PARTICULAR FONT, STYLE, SIZE, OR COLOR.

FOR ARBITRATION SERVICES; ATTORNEY SERVICES; LEGAL SERVICES; LITIGATION SERVICES; MEDIATION; ON-SITE LEGAL SERVICES; PROVIDING INFORMATION RELATING TO LEGAL AFFAIRS (U.S. CLS. 100 AND 101).

FIRST USE 12-8-2009; IN COMMERCE 12-8-2009.
DAVID COLLIER, EXAMINING ATTORNEY

SN 77-890,677. ZONEIN2, INC., ORANGE, CA. FILED 12-10-2009.

EMPOWERED BY YOU

THE MARK CONSISTS OF STANDARD CHARACTERS WITHOUT CLAIM TO ANY PARTICULAR FONT, STYLE, SIZE, OR COLOR.

FOR PROVIDING SOCIAL NETWORKING SERVICES THROUGH A COMMUNITY WEBSITE (U.S. CLS. 100 AND 101).

FIRST USE 10-20-2008; IN COMMERCE 12-9-2009.
TRACY WHITTAKER-BROWN, EXAMINING ATTORNEY

SN 77-891,415. AROUND THE WORLD BRIDES, INC., ST. PETERSBURG, FL. FILED 12-11-2009.

Around The World Brides

THE MARK CONSISTS OF STANDARD CHARACTERS WITHOUT CLAIM TO ANY PARTICULAR FONT, STYLE, SIZE, OR COLOR.

NO CLAIM IS MADE TO THE EXCLUSIVE RIGHT TO USE "BRIDES", APART FROM THE MARK AS SHOWN.

FOR DATING SERVICES; DATING SERVICES, NAMELY, PROVIDING AN ON-LINE COMPUTER DATABASE FEATURING SINGLE PEOPLE INTERESTED IN MEETING OTHER SINGLE PEOPLE; INTERNET BASED SOCIAL NETWORKING, INTRODUCTION, AND DATING SERVICES; INTERNET-BASED DATING, SOCIAL INTRODUCTION AND SOCIAL NETWORKING SERVICES; MARRIAGE PARTNER INTRODUCTION OR DATING SERVICES; ON-LINE IDENTITY RELIABILITY INVESTIGATION IN THE FIELD OF ON-LINE DATING AND CLAIMS MADE ABOUT AGE, GENDER (U.S. CLS. 100 AND 101).

JENNIFER HETU, EXAMINING ATTORNEY

CLASS 45—(Continued).

SN 77-891,509. SUNSTEIN KANN MURPHY & TIMBERS LLP, BOSTON, MA. FILED 12-11-2009.

SUNSTEIN 

THE MARK CONSISTS OF THE WORD "SUNSTEIN" TO THE LEFT OF A FOUR-POINT STAR.

FOR LEGAL SERVICES; PROVIDING INFORMATION TO OTHERS IN THE AREA OF BUSINESS LAW, LITIGATION AND INTELLECTUAL PROPERTY (U.S. CLS. 100 AND 101).

FIRST USE 7-20-2009; IN COMMERCE 7-20-2009.
ESTHER BELENKER, EXAMINING ATTORNEY

CLASS 45—(Continued).

SN 77-894,010. LAW OFFICES OF SEPEHR DAGHIGHIAN, P.C., BEVERLY HILLS, CA. FILED 12-15-2009.

INGENUITY AT WORK

THE MARK CONSISTS OF STANDARD CHARACTERS WITHOUT CLAIM TO ANY PARTICULAR FONT, STYLE, SIZE, OR COLOR.

FOR LEGAL SERVICES (U.S. CLS. 100 AND 101).
FIRST USE 12-15-2009; IN COMMERCE 12-15-2009.
SUSAN STIGLITZ, EXAMINING ATTORNEY

SN 77-891,516. SUNSTEIN KANN MURPHY & TIMBERS LLP, BOSTON, MA. FILED 12-11-2009.

SUNSTEIN KANN MURPHY &
TIMBERS

THE MARK CONSISTS OF STANDARD CHARACTERS WITHOUT CLAIM TO ANY PARTICULAR FONT, STYLE, SIZE, OR COLOR.

FOR LEGAL SERVICES; PROVIDING INFORMATION TO OTHERS IN THE AREA OF BUSINESS LAW, LITIGATION AND INTELLECTUAL PROPERTY (U.S. CLS. 100 AND 101).

FIRST USE 7-20-2009; IN COMMERCE 7-20-2009.
ESTHER BELENKER, EXAMINING ATTORNEY

SN 77-894,124. DOMUS, INC., PHILADELPHIA, PA. FILED 12-15-2009.

GannettConnect

THE MARK CONSISTS OF STANDARD CHARACTERS WITHOUT CLAIM TO ANY PARTICULAR FONT, STYLE, SIZE, OR COLOR.

FOR ON-LINE SOCIAL NETWORKING SERVICES (U.S. CLS. 100 AND 101).

LAURA KOVALSKY, EXAMINING ATTORNEY

SN 77-892,594. TRAVELFRIENDS, INC, LOS ALTOS HILLS, CA. FILED 12-14-2009.

TravelFriends

THE MARK CONSISTS OF STANDARD CHARACTERS WITHOUT CLAIM TO ANY PARTICULAR FONT, STYLE, SIZE, OR COLOR.

FOR ON-LINE SOCIAL NETWORKING SERVICES (U.S. CLS. 100 AND 101).

FIRST USE 4-21-2009; IN COMMERCE 4-21-2009.
KATHERINE CONNOLLY, EXAMINING ATTORNEY

SN 77-898,876. HALLMARK LICENSING, INC., KANSAS CITY, MO. FILED 12-22-2009.

ONE TOUGH CHICK

THE MARK CONSISTS OF STANDARD CHARACTERS WITHOUT CLAIM TO ANY PARTICULAR FONT, STYLE, SIZE, OR COLOR.

FOR PROVIDING A SELECTION OF ON-LINE ELECTRONIC GREETING CARDS (U.S. CLS. 100 AND 101).

ELIZABETH KAJUBI, EXAMINING ATTORNEY

MAY 4, 2010

U.S. PATENT AND TRADEMARK OFFICE

TM 1199

CLASS 45—(Continued).

SN 77-913,256. YOOSER LLC, CHAMPAIGN, IL. FILED 1-15-2010.

CLASS 45—(Continued).

SN 77-933,889. BEST EVIDENCE, INC., TAMPA, FL. FILED 2-11-2010.

Yoosit

BEST EVIDENCE

THE MARK CONSISTS OF STANDARD CHARACTERS WITHOUT CLAIM TO ANY PARTICULAR FONT, STYLE, SIZE, OR COLOR.

FOR ON-LINE SOCIAL NETWORKING SERVICES (U.S. CLS. 100 AND 101).
SUSAN RICHARDS, EXAMINING ATTORNEY

THE MARK CONSISTS OF STANDARD CHARACTERS WITHOUT CLAIM TO ANY PARTICULAR FONT, STYLE, SIZE, OR COLOR.

FOR LITIGATION SUPPORT SERVICES (U.S. CLS. 100 AND 101).
FIRST USE 4-15-1997; IN COMMERCE 8-31-1997.
ESTHER BELENKER, EXAMINING ATTORNEY

* * * * *

SECTION 3.—PRIOR UNITED STATES CLASSIFICATION

APPLICATION IN MORE THAN ONE CLASS

SN 77-720,236. NSF INTERNATIONAL, ANN ARBOR, MI.
FILED 4-23-2009.



OWNER OF U.S. REG. NOS. 1,139,117, 2,727,760 AND
OTHERS.

NO CLAIM IS MADE TO THE EXCLUSIVE RIGHT TO
USE "INDEPENDENTLY CERTIFIED", APART FROM THE
MARK AS SHOWN.

THE MARK CONSISTS OF THE LETTERS "NSF" WITHIN
A CIRCLE WITH THE TERMS "INDEPENDENTLY CERTI-
FIED" IN AN OUTER CIRCLE.

THE CERTIFICATION MARK, AS USED BY PERSONS
AUTHORIZED BY THE CERTIFIER, CERTIFIES THAT THE
GOODS AND/OR SERVICES PROVIDED CONFORM TO
PUBLIC HEALTH AND ENVIRONMENTAL QUALITY
STANDARDS, REGULATIONS AND SPECIFICATIONS
SET FORTH BY THE CERTIFIER.

CLASS A—GOODS

FOR DIETARY SUPPLEMENTS, BEVERAGES AND
BOTTLED WATER, FUNCTIONAL FOODS, DRINKING
WATER TREATMENT UNITS, PURIFIERS, DRINKING
WATER SYSTEMS, AND FILTERS; PERSONAL CARE
PRODUCTS, BATHROOM TISSUE; CLOTHES
WASHERS, CLOTHES DRYERS, PRODUCTS CONTAIN-
ING INCORPORATED INORGANIC ANTIMICROBIAL
AGENTS.

FIRST USE 0-0-2004; IN COMMERCE 0-0-2004.

CLASS B—SERVICES

FOR QUALITY CONTROL AND ENVIRONMENTAL
HEALTH PROCEDURES AND PRACTICES IN THE
MANUFACTURING AND SERVICE INDUSTRIES.

FIRST USE 0-0-2006; IN COMMERCE 0-0-2006.

RONALD DELGIZZI, EXAMINING ATTORNEY

* * * * *

SECTION 4.—PRIOR UNITED STATES CLASSIFICATION

APPLICATION IN ONE CLASS

COLLECTIVE MEMBERSHIP MARKS

CLASS 200—COLLECTIVE MEMBERSHIP
SN 76-697,757. 'AHA HIPU'U PARTNERSHIP, THE, HONO-
LULU, HI. FILED 6-4-2009.

SN 77-737,160. US TRAVEL INSURANCE ASSOCIATION,
INC., WASHINGTON, DC. FILED 5-14-2009.

US TRAVEL INSURANCE
ASSOCIATION



THE MARK CONSISTS OF STANDARD CHARACTERS WITHOUT CLAIM TO ANY PARTICULAR FONT, STYLE, SIZE, OR COLOR.

NO CLAIM IS MADE TO THE EXCLUSIVE RIGHT TO USE "ASSOCIATION", APART FROM THE MARK AS SHOWN.

SEC. 2(F).

FOR INDICATING MEMBERSHIP IN A(N) TRADE ASSOCIATION OF TRAVEL INSURANCE PROVIDERS AND DISTRIBUTORS AND ALLIED BUSINESSES.

FIRST USE 9-0-2004; IN COMMERCE 9-0-2004.

DEBRA LEE, EXAMINING ATTORNEY

SN 77-787,759. AMERICAN SCHOOL COUNSELOR ASSO-
CIATION, ALEXANDRIA, VA. FILED 7-23-2009.

NO CLAIM IS MADE TO THE EXCLUSIVE RIGHT TO USE "KAAHUMANU", APART FROM THE MARK AS SHOWN.

THE MARK CONSISTS OF THE WORDING "AHA HIPU'U" AND "KAAHUMANU" AND A DESIGN FEATURE COMPRISED OF SEVERAL ELEMENTS. THE WORDING "AHA HIPU'U" SITS ON THE INSIDE AND AT THE BOTTOM OF A CIRCLE OF ROPE. A CROWN TOPPED WITH A BALL AND CROSS SIT ON THE TOP OF THE ROPE CIRCLE. WITHIN THE ROPE CIRCLE ARE FOUR SEPARATE ELEMENTS. THE FIRST COMPRISES A DIAMOND DESIGN WITH A SPEAR PIERCING A BALL AND TWO INTERSECTING FEATHER STANDARDS WITHIN THE DIAMOND. THE SECOND COMPRISES THE WORDING "KAAHUMANU" WITHIN A BANNER AND WRAPPED AROUND A CIRCLE MEDALLION DESIGN THAT IS TOPPED WITH A CROWN. THE THIRD ELEMENT SITS ABOVE THE WORDING "AHA HIPU'U" AND COMPRISES THREE INTERSECTING SPEARS. THE FOURTH DESIGN ELEMENT CONSISTS OF A CROWN ON THE TOP OF A MEDAL DESIGN FEATURE.

THE ENGLISH TRANSLATION OF "AHA HIPU'U" AND "KAAHUMANU" IN THE MARK IS "CORDAGE THAT BINDS" AND "THE CLOAK MADE OF FEATHERS".

FOR UNION OF FOUR HAWAIIAN ROYAL BENEVO-
LENT SOCIETIES.

SHARON MEIER, EXAMINING ATTORNEY



NO CLAIM IS MADE TO THE EXCLUSIVE RIGHT TO USE "MEMBER", APART FROM THE MARK AS SHOWN.

THE MARK CONSISTS OF THE DESIGN OF THREE CIRCLES APPEARING IN AN ARC WITH THE CENTER CIRCLE APPEARING SLIGHTLY LARGER THAN THE CIRCLES ON THE LEFT AND RIGHT. BELOW THE CIRCLES IS A DOWNWARD FACING ARC WITH THREE SETS OF TWO PARALLEL, VERTICAL LINES APPEARING BENEATH IT. THE STYLIZED WORDING "ASCA MEMBER" APPEARS TO THE RIGHT OF THE DESIGN.

FOR INDICATING MEMBERSHIP IN AN ORGANIZA-
TION OF SCHOOL COUNSELING PROFESSIONALS.

FIRST USE 3-30-2001; IN COMMERCE 3-30-2001.

AMY KERTGATE, EXAMINING ATTORNEY

SN 77-883,549. LOST SONS INTERNATIONAL, SAN ANTONIO, TX. FILED 12-1-2009.



NO CLAIM IS MADE TO THE EXCLUSIVE RIGHT TO USE "MC INTERNATIONAL", APART FROM THE MARK AS SHOWN.

THE MARK CONSISTS OF A DESIGN OF SKULL WEARING A MILITARY COMBAT HELMET WITH TWO RIFLES CRISSCROSSING BEHIND THE SKULL WITH A SET OF BIRD'S WINGS ATTACHED FROM BEHIND. THE WORDING "LOST SONS" APPEARS ABOVE THE DESIGN, THE WORDING "MC" APPEARS UNDERNEATH THE SKULL, AND THE WORDING "INTERNATIONAL" APPEARS BELOW THE WORDING "MC".

FOR INDICATING MEMBERSHIP IN A(N) ASSOCIATION OF MOTORCYCLE RIDERS.

FIRST USE 2-12-2004; IN COMMERCE 2-12-2004.
MATTHEW EINSTEIN, EXAMINING ATTORNEY

CERTIFICATION MARKS

CLASS A—GOODS

SN 77-785,131. INTERNATIONAL PHARMACEUTICAL EXCIPIENTS AUDITING INC., ARLINGTON, VA. FILED 7-20-2009.



OWNER OF U.S. REG. NOS. 2,683,492 AND 2,683,493.
NO CLAIM IS MADE TO THE EXCLUSIVE RIGHT TO USE "CERTIFIED TO EXCIPIENT GMP", APART FROM THE MARK AS SHOWN.

THE MARK CONSISTS OF THE STYLIZED WORDING "IPEA CERTIFIED TO EXCIPIENT GMP" AND A DESIGN COMPRISED OF A SHADED CIRCLE FEATURING TWO CONCENTRIC CIRCLES AND A STYLIZED MORTAR AND PESTLE, WITH THE WORDING "IPEA" APPEARING ON THE STYLIZED MORTAR AND PESTLE AT THE CENTER OF THE CONCENTRIC CIRCLES AND WITH THE WORDING "CERTIFIED TO EXCIPIENT GMP" APPEARING BETWEEN THE CONCENTRIC CIRCLES.

THE CERTIFICATION MARK, AS USED OR INTENDED TO BE USED BY PERSONS AUTHORIZED BY THE CERTIFIER, CERTIFIES OR IS INTENDED TO CERTIFY THAT THE EXCIPIENTS PROVIDED HAVE BEEN PRODUCED IN ACCORDANCE WITH GOOD MANUFACTURING PRACTICES (GMPS) ESTABLISHED BY THE INTERNATIONAL PHARMACEUTICAL EXCIPIENTS COUNCIL (IPEC) FOR EXCIPIENTS USED IN THE PHARMACEUTICALS INDUSTRY. THE EXCIPIENT GMPS GOVERN THE QUALITY SYSTEM REQUIREMENTS USED IN THEIR MANUFACTURE.

FOR EXCIPIENTS USED IN THE MANUFACTURE OF PHARMACEUTICALS.

CYNTHIA TRIPI, EXAMINING ATTORNEY

SN 77-785,148. INTERNATIONAL PHARMACEUTICAL EXCIPIENTS AUDITING INC., ARLINGTON, VA. FILED 7-20-2009.

IPEA CERTIFIED TO EXCIPIENT GMP

THE MARK CONSISTS OF STANDARD CHARACTERS WITHOUT CLAIM TO ANY PARTICULAR FONT, STYLE, SIZE, OR COLOR.

OWNER OF U.S. REG. NOS. 2,683,492 AND 2,683,493.

NO CLAIM IS MADE TO THE EXCLUSIVE RIGHT TO USE "CERTIFIED TO EXCIPIENT GMP", APART FROM THE MARK AS SHOWN.

THE CERTIFICATION MARK, AS USED OR INTENDED TO BE USED BY PERSONS AUTHORIZED BY THE CERTIFIER, CERTIFIES OR IS INTENDED TO CERTIFY THAT THE EXCIPIENTS PROVIDED HAVE BEEN PRODUCED IN ACCORDANCE WITH GOOD MANUFACTURING PRACTICES (GMPS) ESTABLISHED BY THE INTERNATIONAL PHARMACEUTICAL EXCIPIENTS COUNCIL (IPEC) FOR EXCIPIENTS USED IN THE PHARMACEUTICALS INDUSTRY. THE EXCIPIENT GMPS GOVERN THE QUALITY SYSTEM REQUIREMENTS USED IN THEIR MANUFACTURE.

FOR EXCIPIENTS USED IN THE MANUFACTURE OF PHARMACEUTICALS.

CYNTHIA TRIPI, EXAMINING ATTORNEY

CLASS B—SERVICES

SN 77-765,903. ARCMELT COMPANY, LC, BRIDGETON, MO. FILED 6-23-2009.



OWNER OF U.S. REG. NO. 3,270,104.

NO CLAIM IS MADE TO THE EXCLUSIVE RIGHT TO USE "CERTIFIED APPLICATOR", APART FROM THE MARK AS SHOWN.

THE MARK CONSISTS OF THE WORDS "ARCMELT CERTIFIED APPLICATOR". THE WORD "ARCMELT" APPEARS IN AN ITALICIZED FONT RESEMBLING BRUSH STROKES. A JAGGED, CURVED LINE EXTENDS FROM THE BASE OF ONE LEG OF THE LETTER "A", FORMS THE CROSSBAR OF THE LETTER "A" AND EXTENDS ABOVE THE REMAINING LETTERS IN THE WORD "ARCMELT". THE WORDS "CERTIFIED APPLICATOR" APPEAR IN CAPITAL LETTERS DIRECTLY UNDER THE WORD "ARCMELT".

THE CERTIFICATION MARK, AS USED OR INTENDED TO BE USED BY PERSONS AUTHORIZED BY THE CERTIFIER, CERTIFIES THAT THE SERVICES PROVIDED ARE PERFORMED BY PERSONS MEETING THE STANDARDS AND TESTS OF COMPETENCY, SKILL, AND KNOWLEDGE SET BY THE CERTIFIER IN THE FIELD OF THERMAL SPRAY COATING APPLICATION.

FOR THERMAL SPRAY COATING APPLICATION SERVICES.

KIMBERLY FRYE, EXAMINING ATTORNEY

SN 77-769,359. LASER INSTITUTE OF AMERICA, ORLANDO, FL. FILED 6-26-2009.

CMLSO

THE MARK CONSISTS OF STANDARD CHARACTERS WITHOUT CLAIM TO ANY PARTICULAR FONT, STYLE, SIZE, OR COLOR.

THE CERTIFICATION MARK, AS USED BY AUTHORIZED PERSONS, CERTIFIES THAT THE CERTIFIED PARTY HAS MET THE CERTIFIER'S MINIMUM STANDARDS FOR PROFESSIONAL EXPERIENCE AND HAS SUCCESSFULLY COMPLETED AN EXAMINATION IN THE FIELD OF MEDICAL LASER SAFETY.

FOR MEDICAL SERVICES EMPLOYING LASERS.

FIRST USE 3-18-2004; IN COMMERCE 3-18-2004.

MICHAEL ENGEL, EXAMINING ATTORNEY

SN 77-831,715. AMERICAN ACADEMY OF WOUND MANAGEMENT, INC., WASHINGTON, DC. FILED 9-22-2009.

CERTIFIED WOUND SPECIALIST

THE MARK CONSISTS OF STANDARD CHARACTERS WITHOUT CLAIM TO ANY PARTICULAR FONT, STYLE, SIZE, OR COLOR.

THE CERTIFICATION MARK, AS USED BY AUTHORIZED PERSONS, CERTIFIES THAT THE PERSON USING THE MARK HAS SUCCESSFULLY SATISFIED SPECIFIC LEVELS OF EDUCATION, EXPERIENCE, AND KNOWLEDGE IN THE FIELD OF WOUND MANAGEMENT AND THAT THE WORK IN RENDERING THE SERVICES WAS PERFORMED BY PERSONS WHO HAVE MET THE STANDARDS ESTABLISHED BY THE CERTIFIER.

FOR MEDICAL SERVICES OF MEDICAL HEALTH CARE PROFESSIONALS IN THE FIELD OF WOUND MANAGEMENT.

FIRST USE 1-10-1996; IN COMMERCE 1-10-1996.

BARBARA BROWN, EXAMINING ATTORNEY

SN 77-877,722. AMERICAN ACADEMY OF WOUND MANAGEMENT, INC., WASHINGTON, DC. FILED 11-20-2009.

CWSP

THE MARK CONSISTS OF STANDARD CHARACTERS WITHOUT CLAIM TO ANY PARTICULAR FONT, STYLE, SIZE, OR COLOR.

THE CERTIFICATION MARK, AS INTENDED TO BE USED BY AUTHORIZED PERSONS, IS INTENDED TO CERTIFY THAT THE PERSON USING THE MARK HAS SUCCESSFULLY SATISFIED SPECIFIC LEVELS OF EDUCATION, EXPERIENCE, AND KNOWLEDGE IN THE FIELD OF WOUND MANAGEMENT AND THAT THE WORK IN RENDERING THE SERVICES WAS PERFORMED BY PERSONS WHO HAVE MET THE STANDARDS ESTABLISHED BY THE CERTIFIER.

FOR MEDICAL SERVICES OF PHYSICIANS, NAMELY, MEDICAL DOCTORS, DOCTORS OF OSTEOPATHY AND DOCTORS OF PODIATRY, IN THE FIELD OF WOUND MANAGEMENT.

KARANENDRA S. CHHINA, EXAMINING ATTORNEY

SN 77-900,106. WATER QUALITY ASSOCIATION, LISLE, IL. FILED 12-23-2009.



OWNER OF U.S. REG. NOS. 1,111,990, 1,519,369 AND OTHERS.

NO CLAIM IS MADE TO THE EXCLUSIVE RIGHT TO USE "WATER QUALITY ASSOCIATION" AND "CERTIFIED INSTALLER", APART FROM THE MARK AS SHOWN.

THE MARK CONSISTS OF THE WORDS "CERTIFIED INSTALLER" OVER A PARTIAL CIRCLE WHERE THE PARTIAL CIRCLE CONTAINS THREE WAVY LINES ABOVE THE WORDS "WATER QUALITY ASSOCIATION".

THE CERTIFICATION MARK, AS USED BY AUTHORIZED PERSONS, CERTIFIES THAT THE SERVICES ARE PERFORMED BY PERSONS WHO HAVE SATISFIED THE CERTIFIER'S REQUIREMENTS RELATING TO EXPERIENCE, KNOWLEDGE, EDUCATION AND PROFESSIONAL COMPETENCE AND BY SUCCESSFUL COMPLETION OF AN EXAMINATION ADMINISTERED BY THE CERTIFIER.

FOR INSTALLATION OF WATER QUALITY IMPROVEMENT EQUIPMENT.

FIRST USE 7-25-2003; IN COMMERCE 7-25-2003.

TM 1204

OFFICIAL GAZETTE

MAY 4, 2010

INGA ERVIN, EXAMINING ATTORNEY

* * * * *

TRADEMARK REGISTRATIONS ISSUED

PRINCIPAL REGISTER

SECTION 1.— INTERNATIONAL CLASSIFICATION

The short titles associated below with the international class numbers are terms designed merely for quick identification and are not an official part of the international classification. The full names of international classes are given in section 6.1 of the trademark rules of practice.

The designation "U.S. Cl." appearing in this section refers to the U.S. class in effect prior to Sep. 1, 1973 rather than the international class which applies to applications filed on or after that date. For adoption of international classification see notice in the OFFICIAL GAZETTE of Jun. 26, 1973 (911 O.G. TM 210).

CLASS 1—CHEMICALS

- 3,783,106. **STAT-BLUE AND DESIGN. PROFESSIONAL TOXICOLOGY SERVICES, INC.**, (U.S. CLS. 1, 5, 6, 10, 26 AND 46). SN 76-696,313. PUB. 2-16-2010. FILED 3-16-2009.
- 3,783,166. **MUC-OFF (BLOCK FORM). TRIMNEL, MARILYN GRATIA, MULTIPLE CLASS, (INT. CLS. 1, 4 AND 21), (U.S. CLS. 1, 2, 5, 6, 10, 13, 15, 23, 26, 29, 30, 33, 40, 46 AND 50).** SN 77-205,307. PUB. 2-16-2010. FILED 6-13-2007.
- 3,783,255. **MYG (MEGA-YOU-GROW) (BLOCK FORM). ISLAND MUSHROOMS INC., MULTIPLE CLASS, (INT. CLS. 1 AND 35), (U.S. CLS. 1, 5, 6, 10, 26, 46, 100, 101 AND 102).** SN 77-530,662. PUB. 12-1-2009. FILED 7-24-2008.
- 3,783,375. **MOP (BLOCK FORM). KEMIRA OYJ, MULTIPLE CLASS, (INT. CLS. 1, 40 AND 42), (U.S. CLS. 1, 5, 6, 10, 26, 46, 100, 101, 103 AND 106).** SN 77-682,522. PUB. 2-16-2010. FILED 3-3-2009.
- 3,783,380. **LYTHIC (BLOCK FORM). LYTHIC SOLUTIONS, INC., (U.S. CLS. 1, 5, 6, 10, 26 AND 46).** SN 77-683,222. PUB. 2-16-2010. FILED 3-4-2009.
- 3,783,390. **CRISTALHYAL (BLOCK FORM). SOLIANCE, (U.S. CLS. 1, 5, 6, 10, 26 AND 46).** SN 77-686,967. PUB. 2-16-2010. FILED 3-10-2009.
- 3,783,401. **MEDICINE MAN (BLOCK FORM). EVIROAG LTD., (U.S. CLS. 1, 5, 6, 10, 26 AND 46).** SN 77-691,178. PUB. 7-14-2009. FILED 3-14-2009.
- 3,783,404. **EPOBIOX (BLOCK FORM). AMROY EUROPE OY, (U.S. CLS. 1, 5, 6, 10, 26 AND 46).** SN 77-691,867. PUB. 2-16-2010. FILED 3-16-2009.
- 3,783,827. **COMPASS MINERALS (BLOCK FORM). COMPASS MINERALS INTERNATIONAL, INC., (U.S. CLS. 1, 5, 6, 10, 26 AND 46).** SN 77-810,049. PUB. 2-16-2010. FILED 8-21-2009.
- 3,783,859. **"POND MAGICIAN" (BLOCK FORM). ORGANIC ENVIRONMENTAL SERVICES INC., (U.S. CLS. 1, 5, 6, 10, 26 AND 46).** SN 77-814,630. PUB. 2-16-2010. FILED 8-27-2009.
- 3,783,877. **ACCUCCELL (BLOCK FORM). KIBBECEM, INC., (U.S. CLS. 1, 5, 6, 10, 26 AND 46).** SN 77-816,447. PUB. 2-16-2010. FILED 8-31-2009.
- 3,783,917. **SILTECH (BLOCK FORM). SILTECH LLC, (U.S. CLS. 1, 5, 6, 10, 26 AND 46).** SN 77-820,827. PUB. 2-16-2010. FILED 9-4-2009.
- 3,783,935. **KELLOGG QUALITY ORGANICS SINCE 1925 (BLOCK FORM). KELLOGG SUPPLY, INC., (U.S. CLS. 1, 5, 6, 10, 26 AND 46).** SN 77-822,179. PUB. 2-16-2010. FILED 9-8-2009.
- 3,784,033. **ULTRA LC/MS (BLOCK FORM). MALLINCKRODT BAKER, INC., (U.S. CLS. 1, 5, 6, 10, 26 AND 46).** SN 77-826,073. PUB. 2-16-2010. FILED 9-14-2009.
- 3,784,064. **FISH-IT FERTILIZER CO. AND DESIGN. DANISON III, ARTHUR L., (U.S. CLS. 1, 5, 6, 10, 26 AND 46).** SN 77-827,050. PUB. 2-16-2010. FILED 9-15-2009.
- 3,784,128. **ZEOLYST INTERNATIONAL AND DESIGN. ZEOLYST INTERNATIONAL, (U.S. CLS. 1, 5, 6, 10, 26 AND 46).** SN 77-828,550. PUB. 2-16-2010. FILED 9-17-2009.
- 3,784,154. **PERMAZYME 11X (BLOCK FORM). PACIFIC ENZYMES, INC., (U.S. CLS. 1, 5, 6, 10, 26 AND 46).** SN 77-828,971. PUB. 2-16-2010. FILED 9-17-2009.
- 3,784,198. **EARTH GUARD AND DESIGN. MAGCO INCORPORATED, (U.S. CLS. 1, 5, 6, 10, 26 AND 46).** SN 77-829,879. PUB. 2-16-2010. FILED 9-18-2009.
- 3,784,200. **EVERGREEN (BLOCK FORM). MAGCO INCORPORATED, (U.S. CLS. 1, 5, 6, 10, 26 AND 46).** SN 77-829,895. PUB. 2-16-2010. FILED 9-18-2009.
- 3,784,247. **UV-CURE (BLOCK FORM). INNOVATIVE RESIN SYSTEMS, INC., (U.S. CLS. 1, 5, 6, 10, 26 AND 46).** SN 77-830,587. PUB. 2-16-2010. FILED 9-20-2009.
- 3,784,248. **ACRYLIC-CURE (BLOCK FORM). INNOVATIVE RESIN SYSTEMS, INC., (U.S. CLS. 1, 5, 6, 10, 26 AND 46).** SN 77-830,590. PUB. 2-16-2010. FILED 9-20-2009.
- 3,784,467. **HOE-DOWN (BLOCK FORM). TIN INC., (U.S. CLS. 1, 5, 6, 10, 26 AND 46).** SN 77-833,323. PUB. 2-16-2010. FILED 9-23-2009.
- 3,784,685. **XP-911 (BLOCK FORM). SETAC CORPORATION, (U.S. CLS. 1, 5, 6, 10, 26 AND 46).** SN 77-836,614. PUB. 2-16-2010. FILED 9-28-2009.
- 3,784,840. **CURAMIK (BLOCK FORM). ELECTROVAC AG, MULTIPLE CLASS, (INT. CLS. 1, 6 AND 9), (U.S. CLS. 1, 2, 5, 6, 10, 12, 13, 14, 21, 23, 25, 26, 36, 38, 46 AND 50).** SN 78-811,275. PUB. 12-9-2008. FILED 2-9-2006.
- 3,784,841. **CURAMIK | AND DESIGN. ELECTROVAC AG, MULTIPLE CLASS, (INT. CLS. 1, 6 AND 9), (U.S. CLS. 1, 2, 5, 6, 10, 12, 13, 14, 21, 23, 25, 26, 36, 38, 46 AND 50).** SN 78-811,341. PUB. 12-9-2008. FILED 2-9-2006.
- 3,784,850. **TUFF TURF (BLOCK FORM). TURFGRASS MANAGEMENT, INC., DBA GRIGG BROS., (U.S. CLS. 1, 5, 6, 10, 26 AND 46).** SN 78-938,300. PUB. 2-16-2010. FILED 7-26-2006.
- 3,784,854. **BIOSIL AND DESIGN. BIOSIL TECHNOLOGIES, INC., (U.S. CLS. 1, 5, 6, 10, 26 AND 46).** SN 78-981,344. PUB. 4-21-2009. FILED 6-14-2006.
- 3,784,889. **BOLIFOR (STYLIZED). YARA PHOSPHATES OY, MULTIPLE CLASS, (INT. CLS. 1 AND 31), (U.S. CLS. 1, 5, 6, 10, 26 AND 46).** SN 79-058,789. PUB. 2-16-2010. FILED 1-25-2008.
- 3,784,906. **MISCELLANEOUS DESIGN. CHOREN INDUSTRIES GMBH, MULTIPLE CLASS, (INT. CLS. 1, 4, 9, 35, 37, 39, 40 AND 42), (U.S. CLS. 1, 5, 6, 10, 15, 21, 23, 26, 36, 38, 46, 100, 101, 102, 103, 105 AND 106).** SN 79-061,304. PUB. 2-16-2010. FILED 1-24-2008.
- 3,784,907. **CHOREN (BLOCK FORM). CHOREN INDUSTRIES GMBH, MULTIPLE CLASS, (INT. CLS. 1, 4, 9, 35, 37, 39, 40 AND 42), (U.S. CLS. 1, 5, 6, 10, 15, 21, 23, 26, 36, 38, 46, 100, 101, 102, 103, 105 AND 106).** SN 79-061,305. PUB. 2-16-2010. FILED 1-24-2008.
- 3,784,913. **ESSECO (BLOCK FORM). ESSECO S.R.L., MULTIPLE CLASS, (INT. CLS. 1, 4 AND 5), (U.S. CLS. 1, 5, 6, 10, 15, 18, 26, 44, 46, 51 AND 52).** SN 79-062,312. PUB. 2-16-2010. FILED 9-17-2008.
- 3,784,932. **SKINASENSYL (BLOCK FORM). COGNIS IP MANAGEMENT GMBH, MULTIPLE CLASS, (INT. CLS. 1 AND 3), (U.S. CLS. 1, 4, 5, 6, 10, 26, 46, 50, 51 AND 52).** SN 79-066,387. PUB. 2-16-2010. FILED 1-19-2009.
- 3,784,938. **NEXIPAL (BLOCK FORM). WACKER CHEMIE AG, MULTIPLE CLASS, (INT. CLS. 1 AND 17), (U.S. CLS. 1, 5, 6, 10, 12, 13, 26, 35, 46 AND 50).** SN 79-066,816. PUB. 2-16-2010. FILED 12-3-2008.
- 3,784,961. **CERTESS (BLOCK FORM). H.E.F., MULTIPLE CLASS, (INT. CLS. 1 AND 6), (U.S. CLS. 1, 2, 5, 6, 10, 12,**

- 13, 14, 23, 25, 26, 46 AND 50). SN 79-067,920. PUB. 2-16-2010. FILED 2-18-2009.
- 3,784,989. **R.S. AND DESIGN. VITAMIN C60; BIORESEARCH CORPORATION, MULTIPLE CLASS, (INT. CLS. 1 AND 3), (U.S. CLS. 1, 4, 5, 6, 10, 26, 46, 50, 51 AND 52).** SN 79-068,619. PUB. 2-16-2010. FILED 3-19-2009.
- 3,784,994. **GLOBOCER (BLOCK FORM). HOLLOWET GMBH, MULTIPLE CLASS, (INT. CLS. 1 AND 42), (U.S. CLS. 1, 5, 6, 10, 26, 46, 100 AND 101).** SN 79-068,857. PUB. 2-16-2010. FILED 4-9-2009.
- 3,785,023. **NWR NEW WORLD RESOURCES AND DESIGN. NEW WORLD RESOURCES N.V., MULTIPLE CLASS, (INT. CLS. 1, 4, 7, 9, 35, 36, 37, 39, 40, 42 AND 44), (U.S. CLS. 1, 5, 6, 10, 13, 15, 19, 21, 23, 26, 31, 34, 35, 36, 38, 46, 100, 101, 102, 103, 105 AND 106).** SN 79-071,928. PUB. 2-16-2010. FILED 4-27-2009.

CLASS 2—PAINTS

- 3,783,494. **LIFETIME REPAIR KITS (BLOCK FORM). LIFE-TIME REPAIR, LLC, (U.S. CLS. 6, 11 AND 16).** SN 77-705,777. PUB. 2-16-2010. FILED 4-2-2009.
- 3,783,714. **PRIME START (BLOCK FORM). XIM PRODUCTS, INC., (U.S. CLS. 6, 11 AND 16).** SN 77-783,355. PUB. 2-16-2010. FILED 7-17-2009.
- 3,784,339. **ANCHORSEAL 2 (BLOCK FORM). U.C COATINGS CORPORATION, (U.S. CLS. 6, 11 AND 16).** SN 77-831,743. PUB. 2-16-2010. FILED 9-22-2009.
- 3,784,344. **AS2 (BLOCK FORM). U.C COATINGS CORPORATION, (U.S. CLS. 6, 11 AND 16).** SN 77-831,785. PUB. 2-16-2010. FILED 9-22-2009.
- 3,784,715. **EPOXOLINE (BLOCK FORM). TNEMEC COMPANY, INC., (U.S. CLS. 6, 11 AND 16).** SN 77-840,057. PUB. 2-16-2010. FILED 10-2-2009.

CLASS 3—COSMETICS AND CLEANING PREPARATIONS

- 3,783,160. **YES TO EGGPLANTS AND DESIGN. YES TO LTD., (U.S. CLS. 1, 4, 6, 50, 51 AND 52).** SN 77-176,642. PUB. 6-9-2009. FILED 5-9-2007.
- 3,783,161. **YES TO EGGPLANTS (BLOCK FORM). YES TO LTD., (U.S. CLS. 1, 4, 6, 50, 51 AND 52).** SN 77-176,746. PUB. 6-9-2009. FILED 5-9-2007.
- 3,783,191. **GOOD WORKS (BLOCK FORM). THIS WORKS LIMITED, MULTIPLE CLASS, (INT. CLS. 3 AND 21), (U.S. CLS. 1, 2, 4, 6, 13, 23, 29, 30, 33, 40, 50, 51 AND 52).** SN 77-363,186. PUB. 12-9-2008. FILED 1-3-2008.
- 3,783,242. **PRE NA TAL (STYLIZED). PRENATAL S.P.A., MULTIPLE CLASS, (INT. CLS. 3, 10, 12, 28 AND 35), (U.S. CLS. 1, 4, 6, 19, 21, 22, 23, 26, 31, 35, 38, 39, 44, 50, 51, 52, 100, 101 AND 102).** SN 77-506,152. PUB. 9-15-2009. FILED 6-24-2008.
- 3,783,260. **HERPCLAIR (BLOCK FORM). SINCLAIR PHARMACEUTICALS LIMITED, MULTIPLE CLASS, (INT. CLS. 3 AND 5), (U.S. CLS. 1, 4, 6, 18, 44, 46, 50, 51 AND 52).** SN 77-536,353. PUB. 8-18-2009. FILED 7-31-2008.
- 3,783,270. **CHRIO (BLOCK FORM). CHRIO AMERICA, INC., DBA CHRIO, MULTIPLE CLASS, (INT. CLS. 3, 14 AND 28), (U.S. CLS. 1, 2, 4, 6, 22, 23, 27, 28, 38, 50, 51 AND 52).** SN 77-548,734. PUB. 2-16-2010. FILED 8-16-2008.
- 3,783,338. **CUSTOMIZING COMPLEX (BLOCK FORM). NATURAL THOUGHTS, INC., DBA BIOTONE, (U.S. CLS. 1, 4, 6, 50, 51 AND 52).** SN 77-657,306. PUB. 2-16-2010. FILED 1-27-2009.
- 3,783,344. **SUPER "REMEDY" (BLOCK FORM). MEEKS, MARY GROSSMAN, (U.S. CLS. 1, 4, 6, 50, 51 AND 52).** SN 77-664,499. PUB. 2-16-2010. FILED 2-5-2009.
- 3,783,358. **SLIM ICE 906090 MEDIDAS BAJO CERO AND DESIGN. MARCAS DE RENOMBRE, S.A. DE C.V., (U.S. CLS. 1, 4, 6, 50, 51 AND 52).** SN 77-672,899. PUB. 2-16-2010. FILED 2-18-2009.
- 3,783,378. **ECRU NEW YORK (BLOCK FORM). DEPAS-**

- QUALE, CARMEN, (U.S. CLS. 1, 4, 6, 50, 51 AND 52).** SN 77-683,007. PUB. 2-16-2010. FILED 3-4-2009.
- 3,783,413. **DAY ZYME (BLOCK FORM). JAN MARINI SKIN RESEARCH, INC., (U.S. CLS. 1, 4, 6, 50, 51 AND 52).** SN 77-694,188. PUB. 2-16-2010. FILED 3-18-2009.
- 3,783,414. **NIGHT ZYME (BLOCK FORM). JAN MARINI SKIN RESEARCH, INC., (U.S. CLS. 1, 4, 6, 50, 51 AND 52).** SN 77-694,203. PUB. 2-16-2010. FILED 3-18-2009.
- 3,783,488. **UN-ODORANT (BLOCK FORM). FRENCH TRANSIT, LTD., (U.S. CLS. 1, 4, 6, 50, 51 AND 52).** SN 77-704,868. PUB. 2-16-2010. FILED 4-1-2009.
- 3,783,512. **GARNIER BODYTONIC (BLOCK FORM). LABORATOIRE GARNIER & CIE, (U.S. CLS. 1, 4, 6, 50, 51 AND 52).** SN 77-709,654. PUB. 2-16-2010. FILED 4-8-2009.
- 3,783,533. **CLEAN ZYME (BLOCK FORM). JAN MARINI SKIN RESEARCH, INC., (U.S. CLS. 1, 4, 6, 50, 51 AND 52).** SN 77-712,845. PUB. 2-16-2010. FILED 4-13-2009.
- 3,783,534. **SKIN ZYME (BLOCK FORM). JAN MARINI SKIN RESEARCH, INC., (U.S. CLS. 1, 4, 6, 50, 51 AND 52).** SN 77-712,882. PUB. 2-16-2010. FILED 4-13-2009.
- 3,783,542. **CLAMUE (BLOCK FORM). INEL COSMETICS CO., LTD., (U.S. CLS. 1, 4, 6, 50, 51 AND 52).** SN 77-713,356. PUB. 2-16-2010. FILED 4-14-2009.
- 3,783,545. **M MAGIS LENE AND DESIGN. INEL COSMETICS CO., LTD., (U.S. CLS. 1, 4, 6, 50, 51 AND 52).** SN 77-713,554. PUB. 2-16-2010. FILED 4-14-2009.
- 3,783,585. **J GIRL (BLOCK FORM). J GIRL, INC., (U.S. CLS. 1, 4, 6, 50, 51 AND 52).** SN 77-728,860. PUB. 2-16-2010. FILED 5-5-2009.
- 3,783,648. **RUEHL (BLOCK FORM). ABERCROMBIE & FITCH TRADING CO., (U.S. CLS. 1, 4, 6, 50, 51 AND 52).** SN 77-761,562. PUB. 2-16-2010. FILED 6-17-2009.
- 3,783,655. **RX11-FLUSH (BLOCK FORM). NU-CALGON WHOLESALE, INC., (U.S. CLS. 1, 4, 6, 50, 51 AND 52).** SN 77-762,328. PUB. 2-16-2010. FILED 6-17-2009.
- 3,783,685. **SHOWER IN A BOTTLE (STYLIZED). GRANT, MOLLIE HUNTER, (U.S. CLS. 1, 4, 6, 50, 51 AND 52).** SN 77-771,323. PUB. 11-10-2009. FILED 6-30-2009.
- 3,783,747. **YGIENE (BLOCK FORM). BIONEUTRAL LABORATORIES CORPORATION USA, MULTIPLE CLASS, (INT. CLS. 3 AND 5), (U.S. CLS. 1, 4, 6, 18, 44, 46, 50, 51 AND 52).** SN 77-794,645. PUB. 1-12-2010. FILED 7-31-2009.
- 3,783,772. **PRANN THE ENERGY OF LIFE AND DESIGN. MIT MONGKOL INDUSTRY CO., LTD., (U.S. CLS. 1, 4, 6, 50, 51 AND 52).** SN 77-799,665. PUB. 2-16-2010. FILED 8-7-2009.
- 3,783,861. **MOUNTAIN LAVENDER (BLOCK FORM). CHURCH & DWIGHT, CO. INC., (U.S. CLS. 1, 4, 6, 50, 51 AND 52).** SN 77-814,907. PUB. 2-16-2010. FILED 8-28-2009.
- 3,783,888. **SUN MOON STARS (BLOCK FORM). COTY PRESTIGE LANCASTER GROUP GMBH, (U.S. CLS. 1, 4, 6, 50, 51 AND 52).** SN 77-817,254. PUB. 2-16-2010. FILED 9-1-2009.
- 3,783,931. **JADE BODY SPA (BLOCK FORM). JADE DISTRIBUTION, INC., (U.S. CLS. 1, 4, 6, 50, 51 AND 52).** SN 77-822,002. PUB. 2-16-2010. FILED 9-8-2009.
- 3,783,937. **SLICK SOAP AND DESIGN. RYPHON G. GRAY, (U.S. CLS. 1, 4, 6, 50, 51 AND 52).** SN 77-822,372. PUB. 2-16-2010. FILED 9-9-2009.
- 3,783,948. **JUNIA SKINCARE (BLOCK FORM). SPARENBERGER, KATHY, (U.S. CLS. 1, 4, 6, 50, 51 AND 52).** SN 77-822,638. PUB. 2-16-2010. FILED 9-9-2009.
- 3,783,959. **BEE RESCUED (BLOCK FORM). WOLF, SUSAN, MULTIPLE CLASS, (INT. CLS. 3 AND 5), (U.S. CLS. 1, 4, 6, 18, 44, 46, 50, 51 AND 52).** SN 77-823,596. PUB. 2-16-2010. FILED 9-10-2009.
- 3,783,965. **THE ORIGINAL MAKEUP SAVER (BLOCK FORM). SKINDINAVIA, INC., DBA SKINDINAVIA, (U.S. CLS. 1, 4, 6, 50, 51 AND 52).** SN 77-823,646. PUB. 2-16-2010. FILED 9-10-2009.
- 3,783,999. **CAREN ORIGINAL (BLOCK FORM). CAREN PRODUCTS, LLC, (U.S. CLS. 1, 4, 6, 50, 51 AND 52).** SN 77-824,983. PUB. 2-16-2010. FILED 9-11-2009.
- 3,784,046. **ORGANOSAFE (BLOCK FORM). OWEN BIOSCIENCES, INC., (U.S. CLS. 1, 4, 6, 50, 51 AND 52).** SN 77-826,423. PUB. 2-16-2010. FILED 9-15-2009.
- 3,784,052. **ORGANOSAFE AND DESIGN. OWEN BIOSCIENCES, INC., (U.S. CLS. 1, 4, 6, 50, 51 AND 52).** SN 77-826,498. PUB. 2-16-2010. FILED 9-15-2009.

- 3,784,084. **VITASPOREX (BLOCK FORM)**. ONDRE SELTZER, (U.S. CLS. 1, 4, 6, 50, 51 AND 52). SN 77-827,589. PUB. 2-16-2010. FILED 9-16-2009.
- 3,784,121. **M MAXIMILIEN SOAP COMPANY AND DESIGN**. MAXIMILIEN SOAP COMPANY, (U.S. CLS. 1, 4, 6, 50, 51 AND 52). SN 77-828,436. PUB. 2-16-2010. FILED 9-17-2009.
- 3,784,140. **POWER HOUSE AND DESIGN**. EBONITE HOLDINGS, INC., (U.S. CLS. 1, 4, 6, 50, 51 AND 52). SN 77-828,758. PUB. 2-16-2010. FILED 9-17-2009.
- 3,784,210. **LIFE IS GREEN (BLOCK FORM)**. GREEN BRIDGE INDUSTRIES, INC. (U.S. CLS. 1, 4, 6, 50, 51 AND 52). SN 77-830,071. PUB. 2-16-2010. FILED 9-18-2009.
- 3,784,288. **THE MYSTICAL SEDUCTRESS (BLOCK FORM)**. CLARK, GINA, (U.S. CLS. 1, 4, 6, 50, 51 AND 52). SN 77-831,077. PUB. 2-16-2010. FILED 9-21-2009.
- 3,784,488. **HAIRCALL (BLOCK FORM)**. KIM, JOO DEOK, AND CHEH, BYUNG JOE, (U.S. CLS. 1, 4, 6, 50, 51 AND 52). SN 77-833,524. PUB. 2-16-2010. FILED 9-23-2009.
- 3,784,501. **STYLE-PREP (BLOCK FORM)**. AVEDA CORPORATION, (U.S. CLS. 1, 4, 6, 50, 51 AND 52). SN 77-833,715. PUB. 2-16-2010. FILED 9-24-2009.
- 3,784,552. **VITAL ASSIST AND DESIGN**. OWEN BIOSCIENCES, INC., (U.S. CLS. 1, 4, 6, 50, 51 AND 52). SN 77-834,236. PUB. 2-16-2010. FILED 9-24-2009.
- 3,784,582. **GENOMA SKIN CARE (BLOCK FORM)**. EPIGENETIC ARCHETYPES, LLC, (U.S. CLS. 1, 4, 6, 50, 51 AND 52). SN 77-834,695. PUB. 2-16-2010. FILED 9-25-2009.
- 3,784,693. **BECOME ULTRA BEAUTIFUL & LOOK YOUNGER (BLOCK FORM)**. GARG, SHYAM S., (U.S. CLS. 1, 4, 6, 50, 51 AND 52). SN 77-836,757. PUB. 2-16-2010. FILED 9-28-2009.
- 3,784,714. **OLIVE OIL CREAMY ALOE SHAMPOO AND DESIGN**. NAMASTE LABORATORIES, L.L.C., (U.S. CLS. 1, 4, 6, 50, 51 AND 52). SN 77-839,364. PUB. 2-16-2010. FILED 10-1-2009.
- 3,784,820. **SILKIENCE (BLOCK FORM)**. SILKIENCE HOLDINGS INC., (U.S. CLS. 1, 4, 6, 50, 51 AND 52). SN 77-979,170. PUB. 7-21-2009. FILED 3-20-2009.
- 3,784,825. **ACTHYDERM (BLOCK FORM)**. ZELDIN, JEFFREY, A., MULTIPLE CLASS, (INT. CLS. 3 AND 10), (U.S. CLS. 1, 4, 6, 26, 39, 44, 50, 51 AND 52). SN 78-465,222. PUB. 5-26-2009. FILED 8-10-2004.
- 3,784,838. **HEAD TO TOE TOUCH (BLOCK FORM)**. LUCKY 11, INC., (U.S. CLS. 1, 4, 6, 50, 51 AND 52). SN 78-798,094. PUB. 12-11-2007. FILED 1-24-2006.
- 3,784,856. **PEDAG (BLOCK FORM)**. SCHELCHEN GMBH, MULTIPLE CLASS, (INT. CLS. 3 AND 25), (U.S. CLS. 1, 4, 6, 22, 39, 50, 51 AND 52). SN 79-009,071. PUB. 8-22-2006. FILED 5-17-2004.
- 3,784,859. **VD (STYLIZED)**. İD GROUP, MULTIPLE CLASS, (INT. CLS. 3, 14, 18 AND 44), (U.S. CLS. 1, 2, 3, 4, 6, 22, 27, 28, 41, 50, 51, 52, 100 AND 101). SN 79-033,913. PUB. 4-1-2008. FILED 10-23-2006.
- 3,784,863. **FORZA (BLOCK FORM)**. COTY DEUTSCHLAND GMBH, (U.S. CLS. 1, 4, 6, 50, 51 AND 52). SN 79-047,280. PUB. 2-16-2010. FILED 11-13-2007.
- 3,784,864. **MITICO (BLOCK FORM)**. COTY DEUTSCHLAND GMBH, (U.S. CLS. 1, 4, 6, 50, 51 AND 52). SN 79-047,471. PUB. 2-16-2010. FILED 11-13-2007.
- 3,784,865. **RENATI (STYLIZED)**. THE HOUSE OF TERENCE PROPRIETARY LIMITED, MULTIPLE CLASS, (INT. CLS. 3, 26, 43 AND 44), (U.S. CLS. 1, 4, 6, 37, 39, 40, 42, 50, 51, 52, 100 AND 101). SN 79-048,704. PUB. 2-16-2010. FILED 10-12-2007.
- 3,784,869. **LAGARDERE (BLOCK FORM)**. LAGARDERE SCA, MULTIPLE CLASS, (INT. CLS. 3, 6, 9, 14, 16, 18, 20, 21, 22, 24, 25, 28, 34, 35, 36, 38, 39, 41, 42, 43, 44 AND 45), (U.S. CLS. 1, 2, 3, 4, 5, 6, 7, 8, 9, 12, 13, 14, 17, 19, 21, 22, 23, 25, 26, 27, 28, 29, 30, 32, 33, 36, 37, 38, 39, 40, 41, 42, 50, 51, 52, 100, 101, 102, 104, 105 AND 107). SN 79-050,280. PUB. 2-16-2010. FILED 8-31-2007.
- 3,784,874. **OLFACTORIUM (STYLIZED)**. CINQUIEME SENS, MULTIPLE CLASS, (INT. CLS. 3, 16, 28 AND 41), (U.S. CLS. 1, 2, 4, 5, 6, 22, 23, 29, 37, 38, 50, 51, 52, 100, 101 AND 107). SN 79-056,282. PUB. 2-16-2010. FILED 3-17-2008.
- 3,784,877. **FRANCISCO ROSAS (STYLIZED)**. FRANCISCO JOSE ROSAS, MULTIPLE CLASS, (INT. CLS. 3, 18, 24 AND 25), (U.S. CLS. 1, 2, 3, 4, 6, 22, 39, 41, 42, 50, 51 AND 52). SN 79-057,338. PUB. 2-16-2010. FILED 7-16-2008.
- 3,784,890. **SORA COOL AIR COLLECTION AND DESIGN**. SORA KOZMETIK VE KIMYA; SANAYI VE TICARET LIMITED SIRKETI, MULTIPLE CLASS, (INT. CLS. 3 AND 5), (U.S. CLS. 1, 4, 6, 18, 44, 46, 50, 51 AND 52). SN 79-058,963. PUB. 2-16-2010. FILED 4-4-2008.
- 3,784,894. **T AND DESIGN**. ROBERT THOMAS METALL-; UND ELEKTROWERKE GMBH & CO. KG, MULTIPLE CLASS, (INT. CLS. 3 AND 7), (U.S. CLS. 1, 4, 6, 13, 19, 21, 23, 31, 34, 35, 50, 51 AND 52). SN 79-059,288. PUB. 2-16-2010. FILED 7-14-2008.
- 3,784,896. **MONCLER (BLOCK FORM)**. MONCLER S.R.L., MULTIPLE CLASS, (INT. CLS. 3, 9, 14, 16, 18, 22, 24, 25 AND 28), (U.S. CLS. 1, 2, 3, 4, 5, 6, 7, 19, 21, 22, 23, 26, 27, 28, 29, 36, 37, 38, 39, 41, 42, 50, 51 AND 52). SN 79-059,493. PUB. 2-16-2010. FILED 6-25-2007.
- 3,784,932 (*See Class 1 for this trademark*).
- 3,784,951. **BELLEPILO (BLOCK FORM)**. ALVEOLA KFT., MULTIPLE CLASS, (INT. CLS. 3 AND 8), (U.S. CLS. 1, 4, 6, 23, 28, 44, 50, 51 AND 52). SN 79-067,489. PUB. 1-12-2010. FILED 3-10-2009.
- 3,784,952. **RIEMANN P10 AND DESIGN**. RIEMANN TRADING APS, MULTIPLE CLASS, (INT. CLS. 3 AND 5), (U.S. CLS. 1, 4, 6, 18, 44, 46, 50, 51 AND 52). SN 79-067,493. PUB. 2-16-2010. FILED 2-28-2009.
- 3,784,953. **RIEMANN P20 AND DESIGN**. RIEMANN TRADING APS, MULTIPLE CLASS, (INT. CLS. 3 AND 5), (U.S. CLS. 1, 4, 6, 18, 44, 46, 50, 51 AND 52). SN 79-067,494. PUB. 2-16-2010. FILED 2-28-2009.
- 3,784,954. **RIEMANN P30 AND DESIGN**. RIEMANN TRADING APS, MULTIPLE CLASS, (INT. CLS. 3 AND 5), (U.S. CLS. 1, 4, 6, 18, 44, 46, 50, 51 AND 52). SN 79-067,495. PUB. 2-16-2010. FILED 2-28-2009.
- 3,784,972. **VELINE (BLOCK FORM)**. ARTE MESTIERE SRL, MULTIPLE CLASS, (INT. CLS. 3, 9, 12, 14, 16, 18, 25, 28, 32, 33 AND 43), (U.S. CLS. 1, 2, 3, 4, 5, 6, 19, 21, 22, 23, 26, 27, 28, 29, 31, 35, 36, 37, 38, 39, 41, 44, 45, 46, 47, 48, 49, 50, 51, 52, 100 AND 101). SN 79-068,212. PUB. 2-16-2010. FILED 1-15-2009.
- 3,784,989 (*See Class 1 for this trademark*).
- 3,785,027. **IPERBOREA (BLOCK FORM)**. LORENZO VILLORRESI, (U.S. CLS. 1, 4, 6, 50, 51 AND 52). SN 79-072,565. PUB. 2-16-2010. FILED 3-18-2009.
- 3,785,050. **HEALTHY MIX (BLOCK FORM)**. BOURJOIS, (U.S. CLS. 1, 4, 6, 50, 51 AND 52). SN 79-075,102. PUB. 2-16-2010. FILED 9-9-2009.

CLASS 4—LUBRICANTS AND FUELS

- 3,783,166 (*See Class 1 for this trademark*).
- 3,783,408. **LM LIKE MAGIC AND DESIGN**. SWIMC, INC., (U.S. CLS. 1, 6 AND 15). SN 77-693,418. PUB. 2-16-2010. FILED 3-18-2009.
- 3,783,703. **EARTH ARMOUR (BLOCK FORM)**. MIDWEST INDUSTRIAL SUPPLY, INC., (U.S. CLS. 1, 6 AND 15). SN 77-778,261. PUB. 2-16-2010. FILED 7-10-2009.
- 3,784,062. **MISCELLANEOUS DESIGN**. HARTMAN OIL CO., INC., MULTIPLE CLASS, (INT. CLS. 4, 42 AND 43), (U.S. CLS. 1, 6, 15, 100 AND 101). SN 77-826,928. PUB. 2-16-2010. FILED 9-15-2009.
- 3,784,349. **TOOL BOX BUDDY (BLOCK FORM)**. LUCASOIL PRODUCTS, INC. (U.S. CLS. 1, 6 AND 15). SN 77-831,844. PUB. 2-16-2010. FILED 9-22-2009.
- 3,784,586. **ODORCLEAR AND DESIGN**. LANCASTER COLONY CORPORATION, (U.S. CLS. 1, 6 AND 15). SN 77-834,857. PUB. 2-16-2010. FILED 9-25-2009.
- 3,784,791. **EMOTIONS (BLOCK FORM)**. SPAISSIMO PURE SPA COLLECTION, LLC., (U.S. CLS. 1, 6 AND 15). SN 77-863,224. PUB. 2-16-2010. FILED 11-2-2009.
- 3,784,906 (*See Class 1 for this trademark*).
- 3,784,907 (*See Class 1 for this trademark*).
- 3,784,913 (*See Class 1 for this trademark*).
- 3,785,023 (*See Class 1 for this trademark*).

CLASS 5—PHARMACEUTICALS

- 3,783,107. **BODY BASIX (BLOCK FORM)**. 338 PARTNERS, LLC, MULTIPLE CLASS, (INT. CLS. 5, 29 AND 32), (U.S. CLS. 6, 18, 44, 45, 46, 48, 51 AND 52). SN 76-697,058. PUB. 2-16-2010. FILED 4-24-2009.
- 3,783,137. **MINSICA (BLOCK FORM)**. ALCON, INC., (U.S. CLS. 6, 18, 44, 46, 51 AND 52). SN 77-024,544. PUB. 2-16-2010. FILED 10-19-2006.
- 3,783,147. **Z-BLOCK (BLOCK FORM)**. FOUNDATION MILLING CENTRE, LLC, (U.S. CLS. 6, 18, 44, 46, 51 AND 52). SN 77-118,161. PUB. 2-16-2010. FILED 2-28-2007.
- 3,783,149. **MINSURG (BLOCK FORM)**. MINSURG CORPORATION, (U.S. CLS. 6, 18, 44, 46, 51 AND 52). SN 77-138,016. PUB. 2-16-2010. FILED 3-22-2007.
- 3,783,162. **GENESIS AND DESIGN**. GENESIS PHARMACEUTICAL, INC., (U.S. CLS. 6, 18, 44, 46, 51 AND 52). SN 77-178,967. PUB. 2-16-2010. FILED 5-11-2007.
- 3,783,200. **VISION AND DESIGN**. SIGNET ARMORLITE EUROPE LIMITED, (U.S. CLS. 6, 18, 44, 46, 51 AND 52). SN 77-396,686. PUB. 2-16-2010. FILED 2-14-2008.
- 3,783,213. **NEXIANGA (BLOCK FORM)**. ASTRAZENECA AB, (U.S. CLS. 6, 18, 44, 46, 51 AND 52). SN 77-422,199. PUB. 6-9-2009. FILED 3-14-2008.
- 3,783,214. **AXANUM (BLOCK FORM)**. ASTRAZENECA AB, (U.S. CLS. 6, 18, 44, 46, 51 AND 52). SN 77-422,310. PUB. 6-9-2009. FILED 3-14-2008.
- 3,783,224. **HYALOSPHERE (BLOCK FORM)**. FIDIA FARMACEUTICI S.P.A., (U.S. CLS. 6, 18, 44, 46, 51 AND 52). SN 77-472,623. PUB. 3-17-2009. FILED 5-13-2008.
- 3,783,230. **SYNERGENZ (BLOCK FORM)**. SYNERGENZ BIOSCIENCE LIMITED, MULTIPLE CLASS, (INT. CLS. 5 AND 44), (U.S. CLS. 6, 18, 44, 46, 51, 52, 100 AND 101). SN 77-488,264. PUB. 9-15-2009. FILED 6-2-2008.
- 3,783,260 (*See Class 3 for this trademark*).
- 3,783,309. **MOCHI MED SPA (BLOCK FORM)**. HANSEN A. CHANG, L.L.C., MULTIPLE CLASS, (INT. CLS. 5 AND 44), (U.S. CLS. 6, 18, 44, 46, 51, 52, 100 AND 101). SN 77-614,807. PUB. 2-16-2010. FILED 11-14-2008.
- 3,783,340. **YUMMI BEARS ORGANICS THE ORIGINAL GUMMY VITAMIN AND DESIGN**. HERO NUTRITIONALS, LLC, (U.S. CLS. 6, 18, 44, 46, 51 AND 52). SN 77-659,579. PUB. 2-16-2010. FILED 1-29-2009.
- 3,783,437. **KUVAN AND DESIGN**. BIOMARIN PHARMACEUTICAL INC., (U.S. CLS. 6, 18, 44, 46, 51 AND 52). SN 77-699,200. PUB. 2-16-2010. FILED 3-25-2009.
- 3,783,465. **VIVO-LIVO AND DESIGN**. SINO-ASIA PHARMACEUTICAL SUPPLIES LTD., (U.S. CLS. 6, 18, 44, 46, 51 AND 52). SN 77-701,840. PUB. 2-16-2010. FILED 3-30-2009.
- 3,783,479. **TAPSIN UP (BLOCK FORM)**. LABORATORIO MAVER LTDA., (U.S. CLS. 6, 18, 44, 46, 51 AND 52). SN 77-703,757. PUB. 2-16-2010. FILED 3-31-2009.
- 3,783,504. **DISMEX SUERO (BLOCK FORM)**. DISMEX FOOD, INC., (U.S. CLS. 6, 18, 44, 46, 51 AND 52). SN 77-707,323. PUB. 2-16-2010. FILED 4-6-2009.
- 3,783,523. **CATTLEMAN'S CHOICE MINERAL SUPPLEMENT AND DESIGN**. AB HOLDINGS, LLC, (U.S. CLS. 6, 18, 44, 46, 51 AND 52). SN 77-712,340. PUB. 2-16-2010. FILED 4-13-2009.
- 3,783,524. **RUMAX LIQUID NUTRIENT SUSPENSION AND DESIGN**. AB HOLDINGS, LLC, (U.S. CLS. 6, 18, 44, 46, 51 AND 52). SN 77-712,344. PUB. 2-16-2010. FILED 4-13-2009.
- 3,783,525. **TOPPEAK DAIRY SUPPLEMENT AND DESIGN**. AB HOLDINGS, LLC, (U.S. CLS. 6, 18, 44, 46, 51 AND 52). SN 77-712,348. PUB. 2-16-2010. FILED 4-13-2009.
- 3,783,526. **FLAVORGLO FEED SUPPLEMENT AND DESIGN**. AB HOLDINGS, LLC, (U.S. CLS. 6, 18, 44, 46, 51 AND 52). SN 77-712,361. PUB. 2-16-2010. FILED 4-13-2009.
- 3,783,527. **ENERGY EXPRESS (BLOCK FORM)**. AB HOLDINGS, LLC, (U.S. CLS. 6, 18, 44, 46, 51 AND 52). SN 77-712,410. PUB. 2-16-2010. FILED 4-13-2009.
- 3,783,555. **VITALZYM (BLOCK FORM)**. WORLD NUTRITION, INC., (U.S. CLS. 6, 18, 44, 46, 51 AND 52). SN 77-716,464. PUB. 2-16-2010. FILED 4-17-2009.
- 3,783,601. **NASALASALT (BLOCK FORM)**. INNOVATIVE CONSULTING, INC., (U.S. CLS. 6, 18, 44, 46, 51 AND 52). SN 77-739,957. PUB. 2-16-2010. FILED 5-19-2009.
- 3,783,616. **MISCELLANEOUS DESIGN**. TSUMURA & CO., (U.S. CLS. 6, 18, 44, 46, 51 AND 52). SN 77-751,221. PUB. 2-16-2010. FILED 6-3-2009.
- 3,783,617. **MISCELLANEOUS DESIGN**. TSUMURA & CO., (U.S. CLS. 6, 18, 44, 46, 51 AND 52). SN 77-751,269. PUB. 2-16-2010. FILED 6-3-2009.
- 3,783,625. **D3-5 (BLOCK FORM)**. BIO-TECH PHARMACAL, INC., (U.S. CLS. 6, 18, 44, 46, 51 AND 52). SN 77-753,573. PUB. 2-16-2010. FILED 6-5-2009.
- 3,783,626. **D3-50 (BLOCK FORM)**. BIO-TECH PHARMACAL, INC., (U.S. CLS. 6, 18, 44, 46, 51 AND 52). SN 77-753,587. PUB. 2-16-2010. FILED 6-5-2009.
- 3,783,632. **FEMOSTON (BLOCK FORM)**. SOLVAY PHARMACEUTICALS B.V., (U.S. CLS. 6, 18, 44, 46, 51 AND 52). SN 77-755,384. PUB. 2-16-2010. FILED 6-9-2009.
- 3,783,635. **F AND DESIGN**. SOLVAY PHARMACEUTICALS B.V., (U.S. CLS. 6, 18, 44, 46, 51 AND 52). SN 77-755,801. PUB. 2-16-2010. FILED 6-9-2009.
- 3,783,688. **VANTELIN (BLOCK FORM)**. KOWA COMPANY, LTD., (U.S. CLS. 6, 18, 44, 46, 51 AND 52). SN 77-773,216. PUB. 2-16-2010. FILED 7-2-2009.
- 3,783,747 (*See Class 3 for this trademark*).
- 3,783,810. **SPEEDCEM (BLOCK FORM)**. IVOCLAR VIVADENT, INC., (U.S. CLS. 6, 18, 44, 46, 51 AND 52). SN 77-807,121. PUB. 2-16-2010. FILED 8-18-2009.
- 3,783,824. **VIBRANCY C (BLOCK FORM)**. NUTRAGENETICS, LLC, (U.S. CLS. 6, 18, 44, 46, 51 AND 52). SN 77-809,589. PUB. 2-16-2010. FILED 8-20-2009.
- 3,783,829. **MULTILINK IMPLANT (BLOCK FORM)**. IVOCLAR VIVADENT, INC., (U.S. CLS. 6, 18, 44, 46, 51 AND 52). SN 77-810,215. PUB. 2-16-2010. FILED 8-21-2009.
- 3,783,836. **DREAMPAK (STYLIZED)**. DREAMPAK, (U.S. CLS. 6, 18, 44, 46, 51 AND 52). SN 77-812,366. PUB. 2-16-2010. FILED 8-25-2009.
- 3,783,885. **NATURAL LIVING (BLOCK FORM)**. NATURAL LIVING, (U.S. CLS. 6, 18, 44, 46, 51 AND 52). SN 77-817,227. PUB. 2-16-2010. FILED 9-1-2009.
- 3,783,925. **PMS PLUS (BLOCK FORM)**. DEMOTT, THALYA C., DBA WOMEN'S NATURAL HEALTH, LLC, (U.S. CLS. 6, 18, 44, 46, 51 AND 52). SN 77-821,370. PUB. 2-16-2010. FILED 9-8-2009.
- 3,783,956. **NO MOSS (BLOCK FORM)**. JH BIOTECH, INC., (U.S. CLS. 6, 18, 44, 46, 51 AND 52). SN 77-823,444. PUB. 2-16-2010. FILED 9-10-2009.
- 3,783,959 (*See Class 3 for this trademark*).
- 3,783,989. **BABY MINE (BLOCK FORM)**. TOP FORM, (U.S. CLS. 6, 18, 44, 46, 51 AND 52). SN 77-824,562. PUB. 2-16-2010. FILED 9-11-2009.
- 3,784,031. **ORGANO GUARD (BLOCK FORM)**. OWEN BIOSCIENCES, INC., (U.S. CLS. 6, 18, 44, 46, 51 AND 52). SN 77-826,030. PUB. 2-16-2010. FILED 9-14-2009.
- 3,784,034. **ORGANO GUARD AND DESIGN**. OWEN BIOSCIENCES, INC., (U.S. CLS. 6, 18, 44, 46, 51 AND 52). SN 77-826,085. PUB. 2-16-2010. FILED 9-14-2009.
- 3,784,208. **DUREZOL (BLOCK FORM)**. SIRION THERAPEUTICS, INC., (U.S. CLS. 6, 18, 44, 46, 51 AND 52). SN 77-830,018. PUB. 2-16-2010. FILED 9-18-2009.
- 3,784,245. **AGAINST24 AND DESIGN**. HARMONY BIOSCIENCE, INC., (U.S. CLS. 6, 18, 44, 46, 51 AND 52). SN 77-830,580. PUB. 2-16-2010. FILED 9-20-2009.
- 3,784,262. **PURELY ELIZABETH. (BLOCK FORM)**. APPETITE FOR HEALTHY LIVING, (U.S. CLS. 6, 18, 44, 46, 51 AND 52). SN 77-830,797. PUB. 2-16-2010. FILED 9-21-2009.
- 3,784,290. **NOURISHMENT FOR LIFE (BLOCK FORM)**. INTRACELL NUTRITION INC., (U.S. CLS. 6, 18, 44, 46, 51 AND 52). SN 77-831,082. PUB. 2-16-2010. FILED 9-21-2009.
- 3,784,305. **HUMIRA (STYLIZED)**. ABBOTT BIOTECHNOLOGY LTD., (U.S. CLS. 6, 18, 44, 46, 51 AND 52). SN 77-831,297. PUB. 2-16-2010. FILED 9-21-2009.
- 3,784,337. **COLIC-EASE (BLOCK FORM)**. COLIC-EASE, INC., (U.S. CLS. 6, 18, 44, 46, 51 AND 52). SN 77-831,737. PUB. 2-16-2010. FILED 9-22-2009.
- 3,784,341. **MEDITIZE (BLOCK FORM)**. RADCO CHEMICAL SOLUTIONS, INC., (U.S. CLS. 6, 18, 44, 46, 51 AND 52). SN 77-831,749. PUB. 2-16-2010. FILED 9-22-2009.
- 3,784,382. **TRICK YOUR BRAIN ! (BLOCK FORM)**. SLIMBOLICS, LLC, (U.S. CLS. 6, 18, 44, 46, 51 AND 52). SN 77-832,255. PUB. 2-16-2010. FILED 9-22-2009.
- 3,784,390. **VNATURAL IMPROVING LIFE AND DESIGN**. CND INTERNATIONAL LLC, (U.S. CLS. 6, 18, 44, 46, 51

AND 52). SN 77-832,351. PUB. 2-16-2010. FILED 9-22-2009.

3,784,413. **BAMBOOBIES (BLOCK FORM)**. GILMARTIN, KAREN W. (U.S. CLS. 6, 18, 44, 46, 51 AND 52). SN 77-832,654. PUB. 2-16-2010. FILED 9-23-2009.

3,784,496. **CARTIGEL (BLOCK FORM)**. AMERO FOODS MFG, CORP., (U.S. CLS. 6, 18, 44, 46, 51 AND 52). SN 77-833,588. PUB. 2-16-2010. FILED 9-23-2009.

3,784,516. **PERFECT MOTHER NATURE AND DESIGN**. GREER, NILDA, (U.S. CLS. 6, 18, 44, 46, 51 AND 52). SN 77-833,853. PUB. 2-16-2010. FILED 9-24-2009.

3,784,570. **TAKE DOWN TD (STYLIZED)**. CLEANPHIRST, LLC, (U.S. CLS. 6, 18, 44, 46, 51 AND 52). SN 77-834,572. PUB. 2-16-2010. FILED 9-24-2009.

3,784,607. **CLENAMINE (BLOCK FORM)**. ITRITION, LLC, (U.S. CLS. 6, 18, 44, 46, 51 AND 52). SN 77-835,111. PUB. 2-16-2010. FILED 9-25-2009.

3,784,626. **HEMO RAGE BLACK (BLOCK FORM)**. NUTREX RESEARCH, INC., (U.S. CLS. 6, 18, 44, 46, 51 AND 52). SN 77-835,411. PUB. 2-16-2010. FILED 9-25-2009.

3,784,667. **COMFORTABLE WEIGHT LOSS (BLOCK FORM)**. ITRITION, LLC, (U.S. CLS. 6, 18, 44, 46, 51 AND 52). SN 77-836,154. PUB. 2-16-2010. FILED 9-28-2009.

3,784,713. **REEOVEER (BLOCK FORM)**. ACTELION PHARMACEUTICALS LTD, (U.S. CLS. 6, 18, 44, 46, 51 AND 52). SN 77-839,171. PUB. 2-16-2010. FILED 10-1-2009.

3,784,716. **PLATINUM HYDRO WHEY (BLOCK FORM)**. ON OPTIMUM NUTRITION LIMITED, (U.S. CLS. 6, 18, 44, 46, 51 AND 52). SN 77-840,175. PUB. 2-16-2010. FILED 10-2-2009.

3,784,740. **ZERO FAT (BLOCK FORM)**. WINDMILL HEALTH PRODUCTS, LLC., (U.S. CLS. 6, 18, 44, 46, 51 AND 52). SN 77-846,407. PUB. 2-16-2010. FILED 10-12-2009.

3,784,743. **NATURAL ELEGANCE (BLOCK FORM)**. HS TM, LLC, (U.S. CLS. 6, 18, 44, 46, 51 AND 52). SN 77-849,334. PUB. 2-16-2010. FILED 10-15-2009.

3,784,762. **ARTICADENT (BLOCK FORM)**. DENTSPLY INTERNATIONAL INC., (U.S. CLS. 6, 18, 44, 46, 51 AND 52). SN 77-855,090. PUB. 2-16-2010. FILED 10-22-2009.

3,784,779. **2SEAL (BLOCK FORM)**. DENTSPLY INTERNATIONAL INC., (U.S. CLS. 6, 18, 44, 46, 51 AND 52). SN 77-860,489. PUB. 2-16-2010. FILED 10-29-2009.

3,784,824. **ELLA'S KITCHEN (BLOCK FORM)**. ELLA'S KITCHEN (IP) LIMITED, MULTIPLE CLASS, (INT. CLS. 5, 29 AND 32), (U.S. CLS. 6, 18, 44, 45, 46, 48, 51 AND 52). SN 77-979,204. PUB. 9-15-2009. FILED 2-3-2009.

3,784,858. **VIVAGEL (BLOCK FORM)**. STARPHARMA PTY LIMITED, MULTIPLE CLASS, (INT. CLS. 5 AND 10), (U.S. CLS. 6, 18, 26, 39, 44, 46, 51 AND 52). SN 79-029,045. PUB. 2-16-2010. FILED 3-27-2006.

3,784,884. **SLAP N TICKLE (BLOCK FORM)**. SLAP N TICKLE PTY LTD, MULTIPLE CLASS, (INT. CLS. 5, 9, 10, 16, 25, 28, 35, 38, 41 AND 45), (U.S. CLS. 2, 5, 6, 18, 21, 22, 23, 26, 29, 36, 37, 38, 39, 44, 46, 50, 51, 52, 100, 101, 102, 104 AND 107). SN 79-058,768. PUB. 5-12-2009. FILED 7-14-2008.

3,784,890 (*See Class 3 for this trademark*).

3,784,898. **ANGIOMITOTIC (BLOCK FORM)**. CYCLACEL LIMITED, MULTIPLE CLASS, (INT. CLS. 5, 41, 42 AND 44), (U.S. CLS. 6, 18, 44, 46, 51, 52, 100, 101 AND 107). SN 79-060,246. PUB. 2-16-2010. FILED 10-1-2008.

3,784,899. **ANGIOCYCLIC (BLOCK FORM)**. CYCLACEL LIMITED, MULTIPLE CLASS, (INT. CLS. 5, 41, 42 AND 44), (U.S. CLS. 6, 18, 44, 46, 51, 52, 100, 101 AND 107). SN 79-060,247. PUB. 2-16-2010. FILED 10-1-2008.

3,784,900. **CCM AND DESIGN**. CENTRO CARDIOLOGICO S.P.A.; "FONDAZIONE MONZINO"; IN FORMA ABBREVIATA; CENTRO CARDIOLOGICO MONZINO S.P.A., MULTIPLE CLASS, (INT. CLS. 5, 35, 41 AND 44), (U.S. CLS. 6, 18, 44, 46, 51, 52, 100, 101, 102 AND 107). SN 79-060,346. PUB. 2-16-2010. FILED 6-30-2008.

3,784,913 (*See Class 1 for this trademark*).

3,784,916. **MISCELLANEOUS DESIGN**. GUIZHOU YIBAI; PHARMACEUTICAL COMPANY LIMITED, (U.S. CLS. 6, 18, 44, 46, 51 AND 52). SN 79-062,489. PUB. 2-16-2010. FILED 9-12-2008.

3,784,921. **SECURIL (BLOCK FORM)**. LEGRAND CHARLES, MULTIPLE CLASS, (INT. CLS. 5 AND 29), (U.S. CLS. 6, 18, 44, 46, 51 AND 52). SN 79-064,470. PUB. 2-16-2010. FILED 11-26-2008.

3,784,935. **VIVINAL (BLOCK FORM)**. FRIESLAND BRANDS

B.V., MULTIPLE CLASS, (INT. CLS. 5, 29 AND 32), (U.S. CLS. 6, 18, 44, 45, 46, 48, 51 AND 52). SN 79-066,693. PUB. 2-16-2010. FILED 7-10-2008.

3,784,942. **IPSATE (BLOCK FORM)**. IPSEN PHARMA S.A.S., (U.S. CLS. 6, 18, 44, 46, 51 AND 52). SN 79-067,203. PUB. 2-16-2010. FILED 3-19-2009.

3,784,952 (*See Class 3 for this trademark*).

3,784,953 (*See Class 3 for this trademark*).

3,784,954 (*See Class 3 for this trademark*).

3,784,962. **SENTIGUARD AND DESIGN**. INVE TECHNOLOGIES, NAAMLOZE VENNOOTSCHAP, (U.S. CLS. 6, 18, 44, 46, 51 AND 52). SN 79-067,946. PUB. 2-16-2010. FILED 1-9-2009.

3,785,046. **TRIDEFA (BLOCK FORM)**. NOVO NORDISK HEALTH CARE AG, (U.S. CLS. 6, 18, 44, 46, 51 AND 52). SN 79-074,468. PUB. 2-16-2010. FILED 9-25-2009.

3,785,047. **HAEMOLAN (BLOCK FORM)**. NOVO NORDISK HEALTH CARE AG, (U.S. CLS. 6, 18, 44, 46, 51 AND 52). SN 79-074,469. PUB. 2-16-2010. FILED 9-25-2009.

CLASS 6—METAL GOODS

3,783,103. **WILL NOT DAMAGE YOUR WALLS (BLOCK FORM)**. MICASA TRADING CORP., DBA IMPEX SYSTEMS GROUP, INC., (U.S. CLS. 2, 12, 13, 14, 23, 25 AND 50). SN 76-695,955. PUB. 2-16-2010. FILED 2-24-2009.

3,783,115. **OHMEGA (BLOCK FORM)**. OHMEGA TECHNOLOGIES, INC., (U.S. CLS. 2, 12, 13, 14, 23, 25 AND 50). SN 76-698,724. PUB. 2-16-2010. FILED 7-31-2009.

3,783,116. **OHMEGA AND DESIGN**. OHMEGA TECHNOLOGIES, INC., (U.S. CLS. 2, 12, 13, 14, 23, 25 AND 50). SN 76-698,725. PUB. 2-16-2010. FILED 7-31-2009.

3,783,117. **OHMEGAPLY RCM AND DESIGN**. OHMEGA TECHNOLOGIES, INC., (U.S. CLS. 2, 12, 13, 14, 23, 25 AND 50). SN 76-698,726. PUB. 2-16-2010. FILED 7-31-2009.

3,783,118. **OHMEGAPLY (BLOCK FORM)**. OHMEGA TECHNOLOGIES, INC., (U.S. CLS. 2, 12, 13, 14, 23, 25 AND 50). SN 76-698,729. PUB. 2-16-2010. FILED 7-31-2009.

3,783,119. **OHMEGAPLY AND DESIGN**. OHMEGA TECHNOLOGIES, INC., (U.S. CLS. 2, 12, 13, 14, 23, 25 AND 50). SN 76-698,730. PUB. 2-16-2010. FILED 7-31-2009.

3,783,157. **POLICELL (BLOCK FORM)**. J & S FRANKLIN LTD, AND TERRAM LIMITED, MULTIPLE CLASS, (INT. CLS. 6, 17, 19, 24, 37, 42 AND 45), (U.S. CLS. 1, 2, 5, 12, 13, 14, 23, 25, 33, 35, 42, 50, 100, 101, 103 AND 106). SN 77-159,977. PUB. 12-1-2009. FILED 4-18-2007.

3,783,259. **MIRO INDUSTRIES, INC. (BLOCK FORM)**. MIRO INDUSTRIES, INC., MULTIPLE CLASS, (INT. CLS. 6 AND 19), (U.S. CLS. 1, 2, 12, 13, 14, 23, 25, 33 AND 50). SN 77-536,346. PUB. 2-16-2010. FILED 7-31-2008.

3,783,297. **API OUTDOORS (BLOCK FORM)**. OUT O' SITE, LLC, MULTIPLE CLASS, (INT. CLS. 6, 12 AND 28), (U.S. CLS. 2, 12, 13, 14, 19, 21, 22, 23, 25, 31, 35, 38, 44 AND 50). SN 77-595,212. PUB. 2-16-2010. FILED 10-17-2008.

3,783,320. **ENGLISH77 (BLOCK FORM)**. ANOK, LLC, DBA STUDSANDSPIKES.COM, (U.S. CLS. 2, 12, 13, 14, 23, 25 AND 50). SN 77-641,648. PUB. 2-16-2010. FILED 12-30-2008.

3,783,321. **77 STUDS (BLOCK FORM)**. ANOK, LLC, DBA STUDSANDSPIKES.COM, (U.S. CLS. 2, 12, 13, 14, 23, 25 AND 50). SN 77-641,666. PUB. 2-16-2010. FILED 12-30-2008.

3,783,369. **M AND DESIGN**. EL MILENO RANCH INC., MULTIPLE CLASS, (INT. CLS. 6, 18, 20, 25, 26, 31 AND 44), (U.S. CLS. 1, 2, 3, 12, 13, 14, 22, 23, 25, 32, 37, 39, 40, 41, 42, 46, 50, 100 AND 101). SN 77-680,223. PUB. 2-16-2010. FILED 2-27-2009.

3,783,487. **HOTWARE BOX (BLOCK FORM)**. ULYSSES BOONE, (U.S. CLS. 2, 12, 13, 14, 23, 25 AND 50). SN 77-704,634. PUB. 2-16-2010. FILED 4-1-2009.

3,783,541. **DEVON (BLOCK FORM)**. DEVON SELF STORAGE HOLDINGS (US) LLC, MULTIPLE CLASS, (INT. CLS. 6, 16, 35 AND 39), (U.S. CLS. 2, 5, 12, 13, 14, 22, 23, 25, 29, 37, 38, 50, 100, 101, 102 AND 105). SN 77-713,354. PUB. 2-16-2010. FILED 4-14-2009.

3,783,687. **MISCELLANEOUS DESIGN**. PRECISION WIRE COMPONENTS, LLC, MULTIPLE CLASS, (INT. CLS. 6 AND 42), (U.S. CLS. 2, 12, 13, 14, 23, 25, 50, 100 AND 101). SN

- 77-772,879. PUB. 2-16-2010. FILED 7-1-2009.
- 3,783,815. **ROCKET RACK (BLOCK FORM)**. UNIQUE METAL SOLUTIONS, LLC, (U.S. CLS. 2, 12, 13, 14, 23, 25 AND 50). SN 77-807,824. PUB. 2-16-2010. FILED 8-19-2009.
- 3,783,873. **ROCKET RACK AND DESIGN**. UNIQUE METAL SOLUTIONS, LLC, (U.S. CLS. 2, 12, 13, 14, 23, 25 AND 50). SN 77-816,040. PUB. 2-16-2010. FILED 8-30-2009.
- 3,783,876. **COLLEGE OF CHARLESTON (BLOCK FORM)**. COLLEGE OF CHARLESTON, MULTIPLE CLASS, (INT. CLS. 6, 16, 18, 20, 21, 25 AND 28), (U.S. CLS. 1, 2, 3, 5, 12, 13, 14, 22, 23, 25, 29, 30, 32, 33, 37, 38, 39, 40, 41 AND 50). SN 77-816,380. PUB. 2-16-2010. FILED 8-31-2009.
- 3,783,929. **SHARK PLY-CLIP (BLOCK FORM)**. TALLMADGE SPINNING & METAL COMPANY, (U.S. CLS. 2, 12, 13, 14, 23, 25 AND 50). SN 77-821,834. PUB. 2-16-2010. FILED 9-8-2009.
- 3,784,116. **TIGER WIRE AND DESIGN**. THE HAMPTON DOOR COMPANY, INC., (U.S. CLS. 2, 12, 13, 14, 23, 25 AND 50). SN 77-828,396. PUB. 2-16-2010. FILED 9-17-2009.
- 3,784,125. **WINDOW-FIX (BLOCK FORM)**. WINDOW-FIX, INC, MULTIPLE CLASS, (INT. CLS. 6, 19 AND 37), (U.S. CLS. 1, 2, 12, 13, 14, 23, 25, 33, 50, 100, 103 AND 106). SN 77-828,519. PUB. 2-16-2010. FILED 9-17-2009.
- 3,784,188. **STRIKEMASTER II (BLOCK FORM)**. SAFE HOMES INTERNATIONAL INC., (U.S. CLS. 2, 12, 13, 14, 23, 25 AND 50). SN 77-829,683. PUB. 2-16-2010. FILED 9-18-2009.
- 3,784,214. **ELEKTROPLATE AND DESIGN**. REAL-TIME MARKETING, LTD., (U.S. CLS. 2, 12, 13, 14, 23, 25 AND 50). SN 77-830,146. PUB. 2-16-2010. FILED 9-18-2009.
- 3,784,255. **MACCOUPLER (BLOCK FORM)**. GTI, LLC, DBA KM NORTH AMERICA, (U.S. CLS. 2, 12, 13, 14, 23, 25 AND 50). SN 77-830,714. PUB. 2-16-2010. FILED 9-21-2009.
- 3,784,256. **TRAIL BOSS (BLOCK FORM)**. RANCH HAND DISTRIBUTION, LLC, (U.S. CLS. 2, 12, 13, 14, 23, 25 AND 50). SN 77-830,752. PUB. 2-16-2010. FILED 9-21-2009.
- 3,784,258. **MISCELLANEOUS DESIGN**. RANCH HAND DISTRIBUTION, LLC, (U.S. CLS. 2, 12, 13, 14, 23, 25 AND 50). SN 77-830,770. PUB. 2-16-2010. FILED 9-21-2009.
- 3,784,322. **MACO (BLOCK FORM)**. MATERIAL ALTERATION CO., INC., (U.S. CLS. 2, 12, 13, 14, 23, 25 AND 50). SN 77-831,544. PUB. 2-16-2010. FILED 9-21-2009.
- 3,784,364. **EBPC (BLOCK FORM)**. BERG EUROPIPE HOLDING CORP., (U.S. CLS. 2, 12, 13, 14, 23, 25 AND 50). SN 77-832,060. PUB. 2-16-2010. FILED 9-22-2009.
- 3,784,680. **SEASPRAY (BLOCK FORM)**. WILBAR INTERNATIONAL, INC., MULTIPLE CLASS, (INT. CLS. 6 AND 19), (U.S. CLS. 1, 2, 12, 13, 14, 23, 25, 33 AND 50). SN 77-836,535. PUB. 2-16-2010. FILED 9-28-2009.
- 3,784,840 (See Class 1 for this trademark).
- 3,784,841 (See Class 1 for this trademark).
- 3,784,869 (See Class 3 for this trademark).
- 3,784,870. **MISCELLANEOUS DESIGN**. SHAO YANPING, (U.S. CLS. 2, 12, 13, 14, 23, 25 AND 50). SN 79-052,583. PUB. 2-16-2010. FILED 4-10-2008.
- 3,784,881. **JUMBOLINE (BLOCK FORM)**. UNILUX AG, MULTIPLE CLASS, (INT. CLS. 6 AND 19), (U.S. CLS. 1, 2, 12, 13, 14, 23, 25, 33 AND 50). SN 79-058,639. PUB. 2-16-2010. FILED 8-29-2008.
- 3,784,901. **BBRV (BLOCK FORM)**. BBR VT INTERNATIONAL LTD., MULTIPLE CLASS, (INT. CLS. 6, 7 AND 19), (U.S. CLS. 1, 2, 12, 13, 14, 19, 21, 23, 25, 31, 33, 34, 35 AND 50). SN 79-060,629. PUB. 2-16-2010. FILED 7-29-2008.
- 3,784,905. **MAGNESIUM ELEKTRON AND DESIGN**. MAGNESIUM ELEKTRON LIMITED, MULTIPLE CLASS, (INT. CLS. 6 AND 10), (U.S. CLS. 2, 12, 13, 14, 23, 25, 26, 39, 44 AND 50). SN 79-060,874. PUB. 2-16-2010. FILED 10-3-2008.
- 3,784,910. **GEMÜ SWISSPURITY (BLOCK FORM)**. GEMÜ GEBR. MÜLLER; APPARATEBAU GMBH & CO. KG, MULTIPLE CLASS, (INT. CLS. 6, 7, 9 AND 10), (U.S. CLS. 2, 12, 13, 14, 19, 21, 23, 25, 26, 31, 34, 35, 36, 38, 39, 44 AND 50). SN 79-062,066. PUB. 2-16-2010. FILED 7-14-2008.
- 3,784,924. **F AND DESIGN**. FIVES, MULTIPLE CLASS, (INT. CLS. 6, 7, 9, 11, 37, 40 AND 42), (U.S. CLS. 2, 12, 13, 14, 19, 21, 23, 25, 26, 31, 34, 35, 36, 38, 50, 100, 101, 103 AND 106). SN 79-065,305. PUB. 11-10-2009. FILED 12-28-2007.
- 3,784,929. **E FRIENDLY AND DESIGN**. THE FURUKAWA ELECTRIC CO., LTD., MULTIPLE CLASS, (INT. CLS. 6, 9, 12, 17 AND 35), (U.S. CLS. 1, 2, 5, 12, 13, 14, 19, 21, 23, 25, 26, 31, 35, 36, 38, 44, 50, 100, 101 AND 102). SN 79-066,048. PUB. 2-16-2010. FILED 11-20-2008.
- 3,784,961 (See Class 1 for this trademark).
- 3,785,010. **DLP D.LAPORTE AND DESIGN**. D. LA PORTE SÖHNE GMBH, MULTIPLE CLASS, (INT. CLS. 6, 9, 20 AND 40), (U.S. CLS. 2, 12, 13, 14, 21, 22, 23, 25, 26, 32, 36, 38, 50, 100, 103 AND 106). SN 79-070,709. PUB. 2-16-2010. FILED 3-31-2009.

CLASS 7—MACHINERY

- 3,783,186. **APEX SKYPARK (BLOCK FORM)**. APEX SKYPARK, (U.S. CLS. 13, 19, 21, 23, 31, 34 AND 35). SN 77-340,132. PUB. 4-29-2008. FILED 11-29-2007.
- 3,783,198. **ACCEL (BLOCK FORM)**. PRESTOLITE WIRE LLC, MULTIPLE CLASS, (INT. CLS. 7, 8 AND 9), (U.S. CLS. 13, 19, 21, 23, 26, 28, 31, 34, 35, 36, 38 AND 44). SN 77-393,552. PUB. 2-16-2010. FILED 2-11-2008.
- 3,783,210. **ECODRUM AND DESIGN**. TRI-FORM POLY INC., (U.S. CLS. 13, 19, 21, 23, 31, 34 AND 35). SN 77-409,495. PUB. 2-16-2010. FILED 2-29-2008.
- 3,783,222. **MISCELLANEOUS DESIGN**. 314321 ONTARIO LIMITED, DBA BULL INDUSTRIAL SUPPLY, MULTIPLE CLASS, (INT. CLS. 7, 12 AND 37), (U.S. CLS. 13, 19, 21, 23, 31, 34, 35, 44, 100, 103 AND 106). SN 77-452,481. PUB. 12-1-2009. FILED 4-18-2008.
- 3,783,254. **BOARDRIDER (BLOCK FORM)**. MURPHY'S WAVES LIMITED, MULTIPLE CLASS, (INT. CLS. 7 AND 28), (U.S. CLS. 13, 19, 21, 22, 23, 31, 34, 35, 38 AND 50). SN 77-524,319. PUB. 2-16-2010. FILED 7-17-2008.
- 3,783,258. **MULTICRACKER (BLOCK FORM)**. MARTIN ROTHMANN, AND DIRK WEBER, (U.S. CLS. 13, 19, 21, 23, 31, 34 AND 35). SN 77-534,387. PUB. 2-16-2010. FILED 7-30-2008.
- 3,783,363. **GREENSAFE (BLOCK FORM)**. WOLFGANG ASTNER, MULTIPLE CLASS, (INT. CLS. 7, 8, 11, 19 AND 21), (U.S. CLS. 1, 2, 12, 13, 19, 21, 23, 28, 29, 30, 31, 33, 34, 35, 40, 44 AND 50). SN 77-676,364. PUB. 2-16-2010. FILED 2-23-2009.
- 3,783,508. **ADVANTAGE ENGINE PARTS POWER UP! AND DESIGN**. HOWARD ENTERPRISES INC., (U.S. CLS. 13, 19, 21, 23, 31, 34 AND 35). SN 77-708,780. PUB. 2-16-2010. FILED 4-7-2009.
- 3,783,566. **TENNANT (BLOCK FORM)**. TENNANT COMPANY, (U.S. CLS. 13, 19, 21, 23, 31, 34 AND 35). SN 77-719,949. PUB. 2-16-2010. FILED 4-22-2009.
- 3,783,605. **RETSSEL (BLOCK FORM)**. RETSEL CORPORATION, MULTIPLE CLASS, (INT. CLS. 7 AND 21), (U.S. CLS. 2, 13, 19, 21, 23, 29, 30, 31, 33, 34, 35, 40 AND 50). SN 77-741,201. PUB. 2-16-2010. FILED 5-20-2009.
- 3,783,658. **AIR N ARC (BLOCK FORM)**. VANAIR MANUFACTURING, INC., MULTIPLE CLASS, (INT. CLS. 7 AND 9), (U.S. CLS. 13, 19, 21, 23, 26, 31, 34, 35, 36 AND 38). SN 77-763,769. PUB. 2-16-2010. FILED 6-19-2009.
- 3,783,669. **WINTERFLEX (BLOCK FORM)**. WINTER EQUIPMENT COMPANY, INC., (U.S. CLS. 13, 19, 21, 23, 31, 34 AND 35). SN 77-766,133. PUB. 2-16-2010. FILED 6-23-2009.
- 3,783,674. **QUIESS (BLOCK FORM)**. SOMFY SAS, MULTIPLE CLASS, (INT. CLS. 7 AND 9), (U.S. CLS. 13, 19, 21, 23, 26, 31, 34, 35, 36 AND 38). SN 77-768,341. PUB. 2-16-2010. FILED 6-25-2009.
- 3,783,723. **TRIMPRO GASOLINE (BLOCK FORM)**. 4522958 CANADA INC., (U.S. CLS. 13, 19, 21, 23, 31, 34 AND 35). SN 77-785,932. PUB. 2-16-2010. FILED 7-21-2009.
- 3,783,737. **ECHONET (BLOCK FORM)**. CENTRAL MELCO CORPORATION, MULTIPLE CLASS, (INT. CLS. 7, 9, 11 AND 20), (U.S. CLS. 2, 13, 19, 21, 22, 23, 25, 26, 31, 32, 34, 35, 36, 38 AND 50). SN 77-793,510. PUB. 12-29-2009. FILED 7-30-2009.
- 3,783,849. **PUMP-A-WAY (BLOCK FORM)**. HIT PRODUCTS CORPORATION, (U.S. CLS. 13, 19, 21, 23, 31, 34 AND 35). SN 77-814,239. PUB. 2-16-2010. FILED 8-27-2009.
- 3,783,850. **THE ORIGINAL PUMP-A-WAY (BLOCK FORM)**. HIT PRODUCTS CORPORATION, (U.S. CLS. 13, 19, 21, 23, 31, 34 AND 35). SN 77-814,245. PUB. 2-16-2010. FILED 8-27-2009.

3,783,894. **RIPTIDE (BLOCK FORM)**. WEATHERFORD/LAMB, INC., (U.S. CLS. 13, 19, 21, 23, 31, 34 AND 35). SN 77-818,440. PUB. 2-16-2010. FILED 9-2-2009.

3,784,035. **CONCEPT DC (BLOCK FORM)**. NATIONAL TANK COMPANY, (U.S. CLS. 13, 19, 21, 23, 31, 34 AND 35). SN 77-826,086. PUB. 2-16-2010. FILED 9-14-2009.

3,784,036. **CONCEPT ICD (BLOCK FORM)**. NATIONAL TANK COMPANY, (U.S. CLS. 13, 19, 21, 23, 31, 34 AND 35). SN 77-826,102. PUB. 2-16-2010. FILED 9-14-2009.

3,784,097. **YOU CAN DIG IT ! (BLOCK FORM)**. PETT, GWYNETH CHRISTINE, TA YOU CAN DIG IT !, (U.S. CLS. 13, 19, 21, 23, 31, 34 AND 35). SN 77-827,833. PUB. 2-16-2010. FILED 9-16-2009.

3,784,221. **NATURAL BIG BALE PRESS (BLOCK FORM)**. DOUBLE PRESS MFG., INC., (U.S. CLS. 13, 19, 21, 23, 31, 34 AND 35). SN 77-830,299. PUB. 2-16-2010. FILED 9-18-2009.

3,784,616. **SCIFLEX (BLOCK FORM)**. SCIOLOG, INC., (U.S. CLS. 13, 19, 21, 23, 31, 34 AND 35). SN 77-835,321. PUB. 2-16-2010. FILED 9-25-2009.

3,784,742. **WARING (BLOCK FORM)**. CONAIR CORPORATION, MULTIPLE CLASS, (INT. CLS. 7, 11 AND 21), (U.S. CLS. 2, 13, 19, 21, 23, 29, 30, 31, 33, 34, 35, 40 AND 50). SN 77-848,140. PUB. 2-16-2010. FILED 10-14-2009.

3,784,828. **THEN AND DESIGN**. THEN MASCHINEN GMBH, MULTIPLE CLASS, (INT. CLS. 7, 9 AND 11), (U.S. CLS. 13, 19, 21, 23, 26, 31, 34, 35, 36 AND 38). SN 78-569,917. PUB. 7-3-2007. FILED 2-17-2005.

3,784,876. **SGF (STYLIZED)**. SGF SÜDDEUTSCHE GELENKSCHIEBENFABRIK; GMBH & CO. KG, MULTIPLE CLASS, (INT. CLS. 7 AND 12), (U.S. CLS. 13, 19, 21, 23, 31, 34, 35 AND 44). SN 79-057,292. PUB. 2-16-2010. FILED 2-8-2008.

3,784,885. **WINKLER + DÜNNEBIER (BLOCK FORM)**. WINKLER + DÜNNEBIER AG, MULTIPLE CLASS, (INT. CLS. 7, 35, 37 AND 42), (U.S. CLS. 13, 19, 21, 23, 31, 34, 35, 100, 101, 102, 103 AND 106). SN 79-058,773. PUB. 2-16-2010. FILED 7-24-2008.

3,784,886. **W + D AND DESIGN**. WINKLER + DÜNNEBIER AG, MULTIPLE CLASS, (INT. CLS. 7, 35, 37 AND 42), (U.S. CLS. 13, 19, 21, 23, 31, 34, 35, 100, 101, 102, 103 AND 106). SN 79-058,780. PUB. 2-16-2010. FILED 7-24-2008.

3,784,887. **W + D (BLOCK FORM)**. WINKLER + DÜNNEBIER AG, MULTIPLE CLASS, (INT. CLS. 7, 35, 37 AND 42), (U.S. CLS. 13, 19, 21, 23, 31, 34, 35, 100, 101, 102, 103 AND 106). SN 79-058,781. PUB. 2-16-2010. FILED 7-24-2008.

3,784,888. **W + D (STYLIZED)**. WINKLER + DÜNNEBIER AG, MULTIPLE CLASS, (INT. CLS. 7, 35, 37 AND 42), (U.S. CLS. 13, 19, 21, 23, 31, 34, 35, 100, 101, 102, 103 AND 106). SN 79-058,782. PUB. 2-16-2010. FILED 7-24-2008.

3,784,894 (*See Class 3 for this trademark*).

3,784,901 (*See Class 6 for this trademark*).

3,784,908. **GIR-O-MATIC (BLOCK FORM)**. KARL MAYER TEXTILMASCHINENFABRIK GMBH, (U.S. CLS. 13, 19, 21, 23, 31, 34 AND 35). SN 79-061,863. PUB. 2-16-2010. FILED 10-10-2008.

3,784,909. **ENERGYCULTURE (BLOCK FORM)**. GAMESA CORPORACION TECNOLOGICA, S.A., MULTIPLE CLASS, (INT. CLS. 7, 9, 35, 37, 39, 40, 41 AND 42), (U.S. CLS. 13, 19, 21, 23, 26, 31, 34, 35, 36, 38, 100, 101, 102, 103, 105, 106 AND 107). SN 79-062,018. PUB. 2-16-2010. FILED 8-5-2008.

3,784,910 (*See Class 6 for this trademark*).

3,784,914. **6M (STYLIZED)**. REPOWER SYSTEMS AG, MULTIPLE CLASS, (INT. CLS. 7, 9 AND 37), (U.S. CLS. 13, 19, 21, 23, 26, 31, 34, 35, 36, 38, 100, 103 AND 106). SN 79-062,417. PUB. 2-16-2010. FILED 7-23-2008.

3,784,924 (*See Class 6 for this trademark*).

3,784,936. **EMUGE (BLOCK FORM)**. EMUGE-WERK RICHARD GLIMPEL; GMBH & CO KG FABRIK FÜR; PRÄZISIONSWERKZEUGE, MULTIPLE CLASS, (INT. CLS. 7 AND 9), (U.S. CLS. 13, 19, 21, 23, 26, 31, 34, 35, 36 AND 38). SN 79-066,703. PUB. 2-16-2010. FILED 3-12-2009.

3,784,944. **ACORN (BLOCK FORM)**. ACORN MOBILITY SERVICES LIMITED, (U.S. CLS. 13, 19, 21, 23, 31, 34 AND 35). SN 79-067,332. PUB. 2-16-2010. FILED 3-6-2009.

3,784,991. **TYRANNOSAURUS (BLOCK FORM)**. BMH TECHNOLOGY OY, (U.S. CLS. 13, 19, 21, 23, 31, 34 AND 35). SN 79-068,780. PUB. 2-16-2010. FILED 3-30-2009.

3,785,005. **R AND DESIGN**. CHONGQING RATO POWER CO., LTD., MULTIPLE CLASS, (INT. CLS. 7 AND 12), (U.S. CLS. 13, 19, 21, 23, 31, 34, 35 AND 44). SN 79-069,660. PUB. 2-16-2010. FILED 12-9-2008.

3,785,008. **SAFEVENT (BLOCK FORM)**. GEA PROCESS ENGINEERING A/S, MULTIPLE CLASS, (INT. CLS. 7 AND 17), (U.S. CLS. 1, 5, 12, 13, 19, 21, 23, 31, 34, 35 AND 50). SN 79-070,417. PUB. 2-16-2010. FILED 5-19-2009.

3,785,014. **EDGE-RAZOR (BLOCK FORM)**. AIRTEC AG, MULTIPLE CLASS, (INT. CLS. 7 AND 37), (U.S. CLS. 13, 19, 21, 23, 31, 34, 35, 100, 103 AND 106). SN 79-071,042. PUB. 2-16-2010. FILED 1-19-2009.

3,785,023 (*See Class 1 for this trademark*).

3,785,055. **FLOWSONIC (BLOCK FORM)**. CAVANNA S.P.A., (U.S. CLS. 13, 19, 21, 23, 31, 34 AND 35). SN 79-075,920. PUB. 2-16-2010. FILED 9-25-2009.

CLASS 8—HAND TOOLS

3,783,125. **SURTEK (STYLIZED)**. URREA HERRAMIENTAS PROFESIONALES, S.A. DE C.V., MULTIPLE CLASS, (INT. CLS. 8, 9 AND 12), (U.S. CLS. 19, 21, 23, 26, 28, 31, 35, 36, 38 AND 44). SN 76-699,324. PUB. 2-16-2010. FILED 9-3-2009.

3,783,198 (*See Class 7 for this trademark*).

3,783,363 (*See Class 7 for this trademark*).

3,783,395. **QUARROW (BLOCK FORM)**. ALLIANCE SPORTS GROUP, L.P., MULTIPLE CLASS, (INT. CLS. 8, 11 AND 28), (U.S. CLS. 13, 21, 22, 23, 28, 31, 34, 38, 44 AND 50). SN 77-688,818. PUB. 2-16-2010. FILED 3-11-2009.

3,784,400. **CABLE GOPHER (BLOCK FORM)**. TOOLCO, INC., (U.S. CLS. 23, 28 AND 44). SN 77-832,466. PUB. 2-16-2010. FILED 9-22-2009.

3,784,517. **TRUNK BUDDY (BLOCK FORM)**. TRUPER HERRAMIENTAS, S.A. DE C.V., (U.S. CLS. 23, 28 AND 44). SN 77-833,879. PUB. 2-16-2010. FILED 9-24-2009.

3,784,951 (*See Class 3 for this trademark*).

3,784,956. **MYCURL (BLOCK FORM)**. ORGANIC EVOLUTION PTY LTD, MULTIPLE CLASS, (INT. CLS. 8 AND 9), (U.S. CLS. 21, 23, 26, 28, 36, 38 AND 44). SN 79-067,573. PUB. 2-16-2010. FILED 3-26-2009.

CLASS 9—ELECTRICAL AND SCIENTIFIC APPARATUS

3,783,085. **COBRA (BLOCK FORM)**. SMITH, JOHN ALFRED, (U.S. CLS. 21, 23, 26, 36 AND 38). SN 76-609,973. PUB. 12-20-2005. FILED 9-2-2004.

3,783,090. **ACCUTRACKER (BLOCK FORM)**. HOLT TEXAS, LTD., (U.S. CLS. 21, 23, 26, 36 AND 38). SN 76-680,878. PUB. 6-17-2008. FILED 8-20-2007.

3,783,125 (*See Class 8 for this trademark*).

3,783,128. **COMMENCE (BLOCK FORM)**. COMMENCE CORPORATION, (U.S. CLS. 21, 23, 26, 36 AND 38). SN 76-699,519. PUB. 2-16-2010. FILED 9-18-2009.

3,783,138. **MISCELLANEOUS DESIGN**. NINTENDO OF AMERICA INC., (U.S. CLS. 21, 23, 26, 36 AND 38). SN 77-039,087. PUB. 2-16-2010. FILED 11-7-2006.

3,783,150. **UNYTE (BLOCK FORM)**. INTERNATIONAL BUSINESS MACHINES CORPORATION, AKA IBM CORPORATION, (U.S. CLS. 21, 23, 26, 36 AND 38). SN 77-142,287. PUB. 2-16-2010. FILED 3-28-2007.

3,783,159. **ADDISCOUNT AND DESIGN**. PINK MUSHROOM B.V., MULTIPLE CLASS, (INT. CLS. 9, 35, 36, 38 AND 42), (U.S. CLS. 21, 23, 26, 36, 38, 100, 101, 102 AND 104). SN 77-168,194. PUB. 12-15-2009. FILED 4-27-2007.

3,783,169. **ORION (STYLIZED)**. ORION PICTURES CORPORATION, MULTIPLE CLASS, (INT. CLS. 9 AND 41), (U.S. CLS. 21, 23, 26, 36, 38, 100, 101 AND 107). SN 77-249,570. PUB. 11-10-2009. FILED 8-7-2007.

3,783,171. **SPHEREING (BLOCK FORM)**. SPHEREMANIA LTD., MULTIPLE CLASS, (INT. CLS. 9, 28 AND 41), (U.S. CLS. 21, 22, 23, 26, 36, 38, 50, 100, 101 AND 107). SN 77-260,242. PUB. 2-16-2010. FILED 8-21-2007.

- 3,783,177. **SRC (BLOCK FORM)**. SRC, LLC, MULTIPLE CLASS, (INT. CLS. 9, 35 AND 39), (U.S. CLS. 21, 23, 26, 36, 38, 100, 101, 102 AND 105). SN 77-282,924. PUB. 2-16-2010. FILED 9-18-2007.
- 3,783,178. **TITANTURBO (BLOCK FORM)**. LAMINA LIGHTING, INC., (U.S. CLS. 21, 23, 26, 36 AND 38). SN 77-283,707. PUB. 2-16-2010. FILED 9-19-2007.
- 3,783,184. **METRA (BLOCK FORM)**. METEOROLOGICAL SERVICE OF NEW ZEALAND LIMITED, AND METRA INFORMATION LIMITED, MULTIPLE CLASS, (INT. CLS. 9, 35 AND 42), (U.S. CLS. 21, 23, 26, 36, 38, 100, 101 AND 102). SN 77-325,264. PUB. 11-24-2009. FILED 11-8-2007.
- 3,783,195. **DIGIPROOF (BLOCK FORM)**. TECHNETIX GROUP LIMITED, MULTIPLE CLASS, (INT. CLS. 9 AND 38), (U.S. CLS. 21, 23, 26, 36, 38, 100, 101 AND 104). SN 77-387,990. PUB. 7-7-2009. FILED 2-4-2008.
- 3,783,198 (*See Class 7 for this trademark*).
- 3,783,199. **INNER ESPRESSO (BLOCK FORM)**. IN JOY MEDIA, INC., (U.S. CLS. 21, 23, 26, 36 AND 38). SN 77-394,232. PUB. 7-1-2008. FILED 2-11-2008.
- 3,783,201. **VISION AND DESIGN**. SIGNET ARMORLITE EUROPE LIMITED, (U.S. CLS. 21, 23, 26, 36 AND 38). SN 77-396,691. PUB. 2-16-2010. FILED 2-14-2008.
- 3,783,223. **MISCELLANEOUS DESIGN**. FUJITSU LIMITED, MULTIPLE CLASS, (INT. CLS. 9 AND 42), (U.S. CLS. 21, 23, 26, 36, 38, 100 AND 101). SN 77-457,632. PUB. 2-16-2010. FILED 4-24-2008.
- 3,783,228. **MESH CITY AND DESIGN**. MESH CITY WIRELESS, LLC, MULTIPLE CLASS, (INT. CLS. 9 AND 38), (U.S. CLS. 21, 23, 26, 36, 38, 100, 101 AND 104). SN 77-480,483. PUB. 2-16-2010. FILED 5-21-2008.
- 3,783,231. **VOLANS (BLOCK FORM)**. VOLANS VENTURES LTD, MULTIPLE CLASS, (INT. CLS. 9, 16, 35, 41 AND 42), (U.S. CLS. 2, 5, 21, 22, 23, 26, 29, 36, 37, 38, 50, 100, 101, 102 AND 107). SN 77-489,575. PUB. 2-16-2010. FILED 6-3-2008.
- 3,783,243. **CONNECTED LIFE (BLOCK FORM)**. DEUTSCHE TELEKOM, (U.S. CLS. 21, 23, 26, 36 AND 38). SN 77-507,775. PUB. 10-27-2009. FILED 6-25-2008.
- 3,783,247. **ECOTRIANGLE AND DESIGN**. SAMSUNG ELECTRONICS CO., LTD., (U.S. CLS. 21, 23, 26, 36 AND 38). SN 77-516,933. PUB. 2-16-2010. FILED 7-8-2008.
- 3,783,256. **AQUANEERING INCORPORATED AND DESIGN**. AQUANEERING, INC., MULTIPLE CLASS, (INT. CLS. 9, 11 AND 21), (U.S. CLS. 2, 13, 21, 23, 26, 29, 30, 31, 33, 34, 36, 38, 40 AND 50). SN 77-533,163. PUB. 2-16-2010. FILED 7-28-2008.
- 3,783,265. **TELEDOCK (BLOCK FORM)**. JVC AMERICAS CORP., (U.S. CLS. 21, 23, 26, 36 AND 38). SN 77-540,700. PUB. 2-16-2010. FILED 8-6-2008.
- 3,783,266. **VESTIGO (BLOCK FORM)**. VESTIGO, INC., MULTIPLE CLASS, (INT. CLS. 9, 35, 37 AND 45), (U.S. CLS. 21, 23, 26, 36, 38, 100, 101, 102, 103 AND 106). SN 77-540,974. PUB. 2-16-2010. FILED 8-6-2008.
- 3,783,275. **WEW (BLOCK FORM)**. THE WRESTLING ZONE, INC., (U.S. CLS. 21, 23, 26, 36 AND 38). SN 77-561,949. PUB. 2-16-2010. FILED 9-4-2008.
- 3,783,292. **LITHOMETRIX (BLOCK FORM)**. GREEN IMAGING TECHNOLOGIES INC., (U.S. CLS. 21, 23, 26, 36 AND 38). SN 77-590,389. PUB. 2-16-2010. FILED 10-10-2008.
- 3,783,294. **QUBE SHARE (BLOCK FORM)**. REAL IMAGE MEDIA TECHNOLOGIES PVT. LTD., (U.S. CLS. 21, 23, 26, 36 AND 38). SN 77-591,621. PUB. 2-16-2010. FILED 10-13-2008.
- 3,783,295. **QUBE VAULT (BLOCK FORM)**. REAL IMAGE MEDIA TECHNOLOGIES PVT. LTD., (U.S. CLS. 21, 23, 26, 36 AND 38). SN 77-591,643. PUB. 2-16-2010. FILED 10-13-2008.
- 3,783,296. **QUBE CENTRAL (BLOCK FORM)**. REAL IMAGE MEDIA TECHNOLOGIES PVT. LTD., (U.S. CLS. 21, 23, 26, 36 AND 38). SN 77-591,649. PUB. 2-16-2010. FILED 10-13-2008.
- 3,783,298. **MARKETING DIRECT (BLOCK FORM)**. TR-BIZ, L.L.C., (U.S. CLS. 21, 23, 26, 36 AND 38). SN 77-595,471. PUB. 2-16-2010. FILED 10-17-2008.
- 3,783,299. **MARKETING DIRECT IDENTIFY... INVITE... INDULGE. AND DESIGN**. TR-BIZ, L.L.C., (U.S. CLS. 21, 23, 26, 36 AND 38). SN 77-595,487. PUB. 2-16-2010. FILED 10-17-2008.
- 3,783,314. **CALLER ID FOR YOUR WEBSITE (BLOCK FORM)**. NETFACTOR CORPORATION, FORMERLY MERIDIAN DIGITAL MARKETING, (U.S. CLS. 21, 23, 26, 36 AND 38). SN 77-632,466. PUB. 2-16-2010. FILED 12-12-2008.
- 3,783,325. **E.MOTION (STYLIZED)**. CASCO GROUP SOCIÉTÉ IN COMANDITA SIMPLA (SCS), (U.S. CLS. 21, 23, 26, 36 AND 38). SN 77-644,112. PUB. 2-16-2010. FILED 1-6-2009.
- 3,783,330. **I LIQ CHUAN (BLOCK FORM)**. CHIN FAMILY I LIQ CHUAN ASSOCIATION, MULTIPLE CLASS, (INT. CLS. 9, 16, 25 AND 41), (U.S. CLS. 2, 5, 21, 22, 23, 26, 29, 36, 37, 38, 39, 50, 100, 101 AND 107). SN 77-648,767. PUB. 2-16-2010. FILED 1-13-2009.
- 3,783,350. **SEA MARSHALL (BLOCK FORM)**. DAVID MARSHALL RESCUE CONCEPTS LLC, (U.S. CLS. 21, 23, 26, 36 AND 38). SN 77-668,582. PUB. 2-16-2010. FILED 2-11-2009.
- 3,783,357. **POISON DIARIES (BLOCK FORM)**. POISON DIARIES LTD, MULTIPLE CLASS, (INT. CLS. 9, 16, 38 AND 41), (U.S. CLS. 2, 5, 21, 22, 23, 26, 29, 36, 37, 38, 50, 100, 101, 104 AND 107). SN 77-672,475. PUB. 2-16-2010. FILED 2-18-2009.
- 3,783,381. **INFO-COP (BLOCK FORM)**. RICHARD PICOLLI, (U.S. CLS. 21, 23, 26, 36 AND 38). SN 77-683,331. PUB. 2-16-2010. FILED 3-4-2009.
- 3,783,383. **YACHT CONTROLLER (BLOCK FORM)**. THE BERTON GROUP LLC, (U.S. CLS. 21, 23, 26, 36 AND 38). SN 77-685,137. PUB. 2-16-2010. FILED 3-6-2009.
- 3,783,393. **DIAMOND RAIN (BLOCK FORM)**. ARISTOCRAT TECHNOLOGIES AUSTRALIA PTY LTD., (U.S. CLS. 21, 23, 26, 36 AND 38). SN 77-688,690. PUB. 2-16-2010. FILED 3-11-2009.
- 3,783,403. **THE WORD FOR TODAY (BLOCK FORM)**. THE WORD FOR TODAY, (U.S. CLS. 21, 23, 26, 36 AND 38). SN 77-691,848. PUB. 2-16-2010. FILED 3-16-2009.
- 3,783,409. **UNIFY COMPOSER (BLOCK FORM)**. UNIFY CORPORATION, MULTIPLE CLASS, (INT. CLS. 9 AND 42), (U.S. CLS. 21, 23, 26, 36, 38, 100 AND 101). SN 77-693,718. PUB. 2-16-2010. FILED 3-18-2009.
- 3,783,411. **WW (STYLIZED)**. WOHLER TECHNOLOGIES, INC., (U.S. CLS. 21, 23, 26, 36 AND 38). SN 77-694,090. PUB. 2-16-2010. FILED 3-18-2009.
- 3,783,415. **WHERE'S MY MAIL (BLOCK FORM)**. WILEN PRESS, LC, DBA WILEN DIRECT, (U.S. CLS. 21, 23, 26, 36 AND 38). SN 77-694,565. PUB. 2-16-2010. FILED 3-19-2009.
- 3,783,418. **MAX ENERGY E-CON (BLOCK FORM)**. HYPERTECH, INC., (U.S. CLS. 21, 23, 26, 36 AND 38). SN 77-695,276. PUB. 2-16-2010. FILED 3-19-2009.
- 3,783,435. **QUADRUS (BLOCK FORM)**. QUADRUS TECHNOLOGY LIMITED, AKA QUADRUS, (U.S. CLS. 21, 23, 26, 36 AND 38). SN 77-698,988. PUB. 2-16-2010. FILED 3-25-2009.
- 3,783,441. **FLOWMASTER (BLOCK FORM)**. MICROPUMP, INC., (U.S. CLS. 21, 23, 26, 36 AND 38). SN 77-700,194. PUB. 2-16-2010. FILED 3-26-2009.
- 3,783,442. **XMLABELING (BLOCK FORM)**. GLEMSER TECHNOLOGIES CORPORATION, (U.S. CLS. 21, 23, 26, 36 AND 38). SN 77-700,261. PUB. 2-16-2010. FILED 3-26-2009.
- 3,783,449. **MASTER SANG'S TNT MARTIAL ARTS SYSTEM BUILDING PERSONAL SUCCESS AND DESIGN**. MASTER SANG'S TNT, INC., MULTIPLE CLASS, (INT. CLS. 9 AND 41), (U.S. CLS. 21, 23, 26, 36, 38, 100, 101 AND 107). SN 77-700,913. PUB. 2-16-2010. FILED 3-27-2009.
- 3,783,464. **INFOWEAPONS (BLOCK FORM)**. INFOWEAPONS, INC., (U.S. CLS. 21, 23, 26, 36 AND 38). SN 77-701,730. PUB. 2-16-2010. FILED 3-29-2009.
- 3,783,466. **PROMETHEAN DEVELOPER NETWORK (BLOCK FORM)**. PROMETHEAN LIMITED, MULTIPLE CLASS, (INT. CLS. 9, 37 AND 42), (U.S. CLS. 21, 23, 26, 36, 38, 100, 101, 103 AND 106). SN 77-701,860. PUB. 2-16-2010. FILED 3-30-2009.
- 3,783,476. **CINECHAT AND DESIGN**. SONY PICTURES HOME ENTERTAINMENT INC., (U.S. CLS. 21, 23, 26, 36 AND 38). SN 77-702,873. PUB. 2-16-2010. FILED 3-31-2009.
- 3,783,485. **GAMEVIZ (BLOCK FORM)**. BUSINESS INTELLIGENCE SOLUTIONS SAFE B.V., (U.S. CLS. 21, 23, 26, 36 AND 38). SN 77-704,481. PUB. 2-16-2010. FILED 4-1-2009.
- 3,783,500. **BALLISTICS AIMING SYSTEM (BLOCK FORM)**. LEUPOLD & STEVENS, INC., (U.S. CLS. 21, 23, 26, 36 AND 38).

- 38). SN 77-706,336. PUB. 2-16-2010. FILED 4-3-2009.
- 3,783,501. **PUBLIC RELATIONS TACTICS (BLOCK FORM)**. PUBLIC RELATIONS SOCIETY OF AMERICA, INC., MULTIPLE CLASS, (INT. CLS. 9 AND 16), (U.S. CLS. 2, 5, 21, 22, 23, 26, 29, 36, 37, 38 AND 50). SN 77-706,482. PUB. 2-16-2010. FILED 4-3-2009.
- 3,783,520. **SINISTER DESIGN AND DESIGN**. SINISTER DESIGN, (U.S. CLS. 21, 23, 26, 36 AND 38). SN 77-712,082. PUB. 2-16-2010. FILED 4-11-2009.
- 3,783,535. **KURUMAME MULTI PLUS (BLOCK FORM)**. KAYABA INDUSTRY CO., LTD., AKA KAYABA KOGYO KABUSHIKI KAISHA, MULTIPLE CLASS, (INT. CLS. 9 AND 37), (U.S. CLS. 21, 23, 26, 36, 38, 100, 103 AND 106). SN 77-713,116. PUB. 2-16-2010. FILED 4-14-2009.
- 3,783,536. **KURUMAME MULTI (BLOCK FORM)**. KAYABA INDUSTRY CO., LTD., AKA KAYABA KOGYO KABUSHIKI KAISHA, MULTIPLE CLASS, (INT. CLS. 9 AND 37), (U.S. CLS. 21, 23, 26, 36, 38, 100, 103 AND 106). SN 77-713,118. PUB. 2-16-2010. FILED 4-14-2009.
- 3,783,539. **POWEROPT (BLOCK FORM)**. CHIPVISION DESIGN SYSTEMS AG, (U.S. CLS. 21, 23, 26, 36 AND 38). SN 77-713,349. PUB. 2-16-2010. FILED 4-14-2009.
- 3,783,543. **COVERCELL (BLOCK FORM)**. GS TELETECH INC., (U.S. CLS. 21, 23, 26, 36 AND 38). SN 77-713,468. PUB. 2-16-2010. FILED 4-14-2009.
- 3,783,546. **FLAGSTONE (BLOCK FORM)**. STONEWOOD GROUP LIMITED, (U.S. CLS. 21, 23, 26, 36 AND 38). SN 77-713,711. PUB. 2-16-2010. FILED 4-14-2009.
- 3,783,551. **STANZA (BLOCK FORM)**. LEXCYCLE, INC., MULTIPLE CLASS, (INT. CLS. 9 AND 42), (U.S. CLS. 21, 23, 26, 36, 38, 100 AND 101). SN 77-714,923. PUB. 2-16-2010. FILED 4-15-2009.
- 3,783,554. **UNIVERSAL PROFILES (STYLIZED)**. XTRACT OY, MULTIPLE CLASS, (INT. CLS. 9, 35 AND 42), (U.S. CLS. 21, 23, 26, 36, 38, 100, 101 AND 102). SN 77-716,077. PUB. 2-16-2010. FILED 4-17-2009.
- 3,783,561. **PIPELINE APPLIED BROADBAND AND DESIGN**. APPLIED BROADBAND INC., (U.S. CLS. 21, 23, 26, 36 AND 38). SN 77-718,714. PUB. 2-16-2010. FILED 4-21-2009.
- 3,783,580. **MYBRAINSOLUTIONS (BLOCK FORM)**. BRC IP PTY LTD, MULTIPLE CLASS, (INT. CLS. 9, 35, 41 AND 44), (U.S. CLS. 21, 23, 26, 36, 38, 100, 101, 102 AND 107). SN 77-726,613. PUB. 2-16-2010. FILED 4-30-2009.
- 3,783,587. **MIE QUOTE IT! (BLOCK FORM)**. MANUFACTURING INFORMATION EXCHANGE SOLUTIONS, INC., AKA MIE SOLUTIONS, (U.S. CLS. 21, 23, 26, 36 AND 38). SN 77-730,879. PUB. 2-16-2010. FILED 5-6-2009.
- 3,783,588. **MIE MAINTENANCE (BLOCK FORM)**. MANUFACTURING INFORMATION EXCHANGE SOLUTIONS, INC., AKA MIE SOLUTIONS, (U.S. CLS. 21, 23, 26, 36 AND 38). SN 77-730,886. PUB. 2-16-2010. FILED 5-6-2009.
- 3,783,589. **MIE TRAK (BLOCK FORM)**. MANUFACTURING INFORMATION EXCHANGE SOLUTIONS, INC., AKA MIE SOLUTIONS, (U.S. CLS. 21, 23, 26, 36 AND 38). SN 77-730,894. PUB. 2-16-2010. FILED 5-6-2009.
- 3,783,594. **BC ESTIMATOR (BLOCK FORM)**. BOISE BUILDING SOLUTIONS MANUFACTURING, L.L.C., (U.S. CLS. 21, 23, 26, 36 AND 38). SN 77-735,390. PUB. 2-16-2010. FILED 5-12-2009.
- 3,783,612. **SANGEETPEDIA (BLOCK FORM)**. AIMREC ENTERPRISE, LLC, DBA AIMREC ENTERPRISE, LLC, (U.S. CLS. 21, 23, 26, 36 AND 38). SN 77-749,565. PUB. 2-16-2010. FILED 6-2-2009.
- 3,783,614. **A GAMBLERS PARADICE RECORDS (BLOCK FORM)**. VINSON, AUDREY, (U.S. CLS. 21, 23, 26, 36 AND 38). SN 77-750,481. PUB. 2-16-2010. FILED 6-2-2009.
- 3,783,630. **TIPFIT GUARANTEE AND DESIGN**. TENNRICH INTERNATIONAL CORP., (U.S. CLS. 21, 23, 26, 36 AND 38). SN 77-755,027. PUB. 2-16-2010. FILED 6-9-2009.
- 3,783,633. **M SYSTEMS AND DESIGN**. MORRIS SYSTEMS INC., DBA M-SYSTEMS, INC., (U.S. CLS. 21, 23, 26, 36 AND 38). SN 77-755,464. PUB. 2-16-2010. FILED 6-9-2009.
- 3,783,637. **DVSPORT (BLOCK FORM)**. DVSPORT, INC., (U.S. CLS. 21, 23, 26, 36 AND 38). SN 77-757,234. PUB. 2-16-2010. FILED 6-11-2009.
- 3,783,658 (*See Class 7 for this trademark*).
- 3,783,659. **BRANDJUNKIE (BLOCK FORM)**. INTERBRAND GROUP, MULTIPLE CLASS, (INT. CLS. 9, 35 AND 41), (U.S. CLS. 21, 23, 26, 36, 38, 100, 101, 102 AND 107). SN 77-763,893. PUB. 2-16-2010. FILED 6-19-2009.
- 3,783,662. **BLACKROCK MICROSYSTEMS AND DESIGN**. I2S MICRO IMPLANTABLE SYSTEMS, LLC, (U.S. CLS. 21, 23, 26, 36 AND 38). SN 77-764,485. PUB. 2-16-2010. FILED 6-19-2009.
- 3,783,663. **BLACKROCK MICROSYSTEMS (BLOCK FORM)**. I2S MICRO IMPLANTABLE SYSTEMS, LLC, MULTIPLE CLASS, (INT. CLS. 9, 10, 41, 42 AND 44), (U.S. CLS. 21, 23, 26, 36, 38, 39, 44, 100, 101 AND 107). SN 77-764,486. PUB. 2-16-2010. FILED 6-19-2009.
- 3,783,674 (*See Class 7 for this trademark*).
- 3,783,677. **OMNOVIA AND DESIGN**. OMNOVIA TECHNOLOGIES, INC., MULTIPLE CLASS, (INT. CLS. 9 AND 38), (U.S. CLS. 21, 23, 26, 36, 38, 100, 101 AND 104). SN 77-769,039. PUB. 2-16-2010. FILED 6-26-2009.
- 3,783,681. **DEAF LINK (BLOCK FORM)**. DEAF LINK, INC., (U.S. CLS. 21, 23, 26, 36 AND 38). SN 77-770,040. PUB. 2-16-2010. FILED 6-29-2009.
- 3,783,689. **PHONICS FANTASY THEATER (BLOCK FORM)**. THE READING STAGE, LLC, DBA PHONICS FANTASY THEATER, (U.S. CLS. 21, 23, 26, 36 AND 38). SN 77-774,186. PUB. 2-16-2010. FILED 7-3-2009.
- 3,783,713. **ELESYS (BLOCK FORM)**. HONDA ELESYS CO., LTD., (U.S. CLS. 21, 23, 26, 36 AND 38). SN 77-782,841. PUB. 2-16-2010. FILED 7-16-2009.
- 3,783,726. **IGO GREEN TECHNOLOGY ELIMINATES VAMPIRE POWER AND DESIGN**. IGO, INC., (U.S. CLS. 21, 23, 26, 36 AND 38). SN 77-787,107. PUB. 2-16-2010. FILED 7-22-2009.
- 3,783,729. **WELLYNX XI (BLOCK FORM)**. ELYNX TECHNOLOGIES, L.L.C., (U.S. CLS. 21, 23, 26, 36 AND 38). SN 77-788,236. PUB. 2-16-2010. FILED 7-23-2009.
- 3,783,734. **AXOSOFT (BLOCK FORM)**. AXOSOFT, LLC, MULTIPLE CLASS, (INT. CLS. 9, 38, 41 AND 42), (U.S. CLS. 21, 23, 26, 36, 38, 100, 101, 104 AND 107). SN 77-791,684. PUB. 2-16-2010. FILED 7-28-2009.
- 3,783,737 (*See Class 7 for this trademark*).
- 3,783,746. **SPECTOR SERVER (BLOCK FORM)**. SPECTOR-SOFT CORPORATION, (U.S. CLS. 21, 23, 26, 36 AND 38). SN 77-794,490. PUB. 2-16-2010. FILED 7-31-2009.
- 3,783,750. **FREECOUPONS AND DESIGN**. FAMILIES.COM LLC, (U.S. CLS. 21, 23, 26, 36 AND 38). SN 77-794,812. PUB. 2-16-2010. FILED S.R. 7-31-2009; AM. P.R. 7-31-2009.
- 3,783,758. **"THE SINGING SAFETY MAN" (BLOCK FORM)**. COCKRUM, JERRY, (U.S. CLS. 21, 23, 26, 36 AND 38). SN 77-796,229. PUB. 2-16-2010. FILED 8-4-2009.
- 3,783,775. **BRIDGEFIVE (BLOCK FORM)**. BRIDGEFIVE SOLUTIONS, LLC, MULTIPLE CLASS, (INT. CLS. 9, 38 AND 42), (U.S. CLS. 21, 23, 26, 36, 38, 100, 101 AND 104). SN 77-800,557. PUB. 2-16-2010. FILED 8-10-2009.
- 3,783,776. **BRIDGEFIVE SOLUTIONS AND DESIGN**. BRIDGEFIVE SOLUTIONS, LLC, MULTIPLE CLASS, (INT. CLS. 9, 38 AND 42), (U.S. CLS. 21, 23, 26, 36, 38, 100, 101 AND 104). SN 77-800,580. PUB. 2-16-2010. FILED 8-10-2009.
- 3,783,782. **ISPEECH AND DESIGN**. ISPEECH INCORPORATED, (U.S. CLS. 21, 23, 26, 36 AND 38). SN 77-802,099. PUB. 2-16-2010. FILED 8-11-2009.
- 3,783,789. **PAINT CAREERS WITH COLORS (BLOCK FORM)**. LEARNING FOR LIFE RESOURCE CENTER, (U.S. CLS. 21, 23, 26, 36 AND 38). SN 77-803,216. PUB. 2-16-2010. FILED 8-12-2009.
- 3,783,790. **TRUE COUNTRY (BLOCK FORM)**. GOTV NETWORKS, INC., (U.S. CLS. 21, 23, 26, 36 AND 38). SN 77-803,340. PUB. 2-16-2010. FILED 8-12-2009.
- 3,783,822. **COUNT BASIE (BLOCK FORM)**. TRUST U/W WILLIAM J. BASIE F/B/O DIANE L. BASIE, MULTIPLE CLASS, (INT. CLS. 9 AND 41), (U.S. CLS. 21, 23, 26, 36, 38, 100, 101 AND 107). SN 77-809,399. PUB. 2-16-2010. FILED 8-20-2009.
- 3,783,823. **COUNT BASIE ORCHESTRA (BLOCK FORM)**. TRUST U/W WILLIAM J. BASIE F/B/O DIANE L. BASIE, MULTIPLE CLASS, (INT. CLS. 9 AND 41), (U.S. CLS. 21, 23, 26, 36, 38, 100, 101 AND 107). SN 77-809,407. PUB. 2-16-2010. FILED 8-20-2009.
- 3,783,828. **HATCH (BLOCK FORM)**. SAFARILAND, LLC, (U.S. CLS. 21, 23, 26, 36 AND 38). SN 77-810,125. PUB. 2-

- 16-2010. FILED 8-21-2009.
- 3,783,837. **SABLE NETWORKS (BLOCK FORM)**. SABLE NETWORKS, INC., (U.S. CLS. 21, 23, 26, 36 AND 38). SN 77-812,611. PUB. 2-16-2010. FILED 8-25-2009.
- 3,783,841. **IKECOOL AND DESIGN**. IKECOOL CORPORATION, (U.S. CLS. 21, 23, 26, 36 AND 38). SN 77-813,353. PUB. 2-16-2010. FILED 8-26-2009.
- 3,783,844. **IMPRO-VISOR AND DESIGN**. KELLER, ROBERT, (U.S. CLS. 21, 23, 26, 36 AND 38). SN 77-813,615. PUB. 2-16-2010. FILED 8-26-2009.
- 3,783,871. **AIRSOFTOLOGY (BLOCK FORM)**. HIGGS, JONATHAN M., (U.S. CLS. 21, 23, 26, 36 AND 38). SN 77-815,981. PUB. 2-16-2010. FILED 8-30-2009.
- 3,783,878. **KIDOS (BLOCK FORM)**. KIDOS, INC., (U.S. CLS. 21, 23, 26, 36 AND 38). SN 77-816,561. PUB. 2-16-2010. FILED 8-31-2009.
- 3,783,912. **GRIOT AUDIO (BLOCK FORM)**. RECORDED BOOKS, LLC, (U.S. CLS. 21, 23, 26, 36 AND 38). SN 77-820,520. PUB. 2-16-2010. FILED 9-4-2009.
- 3,783,916. **SIDE HUSTLE MUSIC GROUP (BLOCK FORM)**. CUMMINGS, FABIAN, (U.S. CLS. 21, 23, 26, 36 AND 38). SN 77-820,770. PUB. 2-16-2010. FILED 9-4-2009.
- 3,783,944. **LANDESK (BLOCK FORM)**. LANDESK SOFTWARE, INC., (U.S. CLS. 21, 23, 26, 36 AND 38). SN 77-822,488. PUB. 2-16-2010. FILED 9-9-2009.
- 3,783,945. **START SMART (BLOCK FORM)**. LIVE THE LIFE MINISTRIES, INC., MULTIPLE CLASS, (INT. CLS. 9, 41 AND 45), (U.S. CLS. 21, 23, 26, 36, 38, 100, 101 AND 107). SN 77-822,542. PUB. 2-16-2010. FILED 9-9-2009.
- 3,783,951. **KNOWLEDGE CENTER AND DESIGN**. KC INTELLECTUAL PROPERTY, LLC, (U.S. CLS. 21, 23, 26, 36 AND 38). SN 77-822,939. PUB. 2-16-2010. FILED 9-9-2009.
- 3,783,953. **INTELLATUNE AND DESIGN**. BRAIN STATE TECHNOLOGIES, L.L.C., (U.S. CLS. 21, 23, 26, 36 AND 38). SN 77-823,261. PUB. 2-16-2010. FILED 9-9-2009.
- 3,783,976. **QPCOM QUALITY PRICE AND DESIGN**. QPCOM, INC., (U.S. CLS. 21, 23, 26, 36 AND 38). SN 77-824,241. PUB. 2-16-2010. FILED 9-10-2009.
- 3,783,980. **VIDEO TEACHER (BLOCK FORM)**. LEXICON MARKETING, LLC, (U.S. CLS. 21, 23, 26, 36 AND 38). SN 77-824,309. PUB. 2-16-2010. FILED 9-10-2009.
- 3,783,985. **THE ODD COUPLE (BLOCK FORM)**. THE ODD COUPLE, LLC, (U.S. CLS. 21, 23, 26, 36 AND 38). SN 77-824,515. PUB. 2-16-2010. FILED 9-11-2009.
- 3,783,986. **SECURESELECT (BLOCK FORM)**. ILLINOIS NATIONAL BANK, MULTIPLE CLASS, (INT. CLS. 9 AND 36), (U.S. CLS. 21, 23, 26, 36, 38, 100, 101 AND 102). SN 77-824,523. PUB. 2-16-2010. FILED 9-11-2009.
- 3,783,994. **2XL SUPERCROSS (BLOCK FORM)**. 2XL GAMES, INC., (U.S. CLS. 21, 23, 26, 36 AND 38). SN 77-824,774. PUB. 2-16-2010. FILED 9-11-2009.
- 3,783,996. **THE NEXT LEVEL GUITAR (BLOCK FORM)**. NEXT LEVEL GUITAR, INC., (U.S. CLS. 21, 23, 26, 36 AND 38). SN 77-824,905. PUB. 2-16-2010. FILED 9-11-2009.
- 3,784,003. **THE NEXT LEVEL GUITAR AND DESIGN**. NEXT LEVEL GUITAR, INC., (U.S. CLS. 21, 23, 26, 36 AND 38). SN 77-825,106. PUB. 2-16-2010. FILED 9-11-2009.
- 3,784,005. **COMPUTER COZY CC A HAND UP FOR HOPE (STYLIZED)**. KUYPERS, WILLIAM, (U.S. CLS. 21, 23, 26, 36 AND 38). SN 77-825,115. PUB. 2-16-2010. FILED 9-11-2009.
- 3,784,006. **MSPOT RADIO (BLOCK FORM)**. MSPOT, INC., MULTIPLE CLASS, (INT. CLS. 9 AND 38), (U.S. CLS. 21, 23, 26, 36, 38, 100, 101 AND 104). SN 77-825,153. PUB. 2-16-2010. FILED 9-11-2009.
- 3,784,011. **RESHARE (BLOCK FORM)**. RESHARE COMMERCE, LLC, (U.S. CLS. 21, 23, 26, 36 AND 38). SN 77-825,254. PUB. 2-16-2010. FILED 9-11-2009.
- 3,784,016. **CLEAN MACHINE (BLOCK FORM)**. FUCHS AUDIO TECHNOLOGY, LLC, (U.S. CLS. 21, 23, 26, 36 AND 38). SN 77-825,500. PUB. 2-16-2010. FILED 9-13-2009.
- 3,784,023. **COZIP (BLOCK FORM)**. LEE, WON CHUL, (U.S. CLS. 21, 23, 26, 36 AND 38). SN 77-825,850. PUB. 2-16-2010. FILED 9-14-2009.
- 3,784,032. **OPTICOUNT (BLOCK FORM)**. SATAKE USA, INC., (U.S. CLS. 21, 23, 26, 36 AND 38). SN 77-826,046. PUB. 2-16-2010. FILED 9-14-2009.
- 3,784,037. **LEASURE COLLECTION (BLOCK FORM)**. LEASURE, SUSAN L., (U.S. CLS. 21, 23, 26, 36 AND 38). SN 77-826,229. PUB. 2-16-2010. FILED 9-14-2009.
- 3,784,044. **360 GRC AND DESIGN**. 360 GRC, INC., (U.S. CLS. 21, 23, 26, 36 AND 38). SN 77-826,340. PUB. 2-16-2010. FILED 9-15-2009.
- 3,784,058. **FREIGHTMATE (BLOCK FORM)**. NEW YORK AIR BRAKE CORPORATION, (U.S. CLS. 21, 23, 26, 36 AND 38). SN 77-826,750. PUB. 2-16-2010. FILED 9-15-2009.
- 3,784,068. **EVIDENCE GRADE (BLOCK FORM)**. ADAMS, BERNARD, (U.S. CLS. 21, 23, 26, 36 AND 38). SN 77-827,175. PUB. 2-16-2010. FILED 9-15-2009.
- 3,784,095. **MIOCON (BLOCK FORM)**. MIOCON CORPORATION, (U.S. CLS. 21, 23, 26, 36 AND 38). SN 77-827,752. PUB. 2-16-2010. FILED 9-16-2009.
- 3,784,098. **EAR BAND-IT (BLOCK FORM)**. JACO ENTERPRISES, INC., (U.S. CLS. 21, 23, 26, 36 AND 38). SN 77-827,856. PUB. 2-16-2010. FILED 9-16-2009.
- 3,784,127. **FLUID TRADE (BLOCK FORM)**. FLUID TRADE, INC., (U.S. CLS. 21, 23, 26, 36 AND 38). SN 77-828,549. PUB. 2-16-2010. FILED 9-17-2009.
- 3,784,131. **MEMS+ (STYLIZED)**. COVENTOR, INC., (U.S. CLS. 21, 23, 26, 36 AND 38). SN 77-828,574. PUB. 2-16-2010. FILED 9-17-2009.
- 3,784,132. **BERNARD DATA SOLUTIONS (BLOCK FORM)**. BERNARD DATA SOLUTIONS, LLC, (U.S. CLS. 21, 23, 26, 36 AND 38). SN 77-828,579. PUB. 2-16-2010. FILED 9-17-2009.
- 3,784,147. **CLARK SONIC AND DESIGN**. TYLER CO., INC., THE, (U.S. CLS. 21, 23, 26, 36 AND 38). SN 77-828,843. PUB. 2-16-2010. FILED 9-17-2009.
- 3,784,190. **MEGATONE AMPS (STYLIZED)**. DJL VIDEO SECURITY SERVICE, INC., (U.S. CLS. 21, 23, 26, 36 AND 38). SN 77-829,727. PUB. 2-16-2010. FILED 9-18-2009.
- 3,784,196. **WEBMASTER WHACKER (BLOCK FORM)**. MARKETS & LANGUAGES INTERNATIONAL CORP, MULTIPLE CLASS, (INT. CLS. 9, 35 AND 42), (U.S. CLS. 21, 23, 26, 36, 38, 100, 101 AND 102). SN 77-829,858. PUB. 2-16-2010. FILED 9-18-2009.
- 3,784,220. **AIM-CART AND DESIGN**. AIM - ARIZONA INTERNET MARKETING, LLC, (U.S. CLS. 21, 23, 26, 36 AND 38). SN 77-830,294. PUB. 2-16-2010. FILED 9-18-2009.
- 3,784,227. **BI (STYLIZED)**. BRAILLE INSTITUTE OF AMERICA, INC., MULTIPLE CLASS, (INT. CLS. 9, 16, 35, 36 AND 41), (U.S. CLS. 2, 5, 21, 22, 23, 26, 29, 36, 37, 38, 50, 100, 101, 102 AND 107). SN 77-830,344. PUB. 2-16-2010. FILED 9-18-2009.
- 3,784,257. **MIKEGYVER (BLOCK FORM)**. MIKEGYVER COMPUTER & TECHNOLOGY, INC., MULTIPLE CLASS, (INT. CLS. 9 AND 35), (U.S. CLS. 21, 23, 26, 36, 38, 100, 101 AND 102). SN 77-830,758. PUB. 2-16-2010. FILED 9-21-2009.
- 3,784,266. **THE PERFECT STUD (BLOCK FORM)**. PIANETTO, NICHOLAS, (U.S. CLS. 21, 23, 26, 36 AND 38). SN 77-830,849. PUB. 2-16-2010. FILED 9-21-2009.
- 3,784,291. **EXTENDAIR (BLOCK FORM)**. EXALT COMMUNICATIONS, INC., (U.S. CLS. 21, 23, 26, 36 AND 38). SN 77-831,090. PUB. 2-16-2010. FILED 9-21-2009.
- 3,784,292. **TIGER STYLE AND DESIGN**. TIGER STYLE LLC, (U.S. CLS. 21, 23, 26, 36 AND 38). SN 77-831,137. PUB. 2-16-2010. FILED 9-21-2009.
- 3,784,294. **SPIDER THE SECRET OF BRYCE MANOR (BLOCK FORM)**. TIGER STYLE LLC, (U.S. CLS. 21, 23, 26, 36 AND 38). SN 77-831,161. PUB. 2-16-2010. FILED 9-21-2009.
- 3,784,297. **FLIPBOX (BLOCK FORM)**. FENLEY, JEFF G., (U.S. CLS. 21, 23, 26, 36 AND 38). SN 77-831,190. PUB. 2-16-2010. FILED 9-21-2009.
- 3,784,323. **V OTTOVUE AND DESIGN**. BRUCE, OSCAR, (U.S. CLS. 21, 23, 26, 36 AND 38). SN 77-831,556. PUB. 2-16-2010. FILED 9-21-2009.
- 3,784,346. **BACKYARD BRAND (BLOCK FORM)**. MCLEAN, JAMES, (U.S. CLS. 21, 23, 26, 36 AND 38). SN 77-831,812. PUB. 2-16-2010. FILED 9-22-2009.
- 3,784,362. **SCI-FRIED (BLOCK FORM)**. SILVER, CHARLES, MULTIPLE CLASS, (INT. CLS. 9 AND 41), (U.S. CLS. 21, 23, 26, 36, 38, 100, 101 AND 107). SN 77-832,033. PUB. 2-16-2010. FILED 9-22-2009.
- 3,784,392. **MISCELLANEOUS DESIGN**. CHROME HEARTS LLC, (U.S. CLS. 21, 23, 26, 36 AND 38). SN 77-832,388. PUB. 2-16-2010. FILED 9-22-2009.
- 3,784,419. **IADDRESS (BLOCK FORM)**. FLAGSHIP SOFT-

- WARE LTD., (U.S. CLS. 21, 23, 26, 36 AND 38). SN 77-832,727. PUB. 2-16-2010. FILED 9-23-2009.
- 3,784,420. **DAYASAGAR (BLOCK FORM)**. DAYSPRING INTERNATIONAL HEADQUARTERS, (U.S. CLS. 21, 23, 26, 36 AND 38). SN 77-832,729. PUB. 2-16-2010. FILED 9-23-2009.
- 3,784,426. **GUSHER AND DESIGN**. TRINITY SAFETY SUPPLY, INC., DBA TRINITY SAFETY SUPPLY, (U.S. CLS. 21, 23, 26, 36 AND 38). SN 77-832,783. PUB. 2-16-2010. FILED 9-23-2009.
- 3,784,442. **THE STEPS (BLOCK FORM)**. THE STEPS PARTNERSHIP, (U.S. CLS. 21, 23, 26, 36 AND 38). SN 77-833,007. PUB. 2-16-2010. FILED 9-23-2009.
- 3,784,455. **RESPONDR (BLOCK FORM)**. RESPONDR, LLC, (U.S. CLS. 21, 23, 26, 36 AND 38). SN 77-833,183. PUB. 2-16-2010. FILED 9-23-2009.
- 3,784,474. **ICHING 2GO (BLOCK FORM)**. INNER SIGHT, LLC, (U.S. CLS. 21, 23, 26, 36 AND 38). SN 77-833,373. PUB. 2-16-2010. FILED 9-23-2009.
- 3,784,478. **MISCELLANEOUS DESIGN**. IMEGO INFINITY LIMITED, (U.S. CLS. 21, 23, 26, 36 AND 38). SN 77-833,424. PUB. 2-16-2010. FILED 9-23-2009.
- 3,784,479. **KINAMAX (BLOCK FORM)**. NEXARK, INC., (U.S. CLS. 21, 23, 26, 36 AND 38). SN 77-833,446. PUB. 2-16-2010. FILED 9-23-2009.
- 3,784,481. **RUGGED. RELIABLE. PROVEN. (BLOCK FORM)**. TRI-TRONICS, INC., (U.S. CLS. 21, 23, 26, 36 AND 38). SN 77-833,484. PUB. 2-16-2010. FILED 9-23-2009.
- 3,784,499. **EZCHECK (BLOCK FORM)**. G-BAGS LLC, (U.S. CLS. 21, 23, 26, 36 AND 38). SN 77-833,619. PUB. 2-16-2010. FILED 9-23-2009.
- 3,784,508. **TOUCHCHARGE (BLOCK FORM)**. GRIFFIN INTERNATIONAL COMPANIES, INC., (U.S. CLS. 21, 23, 26, 36 AND 38). SN 77-833,791. PUB. 2-16-2010. FILED 9-24-2009.
- 3,784,509. **QUICKCULL (BLOCK FORM)**. FTI CONSULTING, INC., (U.S. CLS. 21, 23, 26, 36 AND 38). SN 77-833,792. PUB. 2-16-2010. FILED 9-24-2009.
- 3,784,513. **RECIPROCAL (BLOCK FORM)**. RECIPROCAL, MULTIPLE CLASS, (INT. CLS. 9 AND 41), (U.S. CLS. 21, 23, 26, 36, 38, 100, 101 AND 107). SN 77-833,817. PUB. 2-16-2010. FILED 9-24-2009.
- 3,784,519. **WINGSONIC (STYLIZED)**. WINGSONIC LTD., (U.S. CLS. 21, 23, 26, 36 AND 38). SN 77-833,893. PUB. 2-16-2010. FILED 9-24-2009.
- 3,784,544. **KEEP YOUR CODE. CHOOSE YOUR PRINTER. (BLOCK FORM)**. ATSI HOLDINGS, INC., (U.S. CLS. 21, 23, 26, 36 AND 38). SN 77-834,148. PUB. 2-16-2010. FILED 9-24-2009.
- 3,784,547. **CHECK MARK AND DESIGN**. CHECK MARK SOFTWARE, INC., (U.S. CLS. 21, 23, 26, 36 AND 38). SN 77-834,164. PUB. 2-16-2010. FILED 9-24-2009.
- 3,784,571. **WERF (BLOCK FORM)**. WATER ENVIRONMENT RESEARCH FOUNDATION, MULTIPLE CLASS, (INT. CLS. 9 AND 35), (U.S. CLS. 21, 23, 26, 36, 38, 100, 101 AND 102). SN 77-834,585. PUB. 2-16-2010. FILED 9-24-2009.
- 3,784,579. **DISCOVER SPANISH (BLOCK FORM)**. DISCOVER SPANISH INC., (U.S. CLS. 21, 23, 26, 36 AND 38). SN 77-834,654. PUB. 2-16-2010. FILED 9-25-2009.
- 3,784,588. **HR ELEMENTS (BLOCK FORM)**. UNITED BENEFITS ADVISORS, LLC, MULTIPLE CLASS, (INT. CLS. 9 AND 16), (U.S. CLS. 2, 5, 21, 22, 23, 26, 29, 36, 37, 38 AND 50). SN 77-834,870. PUB. 2-16-2010. FILED 9-25-2009.
- 3,784,589. **SHAKYGLOBE (BLOCK FORM)**. LITTLE RICKY SOFTWARE, LLC, (U.S. CLS. 21, 23, 26, 36 AND 38). SN 77-834,899. PUB. 2-16-2010. FILED 9-25-2009.
- 3,784,590. **FACSONIC (BLOCK FORM)**. CILENTE, FRANK ANTHONY, (U.S. CLS. 21, 23, 26, 36 AND 38). SN 77-834,907. PUB. 2-16-2010. FILED 9-25-2009.
- 3,784,591. **TECHNO EARTH (BLOCK FORM)**. TECHNO LINE L.L.C., (U.S. CLS. 21, 23, 26, 36 AND 38). SN 77-834,913. PUB. 2-16-2010. FILED 9-25-2009.
- 3,784,594. **Z Z2LIVE AND DESIGN**. ZERO260 INCORPORATED, MULTIPLE CLASS, (INT. CLS. 9 AND 42), (U.S. CLS. 21, 23, 26, 36, 38, 100 AND 101). SN 77-834,932. PUB. 2-16-2010. FILED 9-25-2009.
- 3,784,603. **M-BLEND (BLOCK FORM)**. M3 TECHNOLOGY, INC, (U.S. CLS. 21, 23, 26, 36 AND 38). SN 77-835,038. PUB. 2-16-2010. FILED 9-25-2009.
- 3,784,622. **ONCE INNOVATIONS (BLOCK FORM)**. ONCE INNOVATIONS, FORMERLY SCIENTOID TECHNOLOGIES, (U.S. CLS. 21, 23, 26, 36 AND 38). SN 77-835,382. PUB. 2-16-2010. FILED 9-25-2009.
- 3,784,631. **MAELSTROM (BLOCK FORM)**. DIGITAL KEYSTONE, INC., (U.S. CLS. 21, 23, 26, 36 AND 38). SN 77-835,462. PUB. 2-16-2010. FILED 9-25-2009.
- 3,784,635. **ONCE INNOVATIONS INC AND DESIGN**. ONCE INNOVATIONS, FORMERLY SCIENTOID TECHNOLOGIES, (U.S. CLS. 21, 23, 26, 36 AND 38). SN 77-835,500. PUB. 2-16-2010. FILED 9-25-2009.
- 3,784,674. **MEDENET AND DESIGN**. MEDENET, INC., MULTIPLE CLASS, (INT. CLS. 9 AND 35), (U.S. CLS. 21, 23, 26, 36, 38, 100, 101 AND 102). SN 77-836,335. PUB. 2-16-2010. FILED 9-28-2009.
- 3,784,681. **NEMESIS (BLOCK FORM)**. JACKSON PRODUCTS, INC., (U.S. CLS. 21, 23, 26, 36 AND 38). SN 77-836,562. PUB. 2-16-2010. FILED 9-28-2009.
- 3,784,684. **GARDEN OF THE MIND (BLOCK FORM)**. GREAT MINDS, LLC, (U.S. CLS. 21, 23, 26, 36 AND 38). SN 77-836,613. PUB. 2-16-2010. FILED 9-28-2009.
- 3,784,691. **THE HEALING CODES (BLOCK FORM)**. DR. ALEX LOYD SERVICES, LLC, MULTIPLE CLASS, (INT. CLS. 9 AND 16), (U.S. CLS. 2, 5, 21, 22, 23, 26, 29, 36, 37, 38 AND 50). SN 77-836,719. PUB. 2-16-2010. FILED 9-28-2009.
- 3,784,706. **EASYCARPORTAL (BLOCK FORM)**. NATASUDHARMA, DBA EASYCARPORTAL, (U.S. CLS. 21, 23, 26, 36 AND 38). SN 77-838,854. PUB. 2-16-2010. FILED 10-1-2009.
- 3,784,707. **EASYESTATERENTAL (BLOCK FORM)**. NATASUDHARMA, DBA EASYESTATERENTAL, (U.S. CLS. 21, 23, 26, 36 AND 38). SN 77-838,859. PUB. 2-16-2010. FILED 10-1-2009.
- 3,784,760. **MX VS. ATV (BLOCK FORM)**. THQ INC., (U.S. CLS. 21, 23, 26, 36 AND 38). SN 77-853,767. PUB. 2-16-2010. FILED 10-21-2009.
- 3,784,769. **CYWARFIUS (STYLIZED)**. RSIGNIA, INC., (U.S. CLS. 21, 23, 26, 36 AND 38). SN 77-857,434. PUB. 2-16-2010. FILED 10-26-2009.
- 3,784,778. **HONL PHOTO SPEED SYSTEM (BLOCK FORM)**. DAVID HONL, MULTIPLE CLASS, (INT. CLS. 9 AND 11), (U.S. CLS. 13, 21, 23, 26, 31, 34, 36 AND 38). SN 77-859,785. PUB. 2-16-2010. FILED 10-28-2009.
- 3,784,793. **TNT (BLOCK FORM)**. THE ANDERSONS, INC., (U.S. CLS. 21, 23, 26, 36 AND 38). SN 77-864,459. PUB. 2-16-2010. FILED 11-4-2009.
- 3,784,814. **CC CC (STYLIZED)**. COACH SERVICES, INC., (U.S. CLS. 21, 23, 26, 36 AND 38). SN 77-892,921. PUB. 2-16-2010. FILED 12-14-2009.
- 3,784,821. **W WEBSTER CARE AND DESIGN**. MANREX PTY LIMITED, MULTIPLE CLASS, (INT. CLS. 9, 35 AND 42), (U.S. CLS. 21, 23, 26, 36, 38, 100, 101 AND 102). SN 77-979,173. PUB. 2-3-2009. FILED 9-5-2007.
- 3,784,826. **P.H.D. (BLOCK FORM)**. R 525 ENTERPRISES LTD., MULTIPLE CLASS, (INT. CLS. 9, 10, 16, 35, 42 AND 44), (U.S. CLS. 2, 5, 21, 22, 23, 26, 29, 36, 37, 38, 39, 44, 50, 100, 101 AND 102). SN 78-485,733. PUB. 2-16-2010. FILED 9-17-2004.
- 3,784,828 (*See Class 7 for this trademark*).
- 3,784,829. **BETTER INFORMATION FASTER (BLOCK FORM)**. PULSE DATA INC., MULTIPLE CLASS, (INT. CLS. 9, 16 AND 42), (U.S. CLS. 2, 5, 21, 22, 23, 26, 29, 36, 37, 38, 50, 100 AND 101). SN 78-644,742. PUB. 12-9-2008. FILED 6-6-2005.
- 3,784,832. **ZEUGMA SYSTEMS (BLOCK FORM)**. ZEUGMA SYSTEMS INC., MULTIPLE CLASS, (INT. CLS. 9 AND 37), (U.S. CLS. 21, 23, 26, 36, 38, 100, 103 AND 106). SN 78-714,691. PUB. 2-16-2010. FILED 9-16-2005.
- 3,784,833. **LINX (BLOCK FORM)**. ABLE PLANET, INCORPORATED, (U.S. CLS. 21, 23, 26, 36 AND 38). SN 78-721,216. PUB. 3-11-2008. FILED 9-27-2005.
- 3,784,834. **UB ULTIMATEBET.COM WHERE VIRTUALLY EVERYONE PLAYS POKER AND DESIGN**. GAME THEORY LIMITED, MULTIPLE CLASS, (INT. CLS. 9, 25, 28 AND 41), (U.S. CLS. 21, 22, 23, 26, 36, 38, 39, 50, 100, 101 AND 107). SN 78-730,180. PUB. 10-27-2009. FILED 10-10-2005.
- 3,784,835. **CARD EX AND DESIGN**. CARD EXPRESS, INC., MULTIPLE CLASS, (INT. CLS. 9 AND 36), (U.S. CLS. 21, 23, 26, 36, 38, 100, 101 AND 102). SN 78-782,481. PUB. 2-16-2010. FILED 12-29-2005.

- 3,784,836. **IRON TITANS (BLOCK FORM)**. SALVO INC., MULTIPLE CLASS, (INT. CLS. 9 AND 28), (U.S. CLS. 21, 22, 23, 26, 36, 38 AND 50). SN 78-783,929. PUB. 5-12-2009. FILED 1-3-2006.
- 3,784,839. **MONEY TREE (BLOCK FORM)**. ARISTOCRAT TECHNOLOGIES AUSTRALIA PTY LTD, (U.S. CLS. 21, 23, 26, 36 AND 38). SN 78-807,769. PUB. 6-3-2008. FILED 2-6-2006.
- 3,784,840 (*See Class 1 for this trademark*).
- 3,784,841 (*See Class 1 for this trademark*).
- 3,784,843. **MY-HAMMER (BLOCK FORM)**. MY-HAMMER AG, MULTIPLE CLASS, (INT. CLS. 9, 35, 36, 38, 41 AND 42), (U.S. CLS. 21, 23, 26, 36, 38, 100, 101, 102, 104 AND 107). SN 78-855,537. PUB. 12-9-2008. FILED 4-6-2006.
- 3,784,845. **I-NET STREAM AND DESIGN**. VIDEOLOGY IMAGING SOLUTIONS, INC., (U.S. CLS. 21, 23, 26, 36 AND 38). SN 78-865,148. PUB. 8-7-2007. FILED 4-19-2006.
- 3,784,847. **BLADESPACE (BLOCK FORM)**. MICRO DEPOT, INC, (U.S. CLS. 21, 23, 26, 36 AND 38). SN 78-887,506. PUB. 6-19-2007. FILED 5-19-2006.
- 3,784,851. **RAPIDORTHO (BLOCK FORM)**. APPLANIX CORPORATION, (U.S. CLS. 21, 23, 26, 36 AND 38). SN 78-944,926. PUB. 2-16-2010. FILED 8-4-2006.
- 3,784,860. **BYK MAC (BLOCK FORM)**. BYK-GARDNER GMBH, (U.S. CLS. 21, 23, 26, 36 AND 38). SN 79-043,060. PUB. 2-16-2010. FILED 4-5-2007.
- 3,784,861. **DG SCOPE (STYLIZED)**. MONSIEUR BENGANA ABDELHAMID, MULTIPLE CLASS, (INT. CLS. 9, 10, 42 AND 45), (U.S. CLS. 21, 23, 26, 36, 38, 39, 44, 100 AND 101). SN 79-045,387. PUB. 2-16-2010. FILED 1-29-2007.
- 3,784,869 (*See Class 3 for this trademark*).
- 3,784,871. **VALUES JOURNEY (BLOCK FORM)**. VALUES JOURNEY PTY LTD, MULTIPLE CLASS, (INT. CLS. 9, 16 AND 41), (U.S. CLS. 2, 5, 21, 22, 23, 26, 29, 36, 37, 38, 50, 100, 101 AND 107). SN 79-052,964. PUB. 2-16-2010. FILED 2-20-2008.
- 3,784,872. **LAM LILLE MÉTROPOLE MUSÉE D'ART MODERNE BRUT CONTEMPORAIN AND DESIGN**. COMMUNAUTE URBAINE DE LILLE, MULTIPLE CLASS, (INT. CLS. 9, 16, 18, 20, 28, 35, 41 AND 42), (U.S. CLS. 1, 2, 3, 5, 13, 21, 22, 23, 25, 26, 29, 32, 36, 37, 38, 41, 50, 100, 101, 102 AND 107). SN 79-054,761. PUB. 2-16-2010. FILED 5-16-2008.
- 3,784,878. **ASSECO (STYLIZED)**. ASSECO POLAND S.A., MULTIPLE CLASS, (INT. CLS. 9, 35, 36, 37, 38, 41 AND 42), (U.S. CLS. 21, 23, 26, 36, 38, 100, 101, 102, 103, 104, 106 AND 107). SN 79-058,025. PUB. 2-16-2010. FILED 2-12-2008.
- 3,784,880. **ARMOURON (STYLIZED)**. ARMOURON LIMITED, MULTIPLE CLASS, (INT. CLS. 9, 16 AND 28), (U.S. CLS. 2, 5, 21, 22, 23, 26, 29, 36, 37, 38 AND 50). SN 79-058,379. PUB. 9-8-2009. FILED 10-16-2007.
- 3,784,882. **IMB (BLOCK FORM)**. IMBERA ELECTRONICS OY, (U.S. CLS. 21, 23, 26, 36 AND 38). SN 79-058,693. PUB. 2-16-2010. FILED 8-15-2008.
- 3,784,884 (*See Class 5 for this trademark*).
- 3,784,895. **INFOTERRA (BLOCK FORM)**. ASTRUM GMBH, MULTIPLE CLASS, (INT. CLS. 9, 16, 38 AND 42), (U.S. CLS. 2, 5, 21, 22, 23, 26, 29, 36, 37, 38, 50, 100, 101 AND 104). SN 79-059,450. PUB. 2-16-2010. FILED 6-23-2008.
- 3,784,896 (*See Class 3 for this trademark*).
- 3,784,906 (*See Class 1 for this trademark*).
- 3,784,907 (*See Class 1 for this trademark*).
- 3,784,909 (*See Class 7 for this trademark*).
- 3,784,910 (*See Class 6 for this trademark*).
- 3,784,914 (*See Class 7 for this trademark*).
- 3,784,915. **MYMAJORCOMPANY AND DESIGN**. MYMAJORCOMPANY, MULTIPLE CLASS, (INT. CLS. 9, 16, 25, 28, 35, 38, 41, 42 AND 45), (U.S. CLS. 2, 5, 21, 22, 23, 26, 29, 36, 37, 38, 39, 50, 100, 101, 102, 104 AND 107). SN 79-062,425. PUB. 2-16-2010. FILED 9-5-2008.
- 3,784,919. **EURAMIS (STYLIZED)**. THE EUROPEAN UNION, REPRESENTED BY THE EUROPEAN COMMISSION, MULTIPLE CLASS, (INT. CLS. 9, 38, 41 AND 42), (U.S. CLS. 21, 23, 26, 36, 38, 100, 101, 104 AND 107). SN 79-063,462. PUB. 2-16-2010. FILED 11-14-2008.
- 3,784,920. **DECIDO (BLOCK FORM)**. PANGORA GMBH, MULTIPLE CLASS, (INT. CLS. 9, 35, 38 AND 42), (U.S. CLS. 21, 23, 26, 36, 38, 100, 101, 102 AND 104). SN 79-063,783. PUB. 2-16-2010. FILED 8-12-2008.
- 3,784,922. **LUMIVOLTA (BLOCK FORM)**. KEIWA INC., MULTIPLE CLASS, (INT. CLS. 9 AND 17), (U.S. CLS. 1, 5, 12, 13, 21, 23, 26, 35, 36, 38 AND 50). SN 79-064,593. PUB. 2-16-2010. FILED 10-20-2008.
- 3,784,924 (*See Class 6 for this trademark*).
- 3,784,929 (*See Class 6 for this trademark*).
- 3,784,934. **CIVOLUTION (BLOCK FORM)**. CIVOLUTION B.V., MULTIPLE CLASS, (INT. CLS. 9, 37 AND 42), (U.S. CLS. 21, 23, 26, 36, 38, 100, 101, 103 AND 106). SN 79-066,618. PUB. 2-16-2010. FILED 1-15-2009.
- 3,784,936 (*See Class 7 for this trademark*).
- 3,784,939. **NUMERO (BLOCK FORM)**. NUMERO PRESSE, (U.S. CLS. 21, 23, 26, 36 AND 38). SN 79-066,844. PUB. 2-16-2010. FILED 3-6-2009.
- 3,784,946. **WE LIVE IN YOUR WORLD (BLOCK FORM)**. AUSTRALIA AND NEW ZEALAND BANKING GROUP LIMITED, MULTIPLE CLASS, (INT. CLS. 9 AND 36), (U.S. CLS. 21, 23, 26, 36, 38, 100, 101 AND 102). SN 79-067,415. PUB. 2-16-2010. FILED 3-18-2009.
- 3,784,956 (*See Class 8 for this trademark*).
- 3,784,963. **OLIEPOPS (BLOCK FORM)**. CHRISTOPHER OLIE, MULTIPLE CLASS, (INT. CLS. 9, 16 AND 18), (U.S. CLS. 1, 2, 3, 5, 21, 22, 23, 26, 29, 36, 37, 38, 41 AND 50). SN 79-067,968. PUB. 2-16-2010. FILED 2-27-2009.
- 3,784,964. **CLOUDSOFT (BLOCK FORM)**. CLOUDSOFT CORPORATION LIMITED, MULTIPLE CLASS, (INT. CLS. 9, 38 AND 42), (U.S. CLS. 21, 23, 26, 36, 38, 100, 101 AND 104). SN 79-068,006. PUB. 2-16-2010. FILED 3-25-2009.
- 3,784,965. **AUER LIGHTING (BLOCK FORM)**. AUER LIGHTING GMBH, MULTIPLE CLASS, (INT. CLS. 9, 11, 21 AND 40), (U.S. CLS. 2, 13, 21, 23, 26, 29, 30, 31, 33, 34, 36, 38, 40, 50, 100, 103 AND 106). SN 79-068,043. PUB. 2-16-2010. FILED 1-21-2009.
- 3,784,969. **DANE-ELEC AND DESIGN**. DANE-ELEC MEMORY, MULTIPLE CLASS, (INT. CLS. 9, 38 AND 42), (U.S. CLS. 21, 23, 26, 36, 38, 100, 101 AND 104). SN 79-068,186. PUB. 2-16-2010. FILED 10-29-2008.
- 3,784,970. **TRANSFORMING COMMUNICATIONS FOR A WORLD THAT'S ALWAYS ON (BLOCK FORM)**. ALCA-TEL LUCENT, MULTIPLE CLASS, (INT. CLS. 9, 38 AND 42), (U.S. CLS. 21, 23, 26, 36, 38, 100, 101 AND 104). SN 79-068,201. PUB. 2-16-2010. FILED 9-29-2008.
- 3,784,972 (*See Class 3 for this trademark*).
- 3,784,981. **TTIBE (BLOCK FORM)**. TRAVEL TAINMENT AG, MULTIPLE CLASS, (INT. CLS. 9, 35, 38, 39 AND 42), (U.S. CLS. 21, 23, 26, 36, 38, 100, 101, 102, 104 AND 105). SN 79-068,510. PUB. 2-16-2010. FILED 4-8-2009.
- 3,784,982. **GENERAL MAGIC (BLOCK FORM)**. DR. JOHAN B.J.M. LANEN, MULTIPLE CLASS, (INT. CLS. 9, 16, 38 AND 42), (U.S. CLS. 2, 5, 21, 22, 23, 26, 29, 36, 37, 38, 50, 100, 101 AND 104). SN 79-068,515. PUB. 2-16-2010. FILED 6-11-2008.
- 3,784,984. **PREVISITE AND DESIGN**. PREVISITE, MULTIPLE CLASS, (INT. CLS. 9, 35, 36, 38 AND 40), (U.S. CLS. 21, 23, 26, 36, 38, 100, 101, 102, 103, 104 AND 106). SN 79-068,522. PUB. 2-16-2010. FILED 10-2-2008.
- 3,784,985. **MSR (BLOCK FORM)**. MAHA MASCHINENBAU; HALDENWANG GMBH & CO. KG., (U.S. CLS. 21, 23, 26, 36 AND 38). SN 79-068,532. PUB. 2-16-2010. FILED 4-24-2009.
- 3,784,986. **LADONNA (STYLIZED)**. KABUSHIKI KAISHA LADONNA; (LADONNA CO., LTD.), MULTIPLE CLASS, (INT. CLS. 9 AND 16), (U.S. CLS. 2, 5, 21, 22, 23, 26, 29, 36, 37, 38 AND 50). SN 79-068,560. PUB. 2-16-2010. FILED 4-2-2009.
- 3,784,987. **FLEXINAIRE (BLOCK FORM)**. KONINKLIJKE PHILIPS ELECTRONICS N.V., MULTIPLE CLASS, (INT. CLS. 9 AND 11), (U.S. CLS. 13, 21, 23, 26, 31, 34, 36 AND 38). SN 79-068,576. PUB. 2-16-2010. FILED 3-18-2009.
- 3,784,993. **MISCELLANEOUS DESIGN**. MOODS OF NORWAY DA, MULTIPLE CLASS, (INT. CLS. 9, 25, 29, 32 AND 33), (U.S. CLS. 21, 22, 23, 26, 36, 38, 39, 45, 46, 47, 48 AND 49). SN 79-068,812. PUB. 2-16-2010. FILED 3-13-2009.
- 3,784,999. **ANTENA DAT 45 HD (BLOCK FORM)**. TELEVES, S.A., (U.S. CLS. 21, 23, 26, 36 AND 38). SN 79-069,278. PUB. 2-16-2010. FILED 2-26-2009.
- 3,785,000. **IMD AND DESIGN**. IMD - INTERNATIONAL INSTITUTE; FOR MANAGEMENT DEVELOPMENT, MULTIPLE CLASS, (INT. CLS. 9, 16, 35 AND 41), (U.S. CLS. 2, 5, 21, 22, 23, 26, 29, 36, 37, 38, 50, 100, 101, 102 AND

107). SN 79-069,289. PUB. 2-16-2010. FILED 1-9-2009.
 3,785,006. **BAT(H)IUM AND DESIGN**. BOLLORE, MULTIPLE CLASS, (INT. CLS. 9 AND 37), (U.S. CLS. 21, 23, 26, 36, 38, 100, 103 AND 106). SN 79-069,790. PUB. 2-16-2010. FILED 12-9-2008.
 3,785,007. **NIVS AND DESIGN**. HUIZHOU SHI NAWAISHI; SHITINGKEJI YOUXIANGONGSI, (U.S. CLS. 21, 23, 26, 36 AND 38). SN 79-070,317. PUB. 2-16-2010. FILED 6-16-2009.
 3,785,009. **WOOWI (STYLIZED)**. ZHONGSHAN K-MATE; GENERAL ELECTRONICS CO., LTD., (U.S. CLS. 21, 23, 26, 36 AND 38). SN 79-070,646. PUB. 2-16-2010. FILED 6-3-2009.
 3,785,010 (*See Class 6 for this trademark*).
 3,785,022. **BRANDSPEAK (BLOCK FORM)**. INTERBRAND GROUP, MULTIPLE CLASS, (INT. CLS. 9, 38 AND 42), (U.S. CLS. 21, 23, 26, 36, 38, 100, 101 AND 104). SN 79-071,897. PUB. 2-16-2010. FILED 6-12-2009.
 3,785,023 (*See Class 1 for this trademark*).
 3,785,024. **SUGON (STYLIZED)**. TIANJIN DAWNING; COMPUTER INDUSTRY CO., LTD., MULTIPLE CLASS, (INT. CLS. 9, 37, 38 AND 42), (U.S. CLS. 21, 23, 26, 36, 38, 100, 101, 103, 104 AND 106). SN 79-072,409. PUB. 2-16-2010. FILED 7-1-2009.
 3,785,036. **VAS GRAPHICS2GO (BLOCK FORM)**. MÜLLER-BBM VIBROAKUSTIK SYSTEME GMBH, (U.S. CLS. 21, 23, 26, 36 AND 38). SN 79-073,762. PUB. 2-16-2010. FILED 9-8-2009.
 3,785,039. **IMAGES. MY WAY. (BLOCK FORM)**. SIEMENS AKTIENGESELLSCHAFT, (U.S. CLS. 21, 23, 26, 36 AND 38). SN 79-073,847. PUB. 2-16-2010. FILED 9-1-2009.
 3,785,042. **SYNGO.PLAZA (BLOCK FORM)**. SIEMENS AKTIENGESELLSCHAFT, MULTIPLE CLASS, (INT. CLS. 9, 37 AND 42), (U.S. CLS. 21, 23, 26, 36, 38, 100, 101, 103 AND 106). SN 79-073,973. PUB. 2-16-2010. FILED 6-30-2009.
 3,785,044. **CLEO (BLOCK FORM)**. SONOVA HOLDING AG, MULTIPLE CLASS, (INT. CLS. 9 AND 10), (U.S. CLS. 21, 23, 26, 36, 38, 39 AND 44). SN 79-074,265. PUB. 2-16-2010. FILED 9-15-2009.

CLASS 10—MEDICAL APPARATUS

3,783,102. **LEXION AND DESIGN**. LEXION MEDICAL, LLC, (U.S. CLS. 26, 39 AND 44). SN 76-695,756. PUB. 2-16-2010. FILED 2-12-2009.
 3,783,225. **ICON (BLOCK FORM)**. FISHER AND PAYKEL HEALTHCARE LIMITED, (U.S. CLS. 26, 39 AND 44). SN 77-473,770. PUB. 2-16-2010. FILED 5-13-2008.
 3,783,227. **PUREFLOW ORONASAL CANNULA (BLOCK FORM)**. BRAEFON MEDICAL CORPORATION, (U.S. CLS. 26, 39 AND 44). SN 77-476,251. PUB. 11-24-2009. FILED 5-16-2008.
 3,783,242 (*See Class 3 for this trademark*).
 3,783,316. **ALLAY MENSTRUAL PAIN THERAPY AND DESIGN**. BIOELECTRONICS CORPORATION, (U.S. CLS. 26, 39 AND 44). SN 77-634,344. PUB. 2-16-2010. FILED 12-16-2008.
 3,783,388. **CORMET PRIME (BLOCK FORM)**. CORIN LIMITED, (U.S. CLS. 26, 39 AND 44). SN 77-686,209. PUB. 2-16-2010. FILED 3-9-2009.
 3,783,410. **NOT SINCE SELDINGER... (BLOCK FORM)**. ARSTASIS, INC., (U.S. CLS. 26, 39 AND 44). SN 77-693,892. PUB. 2-16-2010. FILED 3-18-2009.
 3,783,451. **NRG (BLOCK FORM)**. SCRIP, INC., MULTIPLE CLASS, (INT. CLS. 10, 12, 20 AND 24), (U.S. CLS. 2, 13, 19, 21, 22, 23, 25, 26, 31, 32, 35, 39, 42, 44 AND 50). SN 77-701,021. PUB. 2-16-2010. FILED 3-27-2009.
 3,783,597. **OSTEOTAPE (STYLIZED)**. IMPLADENT LTD., (U.S. CLS. 26, 39 AND 44). SN 77-735,871. PUB. 2-16-2010. FILED 5-13-2009.
 3,783,622. **CLIMATELINE (BLOCK FORM)**. RESMED LIMITED, (U.S. CLS. 26, 39 AND 44). SN 77-752,389. PUB. 12-8-2009. FILED 6-4-2009.
 3,783,663 (*See Class 9 for this trademark*).
 3,783,991. **VOT ARTHROSCOPIC SOLUTIONS (BLOCK FORM)**. VOT, LLC, (U.S. CLS. 26, 39 AND 44). SN 77-824,629. PUB. 2-16-2010. FILED 9-11-2009.

3,784,018. **WE . VIBE AND DESIGN**. STANDARD INNOVATION CORPORATION, (U.S. CLS. 26, 39 AND 44). SN 77-825,597. PUB. 2-16-2010. FILED 9-14-2009.
 3,784,054. **HI-DOW (BLOCK FORM)**. HI-DOW INTERNATIONAL, (U.S. CLS. 26, 39 AND 44). SN 77-826,539. PUB. 2-16-2010. FILED 9-15-2009.
 3,784,145. **INVISION SYSTEM (BLOCK FORM)**. INNEROPTIC TECHNOLOGY, INC., (U.S. CLS. 26, 39 AND 44). SN 77-828,817. PUB. 2-16-2010. FILED 9-17-2009.
 3,784,358. **KOALA (BLOCK FORM)**. S2S DESIGN, (U.S. CLS. 26, 39 AND 44). SN 77-831,955. PUB. 2-16-2010. FILED 9-22-2009.
 3,784,386. **ISTENT (BLOCK FORM)**. GLAUKOS CORPORATION, (U.S. CLS. 26, 39 AND 44). SN 77-832,287. PUB. 2-16-2010. FILED 9-22-2009.
 3,784,464. **FLEXGUARD (BLOCK FORM)**. GOLDEN PROTECTIVE SERVICES, INC., (U.S. CLS. 26, 39 AND 44). SN 77-833,280. PUB. 2-16-2010. FILED 9-23-2009.
 3,784,493. **CONDOMANIA (BLOCK FORM)**. ADDAZI, INC., DBA CONDOMANIA, MULTIPLE CLASS, (INT. CLS. 10 AND 35), (U.S. CLS. 26, 39, 44, 100, 101 AND 102). SN 77-833,563. PUB. 2-16-2010. FILED 9-23-2009.
 3,784,530. **EQUE (BLOCK FORM)**. HAEMONETICS CORPORATION, (U.S. CLS. 26, 39 AND 44). SN 77-834,033. PUB. 2-16-2010. FILED 9-24-2009.
 3,784,587. **INSTI-DAM (BLOCK FORM)**. ZIRC COMPANY, (U.S. CLS. 26, 39 AND 44). SN 77-834,866. PUB. 2-16-2010. FILED 9-25-2009.
 3,784,721. **FOOT TECH (BLOCK FORM)**. WRYMARK, INC., (U.S. CLS. 26, 39 AND 44). SN 77-841,644. PUB. 2-16-2010. FILED 10-5-2009.
 3,784,750. **CAPTAIN VEIN HOOK (BLOCK FORM)**. SAMUEL WAGNER, DBA WAGNER MEDICAL, (U.S. CLS. 26, 39 AND 44). SN 77-850,649. PUB. 2-16-2010. FILED 10-16-2009.
 3,784,804. **SAFETY SHIELD (BLOCK FORM)**. APOTHECARY PRODUCTS, INC., (U.S. CLS. 26, 39 AND 44). SN 77-870,088. PUB. 2-16-2010. FILED 11-11-2009.
 3,784,825 (*See Class 3 for this trademark*).
 3,784,826 (*See Class 9 for this trademark*).
 3,784,858 (*See Class 5 for this trademark*).
 3,784,861 (*See Class 9 for this trademark*).
 3,784,884 (*See Class 5 for this trademark*).
 3,784,905 (*See Class 6 for this trademark*).
 3,784,910 (*See Class 6 for this trademark*).
 3,785,032. **EVERSUN (STYLIZED)**. SHENZHEN EVERSUN GROUP CO., LTD, (U.S. CLS. 26, 39 AND 44). SN 79-073,209. PUB. 2-16-2010. FILED 6-29-2009.
 3,785,044 (*See Class 9 for this trademark*).
 3,785,051. **X-JAWS (BLOCK FORM)**. MEDICREA INTERNATIONAL, (U.S. CLS. 26, 39 AND 44). SN 79-075,459. PUB. 2-16-2010. FILED 7-7-2009.
 3,785,052. **L-JAWS (BLOCK FORM)**. MEDICREA INTERNATIONAL, (U.S. CLS. 26, 39 AND 44). SN 79-075,460. PUB. 2-16-2010. FILED 7-7-2009.

CLASS 11—ENVIRONMENTAL CONTROL APPARATUS

3,783,094. **PASTA KING EXPRESS (BLOCK FORM)**. ISICRAN INC, (U.S. CLS. 13, 21, 23, 31 AND 34). SN 76-689,981. PUB. 2-16-2010. FILED 5-27-2008.
 3,783,164. **VALOR DIMENSION (BLOCK FORM)**. BAXI HEATING UK LIMITED, (U.S. CLS. 13, 21, 23, 31 AND 34). SN 77-179,089. PUB. 11-10-2009. FILED 5-11-2007.
 3,783,232. **POLARTHERM (BLOCK FORM)**. POLAR THERMAL PRODUCTS LIMITED, (U.S. CLS. 13, 21, 23, 31 AND 34). SN 77-490,231. PUB. 2-16-2010. FILED 6-3-2008.
 3,783,256 (*See Class 9 for this trademark*).
 3,783,288. **BARISTA PROFESSIONAL (BLOCK FORM)**. BSH BOSCH UND SIEMENS HAUSGERAETE GMBH, (U.S. CLS. 13, 21, 23, 31 AND 34). SN 77-583,054. PUB. 2-16-2010. FILED 10-1-2008.
 3,783,363 (*See Class 7 for this trademark*).
 3,783,395 (*See Class 8 for this trademark*).
 3,783,436. **FLO CONTROL (BLOCK FORM)**. NATIONAL DIVERSIFIED SALES, INC., MULTIPLE CLASS, (INT.

- CLS. 11 AND 17), (U.S. CLS. 1, 5, 12, 13, 21, 23, 31, 34, 35 AND 50). SN 77-699,159. PUB. 2-16-2010. FILED 3-25-2009.
- 3,783,456. **BRY-AIR SYSTEMS (BLOCK FORM)**. BRY-AIR (ASIA) PVT. LTD., (U.S. CLS. 13, 21, 23, 31 AND 34). SN 77-701,308. PUB. 2-16-2010. FILED 3-27-2009.
- 3,783,457. **BRY-AIR SYSTEMS EST. 1978 AND DESIGN**. BRY-AIR (ASIA) PVT. LTD., (U.S. CLS. 13, 21, 23, 31 AND 34). SN 77-701,316. PUB. 2-16-2010. FILED 3-27-2009.
- 3,783,628. **RAINWEAVE (BLOCK FORM)**. EVOORGANIC, INC., MULTIPLE CLASS, (INT. CLS. 11 AND 19), (U.S. CLS. 1, 12, 13, 21, 23, 31, 33, 34 AND 50). SN 77-754,707. PUB. 2-16-2010. FILED 6-8-2009.
- 3,783,737 (*See Class 7 for this trademark*).
- 3,783,882. **WWW.AMERICANAGRICULTUREPRODUCTS.COM 580.338.3873 AND DESIGN**. BEER, GERALD, (U.S. CLS. 13, 21, 23, 31 AND 34). SN 77-817,174. PUB. 2-16-2010. FILED 9-1-2009.
- 3,783,896. **NCB-HP (BLOCK FORM)**. GEKAKONUS TECHNOLOGIES GMBH, (U.S. CLS. 13, 21, 23, 31 AND 34). SN 77-818,543. PUB. 2-16-2010. FILED 9-2-2009.
- 3,784,087. **SOLEAIRE (BLOCK FORM)**. VORNADO AIR, LLC, (U.S. CLS. 13, 21, 23, 31 AND 34). SN 77-827,642. PUB. 2-16-2010. FILED 9-16-2009.
- 3,784,163. **GLOBAL GREEN . LED AND DESIGN**. GLOBAL GREEN LED, INC, (U.S. CLS. 13, 21, 23, 31 AND 34). SN 77-829,185. PUB. 2-16-2010. FILED 9-17-2009.
- 3,784,376. **MCL (BLOCK FORM)**. MARIO INDUSTRIES OF VIRGINIA, INC., (U.S. CLS. 13, 21, 23, 31 AND 34). SN 77-832,232. PUB. 2-16-2010. FILED 9-22-2009.
- 3,784,425. **MTI BASICS (BLOCK FORM)**. MTI WHIRLPOOLS, INC., (U.S. CLS. 13, 21, 23, 31 AND 34). SN 77-832,781. PUB. 2-16-2010. FILED 9-23-2009.
- 3,784,497. **SMOKE DADDY (BLOCK FORM)**. CORREA, DENNIS, (U.S. CLS. 13, 21, 23, 31 AND 34). SN 77-833,594. PUB. 2-16-2010. FILED 9-23-2009.
- 3,784,574. **QUARK (BLOCK FORM)**. 4SEVENS, LLC, (U.S. CLS. 13, 21, 23, 31 AND 34). SN 77-834,599. PUB. 2-16-2010. FILED 9-24-2009.
- 3,784,700. **FOSET AND DESIGN**. TRUPER HERRAMIENTAS, S.A. DE C.V., (U.S. CLS. 13, 21, 23, 31 AND 34). SN 77-838,115. PUB. 2-16-2010. FILED 9-30-2009.
- 3,784,742 (*See Class 7 for this trademark*).
- 3,784,778 (*See Class 9 for this trademark*).
- 3,784,808. **GROEN AND DESIGN**. UNIFIED BRANDS, INC., (U.S. CLS. 13, 21, 23, 31 AND 34). SN 77-875,163. PUB. 2-16-2010. FILED 11-18-2009.
- 3,784,828 (*See Class 7 for this trademark*).
- 3,784,866. **AGA TWYFORD AND DESIGN**. AGA RANGE-MASTER GROUP PLC, MULTIPLE CLASS, (INT. CLS. 11, 37 AND 40), (U.S. CLS. 13, 21, 23, 31, 34, 100, 103 AND 106). SN 79-049,833. PUB. 2-16-2010. FILED 11-7-2007.
- 3,784,911. **LOBS (BLOCK FORM)**. ELISABETH SCHÜBLER-KEMPER, MULTIPLE CLASS, (INT. CLS. 11, 35 AND 42), (U.S. CLS. 13, 21, 23, 31, 34, 100, 101 AND 102). SN 79-062,091. PUB. 2-16-2010. FILED 9-18-2008.
- 3,784,924 (*See Class 6 for this trademark*).
- 3,784,965 (*See Class 9 for this trademark*).
- 3,784,987 (*See Class 9 for this trademark*).
- 3,784,992. **GEST (BLOCK FORM)**. GESSI S.P.A., MULTIPLE CLASS, (INT. CLS. 11, 20 AND 21), (U.S. CLS. 2, 13, 21, 22, 23, 25, 29, 30, 31, 32, 33, 34, 40 AND 50). SN 79-068,797. PUB. 2-16-2010. FILED 12-2-2008.
- 3,785,018. **TTTTT AND DESIGN**. TEFAL, MULTIPLE CLASS, (INT. CLS. 11 AND 21), (U.S. CLS. 2, 13, 21, 23, 29, 30, 31, 33, 34, 40 AND 50). SN 79-071,354. PUB. 2-16-2010. FILED 5-18-2009.
- 3,785,033. **KWC ONO HIGHFLEX EXTENDED WATER SYSTEM (STYLIZED)**. KWC AG, (U.S. CLS. 13, 21, 23, 31 AND 34). SN 79-073,506. PUB. 2-16-2010. FILED 5-29-2009.
- NICAL SERVICES, INC., (U.S. CLS. 19, 21, 23, 31, 35 AND 44). SN 76-698,581. PUB. 2-16-2010. FILED 7-23-2009.
- 3,783,125 (*See Class 8 for this trademark*).
- 3,783,222 (*See Class 7 for this trademark*).
- 3,783,242 (*See Class 3 for this trademark*).
- 3,783,273. **CORTINA (BLOCK FORM)**. MARIN MOUNTAIN BIKES, INC., (U.S. CLS. 19, 21, 23, 31, 35 AND 44). SN 77-553,935. PUB. 2-16-2010. FILED 8-22-2008.
- 3,783,297 (*See Class 6 for this trademark*).
- 3,783,306. **IONIA HOT ROD SHOP LLC AND DESIGN**. IONIA HOT ROD SHOP, L.L.C., (U.S. CLS. 19, 21, 23, 31, 35 AND 44). SN 77-611,987. PUB. 2-16-2010. FILED 11-11-2008.
- 3,783,322. **DOCK TORPEDO (BLOCK FORM)**. THOMAS ROBERT KAEMMERLING, (U.S. CLS. 19, 21, 23, 31, 35 AND 44). SN 77-642,064. PUB. 2-16-2010. FILED 12-31-2008.
- 3,783,331. **PUNAHOU SEAL PUNAHOU SCHOOL HONOLULU HAWAII 1841 AND DESIGN**. PUNAHOU SCHOOL, MULTIPLE CLASS, (INT. CLS. 12, 14, 16, 18, 21, 25, 26 AND 41), (U.S. CLS. 1, 2, 3, 5, 13, 19, 21, 22, 23, 27, 28, 29, 30, 31, 33, 35, 37, 38, 39, 40, 41, 42, 44, 50, 100, 101 AND 107). SN 77-649,520. PUB. 2-16-2010. FILED 1-14-2009.
- 3,783,416. **EZEE (BLOCK FORM)**. EZEEBIKE USA, INC., (U.S. CLS. 19, 21, 23, 31, 35 AND 44). SN 77-694,618. PUB. 2-16-2010. FILED 3-19-2009.
- 3,783,451 (*See Class 10 for this trademark*).
- 3,783,467. **SAILUN AND DESIGN**. SAILUN CO., LTD., (U.S. CLS. 19, 21, 23, 31, 35 AND 44). SN 77-702,014. PUB. 2-16-2010. FILED 3-30-2009.
- 3,783,477. **VOLTRIDER (BLOCK FORM)**. GLOBAL DIRECT MARKETING, LLC, DBA VOLTRIDER, (U.S. CLS. 19, 21, 23, 31, 35 AND 44). SN 77-703,256. PUB. 2-16-2010. FILED 3-31-2009.
- 3,783,481. **PCOM (BLOCK FORM)**. SQUIRE TECH SOLUTIONS, LLC, MULTIPLE CLASS, (INT. CLS. 12 AND 38), (U.S. CLS. 19, 21, 23, 31, 35, 44, 100, 101 AND 104). SN 77-703,929. PUB. 2-16-2010. FILED 4-1-2009.
- 3,783,482. **PCOM AND DESIGN**. SQUIRE TECH SOLUTIONS, LLC, MULTIPLE CLASS, (INT. CLS. 12 AND 38), (U.S. CLS. 19, 21, 23, 31, 35, 44, 100, 101 AND 104). SN 77-703,954. PUB. 2-16-2010. FILED 4-1-2009.
- 3,783,848. **SKEGSHIELD "THE ULTIMATE IN SKEG PROTECTION" AND DESIGN**. KS MARINE PRODUCTS, INC., (U.S. CLS. 19, 21, 23, 31, 35 AND 44). SN 77-814,224. PUB. 2-16-2010. FILED 8-27-2009.
- 3,783,851. **BOWSHIELD (BLOCK FORM)**. KS MARINE PRODUCTS, INC., (U.S. CLS. 19, 21, 23, 31, 35 AND 44). SN 77-814,305. PUB. 2-16-2010. FILED 8-27-2009.
- 3,783,889. **INTELLISYNC (BLOCK FORM)**. DALLAS SMITH CORP., (U.S. CLS. 19, 21, 23, 31, 35 AND 44). SN 77-817,270. PUB. 2-16-2010. FILED 9-1-2009.
- 3,783,908. **INTELLISYNC AND DESIGN**. DALLAS SMITH CORP., (U.S. CLS. 19, 21, 23, 31, 35 AND 44). SN 77-820,153. PUB. 2-16-2010. FILED 9-4-2009.
- 3,784,041. **MOBO (BLOCK FORM)**. ASA PRODUCTS, INC., TA ASA PRODUCTS, INC., (U.S. CLS. 19, 21, 23, 31, 35 AND 44). SN 77-826,294. PUB. 2-16-2010. FILED 9-14-2009.
- 3,784,049. **ISAS (BLOCK FORM)**. AXLETECH INTERNATIONAL IP HOLDING, L.L.C., (U.S. CLS. 19, 21, 23, 31, 35 AND 44). SN 77-826,445. PUB. 2-16-2010. FILED 9-15-2009.
- 3,784,124. **FUEL SAFE RACING CELLS AND DESIGN**. AIRCRAFT RUBBER MANUFACTURING, INC, (U.S. CLS. 19, 21, 23, 31, 35 AND 44). SN 77-828,517. PUB. 2-16-2010. FILED 9-17-2009.
- 3,784,168. **HEADWAY AND DESIGN**. SHANDONG HENGYU RUBBER CO.,LTD., (U.S. CLS. 19, 21, 23, 31, 35 AND 44). SN 77-829,324. PUB. 2-16-2010. FILED 9-17-2009.
- 3,784,179. **HERO EDITION (BLOCK FORM)**. UNITED CHARITIES INTERNATIONAL, INC., (U.S. CLS. 19, 21, 23, 31, 35 AND 44). SN 77-829,547. PUB. 2-16-2010. FILED 9-18-2009.
- 3,784,269. **MISCELLANEOUS DESIGN**. JAYCO, INC., (U.S. CLS. 19, 21, 23, 31, 35 AND 44). SN 77-830,882. PUB. 2-16-2010. FILED 9-21-2009.
- 3,784,307. **RIDLER (STYLIZED)**. CIA WHEEL GROUP, (U.S. CLS. 19, 21, 23, 31, 35 AND 44). SN 77-831,332. PUB. 2-16-2010. FILED 9-21-2009.
- 3,784,399. **T-REX GRILLES AND DESIGN**. T-REX TRUCK PRODUCTS INC., AKA T-REX GRILLES, (U.S. CLS. 19, 21, 23, 31, 35 AND 44). SN 77-832,452. PUB. 2-16-2010. FILED 9-21-2009.

CLASS 12—VEHICLES

- 3,783,104. **MERIDIAN (BLOCK FORM)**. WINNEBAGO INDUSTRIES, INC., (U.S. CLS. 19, 21, 23, 31, 35 AND 44). SN 76-695,975. PUB. 2-16-2010. FILED 2-23-2009.
- 3,783,114. **FUEL JACK (BLOCK FORM)**. HAMMONDS TECH-

- 22-2009.
 3,784,503. **AMTRYKE (BLOCK FORM)**. AMTRYKE, LLC, FORMERLY AMTRYKE, INC., (U.S. CLS. 19, 21, 23, 31, 35 AND 44). SN 77-833,741. PUB. 2-16-2010. FILED 9-24-2009.
 3,784,532. **ALOHA PONTOONS (BLOCK FORM)**. WACO MANUFACTURING, INC., (U.S. CLS. 19, 21, 23, 31, 35 AND 44). SN 77-834,045. PUB. 2-16-2010. FILED 9-24-2009.
 3,784,849. **ADAPTIVEONE (BLOCK FORM)**. GENUINE PARTS COMPANY, (U.S. CLS. 19, 21, 23, 31, 35 AND 44). SN 78-920,664. PUB. 2-16-2010. FILED 6-30-2006.
 3,784,876 (*See Class 7 for this trademark*).
 3,784,918. **ECORIZON (STYLIZED)**. STX FRANCE S.A., MULTIPLE CLASS, (INT. CLS. 12, 37, 40 AND 42), (U.S. CLS. 19, 21, 23, 31, 35, 44, 100, 101, 103 AND 106). SN 79-063,239. PUB. 2-16-2010. FILED 7-3-2008.
 3,784,925. **BEAUTIFORDABLE (BLOCK FORM)**. MICHAEL WELKE, MULTIPLE CLASS, (INT. CLS. 12, 25, 35 AND 36), (U.S. CLS. 19, 21, 22, 23, 31, 35, 39, 44, 100, 101 AND 102). SN 79-065,735. PUB. 11-10-2009. FILED 12-4-2008.
 3,784,929 (*See Class 6 for this trademark*).
 3,784,967. **ROCA AND DESIGN**. ROCA INDUSTRY AB, (U.S. CLS. 19, 21, 23, 31, 35 AND 44). SN 79-068,074. PUB. 2-16-2010. FILED 3-25-2009.
 3,784,972 (*See Class 3 for this trademark*).
 3,784,988. **SKYBIKE (BLOCK FORM)**. GILO INDUSTRIES LIMITED, (U.S. CLS. 19, 21, 23, 31, 35 AND 44). SN 79-068,604. PUB. 2-16-2010. FILED 12-10-2008.
 3,785,005 (*See Class 7 for this trademark*).
 3,785,029. **ZNP (STYLIZED)**. TAIZHOU ZHENPENG OVER-RUNNING CLUTCH CO., LTD., (U.S. CLS. 19, 21, 23, 31, 35 AND 44). SN 79-072,947. PUB. 2-16-2010. FILED 6-29-2009.
 3,785,043. **WAYEL (BLOCK FORM)**. WAYEL SRL, MULTIPLE CLASS, (INT. CLS. 12, 18, 25, 37 AND 42), (U.S. CLS. 1, 2, 3, 19, 21, 22, 23, 31, 35, 39, 41, 44, 100, 101, 103 AND 106). SN 79-074,009. PUB. 2-16-2010. FILED 7-29-2009.
 3,785,048. **BESSIE (BLOCK FORM)**. CM ENGINEERING CONSULTANTS LIMITED, MULTIPLE CLASS, (INT. CLS. 12 AND 17), (U.S. CLS. 1, 5, 12, 13, 19, 21, 23, 31, 35, 44 AND 50). SN 79-074,471. PUB. 2-16-2010. FILED 9-25-2009.

CLASS 13—FIREARMS

- 3,783,267. **DRAGON FIRE (BLOCK FORM)**. AIRSOFT AMERICA, INC., (U.S. CLS. 2 AND 9). SN 77-544,327. PUB. 2-16-2010. FILED 8-11-2008.
 3,783,756. **GREN (BLOCK FORM)**. ALEXANDER INDUSTRIES, INC., (U.S. CLS. 2 AND 9). SN 77-795,477. PUB. 2-16-2010. FILED 8-3-2009.
 3,783,982. **CRAZY EXCITING ON STEROIDS (BLOCK FORM)**. JAKE'S FIREWORKS INC., (U.S. CLS. 2 AND 9). SN 77-824,412. PUB. 2-16-2010. FILED 9-11-2009.
 3,784,395. **REZOLUTION (BLOCK FORM)**. ZIMMERMAN ARMS LLC, (U.S. CLS. 2 AND 9). SN 77-832,422. PUB. 2-16-2010. FILED 9-22-2009.

CLASS 14—JEWELRY

- 3,783,083. **TH&B AND DESIGN**. CANADIAN PACIFIC RAILWAY COMPANY, MULTIPLE CLASS, (INT. CLS. 14, 16 AND 28), (U.S. CLS. 2, 5, 22, 23, 27, 28, 29, 37, 38 AND 50). SN 76-579,751. PUB. 2-16-2010. FILED 3-8-2004.
 3,783,124. **ATTACHÉ (BLOCK FORM)**. AUGUSTIN, SUZY, (U.S. CLS. 2, 27, 28 AND 50). SN 76-699,275. PUB. 2-16-2010. FILED 9-1-2009.
 3,783,141. **WELL DONE EXPERIENCE AND DESIGN**. WELL DONE EXPERIENCE, LTD., MULTIPLE CLASS, (INT. CLS. 14, 23 AND 26), (U.S. CLS. 2, 27, 28, 37, 39, 40, 42, 43 AND 50). SN 77-057,822. PUB. 7-8-2008. FILED 12-6-2006.
 3,783,142. **FORMULA AND DESIGN**. SANWIN INDUSTRIES LTD, (U.S. CLS. 2, 27, 28 AND 50). SN 77-059,726. PUB. 2-16-2010. FILED 12-8-2006.
 3,783,246. **PINK LOTUS JEWELRY INSPIRED BY ANCIENT CULTURES AND DESIGN**. PINK LOTUS, DBA PINK LOTUS, (U.S. CLS. 2, 27, 28 AND 50). SN 77-515,458. PUB. 2-16-2010. FILED 7-7-2008.
 3,783,270 (*See Class 3 for this trademark*).
 3,783,331 (*See Class 12 for this trademark*).
 3,783,341. **VIOLUNA JEWELLERY (BLOCK FORM)**. CSH ADORNED, INC., (U.S. CLS. 2, 27, 28 AND 50). SN 77-661,869. PUB. 2-16-2010. FILED 2-3-2009.
 3,783,607. **BORGIONI (BLOCK FORM)**. BORGIONI LLC, (U.S. CLS. 2, 27, 28 AND 50). SN 77-743,725. PUB. 2-16-2010. FILED 5-23-2009.
 3,783,608. **BORGIONI (STYLIZED)**. BORGIONI LLC, (U.S. CLS. 2, 27, 28 AND 50). SN 77-743,729. PUB. 2-16-2010. FILED 5-23-2009.
 3,783,649. **RUEHL (BLOCK FORM)**. ABERCROMBIE & FITCH TRADING CO., (U.S. CLS. 2, 27, 28 AND 50). SN 77-761,566. PUB. 2-16-2010. FILED 6-17-2009.
 3,783,673. **LC AND DESIGN**. LIZ CLAIBORNE, INC., (U.S. CLS. 2, 27, 28 AND 50). SN 77-767,901. PUB. 11-10-2009. FILED 6-25-2009.
 3,783,720. **LEIGHTWORKS (BLOCK FORM)**. LEIGHT, DAVID ELLIOTT, DBA LEIGHTWORKS, (U.S. CLS. 2, 27, 28 AND 50). SN 77-785,448. PUB. 2-16-2010. FILED 7-21-2009.
 3,783,778. **NIGHTINGALE WATCH (BLOCK FORM)**. JESSICA P GILL, DBA KARN GILL ASSOCIATES, (U.S. CLS. 2, 27, 28 AND 50). SN 77-801,433. PUB. 2-16-2010. FILED 8-11-2009.
 3,783,847. **GENESIS BRIDAL COLLECTION (BLOCK FORM)**. BEZALEL, MOSHE, (U.S. CLS. 2, 27, 28 AND 50). SN 77-814,040. PUB. 2-16-2010. FILED 8-27-2009.
 3,783,853. **¡ BÉZAME ! AND DESIGN**. BEZALEL, MOSHE, (U.S. CLS. 2, 27, 28 AND 50). SN 77-814,347. PUB. 2-16-2010. FILED 8-27-2009.
 3,783,926. **VAN GALZ (BLOCK FORM)**. SAX ADVERTISING, INC., DBA VAN GALZ, (U.S. CLS. 2, 27, 28 AND 50). SN 77-821,446. PUB. 2-16-2010. FILED 9-8-2009.
 3,784,091. **ASHLEY COOPER (BLOCK FORM)**. BOSCOV'S INVESTMENT COMPANY, INC., MULTIPLE CLASS, (INT. CLS. 14, 18, 20, 21, 24, 25 AND 26), (U.S. CLS. 1, 2, 3, 13, 22, 23, 25, 27, 28, 29, 30, 32, 33, 37, 39, 40, 41, 42 AND 50). SN 77-827,686. PUB. 2-16-2010. FILED 9-16-2009.
 3,784,105. **KEWL JEWELS (BLOCK FORM)**. PHILLIPS INTERNATIONAL, INC., (U.S. CLS. 2, 27, 28 AND 50). SN 77-828,121. PUB. 2-16-2010. FILED 9-16-2009.
 3,784,301. **MISCELLANEOUS DESIGN**. OUR LOVE WILL TURN YOU ON, LLC, (U.S. CLS. 2, 27, 28 AND 50). SN 77-831,203. PUB. 2-16-2010. FILED 9-21-2009.
 3,784,302. **NOW AND DESIGN**. OUR LOVE WILL TURN YOU ON, LLC, (U.S. CLS. 2, 27, 28 AND 50). SN 77-831,238. PUB. 2-16-2010. FILED 9-21-2009.
 3,784,306. **LILYRAIN (BLOCK FORM)**. FRANCESCA'S COLLECTIONS, INC., (U.S. CLS. 2, 27, 28 AND 50). SN 77-831,302. PUB. 2-16-2010. FILED 9-21-2009.
 3,784,598. **MISCELLANEOUS DESIGN**. NANCY BELLEY, (U.S. CLS. 2, 27, 28 AND 50). SN 77-834,969. PUB. 2-16-2010. FILED 9-25-2009.
 3,784,802. **A AND DESIGN**. AFFLICTION HOLDINGS LLC, MULTIPLE CLASS, (INT. CLS. 14 AND 18), (U.S. CLS. 1, 2, 3, 22, 27, 28, 41 AND 50). SN 77-869,189. PUB. 2-16-2010. FILED 11-10-2009.
 3,784,803. **A AFFLICTION LIVE FAST AND DESIGN**. AFFLICTION HOLDINGS LLC, (U.S. CLS. 2, 27, 28 AND 50). SN 77-869,490. PUB. 2-16-2010. FILED 11-10-2009.
 3,784,805. **AFFLICTION AND DESIGN**. AFFLICTION HOLDINGS LLC, (U.S. CLS. 2, 27, 28 AND 50). SN 77-870,979. PUB. 2-16-2010. FILED 11-12-2009.
 3,784,859 (*See Class 3 for this trademark*).
 3,784,869 (*See Class 3 for this trademark*).
 3,784,896 (*See Class 3 for this trademark*).
 3,784,912. **ARGYLE DIAMONDS (BLOCK FORM)**. ARGYLE DIAMONDS LIMITED, MULTIPLE CLASS, (INT. CLS. 14 AND 35), (U.S. CLS. 2, 27, 28, 50, 100, 101 AND 102). SN 79-062,206. PUB. 2-16-2010. FILED 8-26-2008.
 3,784,923. **ARGYLE PINK DIAMONDS AUTHORISED PARTNER (BLOCK FORM)**. ARGYLE DIAMONDS LIMITED, MULTIPLE CLASS, (INT. CLS. 14 AND 35), (U.S. CLS. 2, 27, 28, 50, 100, 101 AND 102). SN 79-064,718. PUB. 2-16-2010. FILED 12-4-2008.
 3,784,972 (*See Class 3 for this trademark*).
 3,784,983. **SCARPE & SCARPE AND DESIGN**. SCARPE &

SCARPE S.P.A., MULTIPLE CLASS, (INT. CLS. 14, 18 AND 25), (U.S. CLS. 1, 2, 3, 22, 27, 28, 39, 41 AND 50). SN 79-068,520. PUB. 2-16-2010. FILED 6-6-2008.

CLASS 15—MUSICAL INSTRUMENTS

- 3,783,405. **OVERTONE ACCESSORIES AND DESIGN**. BRADY BRIDGES, (U.S. CLS. 2, 21 AND 36). SN 77-692,055. PUB. 2-16-2010. FILED 3-16-2009.
- 3,783,579. **VIRTUOSO (BLOCK FORM)**. RS BERKELEY INC, (U.S. CLS. 2, 21 AND 36). SN 77-725,915. PUB. 1-12-2010. FILED 4-30-2009.
- 3,784,261. **NUANCE (BLOCK FORM)**. M.V. PEDULLA GUITARS, INC., (U.S. CLS. 2, 21 AND 36). SN 77-830,793. PUB. 2-16-2010. FILED 9-21-2009.
- 3,784,549. **DAN ELECTRODE (BLOCK FORM)**. EVETS CORPORATION, DBA DANELECTRO, (U.S. CLS. 2, 21 AND 36). SN 77-834,202. PUB. 2-16-2010. FILED 9-24-2009.

CLASS 16—PAPER GOODS AND PRINTED MATTER

- 3,783,083 (*See Class 14 for this trademark*).
- 3,783,087. **PETERSON INSTITUTE FOR INTERNATIONAL ECONOMICS (BLOCK FORM)**. INSTITUTE FOR INTERNATIONAL ECONOMICS, MULTIPLE CLASS, (INT. CLS. 16, 41 AND 42), (U.S. CLS. 2, 5, 22, 23, 29, 37, 38, 50, 100, 101 AND 107). SN 76-667,925. PUB. 2-16-2010. FILED 10-23-2006.
- 3,783,088. **PETERSON INSTITUTE (BLOCK FORM)**. INSTITUTE FOR INTERNATIONAL ECONOMICS, MULTIPLE CLASS, (INT. CLS. 16, 41 AND 42), (U.S. CLS. 2, 5, 22, 23, 29, 37, 38, 50, 100, 101 AND 107). SN 76-667,935. PUB. 2-16-2010. FILED 10-23-2006.
- 3,783,089. **PETER G. PETERSON INSTITUTE FOR INTERNATIONAL ECONOMICS (BLOCK FORM)**. INSTITUTE FOR INTERNATIONAL ECONOMICS, MULTIPLE CLASS, (INT. CLS. 16, 41 AND 42), (U.S. CLS. 2, 5, 22, 23, 29, 37, 38, 50, 100, 101 AND 107). SN 76-667,936. PUB. 2-16-2010. FILED 10-23-2006.
- 3,783,092. **COWBOY UP (BLOCK FORM)**. WYOMING WEST DESIGNS II, INC., (U.S. CLS. 2, 5, 22, 23, 29, 37, 38 AND 50). SN 76-686,405. PUB. 2-16-2010. FILED 2-1-2008.
- 3,783,098. **FIND A TREE (BLOCK FORM)**. ARMSTRONG, DANIEL, (U.S. CLS. 2, 5, 22, 23, 29, 37, 38 AND 50). SN 76-694,067. PUB. 2-16-2010. FILED 11-6-2008.
- 3,783,212. **FERRARI MAGIC INDIA DISCOVERY (STYLIZED)**. FERRARI S.P.A., (U.S. CLS. 2, 5, 22, 23, 29, 37, 38 AND 50). SN 77-418,754. PUB. 12-22-2009. FILED 3-11-2008.
- 3,783,231 (*See Class 9 for this trademark*).
- 3,783,236. **PSALMS OF PEACE (BLOCK FORM)**. BELA BALIKO PHOTOGRAPHY & PUBLISHING INC., (U.S. CLS. 2, 5, 22, 23, 29, 37, 38 AND 50). SN 77-495,634. PUB. 2-16-2010. FILED 6-10-2008.
- 3,783,268. **MONITOR 100 (BLOCK FORM)**. XANDER MEDIA GROUP, INC., (U.S. CLS. 2, 5, 22, 23, 29, 37, 38 AND 50). SN 77-545,818. PUB. 2-16-2010. FILED 8-13-2008.
- 3,783,278. **JET BEAUTY (BLOCK FORM)**. JOHNSON PUBLISHING COMPANY, INC., (U.S. CLS. 2, 5, 22, 23, 29, 37, 38 AND 50). SN 77-565,515. PUB. 2-16-2010. FILED 9-9-2008.
- 3,783,289. **EASL THE INTERNATIONAL LIVER CONGRESS AND DESIGN**. EUROPEAN ASSOCIATION FOR THE STUDY OF THE LIVER, MULTIPLE CLASS, (INT. CLS. 16 AND 41), (U.S. CLS. 2, 5, 22, 23, 29, 37, 38, 50, 100, 101 AND 107). SN 77-585,973. PUB. 12-1-2009. FILED 10-6-2008.
- 3,783,318. **STRATICUBE (BLOCK FORM)**. COGENCY GROUP, INC., (U.S. CLS. 2, 5, 22, 23, 29, 37, 38 AND 50). SN 77-635,865. PUB. 2-16-2010. FILED 12-18-2008.
- 3,783,328. **SCHNUCKS COOKS AND DESIGN**. SCHNUCK MARKETS, INC., (U.S. CLS. 2, 5, 22, 23, 29, 37, 38 AND 50). SN 77-648,216. PUB. 2-16-2010. FILED 1-13-2009.
- 3,783,330 (*See Class 9 for this trademark*).
- 3,783,331 (*See Class 12 for this trademark*).
- 3,783,357 (*See Class 9 for this trademark*).

- 3,783,377. **SURGINK CUT HERE AND DESIGN**. ALLEN, MICHAEL W., (U.S. CLS. 2, 5, 22, 23, 29, 37, 38 AND 50). SN 77-682,666. PUB. 2-16-2010. FILED 3-3-2009.
- 3,783,396. **LOBIRD (BLOCK FORM)**. ROHRBACH, LAURIE MACK, DBA LOBIRD, (U.S. CLS. 2, 5, 22, 23, 29, 37, 38 AND 50). SN 77-689,640. PUB. 2-16-2010. FILED 3-12-2009.
- 3,783,402. **THE WORD FOR TODAY (BLOCK FORM)**. THE WORD FOR TODAY, (U.S. CLS. 2, 5, 22, 23, 29, 37, 38 AND 50). SN 77-691,764. PUB. 2-16-2010. FILED 3-16-2009.
- 3,783,434. **PINWHEEL (BLOCK FORM)**. PEAFIELD PRODUCTS, INC., (U.S. CLS. 2, 5, 22, 23, 29, 37, 38 AND 50). SN 77-698,763. PUB. 2-16-2010. FILED 3-25-2009.
- 3,783,491. **FROG (BLOCK FORM)**. INSPIRED TECHNOLOGIES, INC., (U.S. CLS. 2, 5, 22, 23, 29, 37, 38 AND 50). SN 77-705,654. PUB. 2-16-2010. FILED 4-2-2009.
- 3,783,492. **MISCELLANEOUS DESIGN**. INSPIRED TECHNOLOGIES, INC., (U.S. CLS. 2, 5, 22, 23, 29, 37, 38 AND 50). SN 77-705,677. PUB. 2-16-2010. FILED 4-2-2009.
- 3,783,501 (*See Class 9 for this trademark*).
- 3,783,528. **GREEN EARTH MEMORIAL LINE (BLOCK FORM)**. DEATON-KENNEDY COMPANY, (U.S. CLS. 2, 5, 22, 23, 29, 37, 38 AND 50). SN 77-712,711. PUB. 2-16-2010. FILED 4-13-2009.
- 3,783,541 (*See Class 6 for this trademark*).
- 3,783,559. **IRISH WISDOM (STYLIZED)**. PETERSON, ANN, (U.S. CLS. 2, 5, 22, 23, 29, 37, 38 AND 50). SN 77-718,225. PUB. 2-16-2010. FILED 4-21-2009.
- 3,783,591. **LAND & SEA GARY MILES PHOTOS (BLOCK FORM)**. MILES, GARY, (U.S. CLS. 2, 5, 22, 23, 29, 37, 38 AND 50). SN 77-731,655. PUB. 2-16-2010. FILED 5-7-2009.
- 3,783,644. **CONSTRUCTION BOOK EXPRESS (BLOCK FORM)**. LAB SAFETY SUPPLY, INC., MULTIPLE CLASS, (INT. CLS. 16 AND 35), (U.S. CLS. 2, 5, 22, 23, 29, 37, 38, 50, 100, 101 AND 102). SN 77-761,131. PUB. 2-16-2010. FILED 6-16-2009.
- 3,783,653. **SCI SPARK AND DESIGN**. PECHENIK, JAN A., DBA SCISPARK.COM, (U.S. CLS. 2, 5, 22, 23, 29, 37, 38 AND 50). SN 77-761,952. PUB. 11-10-2009. FILED 6-17-2009.
- 3,783,670. **COMMERCIAL TRUCK, TRAILER & EQUIPMENT TRADER (BLOCK FORM)**. TPI HOLDINGS, INC., (U.S. CLS. 2, 5, 22, 23, 29, 37, 38 AND 50). SN 77-766,415. PUB. 2-16-2010. FILED 6-23-2009.
- 3,783,702. **MANHATTAN INSTITUTE FOR POLICY RESEARCH (BLOCK FORM)**. MANHATTAN INSTITUTE FOR POLICY RESEARCH, MULTIPLE CLASS, (INT. CLS. 16, 35 AND 41), (U.S. CLS. 2, 5, 22, 23, 29, 37, 38, 50, 100, 101, 102 AND 107). SN 77-778,254. PUB. 2-16-2010. FILED 7-10-2009.
- 3,783,825. **SIP MAGAZINE (BLOCK FORM)**. ELISE E. SCOTT, DBA PEARL FINE TEAS, (U.S. CLS. 2, 5, 22, 23, 29, 37, 38 AND 50). SN 77-809,724. PUB. 2-16-2010. FILED 8-21-2009.
- 3,783,842. **RPS (BLOCK FORM)**. TYCO ELECTRONICS CORPORATION, (U.S. CLS. 2, 5, 22, 23, 29, 37, 38 AND 50). SN 77-813,428. PUB. 2-16-2010. FILED 8-26-2009.
- 3,783,846. **COLLEGE OF CHARLESTON COUGARS AND DESIGN**. COLLEGE OF CHARLESTON, MULTIPLE CLASS, (INT. CLS. 16, 25 AND 28), (U.S. CLS. 2, 5, 22, 23, 29, 37, 38, 39 AND 50). SN 77-813,772. PUB. 2-16-2010. FILED 8-27-2009.
- 3,783,876 (*See Class 6 for this trademark*).
- 3,783,905. **PAIGEIPAC (BLOCK FORM)**. PAIGE ELECTRIC CO, LP, (U.S. CLS. 2, 5, 22, 23, 29, 37, 38 AND 50). SN 77-819,351. PUB. 2-16-2010. FILED 9-3-2009.
- 3,783,924. **MISCELLANEOUS DESIGN**. HOFFMANN, ISABELLA, DBA BEARLY COLLECTIBLES, (U.S. CLS. 2, 5, 22, 23, 29, 37, 38 AND 50). SN 77-821,285. PUB. 2-16-2010. FILED 9-7-2009.
- 3,783,974. **IDENTITY CHECK PRINTERS (BLOCK FORM)**. CUSTOM DIRECT, LLC, MULTIPLE CLASS, (INT. CLS. 16 AND 40), (U.S. CLS. 2, 5, 22, 23, 29, 37, 38, 50, 100, 103 AND 106). SN 77-824,122. PUB. 2-16-2010. FILED 9-10-2009.
- 3,783,977. **IDENTITY CHECKS (BLOCK FORM)**. CUSTOM DIRECT, LLC, DBA IDENTITY CHECK PRINTERS, (U.S. CLS. 2, 5, 22, 23, 29, 37, 38 AND 50). SN 77-824,252. PUB. 2-16-2010. FILED 9-10-2009.
- 3,783,990. **UNIQUE CHECKS (BLOCK FORM)**. CUSTOM DIRECT, LLC, DBA UNIQUE PRODUCTS, (U.S. CLS. 2, 5, 22, 23, 29, 37, 38 AND 50). SN 77-824,616. PUB. 2-16-2010.

- FILED 9-11-2009.
- 3,784,010. **ESSENTIAL HOMME (STYLIZED)**. ESSENTIAL PUBLICATIONS U.S., (U.S. CLS. 2, 5, 22, 23, 29, 37, 38 AND 50). SN 77-825,236. PUB. 2-16-2010. FILED 9-11-2009.
- 3,784,014. **EDUCATIONAL HORIZONS (BLOCK FORM)**. PI LAMBDA THETA, INC., (U.S. CLS. 2, 5, 22, 23, 29, 37, 38 AND 50). SN 77-825,493. PUB. 2-16-2010. FILED 9-13-2009.
- 3,784,028. **LUSSO (STYLIZED)**. SWR MEDIA LTD., DBA LUSSO MAGAZINE, MULTIPLE CLASS, (INT. CLS. 16 AND 41), (U.S. CLS. 2, 5, 22, 23, 29, 37, 38, 50, 100, 101 AND 107). SN 77-825,994. PUB. 2-16-2010. FILED 9-14-2009.
- 3,784,078. **MISCELLANEOUS DESIGN**. WILDERNESS SOCIETY, THE, (U.S. CLS. 2, 5, 22, 23, 29, 37, 38 AND 50). SN 77-827,407. PUB. 2-16-2010. FILED 9-16-2009.
- 3,784,103. **PRO-TROLL (BLOCK FORM)**. PRO-TROLL, MULTIPLE CLASS, (INT. CLS. 16 AND 28), (U.S. CLS. 2, 5, 22, 23, 29, 37, 38 AND 50). SN 77-828,116. PUB. 2-16-2010. FILED 9-16-2009.
- 3,784,110. **YOUR GREEN CHOICE FOR CHECKS AND DESIGN**. CUSTOM DIRECT, LLC, DBA THE CHECK GALLERY, (U.S. CLS. 2, 5, 22, 23, 29, 37, 38 AND 50). SN 77-828,256. PUB. 2-16-2010. FILED 9-16-2009.
- 3,784,134. **STOP TALKING (BLOCK FORM)**. SET EDITIONS, (U.S. CLS. 2, 5, 22, 23, 29, 37, 38 AND 50). SN 77-828,583. PUB. 2-16-2010. FILED 9-17-2009.
- 3,784,148. **ROSELIGHT HEALING (BLOCK FORM)**. ONE WORLD HEART INSTITUTE, INC., (U.S. CLS. 2, 5, 22, 23, 29, 37, 38 AND 50). SN 77-828,846. PUB. 2-16-2010. FILED 9-17-2009.
- 3,784,173. **ARTISTIC CHECKS AND DESIGN**. CUSTOM DIRECT, LLC, DBA ARTISTIC CHECKS, MULTIPLE CLASS, (INT. CLS. 16 AND 40), (U.S. CLS. 2, 5, 22, 23, 29, 37, 38, 50, 100, 103 AND 106). SN 77-829,467. PUB. 2-16-2010. FILED 9-18-2009.
- 3,784,225. **SAKINA DESIGN (BLOCK FORM)**. SAKINA DESIGN, LLC, (U.S. CLS. 2, 5, 22, 23, 29, 37, 38 AND 50). SN 77-830,322. PUB. 2-16-2010. FILED 9-18-2009.
- 3,784,227 (*See Class 9 for this trademark*).
- 3,784,229. **LIFECHECKS (STYLIZED)**. CUSTOM DIRECT, LLC, DBA LIFE CHECKS, MULTIPLE CLASS, (INT. CLS. 16 AND 40), (U.S. CLS. 2, 5, 22, 23, 29, 37, 38, 50, 100, 103 AND 106). SN 77-830,393. PUB. 2-16-2010. FILED 9-19-2009.
- 3,784,230. **IDENTITY CHECK PRINTERS AND DESIGN**. CUSTOM DIRECT, LLC, DBA IDENTITY CHECK PRINTERS, MULTIPLE CLASS, (INT. CLS. 16 AND 40), (U.S. CLS. 2, 5, 22, 23, 29, 37, 38, 50, 100, 103 AND 106). SN 77-830,396. PUB. 2-16-2010. FILED 9-19-2009.
- 3,784,250. **WINGS FOR WISHES (BLOCK FORM)**. EDIE RAETHER ENTERPRISES, LLC, (U.S. CLS. 2, 5, 22, 23, 29, 37, 38 AND 50). SN 77-830,635. PUB. 2-16-2010. FILED 9-20-2009.
- 3,784,265. **BOPAGLA (BLOCK FORM)**. COMPETITIVE ADVANTAGE GROUP, INC., (U.S. CLS. 2, 5, 22, 23, 29, 37, 38 AND 50). SN 77-830,839. PUB. 2-16-2010. FILED 9-21-2009.
- 3,784,286. **VIRTUALLY ONSTAGE (BLOCK FORM)**. BALCH, DARREN, (U.S. CLS. 2, 5, 22, 23, 29, 37, 38 AND 50). SN 77-831,051. PUB. 2-16-2010. FILED 9-21-2009.
- 3,784,384. **SCULPTING WITH LIGHT (BLOCK FORM)**. EARNEST, ALLISON, MULTIPLE CLASS, (INT. CLS. 16 AND 41), (U.S. CLS. 2, 5, 22, 23, 29, 37, 38, 50, 100, 101 AND 107). SN 77-832,274. PUB. 2-16-2010. FILED 9-22-2009.
- 3,784,432. **SIERRA ANGLICAN CHURCH (BLOCK FORM)**. ALFREDO M. AMEZAGA JR., MULTIPLE CLASS, (INT. CLS. 16 AND 45), (U.S. CLS. 2, 5, 22, 23, 29, 37, 38, 50, 100 AND 101). SN 77-832,886. PUB. 2-16-2010. FILED 9-23-2009.
- 3,784,454. **AEROBINDER (BLOCK FORM)**. AEROBIND INC, (U.S. CLS. 2, 5, 22, 23, 29, 37, 38 AND 50). SN 77-833,181. PUB. 2-16-2010. FILED 9-23-2009.
- 3,784,466. **VISUAL VINYL (BLOCK FORM)**. VANDERMEERSCH, WILLEM FREDERIK, (U.S. CLS. 2, 5, 22, 23, 29, 37, 38 AND 50). SN 77-833,290. PUB. 2-16-2010. FILED 9-23-2009.
- 3,784,512. **TRIAGEFIRST EDUCATION (BLOCK FORM)**. TRIAGE FIRST, INC., (U.S. CLS. 2, 5, 22, 23, 29, 37, 38 AND 50). SN 77-833,803. PUB. 2-16-2010. FILED 9-24-2009.
- 3,784,523. **HELLO GENIUS (BLOCK FORM)**. COUGHLAN COMPANIES, INC., (U.S. CLS. 2, 5, 22, 23, 29, 37, 38 AND 50). SN 77-833,938. PUB. 2-16-2010. FILED 9-24-2009.
- 3,784,535. **SNUKUMS N' SNUKS (BLOCK FORM)**. GENESIS LIU, DBA SNUKUMS N' SNUKS, (U.S. CLS. 2, 5, 22, 23, 29, 37, 38 AND 50). SN 77-834,072. PUB. 2-16-2010. FILED 9-24-2009.
- 3,784,557. **SYSTEM QUALITY NUMBER (BLOCK FORM)**. INTERNATIONAL INSTITUTE OF TRADING MASTERY CORPORATION, (U.S. CLS. 2, 5, 22, 23, 29, 37, 38 AND 50). SN 77-834,322. PUB. 2-16-2010. FILED 9-24-2009.
- 3,784,561. **R (STYLIZED)**. RAPID CITY PROFESSIONAL HOCKEY, LLC, DBA RAPID CITY RUSH, MULTIPLE CLASS, (INT. CLS. 16, 25, 28 AND 41), (U.S. CLS. 2, 5, 22, 23, 29, 37, 38, 39, 50, 100, 101 AND 107). SN 77-834,418. PUB. 2-16-2010. FILED 9-24-2009.
- 3,784,588 (*See Class 9 for this trademark*).
- 3,784,597. **BY DRUM LIGHT (BLOCK FORM)**. BUCHANAN, MYRON K., (U.S. CLS. 2, 5, 22, 23, 29, 37, 38 AND 50). SN 77-834,963. PUB. 2-16-2010. FILED 9-25-2009.
- 3,784,617. **AE ATRIA ESPAÑOL (STYLIZED)**. SIMON & SCHUSTER, INC., (U.S. CLS. 2, 5, 22, 23, 29, 37, 38 AND 50). SN 77-835,325. PUB. 2-16-2010. FILED 9-25-2009.
- 3,784,618. **AI ATRIA INTERNATIONAL (STYLIZED)**. SIMON & SCHUSTER, INC., (U.S. CLS. 2, 5, 22, 23, 29, 37, 38 AND 50). SN 77-835,330. PUB. 2-16-2010. FILED 9-25-2009.
- 3,784,619. **AP ATRIA PAPERBACK (STYLIZED)**. SIMON & SCHUSTER, INC., (U.S. CLS. 2, 5, 22, 23, 29, 37, 38 AND 50). SN 77-835,335. PUB. 2-16-2010. FILED 9-25-2009.
- 3,784,691 (*See Class 9 for this trademark*).
- 3,784,717. **NEWS CHIEF (BLOCK FORM)**. NEW YORK TIMES COMPANY, THE, MULTIPLE CLASS, (INT. CLS. 16 AND 41), (U.S. CLS. 2, 5, 22, 23, 29, 37, 38, 50, 100, 101 AND 107). SN 77-840,401. PUB. 2-16-2010. FILED 10-2-2009.
- 3,784,725. **THE ADVENTURES OF DIGGER AND FRIENDS (BLOCK FORM)**. TWENTIETH CENTURY FOX FILM CORPORATION, (U.S. CLS. 2, 5, 22, 23, 29, 37, 38 AND 50). SN 77-842,896. PUB. 2-16-2010. FILED 10-6-2009.
- 3,784,734. **STICKTASTIC (BLOCK FORM)**. NORWOOD PROMOTIONAL PRODUCTS, LLC, (U.S. CLS. 2, 5, 22, 23, 29, 37, 38 AND 50). SN 77-845,493. PUB. 2-16-2010. FILED 10-9-2009.
- 3,784,735. **DIAMOND RESORTS INTERNATIONAL (BLOCK FORM)**. DIAMOND RESORTS HOLDINGS, LLC, (U.S. CLS. 2, 5, 22, 23, 29, 37, 38 AND 50). SN 77-845,538. PUB. 2-16-2010. FILED 10-9-2009.
- 3,784,737. **V100 (BLOCK FORM)**. VSPRING CAPITAL, LLC, MULTIPLE CLASS, (INT. CLS. 16 AND 35), (U.S. CLS. 2, 5, 22, 23, 29, 37, 38, 50, 100, 101 AND 102). SN 77-846,017. PUB. 2-16-2010. FILED 10-9-2009.
- 3,784,738. **V100 AND DESIGN**. VSPRING CAPITAL, LLC, MULTIPLE CLASS, (INT. CLS. 16 AND 35), (U.S. CLS. 2, 5, 22, 23, 29, 37, 38, 50, 100, 101 AND 102). SN 77-846,018. PUB. 2-16-2010. FILED 10-9-2009.
- 3,784,776. **DOCTOR SOLAR (BLOCK FORM)**. RANDOM HOUSE, INC., (U.S. CLS. 2, 5, 22, 23, 29, 37, 38 AND 50). SN 77-858,767. PUB. 2-16-2010. FILED 10-27-2009.
- 3,784,777. **MAGNUS ROBOT FIGHTER (BLOCK FORM)**. RANDOM HOUSE, INC., (U.S. CLS. 2, 5, 22, 23, 29, 37, 38 AND 50). SN 77-858,806. PUB. 2-16-2010. FILED 10-27-2009.
- 3,784,818. **DR. FEELGOOD (BLOCK FORM)**. MOTLEY CRUE, INC., MULTIPLE CLASS, (INT. CLS. 16 AND 25), (U.S. CLS. 2, 5, 22, 23, 29, 37, 38, 39 AND 50). SN 77-979,101. PUB. 3-10-2009. FILED 3-22-2008.
- 3,784,826 (*See Class 9 for this trademark*).
- 3,784,827. **SUPER CODER (BLOCK FORM)**. WANG, ROGER H., (U.S. CLS. 2, 5, 22, 23, 29, 37, 38 AND 50). SN 78-533,588. PUB. 2-16-2010. FILED 12-16-2004.
- 3,784,829 (*See Class 9 for this trademark*).
- 3,784,852. **TAPESH (BLOCK FORM)**. JAMALI, MASOUD, AND AMIRGHASSEMI, ALIREZA, (U.S. CLS. 2, 5, 22, 23, 29, 37, 38 AND 50). SN 78-953,140. PUB. 2-16-2010. FILED 8-16-2006.
- 3,784,869 (*See Class 3 for this trademark*).
- 3,784,871 (*See Class 9 for this trademark*).
- 3,784,872 (*See Class 9 for this trademark*).
- 3,784,874 (*See Class 3 for this trademark*).
- 3,784,879. **VICTORY TENACITY KING (BLOCK FORM)**. WINTOUSKY PHILIPPE, MULTIPLE CLASS, (INT. CLS. 16, 18, 24, 25, 27, 28, 35 AND 41), (U.S. CLS. 1, 2, 3, 5, 19, 20, 22, 23, 29, 37, 38, 39, 41, 42, 50, 100, 101, 102 AND 107). SN 79-058,118. PUB. 2-16-2010. FILED 7-23-2008.

- 3,784,880 (*See Class 9 for this trademark.*)
 3,784,883. **MISCELLANEOUS DESIGN.** NATHAN CONNOLLY, GARY LIGHTBODY, JONATHAN QUINN, TOM SIMPSON, PAUL WILSON, DBA SNOW PATROL, MULTIPLE CLASS, (INT. CLS. 16, 25 AND 41), (U.S. CLS. 2, 5, 22, 23, 29, 37, 38, 39, 50, 100, 101 AND 107). SN 79-058,748. PUB. 2-16-2010. FILED 8-27-2008.
 3,784,884 (*See Class 5 for this trademark.*)
 3,784,895 (*See Class 9 for this trademark.*)
 3,784,896 (*See Class 3 for this trademark.*)
 3,784,897. **INSEAD (BLOCK FORM).** INSTITUT EUROPEEN D'ADMINISTRATION DES AFFAIRES (INSEAD), MULTIPLE CLASS, (INT. CLS. 16, 35 AND 41), (U.S. CLS. 2, 5, 22, 23, 29, 37, 38, 50, 100, 101, 102 AND 107). SN 79-059,825. PUB. 2-16-2010. FILED 9-17-2008.
 3,784,915 (*See Class 9 for this trademark.*)
 3,784,917. **OPENBUILDING 3 D (BLOCK FORM).** HABITAT FUTURE ACT, MULTIPLE CLASS, (INT. CLS. 16, 36 AND 38), (U.S. CLS. 2, 5, 22, 23, 29, 37, 38, 50, 100, 101, 102 AND 104). SN 79-062,785. PUB. 2-16-2010. FILED 11-4-2008.
 3,784,943. **HEIDELBERGER AND DESIGN.** HEIDELBERGER BRAUEREI GMBH, MULTIPLE CLASS, (INT. CLS. 16 AND 32), (U.S. CLS. 2, 5, 22, 23, 29, 37, 38, 45, 46, 48 AND 50). SN 79-067,315. PUB. 2-16-2010. FILED 2-13-2009.
 3,784,957. **M.T.O. TAMARKOS (BLOCK FORM).** NADER ANGHA, MULTIPLE CLASS, (INT. CLS. 16, 41 AND 44), (U.S. CLS. 2, 5, 22, 23, 29, 37, 38, 50, 100, 101 AND 107). SN 79-067,883. PUB. 2-16-2010. FILED 3-4-2009.
 3,784,958. **M.T.O. SHAHMAHAGHSUDI TAMARKOS (BLOCK FORM).** NADER ANGHA, MULTIPLE CLASS, (INT. CLS. 16, 41 AND 44), (U.S. CLS. 2, 5, 22, 23, 29, 37, 38, 50, 100, 101 AND 107). SN 79-067,885. PUB. 2-16-2010. FILED 3-4-2009.
 3,784,959. **TAMARKOS (BLOCK FORM).** NADER ANGHA, MULTIPLE CLASS, (INT. CLS. 16, 41 AND 44), (U.S. CLS. 2, 5, 22, 23, 29, 37, 38, 50, 100, 101 AND 107). SN 79-067,886. PUB. 2-16-2010. FILED 3-4-2009.
 3,784,963 (*See Class 9 for this trademark.*)
 3,784,972 (*See Class 3 for this trademark.*)
 3,784,973. **M.T.O. SCHOOL (BLOCK FORM).** NADER ANGHA, MULTIPLE CLASS, (INT. CLS. 16, 41 AND 45), (U.S. CLS. 2, 5, 22, 23, 29, 37, 38, 50, 100, 101 AND 107). SN 79-068,258. PUB. 2-16-2010. FILED 3-3-2009.
 3,784,974. **M.T.O. SUFISM (BLOCK FORM).** NADER ANGHA, MULTIPLE CLASS, (INT. CLS. 16, 41 AND 45), (U.S. CLS. 2, 5, 22, 23, 29, 37, 38, 50, 100, 101 AND 107). SN 79-068,259. PUB. 2-16-2010. FILED 3-3-2009.
 3,784,975. **M.T.O. SCHOOL OF SUFISM (BLOCK FORM).** NADER ANGHA, MULTIPLE CLASS, (INT. CLS. 16, 41 AND 45), (U.S. CLS. 2, 5, 22, 23, 29, 37, 38, 50, 100, 101 AND 107). SN 79-068,260. PUB. 2-16-2010. FILED 3-3-2009.
 3,784,982 (*See Class 9 for this trademark.*)
 3,784,986 (*See Class 9 for this trademark.*)
 3,784,995. **THE SWEET SIDES OF LIFE (BLOCK FORM).** ZOTTER HOLDING GMBH, MULTIPLE CLASS, (INT. CLS. 16, 29 AND 30), (U.S. CLS. 2, 5, 22, 23, 29, 37, 38, 46 AND 50). SN 79-068,868. PUB. 2-16-2010. FILED 1-15-2009.
 3,784,997. **TOWCUBE (BLOCK FORM).** RHODIA ACETOW GMBH, MULTIPLE CLASS, (INT. CLS. 16 AND 22), (U.S. CLS. 1, 2, 5, 7, 19, 22, 23, 29, 37, 38, 42 AND 50). SN 79-069,041. PUB. 2-16-2010. FILED 4-3-2009.
 3,785,000 (*See Class 9 for this trademark.*)
 3,785,038. **DESIGNED FOR ACTION (BLOCK FORM).** THORSTEINN GARDARSSON, (U.S. CLS. 2, 5, 22, 23, 29, 37, 38 AND 50). SN 79-073,827. PUB. 2-16-2010. FILED 4-7-2009.

CLASS 17—RUBBER GOODS

- 3,783,123. **LEAK-B-GONE (BLOCK FORM).** KING TECHNOLOGY OF MISSOURI, INC., (U.S. CLS. 1, 5, 12, 13, 35 AND 50). SN 76-699,132. PUB. 2-16-2010. FILED 8-24-2009.
 3,783,157 (*See Class 6 for this trademark.*)
 3,783,233. **POLARTHERM (BLOCK FORM).** POLAR THERMAL PRODUCTS LIMITED, MULTIPLE CLASS, (INT. CLS. 17 AND 21), (U.S. CLS. 1, 2, 5, 12, 13, 23, 29, 30, 33, 35, 40 AND 50). SN 77-490,235. PUB. 2-16-2010. FILED 6-3-2008.
 3,783,274. **DURA BLOC EXP (BLOCK FORM).** RANGE

- SYSTEMS, (U.S. CLS. 1, 5, 12, 13, 35 AND 50). SN 77-555,197. PUB. 2-16-2010. FILED 8-25-2008.
 3,783,293. **BOW SUPERFLO CPVC AND DESIGN.** BOW PLUMBING GROUP INC., MULTIPLE CLASS, (INT. CLS. 17 AND 19), (U.S. CLS. 1, 5, 12, 13, 33, 35 AND 50). SN 77-590,497. PUB. 2-16-2010. FILED 10-10-2008.
 3,783,432. **K-FLEX DUCT (BLOCK FORM).** L'ISOLANTE K-FLEX S.R.L., (U.S. CLS. 1, 5, 12, 13, 35 AND 50). SN 77-698,121. PUB. 2-16-2010. FILED 3-24-2009.
 3,783,433. **K-FLEX CLAD (BLOCK FORM).** L'ISOLANTE K-FLEX S.R.L., (U.S. CLS. 1, 5, 12, 13, 35 AND 50). SN 77-698,457. PUB. 2-16-2010. FILED 3-25-2009.
 3,783,436 (*See Class 11 for this trademark.*)
 3,783,719. **TIMCOGRIP (BLOCK FORM).** TIMCO, INC., (U.S. CLS. 1, 5, 12, 13, 35 AND 50). SN 77-785,072. PUB. 2-16-2010. FILED 7-20-2009.
 3,783,890. **WWW.AMERICANAGRICULTUREPRODUCTS.-COM 580.338.3873 AND DESIGN.** BEER, GERALD, (U.S. CLS. 1, 5, 12, 13, 35 AND 50). SN 77-817,301. PUB. 2-16-2010. FILED 9-1-2009.
 3,783,983. **MOSES MIRACLE (BLOCK FORM).** MOSES MIRACLE, LLC, (U.S. CLS. 1, 5, 12, 13, 35 AND 50). SN 77-824,418. PUB. 2-16-2010. FILED 9-11-2009.
 3,784,171. **PURECORE (BLOCK FORM).** SEASE, R. GREGG, (U.S. CLS. 1, 5, 12, 13, 35 AND 50). SN 77-829,405. PUB. 2-16-2010. FILED 9-18-2009.
 3,784,798. **HEAT SAFE (BLOCK FORM).** AIRCRAFT RUBBER MANUFACTURING, INC, (U.S. CLS. 1, 5, 12, 13, 35 AND 50). SN 77-866,634. PUB. 2-16-2010. FILED 11-6-2009.
 3,784,922 (*See Class 9 for this trademark.*)
 3,784,929 (*See Class 6 for this trademark.*)
 3,784,938 (*See Class 1 for this trademark.*)
 3,785,008 (*See Class 7 for this trademark.*)
 3,785,048 (*See Class 12 for this trademark.*)

CLASS 18—LEATHER GOODS

- 3,783,084. **TUFFRIDER (BLOCK FORM).** JPC, MULTIPLE CLASS, (INT. CLS. 18 AND 25), (U.S. CLS. 1, 2, 3, 22, 39 AND 41). SN 76-603,456. PUB. 12-26-2006. FILED 7-22-2004.
 3,783,144. **AMAZONLIFE (STYLIZED).** AMAZONLIFE PRODUTOS E SERVICOS LTDA, (U.S. CLS. 1, 2, 3, 22 AND 41). SN 77-071,969. PUB. 7-29-2008. FILED 12-27-2006.
 3,783,190. **AUGUSTA JONES (BLOCK FORM).** AUGUSTA JONES LIMITED, MULTIPLE CLASS, (INT. CLS. 18, 25 AND 35), (U.S. CLS. 1, 2, 3, 22, 39, 41, 100, 101 AND 102). SN 77-361,205. PUB. 2-16-2010. FILED 12-28-2007.
 3,783,205. **WILDLAND (BLOCK FORM).** QINGWEN XU, (U.S. CLS. 1, 2, 3, 22 AND 41). SN 77-406,969. PUB. 2-16-2010. FILED 2-27-2008.
 3,783,207. **FRANCESCA V (STYLIZED).** VERSACE, FRANCESCA, MULTIPLE CLASS, (INT. CLS. 18, 24 AND 25), (U.S. CLS. 1, 2, 3, 22, 39, 41, 42 AND 50). SN 77-408,957. PUB. 6-9-2009. FILED 2-28-2008.
 3,783,331 (*See Class 12 for this trademark.*)
 3,783,369 (*See Class 6 for this trademark.*)
 3,783,448. **ARVICA (BLOCK FORM).** EDGYGEAR INC., (U.S. CLS. 1, 2, 3, 22 AND 41). SN 77-700,826. PUB. 2-16-2010. FILED 3-27-2009.
 3,783,575. **BRA-LICIOUS (BLOCK FORM).** CLAY, REBECCA E., DBA THE BRA-CKETBOOK FOUNDATION, (U.S. CLS. 1, 2, 3, 22 AND 41). SN 77-723,554. PUB. 2-16-2010. FILED 4-27-2009.
 3,783,762. **EMMA FOX (BLOCK FORM).** EMMA FOX LEATHERWARE, LLC, (U.S. CLS. 1, 2, 3, 22 AND 41). SN 77-797,310. PUB. 2-16-2010. FILED 8-5-2009.
 3,783,876 (*See Class 6 for this trademark.*)
 3,783,895. **FIGHT FACTORY (BLOCK FORM).** RULE 66, LLC, MULTIPLE CLASS, (INT. CLS. 18, 28 AND 35), (U.S. CLS. 1, 2, 3, 22, 23, 38, 41, 50, 100, 101 AND 102). SN 77-818,488. PUB. 2-16-2010. FILED 9-2-2009.
 3,783,936. **THE JEANS WHISPERER (BLOCK FORM).** JAN FORMAN, MULTIPLE CLASS, (INT. CLS. 18 AND 35), (U.S. CLS. 1, 2, 3, 22, 41, 100, 101 AND 102). SN 77-822,364. PUB. 2-16-2010. FILED 9-9-2009.
 3,783,966. **APHI (BLOCK FORM).** ALPHA PHI INTERNA-

TIONAL FRATERNITY, INCORPORATED, AKA ALPHA PHI SORORITY, (U.S. CLS. 1, 2, 3, 22 AND 41). SN 77-823,670. PUB. 2-16-2010. FILED 9-10-2009.

3,784,091 (*See Class 14 for this trademark.*).

3,784,117. **BF BATTLE FOAM AND DESIGN**. BATTLE FOAM, LLC, (U.S. CLS. 1, 2, 3, 22 AND 41). SN 77-828,397. PUB. 2-16-2010. FILED 9-17-2009.

3,784,118. **PERSONAL ARMY COMBAT KIT (BLOCK FORM)**. BATTLE FOAM, LLC, (U.S. CLS. 1, 2, 3, 22 AND 41). SN 77-828,409. PUB. 2-16-2010. FILED 9-17-2009.

3,784,120. **PROTECTING YOUR ARMY (BLOCK FORM)**. BATTLE FOAM, LLC, (U.S. CLS. 1, 2, 3, 22 AND 41). SN 77-828,417. PUB. 2-16-2010. FILED 9-17-2009.

3,784,688. **7CHI (BLOCK FORM)**. TRIPLE 7 GLOBAL, INC., (U.S. CLS. 1, 2, 3, 22 AND 41). SN 77-836,712. PUB. 2-16-2010. FILED 9-28-2009.

3,784,802 (*See Class 14 for this trademark.*).

3,784,855. **RACETIGER (BLOCK FORM)**. MARKER VÖLKL INTERNATIONAL GMBH, MULTIPLE CLASS, (INT. CLS. 18, 25 AND 28), (U.S. CLS. 1, 2, 3, 22, 23, 38, 39, 41 AND 50). SN 79-004,826. PUB. 4-4-2006. FILED 7-20-2004.

3,784,859 (*See Class 3 for this trademark.*).

3,784,869 (*See Class 3 for this trademark.*).

3,784,872 (*See Class 9 for this trademark.*).

3,784,877 (*See Class 3 for this trademark.*).

3,784,879 (*See Class 16 for this trademark.*).

3,784,896 (*See Class 3 for this trademark.*).

3,784,963 (*See Class 9 for this trademark.*).

3,784,972 (*See Class 3 for this trademark.*).

3,784,983 (*See Class 14 for this trademark.*).

3,785,011. **GOYARD (BLOCK FORM)**. GOYARD ST-HONORE, MULTIPLE CLASS, (INT. CLS. 18, 20, 21 AND 24), (U.S. CLS. 1, 2, 3, 13, 22, 23, 25, 29, 30, 32, 33, 40, 41, 42 AND 50). SN 79-070,786. PUB. 2-16-2010. FILED 4-7-2009.

3,785,031. **FERCHI (STYLIZED)**. MONZO ALBERT, RAFAEL, MULTIPLE CLASS, (INT. CLS. 18, 25 AND 39), (U.S. CLS. 1, 2, 3, 22, 39, 41, 100 AND 105). SN 79-073,175. PUB. 2-16-2010. FILED 7-27-2009.

3,785,043 (*See Class 12 for this trademark.*).

CLASS 19—NON-METALLIC BUILDING MATERIALS

3,783,146. **SONOCLIMAT (BLOCK FORM)**. MATÉRIAUX SPÉCIALISÉS LOUISEVILLE INC., MULTIPLE CLASS, (INT. CLS. 19 AND 20), (U.S. CLS. 1, 2, 12, 13, 22, 25, 32, 33 AND 50). SN 77-112,151. PUB. 2-16-2010. FILED 2-21-2007.

3,783,151. **PRO CHOICE (BLOCK FORM)**. SUNSET INDUSTRIES INC., (U.S. CLS. 1, 12, 33 AND 50). SN 77-148,552. PUB. 2-16-2010. FILED 4-4-2007.

3,783,157 (*See Class 6 for this trademark.*).

3,783,259 (*See Class 6 for this trademark.*).

3,783,293 (*See Class 17 for this trademark.*).

3,783,363 (*See Class 7 for this trademark.*).

3,783,499. **ROYAL DECK (BLOCK FORM)**. ROYAL GROUP, INC., (U.S. CLS. 1, 12, 33 AND 50). SN 77-706,245. PUB. 2-16-2010. FILED 4-3-2009.

3,783,628 (*See Class 11 for this trademark.*).

3,783,930. **COVER LOGIX (BLOCK FORM)**. PLASTIMAYD, LLC, AKA VYN-ALL POOL PRODUCTS, (U.S. CLS. 1, 12, 33 AND 50). SN 77-821,989. PUB. 2-16-2010. FILED 9-8-2009.

3,784,125 (*See Class 6 for this trademark.*).

3,784,356. **KOMPONENT (BLOCK FORM)**. PKL CORPORATION, (U.S. CLS. 1, 12, 33 AND 50). SN 77-831,947. PUB. 2-16-2010. FILED 9-22-2009.

3,784,388. **XERIPAVE (BLOCK FORM)**. XERIPAVE, LLC, (U.S. CLS. 1, 12, 33 AND 50). SN 77-832,317. PUB. 2-16-2010. FILED 9-22-2009.

3,784,408. **GOODWOOD FLOORING AND DESIGN**. GOODWOOD FLOORING, INC., (U.S. CLS. 1, 12, 33 AND 50). SN 77-832,616. PUB. 2-16-2010. FILED 9-22-2009.

3,784,411. **STARPPI (BLOCK FORM)**. STAR PLUMBING PRODUCTS, INC., (U.S. CLS. 1, 12, 33 AND 50). SN 77-832,636. PUB. 2-16-2010. FILED 9-22-2009.

3,784,680 (*See Class 6 for this trademark.*).

3,784,881 (*See Class 6 for this trademark.*).

3,784,901 (*See Class 6 for this trademark.*).

3,784,971. **FITOK AND DESIGN**. CONSORZIO SERVIZI LEGNO-SUGHERO, MULTIPLE CLASS, (INT. CLS. 19, 20, 22, 31, 37 AND 42), (U.S. CLS. 1, 2, 7, 12, 13, 19, 22, 25, 32, 33, 42, 46, 50, 100, 101, 103 AND 106). SN 79-068,211. PUB. 2-16-2010. FILED 11-12-2008.

3,785,002. **KAINDL NATURAL TOUCH (BLOCK FORM)**. KAINDL FLOORING GMBH, MULTIPLE CLASS, (INT. CLS. 19 AND 27), (U.S. CLS. 1, 12, 19, 20, 33, 37, 42 AND 50). SN 79-069,357. PUB. 2-16-2010. FILED 5-6-2009.

CLASS 20—FURNITURE AND ARTICLES NOT OTHERWISE CLASSIFIED

3,783,146 (*See Class 19 for this trademark.*).

3,783,251. **STUDIO SLEEPERS BY PRIMO INTERNATIONAL (BLOCK FORM)**. LITERIE PRIMO INC./PRIMO BEDDING COMPANY INC., (U.S. CLS. 2, 13, 22, 25, 32 AND 50). SN 77-521,242. PUB. 2-16-2010. FILED 7-14-2008.

3,783,356. **TEAM JACOB (BLOCK FORM)**. SUMMIT ENTERTAINMENT, LLC, (U.S. CLS. 2, 13, 22, 25, 32 AND 50). SN 77-671,090. PUB. 2-16-2010. FILED 2-16-2009.

3,783,369 (*See Class 6 for this trademark.*).

3,783,451 (*See Class 10 for this trademark.*).

3,783,574. **EZ DECORATING SOLUTIONS AND DESIGN**. DYNO SEASONAL SOLUTIONS, LLC, MULTIPLE CLASS, (INT. CLS. 20 AND 22), (U.S. CLS. 1, 2, 7, 13, 19, 22, 25, 32, 42 AND 50). SN 77-722,156. PUB. 2-16-2010. FILED 4-24-2009.

3,783,705. **POLLENEX (BLOCK FORM)**. CONAIR CORPORATION, (U.S. CLS. 2, 13, 22, 25, 32 AND 50). SN 77-778,694. PUB. 2-16-2010. FILED 7-10-2009.

3,783,737 (*See Class 7 for this trademark.*).

3,783,766. **THE MAN WALL (BLOCK FORM)**. VINCE CARUSO, MULTIPLE CLASS, (INT. CLS. 20, 40 AND 42), (U.S. CLS. 2, 13, 22, 25, 32, 50, 100, 101, 103 AND 106). SN 77-798,659. PUB. 2-16-2010. FILED 8-6-2009.

3,783,869. **PET-A-CARE CARD (BLOCK FORM)**. SPACIOUS SKIES LLC, (U.S. CLS. 2, 13, 22, 25, 32 AND 50). SN 77-815,644. PUB. 2-16-2010. FILED 8-28-2009.

3,783,876 (*See Class 6 for this trademark.*).

3,783,903. **VANITY LICENSE PLATE PET ID TAG (BLOCK FORM)**. SPACIOUS SKIES LLC, (U.S. CLS. 2, 13, 22, 25, 32 AND 50). SN 77-819,334. PUB. 2-16-2010. FILED 9-3-2009.

3,783,921. **TINY SLEEPER AND DESIGN**. TINY SLEEPER, LLC, (U.S. CLS. 2, 13, 22, 25, 32 AND 50). SN 77-821,152. PUB. 2-16-2010. FILED 9-6-2009.

3,784,053. **MISCELLANEOUS DESIGN**. TATSEY, RICHARD, (U.S. CLS. 2, 13, 22, 25, 32 AND 50). SN 77-826,526. PUB. 2-16-2010. FILED 9-15-2009.

3,784,075. **ENVELLOP (BLOCK FORM)**. PRAIRIE PACKAGING, INC., (U.S. CLS. 2, 13, 22, 25, 32 AND 50). SN 77-827,372. PUB. 2-16-2010. FILED 9-16-2009.

3,784,091 (*See Class 14 for this trademark.*).

3,784,094. **SORT A TOOL (BLOCK FORM)**. SORT A TOOL INC., (U.S. CLS. 2, 13, 22, 25, 32 AND 50). SN 77-827,742. PUB. 2-16-2010. FILED 9-16-2009.

3,784,237. **BEETLE JAIL (BLOCK FORM)**. MILLER, DAVID, DBA MILLERBEES MANUFACTURING, (U.S. CLS. 2, 13, 22, 25, 32 AND 50). SN 77-830,544. PUB. 2-16-2010. FILED 9-20-2009.

3,784,252. **GO & GROW CHAIR (BLOCK FORM)**. KRISTI G. COMPANY, (U.S. CLS. 2, 13, 22, 25, 32 AND 50). SN 77-830,682. PUB. 2-16-2010. FILED 9-21-2009.

3,784,401. **REST WELL SLEEP PRODUCTS FULFIL LIFE ENERGY AND DESIGN**. YANLORD INDUSTRY (THAILAND) CO., LTD, (U.S. CLS. 2, 13, 22, 25, 32 AND 50). SN 77-832,516. PUB. 2-16-2010. FILED 9-22-2009.

3,784,428. **MAXTRIX (BLOCK FORM)**. MAXWOOD FURNITURE, INC., (U.S. CLS. 2, 13, 22, 25, 32 AND 50). SN 77-832,832. PUB. 2-16-2010. FILED 9-23-2009.

3,784,510. **PERFAPACK (BLOCK FORM)**. DETOTEC NORTH AMERICA, INC., (U.S. CLS. 2, 13, 22, 25, 32 AND 50). SN 77-833,798. PUB. 2-16-2010. FILED 9-24-2009.

3,784,602. **DOCKING MADE EASY! (BLOCK FORM)**. BROWN LOAFERS SIZE 9, LLC, DBA FENDERRODS, (U.S. CLS. 2, 13, 22, 25, 32 AND 50). SN 77-835,035. PUB. 2-16-2010. FILED

- 9-25-2009.
 3,784,604. **FENDERRODS AND DESIGN**. BROWN LOAFERS SIZE 9, LLC, DBA FENDERRODS, (U.S. CLS. 2, 13, 22, 25, 32 AND 50). SN 77-835,045. PUB. 2-16-2010. FILED 9-25-2009.
 3,784,642. **ECO-ELEMENTS (BLOCK FORM)**. FETCO HOME DECOR, INC., (U.S. CLS. 2, 13, 22, 25, 32 AND 50). SN 77-835,599. PUB. 2-16-2010. FILED 9-25-2009.
 3,784,857. **THELIFESHOP AND DESIGN**. THE LIFE SHOP PTE LTD, MULTIPLE CLASS, (INT. CLS. 20 AND 24), (U.S. CLS. 2, 13, 22, 25, 32, 42 AND 50). SN 79-019,258. PUB. 2-16-2010. FILED 12-31-2004.
 3,784,869 (*See Class 3 for this trademark*).
 3,784,872 (*See Class 9 for this trademark*).
 3,784,971 (*See Class 19 for this trademark*).
 3,784,990. **CHIVAS REGAL BLENDED SCOTCH WHISKY AGED 12 YEARS PRODUCE OF SCOTLAND BLENDED AND BOTTLED IN SCOTLAND BY CHIVAS BROTHERS LTD AND DESIGN**. CHIVAS HOLDINGS (IP) LIMITED, MULTIPLE CLASS, (INT. CLS. 20 AND 33), (U.S. CLS. 2, 13, 22, 25, 32, 47, 49 AND 50). SN 79-068,688. PUB. 2-16-2010. FILED 3-6-2009.
 3,784,992 (*See Class 11 for this trademark*).
 3,785,010 (*See Class 6 for this trademark*).
 3,785,011 (*See Class 18 for this trademark*).

CLASS 21—HOUSEWARES AND GLASS

- 3,783,095. **CONCEPT INTERNATIONAL AND DESIGN**. CONCEPT INTERNATIONAL UK LIMITED, (U.S. CLS. 2, 13, 23, 29, 30, 33, 40 AND 50). SN 76-691,608. PUB. 2-16-2010. FILED 7-28-2008.
 3,783,100. **OCCUPI (BLOCK FORM)**. PETSTAGES, INC., DBA PETSTAGES, MULTIPLE CLASS, (INT. CLS. 21 AND 28), (U.S. CLS. 2, 13, 22, 23, 29, 30, 33, 38, 40 AND 50). SN 76-695,597. PUB. 2-16-2010. FILED 2-2-2009.
 3,783,166 (*See Class 1 for this trademark*).
 3,783,191 (*See Class 3 for this trademark*).
 3,783,233 (*See Class 17 for this trademark*).
 3,783,256 (*See Class 9 for this trademark*).
 3,783,261. **AQUA GLOBES AND DESIGN**. ALLSTAR MARKETING GROUP, LLC, (U.S. CLS. 2, 13, 23, 29, 30, 33, 40 AND 50). SN 77-536,504. PUB. 2-16-2010. FILED 7-31-2008.
 3,783,331 (*See Class 12 for this trademark*).
 3,783,363 (*See Class 7 for this trademark*).
 3,783,367. **CLARUS (BLOCK FORM)**. CLARUS MFG, (U.S. CLS. 2, 13, 23, 29, 30, 33, 40 AND 50). SN 77-678,880. PUB. 2-16-2010. FILED 2-26-2009.
 3,783,372. **URBAN CANTEEN (BLOCK FORM)**. URBAN CANTEEN LLC, (U.S. CLS. 2, 13, 23, 29, 30, 33, 40 AND 50). SN 77-680,787. PUB. 2-16-2010. FILED 2-28-2009.
 3,783,505. **CLEANPASTE (BLOCK FORM)**. JOHNSON & JOHNSON, (U.S. CLS. 2, 13, 23, 29, 30, 33, 40 AND 50). SN 77-708,613. PUB. 2-16-2010. FILED 4-7-2009.
 3,783,605 (*See Class 7 for this trademark*).
 3,783,676. **MISTYSTIX (BLOCK FORM)**. CHEMICAL ARTS INC, DBA CHEMICAL ARTS, (U.S. CLS. 2, 13, 23, 29, 30, 33, 40 AND 50). SN 77-768,792. PUB. 2-16-2010. FILED 6-26-2009.
 3,783,769. **AMMELOO (BLOCK FORM)**. AMMELON COOKWARE, CO., (U.S. CLS. 2, 13, 23, 29, 30, 33, 40 AND 50). SN 77-799,224. PUB. 2-16-2010. FILED 8-6-2009.
 3,783,876 (*See Class 6 for this trademark*).
 3,784,045. **APHI (BLOCK FORM)**. ALPHA PHI INTERNATIONAL FRATERNITY, INCORPORATED, AKA ALPHA PHI SORORITY, (U.S. CLS. 2, 13, 23, 29, 30, 33, 40 AND 50). SN 77-826,387. PUB. 2-16-2010. FILED 9-15-2009.
 3,784,091 (*See Class 14 for this trademark*).
 3,784,092. **CENTREX (BLOCK FORM)**. CENTREX PLASTICS, LLC, (U.S. CLS. 2, 13, 23, 29, 30, 33, 40 AND 50). SN 77-827,724. PUB. 2-16-2010. FILED 9-16-2009.
 3,784,161. **BENIHANA (BLOCK FORM)**. NOODLE TIME, INC., (U.S. CLS. 2, 13, 23, 29, 30, 33, 40 AND 50). SN 77-829,100. PUB. 2-16-2010. FILED 9-17-2009.
 3,784,458. **THERMOCERAMIC (BLOCK FORM)**. DENROY GROUP LIMITED, MULTIPLE CLASS, (INT. CLS. 21 AND 26), (U.S. CLS. 2, 13, 23, 29, 30, 33, 37, 39, 40, 42 AND 50). SN 77-833,190. PUB. 2-16-2010. FILED 9-23-2009.

- 3,784,475. **TOOL WIZARD (BLOCK FORM)**. BOEHRINGER MANUFACTURING CO., INC., DBA BARR BROTHERS CO., (U.S. CLS. 2, 13, 23, 29, 30, 33, 40 AND 50). SN 77-833,387. PUB. 2-16-2010. FILED 9-23-2009.
 3,784,525. **PARTY PLANK (BLOCK FORM)**. PARTY PLANK, LLC, (U.S. CLS. 2, 13, 23, 29, 30, 33, 40 AND 50). SN 77-833,963. PUB. 2-16-2010. FILED 9-24-2009.
 3,784,660. **ITEEZE (BLOCK FORM)**. RICHARD D MORRILL, (U.S. CLS. 2, 13, 23, 29, 30, 33, 40 AND 50). SN 77-835,844. PUB. 2-16-2010. FILED 9-27-2009.
 3,784,742 (*See Class 7 for this trademark*).
 3,784,759. **PERFECT TEAR (BLOCK FORM)**. LIFETIME BRANDS, INC., (U.S. CLS. 2, 13, 23, 29, 30, 33, 40 AND 50). SN 77-853,603. PUB. 2-16-2010. FILED 10-21-2009.
 3,784,869 (*See Class 3 for this trademark*).
 3,784,947. **INFINITE GLASS (STYLIZED)**. SGD S.A., (U.S. CLS. 2, 13, 23, 29, 30, 33, 40 AND 50). SN 79-067,417. PUB. 2-16-2010. FILED 2-27-2009.
 3,784,948. **VERRE INFINI AND DESIGN**. SGD S.A., (U.S. CLS. 2, 13, 23, 29, 30, 33, 40 AND 50). SN 79-067,419. PUB. 2-16-2010. FILED 2-27-2009.
 3,784,949. **VERRE INFINI (STYLIZED)**. SGD S.A., (U.S. CLS. 2, 13, 23, 29, 30, 33, 40 AND 50). SN 79-067,420. PUB. 2-16-2010. FILED 2-27-2009.
 3,784,965 (*See Class 9 for this trademark*).
 3,784,992 (*See Class 11 for this trademark*).
 3,785,011 (*See Class 18 for this trademark*).
 3,785,018 (*See Class 11 for this trademark*).

CLASS 22—CORDAGE AND FIBERS

- 3,783,574 (*See Class 20 for this trademark*).
 3,783,578. **GAMEDAY SAVER AND DESIGN**. GENERAL SPORTS VENUE, LLC, (U.S. CLS. 1, 2, 7, 19, 22, 42 AND 50). SN 77-725,314. PUB. 2-16-2010. FILED 4-29-2009.
 3,784,343. **GUST GUARD (BLOCK FORM)**. M. LAWRENCE PARKER, (U.S. CLS. 1, 2, 7, 19, 22, 42 AND 50). SN 77-831,777. PUB. 2-16-2010. FILED 9-22-2009.
 3,784,460. **JOOJE (BLOCK FORM)**. JOJO LLC, MULTIPLE CLASS, (INT. CLS. 22 AND 28), (U.S. CLS. 1, 2, 7, 19, 22, 23, 38, 42 AND 50). SN 77-833,249. PUB. 2-16-2010. FILED 9-23-2009.
 3,784,869 (*See Class 3 for this trademark*).
 3,784,896 (*See Class 3 for this trademark*).
 3,784,971 (*See Class 19 for this trademark*).
 3,784,997 (*See Class 16 for this trademark*).

CLASS 23—YARNS AND THREADS

- 3,783,141 (*See Class 14 for this trademark*).

CLASS 24—FABRICS

- 3,783,157 (*See Class 6 for this trademark*).
 3,783,207 (*See Class 18 for this trademark*).
 3,783,451 (*See Class 10 for this trademark*).
 3,783,857. **TREND GREEN AND DESIGN**. REID WITLIN LTD, DBA TREND GREEN, (U.S. CLS. 42 AND 50). SN 77-814,560. PUB. 2-16-2010. FILED 8-27-2009.
 3,784,079. **POWEL AND DESIGN**. MONTONE, PAUL, (U.S. CLS. 42 AND 50). SN 77-827,449. PUB. 2-16-2010. FILED 9-16-2009.
 3,784,091 (*See Class 14 for this trademark*).
 3,784,170. **SIMPLE DIY SOLUTIONS (BLOCK FORM)**. BONITA J YOUNG, DBA SIMPLE DIY SOLUTIONS, (U.S. CLS. 42 AND 50). SN 77-829,362. PUB. 2-16-2010. FILED 9-18-2009.
 3,784,219. **TUSHEE (BLOCK FORM)**. NYBLIN, ART, (U.S. CLS. 42 AND 50). SN 77-830,286. PUB. 2-16-2010. FILED 9-18-2009.
 3,784,431. **FACEPLANT (BLOCK FORM)**. FACEPLANT, INC., (U.S. CLS. 42 AND 50). SN 77-832,856. PUB. 2-16-2010.

- FILED 9-23-2009.
 3,784,459. **SLEIGH RIDE (BLOCK FORM)**. VICTOR J. MUR-AUSKOS, DBA SLEIGHRIDE, (U.S. CLS. 42 AND 50). SN 77-833,202. PUB. 2-16-2010. FILED 9-23-2009.
 3,784,766. **WORSTERLON (BLOCK FORM)**. MILLIKEN & COMPANY, (U.S. CLS. 42 AND 50). SN 77-856,189. PUB. 2-16-2010. FILED 10-23-2009.
 3,784,857 (*See Class 20 for this trademark*).
 3,784,869 (*See Class 3 for this trademark*).
 3,784,877 (*See Class 3 for this trademark*).
 3,784,879 (*See Class 16 for this trademark*).
 3,784,896 (*See Class 3 for this trademark*).
 3,784,980. **RAIN&WIND SYSTEM (BLOCK FORM)**. LORO PIANA S.P.A., MULTIPLE CLASS, (INT. CLS. 24 AND 25), (U.S. CLS. 22, 39, 42 AND 50). SN 79-068,345. PUB. 2-16-2010. FILED 3-11-2009.
 3,785,011 (*See Class 18 for this trademark*).
 3,785,026. **COPPANA AND DESIGN**. DAICHI ORIMONO CO., LTD., (U.S. CLS. 42 AND 50). SN 79-072,555. PUB. 2-16-2010. FILED 3-2-2009.

CLASS 25—CLOTHING

- 3,783,082. **FEMININE SECRET**. KAMTEX USA, INC., (U.S. CLS. 22 AND 39). SN 76-299,987. PUB. 2-16-2010. FILED 8-16-2001.
 3,783,084 (*See Class 18 for this trademark*).
 3,783,093. **O K A M O T O AND DESIGN**. OKAMOTO CORPORATION, (U.S. CLS. 22 AND 39). SN 76-688,858. PUB. 2-16-2010. FILED 4-21-2008.
 3,783,110. **KINGSTON UNITED (BLOCK FORM)**. UNITED LEGWEAR CO., L.L.C., (U.S. CLS. 22 AND 39). SN 76-697,132. PUB. 2-16-2010. FILED 4-29-2009.
 3,783,111. **GLAMOUR KILLS A CLOTHING COMPANY . GLAMOURKILLS.COM AND DESIGN**. GLAMOUR KILLS CLOTHING, LLC, (U.S. CLS. 22 AND 39). SN 76-697,140. PUB. 2-16-2010. FILED 4-29-2009.
 3,783,165. **WISH (STYLIZED)**. WISH ATLANTA, LLC, MULTIPLE CLASS, (INT. CLS. 25 AND 35), (U.S. CLS. 22, 39, 100, 101 AND 102). SN 77-184,250. PUB. 2-16-2010. FILED 5-18-2007.
 3,783,179. **CHERISA (BLOCK FORM)**. SHANE HUNTER, INC., (U.S. CLS. 22 AND 39). SN 77-299,329. PUB. 2-16-2010. FILED 10-9-2007.
 3,783,185. **ANTHONY MARTINI (BLOCK FORM)**. MARTINI, ANTHONY, (U.S. CLS. 22 AND 39). SN 77-334,844. PUB. 2-16-2010. FILED S.R. 11-21-2007; AM. P.R. 1-11-2010.
 3,783,190 (*See Class 18 for this trademark*).
 3,783,197. **LE GRAND MECHANT LOOK (BLOCK FORM)**. NAF NAF, (U.S. CLS. 22 AND 39). SN 77-392,988. PUB. 2-16-2010. FILED 2-8-2008.
 3,783,207 (*See Class 18 for this trademark*).
 3,783,220. **LIVING ROOM CLOTHING (BLOCK FORM)**. GARSON, MICHAEL K., (U.S. CLS. 22 AND 39). SN 77-446,853. PUB. 2-16-2010. FILED 4-13-2008.
 3,783,221. **SHOE ETI-KIT (BLOCK FORM)**. SHOE ETI-KIT, INC, (U.S. CLS. 22 AND 39). SN 77-451,438. PUB. 2-16-2010. FILED 4-17-2008.
 3,783,248. **EMU (BLOCK FORM)**. EMU RIDGE HOLDINGS PTY LTD AS TRUSTEE OF THE EMU RIDGE TRUST, (U.S. CLS. 22 AND 39). SN 77-517,493. PUB. 12-2-2008. FILED 7-8-2008.
 3,783,283. **SPECTACULAR ATTACKS (BLOCK FORM)**. DOBBIE, MUNGO, JOHN, DBA SPECTACULAR ATTACKS, MULTIPLE CLASS, (INT. CLS. 25 AND 41), (U.S. CLS. 22, 39, 100, 101 AND 107). SN 77-571,781. PUB. 2-16-2010. FILED 9-17-2008.
 3,783,284. **GP (STYLIZED)**. GENERAL PUBLIC LIMITED, (U.S. CLS. 22 AND 39). SN 77-576,238. PUB. 2-16-2010. FILED 9-23-2008.
 3,783,315. **DYNAMIC PLUS (BLOCK FORM)**. MIZUNO CORPORATION, (U.S. CLS. 22 AND 39). SN 77-632,871. PUB. 2-16-2010. FILED 12-15-2008.
 3,783,330 (*See Class 9 for this trademark*).
 3,783,331 (*See Class 12 for this trademark*).
 3,783,337. **G.G. PINK (BLOCK FORM)**. AVA DESIGN LLC, (U.S. CLS. 22 AND 39). SN 77-657,146. PUB. 2-16-2010. FILED 1-27-2009.
 3,783,369 (*See Class 6 for this trademark*).
 3,783,373. **TU TURTLE AND DESIGN**. CHON, HYUN-SOO S., DBA TURTLE, (U.S. CLS. 22 AND 39). SN 77-680,803. PUB. 2-16-2010. FILED 2-28-2009.
 3,783,379. **LIGHTNING GAVE THEM LIFE (BLOCK FORM)**. RIGHTEOUS KUNG FU, LLC, (U.S. CLS. 22 AND 39). SN 77-683,108. PUB. 2-16-2010. FILED 3-4-2009.
 3,783,386. **JARED . ALLEN . SIXTY . NINE INC. JA 69 AND DESIGN**. JARED ALLEN 69, LLC, (U.S. CLS. 22 AND 39). SN 77-685,816. PUB. 2-16-2010. FILED 3-6-2009.
 3,783,387. **1500 OR NOTHIN (BLOCK FORM)**. LARRANCE DOPSON, DBA LARRANCE DOPSON PRODUCTIONS, LLC, MULTIPLE CLASS, (INT. CLS. 25 AND 41), (U.S. CLS. 22, 39, 100, 101 AND 107). SN 77-686,093. PUB. 2-16-2010. FILED 3-8-2009.
 3,783,425. **IKON INK. AND DESIGN**. AVILA, CARLOS, (U.S. CLS. 22 AND 39). SN 77-697,248. PUB. 2-16-2010. FILED 3-23-2009.
 3,783,443. **G DIAPERS (BLOCK FORM)**. DOWN TO EARTH DESIGNS, INC., (U.S. CLS. 22 AND 39). SN 77-700,273. PUB. 2-16-2010. FILED 3-26-2009.
 3,783,444. **G (STYLIZED)**. DOWN TO EARTH DESIGNS, INC., (U.S. CLS. 22 AND 39). SN 77-700,292. PUB. 2-16-2010. FILED 3-26-2009.
 3,783,493. **MISCELLANEOUS DESIGN**. INSPIRED TECHNOLOGIES, INC., (U.S. CLS. 22 AND 39). SN 77-705,723. PUB. 2-16-2010. FILED 4-2-2009.
 3,783,576. **LULU AND LUSH (BLOCK FORM)**. FGM UK LTD, TA LULU AND LUSH, (U.S. CLS. 22 AND 39). SN 77-724,884. PUB. 2-16-2010. FILED 4-29-2009.
 3,783,577. **AMERICAN STEEL (BLOCK FORM)**. MOLLICONE, ANTHONY R., (U.S. CLS. 22 AND 39). SN 77-725,164. PUB. 2-16-2010. FILED 4-29-2009.
 3,783,639. **FOCUSFITWEAR AND DESIGN**. FOCUS FITWEAR, INC., (U.S. CLS. 22 AND 39). SN 77-759,088. PUB. 2-16-2010. FILED 6-13-2009.
 3,783,650. **RUEHL (BLOCK FORM)**. ABERCROMBIE & FITCH TRADING CO., (U.S. CLS. 22 AND 39). SN 77-761,575. PUB. 2-16-2010. FILED 6-17-2009.
 3,783,660. **CR CREAMY RACH (STYLIZED)**. AXCELLENT, INC., (U.S. CLS. 22 AND 39). SN 77-764,399. PUB. 2-16-2010. FILED 6-19-2009.
 3,783,665. **MISCELLANEOUS DESIGN**. LI & FUNG (B.V.I) LIMITED, (U.S. CLS. 22 AND 39). SN 77-765,030. PUB. 2-16-2010. FILED 6-22-2009.
 3,783,668. **E EXONERATED AND DESIGN**. EXONERATED, LLC, (U.S. CLS. 22 AND 39). SN 77-766,032. PUB. 2-16-2010. FILED 6-23-2009.
 3,783,672. **VICE REPUBLIC (BLOCK FORM)**. VIGO MAK, (U.S. CLS. 22 AND 39). SN 77-767,765. PUB. 2-16-2010. FILED 6-25-2009.
 3,783,679. **NOGINZ HEAD WEAR AND DESIGN**. DICKERSON, SANDRA K, DBA NOGINZ HEAD WEAR, (U.S. CLS. 22 AND 39). SN 77-769,793. PUB. 2-16-2010. FILED S.R. 6-28-2009; AM. P.R. 1-6-2010.
 3,783,707. **YXXX AND DESIGN**. C I PRENDACOL S.A., (U.S. CLS. 22 AND 39). SN 77-779,115. PUB. 2-16-2010. FILED 7-12-2009.
 3,783,708. **6.8 AND DESIGN**. BOGARI HOLDINGS, INC., (U.S. CLS. 22 AND 39). SN 77-779,334. PUB. 2-16-2010. FILED 7-13-2009.
 3,783,711. **SEX FOOD ROCK & ROLL (BLOCK FORM)**. BELLINO, GIOVANNINA JENNIFER, (U.S. CLS. 22 AND 39). SN 77-781,884. PUB. 2-16-2010. FILED 7-15-2009.
 3,783,717. **WIN SOME, BRUISE SOME. (BLOCK FORM)**. OBJECTS & IMAGES, INC., (U.S. CLS. 22 AND 39). SN 77-784,607. PUB. 2-16-2010. FILED 7-20-2009.
 3,783,741. **THE GOOD DOG COMPANY AND DESIGN**. JOHN P. DAVEY III, DBA THE GOOD DOG COMPANY, (U.S. CLS. 22 AND 39). SN 77-793,618. PUB. 2-16-2010. FILED 7-30-2009.
 3,783,768. **HANIA BY ANYA COLE (BLOCK FORM)**. HANIA BY ANYA COLE, L.L.C., (U.S. CLS. 22 AND 39). SN 77-798,979. PUB. 2-16-2010. FILED 8-6-2009.
 3,783,773. **TANZE (STYLIZED)**. BRIDGETT, TANZANIA, (U.S. CLS. 22 AND 39). SN 77-799,882. PUB. 2-16-2010.

- FILED 8-7-2009.
- 3,783,780. **SMARTFIT (BLOCK FORM)**. ARIZONA MAIL ORDER COMPANY, INC., (U.S. CLS. 22 AND 39). SN 77-801,841. PUB. 2-16-2010. FILED 8-11-2009.
- 3,783,807. **WILLOW & CLAY (STYLIZED)**. COMPLETE CLOTHING COMPANY, (U.S. CLS. 22 AND 39). SN 77-806,528. PUB. 1-12-2010. FILED 8-17-2009.
- 3,783,817. **THE MAN CAVE AND CIGAR SHOP AND DESIGN**. HEARTSTONE MERCANTILE LLC, MULTIPLE CLASS, (INT. CLS. 25 AND 35), (U.S. CLS. 22, 39, 100, 101 AND 102). SN 77-807,955. PUB. 2-16-2010. FILED 8-19-2009.
- 3,783,821. **NATURAL REFLECTIONS (BLOCK FORM)**. BASS PRO INTELLECTUAL PROPERTY, L.L.C., (U.S. CLS. 22 AND 39). SN 77-809,209. PUB. 2-16-2010. FILED 8-20-2009.
- 3,783,846 (*See Class 16 for this trademark*).
- 3,783,863. **ANNIE FINK DESIGNS (BLOCK FORM)**. ANNIE FINK DESIGNS, LLC, (U.S. CLS. 22 AND 39). SN 77-815,046. PUB. 2-16-2010. FILED 8-28-2009.
- 3,783,868. **COLLEGE OF CHARLESTON COUGARS AND DESIGN**. COLLEGE OF CHARLESTON, MULTIPLE CLASS, (INT. CLS. 25 AND 28), (U.S. CLS. 22, 23, 38, 39 AND 50). SN 77-815,542. PUB. 2-16-2010. FILED 8-28-2009.
- 3,783,876 (*See Class 6 for this trademark*).
- 3,783,910. **BG THE AUTHENTIC SHIRT MAKER AND DESIGN**. TARDIEU GROUP, INC., (U.S. CLS. 22 AND 39). SN 77-820,203. PUB. 2-16-2010. FILED 9-4-2009.
- 3,783,967. **APHI (BLOCK FORM)**. ALPHA PHI INTERNATIONAL FRATERNITY, INCORPORATED, AKA ALPHA PHI SORORITY, (U.S. CLS. 22 AND 39). SN 77-823,672. PUB. 2-16-2010. FILED 9-10-2009.
- 3,783,988. **MISCELLANEOUS DESIGN**. MOREHOUSE JR., DONALD, (U.S. CLS. 22 AND 39). SN 77-824,548. PUB. 2-16-2010. FILED 9-11-2009.
- 3,784,019. **CULTURE JEANS 6 AND DESIGN**. PACIFIC JEANSWEAR, INC., (U.S. CLS. 22 AND 39). SN 77-825,769. PUB. 2-16-2010. FILED 9-14-2009.
- 3,784,030. **BONTRAGER (BLOCK FORM)**. TREK BICYCLE CORPORATION, (U.S. CLS. 22 AND 39). SN 77-826,018. PUB. 2-16-2010. FILED 9-14-2009.
- 3,784,039. **HIGH LIMIT CLOTHING COMPANY EST.1983 AND DESIGN**. GARCIA, MICHAEL, (U.S. CLS. 22 AND 39). SN 77-826,284. PUB. 2-16-2010. FILED 9-14-2009.
- 3,784,082. **AMERICAN MINIATURE ZEBU ASSOCIATION AMZA AND DESIGN**. AMERICAN MINIATURE ZEBU ASSOCIATION INC., (U.S. CLS. 22 AND 39). SN 77-827,557. PUB. 2-16-2010. FILED 9-16-2009.
- 3,784,091 (*See Class 14 for this trademark*).
- 3,784,156. **SOFT SENSATIONS (BLOCK FORM)**. SHOPKO STORES OPERATING CO., LLC, (U.S. CLS. 22 AND 39). SN 77-828,990. PUB. 2-16-2010. FILED 9-17-2009.
- 3,784,165. **LADY LUX (BLOCK FORM)**. LADY LUX SWIMWEAR CORPORATION, (U.S. CLS. 22 AND 39). SN 77-829,222. PUB. 2-16-2010. FILED 9-17-2009.
- 3,784,172. **TOUCH DOWN (BLOCK FORM)**. TNT APPAREL, INC., (U.S. CLS. 22 AND 39). SN 77-829,418. PUB. 2-16-2010. FILED 9-18-2009.
- 3,784,187. **SHINE WITH HIM AND DESIGN**. SHINE WITH HIM, (U.S. CLS. 22 AND 39). SN 77-829,682. PUB. 2-16-2010. FILED 9-18-2009.
- 3,784,195. **UNDONE... (STYLIZED)**. RAMSEY, NATHAN M., (U.S. CLS. 22 AND 39). SN 77-829,834. PUB. 2-16-2010. FILED 9-18-2009.
- 3,784,233. **ASH FOX (BLOCK FORM)**. THE ASH FOX GROUP LLC, (U.S. CLS. 22 AND 39). SN 77-830,464. PUB. 2-16-2010. FILED 9-19-2009.
- 3,784,249. **FLOW FOR LOVE OF THE WORLD (BLOCK FORM)**. FLOW APPAREL, LLC, (U.S. CLS. 22 AND 39). SN 77-830,616. PUB. 2-16-2010. FILED 9-20-2009.
- 3,784,270. **CAMO YOUR ART (BLOCK FORM)**. INK ARMOR, LLC, (U.S. CLS. 22 AND 39). SN 77-830,894. PUB. 2-16-2010. FILED 9-21-2009.
- 3,784,295. **WINE-EE WOMEN (BLOCK FORM)**. THE WINERY AT WILCOX, INC., MULTIPLE CLASS, (INT. CLS. 25 AND 41), (U.S. CLS. 22, 39, 100, 101 AND 107). SN 77-831,172. PUB. 2-16-2010. FILED 9-21-2009.
- 3,784,299. **WINE-EE WOMEN AND DESIGN**. THE WINERY AT WILCOX, INC., MULTIPLE CLASS, (INT. CLS. 25 AND 41), (U.S. CLS. 22, 39, 100, 101 AND 107). SN 77-831,200. PUB. 2-16-2010. FILED 9-21-2009.
- 3,784,352. **COLLEGIATE FASHIONISTA (BLOCK FORM)**. DIANE DAL LAGO LTD, MULTIPLE CLASS, (INT. CLS. 25 AND 35), (U.S. CLS. 22, 39, 100, 101 AND 102). SN 77-831,925. PUB. 2-16-2010. FILED 9-22-2009.
- 3,784,368. **TONEKA (STYLIZED)**. MILIDAK USA INC., DBA TONEKA, (U.S. CLS. 22 AND 39). SN 77-832,160. PUB. 2-16-2010. FILED 9-22-2009.
- 3,784,378. **ART BROKEN AND DESIGN**. DOELL, ADRIAN, (U.S. CLS. 22 AND 39). SN 77-832,242. PUB. 2-16-2010. FILED 9-22-2009.
- 3,784,393. **2 STROKE SMOKE (BLOCK FORM)**. JEREMY HILMO, (U.S. CLS. 22 AND 39). SN 77-832,391. PUB. 2-16-2010. FILED 9-22-2009.
- 3,784,402. **RANDORI (BLOCK FORM)**. VULKAN FIGHT COMPANY CONFECÇÕES LTDA, (U.S. CLS. 22 AND 39). SN 77-832,531. PUB. 2-16-2010. FILED 9-22-2009.
- 3,784,412. **CONCRETE ROOTS QUEST FOR ONENESS (BLOCK FORM)**. JONES, JORGE B, (U.S. CLS. 22 AND 39). SN 77-832,646. PUB. 2-16-2010. FILED 9-22-2009.
- 3,784,429. **SPRINKLES (BLOCK FORM)**. SUNSETS, INC., (U.S. CLS. 22 AND 39). SN 77-832,835. PUB. 2-16-2010. FILED 9-23-2009.
- 3,784,440. **FRIGGINRIGGIN (BLOCK FORM)**. FRIGGINRIGGIN, (U.S. CLS. 22 AND 39). SN 77-832,987. PUB. 2-16-2010. FILED 9-23-2009.
- 3,784,451. **574 (BLOCK FORM)**. NEW BALANCE ATHLETIC SHOE, INC., (U.S. CLS. 22 AND 39). SN 77-833,159. PUB. 2-16-2010. FILED 9-23-2009.
- 3,784,465. **WHAT IS YOUR ?ORN (STYLIZED)**. SZWED, JASON, (U.S. CLS. 22 AND 39). SN 77-833,285. PUB. 2-16-2010. FILED 9-23-2009.
- 3,784,485. **CHARMMIS.COM (BLOCK FORM)**. ANNE WON LEE, (U.S. CLS. 22 AND 39). SN 77-833,506. PUB. 2-16-2010. FILED 9-23-2009.
- 3,784,536. **MOBILITY AND DESIGN**. NINA FOOTWEAR CORP., (U.S. CLS. 22 AND 39). SN 77-834,087. PUB. 2-16-2010. FILED 9-24-2009.
- 3,784,561 (*See Class 16 for this trademark*).
- 3,784,580. **DON'T WORRY, BE BUNNY (BLOCK FORM)**. KOZLOVA, OLGA, (U.S. CLS. 22 AND 39). SN 77-834,673. PUB. 2-16-2010. FILED 9-25-2009.
- 3,784,584. **MISCELLANEOUS DESIGN**. CHARACTER BEE, LLC, (U.S. CLS. 22 AND 39). SN 77-834,764. PUB. 2-16-2010. FILED 9-25-2009.
- 3,784,612. **MOTOTAINMENT (BLOCK FORM)**. MONTGOMERY MOTOR SPORTS, INC., (U.S. CLS. 22 AND 39). SN 77-835,178. PUB. 2-16-2010. FILED 9-25-2009.
- 3,784,613. **ULTRAVIOLENT (BLOCK FORM)**. EVANS, CHRIS, (U.S. CLS. 22 AND 39). SN 77-835,208. PUB. 2-16-2010. FILED 9-25-2009.
- 3,784,644. **HINDSIGHT U (STYLIZED)**. WOMACK, RICHARD, AND WOMACK, MICKEY, (U.S. CLS. 22 AND 39). SN 77-835,643. PUB. 2-16-2010. FILED 9-25-2009.
- 3,784,653. **500 LUX (BLOCK FORM)**. 500 LUX LLC, DBA 500 LUX, (U.S. CLS. 22 AND 39). SN 77-835,747. PUB. 2-16-2010. FILED 9-26-2009.
- 3,784,662. **CLEAVA (BLOCK FORM)**. DE SOUSA MICHELLE ELIZABETH, (U.S. CLS. 22 AND 39). SN 77-835,919. PUB. 2-16-2010. FILED 9-27-2009.
- 3,784,664. **EROJICA (BLOCK FORM)**. SALLY, MARTINA, (U.S. CLS. 22 AND 39). SN 77-835,945. PUB. 2-16-2010. FILED 9-27-2009.
- 3,784,669. **TOLEDO WALLEYE AND DESIGN**. TOLEDO ARENA SPORTS INC., DBA TOLEDO WALLEY CORPORATION, MULTIPLE CLASS, (INT. CLS. 25 AND 41), (U.S. CLS. 22, 39, 100, 101 AND 107). SN 77-836,197. PUB. 2-16-2010. FILED 9-28-2009.
- 3,784,671. **BONNEVILLE RACER (BLOCK FORM)**. LANDSPEED UNLIMITED, (U.S. CLS. 22 AND 39). SN 77-836,323. PUB. 2-16-2010. FILED 9-28-2009.
- 3,784,687. **ANNTE AND DESIGN**. ANNTE SHOES INC., (U.S. CLS. 22 AND 39). SN 77-836,654. PUB. 2-16-2010. FILED 9-28-2009.
- 3,784,694. **MISCELLANEOUS DESIGN**. FUJIAN QUANZHOU PEAK SPORTS PRODUCTS CO., LTD., (U.S. CLS. 22 AND 39). SN 77-836,758. PUB. 2-16-2010. FILED 9-28-2009.
- 3,784,696. **VANISHING EDGE (BLOCK FORM)**. CHICO'S

BRANDS INVESTMENTS, INC., (U.S. CLS. 22 AND 39). SN 77-836,890. PUB. 2-16-2010. FILED 9-29-2009.

3,784,726. **NSFW NOT SAFE FOR WORK (BLOCK FORM)**. VISIONEERING MARKETING LLC, (U.S. CLS. 22 AND 39). SN 77-842,944. PUB. 2-16-2010. FILED 10-6-2009.

3,784,733. **SNUGARS (BLOCK FORM)**. GARLANDS OF GRACE, (U.S. CLS. 22 AND 39). SN 77-844,914. PUB. 2-16-2010. FILED 10-8-2009.

3,784,751. **PLAYERS CHOICE SIGNATURE SERIES (BLOCK FORM)**. MAJOR LEAGUE BASEBALL PLAYERS ASSOCIATION, (U.S. CLS. 22 AND 39). SN 77-850,687. PUB. 2-16-2010. FILED 10-16-2009.

3,784,753. **SLEEPY DOLL (BLOCK FORM)**. MAX FASHION GROUP, CORP., (U.S. CLS. 22 AND 39). SN 77-851,476. PUB. 2-16-2010. FILED 10-19-2009.

3,784,764. **HOOP PLANET (BLOCK FORM)**. HOOP PLANET, (U.S. CLS. 22 AND 39). SN 77-855,611. PUB. 2-16-2010. FILED 10-23-2009.

3,784,792. **A AND DESIGN**. AFFLICTION HOLDINGS LLC, (U.S. CLS. 22 AND 39). SN 77-863,909. PUB. 2-16-2010. FILED 11-3-2009.

3,784,795. **A (STYLIZED)**. AFFLICTION HOLDINGS LLC, (U.S. CLS. 22 AND 39). SN 77-864,920. PUB. 2-16-2010. FILED 11-4-2009.

3,784,818 (*See Class 16 for this trademark*).

3,784,819. **BACKSWING (BLOCK FORM)**. PRIMARK HOLDINGS, (U.S. CLS. 22 AND 39). SN 77-979,168. PUB. 9-1-2009. FILED 1-23-2008.

3,784,834 (*See Class 9 for this trademark*).

3,784,855 (*See Class 18 for this trademark*).

3,784,856 (*See Class 3 for this trademark*).

3,784,869 (*See Class 3 for this trademark*).

3,784,877 (*See Class 3 for this trademark*).

3,784,879 (*See Class 16 for this trademark*).

3,784,883 (*See Class 16 for this trademark*).

3,784,884 (*See Class 5 for this trademark*).

3,784,896 (*See Class 3 for this trademark*).

3,784,915 (*See Class 9 for this trademark*).

3,784,925 (*See Class 12 for this trademark*).

3,784,960. **EQUUMEN AND DESIGN**. EQUUMEN PTY LTD., (U.S. CLS. 22 AND 39). SN 79-067,909. PUB. 2-16-2010. FILED 3-18-2009.

3,784,972 (*See Class 3 for this trademark*).

3,784,980 (*See Class 24 for this trademark*).

3,784,983 (*See Class 14 for this trademark*).

3,784,993 (*See Class 9 for this trademark*).

3,785,001. **MISCELLANEOUS DESIGN**. LOTTE CO., LTD., MULTIPLE CLASS, (INT. CLS. 25 AND 28), (U.S. CLS. 22, 23, 38, 39 AND 50). SN 79-069,325. PUB. 2-16-2010. FILED 4-9-2009.

3,785,020. **ASTRID POPKEN (BLOCK FORM)**. ULLA POPKEN GMBH, (U.S. CLS. 22 AND 39). SN 79-071,442. PUB. 2-16-2010. FILED 4-16-2009.

3,785,031 (*See Class 18 for this trademark*).

3,785,040. **MISCELLANEOUS DESIGN**. YOOX SPA, (U.S. CLS. 22 AND 39). SN 79-073,930. PUB. 2-16-2010. FILED 6-29-2009.

3,785,041. **THECORNER.COM (STYLIZED)**. YOOX SPA, (U.S. CLS. 22 AND 39). SN 79-073,931. PUB. 2-16-2010. FILED 6-29-2009.

3,785,043 (*See Class 12 for this trademark*).

3,785,045. **LE TOFFOLE (STYLIZED)**. REGINA REGIS S.R.L., (U.S. CLS. 22 AND 39). SN 79-074,460. PUB. 2-16-2010. FILED 9-11-2009.

CLASS 26—FANCY GOODS

3,783,141 (*See Class 14 for this trademark*).

3,783,331 (*See Class 12 for this trademark*).

3,783,369 (*See Class 6 for this trademark*).

3,783,666. **WEAR HIGH HEELS THIS MORNING AND SANDALS TONIGHT ... WITH HEM-EZE (STYLIZED)**. DEBRA WEISSER, (U.S. CLS. 37, 39, 40, 42 AND 50). SN 77-765,971. PUB. 2-16-2010. FILED 6-23-2009.

3,784,091 (*See Class 14 for this trademark*).

3,784,136. **QUICKLON (STYLIZED)**. YKK CORPORATION,

(U.S. CLS. 37, 39, 40, 42 AND 50). SN 77-828,640. PUB. 2-16-2010. FILED 9-17-2009.

3,784,215. **LOX-EZE (BLOCK FORM)**. NONA BRITTON, (U.S. CLS. 37, 39, 40, 42 AND 50). SN 77-830,183. PUB. 2-16-2010. FILED 9-18-2009.

3,784,458 (*See Class 21 for this trademark*).

3,784,568. **BY LILLA AND DESIGN**. BY LILLA LLC, (U.S. CLS. 37, 39, 40, 42 AND 50). SN 77-834,528. PUB. 2-16-2010. FILED 9-24-2009.

3,784,780. **MISCELLANEOUS DESIGN**. CHROME HEARTS LLC, (U.S. CLS. 37, 39, 40, 42 AND 50). SN 77-860,520. PUB. 2-16-2010. FILED 10-29-2009.

3,784,781. **MISCELLANEOUS DESIGN**. CHROME HEARTS LLC, (U.S. CLS. 37, 39, 40, 42 AND 50). SN 77-860,528. PUB. 2-16-2010. FILED 10-29-2009.

3,784,782. **MISCELLANEOUS DESIGN**. CHROME HEARTS LLC, (U.S. CLS. 37, 39, 40, 42 AND 50). SN 77-860,552. PUB. 2-16-2010. FILED 10-29-2009.

3,784,783. **MISCELLANEOUS DESIGN**. CHROME HEARTS LLC, (U.S. CLS. 37, 39, 40, 42 AND 50). SN 77-860,722. PUB. 2-16-2010. FILED 10-29-2009.

3,784,784. **MISCELLANEOUS DESIGN**. CHROME HEARTS LLC, (U.S. CLS. 37, 39, 40, 42 AND 50). SN 77-860,728. PUB. 2-16-2010. FILED 10-29-2009.

3,784,785. **MISCELLANEOUS DESIGN**. CHROME HEARTS LLC, (U.S. CLS. 37, 39, 40, 42 AND 50). SN 77-860,732. PUB. 2-16-2010. FILED 10-29-2009.

3,784,786. **MISCELLANEOUS DESIGN**. CHROME HEARTS LLC, (U.S. CLS. 37, 39, 40, 42 AND 50). SN 77-860,741. PUB. 2-16-2010. FILED 10-29-2009.

3,784,865 (*See Class 3 for this trademark*).

CLASS 27—FLOOR COVERINGS

3,783,569. **INFEEL (STYLIZED)**. INFEEL USA CORP., (U.S. CLS. 19, 20, 37, 42 AND 50). SN 77-720,471. PUB. 2-16-2010. FILED 4-23-2009.

3,784,879 (*See Class 16 for this trademark*).

3,785,002 (*See Class 19 for this trademark*).

CLASS 28—TOYS AND SPORTING GOODS

3,783,083 (*See Class 14 for this trademark*).

3,783,100 (*See Class 21 for this trademark*).

3,783,109. **AIRBORNE ATHLETICS, INC. AND DESIGN**. AIRBORNE ATHLETICS, INC., (U.S. CLS. 22, 23, 38 AND 50). SN 76-697,099. PUB. 2-16-2010. FILED 4-27-2009.

3,783,143. **REFLEX (BLOCK FORM)**. SPIN MASTER LTD., (U.S. CLS. 22, 23, 38 AND 50). SN 77-067,048. PUB. 2-16-2010. FILED 12-19-2006.

3,783,171 (*See Class 9 for this trademark*).

3,783,176. **PROTO (BLOCK FORM)**. DYE PRECISION, INC., (U.S. CLS. 22, 23, 38 AND 50). SN 77-281,453. PUB. 2-16-2010. FILED 9-17-2007.

3,783,242 (*See Class 3 for this trademark*).

3,783,254 (*See Class 7 for this trademark*).

3,783,270 (*See Class 3 for this trademark*).

3,783,297 (*See Class 6 for this trademark*).

3,783,324. **MISCELLANEOUS DESIGN**. NAUTILUS, INC., (U.S. CLS. 22, 23, 38 AND 50). SN 77-644,102. PUB. 2-16-2010. FILED 1-6-2009.

3,783,355. **WACKEM CRAZY BAIT (BLOCK FORM)**. STEVEN SCOTT PLEDGER, DBA WACKEM CRAZY BAIT, (U.S. CLS. 22, 23, 38 AND 50). SN 77-671,038. PUB. 2-16-2010. FILED 2-15-2009.

3,783,395 (*See Class 8 for this trademark*).

3,783,421. **BLADEMILL (STYLIZED)**. EAMATECH CANADA INC., (U.S. CLS. 22, 23, 38 AND 50). SN 77-695,741. PUB. 2-16-2010. FILED 3-20-2009.

3,783,615. **XBOARD ILLUMINATORS (BLOCK FORM)**. HOLDING PATTERN PRODCUTS LLC, (U.S. CLS. 22, 23, 38 AND 50). SN 77-751,070. PUB. 2-16-2010. FILED 6-3-2009.

3,783,675. **MISS BACHELORETTE'S (BLOCK FORM)**. LIT-

TLE GENIE PRODUCTIONS, LLC, (U.S. CLS. 22, 23, 38 AND 50). SN 77-768,741. PUB. 2-16-2010. FILED 6-25-2009.

3,783,712. **MY AND DESIGN**. MYSURF, INC., (U.S. CLS. 22, 23, 38 AND 50). SN 77-782,102. PUB. 2-16-2010. FILED 7-15-2009.

3,783,846 (*See Class 16 for this trademark*).

3,783,864. **DURA DOGGIE (BLOCK FORM)**. DURABLE IDEAS LLC, (U.S. CLS. 22, 23, 38 AND 50). SN 77-815,094. PUB. 2-16-2010. FILED 8-28-2009.

3,783,868 (*See Class 25 for this trademark*).

3,783,876 (*See Class 6 for this trademark*).

3,783,895 (*See Class 18 for this trademark*).

3,783,957. **CATCH MY DRIFT???** (BLOCK FORM). SLANGUAGE GAMEZ, (U.S. CLS. 22, 23, 38 AND 50). SN 77-823,471. PUB. 2-16-2010. FILED 9-10-2009.

3,784,061. **DRAG-N-BAIT (BLOCK FORM)**. KILLER BEE INC., (U.S. CLS. 22, 23, 38 AND 50). SN 77-826,926. PUB. 2-16-2010. FILED 9-15-2009.

3,784,103 (*See Class 16 for this trademark*).

3,784,240. **MARSHMALLOW BOW & MALLOW (BLOCK FORM)**. MARSHMALLOW FUN COMPANY, LLC, (U.S. CLS. 22, 23, 38 AND 50). SN 77-830,568. PUB. 2-16-2010. FILED 9-20-2009.

3,784,242. **MARSHMALLOW MAZOOKA (BLOCK FORM)**. MARSHMALLOW FUN COMPANY, LLC, (U.S. CLS. 22, 23, 38 AND 50). SN 77-830,571. PUB. 2-16-2010. FILED 9-20-2009.

3,784,243. **MARSHMALLOW STRYKER (BLOCK FORM)**. MARSHMALLOW FUN COMPANY, LLC, (U.S. CLS. 22, 23, 38 AND 50). SN 77-830,572. PUB. 2-16-2010. FILED 9-20-2009.

3,784,271. **ROCK DANCER (BLOCK FORM)**. MACK'S LURE, INC, (U.S. CLS. 22, 23, 38 AND 50). SN 77-830,895. PUB. 2-16-2010. FILED 9-21-2009.

3,784,273. **SLEDGE HAMMER (BLOCK FORM)**. MACK'S LURE, INC, (U.S. CLS. 22, 23, 38 AND 50). SN 77-830,919. PUB. 2-16-2010. FILED 9-21-2009.

3,784,359. **LMN-TOSS JR. (BLOCK FORM)**. BEN-BASSAT, JACKY, (U.S. CLS. 22, 23, 38 AND 50). SN 77-831,963. PUB. 2-16-2010. FILED 9-22-2009.

3,784,360. **ROBERTS (BLOCK FORM)**. ROBERT'S SURF-BOARDS, INC., (U.S. CLS. 22, 23, 38 AND 50). SN 77-831,965. PUB. 2-16-2010. FILED 9-22-2009.

3,784,416. **MY STAR REWARDS (BLOCK FORM)**. ADAM CORNELIUS KING, (U.S. CLS. 22, 23, 38 AND 50). SN 77-832,669. PUB. 2-16-2010. FILED 9-23-2009.

3,784,460 (*See Class 22 for this trademark*).

3,784,483. **SUPERWOMAN (BLOCK FORM)**. DC COMICS, (U.S. CLS. 22, 23, 38 AND 50). SN 77-833,501. PUB. 2-16-2010. FILED 9-23-2009.

3,784,487. **BLACK CANARY (BLOCK FORM)**. DC COMICS, (U.S. CLS. 22, 23, 38 AND 50). SN 77-833,516. PUB. 2-16-2010. FILED 9-23-2009.

3,784,515. **ROAD WAR (BLOCK FORM)**. MEARTHANE PRODUCTS CORPORATION, (U.S. CLS. 22, 23, 38 AND 50). SN 77-833,835. PUB. 2-16-2010. FILED 9-24-2009.

3,784,561 (*See Class 16 for this trademark*).

3,784,611. **DARDA (BLOCK FORM)**. WM K. WALTHERS, INC., (U.S. CLS. 22, 23, 38 AND 50). SN 77-835,164. PUB. 2-16-2010. FILED 9-25-2009.

3,784,634. **DIVAGIRL (BLOCK FORM)**. DIVAGIRL, LLC, (U.S. CLS. 22, 23, 38 AND 50). SN 77-835,490. PUB. 2-16-2010. FILED 9-25-2009.

3,784,663. **I CAN DO THAT! GAMES AND DESIGN**. THE WONDER FORGE, LLC, (U.S. CLS. 22, 23, 38 AND 50). SN 77-835,928. PUB. 2-16-2010. FILED 9-27-2009.

3,784,698. **MARSHMALLOW MFORCER (BLOCK FORM)**. MARSHMALLOW FUN COMPANY, LLC, (U.S. CLS. 22, 23, 38 AND 50). SN 77-837,965. PUB. 2-16-2010. FILED 9-30-2009.

3,784,699. **GIGA (BLOCK FORM)**. ELAUT USA, INC., (U.S. CLS. 22, 23, 38 AND 50). SN 77-837,976. PUB. 2-16-2010. FILED 9-30-2009.

3,784,722. **BUSTER BLACKJACK (BLOCK FORM)**. BETWISER GAMES, LLC, (U.S. CLS. 22, 23, 38 AND 50). SN 77-841,733. PUB. 2-16-2010. FILED 10-5-2009.

3,784,739. **EYE FOUND IT! (BLOCK FORM)**. THE WONDER FORGE, LLC, (U.S. CLS. 22, 23, 38 AND 50). SN 77-846,116.

PUB. 2-16-2010. FILED 10-10-2009.

3,784,790. **MISCELLANEOUS DESIGN**. ELAUT USA, INC., (U.S. CLS. 22, 23, 38 AND 50). SN 77-862,715. PUB. 2-16-2010. FILED 11-2-2009.

3,784,834 (*See Class 9 for this trademark*).

3,784,836 (*See Class 9 for this trademark*).

3,784,842. **FROM THE GECKO (BLOCK FORM)**. BARKING PENGUINS, LLC, (U.S. CLS. 22, 23, 38 AND 50). SN 78-818,325. PUB. 4-24-2007. FILED 2-18-2006.

3,784,855 (*See Class 18 for this trademark*).

3,784,869 (*See Class 3 for this trademark*).

3,784,872 (*See Class 9 for this trademark*).

3,784,873. **SAFE TOYS AND DESIGN**. ISTITUTO ITALIANO; SICUREZZA DEI GIOCATTOLE S.R.L., MULTIPLE CLASS, (INT. CLS. 28 AND 42), (U.S. CLS. 22, 23, 38, 50, 100 AND 101). SN 79-055,442. PUB. 2-16-2010. FILED 5-5-2008.

3,784,874 (*See Class 3 for this trademark*).

3,784,879 (*See Class 16 for this trademark*).

3,784,880 (*See Class 9 for this trademark*).

3,784,884 (*See Class 5 for this trademark*).

3,784,896 (*See Class 3 for this trademark*).

3,784,915 (*See Class 9 for this trademark*).

3,784,966. **CORMORAN (STYLIZED)**. DAIWA-CORMORAN SPORTARTIKEL; VERTRIEB GMBH, (U.S. CLS. 22, 23, 38 AND 50). SN 79-068,056. PUB. 2-16-2010. FILED 1-12-2009.

3,784,972 (*See Class 3 for this trademark*).

3,785,001 (*See Class 25 for this trademark*).

3,785,004. **HYPER LOOP (BLOCK FORM)**. SHIMANO INC, (U.S. CLS. 22, 23, 38 AND 50). SN 79-069,602. PUB. 2-16-2010. FILED 6-1-2009.

3,785,030. **CHAMBERLAIN (BLOCK FORM)**. CAC AUSTRALIA PTY LTD, (U.S. CLS. 22, 23, 38 AND 50). SN 79-073,087. PUB. 2-16-2010. FILED 7-15-2009.

3,785,049. **PASS THE PRICKS (BLOCK FORM)**. KJELL ENGSTRÖM, (U.S. CLS. 22, 23, 38 AND 50). SN 79-074,884. PUB. 2-16-2010. FILED 9-15-2009.

CLASS 29—MEATS AND PROCESSED FOODS

3,783,107 (*See Class 5 for this trademark*).

3,783,304. **MARIACHITO (BLOCK FORM)**. GUDINO, MANUEL, DBA FESTIMEX, MULTIPLE CLASS, (INT. CLS. 29 AND 30), (U.S. CL. 46). SN 77-599,623. PUB. 2-16-2010. FILED 10-24-2008.

3,783,305. **RUDE HEALTH (BLOCK FORM)**. RUDE HEALTH FOODS LIMITED, MULTIPLE CLASS, (INT. CLS. 29 AND 30), (U.S. CL. 46). SN 77-601,767. PUB. 2-16-2010. FILED 10-28-2008.

3,783,399. **MAMMA MIA AND DESIGN**. EASTERN STATES MARKETING, INC., (U.S. CL. 46). SN 77-690,255. PUB. 2-16-2010. FILED 3-13-2009.

3,783,400. **CATERING SOLUTIONS (BLOCK FORM)**. PROGRESSIVE GOURMET, INC., MULTIPLE CLASS, (INT. CLS. 29 AND 30), (U.S. CL. 46). SN 77-690,790. PUB. 2-16-2010. FILED 3-13-2009.

3,783,407. **LOTUS RESTAURANT AND DESIGN**. CRAIGADOR CORPORATION, MULTIPLE CLASS, (INT. CLS. 29, 30 AND 35), (U.S. CLS. 46, 100, 101 AND 102). SN 77-693,272. PUB. 2-16-2010. FILED 3-17-2009.

3,783,495. **NEELY'S BAR-B-QUE AND DESIGN**. NEELY'S INTELLECTUAL PROPERTIES, LLC, MULTIPLE CLASS, (INT. CLS. 29, 30, 35 AND 43), (U.S. CLS. 46, 100, 101 AND 102). SN 77-705,841. PUB. 2-16-2010. FILED 4-2-2009.

3,783,515. **JACK IN THE BOX AND DESIGN**. JACK IN THE BOX INC., MULTIPLE CLASS, (INT. CLS. 29, 30 AND 43), (U.S. CLS. 46, 100 AND 101). SN 77-710,074. PUB. 2-16-2010. FILED 4-8-2009.

3,783,602. **RED MESA RANCH (BLOCK FORM)**. RED BIRD FARMS DISTRIBUTION COMPANY, (U.S. CL. 46). SN 77-740,010. PUB. 2-16-2010. FILED 5-19-2009.

3,783,603. **RED MESA RANCH AND DESIGN**. RED BIRD FARMS DISTRIBUTION COMPANY, (U.S. CL. 46). SN 77-740,018. PUB. 2-16-2010. FILED 5-19-2009.

3,783,618. **KIDZ NIBBLER (BLOCK FORM)**. ZAXBY'S FRANCHISING, INC., (U.S. CL. 46). SN 77-751,746. PUB. 2-16-2010.

- FILED 6-4-2009.
- 3,783,736. **40 POINTS FRESHFUNDS.COM AND DESIGN.** FRESH EXPRESS INCORPORATED, MULTIPLE CLASS, (INT. CLS. 29 AND 35), (U.S. CLS. 46, 100, 101 AND 102). SN 77-793,370. PUB. 2-16-2010. FILED 7-30-2009.
- 3,783,792. **SINCE 1973 QUALITY AUTHENTICITY INTEGRITY FAMILY (BLOCK FORM).** CACIQUE INC, (U.S. CL. 46). SN 77-803,848. PUB. 2-16-2010. FILED 8-13-2009.
- 3,783,818. **PAPAS TOREADAS LIME & CHIPOTLE AND DESIGN.** GRUPO BIMBO, S.A. B. DE C.V., (U.S. CL. 46). SN 77-808,046. PUB. 2-16-2010. FILED 8-19-2009.
- 3,783,852. **GW CHEESESTEAKS (BLOCK FORM).** GREAT WRAPS, INC., MULTIPLE CLASS, (INT. CLS. 29 AND 43), (U.S. CLS. 46, 100 AND 101). SN 77-814,333. PUB. 2-16-2010. FILED 8-27-2009.
- 3,783,892. **SMOOTHIE STARTERS (BLOCK FORM).** DOLE FOOD COMPANY, INC., (U.S. CL. 46). SN 77-817,948. PUB. 2-16-2010. FILED 9-1-2009.
- 3,783,984. **MR. ROTISSERIE AND DESIGN.** HOLLY POULTRY, INC., (U.S. CL. 46). SN 77-824,493. PUB. 2-16-2010. FILED 9-11-2009.
- 3,784,112. **THE OLD WINDMILL DAIRY (BLOCK FORM).** HUERFANO FARM, INC., (U.S. CL. 46). SN 77-828,294. PUB. 2-16-2010. FILED 9-17-2009.
- 3,784,139. **HAPPY MONKEY (BLOCK FORM).** HAPPY MONKEY HUMMUS, LLC, (U.S. CL. 46). SN 77-828,724. PUB. 2-16-2010. FILED 9-17-2009.
- 3,784,330. **INDIAN SUMMER (BLOCK FORM).** INDIAN SUMMER COOPERATIVE, INC., (U.S. CL. 46). SN 77-831,658. PUB. 2-16-2010. FILED 9-22-2009.
- 3,784,407. **ARTESIA AND DESIGN.** INTERNATIONAL INGREDIENTS, INC., MULTIPLE CLASS, (INT. CLS. 29 AND 30), (U.S. CL. 46). SN 77-832,612. PUB. 2-16-2010. FILED 9-22-2009.
- 3,784,484. **PRESTO! POULET (BLOCK FORM).** EPICUREAN FARMS, LLC, (U.S. CL. 46). SN 77-833,503. PUB. 2-16-2010. FILED 9-23-2009.
- 3,784,596. **CAVIAR KID AND DESIGN.** CALIFORNIA CAVIAR COMPANY, (U.S. CL. 46). SN 77-834,952. PUB. 2-16-2010. FILED 9-25-2009.
- 3,784,629. **EARLY DAWN (BLOCK FORM).** AJC INTERNATIONAL, INC., (U.S. CL. 46). SN 77-835,460. PUB. 2-16-2010. FILED 9-25-2009.
- 3,784,633. **NICHE FOODS (BLOCK FORM).** NICHE FOODS LLC, (U.S. CL. 46). SN 77-835,489. PUB. 2-16-2010. FILED 9-25-2009.
- 3,784,673. **SPREAD THE LOVE (BLOCK FORM).** SPREAD THE LOVE, LLC, (U.S. CL. 46). SN 77-836,331. PUB. 2-16-2010. FILED 9-28-2009.
- 3,784,761. **MISCELLANEOUS DESIGN.** BUNGE OILS, INC., (U.S. CL. 46). SN 77-854,123. PUB. 2-16-2010. FILED 10-21-2009.
- 3,784,763. **WONDERFUL AND DESIGN.** PARAMOUNT FARMS, INC., (U.S. CL. 46). SN 77-855,511. PUB. 2-16-2010. FILED 10-22-2009.
- 3,784,824 (*See Class 5 for this trademark*).
- 3,784,862. **PENGUEN AND DESIGN.** PENGUEN GIDA SANAYI ANONIM SIRKETI, MULTIPLE CLASS, (INT. CLS. 29, 30 AND 31), (U.S. CLS. 1 AND 46). SN 79-046,479. PUB. 2-16-2010. FILED 7-16-2007.
- 3,784,921 (*See Class 5 for this trademark*).
- 3,784,935 (*See Class 5 for this trademark*).
- 3,784,976. **O AND DESIGN.** AZIENDA AGRICOLA L'OLIVAIA DI FABRIZIA CUSANI, (U.S. CL. 46). SN 79-068,278. PUB. 2-16-2010. FILED 3-18-2009.
- 3,784,978. **MIXYBAR AND DESIGN.** FABBRI 1905 S.P.A., MULTIPLE CLASS, (INT. CLS. 29 AND 32), (U.S. CLS. 45, 46 AND 48). SN 79-068,320. PUB. 2-16-2010. FILED 2-26-2009.
- 3,784,993 (*See Class 9 for this trademark*).
- 3,784,995 (*See Class 16 for this trademark*).
- 3,784,996. **SEARSPORT AND DESIGN.** SHANDONG SEARSPORT FOODS CO., LTD., MULTIPLE CLASS, (INT. CLS. 29 AND 31), (U.S. CLS. 1 AND 46). SN 79-069,022. PUB. 2-16-2010. FILED 4-3-2009.
- 3,785,013. **NOYAN (STYLIZED).** "EUROTERM" CLOSED JOINT-STOCK COMPANY, MULTIPLE CLASS, (INT. CLS. 29, 30, 31 AND 32), (U.S. CLS. 1, 45, 46 AND 48). SN 79-071,032. PUB. 2-16-2010. FILED 7-8-2009.
- 3,785,015. **MINI FARMER AND DESIGN.** XIAMEN INTERNATIONAL; TRADE & INDUSTRIAL CO., LTD., (U.S. CL. 46). SN 79-071,045. PUB. 2-16-2010. FILED 3-10-2009.

CLASS 30—STAPLE FOODS

- 3,783,131. **LITTLE ANGEL'S AND DESIGN.** NEBRASKA-LAND INC., (U.S. CL. 46). SN 76-699,586. PUB. 2-16-2010. FILED 9-23-2009.
- 3,783,244. **MAMA'S PROMISE (BLOCK FORM).** EARTH MAMA ANGEL BABY, LLC, (U.S. CL. 46). SN 77-507,980. PUB. 2-16-2010. FILED 6-25-2008.
- 3,783,282. **SHARI'S BERRIES (BLOCK FORM).** PROVIDE BERRIES, INC., MULTIPLE CLASS, (INT. CLS. 30 AND 35), (U.S. CLS. 46, 100, 101 AND 102). SN 77-571,468. PUB. 2-16-2010. FILED 9-16-2008.
- 3,783,304 (*See Class 29 for this trademark*).
- 3,783,305 (*See Class 29 for this trademark*).
- 3,783,400 (*See Class 29 for this trademark*).
- 3,783,407 (*See Class 29 for this trademark*).
- 3,783,419. **SWEETIE PIE OH MI (BLOCK FORM).** CALLOWAY, DONNA C., (U.S. CL. 46). SN 77-695,429. PUB. 2-16-2010. FILED 3-20-2009.
- 3,783,439. **GRANNIOLA (BLOCK FORM).** MEISSNER, MARK E., (U.S. CL. 46). SN 77-699,278. PUB. 2-16-2010. FILED 3-25-2009.
- 3,783,495 (*See Class 29 for this trademark*).
- 3,783,515 (*See Class 29 for this trademark*).
- 3,783,560. **DIP YOUR OWN BERRIES (BLOCK FORM).** THE CHOCOLATE BAR RESTAURANTS INC., (U.S. CL. 46). SN 77-718,450. PUB. 2-16-2010. FILED 4-21-2009.
- 3,783,611. **CHOCORETAS (BLOCK FORM).** GRUPO BIMBO, S.A. B DE C.V., (U.S. CL. 46). SN 77-748,747. PUB. 2-16-2010. FILED 6-1-2009.
- 3,783,690. **COMPASS MINERALS (BLOCK FORM).** COMPASS MINERALS INTERNATIONAL, INC., (U.S. CL. 46). SN 77-774,196. PUB. 2-16-2010. FILED 7-3-2009.
- 3,783,696. **WICKLES RELISH A WICKEDLY DELICIOUS RELISH ORIGINAL AND DESIGN.** THE WICKLES COMPANY, (U.S. CL. 46). SN 77-775,673. PUB. 2-16-2010. FILED 7-7-2009.
- 3,783,765. **ALL SPICE CAFE (BLOCK FORM).** JOHN COWLES, DBA ALL SPICE CAFE, (U.S. CL. 46). SN 77-798,141. PUB. 2-16-2010. FILED 8-5-2009.
- 3,783,767. **TAKIS FUEGO AND DESIGN.** GRUPO BIMBO, S.A. B. DE C.V., (U.S. CL. 46). SN 77-798,778. PUB. 2-16-2010. FILED 8-6-2009.
- 3,783,777. **EASY BROWN (BLOCK FORM).** ADVANCED FOOD SYSTEMS, INC., (U.S. CL. 46). SN 77-801,054. PUB. 2-16-2010. FILED 8-10-2009.
- 3,783,785. **TAKIS GUACAMOLE AND DESIGN.** GRUPO BIMBO, S.A. B. DE C.V., (U.S. CL. 46). SN 77-802,694. PUB. 2-16-2010. FILED 8-12-2009.
- 3,783,794. **CHARLOTTE'S BAKERY (BLOCK FORM).** THE PIG BOYS, INC., DBA CHARLOTTE'S BAKERY, (U.S. CL. 46). SN 77-803,885. PUB. 2-16-2010. FILED 8-13-2009.
- 3,783,796. **TAKIS CRUNCHY FAJITA AND DESIGN.** GRUPO BIMBO, S.A. B. DE C.V., (U.S. CL. 46). SN 77-803,955. PUB. 2-16-2010. FILED 8-13-2009.
- 3,783,797. **TAKIS SALSA BRAVA AND DESIGN.** GRUPO BIMBO, S.A. B. DE C.V., (U.S. CL. 46). SN 77-804,016. PUB. 2-16-2010. FILED 8-13-2009.
- 3,783,798. **MINI TAKIS CRUNCHY FAJITA AND DESIGN.** GRUPO BIMBO, S.A. B. DE C.V., (U.S. CL. 46). SN 77-804,304. PUB. 2-16-2010. FILED 8-13-2009.
- 3,783,927. **CHUCKWAGON SALLY WILD WEST SEASONINGS AND DESIGN.** CHUCKWAGON SALLY, INC., DBA CHUCKWAGON SALLY, (U.S. CL. 46). SN 77-821,671. PUB. 2-16-2010. FILED 9-8-2009.
- 3,784,022. **THE BIG HARDEE (BLOCK FORM).** HARDEE'S FOOD SYSTEMS, INC., (U.S. CL. 46). SN 77-825,789. PUB. 2-16-2010. FILED 9-14-2009.
- 3,784,042. **DEIMAN (BLOCK FORM).** DEIMAN, S.A. DE C.V., (U.S. CL. 46). SN 77-826,309. PUB. 2-16-2010. FILED 9-14-2009.
- 3,784,047. **STEWART'S (BLOCK FORM).** STEWARTS RES-

TAURANTS INCORPORATED, (U.S. CL. 46). SN 77-826,428. PUB. 2-16-2010. FILED 9-15-2009.

3,784,122. **FETCH CHOCOLATES (BLOCK FORM)**. G & G MANHATTAN FRUITIER, INC., DBA MANHATTAN FRUITIER, (U.S. CL. 46). SN 77-828,479. PUB. 2-16-2010. FILED 9-17-2009.

3,784,186. **ROXANNE'S COOKIES (BLOCK FORM)**. HALL, ROXANNE, (U.S. CL. 46). SN 77-829,664. PUB. 2-16-2010. FILED 9-18-2009.

3,784,217. **SWEET REPUBLIC (BLOCK FORM)**. SWEET REPUBLIC INCORPORATED, DBA SWEET REPUBLIC, (U.S. CL. 46). SN 77-830,258. PUB. 2-16-2010. FILED 9-18-2009.

3,784,218. **BEST WISHES & GREAT DISHES! (BLOCK FORM)**. CASSLEE CORPORATION, DBA CLEVER CLEAVER PRODUCTIONS, (U.S. CL. 46). SN 77-830,280. PUB. 2-16-2010. FILED 9-18-2009.

3,784,222. **THE CLEVER CLEAVER KITCHEN (BLOCK FORM)**. CASSLEE CORPORATION, DBA CLEVER CLEAVER PRODUCTIONS, (U.S. CL. 46). SN 77-830,303. PUB. 2-16-2010. FILED 9-18-2009.

3,784,235. **CARMEL VALLEY COFFEE ROASTING CO. COME TASTE THE AROMA AND DESIGN**. CARMEL ROASTERS, INC., DBA CARMEL VALLEY COFFEE ROASTING COMPANY, (U.S. CL. 46). SN 77-830,495. PUB. 2-16-2010. FILED 9-19-2009.

3,784,254. **2R-HEALTH BAR (BLOCK FORM)**. 2R-HEALTH, INC., (U.S. CL. 46). SN 77-830,710. PUB. 2-16-2010. FILED 9-21-2009.

3,784,281. **AUTHENTICITY NEVER TASTED SO GOOD (BLOCK FORM)**. HURTADO CHILE COMPANY, (U.S. CL. 46). SN 77-830,996. PUB. 2-16-2010. FILED 9-21-2009.

3,784,283. **GOOD SEED AND DESIGN**. AVB, INC., (U.S. CL. 46). SN 77-831,016. PUB. 2-16-2010. FILED 9-21-2009.

3,784,317. **SLOPPY DAVE'S BBQ (BLOCK FORM)**. AMC BURGERS, INC., (U.S. CL. 46). SN 77-831,421. PUB. 2-16-2010. FILED 9-21-2009.

3,784,373. **COFFEE BY DESIGN (BLOCK FORM)**. COFFEE BY DESIGN, INC., (U.S. CL. 46). SN 77-832,220. PUB. 2-16-2010. FILED 9-22-2009.

3,784,377. **CBD (BLOCK FORM)**. COFFEE BY DESIGN, INC., (U.S. CL. 46). SN 77-832,233. PUB. 2-16-2010. FILED 9-22-2009.

3,784,403. **TWO-HANDED RUMP RUB (BLOCK FORM)**. JUBES FIREHOUSE BBQ, LLC, DBA JUBE'S FIREHOUSE BBQ, (U.S. CL. 46). SN 77-832,532. PUB. 2-16-2010. FILED 9-22-2009.

3,784,407 (*See Class 29 for this trademark*).

3,784,422. **MISCELLANEOUS DESIGN**. PRODUCTOS MEXICANOS, S.A. DE C.V., (U.S. CL. 46). SN 77-832,757. PUB. 2-16-2010. FILED 9-23-2009.

3,784,468. **MINER'S GOLD (BLOCK FORM)**. WORLD GOURMET MARKETING LLC, (U.S. CL. 46). SN 77-833,325. PUB. 2-16-2010. FILED 9-23-2009.

3,784,527. **BONAPARTE Á LA GRAD (BLOCK FORM)**. MOLLERSON, URVE, (U.S. CL. 46). SN 77-834,012. PUB. 2-16-2010. FILED 9-24-2009.

3,784,538. **MISCELLANEOUS DESIGN**. GRANDAD'S SWEET TEA, LLC, (U.S. CL. 46). SN 77-834,102. PUB. 2-16-2010. FILED 9-24-2009.

3,784,559. **SLAVO SALT AND DESIGN**. SLAVO ENTERPRISES, L.L.C., (U.S. CL. 46). SN 77-834,400. PUB. 2-16-2010. FILED 9-24-2009.

3,784,654. **UNDERGROUND FLAVOR (BLOCK FORM)**. GREGORY L. CHAIN, (U.S. CL. 46). SN 77-835,754. PUB. 2-16-2010. FILED 9-26-2009.

3,784,666. **SIN DAWG (BLOCK FORM)**. AVB, INC., (U.S. CL. 46). SN 77-835,989. PUB. 2-16-2010. FILED 9-28-2009.

3,784,767. **SAVOR-SIZE (BLOCK FORM)**. BOB EVANS RESTAURANTS OF MICHIGAN, LLC, (U.S. CL. 46). SN 77-856,916. PUB. 2-16-2010. FILED 10-26-2009.

3,784,815. **SILVER CLOUD ESTATES (BLOCK FORM)**. SILVER CLOUD ESTATES, LLC, (U.S. CL. 46). SN 77-977,954. PUB. 6-10-2008. FILED 11-6-2006.

3,784,831. **TUTSI BOTA (BLOCK FORM)**. TOOTSIE ROLL INDUSTRIES, LLC, (U.S. CL. 46). SN 78-707,188. PUB. 2-16-2010. FILED 9-6-2005.

3,784,846. **INDIA'S OWN (BLOCK FORM)**. KHANNA INTERNATIONAL TRADING INC., (U.S. CL. 46). SN 78-887,441.

PUB. 11-25-2008. FILED 5-19-2006.

3,784,862 (*See Class 29 for this trademark*).

3,784,891. **MARCOLINI CARRÉ 2 CHOCOLAT AND DESIGN**. LES CHOCOLATS DE L'IRIS SA/NV, (U.S. CL. 46). SN 79-059,113. PUB. 2-16-2010. FILED 7-24-2008.

3,784,892. **COEUR DE GUANAJA (BLOCK FORM)**. SONAFI, (U.S. CL. 46). SN 79-059,174. PUB. 2-16-2010. FILED 8-27-2008.

3,784,928. **MILKMICE (BLOCK FORM)**. AUGUST STORCK KG, (U.S. CL. 46). SN 79-065,869. PUB. 2-16-2010. FILED 1-6-2009.

3,784,995 (*See Class 16 for this trademark*).

3,785,013 (*See Class 29 for this trademark*).

CLASS 31—NATURAL AGRICULTURAL PRODUCTS

3,783,130. **BUCCANEER (BLOCK FORM)**. CENTRAL STATES ENTERPRISES, INC, (U.S. CLS. 1 AND 46). SN 76-699,585. PUB. 2-16-2010. FILED 9-23-2009.

3,783,158. **GO! (BLOCK FORM)**. CAN PRO PET PRODUCTS LTD., (U.S. CLS. 1 AND 46). SN 77-160,089. PUB. 2-16-2010. FILED 4-18-2007.

3,783,235. **JEALOUS FRUITS (STYLIZED)**. 0824373 B.C. LTD., MULTIPLE CLASS, (INT. CLS. 31 AND 35), (U.S. CLS. 1, 46, 100, 101 AND 102). SN 77-495,384. PUB. 2-16-2010. FILED 6-10-2008.

3,783,281. **WESTERN GRILL (BLOCK FORM)**. WAGGIN' TRAIN, LLC, (U.S. CLS. 1 AND 46). SN 77-571,104. PUB. 2-16-2010. FILED 9-16-2008.

3,783,327. **ARCADA (BLOCK FORM)**. ERNST BENARY SAMENZUCHT GMBH, (U.S. CLS. 1 AND 46). SN 77-646,715. PUB. 2-16-2010. FILED 1-9-2009.

3,783,369 (*See Class 6 for this trademark*).

3,783,394. **BELLS BEND NEIGHBORHOOD FARMS AND DESIGN**. BELLS BEND NEIGHBORHOOD FARMS, (U.S. CLS. 1 AND 46). SN 77-688,716. PUB. 2-16-2010. FILED 3-11-2009.

3,783,623. **HR AND DESIGN**. HALEAKALA RANCH COMPANY, (U.S. CLS. 1 AND 46). SN 77-752,829. PUB. 2-16-2010. FILED 6-5-2009.

3,783,647. **FINN (STYLIZED)**. FINN CORPORATION, (U.S. CLS. 1 AND 46). SN 77-761,506. PUB. 2-16-2010. FILED 6-17-2009.

3,783,754. **RADEBAUGH FLORIST & GREENHOUSES (BLOCK FORM)**. GEORGE W. RADEBAUGH & SONS, INC., (U.S. CLS. 1 AND 46). SN 77-795,233. PUB. 2-16-2010. FILED 8-3-2009.

3,783,812. **VERUS (BLOCK FORM)**. RUSSELL ARMSTRONG, (U.S. CLS. 1 AND 46). SN 77-807,501. PUB. 2-16-2010. FILED 8-18-2009.

3,783,897. **FULL LIFE FOR PETS (BLOCK FORM)**. CARDINAL LABORATORIES, INC., (U.S. CLS. 1 AND 46). SN 77-818,544. PUB. 2-16-2010. FILED 9-2-2009.

3,784,141. **LE JAUNE ROYALE (BLOCK FORM)**. SUN WORLD INTERNATIONAL, LLC, (U.S. CLS. 1 AND 46). SN 77-828,763. PUB. 2-16-2010. FILED 9-17-2009.

3,784,144. **LE ROUGE ROYALE (BLOCK FORM)**. SUN WORLD INTERNATIONAL, LLC, (U.S. CLS. 1 AND 46). SN 77-828,775. PUB. 2-16-2010. FILED 9-17-2009.

3,784,272. **PUGH'S FLOWERS AND DESIGN**. FLORAL ACCOUNTING SERVICES, DBA PUGH'S FLOWERS, (U.S. CLS. 1 AND 46). SN 77-830,909. PUB. 2-16-2010. FILED 9-21-2009.

3,784,314. **PINK RIBBON (BLOCK FORM)**. FORT BOISE PRODUCE, (U.S. CLS. 1 AND 46). SN 77-831,384. PUB. 2-16-2010. FILED 9-21-2009.

3,784,334. **GOODNESS FROM THE EARTH (BLOCK FORM)**. MERRICK PET CARE, INC., (U.S. CLS. 1 AND 46). SN 77-831,717. PUB. 2-16-2010. FILED 9-22-2009.

3,784,423. **COVE (BLOCK FORM)**. SUNNY COVE CITRUS LLC, (U.S. CLS. 1 AND 46). SN 77-832,760. PUB. 2-16-2010. FILED 9-23-2009.

3,784,427. **TOTAL CUISINE (BLOCK FORM)**. D & D COMMODITIES LIMITED, (U.S. CLS. 1 AND 46). SN 77-832,786. PUB. 2-16-2010. FILED 9-23-2009.

3,784,430. **BREWBALLS DO YOU HAVE THE BALLS TO BREW TO PERFECTION? (BLOCK FORM)**. MERLINE, THOMAS, AND SANDRIN, COLLEEN, (U.S. CLS. 1 AND 46). SN 77-832,854. PUB. 2-16-2010. FILED 9-23-2009.

3,784,461. **DAVE'S 95% PREMIUM MEATS (BLOCK FORM)**. DAVE'S SODA & PET CITY, (U.S. CLS. 1 AND 46). SN 77-833,253. PUB. 2-16-2010. FILED 9-23-2009.

3,784,469. **DAVE'S DELICATE DINNERS (BLOCK FORM)**. DAVE'S SODA & PET CITY, (U.S. CLS. 1 AND 46). SN 77-833,339. PUB. 2-16-2010. FILED 9-23-2009.

3,784,472. **DAVE'S DELECTABLE DINNERS (BLOCK FORM)**. DAVE'S SODA & PET CITY, (U.S. CLS. 1 AND 46). SN 77-833,359. PUB. 2-16-2010. FILED 9-23-2009.

3,784,476. **WE GROW SMILES (BLOCK FORM)**. PROVEN WINNERS NORTH AMERICA LLC, (U.S. CLS. 1 AND 46). SN 77-833,398. PUB. 2-16-2010. FILED 9-23-2009.

3,784,796. **PLANTS THAT WORK IN THE SHADE (BLOCK FORM)**. CAROLINA NURSERIES, INC., (U.S. CLS. 1 AND 46). SN 77-864,927. PUB. 2-16-2010. FILED 11-4-2009.

3,784,806. **GOURMET GOODIES (BLOCK FORM)**. D & D COMMODITIES LIMITED, (U.S. CLS. 1 AND 46). SN 77-874,183. PUB. 2-16-2010. FILED 11-17-2009.

3,784,862 (*See Class 29 for this trademark*).

3,784,889 (*See Class 1 for this trademark*).

3,784,971 (*See Class 19 for this trademark*).

3,784,996 (*See Class 29 for this trademark*).

3,785,013 (*See Class 29 for this trademark*).

CLASS 32—LIGHT BEVERAGES

3,783,105. **T'BEST AND DESIGN**. TULIP INTERNATIONAL, INC., (U.S. CLS. 45, 46 AND 48). SN 76-696,145. PUB. 2-16-2010. FILED 3-5-2009.

3,783,107 (*See Class 5 for this trademark*).

3,783,170. **GLORIOUS GREENS (BLOCK FORM)**. SUNKIST GROWERS, INC., (U.S. CLS. 45, 46 AND 48). SN 77-255,829. PUB. 2-16-2010. FILED 8-15-2007.

3,783,187. **MISCELLANEOUS DESIGN**. CHERNYAK, YEVGENY OLEKSANDROVYCH, MULTIPLE CLASS, (INT. CLS. 32, 33, 35 AND 43), (U.S. CLS. 45, 46, 47, 48, 49, 100, 101 AND 102). SN 77-344,277. PUB. 2-16-2010. FILED 12-5-2007.

3,783,302. **MOSTO CLASSICO (BLOCK FORM)**. 3091287 CANADA INC., (U.S. CLS. 45, 46 AND 48). SN 77-599,396. PUB. 12-8-2009. FILED 10-23-2008.

3,783,801. **BECAUSE MIX MATTERS (BLOCK FORM)**. CALIFORNIA QUIVERS INC., (U.S. CLS. 45, 46 AND 48). SN 77-804,539. PUB. 2-16-2010. FILED 8-14-2009.

3,784,008. **BLUE RHINO RASPBERRY (BLOCK FORM)**. COLD SPRING BREWING COMPANY, (U.S. CLS. 45, 46 AND 48). SN 77-825,229. PUB. 2-16-2010. FILED 9-11-2009.

3,784,043. **DEIMAN (BLOCK FORM)**. DEIMAN, S.A. DE C.V., (U.S. CLS. 45, 46 AND 48). SN 77-826,321. PUB. 2-16-2010. FILED 9-14-2009.

3,784,133. **USA PH 7.4 AND DESIGN**. NEW YORK STATE'S BEST TASTING WATER, LLC, (U.S. CLS. 45, 46 AND 48). SN 77-828,582. PUB. 2-16-2010. FILED 9-17-2009.

3,784,267. **AUXXANO (BLOCK FORM)**. AUXXANO INC., (U.S. CLS. 45, 46 AND 48). SN 77-830,861. PUB. 2-16-2010. FILED 9-21-2009.

3,784,340. **UNLEASH THE POWER IN YOU (BLOCK FORM)**. RIVEREDGE, LLC, (U.S. CLS. 45, 46 AND 48). SN 77-831,744. PUB. 2-16-2010. FILED 9-22-2009.

3,784,350. **DRY DOCK BREWING, CO. (BLOCK FORM)**. DRY DOCK ENTERPRISES, INC., DBA DRY DOCK BREWING, CO., (U.S. CLS. 45, 46 AND 48). SN 77-831,872. PUB. 2-16-2010. FILED 9-22-2009.

3,784,381. **COOLER CLEANSE AND DESIGN**. ERIC HELMS, (U.S. CLS. 45, 46 AND 48). SN 77-832,253. PUB. 2-16-2010. FILED 9-22-2009.

3,784,824 (*See Class 5 for this trademark*).

3,784,935 (*See Class 5 for this trademark*).

3,784,943 (*See Class 16 for this trademark*).

3,784,968. **SNOWFLAKE (STYLIZED)**. CHINA RESOURCES SNOW BREWERY; (LIAO NING) COMPANY LIMITED, (U.S. CLS. 45, 46 AND 48). SN 79-068,107. PUB. 2-16-2010. FILED 4-20-2009.

3,784,972 (*See Class 3 for this trademark*).

3,784,978 (*See Class 29 for this trademark*).

3,784,979. **SNOW AND DESIGN**. CHINA RESOURCES SNOW BREWERY; (LIAO NING) COMPANY LIMITED, (U.S. CLS. 45, 46 AND 48). SN 79-068,331. PUB. 2-16-2010. FILED 4-20-2009.

3,784,993 (*See Class 9 for this trademark*).

3,785,013 (*See Class 29 for this trademark*).

3,785,016. **FASSBIND TASTE THE SPIRIT. SINCE 1846. AND DESIGN**. S. FASSBIND AG, MULTIPLE CLASS, (INT. CLS. 32 AND 33), (U.S. CLS. 45, 46, 47, 48 AND 49). SN 79-071,202. PUB. 2-16-2010. FILED 5-1-2009.

3,785,017. **FASSBIND SAUVOURER AVEC ESPRIT. DEPUIS 1846. AND DESIGN**. S. FASSBIND AG, MULTIPLE CLASS, (INT. CLS. 32 AND 33), (U.S. CLS. 45, 46, 47, 48 AND 49). SN 79-071,204. PUB. 2-16-2010. FILED 5-1-2009.

CLASS 33—WINES AND SPIRITS

3,783,187 (*See Class 32 for this trademark*).

3,783,218. **CAORUNN (BLOCK FORM)**. INVER HOUSE DISTILLERS LIMITED, (U.S. CLS. 47 AND 49). SN 77-434,346. PUB. 2-16-2010. FILED 3-28-2008.

3,783,310. **J.D. LAURENT JDL AND DESIGN**. JDL WINES, (U.S. CLS. 47 AND 49). SN 77-616,623. PUB. 2-16-2010. FILED 11-18-2008.

3,783,311. **J.D. LAURENT JDL AND DESIGN**. JDL WINES, (U.S. CLS. 47 AND 49). SN 77-616,667. PUB. 2-16-2010. FILED 11-18-2008.

3,783,342. **STOLLER (BLOCK FORM)**. STOLLER VINEYARDS, INC., MULTIPLE CLASS, (INT. CLS. 33 AND 39), (U.S. CLS. 47, 49, 100 AND 105). SN 77-663,572. PUB. 2-16-2010. FILED 2-4-2009.

3,783,397. **LEBLON AND DESIGN**. LEBLON HOLDINGS LLC, (U.S. CLS. 47 AND 49). SN 77-689,818. PUB. 2-16-2010. FILED 3-12-2009.

3,783,516. **HUDSON WHISKEY (BLOCK FORM)**. TUTHILLTOWN SPIRITS, LLC, (U.S. CLS. 47 AND 49). SN 77-710,146. PUB. 2-16-2010. FILED 4-8-2009.

3,783,567. **YALUMBA AUSTRALIA'S OLDEST FAMILY OWNED WINERY THE SIGNATURE (BLOCK FORM)**. SAMUEL SMITH & SON PTY LTD, (U.S. CLS. 47 AND 49). SN 77-720,418. PUB. 2-16-2010. FILED 4-23-2009.

3,783,609. **VINO FRESCO (BLOCK FORM)**. CAHILL, JONATHAN P., (U.S. CLS. 47 AND 49). SN 77-745,080. PUB. 2-16-2010. FILED 5-27-2009.

3,783,656. **MISCELLANEOUS DESIGN**. GRAND TRAVERSE DISTILLERY, L.L.C., (U.S. CLS. 47 AND 49). SN 77-762,663. PUB. 11-10-2009. FILED 6-18-2009.

3,783,699. **BUCKIN' HORSE RED (BLOCK FORM)**. GEORGETOWN WINERY, LLC, (U.S. CLS. 47 AND 49). SN 77-777,251. PUB. 2-16-2010. FILED S.R. 7-9-2009; AM. P.R. 12-15-2009.

3,783,728. **A ALMA (STYLIZED)**. DALTON WINERY, LTD., (U.S. CLS. 47 AND 49). SN 77-787,709. PUB. 1-12-2010. FILED 7-23-2009.

3,783,757. **VELO AND DESIGN**. VELOCITY WINE CELLARS, LLC, (U.S. CLS. 47 AND 49). SN 77-795,902. PUB. 2-16-2010. FILED 8-3-2009.

3,783,760. **MIXXA (BLOCK FORM)**. MANUFACTURAS INTERNACIONALES K. S.A. DE C.V., (U.S. CLS. 47 AND 49). SN 77-796,253. PUB. 2-16-2010. FILED 8-4-2009.

3,783,826. **BELLA BIANCA (BLOCK FORM)**. PALOTAI OLSON PRUKOP INDUSTRIES, INC., (U.S. CLS. 47 AND 49). SN 77-810,018. PUB. 2-16-2010. FILED 8-21-2009.

3,783,830. **MISCELLANEOUS DESIGN**. VINTAGE WINE ESTATES, INC., (U.S. CLS. 47 AND 49). SN 77-810,750. PUB. 2-16-2010. FILED 8-23-2009.

3,783,867. **BD (STYLIZED)**. BARONESS SMALL ESTATES, INC., (U.S. CLS. 47 AND 49). SN 77-815,541. PUB. 2-16-2010. FILED 8-28-2009.

3,784,029. **THE GONDOLIER (BLOCK FORM)**. ARBORWAY IMPORTS, INC., (U.S. CLS. 47 AND 49). SN 77-825,995. PUB. 2-16-2010. FILED 9-14-2009.

3,784,153. **FATICA CONTADINA (BLOCK FORM)**. TERREDORA DI PAOLO SOCIETA' SEMPLICE AGRICOLA O PIU'

- BREVENTE TERREDORA S.S.A. O TDDP S.S.A., (U.S. CLS. 47 AND 49). SN 77-828,969. PUB. 2-16-2010. FILED 9-17-2009.
- 3,784,183. **VISION VODKA (BLOCK FORM)**. AMBITION BEVERAGES, INC., (U.S. CLS. 47 AND 49). SN 77-829,632. PUB. 2-16-2010. FILED 9-18-2009.
- 3,784,457. **TURROI (BLOCK FORM)**. ZHANG WEI WEN, (U.S. CLS. 47 AND 49). SN 77-833,188. PUB. 2-16-2010. FILED 9-23-2009.
- 3,784,534. **MELROSE (BLOCK FORM)**. MELROSE VINEYARDS, INC., DBA MELROSE VINEYARDS, (U.S. CLS. 47 AND 49). SN 77-834,069. PUB. 2-16-2010. FILED 9-24-2009.
- 3,784,711. **SHAYA HABIS (BLOCK FORM)**. FINE ESTATES FROM SPAIN, (U.S. CLS. 47 AND 49). SN 77-839,027. PUB. 2-16-2010. FILED 10-1-2009.
- 3,784,809. **MISCELLANEOUS DESIGN**. GRUPO INDUSTRIAL GP, S.A. DE C.V., (U.S. CLS. 47 AND 49). SN 77-876,955. PUB. 2-16-2010. FILED 11-19-2009.
- 3,784,848. **V2 (BLOCK FORM)**. EVERGLO INTERNATIONAL, LLC, (U.S. CLS. 47 AND 49). SN 78-907,441. PUB. 2-16-2010. FILED 6-13-2006.
- 3,784,931. **THE STANDISH (BLOCK FORM)**. THE STANDISH WINE COMPANY PTY LTD, (U.S. CLS. 47 AND 49). SN 79-066,330. PUB. 2-16-2010. FILED 2-3-2009.
- 3,784,972 (*See Class 3 for this trademark*).
- 3,784,977. **DYADES2 AND DESIGN**. WSG WEINGÄRTNER SERVICEGESELLSCHAFT MBH, (U.S. CLS. 47 AND 49). SN 79-068,295. PUB. 2-16-2010. FILED 3-27-2009.
- 3,784,990 (*See Class 20 for this trademark*).
- 3,784,993 (*See Class 9 for this trademark*).
- 3,785,003. **CABRO BLACK (BLOCK FORM)**. AMBROGIO E GIOVANNI FOLONARI TENUTE; SOCIETÀ AGRICOLA A RESPONSABILITÀ LIMITATA, (U.S. CLS. 47 AND 49). SN 79-069,393. PUB. 2-16-2010. FILED 4-27-2009.
- 3,785,012. **QUINTA DA LAGOALVA (BLOCK FORM)**. SOCIEDADE AGRÍCOLA; DA QUINTA DA LAGOALVA DE CIMA, S.A., (U.S. CLS. 47 AND 49). SN 79-070,880. PUB. 2-16-2010. FILED 7-2-2009.
- 3,785,016 (*See Class 32 for this trademark*).
- 3,785,017 (*See Class 32 for this trademark*).
- 3,785,028. **N.P.U. - "NEC PLUS ULTRA" (BLOCK FORM)**. BRUNO PAILLARD, (U.S. CLS. 47 AND 49). SN 79-072,653. PUB. 2-16-2010. FILED 7-9-2009.
- 3,785,035. **THE ROYAL & ANCIENT (BLOCK FORM)**. WELLS & YOUNGS BREWING; COMPANY LIMITED, (U.S. CLS. 47 AND 49). SN 79-073,664. PUB. 2-16-2010. FILED 9-15-2009.
- 3,785,053. **COVA SANTA (BLOCK FORM)**. ANECOOP S. COOP., (U.S. CLS. 47 AND 49). SN 79-075,570. PUB. 2-16-2010. FILED 9-23-2009.

CLASS 34—SMOKERS' ARTICLES

- 3,783,252. **PREMIUM ONE (BLOCK FORM)**. KRETEK INTERNATIONAL, INC., (U.S. CLS. 2, 8, 9 AND 17). SN 77-522,329. PUB. 5-26-2009. FILED 7-15-2008.
- 3,783,820. **HARVEST SELECTION (BLOCK FORM)**. FAIRMONT HOLDINGS, INC., (U.S. CLS. 2, 8, 9 AND 17). SN 77-808,924. PUB. 2-16-2010. FILED 8-20-2009.
- 3,783,883. **VIRGINIA SLIMS SUPERSLIMS VS MENTHOL 20 CLASS A CIGARETTES AND DESIGN**. PHILIP MORRIS USA INC., (U.S. CLS. 2, 8, 9 AND 17). SN 77-817,187. PUB. 2-16-2010. FILED 9-1-2009.
- 3,783,884. **VIRGINIA SLIMS SUPERSLIMS LIGHTS VS 20 CLASS A CIGARETTES AND DESIGN**. PHILIP MORRIS USA INC., (U.S. CLS. 2, 8, 9 AND 17). SN 77-817,226. PUB. 2-16-2010. FILED 9-1-2009.
- 3,783,886. **VIRGINIA SLIMS SUPERSLIMS LIGHTS VS 20 CLASS A CIGARETTES AND DESIGN**. PHILIP MORRIS USA INC., (U.S. CLS. 2, 8, 9 AND 17). SN 77-817,229. PUB. 2-16-2010. FILED 9-1-2009.
- 3,783,887. **VIRGINIA SLIMS SUPERSLIMS LIGHTS VS MENTHOL 20 CLASS A CIGARETTES AND DESIGN**. PHILIP MORRIS USA INC., (U.S. CLS. 2, 8, 9 AND 17). SN 77-817,239. PUB. 2-16-2010. FILED 9-1-2009.
- 3,784,676. **RICH LAND RED (BLOCK FORM)**. BELCORP NC INC, (U.S. CLS. 2, 8, 9 AND 17). SN 77-836,456. PUB. 2-16-

2010. FILED 9-28-2009.
3,784,869 (*See Class 3 for this trademark*).

SERVICE MARKS

CLASS 35—ADVERTISING AND BUSINESS

- 3,783,086. **BUCKY'S (BLOCK FORM)**. BUCKY'S, INC., (U.S. CLS. 100, 101 AND 102). SN 76-653,211. PUB. 2-13-2007. FILED 1-4-2006.
- 3,783,099. **LODGEX (BLOCK FORM)**. LJK COMPANIES, INC., (U.S. CLS. 100, 101 AND 102). SN 76-694,902. PUB. 2-16-2010. FILED 12-18-2008.
- 3,783,108. **NATURES GROWN ORGANICS AND DESIGN**. HEARTLAND COUNTRY CO-OP, MULTIPLE CLASS, (INT. CLS. 35 AND 44), (U.S. CLS. 100, 101 AND 102). SN 76-697,088. PUB. 10-13-2009. FILED 4-27-2009.
- 3,783,127. **YACHTBLUE (BLOCK FORM)**. YACHTBLUE, LLC, (U.S. CLS. 100, 101 AND 102). SN 76-699,436. PUB. 2-16-2010. FILED 9-14-2009.
- 3,783,133. **SPANNING THE CLINICAL DIVIDE (BLOCK FORM)**. BIOBRIDGES, LLC, (U.S. CLS. 100, 101 AND 102). SN 76-699,614. PUB. 2-16-2010. FILED 9-24-2009.
- 3,783,134. **BIOBRIDGES (BLOCK FORM)**. BIOBRIDGES, LLC, (U.S. CLS. 100, 101 AND 102). SN 76-699,615. PUB. 2-16-2010. FILED 9-24-2009.
- 3,783,145. **LB LEBUA HOTELS & RESORTS AND DESIGN**. LEBUA HOTELS & RESORTS COMPANY LIMITED, MULTIPLE CLASS, (INT. CLS. 35, 43 AND 44), (U.S. CLS. 100, 101 AND 102). SN 77-078,787. PUB. 2-16-2010. FILED 1-9-2007.
- 3,783,159 (*See Class 9 for this trademark*).
- 3,783,165 (*See Class 25 for this trademark*).
- 3,783,167. **MUSIC RESOURCE GROUP (BLOCK FORM)**. MUSIC RESOURCE GROUP, LLC, (U.S. CLS. 100, 101 AND 102). SN 77-239,044. PUB. 2-16-2010. FILED 7-26-2007.
- 3,783,173. **BRIGHT FUTURES (BLOCK FORM)**. ELECTRICITY SECTOR COUNCIL, (U.S. CLS. 100, 101 AND 102). SN 77-273,289. PUB. 8-18-2009. FILED 9-6-2007.
- 3,783,174. **BUILDING BRIGHT FUTURES (BLOCK FORM)**. ELECTRICITY SECTOR COUNCIL, (U.S. CLS. 100, 101 AND 102). SN 77-273,425. PUB. 8-18-2009. FILED 9-6-2007.
- 3,783,177 (*See Class 9 for this trademark*).
- 3,783,181. **MISCELLANEOUS DESIGN**. SUISSE PROGRAMME LIMITED, (U.S. CLS. 100, 101 AND 102). SN 77-316,608. PUB. 2-16-2010. FILED 10-30-2007.
- 3,783,184 (*See Class 9 for this trademark*).
- 3,783,187 (*See Class 32 for this trademark*).
- 3,783,188. **SALESTRO (BLOCK FORM)**. GOLITZ, BERNHARD, MULTIPLE CLASS, (INT. CLS. 35 AND 42), (U.S. CLS. 100, 101 AND 102). SN 77-358,390. PUB. 7-7-2009. FILED 12-21-2007.
- 3,783,190 (*See Class 18 for this trademark*).
- 3,783,194. **MEDIA WHIZ SEARCH AND DESIGN**. MEDIA-WHIZ HOLDINGS, INC., (U.S. CLS. 100, 101 AND 102). SN 77-387,612. PUB. 2-16-2010. FILED 2-4-2008.
- 3,783,202. **VISION AND DESIGN**. SIGNET ARMORLITE EUROPE LIMITED, (U.S. CLS. 100, 101 AND 102). SN 77-396,694. PUB. 2-16-2010. FILED 2-14-2008.
- 3,783,208. **TECHWEB (BLOCK FORM)**. UNITED BUSINESS MEDIA LLC, (U.S. CLS. 100, 101 AND 102). SN 77-409,259. PUB. 2-16-2010. FILED 2-28-2008.
- 3,783,209. **TECHWEB AND DESIGN**. UNITED BUSINESS MEDIA LLC, (U.S. CLS. 100, 101 AND 102). SN 77-409,281. PUB. 2-16-2010. FILED 2-28-2008.
- 3,783,215. **MEDIA WHIZ DISPLAY AND DESIGN**. MEDIA-WHIZ HOLDINGS, INC., (U.S. CLS. 100, 101 AND 102). SN 77-423,880. PUB. 2-16-2010. FILED 3-17-2008.
- 3,783,217. **MEDASTAT (BLOCK FORM)**. RECOVERCARE, LLC, MULTIPLE CLASS, (INT. CLS. 35 AND 44), (U.S. CLS. 100, 101 AND 102). SN 77-432,780. PUB. 2-16-2010. FILED 3-27-2008.
- 3,783,226. **BIZJAM (BLOCK FORM)**. BIZNIK INC., DBA BIZNIK, (U.S. CLS. 100, 101 AND 102). SN 77-474,482.

- PUB. 1-6-2009. FILED 5-14-2008.
 3,783,231 (*See Class 3 for this trademark*).
 3,783,235 (*See Class 31 for this trademark*).
 3,783,238. **INTECHNO CONSULTING (BLOCK FORM)**. INTECHNO CONSULTING, MULTIPLE CLASS, (INT. CLS. 35, 41 AND 42), (U.S. CLS. 100, 101, 102 AND 107). SN 77-499,759. PUB. 9-29-2009. FILED 6-16-2008.
 3,783,242 (*See Class 3 for this trademark*).
 3,783,245. **VEILENS DETOX.SLIMMING.ANTI-AGING AND DESIGN**. SIMPLE GROUP, LLC, (U.S. CLS. 100, 101 AND 102). SN 77-513,601. PUB. 2-16-2010. FILED 7-2-2008.
 3,783,253. **TRESSFORT (BLOCK FORM)**. FORTRESS PARTICIPATIONS B.V., MULTIPLE CLASS, (INT. CLS. 35, 36 AND 37), (U.S. CLS. 100, 101, 102, 103 AND 106). SN 77-522,440. PUB. 2-16-2010. FILED 7-15-2008.
 3,783,255 (*See Class 1 for this trademark*).
 3,783,257. **D2XCHANGE, INFORMATION AT THE POINT YOU NEED IT AND DESIGN**. D2XCHANGE, LLC, (U.S. CLS. 100, 101 AND 102). SN 77-533,556. PUB. 2-16-2010. FILED 7-29-2008.
 3,783,262. **GEN79 AND DESIGN**. RED DISTRIBUTION, LLC, (U.S. CLS. 100, 101 AND 102). SN 77-536,769. PUB. 2-16-2010. FILED 8-1-2008.
 3,783,266 (*See Class 9 for this trademark*).
 3,783,271. **THE SPORTSMEN'S NATIONAL LAND TRUST (BLOCK FORM)**. SPORTSMEN'S NATIONAL LAND TRUST, INC., MULTIPLE CLASS, (INT. CLS. 35 AND 36), (U.S. CLS. 100, 101 AND 102). SN 77-550,204. PUB. 2-16-2010. FILED 8-19-2008.
 3,783,276. **TWSE (STYLIZED)**. TAIWAN STOCK EXCHANGE CORPORATION, MULTIPLE CLASS, (INT. CLS. 35 AND 36), (U.S. CLS. 100, 101 AND 102). SN 77-562,247. PUB. 10-13-2009. FILED 9-4-2008.
 3,783,279. **SINNERS AND DESIGN**. DIETRICH, MICHAEL J., (U.S. CLS. 100, 101 AND 102). SN 77-566,605. PUB. 2-16-2010. FILED 9-10-2008.
 3,783,282 (*See Class 30 for this trademark*).
 3,783,290. **MISCELLANEOUS DESIGN**. ADVENTURE DIVERS, INC., (U.S. CLS. 100, 101 AND 102). SN 77-587,413. PUB. 2-16-2010. FILED 10-7-2008.
 3,783,300. **LET YOUR FACE DO THE TALKING (BLOCK FORM)**. X-SCREAM VIDEO PRODUCTIONS INC., (U.S. CLS. 100, 101 AND 102). SN 77-596,521. PUB. 12-1-2009. FILED 10-20-2008.
 3,783,301. **IAC (BLOCK FORM)**. IAC/INTERACTIVECORP, (U.S. CLS. 100, 101 AND 102). SN 77-598,762. PUB. 2-16-2010. FILED 10-23-2008.
 3,783,313. **ONE TOUCH INTELLIGENCE AND DESIGN**. ONE TOUCH INTELLIGENCE, LLC, (U.S. CLS. 100, 101 AND 102). SN 77-630,148. PUB. 11-10-2009. FILED 12-10-2008.
 3,783,332. **STEINER (BLOCK FORM)**. STEINER ELECTRIC COMPANY, MULTIPLE CLASS, (INT. CLS. 35, 37, 40, 41, 42 AND 45), (U.S. CLS. 100, 101, 102, 103, 106 AND 107). SN 77-652,678. PUB. 2-16-2010. FILED 1-20-2009.
 3,783,333. **STEINER ELECTRIC COMPANY (BLOCK FORM)**. STEINER ELECTRIC COMPANY, MULTIPLE CLASS, (INT. CLS. 35, 37, 40, 41, 42 AND 45), (U.S. CLS. 100, 101, 102, 103, 106 AND 107). SN 77-652,703. PUB. 2-16-2010. FILED 1-20-2009.
 3,783,334. **STEINER POWER SYSTEMS (BLOCK FORM)**. STEINER ELECTRIC COMPANY, MULTIPLE CLASS, (INT. CLS. 35, 37, 40, 41 AND 42), (U.S. CLS. 100, 101, 102, 103, 106 AND 107). SN 77-652,731. PUB. 2-16-2010. FILED 1-20-2009.
 3,783,339. **STRATEGIC TALENT LIFE CYCLE (BLOCK FORM)**. BATRUS HOLLWEG INTERNATIONAL SELECTION SERVICES, LTD., (U.S. CLS. 100, 101 AND 102). SN 77-657,996. PUB. 2-16-2010. FILED 1-28-2009.
 3,783,346. **MYLIVEADS.COM SEE AND BE SEEN, AND DESIGN**. MY LIVE ADS, LLC, MULTIPLE CLASS, (INT. CLS. 35, 38 AND 42), (U.S. CLS. 100, 101, 102 AND 104). SN 77-667,868. PUB. 2-16-2010. FILED 2-11-2009.
 3,783,347. **MYLIVEADS (BLOCK FORM)**. MY LIVE ADS, LLC, MULTIPLE CLASS, (INT. CLS. 35, 38 AND 42), (U.S. CLS. 100, 101, 102 AND 104). SN 77-667,883. PUB. 2-16-2010. FILED 2-11-2009.
 3,783,351. **ELP EVENT LOGISTICS PARTNERSHIP AND DESIGN**. ROCK-IT CARGO USA LLC, (U.S. CLS. 100, 101 AND 102). SN 77-669,833. PUB. 2-16-2010. FILED 2-13-2009.
 3,783,352. **ROCKET YOUR BUSINESS TO THE NEXT LEVEL! (BLOCK FORM)**. MARKETING MIRACLES, INC., MULTIPLE CLASS, (INT. CLS. 35 AND 42), (U.S. CLS. 100, 101 AND 102). SN 77-670,186. PUB. 2-16-2010. FILED 2-13-2009.
 3,783,354. **INDEPENDENT CONNECTION (BLOCK FORM)**. OCCK, INC., MULTIPLE CLASS, (INT. CLS. 35, 41 AND 45), (U.S. CLS. 100, 101, 102 AND 107). SN 77-670,638. PUB. 2-16-2010. FILED 2-13-2009.
 3,783,361. **COPPER DEVELOPMENT ASSOCIATION AND DESIGN**. COPPER DEVELOPMENT ASSOCIATION INC., (U.S. CLS. 100, 101 AND 102). SN 77-674,743. PUB. 2-16-2010. FILED 2-20-2009.
 3,783,362. **QUINN MANAGEMENT SERVICES, INC. (BLOCK FORM)**. QUINN MANAGEMENT SERVICES, INC., (U.S. CLS. 100, 101 AND 102). SN 77-676,042. PUB. 2-16-2010. FILED 2-23-2009.
 3,783,364. **CIS COMPLIANCE IMPLEMENTATION SERVICES (STYLIZED)**. BARSH, TONI, (U.S. CLS. 100, 101 AND 102). SN 77-676,705. PUB. 2-16-2010. FILED 2-24-2009.
 3,783,366. **CROSS+ADS (BLOCK FORM)**. CROSS MEDIA CORPORATION, DBA CROSS.TV, (U.S. CLS. 100, 101 AND 102). SN 77-677,790. PUB. 1-12-2010. FILED 2-25-2009.
 3,783,368. **ACTIVFILE (BLOCK FORM)**. IRON MOUNTAIN INCORPORATED, MULTIPLE CLASS, (INT. CLS. 35, 38, 39 AND 42), (U.S. CLS. 100, 101, 102, 104 AND 105). SN 77-679,997. PUB. 2-16-2010. FILED 2-27-2009.
 3,783,376. **TURBO TRAFFIC TECHNOLOGY (BLOCK FORM)**. ASTONISH RESULTS, LP, MULTIPLE CLASS, (INT. CLS. 35 AND 42), (U.S. CLS. 100, 101 AND 102). SN 77-682,551. PUB. 2-16-2010. FILED 3-3-2009.
 3,783,391. **TELDX (BLOCK FORM)**. THE TRUSTEES OF THE TELDX AUSTRALIA TRUST, AN AUSTRALIAN TRUST, THE TRUSTEES COMPRISING OF TELDX HOLDING PTY LTD., AN AUSTRALIAN COMPANY, (U.S. CLS. 100, 101 AND 102). SN 77-687,006. PUB. 2-16-2010. FILED 3-10-2009.
 3,783,406. **CRAZY GUYS COMMUNICATIONS (BLOCK FORM)**. A & B COMM., INC., DBA CRAZY GUYS COMMUNICATIONS, (U.S. CLS. 100, 101 AND 102). SN 77-692,154. PUB. 2-16-2010. FILED S.R. 3-16-2009; AM. P.R. 12-8-2009.
 3,783,407 (*See Class 29 for this trademark*).
 3,783,422. **VALKRE (BLOCK FORM)**. VALKRE SOLUTIONS, INC., MULTIPLE CLASS, (INT. CLS. 35, 41 AND 42), (U.S. CLS. 100, 101, 102 AND 107). SN 77-695,882. PUB. 2-16-2010. FILED 3-20-2009.
 3,783,426. **MAKE IT HAPPEN FOR WOMEN AND DESIGN**. MAKE IT HAPPEN CONSULTING LLC, MULTIPLE CLASS, (INT. CLS. 35 AND 41), (U.S. CLS. 100, 101, 102 AND 107). SN 77-697,315. PUB. 2-16-2010. FILED 3-23-2009.
 3,783,428. **USF (BLOCK FORM)**. PRWT SERVICES, INC., MULTIPLE CLASS, (INT. CLS. 35 AND 37), (U.S. CLS. 100, 101, 102, 103 AND 106). SN 77-698,086. PUB. 2-16-2010. FILED 3-24-2009.
 3,783,429. **PRWT AND DESIGN**. PRWT SERVICES, INC., MULTIPLE CLASS, (INT. CLS. 35, 40 AND 42), (U.S. CLS. 100, 101, 102, 103 AND 106). SN 77-698,088. PUB. 2-16-2010. FILED 3-24-2009.
 3,783,430. **PRWT SERVICES, INC. (BLOCK FORM)**. PRWT SERVICES, INC., MULTIPLE CLASS, (INT. CLS. 35, 40 AND 42), (U.S. CLS. 100, 101, 102, 103 AND 106). SN 77-698,105. PUB. 2-16-2010. FILED 3-24-2009.
 3,783,431. **PRWT (BLOCK FORM)**. PRWT SERVICES, INC., MULTIPLE CLASS, (INT. CLS. 35, 40 AND 42), (U.S. CLS. 100, 101, 102, 103 AND 106). SN 77-698,113. PUB. 2-16-2010. FILED 3-24-2009.
 3,783,438. **STARBUZZ TOBACCO SINCE 2005 AND DESIGN**. STARBUZZ TOBACCO, INC., (U.S. CLS. 100, 101 AND 102). SN 77-699,268. PUB. 2-16-2010. FILED 3-25-2009.
 3,783,440. **PERFUMANIA AMERICA'S LEADING PERFUMERY CHAIN (STYLIZED)**. PERFUMANIA, INC., (U.S. CLS. 100, 101 AND 102). SN 77-699,626. PUB. 2-16-2010. FILED 3-26-2009.
 3,783,453. **SKYCO EQUIPMENT (BLOCK FORM)**. LEONARD HOLDINGS, LLC, MULTIPLE CLASS, (INT. CLS. 35 AND 37), (U.S. CLS. 100, 101, 102, 103 AND 106). SN 77-701,194. PUB. 2-16-2010. FILED 3-27-2009.

- 3,783,454. **NFTN (BLOCK FORM)**. PROFESSIONAL CONVENTION MANAGEMENT ASSOCIATION, MULTIPLE CLASS, (INT. CLS. 35 AND 43), (U.S. CLS. 100, 101 AND 102). SN 77-701,236. PUB. 2-16-2010. FILED 3-27-2009.
- 3,783,455. **NETWORK FOR THE NEEDY (BLOCK FORM)**. PROFESSIONAL CONVENTION MANAGEMENT ASSOCIATION, MULTIPLE CLASS, (INT. CLS. 35 AND 43), (U.S. CLS. 100, 101 AND 102). SN 77-701,242. PUB. 2-16-2010. FILED 3-27-2009.
- 3,783,458. **LANDAMERICA (BLOCK FORM)**. LANDAMERICA FINANCIAL GROUP, INC., MULTIPLE CLASS, (INT. CLS. 35, 36 AND 42), (U.S. CLS. 100, 101 AND 102). SN 77-701,438. PUB. 2-16-2010. FILED 3-27-2009.
- 3,783,460. **WE MONETIZE (BLOCK FORM)**. GIMMESOME-CANDY LLC, MULTIPLE CLASS, (INT. CLS. 35 AND 36), (U.S. CLS. 100, 101 AND 102). SN 77-701,637. PUB. 2-16-2010. FILED 3-29-2009.
- 3,783,461. **MCQUEEN & ASSOCIATES (BLOCK FORM)**. ROY D. MCQUEEN & ASSOCIATES, LTD., (U.S. CLS. 100, 101 AND 102). SN 77-701,701. PUB. 2-16-2010. FILED 3-29-2009.
- 3,783,463. **RDM (BLOCK FORM)**. ROY D. MCQUEEN & ASSOCIATES, LTD., (U.S. CLS. 100, 101 AND 102). SN 77-701,710. PUB. 2-16-2010. FILED 3-29-2009.
- 3,783,468. **STORECASTING (BLOCK FORM)**. AMERICAN MEDIA SERVICES INTERACTIVE, LLC, FORMERLY AMERICAN MEDIA SERVICES - INTERNET, LLC, (U.S. CLS. 100, 101 AND 102). SN 77-702,361. PUB. 2-16-2010. FILED 3-30-2009.
- 3,783,469. **STORECASTING ENTERTAIN, ADVERTISE, SELL AND DESIGN**. AMERICAN MEDIA SERVICES INTERACTIVE, LLC, FORMERLY AMERICAN MEDIA SERVICES - INTERNET, LLC, (U.S. CLS. 100, 101 AND 102). SN 77-702,372. PUB. 2-16-2010. FILED 3-30-2009.
- 3,783,470. **DENVER GOLD GROUP DENVER GOLD FORUM AND DESIGN**. DENVER GOLD GROUP, INC., (U.S. CLS. 100, 101 AND 102). SN 77-702,652. PUB. 2-16-2010. FILED 3-30-2009.
- 3,783,471. **DENVER GOLD GROUP EUROPEAN GOLD FORUM AND DESIGN**. DENVER GOLD GROUP, INC., (U.S. CLS. 100, 101 AND 102). SN 77-702,657. PUB. 2-16-2010. FILED 3-30-2009.
- 3,783,472. **DGG DENVER GOLD GROUP AND DESIGN**. DENVER GOLD GROUP, INC., (U.S. CLS. 100, 101 AND 102). SN 77-702,659. PUB. 2-16-2010. FILED 3-30-2009.
- 3,783,474. **FERTILEHOPE AND DESIGN**. LANCE ARMSTRONG FOUNDATION, (U.S. CLS. 100, 101 AND 102). SN 77-702,841. PUB. 2-16-2010. FILED 3-31-2009.
- 3,783,475. **FERTILE HOPE (BLOCK FORM)**. LANCE ARMSTRONG FOUNDATION, (U.S. CLS. 100, 101 AND 102). SN 77-702,843. PUB. 2-16-2010. FILED 3-31-2009.
- 3,783,478. **OE REMAN DIRECT AND DESIGN**. OE REMAN DIRECT LLC, (U.S. CLS. 100, 101 AND 102). SN 77-703,667. PUB. 2-16-2010. FILED 3-31-2009.
- 3,783,486. **ORIDIAN (BLOCK FORM)**. ORIDIAN CONSTRUCTION SERVICES, LLC, (U.S. CLS. 100, 101 AND 102). SN 77-704,620. PUB. 2-16-2010. FILED 4-1-2009.
- 3,783,489. **TERRIFICPETS (BLOCK FORM)**. TERRIFIC PETS, INC., (U.S. CLS. 100, 101 AND 102). SN 77-705,066. PUB. 2-16-2010. FILED 4-2-2009.
- 3,783,495 (*See Class 29 for this trademark*).
- 3,783,518. **PYROLYZER AND DESIGN**. PYROLYZER LLC, (U.S. CLS. 100, 101 AND 102). SN 77-711,163. PUB. 2-16-2010. FILED 4-9-2009.
- 3,783,519. **THE MARSO GROUP (BLOCK FORM)**. SOLORZANO, MARIO, DBA THE MARSO GROUP, (U.S. CLS. 100, 101 AND 102). SN 77-711,185. PUB. 2-16-2010. FILED 4-9-2009.
- 3,783,540. **BOXOFFICE (BLOCK FORM)**. BOXOFFICE MEDIA, LLC, MULTIPLE CLASS, (INT. CLS. 35 AND 41), (U.S. CLS. 100, 101, 102 AND 107). SN 77-713,352. PUB. 2-16-2010. FILED 4-14-2009.
- 3,783,541 (*See Class 6 for this trademark*).
- 3,783,544. **STARCOM MEDIAVEST GROUP (BLOCK FORM)**. STARCOM MEDIAVEST GROUP, INC., (U.S. CLS. 100, 101 AND 102). SN 77-713,528. PUB. 2-16-2010. FILED 4-14-2009.
- 3,783,550. **WABASH VALLEY POWER ENERGY SMART (BLOCK FORM)**. WABASH VALLEY POWER ASSOCIATION, MULTIPLE CLASS, (INT. CLS. 35 AND 37), (U.S. CLS. 100, 101, 102, 103 AND 106). SN 77-714,525. PUB. 2-16-2010. FILED 4-15-2009.
- 3,783,554 (*See Class 9 for this trademark*).
- 3,783,563. **SUPPLIERGATEWAY (BLOCK FORM)**. MID-AMERICA CONSULTING GROUP INC., (U.S. CLS. 100, 101 AND 102). SN 77-719,327. PUB. 2-16-2010. FILED 4-22-2009.
- 3,783,580 (*See Class 9 for this trademark*).
- 3,783,584. **J GIRL (BLOCK FORM)**. J GIRL, INC., (U.S. CLS. 100, 101 AND 102). SN 77-728,859. PUB. 2-16-2010. FILED 5-5-2009.
- 3,783,586. **HOLLISTER CALIFORNIA AND DESIGN**. ABERCROMBIE & FITCH TRADING CO., (U.S. CLS. 100, 101 AND 102). SN 77-730,229. PUB. 2-16-2010. FILED 5-6-2009.
- 3,783,599. **CAREER SOLUTIONS INTERNATIONAL (BLOCK FORM)**. CAREER SOLUTIONS INTERNATIONAL, INC., (U.S. CLS. 100, 101 AND 102). SN 77-736,337. PUB. 2-16-2010. FILED 5-13-2009.
- 3,783,620. **CEA CONSUMER ENERGY ALLIANCE (BLOCK FORM)**. CONSUMER ENERGY ALLIANCE, (U.S. CLS. 100, 101 AND 102). SN 77-751,986. PUB. 2-16-2010. FILED 6-4-2009.
- 3,783,621. **HELPING HANDS MOVERS, INC. NEED A HAND CALL US AND DESIGN**. HELPING HANDS MOVERS, INC., (U.S. CLS. 100, 101 AND 102). SN 77-752,263. PUB. 11-10-2009. FILED 6-4-2009.
- 3,783,627. **ECOUNTIT (BLOCK FORM)**. RAGEN, KENT, (U.S. CLS. 100, 101 AND 102). SN 77-753,625. PUB. 2-16-2010. FILED 6-5-2009.
- 3,783,629. **CHUBBYBRAIN (BLOCK FORM)**. ANAND SANWAL, (U.S. CLS. 100, 101 AND 102). SN 77-754,728. PUB. 2-16-2010. FILED 6-8-2009.
- 3,783,634. **COBRASIMPLE AND DESIGN**. BENEFITS RESOURCE, LLC, DBA BRLLC INSURANCE SERVICES, (U.S. CLS. 100, 101 AND 102). SN 77-755,788. PUB. 2-16-2010. FILED 6-9-2009.
- 3,783,636. **MTA BENEFITS MASSACHUSETTS TEACHERS ASSOCIATION AND DESIGN**. MASSACHUSETTS TEACHERS ASSOCIATION, (U.S. CLS. 100, 101 AND 102). SN 77-755,904. PUB. 2-16-2010. FILED 6-10-2009.
- 3,783,641. **BIOSTRATEGIES GROUP AND DESIGN**. BIOS-TRATEGIES GROUP, INC., (U.S. CLS. 100, 101 AND 102). SN 77-760,168. PUB. 2-16-2010. FILED 6-15-2009.
- 3,783,643. **NYCRUISE AND DESIGN**. NEW YORK CITY ECONOMIC DEVELOPMENT CORPORATION, (U.S. CLS. 100, 101 AND 102). SN 77-760,679. PUB. 11-10-2009. FILED 6-16-2009.
- 3,783,644 (*See Class 16 for this trademark*).
- 3,783,646. **A AHEAD AND DESIGN**. AHEAD, LLC, MULTIPLE CLASS, (INT. CLS. 35 AND 42), (U.S. CLS. 100, 101 AND 102). SN 77-761,500. PUB. 2-16-2010. FILED 6-17-2009.
- 3,783,651. **RUEHL (BLOCK FORM)**. ABERCROMBIE & FITCH TRADING CO., (U.S. CLS. 100, 101 AND 102). SN 77-761,581. PUB. 2-16-2010. FILED 6-17-2009.
- 3,783,659 (*See Class 9 for this trademark*).
- 3,783,678. **FLOWMONITOR AND DESIGN**. AOYAMA, MAMORU ABRAHAM, (U.S. CLS. 100, 101 AND 102). SN 77-769,239. PUB. 2-16-2010. FILED 6-26-2009.
- 3,783,693. **GAMESLOAD (BLOCK FORM)**. DEUTSCHE TELEKOM A.G., (U.S. CLS. 100, 101 AND 102). SN 77-774,749. PUB. 12-1-2009. FILED 7-6-2009.
- 3,783,694. **OPPORTUNE RISK (BLOCK FORM)**. OPPORTUNE RISK BRIDGING, LLC, (U.S. CLS. 100, 101 AND 102). SN 77-774,964. PUB. 2-16-2010. FILED 7-6-2009.
- 3,783,700. **MISCELLANEOUS DESIGN**. SARPINO'S USA, INC., (U.S. CLS. 100, 101 AND 102). SN 77-777,743. PUB. 2-16-2010. FILED 7-9-2009.
- 3,783,702 (*See Class 16 for this trademark*).
- 3,783,709. **ACTION REFLECTION LEARNING (BLOCK FORM)**. LEADERSHIP IN INTERNATIONAL MANAGEMENT LLC, (U.S. CLS. 100, 101 AND 102). SN 77-779,593. PUB. 2-16-2010. FILED 7-13-2009.
- 3,783,715. **FAST TRAK (BLOCK FORM)**. ADVANTEK, INC., (U.S. CLS. 100, 101 AND 102). SN 77-783,504. PUB. 2-16-2010. FILED 7-17-2009.
- 3,783,716. **GO GREEN & FEED THE NEEDY (BLOCK FORM)**. BOURGEOIS, GEORGE M., DBA BOURGEOIS ENTERPRISES, (U.S. CLS. 100, 101 AND 102). SN 77-784,231. PUB.

- 2-16-2010. FILED 7-17-2009.
- 3,783,718. **WE KNOW FRUIT (BLOCK FORM)**. EDIBLE ARRANGEMENTS, LLC, (U.S. CLS. 100, 101 AND 102). SN 77-784,798. PUB. 2-16-2010. FILED 7-20-2009.
- 3,783,721. **MCC (BLOCK FORM)**. MEDICAL COMMUNICATION CONSULTANTS, LLC, MULTIPLE CLASS, (INT. CLS. 35, 41 AND 42), (U.S. CLS. 100, 101, 102 AND 107). SN 77-785,484. PUB. 2-16-2010. FILED 7-21-2009.
- 3,783,722. **MCC AND DESIGN**. MEDICAL COMMUNICATION CONSULTANTS, LLC, MULTIPLE CLASS, (INT. CLS. 35, 41 AND 42), (U.S. CLS. 100, 101, 102 AND 107). SN 77-785,488. PUB. 2-16-2010. FILED 7-21-2009.
- 3,783,724. **BEST FRIEND SERVICES (BLOCK FORM)**. SAIF AUTO INC., (U.S. CLS. 100, 101 AND 102). SN 77-786,678. PUB. 2-16-2010. FILED 7-22-2009.
- 3,783,725. **MEMORIALS FOR A LIFETIME (BLOCK FORM)**. SAIF AUTO INC., (U.S. CLS. 100, 101 AND 102). SN 77-786,689. PUB. 2-16-2010. FILED 7-22-2009.
- 3,783,736 (*See Class 29 for this trademark*).
- 3,783,738. **DEFINITIVE (BLOCK FORM)**. DEFINITIVE AUDIO, INC., (U.S. CLS. 100, 101 AND 102). SN 77-793,548. PUB. 2-16-2010. FILED 7-30-2009.
- 3,783,740. **MISCELLANEOUS DESIGN**. THE BROADWAY LEAGUE INC., MULTIPLE CLASS, (INT. CLS. 35 AND 41), (U.S. CLS. 100, 101, 102 AND 107). SN 77-793,613. PUB. 2-16-2010. FILED 7-30-2009.
- 3,783,744. **A ALLEGRA (STYLIZED)**. ALLEGRA HOLDINGS LLC, MULTIPLE CLASS, (INT. CLS. 35, 40 AND 42), (U.S. CLS. 100, 101, 102, 103 AND 106). SN 77-794,210. PUB. 2-16-2010. FILED 7-31-2009.
- 3,783,745. **JERSEY ANGEL (BLOCK FORM)**. VILLANO, MARY, (U.S. CLS. 100, 101 AND 102). SN 77-794,258. PUB. 2-16-2010. FILED 7-31-2009.
- 3,783,749. **MARINA DEL REY (BLOCK FORM)**. MARINA DEL REY CONVENTION AND VISITORS BUREAU, (U.S. CLS. 100, 101 AND 102). SN 77-794,720. PUB. 2-16-2010. FILED 7-31-2009.
- 3,783,755. **RADEBAUGH FLORIST & GREENHOUSES (BLOCK FORM)**. GEORGE W. RADEBAUGH & SONS, INC., (U.S. CLS. 100, 101 AND 102). SN 77-795,265. PUB. 2-16-2010. FILED 8-3-2009.
- 3,783,761. **LENOX AMERICAN BY DESIGN AND DESIGN**. LENOX CORPORATION, FORMERLY LENOX, INCORPORATED, (U.S. CLS. 100, 101 AND 102). SN 77-796,659. PUB. 2-16-2010. FILED 8-4-2009.
- 3,783,774. **MARIE DENEÉ CURVY.CONFIDENT.CHIC.WWW.MARIEDENEÉ.COM AND DESIGN**. MARIE DENEÉ LLC, (U.S. CLS. 100, 101 AND 102). SN 77-800,431. PUB. 2-16-2010. FILED 8-9-2009.
- 3,783,784. **CORBETT (BLOCK FORM)**. CORBETT ACCEL HEALTHCARE GROUP CHICAGO INC., (U.S. CLS. 100, 101 AND 102). SN 77-802,605. PUB. 2-16-2010. FILED 8-12-2009.
- 3,783,786. **JOE DAVIDSON'S GRILL CAMP (BLOCK FORM)**. JOE DAVIDSON'S GRILL CAMP, LLC, (U.S. CLS. 100, 101 AND 102). SN 77-802,817. PUB. 2-16-2010. FILED 8-12-2009.
- 3,783,800. **SHOPKOMEN.COM (BLOCK FORM)**. THE SUSAN G. KOMEN BREAST CANCER FOUNDATION, INC., (U.S. CLS. 100, 101 AND 102). SN 77-804,391. PUB. 2-16-2010. FILED 8-13-2009.
- 3,783,803. **FIVE DISCIPLINES OF INNOVATION (BLOCK FORM)**. SRI INTERNATIONAL, MULTIPLE CLASS, (INT. CLS. 35 AND 41), (U.S. CLS. 100, 101, 102 AND 107). SN 77-804,885. PUB. 2-16-2010. FILED 8-14-2009.
- 3,783,809. **MISCELLANEOUS DESIGN**. CHAD FORBUSH, AMERICAN HOME GUARDIAN, (U.S. CLS. 100, 101 AND 102). SN 77-806,928. PUB. 2-16-2010. FILED 8-18-2009.
- 3,783,811. **BESS (BLOCK FORM)**. MORSELS, L.P., (U.S. CLS. 100, 101 AND 102). SN 77-807,365. PUB. 2-16-2010. FILED 8-18-2009.
- 3,783,817 (*See Class 25 for this trademark*).
- 3,783,834. **EAST RIVER ENERGY (BLOCK FORM)**. EAST RIVER ENERGY, INC., FORMERLY EAST RIVER OIL COMPANY, INC., MULTIPLE CLASS, (INT. CLS. 35, 36, 37 AND 39), (U.S. CLS. 100, 101, 102, 103, 105 AND 106). SN 77-811,263. PUB. 2-16-2010. FILED 8-24-2009.
- 3,783,840. **CRYSTAL CLEAR CONNEXIONS (BLOCK FORM)**. CRYSTAL CLEAR CONNEXIONS LLC, MULTIPLE CLASS, (INT. CLS. 35, 41 AND 45), (U.S. CLS. 100, 101, 102 AND 107). SN 77-813,091. PUB. 2-16-2010. FILED 8-26-2009.
- 3,783,858. **ADTOLIST.COM (BLOCK FORM)**. ADVIRTPRO, LLC, DBA ADTOLIST.COM, (U.S. CLS. 100, 101 AND 102). SN 77-814,617. PUB. 2-16-2010. FILED 8-27-2009.
- 3,783,865. **MY ALUMNI LINK AND DESIGN**. MY ALUMNI LINK LLC, (U.S. CLS. 100, 101 AND 102). SN 77-815,144. PUB. 2-16-2010. FILED 8-28-2009.
- 3,783,866. **CHOCOLATE MILK: THE OFFICIAL DRINK OF HALLOWEEN (BLOCK FORM)**. NATIONAL FLUID MILK PROCESSOR PROMOTION BOARD, (U.S. CLS. 100, 101 AND 102). SN 77-815,388. PUB. 2-16-2010. FILED 8-28-2009.
- 3,783,872. **NOVA . CORP AND DESIGN**. JULIAN SAROKIN, (U.S. CLS. 100, 101 AND 102). SN 77-816,031. PUB. 2-16-2010. FILED 8-30-2009.
- 3,783,880. **FOOTBALL AMERICA (BLOCK FORM)**. TEAM EXPRESS DISTRIBUTING, LLC, (U.S. CLS. 100, 101 AND 102). SN 77-817,134. PUB. 2-16-2010. FILED 9-1-2009.
- 3,783,881. **FOOTBALL AMERICA AND DESIGN**. TEAM EXPRESS DISTRIBUTING, LLC, (U.S. CLS. 100, 101 AND 102). SN 77-817,148. PUB. 2-16-2010. FILED 9-1-2009.
- 3,783,893. **PUMP-N-SHOP (BLOCK FORM)**. ARGUINDEGUI PUMP-N-SHOP, LTD., (U.S. CLS. 100, 101 AND 102). SN 77-818,276. PUB. 2-16-2010. FILED 9-2-2009.
- 3,783,895 (*See Class 18 for this trademark*).
- 3,783,904. **BRATNEY COMPANIES (BLOCK FORM)**. KEN BRATNEY CO., THE, MULTIPLE CLASS, (INT. CLS. 35 AND 42), (U.S. CLS. 100, 101 AND 102). SN 77-819,336. PUB. 2-16-2010. FILED 9-3-2009.
- 3,783,909. **MHQ (STYLIZED)**. NATICK AUTO SALES, INC., MULTIPLE CLASS, (INT. CLS. 35 AND 37), (U.S. CLS. 100, 101, 102, 103 AND 106). SN 77-820,161. PUB. 2-16-2010. FILED 9-4-2009.
- 3,783,915. **NOTICE KIOSK (BLOCK FORM)**. UNMANIFESTED, LLC, (U.S. CLS. 100, 101 AND 102). SN 77-820,703. PUB. 2-16-2010. FILED 9-4-2009.
- 3,783,918. **RED, BROWN AND BLUE (BLOCK FORM)**. VICTORY BOULEVARD CORPORATION, (U.S. CLS. 100, 101 AND 102). SN 77-820,855. PUB. 2-16-2010. FILED 9-4-2009.
- 3,783,920. **LC 411 WWW.LOCALCHURCH411.COM (STYLIZED)**. BULLOCK, LEILA ANN, DBA LOCAL CHURCH 411, (U.S. CLS. 100, 101 AND 102). SN 77-820,995. PUB. 2-16-2010. FILED 9-5-2009.
- 3,783,932. **SHARKBUYER AND DESIGN**. URBAN HOMES AND INVESTMENTS, MULTIPLE CLASS, (INT. CLS. 35 AND 39), (U.S. CLS. 100, 101, 102 AND 105). SN 77-822,121. PUB. 2-16-2010. FILED 9-8-2009.
- 3,783,936 (*See Class 18 for this trademark*).
- 3,783,938. **TM AND DESIGN**. TRANSMONTAIGNE INC., MULTIPLE CLASS, (INT. CLS. 35, 39 AND 40), (U.S. CLS. 100, 101, 102, 103, 105 AND 106). SN 77-822,374. PUB. 2-16-2010. FILED 9-9-2009.
- 3,783,939. **GRAPHENE (BLOCK FORM)**. GRAPHENE, LLC, MULTIPLE CLASS, (INT. CLS. 35 AND 42), (U.S. CLS. 100, 101 AND 102). SN 77-822,399. PUB. 2-16-2010. FILED 9-9-2009.
- 3,783,942. **UNRULY MEDIA (BLOCK FORM)**. UNRULY MEDIA LTD, MULTIPLE CLASS, (INT. CLS. 35 AND 42), (U.S. CLS. 100, 101 AND 102). SN 77-822,455. PUB. 2-16-2010. FILED 9-9-2009.
- 3,783,946. **CHOCOLATE MONKEY AND DESIGN**. BRANHAM, MARY, (U.S. CLS. 100, 101 AND 102). SN 77-822,563. PUB. 2-16-2010. FILED 9-9-2009.
- 3,783,947. **EVISOS (BLOCK FORM)**. ESCOLAR, JULIO ALFREDO, (U.S. CLS. 100, 101 AND 102). SN 77-822,569. PUB. 2-16-2010. FILED 9-9-2009.
- 3,783,950. **PROFESSIONAL BOWHUNTERS SOCIETY QUALIFIED MEMBER AND DESIGN**. PROFESSIONAL BOWHUNTERS SOCIETY, INC., (U.S. CLS. 100, 101 AND 102). SN 77-822,829. PUB. 2-16-2010. FILED 9-9-2009.
- 3,783,960. **IMC AND DESIGN**. INTERAMERICAN MOTOR CORPORATION, (U.S. CLS. 100, 101 AND 102). SN 77-823,605. PUB. 2-16-2010. FILED 9-10-2009.
- 3,783,970. **DMS MOVING SYSTEMS (BLOCK FORM)**. DEARBORN MOVING AND STORAGE, INC., MULTIPLE CLASS, (INT. CLS. 35 AND 39), (U.S. CLS. 100, 101, 102

- AND 105). SN 77-823,862. PUB. 2-16-2010. FILED 9-10-2009.
- 3,783,971. **DMS MOVING SYSTEMS AND DESIGN**. DEARBORN MOVING AND STORAGE, INC., MULTIPLE CLASS, (INT. CLS. 35 AND 39), (U.S. CLS. 100, 101, 102 AND 105). SN 77-823,906. PUB. 2-16-2010. FILED 9-10-2009.
- 3,784,017. **SINGER22 (BLOCK FORM)**. GOSI ENTERPRISES, LTD., (U.S. CLS. 100, 101 AND 102). SN 77-825,518. PUB. 2-16-2010. FILED 9-13-2009.
- 3,784,020. **RED STRIPE PLANE GROUP (BLOCK FORM)**. RS PLANES, INC., (U.S. CLS. 100, 101 AND 102). SN 77-825,772. PUB. 2-16-2010. FILED 9-14-2009.
- 3,784,021. **RED STRIPE PLANE GROUP AND DESIGN**. RS PLANES, INC., (U.S. CLS. 100, 101 AND 102). SN 77-825,773. PUB. 2-16-2010. FILED 9-14-2009.
- 3,784,040. **PRIME CUTS OF BLUEGRASS AND DESIGN**. KBC MUSIC, INC., (U.S. CLS. 100, 101 AND 102). SN 77-826,285. PUB. 2-16-2010. FILED 9-14-2009.
- 3,784,060. **RANA FURNITURE AND DESIGN**. MADESA, INC., DBA RANA FURNITURE, (U.S. CLS. 100, 101 AND 102). SN 77-826,924. PUB. 2-16-2010. FILED 9-15-2009.
- 3,784,065. **MISCELLANEOUS DESIGN**. SAFE HOME PRODUCTS, INC., (U.S. CLS. 100, 101 AND 102). SN 77-827,061. PUB. 2-16-2010. FILED 9-15-2009.
- 3,784,076. **IDEATION NATION (BLOCK FORM)**. CERULLO, WAYNE, (U.S. CLS. 100, 101 AND 102). SN 77-827,393. PUB. 2-16-2010. FILED 9-16-2009.
- 3,784,083. **UPLANDERS WAREHOUSE (BLOCK FORM)**. UPLANDERS WAREHOUSE LLC, DBA UPLANDERS WAREHOUSE, (U.S. CLS. 100, 101 AND 102). SN 77-827,584. PUB. 2-16-2010. FILED 9-16-2009.
- 3,784,096. **SQUIRREL'S BAKERY AND DESIGN**. SQUIRREL'S LLC, (U.S. CLS. 100, 101 AND 102). SN 77-827,812. PUB. 2-16-2010. FILED 9-16-2009.
- 3,784,100. **ARC FRAMEWORK (BLOCK FORM)**. QUANTUM LEADERS, INC., (U.S. CLS. 100, 101 AND 102). SN 77-827,931. PUB. 2-16-2010. FILED 9-16-2009.
- 3,784,104. **HAN-DEE HUGO'S (BLOCK FORM)**. SAMPSON-BLADEN OIL COMPANY, INC., (U.S. CLS. 100, 101 AND 102). SN 77-828,117. PUB. 2-16-2010. FILED 9-16-2009.
- 3,784,108. **THE VALUE OF ONE (BLOCK FORM)**. PENDUM LLC, MULTIPLE CLASS, (INT. CLS. 35 AND 36), (U.S. CLS. 100, 101 AND 102). SN 77-828,221. PUB. 2-16-2010. FILED 9-16-2009.
- 3,784,114. **HITBOARDJOBS.COM AND DESIGN**. COLASOCIATES, (U.S. CLS. 100, 101 AND 102). SN 77-828,362. PUB. 2-16-2010. FILED 9-17-2009.
- 3,784,119. **ONE STOP JERKY SHOP (BLOCK FORM)**. BUEGE, DENNIS, DBA ONE STOP JERKY SHOP, (U.S. CLS. 100, 101 AND 102). SN 77-828,410. PUB. 2-16-2010. FILED 9-17-2009.
- 3,784,135. **GENESIS PROFESSIONAL ORGANIZERS "THE BEGINNING OF THE END OF THE CLUTTER" AND DESIGN**. DINA MARTIN, (U.S. CLS. 100, 101 AND 102). SN 77-828,585. PUB. 2-16-2010. FILED 9-17-2009.
- 3,784,143. **MISSISSIPPI RIVER HILLS ASSOCIATION FOUNDED 2007 AND DESIGN**. MISSISSIPPI RIVER HILLS ASSOCIATION, (U.S. CLS. 100, 101 AND 102). SN 77-828,772. PUB. 2-16-2010. FILED 9-17-2009.
- 3,784,149. **VMS REALTIME (BLOCK FORM)**. VIDEO MONITORING SERVICES OF AMERICA, L.P., (U.S. CLS. 100, 101 AND 102). SN 77-828,876. PUB. 2-16-2010. FILED 9-17-2009.
- 3,784,150. **OFFER BADGE (BLOCK FORM)**. TRAFFICMARKETPLACE, INC., (U.S. CLS. 100, 101 AND 102). SN 77-828,888. PUB. 2-16-2010. FILED 9-17-2009.
- 3,784,152. **DRAGON*CON AND DESIGN**. DRAGONCON/ACE, INC., (U.S. CLS. 100, 101 AND 102). SN 77-828,959. PUB. 2-16-2010. FILED 9-17-2009.
- 3,784,157. **ADSIGHT MAX (BLOCK FORM)**. VIDEO MONITORING SERVICES OF AMERICA, L.P., (U.S. CLS. 100, 101 AND 102). SN 77-829,002. PUB. 2-16-2010. FILED 9-17-2009.
- 3,784,158. **SGMP (BLOCK FORM)**. SOCIETY OF GOVERNMENT MEETING PROFESSIONALS, INC., (U.S. CLS. 100, 101 AND 102). SN 77-829,043. PUB. 2-16-2010. FILED 9-17-2009.
- 3,784,162. **MINDING YOUR BUSINESS AND DESIGN**. MINDING YOUR BUSINESS, INC., (U.S. CLS. 100, 101 AND 102). SN 77-829,117. PUB. 2-16-2010. FILED 9-17-2009.
- 3,784,164. **GRAND PLAY MEDIA (BLOCK FORM)**. GRAND PLAY MEDIA, LLC, (U.S. CLS. 100, 101 AND 102). SN 77-829,202. PUB. 2-16-2010. FILED 9-17-2009.
- 3,784,166. **YOU'VE ARRIVED (BLOCK FORM)**. GUARANTEED MERCHANDISE, INC., (U.S. CLS. 100, 101 AND 102). SN 77-829,230. PUB. 2-16-2010. FILED 9-17-2009.
- 3,784,174. **THE SCIENCE TO LEAD MARKETS (BLOCK FORM)**. SENTRANA, INC., MULTIPLE CLASS, (INT. CLS. 35 AND 42), (U.S. CLS. 100, 101 AND 102). SN 77-829,470. PUB. 2-16-2010. FILED 9-18-2009.
- 3,784,175. **RUTTER'S REWARDS (BLOCK FORM)**. RUTTER'S HOLDINGS, INC., (U.S. CLS. 100, 101 AND 102). SN 77-829,472. PUB. 2-16-2010. FILED 9-18-2009.
- 3,784,177. **TMC THE MEN'S CLUB EST. 2009 - CHICAGO, IL AND DESIGN**. THE MEN'S CLUB, INC., (U.S. CLS. 100, 101 AND 102). SN 77-829,487. PUB. 2-16-2010. FILED 9-18-2009.
- 3,784,178. **E-WEBSMART (BLOCK FORM)**. E-WEBSMART L.L.C., (U.S. CLS. 100, 101 AND 102). SN 77-829,519. PUB. 2-16-2010. FILED 9-18-2009.
- 3,784,180. **SANDSATIONAL (BLOCK FORM)**. KEVMAR VENTURES, LLC, (U.S. CLS. 100, 101 AND 102). SN 77-829,591. PUB. 2-16-2010. FILED 9-18-2009.
- 3,784,181. **TMF HEALTH QUALITY INSTITUTE (BLOCK FORM)**. TMF HEALTH QUALITY INSTITUTE, (U.S. CLS. 100, 101 AND 102). SN 77-829,614. PUB. 2-16-2010. FILED 9-18-2009.
- 3,784,193. **E EMPLOYER FLEXIBLE A BETTER WAY TO DO BUSINESS (STYLIZED)**. EMPLOYER FLEXIBLE HR INC., (U.S. CLS. 100, 101 AND 102). SN 77-829,772. PUB. 2-16-2010. FILED 9-18-2009.
- 3,784,196 (*See Class 9 for this trademark*).
- 3,784,199. **TMF HEALTH QUALITY INSTITUTE AND DESIGN**. TMF HEALTH QUALITY INSTITUTE, (U.S. CLS. 100, 101 AND 102). SN 77-829,892. PUB. 2-16-2010. FILED 9-18-2009.
- 3,784,216. **XPLORE SOFTWARE CONSULTING (BLOCK FORM)**. XPLORE SOFTWARE CONSULTING, INC., MULTIPLE CLASS, (INT. CLS. 35 AND 42), (U.S. CLS. 100, 101 AND 102). SN 77-830,257. PUB. 2-16-2010. FILED 9-18-2009.
- 3,784,227 (*See Class 9 for this trademark*).
- 3,784,234. **HEADSTART AND DESIGN**. HEADSTART CORPORATION, LTD, (U.S. CLS. 100, 101 AND 102). SN 77-830,468. PUB. 2-16-2010. FILED 9-19-2009.
- 3,784,236. **GP A GRAPE PEAR WINE BOUTIQUE AND DESIGN**. KRYSTLE HARB CORPORATION, DBA A GRAPE PEAR WINE BOUTIQUE, (U.S. CLS. 100, 101 AND 102). SN 77-830,496. PUB. 2-16-2010. FILED 9-19-2009.
- 3,784,244. **AUTOREEL (BLOCK FORM)**. ECARLIST, LLC, (U.S. CLS. 100, 101 AND 102). SN 77-830,578. PUB. 2-16-2010. FILED 9-20-2009.
- 3,784,246. **DESIGNERGIST (BLOCK FORM)**. DESIGNERGIST, (U.S. CLS. 100, 101 AND 102). SN 77-830,585. PUB. 2-16-2010. FILED 9-20-2009.
- 3,784,253. **AM AND DESIGN**. ALLIED MARINE, LLC, MULTIPLE CLASS, (INT. CLS. 35, 36, 37, 39 AND 42), (U.S. CLS. 100, 101, 102, 103, 105 AND 106). SN 77-830,701. PUB. 2-16-2010. FILED 9-21-2009.
- 3,784,257 (*See Class 9 for this trademark*).
- 3,784,275. **IOWA80.COM (BLOCK FORM)**. IOWA 80 GROUP, INC., (U.S. CLS. 100, 101 AND 102). SN 77-830,923. PUB. 2-16-2010. FILED 9-21-2009.
- 3,784,287. **UNITED SOURCING ALLIANCE (BLOCK FORM)**. UNITED SOURCING ALLIANCE, LLC, (U.S. CLS. 100, 101 AND 102). SN 77-831,068. PUB. 2-16-2010. FILED 9-21-2009.
- 3,784,298. **ATLANTIC TILE IMPORTS (BLOCK FORM)**. VESTAL TILE DISTRIBUTORS, INC., (U.S. CLS. 100, 101 AND 102). SN 77-831,191. PUB. 2-16-2010. FILED 9-21-2009.
- 3,784,300. **+ COLLEGE (BLOCK FORM)**. GREATER CLEVELAND PARTNERSHIP, (U.S. CLS. 100, 101 AND 102). SN 77-831,202. PUB. 2-16-2010. FILED 9-21-2009.
- 3,784,308. **MUDPIES MALL (BLOCK FORM)**. SCHOOLHOUSE LEARNING COMMUNITIES, INC., (U.S. CLS. 100, 101 AND 102). SN 77-831,333. PUB. 2-16-2010. FILED 9-21-2009.
- 3,784,313. **RIPPHONE (BLOCK FORM)**. RIPPHONE, INC., (U.S. CLS. 100, 101 AND 102). SN 77-831,374. PUB. 2-16-2010. FILED 9-21-2009.

- 3,784,318. **ARDENT IMPRESSIONS (BLOCK FORM)**. ARDENT IMPRESSIONS INC., FORMERLY INSTAFOTOS INC., (U.S. CLS. 100, 101 AND 102). SN 77-831,476. PUB. 2-16-2010. FILED 9-21-2009.
- 3,784,320. **LEATHERUP.COM (BLOCK FORM)**. NANAL INC., (U.S. CLS. 100, 101 AND 102). SN 77-831,530. PUB. 2-16-2010. FILED 9-21-2009.
- 3,784,321. **VENTUREMASH (BLOCK FORM)**. VENTUREMASH LLC, (U.S. CLS. 100, 101 AND 102). SN 77-831,534. PUB. 2-16-2010. FILED 9-21-2009.
- 3,784,329. **WE COUNT CARBON (BLOCK FORM)**. FUTUREPAST: INC., (U.S. CLS. 100, 101 AND 102). SN 77-831,648. PUB. 2-16-2010. FILED 9-22-2009.
- 3,784,332. **MISCELLANEOUS DESIGN**. EXPONATION, L.L.C., (U.S. CLS. 100, 101 AND 102). SN 77-831,691. PUB. 2-16-2010. FILED 9-22-2009.
- 3,784,338. **MUDPIES AND BUTTERFLIES (BLOCK FORM)**. SCHOOLHOUSE LEARNING COMMUNITIES, INC., MULTIPLE CLASS, (INT. CLS. 35, 38 AND 41), (U.S. CLS. 100, 101, 102, 104 AND 107). SN 77-831,738. PUB. 2-16-2010. FILED 9-22-2009.
- 3,784,352 (*See Class 25 for this trademark*).
- 3,784,367. **DODGING DIABETES CHARITY DODGEBALL TOURNAMENT AND DESIGN**. DODGING DIABETES, INC., MULTIPLE CLASS, (INT. CLS. 35, 36 AND 41), (U.S. CLS. 100, 101, 102 AND 107). SN 77-832,151. PUB. 2-16-2010. FILED 9-22-2009.
- 3,784,369. **DODGING DIABETES (BLOCK FORM)**. DODGING DIABETES, INC., MULTIPLE CLASS, (INT. CLS. 35, 36 AND 41), (U.S. CLS. 100, 101, 102 AND 107). SN 77-832,161. PUB. 2-16-2010. FILED 9-22-2009.
- 3,784,383. **PROJECT INNOCENT HEART (BLOCK FORM)**. TACHBULOS-STRATEGIES, INC., (U.S. CLS. 100, 101 AND 102). SN 77-832,259. PUB. 2-16-2010. FILED 9-22-2009.
- 3,784,389. **KNOWCLICK (BLOCK FORM)**. KNOWCLICK LLC, DBA KNOWCLICK, (U.S. CLS. 100, 101 AND 102). SN 77-832,323. PUB. 2-16-2010. FILED 9-22-2009.
- 3,784,409. **RADIANT EDGE (BLOCK FORM)**. RADIANT, LLC, (U.S. CLS. 100, 101 AND 102). SN 77-832,629. PUB. 2-16-2010. FILED 9-22-2009.
- 3,784,410. **CINNAHOLIC (BLOCK FORM)**. RADKE, FLORIAN, (U.S. CLS. 100, 101 AND 102). SN 77-832,634. PUB. 2-16-2010. FILED 9-22-2009.
- 3,784,418. **FAAST FAITH ALLIANCE AGAINST SLAVERY AND TRAFFICKING AND DESIGN**. WORLD HOPE INTERNATIONAL INC., (U.S. CLS. 100, 101 AND 102). SN 77-832,692. PUB. 2-16-2010. FILED 9-23-2009.
- 3,784,444. **AMERIVISION (BLOCK FORM)**. AMERIFLEET TRANSPORTATION, INC., (U.S. CLS. 100, 101 AND 102). SN 77-833,031. PUB. 2-16-2010. FILED 9-23-2009.
- 3,784,450. **MARKETICITY (BLOCK FORM)**. MARKETICITY INC., FORMERLY RON SCHERER & COMPANY, (U.S. CLS. 100, 101 AND 102). SN 77-833,145. PUB. 2-16-2010. FILED 9-23-2009.
- 3,784,471. **WHERE BRANDS AND WOMEN CLICK (BLOCK FORM)**. PROSPECTIV DIRECT, INC., (U.S. CLS. 100, 101 AND 102). SN 77-833,356. PUB. 2-16-2010. FILED 9-23-2009.
- 3,784,486. **BROTHERS BY CHOICE (STYLIZED)**. BROTHERS BY CHOICE, LLC., (U.S. CLS. 100, 101 AND 102). SN 77-833,510. PUB. 2-16-2010. FILED 9-23-2009.
- 3,784,489. **ENMARKET AND DESIGN**. GOODE, WILLIAM H., DBA GPM PRINT MAIL SOLUTIONS, MULTIPLE CLASS, (INT. CLS. 35 AND 40), (U.S. CLS. 100, 101, 102, 103 AND 106). SN 77-833,533. PUB. 2-16-2010. FILED 9-23-2009.
- 3,784,491. **OPEN MINDS OPEN MINDS (BLOCK FORM)**. LEICHLITER ASSOCIATES, LLC, (U.S. CLS. 100, 101 AND 102). SN 77-833,543. PUB. 2-16-2010. FILED 9-23-2009.
- 3,784,492. **ENFLOW AND DESIGN**. GOODE, WILLIAM H., DBA GPM PRINT MAIL SOLUTIONS, MULTIPLE CLASS, (INT. CLS. 35 AND 40), (U.S. CLS. 100, 101, 102, 103 AND 106). SN 77-833,560. PUB. 2-16-2010. FILED 9-23-2009.
- 3,784,493 (*See Class 10 for this trademark*).
- 3,784,502. **KGS (BLOCK FORM)**. KFORCE INC., (U.S. CLS. 100, 101 AND 102). SN 77-833,735. PUB. 2-16-2010. FILED 9-24-2009.
- 3,784,505. **MISCELLANEOUS DESIGN**. POLICY IMPACT STRATEGIC COMMUNICATIONS, INC., DBA POLICY IMPACT COMMUNICATIONS, (U.S. CLS. 100, 101 AND 102). SN 77-833,751. PUB. 2-16-2010. FILED 9-24-2009.
- 3,784,506. **WHEN ONLY BOLD WILL DO. (BLOCK FORM)**. POLICY IMPACT STRATEGIC COMMUNICATIONS, INC., DBA POLICY IMPACT COMMUNICATIONS, (U.S. CLS. 100, 101 AND 102). SN 77-833,755. PUB. 2-16-2010. FILED 9-24-2009.
- 3,784,514. **ZUMI (STYLIZED)**. ZUMI COLLECTION, (U.S. CLS. 100, 101 AND 102). SN 77-833,818. PUB. 2-16-2010. FILED 9-24-2009.
- 3,784,522. **UBELONG VOLUNTEER. DISCOVER. IMPACT. AND DESIGN**. UBELONG LLC, DBA UBELONG, (U.S. CLS. 100, 101 AND 102). SN 77-833,935. PUB. 2-16-2010. FILED 9-24-2009.
- 3,784,526. **4A WORLD (BLOCK FORM)**. AAAA WORLD IMPORT-EXPORT, INC., (U.S. CLS. 100, 101 AND 102). SN 77-833,974. PUB. 2-16-2010. FILED 9-24-2009.
- 3,784,539. **MATTRESS CAPITAL (BLOCK FORM)**. MATTRESS CAPITAL, (U.S. CLS. 100, 101 AND 102). SN 77-834,103. PUB. 2-16-2010. FILED 9-24-2009.
- 3,784,541. **DBCONSULTATION HR PROFESSIONALS DEDICATED TO YOUR SUCCESS AND DESIGN**. JOHANSON CONSULTING, INC., DBA JOHANSON GROUP, (U.S. CLS. 100, 101 AND 102). SN 77-834,124. PUB. 2-16-2010. FILED 9-24-2009.
- 3,784,543. **INFOBATE (BLOCK FORM)**. DEBS INFONET, INC., (U.S. CLS. 100, 101 AND 102). SN 77-834,146. PUB. 2-16-2010. FILED 9-24-2009.
- 3,784,546. **CAPSTONE REWARDS (BLOCK FORM)**. CAPSTONE PRESS, INC., (U.S. CLS. 100, 101 AND 102). SN 77-834,156. PUB. 2-16-2010. FILED 9-24-2009.
- 3,784,551. **REAL MAN. RIGHT VOICE. (BLOCK FORM)**. HICKSON, STEVE, (U.S. CLS. 100, 101 AND 102). SN 77-834,221. PUB. 2-16-2010. FILED 9-24-2009.
- 3,784,554. **BLABGRAB (BLOCK FORM)**. BLAB GRAB LLC, (U.S. CLS. 100, 101 AND 102). SN 77-834,273. PUB. 2-16-2010. FILED 9-24-2009.
- 3,784,555. **BLUE GURUS (BLOCK FORM)**. BLUE GURUS, LLC, MULTIPLE CLASS, (INT. CLS. 35 AND 42), (U.S. CLS. 100, 101 AND 102). SN 77-834,282. PUB. 2-16-2010. FILED 9-24-2009.
- 3,784,556. **NAPLESAREA.COM (BLOCK FORM)**. NAPLES AREA BOARD OF REALTORS, INC., MULTIPLE CLASS, (INT. CLS. 35 AND 36), (U.S. CLS. 100, 101 AND 102). SN 77-834,299. PUB. 2-16-2010. FILED 9-24-2009.
- 3,784,566. **PRISTINE PLANET (BLOCK FORM)**. FINN, CATHERINE, MULTIPLE CLASS, (INT. CLS. 35 AND 41), (U.S. CLS. 100, 101, 102 AND 107). SN 77-834,506. PUB. 2-16-2010. FILED 9-24-2009.
- 3,784,571 (*See Class 9 for this trademark*).
- 3,784,572. **STUDENT DIRECTION (BLOCK FORM)**. STUDENT DIRECTION, LLC, DBA STUDENT DIRECTION, LLC, (U.S. CLS. 100, 101 AND 102). SN 77-834,590. PUB. 2-16-2010. FILED 9-24-2009.
- 3,784,573. **VIRTUAL COORDINATOR (BLOCK FORM)**. BJM ENTERPRISES, LLC, (U.S. CLS. 100, 101 AND 102). SN 77-834,596. PUB. 2-16-2010. FILED 9-24-2009.
- 3,784,577. **3DPRO (BLOCK FORM)**. INTERNATIONAL 3D SOCIETY, LLC, MULTIPLE CLASS, (INT. CLS. 35 AND 41), (U.S. CLS. 100, 101, 102 AND 107). SN 77-834,648. PUB. 2-16-2010. FILED 9-25-2009.
- 3,784,578. **3DNA (BLOCK FORM)**. INTERNATIONAL 3D SOCIETY, LLC, MULTIPLE CLASS, (INT. CLS. 35 AND 41), (U.S. CLS. 100, 101, 102 AND 107). SN 77-834,650. PUB. 2-16-2010. FILED 9-25-2009.
- 3,784,601. **PUBMATIC (BLOCK FORM)**. PUBMATIC, INC., (U.S. CLS. 100, 101 AND 102). SN 77-835,027. PUB. 2-16-2010. FILED 9-25-2009.
- 3,784,605. **BEAUTIFUL GORGEOUS FABULOUSUNIQUE PRETTY THINGSBOUTIQUE WHY PAY MORE? BE FABULOUS FOR LESS! (STYLIZED)**. PRETTY THINGS BOUTIQUE, LLC, (U.S. CLS. 100, 101 AND 102). SN 77-835,062. PUB. 2-16-2010. FILED 9-25-2009.
- 3,784,608. **TECHNOLINE (BLOCK FORM)**. TECHNOLINE L.L.C., (U.S. CLS. 100, 101 AND 102). SN 77-835,117. PUB. 2-16-2010. FILED 9-25-2009.
- 3,784,624. **MISCELLANEOUS DESIGN**. HOUSE LOANS MORTGAGE SERVICES CORP., DBA LDS LENDERS, (U.S. CLS. 100, 101 AND 102). SN 77-835,394. PUB. 2-16-

2010. FILED 9-25-2009.
- 3,784,630. **PLAYER'S PASS AND DESIGN**. MOXY LLC, (U.S. CLS. 100, 101 AND 102). SN 77-835,461. PUB. 2-16-2010. FILED 9-25-2009.
- 3,784,639. **MISCELLANEOUS DESIGN**. EAGLEMED LLC, MULTIPLE CLASS, (INT. CLS. 35, 39 AND 44), (U.S. CLS. 100, 101, 102 AND 105). SN 77-835,531. PUB. 2-16-2010. FILED 9-25-2009.
- 3,784,640. **PLAYER'S PASS (BLOCK FORM)**. MOXY LLC, (U.S. CLS. 100, 101 AND 102). SN 77-835,545. PUB. 2-16-2010. FILED 9-25-2009.
- 3,784,641. **EAGLEMED (BLOCK FORM)**. EAGLEMED LLC, MULTIPLE CLASS, (INT. CLS. 35, 39 AND 44), (U.S. CLS. 100, 101, 102 AND 105). SN 77-835,558. PUB. 2-16-2010. FILED 9-25-2009.
- 3,784,643. **MODAVORE (BLOCK FORM)**. MODAVORE INC., (U.S. CLS. 100, 101 AND 102). SN 77-835,605. PUB. 2-16-2010. FILED 9-25-2009.
- 3,784,645. **BATTER'S EDGE (BLOCK FORM)**. WELLLIVING CORPORATION, DBA MVP INTERACTIVE SPORTS, MULTIPLE CLASS, (INT. CLS. 35 AND 41), (U.S. CLS. 100, 101, 102 AND 107). SN 77-835,661. PUB. 2-16-2010. FILED 9-25-2009.
- 3,784,648. **THE READERS' CROWN (BLOCK FORM)**. ROMANCE CONVENTIONS, INC., (U.S. CLS. 100, 101 AND 102). SN 77-835,707. PUB. 2-16-2010. FILED 9-25-2009.
- 3,784,650. **MISCELLANEOUS DESIGN**. MYRIAD GREEYN LLC, (U.S. CLS. 100, 101 AND 102). SN 77-835,726. PUB. 2-16-2010. FILED 9-26-2009.
- 3,784,651. **THE Y IN GREEYN IS YOU (BLOCK FORM)**. MYRIAD GREEYN LLC, (U.S. CLS. 100, 101 AND 102). SN 77-835,727. PUB. 2-16-2010. FILED 9-26-2009.
- 3,784,657. **BUSTER MURPHY AND DESIGN**. BUSTER MURPHY LLC, (U.S. CLS. 100, 101 AND 102). SN 77-835,806. PUB. 2-16-2010. FILED 9-26-2009.
- 3,784,661. **DARK MATTER MATTERS (BLOCK FORM)**. GRAMS, CHRISTOPHER D., DBA CHRIS GRAMS, (U.S. CLS. 100, 101 AND 102). SN 77-835,901. PUB. 2-16-2010. FILED 9-27-2009.
- 3,784,674 (*See Class 9 for this trademark*).
- 3,784,682. **COMPETITION REMOVAL (BLOCK FORM)**. HITMAN, INC., (U.S. CLS. 100, 101 AND 102). SN 77-836,568. PUB. 2-16-2010. FILED 9-28-2009.
- 3,784,690. **SAVOR CALIFORNIA (BLOCK FORM)**. ST. CLAIRE, JANE, (U.S. CLS. 100, 101 AND 102). SN 77-836,716. PUB. 2-16-2010. FILED 9-28-2009.
- 3,784,695. **DENTISTRY IQ AND DESIGN**. PENNWELL CORPORATION, MULTIPLE CLASS, (INT. CLS. 35 AND 44), (U.S. CLS. 100, 101 AND 102). SN 77-836,863. PUB. 2-16-2010. FILED 9-29-2009.
- 3,784,705. **THE VENUS PROJECT (BLOCK FORM)**. THE VENUS PROJECT, INC., (U.S. CLS. 100, 101 AND 102). SN 77-838,736. PUB. 2-16-2010. FILED 9-30-2009.
- 3,784,708. **QVL WORKS (BLOCK FORM)**. QVL PHARMACY HOLDINGS, INC., (U.S. CLS. 100, 101 AND 102). SN 77-838,917. PUB. 2-16-2010. FILED 10-1-2009.
- 3,784,709. **CIRCLE OF CARE COMPLIANCE (BLOCK FORM)**. QVL PHARMACY HOLDINGS, INC., (U.S. CLS. 100, 101 AND 102). SN 77-838,955. PUB. 2-16-2010. FILED 10-1-2009.
- 3,784,728. **WONDER NANNIES (BLOCK FORM)**. WONDER NANNIES, LLC, (U.S. CLS. 100, 101 AND 102). SN 77-844,176. PUB. 2-16-2010. FILED 10-8-2009.
- 3,784,737 (*See Class 16 for this trademark*).
- 3,784,738 (*See Class 16 for this trademark*).
- 3,784,741. **STEWART'S (BLOCK FORM)**. STEWARTS RESTAURANTS INCORPORATED, (U.S. CLS. 100, 101 AND 102). SN 77-847,267. PUB. 2-16-2010. FILED 10-13-2009.
- 3,784,755. **PROPERTIES PLUS (BLOCK FORM)**. SCIENTIFIC GAMES INTERNATIONAL, INC., MULTIPLE CLASS, (INT. CLS. 35, 41 AND 45), (U.S. CLS. 100, 101, 102 AND 107). SN 77-851,674. PUB. 2-16-2010. FILED 10-19-2009.
- 3,784,770. **SPREAD THE WORD TO END THE WORD (BLOCK FORM)**. SPECIAL OLYMPICS, INC., MULTIPLE CLASS, (INT. CLS. 35 AND 41), (U.S. CLS. 100, 101, 102 AND 107). SN 77-858,107. PUB. 2-16-2010. FILED 10-27-2009.
- 3,784,788. **MORE OF THE GOOD STUFF FOR LESS (BLOCK FORM)**. WHOLE FOODS MARKET IP, L.P., (U.S. CLS. 100, 101 AND 102). SN 77-861,462. PUB. 2-16-2010. FILED 10-30-2009.
- 3,784,789. **MGS (BLOCK FORM)**. THE ANDERSONS, INC., (U.S. CLS. 100, 101 AND 102). SN 77-862,441. PUB. 2-16-2010. FILED 11-2-2009.
- 3,784,794. **COREMETRICS AND DESIGN**. COREMETRICS, INC., (U.S. CLS. 100, 101 AND 102). SN 77-864,858. PUB. 2-16-2010. FILED 11-4-2009.
- 3,784,797. **ALTO A LA DIABETES (BLOCK FORM)**. AMERICAN DIABETES ASSOCIATION, INC., MULTIPLE CLASS, (INT. CLS. 35, 36 AND 41), (U.S. CLS. 100, 101, 102 AND 107). SN 77-866,599. PUB. 2-16-2010. FILED 11-6-2009.
- 3,784,801. **ASIAN TREASURE (BLOCK FORM)**. UNITED HEALTH GROUP INCORPORATED, MULTIPLE CLASS, (INT. CLS. 35, 36 AND 44), (U.S. CLS. 100, 101 AND 102). SN 77-867,495. PUB. 2-16-2010. FILED 11-6-2009.
- 3,784,810. **AFFLICTION (STYLIZED)**. AFFLICTION HOLDINGS LLC, (U.S. CLS. 100, 101 AND 102). SN 77-880,148. PUB. 2-16-2010. FILED 11-24-2009.
- 3,784,812. **IAVA IRAQ AND AFGHANISTAN VETERANS OF AMERICA AND DESIGN**. IRAQ AND AFGHANISTAN VETERANS OF AMERICA, INC., (U.S. CLS. 100, 101 AND 102). SN 77-886,331. PUB. 2-16-2010. FILED 12-4-2009.
- 3,784,816. **TAKE CONTROL & SAVE AND DESIGN**. ASSOCIATED ELECTRIC COOPERATIVE, INC., (U.S. CLS. 100, 101 AND 102). SN 77-978,104. PUB. 2-16-2010. FILED 2-25-2009.
- 3,784,817. **TRIBUTES.COM (BLOCK FORM)**. TRIBUTES, INC., MULTIPLE CLASS, (INT. CLS. 35, 36 AND 45), (U.S. CLS. 100, 101 AND 102). SN 77-978,566. PUB. 2-16-2010. FILED 5-2-2008.
- 3,784,821 (*See Class 9 for this trademark*).
- 3,784,822. **THE GREAT AMERICAN (BLOCK FORM)**. ALLEN, BENJAMIN L., (U.S. CLS. 100, 101 AND 102). SN 77-979,174. PUB. 5-19-2009. FILED 3-1-2008.
- 3,784,826 (*See Class 9 for this trademark*).
- 3,784,843 (*See Class 9 for this trademark*).
- 3,784,853. **MEDICAL BRIDGES AND DESIGN**. MEDICAL BRIDGES, INC., (U.S. CLS. 100, 101 AND 102). SN 78-959,247. PUB. 2-16-2010. FILED 8-24-2006.
- 3,784,867. **COREAL (BLOCK FORM)**. COREALCREDIT BANK AG, MULTIPLE CLASS, (INT. CLS. 35, 36 AND 38), (U.S. CLS. 100, 101, 102 AND 104). SN 79-050,144. PUB. 2-16-2010. FILED 10-15-2007.
- 3,784,868. **COREALBANK (STYLIZED)**. COREALCREDIT BANK AG, MULTIPLE CLASS, (INT. CLS. 35, 36 AND 38), (U.S. CLS. 100, 101, 102 AND 104). SN 79-050,145. PUB. 2-16-2010. FILED 10-15-2007.
- 3,784,869 (*See Class 3 for this trademark*).
- 3,784,872 (*See Class 9 for this trademark*).
- 3,784,875. **PROUD (BLOCK FORM)**. A. BLOK BEHEER B.V., MULTIPLE CLASS, (INT. CLS. 35, 41, 42 AND 44), (U.S. CLS. 100, 101, 102 AND 107). SN 79-056,613. PUB. 5-19-2009. FILED 2-15-2008.
- 3,784,878 (*See Class 9 for this trademark*).
- 3,784,879 (*See Class 16 for this trademark*).
- 3,784,884 (*See Class 5 for this trademark*).
- 3,784,885 (*See Class 7 for this trademark*).
- 3,784,886 (*See Class 7 for this trademark*).
- 3,784,887 (*See Class 7 for this trademark*).
- 3,784,888 (*See Class 7 for this trademark*).
- 3,784,893. **MORE INVEST AND DESIGN**. M.O.R.E. INVEST MANAGEMENT AG, MULTIPLE CLASS, (INT. CLS. 35 AND 36), (U.S. CLS. 100, 101 AND 102). SN 79-059,272. PUB. 2-16-2010. FILED 5-5-2008.
- 3,784,897 (*See Class 16 for this trademark*).
- 3,784,900 (*See Class 5 for this trademark*).
- 3,784,902. **UBINAV (BLOCK FORM)**. UBIEST SPA, MULTIPLE CLASS, (INT. CLS. 35, 38, 42 AND 45), (U.S. CLS. 100, 101, 102 AND 104). SN 79-060,665. PUB. 2-16-2010. FILED 7-15-2008.
- 3,784,903. **APG ALL PENSIONS GROUP AND DESIGN**. APG GROEP N.V., MULTIPLE CLASS, (INT. CLS. 35, 36, 42, 44 AND 45), (U.S. CLS. 100, 101 AND 102). SN 79-060,742. PUB. 2-16-2010. FILED 7-17-2008.
- 3,784,904. **APG AND DESIGN**. APG GROEP N.V., MULTIPLE CLASS, (INT. CLS. 35, 36, 42, 44 AND 45), (U.S. CLS. 100, 101 AND 102). SN 79-060,800. PUB. 2-16-2010. FILED 7-17-2008.
- 3,784,906 (*See Class 1 for this trademark*).

- 3,784,907 (*See Class 1 for this trademark.*)
 3,784,909 (*See Class 7 for this trademark.*)
 3,784,911 (*See Class 11 for this trademark.*)
 3,784,912 (*See Class 14 for this trademark.*)
 3,784,915 (*See Class 9 for this trademark.*)
 3,784,920 (*See Class 9 for this trademark.*)
 3,784,923 (*See Class 14 for this trademark.*)
 3,784,925 (*See Class 12 for this trademark.*)
 3,784,929 (*See Class 6 for this trademark.*)
 3,784,933. **CONTAGIOUS IDEAS THAT CHANGE THE CONVERSATION (BLOCK FORM)**. PUBLICIS GROUPE SA, MULTIPLE CLASS, (INT. CLS. 35, 38 AND 41), (U.S. CLS. 100, 101, 102, 104 AND 107). SN 79-066,520. PUB. 9-15-2009. FILED 12-29-2008.
 3,784,941. **ENCURIO (BLOCK FORM)**. RAHMEL, SEBASTIAN, MULTIPLE CLASS, (INT. CLS. 35 AND 42), (U.S. CLS. 100, 101 AND 102). SN 79-067,058. PUB. 2-16-2010. FILED 2-20-2009.
 3,784,981 (*See Class 9 for this trademark.*)
 3,784,984 (*See Class 9 for this trademark.*)
 3,784,998. **DESERTEC (BLOCK FORM)**. DESERTEC FOUNDATION, MULTIPLE CLASS, (INT. CLS. 35, 39 AND 42), (U.S. CLS. 100, 101, 102 AND 105). SN 79-069,114. PUB. 2-16-2010. FILED 3-6-2009.
 3,785,000 (*See Class 9 for this trademark.*)
 3,785,019. **EXPO POLIS (BLOCK FORM)**. VAN DER AUWERMEULEN, THIBAUT FÉLIX BÉATRICE JEAN JOSEPH MARIE, AND VAN KERCKHOVE, PASCALE, MULTIPLE CLASS, (INT. CLS. 35 AND 42), (U.S. CLS. 100, 101 AND 102). SN 79-071,365. PUB. 2-16-2010. FILED 2-6-2009.
 3,785,021. **ARENDE ARENDE & MEDERNACH AND DESIGN**. AIM SERVICES S.A.R.L., MULTIPLE CLASS, (INT. CLS. 35, 36 AND 45), (U.S. CLS. 100, 101 AND 102). SN 79-071,880. PUB. 2-16-2010. FILED 3-5-2009.
 3,785,023 (*See Class 1 for this trademark.*)
 3,785,025. **CONNECTING SOLAR BUSINESS AND DESIGN**. FREIBURG WIRTSCHAFT TOURISTIK; UND MESSE GMBH & CO. KG, (U.S. CLS. 100, 101 AND 102). SN 79-072,522. PUB. 2-16-2010. FILED 7-27-2009.
 3,785,034. **MUSIC KEY (BLOCK FORM)**. EMI (IP) LIMITED, MULTIPLE CLASS, (INT. CLS. 35 AND 41), (U.S. CLS. 100, 101, 102 AND 107). SN 79-073,618. PUB. 2-16-2010. FILED 8-14-2009.
 3,785,037. **CHEQER AND DESIGN**. TUI NEDERLAND N.V., MULTIPLE CLASS, (INT. CLS. 35, 38, 39, 41 AND 43), (U.S. CLS. 100, 101, 102, 104, 105 AND 107). SN 79-073,765. PUB. 2-16-2010. FILED 8-14-2009.
-
- CLASS 36—INSURANCE AND FINANCIAL**
- 3,783,081. **DYNAMIC CMP FUNDS**. DUNDEE CORPORATION, (U.S. CLS. 100, 101 AND 102). SN 76-079,730. PUB. 12-22-2009. FILED 6-28-2000.
 3,783,152. **GEMM EXCESS CASUALTY (BLOCK FORM)**. AMERICAN INTERNATIONAL GROUP, INC., (U.S. CLS. 100, 101 AND 102). SN 77-157,786. PUB. 2-16-2010. FILED 4-16-2007.
 3,783,153. **GEMM (BLOCK FORM)**. AMERICAN INTERNATIONAL GROUP, INC., (U.S. CLS. 100, 101 AND 102). SN 77-158,490. PUB. 2-16-2010. FILED 4-17-2007.
 3,783,154. **GEMM PROPERTY (BLOCK FORM)**. AMERICAN INTERNATIONAL GROUP, INC., (U.S. CLS. 100, 101 AND 102). SN 77-158,505. PUB. 2-16-2010. FILED 4-17-2007.
 3,783,155. **GEMM PRIMARY CASUALTY (BLOCK FORM)**. AMERICAN INTERNATIONAL GROUP, INC., (U.S. CLS. 100, 101 AND 102). SN 77-158,666. PUB. 2-16-2010. FILED 4-17-2007.
 3,783,156. **GEMM PLUS (BLOCK FORM)**. AMERICAN INTERNATIONAL GROUP, INC., (U.S. CLS. 100, 101 AND 102). SN 77-158,702. PUB. 2-16-2010. FILED 4-17-2007.
 3,783,159 (*See Class 9 for this trademark.*)
 3,783,182. **GO GREEN (BLOCK FORM)**. BODY PLUS NUTRITIONAL PRODUCTS INC., (U.S. CLS. 100, 101 AND 102). SN 77-319,236. PUB. 2-16-2010. FILED 11-1-2007.
 3,783,253 (*See Class 35 for this trademark.*)
 3,783,271 (*See Class 35 for this trademark.*)
 3,783,276 (*See Class 35 for this trademark.*)
 3,783,291. **SQUARE 1 VENTURES (BLOCK FORM)**. SQUARE 1 FINANCIAL, INC., (U.S. CLS. 100, 101 AND 102). SN 77-590,271. PUB. 2-16-2010. FILED 10-10-2008.
 3,783,307. **ART ROCKS! (BLOCK FORM)**. BERRIE, NICOLE ALANNA, (U.S. CLS. 100, 101 AND 102). SN 77-612,139. PUB. 2-16-2010. FILED 11-11-2008.
 3,783,343. **MICHELLE ESQUENAZI (BLOCK FORM)**. EMPIRE BONDING AGENCY INC., (U.S. CLS. 100, 101 AND 102). SN 77-663,826. PUB. 2-16-2010. FILED 2-5-2009.
 3,783,374. **DELVE AUDIT (BLOCK FORM)**. CUSTOM BENEFIT PROGRAMS, INC., DBA UNIVERS WORKPLACE SOLUTIONS, (U.S. CLS. 100, 101 AND 102). SN 77-681,278. PUB. 2-16-2010. FILED 3-2-2009.
 3,783,392. **A AND DESIGN**. APOLLO BANCSHARES, INC., (U.S. CLS. 100, 101 AND 102). SN 77-687,626. PUB. 2-16-2010. FILED 3-10-2009.
 3,783,417. **C D M CONSULT DESIGN MANAGE AND DESIGN**. CDM RETIREMENT CONSULTANTS, INC., (U.S. CLS. 100, 101 AND 102). SN 77-694,625. PUB. 2-16-2010. FILED 3-19-2009.
 3,783,458 (*See Class 35 for this trademark.*)
 3,783,460 (*See Class 35 for this trademark.*)
 3,783,484. **ASSET PROTECTION AND INCOME PLANNING FOR THOSE 60 AND BETTER (BLOCK FORM)**. THE SENIOR FINANCIAL CENTER, INC., (U.S. CLS. 100, 101 AND 102). SN 77-704,475. PUB. 2-16-2010. FILED 4-1-2009.
 3,783,496. **HAMPSHIRE AND DESIGN**. THE HAMPSHIRE COMPANIES LLC, MULTIPLE CLASS, (INT. CLS. 36 AND 37), (U.S. CLS. 100, 101, 102, 103 AND 106). SN 77-706,017. PUB. 2-16-2010. FILED 4-3-2009.
 3,783,497. **HAMPSHIRE (BLOCK FORM)**. THE HAMPSHIRE COMPANIES LLC, MULTIPLE CLASS, (INT. CLS. 36 AND 37), (U.S. CLS. 100, 101, 102, 103 AND 106). SN 77-706,033. PUB. 2-16-2010. FILED 4-3-2009.
 3,783,502. **Ireo AND DESIGN**. IREO MANAGEMENT I, LTD., (U.S. CLS. 100, 101 AND 102). SN 77-706,496. PUB. 2-16-2010. FILED 4-3-2009.
 3,783,511. **H THE HISSONG GROUP A COMMITMENT TO EXCELLENCE AND DESIGN**. HISSONG DEVELOPMENT CORPORATION, MULTIPLE CLASS, (INT. CLS. 36, 37 AND 43), (U.S. CLS. 100, 101, 102, 103 AND 106). SN 77-709,580. PUB. 2-16-2010. FILED 4-8-2009.
 3,783,514. **A AMERICAN REALTY ADVISORS AND DESIGN**. AMERICAN REALTY ADVISORS, (U.S. CLS. 100, 101 AND 102). SN 77-710,044. PUB. 2-16-2010. FILED 4-8-2009.
 3,783,538. **MISCELLANEOUS DESIGN**. FLAGSTAR BANK, FSB, (U.S. CLS. 100, 101 AND 102). SN 77-713,250. PUB. 2-16-2010. FILED 4-14-2009.
 3,783,548. **THE DREAM MERCHANTS (BLOCK FORM)**. LAZARUS, GARY AND LEVIN, S. MONTE, AKA THE DREAM MERCHANTS, (U.S. CLS. 100, 101 AND 102). SN 77-714,153. PUB. 2-16-2010. FILED 4-15-2009.
 3,783,570. **LIPSTICK BAIL BONDS (BLOCK FORM)**. LIPSTICK BAIL BONDS INC., (U.S. CLS. 100, 101 AND 102). SN 77-720,580. PUB. 2-16-2010. FILED 4-23-2009.
 3,783,583. **ROK REAL ESTATE (BLOCK FORM)**. PINSON, KENNETH D., (U.S. CLS. 100, 101 AND 102). SN 77-728,770. PUB. 10-20-2009. FILED 5-4-2009.
 3,783,619. **MCIM MICHIGAN COMMERCIAL INSURANCE MUTUAL AND DESIGN**. MICHIGAN COMMERCIAL INSURANCE MUTUAL, (U.S. CLS. 100, 101 AND 102). SN 77-751,842. PUB. 2-16-2010. FILED 6-4-2009.
 3,783,684. **WEST BEND AND DESIGN**. WEST BEND MUTUAL INSURANCE COMPANY, (U.S. CLS. 100, 101 AND 102). SN 77-770,938. PUB. 2-16-2010. FILED 6-30-2009.
 3,783,706. **LUTHER BURBANK SAVINGS AND DESIGN**. LUTHER BURBANK SAVINGS, (U.S. CLS. 100, 101 AND 102). SN 77-778,742. PUB. 2-16-2010. FILED 7-10-2009.
 3,783,731. **OLYMPUS PARTNERS AND DESIGN**. OLYMPUS ADVISORS V, LLC, (U.S. CLS. 100, 101 AND 102). SN 77-789,522. PUB. 1-12-2010. FILED 7-24-2009.
 3,783,732. **MISCELLANEOUS DESIGN**. HOLE IN THE WALL GANG FUND, INC., (U.S. CLS. 100, 101 AND 102). SN 77-789,746. PUB. 2-16-2010. FILED 7-26-2009.
 3,783,733. **ANGEL RIDE AND DESIGN**. HOLE IN THE WALL GANG FUND, INC., (U.S. CLS. 100, 101 AND 102). SN 77-789,751. PUB. 2-16-2010. FILED 7-26-2009.

- 3,783,779. **TOTAL VALUE (BLOCK FORM)**. UNITED OF OMAHA LIFE INSURANCE COMPANY, (U.S. CLS. 100, 101 AND 102). SN 77-801,490. PUB. 2-16-2010. FILED 8-11-2009.
- 3,783,795. **GRIGIO METRO AND DESIGN**. GDG ENTERPRISES LLC, (U.S. CLS. 100, 101 AND 102). SN 77-803,936. PUB. 2-16-2010. FILED 8-13-2009.
- 3,783,834 (*See Class 35 for this trademark*).
- 3,783,856. **BANKSERV (BLOCK FORM)**. BSERV, INC., DBA BANKSERV, INC., MULTIPLE CLASS, (INT. CLS. 36 AND 42), (U.S. CLS. 100, 101 AND 102). SN 77-814,520. PUB. 2-16-2010. FILED 8-27-2009.
- 3,783,860. **1% CHASE EXCLUSIVES MORTGAGE CASH BACK AND DESIGN**. JPMORGAN CHASE & CO., (U.S. CLS. 100, 101 AND 102). SN 77-814,896. PUB. 2-16-2010. FILED 8-28-2009.
- 3,783,879. **EAGLE VISION PLANS (BLOCK FORM)**. BEN-ELECT, INC., (U.S. CLS. 100, 101 AND 102). SN 77-816,885. PUB. 2-16-2010. FILED 8-31-2009.
- 3,783,899. **REO PROPERTY ADVISORS AND DESIGN**. REO PROPERTY ADVISORS, LLC, (U.S. CLS. 100, 101 AND 102). SN 77-819,212. PUB. 2-16-2010. FILED 9-3-2009.
- 3,783,913. **TAKE MORE OF YOUR LIFE WITH YOU (BLOCK FORM)**. PREMIERE EXECUTIVE SUITES LIMITED, DBA PREMIERE EXECUTIVE SUITES, (U.S. CLS. 100, 101 AND 102). SN 77-820,597. PUB. 2-16-2010. FILED 9-4-2009.
- 3,783,972. **PHILADELPHIA INSURANCE COMPANIES AND DESIGN**. PHILADELPHIA CONSOLIDATED HOLDING CORPORATION, DBA PHILADELPHIA INSURANCE COMPANIES, (U.S. CLS. 100, 101 AND 102). SN 77-824,020. PUB. 2-16-2010. FILED 9-10-2009.
- 3,783,981. **MILE ONE REAL ESTATE 1 RESULTS BEGIN AT MILE ONE AND DESIGN**. TOM & NICOLE TROLI REALTY, INC., (U.S. CLS. 100, 101 AND 102). SN 77-824,339. PUB. 2-16-2010. FILED 9-10-2009.
- 3,783,986 (*See Class 9 for this trademark*).
- 3,783,992. **ADVANTAGE DEBT MANAGEMENT OF AMERICA (BLOCK FORM)**. ADVANTAGE DEBT MANAGEMENT OF AMERICA, INC., (U.S. CLS. 100, 101 AND 102). SN 77-824,675. PUB. 2-16-2010. FILED 9-11-2009.
- 3,783,993. **WALK TO EMPOWER AND DESIGN**. BREAST CANCER NETWORK OF STRENGTH, INC., (U.S. CLS. 100, 101 AND 102). SN 77-824,735. PUB. 2-16-2010. FILED 9-11-2009.
- 3,784,000. **THE LATINO PROMISE PROGRAM (BLOCK FORM)**. FAIRLEIGH DICKINSON UNIVERSITY, MULTIPLE CLASS, (INT. CLS. 36 AND 41), (U.S. CLS. 100, 101, 102 AND 107). SN 77-825,069. PUB. 2-16-2010. FILED 9-11-2009.
- 3,784,015. **THE CONNECT THE DOTS PROCESS (BLOCK FORM)**. REBECCA CHACKO, DBA CHACKO-HERTZ FINANCIAL SOLUTIONS, (U.S. CLS. 100, 101 AND 102). SN 77-825,496. PUB. 2-16-2010. FILED 9-13-2009.
- 3,784,025. **WHERE INSURANCE AND STRATEGY MEET (BLOCK FORM)**. INSUREGY AGENCY, INC., (U.S. CLS. 100, 101 AND 102). SN 77-825,980. PUB. 2-16-2010. FILED 9-14-2009.
- 3,784,026. **PLANNING FOR GENERATIONS (BLOCK FORM)**. MICHAEL C. RIDDLE, (U.S. CLS. 100, 101 AND 102). SN 77-825,984. PUB. 2-16-2010. FILED 9-14-2009.
- 3,784,048. **PARTNERS IN TZEDAKAH (BLOCK FORM)**. TUCCARONE, JOSEPH W., (U.S. CLS. 100, 101 AND 102). SN 77-826,432. PUB. 2-16-2010. FILED 9-15-2009.
- 3,784,056. **ARCH PERSONAL ADVANTAGE (BLOCK FORM)**. ARCH CAPITAL GROUP (U.S.) INC., (U.S. CLS. 100, 101 AND 102). SN 77-826,681. PUB. 2-16-2010. FILED 9-15-2009.
- 3,784,066. **CAPITAL GOOD FUND AND DESIGN**. CAPITAL GOOD FUND, (U.S. CLS. 100, 101 AND 102). SN 77-827,094. PUB. 2-16-2010. FILED 9-15-2009.
- 3,784,077. **IRM AND DESIGN**. INTERNATIONAL REINSURANCE MANAGERS, LLC, (U.S. CLS. 100, 101 AND 102). SN 77-827,402. PUB. 2-16-2010. FILED 9-16-2009.
- 3,784,099. **TOTAL COMPRESSION CARE (BLOCK FORM)**. SALZMAN AG, (U.S. CLS. 100, 101 AND 102). SN 77-827,895. PUB. 2-16-2010. FILED 9-16-2009.
- 3,784,102. **. ECO-FRIENDLY . RECOVER . RECLAIM . RECYCLE AND DESIGN**. BARNABY HEATING & AIR, LLC, (U.S. CLS. 100, 101 AND 102). SN 77-828,040. PUB. 2-16-2010. FILED 9-16-2009.
- 3,784,108 (*See Class 35 for this trademark*).
- 3,784,113. **INSTANT ANALYST (BLOCK FORM)**. EQUITY RESEARCH ONLINE, INC., (U.S. CLS. 100, 101 AND 102). SN 77-828,297. PUB. 2-16-2010. FILED 9-16-2009.
- 3,784,205. **CORPORATE PROFILE (BLOCK FORM)**. CORPORATE PROFILE MEDIA LLC, (U.S. CLS. 100, 101 AND 102). SN 77-829,984. PUB. 2-16-2010. FILED 9-18-2009.
- 3,784,207. **SCINSURANCEMART AND DESIGN**. PEO MANAGEMENT GROUP, INC., (U.S. CLS. 100, 101 AND 102). SN 77-830,012. PUB. 2-16-2010. FILED 9-18-2009.
- 3,784,211. **MISCELLANEOUS DESIGN**. CLEAR ONE HEALTH PLANS, INC., (U.S. CLS. 100, 101 AND 102). SN 77-830,077. PUB. 2-16-2010. FILED 9-18-2009.
- 3,784,223. **MISCELLANEOUS DESIGN**. GLOBAL DOWN SYNDROME FOUNDATION, (U.S. CLS. 100, 101 AND 102). SN 77-830,306. PUB. 2-16-2010. FILED 9-18-2009.
- 3,784,227 (*See Class 9 for this trademark*).
- 3,784,251. **BOOKMYRENTAL (BLOCK FORM)**. OWNER ON CALL, LLC, (U.S. CLS. 100, 101 AND 102). SN 77-830,647. PUB. 2-16-2010. FILED 9-21-2009.
- 3,784,253 (*See Class 35 for this trademark*).
- 3,784,259. **ANOVA (BLOCK FORM)**. ANOVA FINANCIAL CORPORATION, (U.S. CLS. 100, 101 AND 102). SN 77-830,774. PUB. 2-16-2010. FILED 9-21-2009.
- 3,784,293. **ACUIBRANCH (BLOCK FORM)**. ALABAMA CREDIT UNION, (U.S. CLS. 100, 101 AND 102). SN 77-831,154. PUB. 2-16-2010. FILED 9-21-2009.
- 3,784,336. **COMPUPAK (BLOCK FORM)**. HARLEYSVILLE MUTUAL INSURANCE COMPANY, (U.S. CLS. 100, 101 AND 102). SN 77-831,735. PUB. 2-16-2010. FILED 9-22-2009.
- 3,784,347. **MISCELLANEOUS DESIGN**. DENTAL BENEFIT MANAGEMENT, INC., DBA BENECARE DENTAL PLANS, (U.S. CLS. 100, 101 AND 102). SN 77-831,817. PUB. 2-16-2010. FILED 9-22-2009.
- 3,784,367 (*See Class 35 for this trademark*).
- 3,784,369 (*See Class 35 for this trademark*).
- 3,784,370. **CLARK INSURANCE (BLOCK FORM)**. CLARK INSURANCE, (U.S. CLS. 100, 101 AND 102). SN 77-832,184. PUB. 2-16-2010. FILED 9-22-2009.
- 3,784,371. **CLARK INSURANCE AND DESIGN**. CLARK INSURANCE, (U.S. CLS. 100, 101 AND 102). SN 77-832,202. PUB. 2-16-2010. FILED 9-22-2009.
- 3,784,391. **ZON ENERGY AND DESIGN**. ZON ENERGY INC., (U.S. CLS. 100, 101 AND 102). SN 77-832,380. PUB. 2-16-2010. FILED 9-22-2009.
- 3,784,394. **ZON ENERGY (BLOCK FORM)**. ZON ENERGY INC., (U.S. CLS. 100, 101 AND 102). SN 77-832,397. PUB. 2-16-2010. FILED 9-22-2009.
- 3,784,415. **SUITELINK (BLOCK FORM)**. TEAM HOUSING SOLUTIONS, INC., (U.S. CLS. 100, 101 AND 102). SN 77-832,667. PUB. 2-16-2010. FILED 9-23-2009.
- 3,784,452. **WE WORK (BLOCK FORM)**. MCKELVEY, MIGUEL ANGEL, MULTIPLE CLASS, (INT. CLS. 36 AND 42), (U.S. CLS. 100, 101 AND 102). SN 77-833,178. PUB. 2-16-2010. FILED 9-23-2009.
- 3,784,477. **A WEALTH OF KNOWLEDGE ABOUT WEALTH (BLOCK FORM)**. SMITH, KEVIN J., AND MAYER, HOLLY A., AND LIDDLE, JAMES C., (U.S. CLS. 100, 101 AND 102). SN 77-833,402. PUB. 2-16-2010. FILED 9-23-2009.
- 3,784,494. **MISCELLANEOUS DESIGN**. DODGE & COX, (U.S. CLS. 100, 101 AND 102). SN 77-833,565. PUB. 2-16-2010. FILED 9-23-2009.
- 3,784,500. **ROLLOVERSYSTEMS (BLOCK FORM)**. ROLLOVER SYSTEMS, INC., (U.S. CLS. 100, 101 AND 102). SN 77-833,699. PUB. 2-16-2010. FILED 9-24-2009.
- 3,784,504. **KGS (BLOCK FORM)**. KFORCE INC., (U.S. CLS. 100, 101 AND 102). SN 77-833,746. PUB. 2-16-2010. FILED 9-24-2009.
- 3,784,507. **DIVORCE YOUR SPOUSE, NOT YOUR MONEY (BLOCK FORM)**. DECKER, LISA C., (U.S. CLS. 100, 101 AND 102). SN 77-833,775. PUB. 2-16-2010. FILED 9-24-2009.
- 3,784,545. **MISCELLANEOUS DESIGN**. WILDERNESS SOCIETY, THE, (U.S. CLS. 100, 101 AND 102). SN 77-834,155. PUB. 2-16-2010. FILED 9-24-2009.
- 3,784,553. **LIFE IS TOUGH. IT'S TOUGHER WITHOUT A GREAT REAL ESTATE AGENT. (BLOCK FORM)**. VIRGINIA ADVNTAGE REALTY INC, DBA Q REAL ESTATE, (U.S. CLS. 100, 101 AND 102). SN 77-834,272. PUB. 2-16-2010.

FILED 9-24-2009.
 3,784,556 (*See Class 35 for this trademark*).
 3,784,620. **MISCELLANEOUS DESIGN**. SOCIAL SERVICE COORDINATORS, INC., (U.S. CLS. 100, 101 AND 102). SN 77-835,341. PUB. 2-16-2010. FILED 9-25-2009.
 3,784,628. **CLAREMONT GROUP (BLOCK FORM)**. CLAREMONT GROUP, LLC, MULTIPLE CLASS, (INT. CLS. 36 AND 37), (U.S. CLS. 100, 101, 102, 103 AND 106). SN 77-835,437. PUB. 2-16-2010. FILED 9-25-2009.
 3,784,637. **COACH CARES (BLOCK FORM)**. COACH SERVICES, INC., (U.S. CLS. 100, 101 AND 102). SN 77-835,518. PUB. 2-16-2010. FILED 9-25-2009.
 3,784,638. **MACROMAVENS (BLOCK FORM)**. MACROMAVENS, LLC, (U.S. CLS. 100, 101 AND 102). SN 77-835,527. PUB. 2-16-2010. FILED 9-25-2009.
 3,784,656. **FLYIN REALTY (BLOCK FORM)**. KARLHAUS LLC, AKA KARLHAUS REALTY, (U.S. CLS. 100, 101 AND 102). SN 77-835,803. PUB. 2-16-2010. FILED 9-26-2009.
 3,784,702. **SMARTCENTS (BLOCK FORM)**. CAPITAL ONE FINANCIAL CORPORATION, (U.S. CLS. 100, 101 AND 102). SN 77-838,328. PUB. 2-16-2010. FILED 9-30-2009.
 3,784,718. **FLEXASSURE (BLOCK FORM)**. AKITA, INC., (U.S. CLS. 100, 101 AND 102). SN 77-840,447. PUB. 2-16-2010. FILED 10-2-2009.
 3,784,719. **U.S. PROPERTIES GROUP (BLOCK FORM)**. U.S. PROPERTIES GROUP, INC., (U.S. CLS. 100, 101 AND 102). SN 77-841,472. PUB. 2-16-2010. FILED 10-5-2009.
 3,784,723. **EXCESSPRIME (BLOCK FORM)**. AKITA, INC., (U.S. CLS. 100, 101 AND 102). SN 77-842,138. PUB. 2-16-2010. FILED 10-6-2009.
 3,784,731. **NETADVANTAGE (BLOCK FORM)**. AKITA, INC., (U.S. CLS. 100, 101 AND 102). SN 77-844,703. PUB. 2-16-2010. FILED 10-8-2009.
 3,784,744. **ARCH ESSENTIAL EXCESS POLICY (BLOCK FORM)**. ARCH CAPITAL GROUP (U.S.) INC., (U.S. CLS. 100, 101 AND 102). SN 77-849,507. PUB. 2-16-2010. FILED 10-15-2009.
 3,784,745. **CHECK IT! (BLOCK FORM)**. DENTAL BENEFIT MANAGEMENT, INC., DBA BENECARE DENTAL PLANS, (U.S. CLS. 100, 101 AND 102). SN 77-849,543. PUB. 2-16-2010. FILED 10-15-2009.
 3,784,746. **POWER YOUR SMILE AND DESIGN**. DENTAL BENEFIT MANAGEMENT, INC., DBA BENECARE DENTAL PLANS, (U.S. CLS. 100, 101 AND 102). SN 77-849,576. PUB. 2-16-2010. FILED 10-15-2009.
 3,784,747. **DON'T BAD-MOUTH YOUR KIDS! (BLOCK FORM)**. DENTAL BENEFIT MANAGEMENT, INC., DBA BENECARE DENTAL PLANS, (U.S. CLS. 100, 101 AND 102). SN 77-849,581. PUB. 2-16-2010. FILED 10-15-2009.
 3,784,748. **SMILE GIVES YOU GAME! (BLOCK FORM)**. DENTAL BENEFIT MANAGEMENT, INC., DBA BENECARE DENTAL PLANS, (U.S. CLS. 100, 101 AND 102). SN 77-849,584. PUB. 2-16-2010. FILED 10-15-2009.
 3,784,754. **REPOWER (BLOCK FORM)**. MASTERCARD INTERNATIONAL INCORPORATED, (U.S. CLS. 100, 101 AND 102). SN 77-851,567. PUB. 2-16-2010. FILED 10-19-2009.
 3,784,756. **V3 INSURANCE PARTNERS AND DESIGN**. V3 INSURANCE PARTNERS LLC, (U.S. CLS. 100, 101 AND 102). SN 77-852,437. PUB. 2-16-2010. FILED 10-20-2009.
 3,784,771. **PARTNER PARITY PLAN (BLOCK FORM)**. JPMORGAN CHASE & CO., (U.S. CLS. 100, 101 AND 102). SN 77-858,378. PUB. 2-16-2010. FILED 10-27-2009.
 3,784,772. **BLUEPRINT AND DESIGN**. JPMORGAN CHASE & CO., (U.S. CLS. 100, 101 AND 102). SN 77-858,441. PUB. 2-16-2010. FILED 10-27-2009.
 3,784,797 (*See Class 35 for this trademark*).
 3,784,801 (*See Class 35 for this trademark*).
 3,784,817 (*See Class 35 for this trademark*).
 3,784,823. **DIAMOND RESORTS INTERNATIONAL D AND DESIGN**. DIAMOND RESORTS HOLDINGS, LLC, MULTIPLE CLASS, (INT. CLS. 36 AND 43), (U.S. CLS. 100, 101 AND 102). SN 77-979,201. PUB. 11-3-2009. FILED 6-18-2009.
 3,784,830. **TOTAL REWARDS (BLOCK FORM)**. HARRAHS LICENSE COMPANY, LLC, (U.S. CLS. 100, 101 AND 102). SN 78-703,715. PUB. 2-16-2010. FILED 8-30-2005.
 3,784,835 (*See Class 9 for this trademark*).
 3,784,843 (*See Class 9 for this trademark*).
 3,784,844. **KKL-PLANT A TREE IN ISRAEL (BLOCK FORM)**.

KEREN KAYEMETH LEISRAEL, (U.S. CLS. 100, 101 AND 102). SN 78-860,244. PUB. 2-16-2010. FILED 4-12-2006.
 3,784,867 (*See Class 35 for this trademark*).
 3,784,868 (*See Class 35 for this trademark*).
 3,784,869 (*See Class 3 for this trademark*).
 3,784,878 (*See Class 9 for this trademark*).
 3,784,893 (*See Class 35 for this trademark*).
 3,784,903 (*See Class 35 for this trademark*).
 3,784,904 (*See Class 35 for this trademark*).
 3,784,917 (*See Class 16 for this trademark*).
 3,784,925 (*See Class 12 for this trademark*).
 3,784,937. **CULT'LIVING (BLOCK FORM)**. SYLVIA GÄDEKE (MS.), MULTIPLE CLASS, (INT. CLS. 36 AND 43), (U.S. CLS. 100, 101 AND 102). SN 79-066,808. PUB. 2-16-2010. FILED 2-18-2009.
 3,784,946 (*See Class 9 for this trademark*).
 3,784,984 (*See Class 9 for this trademark*).
 3,785,021 (*See Class 35 for this trademark*).
 3,785,023 (*See Class 1 for this trademark*).

CLASS 37—CONSTRUCTION AND REPAIR

3,783,157 (*See Class 6 for this trademark*).
 3,783,193. **POWER WINDOWS & SIDING AND DESIGN**. POWER WINDOWS AND SIDING, INC., (U.S. CLS. 100, 103 AND 106). SN 77-385,602. PUB. 2-16-2010. FILED S.R. 1-31-2008; AM. P.R. 1-5-2009.
 3,783,222 (*See Class 7 for this trademark*).
 3,783,229. **G GARAGE PCS AND DESIGN**. LOOR, JORGE, DBA GARAGE PCS, (U.S. CLS. 100, 103 AND 106). SN 77-488,174. PUB. 2-16-2010. FILED 6-1-2008.
 3,783,253 (*See Class 35 for this trademark*).
 3,783,266 (*See Class 9 for this trademark*).
 3,783,317. **SERVICE ALL (BLOCK FORM)**. SERVICE ALL, INC., (U.S. CLS. 100, 103 AND 106). SN 77-634,755. PUB. 2-16-2010. FILED 12-17-2008.
 3,783,332 (*See Class 35 for this trademark*).
 3,783,333 (*See Class 35 for this trademark*).
 3,783,334 (*See Class 35 for this trademark*).
 3,783,345. **DEEP INJECTION (BLOCK FORM)**. URETEK USA, INC., (U.S. CLS. 100, 103 AND 106). SN 77-666,122. PUB. 2-16-2010. FILED 2-9-2009.
 3,783,348. **HEE (STYLIZED)**. HUGHES ENVIRONMENTAL ENGINEERING, INC., (U.S. CLS. 100, 103 AND 106). SN 77-668,133. PUB. 2-16-2010. FILED 2-11-2009.
 3,783,365. **CPS CONCRETE PREPARATION SERVICES, LLC AND DESIGN**. CONCRETE PREPARATION SERVICES, LLC, MULTIPLE CLASS, (INT. CLS. 37 AND 40), (U.S. CLS. 100, 103 AND 106). SN 77-677,088. PUB. 2-16-2010. FILED 2-24-2009.
 3,783,398. **TERRAFIRMA FOUNDATION SYSTEMS AND DESIGN**. TERRAFIRMA FOUNDATION REPAIR, INC., (U.S. CLS. 100, 103 AND 106). SN 77-689,902. PUB. 2-16-2010. FILED 3-12-2009.
 3,783,420. **PLAYGROUNDS FOR EVERYBODY. (BLOCK FORM)**. BUILD JAKE'S PLACE, INC., (U.S. CLS. 100, 103 AND 106). SN 77-695,724. PUB. 2-16-2010. FILED 3-20-2009.
 3,783,428 (*See Class 35 for this trademark*).
 3,783,453 (*See Class 35 for this trademark*).
 3,783,462. **RDM (BLOCK FORM)**. ROY D. MCQUEEN & ASSOCIATES, LTD., (U.S. CLS. 100, 103 AND 106). SN 77-701,706. PUB. 2-16-2010. FILED 3-29-2009.
 3,783,466 (*See Class 9 for this trademark*).
 3,783,496 (*See Class 36 for this trademark*).
 3,783,497 (*See Class 36 for this trademark*).
 3,783,511 (*See Class 36 for this trademark*).
 3,783,535 (*See Class 9 for this trademark*).
 3,783,536 (*See Class 9 for this trademark*).
 3,783,547. **DREAMHOME BATH & KITCHEN YOUR ONLY HOME REMODELING SOLUTION AND DESIGN**. WILLIAM THOMAS DESIGNS INC., (U.S. CLS. 100, 103 AND 106). SN 77-713,890. PUB. 2-16-2010. FILED 4-14-2009.
 3,783,550 (*See Class 35 for this trademark*).
 3,783,562. **MISCELLANEOUS DESIGN**. PACIFIC CRANE MAINTENANCE COMPANY, L.P., (U.S. CLS. 100, 103 AND 106). SN 77-719,000. PUB. 2-16-2010. FILED 4-21-2009.

- 3,783,739. **DEFINITIVE (BLOCK FORM)**. DEFINITIVE AUDIO, INC., (U.S. CLS. 100, 103 AND 106). SN 77-793,555. PUB. 2-16-2010. FILED 7-30-2009.
- 3,783,764. **NATIONWIDE ENVIRONMENTAL SERVICES (BLOCK FORM)**. JOE'S SWEEPING, INC., (U.S. CLS. 100, 103 AND 106). SN 77-797,566. PUB. 2-16-2010. FILED 8-5-2009.
- 3,783,783. **EMCOR SERVICES (BLOCK FORM)**. EMCOR GROUP, INC., (U.S. CLS. 100, 103 AND 106). SN 77-802,146. PUB. 2-16-2010. FILED 8-11-2009.
- 3,783,813. **BUILDING WITH INTELLIGENCE (BLOCK FORM)**. J.C. CANNISTRARO, LLC, MULTIPLE CLASS, (INT. CLS. 37, 42 AND 45), (U.S. CLS. 100, 101, 103 AND 106). SN 77-807,682. PUB. 2-16-2010. FILED 8-19-2009.
- 3,783,834 (See Class 35 for this trademark).
- 3,783,909 (See Class 35 for this trademark).
- 3,783,962. **TILE KING (BLOCK FORM)**. PALMER, ROB, DBA GROUT & TILE MAGIC, (U.S. CLS. 100, 103 AND 106). SN 77-823,628. PUB. 2-16-2010. FILED 9-10-2009.
- 3,784,081. **CLEAN & GREEN DRYER VENT EXPERTS AND DESIGN**. CLEAN AND GREEN DRYER VENT EXPERTS, LLC, (U.S. CLS. 100, 103 AND 106). SN 77-827,519. PUB. 2-16-2010. FILED 9-16-2009.
- 3,784,125 (See Class 6 for this trademark).
- 3,784,137. **UNITEDCAMERA A BETTER REPAIR EXPERIENCE AND DESIGN**. UNITED CAMERA & BINOCULAR CORP, LLC, (U.S. CLS. 100, 103 AND 106). SN 77-828,676. PUB. 2-16-2010. FILED 9-17-2009.
- 3,784,138. **PLUMB BETTER "DON'T GET WETTER...CALL PLUMB BETTER!" AND DESIGN**. PLUMB BETTER, INC., (U.S. CLS. 100, 103 AND 106). SN 77-828,709. PUB. 2-16-2010. FILED 9-17-2009.
- 3,784,142. **FABRIC FINISH (BLOCK FORM)**. WINN, FREDERICK, (U.S. CLS. 100, 103 AND 106). SN 77-828,769. PUB. 2-16-2010. FILED 9-17-2009.
- 3,784,146. **BONTERRA (BLOCK FORM)**. BONTERRA, LLC, (U.S. CLS. 100, 103 AND 106). SN 77-828,838. PUB. 2-16-2010. FILED 9-17-2009.
- 3,784,253 (See Class 35 for this trademark).
- 3,784,351. **FOR BETTER HOME COMFORT, BETTER CALL BLACKWELL (BLOCK FORM)**. BLACKWELL HEATING & AIR CONDITIONING, INC., (U.S. CLS. 100, 103 AND 106). SN 77-831,890. PUB. 2-16-2010. FILED 9-22-2009.
- 3,784,372. **BRING OUR EXPERIENCE HOME (BLOCK FORM)**. ALURE HOME IMPROVEMENTS, INC., (U.S. CLS. 100, 103 AND 106). SN 77-832,208. PUB. 2-16-2010. FILED 9-22-2009.
- 3,784,575. **SUPERIOR HEATING AND AIR INC YEAH, WE'RE THAT GOOD AND DESIGN**. SUPERIOR HEATING & AIR INC., (U.S. CLS. 100, 103 AND 106). SN 77-834,629. PUB. 2-16-2010. FILED 9-24-2009.
- 3,784,576. **RECYCLE A BOOK, SAVE A TREE (BLOCK FORM)**. GREEN WHEEL BOOKS LLC, (U.S. CLS. 100, 103 AND 106). SN 77-834,632. PUB. 2-16-2010. FILED 9-24-2009.
- 3,784,599. **MISCELLANEOUS DESIGN**. NEW GLOBAL SOLUTIONS, INC., MULTIPLE CLASS, (INT. CLS. 37 AND 42), (U.S. CLS. 100, 101, 103 AND 106). SN 77-834,985. PUB. 2-16-2010. FILED 9-25-2009.
- 3,784,610. **CLEAN THE WORLD AND DESIGN**. SEIPLER, SHAWN, (U.S. CLS. 100, 103 AND 106). SN 77-835,149. PUB. 2-16-2010. FILED 9-25-2009.
- 3,784,628 (See Class 36 for this trademark).
- 3,784,672. **BOLDTHINKING (STYLIZED)**. THE BOLDT GROUP, INC., MULTIPLE CLASS, (INT. CLS. 37 AND 42), (U.S. CLS. 100, 101, 103 AND 106). SN 77-836,324. PUB. 2-16-2010. FILED 9-28-2009.
- 3,784,832 (See Class 9 for this trademark).
- 3,784,866 (See Class 11 for this trademark).
- 3,784,878 (See Class 9 for this trademark).
- 3,784,885 (See Class 7 for this trademark).
- 3,784,886 (See Class 7 for this trademark).
- 3,784,887 (See Class 7 for this trademark).
- 3,784,888 (See Class 7 for this trademark).
- 3,784,906 (See Class 1 for this trademark).
- 3,784,907 (See Class 1 for this trademark).
- 3,784,909 (See Class 7 for this trademark).
- 3,784,914 (See Class 7 for this trademark).
- 3,784,918 (See Class 12 for this trademark).
- 3,784,924 (See Class 6 for this trademark).
- 3,784,934 (See Class 9 for this trademark).
- 3,784,971 (See Class 19 for this trademark).
- 3,785,006 (See Class 9 for this trademark).
- 3,785,014 (See Class 7 for this trademark).
- 3,785,023 (See Class 1 for this trademark).
- 3,785,024 (See Class 9 for this trademark).
- 3,785,042 (See Class 9 for this trademark).
- 3,785,043 (See Class 12 for this trademark).

CLASS 38—COMMUNICATION

- 3,783,091. **INSTANTSERVICE (BLOCK FORM)**. INSTANT-SERVICE.COM, INC., (U.S. CLS. 100, 101 AND 104). SN 76-684,289. PUB. 2-16-2010. FILED 11-26-2007.
- 3,783,159 (See Class 9 for this trademark).
- 3,783,195 (See Class 9 for this trademark).
- 3,783,228 (See Class 9 for this trademark).
- 3,783,240. **CELEBRITIES CALL YOU (BLOCK FORM)**. WEBB, CHRIS A., AND YELICH, JAMES JOSEPH, (U.S. CLS. 100, 101 AND 104). SN 77-504,843. PUB. 2-16-2010. FILED 6-21-2008.
- 3,783,241. **CELEBRITIES CALLYOU.COM AND DESIGN**. WEBB, CHRIS A., AND YELICH, JAMES JOSEPH, (U.S. CLS. 100, 101 AND 104). SN 77-504,846. PUB. 2-16-2010. FILED 6-21-2008.
- 3,783,249. **ESPERANZA TV AND DESIGN**. GENERAL CONFERENCE CORPORATION OF SEVENTH-DAY ADVENTISTS, MULTIPLE CLASS, (INT. CLS. 38 AND 41), (U.S. CLS. 100, 101, 104 AND 107). SN 77-517,973. PUB. 2-16-2010. FILED 7-9-2008.
- 3,783,264. **OVALSTUDY (BLOCK FORM)**. TISHMAN SPEYER PCVST MANAGEMENT, L.L.C., MULTIPLE CLASS, (INT. CLS. 38 AND 41), (U.S. CLS. 100, 101, 104 AND 107). SN 77-538,346. PUB. 2-16-2010. FILED 8-4-2008.
- 3,783,280. **B AND DESIGN**. BINARY POETRY, INC., (U.S. CLS. 100, 101 AND 104). SN 77-567,107. PUB. 2-16-2010. FILED 9-10-2008.
- 3,783,346 (See Class 35 for this trademark).
- 3,783,347 (See Class 35 for this trademark).
- 3,783,357 (See Class 9 for this trademark).
- 3,783,368 (See Class 35 for this trademark).
- 3,783,481 (See Class 12 for this trademark).
- 3,783,482 (See Class 12 for this trademark).
- 3,783,490. **YOU TELL IT AND DESIGN**. CHANNEL ONE, LLC, MULTIPLE CLASS, (INT. CLS. 38, 41 AND 42), (U.S. CLS. 100, 101, 104 AND 107). SN 77-705,222. PUB. 2-16-2010. FILED 4-2-2009.
- 3,783,530. **HIGH-SPEED 2GO (BLOCK FORM)**. COMCAST CORPORATION, (U.S. CLS. 100, 101 AND 104). SN 77-712,764. PUB. 2-16-2010. FILED 4-13-2009.
- 3,783,531. **HIGH-SPEED 2GO AND DESIGN**. COMCAST CORPORATION, (U.S. CLS. 100, 101 AND 104). SN 77-712,774. PUB. 2-16-2010. FILED 4-13-2009.
- 3,783,537. **MISCELLANEOUS DESIGN**. CLEAR PEAK COMMUNICATIONS, LLC, (U.S. CLS. 100, 101 AND 104). SN 77-713,234. PUB. 2-16-2010. FILED 4-14-2009.
- 3,783,572. **AUDIO CONFERENCING MADE EASY (BLOCK FORM)**. CITRIX ONLINE, LLC, MULTIPLE CLASS, (INT. CLS. 38 AND 42), (U.S. CLS. 100, 101 AND 104). SN 77-721,034. PUB. 2-16-2010. FILED 4-23-2009.
- 3,783,677 (See Class 9 for this trademark).
- 3,783,727. **GREENORGO AND DESIGN**. SALADIN, TANVEER, (U.S. CLS. 100, 101 AND 104). SN 77-787,140. PUB. 2-16-2010. FILED 7-22-2009.
- 3,783,734 (See Class 9 for this trademark).
- 3,783,743. **NETSELECT (BLOCK FORM)**. HEALTH SCIENCES LIBRARIES CONSORTIUM, (U.S. CLS. 100, 101 AND 104). SN 77-794,124. PUB. 2-16-2010. FILED 7-31-2009.
- 3,783,751. **REUNITE AND DESIGN**. FAMILIES.COM LLC, (U.S. CLS. 100, 101 AND 104). SN 77-794,831. PUB. 2-16-2010. FILED 7-31-2009.
- 3,783,775 (See Class 9 for this trademark).
- 3,783,776 (See Class 9 for this trademark).
- 3,783,968. **SIPHONY (BLOCK FORM)**. NOBLE SYSTEMS

- CORPORATION, (U.S. CLS. 100, 101 AND 104). SN 77-823,679. PUB. 2-16-2010. FILED 9-10-2009.
3,784,006 (*See Class 9 for this trademark*).
- 3,784,063. **MEETING ON THE MOVE (BLOCK FORM)**. MARKEY'S VIDEO IMAGES, LLC, (U.S. CLS. 100, 101 AND 104). SN 77-826,982. PUB. 2-16-2010. FILED 9-15-2009.
3,784,080. **SHOP2EARN (BLOCK FORM)**. SHOP2EARN NET, DBA SHOPEARN, (U.S. CLS. 100, 101 AND 104). SN 77-827,500. PUB. 2-16-2010. FILED 9-16-2009.
3,784,239. **MIMUSICA AND DESIGN**. LATIN ENTERTAINMENT GROUP, LLC, (U.S. CLS. 100, 101 AND 104). SN 77-830,567. PUB. 2-16-2010. FILED 9-20-2009.
3,784,241. **MIMUSICA (BLOCK FORM)**. LATIN ENTERTAINMENT GROUP, LLC, (U.S. CLS. 100, 101 AND 104). SN 77-830,569. PUB. 2-16-2010. FILED 9-20-2009.
3,784,335. **SHOP2EARTH (BLOCK FORM)**. SHOP2EARN NET, DBA SHOPEARN, (U.S. CLS. 100, 101 AND 104). SN 77-831,729. PUB. 2-16-2010. FILED 9-22-2009.
3,784,338 (*See Class 35 for this trademark*).
- 3,784,456. **CAMP G AND DESIGN**. STOKELY-VAN CAMP, INC., (U.S. CLS. 100, 101 AND 104). SN 77-833,185. PUB. 2-16-2010. FILED 9-23-2009.
3,784,482. **MISCELLANEOUS DESIGN**. WESTERN FIBER-NET, LLC, (U.S. CLS. 100, 101 AND 104). SN 77-833,490. PUB. 2-16-2010. FILED 9-23-2009.
3,784,625. **WHINER LINE (BLOCK FORM)**. ENTERCOM COMMUNICATIONS CORP., MULTIPLE CLASS, (INT. CLS. 38 AND 41), (U.S. CLS. 100, 101, 104 AND 107). SN 77-835,398. PUB. 2-16-2010. FILED 9-25-2009.
3,784,799. **WORDGIRL (BLOCK FORM)**. SCHOLASTIC INC., (U.S. CLS. 100, 101 AND 104). SN 77-867,176. PUB. 2-16-2010. FILED 11-6-2009.
3,784,800. **K-ACE (BLOCK FORM)**. CBS RADIO INC., (U.S. CLS. 100, 101 AND 104). SN 77-867,215. PUB. 2-16-2010. FILED 11-6-2009.
3,784,843 (*See Class 9 for this trademark*).
3,784,867 (*See Class 35 for this trademark*).
3,784,868 (*See Class 35 for this trademark*).
3,784,869 (*See Class 3 for this trademark*).
3,784,878 (*See Class 9 for this trademark*).
3,784,884 (*See Class 5 for this trademark*).
3,784,895 (*See Class 9 for this trademark*).
3,784,902 (*See Class 35 for this trademark*).
3,784,915 (*See Class 9 for this trademark*).
3,784,917 (*See Class 16 for this trademark*).
3,784,919 (*See Class 9 for this trademark*).
3,784,920 (*See Class 9 for this trademark*).
3,784,933 (*See Class 35 for this trademark*).
3,784,964 (*See Class 9 for this trademark*).
3,784,969 (*See Class 9 for this trademark*).
3,784,970 (*See Class 9 for this trademark*).
3,784,981 (*See Class 9 for this trademark*).
3,784,982 (*See Class 9 for this trademark*).
3,784,984 (*See Class 9 for this trademark*).
3,785,022 (*See Class 9 for this trademark*).
3,785,024 (*See Class 9 for this trademark*).
3,785,037 (*See Class 35 for this trademark*).
- 2-16-2010. FILED 6-16-2008.
3,783,287. **ALL POINTS AUTO TRANSPORT (BLOCK FORM)**. ALL POINTS AUTO TRANSPORT, LP, (U.S. CLS. 100 AND 105). SN 77-580,959. PUB. 2-16-2010. FILED 9-29-2008.
3,783,329. **CALL TODAY HAUL TODAY (BLOCK FORM)**. BUNTE, STEVEN RAY, (U.S. CLS. 100 AND 105). SN 77-648,558. PUB. 2-16-2010. FILED 1-13-2009.
3,783,335. **MISCELLANEOUS DESIGN**. THE CAREY GROUP INC., (U.S. CLS. 100 AND 105). SN 77-654,283. PUB. 2-16-2010. FILED 1-22-2009.
3,783,342 (*See Class 33 for this trademark*).
3,783,368 (*See Class 35 for this trademark*).
3,783,529. **EASY RESERVATIONS (BLOCK FORM)**. EASY RESERVATIONS, INC, AKA EASYRESERVATIONS.COM, (U.S. CLS. 100 AND 105). SN 77-712,713. PUB. 2-16-2010. FILED 4-13-2009.
3,783,532. **DANCIN' ON DECK (BLOCK FORM)**. HELLER, DIANE, (U.S. CLS. 100 AND 105). SN 77-712,837. PUB. 2-16-2010. FILED 4-13-2009.
3,783,541 (*See Class 6 for this trademark*).
3,783,565. **COOL BOX (BLOCK FORM)**. COOL BOX PORTABLE EQUIPMENT RENTAL & SALES, L.L.C., DBA COOL BOX PORTABLE STORAGE, (U.S. CLS. 100 AND 105). SN 77-719,510. PUB. 9-15-2009. FILED 4-22-2009.
3,783,695. **FIRST TO FLY (BLOCK FORM)**. SHERPA PET GROUP, LLC, (U.S. CLS. 100 AND 105). SN 77-775,436. PUB. 2-16-2010. FILED 7-7-2009.
3,783,799. **THIRSTY GIRL LIFE. DRINK IT UP! AND DESIGN**. SBROCCO, LESLIE, DBA THIRSTY GIRL, MULTIPLE CLASS, (INT. CLS. 39, 41 AND 43), (U.S. CLS. 100, 101, 105 AND 107). SN 77-804,336. PUB. 2-16-2010. FILED 8-13-2009.
3,783,834 (*See Class 35 for this trademark*).
3,783,932 (*See Class 35 for this trademark*).
3,783,938 (*See Class 35 for this trademark*).
3,783,954. **HELPING TO KEEP THE LIGHTS ON, BUSINESSES RUNNING AND COMMUNITIES STRONG (BLOCK FORM)**. AMERICAN TRANSMISSION COMPANY, (U.S. CLS. 100 AND 105). SN 77-823,406. PUB. 2-16-2010. FILED 9-10-2009.
3,783,955. **MISCELLANEOUS DESIGN**. GLOBALBIKE, INC., (U.S. CLS. 100 AND 105). SN 77-823,431. PUB. 2-16-2010. FILED 9-10-2009.
3,783,970 (*See Class 35 for this trademark*).
3,783,971 (*See Class 35 for this trademark*).
3,783,979. **TRIPZIPR (BLOCK FORM)**. YARGER, STEVEN EDWARD, (U.S. CLS. 100 AND 105). SN 77-824,305. PUB. 2-16-2010. FILED 9-10-2009.
3,784,073. **SOLVERA AND DESIGN**. RODRIGUEZ, PABLO HECTOR, (U.S. CLS. 100 AND 105). SN 77-827,314. PUB. 2-16-2010. FILED 9-16-2009.
3,784,074. **MYTRIPGURU (BLOCK FORM)**. JOHANSSON, NICOLAS F., DBA MYTRIPGURU.COM, (U.S. CLS. 100 AND 105). SN 77-827,341. PUB. 2-16-2010. FILED 9-16-2009.
3,784,101. **FORTUNATE SUN AND DESIGN**. NORMANDY SHIPPING, L.L.C., (U.S. CLS. 100 AND 105). SN 77-827,970. PUB. 2-16-2010. FILED 9-16-2009.
3,784,107. **MADTRAVELERS (BLOCK FORM)**. MADTRAVELERS, LLC, (U.S. CLS. 100 AND 105). SN 77-828,198. PUB. 2-16-2010. FILED 9-16-2009.
3,784,151. **LEP (STYLIZED)**. AGILITY HOLDINGS, INC., (U.S. CLS. 100 AND 105). SN 77-828,904. PUB. 2-16-2010. FILED 9-17-2009.
3,784,167. **ETHANOL EXPRESS (BLOCK FORM)**. BNSF RAILWAY COMPANY, (U.S. CLS. 100 AND 105). SN 77-829,240. PUB. 2-16-2010. FILED 9-17-2009.
3,784,228. **ENCOUNTOUR (BLOCK FORM)**. ENCOUNTOUR LLC, (U.S. CLS. 100 AND 105). SN 77-830,367. PUB. 2-16-2010. FILED 9-18-2009.
3,784,253 (*See Class 35 for this trademark*).
3,784,424. **CSAV AND DESIGN**. COMPANIA SUD AMERICANA DE VAPORES S.A., (U.S. CLS. 100 AND 105). SN 77-832,775. PUB. 2-16-2010. FILED 9-23-2009.
3,784,563. **CHOICEAIR (BLOCK FORM)**. ROYAL CARIBBEAN CRUISES LTD., (U.S. CLS. 100 AND 105). SN 77-834,457. PUB. 2-16-2010. FILED 9-24-2009.
3,784,639 (*See Class 35 for this trademark*).
3,784,641 (*See Class 35 for this trademark*).
3,784,649. **COWBOY STORAGE AND DESIGN**. HOLT, DAVID

CLASS 39—TRANSPORTATION AND STORAGE

- 3,783,140. **CLICK AND PARK COM AND DESIGN**. CLICK AND PARK, LLC, (U.S. CLS. 100 AND 105). SN 77-054,446. PUB. 2-16-2010. FILED 11-30-2006.
3,783,177 (*See Class 9 for this trademark*).
- 3,783,180. **MARTIN MARINE AND DESIGN**. MARTIN OPERATING PARTNERSHIP L.P., (U.S. CLS. 100 AND 105). SN 77-310,096. PUB. 2-16-2010. FILED 10-22-2007.
3,783,183. **MARTIN MARINE (BLOCK FORM)**. MARTIN OPERATING PARTNERSHIP L.P., (U.S. CLS. 100 AND 105). SN 77-325,050. PUB. 2-16-2010. FILED 11-8-2007.
3,783,189. **NEXUS HOLIDAYS AND DESIGN**. NEXUS HOLIDAYS CHICAGO INC., (U.S. CLS. 100 AND 105). SN 77-359,583. PUB. 2-16-2010. FILED 12-26-2007.
3,783,239. **CLICK AND PARK (BLOCK FORM)**. CLICK AND PARK, LLC, (U.S. CLS. 100 AND 105). SN 77-499,904. PUB.

P, (U.S. CLS. 100 AND 105). SN 77-835,718. PUB. 2-16-2010. FILED 9-26-2009.
 3,784,732. **RIDEMATCHER AND DESIGN**. SAN DIEGO ASSOCIATION OF GOVERNMENTS, (U.S. CLS. 100 AND 105). SN 77-844,751. PUB. 2-16-2010. FILED 10-8-2009.
 3,784,869 (*See Class 3 for this trademark*).
 3,784,906 (*See Class 1 for this trademark*).
 3,784,907 (*See Class 1 for this trademark*).
 3,784,909 (*See Class 7 for this trademark*).
 3,784,955. **MISCELLANEOUS DESIGN**. HANATOUR SERVICE INC., (U.S. CLS. 100 AND 105). SN 79-067,547. PUB. 2-16-2010. FILED 4-1-2009.
 3,784,981 (*See Class 9 for this trademark*).
 3,784,998 (*See Class 35 for this trademark*).
 3,785,023 (*See Class 1 for this trademark*).
 3,785,031 (*See Class 18 for this trademark*).
 3,785,037 (*See Class 35 for this trademark*).

16-2010. FILED 9-22-2009.
 3,784,489 (*See Class 35 for this trademark*).
 3,784,492 (*See Class 35 for this trademark*).
 3,784,866 (*See Class 11 for this trademark*).
 3,784,906 (*See Class 1 for this trademark*).
 3,784,907 (*See Class 1 for this trademark*).
 3,784,909 (*See Class 7 for this trademark*).
 3,784,918 (*See Class 12 for this trademark*).
 3,784,924 (*See Class 6 for this trademark*).
 3,784,930. **MBK IAC GROUP AND DESIGN**. MITSUBOSHI KASEIHIN CO., LTD., (U.S. CLS. 100, 103 AND 106). SN 79-066,245. PUB. 2-16-2010. FILED 12-26-2008.
 3,784,965 (*See Class 9 for this trademark*).
 3,784,984 (*See Class 9 for this trademark*).
 3,785,010 (*See Class 6 for this trademark*).
 3,785,023 (*See Class 1 for this trademark*).

CLASS 40—MATERIAL TREATMENT

3,783,203. **VISION AND DESIGN**. SIGNET ARMORLITE EUROPE LIMITED, (U.S. CLS. 100, 103 AND 106). SN 77-396,696. PUB. 2-16-2010. FILED 2-14-2008.
 3,783,332 (*See Class 35 for this trademark*).
 3,783,333 (*See Class 35 for this trademark*).
 3,783,334 (*See Class 35 for this trademark*).
 3,783,353. **ART AS RESPONSA (BLOCK FORM)**. MARSHA PLAFKIN-HURWITZ, (U.S. CLS. 100, 103 AND 106). SN 77-670,301. PUB. 2-16-2010. FILED 2-13-2009.
 3,783,365 (*See Class 37 for this trademark*).
 3,783,375 (*See Class 1 for this trademark*).
 3,783,385. **HOME SOURCE INTERNATIONAL (BLOCK FORM)**. HOME SOURCE INTERNATIONAL, (U.S. CLS. 100, 103 AND 106). SN 77-685,566. PUB. 2-16-2010. FILED 3-6-2009.
 3,783,429 (*See Class 35 for this trademark*).
 3,783,430 (*See Class 35 for this trademark*).
 3,783,431 (*See Class 35 for this trademark*).
 3,783,446. **PROMO LOGIC, LLC (BLOCK FORM)**. PROMO LOGIC, LLC, (U.S. CLS. 100, 103 AND 106). SN 77-700,753. PUB. 8-4-2009. FILED 3-27-2009.
 3,783,558. **QZOTIC AND DESIGN**. LAVALA, JAMES, (U.S. CLS. 100, 103 AND 106). SN 77-717,938. PUB. 2-16-2010. FILED 4-20-2009.
 3,783,598. **STOCK TINS THAT GO BEYOND (BLOCK FORM)**. PLANET CANIT, LLC, (U.S. CLS. 100, 103 AND 106). SN 77-736,260. PUB. 2-16-2010. FILED 5-13-2009.
 3,783,686. **NORTHERN LABS, INC. (BLOCK FORM)**. NORTHERN LABS, INC., (U.S. CLS. 100, 103 AND 106). SN 77-771,569. PUB. 2-16-2010. FILED 6-30-2009.
 3,783,744 (*See Class 35 for this trademark*).
 3,783,766 (*See Class 20 for this trademark*).
 3,783,832. **A AMERICAN PACKAGING CORPORATION (STYLIZED)**. AMERICAN PACKAGING CORPORATION, (U.S. CLS. 100, 103 AND 106). SN 77-811,044. PUB. 2-16-2010. FILED 8-24-2009.
 3,783,901. **IDWRAPS.COM VEHICLE ADVERTISING (STYLIZED)**. IDENTITY GROUP, LLC, (U.S. CLS. 100, 103 AND 106). SN 77-819,286. PUB. 2-16-2010. FILED 9-3-2009.
 3,783,906. **UNTAMED TAXIDERM (BLOCK FORM)**. COOK THOMAS E, DBA UNTAMED TAXIDERM, (U.S. CLS. 100, 103 AND 106). SN 77-819,756. PUB. 2-16-2010. FILED 9-3-2009.
 3,783,938 (*See Class 35 for this trademark*).
 3,783,974 (*See Class 16 for this trademark*).
 3,784,093. **CENTREX (BLOCK FORM)**. CENTREX PLASTICS, LLC, (U.S. CLS. 100, 103 AND 106). SN 77-827,736. PUB. 2-16-2010. FILED 9-16-2009.
 3,784,173 (*See Class 16 for this trademark*).
 3,784,229 (*See Class 16 for this trademark*).
 3,784,230 (*See Class 16 for this trademark*).
 3,784,284. **FWTW AND DESIGN**. FORTUNE WATER TECHNOLOGIES, INC., (U.S. CLS. 100, 103 AND 106). SN 77-831,028. PUB. 2-16-2010. FILED 9-21-2009.
 3,784,363. **EB (BLOCK FORM)**. BERG EUROPIPE HOLDING CORP., (U.S. CLS. 100, 103 AND 106). SN 77-832,056. PUB. 2-

CLASS 41—EDUCATION AND ENTERTAINMENT

3,783,087 (*See Class 16 for this trademark*).
 3,783,088 (*See Class 16 for this trademark*).
 3,783,089 (*See Class 16 for this trademark*).
 3,783,096. **TUSKEGEE AIRMEN NATIONAL MUSEUM (BLOCK FORM)**. TUSKEGEE AIRMEN NATIONAL HISTORICAL MUSEUM, THE, (U.S. CLS. 100, 101 AND 107). SN 76-692,249. PUB. 2-16-2010. FILED 8-20-2008.
 3,783,097. **THE NATIONAL MUSEUM OF THE TUSKEGEE AIRMEN AND DESIGN**. TUSKEGEE AIRMEN NATIONAL HISTORICAL MUSEUM, THE, (U.S. CLS. 100, 101 AND 107). SN 76-692,258. PUB. 2-16-2010. FILED 8-20-2008.
 3,783,101. **JAKAFELLA ENTERTAINMENT LLC (BLOCK FORM)**. JAKAFELLA ENTERTAINMENT LLC, (U.S. CLS. 100, 101 AND 107). SN 76-695,697. PUB. 2-16-2010. FILED 2-9-2009.
 3,783,112. **GLOBAL CASH FLOW NETWORK AND DESIGN**. KT IP MANAGEMENT, L.L.C., (U.S. CLS. 100, 101 AND 107). SN 76-697,488. PUB. 2-16-2010. FILED S.R. 5-18-2009; AM. P.R. 1-11-2010.
 3,783,113. **MODEL CHILD (BLOCK FORM)**. PARKER, SARAH SPRINGER, (U.S. CLS. 100, 101 AND 107). SN 76-698,452. PUB. 2-16-2010. FILED 7-16-2009.
 3,783,120. **HOLLYWOOD WITHOUT THE ATTITUDE! (BLOCK FORM)**. URBAN TRUTH LLC, (U.S. CLS. 100, 101 AND 107). SN 76-698,890. PUB. 2-16-2010. FILED 8-10-2009.
 3,783,121. **THE REAL UNPLUGGED TOUR (BLOCK FORM)**. NEILL CORPORATION, (U.S. CLS. 100, 101 AND 107). SN 76-698,936. PUB. 2-16-2010. FILED 8-12-2009.
 3,783,122. **XCELLENCE UNPLUGGED (BLOCK FORM)**. NEILL CORPORATION, (U.S. CLS. 100, 101 AND 107). SN 76-698,937. PUB. 2-16-2010. FILED 8-12-2009.
 3,783,135. **SOUND KITCHEN (BLOCK FORM)**. SOUND KITCHEN STUDIOS, LLC, (U.S. CLS. 100, 101 AND 107). SN 76-699,624. PUB. 2-16-2010. FILED 9-25-2009.
 3,783,136. **EAT MUSIC (BLOCK FORM)**. SOUND KITCHEN STUDIOS, LLC, (U.S. CLS. 100, 101 AND 107). SN 76-699,626. PUB. 2-16-2010. FILED 9-25-2009.
 3,783,139. **THRIVING AT WORK (BLOCK FORM)**. KRALOVEC, OTTO J., III, (U.S. CLS. 100, 101 AND 107). SN 77-049,682. PUB. 1-1-2008. FILED 11-22-2006.
 3,783,148. **SOUTHWESTERN COMPANY (BLOCK FORM)**. SOUTHWESTERN/GREAT AMERICAN, INC., DBA THE SOUTHWESTERN COMPANY, (U.S. CLS. 100, 101 AND 107). SN 77-119,848. PUB. 2-16-2010. FILED 3-1-2007.
 3,783,168. **MTO ACADEMY (BLOCK FORM)**. ANGHA, NADER, (U.S. CLS. 100, 101 AND 107). SN 77-247,073. PUB. 2-16-2010. FILED 8-3-2007.
 3,783,169 (*See Class 9 for this trademark*).
 3,783,171 (*See Class 9 for this trademark*).
 3,783,175. **BUILDING MUSEUMS AND DESIGN**. MID-ATLANTIC ASSOCIATION OF MUSEUMS, (U.S. CLS. 100, 101 AND 107). SN 77-274,128. PUB. 2-16-2010. FILED 9-7-2007.
 3,783,196. **H.E.L.P. FOR U AND DESIGN**. HOLMES, AUDREY

- N., (U.S. CLS. 100, 101 AND 107). SN 77-390,562. PUB. 11-10-2009. FILED 2-6-2008.
- 3,783,204. **IEBB MEDIA AND DESIGN**. WEST, RENEE, (U.S. CLS. 100, 101 AND 107). SN 77-406,723. PUB. 2-16-2010. FILED 2-26-2008.
- 3,783,206. **LAYOFF (BLOCK FORM)**. AURIOLES ERIC, (U.S. CLS. 100, 101 AND 107). SN 77-407,433. PUB. 2-16-2010. FILED 2-27-2008.
- 3,783,211. **GIANT AND DESIGN**. SHANGHAI GIANT NETWORK TECHNOLOGY CO., LTD., (U.S. CLS. 100, 101 AND 107). SN 77-415,664. PUB. 1-13-2009. FILED 3-7-2008.
- 3,783,219. **STYLESPOT AND DESIGN**. STYLESPOT, LLC, (U.S. CLS. 100, 101 AND 107). SN 77-441,848. PUB. 8-26-2008. FILED 4-7-2008.
- 3,783,231 (*See Class 9 for this trademark*).
- 3,783,234. **BARRY MCGUIRE (BLOCK FORM)**. BARRY E. MCGUIRE, DBA BARRY MCGUIRE, (U.S. CLS. 100, 101 AND 107). SN 77-494,733. PUB. 9-8-2009. FILED 6-9-2008.
- 3,783,237. **SERIOUS CLOWNING A STORY BEHIND EVERY SMILE (BLOCK FORM)**. LEV LEYTZAN: THE COMPASSIONATE CLOWN ALLEY, INC., (U.S. CLS. 100, 101 AND 107). SN 77-498,147. PUB. 2-16-2010. FILED 6-13-2008.
- 3,783,238 (*See Class 35 for this trademark*).
- 3,783,249 (*See Class 38 for this trademark*).
- 3,783,250. **EXPLORECALLING.ORG (BLOCK FORM)**. GENERAL BOARD OF HIGHER EDUCATION AND MINISTRY OF THE UNITED METHODIST CHURCH, (U.S. CLS. 100, 101 AND 107). SN 77-520,538. PUB. 2-16-2010. FILED 7-11-2008.
- 3,783,263. **CONSCIOUS PEOPLE, CONSCIOUS BUSINESS, CONSCIOUS CAPITALISM (BLOCK FORM)**. FREEDOM LIGHTS OUR WORLD (FLOW), INC., (U.S. CLS. 100, 101 AND 107). SN 77-537,383. PUB. 7-7-2009. FILED 8-1-2008.
- 3,783,264 (*See Class 38 for this trademark*).
- 3,783,272. **SESSLER'S SOAPBOX (BLOCK FORM)**. G4 MEDIA, INC., (U.S. CLS. 100, 101 AND 107). SN 77-552,519. PUB. 2-16-2010. FILED 8-21-2008.
- 3,783,277. **MEDED AT SEA AND DESIGN**. THE POLLIN GROUP LLC, (U.S. CLS. 100, 101 AND 107). SN 77-563,056. PUB. 2-16-2010. FILED 9-5-2008.
- 3,783,283 (*See Class 25 for this trademark*).
- 3,783,286. **KIDS THINK BIG WWW.KIDSTHINKBIG.COM AND DESIGN**. KIDS THINK BIG LLC, (U.S. CLS. 100, 101 AND 107). SN 77-578,290. PUB. 2-16-2010. FILED 9-25-2008.
- 3,783,289 (*See Class 16 for this trademark*).
- 3,783,312. **KOSMIX (BLOCK FORM)**. KOSMIX CORPORATION, MULTIPLE CLASS, (INT. CLS. 41 AND 42), (U.S. CLS. 100, 101 AND 107). SN 77-624,769. PUB. 2-16-2010. FILED 12-2-2008.
- 3,783,319. **DAVE BARZ (BLOCK FORM)**. MILLER, DAVID, (U.S. CLS. 100, 101 AND 107). SN 77-639,760. PUB. 2-16-2010. FILED 12-24-2008.
- 3,783,326. **HIGH TIDE AND DESIGN**. RISSOLO, BOB, DBA BOB RISSOLO SOUNDS, AND BARRENA, EDWARD, AND MURRAY, CHRISTOPHER, AND FRITSCH, JUSTIN, AND HEITERT, FOREST, (U.S. CLS. 100, 101 AND 107). SN 77-644,979. PUB. 2-16-2010. FILED 1-7-2009.
- 3,783,330 (*See Class 9 for this trademark*).
- 3,783,331 (*See Class 12 for this trademark*).
- 3,783,332 (*See Class 35 for this trademark*).
- 3,783,333 (*See Class 35 for this trademark*).
- 3,783,334 (*See Class 35 for this trademark*).
- 3,783,336. **JUST BELIEVE (BLOCK FORM)**. LIFE IS NOW, INC., (U.S. CLS. 100, 101 AND 107). SN 77-656,038. PUB. 2-16-2010. FILED 1-25-2009.
- 3,783,354 (*See Class 35 for this trademark*).
- 3,783,357 (*See Class 9 for this trademark*).
- 3,783,359. **7ATE9 (BLOCK FORM)**. 7ATE9 INC., (U.S. CLS. 100, 101 AND 107). SN 77-673,601. PUB. 2-16-2010. FILED 2-19-2009.
- 3,783,360. **SKYDIVE ALABAMA (BLOCK FORM)**. SKYDIVE ALABAMA, INC., (U.S. CLS. 100, 101 AND 107). SN 77-674,596. PUB. 6-30-2009. FILED 2-20-2009.
- 3,783,370. **BUCK REED (BLOCK FORM)**. REED, BUCK D., DBA REED ENTERPRISES, (U.S. CLS. 100, 101 AND 107). SN 77-680,374. PUB. 2-16-2010. FILED 2-27-2009.
- 3,783,371. **TRUE 2 VODOO (BLOCK FORM)**. PAUL R. ABRAMSON, (U.S. CLS. 100, 101 AND 107). SN 77-680,659. PUB. 2-16-2010. FILED 2-27-2009.
- 3,783,384. **PEEKABOO PHOTO BOOTH (BLOCK FORM)**. PEEKABOO PHOTO BOOTH, LLC, (U.S. CLS. 100, 101 AND 107). SN 77-685,234. PUB. 2-16-2010. FILED 3-6-2009.
- 3,783,387 (*See Class 25 for this trademark*).
- 3,783,389. **THE NATIONAL HISPANIC PRAYER BREAKFAST AND CONFERENCE (BLOCK FORM)**. NUEVA ESPERANZA INC., (U.S. CLS. 100, 101 AND 107). SN 77-686,474. PUB. 2-16-2010. FILED 3-9-2009.
- 3,783,412. **P PENSAR EN ESPAÑOL AND DESIGN**. FUNDACION ESPAÑOLA PARA LA CIENCIA Y LA TECNOLOGIA, (U.S. CLS. 100, 101 AND 107). SN 77-694,128. PUB. 2-16-2010. FILED 3-18-2009.
- 3,783,422 (*See Class 35 for this trademark*).
- 3,783,423. **COLLEGE OF ST. CATHERINE (BLOCK FORM)**. ST. CATHERINE UNIVERSITY, (U.S. CLS. 100, 101 AND 107). SN 77-695,996. PUB. 2-16-2010. FILED 3-20-2009.
- 3,783,426 (*See Class 35 for this trademark*).
- 3,783,445. **LICENSED . PARELLI PROFESSIONAL AND DESIGN**. PARELLI NATURAL HORSEMANSHIP, INC., (U.S. CLS. 100, 101 AND 107). SN 77-700,522. PUB. 2-16-2010. FILED 3-27-2009.
- 3,783,449 (*See Class 9 for this trademark*).
- 3,783,450. **CAMP MODIN (BLOCK FORM)**. KFAR CAMPING CO., INC., (U.S. CLS. 100, 101 AND 107). SN 77-700,986. PUB. 2-16-2010. FILED 3-27-2009.
- 3,783,452. **ARCHIE LEAGUE MEDAL OF SAFETY AWARDS (BLOCK FORM)**. NATIONAL AIR TRAFFIC CONTROLLERS ASSOCIATION, (U.S. CLS. 100, 101 AND 107). SN 77-701,160. PUB. 2-16-2010. FILED 3-27-2009.
- 3,783,459. **LAMININ PRODUCTIONS, INC AND DESIGN**. LAMININ PRODUCTIONS, INC., (U.S. CLS. 100, 101 AND 107). SN 77-701,557. PUB. 2-16-2010. FILED 3-28-2009.
- 3,783,473. **WGN AMERICA (BLOCK FORM)**. WGN CONTINENTAL BROADCASTING COMPANY, (U.S. CLS. 100, 101 AND 107). SN 77-702,750. PUB. 2-16-2010. FILED 3-31-2009.
- 3,783,483. **TOUGHEST & BADDEST BRAWL (BLOCK FORM)**. HINES, JAMES, (U.S. CLS. 100, 101 AND 107). SN 77-704,145. PUB. 2-16-2010. FILED 4-1-2009.
- 3,783,490 (*See Class 38 for this trademark*).
- 3,783,498. **PROACTIVE CAREGIVING IN A REACTIVE WORLD. WCI WORKING CAREGIVER INITIATIVE (STYLIZED)**. WORKING CAREGIVER INITIATIVE, (U.S. CLS. 100, 101 AND 107). SN 77-706,150. PUB. 2-16-2010. FILED 4-3-2009.
- 3,783,507. **BOWERS MUSEUM (BLOCK FORM)**. THE CHARLES W. BOWERS MUSEUM CORPORATION, (U.S. CLS. 100, 101 AND 107). SN 77-708,641. PUB. 2-16-2010. FILED 4-7-2009.
- 3,783,509. **VTS VIRTUAL TRAINING SYSTEMS AND DESIGN**. VIRTUAL TRAINING SYSTEMS, INC., (U.S. CLS. 100, 101 AND 107). SN 77-708,787. PUB. 2-16-2010. FILED 4-7-2009.
- 3,783,510. **EMQ FAMILIESFIRST AND DESIGN**. FAMILIES FIRST, INC., DBA EMQ FAMILIESFIRST, MULTIPLE CLASS, (INT. CLS. 41, 44 AND 45), (U.S. CLS. 100, 101 AND 107). SN 77-708,903. PUB. 2-16-2010. FILED 4-7-2009.
- 3,783,517. **RPM RACING (BLOCK FORM)**. RPM RACING, INC., (U.S. CLS. 100, 101 AND 107). SN 77-710,340. PUB. 2-16-2010. FILED 4-9-2009.
- 3,783,522. **MISCELLANEOUS DESIGN**. INDIANA ORGAN PROCUREMENT ORGANIZATION, INC., MULTIPLE CLASS, (INT. CLS. 41 AND 44), (U.S. CLS. 100, 101 AND 107). SN 77-712,223. PUB. 2-16-2010. FILED 4-13-2009.
- 3,783,540 (*See Class 35 for this trademark*).
- 3,783,552. **YOUR SOCIAL WORKER WITH A MICROPHONE (BLOCK FORM)**. ZOX, KATHRYN, (U.S. CLS. 100, 101 AND 107). SN 77-715,207. PUB. 2-16-2010. FILED 4-16-2009.
- 3,783,556. **STAY CONNECTED (BLOCK FORM)**. CBS BROADCASTING INC., (U.S. CLS. 100, 101 AND 107). SN 77-717,621. PUB. 2-16-2010. FILED 4-20-2009.
- 3,783,557. **CONSCIOUS BUSINESS (BLOCK FORM)**. FREEDOM LIGHTS OUR WORLD (FLOW), INC., (U.S. CLS. 100, 101 AND 107). SN 77-717,916. PUB. 8-18-2009. FILED 4-20-2009.
- 3,783,564. **FLYBOYZS (BLOCK FORM)**. FREENY, JEFFERY A., (U.S. CLS. 100, 101 AND 107). SN 77-719,487. PUB. 2-16-

2010. FILED 4-22-2009.
- 3,783,568. **CARA A CARA (BLOCK FORM)**. TWENTIETH CENTURY FOX FILM CORPORATION, (U.S. CLS. 100, 101 AND 107). SN 77-720,463. PUB. 2-16-2010. FILED 4-23-2009.
- 3,783,580 (*See Class 9 for this trademark*).
- 3,783,581. **CHASE REVIEW (BLOCK FORM)**. JPMORGAN CHASE & CO., (U.S. CLS. 100, 101 AND 107). SN 77-727,347. PUB. 2-16-2010. FILED 5-1-2009.
- 3,783,592. **VALUEMD (STYLIZED)**. VALUEMD, LLC, (U.S. CLS. 100, 101 AND 107). SN 77-733,705. PUB. 2-16-2010. FILED 5-11-2009.
- 3,783,595. **TEAM RC (BLOCK FORM)**. RUNNING CENTRAL, INC., (U.S. CLS. 100, 101 AND 107). SN 77-735,668. PUB. 2-16-2010. FILED 5-13-2009.
- 3,783,596. **TEAM RC AND DESIGN**. RUNNING CENTRAL, INC., (U.S. CLS. 100, 101 AND 107). SN 77-735,686. PUB. 2-16-2010. FILED 5-13-2009.
- 3,783,600. **LEE (STYLIZED)**. LEE UNIVERSITY, (U.S. CLS. 100, 101 AND 107). SN 77-736,659. PUB. 2-16-2010. FILED 5-14-2009.
- 3,783,604. **LOS RODRIGUEZ DE SINALOA AND DESIGN**. RODRIGUEZ ENTERPRISE, INC., (U.S. CLS. 100, 101 AND 107). SN 77-740,662. PUB. 2-16-2010. FILED 5-19-2009.
- 3,783,610. **DENVER MOUNTAIN PARKS AND DESIGN**. CITY AND COUNTY OF DENVER, PARKS & RECREATION DEPARTMENT, (U.S. CLS. 100, 101 AND 107). SN 77-745,625. PUB. 2-16-2010. FILED 5-27-2009.
- 3,783,624. **U.S. NATIONAL EXERCISE (BLOCK FORM)**. KIM, YOUNG K., (U.S. CLS. 100, 101 AND 107). SN 77-753,419. PUB. 2-16-2010. FILED 6-5-2009.
- 3,783,631. **EMOTIONAL ECONOMICS (BLOCK FORM)**. KRUEGER HOLDINGS LLC, (U.S. CLS. 100, 101 AND 107). SN 77-755,374. PUB. 2-16-2010. FILED 6-9-2009.
- 3,783,638. **IVANNA S. PANKIN (BLOCK FORM)**. IVANNA S. PANKIN, (U.S. CLS. 100, 101 AND 107). SN 77-757,293. PUB. 2-16-2010. FILED 6-11-2009.
- 3,783,640. **CABLE MAVERICKS (BLOCK FORM)**. CABLE CENTER, INC., THE, (U.S. CLS. 100, 101 AND 107). SN 77-760,153. PUB. 2-16-2010. FILED 6-15-2009.
- 3,783,645. **BATTLE SPACE STABILITY OPERATIONS: THE CAPACITY TO DELIVER RESULTS IN NON-PERMISSIVE SETTINGS HUMANITARIAN SPACE CREATIVE CENTER FOR STABILIZATION AND DEVELOPMENT AND DESIGN**. CREATIVE ASSOCIATES INTERNATIONAL, INC., (U.S. CLS. 100, 101 AND 107). SN 77-761,145. PUB. 2-16-2010. FILED 6-16-2009.
- 3,783,657. **THE HAPPY TEACHER CAMPAIGN (BLOCK FORM)**. THE HAPPY TEACHER CAMPAIGN, LLC, DBA THE HAPPY TEACHER CAMPAIGN, (U.S. CLS. 100, 101 AND 107). SN 77-763,432. PUB. 2-16-2010. FILED 6-18-2009.
- 3,783,659 (*See Class 9 for this trademark*).
- 3,783,661. **BLACKROCK MICROSYSTEMS AND DESIGN**. I2S MICRO IMPLANTABLE SYSTEMS, LLC, MULTIPLE CLASS, (INT. CLS. 41 AND 42), (U.S. CLS. 100, 101 AND 107). SN 77-764,484. PUB. 2-16-2010. FILED 6-19-2009.
- 3,783,663 (*See Class 9 for this trademark*).
- 3,783,667. **MISCELLANEOUS DESIGN**. THE HAPPY TEACHER CAMPAIGN, LLC, DBA THE HAPPY TEACHER CAMPAIGN, (U.S. CLS. 100, 101 AND 107). SN 77-766,001. PUB. 2-16-2010. FILED 6-23-2009.
- 3,783,671. **AQUARELLE KIDS ACADEMY (BLOCK FORM)**. AQUARELLE KIDS LLC, (U.S. CLS. 100, 101 AND 107). SN 77-766,518. PUB. 2-16-2010. FILED 6-23-2009.
- 3,783,682. **DEAF LINK (BLOCK FORM)**. DEAF LINK, INC., (U.S. CLS. 100, 101 AND 107). SN 77-770,049. PUB. 2-16-2010. FILED 6-29-2009.
- 3,783,683. **GNOMON SCHOOL OF VISUAL EFFECTS (BLOCK FORM)**. GNOMON, INC., (U.S. CLS. 100, 101 AND 107). SN 77-770,514. PUB. 2-16-2010. FILED 6-29-2009.
- 3,783,691. **PHONICS FANTASY THEATER (BLOCK FORM)**. THE READING STAGE, LLC, DBA PHONICS FANTASY THEATER, (U.S. CLS. 100, 101 AND 107). SN 77-774,205. PUB. 2-16-2010. FILED 7-3-2009.
- 3,783,697. **OTTAWA UNIVERSITY LIVE. LEARN. LEAD! VERITAS VOS LIBERABIT 1865 OTTAWA UNIVERSITY AND DESIGN**. OTTAWA UNIVERSITY, (U.S. CLS. 100, 101 AND 107). SN 77-775,981. PUB. 2-16-2010. FILED 7-7-2009.
- 3,783,702 (*See Class 16 for this trademark*).
- 3,783,704. **MISS NUDE NEW ENGLAND (BLOCK FORM)**. 4 WILD WITCHES INC., DBA WILD WITCHES, (U.S. CLS. 100, 101 AND 107). SN 77-778,533. PUB. 2-16-2010. FILED 7-10-2009.
- 3,783,721 (*See Class 35 for this trademark*).
- 3,783,722 (*See Class 35 for this trademark*).
- 3,783,734 (*See Class 9 for this trademark*).
- 3,783,735. **BIRDPHOTOGRAPHERS.NET AND DESIGN**. BIRDPHOTOGRAPHERS.NET INC., (U.S. CLS. 100, 101 AND 107). SN 77-792,055. PUB. 2-16-2010. FILED 7-29-2009.
- 3,783,740 (*See Class 35 for this trademark*).
- 3,783,752. **ANTHONY HOPKINS (BLOCK FORM)**. THE TRUSTEES OF THE THE SAMSON HOLDING TRUST, DATED DECEMBER 12, 2005, (U.S. CLS. 100, 101 AND 107). SN 77-794,981. PUB. 2-16-2010. FILED 8-1-2009.
- 3,783,753. **CONNECTILE DYSFUNCTION (BLOCK FORM)**. INSIGHT I.P. HOLDINGS INC., (U.S. CLS. 100, 101 AND 107). SN 77-795,153. PUB. 2-16-2010. FILED 8-3-2009.
- 3,783,763. **HOTSE (BLOCK FORM)**. ONE EYED SPARK PRODUCTIONS, INC., (U.S. CLS. 100, 101 AND 107). SN 77-797,550. PUB. 2-16-2010. FILED 8-5-2009.
- 3,783,770. **I CAN HAS CHEEZ BURGER AND DESIGN**. PET HOLDINGS, INC., (U.S. CLS. 100, 101 AND 107). SN 77-799,261. PUB. 2-16-2010. FILED 8-7-2009.
- 3,783,787. **HOMER MCFANBOY (BLOCK FORM)**. MURPHY, BRIAN MICHAEL, (U.S. CLS. 100, 101 AND 107). SN 77-803,018. PUB. 2-16-2010. FILED 8-12-2009.
- 3,783,788. **KIDS GYM GYMNASTICS... BECAUSE THE WORLD LOOKS DIFFERENT UPSIDE DOWN! KIDS GYM AND DESIGN**. KIDS'S GYM, INC., (U.S. CLS. 100, 101 AND 107). SN 77-803,212. PUB. 2-16-2010. FILED 8-12-2009.
- 3,783,793. **NEW HORIZONS MAPPING YOUR PATH TO RETIREMENT AND DESIGN**. CAREER PARTNERS INTERNATIONAL LLC, (U.S. CLS. 100, 101 AND 107). SN 77-803,851. PUB. 2-16-2010. FILED 8-13-2009.
- 3,783,799 (*See Class 39 for this trademark*).
- 3,783,803 (*See Class 35 for this trademark*).
- 3,783,819. **CELLPHONESKETCHPAD (BLOCK FORM)**. WEINBERG, DAVID SAMUEL, (U.S. CLS. 100, 101 AND 107). SN 77-808,048. PUB. 2-16-2010. FILED 8-19-2009.
- 3,783,822 (*See Class 9 for this trademark*).
- 3,783,823 (*See Class 9 for this trademark*).
- 3,783,835. **PLANET SNOOPY (BLOCK FORM)**. UNITED FEATURE SYNDICATE, INC., DBA UNITED MEDIA, (U.S. CLS. 100, 101 AND 107). SN 77-811,897. PUB. 2-16-2010. FILED 8-25-2009.
- 3,783,840 (*See Class 35 for this trademark*).
- 3,783,854. **EPATH ASSESS (BLOCK FORM)**. PEOPLES EDUCATION, INC., (U.S. CLS. 100, 101 AND 107). SN 77-814,363. PUB. 2-16-2010. FILED 8-27-2009.
- 3,783,862. **BRIDGEMONT COMMUNITY & TECHNICAL COLLEGE (BLOCK FORM)**. BOARD OF GOVERNORS OF BRIDGEMONT COMMUNITY AND TECHNICAL COLLEGE, DBA BRIDGEMONT COMMUNITY AND TECHNICAL COLLEGE, (U.S. CLS. 100, 101 AND 107). SN 77-815,020. PUB. 2-16-2010. FILED 8-28-2009.
- 3,783,870. **JEDBURGH PARTUM FORMIDONIS INGERO NEX AND DESIGN**. NEK ADVANCED SECURITIES GROUP, INC., (U.S. CLS. 100, 101 AND 107). SN 77-815,750. PUB. 2-16-2010. FILED 8-28-2009.
- 3,783,874. **PURE REIKI AND DESIGN**. PURE REIKI, INC., (U.S. CLS. 100, 101 AND 107). SN 77-816,191. PUB. 2-16-2010. FILED 8-31-2009.
- 3,783,875. **EMS TRAINING INSTITUTE, INC. AND DESIGN**. EMS TRAINING INSTITUTE, INC., (U.S. CLS. 100, 101 AND 107). SN 77-816,310. PUB. 2-16-2010. FILED 8-31-2009.
- 3,783,898. **GEORGIA SOUTHERN (BLOCK FORM)**. BOARD OF REGENTS OF THE UNIVERSITY SYSTEM OF GEORGIA, (U.S. CLS. 100, 101 AND 107). SN 77-818,581. PUB. 2-16-2010. FILED 9-2-2009.
- 3,783,900. **PURPOSE TOMORROW AND DESIGN**. GROUP O, (U.S. CLS. 100, 101 AND 107). SN 77-819,253. PUB. 2-16-2010. FILED 9-3-2009.
- 3,783,902. **PURPOSE TOMORROW AND DESIGN**. GROUP O, (U.S. CLS. 100, 101 AND 107). SN 77-819,328. PUB. 2-16-2010. FILED 9-3-2009.
- 3,783,907. **DESIGN*SPONGE (BLOCK FORM)**. BONNEY,

- GRACE S, (U.S. CLS. 100, 101 AND 107). SN 77-820,120. PUB. 2-16-2010. FILED 9-4-2009.
- 3,783,911. **A OF A (BLOCK FORM)**. ARCHITECTS OF ACHIEVEMENT, LLC, (U.S. CLS. 100, 101 AND 107). SN 77-820,323. PUB. 2-16-2010. FILED 9-4-2009.
- 3,783,945 (*See Class 9 for this trademark*).
- 3,783,949. **DIVORCE YOUR SPOUSE, NOT YOUR MONEY (BLOCK FORM)**. LISA C. DECKER, (U.S. CLS. 100, 101 AND 107). SN 77-822,707. PUB. 2-16-2010. FILED 9-9-2009.
- 3,783,952. **WILD YOGA (BLOCK FORM)**. WILDBEAR, REBECCA, (U.S. CLS. 100, 101 AND 107). SN 77-823,212. PUB. 2-16-2010. FILED 9-9-2009.
- 3,783,958. **GREEN WORKS PRESCHOOL ACADEMY AND DESIGN**. AVILES, KATHLEEN, (U.S. CLS. 100, 101 AND 107). SN 77-823,542. PUB. 2-16-2010. FILED 9-10-2009.
- 3,783,969. **IHS AND DESIGN**. THE INSTITUTE FOR WORSHIP STUDIES FLORIDA CAMPUS, INC., (U.S. CLS. 100, 101 AND 107). SN 77-823,771. PUB. 2-16-2010. FILED 9-10-2009.
- 3,783,998. **THE NEXT LEVEL GUITAR (BLOCK FORM)**. NEXT LEVEL GUITAR, INC., (U.S. CLS. 100, 101 AND 107). SN 77-824,951. PUB. 2-16-2010. FILED 9-11-2009.
- 3,784,000 (*See Class 36 for this trademark*).
- 3,784,001. **THE NEXT LEVEL GUITAR AND DESIGN**. NEXT LEVEL GUITAR, INC., (U.S. CLS. 100, 101 AND 107). SN 77-825,072. PUB. 2-16-2010. FILED 9-11-2009.
- 3,784,002. **GATEWAY TO THE FUTURE (BLOCK FORM)**. FAIRLEIGH DICKINSON UNIVERSITY, (U.S. CLS. 100, 101 AND 107). SN 77-825,094. PUB. 2-16-2010. FILED 9-11-2009.
- 3,784,004. **PUERTA AL FUTURO (BLOCK FORM)**. FAIRLEIGH DICKINSON UNIVERSITY, (U.S. CLS. 100, 101 AND 107). SN 77-825,114. PUB. 2-16-2010. FILED 9-11-2009.
- 3,784,007. **GREENMAIL (BLOCK FORM)**. SEQUOIA CAPITAL OPERATIONS, LLC, (U.S. CLS. 100, 101 AND 107). SN 77-825,214. PUB. 2-16-2010. FILED 9-11-2009.
- 3,784,009. **THE GREENSHEET (BLOCK FORM)**. SEQUOIA CAPITAL OPERATIONS, LLC, (U.S. CLS. 100, 101 AND 107). SN 77-825,231. PUB. 2-16-2010. FILED 9-11-2009.
- 3,784,013. **THE TORN CURTAIN MINISTRIES (BLOCK FORM)**. THE TORN CURTAIN LLC, (U.S. CLS. 100, 101 AND 107). SN 77-825,487. PUB. 2-16-2010. FILED 9-13-2009.
- 3,784,028 (*See Class 16 for this trademark*).
- 3,784,050. **THURSDAY NIGHT LIGHTS (BLOCK FORM)**. SINCLAIR TELEVISION GROUP, INC., (U.S. CLS. 100, 101 AND 107). SN 77-826,446. PUB. 2-16-2010. FILED 9-15-2009.
- 3,784,055. **NETWORKING NATURALLY AND DESIGN**. MY ALUMNI LINK LLC, (U.S. CLS. 100, 101 AND 107). SN 77-826,657. PUB. 2-16-2010. FILED 9-15-2009.
- 3,784,057. **OTC OKLAHOMA TECHNICAL COLLEGE AND DESIGN**. DENTAL DIRECTIONS, INC., (U.S. CLS. 100, 101 AND 107). SN 77-826,687. PUB. 2-16-2010. FILED 9-15-2009.
- 3,784,059. **IGNITING THE MORAL IMAGINATION OF 21ST CENTURY LEADERS (BLOCK FORM)**. EMORY UNIVERSITY, (U.S. CLS. 100, 101 AND 107). SN 77-826,805. PUB. 2-16-2010. FILED 9-15-2009.
- 3,784,069. **LIVE THE LIFESTYLE (BLOCK FORM)**. THE STOCKROOM, INC., MULTIPLE CLASS, (INT. CLS. 41 AND 42), (U.S. CLS. 100, 101 AND 107). SN 77-827,213. PUB. 2-16-2010. FILED 9-15-2009.
- 3,784,070. **SWIY (BLOCK FORM)**. WAYLAND, ROBERT, (U.S. CLS. 100, 101 AND 107). SN 77-827,297. PUB. 2-16-2010. FILED 9-16-2009.
- 3,784,071. **HOW TO CHARGE WHAT YOU'RE WORTH AND GET IT! (BLOCK FORM)**. HEART OF SUCCESS, INC., (U.S. CLS. 100, 101 AND 107). SN 77-827,305. PUB. 2-16-2010. FILED 9-16-2009.
- 3,784,072. **FUNOLOGY (BLOCK FORM)**. MAGICAMP INC., (U.S. CLS. 100, 101 AND 107). SN 77-827,306. PUB. 2-16-2010. FILED 9-16-2009.
- 3,784,085. **PROFESSIONAL PHOTOGRAPHERS PP NE INSTITUTE OF NEW ENGLAND AND DESIGN**. PROFESSIONAL PHOTOGRAPHERS INSTITUTE OF NEW ENGLAND, (U.S. CLS. 100, 101 AND 107). SN 77-827,619. PUB. 2-16-2010. FILED 9-16-2009.
- 3,784,086. **THE MENU CONNECTION (BLOCK FORM)**. HOMEMADE PUBLICATIONS, (U.S. CLS. 100, 101 AND 107). SN 77-827,628. PUB. 2-16-2010. FILED 9-16-2009.
- 3,784,109. **LEARNING EARNINGS.COM AND DESIGN**. STUDENTS FIRST, LLC, (U.S. CLS. 100, 101 AND 107). SN 77-828,235. PUB. 2-16-2010. FILED 9-16-2009.
- 3,784,115. **DOKTOR KABOOM! (BLOCK FORM)**. DOKTOR KABOOM, LLC, (U.S. CLS. 100, 101 AND 107). SN 77-828,393. PUB. 2-16-2010. FILED 9-17-2009.
- 3,784,126. **BUSHWICK STUDIO (BLOCK FORM)**. KESSLER, JOSHUA, (U.S. CLS. 100, 101 AND 107). SN 77-828,548. PUB. 2-16-2010. FILED 9-17-2009.
- 3,784,155. **DRAGON*CON AND DESIGN**. DRAGONCON/ACE, INC., (U.S. CLS. 100, 101 AND 107). SN 77-828,973. PUB. 2-16-2010. FILED 9-17-2009.
- 3,784,169. **KALEO (BLOCK FORM)**. KELIIKIPI, JOSEPH G, (U.S. CLS. 100, 101 AND 107). SN 77-829,361. PUB. 2-16-2010. FILED 9-18-2009.
- 3,784,184. **TMF HEALTH QUALITY INSTITUTE (BLOCK FORM)**. TMF HEALTH QUALITY INSTITUTE, (U.S. CLS. 100, 101 AND 107). SN 77-829,641. PUB. 2-16-2010. FILED 9-18-2009.
- 3,784,201. **TMF HEALTH QUALITY INSTITUTE AND DESIGN**. TMF HEALTH QUALITY INSTITUTE, (U.S. CLS. 100, 101 AND 107). SN 77-829,908. PUB. 2-16-2010. FILED 9-18-2009.
- 3,784,209. **REIMAGINE MONEY (BLOCK FORM)**. RUDOLF STEINER FOUNDATION, INC., (U.S. CLS. 100, 101 AND 107). SN 77-830,034. PUB. 2-16-2010. FILED 9-18-2009.
- 3,784,213. **THE BETTER PLACE TO PLAY (BLOCK FORM)**. BOYD GAMING CORPORATION, (U.S. CLS. 100, 101 AND 107). SN 77-830,137. PUB. 2-16-2010. FILED 9-18-2009.
- 3,784,224. **THE MOST TRUSTED RURAL PROPERTY PROFESSIONALS ASFMRA AMERICAN SOCIETY OF FARM MANAGERS AND RURAL APPRAISERS AND DESIGN**. AMERICAN SOCIETY OF FARM MANAGERS AND RURAL APPRAISERS, INC., (U.S. CLS. 100, 101 AND 107). SN 77-830,308. PUB. 2-16-2010. FILED 9-18-2009.
- 3,784,227 (*See Class 9 for this trademark*).
- 3,784,231. **MANSOUR (BLOCK FORM)**. MANSOUR JAFARI, DBA MANSOURMUSIC CO., (U.S. CLS. 100, 101 AND 107). SN 77-830,397. PUB. 2-16-2010. FILED 9-19-2009.
- 3,784,232. **FITNESS WITH A CONSCIENCE (BLOCK FORM)**. ECA WORLD FITNESS ALLIANCE, (U.S. CLS. 100, 101 AND 107). SN 77-830,423. PUB. 2-16-2010. FILED 9-19-2009.
- 3,784,238. **EVERYDAY BALANCE (BLOCK FORM)**. TOMAS ANTHONY, (U.S. CLS. 100, 101 AND 107). SN 77-830,546. PUB. 2-16-2010. FILED 9-20-2009.
- 3,784,260. **UNIVERSAL CLASS (BLOCK FORM)**. UNIVERSAL CLASS, INC., (U.S. CLS. 100, 101 AND 107). SN 77-830,777. PUB. 2-16-2010. FILED 9-21-2009.
- 3,784,274. **KAZAXÉ (BLOCK FORM)**. AZUKA-BOM LLC, (U.S. CLS. 100, 101 AND 107). SN 77-830,921. PUB. 2-16-2010. FILED 9-21-2009.
- 3,784,278. **MISCELLANEOUS DESIGN**. GREENSBORO MONTESSORI SCHOOL, THE, (U.S. CLS. 100, 101 AND 107). SN 77-830,961. PUB. 2-16-2010. FILED 9-21-2009.
- 3,784,295 (*See Class 25 for this trademark*).
- 3,784,299 (*See Class 25 for this trademark*).
- 3,784,303. **EMPOWERED YOUTH (BLOCK FORM)**. EMPOWERED YOUTH, INC., (U.S. CLS. 100, 101 AND 107). SN 77-831,252. PUB. 2-16-2010. FILED 9-21-2009.
- 3,784,309. **PERENNIAL (BLOCK FORM)**. ULRICH HARLAN, (U.S. CLS. 100, 101 AND 107). SN 77-831,338. PUB. 2-16-2010. FILED 9-21-2009.
- 3,784,310. **TAILGATEVILLE (BLOCK FORM)**. CREATIVE SERVICES EVENT CO., MULTIPLE CLASS, (INT. CLS. 41 AND 43), (U.S. CLS. 100, 101 AND 107). SN 77-831,342. PUB. 2-16-2010. FILED 9-21-2009.
- 3,784,319. **KEVSHOTS (BLOCK FORM)**. OATSVALL, KEVIN, (U.S. CLS. 100, 101 AND 107). SN 77-831,494. PUB. 2-16-2010. FILED 9-21-2009.
- 3,784,331. **IBE AND DESIGN**. BOB JONES UNIVERSITY, INC., (U.S. CLS. 100, 101 AND 107). SN 77-831,681. PUB. 2-16-2010. FILED 9-22-2009.
- 3,784,338 (*See Class 35 for this trademark*).
- 3,784,345. **RE VAT (BLOCK FORM)**. WING TSUN CHICAGO, INC., (U.S. CLS. 100, 101 AND 107). SN 77-831,806. PUB. 2-16-2010. FILED 9-22-2009.
- 3,784,354. **MISCELLANEOUS DESIGN**. SOL SURFERS SURF

- CAMP, LLC, (U.S. CLS. 100, 101 AND 107). SN 77-831,942. PUB. 2-16-2010. FILED 9-22-2009.
- 3,784,362 (*See Class 9 for this trademark.*).
- 3,784,366. **GRYPHON (BLOCK FORM)**. ARISTEN GROUP, LLC, (U.S. CLS. 100, 101 AND 107). SN 77-832,125. PUB. 2-16-2010. FILED 9-22-2009.
- 3,784,367 (*See Class 35 for this trademark.*).
- 3,784,369 (*See Class 35 for this trademark.*).
- 3,784,384 (*See Class 16 for this trademark.*).
- 3,784,398. **ZOOTOPIA (BLOCK FORM)**. CAPSTAR RADIO OPERATING COMPANY, (U.S. CLS. 100, 101 AND 107). SN 77-832,444. PUB. 2-16-2010. FILED 9-22-2009.
- 3,784,406. **E ENERGY PRODUCTIONS AND DESIGN**. YOSHINO, JASON, (U.S. CLS. 100, 101 AND 107). SN 77-832,597. PUB. 2-16-2010. FILED 9-23-2009.
- 3,784,414. **MY HACKER WARS (BLOCK FORM)**. GERNER, SHAUN R., (U.S. CLS. 100, 101 AND 107). SN 77-832,655. PUB. 2-16-2010. FILED 9-23-2009.
- 3,784,433. **PATHWAY TO COMPETENCY (BLOCK FORM)**. TRIAGE FIRST, INC., (U.S. CLS. 100, 101 AND 107). SN 77-832,892. PUB. 2-16-2010. FILED 9-23-2009.
- 3,784,434. **"BUILDING FLORIDA'S PAST" (BLOCK FORM)**. FLORIDA GEOLOGICAL FOUNDATION, INC., MULTIPLE CLASS, (INT. CLS. 41 AND 42), (U.S. CLS. 100, 101 AND 107). SN 77-832,948. PUB. 2-16-2010. FILED 9-23-2009.
- 3,784,439. **CREATIVE CONTRABAND (BLOCK FORM)**. CREATIVE CONTRABAND, INC., (U.S. CLS. 100, 101 AND 107). SN 77-832,974. PUB. 2-16-2010. FILED 9-23-2009.
- 3,784,445. **SHACKNEWS AND DESIGN**. GAMEFLY, INC., (U.S. CLS. 100, 101 AND 107). SN 77-833,071. PUB. 2-16-2010. FILED 9-23-2009.
- 3,784,446. **MISCELLANEOUS DESIGN**. TRIAGE FIRST, INC., (U.S. CLS. 100, 101 AND 107). SN 77-833,083. PUB. 2-16-2010. FILED 9-23-2009.
- 3,784,448. **TRIAGEFIRST (BLOCK FORM)**. TRIAGE FIRST, INC., (U.S. CLS. 100, 101 AND 107). SN 77-833,106. PUB. 2-16-2010. FILED 9-23-2009.
- 3,784,449. **SHACKVIDEO AND DESIGN**. GAMEFLY, INC., (U.S. CLS. 100, 101 AND 107). SN 77-833,118. PUB. 2-16-2010. FILED 9-23-2009.
- 3,784,463. **MISCELLANEOUS DESIGN**. DESIGNING-WITHYOUINMIND.COM, LLC, (U.S. CLS. 100, 101 AND 107). SN 77-833,268. PUB. 2-16-2010. FILED 9-23-2009.
- 3,784,480. **IO AND DESIGN**. JUSTIN ORR, DBA IRON ORR FITNESS, (U.S. CLS. 100, 101 AND 107). SN 77-833,476. PUB. 2-16-2010. FILED 9-23-2009.
- 3,784,490. **THE CALEPS (BLOCK FORM)**. CALEPS, (U.S. CLS. 100, 101 AND 107). SN 77-833,541. PUB. 2-16-2010. FILED 9-23-2009.
- 3,784,513 (*See Class 9 for this trademark.*).
- 3,784,518. **FOX CONNECT (BLOCK FORM)**. TWENTIETH CENTURY FOX FILM CORPORATION, (U.S. CLS. 100, 101 AND 107). SN 77-833,889. PUB. 2-16-2010. FILED 9-24-2009.
- 3,784,521. **TDT (BLOCK FORM)**. UNITED STATES OF AMERICA AS REPRESENTED BY THE SECRETARY OF THE NAVY, DBA NAVAL AIR WARFARE CENTER TRAINING SYSTEMS DIVISION, (U.S. CLS. 100, 101 AND 107). SN 77-833,906. PUB. 2-16-2010. FILED 9-24-2009.
- 3,784,528. **TENNIS-TYKES (BLOCK FORM)**. ROBERTS, JOHN P., DBA TYKE-SPORTS, (U.S. CLS. 100, 101 AND 107). SN 77-834,014. PUB. 2-16-2010. FILED 9-24-2009.
- 3,784,540. **WOODLAWN (BLOCK FORM)**. NATIONAL TRUST FOR HISTORIC PRESERVATION IN THE UNITED STATES, MULTIPLE CLASS, (INT. CLS. 41 AND 43), (U.S. CLS. 100, 101 AND 107). SN 77-834,122. PUB. 2-16-2010. FILED 9-24-2009.
- 3,784,558. **RESCUE 3 AND DESIGN**. RESCUE 3 INTERNATIONAL, INC., (U.S. CLS. 100, 101 AND 107). SN 77-834,363. PUB. 2-16-2010. FILED 9-24-2009.
- 3,784,560. **SUNTASTE (BLOCK FORM)**. THE JAZZ GROUP, INC., (U.S. CLS. 100, 101 AND 107). SN 77-834,417. PUB. 2-16-2010. FILED 9-24-2009.
- 3,784,561 (*See Class 16 for this trademark.*).
- 3,784,566 (*See Class 35 for this trademark.*).
- 3,784,569. **SACRED CIRCLE AND DESIGN**. NEWMAN, SYLVIA, DBA SACRED CIRCLE TRANSFORMATIONAL COACHING, (U.S. CLS. 100, 101 AND 107). SN 77-834,547. PUB. 2-16-2010. FILED 9-24-2009.
- 3,784,577 (*See Class 35 for this trademark.*).
- 3,784,578 (*See Class 35 for this trademark.*).
- 3,784,581. **ONE ROAD HOME (BLOCK FORM)**. REGAN, STEVEN, (U.S. CLS. 100, 101 AND 107). SN 77-834,685. PUB. 2-16-2010. FILED 9-25-2009.
- 3,784,592. **THICKER THAN WATER (BLOCK FORM)**. THICKER THAN WATER, (U.S. CLS. 100, 101 AND 107). SN 77-834,914. PUB. 2-16-2010. FILED 9-25-2009.
- 3,784,614. **MORTGAGEORB (BLOCK FORM)**. ZACKIN PUBLICATIONS, (U.S. CLS. 100, 101 AND 107). SN 77-835,223. PUB. 2-16-2010. FILED 9-25-2009.
- 3,784,615. **CORPORATION OF ONE (BLOCK FORM)**. RARE INSIGHT, LLC, (U.S. CLS. 100, 101 AND 107). SN 77-835,316. PUB. 2-16-2010. FILED 9-25-2009.
- 3,784,621. **SYSTEM QUALITY NUMBER (BLOCK FORM)**. INTERNATIONAL INSTITUTE OF TRADING MASTERY CORPORATION, (U.S. CLS. 100, 101 AND 107). SN 77-835,381. PUB. 2-16-2010. FILED 9-25-2009.
- 3,784,623. **SQN (BLOCK FORM)**. INTERNATIONAL INSTITUTE OF TRADING MASTERY CORPORATION, (U.S. CLS. 100, 101 AND 107). SN 77-835,393. PUB. 2-16-2010. FILED 9-25-2009.
- 3,784,625 (*See Class 38 for this trademark.*).
- 3,784,636. **HALOGENLIFE (BLOCK FORM)**. HALOGEN GUIDES LLC, (U.S. CLS. 100, 101 AND 107). SN 77-835,517. PUB. 2-16-2010. FILED 9-25-2009.
- 3,784,645 (*See Class 35 for this trademark.*).
- 3,784,647. **SLIDE:OLOGY (BLOCK FORM)**. DUARTE DESIGN, INC., (U.S. CLS. 100, 101 AND 107). SN 77-835,703. PUB. 2-16-2010. FILED 9-25-2009.
- 3,784,652. **ROMCON (BLOCK FORM)**. ROMANCE CONVENTIONS, INC., (U.S. CLS. 100, 101 AND 107). SN 77-835,731. PUB. 2-16-2010. FILED 9-26-2009.
- 3,784,655. **PORTALPOTTY (BLOCK FORM)**. FASSELL, NOAH THOMAS, DBA DREAMAWAKE PRODUCTIONS, (U.S. CLS. 100, 101 AND 107). SN 77-835,801. PUB. 2-16-2010. FILED 9-26-2009.
- 3,784,658. **MINDFUL MOVEMENT (BLOCK FORM)**. MATT, PAMELA H., (U.S. CLS. 100, 101 AND 107). SN 77-835,817. PUB. 2-16-2010. FILED 9-26-2009.
- 3,784,659. **MISCELLANEOUS DESIGN**. COTRONEO, PHILIP JOSEPH, (U.S. CLS. 100, 101 AND 107). SN 77-835,821. PUB. 2-16-2010. FILED 9-26-2009.
- 3,784,665. **ENSMUTE (BLOCK FORM)**. PARK, JEREMY JAY, (U.S. CLS. 100, 101 AND 107). SN 77-835,946. PUB. 2-16-2010. FILED 9-27-2009.
- 3,784,668. **C.R.I.T. (BLOCK FORM)**. HARD CORE FITNESS, LLC, (U.S. CLS. 100, 101 AND 107). SN 77-836,162. PUB. 2-16-2010. FILED 9-28-2009.
- 3,784,669 (*See Class 25 for this trademark.*).
- 3,784,670. **MISCELLANEOUS DESIGN**. TOLEDO ARENA SPORTS, INC., DBA TOLEDO WALLEYE, (U.S. CLS. 100, 101 AND 107). SN 77-836,221. PUB. 2-16-2010. FILED 9-28-2009.
- 3,784,678. **DUCKPOWER (BLOCK FORM)**. DUCKELS, THOMAS, (U.S. CLS. 100, 101 AND 107). SN 77-836,533. PUB. 2-16-2010. FILED 9-28-2009.
- 3,784,679. **SILVERDOCS (BLOCK FORM)**. AMERICAN FILM INSTITUTE, AND DISCOVERY COMMUNICATIONS, LLC, (U.S. CLS. 100, 101 AND 107). SN 77-836,534. PUB. 2-16-2010. FILED 9-28-2009.
- 3,784,686. **PINK PEPPERCORN PRESS (BLOCK FORM)**. TSCO, INCORPORATED, DBA PINK PEPPERCORN PRESS, (U.S. CLS. 100, 101 AND 107). SN 77-836,615. PUB. 2-16-2010. FILED 9-28-2009.
- 3,784,692. **PRESCRIPTIONS (BLOCK FORM)**. NEW YORK TIMES COMPANY, THE, (U.S. CLS. 100, 101 AND 107). SN 77-836,731. PUB. 2-16-2010. FILED 9-28-2009.
- 3,784,697. **COAST CASINOS BARRELS OF CASH GIVEAWAY (BLOCK FORM)**. BOYD GAMING CORPORATION, (U.S. CLS. 100, 101 AND 107). SN 77-837,567. PUB. 2-16-2010. FILED 9-29-2009.
- 3,784,701. **KOPIXMO PHOTOGRAPHY AND DESIGN**. MRKOHN LLC, (U.S. CLS. 100, 101 AND 107). SN 77-838,218. PUB. 2-16-2010. FILED 9-30-2009.
- 3,784,704. **ROCK THIS WAY (BLOCK FORM)**. MILLENNIA PRODUCTIONS, INC., (U.S. CLS. 100, 101 AND 107). SN 77-838,715. PUB. 2-16-2010. FILED 9-30-2009.

3,784,710. **M.A.C. ADVANTAGE AND DESIGN.** COLUMBIA INSURANCE COMPANY, (U.S. CLS. 100, 101 AND 107). SN 77-838,956. PUB. 2-16-2010. FILED 10-1-2009.

3,784,712. **PHUSIA (BLOCK FORM).** PHUSION, LLC, (U.S. CLS. 100, 101 AND 107). SN 77-839,063. PUB. 2-16-2010. FILED 10-1-2009.

3,784,717 (*See Class 16 for this trademark.*)

3,784,724. **TNF MIND, BODY, SOUL - TAKE CONTROL AND DESIGN.** NISENSEN, PATRICIA M. AKA TRICIA NISENSEN, (U.S. CLS. 100, 101 AND 107). SN 77-842,414. PUB. 2-16-2010. FILED 10-6-2009.

3,784,736. **OPPORTUNITY ROCKS (BLOCK FORM).** MILLENNIA PRODUCTIONS, INC., (U.S. CLS. 100, 101 AND 107). SN 77-845,984. PUB. 2-16-2010. FILED 10-9-2009.

3,784,755 (*See Class 35 for this trademark.*)

3,784,758. **SHOPTOEARH ETRAIN (BLOCK FORM).** SHOPEARN NET, DBA SHOPEARN, (U.S. CLS. 100, 101 AND 107). SN 77-853,074. PUB. 2-16-2010. FILED 10-20-2009.

3,784,765. **MONKEYMEDIA (BLOCK FORM).** MONKEYMEDIA, INC., MULTIPLE CLASS, (INT. CLS. 41 AND 45), (U.S. CLS. 100, 101 AND 107). SN 77-855,853. PUB. 2-16-2010. FILED 10-23-2009.

3,784,768. **AZUKA-BOM (BLOCK FORM).** AZUKA-BOM LLC, (U.S. CLS. 100, 101 AND 107). SN 77-857,226. PUB. 2-16-2010. FILED 10-26-2009.

3,784,770 (*See Class 35 for this trademark.*)

3,784,773. **FARMERS FOR THE FUTURE (BLOCK FORM).** MEREDITH CORPORATION, (U.S. CLS. 100, 101 AND 107). SN 77-858,711. PUB. 2-16-2010. FILED 10-27-2009.

3,784,787. **THE ORLEANS HOTEL & CASINO - LAS VEGAS (BLOCK FORM).** BOYD GAMING CORPORATION, (U.S. CLS. 100, 101 AND 107). SN 77-860,759. PUB. 2-16-2010. FILED 10-29-2009.

3,784,797 (*See Class 35 for this trademark.*)

3,784,811. **SURVIVOR GUY (BLOCK FORM).** POARCH BAND OF CREEK INDIANS, DBA PCI GAMING AUTHORITY, MULTIPLE CLASS, (INT. CLS. 41 AND 43), (U.S. CLS. 100, 101 AND 107). SN 77-883,967. PUB. 2-16-2010. FILED 12-2-2009.

3,784,834 (*See Class 9 for this trademark.*)

3,784,843 (*See Class 9 for this trademark.*)

3,784,869 (*See Class 3 for this trademark.*)

3,784,871 (*See Class 9 for this trademark.*)

3,784,872 (*See Class 9 for this trademark.*)

3,784,874 (*See Class 3 for this trademark.*)

3,784,875 (*See Class 35 for this trademark.*)

3,784,878 (*See Class 9 for this trademark.*)

3,784,879 (*See Class 16 for this trademark.*)

3,784,883 (*See Class 16 for this trademark.*)

3,784,884 (*See Class 5 for this trademark.*)

3,784,897 (*See Class 16 for this trademark.*)

3,784,898 (*See Class 5 for this trademark.*)

3,784,899 (*See Class 5 for this trademark.*)

3,784,900 (*See Class 5 for this trademark.*)

3,784,909 (*See Class 7 for this trademark.*)

3,784,915 (*See Class 9 for this trademark.*)

3,784,919 (*See Class 9 for this trademark.*)

3,784,926. **CALDECOTT HD AND DESIGN.** MEDIACORP PTE. LTD., (U.S. CLS. 100, 101 AND 107). SN 79-065,756. PUB. 2-16-2010. FILED 12-29-2008.

3,784,927. **CALDECOTT HD AND DESIGN.** MEDIACORP PTE. LTD., (U.S. CLS. 100, 101 AND 107). SN 79-065,770. PUB. 2-16-2010. FILED 12-29-2008.

3,784,933 (*See Class 35 for this trademark.*)

3,784,957 (*See Class 16 for this trademark.*)

3,784,958 (*See Class 16 for this trademark.*)

3,784,959 (*See Class 16 for this trademark.*)

3,784,973 (*See Class 16 for this trademark.*)

3,784,974 (*See Class 16 for this trademark.*)

3,784,975 (*See Class 16 for this trademark.*)

3,785,000 (*See Class 9 for this trademark.*)

3,785,034 (*See Class 35 for this trademark.*)

3,785,037 (*See Class 35 for this trademark.*)

CLASS 42—SCIENTIFIC AND COMPUTER SERVICES

3,783,087 (*See Class 16 for this trademark.*)

3,783,088 (*See Class 16 for this trademark.*)

3,783,089 (*See Class 16 for this trademark.*)

3,783,129. **HOBSONS (BLOCK FORM).** HOBSONS, INC., (U.S. CLS. 100 AND 101). SN 76-699,583. PUB. 2-16-2010. FILED 9-23-2009.

3,783,157 (*See Class 6 for this trademark.*)

3,783,159 (*See Class 9 for this trademark.*)

3,783,184 (*See Class 9 for this trademark.*)

3,783,188 (*See Class 35 for this trademark.*)

3,783,192. **ENERGENIC (BLOCK FORM).** SOUTH JERSEY INDUSTRIES, (U.S. CLS. 100 AND 101). SN 77-383,296. PUB. 2-16-2010. FILED 1-29-2008.

3,783,216. **MISCELLANEOUS DESIGN.** DEUTSCHE TELEKOM AG, (U.S. CLS. 100 AND 101). SN 77-427,813. PUB. 10-20-2009. FILED 3-20-2008.

3,783,223 (*See Class 9 for this trademark.*)

3,783,231 (*See Class 9 for this trademark.*)

3,783,238 (*See Class 35 for this trademark.*)

3,783,269. **WEBEQUITY SOLUTIONS (BLOCK FORM).** WEBEQUITY SOLUTIONS, LLC, (U.S. CLS. 100 AND 101). SN 77-546,238. PUB. 2-16-2010. FILED 8-13-2008.

3,783,312 (*See Class 41 for this trademark.*)

3,783,323. **ARCSAGE (BLOCK FORM).** DAIGNEAU, ROBERT J., (U.S. CLS. 100 AND 101). SN 77-642,449. PUB. 2-16-2010. FILED 1-1-2009.

3,783,332 (*See Class 35 for this trademark.*)

3,783,333 (*See Class 35 for this trademark.*)

3,783,334 (*See Class 35 for this trademark.*)

3,783,346 (*See Class 35 for this trademark.*)

3,783,347 (*See Class 35 for this trademark.*)

3,783,352 (*See Class 35 for this trademark.*)

3,783,368 (*See Class 35 for this trademark.*)

3,783,375 (*See Class 1 for this trademark.*)

3,783,376 (*See Class 35 for this trademark.*)

3,783,409 (*See Class 9 for this trademark.*)

3,783,422 (*See Class 35 for this trademark.*)

3,783,427. **MIDWEST DIABETES COALITION AND DESIGN.** THE UNIVERSITY OF KANSAS, MULTIPLE CLASS, (INT. CLS. 42 AND 44), (U.S. CLS. 100 AND 101). SN 77-697,837. PUB. 2-16-2010. FILED 3-24-2009.

3,783,429 (*See Class 35 for this trademark.*)

3,783,430 (*See Class 35 for this trademark.*)

3,783,431 (*See Class 35 for this trademark.*)

3,783,447. **EMEXEMANAGEREXCHANGE (STYLIZED).** PROGRESS INVESTMENT MANAGEMENT COMPANY, LLC, (U.S. CLS. 100 AND 101). SN 77-700,787. PUB. 2-16-2010. FILED 3-27-2009.

3,783,458 (*See Class 35 for this trademark.*)

3,783,466 (*See Class 9 for this trademark.*)

3,783,480. **MYBLACKBOX (BLOCK FORM).** ALLEN, REGINALD, (U.S. CLS. 100 AND 101). SN 77-703,846. PUB. 2-16-2010. FILED 3-31-2009.

3,783,490 (*See Class 38 for this trademark.*)

3,783,513. **INQUENT (BLOCK FORM).** NETWORK SOLUTIONS, LLC, (U.S. CLS. 100 AND 101). SN 77-710,023. PUB. 2-16-2010. FILED 4-8-2009.

3,783,521. **DESIGN NURTURES ART (BLOCK FORM).** WALT, WILLIAM SHANE, (U.S. CLS. 100 AND 101). SN 77-712,115. PUB. 2-16-2010. FILED 4-12-2009.

3,783,551 (*See Class 9 for this trademark.*)

3,783,553. **AB APPLIED BROADBAND (STYLIZED).** APPLIED BROADBAND INC., (U.S. CLS. 100 AND 101). SN 77-715,629. PUB. 2-16-2010. FILED 4-16-2009.

3,783,554 (*See Class 9 for this trademark.*)

3,783,571. **BRANDWISE TECHNOLOGY TO HELP YOU SELL MORE AND DESIGN.** BRANDWISE, INC., (U.S. CLS. 100 AND 101). SN 77-720,698. PUB. 2-16-2010. FILED 4-23-2009.

3,783,572 (*See Class 38 for this trademark.*)

3,783,646 (*See Class 35 for this trademark.*)

3,783,661 (*See Class 41 for this trademark.*)

3,783,663 (*See Class 9 for this trademark.*)

3,783,687 (*See Class 6 for this trademark.*)

3,783,692. **LUNARI CONSULTING (BLOCK FORM).** LUNARI CONSULTING LLC, DBA LUNARI CONSULTING, (U.S. CLS. 100 AND 101). SN 77-774,295. PUB. 2-16-2010. FILED 7-

- 4-2009.
- 3,783,698. **RAMIUS (BLOCK FORM)**. RAMIUS CORPORATION, (U.S. CLS. 100 AND 101). SN 77-776,830. PUB. 2-16-2010. FILED 7-8-2009.
- 3,783,701. **CALSOFT SYSTEMS (BLOCK FORM)**. CALSOFT SYSTEMS, (U.S. CLS. 100 AND 101). SN 77-777,975. PUB. 2-16-2010. FILED 7-9-2009.
- 3,783,710. **RAI STONE R ANALYTICS AND DESIGN**. STONEGATE BUSINESS CONSULTING, LTD., DBA STONEGATE GROWTH STRATEGIES, LTD., (U.S. CLS. 100 AND 101). SN 77-781,868. PUB. 2-16-2010. FILED 7-15-2009.
- 3,783,721 (*See Class 35 for this trademark*).
- 3,783,722 (*See Class 35 for this trademark*).
- 3,783,730. **INSTALLERPOOL.COM (BLOCK FORM)**. INSTALLERPOOL.COM LLC, AKA INSTALLERPOOL, (U.S. CLS. 100 AND 101). SN 77-788,305. PUB. 2-16-2010. FILED 7-23-2009.
- 3,783,734 (*See Class 9 for this trademark*).
- 3,783,742. **DEFINITIVE (BLOCK FORM)**. DEFINITIVE AUDIO, INC., (U.S. CLS. 100 AND 101). SN 77-793,631. PUB. 2-16-2010. FILED 7-30-2009.
- 3,783,744 (*See Class 35 for this trademark*).
- 3,783,766 (*See Class 20 for this trademark*).
- 3,783,771. **IT BUDGET ACCOUNTABILITY (BLOCK FORM)**. POLARDENE CORPORATION, (U.S. CLS. 100 AND 101). SN 77-799,495. PUB. 2-16-2010. FILED 8-7-2009.
- 3,783,775 (*See Class 9 for this trademark*).
- 3,783,776 (*See Class 9 for this trademark*).
- 3,783,808. **PROJECTIONS RESEARCH 0 AND DESIGN**. PROJECTIONS RESEARCH INC, (U.S. CLS. 100 AND 101). SN 77-806,688. PUB. 2-16-2010. FILED 8-18-2009.
- 3,783,813 (*See Class 37 for this trademark*).
- 3,783,814. **DESIGN FOR A SUSTAINABLE FUTURE (BLOCK FORM)**. SLATERPAULL ARCHITECTS, (U.S. CLS. 100 AND 101). SN 77-807,779. PUB. 2-16-2010. FILED 8-19-2009.
- 3,783,816. **IT'S FREE UNTIL IT'S CHEAP! (BLOCK FORM)**. ROTON PRODUCTS, INC., (U.S. CLS. 100 AND 101). SN 77-807,842. PUB. 2-16-2010. FILED 8-19-2009.
- 3,783,845. **AXEMATCH.COM AND DESIGN**. KEARNEY, JAMES, (U.S. CLS. 100 AND 101). SN 77-813,624. PUB. 2-16-2010. FILED 8-26-2009.
- 3,783,855. **APPERIAN (BLOCK FORM)**. APPERIAN, INC., (U.S. CLS. 100 AND 101). SN 77-814,518. PUB. 2-16-2010. FILED 8-27-2009.
- 3,783,856 (*See Class 36 for this trademark*).
- 3,783,904 (*See Class 35 for this trademark*).
- 3,783,922. **COOPERATING FOR FOOD SAFETY AND DESIGN**. COOPERATING FOR FOOD SAFETY, INC., (U.S. CLS. 100 AND 101). SN 77-821,174. PUB. 2-16-2010. FILED 9-6-2009.
- 3,783,923. **ENCIRCLE HEALTHCARE AND DESIGN**. ENCIRCLE HEALTHCARE MANAGEMENT LLC, DBA ENCIRCLE HEALTHCARE, (U.S. CLS. 100 AND 101). SN 77-821,237. PUB. 2-16-2010. FILED 9-7-2009.
- 3,783,939 (*See Class 35 for this trademark*).
- 3,783,942 (*See Class 35 for this trademark*).
- 3,783,961. **EQUIP (STYLIZED)**. THE COLORADO PREVENTION CENTER, (U.S. CLS. 100 AND 101). SN 77-823,622. PUB. 2-16-2010. FILED 9-10-2009.
- 3,783,997. **COMWIRED AND DESIGN**. COMWIRED, LLC, (U.S. CLS. 100 AND 101). SN 77-824,937. PUB. 2-16-2010. FILED 9-11-2009.
- 3,784,027. **PD PORTAVIOLA DESIGN AND DESIGN**. LEHMAN, GRETCHEN M., DBA PORTAVIOLA DESIGN, (U.S. CLS. 100 AND 101). SN 77-825,993. PUB. 2-16-2010. FILED 9-14-2009.
- 3,784,062 (*See Class 4 for this trademark*).
- 3,784,069 (*See Class 41 for this trademark*).
- 3,784,111. **SPREADSHEET ABUSE (BLOCK FORM)**. MCF TECHNOLOGY SOLUTIONS, LLC, (U.S. CLS. 100 AND 101). SN 77-828,291. PUB. 2-16-2010. FILED 9-16-2009.
- 3,784,123. **POWERED BY RECONDO AND DESIGN**. RECONDO TECHNOLOGY, INC., (U.S. CLS. 100 AND 101). SN 77-828,481. PUB. 2-16-2010. FILED 9-17-2009.
- 3,784,160. **DATA2IMPACT (BLOCK FORM)**. DATA2IMPACT LLC, (U.S. CLS. 100 AND 101). SN 77-829,094. PUB. 2-16-2010. FILED 9-17-2009.
- 3,784,174 (*See Class 35 for this trademark*).
- 3,784,176. **CHAMPION CLOUD (BLOCK FORM)**. CHAMPION SOLUTIONS GROUP, (U.S. CLS. 100 AND 101). SN 77-829,486. PUB. 2-16-2010. FILED 9-18-2009.
- 3,784,185. **TMF HEALTH QUALITY INSTITUTE (BLOCK FORM)**. TMF HEALTH QUALITY INSTITUTE, MULTIPLE CLASS, (INT. CLS. 42 AND 44), (U.S. CLS. 100 AND 101). SN 77-829,655. PUB. 2-16-2010. FILED 9-18-2009.
- 3,784,192. **WHERE ACCOUNTING AND TECHNOLOGY CONNECT (BLOCK FORM)**. KARA R. HAAS, CPA, PA, (U.S. CLS. 100 AND 101). SN 77-829,754. PUB. 2-16-2010. FILED 9-18-2009.
- 3,784,196 (*See Class 9 for this trademark*).
- 3,784,202. **TMF HEALTH QUALITY INSTITUTE AND DESIGN**. TMF HEALTH QUALITY INSTITUTE, MULTIPLE CLASS, (INT. CLS. 42 AND 44), (U.S. CLS. 100 AND 101). SN 77-829,928. PUB. 2-16-2010. FILED 9-18-2009.
- 3,784,204. **STAGE-2 HOME PREPARATION (BLOCK FORM)**. FILIPPONE, AL N., AKA PREMIER HOMES LLC, (U.S. CLS. 100 AND 101). SN 77-829,975. PUB. 2-16-2010. FILED 9-18-2009.
- 3,784,216 (*See Class 35 for this trademark*).
- 3,784,226. **ALINE ARCHITECTURE (BLOCK FORM)**. ALINE ARCHITECTURE, LLC, (U.S. CLS. 100 AND 101). SN 77-830,328. PUB. 2-16-2010. FILED 9-18-2009.
- 3,784,253 (*See Class 35 for this trademark*).
- 3,784,264. **ORDERWORKS (BLOCK FORM)**. SERVICE WEST, INC., (U.S. CLS. 100 AND 101). SN 77-830,838. PUB. 2-16-2010. FILED 9-21-2009.
- 3,784,268. **MACHINE CLOUD AND DESIGN**. MACHINE CLOUD LLC, (U.S. CLS. 100 AND 101). SN 77-830,870. PUB. 2-16-2010. FILED 9-21-2009.
- 3,784,276. **BERTL (BLOCK FORM)**. BERTL, INC., (U.S. CLS. 100 AND 101). SN 77-830,929. PUB. 2-16-2010. FILED 9-21-2009.
- 3,784,280. **SCHOOLDUDE.COM (BLOCK FORM)**. SCHOOLDUDE.COM, INC., (U.S. CLS. 100 AND 101). SN 77-830,968. PUB. 2-16-2010. FILED 9-21-2009.
- 3,784,282. **FACILITYDUDE (BLOCK FORM)**. FACILITYDUDE.COM, INC., (U.S. CLS. 100 AND 101). SN 77-830,999. PUB. 2-16-2010. FILED 9-21-2009.
- 3,784,289. **ANTENNASYS (BLOCK FORM)**. ANTENNASYS, INC., (U.S. CLS. 100 AND 101). SN 77-831,081. PUB. 2-16-2010. FILED 9-21-2009.
- 3,784,304. **A AND DESIGN**. CORNELL, ALEX, (U.S. CLS. 100 AND 101). SN 77-831,284. PUB. 2-16-2010. FILED 9-21-2009.
- 3,784,316. **ICC-ES (BLOCK FORM)**. ICC EVALUATION SERVICE, INC., (U.S. CLS. 100 AND 101). SN 77-831,401. PUB. 2-16-2010. FILED 9-21-2009.
- 3,784,328. **INVIRTECH (BLOCK FORM)**. INVIRTECH LLC, (U.S. CLS. 100 AND 101). SN 77-831,631. PUB. 2-16-2010. FILED 9-22-2009.
- 3,784,342. **MAGCUBE (BLOCK FORM)**. FUGRO GRAVITY & MAGNETIC SERVICES INC., (U.S. CLS. 100 AND 101). SN 77-831,771. PUB. 2-16-2010. FILED 9-22-2009.
- 3,784,357. **OMNISOCIAL (BLOCK FORM)**. MZINGA, INC., (U.S. CLS. 100 AND 101). SN 77-831,952. PUB. 2-16-2010. FILED 9-22-2009.
- 3,784,387. **FILESANYWHERE (BLOCK FORM)**. OFFICEWARE CORPORATION, DBA FILESANYWHERE.COM, (U.S. CLS. 100 AND 101). SN 77-832,310. PUB. 2-16-2010. FILED 9-22-2009.
- 3,784,397. **EMOCHILA AND DESIGN**. E. MOCHILA, AKA EMOCHILA, (U.S. CLS. 100 AND 101). SN 77-832,437. PUB. 2-16-2010. FILED 9-22-2009.
- 3,784,417. **ONE DID IT (BLOCK FORM)**. ONE DID IT OY, (U.S. CLS. 100 AND 101). SN 77-832,681. PUB. 2-16-2010. FILED 9-23-2009.
- 3,784,434 (*See Class 41 for this trademark*).
- 3,784,441. **ROCKALL PARTNERS (BLOCK FORM)**. ROCKALL DATA, LLC, (U.S. CLS. 100 AND 101). SN 77-832,993. PUB. 2-16-2010. FILED 9-23-2009.
- 3,784,443. **MAKING SCIENCE GREEN (BLOCK FORM)**. CALIFORNIA PACIFIC LAB INC, AKA CP LAB SAFETY, (U.S. CLS. 100 AND 101). SN 77-833,016. PUB. 2-16-2010. FILED 9-23-2009.
- 3,784,447. **FILESHACK AND DESIGN**. GAMEFLY, INC., (U.S. CLS. 100 AND 101). SN 77-833,084. PUB. 2-16-2010. FILED 9-23-2009.

3,784,452 (See Class 36 for this trademark).
 3,784,470. **WHERE BRANDS AND WOMEN CLICK (BLOCK FORM)**. PROSPECTIV DIRECT, INC., (U.S. CLS. 100 AND 101). SN 77-833,342. PUB. 2-16-2010. FILED 9-23-2009.
 3,784,524. **TAKE BACK YOUR PRIVACY (BLOCK FORM)**. PRIVACYHARBOR, INC., DBA PRIVACYHARBOR.COM, (U.S. CLS. 100 AND 101). SN 77-833,953. PUB. 2-16-2010. FILED 9-24-2009.
 3,784,531. **STREAMPAD (BLOCK FORM)**. AOL LLC, (U.S. CLS. 100 AND 101). SN 77-834,034. PUB. 2-16-2010. FILED 9-24-2009.
 3,784,542. **INVECTRA (BLOCK FORM)**. INVECTRA, INC., (U.S. CLS. 100 AND 101). SN 77-834,129. PUB. 2-16-2010. FILED 9-24-2009.
 3,784,550. **AIMAZ (BLOCK FORM)**. AIM-ARIZONA INTERNET MARKETING, LLC, (U.S. CLS. 100 AND 101). SN 77-834,218. PUB. 2-16-2010. FILED 9-24-2009.
 3,784,555 (See Class 35 for this trademark).
 3,784,594 (See Class 9 for this trademark).
 3,784,599 (See Class 37 for this trademark).
 3,784,606. **SPATIALKEY (BLOCK FORM)**. UNIVERSAL MIND, INC., (U.S. CLS. 100 AND 101). SN 77-835,108. PUB. 2-16-2010. FILED 9-25-2009.
 3,784,672 (See Class 37 for this trademark).
 3,784,675. **SAGAMY (BLOCK FORM)**. SAGAMY LLC, (U.S. CLS. 100 AND 101). SN 77-836,420. PUB. 2-16-2010. FILED 9-28-2009.
 3,784,689. **TRANSARRAY (BLOCK FORM)**. TRANSGENOMIC, INC., (U.S. CLS. 100 AND 101). SN 77-836,714. PUB. 2-16-2010. FILED 9-28-2009.
 3,784,720. **TIMELINES AND DESIGN**. TIMELINES, INC., (U.S. CLS. 100 AND 101). SN 77-841,615. PUB. 2-16-2010. FILED 10-5-2009.
 3,784,774. **FARMERS FOR THE FUTURE (BLOCK FORM)**. MEREDITH CORPORATION, (U.S. CLS. 100 AND 101). SN 77-858,721. PUB. 2-16-2010. FILED 10-27-2009.
 3,784,821 (See Class 9 for this trademark).
 3,784,826 (See Class 9 for this trademark).
 3,784,829 (See Class 9 for this trademark).
 3,784,837. **ALPHAFRONTIER (BLOCK FORM)**. STATE STREET CORPORATION, (U.S. CLS. 100 AND 101). SN 78-787,344. PUB. 2-16-2010. FILED 1-9-2006.
 3,784,843 (See Class 9 for this trademark).
 3,784,861 (See Class 9 for this trademark).
 3,784,869 (See Class 3 for this trademark).
 3,784,872 (See Class 9 for this trademark).
 3,784,873 (See Class 28 for this trademark).
 3,784,875 (See Class 35 for this trademark).
 3,784,878 (See Class 9 for this trademark).
 3,784,885 (See Class 7 for this trademark).
 3,784,886 (See Class 7 for this trademark).
 3,784,887 (See Class 7 for this trademark).
 3,784,888 (See Class 7 for this trademark).
 3,784,895 (See Class 9 for this trademark).
 3,784,898 (See Class 5 for this trademark).
 3,784,899 (See Class 5 for this trademark).
 3,784,902 (See Class 35 for this trademark).
 3,784,903 (See Class 35 for this trademark).
 3,784,904 (See Class 35 for this trademark).
 3,784,906 (See Class 1 for this trademark).
 3,784,907 (See Class 1 for this trademark).
 3,784,909 (See Class 7 for this trademark).
 3,784,911 (See Class 11 for this trademark).
 3,784,915 (See Class 9 for this trademark).
 3,784,918 (See Class 12 for this trademark).
 3,784,919 (See Class 9 for this trademark).
 3,784,920 (See Class 9 for this trademark).
 3,784,924 (See Class 6 for this trademark).
 3,784,934 (See Class 9 for this trademark).
 3,784,940. **PERMAFOOD (BLOCK FORM)**. PERMAFOOD AG, (U.S. CLS. 100 AND 101). SN 79-067,024. PUB. 2-16-2010. FILED 2-20-2009.
 3,784,941 (See Class 35 for this trademark).
 3,784,964 (See Class 9 for this trademark).
 3,784,969 (See Class 9 for this trademark).
 3,784,970 (See Class 9 for this trademark).
 3,784,971 (See Class 19 for this trademark).
 3,784,981 (See Class 9 for this trademark).

3,784,982 (See Class 9 for this trademark).
 3,784,994 (See Class 1 for this trademark).
 3,784,998 (See Class 35 for this trademark).
 3,785,019 (See Class 35 for this trademark).
 3,785,022 (See Class 9 for this trademark).
 3,785,023 (See Class 1 for this trademark).
 3,785,024 (See Class 9 for this trademark).
 3,785,042 (See Class 9 for this trademark).
 3,785,043 (See Class 12 for this trademark).

CLASS 43—HOTEL AND RESTAURANT SERVICES

3,783,126. **ESPRESSO PEOPLE (BLOCK FORM)**. ESPRESSO PEOPLE, INC., (U.S. CLS. 100 AND 101). SN 76-699,381. PUB. 2-16-2010. FILED 9-8-2009.
 3,783,145 (See Class 35 for this trademark).
 3,783,163. **WHAT'S MY SECRET? I SPEND HOURS AND HOURS AT THE LIBRARY (BLOCK FORM)**. 407 ENTERPRISES, LTD., L.L.P., (U.S. CLS. 100 AND 101). SN 77-179,026. PUB. 11-10-2009. FILED 5-11-2007.
 3,783,172. **HIPHOP SODASHOP AND DESIGN**. H3ENTERPRISES INC. (HTRE), (U.S. CLS. 100 AND 101). SN 77-268,708. PUB. 2-16-2010. FILED 8-30-2007.
 3,783,187 (See Class 32 for this trademark).
 3,783,308. **EAT WELL FOR LIFE (BLOCK FORM)**. V.G.'S FOOD CENTER, INC., (U.S. CLS. 100 AND 101). SN 77-613,936. PUB. 2-16-2010. FILED 11-13-2008.
 3,783,424. **INTERSTATE BAR-B-QUE (BLOCK FORM)**. JAMES L. NEELY, (U.S. CLS. 100 AND 101). SN 77-696,358. PUB. 2-16-2010. FILED 3-21-2009.
 3,783,454 (See Class 35 for this trademark).
 3,783,455 (See Class 35 for this trademark).
 3,783,495 (See Class 29 for this trademark).
 3,783,511 (See Class 36 for this trademark).
 3,783,515 (See Class 29 for this trademark).
 3,783,582. **LOBSTER HOUSE ON FISHERMAN'S WHARF CAPE MAY, N.J. AND DESIGN**. THE COLD SPRING FISH AND SUPPLY COMPANY, (U.S. CLS. 100 AND 101). SN 77-728,243. PUB. 2-16-2010. FILED 5-4-2009.
 3,783,606. **PINE STREET INN (BLOCK FORM)**. PINE STREET INN, INC., (U.S. CLS. 100 AND 101). SN 77-741,302. PUB. 2-16-2010. FILED 5-20-2009.
 3,783,613. **S AND DESIGN**. SHONEY'S NORTH AMERICA CORPORATION, (U.S. CLS. 100 AND 101). SN 77-749,732. PUB. 2-16-2010. FILED 6-2-2009.
 3,783,652. **VILLA NOVA PIZZA (BLOCK FORM)**. VILLA NOVA PIZZA INC, (U.S. CLS. 100 AND 101). SN 77-761,771. PUB. 2-16-2010. FILED 6-17-2009.
 3,783,664. **BINGA'S WINGAS AND DESIGN**. BINGA'S WINGAS, LLC, (U.S. CLS. 100 AND 101). SN 77-764,948. PUB. 2-16-2010. FILED 6-22-2009.
 3,783,791. **EAT. DRINK. SPORTS. (BLOCK FORM)**. MARIOTT INTERNATIONAL, INC., (U.S. CLS. 100 AND 101). SN 77-803,572. PUB. 2-16-2010. FILED 8-13-2009.
 3,783,799 (See Class 39 for this trademark).
 3,783,802. **VT (BLOCK FORM)**. THE VILLAGE TAVERN, INC., (U.S. CLS. 100 AND 101). SN 77-804,867. PUB. 2-16-2010. FILED 8-14-2009.
 3,783,804. **MISCELLANEOUS DESIGN**. BERRY HAPPY, INC., (U.S. CLS. 100 AND 101). SN 77-805,099. PUB. 2-16-2010. FILED 8-14-2009.
 3,783,805. **THE GLEN IVY CENTER (BLOCK FORM)**. EMISARIES OF DIVINE LIGHT, DBA THE GLEN IVY CENTER, (U.S. CLS. 100 AND 101). SN 77-805,821. PUB. 2-16-2010. FILED 8-17-2009.
 3,783,838. **GROUNDS BAKERY & CAFE AND DESIGN**. GROUNDS BAKERY CAFE, (U.S. CLS. 100 AND 101). SN 77-812,672. PUB. 2-16-2010. FILED 8-25-2009.
 3,783,852 (See Class 29 for this trademark).
 3,783,919. **NUBI YOGURT (STYLIZED)**. LUSH YOGURT, INC., (U.S. CLS. 100 AND 101). SN 77-820,979. PUB. 2-16-2010. FILED 9-4-2009.
 3,783,933. **SPRINGHILL SUITES MARRIOTT AND DESIGN**. MARRIOTT INTERNATIONAL, INC., (U.S. CLS. 100 AND 101). SN 77-822,141. PUB. 2-16-2010. FILED 9-8-2009.

- 3,783,934. **RESIDENCE INN MARRIOTT AND DESIGN.** MARRIOTT INTERNATIONAL, INC., (U.S. CLS. 100 AND 101). SN 77-822,148. PUB. 2-16-2010. FILED 9-8-2009.
- 3,783,975. **TOWNEPLACE SUITES MARRIOTT AND DESIGN.** MARRIOTT INTERNATIONAL, INC., (U.S. CLS. 100 AND 101). SN 77-824,143. PUB. 2-16-2010. FILED 9-10-2009.
- 3,783,978. **TIN CANTINA (BLOCK FORM).** WOHLGEMUTH, DEANNA, (U.S. CLS. 100 AND 101). SN 77-824,261. PUB. 2-16-2010. FILED 9-10-2009.
- 3,783,995. **FAIRFIELD INN MARRIOTT AND DESIGN.** MARRIOTT INTERNATIONAL, INC., (U.S. CLS. 100 AND 101). SN 77-824,797. PUB. 2-16-2010. FILED 9-11-2009.
- 3,784,062 (*See Class 4 for this trademark*).
- 3,784,090. **SHOOP'S (BLOCK FORM).** MATTHEW SCHUPPEL COMPANY, LLC, DBA SHOOP'S, (U.S. CLS. 100 AND 101). SN 77-827,679. PUB. 2-16-2010. FILED 9-16-2009.
- 3,784,263. **OPA! OPA! EAT WELL...EAT GREEK! AND DESIGN.** OPA! OPA! LLC, (U.S. CLS. 100 AND 101). SN 77-830,835. PUB. 2-16-2010. FILED 9-21-2009.
- 3,784,285. **LEPIGEON AND DESIGN.** LE PIGEON, (U.S. CLS. 100 AND 101). SN 77-831,034. PUB. 2-16-2010. FILED 9-21-2009.
- 3,784,296. **SWAGGER (BLOCK FORM).** HASKIN MARKETING, LLC, (U.S. CLS. 100 AND 101). SN 77-831,188. PUB. 2-16-2010. FILED 9-21-2009.
- 3,784,310 (*See Class 41 for this trademark*).
- 3,784,311. **YOU KNOW WHEN IT'S REAL. (BLOCK FORM).** OLDEMARK LLC, (U.S. CLS. 100 AND 101). SN 77-831,343. PUB. 2-16-2010. FILED 9-21-2009.
- 3,784,312. **QUIKBOOK.COM (BLOCK FORM).** QUIKBOOK, INC., (U.S. CLS. 100 AND 101). SN 77-831,373. PUB. 2-16-2010. FILED 9-21-2009.
- 3,784,315. **EL AZTECO (BLOCK FORM).** SANTA CRUZ, ARTHUR W., (U.S. CLS. 100 AND 101). SN 77-831,388. PUB. 2-16-2010. FILED 9-21-2009.
- 3,784,324. **MISCELLANEOUS DESIGN.** BOILING POINT CORPORATION, (U.S. CLS. 100 AND 101). SN 77-831,577. PUB. 2-16-2010. FILED 9-21-2009.
- 3,784,325. **MISCELLANEOUS DESIGN.** BOILING POINT CORPORATION, (U.S. CLS. 100 AND 101). SN 77-831,583. PUB. 2-16-2010. FILED 9-21-2009.
- 3,784,326. **THE ORIGINAL HAWAIIAN BARBECUE (BLOCK FORM).** L & L FRANCHISE, INC., (U.S. CLS. 100 AND 101). SN 77-831,587. PUB. 2-16-2010. FILED 9-21-2009.
- 3,784,327. **BOILING POINT (BLOCK FORM).** BOILING POINT CORPORATION, (U.S. CLS. 100 AND 101). SN 77-831,596. PUB. 2-16-2010. FILED 9-21-2009.
- 3,784,353. **WE THINK, YOU EAT. (BLOCK FORM).** PUMP HOLDINGS, LLC, DBA THE PUMP ENERGY FOOD, (U.S. CLS. 100 AND 101). SN 77-831,929. PUB. 2-16-2010. FILED 9-22-2009.
- 3,784,355. **CUT THE CRAP. (BLOCK FORM).** PUMP HOLDINGS, LLC, DBA THE PUMP ENERGY FOOD, (U.S. CLS. 100 AND 101). SN 77-831,946. PUB. 2-16-2010. FILED 9-22-2009.
- 3,784,361. **SANS CRAP (BLOCK FORM).** PUMP HOLDINGS, LLC, DBA THE PUMP ENERGY FOOD, (U.S. CLS. 100 AND 101). SN 77-831,992. PUB. 2-16-2010. FILED 9-22-2009.
- 3,784,374. **COFFEE BY DESIGN (BLOCK FORM).** COFFEE BY DESIGN, INC., (U.S. CLS. 100 AND 101). SN 77-832,226. PUB. 2-16-2010. FILED 9-22-2009.
- 3,784,375. **CBD (BLOCK FORM).** COFFEE BY DESIGN, INC., (U.S. CLS. 100 AND 101). SN 77-832,231. PUB. 2-16-2010. FILED 9-22-2009.
- 3,784,396. **FAIRFIELD INN & SUITES MARRIOTT AND DESIGN.** MARRIOTT INTERNATIONAL, INC., (U.S. CLS. 100 AND 101). SN 77-832,429. PUB. 2-16-2010. FILED 9-22-2009.
- 3,784,421. **SIMPLY THE BEST PLACE TO BE (BLOCK FORM).** J&H FOODS, INC., (U.S. CLS. 100 AND 101). SN 77-832,741. PUB. 2-16-2010. FILED 9-23-2009.
- 3,784,435. **VEG IT. (BLOCK FORM).** HARDEE'S FOOD SYSTEMS, INC., (U.S. CLS. 100 AND 101). SN 77-832,956. PUB. 2-16-2010. FILED 9-23-2009.
- 3,784,436. **LOW CARB IT. (BLOCK FORM).** HARDEE'S FOOD SYSTEMS, INC., (U.S. CLS. 100 AND 101). SN 77-832,957. PUB. 2-16-2010. FILED 9-23-2009.
- 3,784,437. **GLUTEN-FREE IT. (BLOCK FORM).** HARDEE'S FOOD SYSTEMS, INC., (U.S. CLS. 100 AND 101). SN 77-832,962. PUB. 2-16-2010. FILED 9-23-2009.
- 3,784,438. **TRIM IT. (BLOCK FORM).** HARDEE'S FOOD SYSTEMS, INC., (U.S. CLS. 100 AND 101). SN 77-832,966. PUB. 2-16-2010. FILED 9-23-2009.
- 3,784,540 (*See Class 41 for this trademark*).
- 3,784,595. **ELETTARIA AND DESIGN.** NAWAB, AKHTAR, (U.S. CLS. 100 AND 101). SN 77-834,934. PUB. 2-16-2010. FILED 9-25-2009.
- 3,784,600. **HOT HARRY'S (BLOCK FORM).** HOT HARRY'S FRESH BURRITOS, INC., (U.S. CLS. 100 AND 101). SN 77-835,017. PUB. 2-16-2010. FILED 9-25-2009.
- 3,784,632. **MISCELLANEOUS DESIGN.** LIV VENTURES INC., (U.S. CLS. 100 AND 101). SN 77-835,463. PUB. 2-16-2010. FILED 9-25-2009.
- 3,784,683. **ARIZONA GRAND RESORT (BLOCK FORM).** ARIZONA GRAND RESORT, LLC, MULTIPLE CLASS, (INT. CLS. 43 AND 44), (U.S. CLS. 100 AND 101). SN 77-836,595. PUB. 2-16-2010. FILED 9-28-2009.
- 3,784,703. **TACKLE BOX AND DESIGN.** UMBEL, JONATHAN S., (U.S. CLS. 100 AND 101). SN 77-838,605. PUB. 2-16-2010. FILED 9-30-2009.
- 3,784,757. **GIVE THE GIFT OF HOMESTYLE (BLOCK FORM).** BOB EVANS RESTAURANTS OF MICHIGAN, LLC, (U.S. CLS. 100 AND 101). SN 77-852,571. PUB. 2-16-2010. FILED 10-20-2009.
- 3,784,811 (*See Class 41 for this trademark*).
- 3,784,823 (*See Class 36 for this trademark*).
- 3,784,865 (*See Class 3 for this trademark*).
- 3,784,869 (*See Class 3 for this trademark*).
- 3,784,937 (*See Class 36 for this trademark*).
- 3,784,945. **HAKOYA AND DESIGN.** LF FOOD CORP, (U.S. CLS. 100 AND 101). SN 79-067,389. PUB. 2-16-2010. FILED 3-26-2009.
- 3,784,950. **LITTLE SWISS AND DESIGN.** GEORGES MAGNIN, (U.S. CLS. 100 AND 101). SN 79-067,425. PUB. 2-16-2010. FILED 3-9-2009.
- 3,784,972 (*See Class 3 for this trademark*).
- 3,785,037 (*See Class 35 for this trademark*).
- 3,785,054. **LATEST RECIPE (STYLIZED).** SOCIETE DES HOTELS MERIDIEN, (U.S. CLS. 100 AND 101). SN 79-075,680. PUB. 2-16-2010. FILED 8-27-2009.

CLASS 44—MEDICAL, BEAUTY AND AGRICULTURAL SERVICES

- 3,783,108 (*See Class 35 for this trademark*).
- 3,783,145 (*See Class 35 for this trademark*).
- 3,783,217 (*See Class 35 for this trademark*).
- 3,783,230 (*See Class 5 for this trademark*).
- 3,783,303. **MEDIPEDIA (BLOCK FORM).** MEDPEDIA, INC., (U.S. CLS. 100 AND 101). SN 77-599,555. PUB. 2-16-2010. FILED 10-23-2008.
- 3,783,309 (*See Class 5 for this trademark*).
- 3,783,369 (*See Class 6 for this trademark*).
- 3,783,427 (*See Class 42 for this trademark*).
- 3,783,503. **TATTOO LOU'S (BLOCK FORM).** ARTISTIC TATTOOING, INC., (U.S. CLS. 100 AND 101). SN 77-707,204. PUB. 2-16-2010. FILED 4-6-2009.
- 3,783,506. **ADVANCING ORAL HEALTH...IMPROVING OVERALL HEALTH (BLOCK FORM).** JOHNSON & JOHNSON, (U.S. CLS. 100 AND 101). SN 77-708,615. PUB. 2-16-2010. FILED 4-7-2009.
- 3,783,510 (*See Class 41 for this trademark*).
- 3,783,522 (*See Class 41 for this trademark*).
- 3,783,573. **HAIR FAIR LTD. II, LLC (BLOCK FORM).** BEGER, JULIE A, DBA HAIR FAIR LTD. II, LLC, (U.S. CLS. 100 AND 101). SN 77-721,375. PUB. 2-16-2010. FILED 4-24-2009.
- 3,783,580 (*See Class 9 for this trademark*).
- 3,783,590. **J GIRL (BLOCK FORM).** J GIRL, INC., (U.S. CLS. 100 AND 101). SN 77-731,412. PUB. 2-16-2010. FILED 5-7-2009.
- 3,783,593. **LAWN LAB AND DESIGN.** LAWNLAB, INC., (U.S. CLS. 100 AND 101). SN 77-735,293. PUB. 2-16-2010. FILED 5-12-2009.

- 3,783,642. **EDS EMPIRE DIAGNOSTIC SOLUTIONS AND DESIGN. EMPIRE DIAGNOSTIC SOLUTIONS, INC.**, (U.S. CLS. 100 AND 101). SN 77-760,642. PUB. 2-16-2010. FILED 6-16-2009.
- 3,783,654. **PDRHEALTH PHYSICIANS' DESKTOP REFERENCE AND DESIGN. PDR NETWORK, LLC**, (U.S. CLS. 100 AND 101). SN 77-762,215. PUB. 2-16-2010. FILED 6-17-2009.
- 3,783,663 (*See Class 9 for this trademark*).
- 3,783,831. **MAKE MY DAY BEAUTIFUL! (BLOCK FORM). LINDA LITZINGER BECK, DBA MAKE MY DAY BEAUTIFUL**, (U.S. CLS. 100 AND 101). SN 77-810,836. PUB. 2-16-2010. FILED 8-23-2009.
- 3,783,833. **GET CONSTIPATION RELIEF.COM FIND THE RELIEF THAT'S RIGHT FOR YOU AND DESIGN. PURDUE PRODUCTS L.P.**, (U.S. CLS. 100 AND 101). SN 77-811,122. PUB. 2-16-2010. FILED 8-24-2009.
- 3,783,839. **MISCELLANEOUS DESIGN. SAMARITAN HOSPICE, INC.**, MULTIPLE CLASS, (INT. CLS. 44 AND 45), (U.S. CLS. 100 AND 101). SN 77-812,990. PUB. 2-16-2010. FILED 8-26-2009.
- 3,783,843. **MPS AND DESIGN. MEDICAL PHYSICS SERVICES, LLC**, (U.S. CLS. 100 AND 101). SN 77-813,507. PUB. 2-16-2010. FILED 8-26-2009.
- 3,783,914. **MEDICAL PHYSICS SERVICES LLC AND DESIGN. MEDICAL PHYSICS SERVICES, LLC**, (U.S. CLS. 100 AND 101). SN 77-820,691. PUB. 2-16-2010. FILED 9-4-2009.
- 3,783,964. **MISCELLANEOUS DESIGN. NEW MEXICO CHIROPRACTIC ASSOCIATION**, (U.S. CLS. 100 AND 101). SN 77-823,645. PUB. 2-16-2010. FILED 9-10-2009.
- 3,783,973. **E VISION VISION QUEST QUEST AND DESIGN. JH & AH ENTERPRISES, INC.**, (U.S. CLS. 100 AND 101). SN 77-824,095. PUB. 2-16-2010. FILED 9-10-2009.
- 3,784,024. **LIQUID SUN RAYZ (BLOCK FORM). LIQUID SUN RAYZ, LLC. DBA LIQUID SUN RAYZ**, (U.S. CLS. 100 AND 101). SN 77-825,875. PUB. 2-16-2010. FILED 9-14-2009.
- 3,784,038. **HOME COOKED HEALTH (BLOCK FORM). REDMOND, MICHELE**, (U.S. CLS. 100 AND 101). SN 77-826,252. PUB. 2-16-2010. FILED 9-14-2009.
- 3,784,051. **LUNAR (BLOCK FORM). QUY T. TON**, (U.S. CLS. 100 AND 101). SN 77-826,447. PUB. 2-16-2010. FILED 9-15-2009.
- 3,784,088. **AVANTUS RENAL THERAPY (BLOCK FORM). FRESENIUS MEDICAL CARE HOLDINGS, INC.**, (U.S. CLS. 100 AND 101). SN 77-827,673. PUB. 2-16-2010. FILED 9-16-2009.
- 3,784,089. **AVANTUS RENAL THERAPY AND DESIGN. FRESENIUS MEDICAL CARE HOLDINGS, INC.**, (U.S. CLS. 100 AND 101). SN 77-827,677. PUB. 2-16-2010. FILED 9-16-2009.
- 3,784,129. **MY FOOD ADVISOR (BLOCK FORM). AMERICAN DIABETES ASSOCIATION, INC.**, (U.S. CLS. 100 AND 101). SN 77-828,556. PUB. 2-16-2010. FILED 9-17-2009.
- 3,784,185 (*See Class 42 for this trademark*).
- 3,784,189. **GOLDEN REHAB (BLOCK FORM). GOLDEN GATE NATIONAL SENIOR CARE LLC**, (U.S. CLS. 100 AND 101). SN 77-829,715. PUB. 2-16-2010. FILED 9-18-2009.
- 3,784,191. **GOLDEN REHAB (STYLIZED). GOLDEN GATE NATIONAL SENIOR CARE LLC**, (U.S. CLS. 100 AND 101). SN 77-829,729. PUB. 2-16-2010. FILED 9-18-2009.
- 3,784,194. **O (STYLIZED). OXFORD BARIATRIC, GENERAL AND METABOLIC SURGERY, PLLC**, (U.S. CLS. 100 AND 101). SN 77-829,800. PUB. 2-16-2010. FILED 9-18-2009.
- 3,784,197. **ADVANCED CHIROPRACTIC SERVICES (BLOCK FORM). ADVANCED CHIROPRACTIC SERVICES, P.A.**, (U.S. CLS. 100 AND 101). SN 77-829,859. PUB. 2-16-2010. FILED 9-18-2009.
- 3,784,202 (*See Class 42 for this trademark*).
- 3,784,212. **THE BEAUTY BITCH (BLOCK FORM). WALLACE, CHRISTINA**, (U.S. CLS. 100 AND 101). SN 77-830,135. PUB. 2-16-2010. FILED 9-18-2009.
- 3,784,277. **SEE A SPECIALIST...THE DIFFERENCE WILL MAKE YOU SMILE (BLOCK FORM). NEWTON PROSTHODONTICS**, (U.S. CLS. 100 AND 101). SN 77-830,935. PUB. 2-16-2010. FILED 9-21-2009.
- 3,784,348. **YUMMY DENTAL FOR KIDS AND DESIGN. YUMMY DENTAL, LTD.**, (U.S. CLS. 100 AND 101). SN 77-831,840. PUB. 2-16-2010. FILED 9-22-2009.
- 3,784,365. **"A PRESCRIPTION FOR HEALING." (BLOCK FORM). NACOGDOCHES REHABILITATION GROUP, INC.**, (U.S. CLS. 100 AND 101). SN 77-832,066. PUB. 2-16-2010. FILED 9-22-2009.
- 3,784,404. **DIABETES NATION (BLOCK FORM). DIABETES NATION**, (U.S. CLS. 100 AND 101). SN 77-832,540. PUB. 2-16-2010. FILED 9-22-2009.
- 3,784,453. **CHANGING THE WORLD, ONE SMILE AT A TIME. (BLOCK FORM). JOHN H. WARFORD, JR., DDS, P.C., DBA WARFORD ORTHODONTICS**, (U.S. CLS. 100 AND 101). SN 77-833,180. PUB. 2-16-2010. FILED 9-23-2009.
- 3,784,462. **THE WIZ QUIZ AND DESIGN. THE WIZ QUIZ, LLC**, (U.S. CLS. 100 AND 101). SN 77-833,256. PUB. 2-16-2010. FILED 9-23-2009.
- 3,784,495. **SAMBA GLOW AND DESIGN. SAMBA GLOW**, (U.S. CLS. 100 AND 101). SN 77-833,577. PUB. 2-16-2010. FILED 9-23-2009.
- 3,784,567. **INKIES (BLOCK FORM). ARQUERO, ROBERT**, (U.S. CLS. 100 AND 101). SN 77-834,522. PUB. 2-16-2010. FILED 9-24-2009.
- 3,784,583. **NATIONAL CENTER FOR MEDICAL READINESS WRIGHT STATE UNIVERSITY AND DESIGN. WRIGHT STATE UNIVERSITY**, MULTIPLE CLASS, (INT. CLS. 44 AND 45), (U.S. CLS. 100 AND 101). SN 77-834,751. PUB. 2-16-2010. FILED 9-25-2009.
- 3,784,585. **KUTE KUTS (BLOCK FORM). KUTE KUTS, INC.**, (U.S. CLS. 100 AND 101). SN 77-834,821. PUB. 2-16-2010. FILED 9-25-2009.
- 3,784,609. **EVERY TOOTH COUNTS (BLOCK FORM). CARMELLA BARRETT PERRY DDS, P.C.**, (U.S. CLS. 100 AND 101). SN 77-835,125. PUB. 2-16-2010. FILED 9-25-2009.
- 3,784,627. **STAR (BLOCK FORM). PACIFIC AG RENTALS, LLC**, (U.S. CLS. 100 AND 101). SN 77-835,416. PUB. 2-16-2010. FILED 9-25-2009.
- 3,784,639 (*See Class 35 for this trademark*).
- 3,784,641 (*See Class 35 for this trademark*).
- 3,784,683 (*See Class 43 for this trademark*).
- 3,784,695 (*See Class 35 for this trademark*).
- 3,784,727. **REVOLUTIONARYMD (BLOCK FORM). GROVER JR. M.D., FRED, DBA REVOLUTIONARYMD**, (U.S. CLS. 100 AND 101). SN 77-843,991. PUB. 2-16-2010. FILED 10-7-2009.
- 3,784,775. **FARMERS FOR THE FUTURE (BLOCK FORM). MEREDITH CORPORATION**, (U.S. CLS. 100 AND 101). SN 77-858,735. PUB. 2-16-2010. FILED 10-27-2009.
- 3,784,801 (*See Class 35 for this trademark*).
- 3,784,807. **PURESCRIPTIONS (BLOCK FORM). AVEDA CORPORATION**, (U.S. CLS. 100 AND 101). SN 77-874,579. PUB. 2-16-2010. FILED 11-17-2009.
- 3,784,813. **GOLDEN LIVING (STYLIZED). GOLDEN GATE NATIONAL SENIOR CARE LLC**, (U.S. CLS. 100 AND 101). SN 77-887,419. PUB. 2-16-2010. FILED 12-7-2009.
- 3,784,826 (*See Class 9 for this trademark*).
- 3,784,859 (*See Class 3 for this trademark*).
- 3,784,865 (*See Class 3 for this trademark*).
- 3,784,869 (*See Class 3 for this trademark*).
- 3,784,875 (*See Class 35 for this trademark*).
- 3,784,898 (*See Class 5 for this trademark*).
- 3,784,899 (*See Class 5 for this trademark*).
- 3,784,900 (*See Class 5 for this trademark*).
- 3,784,903 (*See Class 35 for this trademark*).
- 3,784,904 (*See Class 35 for this trademark*).
- 3,784,957 (*See Class 16 for this trademark*).
- 3,784,958 (*See Class 16 for this trademark*).
- 3,784,959 (*See Class 16 for this trademark*).
- 3,785,023 (*See Class 1 for this trademark*).

CLASS 45—PERSONAL AND LEGAL SERVICES

- 3,783,132. **"LAW I CAN AFFORD" (BLOCK FORM). LAW29 A PROFESSIONAL CORPORATION**, (U.S. CLS. 100 AND 101). SN 76-699,602. PUB. 2-16-2010. FILED 9-23-2009.
- 3,783,157 (*See Class 6 for this trademark*).
- 3,783,266 (*See Class 9 for this trademark*).
- 3,783,285. **C COMPANION CHOICE AND DESIGN. GURROLA, LA SHON**, (U.S. CLS. 100 AND 101). SN 77-576,811.

- PUB. 2-16-2010. FILED 9-23-2008.
 3,783,332 (*See Class 35 for this trademark*).
 3,783,333 (*See Class 35 for this trademark*).
 3,783,354 (*See Class 35 for this trademark*).
 3,783,382. **SCANDIA GERMANIA (BLOCK FORM)**. DAVIS, T. MICHAEL, (U.S. CLS. 100 AND 101). SN 77-683,787. PUB. 2-16-2010. FILED 3-4-2009.
 3,783,510 (*See Class 41 for this trademark*).
 3,783,549. **THE BABY NURSE "WHERE BABIES ARE OUR BUSINESS" AND DESIGN**. THE BABY NURSE-WHERE BABIES ARE OUR BUSINESS, (U.S. CLS. 100 AND 101). SN 77-714,278. PUB. 2-16-2010. FILED 4-15-2009.
 3,783,680. **MY DADDY LOVES ME (BLOCK FORM)**. LOST WITHOUT JESUS MINISTRIES, (U.S. CLS. 100 AND 101). SN 77-769,809. PUB. 2-16-2010. FILED 6-28-2009.
 3,783,748. **THE ECONOMIC JUDICIAL REPORT (BLOCK FORM)**. SEQUOYAH INFORMATION SYSTEMS, LTD., (U.S. CLS. 100 AND 101). SN 77-794,680. PUB. 2-16-2010. FILED 7-31-2009.
 3,783,759. **E HEALTH WWW.OAKGOV.COM/HEALTH AND DESIGN**. OAKLAND COUNTY, (U.S. CLS. 100 AND 101). SN 77-796,238. PUB. 2-16-2010. FILED 8-4-2009.
 3,783,781. **TRAFFICKING HOPE (BLOCK FORM)**. CYRUS INTERNATIONAL, (U.S. CLS. 100 AND 101). SN 77-801,909. PUB. 2-16-2010. FILED 8-11-2009.
 3,783,806. **GRACY TITLE (BLOCK FORM)**. GRACY TITLE COMPANY, LLC, (U.S. CLS. 100 AND 101). SN 77-806,065. PUB. 2-16-2010. FILED 8-17-2009.
 3,783,813 (*See Class 37 for this trademark*).
 3,783,839 (*See Class 44 for this trademark*).
 3,783,840 (*See Class 35 for this trademark*).
 3,783,928. **ASK THE COSMIC CLOCK DOC (BLOCK FORM)**. RODECK, SANDRA L., (U.S. CLS. 100 AND 101). SN 77-821,750. PUB. 2-16-2010. FILED 9-8-2009.
 3,783,940. **LOVE OF GOD (BLOCK FORM)**. MICHIANA YOUTH MINISTRIES, INC., (U.S. CLS. 100 AND 101). SN 77-822,449. PUB. 2-16-2010. FILED 9-9-2009.
 3,783,941. **L. O. G. (BLOCK FORM)**. MICHIANA YOUTH MINISTRIES, INC., (U.S. CLS. 100 AND 101). SN 77-822,453. PUB. 2-16-2010. FILED 9-9-2009.
 3,783,943. **L. O. G. AND DESIGN**. MICHIANA YOUTH MINISTRIES, INC., (U.S. CLS. 100 AND 101). SN 77-822,457. PUB. 2-16-2010. FILED 9-9-2009.
 3,783,945 (*See Class 9 for this trademark*).
 3,783,987. **CHRISTIAN REFORMED CHURCH (BLOCK FORM)**. THE CHRISTIAN REFORMED CHURCH IN NORTH AMERICA, (U.S. CLS. 100 AND 101). SN 77-824,540. PUB. 2-16-2010. FILED 9-11-2009.
 3,784,012. **IDR AND DESIGN**. INTELLIGENT DOCUMENT REVIEW, INC., (U.S. CLS. 100 AND 101). SN 77-825,479. PUB. 2-16-2010. FILED 9-13-2009.
 3,784,067. **THE INDUSTRY'S MOST INTELLIGENT DOCUMENT REVIEW (BLOCK FORM)**. INTELLIGENT DOCUMENT REVIEW, INC., (U.S. CLS. 100 AND 101). SN 77-827,123. PUB. 2-16-2010. FILED 9-15-2009.
 3,784,106. **GLEEDEN (BLOCK FORM)**. BLACKDIVINE LLC, (U.S. CLS. 100 AND 101). SN 77-828,189. PUB. 2-16-2010. FILED 9-16-2009.
 3,784,130. **KELLY BAGLA, ESQ. A PROFESSIONAL CORPORATION AND DESIGN**. BAGLA, KELLY, (U.S. CLS. 100 AND 101). SN 77-828,558. PUB. 2-16-2010. FILED 9-17-2009.
 3,784,159. **KOG AND DESIGN**. KINGDOM OF GOD EVANGELISTIC OUTREACH MINISTRY, INC., THE, (U.S. CLS. 100 AND 101). SN 77-829,061. PUB. 2-16-2010. FILED 9-17-2009.
 3,784,182. **THE SALVATION SALOON (BLOCK FORM)**. WHITE, PAUL, (U.S. CLS. 100 AND 101). SN 77-829,624. PUB. 2-16-2010. FILED 9-18-2009.
 3,784,203. **DOMESTIC UNIFORM RENTAL (BLOCK FORM)**. DOMESTIC LINEN SUPPLY & LAUNDRY CO., (U.S. CLS. 100 AND 101). SN 77-829,966. PUB. 2-16-2010. FILED 9-18-2009.
 3,784,206. **DOMESTIC UNIFORM RENTAL AND DESIGN**. DOMESTIC LINEN SUPPLY & LAUNDRY CO., (U.S. CLS. 100 AND 101). SN 77-830,003. PUB. 2-16-2010. FILED 9-18-2009.
 3,784,279. **TOREROS DE LA LAY (BLOCK FORM)**. GERACI, PETER F., (U.S. CLS. 100 AND 101). SN 77-830,967. PUB. 2-16-2010. FILED 9-21-2009.
 3,784,379. **THE CALL COSTS YOU NOTHING...IT COULD MEAN EVERYTHING. (BLOCK FORM)**. THE ROBERTS LAW FIRM, A PROFESSIONAL CORPORATION, DBA ROBERTS & ROBERTS, (U.S. CLS. 100 AND 101). SN 77-832,244. PUB. 2-16-2010. FILED 9-22-2009.
 3,784,380. **HELPING BUSINESSES SUCCEED (BLOCK FORM)**. STIBBS & CO., P.C., (U.S. CLS. 100 AND 101). SN 77-832,250. PUB. 2-16-2010. FILED 9-22-2009.
 3,784,385. **MISCELLANEOUS DESIGN**. BLUE RIDGE LEGAL SERVICES, INC., (U.S. CLS. 100 AND 101). SN 77-832,284. PUB. 2-16-2010. FILED 9-22-2009.
 3,784,405. **MYPULSECITY (BLOCK FORM)**. TREJO, ANDY, (U.S. CLS. 100 AND 101). SN 77-832,557. PUB. 2-16-2010. FILED 9-22-2009.
 3,784,432 (*See Class 16 for this trademark*).
 3,784,473. **RESPECT THE ART (BLOCK FORM)**. MCGARRY BAIR PC, (U.S. CLS. 100 AND 101). SN 77-833,369. PUB. 2-16-2010. FILED 9-23-2009.
 3,784,498. **ALWAYSVIEW (BLOCK FORM)**. ALWAYSVIEW, INC., (U.S. CLS. 100 AND 101). SN 77-833,599. PUB. 2-16-2010. FILED 9-23-2009.
 3,784,511. **PARSUS LLP (STYLIZED)**. PARSUS LLP, (U.S. CLS. 100 AND 101). SN 77-833,802. PUB. 2-16-2010. FILED 9-24-2009.
 3,784,520. **PATENTSCOPE (BLOCK FORM)**. WORLD INTELLECTUAL PROPERTY ORGANIZATION, (U.S. CLS. 100 AND 101). SN 77-833,900. PUB. 2-16-2010. FILED 9-24-2009.
 3,784,529. **ALWAYSVIEW AND DESIGN**. ALWAYSVIEW, INC., (U.S. CLS. 100 AND 101). SN 77-834,023. PUB. 2-16-2010. FILED 9-24-2009.
 3,784,533. **CHEWBARKA (BLOCK FORM)**. FRED RICCI TOOL CO., INC., (U.S. CLS. 100 AND 101). SN 77-834,050. PUB. 2-16-2010. FILED 9-24-2009.
 3,784,537. **HOMEBRIDGE (BLOCK FORM)**. HOMEBRIDGE SECURITY, LLC, (U.S. CLS. 100 AND 101). SN 77-834,100. PUB. 2-16-2010. FILED 9-24-2009.
 3,784,548. **PRESS4JUSTICE (BLOCK FORM)**. JAN ANDREW PRESS, (U.S. CLS. 100 AND 101). SN 77-834,187. PUB. 2-16-2010. FILED 9-24-2009.
 3,784,562. **PRACTICAL ADVICE FOR THE REAL WORLD (BLOCK FORM)**. COX SMITH MATTHEWS INCORPORATED, (U.S. CLS. 100 AND 101). SN 77-834,452. PUB. 2-16-2010. FILED 9-24-2009.
 3,784,564. **MEDIATION WITHOUT WALLS (BLOCK FORM)**. MARILYN A. WESTLAKE, (U.S. CLS. 100 AND 101). SN 77-834,494. PUB. 2-16-2010. FILED 9-24-2009.
 3,784,565. **PROJECT WINGMAN (BLOCK FORM)**. WALKO, JOSEPH, (U.S. CLS. 100 AND 101). SN 77-834,501. PUB. 2-16-2010. FILED 9-24-2009.
 3,784,583 (*See Class 44 for this trademark*).
 3,784,593. **WE WALK TOGETHER (BLOCK FORM)**. DUNLAP CODDING, P.C., (U.S. CLS. 100 AND 101). SN 77-834,921. PUB. 2-16-2010. FILED 9-25-2009.
 3,784,646. **CHOSEN FOR MIRACLES (BLOCK FORM)**. WILLIAMS, THERESA LAVERNE, (U.S. CLS. 100 AND 101). SN 77-835,696. PUB. 2-16-2010. FILED 9-25-2009.
 3,784,677. **REAPERLIST (BLOCK FORM)**. WEATHER GAUGE, LLC, (U.S. CLS. 100 AND 101). SN 77-836,518. PUB. 2-16-2010. FILED 9-28-2009.
 3,784,749. **FSB LEGAL COUNSEL (BLOCK FORM)**. FSB LEGAL COUNSEL, A FISHER BROYLES LLP, (U.S. CLS. 100 AND 101). SN 77-850,478. PUB. 2-16-2010. FILED 10-16-2009.
 3,784,752. **KNOW YOUR RIGHTS...LET US PROTECT THEM. (BLOCK FORM)**. THE ROBERTS LAW FIRM, A PROFESSIONAL CORPORATION, DBA ROBERTS & ROBERTS, (U.S. CLS. 100 AND 101). SN 77-851,462. PUB. 2-16-2010. FILED 10-19-2009.
 3,784,755 (*See Class 35 for this trademark*).
 3,784,765 (*See Class 41 for this trademark*).
 3,784,817 (*See Class 35 for this trademark*).
 3,784,861 (*See Class 9 for this trademark*).
 3,784,869 (*See Class 3 for this trademark*).
 3,784,884 (*See Class 5 for this trademark*).
 3,784,902 (*See Class 35 for this trademark*).
 3,784,903 (*See Class 35 for this trademark*).
 3,784,904 (*See Class 35 for this trademark*).

MAY 4, 2010

U.S. PATENT AND TRADEMARK OFFICE

TM 1255

3,784,915 (*See Class 9 for this trademark.*)
3,784,973 (*See Class 16 for this trademark.*)
3,784,974 (*See Class 16 for this trademark.*)
3,784,975 (*See Class 16 for this trademark.*)
3,785,021 (*See Class 35 for this trademark.*)

* * * * *

SECTION 2.—PRIOR UNITED STATES CLASSIFICATION

COLLECTIVE MEMBERSHIP MARKS

CLASS 200—COLLECTIVE MEMBERSHIP

3,783,963. **MISCELLANEOUS DESIGN**. NEW MEXICO CHIROPRACTIC ASSOCIATION, SN 77-823,638. PUB. 2-16-2010. FILED 9-10-2009.

TRUST, SN 77-668,567. PUB. 2-16-2010. FILED 2-11-2009.

3,783,891. **PCGI CERTIFIED MULTI-PITCH GUIDE (BLOCK FORM)**. PROFESSIONAL CLIMBING GUIDES INSTITUTE, SN 77-817,664. PUB. 2-16-2010. FILED 9-1-2009.

3,784,333. **CWS (BLOCK FORM)**. AMERICAN ACADEMY OF WOUND MANAGEMENT, INC., SN 77-831,710. PUB. 2-16-2010. FILED 9-22-2009.

CERTIFICATION MARKS

CLASS B—SERVICES

3,783,349. **AMERICAN BOARD FOR CERTIFICATION IN HOMELAND SECURITY . A.B.C.H.S. . A LOYAL AND TRUSTWORTHY MEMBER SCIENCE . INTEGRITY . JUSTICE AND DESIGN**. ROBERT L. O'BLOCK REVOCABLE

3,784,729. **PCGI CERTIFIED TOP-ROPE GUIDE (BLOCK FORM)**. PROFESSIONAL CLIMBING GUIDES INSTITUTE, SN 77-844,297. PUB. 2-16-2010. FILED 10-8-2009.

3,784,730. **PCGI CERTIFIED LEAD GUIDE (BLOCK FORM)**. PROFESSIONAL CLIMBING GUIDES INSTITUTE, SN 77-844,311. PUB. 2-16-2010. FILED 10-8-2009.

* * * * *

TRADEMARK REGISTRATIONS ISSUED UNDER SECTION 1(d)

The following marks have registered on the Principal Register pursuant to the intent-to-use provisions of Section 1(d) of the Trademark Act of 1946, as amended.

SECTION 1.— INTERNATIONAL CLASSIFICATION

The short titles associated below with the international class numbers are terms designed merely for quick identification and are not an official part of the international classification. The full names of international classes are given in section 6.1 of the trademark rules of practice.

The designation "U.S. Cl." appearing in this section refers to the U.S. class in effect prior to Sep. 1, 1973 rather than the international class which applies to applications filed on or after that date. For adoption of international classification see notice in the OFFICIAL GAZETTE of Jun. 26, 1973 (911 O.G. TM 210).

Application in more than one class

3,785,056. CHANCELLOR MASTERS AND SCHOLARS OF THE UNIVERSITY OF OXFORD, TA OXFORD UNIVERSITY PRESS, THE, OXFORD, OX2 6DP, UNITED KINGDOM. SN 76-067,308. PUB. 1-10-2006, FILED 6-9-2000.

GROVE

OWNER OF U.S. REG. NOS. 1,275,151 AND 1,276,971.

CLASS 16—PAPER GOODS AND PRINTED MATTER

FOR PRINTED MATERIALS, NAMELY, BOOKS, DICTIONARIES IN THE FIELDS OF ART, ARTISTS, MUSIC, MUSICIANS (U.S. CLS. 2, 5, 22, 23, 29, 37, 38 AND 50). FIRST USE 0-0-1904; IN COMMERCE 0-0-1904.

CLASS 41—EDUCATION AND ENTERTAINMENT

FOR INFORMATION SERVICES, NAMELY, PROVIDING INFORMATION RELATING TO MUSIC, MUSICIANS, MUSICAL INSTRUMENTS, ART; COMPUTER SERVICES, NAMELY, PROVIDING ON-LINE BOOKS, AND TEACHING AND INSTRUCTIONAL MATERIALS IN THE FIELDS OF ART, ARTISTS, MUSIC, MUSICIANS, MUSICAL INSTRUMENTS (U.S. CLS. 100, 101 AND 107). FIRST USE 0-0-2001; IN COMMERCE 0-0-2001.

3,785,057. D'ASCOLI, EDMONT P., TRUSTEE OF THE EDMONT P. D' ASCOLI REVOCABLE LIVING TRUST DATED MAY 24, 1996, HALEIWA, HI. SN 76-272,356. PUB. 1-27-2004, FILED 6-13-2001.

XCEL

OWNER OF U.S. REG. NOS. 1,292,982, 2,217,115, AND OTHERS.

CLASS 18—LEATHER GOODS

FOR DUFFEL BAGS; BEACH BAGS; BACKPACKS (U.S. CLS. 1, 2, 3, 22 AND 41). FIRST USE 0-0-1984; IN COMMERCE 0-0-1984.

CLASS 28—TOYS AND SPORTING GOODS

FOR DIVING BAGS (U.S. CLS. 22, 23, 38 AND 50). FIRST USE 8-29-2008; IN COMMERCE 8-29-2008.

3,785,059. LEDLUMINA TECHNOLOGY A/S, STRUER, DENMARK. SN 76-386,927. PUB. 4-29-2008, FILED 3-27-2002.

LEDLUMINA

CLASS 6—METAL GOODS

FOR SIGNBOARDS OF METAL (U.S. CLS. 2, 12, 13, 14, 23, 25 AND 50). FIRST USE 1-15-2010; IN COMMERCE 1-15-2010.

CLASS 9—ELECTRICAL AND SCIENTIFIC APPARATUS

FOR ELECTRICAL ADAPTORS, ADAPTORS FOR DIODES; ELECTRIC SOCKETS, ELECTRIC PLUGS, ELECTRIC CONNECTIONS; ELECTRICITY SWITCH BOXES; ELECTRICITY INDICATORS; ELECTRICAL CONDUCTORS; ELECTRIC CONVERTERS; LUMINOUS SIGNAL DEVICES, CURRENT RECTIFIERS; ELECTRICITY INVERTERS (U.S. CLS. 21, 23, 26, 36 AND 38). FIRST USE 1-15-2010; IN COMMERCE 1-15-2010.

CLASS 11—ENVIRONMENTAL CONTROL APPARATUS

FOR ELECTRIC LIGHTING FIXTURES, SOCKETS FOR ELECTRIC LIGHTS (U.S. CLS. 13, 21, 23, 31 AND 34). FIRST USE 1-15-2010; IN COMMERCE 1-15-2010.

3,785,062. FUTUREBOY, LLC, LOS ANGELES, CA. SN 76-639,834. PUB. 2-28-2006, FILED 6-1-2005.



CLASS 11—ENVIRONMENTAL CONTROL APPARATUS

FOR LIGHTING, NAMELY, TABLE LAMPS, STANDING LAMPS, HANGING LIGHTS, READING LIGHTS, WALL MOUNTED LIGHTS, AND ELECTRIC LIGHTING FIXTURES, NAMELY, SCONCES (U.S. CLS. 13, 21, 23, 31 AND 34).

FIRST USE 8-26-2009; IN COMMERCE 8-26-2009.

CLASS 25—CLOTHING

FOR CLOTHING, NAMELY, T-SHIRTS, LONG SLEEVE SHIRTS, TANK TOPS, AND SWEAT SHIRTS (U.S. CLS. 22 AND 39).

FIRST USE 8-26-2009; IN COMMERCE 8-26-2009.

3,785,071. HOME LEGEND INT'L INC., CHINO, CA. SN 76-660,122. PUB. 12-26-2006, FILED 5-16-2006.



OWNER OF U.S. REG. NO. 2,792,973.

THE MARK CONSISTS OF THE WORD "HOMELEGEND" AND THE DESIGN AS SHOWN IN THE DRAWING OF A BALL WITHIN A HOUSING HAVING AN OPENING IN THE TOP WALL.

CLASS 16—PAPER GOODS AND PRINTED MATTER

FOR FILE STORAGE BOXES AND MOVING BOXES MADE OF CARDBOARD AND BUBBLE PACKING FOR WRAPPING OR PACKING MADE OF PLASTIC (U.S. CLS. 2, 5, 22, 23, 29, 37, 38 AND 50).

FIRST USE 10-1-2009; IN COMMERCE 10-1-2009.

CLASS 19—NON-METALLIC BUILDING MATERIALS

FOR WOOD FLOORING, PARQUET WOOD FLOORING, WOOD TILE FOR DECORATING, MARBLE FLOORING, WOOD MOLDING, PLASTIC TILES AND VINYL TILES (U.S. CLS. 1, 12, 33 AND 50).

FIRST USE 10-1-2009; IN COMMERCE 10-1-2009.

CLASS 20—FURNITURE AND ARTICLES NOT OTHERWISE CLASSIFIED

FOR FURNITURE, NAMELY, DINING TABLES, CHAIRS, SOFAS, LOVE SEATS, OTTOMANS, CARTS FOR TEA AND FOOD, TABLES, END TABLES, KITCHEN TABLES, BEDROOM FURNITURE, BEDS, NIGHT TABLES, DRESSERS, OFFICE FURNITURE, DESKS, CREDENZAS, AND CABINETS (U.S. CLS. 2, 13, 22, 25, 32 AND 50).

FIRST USE 11-1-2009; IN COMMERCE 11-1-2009.

CLASS 24—FABRICS

FOR BATH LINENS, BED BLANKETS, BED CANOPIES, BED LINENS, BED SHEETS, BEDSPREADS, BED BLANKETS, COVERING BLANKETS, PILLOWCASES, DUVET COVERS, MATTRESS COVERS, CURTAINS, DRAPERIES, DUST RUFFLES, TOWELS, TABLE LINENS, WASH CLOTHS (U.S. CLS. 42 AND 50).

FIRST USE 10-1-2009; IN COMMERCE 10-1-2009.

3,785,075. MOSS, ROGER J., STOCKBRIDGE, GA. SN 76-666,766. PUB. 12-11-2007, FILED 9-29-2006.

DADGUM

THE MARK CONSISTS OF STANDARD CHARACTERS WITHOUT CLAIM TO ANY PARTICULAR FONT, STYLE, SIZE, OR COLOR.

CLASS 25—CLOTHING

FOR CLOTHING, NAMELY, SHIRTS, T-SHIRTS, DRESS SHIRTS, SWEATSHIRTS, SWEATERS, JACKETS, TANK TOPS, BATHING SUIT TOPS, HATS, CAPS, NECKWEAR, SCARVES AND BANDANAS (U.S. CLS. 22 AND 39).

FIRST USE 2-1-2009; IN COMMERCE 2-1-2009.

CLASS 30—STAPLE FOODS

FOR CHEWING GUM, BUBBLE GUM AND CANDY (U.S. CL. 46).

FIRST USE 8-17-2009; IN COMMERCE 8-17-2009.

3,785,079. RIVERSSET CREDIT UNION, PITTSBURGH, PA. SN 76-682,287. PUB. 12-9-2008, FILED 9-25-2007.



THE COLOR(S) BURNT ORANGE, MEDIUM GREEN AND DARK GREEN IS/ARE CLAIMED AS A FEATURE OF THE MARK.

THE MARK CONSISTS OF THE COLOR BURNT ORANGE APPEARS IN THE WORD "RIVERSSET" AND THE COLOR APPEARS IN THE DESIGN OF THE CIRCLE. THE COLOR MEDIUM GREEN APPEARS IN THE DESIGN OF THE TRIANGLE. THE COLOR DARK GREEN APPEARS IN THE DESIGN OF THE TWO SIDE-WAY TRIANGLES ABOVE THE WORD "RIVERSSET".

CLASS 35—ADVERTISING AND BUSINESS

FOR TAX PREPARATION; MARKETING SERVICES, NAMELY, PROMOTING THE GOODS AND SERVICES OF OTHERS VIA A GLOBAL COMPUTER NETWORK; E-COMMERCE SERVICES, NAMELY, ELECTRONIC ADMINISTRATIVE PROCESSING OF LOAN APPLICATIONS FOR OTHERS; AUTOMOBILE BUYING, NAMELY, PROCURING USED CARS FOR OTHERS (U.S. CLS. 100, 101 AND 102).

FIRST USE 1-1-2008; IN COMMERCE 1-1-2008.

CLASS 36—INSURANCE AND FINANCIAL

FOR BANKING SERVICES, CREDIT UNIONS; FINANCIAL PLANNING; CHECK CASHING; MORTGAGE PROCESSING; ELECTRONIC DATA PROCESSING SERVICES, NAMELY, ELECTRONIC PROCESSING OF BILL PAYMENT DATA, ON-LINE BANKING SERVICES, ELECTRONIC PROCESSING OF LOAN DATA; INSURANCE SERVICES, NAMELY, INSURANCE AGENCIES; INVESTMENT SERVICES, NAMELY, INVESTMENT AND TRUST MANAGEMENT; INDIRECT GENERAL LENDING, NAMELY, INDIRECT MORTGAGE LENDING; CREDIT CARD SERVICES; TRUST SERVICES, NAMELY, ESTATE TRUST MANAGEMENT; ITEM PROCESSING, NAMELY, CHECK PROCESSING, DEBIT CARD TRANSACTION PROCESSING, AUTOMATED CLEARING HOUSE PROCESSING, ATM TRANSACTION INTERCHANGE PROCESSING; ELECTRONIC TITLE PROCESSING, NAMELY, INSTANTANEOUS PROCESSING OF CAR LOANS WHEN THERE IS A LIEN ON THE TITLE; BUSINESS LENDING, NAMELY, PROVIDE BUSINESS LOANS TO SOLE PROPRIETORSHIPS; TITLE INSURANCE PROCESSING, NAMELY, TITLE INSURANCE BROKERAGE; PEER TO PEER LENDING SERVICES, NAMELY, COMMERCIAL LENDING, E-COMMERCE SERVICES, NAMELY, HOME BANKING, BILL PAYMENT SERVICES (U.S. CLS. 100, 101 AND 102).

FIRST USE 1-1-2008; IN COMMERCE 1-1-2008.

3,785,091. PEZZINO, DAVID M., ATLANTA, GA. SN 76-695,103. PUB. 5-12-2009, FILED 12-31-2008.

SUCCESS WITHIN REACH PROFESSIONAL LIFE COACHING

THE MARK CONSISTS OF STANDARD CHARACTERS WITHOUT CLAIM TO ANY PARTICULAR FONT, STYLE, SIZE, OR COLOR.

NO CLAIM IS MADE TO THE EXCLUSIVE RIGHT TO USE "PROFESSIONAL LIFE COACHING", APART FROM THE MARK AS SHOWN.

CLASS 16—PAPER GOODS AND PRINTED MATTER

FOR PRINTED MATERIALS, NAMELY, BOOKS, ARTICLES, WORKBOOKS AND INSTRUCTIONAL MANUALS CONCERNING ENHANCING PERSONAL EFFECTIVENESS AND PRODUCTIVITY, AND OBTAINING PERSONAL SATISFACTION WITH LIFE AND WORK THROUGH ACHIEVEMENT OF RELEVANT GOALS (U.S. CLS. 2, 5, 22, 23, 29, 37, 38 AND 50).

FIRST USE 3-1-2006; IN COMMERCE 3-1-2006.

CLASS 41—EDUCATION AND ENTERTAINMENT

FOR EDUCATIONAL SERVICES, NAMELY, CONDUCTING CLASSES, SEMINARS, WORKSHOPS AND PROVIDING ONE-TO-ONE PERSONAL COACHING TO ENHANCE PERSONAL EFFECTIVENESS AND PRODUCTIVITY, AND OBTAIN PERSONAL SATISFACTION WITH LIFE AND WORK THROUGH ACHIEVEMENT OF RELEVANT GOALS (U.S. CLS. 100, 101 AND 107).

FIRST USE 3-1-2006; IN COMMERCE 3-1-2006.

3,785,092. PEZZINO, DAVID M., ATLANTA, GA. SN 76-695,104. PUB. 4-28-2009, FILED 12-31-2008.

KUMBAYA FACTOR

THE MARK CONSISTS OF STANDARD CHARACTERS WITHOUT CLAIM TO ANY PARTICULAR FONT, STYLE, SIZE, OR COLOR.

CLASS 16—PAPER GOODS AND PRINTED MATTER

FOR PRINTED MATERIALS, NAMELY, BOOKS, ARTICLES, WORKBOOKS AND INSTRUCTIONAL MANUALS CONCERNING ENHANCING PERSONAL EFFECTIVENESS AND PRODUCTIVITY, AND OBTAINING PERSONAL SATISFACTION WITH LIFE AND WORK THROUGH ACHIEVEMENT OF RELEVANT GOALS (U.S. CLS. 2, 5, 22, 23, 29, 37, 38 AND 50).

FIRST USE 1-18-2006; IN COMMERCE 5-12-2009.

CLASS 41—EDUCATION AND ENTERTAINMENT

FOR EDUCATIONAL SERVICES, NAMELY, CONDUCTING CLASSES, SEMINARS, WORKSHOPS AND PROVIDING ONE-TO-ONE PERSONAL COACHING TO ENHANCE PERSONAL EFFECTIVENESS AND PRODUCTIVITY, AND OBTAIN PERSONAL SATISFACTION WITH LIFE AND WORK THROUGH ACHIEVEMENT OF RELEVANT GOALS (U.S. CLS. 100, 101 AND 107).

FIRST USE 1-18-2006; IN COMMERCE 2-27-2008.

3,785,093. SYSTEMFORWARD AMERICA, INC., LAFAYETTE, LA. SN 76-695,105. PUB. 5-19-2009, FILED 12-31-2008.

POP A LOCKSMITH

THE MARK CONSISTS OF STANDARD CHARACTERS WITHOUT CLAIM TO ANY PARTICULAR FONT, STYLE, SIZE, OR COLOR.

OWNER OF U.S. REG. NOS. 1,798,348, 3,219,253, AND OTHERS.

NO CLAIM IS MADE TO THE EXCLUSIVE RIGHT TO USE "LOCKSMITH", APART FROM THE MARK AS SHOWN.

CLASS 37—CONSTRUCTION AND REPAIR

FOR EMERGENCY ROADSIDE ASSISTANCE SERVICES, NAMELY, RESPONDING TO CALLS FOR ROADSIDE ASSISTANCE, FLAT TIRE CHANGING, EMERGENCY FUEL SUPPLY AND BATTERY JUMP STARTING (U.S. CLS. 100, 103 AND 106).

FIRST USE 2-10-2010; IN COMMERCE 2-10-2010.

CLASS 40—MATERIAL TREATMENT

FOR LOCKSMITHING, NAMELY, CUSTOM FABRICATION OF KEYS AND LOCKS (U.S. CLS. 100, 103 AND 106).

FIRST USE 2-10-2010; IN COMMERCE 2-10-2010.

CLASS 45—PERSONAL AND LEGAL SERVICES

FOR LOCKSMITHING, NAMELY, OPENING LOCKS ON VEHICLE DOORS (U.S. CLS. 100 AND 101).

FIRST USE 2-10-2010; IN COMMERCE 2-10-2010.

3,785,094. PACIFICHEALTH LABORATORIES, INC., MATAWAN, NJ. SN 76-695,170. PUB. 4-28-2009, FILED 1-6-2009.



THE MARK CONSISTS OF A COMPOSITE DESIGN OF FIVE FIGURES. THE LEFTMOST FIGURE IS A SILHOUETTE OF A MAN WALKING. THE TWO FIGURES NEXT TO THE WALKING MAN ARE SILHOUETTES OF MEN RUNNING. THE TWO RIGHTMOST FIGURES ARE SILHOUETTES OF CATS RUNNING.

CLASS 5—PHARMACEUTICALS

FOR THERAPEUTIC AGENTS FOR WEIGHT CONTROL AND APPETITE SUPPRESSION; NUTRITIONAL BEVERAGES HAVING VITAMINS AND/OR NATURAL SUPPLEMENTS (U.S. CLS. 6, 18, 44, 46, 51 AND 52).

FIRST USE 3-0-2009; IN COMMERCE 3-0-2009.

CLASS 32—LIGHT BEVERAGES

FOR FRUIT FLAVORED BEVERAGES; SOY-BASED BEVERAGES NOT BEING MILK SUBSTITUTES; WHEY BEVERAGES (U.S. CLS. 45, 46 AND 48).

FIRST USE 3-0-2009; IN COMMERCE 3-0-2009.

3,785,105. PLAID ENTERPRISES, INC., NORCROSS, GA. SN 76-698,535. PUB. 10-27-2009, FILED 7-20-2009.

SIMPLY SCREEN

THE MARK CONSISTS OF STANDARD CHARACTERS WITHOUT CLAIM TO ANY PARTICULAR FONT, STYLE, SIZE, OR COLOR.

OWNER OF U.S. REG. NO. 1,454,188.

NO CLAIM IS MADE TO THE EXCLUSIVE RIGHT TO USE "SCREEN", APART FROM THE MARK AS SHOWN.

CLASS 2—PAINTS

FOR COLORANTS; PRECIOUS METAL FOIL FOR PAINTERS, DECORATORS, PRINTERS AND ARTISTS (U.S. CLS. 6, 11 AND 16).

FIRST USE 9-21-2009; IN COMMERCE 9-21-2009.

CLASS 16—PAPER GOODS AND PRINTED MATTER

FOR PRINTED PATTERNS; BOOKS IN THE FIELD OF DESIGN; STENCILS (U.S. CLS. 2, 5, 22, 23, 29, 37, 38 AND 50).

FIRST USE 9-21-2009; IN COMMERCE 9-21-2009.

3,785,117. CHILDREN'S LEARNING ADVENTURE LICENSING, LLC, PHOENIX, AZ. SN 77-034,499. PUB. 11-27-2007, FILED 11-1-2006.

CHILDREN'S LEARNING ADVENTURE

THE MARK CONSISTS OF STANDARD CHARACTERS WITHOUT CLAIM TO ANY PARTICULAR FONT, STYLE, SIZE, OR COLOR.

NO CLAIM IS MADE TO THE EXCLUSIVE RIGHT TO USE "CHILDREN'S LEARNING", APART FROM THE MARK AS SHOWN.

CLASS 16—PAPER GOODS AND PRINTED MATTER

FOR PRINTED MATERIALS, NAMELY, TEXTBOOKS, MANUALS, ACTIVITY BOOKS AND WORKBOOKS FEATURING EDUCATIONAL CURRICULUM SUBJECTS IN THE AREAS OF SCHOOL READINESS, SOCIAL SKILL DEVELOPMENT, GENERAL ACADEMIC INSTRUCTION, DRAMATIC ARTS, MUSIC, ARTS AND CRAFTS, SPORTS, AND CULTURAL ENRICHMENT FOR USE IN TEACHING AND TRAINING CHILDREN (U.S. CLS. 2, 5, 22, 23, 29, 37, 38 AND 50).

FIRST USE 5-5-2008; IN COMMERCE 5-5-2008.

CLASS 41—EDUCATION AND ENTERTAINMENT

FOR EDUCATION SERVICES FOR CHILDREN, NAMELY, PRE-SCHOOLS; PROVIDING COURSES OF INSTRUCTION AT THE KINDERGARTEN LEVEL; PROVIDING AFTER-SCHOOL EDUCATIONAL PROGRAMS FOR CHILDREN IN GRADES PRE-K THROUGH 8; ENTERTAINMENT SERVICES FOR CHILDREN, NAMELY, PROVIDING AFTER-SCHOOL PROGRAMS COMPRISING ACTIVITIES AND EVENTS IN THE AREAS OF SCHOOL READINESS, SOCIAL SKILL DEVELOPMENT, GENERAL ACADEMIC INSTRUCTION, DRAMATIC ARTS, MUSIC, ARTS AND CRAFTS, SPORTS, AND CULTURAL ENRICHMENT; INSTRUCTION AND TUTORING SERVICES FOR CHILDREN IN THE AREAS OF SCHOOL READINESS, SOCIAL SKILL DEVELOPMENT, AND GENERAL ACADEMIC INSTRUCTION; EDUCATIONAL SERVICES, NAMELY, DEVELOPING CURRICULUM FOR OTHERS IN THE AREAS OF SCHOOL READINESS, SOCIAL SKILL DEVELOPMENT, GENERAL ACADEMIC INSTRUCTION, DRAMATIC ARTS, MUSIC, ARTS AND CRAFTS, SPORTS, AND CULTURAL ENRICHMENT (U.S. CLS. 100, 101 AND 107).

FIRST USE 5-5-2008; IN COMMERCE 5-5-2008.

CLASS 43—HOTEL AND RESTAURANT SERVICES

FOR CHILDCARE SERVICES PROVIDED IN CHILDREN'S EDUCATIONAL CENTERS (U.S. CLS. 100 AND 101).

FIRST USE 5-5-2008; IN COMMERCE 5-5-2008.

3,785,119. ALTANA AG, 46483 WESEL, FED REP GERMANY. SN 77-041,692. PUB. 5-5-2009, FILED 11-10-2006.

ALTANA

THE MARK CONSISTS OF STANDARD CHARACTERS WITHOUT CLAIM TO ANY PARTICULAR FONT, STYLE, SIZE, OR COLOR.

PRIORITY CLAIMED UNDER SEC. 44(D) ON ERPN CMNTY TM OFC APPLICATION NO. 005121934, FILED 5-22-2006, REG. NO. 30058263, DATED 1-16-2001, EXPIRES 8-31-2010.

PRIORITY CLAIMED UNDER SEC. 44(D) ON ERPN CMNTY TM OFC APPLICATION NO. 005121934, FILED 5-22-2006, REG. NO. 30058042, DATED 3-30-2001, EXPIRES 8-31-2010.

OWNER OF U.S. REG. NOS. 2,594,497 AND 2,963,594.

CLASS 1—CHEMICALS

FOR CHEMICAL PRODUCTS FOR INDUSTRIAL AND SCIENTIFIC USE, NAMELY, CHEMICAL ADDITIVES AND ADJUVANTS FOR THE PAINT, LACQUER, AND ADHESIVE INDUSTRY; DIAGNOSTIC PREPARATIONS FOR SCIENTIFIC OR RESEARCH USE; CHEMICAL ADDITIVES FOR USE IN THE MANUFACTURE OF LACQUERS, NAMELY, EMULSIFYING AGENTS, MATERIAL FOR DISPERSION, AND MATERIAL FOR THICKENING; CHEMICALS USED IN THE MANUFACTURE OF PAPER; WETTING AND DISPERSING ADDITIVES FOR PIGMENTS AND FILLERS; CHEMICAL ADDITIVES TO IMPROVE THE SURFACE SLIP, FLOW AND SUBSTRATE WETTING; CHEMICAL ADDITIVES, NAMELY, DEFOAMERS AND AIR RELEASE AGENTS, VISCOSITY DEPRESSANTS AND CHEMICAL RHEOLOGICAL ADDITIVES FOR USE IN THE MANUFACTURE OF PAINTS AND COATINGS (U.S. CLS. 1, 5, 6, 10, 26 AND 46).

FIRST USE 12-31-1997; IN COMMERCE 12-31-1997.

CLASS 2—PAINTS

FOR EXTERIOR PAINTS, INTERIOR PAINTS FOR BUILDINGS, METAL PAINTS, PLASTIC PAINTS, PAINTS FOR USE IN THE AUTOMOTIVE INDUSTRY; VARNISHES, LACQUERS, IN THE NATURE OF COATING, WOOD AND FURNITURE COATINGS, COIL AND CAN COATINGS, NAMELY, CORROSION INHIBITING PAINT, PROTECTIVE AND ANTI-CORROSIVE COATINGS, POWDER COATINGS FOR USE IN THE AUTOMOTIVE, ELECTRICAL AND ELECTRICAL INSULATION INDUSTRY, SEALER COATINGS FOR USE IN THE AUTOMOTIVE, ELECTRICAL AND ELECTRICAL INSULATION INDUSTRY, COLORANTS FOR USE IN THE MANUFACTURE OF PAINTS AND COATINGS, PIGMENT CONCENTRATES FOR INDUSTRIAL USE (U.S. CLS. 6, 11 AND 16).

FIRST USE 12-31-1997; IN COMMERCE 1-1-2010.

CLASS 9—ELECTRICAL AND SCIENTIFIC APPARATUS

FOR MEASURING, TESTING AND CHECKING SUPERVISION APPARATUS AND INSTRUMENTS FOR SCIENTIFIC AND INDUSTRIAL USE, NAMELY, SCALES, BALANCES, THERMOMETERS, MOISTURE ANALYZERS, HYGROMETERS, CALCULATORS, TIMERS, VISCOMETERS, ADHESION TESTERS, STRENGTH TESTERS, MELT FLOW INDEXERS, GAUGES, SPECTROPHOTOMETERS, HARDNESS, FLEXIBILITY AND THICKNESS TESTERS, DISSOLVER INSTRUMENTS, CONTACT ANGLE METERS (U.S. CLS. 21, 23, 26, 36 AND 38).

FIRST USE 12-31-1997; IN COMMERCE 12-31-1997.

CLASS 17—RUBBER GOODS

FOR EXTRUDED PLASTICS IN THE FORM OF BARS, BLOCKS, PELLETS, RODS, SHEETS AND TUBES FOR USE IN MANUFACTURING; PACKING MATERIAL FOR FORMING SEALS; INSULATING PLASTER, LIQUID INSULATION MATERIAL FOR ELECTRICAL DEVICES AND WIRES; NON-METAL SEALS FOR CLOSURES, GLASS AND ALUMINUM CONTAINERS, CANS, LID FOILS OF FOOD AND PLASTIC PACKAGES, PHARMACEUTICAL BLISTERS AND CAPS, METAL TRAYS, ALUMINUM SCREW CAPS, INSULATION PANELS AND HEAT EXCHANGER FINS, TECHNICAL AND HEAVY PACKAGES (U.S. CLS. 1, 5, 12, 13, 35 AND 50).

FIRST USE 12-31-1997; IN COMMERCE 12-31-1997.

3,785,124. CONSOLIDATED PROPERTY HOLDINGS, INC., LAS VEGAS, NV. SN 77-064,410. PUB. 6-10-2008, FILED 12-14-2006.

WILSON + FISHER

THE MARK CONSISTS OF STANDARD CHARACTERS WITHOUT CLAIM TO ANY PARTICULAR FONT, STYLE, SIZE, OR COLOR.

CLASS 11—ENVIRONMENTAL CONTROL APPARATUS

FOR SOLAR LANDSCAPE LIGHTING INSTALLATIONS (U.S. CLS. 13, 21, 23, 31 AND 34).

FIRST USE 12-13-2007; IN COMMERCE 12-13-2007.

CLASS 20—FURNITURE AND ARTICLES NOT OTHERWISE CLASSIFIED

FOR LAWN GARDEN AND PATIO ACCESSORIES, NAMELY, PLANT STANDS, LAWN CHAIRS AND TABLES, AND SETS OF PATIO FURNITURE (U.S. CLS. 2, 13, 22, 25, 32 AND 50).

FIRST USE 1-25-2007; IN COMMERCE 1-25-2007.

3,785,126. ISHRED, LLC, BOSTON, MA. SN 77-072,844. PUB. 3-11-2008, FILED 12-28-2006.



NO CLAIM IS MADE TO THE EXCLUSIVE RIGHT TO USE "PINK CRATES", APART FROM THE MARK AS SHOWN.

THE COLOR(S) BLACK, PINK, WHITE AND GRAY IS/ARE CLAIMED AS A FEATURE OF THE MARK.

THE MARK CONSISTS OF THE WORDS "PINK CRATES" IN STYLIZED FONT. THE COLOR BLACK APPEARS IN THE WORDING "PINK CRATES"; THE COLOR PINK APPEARS IN THE DESIGN OF THE RIBBON; THE COLOR WHITE APPEARS IN THE DESIGN OF THE HIGHLIGHT ON THE RIBBON; THE COLOR GRAY APPEARS IN THE DESIGN OF THE SHADOW SURROUNDING THE RIBBON.

CLASS 20—FURNITURE AND ARTICLES NOT OTHERWISE CLASSIFIED

FOR PLASTIC CRATES, WOOD CRATES (U.S. CLS. 2, 13, 22, 25, 32 AND 50).

FIRST USE 12-15-2006; IN COMMERCE 2-1-2007.

CLASS 39—TRANSPORTATION AND STORAGE

FOR RENTAL OF MOVING AND STORAGE EQUIPMENT, NAMELY, CRATES, DOLLIES, CARRIERS, HAND TRUCKS, TRUCKS, VANS, AUTOMOBILES, AUTOMOBILE FREIGHT TRAILERS, HITCHES, PADS, TOW BARS, VEHICLES, MOVING VANS, MOVING BOXES, STORAGE ROOMS, STORAGE CONTAINERS, AND SHIPPING CONTAINERS; GENERAL STORAGE SERVICES; RENTAL OF WAREHOUSE SPACE AND STORAGE SPACE; CARGO HANDLING, MOVING VAN SERVICES, MOVING VAN TRANSPORT, DELIVERY OF GOODS BY TRUCK, CAR OR VAN (U.S. CLS. 100 AND 105).

FIRST USE 12-15-2006; IN COMMERCE 2-1-2007.

3,785,127. INTERNATIONAL BUSINESS MACHINES CORPORATION, ARMONK, NY. SN 77-074,829. PUB. 6-24-2008, FILED 1-3-2007.



THE MARK CONSISTS OF A STYLIZED "W" FOLLOWED BY A VERTICAL LINE FOLLOWED BY THE WORDS "ACCESSIBILITYWORKS".

CLASS 9—ELECTRICAL AND SCIENTIFIC APPARATUS

FOR COMPUTER SOFTWARE FOR USE IN MANIPULATING AND TRANSFORMING WEB CONTENT, CREATING CUSTOM INTERFACES AND PERSONAL PREFERENCE ACCOMMODATIONS; COMPUTER SOFTWARE FOR USE IN ENLARGING TEXT AND REDUCING VISUAL CLUTTER OF WEB PAGES, READING WEB PAGE TEXT ALOUD, AND ENHANCING EASE OF USE OF THE WEB BROWSER, MOUSE AND KEYBOARD; COMPUTER SOFTWARE FOR ASSISTING VISUAL, HEARING OR MOTOR IMPAIRED USERS WITH ACCESS AND USE OF WEB CONTENT AND COMPUTERS; AND INSTRUCTION MANUALS SOLD AS A UNIT THEREWITH (U.S. CLS. 21, 23, 26, 36 AND 38).

FIRST USE 9-0-2003; IN COMMERCE 9-0-2003.

CLASS 41—EDUCATION AND ENTERTAINMENT

FOR PROVIDING ONLINE TUTORIALS AND EDUCATIONAL DEMONSTRATIONS IN THE FIELD OF COMPUTER SOFTWARE FOR USE IN MANIPULATING AND TRANSFORMING WEB CONTENT, CREATING CUSTOM INTERFACES AND PERSONAL PREFERENCE ACCOMMODATIONS, ENLARGING TEXT AND REDUCING VISUAL CLUTTER OF WEB PAGES, READING WEB PAGE TEXT ALOUD, ENHANCING EASE OF USE OF THE WEB BROWSER, MOUSE AND KEYBOARD, AND ASSISTING VISUAL, HEARING OR MOTOR IMPAIRED USERS WITH ACCESS AND USE OF WEB CONTENT AND COMPUTERS (U.S. CLS. 100, 101 AND 107).

FIRST USE 9-0-2003; IN COMMERCE 9-0-2003.

CLASS 42—SCIENTIFIC AND COMPUTER SERVICES

FOR PHILANTHROPIC AND CHARITABLE SERVICES, NAMELY, PROVIDING FREE AND DISCOUNTED COMPUTERS, COMPUTER SOFTWARE AND COMPUTER CONSULTATION SERVICES TO SCHOOLS AND NOT-FOR-PROFIT ORGANIZATIONS; COMPUTER CONSULTATION AND COMPUTER SYSTEMS DESIGN SERVICES FOR OTHERS; TECHNICAL SUPPORT SERVICES, NAMELY, TROUBLESHOOTING OF COMPUTER HARDWARE AND COMPUTER SOFTWARE PROBLEMS; INSTALLATION, UPDATING AND MAINTENANCE OF COMPUTER SOFTWARE; ONLINE HELP FEATURES IN THE FIELD OF COMPUTER SOFTWARE (U.S. CLS. 100 AND 101).

FIRST USE 9-0-2003; IN COMMERCE 9-0-2003.

3,785,128. TINUBU, GLORIA BROMELL, ATLANTA, GA. SN 77-076,283. PUB. 7-31-2007, FILED 1-4-2007.



THE MARK CONSISTS OF STANDARD CHARACTERS WITHOUT CLAIM TO ANY PARTICULAR FONT, STYLE, SIZE, OR COLOR.

CLASS 35—ADVERTISING AND BUSINESS

FOR BUYING CLUBS (U.S. CLS. 100, 101 AND 102). FIRST USE 6-1-2009; IN COMMERCE 11-8-2009.

CLASS 36—INSURANCE AND FINANCIAL

FOR EQUITY CAPITAL INVESTMENT; VENTURE CAPITAL FUNDING SERVICES TO EMERGING AND START-UP COMPANIES; VENTURE CAPITAL SERVICES, NAMELY, PROVIDING FINANCING TO EMERGING AND START-UP COMPANIES (U.S. CLS. 100, 101 AND 102).

FIRST USE 6-1-2009; IN COMMERCE 11-8-2009.

3,785,131. DELTA MEDICAL SYSTEMS, INC., ALPHARETTA, GA. AND DELTA MEDICAL SUPPLY GROUP, INC., WEST CHESTER, PA. SN 77-084,678. PUB. 11-25-2008, FILED 1-17-2007.

BLACK VIPER

THE MARK CONSISTS OF STANDARD CHARACTERS WITHOUT CLAIM TO ANY PARTICULAR FONT, STYLE, SIZE, OR COLOR.

CLASS 9—ELECTRICAL AND SCIENTIFIC APPARATUS

FOR DISPOSABLE GLOVES FOR LABORATORY USE AND PROTECTIVE GLOVES FOR INDUSTRIAL USE (U.S. CLS. 21, 23, 26, 36 AND 38).

FIRST USE 4-0-2008; IN COMMERCE 4-0-2008.

CLASS 10—MEDICAL APPARATUS

FOR GLOVES FOR MEDICAL USE (U.S. CLS. 26, 39 AND 44).

FIRST USE 4-0-2008; IN COMMERCE 4-0-2008.

3,785,132. THE DURHAM BULLS BASEBALL CLUB, INC., DURHAM, NC. SN 77-096,023. PUB. 8-7-2007, FILED 1-31-2007.

**CLASS 25—CLOTHING**

FOR CLOTHING, NAMELY, T-SHIRTS (U.S. CLS. 22 AND 39).

FIRST USE 2-14-2007; IN COMMERCE 2-14-2007.

CLASS 28—TOYS AND SPORTING GOODS

FOR TOYS AND SPORTING GOODS, NAMELY, BASEBALLS AND INFLATABLE TOY BASEBALL BATS (U.S. CLS. 22, 23, 38 AND 50).

FIRST USE 2-14-2007; IN COMMERCE 2-14-2007.

3,785,136. OHAYON, EDO, RAANANA, ISRAEL. SN 77-106,974. PUB. 7-1-2008, FILED 2-14-2007.

bidyourcase

THE MARK CONSISTS OF STANDARD CHARACTERS WITHOUT CLAIM TO ANY PARTICULAR FONT, STYLE, SIZE, OR COLOR.

CLASS 42—SCIENTIFIC AND COMPUTER SERVICES

FOR WEBSITE DEVELOPMENT FOR OTHERS; COMPUTER PROGRAMMING FOR OTHERS; PROVIDING TEMPORARY USE OF NON-DOWNLOADABLE COMPUTER SOFTWARE THAT ALLOWS POTENTIAL CLIENTS TO COMMUNICATE WITH LAWYERS (U.S. CLS. 100 AND 101).

FIRST USE 1-1-2010; IN COMMERCE 1-1-2010.

CLASS 45—PERSONAL AND LEGAL SERVICES

FOR LEGAL SERVICES; PROVIDING ONLINE INFORMATION RELATING TO LEGAL SERVICES (U.S. CLS. 100 AND 101).

FIRST USE 1-1-2010; IN COMMERCE 1-1-2010.

3,785,138. EDGECAST NETWORKS, INC., SANTA MONICA, CA. SN 77-126,752. PUB. 8-4-2009, FILED 3-9-2007.

EDGECAST

THE MARK CONSISTS OF STANDARD CHARACTERS WITHOUT CLAIM TO ANY PARTICULAR FONT, STYLE, SIZE, OR COLOR.

CLASS 38—COMMUNICATION

FOR DATA AND ELECTRONIC MEDIA TRANSMISSION SERVICES VIA ON-LINE GLOBAL AND LOCAL COMPUTER NETWORKS OF THIRD PARTY CONTENT, NAMELY, ELECTRONIC TRANSMISSION OF VIDEO, MUSIC, GAMES, PHOTOS, HTML SOURCE, DYNAMIC WEB CONTENT AND DIGITAL MEDIA FROM A CONTENT DELIVERY NETWORK (U.S. CLS. 100, 101 AND 104).

FIRST USE 8-15-2007; IN COMMERCE 8-15-2007.

CLASS 39—TRANSPORTATION AND STORAGE

FOR ELECTRONIC STORAGE OF THIRD PARTY FILE AND DOCUMENT DATA ACROSS A COMPUTER NETWORK (U.S. CLS. 100 AND 105).

FIRST USE 8-15-2007; IN COMMERCE 8-15-2007.

CLASS 42—SCIENTIFIC AND COMPUTER SERVICES

FOR HOSTING AND INTEGRATING THIRD PARTY WEB CONTENT AND SOFTWARE APPLICATIONS FOR DELIVERY FROM A CONTENT DELIVERY NETWORK; REPLICATION OF THIRD PARTY DATA ACROSS A COMPUTER NETWORK, NAMELY, DATA CONVERSION OF COMPUTER NETWORK DATA OR INFORMATION; COMPUTER NETWORK MANAGEMENT, NAMELY, GLOBAL TRAFFIC MANAGEMENT; WEB SITE TRAFFIC MONITORING, ANALYSIS AND REPORTING; DIGITAL RIGHTS MANAGEMENT SERVICES TO PROTECT DATA AND ELECTRONIC MEDIA; DESIGNING COMPUTER NETWORKS AND SOFTWARE FOR OTHERS (U.S. CLS. 100 AND 101).

FIRST USE 8-15-2007; IN COMMERCE 8-15-2007.

3,785,149. VERGE RECORDS INTERNATIONAL LLC, BROOKLYN, NY. SN 77-154,228. PUB. 12-30-2008, FILED 4-11-2007.

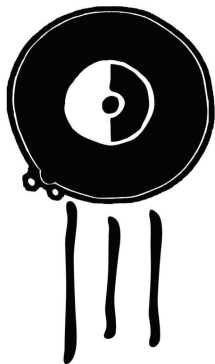

THE MARK CONSISTS OF THE FANCIFUL DESIGN OF A VINYL MUSICAL RECORD WITH THREE VERTICAL LINES UNDERNEATH.

CLASS 35—ADVERTISING AND BUSINESS

FOR MARKETING AND PROMOTION OF MUSICAL SOUND AND VIDEO RECORDINGS AND ARTISTS; DISTRIBUTORSHIPS IN THE FIELD OF MUSICAL SOUND AND VIDEO RECORDINGS (U.S. CLS. 100, 101 AND 102).

FIRST USE 1-23-2007; IN COMMERCE 7-1-2007.

CLASS 41—EDUCATION AND ENTERTAINMENT

FOR PRODUCTION OF MUSICAL SOUND AND VIDEO RECORDINGS (U.S. CLS. 100, 101 AND 107).

FIRST USE 1-23-2007; IN COMMERCE 7-1-2007.

3,785,152. ADVANCED SEMICONDUCTOR ENGINEERING, INC., KAOSHIUNG, TAIWAN. SN 77-158,650. PUB. 5-13-2008, FILED 4-17-2007.

aQFN

THE MARK CONSISTS OF STANDARD CHARACTERS WITHOUT CLAIM TO ANY PARTICULAR FONT, STYLE, SIZE, OR COLOR.

CLASS 9—ELECTRICAL AND SCIENTIFIC APPARATUS

FOR SEMICONDUCTOR DEVICE, PRODUCT FEATURING SEMICONDUCTOR PACKAGE, NAMELY, COMPUTER HARDWARE IN THE NATURE OF WIRELESS ACCESS POINT DEVICES; WAFER LEVEL PACKAGE COMPRISING SILICON WAFERS, STRUCTURED SEMICONDUCTOR WAFERS (U.S. CLS. 21, 23, 26, 36 AND 38).

FIRST USE 6-0-2007; IN COMMERCE 6-0-2007.

CLASS 40—MATERIAL TREATMENT

FOR WAFER LEVEL AND SINGLE-WAFER TECHNOLOGY PROCESSING, NAMELY, TREATMENT OF SEMICONDUCTOR WAFERS; SEMICONDUCTOR PROCESSING, NAMELY, TREATMENT OF SEMICONDUCTOR DEVICES (U.S. CLS. 100, 103 AND 106).

FIRST USE 6-0-2007; IN COMMERCE 6-0-2007.

CLASS 42—SCIENTIFIC AND COMPUTER SERVICES

FOR DESIGN FOR OTHERS OF SEMICONDUCTOR PACKAGES, CONSULTING SERVICES IN THE FIELD OF SEMICONDUCTOR ELECTRO-MECHANICAL ENGINEERING (U.S. CLS. 100 AND 101).

FIRST USE 6-0-2007; IN COMMERCE 6-0-2007.

3,785,154. BUTLER PRODUCTS CORPORATION, FLORENCE, KY. SN 77-165,625. PUB. 4-14-2009, FILED 4-25-2007.

BUTLER PRODUCTS

THE MARK CONSISTS OF STANDARD CHARACTERS WITHOUT CLAIM TO ANY PARTICULAR FONT, STYLE, SIZE, OR COLOR.

NO CLAIM IS MADE TO THE EXCLUSIVE RIGHT TO USE "PRODUCTS", APART FROM THE MARK AS SHOWN.

CLASS 7—MACHINERY

FOR HYDRAULIC, PNEUMATIC, AND POWER OPERATED JACKS FOR VARIOUS SIZED TRAILERS; TRAILER-MOUNTED HYDRAULIC, PNEUMATIC, AND POWER OPERATED JACKS; STRUCTURAL REPLACEMENT PARTS AND STRUCTURAL REPLACEMENT FITTINGS FOR HYDRAULIC, PNEUMATIC, AND POWER OPERATED TRAILER JACKS (U.S. CLS. 13, 19, 21, 23, 31, 34 AND 35).

FIRST USE 9-1-2006; IN COMMERCE 9-1-2006.

CLASS 8—HAND TOOLS

FOR MANUAL OPERATED JACKS FOR VARIOUS SIZED TRAILERS, MANUAL OPERATED JACKS, AND STRUCTURAL REPLACEMENT PARTS AND STRUCTURAL REPLACEMENT FITTINGS FOR MANUAL OPERATED TRAILER JACKS (U.S. CLS. 23, 28 AND 44).
FIRST USE 9-1-2006; IN COMMERCE 9-1-2006.

CLASS 12—VEHICLES

FOR TRAILER PARTS, NAMELY, COUPLERS FOR VARIOUS SIZED TRAILERS; TRAILER PARTS, NAMELY, HITCHES AND COUPLERS AND THE STRUCTURAL PARTS AND STRUCTURAL FITTINGS THEREOF; LAND VEHICLE PARTS, NAMELY, TRAILER COUPLERS, GOOSENECK COUPLERS, TRAILER STABILIZERS, AND COUPLER INSERTS FOR TRUCK TRAILERS; TRAILER STANDS (U.S. CLS. 19, 21, 23, 31, 35 AND 44).
FIRST USE 9-1-2006; IN COMMERCE 9-1-2006.

CLASS 9—ELECTRICAL AND SCIENTIFIC APPARATUS

FOR LIGHT EMITTING DIODES (LED), LIGHT EMITTING DIODE (LED) DISPLAYS (U.S. CLS. 21, 23, 26, 36 AND 38).
FIRST USE 11-9-2009; IN COMMERCE 11-9-2009.

CLASS 11—ENVIRONMENTAL CONTROL APPARATUS

FOR LIGHT EMITTING DIODE (LED) LIGHTING PRODUCTS, NAMELY, LED LIGHT BULBS, LED LIGHT SOURCES, NAMELY, LAMPS, LED LUMINARIES, AND LED LIGHT FIXTURES (U.S. CLS. 13, 21, 23, 31 AND 34).
FIRST USE 11-9-2009; IN COMMERCE 11-9-2009.

3,785,161. KEENAN, MAYNARD JAMES, DBA PUSCIFER, LOS ANGELES, CA. SN 77-189,929. PUB. 12-11-2007, FILED 5-24-2007.

3,785,163. FOXSEMICON INTEGRATED TECHNOLOGY INC., MIAO-LI HSIEN, TAIWAN. SN 77-191,676. PUB. 5-19-2009, FILED 5-29-2007.

PUSCIFER

THE MARK CONSISTS OF STANDARD CHARACTERS WITHOUT CLAIM TO ANY PARTICULAR FONT, STYLE, SIZE, OR COLOR.

CLASS 10—MEDICAL APPARATUS

FOR CONDOMS; CARRYING CASES FOR CONDOMS (U.S. CLS. 26, 39 AND 44).
FIRST USE 1-1-2009; IN COMMERCE 1-1-2009.

CLASS 16—PAPER GOODS AND PRINTED MATTER

FOR PENS (U.S. CLS. 2, 5, 22, 23, 29, 37, 38 AND 50).
FIRST USE 12-1-2008; IN COMMERCE 12-1-2008.

CLASS 18—LEATHER GOODS

FOR PURSES, POUCHES, CHANGE PURSES, LEATHER KEY CHAINS (U.S. CLS. 1, 2, 3, 22 AND 41).
FIRST USE 6-1-2009; IN COMMERCE 6-1-2009.

CLASS 30—STAPLE FOODS

FOR COFFEE (U.S. CL. 46).
FIRST USE 6-1-2009; IN COMMERCE 6-1-2009.

**CLASS 9—ELECTRICAL AND SCIENTIFIC APPARATUS**

FOR LIGHT EMITTING DIODES (LED), LIGHT EMITTING DIODE (LED) DISPLAYS (U.S. CLS. 21, 23, 26, 36 AND 38).
FIRST USE 11-9-2009; IN COMMERCE 11-9-2009.

CLASS 11—ENVIRONMENTAL CONTROL APPARATUS

FOR LIGHT EMITTING DIODE (LED) LIGHTING PRODUCTS, NAMELY, LED LIGHT BULBS, LED LIGHT SOURCES, NAMELY, LAMPS, LED LUMINARIES, AND LED LIGHT FIXTURES (U.S. CLS. 13, 21, 23, 31 AND 34).
FIRST USE 11-9-2009; IN COMMERCE 11-9-2009.

3,785,162. FOXSEMICON INTEGRATED TECHNOLOGY INC., MIAO-LI HSIEN, TAIWAN. SN 77-191,672. PUB. 5-26-2009, FILED 5-29-2007.

FOXSEMICON

OWNER OF U.S. REG. NO. 3,042,151.

3,785,164. RODGVELLER, CATHI, BRIER, WA. SN 77-192,433. PUB. 6-9-2009, FILED 5-29-2007.

3,785,165. SECOND LICENSE APPLICATION CORPORATION, D/FW AIRPORT, TX. SN 77-197,811. PUB. 11-27-2007, FILED 6-5-2007.



THE MARK CONSISTS OF FLAMES WITH WORD "IGNITE".

CLASS 9—ELECTRICAL AND SCIENTIFIC APPARATUS

FOR PRE-RECORDED AUDIO VISUAL INSTRUCTIONAL, EDUCATIONAL, AND TEACHING MATERIALS, NAMELY, PRERECORDED MOTION PICTURE FILM STRIPS, VIDEO TAPES, DVDS, CD ROMS (COMPACT DISC READ ONLY MEMORY), AND AUDIO CASSETTES IN THE FIELD OF INSPIRING GIRLS IN TECHNOLOGY EDUCATION (U.S. CLS. 21, 23, 26, 36 AND 38).

FIRST USE 1-31-2007; IN COMMERCE 1-31-2007.

CLASS 16—PAPER GOODS AND PRINTED MATTER

FOR PRINTED INSTRUCTIONAL, EDUCATIONAL, AND TEACHING MATERIALS IN THE FIELD OF INSPIRING GIRLS IN TECHNOLOGY EDUCATION (U.S. CLS. 2, 5, 22, 23, 29, 37, 38 AND 50).

FIRST USE 1-31-2007; IN COMMERCE 1-31-2007.

CLASS 35—ADVERTISING AND BUSINESS

FOR PROVIDING INTERACTIVE COMPUTER DATABASE FEATURING INFORMATION ON EMPLOYMENT IN THE FIELD OF TECHNOLOGY; CONSULTING AND STAR-UP SUPPORT SERVICES REGARDING SETTING UP AND MAINTAINING LOCAL CHAPTERS OF EDUCATIONAL ORGANIZATION (U.S. CLS. 100, 101 AND 102).

FIRST USE 3-31-2002; IN COMMERCE 3-31-2002.

CLASS 38—COMMUNICATION

FOR PROVIDING ON-LINE FORUMS FOR TRANSMISSION OF MESSAGES AMONG COMPUTER USERS CONCERNING INSPIRING GIRLS IN TECHNOLOGY EDUCATION; PROVIDING ON-LINE LIST SERVERS FOR TRANSMISSION OF MESSAGES AMONG COMPUTER USERS CONCERNING INSPIRING GIRLS IN TECHNOLOGY EDUCATION; PROVIDING ELECTRONIC MAIL SERVICES (U.S. CLS. 100, 101 AND 104).

FIRST USE 2-28-2006; IN COMMERCE 2-28-2006.

CLASS 41—EDUCATION AND ENTERTAINMENT

FOR PROVIDING A WEB SITE WHERE USERS CAN POST RATINGS, REVIEWS AND RECOMMENDATIONS ON EVENTS AND ACTIVITIES IN THE FIELD OF INSPIRING GIRLS IN TECHNOLOGY EDUCATION; PROVIDING INFORMATION ON EDUCATION AND MENTORING IN THE FIELD OF TECHNOLOGY (U.S. CLS. 100, 101 AND 107).

FIRST USE 1-29-2003; IN COMMERCE 1-29-2003.



NO CLAIM IS MADE TO THE EXCLUSIVE RIGHT TO USE "MEDIA", APART FROM THE MARK AS SHOWN.

THE COLOR(S) BLUE, GRAY AND GREEN IS/ARE CLAIMED AS A FEATURE OF THE MARK.

THE MARK CONSISTS OF THE WORD "IDEARC", WHICH APPEARS IN GRAY, AND THE WORD "MEDIA", WHICH APPEARS IN THE COLOR GREEN, NEXT TO THREE CONCENTRIC ARCS WHICH APPEAR IN THE COLORS BLUE, GRAY AND GREEN.

CLASS 9—ELECTRICAL AND SCIENTIFIC APPARATUS

FOR ELECTRONIC PUBLICATIONS, NAMELY, TELEPHONE DIRECTORIES, BUSINESS TELEPHONE LISTINGS, RESIDENTIAL TELEPHONE LISTINGS, BUSINESS DIRECTORIES, AND CITY DIRECTORIES, RECORDED ON ELECTRONIC RECORDING MEDIA, NAMELY, CD-ROM (U.S. CLS. 21, 23, 26, 36 AND 38).

FIRST USE 11-0-2006; IN COMMERCE 11-0-2006.

CLASS 16—PAPER GOODS AND PRINTED MATTER

FOR PRINTED TELEPHONE DIRECTORIES, BUSINESS DIRECTORIES AND CITY DIRECTORIES (U.S. CLS. 2, 5, 22, 23, 29, 37, 38 AND 50).

FIRST USE 11-0-2006; IN COMMERCE 11-0-2006.

CLASS 35—ADVERTISING AND BUSINESS

FOR ADVERTISING AND PROMOTION SERVICES; PROMOTING THE GOODS AND SERVICES OF OTHERS VIA THE PREPARATION AND PLACEMENT OF ADVERTISING AND BUSINESS LISTINGS IN PRINT PUBLICATIONS AND ON THE INTERNET; PROVIDING BUSINESS AND RESIDENTIAL TELEPHONE DIRECTORY INFORMATION SERVICES INCLUDING INFORMATION REGARDING TELEPHONE AREA CODES, ZIP CODES AND REVERSE TELEPHONE NUMBER LOOKUPS VIA AN INTERACTIVE WEBSITE AND TO MOBILE COMMUNICATIONS DEVICES; PROVIDING DIRECTORY INFORMATION SERVICES FEATURING INFORMATION REGARDING COMMUNITY RESOURCES, WEATHER, TRAVEL, LOCAL ATTRACTIONS, MAPS, DRIVING DIRECTIONS, AND PRODUCT RATINGS OF CONSUMER GOODS AND SERVICES OF OTHERS VIA AN INTERACTIVE WEB SITE AND TO MOBILE COMMUNICATIONS DEVICES; PROVIDING A WEB SITE WHICH FEATURES ADVERTISEMENTS FOR THE GOODS AND SERVICES OF OTHERS AND RELATED HYPERTEXT LINKS TO THE ADVERTISERS' WEB SITES (U.S. CLS. 100, 101 AND 102).

FIRST USE 11-0-2006; IN COMMERCE 11-0-2006.

CLASS 41—EDUCATION AND ENTERTAINMENT

FOR PUBLISHING DIRECTORIES AND GUIDES, NAMELY, TELEPHONE DIRECTORIES, BUSINESS DIRECTORIES, BUSINESS TELEPHONE LISTINGS, RESIDENTIAL TELEPHONE LISTINGS AND CITY DIRECTORIES; PROVIDING AN INTERACTIVE WEBSITE FEATURING INFORMATION IN THE FIELD OF ENTERTAINMENT INCLUDING MOVIE LISTINGS, MOVIE THEATER LOCATIONS AND MOVIE SHOWING TIMES (U.S. CLS. 100, 101 AND 107).
FIRST USE 11-0-2006; IN COMMERCE 11-0-2006.

3,785,178. LIFECARE, INC., SHELTON, CT. SN 77-209,242.
PUB. 9-30-2008, FILED S.R. 6-19-2007; AM. P.R. 2-11-2008.

LIFECARE FIT KIT

THE MARK CONSISTS OF STANDARD CHARACTERS WITHOUT CLAIM TO ANY PARTICULAR FONT, STYLE, SIZE, OR COLOR.

OWNER OF U.S. REG. NOS. 2,516,436, 2,584,355, AND OTHERS.

NO CLAIM IS MADE TO THE EXCLUSIVE RIGHT TO USE "KIT", APART FROM THE MARK AS SHOWN.
SEC. 2(F) AS TO "LIFECARE".

CLASS 16—PAPER GOODS AND PRINTED MATTER

FOR PRINTED MATERIALS, NAMELY, BROCHURES, BOOKLETS, AND INSTRUCTIONAL MATERIALS IN THE FIELDS OF HEALTH, WELLNESS, EXERCISE, AND NUTRITION (U.S. CLS. 2, 5, 22, 23, 29, 37, 38 AND 50).

FIRST USE 12-4-2009; IN COMMERCE 12-4-2009.

CLASS 28—TOYS AND SPORTING GOODS

FOR PERSONAL FITNESS KITS COMPRISED OF EXERCISE EQUIPMENT, NAMELY, Pedometers, WATER BOTTLES, AND EXERCISE BANDS, PACKAGED WITH ACCOMPANYING BROCHURES, BOOKLETS, AND INSTRUCTIONAL MATERIALS IN THE FIELDS OF FITNESS, HEALTH AND WELLNESS, AND NUTRITION (U.S. CLS. 22, 23, 38 AND 50).

FIRST USE 12-4-2009; IN COMMERCE 12-4-2009.

3,785,179. SOUTHWEST PROGRESSIVE ENTERPRISES, INC., DALLAS, TX. SN 77-210,115. PUB. 1-20-2009, FILED 6-19-2007.

MAGNA STONE

THE MARK CONSISTS OF STANDARD CHARACTERS WITHOUT CLAIM TO ANY PARTICULAR FONT, STYLE, SIZE, OR COLOR.

NO CLAIM IS MADE TO THE EXCLUSIVE RIGHT TO USE "STONE", APART FROM THE MARK AS SHOWN.

CLASS 19—NON-METALLIC BUILDING MATERIALS

FOR DECORATIVE WALL FINISHES, NAMELY, PLASTER (U.S. CLS. 1, 12, 33 AND 50).
FIRST USE 8-15-2007; IN COMMERCE 8-15-2007.

CLASS 37—CONSTRUCTION AND REPAIR

FOR INSTALLATION AND APPLICATION OF DECORATIVE WALL FINISHES, NAMELY, PLASTER (U.S. CLS. 100, 103 AND 106).
FIRST USE 8-15-2007; IN COMMERCE 8-15-2007.

CLASS 42—SCIENTIFIC AND COMPUTER SERVICES

FOR DESIGN OF DECORATIVE WALL FINISHES, NAMELY, PLASTER (U.S. CLS. 100 AND 101).
FIRST USE 8-15-2007; IN COMMERCE 8-15-2007.

3,785,192. INDEPENDENT SALT ALLIANCE, COLUMBUS, OH. SN 77-238,455. PUB. 5-20-2008, FILED 7-25-2007.

ISA

THE MARK CONSISTS OF STANDARD CHARACTERS WITHOUT CLAIM TO ANY PARTICULAR FONT, STYLE, SIZE, OR COLOR.

CLASS 35—ADVERTISING AND BUSINESS

FOR PROMOTING THE GOODS AND SERVICES OF ITS MEMBERS AND OTHERS BY PROVIDING HYPERTEXT LINKS TO THE WEB SITES OF MEMBERS AND OTHERS, AS WELL AS BUSINESS CONTACT INFORMATION AND BIOS OF MEMBERS; PROVIDING BUSINESS INFORMATION ABOUT THE MEMBERS; MARKETING SERVICES, NAMELY, PROVIDING INFORMATIONAL WEB PAGES DESIGNED TO GENERATE SALES TRAFFIC VIA HYPERLINKS TO OTHER WEB SITES (U.S. CLS. 100, 101 AND 102).
FIRST USE 6-30-2006; IN COMMERCE 6-30-2006.

CLASS 36—INSURANCE AND FINANCIAL

FOR PROVIDING TAX INFORMATION, NAMELY, IN THE FIELD OF TAX ISSUES AND DEVELOPMENTS (U.S. CLS. 100, 101 AND 102).
FIRST USE 6-30-2006; IN COMMERCE 6-30-2006.

CLASS 38—COMMUNICATION

FOR WEB CASTING SERVICES; WEB CONFERENCING SERVICES (U.S. CLS. 100, 101 AND 104).
FIRST USE 6-30-2006; IN COMMERCE 6-30-2006.

CLASS 41—EDUCATION AND ENTERTAINMENT

FOR EDUCATION SERVICES, NAMELY, CONDUCTING WORKSHOPS, SEMINARS, AND CLASSES, LIVE, ONLINE, AND VIA TELEPHONE CONFERENCE CALLS, IN THE FIELD OF TAX ISSUES, TAX DEVELOPMENTS AND SMALL BUSINESS PRACTICE ISSUES; EDUCATION SERVICES, NAMELY, PROVIDING SEMINARS AND WORKSHOPS, LIVE, ONLINE, AND VIA TELEPHONE CONFERENCE CALLS, IN THE FIELD OF TAX ISSUES AND DEVELOPMENTS; EDUCATION SERVICES, NAMELY, SPONSORING WORKSHOPS AND SEMINARS IN THE FIELD OF TAX ISSUES AND DEVELOPMENTS (U.S. CLS. 100, 101 AND 107).
FIRST USE 6-30-2006; IN COMMERCE 6-30-2006.

3,785,193. MCBW RENTALS, LLP, WATERTOWN, WI. SN 77-238,754. PUB. 12-11-2007, FILED 7-25-2007.

NORTHERN TRAILS

THE MARK CONSISTS OF STANDARD CHARACTERS WITHOUT CLAIM TO ANY PARTICULAR FONT, STYLE, SIZE, OR COLOR.

CLASS 29—MEATS AND PROCESSED FOODS

FOR MEAT (U.S. CL. 46).
FIRST USE 3-1-2010; IN COMMERCE 3-1-2010.

CLASS 35—ADVERTISING AND BUSINESS

FOR RETAIL STORE SERVICES FEATURING FOOD PRODUCTS (U.S. CLS. 100, 101 AND 102).
FIRST USE 1-1-2010; IN COMMERCE 1-1-2010.

3,785,208. TRX, INC., ATLANTA, GA. SN 77-259,408. PUB. 7-14-2009, FILED 8-20-2007.

TRAVELTRAX

THE MARK CONSISTS OF STANDARD CHARACTERS WITHOUT CLAIM TO ANY PARTICULAR FONT, STYLE, SIZE, OR COLOR.

CLASS 9—ELECTRICAL AND SCIENTIFIC APPARATUS

FOR COMPUTER SOFTWARE FOR USE IN EXPENSE MANAGEMENT AND REPORTING; DOWNLOADABLE SOFTWARE FOR DATA ANALYSIS AND REPORTING FOR CORPORATE TRAVEL; DOWNLOADABLE SOFTWARE FOR DATA CONSOLIDATION AND DATA CONFIGURATION; DOWNLOADABLE SOFTWARE FOR USE IN DATABASE MANAGEMENT IN THE FIELD OF TRAVEL MANAGEMENT, AND FOR DATA QUALITY CONTROL AND TRAVEL PLANNING IN THE FIELD OF TRAVEL MANAGEMENT (U.S. CLS. 21, 23, 26, 36 AND 38).
FIRST USE 6-18-2007; IN COMMERCE 6-18-2007.

CLASS 35—ADVERTISING AND BUSINESS

FOR TRAVEL DATA MANAGEMENT SERVICES, NAMELY, ELECTRONIC DATA COLLECTION, ONLINE ANALYSIS AND PRODUCTION OF REPORTS OF CORPORATE TRAVEL DATA; OUTSOURCING SERVICES FOR OTHERS IN THE FIELDS OF TRAVEL MANAGEMENT, PROVIDING CUSTOMER SERVICE SUPPORT AND DATA MANAGEMENT AND REPORTING; DATA CONFIGURATION FOR COLLECTED ELECTRONIC DATA FOR USE IN ONLINE ANALYSIS AND REPORT PRODUCTION FOR CORPORATE TRAVEL DATA (U.S. CLS. 100, 101 AND 102).

FIRST USE 4-3-2007; IN COMMERCE 4-3-2007.

CLASS 42—SCIENTIFIC AND COMPUTER SERVICES

FOR APPLICATION SERVICE PROVIDER FEATURING SOFTWARE FOR PROVIDING AN ON-LINE DATABASE IN THE FIELD OF CORPORATE TRAVEL TO UPLOAD CORPORATE TRAVEL DATA, PROVIDE STATISTICAL ANALYSIS, FILTER DATA AND PRODUCE REPORTS; PROVIDING TEMPORARY USE OF NON-DOWNLOADABLE SOFTWARE FOR DATA ANALYSIS AND REPORTING FOR CORPORATE TRAVEL; PROVIDING TEMPORARY USE OF NON-DOWNLOADABLE SOFTWARE FOR DATA CONSOLIDATION; DATA CONFIGURATION, NAMELY, ARRANGING DATA RECORDS FROM COLLECTED ELECTRONIC DATA FOR USE IN ONLINE ANALYSIS AND REPORT PRODUCTION FOR CORPORATE TRAVEL DATA; APPLICATION SERVICE PROVIDER FEATURING SOFTWARE FOR USE IN EXPENSE MANAGEMENT AND REPORTING; PROVIDING TEMPORARY USE OF ON-LINE NON-DOWNLOADABLE SOFTWARE FOR USE IN DATABASE MANAGEMENT IN THE FIELD OF TRAVEL MANAGEMENT AND PLANNING, AND FOR QUALITY CONTROL, NAMELY, MATCHING DATA RECORDS FROM UNIQUE DATA SOURCES TO PROVIDE IMPROVED DATA ACCURACY IN THE FIELD OF TRAVEL MANAGEMENT AND TRAVEL PLANNING, ALL IN THE FIELD OF TRAVEL MANAGEMENT; MAINTENANCE OF COMPUTER SOFTWARE; TECHNICAL SUPPORT SERVICES, NAMELY TROUBLESHOOTING OF SOFTWARE PROBLEMS VIA TELEPHONE, E-MAIL AND IN PERSON; AND COMPUTER SERVICE, ACTING AS AN APPLICATION SERVICE PROVIDER IN THE FIELD OF TRAVEL MANAGEMENT TO HOST COMPUTER APPLICATION SOFTWARE FOR CREATING SEARCHABLE DATABASES OF INFORMATION AND DATA TO ALLOW USERS TO PERFORM, ON-LINE, THE COLLECTING AND ANALYZING OF DIFFERENT TYPES OF TRAVEL DATA (U.S. CLS. 100 AND 101).

FIRST USE 4-3-2007; IN COMMERCE 4-3-2007.

3,785,213. ALOYS F. DORNBRACHT GMBH & CO. KG, ISERLOHN, FED REP GERMANY. SN 77-278,613. PUB. 5-19-2009, FILED 9-13-2007.



OWNER OF FED REP GERMANY REG. NO. 2057429, DATED 2-22-1994, EXPIRES 1-30-2013.

OWNER OF U.S. REG. NO. 2,843,339.

THE MARK CONSISTS OF THE TERM "DORN" ABOVE THE TERM "BRACHT" IN UPPER CASE LETTERS, SEPARATED BY A HORIZONTAL LINE, ALL IN A SQUARE FRAME.

CLASS 6—METAL GOODS

FOR SANITARY BATHTUB ACCESSORIES, NAMELY, TOWEL HOLDERS MADE OF METAL, BATHTUB GRAB BARS MADE OF METAL, SHELF BRACKETS MADE OF METAL, TOWEL HOOKS MADE OF METAL, BATHTUB HANDLES MADE OF METAL (U.S. CLS. 2, 12, 13, 14, 23, 25 AND 50).

FIRST USE 12-31-1993; IN COMMERCE 12-31-1993.

CLASS 9—ELECTRICAL AND SCIENTIFIC APPARATUS

FOR ELECTRIC AND ELECTRONIC FITTINGS FOR SUPPLYING, DISTRIBUTING, CONTROLLING AND REGULATING WATER, NAMELY, ELECTRIC THERMOSTATS WITH AND WITHOUT REGULATORS, AND FITTINGS WITH MOTION DETECTORS AND INFRARED SENSORS (U.S. CLS. 21, 23, 26, 36 AND 38).

FIRST USE 12-31-1993; IN COMMERCE 12-31-1993.

CLASS 11—ENVIRONMENTAL CONTROL APPARATUS

FOR APPARATUS FOR LIGHTING, HEATING, STEAM GENERATING, COOKING, REFRIGERATING, DRYING, VENTILATING, WATER SUPPLY AND SANITARY PURPOSES, NAMELY, LIGHTING FIXTURES, LIGHTING FIXTURES FOR BATHTUBS; SANITARY FITTINGS OF METAL AND PLASTIC FOR TOILETS, BATHROOMS AND KITCHENS, NAMELY, FAUCETS, TAPS, STOPS, MIXERS FOR REGULATING FLOW, DISTRIBUTION AND TEMPERATURE OF WATER, SHOWER HEADS, SETS COMPRISING SHOWER HEADS AND PARTS AND FIXTURES THEREFOR, SETS COMPRISING HANDHELD SHOWER HEADS AND PARTS AND FIXTURES THEREFOR; SPRAYERS FOR SINKS AND PARTS AND FIXTURES THEREFOR; BATH AND SHOWER FIXTURE SETS COMPRISING, SHOWER HEADS, FAUCETS, VALVES, HOSES AND PARTS AND FIXTURES THEREFOR; SETS FOR BATH AND SHOWER COMPRISING, SHOWER HEADS, FAUCETS, SHOWER RISER RAIL, WATER DIVERTERS, PLUMBING FITTINGS, NAMELY, VALVES; INSTANTANEOUS WATER HEATERS, WATER TREATMENT EQUIPMENT, NAMELY, CONTROL VALVE COUPLERS, BATHTUBS, SINKS, LAMPS (U.S. CLS. 13, 21, 23, 31 AND 34).

FIRST USE 12-31-1993; IN COMMERCE 12-31-1993.

CLASS 20—FURNITURE AND ARTICLES NOT OTHERWISE CLASSIFIED

FOR FURNITURE, MIRRORS, PICTURE FRAMES MADE OF WOOD, CORK, REED, CANE, WICKER, HORN, BONE, IVORY, WHALEBONE, SHELL, AMBER, MOTHER -OF-PEARL, MEERSCHAUM AND SUBSTITUTES FOR ALL THESE MATERIALS, OR OF PLASTICS, STORAGE UNITS WITH OR WITHOUT MIRRORS, NAMELY, SHELVES, SUSPENDED CABINETS, VANITIES; MIRRORING CABINETS, RACKS, CUPBOARDS FITTED WITH MIRRORS, ALL NOT MADE OF METAL; SANITARY BATHTUB ACCESSORIES, NAMELY, TOWEL HOLDERS NOT MADE OF METAL, BATHTUB GRAB BARS NOT MADE OF METAL, SHELF BRACKETS NOT MADE OF METAL, TOWEL HOOKS NOT MADE OF METAL, BATHTUB HANDLES NOT MADE OF METAL; SHOWER CURTAIN RODS AND PARTS AND FIXTURES THEREFOR; SANITARY STORAGE UNIT FIXTURES MADE OF METAL, WITH OR WITHOUT MIRRORS, NAMELY, SHELVES, SUSPENDED CABINETS, VANITIES, MIRRORING CABINETS, RACKS AND CUPBOARDS FITTED WITH MIRRORS (U.S. CLS. 2, 13, 22, 25, 32 AND 50).

FIRST USE 12-31-1993; IN COMMERCE 12-31-1993.

CLASS 21—HOUSEWARES AND GLASS

FOR HOUSEHOLD OR KITCHEN UTENSILS NOT OF PRECIOUS METAL OR COATED THEREWITH, NAMELY, COLANDERS, GRATERS, HOLDERS FOR HOUSEHOLD IRONS, HOUSEHOLD CONTAINERS FOR FOOD, SIEVES, SPATULAS, STRAINERS, TURNERS, POT OR PAN SCRAPERS, ROLLING PINS, SKIMMERS, PORTABLE PLASTIC CONTAINERS FOR STORING HOUSEHOLD AND KITCHEN GOODS, TRASH CONTAINERS FOR HOUSEHOLD USE; CONTAINERS FOR HOUSEHOLD USE OR KITCHEN NOT OR PRECIOUS METAL OR COATED THEREWITH; COMBS AND SPONGES; TOILET BRUSHES, COSMETIC BRUSHES, HAIR, NAIL AND TOOTH BRUSHES, ELECTRIC TOOTH BRUSHES, EYEBROW BRUSHES; BRUSH-MAKING MATERIALS, FILAMENTS FOR MAKING BRUSHES; ARTICLES FOR CLEANING PURPOSES, NAMELY, MOPS, BROOMS, BUCKETS; STEEL WOOL; UNWORKED OR SEMI-WORKED GLASS EXCEPT GLASS USED IN BUILDING; GLASSWARE, PORCELAIN AND EARTHENWARE, SANITARY FITTINGS OF GLASS, NAMELY, SOAP DISHES, TOILET PAPER HOLDERS, TOOTHBRUSH HOLDERS, BATHTUB HANDLES (U.S. CLS. 2, 13, 23, 29, 30, 33, 40 AND 50).

FIRST USE 12-31-1993; IN COMMERCE 12-31-1993.

3,785,216. BRUNSWICK CORPORATION, LAKE FOREST, IL. SN 77-280,289. PUB. 12-23-2008, FILED 9-14-2007.



THE MARK CONSISTS OF THE STYLIZED LOWER-CASE LETTER "A", SURROUNDED BY AN ASYMMETRICAL SHIELD.

CLASS 6—METAL GOODS

FOR BOAT ACCESSORIES, NAMELY, METAL GAS SPRINGS FOR LIFTING, COUNTERBALANCING, AND LOWERING HATCHES, COVERS, LIDS AND DOORS; FUEL ACCESSORIES, NAMELY, PORTABLE METAL FUEL TANKS SOLD EMPTY AND FITTINGS THEREFOR; MOTOR ACCESSORIES, NAMELY, NON-ELECTRIC METAL MOTOR SAFETY CABLES (U.S. CLS. 2, 12, 13, 14, 23, 25 AND 50).

FIRST USE 1-26-2009; IN COMMERCE 1-26-2009.

CLASS 7—MACHINERY

FOR BOAT ACCESSORIES, NAMELY, BILGE AND ELECTRIC AERATOR PUMPS; BILGE EXHAUST BLOWERS; MOTOR ACCESSORIES, NAMELY, OIL DRAIN PUMPS FOR CHANGING OIL AND EXHAUST PIPES; PARTS OF BOAT MOTORS, NAMELY, MOTOR WELL BOOTS; BOAT TRAILER ACCESSORIES, NAMELY, WINCHES (U.S. CLS. 13, 19, 21, 23, 31, 34 AND 35).

FIRST USE 2-11-2009; IN COMMERCE 2-11-2009.

CLASS 9—ELECTRICAL AND SCIENTIFIC APPARATUS

FOR BOAT ACCESSORIES, NAMELY, ELECTRICAL PRODUCTS, NAMELY, BATTERY BOXES AND HARDWARE, NAMELY, BATTERY CABLES, FUSE PANELS AND HOLDERS, SWITCHES, ROLLING MOTOR CONNECTORS, ACCESSORY ELECTRICAL PLUGS, AND ANTENNA BASES; FUEL ACCESSORIES, NAMELY, VOLT SURGE PROTECTORS; BOAT TRAILER ACCESSORIES, NAMELY, ELECTRICAL WIRING HARNESS FOR TRAILER LIGHTS AND ASSOCIATED ELECTRICAL EQUIPMENT (U.S. CLS. 21, 23, 26, 36 AND 38).

FIRST USE 4-24-2009; IN COMMERCE 4-24-2009.

CLASS 12—VEHICLES

FOR BOAT ACCESSORIES, NAMELY, BOAT TRAILER COMPONENTS, NAMELY, HITCH BALLS, COUPLERS AND TONGUE JACKS, TRAILER HULL SUPPORTS AND ROLLERS, TRAILER ROLLER BRACKETS AND BUNK BRACKETS, AND TRAILER WHEELS; BOAT SEATS; FITTED BOAT COVERS, AND BIMINI TOPS; METAL STRUCTURAL BOAT PARTS, NAMELY, FUEL ACCESSORIES, NAMELY, DECK FILLS, AND FUEL TANK VENTS; MOTOR BOAT ACCESSORIES, NAMELY, HYDRO-STABILIZERS USED AS A STRUCTURAL PART FOR BOATS (U.S. CLS. 19, 21, 23, 31, 35 AND 44).

FIRST USE 1-15-2009; IN COMMERCE 1-15-2009.

CLASS 21—HOUSEWARES AND GLASS

FOR MOTOR ACCESSORIES, NAMELY, FUNNELS (U.S. CLS. 2, 13, 23, 29, 30, 33, 40 AND 50).

FIRST USE 6-10-2009; IN COMMERCE 6-10-2009.

3,785,217. DOTS, LLC, GLENWILLOW, OH. SN 77-289,129. PUB. 5-13-2008, FILED 9-26-2007.

LOVE THE LOOKS. DOTS.

THE MARK CONSISTS OF STANDARD CHARACTERS WITHOUT CLAIM TO ANY PARTICULAR FONT, STYLE, SIZE, OR COLOR.

OWNER OF U.S. REG. NOS. 1,502,671, 2,568,849, AND 2,948,673.

CLASS 25—CLOTHING

FOR WOMEN'S AND CHILDREN'S CLOTHING, NAMELY, DRESSES, SKIRTS, SHIRTS, BLOUSES, PANTS, OVERALLS, JACKETS, COATS, VESTS, SHORTS, T-SHIRTS, SWEATSHIRTS, SWEATERS, HOSIERY, SWIMSUITS, HEADWEAR, SOCKS, HOSIERY, PAJAMAS, UNDERWEAR, BELTS, SCARVES, TIES, GLOVES, SHOES, BOOTS, SNEAKERS, SANDALS AND SLIPPERS (U.S. CLS. 22 AND 39).

FIRST USE 6-30-2007; IN COMMERCE 6-30-2007.

CLASS 35—ADVERTISING AND BUSINESS

FOR RETAIL STORE SERVICES FEATURING CLOTHING, JEWELRY, HANDBAGS AND CLOTHING ACCESSORIES (U.S. CLS. 100, 101 AND 102).

FIRST USE 6-30-2007; IN COMMERCE 6-30-2007.

3,785,220. PHOENIX INTANGIBLES HOLDING COMPANY, GREENVILLE, DE. SN 77-292,850. PUB. 1-8-2008, FILED 10-1-2007.

GIANT EAGLE

THE MARK CONSISTS OF STANDARD CHARACTERS WITHOUT CLAIM TO ANY PARTICULAR FONT, STYLE, SIZE, OR COLOR.

CLASS 9—ELECTRICAL AND SCIENTIFIC APPARATUS

FOR MAGNETICALLY CODED DEBIT CARDS (U.S. CLS. 21, 23, 26, 36 AND 38).

FIRST USE 11-0-2009; IN COMMERCE 11-0-2009.

CLASS 36—INSURANCE AND FINANCIAL

FOR DEBIT CARD SERVICES (U.S. CLS. 100, 101 AND 102).

FIRST USE 11-0-2009; IN COMMERCE 11-0-2009.

3,785,226. BOWTIE, INC., IRVINE, CA. SN 77-295,693. PUB. 1-8-2008, FILED 10-3-2007.

POPULAR GARDENING

THE MARK CONSISTS OF STANDARD CHARACTERS WITHOUT CLAIM TO ANY PARTICULAR FONT, STYLE, SIZE, OR COLOR.

OWNER OF U.S. REG. NOS. 2,632,042, 3,169,425, AND OTHERS.

NO CLAIM IS MADE TO THE EXCLUSIVE RIGHT TO USE "GARDENING", APART FROM THE MARK AS SHOWN.

CLASS 16—PAPER GOODS AND PRINTED MATTER

FOR MAGAZINES IN THE FIELD OF GARDENING, FARMING, AGRICULTURE, HORTICULTURE AND ANIMALS (U.S. CLS. 2, 5, 22, 23, 29, 37, 38 AND 50).

FIRST USE 1-0-2010; IN COMMERCE 1-0-2010.

CLASS 44—MEDICAL, BEAUTY AND AGRICULTURAL SERVICES

FOR PROVIDING ONLINE INFORMATION REGARDING GARDENING, FARMING, AGRICULTURE, HORTICULTURE, AND REGARDING PETS AND ANIMALS RELATING TO BREEDING, SELECTION, GROOMING, CARE, HEALTH AND NUTRITION (U.S. CLS. 100 AND 101).

FIRST USE 3-10-2010; IN COMMERCE 3-10-2010.

3,785,227. PHOENIX INTANGIBLES HOLDING COMPANY, GREENVILLE, DE. SN 77-296,152. PUB. 1-8-2008, FILED 10-4-2007.



THE COLOR(S) RED AND WHITE IS/ARE CLAIMED AS A FEATURE OF THE MARK.

THE MARK CONSISTS OF THE WORDS "GIANT EAGLE" IN WHITE WITH A RED ROUNDED RECTANGULAR BACKGROUND.

CLASS 9—ELECTRICAL AND SCIENTIFIC APPARATUS

FOR MAGNETICALLY CODED DEBIT CARDS (U.S. CLS. 21, 23, 26, 36 AND 38).
FIRST USE 11-0-2009; IN COMMERCE 11-0-2009.

CLASS 36—INSURANCE AND FINANCIAL

FOR DEBIT CARD SERVICES (U.S. CLS. 100, 101 AND 102).
FIRST USE 11-0-2009; IN COMMERCE 11-0-2009.

3,785,236. ITHURTS.COM INC., PARKER, CO. SN 77-324,547. PUB. 7-8-2008, FILED 11-8-2007.



THE MARK CONSISTS OF TWO BANDAGES WITH BLACK DOTS CROSSING OVER EACH OTHER. AT THE BOTTOM TO THE RIGHT OF THE BANDAGES ARE THE STYLIZED WORDS "ITHURTS.COM IF IT HURTS WE CAN HELP!". THE DOT IN THE LETTER "I" IN THE WORD "IT" IN THE PHRASE "IF IT HURTS WE CAN HELP!" IS A CROSS. THE PORTION OF THE MARK COMPRISED OF A CROSS DESIGN IS NOT DISPLAYED IN THE COLOR RED OR A COLORABLE IMITATION THEREOF; AND IS NOT USED AND WILL NOT BE USED IN THE COLOR RED OR A COLORABLE IMITATION THEREOF.

CLASS 35—ADVERTISING AND BUSINESS

FOR PROVIDING AN ONLINE DIRECTORY INFORMATION SERVICE FEATURING INFORMATION REGARDING HEALTH, WELLNESS AND MEDICAL INFORMATION, ON-LINE RETAIL STORE SERVICES FEATURING HEALTH AND WELLNESS PRODUCTS, PROVIDING AN ON-LINE COMMERCIAL INFORMATION DIRECTORY ON THE INTERNET, PROVIDING ON-LINE DIRECTORY INFORMATION SERVICES ALSO FEATURING HYPERLINKS TO OTHER WEB SITES, AND DOCTOR REFERRALS (U.S. CLS. 100, 101 AND 102).
FIRST USE 1-4-2010; IN COMMERCE 1-4-2010.

CLASS 44—MEDICAL, BEAUTY AND AGRICULTURAL SERVICES

FOR INFORMATION IN THE FIELD OF PARENTING CONCERNING THE HEALTH OF CHILDREN, PROVIDING A WEBSITE FEATURING INFORMATION IN THE FIELD OF MENTAL HEALTH AND WELLNESS, PROVIDING HEALTH CARE INFORMATION BY TELEPHONE AND THE INTERNET, PROVIDING HEALTH INFORMATION, PROVIDING A WEBSITE FEATURING EDUCATIONAL INFORMATION REGARDING NUTRITION AND GENETICS, PROVIDING INFORMATION ABOUT DIETARY SUPPLEMENTS AND NUTRITION, AND PROVIDING INFORMATION IN THE FIELD OF HEALTH, WELLNESS AND MEDICAL VIA THE INTERNET (U.S. CLS. 100 AND 101).
FIRST USE 1-4-2010; IN COMMERCE 1-4-2010.

3,785,241. PARTICIPANT MEDIA, LLC, BEVERLY HILLS, CA. SN 77-327,035. PUB. 4-29-2008, FILED 11-12-2007.

TAKEPART

THE MARK CONSISTS OF STANDARD CHARACTERS WITHOUT CLAIM TO ANY PARTICULAR FONT, STYLE, SIZE, OR COLOR.

CLASS 9—ELECTRICAL AND SCIENTIFIC APPARATUS

FOR ONLINE DISCUSSION BOARDS AND WEB CASTS FEATURING MUSIC; NEWS BROADCASTS; DOWNLOADABLE ELECTRONIC PUBLICATIONS IN THE NATURE OF BOOKS AND PERIODICALS IN THE FIELD OF SOCIAL ACTION AND SOCIAL RESPONSIBILITY FOCUSING ON ENVIRONMENTAL PROTECTION, CORPORATE SOCIAL RESPONSIBILITY, HEALTH, HUMAN RIGHTS AND TOLERANCE, PEACE AND SECURITY AND SOCIAL AND ECONOMIC EQUITY (U.S. CLS. 21, 23, 26, 36 AND 38).
FIRST USE 11-1-2007; IN COMMERCE 11-1-2007.

CLASS 16—PAPER GOODS AND PRINTED MATTER

FOR PRINTED EDUCATIONAL, INSTRUCTIONAL AND TEACHING MATERIALS, NAMELY, BOOKS, IN THE FIELDS OF SOCIAL ACTION AND SOCIAL RESPONSIBILITY FOCUSING ON ENVIRONMENTAL PROTECTION, CORPORATE SOCIAL RESPONSIBILITY, HEALTH, HUMAN RIGHTS AND TOLERANCE, PEACE AND SECURITY AND SOCIAL AND ECONOMIC EQUITY (U.S. CLS. 2, 5, 22, 23, 29, 37, 38 AND 50).
FIRST USE 11-1-2007; IN COMMERCE 11-1-2007.

CLASS 35—ADVERTISING AND BUSINESS

FOR SOCIAL ACTION CAMPAIGN SERVICES, NAMELY, ORGANIZING AND DEVELOPING PROMOTIONAL CAMPAIGNS TO EFFECTUATE SOCIAL CHANGE; PROMOTING PUBLIC AWARENESS OF SOCIAL ISSUES THROUGH SOCIAL ACTION CAMPAIGNS, MOTION PICTURE MEDIA, AND PRINT MEDIA; ARRANGING AND CONDUCTING PROMOTIONAL EVENTS FOR OTHERS (U.S. CLS. 100, 101 AND 102).
FIRST USE 11-1-2007; IN COMMERCE 11-1-2007.

CLASS 36—INSURANCE AND FINANCIAL

FOR CHARITABLE FUNDRAISING SERVICES (U.S. CLS. 100, 101 AND 102).
FIRST USE 11-1-2007; IN COMMERCE 11-1-2007.

CLASS 38—COMMUNICATION

FOR VIDEO BROADCASTING SERVICES OVER THE INTERNET OR OTHER COMMUNICATIONS NETWORK, NAMELY, UPLOADING, POSTING, SHOWING, DISPLAYING, TAGGING, AND ELECTRONICALLY TRANSMITTING VIDEO CLIPS AND PROVIDING TELECOMMUNICATION ACCESS TO VIDEO AND AUDIO CONTENT PROVIDED VIA A VIDEO-ON-DEMAND SERVICE VIA THE INTERNET; PROVIDING ONLINE CHAT ROOMS AND ELECTRONIC BULLETIN BOARDS FOR TRANSMISSION OF MESSAGES AMONG COMPUTER USERS IN THE FIELD OF SOCIAL ACTION AND SOCIAL ADVOCACY RELATING TO ENVIRONMENTAL PROTECTION INITIATIVES, CORPORATE SOCIAL RESPONSIBILITY INITIATIVES, HEALTH INITIATIVES, HUMAN RIGHTS AND TOLERANCE INITIATIVES, PEACE AND SECURITY INITIATIVES AND SOCIAL AND ECONOMIC EQUITY INITIATIVES (U.S. CLS. 100, 101 AND 104).

FIRST USE 11-1-2007; IN COMMERCE 11-1-2007.

CLASS 41—EDUCATION AND ENTERTAINMENT

FOR PROVIDING ONLINE INTERACTIVE EDUCATIONAL PROGRAMS AND EDUCATIONAL MATERIALS IN CONNECTION THEREWITH, IN THE FIELDS OF SOCIAL ACTION AND SOCIAL ADVOCACY, ENVIRONMENTAL PROTECTION, CORPORATE SOCIAL RESPONSIBILITY, HEALTH, HUMAN RIGHTS AND TOLERANCE, PEACE AND SECURITY AND SOCIAL AND ECONOMIC EQUITY (U.S. CLS. 100, 101 AND 107).

FIRST USE 11-1-2007; IN COMMERCE 11-1-2007.

CLASS 42—SCIENTIFIC AND COMPUTER SERVICES

FOR COMPUTER SERVICES, NAMELY, HOSTING ONLINE WEB FACILITIES FOR OTHERS FOR ORGANIZING AND CONDUCTING ONLINE MEETINGS, GATHERINGS, AND INTERACTIVE DISCUSSIONS FOCUSED ON SOCIAL ACTION CAMPAIGNS AND SOCIAL ADVOCACY PROGRAMS (U.S. CLS. 100 AND 101).

FIRST USE 11-1-2007; IN COMMERCE 11-1-2007.

CLASS 9—ELECTRICAL AND SCIENTIFIC APPARATUS

FOR NECKPIECES AND STRAPS FOR CELLULAR TELEPHONES; PRE-RECORDED VIDEO DISCS, VIDEO TAPES, CD-ROMS, DVD-ROMS AND OPTICAL DISCS FEATURING ACTION, ADVENTURE, COMEDY AND DRAMA GAMES, ANIMATION AND MUSIC; DOWNLOADABLE ELECTRONIC PUBLICATIONS IN THE NATURE OF MAGAZINES, BOOKS, MANUALS IN THE FIELD OF GAMES, ENTERTAINMENT, MOVIES, SPORTS; CONSUMER VIDEO GAMES, NAMELY, VIDEO GAME DISCS AND VIDEO GAME SOFTWARE; AND SOFTWARE AND ELECTRONIC GAMES, NAMELY, DOWNLOADABLE AND INSTALLABLE SOFTWARE PROGRAMS FOR COMPUTERS, CONSUMER VIDEO GAME PROGRAMS, ARCADE VIDEO GAME PROGRAMS, HAND-HELD GAMES WITH LIQUID CRYSTAL DISPLAY, DOWNLOADABLE SOFTWARE GAME PROGRAMS FOR MOBILE PHONES AND DOWNLOADABLE SOFTWARE FOR MOVING IMAGES, STILL PICTURES, SOUND AND MUSIC VIA THE INTERNET AND WIRELESS DEVICES, DOWNLOADABLE COMPUTER PROGRAMS FOR MOBILE PHONES, IMAGES FOR IDLE SCREENS, RING-TONE MUSIC AND RINGTONE SOUND VIA THE INTERNET AND WIRELESS DEVICES (U.S. CLS. 21, 23, 26, 36 AND 38).

FIRST USE 2-15-2007; IN COMMERCE 2-10-2008.

CLASS 16—PAPER GOODS AND PRINTED MATTER

FOR MANUALS FOR PROGRAMS FOR VIDEO GAMES; MANUALS FOR PROGRAMS FOR HAND-HELD GAME MACHINES WITH LIQUID CRYSTAL DISPLAYS; HANDBOOKS IN THE FIELD OF COMPUTER, HAND-HELD AND VIDEO GAMES AND ON-LINE GAMES; ADVENTURE GAME EQUIPMENT IN THE NATURE OF GAME BOOK MANUALS, COMPUTER GAME INSTRUCTION MANUALS; MAGAZINES IN THE FIELD OF COMPUTER, HAND-HELD AND VIDEO GAMES AND ON-LINE GAMES; AND BOOKS IN THE FIELD OF COMPUTER, HAND-HELD AND VIDEO GAMES AND ON-LINE GAMES (U.S. CLS. 2, 5, 22, 23, 29, 37, 38 AND 50).

FIRST USE 2-15-2007; IN COMMERCE 2-10-2008.

3,785,249. DISCOVERY COMMUNICATIONS, LLC, SILVER SPRING, MD. SN 77-332,037. PUB. 10-14-2008, FILED 11-16-2007.

3,785,246. KABUSHIKI KAISHA LEVEL - 5, DBA LEVEL-5 INC., CHUO-KU, FUKUOKA, JAPAN. SN 77-331,562. PUB. 5-5-2009, FILED 11-16-2007.

INVESTIGATION DISCOVERY**Professor Layton**

THE MARK CONSISTS OF STANDARD CHARACTERS WITHOUT CLAIM TO ANY PARTICULAR FONT, STYLE, SIZE, OR COLOR.

CLASS 9—ELECTRICAL AND SCIENTIFIC APPARATUS

FOR PRE-RECORDED VIDEO DISKS, AUDIO-VISUAL RECORDINGS, AND DVDS ALL FEATURING NON-FICTION SUBJECTS RELATED TO CRIME, CRIMINALS, EVIDENCE, CONSPIRACIES, THE PARANORMAL, AND CRYPTOZOOLOGY (U.S. CLS. 21, 23, 26, 36 AND 38).

FIRST USE 12-17-2007; IN COMMERCE 9-23-2008.

THE MARK CONSISTS OF STANDARD CHARACTERS WITHOUT CLAIM TO ANY PARTICULAR FONT, STYLE, SIZE, OR COLOR.

THE NAME "PROFESSOR LAYTON" DOES NOT IDENTIFY A LIVING INDIVIDUAL.

CLASS 38—COMMUNICATION

FOR BROADCASTING PROGRAMS VIA A GLOBAL COMPUTER NETWORK; CABLE TELEVISION BROADCASTING; PODCASTING SERVICES; PROVIDING ELECTRONIC BULLETIN BOARDS FOR TRANSMISSION OF MESSAGES AMONG USERS IN THE FIELD OF GENERAL INTEREST; SATELLITE TELEVISION BROADCASTING; SATELLITE, CABLE, NETWORK TRANSMISSION OF SOUNDS, IMAGES, SIGNALS AND DATA; STREAMING OF AUDIO MATERIAL ON THE INTERNET; STREAMING OF VIDEO MATERIAL ON THE INTERNET; VIDEO BROADCASTING; VIDEO-ON-DEMAND TRANSMISSION SERVICES; WEBCASTING SERVICES; TELEVISION BROADCASTING SERVICES; MOBILE MEDIA SERVICES IN THE NATURE OF ELECTRONIC TRANSMISSION OF ENTERTAINMENT MEDIA CONTENT; TRANSMISSION OF INFORMATION IN THE AUDIOVISUAL FIELD; TRANSMISSION OF INFORMATION BY ELECTRONIC COMMUNICATIONS NETWORKS (U.S. CLS. 100, 101 AND 104).

FIRST USE 12-17-2007; IN COMMERCE 1-0-2008.

CLASS 41—EDUCATION AND ENTERTAINMENT

FOR ENTERTAINMENT SERVICES, NAMELY, PRODUCTION OF TELEVISION AND BROADBAND AUDIO-VISUAL AND MULTI-MEDIA SHOWS; ENTERTAINMENT IN THE NATURE OF ONGOING AUDIO-VISUAL SHOWS FEATURING NON-FICTION SUBJECTS RELATED TO CRIME, CRIMINALS, EVIDENCE, CONSPIRACIES, THE PARANORMAL, AND CRYPTOZOOLOGY BROADCAST OVER TELEVISION, SATELLITE, AUDIO, AND VIDEO MEDIA (U.S. CLS. 100, 101 AND 107).

FIRST USE 12-17-2007; IN COMMERCE 1-0-2008.

3,785,251. PITA PIT, INC., COEUR D'ALENE, ID. SN 77-335,302. PUB. 12-16-2008, FILED 11-21-2007.



NO CLAIM IS MADE TO THE EXCLUSIVE RIGHT TO USE "SMOOTHIE", APART FROM THE MARK AS SHOWN.

THE COLOR(S) WHITE, PURPLE, NEON GREEN, GREEN AND BLACK IS/ARE CLAIMED AS A FEATURE OF THE MARK.

THE MARK CONSISTS OF A NEON GREEN BACKGROUND WITH A NEON GREEN TRIANGLE OUTLINED IN PURPLE CONTAINING THE WORD "THE" IN WHITE LETTERING OUTLINED IN BLACK WHICH PASSES BEHIND AND THROUGH THE WORD "SMOOTHIE" WHICH WORD IS ALSO IN WHITE LETTERING AND THE LETTER "O" IN THIS WORD ARE FORMED BY A SWIRL ALL OF WHICH IS OUTLINED IN BLACK AND PURPLE OVERLAPPING A NEON GREEN OVAL WHICH HAS A DARKER GREEN SWIRL IN IT AND OUTLINED IN PURPLE CONTAINING THE WORD "PIT" IN WHITE LETTERING WHICH IS ALSO OUTLINED IN BLACK AND NEXT TO THIS WORD ARE THE WORDS "GETTIN' FRESH" ABOVE THE WORDS "GETTIN' SMOOTH" IN SMALLER BLACK LETTERING.

CLASS 32—LIGHT BEVERAGES

FOR BLENDED DRINKS, NAMELY, SMOOTHIES (U.S. CLS. 45, 46 AND 48).

FIRST USE 1-2-2006; IN COMMERCE 1-2-2006.

CLASS 43—HOTEL AND RESTAURANT SERVICES

FOR RESTAURANT SERVICES, NAMELY, PROVISION OF FOOD AND BEVERAGES FOR DINING IN, SELF-SERVICE, DRIVE-IN AND TAKE-OUT SERVICES (U.S. CLS. 100 AND 101).

FIRST USE 1-2-2006; IN COMMERCE 1-2-2006.

3,785,253. INTERNATIONAL PAIRS HOLDINGS LTD., HAMPSHIRE, UNITED KINGDOM. SN 77-336,939. PUB. 12-30-2008, FILED 11-26-2007.



NO CLAIM IS MADE TO THE EXCLUSIVE RIGHT TO USE "PAIRS" IN INTERNATIONAL CLASSES 35 AND 41, APART FROM THE MARK AS SHOWN.

THE MARK CONSISTS OF A GOLFER STANDING UPRIGHT AND SWINGING A GOLF CLUB, WITH A CURVED LINE REPRESENTING THE GOLF CLUB'S SWING. THE GOLFER IS DEPICTED AS THE LETTER "I" OF THE WORD "INTERNATIONAL". THE WORD "INTERNATIONAL" IS ABOVE A SHADED RECTANGLE CONTAINING A GOLFER BENDING DOWN, FOLLOWED BY THE WORD "PAIRS" AND A SECOND GOLFER BENDING DOWN.

CLASS 35—ADVERTISING AND BUSINESS

FOR PROMOTING SPORTS COMPETITIONS AND/OR EVENTS OF OTHERS, NAMELY, PROMOTING GOLF TOURNAMENTS AND COMPETITIONS THROUGH RADIO, PRINT AND ON-LINE ADVERTISING, DISTRIBUTION OF PRINTED ADVERTISING MATERIAL, AND BY ARRANGING FOR SPONSORS TO AFFILIATE GOODS AND SERVICES WITH GOLF TOURNAMENTS AND COMPETITIONS (U.S. CLS. 100, 101 AND 102).

FIRST USE 2-7-2007; IN COMMERCE 2-7-2007.

CLASS 41—EDUCATION AND ENTERTAINMENT

FOR PROVIDING ON-LINE PUBLICATIONS, NAMELY, ONLINE NEWSLETTERS IN THE FIELD OF GOLF; ENTERTAINMENT SERVICES IN THE NATURE OF ORGANIZING, PRESENTING AND CONDUCTING GOLF TOURNAMENTS (U.S. CLS. 100, 101 AND 107).

FIRST USE 2-7-2007; IN COMMERCE 2-7-2007.

3,785,254. ZYMETIS, INC., COLLEGE PARK, MD. SN 77-337,391. PUB. 7-8-2008, FILED 11-27-2007.

ETHAZYME

THE MARK CONSISTS OF STANDARD CHARACTERS WITHOUT CLAIM TO ANY PARTICULAR FONT, STYLE, SIZE, OR COLOR.

CLASS 1—CHEMICALS

FOR ENZYMES FOR SCIENTIFIC AND RESEARCH PURPOSES; ENZYME PRODUCTS, NAMELY, ENZYME PREPARATIONS FOR USE IN THE ALTERNATIVE FUELS INDUSTRY (U.S. CLS. 1, 5, 6, 10, 26 AND 46).
FIRST USE 1-15-2009; IN COMMERCE 1-15-2009.

CLASS 4—LUBRICANTS AND FUELS

FOR ALTERNATIVE FUEL PRODUCTS, NAMELY, ETHANOL FUELS (U.S. CLS. 1, 6 AND 15).
FIRST USE 1-15-2009; IN COMMERCE 1-15-2009.

CLASS 40—MATERIAL TREATMENT

FOR MANUFACTURE OF ALTERNATIVE FUELS TO THE ORDER AND SPECIFICATION OF OTHERS (U.S. CLS. 100, 103 AND 106).
FIRST USE 1-15-2009; IN COMMERCE 1-15-2009.

CLASS 42—SCIENTIFIC AND COMPUTER SERVICES

FOR RESEARCH AND DEVELOPMENT IN THE FIELD OF ENZYMES, RESEARCH AND DEVELOPMENT IN THE FIELD OF ALTERNATIVE FUELS (U.S. CLS. 100 AND 101).
FIRST USE 1-15-2009; IN COMMERCE 1-15-2009.

3,785,258. ENVIRONMENTAL GRAPHICS, LLC, HOPKINS, MN. SN 77-339,295. PUB. 10-28-2008, FILED 11-28-2007.

YOUR WAY BRANDS

THE MARK CONSISTS OF STANDARD CHARACTERS WITHOUT CLAIM TO ANY PARTICULAR FONT, STYLE, SIZE, OR COLOR.

NO CLAIM IS MADE TO THE EXCLUSIVE RIGHT TO USE "BRANDS", APART FROM THE MARK AS SHOWN.

CLASS 27—FLOOR COVERINGS

FOR WALL COVERINGS (U.S. CLS. 19, 20, 37, 42 AND 50).
FIRST USE 12-31-2008; IN COMMERCE 12-31-2008.

CLASS 35—ADVERTISING AND BUSINESS

FOR PROVIDING A WEB SITE AT WHICH USERS CAN OFFER DIGITAL PHOTOGRAPHS, ILLUSTRATIONS, AUDIO, VIDEO, FONTS AND OTHER DESIGN ELEMENTS FOR SALE AND BUY SIMILAR GOODS FROM OTHERS (U.S. CLS. 100, 101 AND 102).
FIRST USE 12-31-2008; IN COMMERCE 12-31-2008.

CLASS 40—MATERIAL TREATMENT

FOR DIGITAL ENHANCEMENT OF PHOTOGRAPHS; ELECTRONIC IMAGING, SCANNING, DIGITIZING, ALTERATION AND/OR RETOUCHING OF PHOTOGRAPHIC IMAGES (U.S. CLS. 100, 103 AND 106).
FIRST USE 12-31-2008; IN COMMERCE 12-31-2008.

CLASS 41—EDUCATION AND ENTERTAINMENT

FOR PROVIDING AN ON-LINE COMPUTER DATABASE IN THE FIELD OF PHOTOGRAPHY AND DIGITAL IMAGING FEATURING DIGITAL PHOTOGRAPHS, ILLUSTRATIONS, AUDIO-VIDEO, FONTS AND OTHER DESIGN ELEMENTS; PROVIDING INFORMATION ABOUT DIGITAL PHOTOGRAPHY VIA A GLOBAL COMPUTER NETWORK (U.S. CLS. 100, 101 AND 107).
FIRST USE 12-31-2008; IN COMMERCE 12-31-2008.

CLASS 42—SCIENTIFIC AND COMPUTER SERVICES

FOR PROVIDING A WEBSITE THAT GIVES COMPUTER USERS THE ABILITY TO UPLOAD, DOWNLOAD, EXCHANGE AND SHARE DIGITAL PHOTOGRAPHS, ILLUSTRATIONS, AUDIO, VIDEO, FONTS AND OTHER DESIGN ELEMENTS; PROVIDING TEMPORARY USE OF ON-LINE NON-DOWNLOADABLE COMPUTER SOFTWARE FOR USE IN DATABASE MANAGEMENT; PROVIDING TEMPORARY USE OF ON-LINE NON-DOWNLOADABLE COMPUTER SOFTWARE FOR UPLOADING, MANIPULATING, AND ENHANCING DIGITAL CONTENT, DOCUMENTS, PHOTOGRAPHS, IMAGES, VIDEO, AND AUDIO; PROVIDING TEMPORARY USE OF ON-LINE NON-DOWNLOADABLE COMPUTER SOFTWARE FOR LINKING METADATA TAGS WITH PHOTOGRAPHIC AND OTHER MEDIA FILES TO ENABLE SEARCH ENGINE RETRIEVAL AND DATABASE SOFTWARE COLLECTIONS OF FILES AND THEIR ON-LINE SHARING, AND FOR LINKING METADATA TAGS WITH WEB PAGES VISITED, TO CREATE LINKS WHICH USERS CAN MAINTAIN FOR THEMSELVES AND SHARE WITH ON-LINE GROUPS AND WEBSITE TAGGING (U.S. CLS. 100 AND 101).
FIRST USE 12-31-2008; IN COMMERCE 12-31-2008.

CLASS 45—PERSONAL AND LEGAL SERVICES

FOR STOCK PHOTOGRAPHY SERVICES, NAMELY, LEASING REPRODUCTION RIGHTS OF DIGITAL PHOTOGRAPHS TO OTHERS VIA A GLOBAL COMPUTER NETWORK (U.S. CLS. 100 AND 101).
FIRST USE 12-31-2008; IN COMMERCE 12-31-2008.

3,785,262. CE INTERACTIVE, INC., NEW YORK, NY. SN 77-341,640. PUB. 10-28-2008, FILED 11-30-2007.

CE INTERACTIVE

THE MARK CONSISTS OF STANDARD CHARACTERS WITHOUT CLAIM TO ANY PARTICULAR FONT, STYLE, SIZE, OR COLOR.

NO CLAIM IS MADE TO THE EXCLUSIVE RIGHT TO USE "INTERACTIVE", APART FROM THE MARK AS SHOWN.

3,785,273. GET OUTSIDE MEDIA LLC, GRAND RAPIDS, MN. SN 77-356,995. PUB. 5-20-2008, FILED 12-20-2007.

CLASS 35—ADVERTISING AND BUSINESS

FOR CUSTOMER SERVICE IN THE FIELD OF ELECTRONIC ENTERTAINMENT SYSTEMS, NAMELY, PROVIDING ASSISTANCE IN SELECTION, SET-UP, AND OPERATION OF PRODUCTS AND PERIPHERALS AND OPTIMIZING PRODUCT PERFORMANCE THROUGH INSTALLATION EVENTS, RETAIL STORE ASSISTANCE, CALL CENTER HELP DESK OR DIRECTLY OVER THE WEB (U.S. CLS. 100, 101 AND 102).

FIRST USE 1-10-2005; IN COMMERCE 1-10-2005.



CLASS 37—CONSTRUCTION AND REPAIR

FOR PROVIDING INFORMATION IN THE FIELD OF INSTALLATION AND MAINTENANCE OF ELECTRONIC ENTERTAINMENT PRODUCTS AND PERIPHERALS THROUGH SERVICE OR INSTALLATION EVENTS, CALL CENTER HELP DESK, OR DIRECTLY OVER THE WEB (U.S. CLS. 100, 103 AND 106).

FIRST USE 1-10-2005; IN COMMERCE 1-10-2005.

NO CLAIM IS MADE TO THE EXCLUSIVE RIGHT TO USE ".COM", APART FROM THE MARK AS SHOWN.

CLASS 35—ADVERTISING AND BUSINESS

FOR PROMOTING THE GOODS AND SERVICES OF OTHERS BY MEANS OF OPERATING AN ON-LINE RETAIL STORE FEATURING FISHING PRODUCTS AND ADVERTISEMENTS OF OTHERS (U.S. CLS. 100, 101 AND 102).

FIRST USE 2-11-2010; IN COMMERCE 2-11-2010.

3,785,263. BRANDED LLC, DALLAS, TX. SN 77-343,084. PUB. 5-26-2009, FILED 12-3-2007.

CLASS 41—EDUCATION AND ENTERTAINMENT

FOR PROVIDING A WEBSITE FEATURING INFORMATION, EDUCATION, INSTRUCTION AND ENTERTAINMENT IN THE FORM OF VIDEO AND AUDIO PRODUCTIONS AND ARTICLES PERTAINING TO THE SPORT OF FISHING (U.S. CLS. 100, 101 AND 107).

FIRST USE 2-12-2010; IN COMMERCE 2-12-2010.

Classic Living

THE MARK CONSISTS OF STANDARD CHARACTERS WITHOUT CLAIM TO ANY PARTICULAR FONT, STYLE, SIZE, OR COLOR.

CLASS 20—FURNITURE AND ARTICLES NOT OTHERWISE CLASSIFIED

FOR BEDROOM FURNITURE; DINING ROOM FURNITURE; LIVING ROOM FURNITURE; OCCASIONAL FURNITURE; MATTRESSES (U.S. CLS. 2, 13, 22, 25, 32 AND 50).

FIRST USE 2-17-2010; IN COMMERCE 2-17-2010.

CLASS 24—FABRICS

FOR BED SHEETS, PILLOW CASES, COMFORTERS, BEDSPREADS, PILLOW SHAMS, BED RUFFLES, DUVET COVERS, COMFORTER COVERS, MATTRESS PADS, BED BLANKETS, TOWELS, WASH CLOTHS, FABRIC SHOWER CURTAINS, DRAPERIES AND FABRIC VALANCES (U.S. CLS. 42 AND 50).

FIRST USE 2-17-2010; IN COMMERCE 2-17-2010.

3,785,274. GET OUTSIDE MEDIA LLC, GRAND RAPIDS, MN. SN 77-357,002. PUB. 5-20-2008, FILED 12-20-2007.



NO CLAIM IS MADE TO THE EXCLUSIVE RIGHT TO USE ".COM", APART FROM THE MARK AS SHOWN.

CLASS 35—ADVERTISING AND BUSINESS

FOR PROMOTING THE GOODS AND SERVICES OF OTHERS BY MEANS OF OPERATING AN ON-LINE RETAIL STORE FEATURING FISHING PRODUCTS AND ADVERTISEMENTS OF OTHERS (U.S. CLS. 100, 101 AND 102).

FIRST USE 2-12-2010; IN COMMERCE 2-12-2010.

CLASS 41—EDUCATION AND ENTERTAINMENT

FOR PROVIDING A WEBSITE FEATURING INFORMATION, EDUCATION, INSTRUCTION AND ENTERTAINMENT IN THE FORM OF VIDEO AND AUDIO PRODUCTIONS AND ARTICLES PERTAINING TO THE SPORT OF FISHING (U.S. CLS. 100, 101 AND 107).

FIRST USE 2-12-2010; IN COMMERCE 2-12-2010.

3,785,281. LINWOOD HOMES, LTD., DELTA, CANADA. SN 77-365,886. PUB. 6-2-2009, FILED 1-7-2008.

SITE SPECIFIC DESIGN

THE MARK CONSISTS OF STANDARD CHARACTERS WITHOUT CLAIM TO ANY PARTICULAR FONT, STYLE, SIZE, OR COLOR.

NO CLAIM IS MADE TO THE EXCLUSIVE RIGHT TO USE "DESIGN", APART FROM THE MARK AS SHOWN.

CLASS 19—NON-METALLIC BUILDING MATERIALS

FOR PREPACKAGED HOMES (U.S. CLS. 1, 12, 33 AND 50).

FIRST USE 5-17-2007; IN COMMERCE 5-17-2007.

CLASS 36—INSURANCE AND FINANCIAL

FOR REAL ESTATE SERVICES, NAMELY, SELLING PREPACKAGED HOMES (U.S. CLS. 100, 101 AND 102).

FIRST USE 5-17-2007; IN COMMERCE 5-17-2007.

CLASS 37—CONSTRUCTION AND REPAIR

FOR CONSTRUCTION SERVICES, NAMELY, PLANNING AND CONSTRUCTION OF PREPACKAGED HOMES (U.S. CLS. 100, 103 AND 106).

FIRST USE 5-17-2007; IN COMMERCE 5-17-2007.

3,785,287. BI-INVEST HOLDINGS S.A., LUXEMBOURG, LUXEMBOURG. SN 77-368,276. PUB. 9-2-2008, FILED 1-10-2008.

Invest industrial

THE MARK CONSISTS OF THE WORD "INVEST" IN BOLD LETTERS FOLLOWED BY THE WORD "INDUSTRIAL".

CLASS 35—ADVERTISING AND BUSINESS

FOR BUSINESS ADVISORY SERVICES; BUSINESS MANAGEMENT; BUSINESS MANAGEMENT CONSULTING, INCLUDING MANAGEMENT BUYOUT ADVICE; BUSINESS ORGANIZATION CONSULTING; BUSINESS RESEARCH; BUSINESS APPRAISALS; BUSINESS PLANNING; BUSINESS INFORMATION SERVICES; ACQUISITION AND MERGER CONSULTATION; PERSONNEL RECRUITMENT AND MANAGEMENT (U.S. CLS. 100, 101 AND 102).

FIRST USE 11-24-2009; IN COMMERCE 11-24-2009.

CLASS 36—INSURANCE AND FINANCIAL

FOR FINANCIAL ADVISORY AND CONSULTANCY SERVICES; FINANCIAL MANAGEMENT; MANAGEMENT OF A CAPITAL INVESTMENT FUND; PROVIDING FINANCIAL INFORMATION; FINANCIAL SERVICES IN THE FIELD OF MONEY LENDING; INVESTMENT CONSULTATION; INVESTMENT MANAGEMENT; FINANCIAL GUARANTEE AND SURETY; FUND RAISING FOR OTHERS FOR THE PURPOSE OF PURCHASING COMPANIES; INVESTMENT ADVISORY SERVICES RELATING TO VENTURE AND CORPORATE CAPITAL (U.S. CLS. 100, 101 AND 102).

FIRST USE 11-24-2009; IN COMMERCE 11-24-2009.

3,785,301. CISCO TECHNOLOGY, INC., SAN JOSE, CA. SN 77-376,306. PUB. 5-13-2008, FILED 1-21-2008.

CCDE

THE MARK CONSISTS OF STANDARD CHARACTERS WITHOUT CLAIM TO ANY PARTICULAR FONT, STYLE, SIZE, OR COLOR.

CLASS 16—PAPER GOODS AND PRINTED MATTER

FOR INSTRUCTIONAL BOOKS AND MANUALS, PRINTED GUIDES FOR TEACHERS, AND TEST BOOKLETS, ALL IN THE FIELD OF INTERNETWORKING (U.S. CLS. 2, 5, 22, 23, 29, 37, 38 AND 50).

FIRST USE 1-0-2008; IN COMMERCE 1-0-2008.

CLASS 35—ADVERTISING AND BUSINESS

FOR PROVIDING TESTING TO DETERMINE PROFESSIONAL SKILLS IN THE FIELD OF NETWORKING EQUIPMENT AND COMPUTER SYSTEMS (U.S. CLS. 100, 101 AND 102).

FIRST USE 1-0-2008; IN COMMERCE 1-0-2008.

CLASS 41—EDUCATION AND ENTERTAINMENT

FOR EDUCATIONAL SERVICES, NAMELY, CONDUCTING SEMINARS, COURSES, AND WORKSHOPS IN THE FIELD OF NETWORKING EQUIPMENT AND COMPUTER SYSTEMS (U.S. CLS. 100, 101 AND 107).

FIRST USE 1-0-2008; IN COMMERCE 1-0-2008.

3,785,309. GARLAND ENERGY SYSTEMS, INC., CLEVELAND, OH. SN 77-384,527. PUB. 4-22-2008, FILED 1-30-2008.



THE MARK CONSISTS OF A CIRCLE WITH TWO SWOOSH MARKS FLOWING THROUGH THE LEFT SIDE OF THE CIRCLE.

CLASS 35—ADVERTISING AND BUSINESS

FOR CONSULTATION SERVICES IN THE FIELD OF ENERGY EFFICIENCY; INFORMATIONAL SERVICES IN THE FIELD OF ENERGY EFFICIENCY AND RENEWAL ENERGY EFFICIENCY; RENEWABLE ENERGY USAGE MANAGEMENT (U.S. CLS. 100, 101 AND 102).
FIRST USE 3-1-2009; IN COMMERCE 3-1-2009.

CLASS 42—SCIENTIFIC AND COMPUTER SERVICES

FOR TECHNICAL PLANNING OF RENEWABLE ENERGY GENERATION SYSTEMS FOR USE ON HOMES AND BUILDINGS; TECHNOLOGY CONSULTATION SERVICES IN THE FIELD OF RENEWABLE ENERGY (U.S. CLS. 100 AND 101).
FIRST USE 3-1-2009; IN COMMERCE 3-1-2009.

3,785,312. SEAGATE TECHNOLOGY LLC, SCOTTS VALLEY, CA. SN 77-386,021. PUB. 6-23-2009, FILED 1-31-2008.

SEACARE

THE MARK CONSISTS OF STANDARD CHARACTERS WITHOUT CLAIM TO ANY PARTICULAR FONT, STYLE, SIZE, OR COLOR.

CLASS 35—ADVERTISING AND BUSINESS

FOR PROVIDING CONSUMER WARRANTY SERVICES, NAMELY, ARRANGING FOR REPAIRS AND REPLACEMENT OF COMPUTER HARDWARE PURSUANT TO SERVICE AGREEMENT (U.S. CLS. 100, 101 AND 102).
FIRST USE 2-24-2010; IN COMMERCE 2-24-2010.

CLASS 36—INSURANCE AND FINANCIAL

FOR PROVIDING EXTENDED WARRANTY AND SERVICE CONTRACTS FOR PURCHASERS OF COMPUTER HARDWARE (U.S. CLS. 100, 101 AND 102).
FIRST USE 2-24-2010; IN COMMERCE 2-24-2010.

CLASS 42—SCIENTIFIC AND COMPUTER SERVICES

FOR COMPUTER TECHNOLOGY SUPPORT SERVICES, NAMELY, HELP DESK SERVICES; TECHNICAL SUPPORT SERVICES, NAMELY, TROUBLESHOOTING OF AND TECHNICAL ADVISING WITH RESPECT TO COMPUTER HARDWARE PROBLEMS (U.S. CLS. 100 AND 101).
FIRST USE 2-24-2010; IN COMMERCE 2-24-2010.

3,785,323. EXAGRID SYSTEMS, INC., WESTBOROUGH, MA. SN 77-391,869. PUB. 10-14-2008, FILED 2-7-2008.

EXAGRID

THE MARK CONSISTS OF STANDARD CHARACTERS WITHOUT CLAIM TO ANY PARTICULAR FONT, STYLE, SIZE, OR COLOR.

OWNER OF U.S. REG. NO. 2,989,981.

CLASS 9—ELECTRICAL AND SCIENTIFIC APPARATUS

FOR COMPUTER HARDWARE AND SOFTWARE FOR DISK-BASED BACKUP AND DATA PROTECTION FOR REPLACEMENT OF TAPE BACKUP SUBSYSTEMS AND EMPLOYING SCALABLE GRID ARCHITECTURE CONFIGURED FOR EXPANSION OF DATA STORAGE CAPACITY, EXCLUDING COMPUTER SOFTWARE FOR DISTRIBUTED COMPUTING (U.S. CLS. 21, 23, 26, 36 AND 38).
FIRST USE 12-0-2003; IN COMMERCE 12-0-2003.

CLASS 42—SCIENTIFIC AND COMPUTER SERVICES

FOR COMPUTER SOFTWARE RELATED SERVICES, NAMELY, PROVIDING CUSTOMER AND TECHNICAL SUPPORT SERVICES IN THE NATURE OF TROUBLESHOOTING COMPUTER SOFTWARE PROBLEMS, PROVIDING END-USERS WITH INFORMATION RELATED TO SOFTWARE IMPLEMENTATION AND USE, AND TROUBLESHOOTING COMPUTER SOFTWARE PROBLEMS RELATING TO THE INSTALLATION, USE AND PROBLEM RESOLUTION OF DISK-BASED BACKUP AND DATA PROTECTION SYSTEM AND SOFTWARE (U.S. CLS. 100 AND 101).
FIRST USE 12-0-2003; IN COMMERCE 12-0-2003.

3,785,325. SURFJAR, INC., SHERWOOD, OR. SN 77-392,337. PUB. 8-5-2008, FILED 2-8-2008.

SURFJAR

THE MARK CONSISTS OF STANDARD CHARACTERS WITHOUT CLAIM TO ANY PARTICULAR FONT, STYLE, SIZE, OR COLOR.

CLASS 9—ELECTRICAL AND SCIENTIFIC APPARATUS

FOR DOWNLOADABLE INTERNET BROWSER PLUG-INS AND CLIENT SERVER APPLICATIONS IN THE NATURE OF MULTI-FUNCTION TOOL BAR PLUG-INS; PROVIDING ON-LINE DOWNLOADABLE SOFTWARE FOR USE IN PROVIDING SEARCH ENGINE SERVICES WHICH ARE PROVIDED THROUGH A BROWSER TOOL BAR (U.S. CLS. 21, 23, 26, 36 AND 38).

FIRST USE 1-1-2008; IN COMMERCE 10-21-2009.

CLASS 35—ADVERTISING AND BUSINESS

FOR MARKETING SERVICES, NAMELY, PROVIDING SEARCH ENGINE MARKETING SERVICES, STRATEGIES AND PROCESSES, INCLUDING PAID PLACEMENT, SEARCH ENGINE RESULTS OPTIMIZATION, BID MANAGEMENT, AND LEAD GENERATION; ON-LINE ADVERTISING AND MARKETING SERVICES, NAMELY, TRACKING AND ANALYZING WEBSITE TRAFFIC FOR USE IN THE DISSEMINATION OF TARGETED ADVERTISEMENTS AND MARKETING MESSAGES TO WEBSITE VISITORS (U.S. CLS. 100, 101 AND 102).

FIRST USE 1-1-2008; IN COMMERCE 10-21-2009.

CLASS 41—EDUCATION AND ENTERTAINMENT

FOR CONDUCTING WORKSHOPS AND SEMINARS IN SELF IMPROVEMENT AND AWARENESS; EDUCATIONAL SERVICES, NAMELY, CONDUCTING SEMINARS AND WORKSHOPS IN THE FIELD OF SELF IMPROVEMENT AND AWARENESS AND DISTRIBUTION OF COURSE MATERIAL IN CONNECTION THEREWITH; EDUCATION SERVICES, NAMELY, PROVIDING LIVE AND ON-LINE SEMINARS AND WORKSHOPS IN THE FIELD OF SELF IMPROVEMENT AND AWARENESS; EDUCATIONAL SERVICES, NAMELY, CONDUCTING INFORMAL PROGRAMS IN THE FIELDS OF SELF IMPROVEMENT AND AWARENESS, USING ON-LINE ACTIVITIES AND INTERACTIVE EXHIBITS, AND PRINTABLE MATERIALS DISTRIBUTED THEREWITH; EDUCATIONAL SERVICES, NAMELY, CONDUCTING PROGRAMS IN THE FIELD OF SELF IMPROVEMENT AND AWARENESS (U.S. CLS. 100, 101 AND 107).

FIRST USE 11-9-2007; IN COMMERCE 5-30-2008.

3,785,330. SYNCADA LLC, MINNEAPOLIS, MN. SN 77-400,596. PUB. 4-28-2009, FILED 2-19-2008.

3,785,329. ZZZ INTECH LLC, MINDEN, NV. SN 77-396,356. PUB. 12-9-2008, FILED 2-13-2008.

TAC-NEURS

THE MARK CONSISTS OF STANDARD CHARACTERS WITHOUT CLAIM TO ANY PARTICULAR FONT, STYLE, SIZE, OR COLOR.

CLASS 16—PAPER GOODS AND PRINTED MATTER

FOR EDUCATIONAL PUBLICATIONS, NAMELY, BOOKS, AND OTHER PRINTED LITERATURE, NAMELY, FLYERS AND NEWSLETTERS, IN THE FIELDS OF SELF IMPROVEMENT AND AWARENESS; PRINTED INSTRUCTIONAL, EDUCATIONAL, AND TEACHING MATERIALS IN THE FIELD OF SELF IMPROVEMENT AND AWARENESS (U.S. CLS. 2, 5, 22, 23, 29, 37, 38 AND 50).

FIRST USE 11-9-2007; IN COMMERCE 5-30-2008.

CLASS 28—TOYS AND SPORTING GOODS

FOR EDUCATIONAL BOARD GAMES IN THE FIELDS OF SELF IMPROVEMENT AND AWARENESS (U.S. CLS. 22, 23, 38 AND 50).

FIRST USE 11-9-2007; IN COMMERCE 5-30-2008.

PowerTrack Network

THE MARK CONSISTS OF STANDARD CHARACTERS WITHOUT CLAIM TO ANY PARTICULAR FONT, STYLE, SIZE, OR COLOR.

NO CLAIM IS MADE TO THE EXCLUSIVE RIGHT TO USE "NETWORK", APART FROM THE MARK AS SHOWN.

CLASS 9—ELECTRICAL AND SCIENTIFIC APPARATUS

FOR COMPUTER E-COMMERCE SOFTWARE TO ALLOW USERS TO PERFORM ELECTRONIC BUSINESS TRANSACTIONS VIA A GLOBAL COMPUTER NETWORK (U.S. CLS. 21, 23, 26, 36 AND 38).

FIRST USE 10-1-2007; IN COMMERCE 10-1-2007.

CLASS 35—ADVERTISING AND BUSINESS

FOR PROVIDING AN ONLINE DATABASE IN THE FIELDS OF FREIGHT BILLING AND COMPUTERIZED TRACKING OF SHIPMENTS IN TRANSIT (U.S. CLS. 100, 101 AND 102).

FIRST USE 10-1-2007; IN COMMERCE 10-1-2007.

CLASS 36—INSURANCE AND FINANCIAL

FOR BANKING SERVICES, NAMELY, PAYMENT PROCESSING SERVICES AND AUTOMATIC BILL PAYMENT SERVICES (U.S. CLS. 100, 101 AND 102).

FIRST USE 10-1-2007; IN COMMERCE 10-1-2007.

CLASS 38—COMMUNICATION

FOR ELECTRONIC TRANSMISSION OF FREIGHT BILLING AND SHIPPING DATA (U.S. CLS. 100, 101 AND 104).

FIRST USE 10-1-2007; IN COMMERCE 10-1-2007.

3,785,331. DISCOVERY COMMUNICATIONS, LLC, SILVER SPRING, MD. SN 77-400,648. PUB. 11-4-2008, FILED 2-19-2008.

3,785,334. CREDIT SUISSE SECURITIES (USA) LLC, NEW YORK, NY. SN 77-404,235. PUB. 8-4-2009, FILED 2-22-2008.



OWNER OF U.S. REG. NOS. 883,953, 1,602,072, AND OTHERS.

NO CLAIM IS MADE TO THE EXCLUSIVE RIGHT TO USE "CHANNEL" FOR INTERNATIONAL CLASSES 038 AND 041, APART FROM THE MARK AS SHOWN.

THE COLOR(S) BLUE, GREEN, WHITE, AND BLACK IS/ARE CLAIMED AS A FEATURE OF THE MARK.

THE MARK CONSISTS OF THE WORD "DISCOVERY" APPEARING IN BLACK ABOVE THE WORD "CHANNEL", ALSO IN BLACK, WITH A GLOBE FEATURING THE COLORS BLUE, GREEN AND WHITE SUPERIMPOSED OVER THE LEFT SIDE OF THE LETTER "D" IN "DISCOVERY".

CLASS 9—ELECTRICAL AND SCIENTIFIC APPARATUS

FOR PRE-RECORDED VIDEO DISKS, AUDIO-VISUAL RECORDINGS AND DVDS, ALL FEATURING NON-FICTION SUBJECTS OF GENERAL HUMAN INTEREST (U.S. CLS. 21, 23, 26, 36 AND 38).

FIRST USE 3-31-2008; IN COMMERCE 5-6-2008.

CLASS 38—COMMUNICATION

FOR BROADCASTING PROGRAMS VIA A GLOBAL COMPUTER NETWORK; CABLE TELEVISION BROADCASTING; PODCASTING SERVICES; PROVIDING ELECTRONIC BULLETIN BOARDS FOR TRANSMISSION OF MESSAGES AMONG USERS IN THE FIELD OF GENERAL INTEREST; SATELLITE TELEVISION BROADCASTING; SATELLITE, CABLE, NETWORK TRANSMISSION OF SOUNDS, IMAGES, SIGNALS AND DATA; STREAMING OF AUDIO MATERIAL ON THE INTERNET; STREAMING OF VIDEO MATERIAL ON THE INTERNET; VIDEO BROADCASTING; VIDEO-ON-DEMAND TRANSMISSION SERVICES; WEBCASTING SERVICES; TELEVISION BROADCASTING SERVICES (U.S. CLS. 100, 101 AND 104).

FIRST USE 3-31-2008; IN COMMERCE 3-31-2008.

CLASS 41—EDUCATION AND ENTERTAINMENT

FOR ENTERTAINMENT SERVICES, NAMELY, PRODUCTION OF TELEVISION SHOWS; ENTERTAINMENT SERVICES, NAMELY, PROVIDING ONGOING TELEVISION PROGRAMS FEATURING SUBJECTS OF GENERAL HUMAN INTEREST VIA A GLOBAL COMPUTER NETWORK; PRODUCTION OF RADIO OR TELEVISION PROGRAMS; ENTERTAINMENT IN THE NATURE OF ON-GOING TELEVISION PROGRAMS FEATURING NON-FICTION SUBJECTS OF GENERAL HUMAN INTEREST BROADCAST OVER TELEVISION, SATELLITE, AUDIO, AND VIDEO MEDIA (U.S. CLS. 100, 101 AND 107).

FIRST USE 3-31-2008; IN COMMERCE 3-31-2008.

SPOLES

THE MARK CONSISTS OF STANDARD CHARACTERS WITHOUT CLAIM TO ANY PARTICULAR FONT, STYLE, SIZE, OR COLOR.

CLASS 36—INSURANCE AND FINANCIAL

FOR FINANCIAL SERVICES, NAMELY, PROVIDING FINANCIAL INFORMATION ABOUT FINANCIAL SECURITIES THAT WILL BE AVAILABLE TO PURCHASE (U.S. CLS. 100, 101 AND 102).

FIRST USE 2-2-2008; IN COMMERCE 7-3-2009.

CLASS 42—SCIENTIFIC AND COMPUTER SERVICES

FOR PROVIDING TEMPORARY USE OF ON-LINE NON-DOWNLOADABLE SOFTWARE FOR COMMUNICATING INDICATIONS OF INTEREST AND BIDS FOR THE PURCHASE OF FINANCIAL SECURITIES (U.S. CLS. 100 AND 101).

FIRST USE 2-2-2008; IN COMMERCE 7-3-2009.

3,785,336. XYLECO, INC., WOBURN, MA. SN 77-405,348. PUB. 1-20-2009, FILED 2-25-2008.

XYLECOL

THE MARK CONSISTS OF STANDARD CHARACTERS WITHOUT CLAIM TO ANY PARTICULAR FONT, STYLE, SIZE, OR COLOR.

CLASS 1—CHEMICALS

FOR CHEMICALS OR CHEMICAL ADDITIVES FOR USE IN THE MANUFACTURE OF ENERGY AND COMBUSTIBLE FUELS; ETHANOL; BUTANOL; ALCOHOL FOR USE AS A FUEL ADDITIVE (U.S. CLS. 1, 5, 6, 10, 26 AND 46).

FIRST USE 11-17-2009; IN COMMERCE 11-17-2009.

CLASS 4—LUBRICANTS AND FUELS

FOR FUELS; BIOFUELS; ETHANOL, BUTANOL, AND ALCOHOL FUELS AND MIXED FUELS (U.S. CLS. 1, 6 AND 15).

FIRST USE 11-17-2009; IN COMMERCE 11-17-2009.

3,785,337. TABLETOPS UNLIMITED, INC., CARSON, CA.
SN 77-406,662. PUB. 5-19-2009, FILED 2-26-2008.



OWNER OF U.S. REG. NOS. 1,797,554, 3,131,632, AND OTHERS.

NO CLAIM IS MADE TO THE EXCLUSIVE RIGHT TO USE "SINCE 1983", APART FROM THE MARK AS SHOWN.

THE COLOR(S) RED, WHITE AND BLACK IS/ARE CLAIMED AS A FEATURE OF THE MARK.

THE MARK CONSIST STYLIZED LETTERS "TTU" IN WHITE, INSIDE A RED RECTANGLE HAVING THE WORDING "TABLETOPS UNLIMITED SINCE 1983" LOCATED BELOW THE RECTANGLE IN THE COLOR BLACK.

CLASS 8—HAND TOOLS

FOR CUTLERY, FLATWARE AND UTENSILS, NAMELY, FORKS, KNIVES AND SPOONS; PIZZA CUTTERS, SCISSORS, CLEAVERS, CAN OPENERS, CAKE CUTTERS, CHEESE SLICERS, COOKING TONGS (U.S. CLS. 23, 28 AND 44).

FIRST USE 5-4-2009; IN COMMERCE 5-4-2009.

CLASS 21—HOUSEWARES AND GLASS

FOR COOKWARE AND KITCHENWARE, NAMELY, DISHES, POTS AND PANS, BEVERAGEWARE, BAKEWARE, SERVING SPOONS, SERVING FORKS, SERVING TONGS, SERVING LADLES, PLATES, CUPS, BOWLS, SAUCERS, MUGS, SERVING TRAYS NOT OF PRECIOUS METALS, SERVING PLATTERS, ICE BUCKETS, SALT AND PEPPER SHAKERS, CHEESE SHAKERS, CHEESE GRATERS, CANISTER SETS, CONTAINERS FOR HOUSEHOLD USE, TEA KETTLES, DUTCH OVENS, STOCK POTS, FRYING PANS, TOWEL BARS, NAPKIN HOLDERS, COOKIE JARS, TRIVETS, VASES, GRAVY BOATS, BOTTLES SOLD EMPTY, PITCHERS, FLOWER POTS, SPOON RESTS, CUTTING BOARDS, NON-ELECTRIC PRESSURE COOKERS, NON-ELECTRIC LOW PRESSURE COOKERS, ROASTING PANS (U.S. CLS. 2, 13, 23, 29, 30, 33, 40 AND 50).

FIRST USE 10-31-2008; IN COMMERCE 10-31-2008.

3,785,338. BRIDGEWATER TECH, INC., FARIBAULT, MN.
SN 77-407,755. PUB. 10-27-2009, FILED 2-27-2008.

TRYSTAR

THE MARK CONSISTS OF STANDARD CHARACTERS WITHOUT CLAIM TO ANY PARTICULAR FONT, STYLE, SIZE, OR COLOR.

CLASS 6—METAL GOODS

FOR INDUSTRIAL WIRE (U.S. CLS. 2, 12, 13, 14, 23, 25 AND 50).

FIRST USE 2-1-1998; IN COMMERCE 2-1-1998.

CLASS 9—ELECTRICAL AND SCIENTIFIC APPARATUS

FOR INDUSTRIAL ELECTRICAL CABLE, NAMELY, WELDING CABLE, INDUSTRIAL POWER CABLE, MINING CABLE, BATTERY CABLE AND GROUNDING CABLE FOR INDUSTRIAL USE; ELECTRICAL PRODUCTS AND ACCESSORIES IN THE NATURE OF POWER DISTRIBUTION EQUIPMENT FOR USE IN PROVIDING TEMPORARY POWER SOURCES, NAMELY, INDUSTRIAL POWER DISTRIBUTORS, POWER TRANSFER SWITCHES, POWER FUSE BOXES, CONNECTORS, CONNECTOR PLUGS (U.S. CLS. 21, 23, 26, 36 AND 38).

FIRST USE 2-1-1998; IN COMMERCE 2-1-1998.

3,785,342. NOAX TECHNOLOGIES AG, EBERSBERG, FED REP GERMANY. SN 77-408,994. PUB. 5-19-2009, FILED 2-28-2008.

NOAX

THE MARK CONSISTS OF STANDARD CHARACTERS WITHOUT CLAIM TO ANY PARTICULAR FONT, STYLE, SIZE, OR COLOR.

CLASS 9—ELECTRICAL AND SCIENTIFIC APPARATUS

FOR COMPUTERS, INDUSTRIAL COMPUTERS; READERS, IN PARTICULAR BAR CODE READERS; COMPUTER PROGRAMS FOR USE IN CONFIGURATION, CONTROL, TESTING, AND DIAGNOSIS OF COMPUTER HARDWARE AND COMPUTER SOFTWARE SYSTEMS; SOFTWARE ON DATA MEDIA FOR USE IN CONFIGURATION, CONTROL, TESTING, AND DIAGNOSIS OF COMPUTER HARDWARE AND COMPUTER SOFTWARE SYSTEMS; SOFTWARE FOR USE IN CONFIGURATION, CONTROL, TESTING, AND DIAGNOSIS OF COMPUTER HARDWARE AND COMPUTER SOFTWARE SYSTEMS (U.S. CLS. 21, 23, 26, 36 AND 38).

FIRST USE 2-29-2000; IN COMMERCE 2-29-2000.

CLASS 42—SCIENTIFIC AND COMPUTER SERVICES

FOR COMPUTER SOFTWARE CONSULTANCY; COMPUTER PROGRAMMING SERVICES; INFORMATION TECHNOLOGY CONSULTANCY; DESIGN OF COMPUTER PROGRAMS FOR DATA PROCESSING; INSTALLATION AND MAINTENANCE OF SOFTWARE (U.S. CLS. 100 AND 101).

FIRST USE 2-29-2000; IN COMMERCE 2-29-2000.

3,785,345. BOWER-MCLAUGHLIN, GLORIA J., CLAREMONT, CA. SN 77-413,033. PUB. 11-25-2008, FILED 3-4-2008.

3,785,347. ZHEN DISTRIBUTION, INC., SEATTLE, WA. SN 77-414,057. PUB. 2-10-2009, FILED 3-5-2008.

TAMING CHAOS BY TAKING CONTROL

THE MARK CONSISTS OF STANDARD CHARACTERS WITHOUT CLAIM TO ANY PARTICULAR FONT, STYLE, SIZE, OR COLOR.

CLASS 16—PAPER GOODS AND PRINTED MATTER

FOR PRINTED MATERIALS, NAMELY, INSTRUCTION AND TRAINING MANUALS, BOOKLETS, SHEETS, AND FORMS IN THE FIELD OF STATISTICAL ANALYSIS, QUALITY IMPROVEMENT, QUALITY CONTROL, PRESENTATION METHODOLOGIES, PRESENTATION SKILLS, DATA COLLECTION, DATA MANAGEMENT, PERFORMANCE MANAGEMENT, PERFORMANCE REPORTING, PERFORMANCE EVALUATION, BOARD OF DIRECTOR'S REPORTING TOOLS, MANAGEMENT REPORTING TOOLS, HEALTHCARE, HEALTHCARE MANAGEMENT (U.S. CLS. 2, 5, 22, 23, 29, 37, 38 AND 50).

FIRST USE 7-1-2009; IN COMMERCE 7-1-2009.

CLASS 35—ADVERTISING AND BUSINESS

FOR BUSINESS CONSULTING IN THE FIELD OF STATISTICAL ANALYSIS, BUSINESS CONSULTING IN THE FIELD OF EMPLOYEE PERFORMANCE, SALES PERFORMANCE, QUALITY IMPROVEMENT AND QUALITY CONTROL, BUSINESS CONSULTING IN THE FIELD OF PRESENTATION METHODOLOGIES AND PRESENTATION SKILLS, BUSINESS CONSULTING IN THE FIELD OF REPORTING, NAMELY, PREPARING BUSINESS REPORTS, CONSULTING IN THE FIELD OF BUSINESS AND EMPLOYMENT, DATA COLLECTION AND DATA MANAGEMENT, CONSULTING IN THE FIELD OF EMPLOYEE AND SALES PERFORMANCE, PERFORMANCE MANAGEMENT, PERFORMANCE REPORTING AND PERFORMANCE EVALUATION, BUSINESS CONSULTING IN THE FIELD OF HEALTHCARE MANAGEMENT (U.S. CLS. 100, 101 AND 102).

FIRST USE 7-1-2009; IN COMMERCE 7-1-2009.

CLASS 41—EDUCATION AND ENTERTAINMENT

FOR TRAINING CONSULTING IN THE FIELD OF BOARD OF DIRECTOR'S TRAINING (U.S. CLS. 100, 101 AND 107).

FIRST USE 7-1-2009; IN COMMERCE 7-1-2009.



NO CLAIM IS MADE TO THE EXCLUSIVE RIGHT TO USE "THE ORIGINAL", APART FROM THE MARK AS SHOWN.

THE MARK CONSISTS OF STYLIZED LOGO WITH THE WORDS "INNER" AND "VIBE" INTERTWINED AND THE WORDS "THE ORIGINAL" APPEARING ABOVE THE INTERTWINED WORDS AND "YOUR PLEASURE PEOPLE" APPEARING BELOW THE INTERTWINED WORDS; ALL OF THE WORDS APPEARING INSIDE A SHAPE WITH POINTS ON THE TOP AND BOTTOM AND ROUNDED ON THE SIDES.

CLASS 10—MEDICAL APPARATUS

FOR PERSONAL PLEASURE DEVICES AS SEXUAL AIDS FOR ADULTS, NAMELY, VIBRATORS (U.S. CLS. 26, 39 AND 44).

FIRST USE 1-1-2005; IN COMMERCE 1-1-2008.

CLASS 35—ADVERTISING AND BUSINESS

FOR RETAIL STORE SERVICES FEATURING PERSONAL PLEASURE DEVICES AS SEXUAL AIDS FOR ADULTS, NAMELY, VIBRATORS (U.S. CLS. 100, 101 AND 102).

FIRST USE 1-1-2005; IN COMMERCE 1-1-2008.

3,785,352. DIXIE CONSUMER PRODUCTS LLC, ATLANTA, GA. SN 77-416,040. PUB. 11-25-2008, FILED 3-7-2008.



OWNER OF U.S. REG. NOS. 1,070,923, 2,420,129, AND OTHERS.

THE MARK CONSISTS OF A STYLIZED LETTER "X".

CLASS 16—PAPER GOODS AND PRINTED MATTER

FOR PAPER NAPKINS (U.S. CLS. 2, 5, 22, 23, 29, 37, 38 AND 50).

FIRST USE 9-4-2007; IN COMMERCE 9-4-2007.

CLASS 21—HOUSEWARES AND GLASS

FOR CUPS; DISPOSABLE TABLE PLATES; BOWLS (U.S. CLS. 2, 13, 23, 29, 30, 33, 40 AND 50).

FIRST USE 12-12-2005; IN COMMERCE 12-12-2005.

3,785,371. TZENG SHYNG INDUSTRIES CORP., TAINAN HSIEN, TAIWAN. SN 77-428,598. PUB. 5-5-2009, FILED 3-21-2008.



THE MARK CONSISTS OF STYLIZED LETTERS "TS" WITHIN A CIRCLE IN BLACK BACKGROUND.

CLASS 9—ELECTRICAL AND SCIENTIFIC APPARATUS

FOR ELECTRONIC ADVERTISING BOARDS; COMPUTER SHELLS; COMPUTERS; CAMERAS; CAMCORDERS; MOVIE PROJECTORS; PHOTOGRAPHY TOOL BOXES, NAMELY, CASES ESPECIALLY MADE FOR PHOTOGRAPHIC APPARATUS AND INSTRUMENTS; VIDEO RECORDERS/PLAYERS; TV SETS; TV SET SHELLS; STEREO SET COVERS; SPEAKER SOUND BOXES; COMPUTER GAME CONSOLES FOR USE WITH AN EXTERNAL DISPLAY SCREEN OR MONITOR; TRAFFIC SAFETY AND WARNING EQUIPMENT, NAMELY, REFLECTING DISCS, FOR WEAR, FOR THE PREVENTION OF TRAFFIC ACCIDENTS, WARNING TRIANGLES FOR VEHICLE BREAKDOWN OR EMERGENCY, SAFETY RESTRAINTS EXCLUDING VEHICLE SEATS AND SPORTS EQUIPMENT, ACOUSTIC ALARMS, LUMINOUS SAFETY BEACONS, PROTECTIVE MASKS AND GLOVES; TELEPHONE SETS; TELEPHONE SET SHELLS; FACSIMILE MACHINES; ELECTRICAL AND MECHANICAL EQUIPMENT SHELLS FOR ELECTRICAL CONDUITS COVERS FOR ELECTRIC OUTLETS, PLUGS, SOCKETS AND OTHER ELECTRIC CONNECTORS, ELECTRICITY DISTRIBUTION BOXES; TESTING INSTRUMENT SHELLS FOR AEROMETERS, ALCOHOLMETERS, ALTIMETERS, AMMETERS, ANEMOMETERS, BAROMETERS, CAPACITY MEASURES, ERGOMETERS, HYGROMETERS, PYROMETERS; AND DRINK VENDING MACHINES (U.S. CLS. 21, 23, 26, 36 AND 38).

FIRST USE 11-1-2009; IN COMMERCE 11-1-2009.

CLASS 11—ENVIRONMENTAL CONTROL APPARATUS

FOR LANTERNS FOR LIGHTING; ELECTRIC LAMPS; LIGHTING FIXTURES; LIGHTING APPARATUS FOR VEHICLES; ELECTRICAL EQUIPMENTS, NAMELY, COOKERS, ELECTRIC COOKING UTENSILS, ELECTRIC COFFEE MACHINES, HAIR DRYERS; BLADES FOR ELECTRIC FANS; BLADES OF CEILING FANS; BATHING INSTALLATIONS, NAMELY, BATHS, BATH-TUBS, WHIRLPOOL, AND BATH INSTALLATIONS; TOILET SEATS; WATER SUPPLIES, NAMELY, HOT WATER TANKS; REFRIGERATING APPLIANCES AND INSTALLATIONS, NAMELY, REFRIGERATORS; COOLING APPLIANCES AND INSTALLATIONS, NAMELY, AIR COOLING APPARATUS; WATER DISPENSERS; WATER FILTERS; WATER SERVERS; WATER STERILIZERS FOR NON-INDUSTRIAL USE; EXHAUST HOODS FOR KITCHENS; ELECTRIC COOKING OVENS; AIR CONDITIONING INSTALLATIONS; AND ELECTRIC RADIATORS; IRONING TABLES THAT GENERATE STEAM FOR IRONING (U.S. CLS. 13, 21, 23, 31 AND 34).

FIRST USE 11-1-2009; IN COMMERCE 11-1-2009.

CLASS 16—PAPER GOODS AND PRINTED MATTER

FOR BOOKS IN THE FIELD OF COMPUTER, CAMERA, ACOUSTICS, COOKING, FURNITURE, TOYS, SPORTS; MAGAZINES IN THE FIELD OF COMPUTER, CAMERA, ACOUSTICS, COOKING, FURNITURE, TOYS, SPORTS; DRAWINGS; PRINTED MATTER, NAMELY, CALENDARS, GEOGRAPHICAL MAPS, PRINTED FORMS, POSTERS (U.S. CLS. 2, 5, 22, 23, 29, 37, 38 AND 50).

FIRST USE 11-1-2009; IN COMMERCE 11-1-2009.

CLASS 20—FURNITURE AND ARTICLES NOT OTHERWISE CLASSIFIED

FOR PAPER PHOTO FRAMES; DESKTOP BOOK-SHELVES AND DESKTOP ARCHIVE BOOKSHELVES; FURNITURE; DESKS; CHAIRS; BOOKCASES; SHOE CABINETS; CUPBOARDS; DISPLAY STANDS; FLOWER RACKS; TV SET RACKS; PLASTIC OR ACRYLIC SCULPTURES PLASTIC OR ACRYLIC FIGURINES; BAMBOO CURTAINS; WINDOW BLINDS; PICTURE FRAMES; PHOTO FRAMES; PLASTIC PACKAGING CONTAINERS; PLASTIC TOOL BOXES; PLASTIC COVERS, NAMELY, PLASTIC TISSUE BOX COVERS; PLASTIC BASEBALL CARD COLLECTORS CASES; PLASTIC PACKAGING CONTAINERS; PLASTIC BULLETIN BOARDS; PLASTIC SIGNBOARDS; TOWEL RACKS; COAT RACKS (U.S. CLS. 2, 13, 22, 25, 32 AND 50).

FIRST USE 11-1-2009; IN COMMERCE 11-1-2009.

CLASS 21—HOUSEWARES AND GLASS

FOR PLASTIC BUCKETS; PLASTIC BOTTLES SOLD EMPTY; PLASTIC BASKETS; PLASTIC FOOD STORAGE CONTAINERS; ANIMAL LITTER BOXES; KITCHEN TOOLS AND TABLEWARE, NAMELY, GRILLS, GRATERS, SIEVES, STRAINERS, SPATULAS, AND TURNERS; CONTAINERS FOR KITCHEN USE; HOUSEHOLD CONTAINERS FOR FOODS; CUPS; BOWLS; DISHES; KETTLES; PANS; AIR PRESSURE SAUCE BOTTLES, NAMELY, SELTZER BOTTLES; CLEANING BRUSHES NOT FOR PERSONAL USE, NAMELY, DISH-WASHING BRUSHES, FLOOR BRUSHES AND SCRUBBING BRUSHES; COMBS; FLOWER VASES; FLOWER POTS; SHOE TREES; SHOE STRETCHERS; IRONING BOARDS; INCENSE BURNERS; CANDLESTICKS; MAKE-UP BRUSHES; LADLES; GARBAGE BINS; CLOTHES DRYING RACKS; WASH BASINS; DENTAL CUPS, NAMELY, PAPER CUPS; SOAP BOXES; WATER BUCKETS; ICE PAILS; VACUUM FLASKS; FOOD VACUUM FLASKS; AND DRINK ADIABATIC CONTAINERS, NAMELY, THERMAL INSULATED CONTAINERS FOR BEVERAGES (U.S. CLS. 2, 13, 23, 29, 30, 33, 40 AND 50).

FIRST USE 11-1-2009; IN COMMERCE 11-1-2009.

CLASS 28—TOYS AND SPORTING GOODS

FOR SPORTS EQUIPMENT, NAMELY, INLINE SKATES, TENNIS RACKETS; SURFBOARDS; SKIS, ANGLING TOOLS, NAMELY, FISHING POLES, FISHING LURES AND FISHING HOOKS; ANGLING BAGS, NAMELY, SPORTSMAN'S FISHING BAGS; CHRISTMAS TREE DECORATIONS EXCLUDING LIGHTING DECORATIONS AND CANDLES; ARTIFICIAL CHRISTMAS TREES; AMUSEMENT PARK RIDES; AND PARTS FOR AMUSEMENT GAME MACHINES AND COIN-OPERATED VIDEO GAMES, NAMELY, OUTER SHELLS (U.S. CLS. 22, 23, 38 AND 50).

FIRST USE 11-1-2009; IN COMMERCE 11-1-2009.

3,785,380. XYSTUS, COOPER CITY, FL. SN 77-442,277. PUB. 9-2-2008, FILED 4-7-2008.



THE COLOR(S) RED, WHITE, BLUE, BLACK. IS/ARE CLAIMED AS A FEATURE OF THE MARK.

THE MARK CONSISTS OF A BLUE CIRCLE WITH A BLACK OUTLINE. A RED HORIZONTAL BANNER THAT WRAPS AROUND THE CIRCLE. THE BANNER ALSO HAS A BLACK OUTLINE. "NUTTY HEADS" IS SPELLED ON TOP OF THE BANNER IN WHITE LETTERS. THE OUTLINE AROUND THE LETTERS IS BLACK AS WELL.

CLASS 9—ELECTRICAL AND SCIENTIFIC APPARATUS

FOR INTERACTIVE VIDEO GAME PROGRAMS (U.S. CLS. 21, 23, 26, 36 AND 38).

FIRST USE 6-2-2008; IN COMMERCE 6-2-2008.

CLASS 25—CLOTHING

FOR T-SHIRTS (U.S. CLS. 22 AND 39).

FIRST USE 6-2-2008; IN COMMERCE 6-2-2008.

CLASS 41—EDUCATION AND ENTERTAINMENT

FOR PRODUCTION OF TELEVISION AND RADIO PROGRAMMES (U.S. CLS. 100, 101 AND 107).

FIRST USE 6-2-2008; IN COMMERCE 6-2-2008.

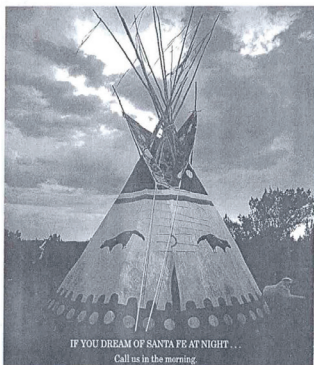

THE MARK CONSISTS OF THE PHRASE "IF YOU DREAM OF SANTA FE AT NIGHT ... CALL US IN THE MORNING." AND AN IMAGE OF A TEEPEE AGAINST THE BACKGROUND OF A CLOUDY EVENING SKY.

CLASS 35—ADVERTISING AND BUSINESS

FOR REAL ESTATE ADVERTISING SERVICES; REAL ESTATE MARKETING SERVICES, NAMELY, ON-LINE SERVICES FEATURING TOURS OF RESIDENTIAL AND COMMERCIAL REAL ESTATE (U.S. CLS. 100, 101 AND 102).

FIRST USE 1-1-1982; IN COMMERCE 1-1-1982.

CLASS 36—INSURANCE AND FINANCIAL

FOR REAL ESTATE ACQUISITION SERVICES; REAL ESTATE AGENCIES; REAL ESTATE APPRAISAL; REAL ESTATE CONSULTANCY; REAL ESTATE CONSULTATION; REAL ESTATE VALUATION SERVICES; REAL ESTATE VALUATIONS; REAL ESTATE BROKERAGE; REAL ESTATE ESCROW SERVICES; REAL ESTATE INVESTMENT; REAL ESTATE LISTING; REAL ESTATE PROCUREMENT FOR OTHERS; REAL ESTATE SYNDICATION; REAL ESTATE EQUITY SHARING, NAMELY, MANAGING AND ARRANGING FOR CO-OWNERSHIP OF REAL ESTATE (U.S. CLS. 100, 101 AND 102).

FIRST USE 1-1-1982; IN COMMERCE 1-1-1982.

3,785,381. XYSTUS, COOPER CITY, FL. SN 77-442,288. PUB. 9-2-2008, FILED 4-7-2008.

Nutty Heads

THE MARK CONSISTS OF STANDARD CHARACTERS WITHOUT CLAIM TO ANY PARTICULAR FONT, STYLE, SIZE, OR COLOR.

CLASS 9—ELECTRICAL AND SCIENTIFIC APPARATUS

FOR INTERACTIVE VIDEO GAME PROGRAMS (U.S. CLS. 21, 23, 26, 36 AND 38).

FIRST USE 3-2-2008; IN COMMERCE 3-2-2008.

CLASS 25—CLOTHING

FOR T-SHIRTS (U.S. CLS. 22 AND 39).

FIRST USE 3-2-2008; IN COMMERCE 3-2-2008.

CLASS 41—EDUCATION AND ENTERTAINMENT

FOR PRODUCTION OF TELEVISION AND RADIO PROGRAMMES (U.S. CLS. 100, 101 AND 107).
FIRST USE 3-2-2008; IN COMMERCE 3-2-2008.

3,785,387. AMERICA'S HEALTH INSURANCE PLANS, INC., WASHINGTON, DC. SN 77-445,350. PUB. 6-30-2009, FILED 4-10-2008.

MY LIFE. MY FAMILY.

3,785,386. AMERICAN SOCIETY OF CLINICAL ONCOLOGY, ALEXANDRIA, VA. SN 77-445,323. PUB. 11-25-2008, FILED 4-10-2008.

THE MARK CONSISTS OF STANDARD CHARACTERS WITHOUT CLAIM TO ANY PARTICULAR FONT, STYLE, SIZE, OR COLOR.

ASCO UNIVERSITY**CLASS 35—ADVERTISING AND BUSINESS**

FOR PROVIDING INFORMATION VIA INTERNET WEB SITES FEATURING INFORMATION ON GOVERNMENTAL AND CORPORATE BUSINESS POLICIES REGARDING LONG-TERM CARE INSURANCE (U.S. CLS. 100, 101 AND 102).
FIRST USE 8-1-2008; IN COMMERCE 8-1-2008.

CLASS 36—INSURANCE AND FINANCIAL

FOR PROVIDING INFORMATION VIA INTERNET WEB SITES FEATURING INFORMATION ON LONG-TERM CARE INSURANCE (U.S. CLS. 100, 101 AND 102).
FIRST USE 8-1-2008; IN COMMERCE 8-1-2008.

THE MARK CONSISTS OF STANDARD CHARACTERS WITHOUT CLAIM TO ANY PARTICULAR FONT, STYLE, SIZE, OR COLOR.

OWNER OF U.S. REG. NOS. 1,280,954, 2,496,317, AND 2,542,674.

NO CLAIM IS MADE TO THE EXCLUSIVE RIGHT TO USE "UNIVERSITY", APART FROM THE MARK AS SHOWN.

3,785,392. CARDWORKS, INC., WOODBURY, NY. SN 77-449,807. PUB. 9-22-2009, FILED 4-16-2008.

CARDWORKS**CLASS 35—ADVERTISING AND BUSINESS**

FOR PROVIDING AN ON-LINE DIRECTORY INFORMATION SERVICE FEATURING INFORMATION REGARDING EDUCATIONAL SERVICES IN THE PRACTICE OF CLINICAL RESEARCH AND MEDICAL CARE OF PATIENTS WITH CANCER (U.S. CLS. 100, 101 AND 102).

FIRST USE 2-14-2008; IN COMMERCE 2-14-2008.

THE MARK CONSISTS OF STANDARD CHARACTERS WITHOUT CLAIM TO ANY PARTICULAR FONT, STYLE, SIZE, OR COLOR.

OWNER OF U.S. REG. NO. 2,358,205.

CLASS 38—COMMUNICATION

FOR PROVIDING ON-LINE FORUMS FOR TRANSMISSION OF MESSAGES AMONG MEMBERS AND ON-LINE GUESTS CONCERNING INFORMATION AND IDEAS RELATING TO ONCOLOGY (U.S. CLS. 100, 101 AND 104).

FIRST USE 8-18-2009; IN COMMERCE 8-18-2009.

CLASS 35—ADVERTISING AND BUSINESS

FOR CUSTOMER SERVICE, NAMELY, ASSISTING MERCHANTS IN ADDRESSING PROBLEMS ARISING FROM THE MERCHANT'S CUSTOMERS USE OF TRANSACTION CARDS FOR PAYMENT FOR GOODS AND SERVICES; ARRANGING FOR MERCHANTS TO ENTER INTO BANKING RELATIONSHIPS WITH BANKS FOR THE PURPOSE OF ALLOWING THE ACCEPTANCE OF TRANSACTION CARDS BY THE MERCHANT FOR PURCHASES (U.S. CLS. 100, 101 AND 102).

FIRST USE 4-0-2008; IN COMMERCE 4-0-2008.

CLASS 41—EDUCATION AND ENTERTAINMENT

FOR EDUCATIONAL SERVICES, NAMELY, PROVIDING TRAINING, ONLINE CLASSES, SEMINARS, CONFERENCES, SYMPOSIA AND WORKSHOPS FOR THE EXCHANGE AND DIFFUSION OF INFORMATION AND IDEAS RELATING TO ONCOLOGY AND RELATING TO THE PRACTICE OF CLINICAL RESEARCH AND MEDICAL CARE OF PATIENTS WITH CANCER; PROVIDING ON-LINE PUBLICATIONS IN THE NATURE OF EDUCATIONAL SELF-ASSESSMENT MATERIALS AND TRAINING MATERIALS IN THE FIELD OF ONCOLOGY VIA A MULTI-USER GLOBAL COMPUTER INFORMATION NETWORK, OR ON-LINE VIA THE INTERNET OR A COMPUTER NETWORK (U.S. CLS. 100, 101 AND 107).

FIRST USE 2-14-2008; IN COMMERCE 2-14-2008.

CLASS 36—INSURANCE AND FINANCIAL

FOR TRANSACTION CARD PAYMENT PROCESSING AND CARD PAYMENT ADJUSTMENT PROCESSING FOR OTHERS, PROVIDED DIRECTLY OR THROUGH THIRD PARTIES; DEBT RECOVERY AND COLLECTION AGENCY SERVICES (U.S. CLS. 100, 101 AND 102).

FIRST USE 0-0-2007; IN COMMERCE 0-0-2007.

3,785,407. TRACKER MARINE, L.L.C., SPRINGFIELD, MO.
SN 77-459,800. PUB. 10-14-2008, FILED 4-28-2008.

WITHOUT CLAIM TO ANY PARTICULAR FONT, STYLE,
SIZE, OR COLOR.

**THE GREAT AMERICAN BOAT
SALE**

THE MARK CONSISTS OF STANDARD CHARACTERS
WITHOUT CLAIM TO ANY PARTICULAR FONT, STYLE,
SIZE, OR COLOR.

NO CLAIM IS MADE TO THE EXCLUSIVE RIGHT TO
USE "BOAT SALE", APART FROM THE MARK AS SHOWN.

CLASS 12—VEHICLES

FOR BOATS AND STRUCTURAL PARTS (U.S. CLS. 19,
21, 23, 31, 35 AND 44).
FIRST USE 4-15-2003; IN COMMERCE 4-15-2003.

CLASS 35—ADVERTISING AND BUSINESS

FOR RETAIL STORE SERVICES IN THE FIELD OF
BOATS AND BOAT ACCESSORIES (U.S. CLS. 100, 101
AND 102).
FIRST USE 4-15-2009; IN COMMERCE 4-15-2003.

3,785,412. BAYER HEALTHCARE LLC, PITTSBURGH, PA.
SN 77-466,082. PUB. 9-30-2008, FILED 5-5-2008.

SIMPLEWINS

THE MARK CONSISTS OF STANDARD CHARACTERS
WITHOUT CLAIM TO ANY PARTICULAR FONT, STYLE,
SIZE, OR COLOR.

CLASS 5—PHARMACEUTICALS

FOR MEDICAL DIAGNOSTIC REAGENTS FOR THE
ANALYSIS OF BODY FLUIDS (U.S. CLS. 6, 18, 44, 46, 51
AND 52).
FIRST USE 4-1-2009; IN COMMERCE 4-1-2009.

CLASS 10—MEDICAL APPARATUS

FOR MEDICAL DIAGNOSTIC INSTRUMENTS FOR
THE ANALYSIS OF BODY FLUIDS; LANCETS (U.S. CLS.
26, 39 AND 44).
FIRST USE 4-1-2009; IN COMMERCE 4-1-2009.

3,785,420. PROFESSIONAL BULL RIDERS, INC., PUEBLO,
CO. SN 77-473,675. PUB. 10-14-2008, FILED 5-13-2008.

MOBULL

THE MARK CONSISTS OF STANDARD CHARACTERS

CLASS 35—ADVERTISING AND BUSINESS

FOR ONLINE RETAIL STORE SERVICES FEATUR-
ING GAMES, CLOTHING, HOME DÉCOR, IMAGES,
MUSIC, VIDEO, GIFTS AND NOVELTIES, AND WALL-
PAPER FOR USE WITH MOBILE COMMUNICATIONS
DEVICES (U.S. CLS. 100, 101 AND 102).
FIRST USE 4-0-2007; IN COMMERCE 4-0-2007.

**CLASS 41—EDUCATION AND ENTERTAIN-
MENT**

FOR ENTERTAINMENT SERVICES, NAMELY, PRO-
VIDING NEWS AND INFORMATION ON THE TOPIC OF
PROFESSIONAL BULL RIDING, PRESENTED TO MO-
BILE COMMUNICATIONS DEVICES VIA A GLOBAL
COMPUTER NETWORK AND WIRELESS NETWORKS
(U.S. CLS. 100, 101 AND 107).
FIRST USE 4-0-2007; IN COMMERCE 4-0-2007.

3,785,421. PROFESSIONAL BULL RIDERS, INC., PUEBLO,
CO. SN 77-473,680. PUB. 10-14-2008, FILED 5-13-2008.

PBR MOBULL

THE MARK CONSISTS OF STANDARD CHARACTERS
WITHOUT CLAIM TO ANY PARTICULAR FONT, STYLE,
SIZE, OR COLOR.

OWNER OF U.S. REG. NOS. 3,097,240, 3,249,568, AND
OTHERS.

CLASS 35—ADVERTISING AND BUSINESS

FOR ONLINE RETAIL STORE SERVICES FEATUR-
ING GAMES, CLOTHING, HOME DÉCOR, IMAGES,
MUSIC, VIDEO, GIFTS AND NOVELTIES, AND WALL-
PAPER FOR USE WITH MOBILE COMMUNICATIONS
DEVICES (U.S. CLS. 100, 101 AND 102).
FIRST USE 4-0-2007; IN COMMERCE 4-0-2007.

**CLASS 41—EDUCATION AND ENTERTAIN-
MENT**

FOR ENTERTAINMENT SERVICES, NAMELY, PRO-
VIDING NEWS AND INFORMATION ON THE TOPIC OF
PROFESSIONAL BULL RIDING, PRESENTED TO MO-
BILE COMMUNICATIONS DEVICES VIA A GLOBAL
COMPUTER NETWORK AND WIRELESS NETWORKS
(U.S. CLS. 100, 101 AND 107).
FIRST USE 4-0-2007; IN COMMERCE 4-0-2007.

3,785,422. PROFESSIONAL BULL RIDERS, INC., PUEBLO, CO. SN 77-473,685. PUB. 10-14-2008, FILED 5-13-2008.



OWNER OF U.S. REG. NOS. 3,097,240, 3,249,568, AND OTHERS.

THE MARK CONSISTS OF A FIVE POINTED STAR OVERLAID WITH A CIRCLE, OVERLAID WITH A QUADRILATERAL CONTAINING RIGHT-SLANTING TEXT DEPICTING THE LETTERS "PBR"; THE WORD "MOBULL" APPEARING BENEATH THE QUADRILATERAL, ALSO IN RIGHT-SLANTING TEXT.

CLASS 35—ADVERTISING AND BUSINESS

FOR ONLINE RETAIL STORE SERVICES FEATURING GAMES, CLOTHING, HOME DÉCOR, IMAGES, MUSIC, VIDEO, GIFTS AND NOVELTIES, AND WALL-PAPER FOR USE WITH MOBILE COMMUNICATIONS DEVICES (U.S. CLS. 100, 101 AND 102).

FIRST USE 4-0-2007; IN COMMERCE 4-0-2007.

CLASS 41—EDUCATION AND ENTERTAINMENT

FOR ENTERTAINMENT SERVICES, NAMELY, PROVIDING NEWS AND INFORMATION ON THE TOPIC OF PROFESSIONAL BULL RIDING, PRESENTED TO MOBILE COMMUNICATIONS DEVICES VIA A GLOBAL COMPUTER NETWORK AND WIRELESS NETWORKS (U.S. CLS. 100, 101 AND 107).

FIRST USE 4-0-2007; IN COMMERCE 4-0-2007.

3,785,423. BRIGHTER PLANET, INC., MIDDLEBURY, VT. SN 77-473,950. PUB. 5-5-2009, FILED 5-14-2008.



THE MARK CONSISTS OF A SPHERE WITH LATITUDE AND LONGITUDE LINES AND WITH A SERIES OF LINES RADIATING AWAY FROM THE SPHERE, ON A DARK,

SQUARE BACKGROUND.

CLASS 16—PAPER GOODS AND PRINTED MATTER

FOR PRINT PUBLICATIONS, NAMELY, NEWSLETTERS AND PAMPHLETS, FEATURING EDITORIAL COMMENTARY, INFORMATION AND NEWS ON ENVIRONMENTAL ISSUES AND ON PRODUCTS AND SERVICES OF OTHERS HAVING ENVIRONMENTALLY BENEFICIAL ATTRIBUTES (U.S. CLS. 2, 5, 22, 23, 29, 37, 38 AND 50).

FIRST USE 11-30-2007; IN COMMERCE 11-30-2007.

CLASS 35—ADVERTISING AND BUSINESS

FOR PROVIDING AN ON-LINE DIRECTORY INFORMATION SERVICE FEATURING INFORMATION REGARDING ENVIRONMENTAL CONCERNS, CLASSIFIEDS, VIRTUAL COMMUNITY, SOCIAL NETWORKING, PHOTO SHARING, AND TRANSMISSION OF PHOTOGRAPHIC IMAGES (U.S. CLS. 100, 101 AND 102).

FIRST USE 4-30-2007; IN COMMERCE 4-30-2007.

CLASS 36—INSURANCE AND FINANCIAL

FOR CREDIT CARD SERVICES; DEBIT CARD SERVICES; MORTGAGE LENDING; REVOLVING LOANS; FINANCING RELATING TO AUTOMOBILES; CARBON OFFSET SERVICES, NAMELY, ARRANGING FOR APPLICATION OF FUNDS GENERATED IN CARBON OFFSET PROGRAMS TOWARD RENEWABLE ENERGY PROJECTS AND CARBON SEQUESTRATION PROJECTS (U.S. CLS. 100, 101 AND 102).

FIRST USE 11-29-2007; IN COMMERCE 11-29-2007.

CLASS 38—COMMUNICATION

FOR PROVIDING ON-LINE CHAT ROOMS AND ELECTRONIC BULLETIN BOARDS FOR REGISTERED USERS FOR TRANSMISSION OF MESSAGES CONCERNING ENVIRONMENTAL ISSUES, CLASSIFIEDS, VIRTUAL COMMUNITY, SOCIAL NETWORKING, PHOTO SHARING, AND TRANSMISSION OF PHOTOGRAPHIC IMAGES; PROVIDING MULTIPLE-USER TELECOMMUNICATIONS ACCESS TO THE ON-LINE CONTENT OF OTHERS IN THE NATURE OF ELECTRONIC DATA, AUDIO, AND VIDEO AVAILABLE THROUGH WEBSITES, ON-LINE FORUMS, CHAT ROOMS, AND ELECTRONIC MAILING LISTS OVER INTRANETS, GLOBAL COMMUNICATION NETWORKS AND OTHER NETWORKS (U.S. CLS. 100, 101 AND 104).

FIRST USE 3-31-2008; IN COMMERCE 3-31-2008.

CLASS 41—EDUCATION AND ENTERTAINMENT

FOR PROVIDING ON-LINE JOURNALS, NAMELY, BLOGS FEATURING ENVIRONMENTAL ISSUES; ENTERTAINMENT AND EDUCATION SERVICES, NAMELY, PROVIDING AUDIO AND VIDEO PRESENTATIONS FEATURING ENVIRONMENTAL ISSUES PERTAINING TO GLOBAL CLIMATE CHANGE OVER INTRANETS, GLOBAL COMMUNICATIONS NETWORKS AND OTHER NETWORKS (U.S. CLS. 100, 101 AND 107).

FIRST USE 5-31-2008; IN COMMERCE 5-31-2008.

CLASS 42—SCIENTIFIC AND COMPUTER SERVICES

FOR PROVIDING ON-LINE COMPUTER DATABASES AND SEARCHABLE DATABASES IN THE FIELD OF ENVIRONMENTAL PROTECTION RESEARCH; PROVIDING AN ON-LINE POLLUTION MEASUREMENT TOOL FOR DETERMINING THE AMOUNT OF POLLUTION EMITTED BY A PERSON, FAMILY OR OTHER ENTITY; COMPUTER SERVICES, NAMELY, CREATING AN ON-LINE COMMUNITY FOR REGISTERED USERS TO PARTICIPATE IN DISCUSSIONS, GET FEEDBACK FROM THEIR PEERS, FORM VIRTUAL COMMUNITIES AND ENGAGE IN SOCIAL NETWORKING; PROVIDING ELECTRONIC INFORMATION IN THE NATURE OF ENVIRONMENTAL ISSUES PERTAINING TO GLOBAL CLIMATE CHANGE PROVIDED OVER INTERNET, GLOBAL COMMUNICATION NETWORKS AND OTHER NETWORKS; PROVIDING ON-LINE COMPUTER DATABASES AND ON-LINE SEARCHABLE DATABASES WHICH ALLOW USERS TO UPLOAD, EXCHANGE AND SHARE PHOTOGRAPHS, VIDEOS, AND VIDEO LOGS (U.S. CLS. 100 AND 101).

FIRST USE 3-31-2008; IN COMMERCE 3-31-2008.

3,785,427. FOLEY, SHARON, MARIE, STILLWATER, MN. SN 77-475,221. PUB. 12-2-2008, FILED 5-15-2008.

GET THAT BODY MOVING

THE MARK CONSISTS OF STANDARD CHARACTERS WITHOUT CLAIM TO ANY PARTICULAR FONT, STYLE, SIZE, OR COLOR.

CLASS 25—CLOTHING

FOR A-SHIRTS; BUTTON-FRONT ALOHA SHIRTS; CAMP SHIRTS; DRESS SHIRTS; GOLF SHIRTS; HOODED SWEAT SHIRTS; KNIT SHIRTS; LONG-SLEEVED SHIRTS; MOISTURE-WICKING SPORTS SHIRTS; NIGHT SHIRTS; OPEN-NECKED SHIRTS; PIQUE SHIRTS; POLO SHIRTS; RUGBY SHIRTS; SHIRT FRONTS; SHIRT YOKES; SHIRTS; SHIRTS FOR SUITS; SHORT-SLEEVED OR LONG-SLEEVED T-SHIRTS; SHORT-SLEEVED SHIRTS; SLEEP SHIRTS; SPORT SHIRTS; SPORTS SHIRTS WITH SHORT SLEEVES; SWEAT SHIRTS; T-SHIRTS; TRIATHLON CLOTHING, NAMELY, TRIATHLON TIGHTS, TRIATHLON SHORTS, TRIATHLON SINGLET, TRIATHLON SHIRTS AND TRIATHLON SUITS; WIND SHIRTS; YOGA SHIRTS; CAP VISORS; CAPS WITH VISORS; SUN VISORS; VISORS; BALLOON PANTS; CAPRI PANTS; CARGO PANTS; DENIMS; JOGGING PANTS; LEATHER PANTS; LOUNGE PANTS; MOISTURE-WICKING SPORTS PANTS; NON-DISPOSABLE CLOTH TRAINING PANTS; NURSE PANTS; PANTS; PETTI-PANTS; SKI PANTS; SNOW PANTS; SNOWBOARD PANTS; SPORTS PANTS; STRETCH PANTS; SWEAT PANTS; TAP PANTS; TOBOGGAN HATS, PANTS AND CAPS; TRACK PANTS; WATERPROOF JACKETS AND PANTS; WIND PANTS; YOGA PANTS; BERMUDA SHORTS; BOARD SHORTS; BOXER SHORTS; FLEECE SHORTS; GYM SHORTS; PANTIES, SHORTS AND BRIEFS; RUGBY SHORTS; SHORT OVERCOAT FOR KIMONO (HAORI); SHORT PETTICOATS; SHORT SETS; SHORT TROUSERS; SHORTS; SLIDING SHORTS; SWEAT SHORTS; UNDERWEAR, NAMELY, BOY SHORTS; WALKING SHORTS; BASEBALL CAPS; BATHING CAPS; CAPS; GOLF CAPS; HEADGEAR, NAMELY, HATS AND CAPS; KNITTED CAPS; SHOWER CAPS; SKULL CAPS; SWIM CAPS; SWIMMING CAPS; TOE CAPS; SWIMWEAR; CLOTHING FOR WEAR IN JUDO PRACTICES; CLOTHING FOR WEAR IN WRESTLING GAMES; FITTED SWIMMING COSTUMES WITH BRA CUPS; HEAD WEAR; INFANT WEAR; SKI WEAR; SURF WEAR; SWIM TRUNKS; SWIM WEAR; SWIM WEAR FOR GENTLEMEN AND

LADIES; SWIMMING COSTUMES; SWIMMING TRUNKS; TENNIS WEAR; AFTER SKI BOOTS; APRES-SKI SHOES; SKI AND SNOWBOARD SHOES AND PARTS THEREOF; SKI BIBS; SKI BOOT BAGS; SKI BOOTS; SKI GLOVES; SKI JACKETS; SKI MASKS; SKI SUITS; SKI SUITS FOR COMPETITION; SKI TROUSERS; SKIING SHOES; WET SUITS FOR WATER-SKIING AND SUB-AQUA; CLEATS FOR ATTACHMENT TO SPORTS SHOES; FOOTWEAR NOT FOR SPORTS; MOISTURE-WICKING SPORTS BRAS; SPORT COATS; SPORTS BRA; SPORTS JACKETS; SPORTS JERSEYS; SPORTS JERSEYS AND BREECHES FOR SPORTS; SPORTS OVERUNIFORMS; GOLF CLEATS; GOLF SHOES; GOLF SPIKES; GOLF TROUSERS; BASEBALL SHOES; ANKLE SOCKS; ANKLETS; ANTI-PERSPIRANT SOCKS; JAPANESE STYLE SOCKS (TABI COVERS); JAPANESE STYLE SOCKS (TABI); MEN'S SOCKS; PAPER SHOES USED WHEN GOING THROUGH METAL DETECTORS TO KEEP FEET AND SOCKS CLEAN; SOCK SUSPENDERS; SOCKS; SOCKS AND STOCKINGS; THERMAL SOCKS; WATER SOCKS; WOOLLEN SOCKS; BATHING SUITS; BATHING SUITS FOR MEN; BODY SUITS; DRESS SUITS; DRY SUITS; FLIGHT SUITS; GYM SUITS; HEADBANDS AGAINST SWEATING; JOGGING SUITS; JUDO SUITS; KARATE SUITS; LADIES' SUITS; MEN'S SUITS; WOMEN'S SUITS; ONE-PIECE PLAY SUITS; PARTS OF CLOTHING, NAMELY, GUSSETS FOR TIGHTS, GUSSETS FOR STOCKINGS, GUSSETS FOR BATHING SUITS, GUSSETS FOR UNDERWEAR, GUSSETS FOR LEOTARDS AND GUSSETS FOR FOOTLETS; PLAY SUITS; RAIN SUITS; SKIRT SUITS; SNOW BOARDING SUITS; SNOW SUITS; STOCKINGS; SUIT COATS; SUITS; SUITS OF LEATHER; SWEAT BANDS; SWEAT JACKETS; SWEAT SUITS; TRACK SUITS; TRAINING SUITS; TROUSERS FOR SWEATING; UNION SUITS; VESTED SUITS; WARM UP SUITS; WET SUIT GLOVES; WET SUITS; ZOOT SUITS; BED JACKETS; DENIM JACKETS; DOWN JACKETS; FISHERMEN'S JACKETS; FUR COATS AND JACKETS; FUR JACKETS; HEAVY JACKETS; JACKET LINERS; JACKETS; LEATHER JACKETS; LIGHT-REFLECTING JACKETS; LONG JACKETS; MEN'S AND WOMEN'S JACKETS, COATS, TROUSERS, VESTS; PADDED JACKETS; PADDING JACKETS; RAIN JACKETS; RAIN-PROOF JACKETS; REVERSIBLE JACKETS; SHELL JACKETS; SLEEVED OR SLEEVELESS JACKETS; SMOKING JACKETS; STUFF JACKETS; SUEDE JACKETS; TRACK JACKETS; WIND RESISTANT JACKETS; WIND-JACKETS; COATS; COATS FOR MEN AND WOMEN; COATS MADE OF COTTON; COATS OF DENIM; DUST COATS; FUR COATS; HEAVY COATS; LAB COATS; LEATHER COATS; LIGHT-REFLECTING COATS; MORNING COATS; OVER COATS; RAIN COATS; RIDING COATS; TOP COATS; TRENCH COATS; WIND COATS; FLEECE PULLOVERS; HOODED PULLOVERS; HOODS; PULLOVERS; JOGGING OUTFITS; KENDO OUTFITS; SKATING OUTFITS; WARM UP OUTFITS; KNITTED UNDERWEAR; WOVEN OR KNITTED UNDERWEAR; LONG SLEEVED VESTS; LONG UNDERWEAR; SUN SLEEVES; NURSE DRESSES; NURSE OVERALLS; NURSE'S APPAREL, NAMELY, SMOCKS, SHIRTS, UNIFORMS, DRESSES AND PANTS; NURSING APPAREL, NAMELY, SHOES; LINGERIE ACCESSORIES, NAMELY, REMOVABLE SILICONE BREAST ENHANCER PADS USED IN A BRA; SHAPEWEAR, NAMELY, BRAS AND GRIDDLES; STRAPLESS BRAS; STRAPS FOR BRAS; ADHESIVE BRAS; BRAS; BABY TOPS; BASELAYER TOPS; CROP TOPS; HALTER TOPS; MUSCLE TOPS; RUGBY TOPS; TANK TOPS; TOPS; BEACH COVER-UPS; TIGHTENING-UP STRINGS FOR KIMONOS (DATEJIME); DECK-SHOES; DRIVER SHOES; FITTED SHOE OR BOOT COVERING TO PROTECT THE SHOES OR BOOT FROM WATER OR OTHER DAMAGE; FOOTBALL SHOES; GYMNASIUM SHOES; HANDBALL SHOES; HEEL PIECES FOR SHOES; HOCKEY SHOES; INFANTS' SHOES AND BOOTS; INSOLES; LEATHER SHOES; PROTECTIVE METAL MEMBERS FOR SHOES AND BOOTS; RUBBER SHOES; RUGBY SHOES; RUNNING SHOES; SHOE DOWELS; SHOE INSERTS FOR PRIMARILY NON-ORTHOPEDIC PURPOSES; SHOE PEGS; SHOE SOLES; SHOE STRAPS; SHOES; SHOES SOLES FOR REPAIR; SOCCER SHOES; TAP SHOES; TENNIS SHOES; TONGUE OR PULLSTRAP FOR SHOES AND BOOTS; TRACK AND FIELD SHOES; TRAINING SHOES; VOLLEYBALL SHOES; WOMEN'S SHOES; WORK SHOES AND BOOTS; ANKLE BOOTS; BOOTS; CLIMBING BOOTS; FOOTBALL BOOTS AND STUDS THEREFOR; FOOTWEAR, NAMELY, WORK BOOTS; HIKING BOOTS; HORSE-RIDING BOOTS;

HUNTING BOOT BAGS; LACE BOOTS; LADIES' BOOTS; MOTORCYCLIST BOOTS; MOUNTAINEERING BOOTS; RAIN BOOTS; RIDING BOOTS; SNOW BOOTS; SNOWBOARD BOOTS; SOCCER BOOTS; WINTER BOOTS; BELTS; BIBS NOT OF CLOTH OR PAPER; CHILDREN'S AND INFANTS' CLOTH BIBS; CHILDREN'S CLOTH EATING BIBS; CLOTH BIBS; CLOTH BIBS FOR ADULT DINERS; CLOTH BIBS FOR USE BY SENIOR CITIZENS OR PHYSICALLY OR MENTALLY-CHALLENGED PERSONS; CLOTH DIAPERS; CLOTHING, NAMELY, ARM WARMERS; CLOTHING, NAMELY, FOLK COSTUMES; CLOTHING, NAMELY, HAND-WARMERS; CLOTHING, NAMELY, KNEE WARMERS; CLOTHING, NAMELY, NECK TUBES; CLOTHING, NAMELY, THOBES; CLOTHING, NAMELY, WRAP-AROUNDS; CORSETS; DUSTERS; FABRIC SOLD AS AN INTEGRAL COMPONENT OF FINISHED CLOTHING ITEMS, NAMELY, SHIRTS AND PANTS; FIGURE SKATING CLOTHING, NAMELY, SKIRTS, SHIRTS, LEGGINGS AND PANTS; FOULARDS (U.S. CLS. 22 AND 39).

FIRST USE 5-28-2009; IN COMMERCE 5-28-2009.

CLASS 35—ADVERTISING AND BUSINESS

FOR COMPUTERIZED ON-LINE RETAIL STORE SERVICES IN THE FIELD OF CLOTHING AND CLOTHING ACCESSORIES; ON-LINE RETAIL STORE SERVICES FEATURING CLOTHING AND CLOTHING ACCESSORIES; RETAIL STORE AND ON-LINE RETAIL STORE SERVICES FEATURING CLOTHING AND CLOTHING ACCESSORIES; WHOLESALE STORES FEATURING CLOTHING AND CLOTHING ACCESSORIES (U.S. CLS. 100, 101 AND 102).

FIRST USE 5-28-2009; IN COMMERCE 5-28-2009.

3,785,434. FOLEY, SHARON, MARIE, STILLWATER, MN. SN 77-478,498. PUB. 12-2-2008, FILED 5-19-2008.

get that body moving

THE MARK CONSISTS OF THE STYLIZED WORDS "GET THAT BODY MOVING".

CLASS 25—CLOTHING

FOR A-SHIRTS; BUTTON-FRONT ALOHA SHIRTS; CAMP SHIRTS; DRESS SHIRTS; GOLF SHIRTS; HOODED SWEAT SHIRTS; KNIT SHIRTS; LONG-SLEEVED SHIRTS; MOISTURE-WICKING SPORTS SHIRTS; NIGHT SHIRTS; OPEN-NECKED SHIRTS; PIQUE SHIRTS; POLO SHIRTS; RUGBY SHIRTS; SHIRT FRONTS; SHIRT YOKES; SHIRTS; SHIRTS FOR SUITS; SHORT-SLEEVED OR LONG-SLEEVED T-SHIRTS; SHORT-SLEEVED SHIRTS; SLEEP SHIRTS; SPORT SHIRTS; SPORTS SHIRTS WITH SHORT SLEEVES; SWEAT SHIRTS; T-SHIRTS; TRIATHLON CLOTHING, NAMELY, TRIATHLON TIGHTS, TRIATHLON SHORTS, TRIATHLON SINGLETTS, TRIATHLON SHIRTS AND TRIATHLON SUITS; WIND SHIRTS; YOGA SHIRTS; CHEF'S HATS; FUR HATS; HAT BANDS; HATS; HEADGEAR, NAMELY, HATS AND CAPS; PAPER HATS FOR USE AS CLOTHING ITEMS; SEDGE HATS (SUGE-GASA); SMALL HATS; TOBOGGAN HATS, PANTS AND CAPS; WOOLLY HATS; BERMUDA SHORTS; BOARD SHORTS; BOXER SHORTS; FLEECE SHORTS; GYM SHORTS; PANTIES, SHORTS AND BRIEFS; RUGBY SHORTS; SHORT OVERCOAT FOR KIMONO (HAORI); SHORT PETTICOATS; SHORT SETS; SHORT TROUSERS; SHORTS; SLIDING SHORTS; SWEAT SHORTS; UNDERWEAR, NAMELY, BOY SHORTS; WALKING SHORTS; CAP VISORS; CAPS WITH VISORS; SUN VISORS; VISORS; SWIMSUITS; BATHING COSTUMES FOR WOMEN; BATHING SUITS FOR MEN; BUSTLE HOLDER BANDS FOR OBI (OBIAGE); BUSTLES FOR OBI-KNOTS (OBIAGE-SHIN); CLEATS FOR ATTACHMENT TO SPORTS SHOES; CLOTH BIBS FOR ADULT DINERS; CLOTH BIBS FOR USE BY SENIOR CITIZENS OR PHYSICALLY OR MENTALLY-CHALLENGED PERSONS; CLOTHING FOR WEAR IN JUDO PRACTICES; CLOTHING FOR WEAR IN WRESTLING GAMES; COATS FOR MEN AND WOMEN; COSTUMES FOR USE IN ROLE-PLAYING GAMES; DETACHABLE NECKPIECES FOR KIMONOS (HANERI); FINISHED TEXTILE LININGS FOR GARMENTS; FOOTWEAR FOR MEN; FOOTWEAR FOR MEN AND WOMEN; FOOTWEAR FOR TRACK AND FIELD ATHLETICS; FOOTWEAR FOR WOMEN; HEEL PIECES FOR SHOES; HIP-GUARDS ESPECIALLY MADE FOR FISHING; INSOLES; LEOTARDS AND TIGHTS FOR WOMEN, MEN AND CHILDREN OF NYLON, COTTON OR OTHER TEXTILE FIBERS; MEN'S AND WOMEN'S JACKETS, COATS, TROUSERS, VESTS; MEN'S SOCKS; MEN'S SUITS; WOMEN'S SUITS; METAL FITTINGS FOR JAPANESE STYLE WOODEN CLOGS; ONE PIECE GARMENT FOR INFANTS AND TODDLERS; PARTS OF CLOTHING, NAMELY, GUSSETS FOR TIGHTS, GUSSETS FOR STOCKINGS, GUSSETS FOR BATHING SUITS, GUSSETS FOR UNDERWEAR, GUSSETS FOR LEOTARDS AND GUSSETS FOR FOOTLETS; PLEATED SKIRTS FOR FORMAL KIMONOS (HAKAMA); PROTECTIVE METAL MEMBERS FOR SHOES AND BOOTS; RUBBER SOLES FOR JIKATABI; SASH BANDS FOR KIMONO (OBI); SCRUBS NOT FOR MEDICAL PURPOSES; SKI SUITS

3,785,429. WEALTHSTONE, INC., COLUMBUS, OH. SN 77-476,638. PUB. 5-12-2009, FILED 5-16-2008.

WEALTHSTONE

THE MARK CONSISTS OF STANDARD CHARACTERS WITHOUT CLAIM TO ANY PARTICULAR FONT, STYLE, SIZE, OR COLOR.

CLASS 35—ADVERTISING AND BUSINESS

FOR TAX PLANNING AND CONSULTING SERVICES REGARDING BUSINESS STRATEGIES (U.S. CLS. 100, 101 AND 102).

FIRST USE 12-15-2008; IN COMMERCE 12-15-2008.

CLASS 36—INSURANCE AND FINANCIAL

FOR BUSINESS AND PERSONAL FINANCIAL CONSULTING SERVICES, NAMELY, FINANCIAL PLANNING, INVESTMENT PLANNING AND FINANCIAL PORTFOLIO MANAGEMENT, AND ASSET MANAGEMENT (U.S. CLS. 100, 101 AND 102).

FIRST USE 12-15-2008; IN COMMERCE 12-15-2008.

FOR COMPETITION; SOLES FOR JAPANESE STYLE SANDALS; SPORTS JERSEYS AND BREECHES FOR SPORTS; STRAPS FOR BRAS; STRING FASTENERS FOR HAORI (HAORI-HIMO); SUSPENDER BELTS FOR MEN; SUSPENDER BELTS FOR WOMEN; SWIM WEAR FOR GENTLEMEN AND LADIES; TIGHTENING-UP STRINGS FOR KIMONOS (DATEJIME); TIPS FOR FOOTWEAR; TOE STRAPS FOR JAPANESE STYLE SANDALSZORI; TOE STRAPS FOR JAPANESE STYLE WOODEN CLOGS; TONGUE OR PULLSTRAP FOR SHOES AND BOOTS; TROUSERS FOR SWEATING; UNDERSHIRTS FOR KIMONOS (JUBAN); UNDERSHIRTS FOR KIMONOS (KOSHIMAKI); UPPERS FOR JAPANESE STYLE SANDALS; UPPERS OF WOVEN RATTAN FOR JAPANESE STYLE SANDALS; WAIST STRINGS FOR KIMONOS (KOSHIHIMO); WET SUITS FOR WATER-SKIING AND SUB-AQUA; WRAP BELTS FOR KIMONOS (DATEMAKI); BASEBALL CAPS; BATHING CAPS; CAPS; FITTED SWIMMING COSTUMES WITH BRA CUPS; GOLF CAPS; KNITTED CAPS; SHOWER CAPS; SKULL CAPS; SWIM CAPS; SWIM TRUNKS; SWIM WEAR; SWIMMING CAPS; SWIMMING COSTUMES; SWIMMING TRUNKS; TOE CAPS; GOLF CLEATS; GOLF SHOES; GOLF SPIKES; GOLF TROUSERS; BALLOON PANTS; CAPRI PANTS; CARGO PANTS; DENIMS; JOGGING PANTS; LEATHER PANTS; LOUNGE PANTS; MOISTURE-WICKING SPORTS PANTS; NON-DISPOSABLE CLOTH TRAINING PANTS; NURSE PANTS; PANTS; PETTI-PANTS; SKI PANTS; SNOW PANTS; SNOWBOARD PANTS; SPORTS PANTS; STRETCH PANTS; SWEAT PANTS; TAP PANTS; TRACK PANTS; WATERPROOF JACKETS AND PANTS; WIND PANTS; YOGA PANTS; TENNIS SHOES; TENNIS WEAR; SKIRT SUITS; SKIRTS; SKIRTS AND DRESSES; HEAD WEAR; INFANT WEAR; SKI WEAR; SURF WEAR; AFTER SKI BOOTS; APRES-SKI SHOES; SKI AND SNOWBOARD SHOES AND PARTS THEREOF; SKI BIBS; SKI BOOT BAGS; SKI BOOTS; SKI GLOVES; SKI JACKETS; SKI MASKS; SKI SUITS; SKI TROUSERS; SKIING SHOES; BED JACKETS; DENIM JACKETS; DOWN JACKETS; FISHERMEN'S JACKETS; FUR COATS AND JACKETS; FUR JACKETS; HEAVY JACKETS; JACKET LINERS; JACKETS; LEATHER JACKETS; LIGHT-REFLECTING JACKETS; LONG JACKETS; PADDED JACKETS; PADDING JACKETS; RAIN JACKETS; RAINPROOF JACKETS; REVERSIBLE JACKETS; SHELL JACKETS; SLEEVED OR SLEEVELESS JACKETS; SMOKING JACKETS; SPORTS JACKETS; STUFF JACKETS; SUEDE JACKETS; SWEAT JACKETS; TRACK JACKETS; WIND RESISTANT JACKETS; WIND-JACKETS; CREW-NECK SWEATERS; MOCK TURTLE-NECK SWEATERS; SWEATERS; TURTLENECK SWEATERS; V-NECK SWEATERS; ANKLE BOOTS; BOOTS; CLIMBING BOOTS; FITTED SHOE OR BOOT COVERING TO PROTECT THE SHOES OR BOOT FROM WATER OR OTHER DAMAGE; FOOTBALL BOOTS AND STUDS THEREFOR; FOOTWEAR, NAMELY, WORK BOOTS; HIKING BOOTS; HORSE-RIDING BOOTS; HUNTING BOOT BAGS; INFANTS' SHOES AND BOOTS; LACE BOOTS; LADIES' BOOTS; MOTORCYCLIST BOOTS; MOUNTAINEERING BOOTS; RAIN BOOTS; RIDING BOOTS; SNOW BOOTS; SNOWBOARD BOOTS; SOCCER BOOTS; WINTER BOOTS; WORK SHOES AND BOOTS; BODY SUITS; DRESS SUITS; DRY SUITS; FLIGHT SUITS; GYM SUITS; JOGGING SUITS; JUDO SUITS; KARATE SUITS; LADIES' SUITS; ONE-PIECE PLAY SUITS; PLAY SUITS; RAIN SUITS; SNOW BOARDING SUITS; SNOW SUITS; SUIT COATS; SUITS; SUITS OF LEATHER; SWEAT SUITS; TRACK SUITS; TRAINING SUITS; UNION SUITS; VESTED SUITS; WARM UP SUITS; WET SUIT GLOVES; WET SUITS; ZOOT SUITS; HEADBANDS AGAINST SWEATING; STOCKINGS; SWEAT BANDS; BATHING SUITS; TIGHTS; SINGLET; FLEECE PULLOVERS; HOODED PULLOVERS; HOODS; PULLOVERS; LONG SLEEVED VESTS; SUN SLEEVES; LONG UNDERWEAR; BABY TOPS; BASELAYER TOPS; CROP TOPS; HALTER TOPS; MUSCLE TOPS; RUGBY TOPS; TANK TOPS; TOP COATS; TOPS; TUBE TOPS; CLOTHING, NAMELY, NECK TUBES; BEACH COVER-UPS; WARM UP OUTFITS; BELTS; BIBS NOT OF CLOTH OR PAPER; CHILDREN'S AND INFANTS' CLOTH BIBS; CHILDREN'S CLOTH EATING BIBS; CLOTH BIBS; CLOTH DIAPERS; CLOTHING, NAMELY, ARM WARMERS; CLOTHING, NAMELY, FOLK COSTUMES; CLOTHING, NAMELY, HAND-WARMERS; CLOTHING, NAMELY, KNEE WARMERS; CLOTHING, NAMELY, THOBES; CLOTHING, NAMELY, WRAP-AROUNDS; CORSETS; DUSTERS; FABRIC SOLD AS AN INTEGRAL COMPONENT OF FINISHED CLOTHING ITEMS, NAMELY,

SHIRTS, PANTS, SHORTS AND SKIRTS; FIGURE SKATING CLOTHING, NAMELY, SKIRTS, SWEATERS, PANTS, TOPS, SHIRTS AND BODYSUITS; FOULARDS; INFANT AND TODDLER ONE PIECE CLOTHING; INFANT CLOTH DIAPERS; JERSEYS; LEATHER BELTS; MANTLES; MUFFLERS; PERSPIRATION ABSORBENT UNDERWEAR CLOTHING; SHIRTS; SHOULDER WRAPS; SWADDLING CLOTHES; TIES; UNDERARM CLOTHING SHIELDS; WRAPS; PAPER SHOES USED WHEN GOING THROUGH METAL DETECTORS TO KEEP FEET AND SOCKS CLEAN; SOCK SUSPENDERS; SOCKS; SOCKS AND STOCKINGS; THERMAL SOCKS; WATER SOCKS; WOOLLEN SOCKS; COATS; COATS MADE OF COTTON; COATS OF DENIM; DUST COATS; FUR COATS; HEAVY COATS; LAB COATS; LEATHER COATS; LIGHT-REFLECTING COATS; MORNING COATS; OVER COATS; RAIN COATS; RIDING COATS; SPORT COATS; TRENCH COATS; WIND COATS; ADHESIVE BRAS; BRAS; LINGERIE ACCESSORIES, NAMELY, REMOVABLE SILICONE BREAST ENHANCER PADS USED IN A BRA; MOISTURE-WICKING SPORTS BRAS; SHAPEWEAR, NAMELY, SPORTS BRAS, GRIDDLES, BRAS AND PANTIES; SPORTS BRAS; STRAPLESS BRAS (U.S. CLS. 22 AND 39).

FIRST USE 5-28-2009; IN COMMERCE 5-28-2009.

CLASS 35—ADVERTISING AND BUSINESS

FOR COMPUTERIZED ON-LINE RETAIL STORE SERVICES IN THE FIELD OF CLOTHING AND CLOTHING ACCESSORIES; ON-LINE RETAIL STORE SERVICES FEATURING CLOTHING AND CLOTHING ACCESSORIES; RETAIL STORE AND ON-LINE RETAIL STORE SERVICES FEATURING CLOTHING AND CLOTHING ACCESSORIES; WHOLESALE STORES FEATURING CLOTHING AND CLOTHING ACCESSORIES (U.S. CLS. 100, 101 AND 102).

FIRST USE 5-28-2009; IN COMMERCE 5-28-2009.

3,785,438. SHENZHEN SHENCHUANG ELECTRICAL APPLIANCE CO. LTD, SHENZHEN, CHINA. SN 77-484,600. PUB. 5-26-2009, FILED 5-28-2008.

YSC 深創
shenchuang

THE MARK CONSISTS OF THE LETTER "YSC SHENCHUANG" AND CHINESE CHARACTERS.

THE ENGLISH TRANSLATION OF "SHENCHUANG" IN THE MARK IS SHENZHEN CREATION.

THE NON-LATIN CHARACTERS IN THE MARK TRANSLITERATE TO "SHENCHUANG" IN THE MARK IS SHENZHEN CREATION.

CLASS 8—HAND TOOLS

FOR BLADES AND BRUSHES FOR ELECTRIC HAIR CLIPPERS AND TRIMMERS; ELECTRIC AND BATTERY-POWERED HAIR CLIPPERS; ELECTRIC AND BATTERY-POWERED HAIR TRIMMERS; ELECTRIC HAIR CLIPPERS; ELECTRIC HAIR CUTTERS; ELECTRIC HAIR TRIMMERS; ELECTRIC RAZORS AND ELECTRIC HAIR CLIPPERS; HAIR CLIPPERS; HAIR CUTTING SCISSORS; HAIR TRIMMERS; HAND-OPERATED HAIR CLIPPERS; NON-ELECTRIC HAIR CLIPPERS (U.S. CLS. 23, 28 AND 44).

FIRST USE 1-24-2005; IN COMMERCE 1-30-2005.

CLASS 9—ELECTRICAL AND SCIENTIFIC APPARATUS

FOR ELECTRIC HAIR CRIMPER; ELECTRIC HAIR CURLERS; ELECTRIC HAIR CURLING IRONS; ELECTRIC HAIR ROLLERS; ELECTRIC HAIR STRAIGHTENER; ELECTRIC HAIR STRAIGHTENING IRONS; ELECTRIC HAIR-CURLERS; ELECTRIC HAND-HELD HAIR STYLING IRONS; ELECTRIC IRONS FOR STYLING HAIR; ELECTRICALLY HEATED HAIR BRUSHES; HAIR-CURLERS, ELECTRICALLY HEATED; HOT AIR HAIR BRUSHES (U.S. CLS. 21, 23, 26, 36 AND 38).

FIRST USE 1-24-2005; IN COMMERCE 1-30-2005.

CLASS 11—ENVIRONMENTAL CONTROL APPARATUS

FOR HAIR DRYERS; HAIR DRYING MACHINES FOR BEAUTY SALON USE; HAIR STEAMERS FOR BEAUTY SALON USE; HAND-HELD ELECTRIC HAIR DRYERS (U.S. CLS. 13, 21, 23, 31 AND 34).

FIRST USE 1-24-2005; IN COMMERCE 1-30-2005.

CLASS 20—FURNITURE AND ARTICLES NOT OTHERWISE CLASSIFIED

FOR CHILDREN'S FURNITURE, NAMELY, TABLES, TABLE AND CHAIR SETS, TOY BOXES, BOOKCASES, CHAIRS, BENCHES; AND CHILDREN'S FURNITURE ACCESSORIES, NAMELY, WOODEN TELEVISION TRAYS, STOOLS, CLOTHES POLES FOR HANGING CLOTHES, WOODEN ACCESSORY ORGANIZERS, WALL SHELVES, TOY BOXES AND MIRRORS (U.S. CLS. 2, 13, 22, 25, 32 AND 50).

FIRST USE 7-9-2008; IN COMMERCE 7-9-2008.

CLASS 28—TOYS AND SPORTING GOODS

FOR CHILDREN'S TOYS, NAMELY, TRAIN SETS, TRAIN TABLES, MULTIPLE ACTIVITY TABLES, DOLL HOUSES, TOYS THAT RESEMBLE KITCHEN APPLIANCES, DOLLS, DOLL FURNITURE, ROCKING HORSES, SOFT PLUSH TOYS; AND CHILDREN'S TOY ACCESSORIES, NAMELY, TOY BOXES, TOY WOOD BLOCKS IN THE SHAPE OF LETTERS/NUMBERS (U.S. CLS. 22, 23, 38 AND 50).

FIRST USE 7-9-2008; IN COMMERCE 7-9-2008.

3,785,445. FLASHFOTO, INC., OAKLAND, CA. SN 77-488,842. PUB. 11-25-2008, FILED 6-2-2008.

FLASHFOTO

THE MARK CONSISTS OF STANDARD CHARACTERS WITHOUT CLAIM TO ANY PARTICULAR FONT, STYLE, SIZE, OR COLOR.

CLASS 9—ELECTRICAL AND SCIENTIFIC APPARATUS

FOR IMAGE PROCESSING COMPUTER SOFTWARE (U.S. CLS. 21, 23, 26, 36 AND 38).

FIRST USE 7-0-2009; IN COMMERCE 7-0-2009.

CLASS 42—SCIENTIFIC AND COMPUTER SERVICES

FOR IMAGE PROCESSING COMPUTER SOFTWARE DESIGN (U.S. CLS. 100 AND 101).

FIRST USE 7-0-2009; IN COMMERCE 7-0-2009.

3,785,449. KIDKRAFT, L.P., DALLAS, TX. SN 77-491,116. PUB. 11-25-2008, FILED 6-4-2008.

SMALL POTATOES

THE MARK CONSISTS OF STANDARD CHARACTERS WITHOUT CLAIM TO ANY PARTICULAR FONT, STYLE, SIZE, OR COLOR.

3,785,452. SINDOH CO., LTD., SEOUL, REPUBLIC OF KOREA. SN 77-493,194. PUB. 4-21-2009, FILED 6-6-2008.

SINDOH

THE MARK CONSISTS OF STANDARD CHARACTERS WITHOUT CLAIM TO ANY PARTICULAR FONT, STYLE, SIZE, OR COLOR.

CLASS 2—PAINTS

FOR ANTI-CORROSIVE PREPARATIONS, NAMELY, COATINGS; FLUORESCENT DYES; CARBON BLACK USED AS A COLORING PIGMENT; PRINTING INK; TONER, TONER FOR PRINTERS AND PHOTOCOPIERS; COLOR PIGMENTS FOR DRAWING PICTURES; ANTI-RUST OILS (U.S. CLS. 6, 11 AND 16).

FIRST USE 7-7-2008; IN COMMERCE 7-7-2008.

CLASS 9—ELECTRICAL AND SCIENTIFIC APPARATUS

FOR CAMERAS; PHOTOCOPYING MACHINES; CONNECTORS FOR ELECTRIC LINES; TELECOMMUNICATIONS CABLES, FACSIMILE MACHINES; MODEMS; SCANNERS; ELECTRIC PHOTOCOPIERS; PRINTER FOR USE WITH COMPUTERS; LCD PROJECTORS (U.S. CLS. 21, 23, 26, 36 AND 38).

FIRST USE 7-7-2008; IN COMMERCE 7-7-2008.

3,785,454. PATENTS360, INC., ELK GROVE VILLAGE, IL. SN 77-494,366. PUB. 11-4-2008, FILED 6-9-2008.

PATENTS 360

THE MARK CONSISTS OF STANDARD CHARACTERS WITHOUT CLAIM TO ANY PARTICULAR FONT, STYLE,

SIZE, OR COLOR.

NO CLAIM IS MADE TO THE EXCLUSIVE RIGHT TO USE "PATENTS", APART FROM THE MARK AS SHOWN.

CLASS 9—ELECTRICAL AND SCIENTIFIC APPARATUS

FOR ELECTRONIC DATABASE IN THE FIELD OF INTELLECTUAL PROPERTY, NAMELY, PATENTS, RECORDED ON COMPUTER MEDIA (U.S. CLS. 21, 23, 26, 36 AND 38).

FIRST USE 8-31-2008; IN COMMERCE 8-31-2008.

CLASS 35—ADVERTISING AND BUSINESS

FOR CONSULTING SERVICES IN THE FIELD OF MANAGING INTELLECTUAL PROPERTIES; MANAGEMENT AND COMPILATION OF COMPUTERIZED DATABASES; PROVIDING AN ON-LINE COMPUTER DATABASE FEATURING TRADE INFORMATION IN THE FIELD OF INTELLECTUAL PROPERTY, NAMELY, PATENTS (U.S. CLS. 100, 101 AND 102).

FIRST USE 8-31-2008; IN COMMERCE 8-31-2008.

3,785,461. IOWA LOTTERY COMMISSION, DES MOINES, IA. SN 77-496,376. PUB. 6-9-2009, FILED 6-11-2008.



THE MARK CONSISTS OF A V-SHAPED DESIGN COMPRISED OF AN EAGLE HEAD AND A STARS AND STRIPES PRINT ON THE OUTSTRETCHED WINGS. BELOW THE DESIGN IS THE WORD "IOWA" WITH THE LETTERS SEPARATED BY RAISED DOTS. BELOW THE TERM "IOWA" IS THE TERM "VETERANS", AND AT THE BOTTOM OF THE MARK IS THE WORDING "TRUST FUND".

CLASS 28—TOYS AND SPORTING GOODS

FOR LOTTERY TICKETS (U.S. CLS. 22, 23, 38 AND 50).
FIRST USE 7-0-2008; IN COMMERCE 7-0-2008.

CLASS 41—EDUCATION AND ENTERTAINMENT

FOR LOTTERY SERVICES (U.S. CLS. 100, 101 AND 107).
FIRST USE 7-0-2008; IN COMMERCE 7-0-2008.

3,785,467. TENCENT HOLDINGS LIMITED, GEORGETOWN, CAYMAN ISLANDS. SN 77-499,948. PUB. 6-2-2009, FILED 6-16-2008.



OWNER OF U.S. REG. NOS. 2,938,524, 3,159,635, AND OTHERS.

NO CLAIM IS MADE TO THE EXCLUSIVE RIGHT TO USE "CHESS", APART FROM THE MARK AS SHOWN.

THE MARK CONSISTS OF A CROWN AND THE LETTERS "QQ" ABOVE THE WORD "CHESS".

CLASS 9—ELECTRICAL AND SCIENTIFIC APPARATUS

FOR DOWNLOADABLE COMPUTER PROGRAMS FOR USE IN TELECOMMUNICATIONS, NAMELY, TELECOMMUNICATIONS SOFTWARE FOR PROVIDING SINGLE USER AND MULTIPLE USER ACCESS TO A GLOBAL COMPUTER NETWORK; DOWNLOADABLE COMPUTER SOFTWARE FOR PLAYING COMPUTER GAMES; DOWNLOADABLE COMPUTER SOFTWARE FEATURING ANIMATED CARTOONS (U.S. CLS. 21, 23, 26, 36 AND 38).

FIRST USE 7-0-2008; IN COMMERCE 7-0-2008.

CLASS 41—EDUCATION AND ENTERTAINMENT

FOR ENTERTAINMENT AND EDUCATION SERVICES, NAMELY, PROVIDING ONLINE GAMES IN THE NATURE OF COMPUTER CONTESTS; PROVIDING ONLINE COMPUTER GAMES (U.S. CLS. 100, 101 AND 107).

FIRST USE 7-0-2008; IN COMMERCE 7-0-2008.

3,785,468. TENCENT HOLDINGS LIMITED, GEORGETOWN, CAYMAN ISLANDS. SN 77-500,003. PUB. 6-2-2009, FILED 6-16-2008.



OWNER OF U.S. REG. NOS. 2,938,524, 3,159,635, AND OTHERS.

NO CLAIM IS MADE TO THE EXCLUSIVE RIGHT TO USE "HEARTS", APART FROM THE MARK AS SHOWN.

THE MARK CONSISTS OF THE LETTERS "QQ" IN STYLIZED FORM ABOVE THE TERM "HEARTS" IN STYLIZED FORM. NEXT TO THE LETTERS "QQ" IS AN ACE OF HEARTS CARD ON TOP OF ANOTHER CARD.

CLASS 9—ELECTRICAL AND SCIENTIFIC APPARATUS

FOR DOWNLOADABLE COMPUTER PROGRAMS FOR USE IN TELECOMMUNICATIONS, NAMELY, TELECOMMUNICATIONS SOFTWARE FOR PROVIDING SINGLE USER AND MULTIPLE USER ACCESS TO A GLOBAL COMPUTER NETWORK; DOWNLOADABLE COMPUTER SOFTWARE FOR PLAYING COMPUTER GAMES; DOWNLOADABLE COMPUTER SOFTWARE FEATURING ANIMATED CARTOONS (U.S. CLS. 21, 23, 26, 36 AND 38).

FIRST USE 4-0-2008; IN COMMERCE 4-0-2008.

CLASS 41—EDUCATION AND ENTERTAINMENT

FOR ENTERTAINMENT AND EDUCATION SERVICES, NAMELY, PROVIDING ONLINE GAMES IN THE NATURE OF COMPUTER CONTESTS; PROVIDING ONLINE COMPUTER GAMES (U.S. CLS. 100, 101 AND 107).

FIRST USE 4-0-2008; IN COMMERCE 4-0-2008.

CLASS 39—TRANSPORTATION AND STORAGE

FOR TRAVEL AGENCY SERVICES, NAMELY, MAKING RESERVATIONS AND BOOKINGS FOR TRANSPORTATION AND PROVIDING INFORMATION AND REVIEWS CONCERNING TRAVEL BY MEANS OF A TELEPHONE, FACSIMILE OR OVER COMPUTER NETWORKS AND GLOBAL COMMUNICATION NETWORKS; PROVIDING A WEBSITE AND WEBSITE LINKS TO GEOGRAPHIC INFORMATION, MAPS, MAP IMAGES AND TRIP ROUTING; ORGANIZING AND ARRANGING TRAVEL ACTIVITIES, NAMELY, TOURS, TRAVEL TO EVENTS AND TRAVEL TO ATTRACTIONS; MAKING RESERVATIONS FOR TRAVEL ACTIVITIES, NAMELY, FOR TOURS, TRAVEL TO EVENTS AND TRAVEL TO ATTRACTIONS; PROVIDING INFORMATION ABOUT TOURS AND TRAVEL TO EVENTS AND ATTRACTIONS; ORGANIZING SIGHT-SEEING TOURS; TRAVEL AND TOUR INFORMATION SERVICES; TRAVEL AND TOUR TICKET RESERVATION SERVICES; ARRANGING BOOKINGS OF DAY TRIPS AND SIGHT-SEEING TOURS (U.S. CLS. 100 AND 105).

FIRST USE 6-0-2008; IN COMMERCE 6-0-2008.

CLASS 42—SCIENTIFIC AND COMPUTER SERVICES

FOR PROVIDING TEMPORARY USE OF ON-LINE NON-DOWNLOADABLE SOFTWARE FOR USE IN THE CUSTOMIZED CREATION AND DELIVERY OF MANAGEMENT REPORTS IN THE FIELD OF CORPORATE TRAVEL (U.S. CLS. 100 AND 101).

FIRST USE 6-0-2008; IN COMMERCE 6-0-2008.

CLASS 43—HOTEL AND RESTAURANT SERVICES

FOR TRAVEL AGENCY SERVICES, NAMELY, MAKING RESERVATIONS AND BOOKINGS FOR TEMPORARY ACCOMMODATIONS; HOTEL AND LODGING SERVICES, NAMELY, PROVIDING AND RELAYING INFORMATION AND SECURING PAYMENT IN CONNECTION WITH RESERVATIONS AND BOOKINGS FOR TEMPORARY LODGING AND PROVIDING REVIEWS OF HOTELS BY MEANS OF A TELEPHONE, FACSIMILE, OR OVER COMPUTER NETWORKS AND GLOBAL COMMUNICATION NETWORKS; TRAVEL INFORMATION SERVICES, NAMELY, PROVIDING TRAVEL ACCOMMODATION INFORMATION FOR USE IN THE PLANNING AND MANAGEMENT OF CORPORATE TRAVEL (U.S. CLS. 100 AND 101).

FIRST USE 6-0-2008; IN COMMERCE 6-0-2008.

3,785,471. EXPEDIA, INC., BELLEVUE, WA. SN 77-500,663. PUB. 4-21-2009, FILED 6-17-2008.

EGENCIA

THE MARK CONSISTS OF STANDARD CHARACTERS WITHOUT CLAIM TO ANY PARTICULAR FONT, STYLE, SIZE, OR COLOR.

CLASS 35—ADVERTISING AND BUSINESS

FOR PROVIDING A WEB SITE FEATURING PRODUCT RATINGS OF THE CONSUMER SERVICES OF OTHERS IN THE FIELD OF ACCOMMODATIONS; CUSTOMER LOYALTY SERVICES AND CUSTOMER CLUB SERVICES, FOR COMMERCIAL, PROMOTIONAL AND/OR ADVERTISING PURPOSES; CONDUCTING CUSTOMER LOYALTY AND INCENTIVE PROGRAMS FOR COMMERCIAL PROMOTION AND FOR ADVERTISING PURPOSES; BUSINESS CONSULTING AND MANAGEMENT SERVICES IN THE FIELD OF TRAVEL AND TRAVEL PLANNING; CORPORATE TRAVEL MANAGEMENT SERVICES, NAMELY, PROVIDING REPORT GENERATION TOOLS FOR PLANNING, AUDITING, AND TRACKING TRAVEL AND ENTERTAINMENT EXPENSES AND TRAVEL REWARDS POINTS (U.S. CLS. 100, 101 AND 102).

FIRST USE 6-0-2008; IN COMMERCE 6-0-2008.

3,785,476. ELDERHOSTEL, INC., BOSTON, MA. SN 77-503,726. PUB. 12-2-2008, FILED 6-20-2008.



THE MARK CONSISTS OF LETTER "E" AND DESIGN, STYLIZED SO THAT THE LETTER "E" APPEARS AS A GLOBE IN A STAND.

CLASS 39—TRANSPORTATION AND STORAGE

FOR ARRANGING TRAVEL TOURS (U.S. CLS. 100 AND 105).

FIRST USE 10-1-2009; IN COMMERCE 10-1-2009.

CLASS 41—EDUCATION AND ENTERTAINMENT

FOR EDUCATIONAL SERVICES, NAMELY, PROVIDING CONFERENCES, WORKSHOPS, SEMINARS, AND CLASSES THROUGH EXPERIENTIAL OR CLASSROOM LEARNING IN THE FIELDS OF HISTORY, NATURE, CULTURES, SCIENCE, ENTERTAINMENT, ART, SELF-IMPROVEMENT, AND POLITICS (U.S. CLS. 100, 101 AND 107).

FIRST USE 10-1-2009; IN COMMERCE 10-1-2009.

3,785,480. PROGRESS MARKET CONSULTING SARL, LE CANNET ROCHEVILLE, FRANCE. SN 77-505,332. PUB. 5-5-2009, FILED 6-23-2008.



THE MARK CONSISTS OF THE STYLIZED LETTERS "S" AND "R" APPEARING ABOVE THE STYLIZED WORDS "SUB RIDE" ALL OF THE TEXT APPEARS UNDER AN OVAL LEANING TO THE LEFT. ALL OF THE FOREGOING APPEARS OVER A CIRCLE BACKGROUND.

3,785,479. PROGRESS MARKET CONSULTING SARL, LE CANNET ROCHEVILLE, FRANCE. SN 77-505,270. PUB. 5-5-2009, FILED 6-23-2008.

CLASS 9—ELECTRICAL AND SCIENTIFIC APPARATUS

FOR FACE MASKS FOR SNORKELING AND SCUBA DIVING, SNORKELS, GOGGLES, AND MASKS FOR SNORKELING AND SCUBA DIVING (U.S. CLS. 21, 23, 26, 36 AND 38).

FIRST USE 11-17-2009; IN COMMERCE 11-17-2009.

CLASS 28—TOYS AND SPORTING GOODS

FOR BAGS SPECIALLY ADAPTED FOR SPORTS EQUIPMENT; CASES SPECIALLY ADAPTED FOR SPORTS EQUIPMENT; FLIPPERS FOR USE IN SCUBA DIVING; SCUBA FINS; SCUBA FLIPPERS; SWIMMING AIDS, NAMELY, FINS (U.S. CLS. 22, 23, 38 AND 50).

FIRST USE 11-17-2009; IN COMMERCE 11-17-2009.



THE COLOR(S) YELLOW AND BLACK IS/ARE CLAIMED AS A FEATURE OF THE MARK.

THE MARK CONSISTS OF A BLACK SILHOUETTE OF A PERSON SCUBA DIVING UNDER TWO BLACK CURVED LINES APPEARING ON A YELLOW TRIANGLE WITH A BLACK BORDER.

CLASS 9—ELECTRICAL AND SCIENTIFIC APPARATUS

FOR FACE MASKS FOR SNORKELING AND SCUBA DIVING, SNORKELS, GOGGLES, AND MASKS FOR SNORKELING AND SCUBA DIVING (U.S. CLS. 21, 23, 26, 36 AND 38).

FIRST USE 11-17-2009; IN COMMERCE 11-17-2009.

CLASS 28—TOYS AND SPORTING GOODS

FOR BAGS SPECIALLY ADAPTED FOR SPORTS EQUIPMENT; CASES SPECIALLY ADAPTED FOR SPORTS EQUIPMENT; FLIPPERS FOR USE IN SCUBA DIVING; SCUBA FINS; SCUBA FLIPPERS; SWIMMING AIDS, NAMELY, FINS (U.S. CLS. 22, 23, 38 AND 50).

FIRST USE 11-17-2009; IN COMMERCE 11-17-2009.

3,785,481. STARS2TRUST LLC, FLORHAM PARK, NJ. SN 77-505,770. PUB. 11-11-2008, FILED 6-23-2008.

STARS2TRUST

THE MARK CONSISTS OF STANDARD CHARACTERS WITHOUT CLAIM TO ANY PARTICULAR FONT, STYLE, SIZE, OR COLOR.

CLASS 35—ADVERTISING AND BUSINESS

FOR MAINTAINING A REGISTRY OF SPORTS MEMORABILIA AND WORKS OF ART; ON-LINE AUCTION SERVICES; ORGANISATION OF INTERNET AUCTIONS (U.S. CLS. 100, 101 AND 102).

FIRST USE 6-25-2008; IN COMMERCE 6-25-2008.

CLASS 42—SCIENTIFIC AND COMPUTER SERVICES

FOR AUTHENTICATION IN THE FIELD OF AUTOGRAPHS AND MEMORABILIA (U.S. CLS. 100 AND 101).

FIRST USE 6-25-2005; IN COMMERCE 6-25-2008.

3,785,482. TC DIGITAL GAMES LLC, WILMINGTON, DE.
SN 77-506,981. PUB. 4-21-2009, FILED 6-24-2008.

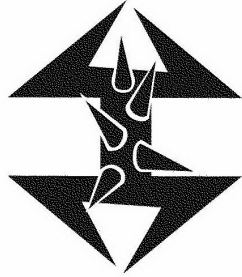

THE MARK CONSISTS OF A DESIGN HAVING A CENTRAL RECTANGULAR BODY WITH TWO ANGLED ARMS, TWO ANGLED LEGS, AND FIVE TRIANGULAR APPENDAGES POINTING IN DIFFERENT DIRECTIONS.

CLASS 16—PAPER GOODS AND PRINTED MATTER

FOR TRADING CARDS (U.S. CLS. 2, 5, 22, 23, 29, 37, 38 AND 50).

FIRST USE 9-0-2008; IN COMMERCE 9-0-2008.

CLASS 28—TOYS AND SPORTING GOODS

FOR TOYS, NAMELY, ACTION FIGURES (U.S. CLS. 22, 23, 38 AND 50).

FIRST USE 9-0-2009; IN COMMERCE 9-0-2009.

3,785,492. MUSIC SCHOOL INTERNATIONAL PTY LTD,
WAHROONGA, AUSTRALIA. SN 77-510,859. PUB. 6-16-
2009, FILED 6-30-2008.



PRIORITY CLAIMED UNDER SEC. 44(D) ON AUSTRALIA APPLICATION NO. 1246953, FILED 6-18-2008, REG. NO. 1246953, DATED 6-18-2008, EXPIRES 6-18-2018.

THE COLOR(S) BLUE, GREEN, YELLOW, RED, BLACK, AND WHITE IS/ARE CLAIMED AS A FEATURE OF THE MARK.

THE MARK CONSISTS OF A GLOBE WITH BLUE OCEAN AND UPPER CONTINENTS IN GREEN WITH BLACK OUTLINE AND LOWER CONTINENT IN WHITE WITH BLACK OUTLINE, MUSICAL NOTES WITH YELLOW ARMS, BLACK LEGS, WHITE AND BLACK EYES, RED MOUTHS, AND, FROM LEFT TO RIGHT, GREEN BODY WITH BLACK TOP, YELLOW BODY WITH BLACK TOP, AND RED BODY WITH BLACK TOP. THE PIANO KEYS ARE ALTERNATING BLACK AND WHITE AS IN A TRADITIONAL PIANO KEYBOARD.

CLASS 16—PAPER GOODS AND PRINTED MATTER

FOR BOOKS IN THE FIELD OF MUSIC; BOOKS FOR CHILDREN; CHILDREN'S BOOKS; INSTRUCTION BOOKS IN THE FIELD OF MUSIC; MUSIC BOOKS; MUSIC MANUSCRIPT BOOKS; MUSIC NOTE BOOKS; SONG BOOKS; PRINTED INSTRUCTION MANUALS IN THE FIELD OF MUSIC; PRINTED INSTRUCTION MANUALS RELATING TO TRAINING SEMINARS IN THE FIELD OF MUSIC; MANUALS AND HANDBOOKS IN THE FIELD OF MUSIC; MANUALS IN THE FIELD OF MUSIC; MANUALS FOR INSTRUCTIONAL PURPOSES IN THE FIELD OF MUSIC; MANUALS FOR REFERENCE PURPOSES IN THE FIELD OF MUSIC; MUSIC INSTRUCTION MANUALS; PRINTED MANUALS IN THE FIELD OF MUSIC; REFERENCE MANUALS IN THE FIELD OF MUSIC; TECHNICAL INSTRUCTION MANUALS IN THE FIELD OF MUSIC; TRAINING MANUALS IN THE FORM OF PRINTED MATTER IN THE FIELD OF MUSIC; USER MANUALS IN THE FORM OF PRINTED MATTER IN THE FIELD OF MUSIC; PRINTED EDUCATIONAL MATERIALS OTHER THAN APPARATUS FOR USE IN TEACHING IN THE FIELD OF MUSIC; TEACHING MANUALS IN THE FIELD OF MUSIC; PRINTED TEACHING MATERIALS FOR INSTRUCTION EXCEPT APPARATUS IN THE FIELD OF MUSIC; PRINTED TEACHING MATERIALS FOR EDUCATION IN THE FIELD OF MUSIC; PRINTED TEACHING MATERIALS FOR INSTRUCTION IN THE FIELD OF MUSIC; INSTRUCTION BOOKS IN THE FIELD OF MUSIC; PRINTED INSTRUCTION MANUALS AND HANDBOOKS IN THE FIELD OF MUSIC; INSTRUCTION MANUALS IN THE FIELD OF MUSIC; INSTRUCTION MANUALS RELATING TO TRAINING SEMINARS IN THE FIELD OF MUSIC; PRINTED INSTRUCTIONAL MATERIAL IN THE FIELD OF MUSIC; MANUALS FOR INSTRUCTIONAL PURPOSES IN THE FIELD OF MUSIC; MUSIC INSTRUCTION MANUALS; PRINTED MATTER FOR INSTRUCTIONAL PURPOSES, NAMELY, INSTRUCTIONAL BOOKS FOR MUSIC; PRINTED TEACHING MATERIALS FOR INSTRUCTION IN THE FIELD OF MUSIC; PRINTED EDUCATIONAL MATERIALS OTHER THAN APPARATUS FOR USE IN TEACHING IN THE FIELD OF MUSIC; TEACHING MANUALS IN THE FIELD OF MUSIC; PRINTED TEACHING MATERIALS EXCEPT APPARATUS IN THE FIELD OF MUSIC; PRINTED TEACHING MATERIALS FOR EDUCATION IN THE FIELD OF MUSIC; MUSIC BOOKS; MUSIC IN BOOK FORM; MUSIC INSTRUCTION MANUALS; MUSIC MANUSCRIPT BOOKS; MUSICAL WORKS, NAMELY, SHEET MUSIC IN THE FORM OF PRINTED MATTER; PRINTED MUSIC SHEETS; PRINTED MUSICAL PUBLICATIONS IN THE NATURE OF BOOKLETS; PRINTED PUBLICATIONS RELATING TO MUSIC IN THE NATURE OF BOOKLETS; INSTRUCTION MANUALS RELATING TO TRAINING SEMINARS IN THE FIELD OF MUSIC; TRAINING GUIDES IN THE FORM OF PRINTED MATTER IN THE FIELD OF MUSIC; TRAINING MANUALS IN THE FORM OF PRINTED MATTER IN THE FIELD OF MUSIC; PRINTED TRAINING MATERIALS OTHER THAN APPARATUS IN THE FIELD OF MUSIC; PRINTED EDUCATIONAL MATERIALS OTHER THAN APPARATUS FOR USE IN TEACHING IN THE FIELD OF MUSIC; EDUCATIONAL MATERIALS IN PRINTED FORM IN THE FIELD OF MUSIC; PRINTED MATTER IN THE NATURE OF BOOKLETS FOR EDUCATIONAL PURPOSES IN THE FIELD OF MUSIC; PRINTED TEACHING MATERIALS FOR EDUCATION IN THE FIELD OF MUSIC (U.S. CLS. 2, 5, 22, 23, 29, 37, 38 AND 50).

FIRST USE 9-0-2008; IN COMMERCE 9-0-2008.

CLASS 41—EDUCATION AND ENTERTAINMENT

FOR CONDUCTING INSTRUCTIONAL COURSES, NAMELY, PROVIDING CLASSES, SEMINARS, CONFERENCES, WORKSHOPS IN THE FIELD OF MUSIC; CONDUCTING OF INSTRUCTIONAL SEMINARS IN THE FIELD OF MUSIC; EDUCATIONAL INSTRUCTION, NAMELY, PROVIDING CLASSES, SEMINARS, CONFERENCES, WORKSHOPS IN THE FIELD OF MUSIC; INSTRUCTION IN MUSIC; PROVIDING COURSES OF INSTRUCTION, NAMELY, PROVIDING CLASSES, SEMINARS, CONFERENCES, WORKSHOPS IN THE FIELD OF MUSIC; PRESCHOOL TEACHING; PROVIDING INSTRUCTION IN MUSIC; MUSICAL EDUCATION SERVICES IN THE NATURE OF CLASSES, SEMINARS, CONFERENCES, WORKSHOPS; MUSICAL ENTERTAINMENT SERVICES IN THE NATURE OF PROVIDING LIVE PERFORMANCES BY A MUSICIAN; MUSICAL INSTRUCTION SERVICES; INSTRUCTION IN SINGING; SINGING CLASSES; EDUCATIONAL AND TRAINING COACHING, NAMELY, PROFESSIONAL COACHING SERVICES IN THE FIELD OF MUSIC; CONDUCTING TRAINING SEMINARS IN THE FIELD OF MUSIC; ORGANIZATION OF TRAINING COURSES IN THE FIELD OF MUSIC; PROVISION OF TRAINING COURSES IN THE USE OF MUSICAL INSTRUMENTS; TEACHER TRAINING SERVICES, NAMELY, CLASSROOM TRAINING FOR CERTIFICATION OF TEACHERS AND CONTINUING EDUCATION FOR TEACHERS AND STUDENTS; TRAINING IN THE USE AND OPERATION OF MUSICAL INSTRUMENTS; CONDUCTING OF EDUCATIONAL CLASSES IN THE FIELD OF MUSIC; CONSULTANCY SERVICES RELATING TO EDUCATION; EDUCATION SERVICES, NAMELY, CLASSES, SEMINAR, CONFERENCES, AND WORKSHOPS IN THE FIELD OF MUSIC AND MUSICAL INSTRUMENTS; EDUCATIONAL INSTRUCTION, NAMELY, INSTRUCTION IN RELATION TO THE PLAYING OF MUSICAL INSTRUMENTS; EDUCATIONAL SEMINARS IN THE FIELD OF MUSIC AND MUSICAL INSTRUMENTS; KINDERGARTEN SERVICES, NAMELY, PROVIDING COURSES OF INSTRUCTION IN RELATION TO MUSIC AND MUSICAL INSTRUMENTS; MUSICAL EDUCATION SERVICES, NAMELY, PROVIDING COURSES OF INSTRUCTION IN RELATION TO MUSIC AND MUSICAL INSTRUMENTS; PROVISION OF EDUCATIONAL COURSES IN THE FIELD OF MUSIC AND MUSICAL INSTRUMENTS; PUBLICATION OF EDUCATIONAL TEXTS (U.S. CLS. 100, 101 AND 107).

FIRST USE 1-0-2008; IN COMMERCE 1-0-2008.

3,785,506. HOMEWISE, INC., SANTA FE, NM. SN 77-515,251. PUB. 5-19-2009, FILED 7-5-2008.

WISE INVESTING BEGINS AT HOME

THE MARK CONSISTS OF STANDARD CHARACTERS WITHOUT CLAIM TO ANY PARTICULAR FONT, STYLE, SIZE, OR COLOR.

CLASS 36—INSURANCE AND FINANCIAL

FOR FINANCIAL SERVICES, NAMELY, LOAN FINANCING TO PROVIDE MODERATE AND LOW-INCOME FAMILIES WITH HOUSING, AND REAL PROPERTY OWNERSHIP AND IMPROVEMENT; REAL ESTATE SERVICES, NAMELY, ASSISTING MODERATE AND LOW-INCOME FAMILIES OBTAIN HOME OWNERSHIP BY PROVIDING REAL ESTATE ADVICE AND MORTGAGE LENDING SERVICES (U.S. CLS. 100, 101 AND 102).

FIRST USE 11-25-2009; IN COMMERCE 11-25-2009.

CLASS 37—CONSTRUCTION AND REPAIR

FOR LAND DEVELOPMENT SERVICES, NAMELY, PROVIDING REAL ESTATE DEVELOPMENT SERVICES FOR AFFORDABLE RESIDENTIAL HOUSING PROJECTS THAT SERVE MODERATE AND LOW INCOME INDIVIDUALS (U.S. CLS. 100, 103 AND 106).

FIRST USE 11-25-2009; IN COMMERCE 11-25-2009.

3,785,507. EDUCADIUM, INC., PORTLAND, OR. SN 77-515,263. PUB. 5-19-2009, FILED 7-5-2008.

Educadium

THE MARK CONSISTS OF STANDARD CHARACTERS WITHOUT CLAIM TO ANY PARTICULAR FONT, STYLE, SIZE, OR COLOR.

CLASS 41—EDUCATION AND ENTERTAINMENT

FOR EDUCATIONAL SERVICES, NAMELY, CONDUCTING WORKSHOPS, CLASSES, AND SEMINARS IN THE FIELD OF ONLINE LEARNING, TEACHING, TRAINING, AND SCHOOL MANAGEMENT (U.S. CLS. 100, 101 AND 107).

FIRST USE 10-0-2008; IN COMMERCE 10-0-2008.

CLASS 42—SCIENTIFIC AND COMPUTER SERVICES

FOR APPLICATION SERVICE PROVIDER (ASP) FEATURING SOFTWARE FOR USE IN DEVELOPING, DELIVERING, AND MANAGING TRAINING AND EDUCATIONAL PROGRAMS FOR BUSINESSES, EDUCATORS, NONPROFITS, AND INDIVIDUALS; COMPUTER TECHNOLOGY SUPPORT SERVICES, NAMELY, HELP DESK SERVICES (U.S. CLS. 100 AND 101).

FIRST USE 10-0-2008; IN COMMERCE 10-0-2008.

3,785,517. ALLIANCE SPORTS GROUP, L.P., GRAND PRAIRIE, TX. SN 77-518,643. PUB. 5-19-2009, FILED 7-10-2008.

WEATHERRITE

THE MARK CONSISTS OF STANDARD CHARACTERS WITHOUT CLAIM TO ANY PARTICULAR FONT, STYLE, SIZE, OR COLOR.

CLASS 18—LEATHER GOODS

FOR UMBRELLAS (U.S. CLS. 1, 2, 3, 22 AND 41).

FIRST USE 1-19-2001; IN COMMERCE 1-19-2001.

CLASS 20—FURNITURE AND ARTICLES NOT OTHERWISE CLASSIFIED

FOR PORTABLE ORGANIZERS, NAMELY, STANDS HAVING A PAPER TOWEL HOLDER, TRASH BAG HOLDER, RADIO OR LANTERN HOLDER, CONDIMENT RACK, AND UTENSIL HOOKS (U.S. CLS. 2, 13, 22, 25, 32 AND 50).
FIRST USE 1-19-2001; IN COMMERCE 1-19-2001.

CLASS 22—CORDAGE AND FIBERS

FOR TENTS, TENTS MADE OF SCREEN; CANVAS CANOPIES AND VINYL GROUND CLOTHS (U.S. CLS. 1, 2, 7, 19, 22, 42 AND 50).
FIRST USE 1-19-2001; IN COMMERCE 1-19-2001.

CLASS 25—CLOTHING

FOR RAINCOATS; RAIN SUITS; RAIN HATS; PONCHOS; WATERPROOF FISHING SHIRTS, HUNTING SHIRTS, VESTS AND JACKETS, SPORT JACKETS, BOOTS, SHOES AND OVERSHOES; FISHING WADERS (U.S. CLS. 22 AND 39).
FIRST USE 1-19-2001; IN COMMERCE 1-19-2001.

3,785,519. KNEAD MARKETPLACE, LAGRANGE, IL. SN 77-520,497. PUB. 5-26-2009, FILED 7-11-2008.

KNEAD MARKETPLACE

THE MARK CONSISTS OF STANDARD CHARACTERS WITHOUT CLAIM TO ANY PARTICULAR FONT, STYLE, SIZE, OR COLOR.

NO CLAIM IS MADE TO THE EXCLUSIVE RIGHT TO USE "MARKETPLACE", APART FROM THE MARK AS SHOWN.

CLASS 30—STAPLE FOODS

FOR SANDWICHES, PASTRIES AND BAKERY DESERTS (U.S. CL. 46).
FIRST USE 12-1-2007; IN COMMERCE 12-1-2007.

CLASS 43—HOTEL AND RESTAURANT SERVICES

FOR RESTAURANT, CAFE, AND CATERING SERVICES (U.S. CLS. 100 AND 101).
FIRST USE 12-1-2007; IN COMMERCE 12-1-2007.

3,785,522. PIONEER DRILLING COMPANY, SAN ANTONIO, TX. SN 77-521,369. PUB. 7-21-2009, FILED 7-14-2008.

PHOENIX SURVEYS

THE MARK CONSISTS OF STANDARD CHARACTERS WITHOUT CLAIM TO ANY PARTICULAR FONT, STYLE, SIZE, OR COLOR.

NO CLAIM IS MADE TO THE EXCLUSIVE RIGHT TO

USE "SURVEYS", APART FROM THE MARK AS SHOWN.

CLASS 37—CONSTRUCTION AND REPAIR

FOR WIRELINING FOR OIL AND GAS WELLS (U.S. CLS. 100, 103 AND 106).
FIRST USE 3-3-2008; IN COMMERCE 3-3-2008.

CLASS 42—SCIENTIFIC AND COMPUTER SERVICES

FOR OIL AND GAS WELL LOGGING AND TESTING (U.S. CLS. 100 AND 101).
FIRST USE 3-3-2008; IN COMMERCE 3-3-2008.

3,785,527. HANSEN BEVERAGE COMPANY, CORONA, CA. SN 77-522,007. PUB. 11-24-2009, FILED 7-14-2008.

SELF BEAUTY ELIXIR

THE MARK CONSISTS OF STANDARD CHARACTERS WITHOUT CLAIM TO ANY PARTICULAR FONT, STYLE, SIZE, OR COLOR.

NO CLAIM IS MADE TO THE EXCLUSIVE RIGHT TO USE "BEAUTY", APART FROM THE MARK AS SHOWN.

CLASS 5—PHARMACEUTICALS

FOR NUTRITIONAL SUPPLEMENTS (U.S. CLS. 6, 18, 44, 46, 51 AND 52).
FIRST USE 8-25-2009; IN COMMERCE 8-25-2009.

CLASS 32—LIGHT BEVERAGES

FOR NON-ALCOHOLIC, NON-CARBONATED BEVERAGES, NAMELY, SOFT DRINKS, FRUIT DRINKS, AND FRUIT-FLAVORED BEVERAGES, ENHANCED WITH VITAMINS AND MINERALS (U.S. CLS. 45, 46 AND 48).
FIRST USE 8-25-2009; IN COMMERCE 8-25-2009.

3,785,530. CHILDREN'S MEDICAL CENTER CORPORATION, BOSTON, MA. SN 77-522,679. PUB. 5-12-2009, FILED 7-15-2008.

ZEBRAFISH

THE MARK CONSISTS OF STANDARD CHARACTERS WITHOUT CLAIM TO ANY PARTICULAR FONT, STYLE, SIZE, OR COLOR.

CLASS 41—EDUCATION AND ENTERTAINMENT

FOR EDUCATION AND ENTERTAINMENT SERVICES, NAMELY, PROVIDING ONLINE INTERACTIVE ANIMATED CHILDREN'S STORIES; ENTERTAINMENT SERVICES, NAMELY, PROVIDING ONLINE COMPUTER GAMES (U.S. CLS. 100, 101 AND 107).

FIRST USE 5-22-2008; IN COMMERCE 5-22-2008.

CLASS 44—MEDICAL, BEAUTY AND AGRICULTURAL SERVICES

FOR PROVIDING A WEBSITE FEATURING EDUCATIONAL INFORMATION IN THE FIELDS OF WELLNESS AND HEALTHCARE (U.S. CLS. 100 AND 101).

FIRST USE 5-22-2008; IN COMMERCE 5-22-2008.

3,785,540. SMALL ACT NETWORK, LLC, MCLEAN, VA. SN 77-527,686. PUB. 6-9-2009, FILED 7-21-2008.



THE MARK CONSISTS OF A HAND DROPPING A COIN INTO A GLOBE-SHAPED BANK.

CLASS 36—INSURANCE AND FINANCIAL

FOR CHARITABLE FUND RAISING SERVICES, NAMELY, PROVIDING INDIVIDUALS WITH THE OPPORTUNITY TO HAVE MONETARY DONATIONS MADE TO THEIR FAVORITE CHARITY (U.S. CLS. 100, 101 AND 102).

FIRST USE 10-25-2008; IN COMMERCE 10-25-2008.

CLASS 42—SCIENTIFIC AND COMPUTER SERVICES

FOR COMPUTER SERVICES, NAMELY, HOSTING AND MAINTAINING AN ON-LINE WEB SITE FOR OTHERS TO MAKE MONETARY DONATIONS TO THEIR FAVORITE CHARITY; COMPUTER SERVICES, NAMELY, HOSTING AND MAINTAINING AN ON-LINE WEB SITE FOR OTHERS TO COMMUNICATE INFORMATION ABOUT CHARITABLE ORGANIZATIONS; COMPUTER SERVICES, NAMELY, HOSTING AND MAINTAINING AN ON-LINE WEB SITE FOR OTHERS TO FOSTER AND INSPIRE MEMBERS OF CHARITABLE ORGANIZATIONS TO TAKE ACTION (U.S. CLS. 100 AND 101).

FIRST USE 10-25-2008; IN COMMERCE 10-25-2008.

3,785,552. LUCKY STRIKE ENTERTAINMENT, LLC, SHERMAN OAKS, CA. SN 77-531,547. PUB. 9-16-2008, FILED 7-25-2008.

LUCKY STRIKE

THE MARK CONSISTS OF STANDARD CHARACTERS WITHOUT CLAIM TO ANY PARTICULAR FONT, STYLE, SIZE, OR COLOR.

OWNER OF U.S. REG. NOS. 810,755, 3,060,821, AND 3,064,076.

CLASS 28—TOYS AND SPORTING GOODS

FOR LOTTERY CARDS; LOTTERY TICKETS; SCRATCH CARDS FOR PLAYING LOTTERY GAMES (U.S. CLS. 22, 23, 38 AND 50).

FIRST USE 3-8-2010; IN COMMERCE 3-8-2010.

CLASS 43—HOTEL AND RESTAURANT SERVICES

FOR COCKTAIL LOUNGES; RESTAURANT AND BAR SERVICES (U.S. CLS. 100 AND 101).

FIRST USE 5-0-2003; IN COMMERCE 5-0-2003.

3,785,555. ACCUQUEST HEARING CENTER, INC., HOFFMAN ESTATES, IL. SN 77-532,873. PUB. 6-16-2009, FILED 7-28-2008.

ACCUQUEST

THE MARK CONSISTS OF STANDARD CHARACTERS WITHOUT CLAIM TO ANY PARTICULAR FONT, STYLE, SIZE, OR COLOR.

CLASS 35—ADVERTISING AND BUSINESS

FOR RETAIL STORE SERVICES FEATURING HEARING AIDS AND RELATED PRODUCTS (U.S. CLS. 100, 101 AND 102).

FIRST USE 8-28-2008; IN COMMERCE 8-28-2008.

CLASS 37—CONSTRUCTION AND REPAIR

FOR REPAIR OF HEARING AIDS AND RELATED PRODUCTS (U.S. CLS. 100, 103 AND 106).

FIRST USE 8-28-2008; IN COMMERCE 8-28-2008.

CLASS 44—MEDICAL, BEAUTY AND AGRICULTURAL SERVICES

FOR HEARING AID SERVICES (U.S. CLS. 100 AND 101).

FIRST USE 8-28-2008; IN COMMERCE 8-28-2008.

3,785,559. VUZE, INC., SAN MATEO, CA. SN 77-534,609. PUB. 4-28-2009, FILED 7-30-2008.



THE MARK CONSISTS OF A FROG.

CLASS 9—ELECTRICAL AND SCIENTIFIC APPARATUS

FOR COMPUTER SOFTWARE FOR PROVIDING ACCESS TO ON-LINE DIRECTORIES, INDICES AND SEARCHABLE DATABASES RELATING TO A VARIETY OF INFORMATION AND DATA AVAILABLE VIA ELECTRONIC COMMUNICATIONS NETWORKS; COMPUTER SOFTWARE TO ENABLE UPLOADING, POSTING, SHOWING, DISPLAYING, TAGGING, BLOGGING, SHARING OR OTHERWISE PROVIDING ELECTRONIC MEDIA OR INFORMATION OVER ELECTRONIC COMMUNICATIONS NETWORKS (U.S. CLS. 21, 23, 26, 36 AND 38).

FIRST USE 10-15-2008; IN COMMERCE 10-15-2008.

CLASS 25—CLOTHING

FOR CLOTHING, NAMELY, SHIRTS, SWEATSHIRTS, JACKETS, COATS, SHORTS, SWEATERS, VISORS, AND CAPS (U.S. CLS. 22 AND 39).

FIRST USE 10-15-2008; IN COMMERCE 10-15-2008.

CLASS 38—COMMUNICATION

FOR BROADCASTING SERVICES OVER ELECTRONIC COMMUNICATIONS NETWORKS, NAMELY, ELECTRONICALLY TRANSMITTING INFORMATION, AUDIO, AND VIDEO CLIPS; PROVIDING ACCESS TO INFORMATION, AUDIO, AND VIDEO CONTENT VIA WEBSITES, ONLINE FORUMS, CHAT ROOMS, LISTSERVS AND BLOGS OVER ELECTRONIC COMMUNICATIONS NETWORKS; PROVIDING ON-LINE CHAT ROOMS AND ELECTRONIC BULLETIN BOARDS FOR TRANSMISSION OF MESSAGES AMONG USERS IN THE FIELD OF GENERAL INTEREST (U.S. CLS. 100, 101 AND 104).

FIRST USE 10-15-2008; IN COMMERCE 10-15-2008.

CLASS 41—EDUCATION AND ENTERTAINMENT

FOR ENTERTAINMENT AND EDUCATION SERVICES, NAMELY, PROVIDING A WEBSITE FEATURING PHOTOGRAPHS, PRE-RECORDED MUSIC, MUSICAL VIDEOS, VIDEO RECORDINGS, AUDIO-VIDEO GAMES, VIDEO CLIPS, FILM CLIPS, ONLINE GAMES AND OTHER MULTIMEDIA MATERIALS, ALL VIA ELECTRONIC COMMUNICATIONS NETWORKS, IN THE FIELDS OF COMEDY, DRAMA, ART, STYLE, CURRENT EVENTS, DOCUMENTARIES, SCIENCE, TEACHING, SPORTS, TRAVEL, AND SELF-IMPROVEMENT; PROVIDING ONLINE COMMENTARY AND RATINGS RELATING TO THE FOREGOING (U.S. CLS. 100, 101 AND 107).

FIRST USE 10-15-2008; IN COMMERCE 10-15-2008.

CLASS 42—SCIENTIFIC AND COMPUTER SERVICES

FOR HOSTING A WEBSITE FOR THE UPLOADING, DOWNLOADING, EDITING, PLAYING, STREAMING, VIEWING, PREVIEWING, POSTING, DISPLAYING, TAGGING, SHARING, PROVIDING, TRANSMITTING AND/OR MANIPULATING OF VIDEO, PICTURES, IMAGES, TEXT, AUDIO AND/OR OTHER ELECTRONIC MEDIA OR INFORMATION; COMPUTER SERVICES, NAMELY, UPLOADING MUSIC AUDIO AND VIDEO CLIPS TO THE INTERNET FOR OTHERS (U.S. CLS. 100 AND 101).

FIRST USE 10-15-2008; IN COMMERCE 10-15-2008.

3,785,561. GEO PLASTICS, LOS ANGELES, CA. SN 77-535,355. PUB. 6-30-2009, FILED 7-30-2008.

DURA SNAP LOCK

THE MARK CONSISTS OF STANDARD CHARACTERS WITHOUT CLAIM TO ANY PARTICULAR FONT, STYLE, SIZE, OR COLOR.

NO CLAIM IS MADE TO THE EXCLUSIVE RIGHT TO USE "SNAP LOCK", APART FROM THE MARK AS SHOWN.

CLASS 12—VEHICLES

FOR PLASTIC WHEELS FOR HANDCARTS, STROLLERS AND PUSH SCOOTERS FOR CHILDREN (U.S. CLS. 19, 21, 23, 31, 35 AND 44).

FIRST USE 12-11-2009; IN COMMERCE 12-11-2009.

CLASS 20—FURNITURE AND ARTICLES NOT OTHERWISE CLASSIFIED

FOR PLASTIC WHEELS FOR BABY AND INFANT WALKERS (U.S. CLS. 2, 13, 22, 25, 32 AND 50).

FIRST USE 12-11-2009; IN COMMERCE 12-11-2009.

CLASS 21—HOUSEWARES AND GLASS

FOR PLASTIC WHEELS FOR PORTABLE COOLERS, GARBAGE CONTAINERS AND HOUSEHOLD TRASH CONTAINERS (U.S. CLS. 2, 13, 23, 29, 30, 33, 40 AND 50).

FIRST USE 12-11-2009; IN COMMERCE 12-11-2009.

CLASS 28—TOYS AND SPORTING GOODS

FOR PLASTIC WHEELS FOR TOYS, NAMELY, WAGONS, TOY VEHICLES, RIDE-ON TOY VEHICLES AND TOY AIRCRAFT (U.S. CLS. 22, 23, 38 AND 50).

FIRST USE 12-11-2009; IN COMMERCE 12-11-2009.

3,785,562. BOARD OF REGENTS OF THE UNIVERSITY SYSTEM OF GEORGIA, ATLANTA, GA. SN 77-535,685. PUB. 10-6-2009, FILED 7-31-2008.

GEORGIA GWINNETT GRIZZLIES

THE MARK CONSISTS OF STANDARD CHARACTERS

WITHOUT CLAIM TO ANY PARTICULAR FONT, STYLE, SIZE, OR COLOR.

OWNER OF U.S. REG. NOS. 1,298,360, 3,031,191, AND OTHERS.

NO CLAIM IS MADE TO THE EXCLUSIVE RIGHT TO USE "GWINNETT" AND "GEORGIA" AS TO CLASS 28 ONLY, APART FROM THE MARK AS SHOWN.

SEC. 2(F) AS TO "GEORGIA" AS TO CLASSES 25 AND 41.

CLASS 25—CLOTHING

FOR HOODED PULLOVERS; HOODED SWEAT SHIRTS; SHIRTS; SWEAT SHIRTS; T-SHIRTS (U.S. CLS. 22 AND 39).

FIRST USE 3-0-2008; IN COMMERCE 3-0-2008.

CLASS 28—TOYS AND SPORTING GOODS

FOR BALLOONS; RUBBER BALLS; SPORT BALLS; STUFFED TOYS (U.S. CLS. 22, 23, 38 AND 50).

FIRST USE 3-0-2008; IN COMMERCE 3-0-2008.

CLASS 41—EDUCATION AND ENTERTAINMENT

FOR EDUCATIONAL SERVICES, NAMELY, PROVIDING COURSES OF INSTRUCTION AT THE COLLEGE LEVEL AND DISTRIBUTION OF COURSE MATERIAL IN CONNECTION THEREWITH; ENTERTAINMENT IN THE NATURE OF COMPETITIONS IN THE FIELD OF ATHLETIC EVENTS (U.S. CLS. 100, 101 AND 107).

FIRST USE 3-0-2008; IN COMMERCE 3-0-2008.

3,785,567. KONAMI DIGITAL ENTERTAINMENT CO., LTD., TOKYO, JAPAN. SN 77-537,373. PUB. 5-5-2009, FILED 8-1-2008.

SUIKODEN TIERKREIS

THE MARK CONSISTS OF STANDARD CHARACTERS WITHOUT CLAIM TO ANY PARTICULAR FONT, STYLE, SIZE, OR COLOR.

OWNER OF U.S. REG. NOS. 2,484,761 AND 3,269,511.

THE ENGLISH TRANSLATION OF "SUIKODEN" AND "TIERKREIS" IN THE MARK IS LEGEND OF SUIKO AND ZODIAC.

CLASS 9—ELECTRICAL AND SCIENTIFIC APPARATUS

FOR VIDEO GAME SOFTWARE; VIDEO GAME PROGRAMS; COMPUTER GAME SOFTWARE; COMPUTER GAME PROGRAMS; ELECTRONIC GAME PROGRAMS (U.S. CLS. 21, 23, 26, 36 AND 38).

FIRST USE 3-17-2009; IN COMMERCE 3-17-2009.

CLASS 41—EDUCATION AND ENTERTAINMENT

FOR ENTERTAINMENT SERVICES, NAMELY, PROVIDING ON-LINE VIDEO GAMES (U.S. CLS. 100, 101 AND 107).

FIRST USE 3-17-2009; IN COMMERCE 3-17-2009.

3,785,576. SERRES, JOHN P., DBA SERRES RANCH, SONOMA, CA. SN 77-544,648. PUB. 6-9-2009, FILED 8-12-2008.



NO CLAIM IS MADE TO THE EXCLUSIVE RIGHT TO USE "RANCH", APART FROM THE MARK AS SHOWN.

THE MARK CONSISTS OF THE WORDING "SR SERRES RANCH" WITH A CHEVRON DESIGN LOCATED ABOVE THE LETTERS "SR" AND AN OVAL DESIGN SURROUNDING THE LETTERS "SR" AND CHEVRON DESIGN.

CLASS 31—NATURAL AGRICULTURAL PRODUCTS

FOR FRESH BLUEBERRIES (U.S. CLS. 1 AND 46).

FIRST USE 6-25-2004; IN COMMERCE 6-25-2004.

CLASS 33—WINES AND SPIRITS

FOR WINE (U.S. CLS. 47 AND 49).

FIRST USE 3-1-2010; IN COMMERCE 3-1-2010.

3,785,580. GFK MEDIAMARK RESEARCH & INTELLIGENCE, LLC, NEW YORK, NY. SN 77-546,153. PUB. 7-14-2009, FILED 8-13-2008.

BRANDPANEL

THE MARK CONSISTS OF STANDARD CHARACTERS WITHOUT CLAIM TO ANY PARTICULAR FONT, STYLE, SIZE, OR COLOR.

CLASS 35—ADVERTISING AND BUSINESS

FOR MARKET RESEARCH SERVICES; CONDUCTING BUSINESS AND MARKET RESEARCH SURVEYS; CONDUCTING MARKETING STUDIES; MARKETING AND ADVERTISING CONSULTATION; BUSINESS CONSULTATION; BUSINESS RESEARCH; CONDUCTING PUBLIC OPINION POLLS; STATISTICAL RESEARCH AND CONSULTATION IN THE FIELDS OF BUSINESS AND MARKETING; BUSINESS CONSULTING AND BUSINESS INFORMATION FOR OTHERS; BUSINESS RESEARCH AND CONSULTING RELATING TO MARKET RESEARCH, CONSUMER PURCHASING INFORMATION, AND BRAND IDENTITY DEVELOPMENT; MARKET ANALYSIS; MARKET OPINION POLLING; CONDUCTING MARKET STUDIES AND ANALYSIS OF MARKET STUDIES; BUSINESS MARKETING SERVICES (U.S. CLS. 100, 101 AND 102).

FIRST USE 10-1-2005; IN COMMERCE 10-1-2005.

CLASS 42—SCIENTIFIC AND COMPUTER SERVICES

FOR ADVISORY SERVICES IN THE FIELD OF PRODUCT DEVELOPMENT (U.S. CLS. 100 AND 101).

FIRST USE 10-1-2005; IN COMMERCE 10-1-2005.

3,785,582. PEACEHEALTH, BELLEVUE, WA. SN 77-547,332.
PUB. 10-20-2009, FILED 8-14-2008.



THE MARK CONSISTS OF THE WORDS "PEACEHEALTH" ABOVE THE WORDS "PATIENTCONNECTION" ARE TO THE LEFT SIDE OF THE MARK. THE WORDS "PATIENTCONNECTION" INTERSECT AT AN OVAL FORMED OF TWO STYLIZED HUMAN FORMS.

CLASS 35—ADVERTISING AND BUSINESS

FOR PROVIDING PATIENT APPOINTMENT SCHEDULING VIA THE GLOBAL COMMUNICATIONS NETWORK; PROVIDING CONSUMER MEDICAL PRODUCT INFORMATION, EXCLUDING INFORMATION REGARDING NEBULIZERS AND NEBULIZER ACCESSORIES VIA THE GLOBAL COMMUNICATIONS NETWORK (U.S. CLS. 100, 101 AND 102).
FIRST USE 8-2-2008; IN COMMERCE 8-2-2008.

CLASS 44—MEDICAL, BEAUTY AND AGRICULTURAL SERVICES

FOR PROVIDING MEDICAL INFORMATION, NAMELY, PERSONAL PATIENT MEDICAL RECORDS, MEDICAL SERVICES, HEALTHCARE INFORMATION AND NOTIFICATIONS AND REPORTS VIA THE GLOBAL COMMUNICATIONS NETWORK (U.S. CLS. 100 AND 101).
FIRST USE 8-2-2008; IN COMMERCE 8-2-2008.

3,785,591. JOSEPH SAYEGH, CORONA DEL MAR, CA. SN 77-553,823. PUB. 6-2-2009, FILED 8-22-2008.

ANTIQUERA

THE MARK CONSISTS OF STANDARD CHARACTERS WITHOUT CLAIM TO ANY PARTICULAR FONT, STYLE, SIZE, OR COLOR.

THE WORDING "ANTIQUERA" HAS NO MEANING IN A FOREIGN LANGUAGE.

CLASS 11—ENVIRONMENTAL CONTROL APPARATUS

FOR ORNAMENTAL FOUNTAINS, WATER FOUNTAINS (U.S. CLS. 13, 21, 23, 31 AND 34).
FIRST USE 11-30-1997; IN COMMERCE 11-30-1997.

CLASS 19—NON-METALLIC BUILDING MATERIALS

FOR NON-METAL DOORS, NON-METAL TILES; SALVAGED NON-METAL ARCHITECTURAL COLUMNS; NON-METAL DECORATIVE MOLDINGS AND DECORATIVE TRIM FOR USE IN BUILDING CONSTRUCTION; WORKS OF ART OF STONE, MARBLE, AND GRANITE; STATUES AND SCULPTURES OF STONE (U.S. CLS. 1, 12, 33 AND 50).
FIRST USE 11-30-1997; IN COMMERCE 11-30-1997.

CLASS 21—HOUSEWARES AND GLASS

FOR WORKS OF ART OF EARTHENWARE, PORCELAIN, TERRA COTTA; HEADS AND BUSTS OF EARTHENWARE, PORCELAIN, TERRA COTTA; STATUES AND SCULPTURES OF EARTHENWARE, PORCELAIN, AND TERRA COTTA (U.S. CLS. 2, 13, 23, 29, 30, 33, 40 AND 50).
FIRST USE 11-30-1997; IN COMMERCE 11-30-1997.

3,785,596. DAIRY MANAGEMENT, INC., ROSEMONT, IL. SN 77-556,124. PUB. 10-6-2009, FILED 8-26-2008.

FUEL UP

THE MARK CONSISTS OF STANDARD CHARACTERS WITHOUT CLAIM TO ANY PARTICULAR FONT, STYLE, SIZE, OR COLOR.

CLASS 35—ADVERTISING AND BUSINESS

FOR PROMOTING PUBLIC AWARENESS OF THE BENEFITS OF ACCESS TO HEALTHY FOODS, GOOD NUTRITION PRACTICES, AND PHYSICAL ACTIVITY FOR PRIMARY AND SECONDARY SCHOOL STUDENTS (U.S. CLS. 100, 101 AND 102).
FIRST USE 9-30-2008; IN COMMERCE 9-30-2008.

CLASS 41—EDUCATION AND ENTERTAINMENT

FOR EDUCATIONAL SERVICES, NAMELY, PROVIDING CLASSROOM INSTRUCTION AND ONLINE INSTRUCTION RELATING TO HEALTH, THE BENEFITS OF PHYSICAL ACTIVITY AND GOOD NUTRITION FOR SCHOOL CHILDREN; PROVIDING INFORMATION RELATING TO PHYSICAL EXERCISE FOR SCHOOL CHILDREN; DEVELOPING AND DISSEMINATING EDUCATIONAL MATERIALS OF OTHERS IN THE FIELDS OF PHYSICAL FITNESS AND NUTRITION FOR PRIMARY AND SECONDARY SCHOOL STUDENTS (U.S. CLS. 100, 101 AND 107).
FIRST USE 9-30-2008; IN COMMERCE 9-30-2008.

CLASS 44—MEDICAL, BEAUTY AND AGRICULTURAL SERVICES

FOR PROVIDING INFORMATION IN THE FIELDS OF HEALTH AND GOOD NUTRITION FOR SCHOOL CHILDREN (U.S. CLS. 100 AND 101).
FIRST USE 9-30-2008; IN COMMERCE 9-30-2008.

3,785,601. MORSELS, L.P., AUSTIN, TX. SN 77-559,340. PUB. 6-2-2009, FILED 8-29-2008.

WALTON'S FANCY AND STAPLE

THE MARK CONSISTS OF STANDARD CHARACTERS WITHOUT CLAIM TO ANY PARTICULAR FONT, STYLE, SIZE, OR COLOR.

NO CLAIM IS MADE TO THE EXCLUSIVE RIGHT TO USE "FANCY AND STAPLE", APART FROM THE MARK AS SHOWN.

CLASS 35—ADVERTISING AND BUSINESS

FOR RETAIL STORE SERVICES FEATURING FLOWERS, FLOWER ARRANGEMENTS, HOUSE PLANTS, SPECIALTY PLANTS, ANTIQUES, GIFT ITEMS, CANDLES, GIFT BAGS, BAKED GOODS, CHEESES, BOTTLED CONDIMENTS, AND COFFEE (U.S. CLS. 100, 101 AND 102).

FIRST USE 5-15-2009; IN COMMERCE 5-15-2009.

CLASS 43—HOTEL AND RESTAURANT SERVICES

FOR DELICATESSEN, RESTAURANT AND CARRY-OUT RESTAURANT SERVICES (U.S. CLS. 100 AND 101).

FIRST USE 5-15-2009; IN COMMERCE 5-15-2009.

CLASS 44—MEDICAL, BEAUTY AND AGRICULTURAL SERVICES

FOR FLOWER AND PLANT ARRANGEMENT AND DESIGN SERVICES FOR BUSINESSES, RESIDENCES, WEDDINGS AND EVENTS (U.S. CLS. 100 AND 101).

FIRST USE 5-15-2009; IN COMMERCE 5-15-2009.

3,785,612. THE NEW YORK STATE WINE AND CULINARY CENTER, INC., CANANDAIGUA, NY. SN 77-569,743. PUB. 5-26-2009, FILED 9-15-2008.



NO CLAIM IS MADE TO THE EXCLUSIVE RIGHT TO USE "NEW YORK", APART FROM THE MARK AS SHOWN.

THE MARK CONSISTS OF THE WORD "SAMPLE" ABOVE A DESIGN OF THE STATE OF "NEW YORK" AND THE WORDS "NEW YORK" BELOW THE DESIGN, ALL ENCLOSED WITHIN TWO CONCENTRIC CIRCLES. THE DESIGN OF THE STATE OF "NEW YORK" IS MADE UP OF SMALLER DESIGNS OF EARS OF CORN, BEANS, STRAWBERRIES, A COW, CARROTS, A FISH, WEDGES OF

SWISS CHEESE, A SLICE OF WATERMELON, CUCUMBERS, BEETS, BELL PEPPERS, EGGS, APPLES, ONIONS, A FLOWER, A JUG WITH A MAPLE LEAF ON THE FRONT OF IT, POTATOES, LETTUCE, A SPRIG OF HERBS, A PUMPKIN, BLUEBERRIES, WHEAT, GRAPES, AND RADISHES.

CLASS 35—ADVERTISING AND BUSINESS

FOR PROMOTIONAL SERVICES, NAMELY, PROMOTING NEW YORK STATE AGRICULTURE; DEVELOPING PROMOTIONAL AND PUBLIC RELATIONS CAMPAIGNS FOR LOCAL FARMS, FARMING AND FOOD; PROMOTING PUBLIC AWARENESS OF NEW YORK STATE AGRICULTURE THROUGH SEASONAL EVENTS AND SPECIAL EVENTS; PROMOTING THE SALE OF GOODS AND SERVICES OF OTHERS THROUGH THE DEVELOPMENT AND DISTRIBUTION OF PRINTED MATERIAL, RADIO AND TELEVISION ADS, ONLINE ADVERTISING, AND EMAIL BLASTS (U.S. CLS. 100, 101 AND 102).

FIRST USE 10-0-2008; IN COMMERCE 10-0-2008.

CLASS 41—EDUCATION AND ENTERTAINMENT

FOR EDUCATIONAL SERVICES, NAMELY, PROVIDING PROFESSIONAL EDUCATION PROGRAMS, NAMELY, HANDS-ON CLASSES, DEMONSTRATION CLASSES AND ONLINE TRAINING FOR FARMERS, FOOD PROCESSORS, CONSUMERS, FOOD AND CULINARY TRADE ASSOCIATES AND AGRICULTURAL INDUSTRY LEADERS IN THE FIELD OF FOOD AND AGRICULTURE; SPECIAL EVENT SERVICES, NAMELY, PLANNING SPECIAL THEMED EVENTS AND SEASONAL EVENTS FOR VARIOUS AGRICULTURAL PRODUCTS (U.S. CLS. 100, 101 AND 107).

FIRST USE 10-0-2008; IN COMMERCE 10-0-2008.

3,785,615. MOHAWK BRANDS, INC., CALHOUN, GA. SN 77-572,973. PUB. 12-23-2008, FILED 9-18-2008.

MOHAWK SIGNAL COLLECTION

THE MARK CONSISTS OF STANDARD CHARACTERS WITHOUT CLAIM TO ANY PARTICULAR FONT, STYLE, SIZE, OR COLOR.

OWNER OF U.S. REG. NO. 1,099,660.

NO CLAIM IS MADE TO THE EXCLUSIVE RIGHT TO USE "COLLECTION", APART FROM THE MARK AS SHOWN.

CLASS 19—NON-METALLIC BUILDING MATERIALS

FOR CERAMIC TILES; WOODEN FLOORING (U.S. CLS. 1, 12, 33 AND 50).

FIRST USE 10-15-2009; IN COMMERCE 10-15-2009.

CLASS 27—FLOOR COVERINGS

FOR CARPETS (U.S. CLS. 19, 20, 37, 42 AND 50).

FIRST USE 10-15-2009; IN COMMERCE 10-15-2009.

3,785,621. SUNBEAM PRODUCTS, INC., DBA JARDEN CONSUMER SOLUTIONS, BOCA RATON, FL. SN 77-576,601. PUB. 5-26-2009, FILED 9-23-2008.

3,785,630. KOELNMESSE GMBH, 50679 KOELN, FED REP GERMANY. SN 77-583,591. PUB. 5-12-2009, FILED 10-1-2008.

MealSaver

THE MARK CONSISTS OF STANDARD CHARACTERS WITHOUT CLAIM TO ANY PARTICULAR FONT, STYLE, SIZE, OR COLOR.

CLASS 7—MACHINERY

FOR VACUUM SEALING APPLIANCES, NAMELY, VACUUM PUMPS (U.S. CLS. 13, 19, 21, 23, 31, 34 AND 35).

FIRST USE 9-15-2009; IN COMMERCE 9-15-2009.

CLASS 21—HOUSEWARES AND GLASS

FOR VACUUM SEALABLE FOOD LEFTOVER CONTAINERS WITH REMOVABLE LIDS (U.S. CLS. 2, 13, 23, 29, 30, 33, 40 AND 50).

FIRST USE 9-15-2009; IN COMMERCE 9-15-2009.

3,785,629. KOELNMESSE GMBH, 50679 KOELN, FED REP GERMANY. SN 77-583,590. PUB. 5-12-2009, FILED 10-1-2008.

CARBON TRADEEX

THE MARK CONSISTS OF STANDARD CHARACTERS WITHOUT CLAIM TO ANY PARTICULAR FONT, STYLE, SIZE, OR COLOR.

NO CLAIM IS MADE TO THE EXCLUSIVE RIGHT TO USE "CARBON", APART FROM THE MARK AS SHOWN.

CLASS 35—ADVERTISING AND BUSINESS

FOR ORGANIZING AND CONDUCTING TRADE SHOWS AND EXHIBITIONS FOR OTHERS FOR BUSINESS PURPOSES IN THE CARBON DIOXIDE MARKET (U.S. CLS. 100, 101 AND 102).

FIRST USE 4-7-2009; IN COMMERCE 4-7-2009.

CLASS 41—EDUCATION AND ENTERTAINMENT

FOR ORGANIZING AND CONDUCTING EDUCATIONAL CONFERENCES, SEMINARS AND WORKSHOPS FOR OTHERS IN THE FIELD OF THE CARBON DIOXIDE MARKET (U.S. CLS. 100, 101 AND 107).

FIRST USE 4-7-2009; IN COMMERCE 4-7-2009.

CARBON TRADEEX AMERICA

THE MARK CONSISTS OF STANDARD CHARACTERS WITHOUT CLAIM TO ANY PARTICULAR FONT, STYLE, SIZE, OR COLOR.

NO CLAIM IS MADE TO THE EXCLUSIVE RIGHT TO USE "CARBON" AND "AMERICA", APART FROM THE MARK AS SHOWN.

CLASS 35—ADVERTISING AND BUSINESS

FOR ORGANIZING AND CONDUCTING TRADE SHOWS AND EXHIBITIONS FOR OTHERS FOR BUSINESS PURPOSES IN THE CARBON DIOXIDE MARKET (U.S. CLS. 100, 101 AND 102).

FIRST USE 4-7-2009; IN COMMERCE 4-7-2009.

CLASS 41—EDUCATION AND ENTERTAINMENT

FOR ORGANIZING AND CONDUCTING EDUCATIONAL CONFERENCES, SEMINARS AND WORKSHOPS FOR OTHERS IN THE FIELD OF THE CARBON DIOXIDE MARKET (U.S. CLS. 100, 101 AND 107).

FIRST USE 4-7-2009; IN COMMERCE 4-7-2009.

3,785,634. JOSEPH SAYEGH, CORONA DEL MAR, CA. SN 77-588,236. PUB. 6-2-2009, FILED 10-8-2008.

PHOENICIAN

THE MARK CONSISTS OF STANDARD CHARACTERS WITHOUT CLAIM TO ANY PARTICULAR FONT, STYLE, SIZE, OR COLOR.

CLASS 11—ENVIRONMENTAL CONTROL APPARATUS

FOR ORNAMENTAL FOUNTAINS, WATER FOUNTAINS (U.S. CLS. 13, 21, 23, 31 AND 34).

FIRST USE 8-10-1986; IN COMMERCE 8-10-1986.

CLASS 19—NON-METALLIC BUILDING MATERIALS

FOR STONE FOR BUILDING AND CONSTRUCTION; MANTELS FOR FIREPLACES OF STONE; NON-METAL DOORS; NON-METAL TILES; SALVAGED NON-METAL ARCHITECTURAL COLUMNS; NON-METAL DECORATIVE MOLDINGS AND DECORATIVE TRIM FOR USE IN BUILDING CONSTRUCTION; NON-METAL CLADDING FOR CONSTRUCTION AND BUILDING; WORKS OF ART OF STONE, MARBLE, AND GRANITE; STATUES AND SCULPTURES OF STONE (U.S. CLS. 1, 12, 33 AND 50).

FIRST USE 8-10-1986; IN COMMERCE 8-10-1986.

CLASS 21—HOUSEWARES AND GLASS

FOR WORKS OF ART OF EARTHENWARE, PORCELAIN, AND TERRA COTTA; HEADS AND BUSTS OF EARTHENWARE, PORCELAIN, AND TERRA COTTA; STATUES AND SCULPTURES OF EARTHENWARE, PORCELAIN, AND TERRA COTTA; URNS (U.S. CLS. 2, 13, 23, 29, 30, 33, 40 AND 50).

FIRST USE 8-10-1986; IN COMMERCE 8-10-1986.

CLASS 35—ADVERTISING AND BUSINESS

FOR WHOLESALE AND RETAIL STORE SERVICES FEATURING STONE FOR BUILDING AND CONSTRUCTION; MANTELS FOR FIREPLACES; ORNAMENTAL FOUNTAINS AND WATER FOUNTAINS; NON-METAL DOORS; NON-METAL TILES; NON-METAL ARCHITECTURAL COLUMNS; NON-METAL DECORATIVE MOLDINGS AND DECORATIVE TRIM FOR USE IN BUILDING CONSTRUCTION; NON-METAL CLADDING FOR CONSTRUCTION AND BUILDING; WORKS OF ART OF STONE, MARBLE, AND GRANITE; WORKS OF ART OF EARTHENWARE, PORCELAIN, AND TERRA COTTA; HEADS AND BUSTS OF EARTHENWARE, PORCELAIN, AND TERRA COTTA; STATUES AND SCULPTURES OF EARTHENWARE, PORCELAIN, STONE, AND TERRA COTTA; URNS (U.S. CLS. 100, 101 AND 102).

FIRST USE 8-10-1986; IN COMMERCE 9-10-1986.

3,785,638. THE LIVINGSTON GROUP FOR MARKETING, INC., LONDONDERRY, NH. SN 77-592,528. PUB. 3-17-2009, FILED 10-14-2008.

ICONICARDS

THE MARK CONSISTS OF STANDARD CHARACTERS WITHOUT CLAIM TO ANY PARTICULAR FONT, STYLE, SIZE, OR COLOR.

CLASS 16—PAPER GOODS AND PRINTED MATTER

FOR EDUCATIONAL PUBLICATIONS, NAMELY, EDUCATIONAL LEARNING CARDS, ACTIVITY CARDS, WORKBOOKS, MANUALS AND EDUCATIONAL BOOKLETS IN THE FIELD OF MARKETING, PERSONAL COACHING, PERSONAL DEVELOPMENT AND SELF-IMPROVEMENT; MOTIVATIONAL CARDS; PRINTED ACTIVITY CARDS USED TO FACILITATE LEARNING EXERCISES IN THE FIELDS OF MARKETING, PERSONAL COACHING, PERSONAL DEVELOPMENT AND SELF-IMPROVEMENT; PRINTED ACTIVITY CARDS USED TO FACILITATE LEARNING EXERCISES IN FOCUS GROUPS, SURVEYS AND STUDIES IN THE FIELD OF MARKETING; NEWSLETTERS IN THE FIELDS OF MARKETING, PERSONAL COACHING, PERSONAL DEVELOPMENT AND SELF-IMPROVEMENT; POSTERS; AND STICKERS (U.S. CLS. 2, 5, 22, 23, 29, 37, 38 AND 50).

FIRST USE 10-1-2008; IN COMMERCE 10-1-2008.

CLASS 41—EDUCATION AND ENTERTAINMENT

FOR PROVIDING ON-LINE NON-DOWNLOADABLE ACTIVITY CARDS USED TO FACILITATE LEARNING EXERCISES IN THE FIELDS OF MARKETING, PERSONAL COACHING, PERSONAL DEVELOPMENT AND SELF-IMPROVEMENT; PROVIDING ONLINE NON-DOWNLOADABLE ACTIVITY CARDS USED TO FACILITATE LEARNING EXERCISES IN FOCUS GROUPS, SURVEYS AND STUDIES IN THE FIELD OF MARKETING (U.S. CLS. 100, 101 AND 107).

FIRST USE 10-1-2008; IN COMMERCE 10-1-2008.

3,785,642. CAL-COMP ELECTRONICS & COMMUNICATIONS COMPANY LIMITED, TAIPEI CITY, TAIWAN. SN 77-594,148. PUB. 9-1-2009, FILED 10-16-2008.

CAL-COMP

THE MARK CONSISTS OF STANDARD CHARACTERS WITHOUT CLAIM TO ANY PARTICULAR FONT, STYLE, SIZE, OR COLOR.

CLASS 9—ELECTRICAL AND SCIENTIFIC APPARATUS

FOR SATELLITE TELEVISION RECEIVERS; SATELLITE TELEVISION CONVERTERS; TELEVISION SET-TOP BOXES AND ON-DEMAND VIDEO BOXES; DVD PLAYERS, AND PORTABLE VIDEO AND AUDIO PLAYERS; VIDEO RECORDERS; DIGITAL, VIDEO AND AUDIO DISK PLAYERS; TELEPHONE APPARATUS, NAMELY, MOBILE PHONE CASINGS, TELEPHONE ANSWERING MACHINES, TWO-WAY RADIOS, WIRELESS TELEPHONES, CELLULAR TELEPHONES, VIDEO TELEPHONES, HANDS-FREE SETS FOR CELLULAR TELEPHONES FOR USE IN VEHICLES, TELEPHONE NETWORK SETS COMPRISED OF CELLULAR TELEPHONES, CAMERAS, MODEMS, PHONES, MICROPHONES; TELEPHONE HEADSETS; MOBILE TELEPHONES FOR VEHICLES; DIGITAL CAMERAS (U.S. CLS. 21, 23, 26, 36 AND 38).

FIRST USE 12-4-1989; IN COMMERCE 12-17-2008.

CLASS 11—ENVIRONMENTAL CONTROL APPARATUS

FOR ELECTRIC CHINESE LANTERNS; LIGHT BULBS; LIGHTING APPARATUS FOR VEHICLES, NAMELY, VEHICLE HEADLIGHTS, TAIL LIGHTS; LED LIGHT BULBS (U.S. CLS. 13, 21, 23, 31 AND 34).

FIRST USE 12-4-1989; IN COMMERCE 12-17-2008.

3,785,647. MAGNETIC ARTS, LLC, NEW YORK, NY. SN 77-599,888. PUB. 5-26-2009, FILED 10-24-2008.

DR. NORRIS CHUMLEY SATISFIED LIFE

THE MARK CONSISTS OF STANDARD CHARACTERS WITHOUT CLAIM TO ANY PARTICULAR FONT, STYLE, SIZE, OR COLOR.

THE NAME "DR. NORRIS CHUMLEY" IDENTIFIES A LIVING INDIVIDUAL WHOSE CONSENT IS OF RECORD.

CLASS 9—ELECTRICAL AND SCIENTIFIC APPARATUS

FOR ONLINE DOWNLOADABLE NEWSLETTERS FEATURING SUBJECTS CONCERNING WEIGHT LOSS AND PHYSICAL FITNESS, NUTRITION AND DIET, SPIRITUAL AND EMOTIONAL HEALTH, SPIRITUALITY, MEDITATION, HEALTHY LIFESTYLES, AND SELF- AND PERSONAL GROWTH (U.S. CLS. 21, 23, 26, 36 AND 38).

FIRST USE 10-29-2008; IN COMMERCE 10-29-2008.

CLASS 16—PAPER GOODS AND PRINTED MATTER

FOR PUBLICATIONS, NAMELY, NEWSLETTERS, LEAFLETS, BROCHURES, MANUALS, GUIDES AND HAND-OUTS FEATURING SUBJECTS CONCERNING WEIGHT LOSS AND PHYSICAL FITNESS, NUTRITION AND DIET, SPIRITUAL AND EMOTIONAL HEALTH, SPIRITUALITY, MEDITATION, HEALTHY LIFESTYLES, AND SELF- AND PERSONAL GROWTH (U.S. CLS. 2, 5, 22, 23, 29, 37, 38 AND 50).

FIRST USE 10-29-2008; IN COMMERCE 10-29-2008.

CLASS 41—EDUCATION AND ENTERTAINMENT

FOR ON-LINE JOURNALS, NAMELY, BLOGS FEATURING SUBJECTS CONCERNING WEIGHT LOSS AND PHYSICAL FITNESS, NUTRITION AND DIET, SPIRITUAL AND EMOTIONAL HEALTH, SPIRITUALITY, MEDITATION, HEALTHY LIFESTYLES, AND SELF- AND PERSONAL GROWTH; ONLINE NONDOWNLOADABLE NEWSLETTERS FEATURING SUBJECTS CONCERNING WEIGHT LOSS AND PHYSICAL FITNESS, NUTRITION AND DIET, SPIRITUAL AND EMOTIONAL HEALTH, SPIRITUALITY, MEDITATION, HEALTHY LIFESTYLES, AND SELF- AND PERSONAL GROWTH; EDUCATION SERVICES, NAMELY, PROVIDING CLASSES, LECTURES, SEMINARS, CONFERENCES, WORKSHOPS, RETREATS, MENTORING AND TUTORIAL SESSIONS ON SUBJECTS OF AND RELATED TO WEIGHT LOSS AND PHYSICAL FITNESS, NUTRITION AND DIET, SPIRITUAL AND EMOTIONAL HEALTH, SPIRITUALITY, MEDITATION, HEALTHY LIFESTYLES, AND SELF- AND PERSONAL GROWTH; EDUCATIONAL AND ENTERTAINMENT SERVICES, NAMELY, PROVIDING MOTIVATIONAL SPEAKING SERVICES IN THE FIELDS OF WEIGHT LOSS AND PHYSICAL FITNESS, NUTRITION AND DIET, SPIRITUAL AND EMOTIONAL HEALTH, SPIRITUALITY, MEDITATION, HEALTHY LIFESTYLES, AND SELF- AND PERSONAL GROWTH (U.S. CLS. 100, 101 AND 107).

FIRST USE 10-29-2008; IN COMMERCE 10-29-2008.

3,785,655. NATURAL CAPITAL GROUP, FORT LAUDERDALE, FL. SN 77-602,706. PUB. 3-17-2009, FILED 10-29-2008.

Blueprint for Green

THE MARK CONSISTS OF STANDARD CHARACTERS WITHOUT CLAIM TO ANY PARTICULAR FONT, STYLE, SIZE, OR COLOR.

CLASS 35—ADVERTISING AND BUSINESS

FOR BUSINESS ADVISORY SERVICES, CONSULTANCY AND INFORMATION; BUSINESS CONSULTATION; CONSULTING SERVICES IN THE AREA OF SUSTAINABLE BUSINESS SOLUTIONS (U.S. CLS. 100, 101 AND 102).

FIRST USE 12-3-2009; IN COMMERCE 12-3-2009.

CLASS 36—INSURANCE AND FINANCIAL

FOR COMMERCIAL LENDING SERVICES; CONSULTANCY CONCERNING FINANCING OF ENERGY PROJECTS; FACILITATING AND ARRANGING FOR THE FINANCING OF ENVIRONMENTALLY RESPONSIBLE REAL ESTATE PROJECTS; FINANCING AND LOAN SERVICES; FINANCING SERVICES; PROJECT FINANCING; REAL ESTATE LENDING SERVICES (U.S. CLS. 100, 101 AND 102).

FIRST USE 12-3-2009; IN COMMERCE 12-3-2009.

3,785,661. IXE GRUPO FINANCIERO S.A.B. DE C.V., MEXICO CITY, MEXICO. SN 77-605,477. PUB. 9-8-2009, FILED 10-31-2008.

EL
BAN
CODE
UNO

THE MARK CONSISTS OF THE FOUR WORDS STACKED IN FOUR LINES ON TOP OF EACH OTHER.

THE FOREIGN WORDING IN THE MARK TRANSLATES INTO ENGLISH AS ONE'S BANK.

CLASS 9—ELECTRICAL AND SCIENTIFIC APPARATUS

FOR CREDIT CARDS AND DEBIT CARDS THAT HAVE AN ELECTRONIC OR MAGNETIC BAND (U.S. CLS. 21, 23, 26, 36 AND 38).

FIRST USE 1-1-2010; IN COMMERCE 1-1-2010.

CLASS 16—PAPER GOODS AND PRINTED MATTER

FOR BLANK CHECKS; CREDIT AND DEBIT CARDS MADE OUT OF PAPER OR PLASTIC THAT DO NOT HAVE AN ELECTRONIC OR MAGNETIC BAND (U.S. CLS. 2, 5, 22, 23, 29, 37, 38 AND 50).

FIRST USE 1-1-2010; IN COMMERCE 1-1-2010.

3,785,663. BRANDED, LLC, DALLAS, TX. SN 77-607,942.
PUB. 5-19-2009, FILED 11-5-2008.

Storehouse

THE MARK CONSISTS OF STANDARD CHARACTERS WITHOUT CLAIM TO ANY PARTICULAR FONT, STYLE, SIZE, OR COLOR.

CLASS 16—PAPER GOODS AND PRINTED MATTER

FOR DESK ACCESSORIES, NAMELY, STAPLERS, LETTER OPENERS, DESK BLOTTERS, PEN AND PENCIL HOLDERS, HOLDERS FOR DESK ACCESSORIES, DESK BASKETS FOR DESK ACCESSORIES, DESK FILE TRAYS, DESK PADS, DESK SETS; STATIONERY AND PAPER GIFT WRAP; CALENDARS; GIFT BOXES; FABRIC GIFT BAGS; PAPER GIFT BAGS; CARDS, NAMELY, GREETING CARDS, NOTE CARDS, BUSINESS CARDS, CHRISTMAS CARDS; PAPER OR CARDBOARD BED STORAGE BOXES; GLOBES (U.S. CLS. 2, 5, 22, 23, 29, 37, 38 AND 50).

FIRST USE 2-11-2010; IN COMMERCE 2-11-2010.

CLASS 21—HOUSEWARES AND GLASS

FOR SOAP PUMPS; SHOWER CADDIES; TOWEL HOLDERS, NAMELY, RINGS AND RAILS; TOILET BRUSH HOLDERS; NAPKIN RINGS, COASTERS NOT OF PAPER AND OTHER THAN TABLE LINEN; DRINKWARE, NAMELY, GLASSES; DINNERWARE, NAMELY, PLATES, CUPS, SAUCERS, BOWLS; SERVEWARE, NAMELY, CAKE SERVERS, PIE SERVERS, COFFEE SERVERS, TEA SERVERS; NAPKIN HOLDERS; PAPER TOWEL HOLDERS; COOKING UTENSILS, NAMELY, WIRE HOLDERS AND WIRE BASKETS; SOAP DISPENSERS; LOTION DISPENSERS; SERVING TRAYS; WOOD CUTTING BOARDS AND BOWLS; BARWARE, NAMELY, SELTZER BOTTLES, GLASSES, CARAFES; COOKWARE, NAMELY, POTS AND PANS; BAKEWARE; COFFEE AND TEA ITEMS, NAMELY, TRAVEL MUGS, NON-ELECTRIC PRESSES, NON-ELECTRIC GRINDERS; CARAFES; COFFEE AND TEA SETS; SALT AND PEPPER SHAKERS; WASTEBASKETS; BASKETS OF WICKER, STRAW, WOOD, CLOTH AND NOT OF METAL AND NOT FOR COMMERCIAL USE; FIGURINES OF CHINA, CRYSTAL, EARTHENWARE, GLASS, PORCELAIN, TERRA COTTA; HANGING GARDEN PLANTERS; BIRD BATHS; BIRDHOUSES; PLANT CADDIES; BIRD FEEDERS; OUTDOOR PLANT CONTAINERS; NON-METAL GARDEN STAKES; GARDEN STATUARY OF CHINA, CRYSTAL, EARTHENWARE, GLASS, TERRA COTTA, PORCELAIN (U.S. CLS. 2, 13, 23, 29, 30, 33, 40 AND 50).

FIRST USE 2-11-2010; IN COMMERCE 2-11-2010.

3,785,664. RECYCLINE, INC., WALTHAM, MA. SN 77-608,792. PUB. 3-24-2009, FILED 11-6-2008.

Nothing wasted. Everything
gained.

THE MARK CONSISTS OF STANDARD CHARACTERS WITHOUT CLAIM TO ANY PARTICULAR FONT, STYLE, SIZE, OR COLOR.

CLASS 8—HAND TOOLS

FOR RAZORS AND RAZOR BLADES; CUTLERY, NAMELY, FORKS, SPOONS, AND KNIVES (U.S. CLS. 23, 28 AND 44).

FIRST USE 4-0-2009; IN COMMERCE 4-0-2009.

CLASS 9—ELECTRICAL AND SCIENTIFIC APPARATUS

FOR MEASURING CUPS (U.S. CLS. 21, 23, 26, 36 AND 38).

FIRST USE 1-0-2009; IN COMMERCE 1-0-2009.

CLASS 21—HOUSEWARES AND GLASS

FOR BOWLS; CUPS; DISHES AND PLATES NOT OF PRECIOUS METAL; SAUCERS NOT OF PRECIOUS METALS; TOOTHPICKS; TOOTHBRUSHES; TOOTHBRUSHES MANUFACTURED FROM RECYCLED MATERIAL; COLANDERS; PLASTIC STORAGE CONTAINERS FOR DOMESTIC USE; CUTTING BOARDS; BOWLS; PLASTIC CUPS; PLASTIC PLATES; CHOPPING BOARDS FOR KITCHEN USE; WOOD CHOPPING BOARDS FOR KITCHEN USE; HOUSEHOLD CONTAINERS FOR FOODS (U.S. CLS. 2, 13, 23, 29, 30, 33, 40 AND 50).

FIRST USE 11-0-2008; IN COMMERCE 11-0-2008.

3,785,670. KOELNMESSE GMBH, KOELN, FED REP GERMANY. SN 77-610,700. PUB. 5-12-2009, FILED 11-10-2008.



NO CLAIM IS MADE TO THE EXCLUSIVE RIGHT TO USE "CARBON" AND "AMERICA", APART FROM THE MARK AS SHOWN.

THE MARK CONSISTS OF THE WORDS "CARBON TRADEEX" FEATURED ABOVE THE WORDING "AMERICA" WITH A SERIES OF THREE FIVE-POINT STARS THAT PROGRESSIVELY BECOME LARGER, WHERE THE THIRD STAR IS INCOMPLETE, ALL ENCASED WITHIN A SQUARE.

CLASS 35—ADVERTISING AND BUSINESS

FOR ORGANIZING AND CONDUCTING TRADE SHOWS AND EXHIBITIONS FOR OTHERS FOR BUSINESS PURPOSES IN THE CARBON DIOXIDE MARKET (U.S. CLS. 100, 101 AND 102).

FIRST USE 4-7-2009; IN COMMERCE 4-7-2009.

CLASS 41—EDUCATION AND ENTERTAINMENT

FOR ORGANIZING AND CONDUCTING EDUCATIONAL CONFERENCES, SEMINARS AND WORKSHOPS FOR OTHERS IN THE FIELD OF THE CARBON DIOXIDE MARKET (U.S. CLS. 100, 101 AND 107).

FIRST USE 4-7-2009; IN COMMERCE 4-7-2009.

3,785,671. BELLATRUE.COM, LLC, NASHVILLE, TN. SN 77-611,273. PUB. 3-24-2009, FILED 11-10-2008.

3,785,684. GABRIELE FUCHS, GÖPPINGEN, FED REP GERMANY. SN 77-617,504. PUB. 10-13-2009, FILED 11-19-2008.

BELLA TRUE

THE MARK CONSISTS OF STANDARD CHARACTERS WITHOUT CLAIM TO ANY PARTICULAR FONT, STYLE, SIZE, OR COLOR.

THE ENGLISH TRANSLATION OF "BELLA" IS "BEAUTIFUL".

CLASS 14—JEWELRY

FOR JEWELRY (U.S. CLS. 2, 27, 28 AND 50).
FIRST USE 9-0-2008; IN COMMERCE 11-15-2008.

CLASS 35—ADVERTISING AND BUSINESS

FOR ON-LINE RETAIL STORE SERVICES FEATURING JEWELRY (U.S. CLS. 100, 101 AND 102).
FIRST USE 9-0-2008; IN COMMERCE 11-15-2008.

3,785,672. OUTLOOK WINDOW FASHIONS CORPORATION, GURNEE, IL. SN 77-611,399. PUB. 10-6-2009, FILED 11-10-2008.

B&W

THE MARK CONSISTS OF STANDARD CHARACTERS WITHOUT CLAIM TO ANY PARTICULAR FONT, STYLE, SIZE, OR COLOR.

CLASS 20—FURNITURE AND ARTICLES NOT OTHERWISE CLASSIFIED

FOR WINDOW TREATMENTS, NAMELY, WINDOW SHADES AND WINDOW BLINDS; PILLOWS; AND DRAPERY HARDWARE, NAMELY, RODS, POLES, FINIALS, CURTAIN RINGS, AND SWAG HOLDERS (U.S. CLS. 2, 13, 22, 25, 32 AND 50).
FIRST USE 1-1-1998; IN COMMERCE 1-1-1998.

CLASS 24—FABRICS

FOR FABRIC WINDOW COVERINGS AND TREATMENTS, NAMELY, CURTAINS, DRAPERIES, SHEERS, SWAGS, VALANCES, AND POUFS; DRAPERY TIE BACKS (U.S. CLS. 42 AND 50).
FIRST USE 1-1-1998; IN COMMERCE 1-1-1998.

BEAUTYPRESS

THE MARK CONSISTS OF STANDARD CHARACTERS WITHOUT CLAIM TO ANY PARTICULAR FONT, STYLE, SIZE, OR COLOR.

PRIORITY CLAIMED UNDER SEC. 44(D) ON FED REP GERMANY APPLICATION NO. 302008059682, FILED 9-17-2008.

CLASS 35—ADVERTISING AND BUSINESS

FOR COMPILATION AND MAINTENANCE OF INFORMATION IN COMPUTER DATABASES; NEWS CLIPPING SERVICES; PUBLIC RELATIONS (U.S. CLS. 100, 101 AND 102).
FIRST USE 4-16-2009; IN COMMERCE 4-16-2009.

CLASS 38—COMMUNICATION

FOR PROVIDING MULTIPLE USER DIAL-UP AND DEDICATED ACCESS TO THE INTERNET; PROVIDING REMOTE INTERNET ACCESS; PROVIDING INTERNET ACCESS VIA BROADBAND OPTICAL OR WIRELESS NETWORKS; PROVIDING TELECOMMUNICATION CONNECTIONS TO THE INTERNET; PROVIDING MULTIPLE-USE ACCESS TO GLOBAL COMPUTER INFORMATION NETWORKS FOR THE TRANSFER AND DISSEMINATION OF A WIDE RANGE OF INFORMATION (U.S. CLS. 100, 101 AND 104).
FIRST USE 4-16-2009; IN COMMERCE 4-16-2009.

CLASS 42—SCIENTIFIC AND COMPUTER SERVICES

FOR COMPUTER SERVICES, NAMELY, PROVIDING SEARCH PLATFORMS TO ALLOW USERS TO REQUEST CONTENT FROM THE INTERNET (U.S. CLS. 100 AND 101).
FIRST USE 4-16-2009; IN COMMERCE 4-16-2009.

3,785,688. KOHL'S ILLINOIS, INC., AURORA, IL. SN 77-621,866. PUB. 2-10-2009, FILED 11-25-2008.



OWNER OF U.S. REG. NOS. 3,068,656, 3,423,647, AND OTHERS.

THE MARK CONSISTS OF THE WORD "SO" WITH THE LETTER "O" AS PART OF A FLOWER.

CLASS 9—ELECTRICAL AND SCIENTIFIC APPARATUS

FOR SUNGLASSES (U.S. CLS. 21, 23, 26, 36 AND 38).
FIRST USE 2-0-2010; IN COMMERCE 2-0-2010.

CLASS 14—JEWELRY

FOR JEWELRY; WATCHES (U.S. CLS. 2, 27, 28 AND 50).
FIRST USE 0-0-2009; IN COMMERCE 0-0-2009.

CLASS 25—CLOTHING

FOR BEACH COVER-UPS; BRAS; COATS; DRESSES; FOOTWEAR; GLOVES; HOSIERY; JACKETS; JEANS; JUMPERS; LINGERIE; LOUNGEWEAR; PANTS; SHORTS; SKIRTS; SLEEPWEAR; SOCKS; SWEATERS; SWIMWEAR; TOPS; UNDERWEAR (U.S. CLS. 22 AND 39).
FIRST USE 1-0-2010; IN COMMERCE 1-0-2010.

CLASS 26—FANCY GOODS

FOR BARRETTES; HAIR BANDS; HAIR CLIPS; HAIR SCRUNCHIES (U.S. CLS. 37, 39, 40, 42 AND 50).
FIRST USE 0-0-2009; IN COMMERCE 0-0-2010.



3,785,692. DOMESTICATIONS, LLC, WEEHAWKEN, NJ. SN 77-622,516. PUB. 7-14-2009, FILED 11-26-2008.

COLORATIONS

THE MARK CONSISTS OF STANDARD CHARACTERS WITHOUT CLAIM TO ANY PARTICULAR FONT, STYLE, SIZE, OR COLOR.

CLASS 20—FURNITURE AND ARTICLES NOT OTHERWISE CLASSIFIED

FOR PILLOWS; DECORATIVE PILLOWS; THROW PILLOWS (U.S. CLS. 2, 13, 22, 25, 32 AND 50).
FIRST USE 9-10-2009; IN COMMERCE 9-10-2009.

CLASS 24—FABRICS

FOR BED BLANKETS, BED SHEETS, BEDSPREADS, BED SKIRT, PILLOWCASES, PILLOW SHAMS, COMFORTERS, FITTED SHEETS, FLAT SHEETS, SHEET SETS, EUROPEAN SHAMS (U.S. CLS. 42 AND 50).
FIRST USE 9-10-2009; IN COMMERCE 9-10-2009.

3,785,712. DCH MANAGEMENT SERVICES INC., SOUTH AMBOY, NJ. SN 77-629,767. PUB. 4-14-2009, FILED 12-9-2008.



OWNER OF U.S. REG. NO. 3,402,575.
NO CLAIM IS MADE TO THE EXCLUSIVE RIGHT TO USE "AUTO GROUP", APART FROM THE MARK AS SHOWN.
THE MARK CONSISTS OF A CARTOON BOBBLEHEAD AND BODY FIGURE. THE HEAD DISPLAYS AN EXPRESSIVE FACE AND IS DETACHED FROM THE BODY, BUT IS BEING HELD BY THE BODY FIGURE'S HANDS IN FRONT OF THE BODY. BELOW THE FIGURE ARE THE WORDS "KEEP IT OUT OF CARS" AND BELOW THOSE WORDS IS THE WORDING "DCH AUTO GROUP" WITHIN A SHADED RECTANGLE.

CLASS 35—ADVERTISING AND BUSINESS

FOR PROMOTING PUBLIC AWARENESS OF SAFE TEEN DRIVING (U.S. CLS. 100, 101 AND 102).
FIRST USE 10-1-2008; IN COMMERCE 10-1-2008.

CLASS 41—EDUCATION AND ENTERTAINMENT

FOR EDUCATIONAL SERVICES, NAMELY, PROVIDING AUTOMOBILE ACCIDENT AVOIDANCE TRAINING AND SAFE DRIVING TRAINING TO TEENAGERS; AND EDUCATIONAL PROGRAMS, NAMELY, DRIVING SAFETY CLASSES AND SEMINARS (U.S. CLS. 100, 101 AND 107).
FIRST USE 10-1-2008; IN COMMERCE 10-1-2008.



3,785,713. DCH MANAGEMENT SERVICES INC., SOUTH AMBOY, NJ. SN 77-629,768. PUB. 4-14-2009, FILED 12-9-2008.

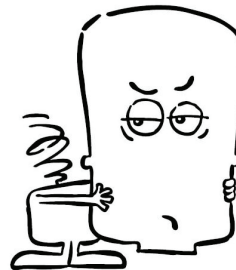

THE MARK CONSISTS OF A CARTOON BOBBLEHEAD AND BODY FIGURE. THE HEAD DISPLAYS AN EXPRESSIVE FACE AND IS DETACHED FROM THE BODY, BUT IS BEING HELD BY THE BODY FIGURE'S HANDS IN FRONT OF THE BODY.

SIVE FACE AND IS DETACHED FROM THE BODY, BUT IS BEING HELD BY THE BODY FIGURE'S HANDS IN FRONT OF THE BODY.

3,785,715. DCH MANAGEMENT SERVICES INC., SOUTH AMBOY, NJ. SN 77-629,772. PUB. 4-14-2009, FILED 12-9-2008.

CLASS 35—ADVERTISING AND BUSINESS

FOR PROMOTING PUBLIC AWARENESS OF SAFE TEEN DRIVING (U.S. CLS. 100, 101 AND 102).
FIRST USE 10-1-2008; IN COMMERCE 10-1-2008.

DRIVEN BY A BETTER WAY

THE MARK CONSISTS OF STANDARD CHARACTERS WITHOUT CLAIM TO ANY PARTICULAR FONT, STYLE, SIZE, OR COLOR.

CLASS 41—EDUCATION AND ENTERTAINMENT

FOR EDUCATIONAL SERVICES, NAMELY, PROVIDING AUTOMOBILE ACCIDENT AVOIDANCE TRAINING AND SAFE DRIVING TRAINING TO TEENAGERS; AND EDUCATIONAL PROGRAMS, NAMELY, DRIVING SAFETY CLASSES AND SEMINARS (U.S. CLS. 100, 101 AND 107).

FIRST USE 10-1-2008; IN COMMERCE 10-1-2008.

CLASS 35—ADVERTISING AND BUSINESS

FOR AUTOMOBILE DEALERSHIPS; RETAIL STORE SERVICES FEATURING AUTOMOBILE PARTS AND ACCESSORIES; AND PROMOTING PUBLIC AWARENESS OF SAFE TEEN DRIVING (U.S. CLS. 100, 101 AND 102).

FIRST USE 1-8-2007; IN COMMERCE 1-8-2007.

3,785,714. DCH MANAGEMENT SERVICES INC., SOUTH AMBOY, NJ. SN 77-629,769. PUB. 4-14-2009, FILED 12-9-2008.

CLASS 37—CONSTRUCTION AND REPAIR

FOR AUTOMOBILE REPAIR AND MAINTENANCE (U.S. CLS. 100, 103 AND 106).

FIRST USE 1-8-2007; IN COMMERCE 1-8-2007.

CLASS 41—EDUCATION AND ENTERTAINMENT

FOR EDUCATIONAL SERVICES, NAMELY, PROVIDING AUTOMOBILE ACCIDENT AVOIDANCE TRAINING AND SAFE DRIVING TRAINING TO TEENAGERS; AND EDUCATIONAL PROGRAMS, NAMELY, DRIVING SAFETY CLASSES AND SEMINARS (U.S. CLS. 100, 101 AND 107).

FIRST USE 10-1-2008; IN COMMERCE 10-1-2008.

DCH AUTO GROUP

THE MARK CONSISTS OF STANDARD CHARACTERS WITHOUT CLAIM TO ANY PARTICULAR FONT, STYLE, SIZE, OR COLOR.

OWNER OF U.S. REG. NO. 3,402,575.

NO CLAIM IS MADE TO THE EXCLUSIVE RIGHT TO USE "AUTO GROUP", APART FROM THE MARK AS SHOWN.

3,785,729. NATIONAL MARROW DONOR PROGRAM, MINNEAPOLIS, MN. SN 77-635,321. PUB. 6-2-2009, FILED 12-17-2008.

CLASS 35—ADVERTISING AND BUSINESS

FOR AUTOMOBILE DEALERSHIPS; RETAIL STORE SERVICES FEATURING AUTOMOBILE PARTS AND ACCESSORIES; AND PROMOTING PUBLIC AWARENESS OF SAFE TEEN DRIVING (U.S. CLS. 100, 101 AND 102).

FIRST USE 1-8-2007; IN COMMERCE 1-8-2007.

BE THE MATCH FOUNDATION

CLASS 37—CONSTRUCTION AND REPAIR

FOR AUTOMOBILE REPAIR AND MAINTENANCE (U.S. CLS. 100, 103 AND 106).

FIRST USE 1-8-2007; IN COMMERCE 1-8-2007.

THE MARK CONSISTS OF STANDARD CHARACTERS WITHOUT CLAIM TO ANY PARTICULAR FONT, STYLE, SIZE, OR COLOR.

OWNER OF U.S. REG. NOS. 1,826,685 AND 1,969,048.

NO CLAIM IS MADE TO THE EXCLUSIVE RIGHT TO USE "FOUNDATION", APART FROM THE MARK AS SHOWN.

CLASS 41—EDUCATION AND ENTERTAINMENT

FOR EDUCATIONAL SERVICES, NAMELY, PROVIDING AUTOMOBILE ACCIDENT AVOIDANCE TRAINING AND SAFE DRIVING TRAINING TO TEENAGERS; AND EDUCATIONAL PROGRAMS, NAMELY, DRIVING SAFETY CLASSES AND SEMINARS (U.S. CLS. 100, 101 AND 107).

FIRST USE 10-1-2008; IN COMMERCE 10-1-2008.

CLASS 35—ADVERTISING AND BUSINESS

FOR CHARITABLE SERVICES, NAMELY, ORGANIZING AND CONDUCTING VOLUNTEER PROGRAMS AND COMMUNITY SERVICE PROJECTS (U.S. CLS. 100, 101 AND 102).

FIRST USE 11-7-2008; IN COMMERCE 4-7-2009.

CLASS 36—INSURANCE AND FINANCIAL

FOR FUNDRAISING SERVICES, NAMELY, ORGANIZING FUNDRAISERS TO RAISE FUNDS TO SUPPORT THE NATIONAL MARROW DONOR PROGRAM AND TO RAISE FUNDS TO SUPPORT THE MATCHING OF POTENTIAL DONORS OF BONE MARROW, PERIPHERAL BLOOD STEM CELLS OR CORD BLOOD WITH PATIENTS IN NEED OF A STEM CELL TRANSPLANT (U.S. CLS. 100, 101 AND 102).

FIRST USE 11-7-2008; IN COMMERCE 4-7-2009.

3,785,752. THE SOUTHERN POVERTY LAW CENTER, INC., MONTGOMERY, AL. SN 77-645,129. PUB. 5-26-2009, FILED 1-7-2009.



3,785,735. BOSTON PROPER, INC., BOCA RATON, FL. SN 77-638,253. PUB. 3-31-2009, FILED 12-22-2008.



THE MARK CONSISTS OF A STYLIZED DEPICTION OF THE LETTER "B".

CLASS 9—ELECTRICAL AND SCIENTIFIC APPARATUS

FOR SUNGLASSES (U.S. CLS. 21, 23, 26, 36 AND 38).
FIRST USE 4-16-2009; IN COMMERCE 4-16-2009.

CLASS 14—JEWELRY

FOR COSTUME JEWELRY; JEWELRY (U.S. CLS. 2, 27, 28 AND 50).
FIRST USE 4-16-2009; IN COMMERCE 4-16-2009.

CLASS 18—LEATHER GOODS

FOR ATHLETIC BAGS; BEACH BAGS; CLUTCH BAGS; DUFFLE BAGS; HANDBAGS; LEATHER PURSES; TOTE BAGS; TRAVEL BAGS (U.S. CLS. 1, 2, 3, 22 AND 41).
FIRST USE 4-16-2009; IN COMMERCE 4-16-2009.

CLASS 25—CLOTHING

FOR BELTS; BLAZERS; BLOUSES; BODY SUITS; BOOTS; BRAS; CAMISOLES; COATS; DRESSES; FOOTWEAR; HATS; JACKETS; JEANS; JUMPERS; LOUNGEWEAR; PAJAMAS; PANTIES; PANTS; POLO SHIRTS; SCARVES; SHOES; SHORTS; SKIRTS; SLACKS; SUITS; SWEATERS; SWIMWEAR; T-SHIRTS; TIGHTS; TOPS; TROUSERS; TUNICS; UNDERWEAR; VESTS (U.S. CLS. 22 AND 39).
FIRST USE 4-16-2009; IN COMMERCE 4-16-2009.

OWNER OF U.S. REG. NO. 1,747,480.

NO CLAIM IS MADE TO THE EXCLUSIVE RIGHT TO USE "LAW CENTER", APART FROM THE MARK AS SHOWN.

THE COLOR(S) RED, BLACK, AND WHITE IS/ARE CLAIMED AS A FEATURE OF THE MARK.

THE MARK CONSISTS OF THE LETTERS "SPLC" IN RED, FOLLOWED BY THE DESIGN OF A PAIR OF WHITE SCALES WITHIN A RED CIRCLE, FOLLOWED BY THE WORDS, "SOUTHERN POVERTY LAW CENTER" IN BLACK, ALL OF THIS OCCURRING ON A SINGLE HORIZONTAL LINE.

SEC. 2(F) AS TO "SOUTHERN POVERTY LAW CENTER".

CLASS 41—EDUCATION AND ENTERTAINMENT

FOR EDUCATIONAL SERVICES, NAMELY, CONDUCTING SEMINARS, CLASSES, WORKSHOPS AND CONFERENCES IN THE FIELDS OF ELIMINATING DISCRIMINATION AND INJUSTICE, AND PREVENTING AND SOLVING CRIMES THAT ARISE OUT OF DISCRIMINATION AND INJUSTICE, AND DISTRIBUTING COURSE MATERIALS IN CONNECTION THEREWITH (U.S. CLS. 100, 101 AND 107).
FIRST USE 2-28-2009; IN COMMERCE 2-28-2009.

CLASS 45—PERSONAL AND LEGAL SERVICES

FOR LEGAL SERVICES, NAMELY, PROVIDING LITIGATION SERVICES FOR PURPOSES OF THE ADVANCEMENT OF THE LEGAL RIGHTS OF VICTIMS OF DISCRIMINATION AND INJUSTICE (U.S. CLS. 100 AND 101).
FIRST USE 2-28-2009; IN COMMERCE 2-28-2009.

3,785,763. APPLIED SYSTEMS, INC., UNIVERSITY PARK, IL. SN 77-648,563. PUB. 7-7-2009, FILED 1-13-2009.



OWNER OF U.S. REG. NOS. 2,377,187, 3,176,431, AND 3,408,717.

NO CLAIM IS MADE TO THE EXCLUSIVE RIGHT TO USE "SYSTEMS", APART FROM THE MARK AS SHOWN.

THE MARK CONSISTS OF FIVE V-SHAPED ELEMENTS ARRANGED IN A CIRCLE AROUND A SINGLE CENTER DOT WITH WORDS "APPLIED SYSTEMS".

CLASS 9—ELECTRICAL AND SCIENTIFIC APPARATUS

FOR COMPUTER PROGRAMS USED FOR AUTOMATING INSURANCE ACCOUNTING, UNDER WRITING, POLICY ISSUANCE, POLICY PROTOCOL, BILLING AND INVOICING, RATE CALCULATION AND COMPARISON, CLAIMS MANAGEMENT, FORM GENERATION, REPORT GENERATION, ELECTRONIC INTERFACE, MARKETING ACTIVITIES, AND OTHER OFFICE MANAGEMENT FUNCTIONS IN THE INSURANCE AND FINANCIAL INDUSTRIES (U.S. CLS. 21, 23, 26, 36 AND 38).

FIRST USE 1-1-2009; IN COMMERCE 1-1-2009.

CLASS 42—SCIENTIFIC AND COMPUTER SERVICES

FOR APPLICATION SERVICE PROVIDER (ASP) SERVICES FEATURING SOFTWARE FOR INSURANCE AND FINANCIAL INDUSTRIES THAT AUTOMATES ACCOUNTING, POLICY ISSUANCE, RATE CALCULATION AND COMPARISON, CLAIMS MANAGEMENT, FORM GENERATION, ELECTRONIC INTERFACE, MARKETING ACTIVITIES, INTEGRATED FAXING AND IMAGING, AND OTHER OFFICE MANAGEMENT FUNCTIONS (U.S. CLS. 100 AND 101).

FIRST USE 1-1-2009; IN COMMERCE 1-1-2009.

3,785,764. APPLIED SYSTEMS, INC., UNIVERSITY PARK, IL. SN 77-648,580. PUB. 7-7-2009, FILED 1-13-2009.

 **APPLIED SYSTEMS**

advancing the business of insurance

OWNER OF U.S. REG. NOS. 2,377,187, 3,176,431, AND 3,408,717.

NO CLAIM IS MADE TO THE EXCLUSIVE RIGHT TO USE "SYSTEMS", APART FROM THE MARK AS SHOWN.

THE MARK CONSISTS OF FIVE V-SHAPED ELEMENTS ARRANGED IN A CIRCLE AROUND A SINGLE CENTER DOT WITH WORDS "APPLIED SYSTEMS" WITH "ADVANCING THE BUSINESS OF INSURANCE" BELOW IT.

CLASS 9—ELECTRICAL AND SCIENTIFIC APPARATUS

FOR COMPUTER PROGRAMS USED FOR AUTOMATING INSURANCE ACCOUNTING, UNDER WRITING, POLICY ISSUANCE, POLICY PROTOCOL, BILLING AND INVOICING, RATE CALCULATION AND COMPARISON, CLAIMS MANAGEMENT, FORM GENERATION, REPORT GENERATION, ELECTRONIC INTERFACE, MARKETING ACTIVITIES, AND OTHER OFFICE MANAGEMENT FUNCTIONS IN THE INSURANCE AND FINANCIAL INDUSTRIES (U.S. CLS. 21, 23, 26, 36 AND 38).

FIRST USE 1-1-2009; IN COMMERCE 1-1-2009.

CLASS 42—SCIENTIFIC AND COMPUTER SERVICES

FOR APPLICATION SERVICE PROVIDER (ASP) SERVICES FEATURING SOFTWARE FOR INSURANCE AND FINANCIAL INDUSTRIES THAT AUTOMATES ACCOUNTING, POLICY ISSUANCE, RATE CALCULATION AND COMPARISON, CLAIMS MANAGEMENT, FORM GENERATION, ELECTRONIC INTERFACE, MARKETING ACTIVITIES, INTEGRATED FAXING AND IMAGING, AND OTHER OFFICE MANAGEMENT FUNCTIONS (U.S. CLS. 100 AND 101).

FIRST USE 1-1-2009; IN COMMERCE 1-1-2009.

3,785,768. BLUESTAR ENERGY SERVICES, INC., CHICAGO, IL. SN 77-650,355. PUB. 5-5-2009, FILED 1-15-2009.

AVIGENT

THE MARK CONSISTS OF STANDARD CHARACTERS WITHOUT CLAIM TO ANY PARTICULAR FONT, STYLE, SIZE, OR COLOR.

CLASS 35—ADVERTISING AND BUSINESS

FOR BUSINESS CONSULTATION; BUSINESS CONSULTATION IN THE FIELD OF INFORMATION TECHNOLOGY AND SYSTEMS; BUSINESS CONSULTATION SERVICES; BUSINESS CONSULTING AND BUSINESS INFORMATION FOR ENTERPRISES; BUSINESS CONSULTING AND INFORMATION SERVICES; BUSINESS CONSULTING SERVICES FOR THE ELECTRIC ENERGY INDUSTRY; BUSINESS MANAGEMENT AND CONSULTATION IN THE FIELD OF INFORMATION TECHNOLOGY AND SYSTEMS; BUSINESS MANAGEMENT CONSULTANCY AND ADVISORY SERVICES; BUSINESS MANAGEMENT CONSULTANCY SERVICES; BUSINESS MANAGEMENT CONSULTATION; BUSINESS MANAGEMENT CONSULTING; CONSULTATION IN THE FIELD OF ENERGY EFFICIENCY (U.S. CLS. 100, 101 AND 102).

FIRST USE 3-24-2009; IN COMMERCE 3-24-2009.

CLASS 42—SCIENTIFIC AND COMPUTER SERVICES

FOR COMPUTER PROGRAMMING; COMPUTER PROGRAMMING AND COMPUTER SYSTEM ANALYSIS; COMPUTER PROGRAMMING AND MAINTENANCE OF COMPUTER PROGRAMS; COMPUTER PROGRAMMING AND SOFTWARE DESIGN; COMPUTER PROGRAMMING FOR OTHERS; COMPUTER PROGRAMMING SERVICES; COMPUTER SERVICES, NAMELY, ON-LINE SCANNING, DETECTING, QUARANTINING AND ELIMINATING VIRUSES, WORMS, TROJANS, SPYWARE, ADWARE, MALWARE AND UNAUTHORIZED DATA AND PROGRAMS ON COMPUTERS AND ELECTRONIC DEVICES; COMPUTER SOFTWARE DESIGN, COMPUTER PROGRAMMING, OR MAINTENANCE OF COMPUTER SOFTWARE; COMPUTER SOFTWARE DEVELOPMENT AND COMPUTER PROGRAMMING DEVELOPMENT FOR OTHERS; DEVELOPMENT OF DATA PROCESSING PROGRAMS BY ORDER OF THIRD PARTIES; DUPLICATING COMPUTER PROGRAMS; DUPLICATION OF COMPUTER PROGRAMS; MONITORING THE COMPUTER SYSTEMS OF OTHERS FOR TECHNICAL PURPOSES AND PROVIDING BACK-UP COMPUTER PROGRAMS AND FACILITIES; PROGRAMMING OF MULTIMEDIA APPLICATIONS; TECHNICAL SUPPORT, NAMELY, PROVIDING BACK-UP COMPUTER PROGRAMS AND FACILITIES; ALL OF THE ABOVE-IDENTIFIED SERVICES EXPRESSLY EXCLUDE THE PROVISION OF SERVICES IN THE FIELD OF COMPUTER SWITCHING, EXTENSION, AND REMOTE ACCESS PRODUCTS (U.S. CLS. 100 AND 101).

FIRST USE 3-24-2009; IN COMMERCE 3-24-2009.

3,785,772. HARVEY BALL SMILE LIMITED, SHINAGAWA-KU TOKYO, JAPAN. SN 77-652,330. PUB. 9-8-2009, FILED 1-20-2009.



OWNER OF U.S. REG. NOS. 3,066,172, 3,502,405, AND 3,502,982.

NO CLAIM IS MADE TO THE EXCLUSIVE RIGHT TO USE "DESIGNED BY" AND "USA 1963", APART FROM THE MARK AS SHOWN.

THE NAME "HARVEY R. BALL" DOES NOT IDENTIFY A LIVING INDIVIDUAL.

THE MARK CONSISTS OF A SMILEY FACE COMPRISED OF A CIRCLE CONTAINING TWO SMALL SHADED OVALS REPRESENTING EYES AND A CURVED LINE REPRESENTING A MOUTH, WITH DEFINED CORNERS, WITH A TONGUE WITH A SHORT LINE ON IT, EXTENDING DOWNWARD FROM THE MOUTH, WITH THE WORDING, "DESIGNED BY HARVEY R. BALL USA 1963" PRINTED FROM THE LEFT TO THE RIGHT SIDE, ALONG THE BOTTOM OF THE SMILEY FACE.

CLASS 14—JEWELRY

FOR ALARM CLOCKS; BRACELETS; BRACELETS OF PRECIOUS METAL; BROOCHES (JEWELRY); CHRONOMETERS; CLOCKS; CUFF-LINKS; EARRINGS; FIGURES OF PRECIOUS METAL; FIGURINES OF PRECIOUS METAL; INSIGNIAS OF PRECIOUS METAL; KEY HOLDERS OF PRECIOUS METALS; KEY RINGS OF PRECIOUS METAL; NECKLACES; PRECIOUS GEMSTONES; TIE CLIPS; TIE PINS; WATCH BANDS; WATCHES; WRIST WATCHES (U.S. CLS. 2, 27, 28 AND 50).

FIRST USE 2-27-2009; IN COMMERCE 2-27-2009.

CLASS 16—PAPER GOODS AND PRINTED MATTER

FOR A SERIES OF BOOKS AND WRITTEN ARTICLES IN THE FIELD OF CULTURE, ARTISTRY, HISTORY, LITERATURE, LANGUAGES AND GEOGRAPHY; ARTISTS' PASTELS; BOOKBINDINGS; DRAWING RULERS; ENVELOPES; EXERCISE BOOKS; GENERAL PURPOSE PLASTIC BAGS; GIFT CARDS; GLUE FOR STATIONERY OR HOUSEHOLD USE; JOURNALS CONCERNING CULTURE, ARTISTRY, HISTORY, LITERATURE, LANGUAGES AND GEOGRAPHY; MAGAZINES FEATURING CULTURE, ARTISTRY, HISTORY, LITERATURE, LANGUAGES AND GEOGRAPHY; MAGNETIC BOARDS; NEWSPAPERS IN THE FIELD OF CULTURE, ARTISTRY, HISTORY, LITERATURE, LANGUAGES AND GEOGRAPHY; OFFICE HOLE PUNCHERS; PAINT BRUSHES; PAMPHLETS IN THE FIELD OF CULTURE, ARTISTRY, HISTORY, LITERATURE, LANGUAGES AND GEOGRAPHY; PAPER CLIPS; PAPER CUTTERS; PAPER FASTENERS; PAPER RIBBONS; PAPERWEIGHTS; PEN CASES; PENCIL CASES; PENCIL SHARPENERS; PENCILS; PENS; PHOTOGRAPH ALBUMS; PUNCHES; RUBBER ERASERS; SCRATCH PADS; WRITING PAPER (U.S. CLS. 2, 5, 22, 23, 29, 37, 38 AND 50).

FIRST USE 2-27-2009; IN COMMERCE 2-27-2009.

CLASS 18—LEATHER GOODS

FOR LEATHER AND IMITATION LEATHER BAGS; LEATHER BAGS AND WALLETS; LEATHER BRIEF-CASES; PARASOLS; TRAVELING BAGS; TRUNKS; UMBRELLAS (U.S. CLS. 1, 2, 3, 22 AND 41).

FIRST USE 2-27-2009; IN COMMERCE 2-27-2009.

CLASS 21—HOUSEWARES AND GLASS

FOR BATH SPONGES; COMBS; CUPS; DRINKING GLASSES; HAIR BRUSHES; PET BRUSHES; PLATES; SERVING PLATTERS (U.S. CLS. 2, 13, 23, 29, 30, 33, 40 AND 50).

FIRST USE 2-27-2009; IN COMMERCE 2-27-2009.

CLASS 28—TOYS AND SPORTING GOODS

FOR ACTION SKILL GAMES; CHILDREN'S MULTIPLE ACTIVITY TOYS; DOLLS; PARLOR GAMES; PLAY FIGURES; PLAY HOUSES; STUFFED TOYS (U.S. CLS. 22, 23, 38 AND 50).

FIRST USE 2-27-2009; IN COMMERCE 2-27-2009.

3,785,773. HARVEY BALL SMILE LIMITED, SHINAGAWA-KU TOKYO, JAPAN. SN 77-652,335. PUB. 7-28-2009, FILED 1-20-2009.



OWNER OF U.S. REG. NOS. 3,066,172, 3,502,982, AND OTHERS.

NO CLAIM IS MADE TO THE EXCLUSIVE RIGHT TO USE "DESIGNED BY" AND "USA 1963", APART FROM THE MARK AS SHOWN.

THE NAME(S), PORTRAIT(S), AND/OR SIGNATURE(S) SHOWN IN THE MARK DOES NOT IDENTIFY A PARTICULAR LIVING INDIVIDUAL.

THE MARK CONSISTS OF A CIRCLE WITH HEARTS FOR EYES AND A SMILE DESIGNED TO APPEAR TO BE MELTING OR DRIPPING, BELOW WHICH APPEAR THE WORDS "DESIGNED BY HARVEY R. BALL USA 1963".

CLASS 14—JEWELRY

FOR ALARM CLOCKS; BRACELETS; BRACELETS OF PRECIOUS METAL; BROOCHES; CHRONOMETERS; CLOCKS; CUFF-LINKS; EARRINGS; FIGURES OF PRECIOUS METAL; FIGURINES OF PRECIOUS METAL; INSIGNIAS OF PRECIOUS METAL; KEY HOLDERS OF PRECIOUS METALS; KEY RINGS OF PRECIOUS METAL; NECKLACES; PRECIOUS GEMSTONES; TIE CLIPS; TIE PINS; WATCH BANDS; WATCHES; WRIST WATCHES (U.S. CLS. 2, 27, 28 AND 50).

FIRST USE 2-27-2009; IN COMMERCE 2-27-2009.

CLASS 16—PAPER GOODS AND PRINTED MATTER

FOR A SERIES OF BOOKS AND WRITTEN ARTICLES IN THE FIELD OF CULTURE, ARTISTRY, HISTORY, LITERATURE, LANGUAGES AND GEOGRAPHY; ARTISTS' PASTELS; BOOKBINDINGS; DRAWING RULERS; ENVELOPES; EXERCISE BOOKS; GENERAL PURPOSE PLASTIC BAGS; GIFT CARDS; GLUE FOR STATIONERY OR HOUSEHOLD USE; JOURNALS CONCERNING CULTURE, ARTISTRY, HISTORY, LITERATURE, LANGUAGES AND GEOGRAPHY; MAGAZINES FEATURING CULTURE, ARTISTRY, HISTORY, LITERATURE, LANGUAGES AND GEOGRAPHY; MAGNETIC BOARDS; NEWSPAPERS IN THE FIELD OF CULTURE, ARTISTRY, HISTORY, LITERATURE, LANGUAGES AND GEOGRAPHY; OFFICE HOLE PUNCHERS; PAINT BRUSHES; PAMPHLETS IN THE FIELD OF CULTURE, ARTISTRY, HISTORY, LITERATURE, LANGUAGES AND GEOGRAPHY; PAPER CLIPS; PAPER CUTTERS; PAPER FASTENERS; PAPER RIBBONS; PAPERWEIGHTS; PEN CASES; PENCIL CASES; PENCIL SHARPENERS; PENCILS; PENS; PHOTOGRAPH ALBUMS; PUNCHES; RUBBER ERASERS; SCRATCH PADS; WRITING PAPER (U.S. CLS. 2, 5, 22, 23, 29, 37, 38 AND 50).

FIRST USE 2-27-2009; IN COMMERCE 2-27-2009.

CLASS 18—LEATHER GOODS

FOR LEATHER AND IMITATION LEATHER BAGS; LEATHER BAGS AND WALLETS; LEATHER BRIEFCASES; PARASOLS; TRAVELING BAGS; TRUNKS; UMBRELLAS (U.S. CLS. 1, 2, 3, 22 AND 41).

FIRST USE 2-27-2009; IN COMMERCE 2-27-2009.

CLASS 21—HOUSEWARES AND GLASS

FOR BATH SPONGES; COMBS; CUPS; DRINKING GLASSES; HAIR BRUSHES; PET BRUSHES; PLATES; SERVING PLATTERS (U.S. CLS. 2, 13, 23, 29, 30, 33, 40 AND 50).

FIRST USE 2-27-2009; IN COMMERCE 2-27-2009.

CLASS 28—TOYS AND SPORTING GOODS

FOR ACTION SKILL GAMES; CHILDREN'S MULTIPLE ACTIVITY TOYS; DOLLS; PARLOR GAMES; PLAY FIGURES; PLAY HOUSES; STUFFED TOYS (U.S. CLS. 22, 23, 38 AND 50).

FIRST USE 2-27-2009; IN COMMERCE 2-27-2009.

3,785,774. HARVEY BALL SMILE LIMITED, SHINAGAWA-KU TOKYO, JAPAN. SN 77-652,344. PUB. 7-28-2009, FILED 1-20-2009.



OWNER OF U.S. REG. NOS. 3,066,172, 3,502,405, AND 3,502,982.

NO CLAIM IS MADE TO THE EXCLUSIVE RIGHT TO USE "DESIGNED BY" AND "USA 1963", APART FROM THE MARK AS SHOWN.

THE NAME(S), PORTRAIT(S), AND/OR SIGNATURE(S) SHOWN IN THE MARK DOES NOT IDENTIFY A PARTI-

CULAR LIVING INDIVIDUAL.

THE MARK CONSISTS OF A CIRCLE WITH AN UPPER-CASE LETTER "X" FOR EACH EYE, BOTH OF WHICH SLANT DOWNWARD SO THAT THE RIGHT EYE IS LOWER THAN THE LEFT, AND A ROUNDED "V" SHAPED SMILE WITH PERPENDICULAR END LINES, BELOW WHICH APPEAR THE WORDS "DESIGNED BY HARVEY R. BALL USA 1963" CURVED AROUND THE BOTTOM OF THE CIRCULAR FACE.

CLASS 14—JEWELRY

FOR BRACELETS; BRACELETS OF PRECIOUS METAL; BROOCHES; CHRONOMETERS; CLOCKS; CUFFLINKS; EARRINGS; FIGURES OF PRECIOUS METAL; FIGURINES OF PRECIOUS METAL; INSIGNIAS OF PRECIOUS METAL; KEY HOLDERS OF PRECIOUS METALS; KEY RINGS OF PRECIOUS METAL; NECKLACES; PRECIOUS GEMSTONES; TIE CLIPS; TIE PINS; WATCH BANDS; WATCHES; WRIST WATCHES (U.S. CLS. 2, 27, 28 AND 50).

FIRST USE 2-27-2009; IN COMMERCE 2-27-2009.

CLASS 16—PAPER GOODS AND PRINTED MATTER

FOR A SERIES OF BOOKS AND WRITTEN ARTICLES IN THE FIELD OF CULTURE, ARTISTRY, HISTORY, LITERATURE, LANGUAGES AND GEOGRAPHY; ARTISTS' PASTELS; BOOKBINDINGS; DRAWING RULERS; ENVELOPES; EXERCISE BOOKS; GENERAL PURPOSE PLASTIC BAGS; GIFT CARDS; GLUE FOR STATIONERY OR HOUSEHOLD USE; JOURNALS CONCERNING CULTURE, ARTISTRY, HISTORY, LITERATURE, LANGUAGES AND GEOGRAPHY; MAGAZINES FEATURING CULTURE, ARTISTRY, HISTORY, LITERATURE, LANGUAGES AND GEOGRAPHY; MAGNETIC BOARDS; NEWSPAPERS IN THE FIELD OF CULTURE, ARTISTRY, HISTORY, LITERATURE, LANGUAGES AND GEOGRAPHY; OFFICE HOLE PUNCHERS; PAINT BRUSHES; PAMPHLETS IN THE FIELD OF CULTURE, ARTISTRY, HISTORY, LITERATURE, LANGUAGES AND GEOGRAPHY; PAPER CLIPS; PAPER CUTTERS; PAPER FASTENERS; PAPER RIBBONS; PAPERWEIGHTS; PEN CASES; PENCIL CASES; PENCIL SHARPENERS; PENCILS; PENS; PHOTOGRAPH ALBUMS; PUNCHES; RUBBER ERASERS; SCRATCH PADS; WRITING PAPER (U.S. CLS. 2, 5, 22, 23, 29, 37, 38 AND 50).

FIRST USE 2-27-2009; IN COMMERCE 2-27-2009.

CLASS 18—LEATHER GOODS

FOR LEATHER AND IMITATION LEATHER BAGS; LEATHER BAGS AND WALLETS; LEATHER BRIEFCASES; PARASOLS; TRAVELING BAGS; TRUNKS; UMBRELLAS (U.S. CLS. 1, 2, 3, 22 AND 41).

FIRST USE 2-27-2009; IN COMMERCE 2-27-2009.

CLASS 21—HOUSEWARES AND GLASS

FOR BATH SPONGES; COMBS; CUPS; DRINKING GLASSES; HAIR BRUSHES; PET BRUSHES; PLATES; SERVING PLATTERS (U.S. CLS. 2, 13, 23, 29, 30, 33, 40 AND 50).

FIRST USE 2-27-2009; IN COMMERCE 2-27-2009.

CLASS 28—TOYS AND SPORTING GOODS

FOR ACTION SKILL GAMES; CHILDREN'S MULTIPLE ACTIVITY TOYS; DOLLS; PARLOR GAMES; PLAY FIGURES; PLAY HOUSES; STUFFED TOYS (U.S. CLS. 22, 23, 38 AND 50).

FIRST USE 2-27-2009; IN COMMERCE 2-27-2009.

3,785,781. AMERICAN SOCIETY FOR QUALITY, INC., MILWAUKEE, WI. SN 77-655,122. PUB. 5-26-2009, FILED 1-23-2009.

ASQ LEARNING INSTITUTE

THE MARK CONSISTS OF STANDARD CHARACTERS WITHOUT CLAIM TO ANY PARTICULAR FONT, STYLE, SIZE, OR COLOR.

OWNER OF U.S. REG. NOS. 2,322,056, 2,879,902, AND 3,228,400.

NO CLAIM IS MADE TO THE EXCLUSIVE RIGHT TO USE "LEARNING INSTITUTE", APART FROM THE MARK AS SHOWN.

CLASS 16—PAPER GOODS AND PRINTED MATTER

FOR PUBLICATIONS, NAMELY, BROCHURES, FLYERS, PAPER BANNERS, PRINTED PAPER SIGNS, BOOKS, AND NEWSLETTERS RELATING TO QUALITY CONTROL MATTERS (U.S. CLS. 2, 5, 22, 23, 29, 37, 38 AND 50).

FIRST USE 2-27-2009; IN COMMERCE 4-1-2009.

CLASS 35—ADVERTISING AND BUSINESS

FOR ASSOCIATION SERVICES, NAMELY, PROMOTING THE INTERESTS OF INDUSTRIAL, COMMERCIAL, AND EDUCATIONAL ORGANIZATIONS INTERESTED IN QUALITY CONTROL MATTERS (U.S. CLS. 100, 101 AND 102).

FIRST USE 2-27-2009; IN COMMERCE 4-1-2009.

3,785,795. ITT MANUFACTURING ENTERPRISES, INC., WILMINGTON, DE. SN 77-658,287. PUB. 5-19-2009, FILED 1-28-2009.

ITT

THE MARK CONSISTS OF STANDARD CHARACTERS WITHOUT CLAIM TO ANY PARTICULAR FONT, STYLE, SIZE, OR COLOR.

OWNER OF U.S. REG. NOS. 2,665,512, 3,324,436, AND OTHERS.

CLASS 9—ELECTRICAL AND SCIENTIFIC APPARATUS

FOR INFORMATION ASSURANCE SOFTWARE; SOFTWARE FOR SECURE INFORMATION AND DATA EXCHANGE (U.S. CLS. 21, 23, 26, 36 AND 38).

FIRST USE 9-3-2009; IN COMMERCE 9-3-2009.

CLASS 35—ADVERTISING AND BUSINESS

FOR BUSINESS CONSULTING SERVICES IN THE FIELD OF INFORMATION ASSURANCE (U.S. CLS. 100, 101 AND 102).

FIRST USE 4-8-2009; IN COMMERCE 4-8-2009.

CLASS 42—SCIENTIFIC AND COMPUTER SERVICES

FOR COMPUTER SECURITY AND INFORMATION ASSURANCE SERVICES, NAMELY, RESTRICTING NETWORK, DATA AND INFORMATION ACCESS; COMPUTER SECURITY AND INFORMATION ASSURANCE SERVICES, NAMELY, SCANNING AND ELIMINATING UNAUTHORIZED DATA AND PROGRAMS FROM FILES AND NETWORKS; COMPUTER CONSULTATION; DEVELOPMENT OF HARDWARE AND SOFTWARE FOR SECURE NETWORK OPERATIONS; TECHNICAL CONSULTATION IN THE FIELD OF INFORMATION ASSURANCE (U.S. CLS. 100 AND 101).

FIRST USE 4-8-2009; IN COMMERCE 4-8-2009.

3,785,796. ITT MANUFACTURING ENTERPRISES, INC., WILMINGTON, DE. SN 77-658,299. PUB. 6-16-2009, FILED 1-28-2009.

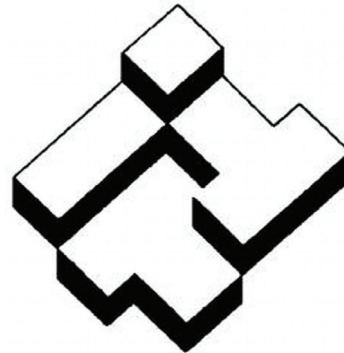

OWNER OF U.S. REG. NOS. 2,486,685, 2,665,512, AND OTHERS.

THE MARK CONSISTS OF STYLIZED "ITT".

CLASS 9—ELECTRICAL AND SCIENTIFIC APPARATUS

FOR INFORMATION ASSURANCE SOFTWARE; SOFTWARE FOR SECURE INFORMATION AND DATA EXCHANGE (U.S. CLS. 21, 23, 26, 36 AND 38).

FIRST USE 9-3-2009; IN COMMERCE 9-3-2009.

CLASS 35—ADVERTISING AND BUSINESS

FOR BUSINESS CONSULTING SERVICES IN THE FIELD OF INFORMATION ASSURANCE (U.S. CLS. 100, 101 AND 102).

FIRST USE 4-8-2009; IN COMMERCE 4-8-2009.

CLASS 42—SCIENTIFIC AND COMPUTER SERVICES

FOR COMPUTER SECURITY AND INFORMATION ASSURANCE SERVICES, NAMELY, RESTRICTING NETWORK, DATA AND INFORMATION ACCESS; COMPUTER SECURITY AND INFORMATION ASSURANCE SERVICES, NAMELY, SCANNING AND ELIMINATING UNAUTHORIZED DATA AND PROGRAMS FROM FILES AND NETWORKS; COMPUTER CONSULTATION; DEVELOPMENT OF HARDWARE AND SOFTWARE FOR SECURE NETWORK OPERATIONS; TECHNICAL CONSULTATION IN THE FIELD OF INFORMATION ASSURANCE (U.S. CLS. 100 AND 101).

FIRST USE 4-8-2009; IN COMMERCE 4-8-2009.

3,785,797. ITT MANUFACTURING ENTERPRISES, INC., WILMINGTON, DE. SN 77-658,313. PUB. 5-19-2009, FILED 1-28-2009.

ENGINEERED FOR LIFE

THE MARK CONSISTS OF STANDARD CHARACTERS WITHOUT CLAIM TO ANY PARTICULAR FONT, STYLE, SIZE, OR COLOR.

OWNER OF U.S. REG. NOS. 2,272,457, 2,665,512, AND OTHERS.

CLASS 9—ELECTRICAL AND SCIENTIFIC APPARATUS

FOR INFORMATION ASSURANCE SOFTWARE; SOFTWARE FOR SECURE INFORMATION AND DATA EXCHANGE (U.S. CLS. 21, 23, 26, 36 AND 38).

FIRST USE 9-3-2009; IN COMMERCE 9-3-2009.

CLASS 35—ADVERTISING AND BUSINESS

FOR BUSINESS CONSULTING SERVICES IN THE FIELD OF INFORMATION ASSURANCE (U.S. CLS. 100, 101 AND 102).

FIRST USE 4-8-2009; IN COMMERCE 4-8-2009.

CLASS 42—SCIENTIFIC AND COMPUTER SERVICES

FOR COMPUTER SECURITY AND INFORMATION ASSURANCE SERVICES, NAMELY, RESTRICTING NETWORK, DATA AND INFORMATION ACCESS; COMPUTER SECURITY AND INFORMATION ASSURANCE SERVICES, NAMELY, SCANNING AND ELIMINATING UNAUTHORIZED DATA AND PROGRAMS FROM FILES AND NETWORKS; COMPUTER CONSULTATION; DEVELOPMENT OF HARDWARE AND SOFTWARE FOR SECURE NETWORK OPERATIONS; TECHNICAL CONSULTATION IN THE FIELD OF INFORMATION ASSURANCE (U.S. CLS. 100 AND 101).

FIRST USE 4-8-2009; IN COMMERCE 4-8-2009.

3,785,803. TAURUS AEROSPACE GROUP, INC., EVERETT, WA. SN 77-659,475. PUB. 5-19-2009, FILED 1-29-2009.



NO CLAIM IS MADE TO THE EXCLUSIVE RIGHT TO USE "AEROSPACE GROUP", APART FROM THE MARK AS SHOWN.

THE MARK CONSISTS OF A CIRCLE WITH A LETTER "V" INCORPORATED IN A STYLIZED BULL'S HEAD DESIGN IN THE CENTER, WITH A HORIZONTAL LINE ACROSS THE MIDDLE BUT NOT TOUCHING THE LETTER "V" AND TWO CURVED LINES OUTSIDE THE RIGHT AND LEFT SIDES OF THE CIRCLE, ALL WITH THE WORDS, "TAURUS AEROSPACE GROUP", TO THE RIGHT.

CLASS 37—CONSTRUCTION AND REPAIR

FOR AIRCRAFT MAINTENANCE, REPAIR AND INSTALLATION; TECHNICAL SUPPORT SERVICES, NAMELY, PROVIDING TECHNICAL ADVICE IN THE FIELD OF AIRCRAFT ENGINE OVERHAUL AND REPAIR (U.S. CLS. 100, 103 AND 106).

FIRST USE 7-28-2008; IN COMMERCE 1-31-2009.

CLASS 40—MATERIAL TREATMENT

FOR AIRCRAFT AND AIRFRAME MANUFACTURING SERVICES FOR OTHERS (U.S. CLS. 100, 103 AND 106).

FIRST USE 7-28-2008; IN COMMERCE 1-31-2009.

CLASS 42—SCIENTIFIC AND COMPUTER SERVICES

FOR AIRCRAFT DESIGN (U.S. CLS. 100 AND 101).

FIRST USE 7-28-2008; IN COMMERCE 1-31-2009.

3,785,804. TAURUS AEROSPACE GROUP, INC., EVERETT, WA. SN 77-659,492. PUB. 5-19-2009, FILED 1-29-2009.



THE MARK CONSISTS OF A CIRCLE WITH A LETTER "V" INCORPORATED IN A STYLIZED BULL'S HEAD DESIGN IN THE CENTER, WITH A HORIZONTAL LINE ACROSS THE MIDDLE BUT NOT TOUCHING THE LETTER "V" AND TWO CURVED LINES OUTSIDE THE RIGHT AND LEFT SIDES OF THE CIRCLE.

CLASS 37—CONSTRUCTION AND REPAIR

FOR AIRCRAFT MAINTENANCE, REPAIR AND INSTALLATION; TECHNICAL SUPPORT SERVICES, NAMELY, PROVIDING TECHNICAL ADVICE IN THE FIELD OF AIRCRAFT ENGINE OVERHAUL AND REPAIR (U.S. CLS. 100, 103 AND 106).

FIRST USE 7-28-2008; IN COMMERCE 1-31-2009.

CLASS 40—MATERIAL TREATMENT

FOR AIRCRAFT AND AIRFRAME MANUFACTURING SERVICES FOR OTHERS (U.S. CLS. 100, 103 AND 106).

FIRST USE 7-28-2008; IN COMMERCE 1-31-2009.

CLASS 42—SCIENTIFIC AND COMPUTER SERVICES

FOR AIRCRAFT DESIGN (U.S. CLS. 100 AND 101).

FIRST USE 7-28-2008; IN COMMERCE 1-31-2009.

3,785,817. OBERON MEDIA, INC., NEW YORK, NY. SN 77-661,044. PUB. 8-4-2009, FILED 2-2-2009.

3,785,846. UNIFIED MARINE, INC., NEWPORT, TN. SN 77-665,315. PUB. 9-22-2009, FILED 2-6-2009.

FABULOUS FINDS

THE MARK CONSISTS OF STANDARD CHARACTERS WITHOUT CLAIM TO ANY PARTICULAR FONT, STYLE, SIZE, OR COLOR.

CLASS 9—ELECTRICAL AND SCIENTIFIC APPARATUS

FOR COMPUTER AND ELECTRONIC GAME SOFTWARE; INTERACTIVE MULTIMEDIA COMPUTER AND ELECTRONIC GAME PROGRAMS; DOWNLOADABLE ELECTRONIC GAMES VIA THE INTERNET (U.S. CLS. 21, 23, 26, 36 AND 38).

FIRST USE 1-7-2009; IN COMMERCE 1-7-2009.

CLASS 41—EDUCATION AND ENTERTAINMENT

FOR ENTERTAINMENT SERVICES, NAMELY, PROVIDING AN ONLINE COMPUTER GAME; PROVIDING COMPUTER AND ELECTRONIC GAMES, THAT MAY BE ACCESSED NETWORK-WIDE BY NETWORK USERS VIA ELECTRONIC, AND COMPUTER NETWORKS AND DEVICES (U.S. CLS. 100, 101 AND 107).

FIRST USE 1-7-2009; IN COMMERCE 1-7-2009.

3,785,845. HARGRAVE, HOLLY, MONTCLAIR, NJ. SN 77-665,128. PUB. 6-2-2009, FILED 2-6-2009.

ATHLETICGENIUS

THE MARK CONSISTS OF STANDARD CHARACTERS WITHOUT CLAIM TO ANY PARTICULAR FONT, STYLE, SIZE, OR COLOR.

CLASS 16—PAPER GOODS AND PRINTED MATTER

FOR EXERCISE BOOKS (U.S. CLS. 2, 5, 22, 23, 29, 37, 38 AND 50).

FIRST USE 8-1-2009; IN COMMERCE 8-1-2009.

CLASS 41—EDUCATION AND ENTERTAINMENT

FOR PERSONAL TRAINING SERVICES, NAMELY, PHYSICAL FITNESS TRAINING (U.S. CLS. 100, 101 AND 107).

FIRST USE 8-1-2009; IN COMMERCE 8-1-2009.

SECURESTACK

THE MARK CONSISTS OF STANDARD CHARACTERS WITHOUT CLAIM TO ANY PARTICULAR FONT, STYLE, SIZE, OR COLOR.

CLASS 12—VEHICLES

FOR PORTABLE FUEL TANKS FOR BOATS (U.S. CLS. 19, 21, 23, 31, 35 AND 44).

FIRST USE 2-17-2009; IN COMMERCE 3-12-2009.

CLASS 20—FURNITURE AND ARTICLES NOT OTHERWISE CLASSIFIED

FOR NON-METAL FUEL STORAGE TANKS (U.S. CLS. 2, 13, 22, 25, 32 AND 50).

FIRST USE 2-17-2009; IN COMMERCE 3-12-2009.

3,785,849. KAITEN SUSHI FRANCHISING, INC., KENT, WA. SN 77-665,719. PUB. 6-2-2009, FILED 2-7-2009.

Kaiten Sushi

THE MARK CONSISTS OF STANDARD CHARACTERS WITHOUT CLAIM TO ANY PARTICULAR FONT, STYLE, SIZE, OR COLOR.

NO CLAIM IS MADE TO THE EXCLUSIVE RIGHT TO USE "SUSHI", APART FROM THE MARK AS SHOWN.

THE ENGLISH TRANSLATION OF "KAITEN" IN THE MARK IS "REVOLUTION".

CLASS 30—STAPLE FOODS

FOR SUSHI (U.S. CL. 46).

FIRST USE 10-20-2009; IN COMMERCE 10-20-2009.

CLASS 43—HOTEL AND RESTAURANT SERVICES

FOR RESTAURANT SERVICES, NAMELY, PROVIDING OF FOOD AND BEVERAGES FOR CONSUMPTION ON AND OFF THE PREMISES (U.S. CLS. 100 AND 101).

FIRST USE 10-20-2009; IN COMMERCE 10-20-2009.

3,785,862. WELLQUEST INTERNATIONAL, INC., NEW YORK, NY. SN 77-667,307. PUB. 6-9-2009, FILED 2-10-2009.

NU BRILLIANCE

THE MARK CONSISTS OF STANDARD CHARACTERS WITHOUT CLAIM TO ANY PARTICULAR FONT, STYLE, SIZE, OR COLOR.

CLASS 3—COSMETICS AND CLEANING PREPARATIONS

FOR NON-MEDICATED SKIN CARE PREPARATIONS; FACE LOTIONS AND CREAMS (U.S. CLS. 1, 4, 6, 50, 51 AND 52).

FIRST USE 7-20-2009; IN COMMERCE 7-20-2009.

CLASS 21—HOUSEWARES AND GLASS

FOR ELECTRICALLY-POWERED MICROABRASION APPARATUS USED TO CLEAN AND EXFOLIATE SKIN (U.S. CLS. 2, 13, 23, 29, 30, 33, 40 AND 50).

FIRST USE 7-20-2009; IN COMMERCE 7-20-2009.

3,785,865. NORTH AMERICAN HEALTH DEVELOPMENT INSTITUTES, INC., FRIENDSWOOD, TX. SN 77-667,993. PUB. 6-30-2009, FILED 2-11-2009.

DM2050

THE MARK CONSISTS OF STANDARD CHARACTERS WITHOUT CLAIM TO ANY PARTICULAR FONT, STYLE, SIZE, OR COLOR.

CLASS 41—EDUCATION AND ENTERTAINMENT

FOR EDUCATIONAL SERVICES, NAMELY, CONDUCTING CLASSES, SEMINARS, CONFERENCES AND WORKSHOPS IN THE FIELD OF MEDICAL ENVIRONMENT DESIGN CONSTRUCTION AND OPERATION OF BUILDINGS AND REAL ESTATE AND WORK AND LIVING SPACE; AND DISSEMINATION OF EDUCATIONAL MATERIALS IN CONNECTION THEREWITH FOR OTHERS IN THE FIELDS OF CONTRACTING, SUPPLIERS, PHYSICIANS, OTHER HEALTH CARE PROFESSIONALS, AND ENVIRONMENTAL EXPERTS, AND OTHER PERSONS WHO STUDY ENVIRONMENTS IN WHICH DISEASE IS FOSTERED AND IS TRANSFERRED TO HUMANS (U.S. CLS. 100, 101 AND 107).

FIRST USE 5-30-2009; IN COMMERCE 5-30-2009.

CLASS 42—SCIENTIFIC AND COMPUTER SERVICES

FOR ACCREDITATION SERVICES, NAMELY, FORMATION OF STANDARDS AND BEST PRACTICES FOR MEDICAL ENVIRONMENTS, CONSTRUCTION, UPGRADING EXISTING FACILITIES, AND OPERATION OF BUILDINGS AND REAL ESTATE AND HABITAT IMPROVEMENT FOR AT RISK DISEASE POPULATIONS IN DISEASE ENVIRONMENTS AND WORK AND LIVING SPACE; AND TESTING, ANALYSIS AND EVALUATION OF SERVICES OF OTHERS FOR HOSPITALS, OTHER TYPE OF HEALTH CARE FACILITIES AND OTHER ENVIRONMENTS IN WHICH DISEASE IS AT RISK OF BEING TRANSFERRED TO HUMANS FOR THE PURPOSE OF ACCREDITATION OF THE SERVICES AND FACILITIES (U.S. CLS. 100 AND 101).

FIRST USE 5-30-2009; IN COMMERCE 5-30-2009.

CLASS 44—MEDICAL, BEAUTY AND AGRICULTURAL SERVICES

FOR MEDICAL CONSULTING SERVICES IN THE FIELD OF DISEASE CONTROL, NAMELY, DEVELOPMENT AND STUDY OF PROCESSES, MATERIALS, CHEMICALS AND TREATMENTS FOR USE IN CONTROLLING AND ERADICATING DISEASE ENVIRONMENTS AND WORK CONDITIONS IN HOSPITALS ENVIRONMENTS, AND OTHER TYPE HEALTH CARE FACILITIES AND OTHER WORK AND LIVING ENVIRONMENTS IN WHICH RISKS EXISTS FOR DISEASE TRANSFER TO HUMANS (U.S. CLS. 100 AND 101).

FIRST USE 5-30-2009; IN COMMERCE 5-30-2009.

3,785,866. SCHAEFFER'S INVESTMENT RESEARCH, INC., CINCINNATI, OH. SN 77-668,085. PUB. 7-7-2009, FILED 2-11-2009.

BERNIE SCHAEFFER'S SENTIMENT

THE MARK CONSISTS OF STANDARD CHARACTERS WITHOUT CLAIM TO ANY PARTICULAR FONT, STYLE, SIZE, OR COLOR.

OWNER OF U.S. REG. NOS. 2,399,367, 2,661,963, AND 3,414,005.

THE NAME(S), PORTRAIT(S), AND/OR SIGNATURE(S) SHOWN IN THE MARK IDENTIFIES "BERNIE SCHAEFFER", WHOSE CONSENT(S) TO REGISTER IS MADE OF RECORD.

CLASS 16—PAPER GOODS AND PRINTED MATTER

FOR MAGAZINE PUBLICATIONS DEALING WITH THE STOCK OPTIONS MARKET (U.S. CLS. 2, 5, 22, 23, 29, 37, 38 AND 50).

FIRST USE 4-13-2009; IN COMMERCE 4-13-2009.

CLASS 41—EDUCATION AND ENTERTAINMENT

FOR ON-LINE MAGAZINE PUBLICATIONS DEALING WITH THE STOCK OPTIONS MARKET (U.S. CLS. 100, 101 AND 107).

FIRST USE 4-13-2009; IN COMMERCE 4-13-2009.

3,785,870. HIGHTECH FISHING LLC, MINNETRISTA, MN. SN 77-668,343. PUB. 6-9-2009, FILED 2-11-2009.

3,785,876. TWINSTRATA, INC., AKA TWINSTRATA, NATICK, MA. SN 77-668,982. PUB. 6-2-2009, FILED 2-12-2009.

DOCTOR SONAR

THE MARK CONSISTS OF STANDARD CHARACTERS WITHOUT CLAIM TO ANY PARTICULAR FONT, STYLE, SIZE, OR COLOR.

CLASS 9—ELECTRICAL AND SCIENTIFIC APPARATUS

FOR DIGITAL MATERIALS, NAMELY, DVDS FEATURING FISHING INFORMATION (U.S. CLS. 21, 23, 26, 36 AND 38).
FIRST USE 2-16-2010; IN COMMERCE 2-16-2010.

CLASS 16—PAPER GOODS AND PRINTED MATTER

FOR NEWSLETTERS IN THE FIELD OF FISHING (U.S. CLS. 2, 5, 22, 23, 29, 37, 38 AND 50).
FIRST USE 2-16-2010; IN COMMERCE 2-16-2010.

3,785,874. SINCLAIR TECHNOLOGIES INC., AURORA, ONTARIO, CANADA. SN 77-668,931. PUB. 6-9-2009, FILED 2-12-2009.

SUPERIOR THEN, SUPERIOR NOW.

THE MARK CONSISTS OF STANDARD CHARACTERS WITHOUT CLAIM TO ANY PARTICULAR FONT, STYLE, SIZE, OR COLOR.

CLASS 9—ELECTRICAL AND SCIENTIFIC APPARATUS

FOR WIRELESS COMMUNICATIONS PRODUCTS, NAMELY, BASE STATION AND MOBILE ANTENNAS, RECEIVER MULTICOUPLERS, DUPLEXERS, TRANSMITTER COMBINERS, BI-BANDPASS, REJECT AND Q-CIRCUIT FILTERS, CIRCULATORS AND ISOLATORS; POWER SUPPLIES AND POWER MONITORING EQUIPMENT, NAMELY, MODULAR POWER AND VSWR (VOLTAGE STORAGE WAVE RATIO) MONITORS WITH ALARMS ACTIVATED BY POWER OUTPUTS BELOW OR IN EXCESS OF PREDETERMINED THRESHOLDS FOR MEASURING POWER OUTPUT CHARACTERISTICS OF RADIO FREQUENCY EQUIPMENT (U.S. CLS. 21, 23, 26, 36 AND 38).
FIRST USE 6-1-2007; IN COMMERCE 6-1-2007.

CLASS 19—NON-METALLIC BUILDING MATERIALS

FOR COMMUNICATIONS EQUIPMENT SHELTERS, NAMELY, FIBERGLASS SHELTERS TO ENCLOSE COMMERCIAL EQUIPMENT TO PROTECT SUCH EQUIPMENT FROM THE ELEMENTS (U.S. CLS. 1, 12, 33 AND 50).
FIRST USE 6-1-2007; IN COMMERCE 6-1-2007.

TwinStrata

THE MARK CONSISTS OF STANDARD CHARACTERS WITHOUT CLAIM TO ANY PARTICULAR FONT, STYLE, SIZE, OR COLOR.

CLASS 9—ELECTRICAL AND SCIENTIFIC APPARATUS

FOR COMPUTER SOFTWARE AND HARDWARE FOR USE IN THE ONLINE STORAGE OF IMAGES, TEXT, DATA AND INFORMATION; COMPUTER SOFTWARE FOR USE IN THE ONLINE STORAGE OF IMAGES, TEXT, DATA AND INFORMATION; COMPUTER SOFTWARE FOR USE IN THE ONLINE STORAGE OF IMAGES, TEXT, DATA AND INFORMATION THAT MAY BE DOWNLOADED FROM A GLOBAL COMPUTER NETWORK; COMPUTER SOFTWARE PLATFORMS FOR USE IN THE ONLINE STORAGE OF IMAGES, TEXT, DATA AND INFORMATION; DOWNLOADABLE COMPUTER SOFTWARE FOR USE IN THE ONLINE STORAGE OF IMAGES, TEXT, DATA AND INFORMATION; FLOPPY DISCS FOR COMPUTERS FEATURING USE IN THE ONLINE STORAGE OF IMAGES, TEXT, DATA AND INFORMATION (U.S. CLS. 21, 23, 26, 36 AND 38).
FIRST USE 10-5-2007; IN COMMERCE 6-11-2008.

CLASS 42—SCIENTIFIC AND COMPUTER SERVICES

FOR APPLICATION SERVICE PROVIDER (ASP) FEATURING SOFTWARE FOR USE IN THE ONLINE STORAGE OF IMAGES, TEXT, DATA AND INFORMATION; SOFTWARE AS A SERVICE (SAAS) SERVICES FEATURING THE ONLINE STORAGE OF IMAGES, TEXT, DATA AND INFORMATION; SOFTWARE AS A SERVICE (SAAS) SERVICES, NAMELY, HOSTING SOFTWARE FOR USE BY OTHERS FOR USE IN THE ONLINE STORAGE OF IMAGES, TEXT, DATA AND INFORMATION (U.S. CLS. 100 AND 101).
FIRST USE 10-5-2007; IN COMMERCE 6-11-2008.

3,785,883. BOBARRA, LLC, SAN FRANCISCO, CA. SN 77-669,677. PUB. 6-9-2009, FILED 2-12-2009.

BOBARRA

THE MARK CONSISTS OF STANDARD CHARACTERS WITHOUT CLAIM TO ANY PARTICULAR FONT, STYLE, SIZE, OR COLOR.

CLASS 9—ELECTRICAL AND SCIENTIFIC APPARATUS

FOR COVERS SPECIALLY ADAPTED FOR E-BOOK DEVICES; LAPTOP CARRYING CASES; PROTECTIVE CARRYING CASES SPECIALLY ADAPTED FOR PERSONAL DIGITAL ASSISTANTS (PDA), PROTECTIVE SLEEVES FOR LAPTOP COMPUTERS (U.S. CLS. 21, 23, 26, 36 AND 38).

FIRST USE 10-21-2008; IN COMMERCE 10-21-2008.

CLASS 18—LEATHER GOODS

FOR ALL-PURPOSE CARRYING BAGS (U.S. CLS. 1, 2, 3, 22 AND 41).

FIRST USE 6-5-2009; IN COMMERCE 6-5-2009.

3,785,900. CARBO CERAMICS INC., HOUSTON, TX. SN 77-674,984. PUB. 6-9-2009, FILED 2-20-2009.

STRATAGEN

THE MARK CONSISTS OF STANDARD CHARACTERS WITHOUT CLAIM TO ANY PARTICULAR FONT, STYLE, SIZE, OR COLOR.

THE WORDING "STRATAGEN" HAS NO MEANING IN A FOREIGN LANGUAGE.

CLASS 40—MATERIAL TREATMENT

FOR CONSULTING SERVICES IN THE FIELD OF OIL WELL AND GAS WELL FRACTURE (U.S. CLS. 100, 103 AND 106).

FIRST USE 4-30-2009; IN COMMERCE 4-30-2009.

CLASS 42—SCIENTIFIC AND COMPUTER SERVICES

FOR CONSULTING SERVICES IN THE FIELD OF RESERVOIR ENGINEERING, AND HYDRAULIC FRACTURE MAPPING AND DIAGNOSTIC SERVICES (U.S. CLS. 100 AND 101).

FIRST USE 4-30-2009; IN COMMERCE 4-30-2009.

3,785,931. AMERICAN CITY BUSINESS JOURNALS, INC., CHARLOTTE, NC. SN 77-683,271. PUB. 6-30-2009, FILED 3-4-2009.

ROWDY

THE MARK CONSISTS OF STANDARD CHARACTERS WITHOUT CLAIM TO ANY PARTICULAR FONT, STYLE, SIZE, OR COLOR.

OWNER OF U.S. REG. NOS. 3,045,113 AND 3,053,454.

CLASS 38—COMMUNICATION

FOR PROVIDING ON-LINE CHAT ROOMS, LISTSERVERS, AND ON-LINE FORUMS FOR TRANSMISSION OF MESSAGES AMONG COMPUTER USERS CONCERNING USER-DEFINED CONTENT; PROVIDING ON-LINE CHAT ROOMS AND ELECTRONIC BULLETIN BOARDS FOR TRANSMISSION OF MESSAGES AMONG USERS IN THE FIELD OF SPORTS (U.S. CLS. 100, 101 AND 104).

FIRST USE 4-22-2003; IN COMMERCE 4-22-2003.

CLASS 41—EDUCATION AND ENTERTAINMENT

FOR PROVIDING INFORMATION ABOUT SPORTS VIA GLOBAL COMPUTER NETWORKS, DIGITAL, SATELLITE, CABLE AND MOBILE NETWORKS (U.S. CLS. 100, 101 AND 107).

FIRST USE 4-22-2003; IN COMMERCE 4-22-2003.

3,785,936. MEDICAL STAFFING SOLUTIONS, INC., ROCKLEDGE, FL. SN 77-684,069. PUB. 10-6-2009, FILED 3-5-2009.

MSS Care

THE MARK CONSISTS OF STANDARD CHARACTERS WITHOUT CLAIM TO ANY PARTICULAR FONT, STYLE, SIZE, OR COLOR.

OWNER OF U.S. REG. NOS. 2,573,436 AND 3,247,298.

NO CLAIM IS MADE TO THE EXCLUSIVE RIGHT TO USE "CARE", APART FROM THE MARK AS SHOWN.

CLASS 35—ADVERTISING AND BUSINESS

FOR EMPLOYMENT AGENCY SERVICES, NAMELY, TEMPORARY STAFFING OF HEALTH CARE PROFESSIONALS (U.S. CLS. 100, 101 AND 102).

FIRST USE 3-5-2009; IN COMMERCE 3-5-2009.

CLASS 44—MEDICAL, BEAUTY AND AGRICULTURAL SERVICES

FOR HOME HEALTH CARE SERVICES (U.S. CLS. 100 AND 101).

FIRST USE 3-5-2009; IN COMMERCE 3-5-2009.

3,785,949. GLOBAL SWEET POLYOLS, LLC, REHOBOTH, MA. SN 77-687,575. PUB. 7-7-2009, FILED 3-10-2009.

BodySong

THE MARK CONSISTS OF STANDARD CHARACTERS WITHOUT CLAIM TO ANY PARTICULAR FONT, STYLE, SIZE, OR COLOR.

CLASS 3—COSMETICS AND CLEANING PREPARATIONS

FOR HAND AND BODY CREAMS, BAR SOAPS, LIQUID SOAPS, BATH GELS, SKIN AND FACE CREAMS, SKIN AND BODY LOTIONS, SKIN EXFOLIANTS, FACIAL TONERS AND ASTRINGENTS, BATH AND BODY OILS, AFTERSHAVE LOTIONS, MAKE-UP, EYE SHADOWS, FOUNDATIONS, SKIN BRONZERS, HAIR STYLING GELS, SHAMPOO, HAIR CONDITIONERS, FACE AND BODY MASKS, BODY AND FACIAL GELS, ESSENTIAL OILS FOR PERSONAL USE, NON-MEDICATED LIP BALM, LIP GLOSS, LIP STICK, LIP SALVE, NON-MEDICATED SKIN BALMS AND SKIN SALVES, NON-MEDICATED BATH SALTS; SCENTED PRODUCTS, NAMELY, PERFUMES, BODY SPRAYS, AND SCENTED ESSENTIAL OILS FOR PERSONAL USE; SUN CARE PRODUCTS, NAMELY, GELS, LOTIONS, SPRAYS, AND AFTER-SUN LOTIONS AND GELS (U.S. CLS. 1, 4, 6, 50, 51 AND 52).

FIRST USE 12-18-2009; IN COMMERCE 12-18-2009.

CLASS 5—PHARMACEUTICALS

FOR DIETARY AND NUTRITIONAL SUPPLEMENTS FOR HEALTH CARE, NAMELY, VITAMINS, MINERALS, TRACE ELEMENTS, EITHER SEPARATELY OR IN COMBINATION; NUTRITIONAL ADDITIVES FOR USE IN DIETARY SUPPLEMENTS, NUTRITIONAL SUPPLEMENTS AND FOOD SUPPLEMENTS, NAMELY, AMINO ACIDS, MINERALS, TRACE ELEMENTS, EITHER SEPARATELY OR IN COMBINATION, AND ALSO IN PILL FORM; VITAMIN PREPARATIONS; TRACE ELEMENTS PREPARATIONS FOR USE IN NUTRITIONAL SUPPLEMENTS, DIETARY SUPPLEMENTS AND FOOD SUPPLEMENTS, MEDICATED SKIN CREAMS (U.S. CLS. 6, 18, 44, 46, 51 AND 52).

FIRST USE 2-1-2010; IN COMMERCE 2-1-2010.

3,785,951. SYCLIPSE TECHNOLOGIES, INC., SAN JOSE, CA.
SN 77-687,702. PUB. 7-21-2009, FILED 3-10-2009.

SYCLIPSE

THE MARK CONSISTS OF STANDARD CHARACTERS WITHOUT CLAIM TO ANY PARTICULAR FONT, STYLE, SIZE, OR COLOR.

CLASS 9—ELECTRICAL AND SCIENTIFIC APPARATUS

FOR SECURITY DEVICES COMPRISING SOFTWARE AND HARDWARE FOR PROVIDING PICTURE, AUDIO, VIDEO, MOTION DATA, ALARM AND OTHER TRIGGER EVENT STATUS, AND OTHER INFORMATION TO A REMOTE STATION; MOBILE VIDEO SURVEILLANCE AND VEHICLE MONITORING SYSTEM WITH A HIGH-RESOLUTION COLOR LENS, GPS TRACKING DEVICE, AND A LIVE LINK TO A REMOTE SERVER; SECURITY SYSTEM WITH HARDWARE AND SOFTWARE ENABLING A USER TO MONITOR, TRACK, AND RECORD EVENTS IN AND OUTSIDE A VEHICLE OR OTHER ASSET AS WELL AS DOWNLOAD, VIEW, AND ARCHIVE FOOTAGE AND AUDIO FOR LATER REFERENCE; SECURITY SYSTEMS WITH MULTIPLE MONITORING DEVICES COUPLED TO A REMOTE SERVER AND SERVER ACCESS FROM WEB ENABLED DEVICES FOR ENABLING THE WEB ENABLED DEVICES TO CONTROL AND ACCESS THE MULTIPLE MONITORING DEVICES (U.S. CLS. 21, 23, 26, 36 AND 38).

FIRST USE 10-20-2008; IN COMMERCE 10-20-2008.

CLASS 37—CONSTRUCTION AND REPAIR

FOR INSTALLATION OF SECURITY SYSTEMS (U.S. CLS. 100, 103 AND 106).
FIRST USE 10-20-2008; IN COMMERCE 10-20-2008.

CLASS 42—SCIENTIFIC AND COMPUTER SERVICES

FOR ON-LINE SYSTEM MANAGEMENT SERVICES THAT ALLOW USERS TO REMOTELY VIEW, MONITOR, PROGRAM, OPERATE AND CONTROL SECURITY, VIDEO SURVEILLANCE AND MONITORING SYSTEMS AND DEVICES (U.S. CLS. 100 AND 101).
FIRST USE 10-20-2008; IN COMMERCE 10-20-2008.

CLASS 45—PERSONAL AND LEGAL SERVICES

FOR SECURITY SYSTEM MANAGEMENT AND MONITORING SERVICES; TECHNICAL SUPPORT SERVICES FOR SECURITY SYSTEMS (U.S. CLS. 100 AND 101).
FIRST USE 10-20-2008; IN COMMERCE 10-20-2008.

3,785,954. MICROSOFT CORPORATION, REDMOND, WA.
SN 77-688,836. PUB. 7-7-2009, FILED 3-11-2009.



THE MARK CONSISTS OF STYLIZED LETTERS "FM".

CLASS 9—ELECTRICAL AND SCIENTIFIC APPARATUS

FOR COMPUTER PROGRAMS, NAMELY, GAME SOFTWARE FOR USE ON COMPUTERS AND VIDEO GAME PLAYERS (U.S. CLS. 21, 23, 26, 36 AND 38).
FIRST USE 10-27-2009; IN COMMERCE 10-27-2009.

CLASS 41—EDUCATION AND ENTERTAINMENT

FOR PROVIDING A WEB SITE FEATURING INFORMATION IN THE FIELD OF COMPUTER GAMES, GAMES AND HOME ENTERTAINMENT; PROVIDING INFORMATION ON-LINE RELATING TO COMPUTER GAMES AND COMPUTER ENHANCEMENTS FOR GAMES; AND ENTERTAINMENT SERVICES, NAMELY, PROVIDING AN ON-LINE COMPUTER GAME (U.S. CLS. 100, 101 AND 107).
FIRST USE 6-0-2009; IN COMMERCE 6-0-2009.

3,785,968. LIL' DRUG STORE PRODUCTS, INC., CEDAR RAPIDS, IA. SN 77-693,912. PUB. 6-2-2009, FILED 3-18-2009.



OWNER OF U.S. REG. NOS. 1,296,316, 1,296,318, AND 1,934,934.

NO CLAIM IS MADE TO THE EXCLUSIVE RIGHT TO USE "DRUG STORE PRODUCTS", APART FROM THE MARK AS SHOWN.

THE MARK CONSISTS OF THE STYLIZED WORDING "LIL' DRUG STORE PRODUCTS".

CLASS 5—PHARMACEUTICALS

FOR NON-PRESCRIPTION DRUGS, NAMELY, ANALGESICS, PREPARATIONS FOR TREATING COLDS AND FLU, NASAL SPRAY PREPARATIONS, ANTACIDS, DIETARY AND NUTRITIONAL SUPPLEMENTS, AND SLEEP AIDS, NAMELY, SLEEPING PILLS AND TABLETS (U.S. CLS. 6, 18, 44, 46, 51 AND 52).

FIRST USE 4-0-2009; IN COMMERCE 4-0-2009.

CLASS 35—ADVERTISING AND BUSINESS

FOR DISTRIBUTORSHIPS IN THE FIELD OF PHARMACEUTICALS, HEALTH PRODUCTS, BEAUTY CARE PRODUCTS, AUTOMOTIVE PRODUCTS, OFFICE SUPPLIES, BEVERAGES, ORTHOPEDIC BRACES AND SUPPORTS, ELECTRONICS, AND AIR FRESHENERS (U.S. CLS. 100, 101 AND 102).

FIRST USE 4-0-2009; IN COMMERCE 4-0-2009.

3,785,986. KARSTEN MANUFACTURING CORPORATION, PHOENIX, AZ. SN 77-700,047. PUB. 7-14-2009, FILED 3-26-2009.

PLAY YOUR BEST

THE MARK CONSISTS OF STANDARD CHARACTERS WITHOUT CLAIM TO ANY PARTICULAR FONT, STYLE, SIZE, OR COLOR.

OWNER OF U.S. REG. NOS. 2,476,383, 2,853,525, AND 3,268,236.

CLASS 18—LEATHER GOODS

FOR BACKPACKS, SHOE BAGS FOR TRAVEL, DUFFEL BAGS AND GOLF UMBRELLAS (U.S. CLS. 1, 2, 3, 22 AND 41).

FIRST USE 10-13-2009; IN COMMERCE 10-13-2009.

CLASS 28—TOYS AND SPORTING GOODS

FOR TRAVEL COVERS FOR GOLF BAGS (U.S. CLS. 22, 23, 38 AND 50).

FIRST USE 9-2-2009; IN COMMERCE 9-2-2009.

3,785,993. SONY COMPUTER ENTERTAINMENT AMERICA INC., FOSTER CITY, CA. SN 77-703,790. PUB. 6-9-2009, FILED 3-31-2009.

WHITE KNIGHT CHRONICLES

THE MARK CONSISTS OF STANDARD CHARACTERS WITHOUT CLAIM TO ANY PARTICULAR FONT, STYLE, SIZE, OR COLOR.

CLASS 9—ELECTRICAL AND SCIENTIFIC APPARATUS

FOR COMPUTER GAME SOFTWARE AND VIDEO GAME SOFTWARE (U.S. CLS. 21, 23, 26, 36 AND 38).

FIRST USE 2-10-2010; IN COMMERCE 2-10-2010.

CLASS 41—EDUCATION AND ENTERTAINMENT

FOR OPERATING A REAL-TIME GAME FOR OTHERS OVER GLOBAL AND LOCAL AREA COMPUTER NETWORKS (U.S. CLS. 100, 101 AND 107).

FIRST USE 2-10-2010; IN COMMERCE 2-10-2010.

3,786,016. KABLE ENTERPRISE CO., LTD., NEI-HU, TAIPEI, TAIWAN. SN 77-713,734. PUB. 8-11-2009, FILED 4-14-2009.



OWNER OF U.S. REG. NO. 3,549,959.

THE MARK CONSISTS OF THE WORD "NORISTEAM" WITH A STYLIZED "I" THAT INCLUDES A DOT ON EACH END AND A SPRAY PATTERN EMANATING FROM BOTH DOTS.

CLASS 7—MACHINERY

FOR STEAM CLEANING MACHINES (U.S. CLS. 13, 19, 21, 23, 31, 34 AND 35).

FIRST USE 11-8-2009; IN COMMERCE 11-8-2009.

CLASS 9—ELECTRICAL AND SCIENTIFIC APPARATUS

FOR ELECTRIC IRONS; STEAM IRONS (U.S. CLS. 21, 23, 26, 36 AND 38).

FIRST USE 11-8-2009; IN COMMERCE 11-8-2009.

3,786,030. GEORGIA TELCO CREDIT UNION, ATLANTA, GA. SN 77-723,288. PUB. 11-3-2009, FILED 4-27-2009.

i[x]ga

THE MARK CONSISTS OF STANDARD CHARACTERS WITHOUT CLAIM TO ANY PARTICULAR FONT, STYLE, SIZE, OR COLOR.

CLASS 16—PAPER GOODS AND PRINTED MATTER

FOR PRINT MAGAZINE FEATURING FINANCIAL AND BANKING INFORMATION (U.S. CLS. 2, 5, 22, 23, 29, 37, 38 AND 50).
FIRST USE 3-31-2009; IN COMMERCE 4-30-2009.

CLASS 25—CLOTHING

FOR T-SHIRTS (U.S. CLS. 22 AND 39).
FIRST USE 3-31-2009; IN COMMERCE 9-30-2009.

CLASS 36—INSURANCE AND FINANCIAL

FOR CREDIT UNION SERVICES; PROVIDING INFORMATION TO TEENS AND YOUNG ADULTS ON THE SUBJECT OF PERSONAL FINANCES (U.S. CLS. 100, 101 AND 102).
FIRST USE 3-31-2009; IN COMMERCE 3-31-2009.

3,786,035. BEBE STUDIO, INC., LOS ANGELES, CA. SN 77-725,407. PUB. 9-8-2009, FILED 4-29-2009.

PH8

THE MARK CONSISTS OF STANDARD CHARACTERS WITHOUT CLAIM TO ANY PARTICULAR FONT, STYLE, SIZE, OR COLOR.

CLASS 18—LEATHER GOODS

FOR GYM BAGS; HANDBAGS; LEATHER AND IMITATION LEATHER BAGS; PURSES; SPORTS BAGS; CLUTCH BAGS; SHOULDER BAGS; TOTE BAGS AND BACKPACKS (U.S. CLS. 1, 2, 3, 22 AND 41).
FIRST USE 11-4-2009; IN COMMERCE 11-4-2009.

CLASS 25—CLOTHING

FOR ARTICLES OF CLOTHING, NAMELY, SHIRTS, T-SHIRTS, SKIRTS, BLOUSES, PANTS, TROUSERS, SLACKS, JACKETS, COATS, SWEATERS, DRESSES, GYM SUITS, JOGGING SUITS, SWEAT PANTS, SWEAT SHIRTS, SWEAT SUITS, TRACK PANTS, TRACK SUITS; ACCESSORIES, NAMELY, BELTS, SCARVES AND HATS; BATHING SUITS; BODY SUITS; FOOTWEAR, NAMELY, ATHLETIC SHOES, ESPADRILLES, SANDALS, AND THONGS (U.S. CLS. 22 AND 39).
FIRST USE 11-4-2009; IN COMMERCE 11-4-2009.

CLASS 35—ADVERTISING AND BUSINESS

FOR ONLINE RETAIL STORE SERVICES FEATURING WOMEN'S CLOTHING AND ACCESSORIES; RETAIL STORE SERVICES FEATURING WOMEN'S CLOTHING AND ACCESSORIES (U.S. CLS. 100, 101 AND 102).

FIRST USE 11-4-2009; IN COMMERCE 11-4-2009.

3,786,039. GUNTHER'S GRADES, LLC, RIVER FOREST, IL. SN 77-728,089. PUB. 10-13-2009, FILED 5-4-2009.



NO CLAIM IS MADE TO THE EXCLUSIVE RIGHT TO USE "GRADES", APART FROM THE MARK AS SHOWN.

THE COLOR(S) BLUE AND YELLOW IS/ARE CLAIMED AS A FEATURE OF THE MARK.

THE MARK CONSISTS OF THE WORDS "GUNTHER'S GRADES". THE APOSTROPHE APPEARS AS A YELLOW STAR, THE WORDING "GUNTHERS" APPEARS IN THE COLOR BLUE AND "GRADES" APPEARS IN THE COLOR YELLOW. THERE ARE THREE ARCS AND TWO OVALS ARRANGED TO DEPICT AN ABSTRACT DRAWING OF A CAREGIVER AND A PATIENT, THE ONE ABOVE APPEARS IN YELLOW AND THE ONE BELOW APPEARS IN BLUE.

CLASS 35—ADVERTISING AND BUSINESS

FOR PROVIDING INFORMATION FEATURING RATINGS, RECOMMENDATIONS AND REFERRALS IN THE FIELDS OF NURSING HOMES, SENIOR LIVING FACILITIES AND LONG-TERM ACUTE CARE FACILITIES VIA A WEBSITE (U.S. CLS. 100, 101 AND 102).
FIRST USE 6-7-2009; IN COMMERCE 6-7-2009.

CLASS 44—MEDICAL, BEAUTY AND AGRICULTURAL SERVICES

FOR PROVIDING INFORMATION IN THE FIELDS OF NURSING HOME SERVICES AND LONG TERM ACUTE CARE FACILITIES VIA A WEBSITE (U.S. CLS. 100 AND 101).

FIRST USE 6-7-2009; IN COMMERCE 6-7-2009.

3,786,060. GEORGIA TELCO CREDIT UNION, ATLANTA, GA. SN 77-738,445. PUB. 11-3-2009, FILED 5-15-2009.



THE MARK CONSISTS OF THE LETTER "X" INSIDE BRACKETS, TO THE RIGHT OF THE LETTER "I". THE LETTERS "GA" ARE DEPICTED ON A THREE-SIDED RECTANGLE ON THE LOWER RIGHT CORNER OF THE BRACKETS.

CLASS 16—PAPER GOODS AND PRINTED MATTER

FOR PRINT MAGAZINE FEATURING FINANCIAL AND BANKING INFORMATION (U.S. CLS. 2, 5, 22, 23, 29, 37, 38 AND 50).

FIRST USE 3-31-2009; IN COMMERCE 4-30-2009.

CLASS 25—CLOTHING

FOR T-SHIRTS (U.S. CLS. 22 AND 39).

FIRST USE 3-31-2009; IN COMMERCE 9-30-2009.

CLASS 36—INSURANCE AND FINANCIAL

FOR CREDIT UNION SERVICES; PROVIDING INFORMATION TO TEENS AND YOUNG ADULTS ON THE SUBJECT OF PERSONAL FINANCES (U.S. CLS. 100, 101 AND 102).

FIRST USE 3-31-2009; IN COMMERCE 3-31-2009.

3,786,063. MEYER, KELLY, IRVING, TX. SN 77-738,898. PUB. 11-3-2009, FILED 5-17-2009.



THE MARK CONSISTS OF THE UPPERCASE WORD "STOP" IN A CALL OUT BOX ABOVE THE LOWERCASE WORDS "START LEARNING".

CLASS 16—PAPER GOODS AND PRINTED MATTER

FOR ART PRINTS (U.S. CLS. 2, 5, 22, 23, 29, 37, 38 AND 50).

FIRST USE 7-1-2008; IN COMMERCE 11-1-2008.

CLASS 41—EDUCATION AND ENTERTAINMENT

FOR YOGA INSTRUCTION; DANCE INSTRUCTION; PHYSICAL FITNESS INSTRUCTION; TRAINING SERVICES IN THE FIELD OF GROUP EXERCISE, TEAM BUILDING, AND HUMAN RESOURCES SKILLS, NAMELY, INTERVIEWING, PERFORMANCE MANAGEMENT, COACHING, SUPERVISION, AND LEADERSHIP; DEVELOPMENT AND DISSEMINATION OF EDUCATIONAL MATERIALS FOR OTHERS IN THE FIELD OF FITNESS AND EXERCISE, TEAM BUILDING, AND HUMAN RESOURCES SKILLS (U.S. CLS. 100, 101 AND 107).

FIRST USE 12-1-2009; IN COMMERCE 12-1-2009.

3,786,064. INVENTIVE CONCEPTS INTERNATIONAL, DBA INVENTIVE CONCEPTS INTERNATIONAL, ELK GROOVE VILLAGE, IL. SN 77-739,807. PUB. 10-6-2009, FILED 5-18-2009.

iSafe Backpacks & Bags

THE MARK CONSISTS OF STANDARD CHARACTERS WITHOUT CLAIM TO ANY PARTICULAR FONT, STYLE, SIZE, OR COLOR.

NO CLAIM IS MADE TO THE EXCLUSIVE RIGHT TO USE "BACKPACKS & BAGS", APART FROM THE MARK AS SHOWN.

CLASS 9—ELECTRICAL AND SCIENTIFIC APPARATUS

FOR BACKPACKS ESPECIALLY ADAPTED FOR HOLDING LAPTOPS; BACKPACKS ESPECIALLY ADAPTED FOR HOLDING LAPTOPS AND NOTEBOOK COMPUTERS; BAGS AND CASES ESPECIALLY ADAPTED FOR HOLDING OR CARRYING PORTABLE TELEPHONES AND TELEPHONE EQUIPMENT AND ACCESSORIES; MESSENGER BAGS ESPECIALLY ADAPTED FOR HOLDING LAPTOPS; WHEELED BACKPACKS ESPECIALLY ADAPTED FOR HOLDING LAPTOPS; WHEELED MESSENGER BAGS ESPECIALLY ADAPTED FOR HOLDING LAPTOPS (U.S. CLS. 21, 23, 26, 36 AND 38).

FIRST USE 1-4-2010; IN COMMERCE 1-4-2010.

CLASS 18—LEATHER GOODS

FOR ALL PURPOSE SPORT BAGS; ALL-PURPOSE ATHLETIC BAGS; ALL-PURPOSE CARRYING BAGS; ATHLETIC BAGS; BABY BACKPACKS; BABY CARRYING BAGS; BACKPACKS; BACKPACKS, BOOK BAGS, SPORTS BAGS, BUM BAGS, WALLETS AND HANDBAGS; BAGS FOR SPORTS; BELT BAGS; BELT BAGS AND HIP BAGS; BOOK BAGS; CLUTCH BAGS; CLUTCH PURSES; CLUTCHES; COIN PURSES; DRAWSTRING BAGS; DUFFEL BAGS FOR TRAVEL; DUFFLE BAGS; HANDBAGS, PURSES AND WALLETS; HIKING BAGS; LEATHER AND IMITATION LEATHER BAGS; LEATHER BAGS AND WALLETS; LEATHER BAGS, SUITCASES AND WALLETS; LEATHER PURSES; MEN'S CLUTCH BAGS; MESSENGER BAGS; MULTI-PURPOSE PURSES; PURSES; PURSES AND WALLETS; PURSES OF PRECIOUS METAL; PURSES, NOT OF PRECIOUS METAL; SCHOOL BAGS; SCHOOL BOOK BAGS; SCHOOL-CHILDREN'S BACKPACKS; SHOULDER BAGS; SLING BAGS; SMALL BACKPACKS; SMALL BAGS FOR MEN; SMALL CLUTCH PURSES; SMALL PURSES; SPORT BAGS; TRAVEL BAGS; TRAVELING BAGS; WAIST BAGS; WHEELED BAGS (U.S. CLS. 1, 2, 3, 22 AND 41).

FIRST USE 1-4-2010; IN COMMERCE 1-4-2010.

3,786,066. STEVENS, JODY, NASHVILLE, TN. AND HARRISON, JAMES, NASHVILLE, TN. SN 77-740,728. PUB. 9-29-2009, FILED 5-19-2009.

3,786,078. KIRUSA INC, NEW PROVIDENCE, NJ. SN 77-747,184. PUB. 10-13-2009, FILED 5-29-2009.

FAST RYDE

THE MARK CONSISTS OF STANDARD CHARACTERS WITHOUT CLAIM TO ANY PARTICULAR FONT, STYLE, SIZE, OR COLOR.

CLASS 9—ELECTRICAL AND SCIENTIFIC APPARATUS

FOR MUSICAL SOUND RECORDINGS; MUSICAL VIDEO RECORDINGS (U.S. CLS. 21, 23, 26, 36 AND 38). FIRST USE 7-1-2009; IN COMMERCE 7-1-2009.

CLASS 25—CLOTHING

FOR SHIRTS (U.S. CLS. 22 AND 39). FIRST USE 10-22-2009; IN COMMERCE 10-22-2009.

CLASS 41—EDUCATION AND ENTERTAINMENT

FOR ENTERTAINMENT, NAMELY, LIVE PERFORMANCES BY A MUSICAL BAND; PRODUCTION OF SOUND AND MUSIC VIDEO RECORDINGS (U.S. CLS. 100, 101 AND 107). FIRST USE 5-16-2009; IN COMMERCE 5-16-2009.

3,786,076. ELEVEN55 DESIGNS, LLC, TA WAGS AND TAGS, LAFAYETTE HILL, PA. SN 77-745,302. PUB. 10-6-2009, FILED 5-27-2009.

WAGS & TAGS

THE MARK CONSISTS OF THE WORD "WAGS", A STYLIZED AMPERSAND AND THE WORD "TAGS".

CLASS 6—METAL GOODS

FOR METAL PET TAGS (U.S. CLS. 2, 12, 13, 14, 23, 25 AND 50). FIRST USE 6-15-2009; IN COMMERCE 12-18-2009.

CLASS 14—JEWELRY

FOR PET JEWELRY (U.S. CLS. 2, 27, 28 AND 50). FIRST USE 6-15-2009; IN COMMERCE 12-18-2009.

KIRUSA DIRECT LISTEN

THE MARK CONSISTS OF STANDARD CHARACTERS WITHOUT CLAIM TO ANY PARTICULAR FONT, STYLE, SIZE, OR COLOR.

NO CLAIM IS MADE TO THE EXCLUSIVE RIGHT TO USE "DIRECT LISTEN", APART FROM THE MARK AS SHOWN.

CLASS 38—COMMUNICATION

FOR COMMUNICATION BY MOBILE TELEPHONE; COMMUNICATIONS BY MEANS OF MOBILE PHONES; COMMUNICATIONS BY MOBILE PHONES; COMMUNICATIONS VIA MULTINATIONAL TELECOMMUNICATION NETWORKS; DATA TRANSMISSION AND RECEPTION SERVICES VIA TELECOMMUNICATION MEANS; MOBILE TELEPHONE COMMUNICATION; TELECOMMUNICATIONS SERVICES, NAMELY, PERSONAL COMMUNICATION SERVICES; TRANSFER OF DATA BY TELECOMMUNICATION; TRANSFER OF DATA BY TELECOMMUNICATIONS; WIRELESS TELEPHONE TELECOMMUNICATIONS SERVICES, NAMELY, WIRELESS MOBILE TELEPHONE CALLING PLANS (U.S. CLS. 100, 101 AND 104). FIRST USE 3-15-2007; IN COMMERCE 3-15-2007.

CLASS 42—SCIENTIFIC AND COMPUTER SERVICES

FOR APPLICATION SERVICE PROVIDER, NAMELY, PROVIDING, HOSTING, MANAGING, DEVELOPING, AND MAINTAINING APPLICATIONS, SOFTWARE, WEB SITES, AND DATABASES IN THE FIELDS OF PERSONAL PRODUCTIVITY, WIRELESS COMMUNICATION, MOBILE INFORMATION ACCESS, AND REMOTE DATA MANAGEMENT FOR WIRELESS DELIVERY OF CONTENT TO HANDHELD COMPUTERS, LAPTOPS AND MOBILE ELECTRONIC DEVICES (U.S. CLS. 100 AND 101). FIRST USE 3-15-2007; IN COMMERCE 3-15-2007.

3,786,079. KIRUSA INC, NEW PROVIDENCE, NJ. SN 77-747,187. PUB. 10-13-2009, FILED 5-29-2009.

KIRUSA SPEED CODES

THE MARK CONSISTS OF STANDARD CHARACTERS WITHOUT CLAIM TO ANY PARTICULAR FONT, STYLE, SIZE, OR COLOR.

NO CLAIM IS MADE TO THE EXCLUSIVE RIGHT TO USE "SPEED CODES", APART FROM THE MARK AS SHOWN.

CLASS 38—COMMUNICATION

FOR COMMUNICATION BY MOBILE TELEPHONE; COMMUNICATIONS BY MEANS OF MOBILE PHONES; COMMUNICATIONS BY MOBILE PHONES; COMMUNICATIONS VIA MULTINATIONAL TELECOMMUNICATION NETWORKS; DATA TRANSMISSION AND RECEPTION SERVICES VIA TELECOMMUNICATION MEANS; MOBILE TELEPHONE COMMUNICATION; TELECOMMUNICATIONS SERVICES, NAMELY, PERSONAL COMMUNICATION SERVICES; TRANSFER OF DATA BY TELECOMMUNICATION; TRANSFER OF DATA BY TELECOMMUNICATIONS; WIRELESS TELEPHONE TELECOMMUNICATIONS SERVICES, NAMELY, WIRELESS MOBILE TELEPHONE CALLING PLANS (U.S. CLS. 100, 101 AND 104).

FIRST USE 3-15-2007; IN COMMERCE 3-15-2007.

CLASS 42—SCIENTIFIC AND COMPUTER SERVICES

FOR APPLICATION SERVICE PROVIDER, NAMELY, PROVIDING, HOSTING, MANAGING, DEVELOPING, AND MAINTAINING APPLICATIONS, SOFTWARE, WEB SITES, AND DATABASES IN THE FIELDS OF PERSONAL PRODUCTIVITY, WIRELESS COMMUNICATION, MOBILE INFORMATION ACCESS, AND REMOTE DATA MANAGEMENT FOR WIRELESS DELIVERY OF CONTENT TO HANDHELD COMPUTERS, LAPTOPS AND MOBILE ELECTRONIC DEVICES (U.S. CLS. 100 AND 101).

FIRST USE 3-15-2007; IN COMMERCE 3-15-2007.

3,786,116. VAN HORN, MARY JO, BISMARCK, ND. AND BLUMHAGEN, TAMMY, BISMARCK, ND. SN 77-759,484. PUB. 11-3-2009, FILED 6-15-2009.

BLUHORN

THE MARK CONSISTS OF STANDARD CHARACTERS WITHOUT CLAIM TO ANY PARTICULAR FONT, STYLE, SIZE, OR COLOR.

CLASS 9—ELECTRICAL AND SCIENTIFIC APPARATUS

FOR ON-LINE DOWNLOADABLE SOFTWARE FOR USE WITH A GLOBAL COMPUTER NETWORK WHICH PROVIDES THE FUNCTIONALITY OF AN ADVERTISING NETWORK, NAMELY, SOFTWARE THAT AUTOMATES THE BUYING, SELLING, PLANNING, ANALYSIS AND REPORTING OF ADVERTISING (U.S. CLS. 21, 23, 26, 36 AND 38).

FIRST USE 1-14-2010; IN COMMERCE 1-14-2010.

CLASS 42—SCIENTIFIC AND COMPUTER SERVICES

FOR APPLICATION SERVICE PROVIDER, NAMELY, HOSTING ON-LINE COMPUTER SOFTWARE FOR USE WITH A GLOBAL COMPUTER NETWORK WHICH PROVIDES THE FUNCTIONALITY OF AN ADVERTISING NETWORK, NAMELY, SOFTWARE THAT AUTOMATES THE BUYING, SELLING, PLANNING, ANALYSIS AND REPORTING OF ADVERTISING (U.S. CLS. 100 AND 101).

FIRST USE 1-14-2010; IN COMMERCE 1-14-2010.

3,786,117. VAN HORN, MARY JO, BISMARCK, ND. AND BLUMHAGEN, TAMMY, BISMARCK, ND. SN 77-759,490. PUB. 11-3-2009, FILED 6-15-2009.

BLUHORN SOLUTIONS

THE MARK CONSISTS OF STANDARD CHARACTERS WITHOUT CLAIM TO ANY PARTICULAR FONT, STYLE, SIZE, OR COLOR.

CLASS 9—ELECTRICAL AND SCIENTIFIC APPARATUS

FOR ON-LINE DOWNLOADABLE SOFTWARE FOR USE WITH A GLOBAL COMPUTER NETWORK WHICH PROVIDES THE FUNCTIONALITY OF AN ADVERTISING NETWORK, NAMELY, SOFTWARE THAT AUTOMATES THE BUYING, SELLING, PLANNING, ANALYSIS AND REPORTING OF ADVERTISING (U.S. CLS. 21, 23, 26, 36 AND 38).

FIRST USE 1-14-2010; IN COMMERCE 1-14-2010.

CLASS 42—SCIENTIFIC AND COMPUTER SERVICES

FOR APPLICATION SERVICE PROVIDER, NAMELY, HOSTING ON-LINE COMPUTER SOFTWARE FOR USE WITH A GLOBAL COMPUTER NETWORK WHICH PROVIDES THE FUNCTIONALITY OF AN ADVERTISING NETWORK, NAMELY, SOFTWARE THAT AUTOMATES THE BUYING, SELLING, PLANNING, ANALYSIS AND REPORTING OF ADVERTISING (U.S. CLS. 100 AND 101).

FIRST USE 1-14-2010; IN COMMERCE 1-14-2010.

3,786,120. SLIMGENICS, LLC, CENTENNIAL, CO. SN 77-759,994. PUB. 11-3-2009, FILED 6-15-2009.

SLIMGENICS

THE MARK CONSISTS OF STANDARD CHARACTERS WITHOUT CLAIM TO ANY PARTICULAR FONT, STYLE, SIZE, OR COLOR.

CLASS 5—PHARMACEUTICALS

FOR DIETARY, NUTRITIONAL, MINERAL, VITAMIN, PROTEIN, AND HERBAL SUPPLEMENTS; DIETARY BEVERAGE SUPPLEMENTS FOR HUMAN CONSUMPTION IN DRY MIX FORM; DIET PILLS; VITAMIN PREPARATIONS; NUTRITIONAL SUPPLEMENT IN THE NATURE OF A NUTRIENT-DENSE, PROTEIN-BASED DRINK MIX; VITAMIN FORTIFIED BEVERAGES IN DRY MIX FORM; NUTRITIONAL MEAL REPLACEMENT SNACKS, DRINKS, SHAKES, CEREALS, POWDERS AND BARS (U.S. CLS. 6, 18, 44, 46, 51 AND 52).

FIRST USE 9-28-2009; IN COMMERCE 9-28-2009.

CLASS 16—PAPER GOODS AND PRINTED MATTER

FOR COOKBOOKS; PRINTED NUTRITIONAL GUIDES AND WORKBOOKS IN THE FIELDS OF WEIGHT CONTROL, NUTRITION, FITNESS AND MENU PLANNING (U.S. CLS. 2, 5, 22, 23, 29, 37, 38 AND 50).

FIRST USE 9-28-2009; IN COMMERCE 9-28-2009.

CLASS 35—ADVERTISING AND BUSINESS

FOR RETAIL STORE SERVICES, ON-LINE RETAIL STORE SERVICES AND MAIL ORDER SERVICES FEATURING PRINTED PUBLICATIONS, FOODS, BEVERAGES, SUPPLEMENTS AND VITAMINS IN THE FIELDS OF WEIGHT CONTROL, NUTRITION AND FITNESS (U.S. CLS. 100, 101 AND 102).

FIRST USE 9-28-2009; IN COMMERCE 9-28-2009.

CLASS 44—MEDICAL, BEAUTY AND AGRICULTURAL SERVICES

FOR WEIGHT REDUCTION AND DIET PLANNING, SUPERVISION AND COUNSELING; NUTRITION COUNSELING AND GUIDANCE; PROVIDING INFORMATION ABOUT DIETARY SUPPLEMENTS AND NUTRITION; PROVIDING INFORMATION ON MAINTAINING A HEALTHY LIFESTYLE AND LOSING WEIGHT (U.S. CLS. 100 AND 101).

FIRST USE 9-28-2009; IN COMMERCE 9-28-2009.

3,786,152. SIX STAR, INC., WINTER PARK, FL. SN 77-778,171. PUB. 10-20-2009, FILED 7-10-2009.

Buy Smart, Be Happy

THE MARK CONSISTS OF STANDARD CHARACTERS WITHOUT CLAIM TO ANY PARTICULAR FONT, STYLE, SIZE, OR COLOR.

CLASS 12—VEHICLES

FOR AUTOMOBILES (U.S. CLS. 19, 21, 23, 31, 35 AND 44).

FIRST USE 9-25-2009; IN COMMERCE 9-25-2009.

CLASS 35—ADVERTISING AND BUSINESS

FOR ADVERTISING AGENCIES, NAMELY, PROMOTING THE SERVICES OF AUTOMOBILES THROUGH THE DISTRIBUTION OF PRINTED AND AUDIO PROMOTIONAL MATERIALS AND BY RENDERING SALES PROMOTION ADVICE; ARRANGING AND CONDUCTING TRADE SHOW EXHIBITIONS IN THE FIELD OF AUTOMOBILES; AUTOMOBILE DEALERSHIPS; MARKETING AND ADVERTISING SERVICES FOR AUTOMOBILE DEALERSHIPS; PROVIDING INFORMATION ABOUT AUTOMOBILES FOR SALE BY MEANS OF THE INTERNET (U.S. CLS. 100, 101 AND 102).

FIRST USE 9-25-2009; IN COMMERCE 9-25-2009.

CLASS 39—TRANSPORTATION AND STORAGE

FOR LEASING OF AUTOMOBILES; PROVIDING INFORMATION ABOUT AUTOMOBILES FOR LEASE BY MEAN OF THE INTERNET (U.S. CLS. 100 AND 105).

FIRST USE 9-25-2009; IN COMMERCE 9-25-2009.

3,786,162. SRI INTERNATIONAL, INC., MENLO PARK, CA. SN 77-978,041. PUB. 12-30-2008, FILED 7-7-2008.

Kick

THE MARK CONSISTS OF STANDARD CHARACTERS WITHOUT CLAIM TO ANY PARTICULAR FONT, STYLE, SIZE, OR COLOR.

CLASS 35—ADVERTISING AND BUSINESS

FOR PROVIDING ONLINE BUSINESS INFORMATION THAT IS SYNCHRONIZED WITH A VIDEO (U.S. CLS. 100, 101 AND 102).

FIRST USE 11-25-2009; IN COMMERCE 11-25-2009.

CLASS 36—INSURANCE AND FINANCIAL

FOR FINANCIAL SERVICES, NAMELY, PROVIDING ONLINE FINANCIAL INFORMATION THAT IS SYNCHRONIZED WITH A VIDEO (U.S. CLS. 100, 101 AND 102).

FIRST USE 11-25-2009; IN COMMERCE 11-25-2009.

CLASS 41—EDUCATION AND ENTERTAINMENT

FOR PROVIDING ONLINE INFORMATION THAT IS SYNCHRONIZED WITH A VIDEO ON A WEBSITE FEATURING CURRENT EVENTS, SPORTING, EDUCATIONAL, CULTURAL AND ENTERTAINMENT CONTENT (U.S. CLS. 100, 101 AND 107).

FIRST USE 11-25-2009; IN COMMERCE 11-25-2009.

3,786,163. KANTOR, KAREN, PORTLAND, OR. AND DORN, MARGARET, NEW YORK, NY. SN 77-978,261. PUB. 4-1-2008, FILED 5-7-2007.

Women of a Certain Age

THE MARK CONSISTS OF STANDARD CHARACTERS WITHOUT CLAIM TO ANY PARTICULAR FONT, STYLE, SIZE, OR COLOR.

OWNER OF U.S. REG. NO. 3,269,428.

CLASS 9—ELECTRICAL AND SCIENTIFIC APPARATUS

FOR DIGITAL MATERIALS, NAMELY, CDS, MP3S, FEATURING MUSIC; DIGITAL MEDIA, NAMELY, CDS, MP3S, FEATURING MUSIC, TELEVISION, MOTION PICTURES, SPOKEN WORD OR STAGE PERFORMANCES BY OLDER WOMEN; DOWNLOADABLE MP3 FILES, MP3 RECORDINGS; DOWNLOADABLE MUSIC VIA A GLOBAL COMPUTER NETWORK AND WIRELESS DEVICES; DOWNLOADABLE VIDEO RECORDINGS FEATURING PERFORMANCES BY OLDER WOMEN; DOWNLOADABLE MUSIC VIA THE INTERNET AND WIRELESS DEVICES; PRE-RECORDED CDS, FEATURING MUSIC, TELEVISION, MOTION PICTURES, SPOKEN WORD OR STAGE PERFORMANCES BY OLDER WOMEN; PRE-RECORDED ELECTRONIC MEDIA FEATURING MUSIC, TELEVISION, MOTION PICTURES, SPOKEN WORD OR STAGE PERFORMANCES BY OLDER WOMEN; AUDIO DISCS FEATURING MUSIC BY OLDER WOMEN; COMPACT DISCS FEATURING MUSIC BY OLDER WOMEN; MUSICAL VIDEO RECORDINGS; VIDEO RECORDINGS FEATURING PERFORMANCES BY OLDER WOMEN; SOUND RECORDINGS FEATURING MUSIC BY OLDER WOMEN; AUDIO RECORDINGS FEATURING MUSIC BY OLDER WOMEN (U.S. CLS. 21, 23, 26, 36 AND 38).
FIRST USE 8-15-2006; IN COMMERCE 8-15-2006.

CLASS 41—EDUCATION AND ENTERTAINMENT

FOR ENTERTAINMENT IN THE NATURE OF VISUAL AND AUDIO PERFORMANCES, AND MUSICAL SHOWS; ENTERTAINMENT IN THE NATURE OF VISUAL AND AUDIO PERFORMANCES, NAMELY, MUSICAL BAND, ROCK GROUP PERFORMANCES; ENTERTAINMENT, NAMELY, LIVE PERFORMANCES BY A MUSICAL BAND; ENTERTAINMENT SERVICES, NAMELY, PROVIDING A WEB SITE FEATURING MUSICAL PERFORMANCES, MUSICAL VIDEOS, RELATED FILM CLIPS, PHOTOGRAPHS, AND OTHER MULTIMEDIA MATERIALS; PRESENTATION OF LIVE SHOW PERFORMANCES; PRESENTATION OF MUSICAL PERFORMANCE; ENTERTAINMENT SERVICES, NAMELY, PROVIDING A WEBSITE FEATURING, PHOTOGRAPHIC, AUDIO, VIDEO PRESENTATIONS FEATURING OLDER WOMEN ARTISTS, ACTORS, COMEDIANS, WRITERS OR MUSICIANS; ENTERTAINMENT IN THE NATURE OF MUSICAL GROUP LIVE PERFORMANCES, THEATRE GROUP LIVE PERFORMANCES; ENTERTAINMENT, NAMELY, PRODUCTION OF MUSIC RECORDINGS, MUSIC VIDEOS, MUSICALS, CONCERTS; ENTERTAINMENT, NAMELY, LIVE MUSIC CONCERTS; COMPOSITION OF MUSIC FOR OTHERS; PRODUCTION OF SOUND AND MUSIC VIDEO RECORDINGS (U.S. CLS. 100, 101 AND 107).
FIRST USE 8-15-2006; IN COMMERCE 8-15-2006.

3,786,168. BOEHRINGER INGELHEIM VETMEDICA, INC., ST. JOSEPH, MO. SN 77-978,796. PUB. 4-8-2008, FILED 5-7-2007.

THE FLEXIBLE SOLUTION

THE MARK CONSISTS OF STANDARD CHARACTERS WITHOUT CLAIM TO ANY PARTICULAR FONT, STYLE, SIZE, OR COLOR.

NO CLAIM IS MADE TO THE EXCLUSIVE RIGHT TO USE "SOLUTION", APART FROM THE MARK AS SHOWN.

CLASS 16—PAPER GOODS AND PRINTED MATTER

FOR PRINTED PUBLICATIONS, NAMELY, PAMPHLETS, BROCHURES, FACT SHEETS, CHECK LISTS, PACKAGE INSERTS, AND INSTRUCTION SHEETS, FEATURING MEDICAL INFORMATION CONCERNING MEDICAL CONDITIONS AND PHARMACEUTICALS FOR DOMESTIC ANIMALS (U.S. CLS. 2, 5, 22, 23, 29, 37, 38 AND 50).
FIRST USE 11-30-2005; IN COMMERCE 12-1-2005.

CLASS 35—ADVERTISING AND BUSINESS

FOR ADVERTISING IN THE FIELD OF MEDICAL CONDITIONS AND PHARMACEUTICALS FOR DOMESTIC ANIMALS THROUGH PRINTED PUBLICATIONS, NAMELY, PAMPHLETS, BROCHURES, FACT SHEETS, CHECK LISTS, PACKAGE INSERTS, AND INSTRUCTION SHEETS, AND THROUGH ELECTRONIC COMMUNICATIONS NETWORKS, NAMELY, THE INTERNET (U.S. CLS. 100, 101 AND 102).
FIRST USE 12-0-2008; IN COMMERCE 12-0-2008.

CLASS 44—MEDICAL, BEAUTY AND AGRICULTURAL SERVICES

FOR PROVIDING INFORMATION IN THE FIELD OF VETERINARY MEDICINE (U.S. CLS. 100 AND 101).
FIRST USE 12-0-2008; IN COMMERCE 12-0-2008.

3,786,171. BORN FREE NOW, LP, BROOKLYN, NY. SN 77-978,839. PUB. 2-10-2009, FILED 3-7-2008.



THE MARK CONSISTS OF A SIX POINTED STAR, VERTICAL AND HORIZONTAL LINES, A HEART SHAPE, AND AN EQUILATERAL TRIANGLE.

CLASS 16—PAPER GOODS AND PRINTED MATTER

FOR DECALS; PAMPHLETS IN THE FIELD OF SPIRITUALITY; PRINTED TEACHING MATERIAL REGARDING SPIRITUALITY AND PERSONAL GROWTH; NEWSLETTERS REGARDING SPIRITUALITY AND PERSONAL GROWTH (U.S. CLS. 2, 5, 22, 23, 29, 37, 38 AND 50).
FIRST USE 7-25-2005; IN COMMERCE 7-25-2005.

CLASS 25—CLOTHING

FOR CLOTHING, NAMELY, HATS, T-SHIRTS, SWEATSHIRTS, SWEATPANTS, JACKETS (U.S. CLS. 22 AND 39).
FIRST USE 2-0-2008; IN COMMERCE 2-0-2008.

3,786,173. LIVIBRANCE CENTER, LLC, ST. PETERSBURG, FL. SN 77-978,931. PUB. 4-28-2009, FILED 6-11-2008.

3,786,175. KATAI, NOELLE C., ENCINITAS, CA. SN 77-978,943. PUB. 4-21-2009, FILED 7-2-2008.



THE MARK CONSISTS OF A MUSIC NOTE WITHIN A FANCIFUL DESIGN.

CLASS 16—PAPER GOODS AND PRINTED MATTER

FOR PRINTED MATTER, NAMELY, BOOKS, WORKBOOKS, MANUALS, BROCHURES AND PUBLICATIONS, NAMELY, JOURNALS, NEWSLETTERS AND MAGAZINES IN THE FIELD OF PSYCHOLOGY, HEALTH, MENTAL HEALTH, PERSONAL DEVELOPMENT AND EXPRESSION, LIFESTYLE AND STRESS MANAGEMENT, GOAL SETTING AND ACHIEVEMENT, SELF-MOTIVATION, SELF-IMPROVEMENT, SELF-ASSERTIVENESS, AND SELF-HELP, INTERPERSONAL RELATIONSHIPS, CREATIVITY AND MUSIC (U.S. CLS. 2, 5, 22, 23, 29, 37, 38 AND 50).

FIRST USE 9-30-2008; IN COMMERCE 9-30-2008.

CLASS 41—EDUCATION AND ENTERTAINMENT

FOR EDUCATIONAL SERVICES, NAMELY, CONFERENCES, SEMINARS, LECTURES, DISCUSSION GROUPS, WORKSHOPS, TRAINING SESSIONS AND ONE ON ONE MENTORING IN FIELD OF PSYCHOLOGY, HEALTH, MENTAL HEALTH, PERSONAL DEVELOPMENT AND EXPRESSION, LIFESTYLE AND STRESS MANAGEMENT, GOAL SETTING AND ACHIEVEMENT, SELF-MOTIVATION, SELF-IMPROVEMENT, SELF-ASSERTIVENESS, AND SELF-HELP, INTERPERSONAL RELATIONSHIPS, CREATIVITY AND MUSIC AND THE DISTRIBUTION OF WRITTEN RESOURCES, MANUALS, AND BOOKS IN CONNECTION THEREWITH (U.S. CLS. 100, 101 AND 107).

FIRST USE 9-30-2008; IN COMMERCE 9-30-2008.

CLASS 44—MEDICAL, BEAUTY AND AGRICULTURAL SERVICES

FOR CONSULTATION SERVICES IN THE FIELD OF PSYCHOLOGY, HEALTH, MENTAL HEALTH, LIFESTYLE, STRESS MANAGEMENT (U.S. CLS. 100 AND 101).

FIRST USE 9-30-2008; IN COMMERCE 9-30-2008.

CLASS 45—PERSONAL AND LEGAL SERVICES

FOR CONSULTATION SERVICES IN THE FIELD OF PERSONAL DEVELOPMENT AND EXPRESSION, GOAL SETTING AND ACHIEVEMENT, MOTIVATION, SELF-IMPROVEMENT, ASSERTIVENESS, AND SELF-HELP AND INTERPERSONAL RELATIONSHIPS (U.S. CLS. 100 AND 101).

FIRST USE 9-30-2008; IN COMMERCE 9-30-2008.



OWNER OF U.S. REG. NO. 3,397,691.
THE MARK CONSISTS OF STYLIZED DESIGNED VERSION OF THE WORD "VIM".

CLASS 3—COSMETICS AND CLEANING PREPARATIONS

FOR AROMATHERAPY CREAMS; AROMATHERAPY LOTIONS; AROMATHERAPY OILS; ESSENTIAL OILS; NATURAL ESSENTIAL OILS; BATH OILS; BODY OILS; COSMETIC OILS FOR THE EPIDERMIS; ESSENTIAL OILS FOR PERSONAL USE; SCENTED AND NON-SCENTED AROMATHERAPY SPRAYS; SCENTED BODY SPRAYS, AROMATHERAPY OILS AND ESSENTIAL OILS FOR USE AS FOOD AND BEVERAGE FLAVORINGS, NUTRITIONAL OILS FOR COSMETIC PURPOSES; SKIN AND BODY TOPICAL LOTIONS, CREAMS AND OILS FOR COSMETIC USE; NON-MEDICATED SKIN CARE PREPARATIONS; SKIN CLEANSERS; SKIN CREAMS; SKIN EMOLLIENTS; SKIN LOTIONS; NON-MEDICATED TOILETRIES, NON-MEDICATED AROMATHERAPY AND ESSENTIAL OILS-BASED SPORT AND MUSCLE CARE RUBS, LOTIONS, OILS, AND CREAMS; FRAGRANCE AND COSMETIC PRODUCTS USING AROMATHERAPY AND OR ESSENTIAL OILS, NAMELY, FACE CREAM; BODY CREAM; NON-MEDICATED ANTI-WRINKLE CREAM; NON-MEDICATED SKIN RENEWAL CREAM; EYE CREAM; BODY LOTION; BODY OIL; NON-MEDICATED LIP BALM; SKIN BALANCING LOTION; OIL CONTROL SKIN LOTION; SKIN FIRING PREPARATION; NON-MEDICATED SKIN BLEMISH PREPARATION; FACIAL TONER; BODY TONER PREPARATIONS; FACIAL CLEANSER; BODY CLEANSER PREPARATION; FACIAL EXFOLIATING PREPARATION; BODY AND HAIR SHAMPOO AND CONDITIONER-IN-ONE; EYE MAKEUP REMOVER; FACIAL MAKEUP REMOVER; FACIAL MASKS; BODY MASQUE; SKIN REFRESHING LOTION, CREAM AND GEL; HAIR SHAMPOO; HAIR CONDITIONER; HAIR SPRAY; HAIR MOUSSE; HAIR GEL; HAIR HUMECTANT; NON-MEDICATED SKIN REVITALIZING CREAM; BODY SUNSCREEN; FACIAL SUNSCREEN; NON-MEDICATED LIP SUNCARE PREPARATION; SELF-TANNING CREAMS; AFTER SUN SOOTHING MOISTURIZING LOTIONS, CREAMS AND GELS; FOUNDATION MAKEUP; LIPSTICK; LIP GLOSS; EYELINER; EYESHADOW; MASCARA; SKINTONE CORRECTOR CREAM; FACE POWDER; BODY POWDER; SKIN BRONZER; SKIN CONCEALER; EYEBROW PENCILS; COSMETIC PENCILS; BLUSHER; NAIL ENAMEL; NAIL ENAMEL TOP COAT; NAIL ENAMEL BASE COAT; QUICK DRY TOP COAT FOR NAILS; NAIL CONDITIONERS; NAIL STRENGTHENERS; NAIL POLISH REMOVER; RIDGE FILLER FOR NAILS; CUTICLE MOISTURIZING CREAM; CUTICLE REMOVING PREPARATIONS; NAIL WHITENING PENCILS AND PREPARATIONS; EAU DE PERFUME; EAU DE TOILETTE; PERFUME; COLOGNE; FRAGRANCED BODY LOTION; FRAGRANCED BODY CREAM; BATH POWDER; BATH OIL; SKIN CLEANSING LOTION; SKIN CLEANSING GEL; FACIAL AND BODY OIL SPRAY; SOAP; SHAVING FOAM; PRE-SHAVE PREPARATIONS; AFTER SHAVE LOTIONS AND GELS; AFTER SHAVE BALM; ANTI-

PERSPIRANT/DEODORANT; POTPOURRI; MASSAGE OIL; ESSENTIAL OILS FOR PERSONAL USE (U.S. CLS. 1, 4, 6, 50, 51 AND 52).

FIRST USE 8-0-2006; IN COMMERCE 9-0-2006.

CLASS 4—LUBRICANTS AND FUELS

FOR AROMATHERAPY CANDLES; PERFUMED ESSENTIAL OIL CANDLES; PERFUMED AROMATHERAPY CANDLES; SCENTED AROMATHERAPY CANDLES (U.S. CLS. 1, 6 AND 15).

FIRST USE 8-0-2006; IN COMMERCE 8-0-2006.

CLASS 5—PHARMACEUTICALS

FOR AIR FRESHENERS CONTAINING AROMATHERAPY AND ESSENTIAL OILS (U.S. CLS. 6, 18, 44, 46, 51 AND 52).

FIRST USE 8-0-2006; IN COMMERCE 8-0-2006.

CLASS 11—ENVIRONMENTAL CONTROL APPARATUS

FOR DIFFUSERS FOR AND USING AROMATHERAPY AND ESSENTIAL OILS, NAMELY, REED DIFFUSERS, CAR DIFFUSERS, PLUG IN NEBULIZING DIFFUSERS, TEA LIGHT DIFFUSERS, LIGHT DIFFUSERS, ELECTRIC AND NON-ELECTRIC DIFFUSERS (U.S. CLS. 13, 21, 23, 31 AND 34).

FIRST USE 8-0-2006; IN COMMERCE 8-0-2006.

3,786,177. CHRISTOPHER & BANKS COMPANY, PLYMOUTH, MN. SN 77-978,958. PUB. 5-5-2009, FILED 4-18-2008.



cj banks

OWNER OF U.S. REG. NO. 2,466,691.

THE NAME "CJ BANKS" DOES NOT IDENTIFY A LIVING INDIVIDUAL.

THE MARK CONSISTS OF THE LETTERS "CJ", ENCLOSED WITHIN A SOLID CIRCLE, ALL OVER THE NAME "CJ BANKS".

CLASS 14—JEWELRY

FOR JEWELRY, NAMELY, NECKLACES, EARRINGS, AND BRACELETS (U.S. CLS. 2, 27, 28 AND 50).

FIRST USE 9-30-2008; IN COMMERCE 12-31-2008.

CLASS 25—CLOTHING

FOR WOMEN'S CLOTHING AND APPAREL, NAMELY, BOTTOMS, JEANS, PANTS, SKIRTS, CAPRIS, SHORTS, KNIT TOPS, BLOUSES, SHIRTS, DRESSES, CAMISOLES, SWEATERS, JACKETS; CLOTHING ACCESSORIES, NAMELY, SCARVES, FABRIC BELTS, BELTS MADE OF LEATHER (U.S. CLS. 22 AND 39).

FIRST USE 9-30-2008; IN COMMERCE 12-31-2008.

CLASS 35—ADVERTISING AND BUSINESS

FOR RETAIL STORE SERVICES, MAIL ORDER SERVICES, AND ON-LINE RETAIL STORE SERVICES FEATURING WOMEN'S CLOTHING AND JEWELRY (U.S. CLS. 100, 101 AND 102).

FIRST USE 9-30-2008; IN COMMERCE 12-31-2008.

3,786,178. GHOST RANCH SALOON, LLC, STEAMBOAT SPRINGS, CO. SN 77-978,967. PUB. 4-14-2009, FILED 12-8-2008.



NO CLAIM IS MADE TO THE EXCLUSIVE RIGHT TO USE "SALOON", APART FROM THE MARK AS SHOWN.

THE MARK CONSISTS OF CIRCULAR DRAWING OF RANCH HOUSE WITH HILLS AND A BUILDING BEHIND, A MOON DESIGN ABOVE AND A MAN IN A HAT STANDING IN ONE WINDOW. THE WORDS "GHOST RANCH SALOON" ARE ARRANGED IN A CIRCULAR FASHION AROUND THE DRAWING. THE WORDS "GHOST RANCH" AND "SALOON" ARE SEPARATED BY TWO STARS.

CLASS 41—EDUCATION AND ENTERTAINMENT

FOR RECORDING STUDIO; ARRANGING AND CONDUCTING CONCERTS AND SPECIAL EVENTS (U.S. CLS. 100, 101 AND 107).

FIRST USE 5-22-2009; IN COMMERCE 5-22-2009.

CLASS 43—HOTEL AND RESTAURANT SERVICES

FOR BAR AND RESTAURANT SERVICES (U.S. CLS. 100 AND 101).

FIRST USE 5-22-2009; IN COMMERCE 5-22-2009.

3,786,180. MOGREET, INC., VENICE, CA. SN 77-978,977. PUB. 4-14-2009, FILED 8-14-2007.

MOGREET

THE MARK CONSISTS OF STANDARD CHARACTERS WITHOUT CLAIM TO ANY PARTICULAR FONT, STYLE, SIZE, OR COLOR.

OWNER OF U.S. REG. NO. 3,499,541.

CLASS 35—ADVERTISING AND BUSINESS

FOR ADVERTISING AND ADVERTISEMENT, PROMOTION AND MARKETING SERVICES FOR BUSINESSES PROVIDING ELECTRONIC MEDIA AND INFORMATION OVER THE INTERNET, WIRELESS NETWORKS, WEBSITES ACCESSIBLE BY WAP DEVICES, AND COMPUTER COMMUNICATION NETWORKS; ADVERTISING SERVICES, NAMELY, PROVIDING ADVERTISING SPACE ON WEBSITES, WEBSITES ACCESSIBLE BY WAP DEVICES, VIDEO MESSAGES, ELECTRONIC GREETING CARDS, SHORT MESSAGES, MULTIMEDIA MESSAGES, VIDEOS AND INSTANT MESSAGES; DISSEMINATION OF ADVERTISING FOR OTHERS VIA THE INTERNET, WIRELESS NETWORKS, WEBSITES ACCESSIBLE BY WAP DEVICES, AND COMPUTER COMMUNICATION NETWORKS (U.S. CLS. 100, 101 AND 102).

FIRST USE 3-0-2009; IN COMMERCE 3-0-2009.

3,786,181. LIVIBRANCE CENTER, LLC, ST. PETERSBURG, FL. SN 77-978,982. PUB. 4-21-2009, FILED 6-11-2008.

LIVIBRANCE

CLASS 38—COMMUNICATION

FOR VIDEO MESSAGING SERVICES; MOBILE MEDIA AND ENTERTAINMENT SERVICES IN THE NATURE OF ELECTRONIC TRANSMISSION OF ENTERTAINMENT MEDIA CONTENT; WIRELESS COMMUNICATIONS SERVICES, NAMELY, WIRELESS ELECTRONIC TRANSMISSION OF AUDIO, VIDEO, AND AUDIO-VISUAL MATERIAL, ELECTRONIC GREETING CARDS, SHORT MESSAGES, MULTIMEDIA MESSAGES, PHONE NUMBERS, AND TEXT AND GRAPHICS TO WEBSITES, MOBILE PHONES, WAP PHONES, SMART PHONES, PDAS, HANDHELD COMPUTERS, LAPTOPS, MOBILE ELECTRONIC DEVICES, AND OTHER MOBILE ELECTRONIC HANDHELD DEVICES; STREAMING OF AUDIO AND VIDEO MATERIAL ON THE INTERNET AND TO WIRELESS NETWORKS, WEBSITES ACCESSIBLE BY WAP DEVICES, MOBILE PHONES, WAP PHONES, SMART PHONES, PDAS, HANDHELD COMPUTERS, LAPTOPS, MOBILE ELECTRONIC DEVICES, AND OTHER MOBILE ELECTRONIC HANDHELD DEVICES; DELIVERY OF ELECTRONIC GREETING CARDS TO OTHERS VIA WIRELESS NETWORKS, AND WAP NETWORKS PROVIDED VIA A GLOBAL COMPUTER NETWORK, WIRELESS PROTOCOL NETWORKS, PERSONAL AREA NETWORKS, DIGITAL NETWORKS, AND WIRELESS NETWORKS (U.S. CLS. 100, 101 AND 104).

FIRST USE 1-0-2008; IN COMMERCE 1-0-2008.

CLASS 42—SCIENTIFIC AND COMPUTER SERVICES

FOR APPLICATION SERVICE PROVIDER, NAMELY, PROVIDING, HOSTING, MANAGING, DEVELOPING, AND MAINTAINING APPLICATIONS, SOFTWARE, WEBSITES, AND DATABASES IN THE FIELDS OF WIRELESS COMMUNICATION AND MOBILE INFORMATION ACCESS FOR WIRELESS DELIVERY OF CONTENT TO WEBSITES, WIRELESS NETWORKS, WEBSITES ACCESSIBLE BY WAP DEVICES, MOBILE PHONES, WAP PHONES, SMART PHONES, PDAS, HANDHELD COMPUTERS, LAPTOPS, MOBILE ELECTRONIC DEVICES, AND OTHER MOBILE ELECTRONIC HANDHELD DEVICES; CREATING, DESIGNING, ENGINEERING AND DEVELOPMENT OF COMPUTER TELECOMMUNICATIONS HARDWARE AND SOFTWARE FOR THE STORAGE, FORWARDING, COLLECTION, EDITING, ORGANIZATION, MODIFICATION, SHARING, ROUTING AND SORTING OF MOBILE DATA, VIDEO MESSAGES, ELECTRONIC GREETING CARDS, SHORT MESSAGES, IMAGES, VIDEOS, PHONE NUMBERS AND MULTIMEDIA MESSAGES BETWEEN END USERS AND FROM SERVICE PROVIDERS TO END USERS (U.S. CLS. 100 AND 101).

FIRST USE 1-0-2008; IN COMMERCE 1-0-2008.

THE MARK CONSISTS OF STANDARD CHARACTERS WITHOUT CLAIM TO ANY PARTICULAR FONT, STYLE, SIZE, OR COLOR.

CLASS 16—PAPER GOODS AND PRINTED MATTER

FOR PRINTED MATTER, NAMELY, BOOKS, WORKBOOKS, MANUALS, BROCHURES AND PUBLICATIONS, NAMELY, JOURNALS, NEWSLETTERS AND MAGAZINES IN THE FIELD OF PSYCHOLOGY, HEALTH, MENTAL HEALTH, PERSONAL DEVELOPMENT AND EXPRESSION, LIFESTYLE AND STRESS MANAGEMENT, GOAL SETTING AND ACHIEVEMENT, SELF-MOTIVATION, SELF-IMPROVEMENT, SELF-ASSERTIVENESS, AND SELF-HELP, INTERPERSONAL RELATIONSHIPS, CREATIVITY AND MUSIC (U.S. CLS. 2, 5, 22, 23, 29, 37, 38 AND 50).

FIRST USE 9-30-2008; IN COMMERCE 9-30-2008.

CLASS 41—EDUCATION AND ENTERTAINMENT

FOR EDUCATIONAL SERVICES, NAMELY, CONFERENCES, SEMINARS, LECTURES, DISCUSSION GROUPS, WORKSHOPS, TRAINING SESSIONS AND ONE ON ONE MENTORING IN FIELD OF PSYCHOLOGY, HEALTH, MENTAL HEALTH, PERSONAL DEVELOPMENT AND EXPRESSION, LIFESTYLE AND STRESS MANAGEMENT, GOAL SETTING AND ACHIEVEMENT, SELF-MOTIVATION, SELF-IMPROVEMENT, SELF-ASSERTIVENESS, AND SELF-HELP, INTERPERSONAL RELATIONSHIPS, CREATIVITY AND MUSIC AND THE DISTRIBUTION OF WRITTEN RESOURCES, MANUALS, AND BOOKS IN CONNECTION THEREWITH (U.S. CLS. 100, 101 AND 107).

FIRST USE 9-30-2008; IN COMMERCE 9-30-2008.

CLASS 44—MEDICAL, BEAUTY AND AGRICULTURAL SERVICES

FOR CONSULTATION SERVICES IN THE FIELD OF PSYCHOLOGY, HEALTH, MENTAL HEALTH, LIFESTYLE, STRESS MANAGEMENT (U.S. CLS. 100 AND 101).

FIRST USE 9-30-2008; IN COMMERCE 9-30-2008.

CLASS 45—PERSONAL AND LEGAL SERVICES

FOR CONSULTATION SERVICES IN THE FIELD OF PERSONAL DEVELOPMENT AND EXPRESSION, GOAL SETTING AND ACHIEVEMENT, MOTIVATION, SELF-IMPROVEMENT, ASSERTIVENESS, AND SELF-HELP AND INTERPERSONAL RELATIONSHIPS (U.S. CLS. 100 AND 101).

FIRST USE 9-30-2008; IN COMMERCE 9-30-2008.

3,786,185. SOCIETE DES PRODUITS NESTLE S.A., 1800 VEVEY, SWITZERLAND. SN 77-978,992. PUB. 7-1-2008, FILED 11-14-2007.



OWNER OF U.S. REG. NO. 3,263,243.
THE COLOR(S) BLUE, YELLOW, GREEN IS/ARE CLAIMED AS A FEATURE OF THE MARK.
THE MARK CONSISTS OF A YELLOW SUN ABOVE GREEN FIELDS WITH BLUE SKY IN THE BACKGROUND, ALL ON A RIBBON.

CLASS 29—MEATS AND PROCESSED FOODS

FOR MILK; CREAM; LIQUID NON-DAIRY CREAMERS; POWDERED NON-DAIRY CREAMERS (U.S. CL. 46).
FIRST USE 6-30-2004; IN COMMERCE 6-30-2004.

CLASS 32—LIGHT BEVERAGES

FOR FRUIT-FLAVORED AND FRUIT-BASED DRINKS; FRUIT AND VEGETABLE JUICES (U.S. CLS. 45, 46 AND 48).
FIRST USE 6-30-2004; IN COMMERCE 6-30-2004.

3,786,187. CHRISTOPHER & BANKS COMPANY, PLYMOUTH, MN. SN 77-979,002. PUB. 4-28-2009, FILED 4-18-2008.

cj banks

THE MARK CONSISTS OF STANDARD CHARACTERS WITHOUT CLAIM TO ANY PARTICULAR FONT, STYLE, SIZE, OR COLOR.

OWNER OF U.S. REG. NO. 2,466,691.
THE NAME "CJ BANKS" DOES NOT IDENTIFY A LIVING INDIVIDUAL.

CLASS 14—JEWELRY

FOR JEWELRY, NAMELY, NECKLACES, EARRINGS, AND BRACELETS (U.S. CLS. 2, 27, 28 AND 50).
FIRST USE 9-30-2008; IN COMMERCE 12-31-2008.

CLASS 25—CLOTHING

FOR WOMEN'S CLOTHING AND APPAREL, NAMELY, BOTTOMS, JEANS, PANTS, SKIRTS, CAPRIS, SHORTS, KNIT TOPS, BLOUSES, SHIRTS, DRESSES, CAMISOLES, SWEATERS, JACKETS; CLOTHING ACCESSORIES, NAMELY, SCARVES (U.S. CLS. 22 AND 39).
FIRST USE 9-30-2008; IN COMMERCE 12-31-2008.

CLASS 35—ADVERTISING AND BUSINESS

FOR RETAIL STORE SERVICES AND ON-LINE RETAIL STORE SERVICES FEATURING WOMEN'S CLOTHING AND JEWELRY (U.S. CLS. 100, 101 AND 102).

FIRST USE 9-30-2008; IN COMMERCE 12-31-2008.

3,786,192. HULU, LLC, LOS ANGELES, CA. SN 77-979,043. PUB. 3-17-2009, FILED 3-11-2008.

SENSORY MARK

THE MARK IS A SOUND. THE MARK CONSISTS OF SUSTAINED C3/G3 WHOLE NOTES OVER WHICH IS PLAYED AN ASCENDING GLISSANDO IN THE KEY OF C MAJOR, STARTING WITH AN E4 TONE AND ENDING WITH A G6 TONE, FOLLOWED BY A C6 EIGHTH NOTE AND THEN C7/G7 EIGHTH NOTES PLAYED TOGETHER.

CLASS 38—COMMUNICATION

FOR BROADCASTING AND STREAMING OF AUDIO-VISUAL CONTENT IN THE FIELDS OF NEWS, ENTERTAINMENT, SPORTS, COMEDY, DRAMA, MUSIC, AND MUSIC VIDEOS VIA A GLOBAL COMPUTER NETWORK (U.S. CLS. 100, 101 AND 104).
FIRST USE 3-12-2008; IN COMMERCE 3-12-2008.

CLASS 41—EDUCATION AND ENTERTAINMENT

FOR EDUCATION AND ENTERTAINMENT SERVICES, NAMELY, ONLINE SERVICES PROVIDING AUDIO-VISUAL CONTENT IN THE FIELDS OF CURRENT EVENT REPORTING, ENTERTAINMENT, SPORTS, COMEDY, DRAMA, MUSIC, AND MUSIC VIDEOS; ELECTRONIC PUBLISHING SERVICES, NAMELY, PUBLICATION OF TEXT, GRAPHICS, PHOTOGRAPHS, IMAGES, AND AUDIO-VISUAL WORKS OF OTHERS ONLINE FOR STREAMING, FEATURING NEWS, ENTERTAINMENT, SPORTS, COMEDY, DRAMA, MUSIC, AND MUSIC VIDEOS; PROVIDING A WEBSITE FEATURING AUDIO-VISUAL CONTENT, SPECIFICALLY, MOTION PICTURES, TELEVISION PROGRAMMING, VIDEOS, MUSIC VIDEOS, AND MUSIC, AND VIDEO CLIPS, AUDIO CLIPS, MUSIC CLIPS, FILM CLIPS, AND PHOTOGRAPHS, IN THE FIELDS OF CURRENT EVENT REPORTING, ENTERTAINMENT, SPORTS, COMEDY, DRAMA, MUSIC, AND MUSIC VIDEOS (U.S. CLS. 100, 101 AND 107).
FIRST USE 3-12-2008; IN COMMERCE 3-12-2008.

CLASS 42—SCIENTIFIC AND COMPUTER SERVICES

FOR HOSTING OF DIGITAL CONTENT ON THE INTERNET (U.S. CLS. 100 AND 101).
FIRST USE 3-12-2008; IN COMMERCE 3-12-2008.

3,786,196. MUHAMMAD ALI ENTERPRISES LLC, BERRIEN SPRINGS, MI. SN 77-979,091. PUB. 4-29-2008, FILED 9-19-2006.

ALI

THE MARK CONSISTS OF STANDARD CHARACTERS

WITHOUT CLAIM TO ANY PARTICULAR FONT, STYLE, SIZE, OR COLOR.

OWNER OF U.S. REG. NOS. 2,683,909 AND 2,845,065.

THE NAME SHOWN IN THE MARK IDENTIFIES A LIVING INDIVIDUAL WHOSE CONSENT IS OF RECORD.

CLASS 9—ELECTRICAL AND SCIENTIFIC APPARATUS

FOR DOWNLOADABLE WALLPAPER, RINGTONES, AND VIDEO GAMES FOR MOBILE PHONES; MOBILE PHONE ACCESSORIES, NAMELY, FACE PLATES AND CELL PHONE COVERS; PRE-RECORDED VIDEO CASSETTES, AUDIO TAPES, CDS AND DVDS FEATURING OR ASSOCIATED WITH ATHLETES, CELEBRITIES AND PUBLIC FIGURES; SUNGLASSES; COMPUTER GAME SOFTWARE AND ONLINE DOWNLOADABLE COMPUTER GAME PROGRAMS; VIDEO GAME SOFTWARE; VIDEO GAME DISCS (U.S. CLS. 21, 23, 26, 36 AND 38).

FIRST USE 12-31-2002; IN COMMERCE 12-31-2002.

CLASS 16—PAPER GOODS AND PRINTED MATTER

FOR ADDRESS BOOKS, PHOTO ALBUMS, AUTOGRAPH BOOKS, PAPER BAGS, BALL POINT PENS, PAPER BANNERS, BLANK NOTE CARDS, POSTER BOARDS, BULLETIN BOARDS, CHILDREN'S BOOKS, COLORING BOOKS, COOK BOOKS, EXERCISE BOOKS, PICTURE BOOKS, SERIES OF FICTION BOOKS FEATURING OR ASSOCIATED WITH ATHLETES, CELEBRITIES AND PUBLIC FIGURES, SERIES OF NON-FICTION BOOKS FEATURING OR ASSOCIATED WITH ATHLETES, CELEBRITIES AND PUBLIC FIGURES, CALENDARS, GIFT CARDS, GREETING CARDS, PEN AND PENCIL CASES, DAILY PLANNERS, DECALS, PAPER PARTY DECORATIONS, DESK SETS, DIARIES, ERASERS, FILE CARDS, GIFT WRAPPING PAPER, BLANK WRITING JOURNALS, MAGAZINES FEATURING OR ASSOCIATED WITH ATHLETES, CELEBRITIES AND PUBLIC FIGURES; SHEET MUSIC; NEWSLETTERS FEATURING OR ASSOCIATED WITH ATHLETES, CELEBRITIES AND PUBLIC FIGURES, DESK PADS, PAINTING SETS, WRITING PAPER, FOUNTAIN PENS, PENCILS, POSTCARDS, SCRAPBOOKS, POSTERS, STATIONERY, STICKERS, PAPER TAPE, TRADING CARDS AND WRITING PADS (U.S. CLS. 2, 5, 22, 23, 29, 37, 38 AND 50).

FIRST USE 12-31-2008; IN COMMERCE 12-31-2008.

3,786,200. DR. SEUSS ENTERPRISES, L.P., LA JOLLA, CA. SN 77-979,121. PUB. 1-20-2009, FILED 7-25-2008.



The LORAX project

OWNER OF U.S. REG. NO. 2,072,896.
THE MARK CONSISTS OF THE STYLIZED WORDS "THE LORAX PROJECT".

CLASS 16—PAPER GOODS AND PRINTED MATTER

FOR PRINTED MATERIALS, NAMELY, CHILDREN'S BOOKS; PAPER PRODUCTS, NAMELY, PRINTER PAPER, COPY PAPER, LINED WRITING PAPER, ENVELOPES, PAPER BAGS, GIFT WRAPPING PAPER, NEWSLETTERS IN THE FIELD OF ENVIRONMENTAL ISSUES AND CONCERNS, STICKERS, CALENDARS; GREETING CARDS; NOTEBOOKS; STATIONERY (U.S. CLS. 2, 5, 22, 23, 29, 37, 38 AND 50).

FIRST USE 1-0-2010; IN COMMERCE 1-0-2010.

CLASS 18—LEATHER GOODS

FOR TEXTILE SHOPPING BAGS; TOTE BAGS (U.S. CLS. 1, 2, 3, 22 AND 41).

FIRST USE 7-0-2008; IN COMMERCE 7-0-2008.

3,786,202. TARGET BRANDS, INC., MINNEAPOLIS, MN. SN 77-979,131. PUB. 11-18-2008, FILED 7-17-2007.

UP & UP

THE MARK CONSISTS OF STANDARD CHARACTERS WITHOUT CLAIM TO ANY PARTICULAR FONT, STYLE, SIZE, OR COLOR.

CLASS 3—COSMETICS AND CLEANING PREPARATIONS

FOR CLEANING PREPARATIONS FOR HOUSEHOLD PURPOSES; LAUNDRY DETERGENT; FABRIC SOFTENERS AND CONDITIONERS FOR LAUNDRY USE; ALL PURPOSE DRAIN OPENERS; AUTOMATIC AND LIQUID DISH WASHING DETERGENTS AND ADDITIVES; CLEANING PREPARATIONS FOR CARPETS, RUGS AND UPHOLSTERY; DISPOSABLE WIPES IMPREGNATED WITH CHEMICALS OR COMPOUNDS FOR HOUSEHOLD USE; HAIR SHAMPOO, CONDITIONER; BABY BATH CLEANSERS; BABY LOTION; BABY OIL, BABY OIL GEL AND CREAMY BABY OIL; BABY POWDER AND CORNSTARCH BABY POWDER; BABY SHAMPOO AND HAIR CONDITIONS; BABY WIPES; COSMETIC PADS AND SPONGES; COTTON SWABS, STICKS, BALLS, AND PUFFS FOR PERSONAL COSMETIC USE; NON-MEDICATED DIAPER RASH OINTMENT; DISPOSABLE WIPES IMPREGNATED WITH CHEMICALS OR COMPOUNDS FOR PERSONAL HYGIENE; NON-MEDICATED FOOT POWDER; PETROLEUM JELLY FOR COSMETIC PURPOSES; SKIN CARE PREPARATIONS, NAMELY, BODY WASH, BODY POWDER, BODY SCRUB, HAND CREAM, AND SKIN LOTION; LIQUID SKIN SOAP; BATH AND SHOWER GEL; BUBBLE BATH; SHAVE FOAM; SHAVE GEL, SHAVE CREAM; DEODORANTS AND ANTIPERSPIRANTS; DISPOSABLE WIPES IMPREGNATED WITH CHEMICALS OR COMPOUNDS FOR USE PERSONAL HYGIENE; LIP BALM; NON-MEDICATED ACNE TREATMENT PREPARATIONS; SUNSCREEN LOTIONS, SPRAYS AND CREAMS; CLEANERS AND CLEANSERS; BREATH FRESHENERS; MOUTHWASH; TOOTHPASTE; TOOTH GEL AND POWDER; TEETH CLEANING PREPARATIONS; TOOTH WHITENING PREPARATIONS; ROOM FRAGRANCES (U.S. CLS. 1, 4, 6, 50, 51 AND 52).

FIRST USE 3-1-2009; IN COMMERCE 3-1-2009.

CLASS 4—LUBRICANTS AND FUELS

FOR CANDLES (U.S. CLS. 1, 6 AND 15).

FIRST USE 10-18-2009; IN COMMERCE 10-18-2009.

CLASS 5—PHARMACEUTICALS

FOR ALCOHOL SWABS FOR TOPICAL USE, ALCOHOL-PREPARED PADS ADHESIVE BANDAGES; AIR FRESHENERS AND ROOM DEODORIZERS; ALCOHOL FOR TOPICAL USE; ALL PURPOSE DISINFECTANTS; ANALGESICS AND PAIN RELIEVERS; ANTI-BACTERIAL AND ANTI-MICROBIAL HAND AND LOTION SOAP; ANTIBIOTIC CREAMS AND OINTMENTS; ANTI-FUNGAL PREPARATIONS FOR PERSONAL USE; ANTI-ITCH CREAMS, LOTIONS, AND OINTMENTS; ANTI-SEPTIC AND MEDICATED MOUTHWASHES; CARPET AND ROOM DEODORIZERS; DISINFECTANT MILDEW REMOVERS; ELECTROLYTE REPLACEMENT SOLUTIONS; EPSOM SALTS; FEMININE HYGIENE PREPARATIONS, NAMELY, DOUCHES; FEMININE HYGIENE AND PROTECTION, NAMELY, TAMPONS, MAXI PADS, MINI PADS, AND PANTY LINERS; GAUZE; HEMORRHOID TREATMENT PREPARATIONS AND PADS; HAND SANITIZING AND DISINFECTING PREPARATIONS; HOUSEHOLD DISINFECTANTS WITH CLEANING, DEODORIZING AND GERMICIDAL PROPERTIES; HYDROCORTISONE CREAMS AND OINTMENTS; HYDROGEN PEROXIDE FOR MEDICAL USE; INFANT FORMULA; MEDICATED SHAMPOO; LICE TREATMENT PREPARATIONS; MEDICAL ADHESIVE TAPE; MEDICATED DIAPER OINTMENT; MEDICATED FOOT POWDER; MEDICATED BODY POWDER; MEDICATED PRE-MOISTENED WIPES; NON-ADHESIVE BANDAGES AND ADHESIVES FOR BANDAGES FOR SKIN WOUNDS; ODOR ELIMINATORS FOR USE ON FABRICS; OINTMENTS FOR THE PREVENTION AND TREATMENT OF DIAPER RASH AND OTHER SKIN IRRITATIONS; OPHTHALMIC PREPARATIONS, NAMELY, EYE DROPS, EYE DROPS CONTAINING ANTIHISTAMINES AND DECONGESTANTS, LUBRICATING AND REWETTING SOLUTIONS, STERILE SALINE SOLUTION, THERAPEUTIC OPHTHALMIC PREPARATIONS; OPHTHALMIC SOLUTIONS FOR USE WITH CONTACT LENSES, NAMELY, CONTACT LENS CLEANERS, CONTACT LENS SOAKING, WETTING AND DISINFECTING SOLUTIONS AND TABLETS; OVULATION TEST KITS; PERSONAL LUBRICATING PREPARATIONS; PETROLEUM JELLY FOR MEDICAL PURPOSES; PHARMACEUTICAL PREPARATIONS, NAMELY, ALLERGY RELIEF MEDICATIONS, ANALGESICS AND PAIN RELIEVERS, ANALGESIC SLEEPING AIDS, ANTIHISTAMINES, ASPIRIN, COLD MEDICATIONS; COUGH TREATMENT MEDICATIONS AND SUPPRESSANTS; DECONGESTANTS, FEVER REDUCERS, FLU MEDICATIONS, MENSTRUAL PAIN AND CRAMP RELIEVERS; MOTION SICKNESS TREATMENT PREPARATIONS, NASAL SPRAY PREPARATIONS, PREPARATIONS FOR THE TREATMENT OF ASTHMA AND HAY FEVER; RESPIRATORY INFECTION MEDICATIONS; SINUS MEDICATIONS, SLEEP-AID PREPARATIONS, THROAT LOZENGES, DROPS AND SPRAYS; PHARMACEUTICAL PREPARATIONS, NAMELY, ANTACIDS, ACID REDUCERS, ANTI-GAS PREPARATIONS, ANTI-DIARRHEA PREPARATIONS, ENEMA PREPARATIONS, LAXATIVES, LACTOSE INTOLERANCE PREPARATIONS, MINERAL OIL, STOOL SOFTENERS; PHARMACEUTICAL PREPARATIONS FOR THE TREATMENT, RELIEF, AND PREVENTION OF GASTROINTESTINAL DISTRESS, GASTROINTESTINAL DISORDERS, CONSTIPATION; PREGNANCY TEST KITS FOR HOME USE; PREPARATIONS FOR DISINFECTING FLOORS; SMOKING CESSATION PREPARATIONS; SUPPLEMENTS, NAMELY, VITAMIN, MINERAL, DIETARY, HERBAL, NUTRITIONAL, AND HOMEOPATHIC SUPPLEMENTS; NUTRITIONALLY FORTIFIED BEVERAGES; AND WITCH HAZEL; ACNE MEDICATIONS; ACNE TREATMENT PREPARATIONS; FIRST AID KITS; DENTURE ADHESIVES (U.S. CLS. 6, 18, 44, 46, 51 AND 52).

FIRST USE 4-18-2009; IN COMMERCE 8-14-2009.

CLASS 6—METAL GOODS

FOR ALUMINUM FOIL (U.S. CLS. 2, 12, 13, 14, 23, 25 AND 50).

FIRST USE 5-24-2009; IN COMMERCE 5-24-2009.

3,786,205. DR. SEUSS ENTERPRISES, L.P., LA JOLLA, CA. SN 77-979,149. PUB. 7-8-2008, FILED 5-15-2007.

LORAX

THE MARK CONSISTS OF STANDARD CHARACTERS WITHOUT CLAIM TO ANY PARTICULAR FONT, STYLE, SIZE, OR COLOR.

OWNER OF U.S. REG. NO. 2,072,896.

CLASS 16—PAPER GOODS AND PRINTED MATTER

FOR PRINTED MATERIALS, NAMELY, CHILDREN'S BOOKS; PAPER PRODUCTS, NAMELY, PRINTER PAPER, COPY PAPER, LINED WRITING PAPER, ENVELOPES, PAPER BAGS, GIFT WRAPPING PAPER, NEWSLETTERS IN THE FIELD OF ENVIRONMENTAL ISSUES AND CONCERNS, STICKERS, CALENDARS; GREETING CARDS; NOTEBOOKS; STATIONERY (U.S. CLS. 2, 5, 22, 23, 29, 37, 38 AND 50).

FIRST USE 1-0-2010; IN COMMERCE 1-0-2010.

CLASS 18—LEATHER GOODS

FOR TEXTILE SHOPPING BAGS; TOTE BAGS (U.S. CLS. 1, 2, 3, 22 AND 41).

FIRST USE 7-0-2008; IN COMMERCE 7-0-2008.

3,786,206. BOSTON WOMEN'S SOCCER, LLC, WESTWOOD, MA. SN 77-979,160. PUB. 5-26-2009, FILED 11-3-2008.



NO CLAIM IS MADE TO THE EXCLUSIVE RIGHT TO USE "BOSTON", APART FROM THE MARK AS SHOWN.

THE COLOR(S) BLUE, BLACK AND WHITE IS/ARE CLAIMED AS A FEATURE OF THE MARK.

THE MARK CONSISTS OF A SHIELD WITH THE WORDS "BOSTON BREAKERS" AT THE TOP. THE WORD "BOSTON" IS IN BLACK AND THE WORD "BREAKERS" IS IN BLUE STYLIZED LETTERS, BORDERED BY WHITE AND BLACK. BELOW THE WORDING ARE A BLUE AND WHITE WAVE AND A SOCCER BALL.

CLASS 18—LEATHER GOODS

FOR BAGS, NAMELY, ALL PURPOSE ATHLETIC BAGS, SHOULDER BAGS (U.S. CLS. 1, 2, 3, 22 AND 41).

FIRST USE 4-11-2009; IN COMMERCE 4-11-2009.

CLASS 25—CLOTHING

FOR HATS, SCARVES, SWEATSHIRTS, SHIRTS, T-SHIRTS, JERSEYS, REPLICAS, JACKETS (U.S. CLS. 22 AND 39).

FIRST USE 4-11-2009; IN COMMERCE 4-11-2009.

CLASS 41—EDUCATION AND ENTERTAINMENT

FOR ENTERTAINMENT SERVICES IN THE NATURE OF PROFESSIONAL SOCCER EXHIBITIONS AND GAMES; PROVIDING INFORMATION VIA A GLOBAL INFORMATION NETWORK REGARDING EDUCATION, ENTERTAINMENT, SPORTS AND NON-FICTIONS TOPICS, NAMELY, INTERVIEWS AND ARTICLES ABOUT APPLICANT'S SOCCER TEAM AND ITS PLAYERS AND STAFF MEMBERS (U.S. CLS. 100, 101 AND 107).

FIRST USE 5-7-2009; IN COMMERCE 5-7-2009.

3,786,215. CLEARPOINT FINANCIAL SOLUTIONS, INC., RICHMOND, VA. SN 78-499,756. PUB. 6-3-2008, FILED 10-14-2004.

ByDesign

THE MARK CONSISTS OF STANDARD CHARACTERS WITHOUT CLAIM TO ANY PARTICULAR FONT, STYLE, SIZE, OR COLOR.

OWNER OF U.S. REG. NO. 2,723,720.

CLASS 36—INSURANCE AND FINANCIAL

FOR DEBT SETTLEMENT NEGOTIATIONS, NAMELY, NEGOTIATING DEBT SETTLEMENT ON BEHALF OF OTHERS; COUNSELING SERVICES IN THE FIELD OF DEBT AND CREDIT MANAGEMENT; DEBT COUNSELING SERVICES (U.S. CLS. 100, 101 AND 102).

FIRST USE 12-28-2004; IN COMMERCE 12-28-2004.

CLASS 41—EDUCATION AND ENTERTAINMENT

FOR EDUCATION SERVICES, NAMELY, PUBLISHING AND DISTRIBUTION OF BOOKS, REVIEWS AND OTHER PRINTED MATTER AS WELL AS RELATED ELECTRONIC DATA CARRIERS, AND PROVIDING ONLINE ARTICLES AND INSTRUCTION IN THE FIELD OF PERSONAL FINANCIAL MANAGEMENT (U.S. CLS. 100, 101 AND 107).

FIRST USE 9-30-2006; IN COMMERCE 9-30-2006.

3,786,216. FUTURE MEDIA ARCHITECTS, INC., ROAD TOWN, TORTOLA, BR. VIRGIN ISLANDS. SN 78-504,693. PUB. 5-9-2006, FILED 10-22-2004.

RADICAL RESULTS

THE MARK CONSISTS OF STANDARD CHARACTERS WITHOUT CLAIM TO ANY PARTICULAR FONT, STYLE, SIZE, OR COLOR.

CLASS 35—ADVERTISING AND BUSINESS

FOR PROMOTING THE GOODS AND SERVICES OF OTHERS BY PROVIDING HYPERTEXT LINKS TO THE WEB SITES OF OTHERS (U.S. CLS. 100, 101 AND 102).

FIRST USE 1-0-2003; IN COMMERCE 1-0-2003.

CLASS 42—SCIENTIFIC AND COMPUTER SERVICES

FOR COMPUTER SERVICES, NAMELY, PROVIDING SEARCH ENGINES FOR OBTAINING DATA ON A GLOBAL COMPUTER NETWORK (U.S. CLS. 100 AND 101).

FIRST USE 1-0-2003; IN COMMERCE 1-0-2003.

3,786,218. MPS MICRO PRECISION SYSTEMS AG, CH - 2504 BIEL/BIENNE, SWITZERLAND. SN 78-547,424. PUB. 11-20-2007, FILED 1-13-2005.

 microsphere

PRIORITY CLAIMED UNDER SEC. 44(D) ON SWITZERLAND APPLICATION NO. 026162004, FILED 7-21-2004, REG. NO. 529769, DATED 7-21-2004, EXPIRES 7-22-2015.

NO CLAIM IS MADE TO THE EXCLUSIVE RIGHT TO USE "MICROSPHERE", APART FROM THE MARK AS SHOWN.

THE MARK CONSISTS OF EIGHT SMALL SHADED CIRCLES FORMING A CIRCLE TO THE LEFT OF THE WORD "MICROSPHERE".

CLASS 7—MACHINERY

FOR COMPONENTS FOR COUPLING FOR MACHINES AND FOR TRANSMISSION GEARS FOR MACHINES; MACHINE PARTS, NAMELY, BALL BEARINGS, RADIAL AND LINEAR BALL BEARINGS, 3-POINT CONTACT BEARINGS, 4-POINT CONTACT BEARINGS, ANGULAR CONTACT BEARINGS, SELF-ALIGNING BEARINGS, SHAFT BEARINGS, BEARINGS FOR OSCILLATING MASS, BIO-COMPATIBLE BEARINGS, LUBRICATION-FREE BEARINGS, MINIATURE BEARINGS, BEARINGS FOR MICRO MOTORS; BEARINGS FOR INDUSTRIAL ASSEMBLY ROBOTS; COMPONENTS FOR THE ABOVE MENTIONED BEARINGS, NAMELY, BALLS AND MINIATURE BALLS; MICRO MOTORS AND MINIATURE DRIVING GEARS FOR MACHINES AND THEIR COMPONENTS (U.S. CLS. 13, 19, 21, 23, 31, 34 AND 35).

FIRST USE 1-23-2009; IN COMMERCE 1-23-2009.

CLASS 9—ELECTRICAL AND SCIENTIFIC APPARATUS

FOR BEARINGS FOR OPTICAL SHUTTERS AND BEARINGS FOR COMPUTER HARD DISKS, AND THEIR COMPONENTS, NAMELY, BALLS AND MINIATURE BALLS (U.S. CLS. 21, 23, 26, 36 AND 38).

FIRST USE 1-23-2009; IN COMMERCE 1-23-2009.

CLASS 14—JEWELRY

FOR WATCHES AND THEIR PARTS, NAMELY, WATCH BEARINGS AND MOVING COMPONENTS OF WATCHES (U.S. CLS. 2, 27, 28 AND 50).

FIRST USE 1-23-2009; IN COMMERCE 1-23-2009.

3,786,222. O'REILLY MEDIA, INC., SEBASTOPOL, CA. SN 78-596,773. PUB. 10-10-2006, FILED 3-29-2005.

O'REILLY

THE MARK CONSISTS OF STANDARD CHARACTERS WITHOUT CLAIM TO ANY PARTICULAR FONT, STYLE, SIZE, OR COLOR.

OWNER OF U.S. REG. NO. 2,128,348.
SEC. 2(F).

CLASS 9—ELECTRICAL AND SCIENTIFIC APPARATUS

FOR DOWNLOADABLE DIGITAL AUDIO FILES THROUGH THE INTERNET CONTAINING NON-FICTIONAL AUDIO RECORDINGS ON THE SUBJECTS OF COMPUTER PROGRAMMING, COMPUTER SOFTWARE, BUSINESS AND CAREER GUIDANCE, THE INTERNET, AND DO-IT-YOURSELF TECHNOLOGY PROJECTS (U.S. CLS. 21, 23, 26, 36 AND 38).

FIRST USE 9-14-2005; IN COMMERCE 9-14-2005.

CLASS 41—EDUCATION AND ENTERTAINMENT

FOR ARRANGING CONFERENCES IN THE FIELDS OF COMPUTER TECHNOLOGY, DIGITAL TECHNOLOGY, EMERGING TECHNOLOGY ISSUES AND EMERGING TECHNOLOGY ISSUES IN THE FIELD OF THE INTERNET (U.S. CLS. 100, 101 AND 107).

FIRST USE 8-17-1998; IN COMMERCE 8-17-1998.

3,786,225. CORD:USE CORD BLOOD BANK, INC., ORLANDO, FL. SN 78-629,619. PUB. 3-14-2006, FILED 5-13-2005.

THE WAY TO SAVE LIFE

THE MARK CONSISTS OF STANDARD CHARACTERS WITHOUT CLAIM TO ANY PARTICULAR FONT, STYLE, SIZE, OR COLOR.

CLASS 39—TRANSPORTATION AND STORAGE

FOR STORAGE OF HUMAN UMBILICAL CORD BLOOD STEM CELLS FOR MEDICAL USE (U.S. CLS. 100 AND 105).

FIRST USE 11-13-2006; IN COMMERCE 11-13-2006.

CLASS 44—MEDICAL, BEAUTY AND AGRICULTURAL SERVICES

FOR BLOOD BANK SERVICES, NAMELY, COLLECTION AND PRESERVATION OF HUMAN UMBILICAL CORD BLOOD STEM CELLS (U.S. CLS. 100 AND 101).

FIRST USE 11-13-2006; IN COMMERCE 11-13-2006.

3,786,228. LEVEL 7 LLC, ALISO VIEJO, CA. SN 78-649,685. PUB. 3-14-2006, FILED 6-13-2005.

LEVEL 7

THE MARK CONSISTS OF STANDARD CHARACTERS WITHOUT CLAIM TO ANY PARTICULAR FONT, STYLE, SIZE, OR COLOR.

CLASS 9—ELECTRICAL AND SCIENTIFIC APPARATUS

FOR DOWNLOADABLE MUSICAL SOUND RECORDINGS AND MUSICAL VIDEO RECORDINGS (U.S. CLS. 21, 23, 26, 36 AND 38).

FIRST USE 8-18-2009; IN COMMERCE 8-18-2009.

CLASS 38—COMMUNICATION

FOR STREAMING OF AUDIO AND VISUAL RECORDINGS FEATURING MUSIC (U.S. CLS. 100, 101 AND 104).

FIRST USE 4-29-2009; IN COMMERCE 4-29-2009.

CLASS 41—EDUCATION AND ENTERTAINMENT

FOR ENTERTAINMENT SERVICES, NAMELY, PRODUCTION OF MULTIMEDIA IN THE NATURE OF MUSIC VIDEOS AND VIDEOS OF MUSIC PERFORMANCES, AND LIVE MUSICAL PERFORMANCES, AUDIO RECORDING AND PRODUCTION, PRODUCTION OF SOUNDTRACK MUSIC FOR USE IN FILM, TELEVISION, RADIO AND VIDEO; VIDEO EDITING; SONG WRITING SERVICES; PROVIDING A WEBSITE ON A GLOBAL COMPUTER NETWORK FEATURING INFORMATION ON MUSICAL PERFORMERS AND THEIR MUSICAL PERFORMANCES, BIOGRAPHIES, SOUND AND VIDEO RECORDINGS, AND APPEARANCES (U.S. CLS. 100, 101 AND 107).

FIRST USE 4-22-2006; IN COMMERCE 4-22-2006.

3,786,232. BIO-PRO RESEARCH, LLC, HICKORY, NC. SN 78-667,639. PUB. 12-19-2006, FILED 7-11-2005.

KENNEL-FRESH

THE MARK CONSISTS OF STANDARD CHARACTERS WITHOUT CLAIM TO ANY PARTICULAR FONT, STYLE, SIZE, OR COLOR.

CLASS 3—COSMETICS AND CLEANING PREPARATIONS

FOR ALL PURPOSE CLEANING PREPARATIONS, SOLVENTS, SOLUTIONS, AND FLUIDS; ALL PURPOSE SCENTED CLEANING PREPARATIONS, SOLVENTS, SOLUTIONS, AND FLUIDS; ALL PURPOSE BIO-ENZYMATIC CLEANING PREPARATIONS, SOLVENTS, SOLUTIONS, AND FLUIDS; STAIN REMOVERS; AND STAIN AND ODOR REMOVAL PREPARATIONS, SOLUTIONS, AND FLUIDS FOR PET STAINS AND ODORS (U.S. CLS. 1, 4, 6, 50, 51 AND 52).

FIRST USE 7-31-2009; IN COMMERCE 7-31-2009.

CLASS 5—PHARMACEUTICALS

FOR ODOR REMOVAL PREPARATIONS, SOLUTIONS AND FLUIDS FOR USE ON CARPETS, TEXTILES, PAINTED SURFACES, TILE, FLOORING, LINOLEUM, CERAMIC SURFACES AND METAL; AND CARPET, ROOM, TILE, FLOORING AND TEXTILE FRESHENERS AND ODOR ELIMINATORS (U.S. CLS. 6, 18, 44, 46, 51 AND 52).

FIRST USE 7-31-2009; IN COMMERCE 7-31-2009.

3,786,234. NESTE OIL OYJ, ESPOO, FINLAND. SN 78-673,673. PUB. 6-26-2007, FILED 7-19-2005.

REFINING THE FUTURE

THE MARK CONSISTS OF STANDARD CHARACTERS WITHOUT CLAIM TO ANY PARTICULAR FONT, STYLE, SIZE, OR COLOR.

PRIORITY CLAIMED UNDER SEC. 44(D) ON FINLAND APPLICATION NO. T200501030, FILED 4-12-2005, REG. NO.

234547, DATED 10-31-2005, EXPIRES 10-31-2015.

CLASS 1—CHEMICALS

FOR PETROCHEMICAL PRODUCTS, NAMELY, N-BUTYL-ALCOHOL, OCTANE ACID, SOLVENTS, ISO-OCTANE, ETHYL TERTIARY-BUTYL ETHER, AND CHEMICAL INTERMEDIATES DERIVED FROM THE ABOVE; CHEMICALS USED IN THE PRODUCTION AND REFINING OF OIL (U.S. CLS. 1, 5, 6, 10, 26 AND 46).

FIRST USE 4-1-2005; IN COMMERCE 5-0-2005.

CLASS 4—LUBRICANTS AND FUELS

FOR INDUSTRIAL OILS AND GREASES, LUBRICANTS, AUTOMOTIVE LUBRICANTS, FUELS, CRUDE OIL, LIQUEFIED PETROLEUM GASES (U.S. CLS. 1, 6 AND 15).

FIRST USE 4-1-2005; IN COMMERCE 5-0-2005.

CLASS 39—TRANSPORTATION AND STORAGE

FOR (BASED ON 44(E)) TRANSPORT BY LAND, AIR AND WATER, NAMELY, FREIGHT TRANSPORTATION, TRANSPORTATION OF PASSENGERS AND/OR GOODS BY BOAT, RAIL OR TRUCK; FREIGHTING AND LEASING OF SHIPS; UNSHIPMENT OF FREIGHT; TRANSMISSION OF OIL AND GAS THROUGH PIPELINES (U.S. CLS. 100 AND 105).

CLASS 40—MATERIAL TREATMENT

FOR (BASED ON 44(E)) PROCESSING OF OIL, NAMELY, INDUSTRIAL OILS AND GREASES, LUBRICANTS, AUTOMOTIVE LUBRICANTS, FUELS, CRUDE OIL, LIQUEFIED PETROLEUM GASES; OIL REFINING (U.S. CLS. 100, 103 AND 106).

CLASS 42—SCIENTIFIC AND COMPUTER SERVICES

FOR (BASED ON 44(E)) CHEMICAL RESEARCH, CHEMICAL ANALYSIS AND CHEMICAL LABORATORY SERVICES; DRAWING UP OF EXPERT TECHNICAL OPINIONS IN CONNECTION WITH OIL DEPOSITS; CONSULTATION IN THE FIELD OF OIL RESEARCH; PRODUCT DEVELOPMENT; DESIGN AND DESIGN CONSULTATION SERVICES RELATING TO THE REFINING, TRANSMISSION, AND DISTRIBUTION OF OIL; TESTING SERVICES RELATING TO THE REFINING OF OIL (U.S. CLS. 100 AND 101).

3,786,235. LIVING MEDIA INDIA LIMITED, NEW DELHI-110001, INDIA. SN 78-682,978. PUB. 11-14-2006, FILED 8-1-2005.

AAJ TAK

THE MARK CONSISTS OF STANDARD CHARACTERS WITHOUT CLAIM TO ANY PARTICULAR FONT, STYLE, SIZE, OR COLOR.

THE ENGLISH TRANSLATION OF "AAJ TAK" IS "TILL TODAY".

CLASS 38—COMMUNICATION

FOR TELEVISION BROADCASTING; STREAMING OF VIDEO MATERIAL ON THE INTERNET (U.S. CLS. 100, 101 AND 104).

FIRST USE 2-6-2010; IN COMMERCE 2-6-2010.

CLASS 41—EDUCATION AND ENTERTAINMENT

FOR PRODUCTION OF TELEVISION PROGRAMS; ENTERTAINMENT SERVICES, NAMELY, PROVIDING A WEBSITE FEATURING CURRENT EVENT, ENTERTAINMENT AND SPORTS NEWS, AND CONDUCTING CONTESTS ON-LINE; PROVIDING ONLINE NON-DOWNLOADABLE PUBLICATIONS, NAMELY, NEWSPAPERS, NEWSLETTERS, AND MAGAZINES IN THE FIELDS OF NEWS, BUSINESS, POLITICS, ENTERTAINMENT, FICTION, AND SPORTS AND LEISURE (U.S. CLS. 100, 101 AND 107).

FIRST USE 12-31-2005; IN COMMERCE 12-31-2005.

3,786,237. BIO-PRO RESEARCH, LLC, SARASOTA, FL. SN 78-687,853. PUB. 6-12-2007, FILED 8-8-2005.

**CLASS 3—COSMETICS AND CLEANING PREPARATIONS**

FOR ALL PURPOSE CLEANING PREPARATIONS, SOLVENTS, SOLUTIONS AND FLUIDS; HOUSEHOLD CLEANING PREPARATIONS, SOLVENTS, SOLUTIONS AND FLUIDS; ALL PURPOSE SCENTED CLEANING PREPARATIONS, SOLVENTS AND FLUIDS; STAIN REMOVERS; PET STAIN REMOVERS; PET ODOR REMOVERS; ALL PURPOSE COMMERCIAL CLEANING PREPARATIONS, SOLVENTS, SOLUTIONS AND FLUIDS; CLEANING PREPARATIONS, SOLVENTS, SOLUTIONS AND FLUIDS FOR FLOORS, WALLS, BATHROOMS AND KITCHENS; ALL PURPOSE BIO-ENZYMATIC CLEANING PREPARATIONS; STAIN REMOVERS FOR PET AND OTHER HOUSEHOLD STAINS; ALL PURPOSE CLEANING SOLUTIONS FOR INANIMATE SURFACES; ANY OF THE FOREGOING PRODUCTS SOLD IN A KIT TOGETHER WITH LIGHTING DEVICES FOR USE IN CONNECTION WITH CLEANING AND DETECTION AND RECOGNITION OF MATTER TO BE CLEANED; AND NONE OF THE FOREGOING FOR CLEANUP OF BIOHAZARDOUS WASTE (U.S. CLS. 1, 4, 6, 50, 51 AND 52).

FIRST USE 12-21-2001; IN COMMERCE 12-21-2001.

CLASS 5—PHARMACEUTICALS

FOR ALL PURPOSE DISINFECTING, DEODORIZING AND SANITIZING PREPARATIONS FOR USE ON INANIMATE SURFACES; ALL PURPOSE DISINFECTANTS; CHEMICAL PREPARATIONS FOR SANITARY USE; ODOR NEUTRALIZING PREPARATIONS FOR USE ON CARPETS, TEXTILES, PAINTED SURFACES, TILE, FLOORING, LINOLEUM; CERAMIC SURFACES AND METAL; CARPET, ROOM, TILE, FLOORING AND TEXTILE FRESHENERS AND ODOR ELIMINATORS; ANY OF THE FOREGOING PRODUCTS SOLD IN A KIT TOGETHER WITH LIGHTING DEVICES FOR USE IN CONNECTION WITH CLEANING AND DETECTION AND RECOGNITION OF MATTER TO BE CLEANED; AND NONE OF THE FOREGOING FOR CLEANUP OF BIOHAZARDOUS WASTE (U.S. CLS. 6, 18, 44, 46, 51 AND 52).

FIRST USE 12-21-2001; IN COMMERCE 12-21-2001.

CLASS 35—ADVERTISING AND BUSINESS

FOR RETAIL STORES, WHOLESALE DISTRIBUTORSHIPS AND STORES, AND E-COMMERCE SERVICES, NAMELY, COMPUTERIZED ONLINE RETAIL STORE SERVICES AND ELECTRONIC CATALOG SERVICES AND CATALOG ORDERING SERVICES, ALL FEATURING ALL PURPOSE CLEANING PREPARATIONS, CLEANING SOLVENTS, CLEANING PRODUCTS, SOLUTIONS, FLUIDS AND PREPARATIONS, SCENTED CLEANING PREPARATIONS, BIO-ENZYMATIC CLEANING PREPARATIONS, AND STAIN AND ODOR REMOVAL PRODUCTS, SOLUTIONS, FLUIDS AND PREPARATIONS OR ANY OF THE FOREGOING PRODUCTS SOLD IN A KIT TOGETHER WITH LIGHTING DEVICES FOR USE IN CONNECTION WITH CLEANING AND DETECTION AND RECOGNITION OF MATTER TO BE CLEANED; AND NONE OF THE FOREGOING FOR CLEANUP OF BIOHAZARDOUS WASTE (U.S. CLS. 100, 101 AND 102).

FIRST USE 12-21-2001; IN COMMERCE 12-21-2001.

3,786,247. UNISEN, INC., IRVINE, CA. SN 78-717,019. PUB. 12-19-2006, FILED 9-20-2005.

DESIGNED TO INSPIRE

THE MARK CONSISTS OF STANDARD CHARACTERS WITHOUT CLAIM TO ANY PARTICULAR FONT, STYLE, SIZE, OR COLOR.

CLASS 16—PAPER GOODS AND PRINTED MATTER

FOR PRINTED MATTER, NAMELY, PRINTED INSTRUCTIONAL AND TEACHING MATERIALS FEATURING INFORMATION ON EXERCISE, EXERCISE EQUIPMENT, THE REPAIR AND MAINTENANCE OF EXERCISE MACHINES AND EQUIPMENT, FITNESS, AND/OR HEALTH; PRINTED MANUALS FEATURING INFORMATION ON EXERCISE, EXERCISE EQUIPMENT, THE REPAIR AND MAINTENANCE OF EXERCISE MACHINES AND EQUIPMENT, FITNESS, AND/OR HEALTH (U.S. CLS. 2, 5, 22, 23, 29, 37, 38 AND 50).

FIRST USE 1-0-2005; IN COMMERCE 1-0-2005.

CLASS 28—TOYS AND SPORTING GOODS

FOR EXERCISE MACHINES AND EQUIPMENT, NAMELY, AN EXERCISE MACHINE OR STATION FOR TONING, AEROBIC, STRENGTH AND RESISTANCE TRAINING, AND PARTS THEREFOR (U.S. CLS. 22, 23, 38 AND 50).

FIRST USE 1-0-2005; IN COMMERCE 1-0-2005.

3,786,249. NATIONAL AUDUBON SOCIETY, INC., NEW YORK, NY. SN 78-725,864. PUB. 5-26-2009, FILED 10-4-2005.

AUDUBON

THE MARK CONSISTS OF STANDARD CHARACTERS WITHOUT CLAIM TO ANY PARTICULAR FONT, STYLE, SIZE, OR COLOR.

OWNER OF U.S. REG. NOS. 1,213,257, 2,732,442, AND OTHERS.

CLASS 6—METAL GOODS

FOR GARDEN METAL HOOKS AND BRACKETS; METAL GARDEN STAKES; GARDEN TRELIS MADE OF METAL (U.S. CLS. 2, 12, 13, 14, 23, 25 AND 50).

FIRST USE 5-30-2002; IN COMMERCE 5-30-2002.

CLASS 9—ELECTRICAL AND SCIENTIFIC APPARATUS

FOR THERMOMETERS (U.S. CLS. 21, 23, 26, 36 AND 38).

FIRST USE 1-0-2009; IN COMMERCE 1-0-2009.

CLASS 21—HOUSEWARES AND GLASS

FOR PLANTERS AND WALL PLANTERS FOR PLANTS AND POTS, POT HUGGERS AND PLANT PICKS (U.S. CLS. 2, 13, 23, 29, 30, 33, 40 AND 50).

FIRST USE 5-24-2005; IN COMMERCE 5-24-2005.

3,786,260. SEITZ, PETER, MÜNCHEN, FED REP GERMANY. SN 78-787,241. PUB. 1-1-2008, FILED 1-9-2006.

Art in Science

THE MARK CONSISTS OF STANDARD CHARACTERS WITHOUT CLAIM TO ANY PARTICULAR FONT, STYLE, SIZE, OR COLOR.

PRIORITY CLAIMED UNDER SEC. 44(D) ON ERP CMNTY TM OFC APPLICATION NO. 004589115, FILED 8-12-2005, REG. NO. 004589115, DATED 7-2-2007, EXPIRES 8-12-2015.

CLASS 9—ELECTRICAL AND SCIENTIFIC APPARATUS

FOR (BASED ON USE IN COMMERCE) DATA PROCESSORS AND COMPUTER PROGRAMMES FOR THE ANALYSIS AND EVALUATION OF MEDICAL DATA; COMPUTER SOFTWARE STORED ON ELECTRONIC DATA CARRIERS FOR THE ANALYSIS AND EVALUATION OF MEDICAL DATA; APPARATUS, NAMELY, PRESSURE DISTRIBUTION MEASURING APPARATUS; EQUIPMENT, NAMELY, PRESSURE DISTRIBUTION MEASURING EQUIPMENT; COMPUTER PROGRAMMES ALL FOR USE IN THE INPUT, RECEIPT, GENERATION, PROCESSING, ACCESS, PRESENTATION, DISPLAY, STORAGE, TRANSMISSION, PRINTING AND SENDING OF DATA AND INFORMATION; COMPUTER DATABASES FOR THE INPUT, RECEIPT,

GENERATION, PROCESSING, ACCESS, PRESENTATION, DISPLAY AND STORAGE OF DATA AND INFORMATION; EQUIPMENT, NAMELY, ELECTRONIC SENSORS, COMPUTERS, PRINTERS FOR THE INPUT AND OUTPUT OF DIGITAL AND ANALOGUE DATA; COMMUNICATION AND TELECOMMUNICATION DEVICES IN THE NATURE OF WIRED AND WIRELESS MEASURING INSTRUMENTS, NAMELY, TELEMETRIC DEVICES FOR TRANSFERRING DATA FROM SENSORS AND SENSOR ARRAYS TO COMPUTERS; EQUIPMENT TO READ AND WRITE FROM DATA PROCESSING MEDIA, NAMELY, MAGNETIC DISK READERS FOR USE IN FORCE DISTRIBUTION ANALYZERS; COMPUTER PROGRAMMES AND DATABASES FOR USE IN CONTROLLING ALL THE AFORESAID GOODS, NAMELY, COMPUTER OPERATING SYSTEMS AND SOFTWARE; COMPUTER SOFTWARE FOR THE CONTROL OF NETWORKS, FOR THE CONTROL OF ADMINISTRATION PROGRAMMES, FOR THE CONTROL OF MEASURING PROGRAMMES, AND FOR ENCODING OR DECODING DATA; COMPUTER SYSTEM PROGRAMMES FOR INPUTTING AND ANALYZING FORCE DISTRIBUTION DATA, SOFTWARE DRIVERS, SOFTWARE TOOLS AND DATABASES FOR COMPUTER AIDED DESIGN; COMPUTER PROGRAMMES FOR DEVELOPMENT OF SHOES, ARTIFICIAL LIMBS, SADDLES, SEATS, PEDALS, STEERING WHEELS, FOR THE ADMINISTRATION OF PRODUCT DATA, MEASURING DATA AND DIAGNOSTIC DATA OVER COMPUTER NETWORKS; COMPUTER PROGRAMMES AND DATABASES FOR ANALYSIS AND STORAGE OF FORCE DISTRIBUTION DATA AND FOR INFORMING PHYSICISTS, SHOE MANUFACTURERS, PROSTHETISTS ON SAID DATA, AND EQUIPMENT, NAMELY, COMPUTERS FOR USE IN STORING AND EXECUTING SUCH COMPUTER PROGRAMMES; CALIBRATION DEVICES FOR CALIBRATING PRESSURE DISTRIBUTION MEASURING INSTRUMENTS; NETWORKS COMPRISING COMPUTER HARDWARE AND COMPUTER PROGRAMMES USED TO REGISTER, MEASURE, MONITOR, CONVERT, INDICATE, RECORD, AMPLIFY, CONNECT, DETECT, ANALYZE AND EVALUATE THE MECHANICAL, ACOUSTIC, THERMAL, OPTICAL, OPTO-ELECTRONIC, ELECTRICAL, ELECTRONIC AND OTHER PHYSICAL PROPERTIES AND EVENTS USED TO ANALYZE AND EVALUATE TWO-DIMENSIONAL AND THREE-DIMENSIONAL FORCE AND PRESSURE DISTRIBUTION THEREIN; COMPUTER PROGRAMMES FOR THE RECORDING AND PROCESSING OF MEDICAL, WORK PHYSIOLOGICAL, ERGONOMIC AND BIOMEDICAL DATA; SCIENTIFIC APPARATUS AND INSTRUMENTS FOR USE IN THE LABORATORY, NAMELY, FOR ANALYZING AND STORING FORCE DISTRIBUTION MEASURING DATA; SCIENTIFIC APPARATUS AND INSTRUMENTS FOR RESEARCH USE, NAMELY, ELECTRIC FORCE DISTRIBUTION MEASURING MATS (U.S. CLS. 21, 23, 26, 36 AND 38).

FIRST USE 9-0-2005; IN COMMERCE 1-0-2006.

CLASS 10—MEDICAL APPARATUS

FOR (BASED ON USE IN COMMERCE) MEDICAL APPARATUS AND INSTRUMENTS FOR MOTION AND AMBULATION ANALYSIS, NAMELY, FORCE DISTRIBUTION MEASURING APPARATUS AND INSTRUMENTS; APPARATUS FOR MEDICAL USE, NAMELY, FOR RESEARCH, DIAGNOSTIC, THERAPY AND MONITORING OF PATIENTS, NAMELY, FOR THE MONITORING OF PATIENT GENERATED AND PATIENT MEASURED PRESSURE DISTRIBUTION PATTERNS, NAMELY, ARRAYS OF PRESSURE SENSITIVE SENSORS; AND PARTS FOR ALL THE AFORESAID GOODS (U.S. CLS. 26, 39 AND 44).

FIRST USE 8-0-2005; IN COMMERCE 1-0-2006.

CLASS 16—PAPER GOODS AND PRINTED MATTER

FOR (BASED ON USE IN COMMERCE) PRINTED MATERIAL, NAMELY, INFORMATION SHEETS, PERIODICALS, BROCHURES, BOOKS AND CATALOGUES, AND ARTICLE RE-PRINTS, ALL FEATURING RESEARCH RESULTS AND EXPERIENCES OBTAINED BY SAMPLING AND ANALYZING PRESSURE DISTRIBUTION DATA (U.S. CLS. 2, 5, 22, 23, 29, 37, 38 AND 50).

FIRST USE 8-0-2005; IN COMMERCE 1-0-2006.

CLASS 35—ADVERTISING AND BUSINESS

FOR (BASED ON 44(E)) BUSINESS MANAGEMENT; FRANCHISING, NAMELY, CONSULTATION AND ASSISTANCE IN BUSINESS MANAGEMENT, ORGANIZATION AND PROMOTION; PLANNING AND CONDUCTING OF TRADE FAIRS IN THE FIELD OF MEDICAL TECHNOLOGY, NETWORKING AND TELECOMMUNICATIONS; PROCUREMENT, NAMELY, PURCHASING FOR OTHERS OF COMPUTER SOFTWARE, DATA PROCESSING EQUIPMENT, EXAMINATION AND MEASURING EQUIPMENT, AND MEDICAL EQUIPMENT, ALL FOR USE IN BUSINESS MANAGEMENT; FRANCHISING SERVICES, NAMELY, OFFERING TECHNICAL ASSISTANCE IN THE ESTABLISHMENT AND/OR OPERATION OF TECHNICAL CONSULTATION BUSINESS CONCENTRATING IN THE ANALYSIS AND EVALUATION OF PRESSURE DISTRIBUTION MEASURING; BUSINESS MANAGEMENT CONSULTATION AND ADVICE IN THE FIELD OF COMPUTERS, ELECTRONIC AND MEDICAL EQUIPMENT FIELDS AND THE PRESSURE DISTRIBUTION MEASURING FIELD (U.S. CLS. 100, 101 AND 102).

CLASS 42—SCIENTIFIC AND COMPUTER SERVICES

FOR (BASED ON 44(E)) DEVELOPMENT OF DATA PROCESSING COMPUTER PROGRAMMES, INCLUDING THE MAINTENANCE OF COMPUTER PROGRAMMES AND DATABASES FOR INFORMATION AND DATA PROCESSING, PROVISION, TRANSMISSION AND CHARGING OF MEDICAL AND BIO-MEDICAL DATA, AND FOR MEASURING DATA PROCESSING, ANALYTICAL AND MEDICAL PRODUCTS; MAINTENANCE OF DATABASES FOR OTHERS, AND TECHNICAL SUPPORT SERVICES, NAMELY, THE MONITORING OF DATA ENTERED INTO AND AVAILABLE ON THE INTERNET (U.S. CLS. 100 AND 101).

3,786,262. IMMUNETICS, INC., BOSTON, MA. SN 78-804,375. PUB. 1-22-2008, FILED 2-1-2006.

BacTx

THE MARK CONSISTS OF STANDARD CHARACTERS WITHOUT CLAIM TO ANY PARTICULAR FONT, STYLE, SIZE, OR COLOR.

CLASS 5—PHARMACEUTICALS

FOR TEST KITS COMPRISING DIAGNOSTIC REAGENTS FOR CLINICAL OR MEDICAL LABORATORY USE (U.S. CLS. 6, 18, 44, 46, 51 AND 52).
FIRST USE 3-22-2010; IN COMMERCE 3-22-2010.

CLASS 9—ELECTRICAL AND SCIENTIFIC APPARATUS

FOR TEST KITS PRIMARILY COMPRISING PHOTOMETERS, PIPETTES AND TUBES (U.S. CLS. 21, 23, 26, 36 AND 38).
FIRST USE 3-22-2010; IN COMMERCE 3-22-2010.

3,786,265. WELLS LAMONT INDUSTRY GROUP LLC, NILES, IL. SN 78-816,175. PUB. 6-26-2007, FILED 2-16-2006.

ALL-DAY

THE MARK CONSISTS OF STANDARD CHARACTERS WITHOUT CLAIM TO ANY PARTICULAR FONT, STYLE, SIZE, OR COLOR.

CLASS 9—ELECTRICAL AND SCIENTIFIC APPARATUS

FOR DISPOSABLE LATEX GLOVES FOR LABORATORY USE; PROTECTIVE GLOVES FOR INDUSTRIAL USE; AND PROTECTIVE SLEEVES FOR LABORATORY AND INDUSTRIAL USE (U.S. CLS. 21, 23, 26, 36 AND 38).
FIRST USE 3-1-2010; IN COMMERCE 3-1-2010.

CLASS 10—MEDICAL APPARATUS

FOR GLOVES FOR MEDICAL USE (U.S. CLS. 26, 39 AND 44).
FIRST USE 3-1-2010; IN COMMERCE 3-1-2010.

3,786,267. SAN FRANCISCO REAL ESTATE BOARD, SAN FRANCISCO, CA. SN 78-829,080. PUB. 10-17-2006, FILED 3-3-2006.

OPENING THE DOOR

THE MARK CONSISTS OF STANDARD CHARACTERS WITHOUT CLAIM TO ANY PARTICULAR FONT, STYLE, SIZE, OR COLOR.

CLASS 35—ADVERTISING AND BUSINESS

FOR ASSOCIATION SERVICES, NAMELY, PROMOTING THE INTERESTS OF REAL ESTATE BROKERS AND REAL ESTATE AGENTS, AND PROMOTING THE INTERESTS OF THE LOCAL REAL ESTATE INDUSTRY (U.S. CLS. 100, 101 AND 102).
FIRST USE 1-8-2010; IN COMMERCE 1-8-2010.

CLASS 41—EDUCATION AND ENTERTAINMENT

FOR PROVIDING NEWSLETTERS IN THE FIELD OF ASSOCIATION SERVICES, NAMELY, PROMOTING THE INTERESTS OF REAL ESTATE BROKERS AND REAL ESTATE AGENTS, AND PROMOTING THE INTERESTS OF THE LOCAL REAL ESTATE INDUSTRY VIA E-MAIL (U.S. CLS. 100, 101 AND 107).
FIRST USE 1-8-2010; IN COMMERCE 1-8-2010.

3,786,273. CHROMOCELL CORPORATION, NORTH BRUNSWICK, NJ. SN 78-842,514. PUB. 10-24-2006, FILED 3-21-2006.

3,786,288. UINTA GOLF, INC., SALT LAKE CITY, UT. SN 78-858,662. PUB. 5-15-2007, FILED 4-11-2006.

NODIUM

A BETTER FIT FOR YOUR GAME

THE MARK CONSISTS OF STANDARD CHARACTERS WITHOUT CLAIM TO ANY PARTICULAR FONT, STYLE, SIZE, OR COLOR.

THE MARK CONSISTS OF STANDARD CHARACTERS WITHOUT CLAIM TO ANY PARTICULAR FONT, STYLE, SIZE, OR COLOR.

CLASS 1—CHEMICALS

FOR CHEMICAL ADDITIVES FOR USE IN THE MANUFACTURE OF FOODS, FOOD FLAVORS, FOOD FLAVOR ENHANCERS AND SALT SUBSTITUTES (U.S. CLS. 1, 5, 6, 10, 26 AND 46).

FIRST USE 11-19-2009; IN COMMERCE 11-19-2009.

CLASS 30—STAPLE FOODS

FOR EDIBLE SALT SUBSTITUTE; FOOD ADDITIVE FOR NON-NUTRITIONAL PURPOSES, NAMELY, A SALT SUBSTITUTE USED AS A FLAVOR ENHANCER FOR FOODS (U.S. CL. 46).

FIRST USE 11-19-2009; IN COMMERCE 11-19-2009.

3,786,279. BELL HELICOPTER TEXTRON INC., FORT WORTH, TX. SN 78-849,117. PUB. 5-22-2007, FILED 3-29-2006.

WELCOME TO THE LEADING EDGE OF VERTICAL LIFT

THE MARK CONSISTS OF STANDARD CHARACTERS WITHOUT CLAIM TO ANY PARTICULAR FONT, STYLE, SIZE, OR COLOR.

CLASS 35—ADVERTISING AND BUSINESS

FOR PROVIDING CUSTOMER SUPPORT SERVICES IN THE FIELD OF AVIATION (U.S. CLS. 100, 101 AND 102).

FIRST USE 2-0-2006; IN COMMERCE 2-0-2006.

CLASS 41—EDUCATION AND ENTERTAINMENT

FOR EDUCATIONAL AND TRAINING SERVICES, NAMELY, CONDUCTING CLASSES, WORKSHOPS AND SEMINARS IN THE FIELD OF AVIATION (U.S. CLS. 100, 101 AND 107).

FIRST USE 2-0-2006; IN COMMERCE 2-0-2006.

CLASS 35—ADVERTISING AND BUSINESS

FOR RETAIL STORE SERVICES, RETAIL CATALOG ORDER SERVICES, RETAIL MAIL ORDER SERVICES, RETAIL TELEPHONE ORDER SERVICES, RETAIL FACSIMILE ORDER SERVICES, ARRANGING AND CONDUCTING TRADE SHOW EXHIBITIONS, PRODUCT DEMONSTRATIONS, RETAIL ONLINE ORDERING SERVICES VIA A GLOBAL COMPUTER NETWORK, AND DISTRIBUTORSHIP SERVICES, ALL IN THE FIELDS OF GOLF CLUBS, GOLF CLUB IRON SETS, GOLF CLUB SINGLE IRONS, GOLF CLUB WEDGES, GOLF CLUB PUTTERS, GOLF CLUB WOOD SETS, GOLF CLUB SINGLE WOODS, GOLF CLUB HYBRID CLUBS, GOLF CLUB COMPONENTS, GOLF CLUB ACCESSORIES, GOLF CLUB GRIPS, GOLF CLUB SHAFTS, GOLF CLUB HEADS, GOLF CLUB HEAD COVERS, GOLF CLUB CLEANING BRUSHES, GOLF BALLS, LOGO GOLF BALLS, IMPRINTED GOLF BALLS, PRACTICE GOLF BALLS, GOLF BAGS, GOLF CART BAGS, GOLF CARRY BAGS, GOLF STAND BAGS, GOLF BAG STANDS, GOLF TRAVEL BAGS, GOLF BOOKS, GOLF VIDEOS, GOLF DIGITAL VIDEO DISKS, GOLF SOFTWARE, GOLF COMPUTER PROGRAMS, GOLF PLAYING AIDS, GOLF TRAINING AIDS, GOLF DIVOT TOOLS, GOLF TEES, GOLF ARTWORK, UMBRELLAS, TOWELS, PURSES, SUNGLASSES, APPAREL, GOLF APPAREL, KNIT APPAREL, WOVEN APPAREL, OUTERWEAR, PANTS, SWEATS, SHORTS, SWEATERS, SWEATSHIRTS, SHIRTS, GOLF SHIRTS, TOPS, CLOTHING ACCESSORIES, SOCKS, GLOVES, GOLF GLOVES, GOLF SHOES, MEN'S GOLF SHOES, LADIES' GOLF SHOES, JUNIOR'S GOLF SHOES, CHILDREN'S GOLF SHOES, SHOE LACES, SHOE CARE PRODUCTS, SHOE BAGS, GOLF GIFTS, GOLF SUPPLIES, AND GOLF ACCESSORIES; SPONSORING GOLF TOURNAMENTS; AND PROVIDING CONSUMER PRODUCT INFORMATION VIA A GLOBAL COMPUTER NETWORK ABOUT GOLF CLUBS, GOLF CLUB IRON SETS, GOLF CLUB SINGLE IRONS, GOLF CLUB WEDGES, GOLF CLUB PUTTERS, GOLF CLUB WOOD SETS, GOLF CLUB SINGLE WOODS, GOLF CLUB HYBRID CLUBS, GOLF CLUB COMPONENTS, GOLF CLUB ACCESSORIES, GOLF CLUB GRIPS, GOLF CLUB SHAFTS, GOLF CLUB HEADS, GOLF CLUB HEAD COVERS, GOLF CLUB CLEANING BRUSHES, GOLF BALLS, LOGO GOLF BALLS, IMPRINTED GOLF BALLS, PRACTICE GOLF BALLS, GOLF BAGS, GOLF CART BAGS, GOLF CARRY BAGS, GOLF STAND BAGS, GOLF BAG STANDS, GOLF TRAVEL BAGS, GOLF BOOKS, GOLF VIDEOS, GOLF DIGITAL VIDEO DISKS, GOLF SOFTWARE, GOLF COMPUTER PROGRAMS, GOLF PLAYING AIDS, GOLF TRAINING AIDS, GOLF DIVOT TOOLS, GOLF TEES, GOLF ARTWORK, UMBRELLAS, TOWELS, PURSES, SUNGLASSES, APPAREL, GOLF APPAREL, KNIT APPAREL, WOVEN APPAREL, OUTERWEAR, PANTS, SWEATS, SHORTS, SWEATERS, SWEATSHIRTS, SHIRTS, GOLF SHIRTS, TOPS, CLOTHING ACCESSORIES, SOCKS, GLOVES, GOLF GLOVES, GOLF SHOES, MEN'S GOLF SHOES, LADIES' GOLF SHOES, JUNIOR'S GOLF SHOES, CHILDREN'S GOLF SHOES, SHOE LACES, SHOE CARE PRODUCTS, SHOE BAGS, GOLF GIFTS, GOLF SUPPLIES, AND GOLF ACCESSORIES (U.S. CLS. 100, 101 AND 102).

FIRST USE 3-1-2006; IN COMMERCE 3-1-2006.

CLASS 37—CONSTRUCTION AND REPAIR

FOR MAINTENANCE AND REPAIR OF GOLF CLUBS, GOLF CLUB COMPONENTS, GOLF CLUB ACCESSORIES, GOLF CLUB GRIPS, GOLF CLUB SHAFTS AND GOLF CLUB HEADS (U.S. CLS. 100, 103 AND 106).
FIRST USE 3-1-2006; IN COMMERCE 3-1-2006.

CLASS 41—EDUCATION AND ENTERTAINMENT

FOR ORGANIZING GOLF COURSE AND GOLF TOURNAMENT EXHIBITIONS; RENTAL SERVICES, NAMELY, RENTAL OF GOLF CLUBS AND GOLF EQUIPMENT; PHYSICAL FITNESS CONSULTATION, INSTRUCTION, TRAINING, CLASSES, SEMINARS, WORKSHOPS AND ONSITE GUIDANCE IN THE FIELDS OF GOLF, GOLF GAME IMPROVEMENT, AND GOLF SWING, AND DISTRIBUTING COURSE MATERIALS IN CONNECTION THEREWITH; VIDEO-TAPING AND VIDEOTAPE PRODUCTION IN THE FIELDS OF GOLF, GOLF GAME IMPROVEMENT, GOLF SWING, GOLF CLUBS, GOLF CLUB COMPONENTS, GOLF CLUB ACCESSORIES, GOLF CLUB GRIPS, GOLF CLUB SHAFTS, GOLF CLUB HEADS AND GOLF BALLS; FITTING OF GOLF CLUBS, GOLF CLUB COMPONENTS, GOLF CLUB ACCESSORIES, GOLF CLUB GRIPS, GOLF CLUB SHAFTS, GOLF CLUB HEADS AND GOLF BALLS TO INDIVIDUAL USERS; AND PROVIDING ONLINE INFORMATION VIA A GLOBAL COMPUTER NETWORK IN THE FIELDS OF GOLF, GOLF GAME IMPROVEMENT, GOLF SWING, AND NEWS RELATING TO GOLF (U.S. CLS. 100, 101 AND 107).

FIRST USE 3-1-2006; IN COMMERCE 3-1-2006.

3,786,299. CLEVER DEVICES LTD., PLAINVIEW, NY. SN 78-881,457. PUB. 8-21-2007, FILED 5-11-2006.

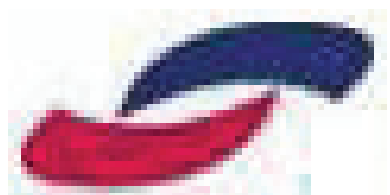

THE COLOR(S) RED AND BLUE IS/ARE CLAIMED AS A FEATURE OF THE MARK.

THE COLOR BLUE APPEARS ON THE UPPER SWOOSH DESIGN AND THE LOWER SWOOSH DESIGN APPEARS IN RED. THE DESIGN IS SET AGAINST A WHITE BACKGROUND WHICH IS NOT A CLAIMED COLOR.

CLASS 37—CONSTRUCTION AND REPAIR

FOR INSTALLATION AND MAINTENANCE OF COMPUTER HARDWARE FOR MASS TRANSIT SYSTEMS (U.S. CLS. 100, 103 AND 106).

FIRST USE 6-28-2005; IN COMMERCE 6-28-2005.

CLASS 42—SCIENTIFIC AND COMPUTER SERVICES

FOR INSTALLATION AND MAINTENANCE OF APPLICATION SOFTWARE FOR MASS TRANSIT SYSTEMS (U.S. CLS. 100 AND 101).

FIRST USE 6-28-2005; IN COMMERCE 6-28-2005.

3,786,300. THE ATEK COMPANIES, PLYMOUTH, MN. SN 78-882,240. PUB. 7-17-2007, FILED 5-12-2006.

ATEK Medical

THE MARK CONSISTS OF STANDARD CHARACTERS WITHOUT CLAIM TO ANY PARTICULAR FONT, STYLE, SIZE, OR COLOR.

NO CLAIM IS MADE TO THE EXCLUSIVE RIGHT TO USE "MEDICAL", APART FROM THE MARK AS SHOWN.

CLASS 35—ADVERTISING AND BUSINESS

FOR BUSINESS MANAGEMENT SERVICES, NAMELY, MANAGING LOGISTICS, REVERSE LOGISTICS, SUPPLY CHAIN SERVICES, SUPPLY CHAIN VISIBILITY AND SYNCHRONIZATION, SUPPLY AND DEMAND FORECASTING AND PRODUCT DISTRIBUTION PROCESSES FOR OTHERS (U.S. CLS. 100, 101 AND 102).

FIRST USE 2-11-2003; IN COMMERCE 2-11-2003.

CLASS 40—MATERIAL TREATMENT

FOR CONTRACT MANUFACTURING IN THE FIELD OF MEDICAL DEVICES AND EQUIPMENT, NAMELY, MANUFACTURING AND ASSEMBLY OF MEDICAL DEVICES AND EQUIPMENT FOR OTHERS (U.S. CLS. 100, 103 AND 106).

FIRST USE 2-11-2003; IN COMMERCE 2-11-2003.

CLASS 42—SCIENTIFIC AND COMPUTER SERVICES

FOR DESIGN ENGINEERING OF MEDICAL DEVICES AND EQUIPMENT AND PACKAGING DESIGN OF MEDICAL DEVICES AND EQUIPMENT FOR OTHERS (U.S. CLS. 100 AND 101).

FIRST USE 2-11-2003; IN COMMERCE 2-11-2003.

3,786,303. ALI WING, INC., NEW YORK, NY. SN 78-884,890. PUB. 3-4-2008, FILED 5-16-2006.

THE CRADLE

THE MARK CONSISTS OF STANDARD CHARACTERS WITHOUT CLAIM TO ANY PARTICULAR FONT, STYLE, SIZE, OR COLOR.

CLASS 38—COMMUNICATION

FOR PROVIDING AN INTERACTIVE ON-LINE FORUM FOR TRANSMISSION OF MESSAGES AMONG COMPUTER USERS CONCERNING INFORMATION OF INTEREST TO EXPECTANT PARENTS RELATING TO EXPERIENCES WITH AND INFORMATION ABOUT BABIES; PROVIDING TOOLS FOR EXPECTANT AND NEW PARENTS, NAMELY, PROVIDING ON-LINE ELECTRONIC BULLETIN BOARDS FOR TRANSMISSION OF MESSAGES AMONG COMPUTER USERS CONCERNING BABY NAMES, INFANT PHOTO GALERIES, ONLINE BIRTH ANNOUNCEMENTS, AND GIFT REGISTRY INFORMATION (U.S. CLS. 100, 101 AND 104).

FIRST USE 11-1-2007; IN COMMERCE 11-1-2007.

CLASS 44—MEDICAL, BEAUTY AND AGRICULTURAL SERVICES

FOR PROVIDING PREGNANCY AND BABY RELATED INFORMATION TO EXPECTANT MOTHERS IN THE FIELD OF PREGNANCY-RELATED AND BABY HEALTHCARE (U.S. CLS. 100 AND 101).

FIRST USE 11-1-2007; IN COMMERCE 11-1-2007.

3,786,313. ACTIVE ORGANICS, LP, LEWISVILLE, TX. SN 78-907,268. PUB. 1-16-2007, FILED 6-13-2006.

ACTIPEEL

THE MARK CONSISTS OF STANDARD CHARACTERS WITHOUT CLAIM TO ANY PARTICULAR FONT, STYLE, SIZE, OR COLOR.

CLASS 1—CHEMICALS

FOR CHEMICALS FOR USE IN THE MANUFACTURE OF COSMETIC AND PERSONAL CARE PRODUCTS (U.S. CLS. 1, 5, 6, 10, 26 AND 46).

FIRST USE 2-11-2010; IN COMMERCE 2-11-2010.

CLASS 3—COSMETICS AND CLEANING PREPARATIONS

FOR NON-MEDICATED SKIN CARE PREPARATIONS, NAMELY, SERUMS, LOTIONS, CREAMS AND GELS (U.S. CLS. 1, 4, 6, 50, 51 AND 52).

FIRST USE 2-11-2010; IN COMMERCE 2-11-2010.

3,786,318. LUCASFILM ENTERTAINMENT COMPANY LTD., SAN FRANCISCO, CA. SN 78-918,344. PUB. 8-21-2007, FILED 6-27-2006.

THE FORCE UNLEASHED

THE MARK CONSISTS OF STANDARD CHARACTERS WITHOUT CLAIM TO ANY PARTICULAR FONT, STYLE, SIZE, OR COLOR.

CLASS 9—ELECTRICAL AND SCIENTIFIC APPARATUS

FOR INTERACTIVE ENTERTAINMENT SOFTWARE AND ACCOMPANYING INSTRUCTION MANUALS SOLD AS A UNIT, NAMELY, COMPUTER GAME SOFTWARE AND MANUALS SOLD AS A UNIT, VIDEO GAME SOFTWARE AND MANUALS SOLD AS A UNIT, INTERACTIVE VIDEO GAME PROGRAMS, INTERACTIVE COMPUTER GAME PROGRAMS; AND PRE-RECORDED CD-ROMS AND DVDS FEATURING GAMES, FILMS, AND MUSIC, COMPUTER GAME SOFTWARE, VIDEO GAME SOFTWARE, DOWNLOADABLE COMPUTER GAME SOFTWARE, DOWNLOADABLE INTERACTIVE ENTERTAINMENT SOFTWARE FOR PLAYING COMPUTER GAMES, AND DOWNLOADABLE INTERACTIVE ENTERTAINMENT SOFTWARE FOR PLAYING COMPUTER GAMES AND VIDEO GAMES (U.S. CLS. 21, 23, 26, 36 AND 38).

FIRST USE 9-16-2008; IN COMMERCE 9-16-2008.

CLASS 41—EDUCATION AND ENTERTAINMENT

FOR ENTERTAINMENT SERVICES, NAMELY, PROVIDING INFORMATION RELATING TO INTERACTIVE COMPUTER GAME SOFTWARE, INTERACTIVE VIDEO GAME SOFTWARE, INTERACTIVE COMPUTER GAMES AND INTERACTIVE VIDEO GAMES ALL VIA LOCAL AREA NETWORKS AND THE GLOBAL COMPUTER INFORMATION NETWORK; PROVIDING ON-LINE NEWS AND INFORMATION RELATING TO INTERACTIVE COMPUTER GAME SOFTWARE, INTERACTIVE VIDEO GAME SOFTWARE, INTERACTIVE COMPUTER GAMES AND INTERACTIVE VIDEO GAMES ALL RELATING TO SCIENCE FICTION; FAN CLUB SERVICES (U.S. CLS. 100, 101 AND 107).

FIRST USE 9-16-2008; IN COMMERCE 9-16-2008.

3,786,323. MASTERBRAND CABINETS, INC., JASPER, IN. SN 78-929,613. PUB. 6-19-2007, FILED 7-14-2006.

BENNER-ROSS

THE MARK CONSISTS OF STANDARD CHARACTERS WITHOUT CLAIM TO ANY PARTICULAR FONT, STYLE, SIZE, OR COLOR.

CLASS 19—NON-METALLIC BUILDING MATERIALS

FOR MODULAR CLOSETS FOR RESIDENTIAL BUILDINGS (U.S. CLS. 1, 12, 33 AND 50).

FIRST USE 4-7-2006; IN COMMERCE 9-1-2006.

CLASS 20—FURNITURE AND ARTICLES NOT OTHERWISE CLASSIFIED

FOR STORAGE CABINETS AND DRAWERS FOR USE IN RESIDENTIAL BUILDINGS (U.S. CLS. 2, 13, 22, 25, 32 AND 50).

FIRST USE 4-7-2006; IN COMMERCE 9-1-2006.

3,786,328. SAGENTIA LTD, CAMBRIDGESHIRE, UNITED KINGDOM. SN 78-946,616. PUB. 5-26-2009, FILED 8-7-2006.

MANY MINDS MAKE BRIGHT WORK

THE MARK CONSISTS OF STANDARD CHARACTERS WITHOUT CLAIM TO ANY PARTICULAR FONT, STYLE, SIZE, OR COLOR.

PRIORITY CLAIMED UNDER SEC. 44(D) ON ERP N CMNTY TM OFC APPLICATION NO. 005239132, FILED 8-3-2006, REG. NO. 005239132, DATED 8-3-2006, EXPIRES 8-3-2016.

CLASS 35—ADVERTISING AND BUSINESS

FOR ADVERTISING AND ADVERTISEMENT SERVICES; BUSINESS MANAGEMENT; BUSINESS ADMINISTRATION AND MANAGEMENT; PROVIDING OFFICE FUNCTIONS; BUSINESS ADMINISTRATION CONSULTANCY; BUSINESS MANAGEMENT CONSULTANCY AND CONSULTANCY SERVICES REGARDING BUSINESS STRATEGIES; BUSINESS CONSULTANCY SERVICES RELATING TO MANUFACTURING; BUSINESS CONSULTANCY TO FIRMS; BUSINESS CONSULTANCY TO INDIVIDUALS; CONSULTANCY RELATING TO BUSINESS ACQUISITION; PROFESSIONAL CONSULTANCY RELATING TO BUSINESS MATTERS; STRATEGIC BUSINESS CONSULTANCY; BUSINESS RESEARCH FOR NEW SERVICES; RESEARCH SERVICES RELATING TO ADVERTISING; RESEARCH SERVICES RELATING TO BUSINESS; RESEARCH SERVICES RELATING TO MARKETING; ADVISORY SERVICES RELATING TO MARKET RESEARCH; ANALYSIS OF MARKET RESEARCH DATA; BUSINESS RESEARCH; BUSINESS RESEARCH FOR NEW BUSINESSES; COLLECTION OF MARKET RESEARCH INFORMATION; COMPUTERIZED BUSINESS RESEARCH; CONDUCTING OF BUSINESS AND MARKET RESEARCH; MARKET RESEARCH CONSULTATION, NAMELY, INTERPRETATION OF MARKET RESEARCH DATA; MARKET RESEARCH; MARKET RESEARCH DATA COLLECTION SERVICES; MARKET RESEARCH SERVICES FOR PUBLISHERS; MARKET RESEARCH SERVICES RELATING TO BROADCAST MEDIA; BUSINESS INFORMATION SERVICES, NAMELY, RESEARCH OF BUSINESS INFORMATION; BUSINESS CONSULTANCY RELATING TO INFORMATION TECHNOLOGY; COMPILATION OF STATISTICAL DATA FOR USE IN SCIENTIFIC RESEARCH; BUSINESS CONSULTING, MANAGEMENT AND SUPERVISION IN THE FIELD OF THE DEVELOPMENT ACQUISITION, AND LICENSING OF INTELLECTUAL PROPERTY RIGHTS, INVENTIONS, PATENTS, TRADEMARKS, COPYRIGHTS AND TRADE SECRETS; CONSULTANCY, ADVISORY AND INFORMATION SERVICES RELATING TO THE AFORESAID SERVICES (U.S. CLS. 100, 101 AND 102).

FIRST USE 10-23-2006; IN COMMERCE 10-23-2006.

CLASS 42—SCIENTIFIC AND COMPUTER SERVICES

FOR SCIENTIFIC AND TECHNOLOGICAL SERVICES AND RESEARCH AND DESIGN FOR OTHERS, NAMELY, PRODUCT RESEARCH, PRODUCT DESIGN, PRODUCT DEVELOPMENT, INDUSTRIAL RESEARCH, INDUSTRIAL ANALYSIS, AND TECHNOLOGICAL CONSULTATION FOR PRODUCT DESIGN AND DEVELOPMENT IN THE FIELD OF CONSUMER PRODUCTS, DOMESTIC APPLIANCES, HOUSEHOLD PRODUCTS, PERSONAL CARE PRODUCTS, TOYS, GAMES AND SPORTING GOODS, FOOD AND BEVERAGE PRODUCTS, MEDICAL DEVICES AND PRODUCTS, TELECOMMUNICATION AND MEDIA PRODUCTS, ENERGY, CHEMICALS, COMPUTERS, AND SOFTWARE, INDUSTRIAL PRODUCTS, OFFICE PRODUCTS, EDUCATION AND EDUCATIONAL PRODUCTS, GOVERNMENT POLICIES AND ECONOMIC

DEVELOPMENT, INDUSTRIAL ANALYSIS AND RESEARCH SERVICES, NAMELY, RESEARCH AND DEVELOPMENT FOR NEW PRODUCTS FOR OTHERS; INDUSTRIAL ANALYSIS AND RESEARCH SERVICES, IN THE FIELD OF CONSUMER PRODUCTS, DOMESTIC APPLIANCES, HOUSEHOLD PRODUCTS, PERSONAL CARE PRODUCTS, TOYS, GAMES AND SPORTING GOODS, FOOD AND BEVERAGE PRODUCTS, MEDICAL DEVICES AND PRODUCTS, TELECOMMUNICATION AND MEDIA PRODUCTS, ENERGY, CHEMICALS, COMPUTERS, AND SOFTWARE, INDUSTRIAL PRODUCTS, OFFICE PRODUCTS, EDUCATION AND EDUCATIONAL PRODUCTS, GOVERNMENT POLICIES AND ECONOMIC DEVELOPMENT, DESIGN AND DEVELOPMENT OF COMPUTER HARDWARE AND SOFTWARE; ADVISORY SERVICES IN THE FIELD OF SCIENTIFIC RESEARCH; ADVISORY SERVICES RELATING TO TECHNOLOGICAL RESEARCH; CONSULTANCY SERVICES RELATING TO TECHNOLOGICAL RESEARCH; PROVISION OF RESEARCH SERVICES IN THE FIELD OF PRODUCT DEVELOPMENT, CONSUMER PRODUCTS, DOMESTIC APPLIANCES, HOUSEHOLD APPLIANCES, PERSONAL CARE PRODUCTS, TOYS, GAMES AND SPORTING GOODS, FOOD AND BEVERAGE PRODUCTS, MEDICAL DEVICES AND PRODUCTS, TELECOMMUNICATION AND MEDIA PRODUCTS, ENERGY, CHEMICALS, COMPUTERS, AND SOFTWARE, INDUSTRIAL PRODUCTS, OFFICE PRODUCTS, EDUCATION AND EDUCATIONAL PRODUCTS, GOVERNMENT POLICIES AND ECONOMIC DEVELOPMENT; ADVISORY SERVICES RELATING TO SCIENTIFIC APPARATUS, NAMELY, MEDICAL DEVICES AND PRODUCTS, MEDICAL DIAGNOSTIC DEVICES AND PRODUCTS, PHARMACEUTICALS, DRUG DELIVERY DEVICES AND PRODUCTS; MANAGEMENT OF SCIENTIFIC RESEARCH PROJECTS; PREPARATION OF SCIENTIFIC REPORTS, PROVISION OF SCIENTIFIC REPORTS; PROVISION OF SCIENTIFIC INFORMATION; PROVISION OF SCIENTIFIC INFORMATION RELATING TO THE CHEMICAL INDUSTRY; SCIENTIFIC CONSULTANCY IN THE FIELD OF MEDICAL DEVICES AND PRODUCTS, MEDICAL DIAGNOSTIC DEVICES AND PRODUCTS, DRUG DELIVERY DEVICES AND PRODUCTS, PHARMACEUTICAL PRODUCTS, OFFICE PRODUCTS, EDUCATION AND EDUCATION PRODUCTS, GOVERNMENT POLICIES AND ECONOMIC DEVELOPMENT, AND PRODUCT DEVELOPMENT; SCIENTIFIC RESEARCH; SCIENTIFIC RESEARCH IN THE FIELD OF PHARMACY; SCIENTIFIC RESEARCH INTO THE DEVELOPMENT OF NEW PRODUCTS; SCIENTIFIC RESEARCH TO BACTERIOLOGY; SCIENTIFIC RESEARCH RELATING TO BIOLOGY; SCIENTIFIC RESEARCH RELATING TO CHEMICAL PRODUCTS; SCIENTIFIC RESEARCH RELATING TO CHEMISTRY; SCIENTIFIC RESEARCH RELATING TO COSMETICS; SCIENTIFIC RESEARCH RELATING TO DERMATOLOGICAL PRODUCTS; SCIENTIFIC RESEARCH RELATING TO ECOLOGY; SCIENTIFIC RESEARCH RELATING TO GENETICS; SCIENTIFIC TESTING SERVICES IN THE FIELD OF MEDICAL DEVICES AND PRODUCTS, MEDICAL DIAGNOSTIC DEVICES AND PRODUCTS, DRUG DELIVERY DEVICES AND PRODUCTS, PHARMACEUTICAL PRODUCTS, INDUSTRIAL PRODUCTS, OFFICE PRODUCTS, EDUCATION AND EDUCATIONAL PRODUCTS, GOVERNMENT POLICIES AND ECONOMIC DEVELOPMENT; COMPILATION OF INFORMATION RELATING TO INFORMATION TECHNOLOGY; CONSULTANCY SERVICES RELATING TO INFORMATION TECHNOLOGY; ENGINEERING SERVICES RELATING TO DATA PROCESSING TECHNOLOGY; ENGINEERING SERVICES RELATING TO INFORMATION TECHNOLOGY; EXPERT ADVICE RELATING TO TECHNOLOGY, NAMELY, ADVISING WHICH TECHNOLOGY TO USE, ASSESSING HOW TECHNOLOGY WILL AFFECT A BUSINESS IN THE FUTURE, ASSESSING THE PERFORMANCE OR THE APPLICABILITY OF TECHNOLOGIES, CREATING AND INNOVATING NEW TECHNOLOGIES, DEVELOPING PRODUCTS OR SERVICES BASED UPON TECHNOLOGY, USING TECHNOLOGY TO REDUCE THE COST OF PRODUCTS AND SERVICES, AND IDENTIFYING NEW BUSINESS OPPORTUNITIES ENABLED BY TECHNOLOGY; EXPERT REPORTING SERVICES RELATING TO TECHNOLOGY, NAMELY, REPORTING WHICH TECHNOLOGY TO USE, REPORTING HOW TECHNOLOGY WILL AFFECT A BUSINESS IN THE FUTURE, REPORTING THE PERFORMANCE OR APPLICABILITY OF TECHNOLOGIES, AND REPORTING ON HOW TO USE TECHNOL-

OGY TO REDUCE THE COST OF PRODUCTS AND SERVICES; PROFESSIONAL CONSULTANCY RELATING TO TECHNOLOGY, NAMELY, CONSULTING ON WHICH TO TECHNOLOGY TO USE, HOW TECHNOLOGY WILL AFFECT A BUSINESS IN THE FUTURE, THE PERFORMANCE OR APPLICABILITY OF TECHNOLOGIES, CREATING AND INNOVATING NEW TECHNOLOGIES, DEVELOPING PRODUCTS OR SERVICES BASED UPON TECHNOLOGY, USING TECHNOLOGY TO REDUCE THE COST OF PRODUCTS AND SERVICES, IDENTIFYING NEW BUSINESS OPPORTUNITIES ENABLED BY TECHNOLOGY AND ENGINEERING CONSULTANCY; PROFESSIONAL CONSULTANCY RELATING TO INFORMATION TECHNOLOGY; RESEARCH FOR OTHERS RELATING TO TECHNOLOGY, NAMELY, RESEARCHING WHICH TECHNOLOGY TO USE, HOW TECHNOLOGY WILL AFFECT A BUSINESS IN THE FUTURE, THE PERFORMANCE OR APPLICABILITY OF TECHNOLOGIES, CREATING AND INNOVATING NEW TECHNOLOGIES, DEVELOPING PRODUCTS OR SERVICES BASED UPON TECHNOLOGY, USING TECHNOLOGY TO REDUCE THE COST OF PRODUCTS AND SERVICES, AND IDENTIFYING NEW BUSINESS OPPORTUNITIES ENABLED BY TECHNOLOGY; BIOCHEMISTRY RESEARCH SERVICES; BIOLOGICAL RESEARCH SERVICES; BIOTECHNOLOGICAL RESEARCH; BIOTECHNOLOGICAL RESEARCH RELATING TO INDUSTRY; BIOTECHNOLOGICAL RESEARCH RELATING TO THE PETROLEUM INDUSTRY; CHEMICAL TECHNOLOGICAL RESEARCH; CONSULTANCY SERVICES RELATING TO RESEARCH INTO THE DEVELOPMENT OF SURGICAL PRODUCTS; ENGINEERING RESEARCH; INDUSTRIAL PROCESS RESEARCH; INDUSTRIAL RESEARCH IN THE FIELD OF PRODUCT DEVELOPMENT, CONSUMER PRODUCTS, DOMESTIC APPLIANCES, HOUSEHOLD PRODUCTS, PERSONAL CARE PRODUCTS, TOYS, GAMES AND SPORTING GOODS, FOOD AND BEVERAGE PRODUCTS, MEDICAL DEVICES AND PRODUCTS, TELECOMMUNICATION AND MEDIA PRODUCTS, ENERGY, CHEMICALS, COMPUTERS, AND SOFTWARE, INDUSTRIAL PRODUCTS, OFFICE PRODUCTS, EDUCATION AND EDUCATIONAL PRODUCTS, GOVERNMENT POLICIES AND ECONOMIC DEVELOPMENT; LABORATORY RESEARCH IN THE FIELD OF CONSUMER PRODUCTS, DOMESTIC APPLIANCES, HOUSEHOLD PRODUCTS, PERSONAL CARE PRODUCTS, TOYS, GAMES AND SPORTING GOODS, FOOD AND BEVERAGE PRODUCTS, MEDICAL DEVICES AND PRODUCTS, TELECOMMUNICATION AND MEDIA PRODUCTS, ENERGY, CHEMICALS, COMPUTERS, AND SOFTWARE, INDUSTRIAL PRODUCTS, OFFICE PRODUCTS, EDUCATION AND EDUCATIONAL PRODUCTS, GOVERNMENT POLICIES AND ECONOMIC DEVELOPMENT; MECHANICAL RESEARCH; MEDICAL RESEARCH; PHARMACEUTICAL RESEARCH SERVICES; PREPARATION OF REPORTS RELATING TO SCIENTIFIC RESEARCH; PREPARATION OF REPORTS RELATING TO TECHNICAL RESEARCH; RESEARCH AND DEVELOPMENT FOR OTHERS IN THE FIELD OF CONSUMER PRODUCTS, DOMESTIC APPLIANCES, HOUSEHOLD PRODUCTS, PERSONAL CARE PRODUCTS, TOYS, GAMES AND SPORTING GOODS, FOOD AND BEVERAGE PRODUCTS, MEDICAL DEVICES AND PRODUCTS, TELECOMMUNICATION AND MEDIA PRODUCTS, ENERGY, CHEMICALS, COMPUTERS, AND SOFTWARE, INDUSTRIAL PRODUCTS, OFFICE PRODUCTS, EDUCATION AND EDUCATIONAL PRODUCTS, GOVERNMENT POLICIES AND ECONOMIC DEVELOPMENT; RESEARCH INTO NEW PRODUCTS; RESEARCH RELATING TO BIOTECHNOLOGY; RESEARCH RELATING TO INDUSTRIAL MACHINERY; RESEARCH RELATING TO MECHANICAL ENGINEERING; RESEARCH RELATING TO MEDICINE; RESEARCH RELATING TO PHARMACEUTICALS; RESEARCH RELATING TO SCIENCE; RESEARCH RELATING TO TELECOMMUNICATION TECHNIQUES; RESEARCH TO DEVELOP NEW PRODUCTS; SCIENTIFIC RESEARCH INTO THE DEVELOPMENT OF NEW PRODUCTS; TECHNOLOGICAL RESEARCH; PRODUCT DEVELOPMENT; ADVISING RELATING TO EXPLOITATION OF TECHNOLOGY, NAMELY, ADVISING WHICH TECHNOLOGY TO USE, ASSESSING HOW TECHNOLOGY WILL AFFECT A BUSINESS IN THE FUTURE, ASSESSING THE PERFORMANCE OR APPLICABILITY OF TECHNOLOGIES, CREATING AND INNOVATING TECHNOLOGIES, DEVELOPING PRODUCTS OR SERVICES BASED UPON TECHNOLOGY, USING TECH-

NOLOGY TO REDUCE THE COST OF PRODUCTS AND SERVICES, AND IDENTIFYING NEW BUSINESS OPPORTUNITIES ENABLED BY TECHNOLOGY; DEVELOPING NEW TECHNOLOGY FOR OTHERS IN THE FIELD OF CONSUMER PRODUCTS, DOMESTIC APPLIANCES, HOUSEHOLD PRODUCTS, PERSONAL CARE PRODUCTS, TOYS, GAMES AND SPORTING GOODS, FOOD AND BEVERAGE PRODUCTS, MEDICAL DEVICES AND PRODUCTS, TELECOMMUNICATION AND MEDIA PRODUCTS, ENERGY, CHEMICALS, COMPUTERS, AND SOFTWARE, INDUSTRIAL PRODUCTS, OFFICE PRODUCTS, EDUCATION AND EDUCATIONAL PRODUCTS, GOVERNMENT POLICIES AND ECONOMIC DEVELOPMENT; PREPARATION OF STATISTICS FOR SCIENTIFIC RESEARCH; CONSULTANCY, ADVISORY AND INFORMATION SERVICES RELATING TO THE AFORESAID SERVICES (U.S. CLS. 100 AND 101).

FIRST USE 10-23-2006; IN COMMERCE 10-23-2006.

CLASS 45—PERSONAL AND LEGAL SERVICES

FOR COMMERCIALIZATION OF INTELLECTUAL PROPERTY RIGHTS, NAMELY, LICENSING INTELLECTUAL PROPERTY RIGHTS; PROVIDING LEGAL ADVICE RELATING TO EXPLOITATION OF INTELLECTUAL PROPERTY; INTELLECTUAL PROPERTY CONSULTING AND RESEARCH, PLANNING, AND ANALYSIS; LICENSING OF TECHNOLOGY IN THE FIELD OF CONSUMER PRODUCTS, DOMESTIC APPLIANCES, HOUSEHOLD PRODUCTS, PERSONAL CARE PRODUCTS, TOYS, GAMES AND SPORTING GOODS, FOOD AND BEVERAGE PRODUCTS, MEDICAL DEVICES AND PRODUCTS, TELECOMMUNICATION AND MEDIA PRODUCTS, ENERGY, CHEMICALS, COMPUTERS, AND SOFTWARE, INDUSTRIAL PRODUCTS, OFFICE PRODUCTS, EDUCATION AND EDUCATIONAL PRODUCTS, GOVERNMENT POLICIES AND ECONOMIC DEVELOPMENT; INDUSTRIAL ANALYSIS AND RESEARCH SERVICES, NAMELY, RESEARCH AND DEVELOPMENT FOR NEW PRODUCTS FOR OTHERS; INDUSTRIAL ANALYSIS AND RESEARCH SERVICES, IN THE FIELD OF CONSUMER PRODUCTS, DOMESTIC APPLIANCES, HOUSEHOLD PRODUCTS, PERSONAL CARE PRODUCTS, TOYS, GAMES AND SPORTING GOODS, FOOD AND BEVERAGE PRODUCTS, MEDICAL DEVICES AND PRODUCTS, TELECOMMUNICATION AND MEDIA PRODUCTS, ENERGY, CHEMICALS, COMPUTERS, AND SOFTWARE, INDUSTRIAL PRODUCTS, OFFICE PRODUCTS, EDUCATION AND EDUCATIONAL PRODUCTS, GOVERNMENT POLICIES AND ECONOMIC DEVELOPMENT; LICENSING OF INTELLECTUAL PROPERTY IN THE FIELD OF RESEARCH AND DEVELOPMENT; LEGAL SERVICES; LEGAL INFORMATION RESEARCH SERVICES; CONSULTANCY RELATING TO INTELLECTUAL PROPERTY; ADVISORY SERVICES RELATING TO INTELLECTUAL PROPERTY RIGHTS; ADVISORY SERVICES RELATING TO INTERNATIONAL REGULATIONS CONCERNING TECHNOLOGY TRANSFER; LICENSING OF INTELLECTUAL PROPERTY; RESEARCH RELATING TO INTELLECTUAL PROPERTY; AND LICENSING OF TECHNOLOGY RELATING TO MANUFACTURE; LICENSING OF RESEARCH AND DEVELOPMENT IN THE FIELD OF CONSUMER PRODUCTS, DOMESTIC APPLIANCES, HOUSEHOLD PRODUCTS, PERSONAL CARE PRODUCTS, TOYS, GAMES AND SPORTING GOODS, FOOD AND BEVERAGE PRODUCTS, MEDICAL DEVICES AND PRODUCTS, TELECOMMUNICATION AND MEDIA PRODUCTS, ENERGY, CHEMICALS, COMPUTERS, AND SOFTWARE, INDUSTRIAL PRODUCTS, OFFICE PRODUCTS, EDUCATION AND EDUCATIONAL PRODUCTS, GOVERNMENT POLICIES AND ECONOMIC DEVELOPMENT; INDUSTRIAL ANALYSIS AND RESEARCH SERVICES, NAMELY, RESEARCH AND DEVELOPMENT FOR NEW PRODUCTS FOR OTHERS (U.S. CLS. 100 AND 101).

FIRST USE 10-23-2006; IN COMMERCE 10-23-2006.

3,786,329. VEER CORPORATION, CALGARY, CANADA. SN 78-947,934. PUB. 5-19-2009, FILED 8-8-2006.

SOMOS

THE MARK CONSISTS OF STANDARD CHARACTERS WITHOUT CLAIM TO ANY PARTICULAR FONT, STYLE, SIZE, OR COLOR.

PRIORITY CLAIMED UNDER SEC. 44(D) ON CANADA APPLICATION NO. 1305905, FILED 6-19-2006, REG. NO. TMA705566, DATED 1-24-2008, EXPIRES 1-24-2023.

THE FOREIGN WORDING IN THE MARK TRANSLATES INTO ENGLISH AS WE ARE.

CLASS 38—COMMUNICATION

FOR ELECTRONIC DELIVERY OF VISUAL MEDIA IN THE FORM OF STOCK PHOTOGRAPHS, ARCHIVAL PHOTOGRAPHS, REPRODUCTIONS OF WORKS OF ART, ILLUSTRATIONS AND GRAPHIC DESIGNS VIA A GLOBAL COMPUTER NETWORK (U.S. CLS. 100, 101 AND 104).

FIRST USE 7-1-2007; IN COMMERCE 7-1-2007.

CLASS 45—PERSONAL AND LEGAL SERVICES

FOR STOCK PHOTOGRAPHY SERVICES, NAMELY, LEASING REPRODUCTION RIGHTS OF DIGITAL IMAGES, STOCK PHOTOGRAPHS, ARCHIVAL PHOTOGRAPHS, REPRODUCTIONS OF WORKS OF ART, ILLUSTRATIONS AND GRAPHIC DESIGNS (U.S. CLS. 100 AND 101).

FIRST USE 7-1-2007; IN COMMERCE 7-1-2007.

3,786,332. IBIS BIOSCIENCES, INC., CARLSBAD, CA. SN 78-951,840. PUB. 7-24-2007, FILED 8-14-2006.

T5000

THE MARK CONSISTS OF STANDARD CHARACTERS WITHOUT CLAIM TO ANY PARTICULAR FONT, STYLE, SIZE, OR COLOR.

CLASS 42—SCIENTIFIC AND COMPUTER SERVICES

FOR SCIENTIFIC AND TECHNOLOGICAL RESEARCH SERVICES IN THE AREAS OF ANALYSIS OF NUCLEIC ACID SEQUENCES, NUCLEIC ACIDS, GENETIC MATERIALS, INFECTIOUS AGENTS AND/OR PATHOGENS; IDENTIFICATION OF NUCLEIC ACID SEQUENCES, NUCLEIC ACIDS, GENETIC MATERIALS, INFECTIOUS AGENTS AND/OR PATHOGENS; DEVELOPMENT FOR OTHERS AND LEASING TO OTHERS OF BIOSENSOR SYSTEMS FOR ANALYSIS OF NUCLEIC ACID SEQUENCES, NUCLEIC ACIDS, GENETIC MATERIALS, INFECTIOUS AND/OR PATHOGENS, AND PARTS THEREFOR, FOR SCIENTIFIC AND RESEARCH USE; DEVELOPMENT FOR OTHERS AND LEASING TO OTHERS OF BIOSENSOR SYSTEMS FOR IDENTIFICATION OF NUCLEIC ACID SEQUENCES, NUCLEIC ACIDS, GENETIC MATERIALS, INFECTIOUS AND/OR PATHOGENS, AND PARTS THEREFOR, FOR SCIENTIFIC AND RESEARCH USE; DEVELOPMENT FOR OTHERS AND LEASING TO OTHERS OF TEST AND COLLECTION DEVICES AND KITS FOR ANALYSIS OF NUCLEIC ACID SEQUENCES, NUCLEIC ACIDS, GENETIC MATERIALS, INFECTIOUS AGENTS AND/OR PATHOGENS; DEVELOPMENT FOR OTHERS AND LEASING TO OTHERS OF COMPUTER SOFTWARE AND HARDWARE FOR ANALYSIS OF NUCLEIC ACID SEQUENCES, NUCLEIC ACIDS, GENETIC MATERIALS, INFECTIOUS AGENTS AND/OR PATHOGENS; DEVELOPMENT FOR OTHERS AND LEASING TO OTHERS OF COMPUTER SOFTWARE AND HARDWARE FOR IDENTIFICATION OF NUCLEIC ACID SEQUENCES, NUCLEIC ACIDS, GENETIC MATERIALS, INFECTIOUS AGENTS AND/OR PATHOGENS; DEVELOPMENT FOR OTHERS OF BIOSENSOR SYSTEMS FOR ANALYSIS OF NUCLEIC ACID SEQUENCES, NUCLEIC ACIDS, GENETIC MATERIALS, INFECTIOUS AND/OR PATHOGENS, AND PARTS THEREFOR, FOR MEDICAL USE; DEVELOPMENT FOR OTHERS OF BIOSENSOR SYSTEMS FOR IDENTIFICATION OF NUCLEIC ACID SEQUENCES, NUCLEIC ACIDS, GENETIC MATERIALS, INFECTIOUS AND/OR PATHOGENS, AND PARTS THEREFOR, FOR MEDICAL USE; DEVELOPMENT FOR OTHERS OF TEST AND COLLECTION DEVICES AND KITS FOR ANALYSIS OF NUCLEIC ACID SEQUENCES, NUCLEIC ACIDS, GENETIC MATERIALS, INFECTIOUS AND/OR PATHOGENS FOR MEDICAL USE; DEVELOPMENT FOR OTHERS OF TEST AND COLLECTION DEVICES AND KITS FOR IDENTIFICATION OF NUCLEIC ACID SEQUENCES, NUCLEIC ACIDS, GENETIC MATERIALS, INFECTIOUS AND/OR PATHOGENS FOR MEDICAL USE (U.S. CLS. 100 AND 101).

FIRST USE 11-30-2006; IN COMMERCE 9-30-2007.

CLASS 44—MEDICAL, BEAUTY AND AGRICULTURAL SERVICES

FOR LEASING TO OTHERS OF BIOSENSOR SYSTEMS FOR ANALYSIS OF NUCLEIC ACID SEQUENCES, NUCLEIC ACIDS, GENETIC MATERIALS, INFECTIOUS AND/OR PATHOGENS, AND PARTS THEREFOR, FOR MEDICAL USE; LEASING TO OTHERS OF BIOSENSOR SYSTEMS FOR IDENTIFICATION OF NUCLEIC ACID SEQUENCES, NUCLEIC ACIDS, GENETIC MATERIALS, INFECTIOUS AND/OR PATHOGENS, AND PARTS THEREFOR, FOR MEDICAL USE; LEASING TO OTHERS OF TEST AND COLLECTION DEVICES AND KITS FOR ANALYSIS OF NUCLEIC ACID SEQUENCES, NUCLEIC ACIDS, GENETIC MATERIALS, INFECTIOUS AND/OR PATHOGENS FOR MEDICAL USE; LEASING TO OTHERS OF TEST AND COLLECTION DEVICES AND KITS FOR IDENTIFICATION OF NUCLEIC ACID SEQUENCES, NUCLEIC ACIDS, GENETIC MATERIALS, INFECTIOUS AND/OR PATHOGENS FOR MEDICAL USE (U.S. CLS. 100 AND 101).

FIRST USE 11-30-2006; IN COMMERCE 9-30-2007.

3,786,341. ANI BIOTECH OY, 00100 HELSINKI, FINLAND.
SN 78-981,216. PUB. 11-11-2008, FILED 5-16-2006.

MYSET

THE MARK CONSISTS OF STANDARD CHARACTERS WITHOUT CLAIM TO ANY PARTICULAR FONT, STYLE, SIZE, OR COLOR.

CLASS 5—PHARMACEUTICALS

FOR DIAGNOSTIC PREPARATIONS FOR MEDICAL USE, BUT NOT INCLUDING CANCER OR ONCOLOGY RELATED DIAGNOSTICS; DIAGNOSTIC AGENTS, AND PREPARATIONS FOR MEDICAL PURPOSES, BUT NOT INCLUDING CANCER OR ONCOLOGY RELATED DIAGNOSTICS (U.S. CLS. 6, 18, 44, 46, 51 AND 52).

FIRST USE 7-7-2009; IN COMMERCE 7-7-2009.

CLASS 9—ELECTRICAL AND SCIENTIFIC APPARATUS

FOR DIAGNOSTIC RAPID TEST KITS COMPRISED OF A LATERAL FLOW TEST DEVICE, SAMPLING STICK, AND INSTRUCTIONS FOR USE FOR LABORATORY USE, BUT NOT INCLUDING CANCER OR ONCOLOGY RELATED DIAGNOSTICS (U.S. CLS. 21, 23, 26, 36 AND 38).

FIRST USE 7-7-2009; IN COMMERCE 7-7-2009.

CLASS 10—MEDICAL APPARATUS

FOR MEDICAL DIAGNOSTIC APPARATUS, NAMELY, COLORIMETRIC PARTICLES READING INSTRUMENTS FOR DIAGNOSING FERTILITY; DIAGNOSTIC RAPID TEST KITS COMPRISED OF A LATERAL FLOW TEST DEVICE, SAMPLING STICK, AND INSTRUCTIONS FOR USE FOR LABORATORY, PHYSICIAN OFFICE AND HOME USE, ALL FOR MEDICAL PURPOSES, BUT NOT INCLUDING CANCER OR ONCOLOGY RELATED DIAGNOSTICS (U.S. CLS. 26, 39 AND 44).

FIRST USE 7-7-2009; IN COMMERCE 7-7-2009.

3,786,345. PANASONIC CORPORATION OF NORTH AMERICA, SECAUCUS, NJ. SN 78-981,341. PUB. 12-18-2007, FILED 5-17-2006.

IDEAS FOR LIFE

THE MARK CONSISTS OF STANDARD CHARACTERS WITHOUT CLAIM TO ANY PARTICULAR FONT, STYLE, SIZE, OR COLOR.

OWNER OF U.S. REG. NOS. 2,882,770, 3,117,492, AND OTHERS.

CLASS 7—MACHINERY

FOR VACUUM CLEANERS FOR HOME USE (U.S. CLS. 13, 19, 21, 23, 31, 34 AND 35).

FIRST USE 10-31-2002; IN COMMERCE 10-31-2002.

CLASS 9—ELECTRICAL AND SCIENTIFIC APPARATUS

FOR PLASMA DISPLAY PANELS; COMPUTER, TELEVISION, AND VIDEO MONITORS; CD PLAYERS; SEMI-CONDUCTORS; CORDLESS ELECTRIC IRONS; PERSONAL STEREOS, RADIOS INCORPORATING DIGITAL CLOCKS, PORTABLE RADIOS, RECHARGEABLE ELECTRIC BATTERIES AND BATTERY PACKS; TELEPHONES; TELEPHONE ANSWERING SYSTEMS COMPRISING A TELEPHONE, A PORTABLE REMOTE CONTROL, AND AN ANSWERING MACHINE, SOLD AS A UNIT AND PARTS THEREFOR; KEY TELEPHONE SYSTEMS COMPRISING AN ELECTRONIC CONTROLLER AND PROGRAMMABLE TELEPHONES, SOLD AS A UNIT, AND PARTS THEREFOR; STEAM IRONS (U.S. CLS. 21, 23, 26, 36 AND 38).

FIRST USE 10-31-2002; IN COMMERCE 10-31-2002.

3,786,348. IMI INTELLIGENT MEDICAL IMPLANTS AG, ZUG, SWITZERLAND. SN 78-981,360. PUB. 4-21-2009, FILED 9-8-2005.

INTELLIGENT RETINAL IMPLANT SYSTEM

THE MARK CONSISTS OF STANDARD CHARACTERS WITHOUT CLAIM TO ANY PARTICULAR FONT, STYLE, SIZE, OR COLOR.

PRIORITY CLAIMED UNDER SEC. 44(D) ON ERPNCMNTY TM OFC APPLICATION NO. 004329975, FILED 3-9-2005, REG. NO. 004329975, DATED 6-5-2008, EXPIRES 3-9-2015.

NO CLAIM IS MADE TO THE EXCLUSIVE RIGHT TO USE "RETINAL IMPLANT SYSTEM", APART FROM THE MARK AS SHOWN.

CLASS 42—SCIENTIFIC AND COMPUTER SERVICES

FOR (BASED ON 44(E)) AND (BASED ON USE IN COMMERCE) UPDATING OF COMPUTER SOFTWARE AND WEB PAGES FOR OTHERS; MEDICAL RESEARCH IN THE FIELD OF TECHNOLOGY (U.S. CLS. 100 AND 101).

FIRST USE 5-16-2007; IN COMMERCE 5-16-2007.

CLASS 44—MEDICAL, BEAUTY AND AGRICULTURAL SERVICES

FOR (BASED ON USE IN COMMERCE) MEDICAL SERVICES, NAMELY, MEDICAL AND CLINICAL EXAMINATIONS AND PROCESSING OF DATA RELATING TO PATIENTS AND/OR IMPLANTS FOR CLINICAL MEDICAL PURPOSES; MEDICAL CARE BY MEANS OF TELEMETRY, INCLUDING LOCALIZATION, FOR PATIENTS AND IMPLANTS (U.S. CLS. 100 AND 101).

FIRST USE 5-16-2007; IN COMMERCE 5-16-2007.

3,786,350. INTERDIGITAL COMMUNICATIONS CORPORATION, KING OF PRUSSIA, PA. SN 78-981,363. PUB. 4-29-2008, FILED 5-31-2006.

3,786,351. CISCO TECHNOLOGY, INC., SAN JOSE, CA. SN 78-981,800. PUB. 4-22-2008, FILED 9-13-2006.

INTERDIGITAL

WELCOME TO THE HUMAN NETWORK

THE MARK CONSISTS OF STANDARD CHARACTERS WITHOUT CLAIM TO ANY PARTICULAR FONT, STYLE, SIZE, OR COLOR.

OWNER OF U.S. REG. NOS. 1,912,057, 1,940,157, AND 1,955,654.

CLASS 9—ELECTRICAL AND SCIENTIFIC APPARATUS

FOR SEMICONDUCTOR DEVICES, INTEGRATED CIRCUIT BASEBANDS, INTEGRATED CIRCUIT MODULES, INTEGRATED CIRCUITS FOR SIGNAL PROCESSING IN WIRELESS COMMUNICATION DEVICES, INTEGRATED CIRCUITS INCORPORATING ALGORITHMS FOR USE IN SIGNAL PROCESSING, APPLICATION SPECIFIC INTEGRATED CIRCUITS (ASIC), COMPUTER CHIPSETS FOR USE IN TRANSMISSION OF DATA TO AND FROM CENTRAL PROCESSING UNITS, AND WIRELESS MODEMS; ARCHITECTURE SYSTEMS COMPRISED OF SOFTWARE AND HARDWARE PLATFORMS FOR FACILITATING VOICE AND DATA TRANSMISSION AND FOR OPERATING COMMUNICATION SYSTEMS, COMMUNICATION DEVICES, COMMUNICATION HUBS, AND ANTENNA; DIGITAL TELEPHONE PLATFORMS AND SOFTWARE; SOFTWARE AND PROTOCOL STACK SOFTWARE USED FOR THE DESIGN, DEVELOPMENT AND DEPLOYMENT OF WIRELESS COMMUNICATION SYSTEMS AND WIRELESS COMMUNICATION DEVICES; SOFTWARE FOR SIGNAL PROCESSING IN WIRELESS COMMUNICATION DEVICES AND SYSTEMS; APPLICATION SOFTWARE FOR OPERATING WIRELESS DEVICES; SOFTWARE FOR USE IN OPERATING ELECTRONIC DEVICES, INCLUDING MODEMS, ANTENNAS, MOBILE PHONES, TELEPHONE SETS AND WIRELESS TERMINALS (U.S. CLS. 21, 23, 26, 36 AND 38).

FIRST USE 7-0-2009; IN COMMERCE 7-0-2009.

CLASS 42—SCIENTIFIC AND COMPUTER SERVICES

FOR ENGINEERING, RESEARCH, AND CONSULTATION SERVICES IN THE FIELD OF WIRELESS AND DIGITAL COMMUNICATIONS; DESIGNING AND TESTING WIRELESS AND DIGITAL COMMUNICATIONS SYSTEMS, EQUIPMENT AND COMPONENTS THEREOF FOR OTHERS; COMPUTER SOFTWARE DESIGN FOR OTHERS IN THE FIELD OF WIRELESS AND DIGITAL COMMUNICATION SYSTEMS; LICENSING INTELLECTUAL PROPERTY; TECHNICAL SUPPORT SERVICES, NAMELY, TROUBLESHOOTING OF COMPUTER HARDWARE AND SOFTWARE PROBLEMS (U.S. CLS. 100 AND 101).

FIRST USE 7-0-2009; IN COMMERCE 7-0-2009.

THE MARK CONSISTS OF STANDARD CHARACTERS WITHOUT CLAIM TO ANY PARTICULAR FONT, STYLE, SIZE, OR COLOR.

CLASS 38—COMMUNICATION

FOR PROVIDING INFORMATION VIA LOCAL AND GLOBAL COMPUTER NETWORKS IN THE FIELDS OF TELECOMMUNICATIONS AND TELEPHONY; BROADCASTING PROGRAMS VIA COMPUTER NETWORKS; PROVIDING TELEPHONE CONFERENCING SERVICES; PROVIDING VIDEO CONFERENCING SERVICES; PROVIDING TELECOMMUNICATIONS SERVICES, NAMELY, WEB CONFERENCING SERVICES; INTERNET TELEPHONY SERVICES (U.S. CLS. 100, 101 AND 104).

FIRST USE 10-0-2006; IN COMMERCE 10-0-2006.

CLASS 41—EDUCATION AND ENTERTAINMENT

FOR EDUCATIONAL SERVICES, NAMELY, CONFERENCES, TRAINING COURSES, TESTING, WORKSHOPS, AND DISTRIBUTING COURSE MATERIALS IN CONNECTION THEREWITH, ALL IN THE FIELDS OF COMPUTER NETWORKING, BROADBAND NETWORKS, COMPUTER SYSTEMS, TELECOMMUNICATION SYSTEMS, IP TELEPHONY, CABLE TELEVISION SYSTEMS, NETWORK SECURITY, AND NETWORK STORAGE (U.S. CLS. 100, 101 AND 107).

FIRST USE 0-0-2006; IN COMMERCE 0-0-2006.

CLASS 42—SCIENTIFIC AND COMPUTER SERVICES

FOR ON-LINE SERVICES, NAMELY, PROVIDING INFORMATION VIA COMPUTER NETWORKS IN THE FIELD OF COMPUTER NETWORKING; CUSTOMER SUPPORT SERVICES IN CONNECTION WITH COMPUTER HARDWARE AND SOFTWARE FOR USE IN INTERCONNECTING, MANAGING AND OPERATING LOCAL AND WIDE AREA NETWORKS, NAMELY, COMPUTER NETWORK DESIGN FOR OTHERS, COMPUTER CONSULTATION SERVICES, UPDATING OF COMPUTER SOFTWARE FOR OTHERS, COMPUTER SYSTEMS ANALYSIS, AND ENGINEERING SERVICES; PROVIDING TECHNICAL CONSULTATION IN CONNECTION WITH COMPUTER HARDWARE, COMPUTER SOFTWARE, COMPUTER NETWORKING EQUIPMENT, TELEPHONY SYSTEMS, TELECOMMUNICATIONS EQUIPMENT, IP TELEPHONY, TELECOMMUNICATION SYSTEMS, COMPUTER NETWORK DESIGN, STORAGE DESIGN, SECURITY OF NETWORKS, AND VOICE AND WIRELESS COMMUNICATIONS; APPLICATION SERVICE PROVIDER (ASP), NAMELY, HOSTING THE SOFTWARE APPLICATIONS OF OTHERS; COMPUTER CONSULTING SERVICES; COMPUTER NETWORK DESIGN FOR OTHERS; ON LINE SERVICES, NAMELY, PROVIDING INFORMATION VIA COMPUTER NETWORKS IN THE FIELDS OF COMPUTER NETWORKS, COMPUTER SYSTEMS, CABLE TELEVISION SYSTEMS, TECHNICAL CONSULTATION AND RESEARCH IN THE FIELD OF COMPUTER NETWORKS, AND NETWORK SYSTEMS DESIGN; APPLICATION SERVICE PROVIDER (ASP) FEATURING SOFTWARE FOR AUDIO CONFERENCING, ELECTRONIC MESSAGING, DOCUMENT COLLABORATION, VIDEO CONFERENCING, AND VOICE AND CALL PROCESSING (U.S. CLS. 100 AND 101).

FIRST USE 0-0-2006; IN COMMERCE 0-0-2006.

* * * * *

SECTION 2.— INTERNATIONAL CLASSIFICATION

The short titles associated below with the international class numbers are terms designed merely for quick identification and are not an official part of the international classification. The full names of international classes are given in section 6.1 of the trademark rules of practice.

The designation "U.S. Cl." appearing in this section refers to the U.S. class in effect prior to Sep. 1, 1973 rather than the international class which applies to applications filed on or after that date. For adoption of international classification see notice in the OFFICIAL GAZETTE of Jun. 26, 1973 (911 O.G. TM 210).

Application in one class

CLASS 1—CHEMICALS

3,785,085. MPGREEN INC., CHULA VISTA, CA. SN 76-689,984. PUB. 11-4-2008, FILED 5-27-2008.

MPGREEN

THE MARK CONSISTS OF STANDARD CHARACTERS WITHOUT CLAIM TO ANY PARTICULAR FONT, STYLE, SIZE, OR COLOR.

FOR CHEMICAL ADDITIVES FOR FUEL TREATMENT, NAMELY, FOR MODIFYING THE PHYSICAL AND CHEMICAL CHARACTERISTICS FOUND IN PETROLEUM DERIVED FUELS, RESULTING IN NOTICEABLE IMPROVEMENTS IN THE COMBUSTION CYCLE, INCREASED FUEL SAVING, LOWER MAINTENANCE COSTS, REDUCED TOXIC GAS AND PARTICULATE EMISSIONS (U.S. CLS. 1, 5, 6, 10, 26 AND 46).
FIRST USE 1-1-2008; IN COMMERCE 11-1-2008.

CLASS 1—(Continued).

3,785,240. CONSORCIO COMEX S.A. DE C.V., MEXICO, MEXICO. SN 77-326,653. PUB. 2-12-2008, FILED 11-11-2007.

OUR PASSION. YOUR RESULTS.

THE MARK CONSISTS OF STANDARD CHARACTERS WITHOUT CLAIM TO ANY PARTICULAR FONT, STYLE, SIZE, OR COLOR.

FOR CHEMICALS FOR USE IN INDUSTRY; CHEMICAL PREPARATIONS FOR USE IN AGRICULTURE, HORTICULTURE AND FORESTRY, NAMELY, CHEMICAL PREPARATIONS FOR THE TREATMENT OF SEEDS; CHEMICAL PRODUCTS FOR THE FRESH-KEEPING AND PRESERVING OF FOOD; UNPROCESSED ARTIFICIAL RESINS; FERTILIZERS; METAL WELDING FLUX; ADHESIVES FOR INDUSTRIAL PURPOSES; ADHESIVES FOR INDUSTRIAL USE; PHOTOGRAPHIC CHEMICALS (U.S. CLS. 1, 5, 6, 10, 26 AND 46).
FIRST USE 4-30-2007; IN COMMERCE 1-31-2009.

3,785,148. ACTIVE ORGANICS, LP, LEWISVILLE, TX. SN 77-145,146. PUB. 10-9-2007, FILED 3-30-2007.

EXFOLIASE

THE MARK CONSISTS OF STANDARD CHARACTERS WITHOUT CLAIM TO ANY PARTICULAR FONT, STYLE, SIZE, OR COLOR.

FOR CHEMICAL INGREDIENTS USED IN THE MANUFACTURE OF COSMETIC, COSMECEUTICAL, DERMATOLOGIC AND PHARMACEUTICAL PRODUCTS AND NUTRITIONAL SUPPLEMENTS, NAMELY, SKIN EXFOLIATING AGENTS (U.S. CLS. 1, 5, 6, 10, 26 AND 46).
FIRST USE 2-11-2010; IN COMMERCE 2-11-2010.

3,785,313. SANSONE, PETER, BEAVERCREEK, OR. SN 77-386,793. PUB. 1-13-2009, FILED 2-1-2008.

PINK STINKER

THE MARK CONSISTS OF STANDARD CHARACTERS WITHOUT CLAIM TO ANY PARTICULAR FONT, STYLE, SIZE, OR COLOR.

NO CLAIM IS MADE TO THE EXCLUSIVE RIGHT TO USE "PINK", APART FROM THE MARK AS SHOWN.
FOR SCENTED CHEMICAL SPRAY COMPOSITIONS FOR USE MARKING LOCATIONS (U.S. CLS. 1, 5, 6, 10, 26 AND 46).
FIRST USE 1-22-2010; IN COMMERCE 1-25-2010.

CLASS 1—(Continued).

3,785,354. SYMRISE GMBH & CO. KG, HOLZMINDEN, FED REP GERMANY. SN 77-420,723. PUB. 7-8-2008, FILED 3-13-2008.

DRAGOCALM

THE MARK CONSISTS OF STANDARD CHARACTERS WITHOUT CLAIM TO ANY PARTICULAR FONT, STYLE, SIZE, OR COLOR.

OWNER OF U.S. REG. NOS. 1,131,570, 2,774,594, AND 3,319,803.

FOR CHEMICALS AND PLANT EXTRACTS USED IN MAKING COSMETICS (U.S. CLS. 1, 5, 6, 10, 26 AND 46). FIRST USE 2-2-2010; IN COMMERCE 2-2-2010.

CLASS 1—(Continued).

3,785,743. NATURALI PRO, LLC, SARASOTA, FL. SN 77-641,551. PUB. 5-5-2009, FILED 12-30-2008.

HOTFIRE

THE MARK CONSISTS OF STANDARD CHARACTERS WITHOUT CLAIM TO ANY PARTICULAR FONT, STYLE, SIZE, OR COLOR.

FOR FERTILIZERS (U.S. CLS. 1, 5, 6, 10, 26 AND 46). FIRST USE 12-0-2006; IN COMMERCE 12-0-2006.

3,785,470. ACTIVE ORGANICS, LP, LEWISVILLE, TX. SN 77-500,613. PUB. 11-11-2008, FILED 6-17-2008.

ACTIPURE

THE MARK CONSISTS OF STANDARD CHARACTERS WITHOUT CLAIM TO ANY PARTICULAR FONT, STYLE, SIZE, OR COLOR.

FOR CHEMICAL COMPOSITIONS CONTAINING BOTANICAL EXTRACTS FOR USE IN THE MANUFACTURE OF COSMETIC, COSMECEUTICAL, DERMATOLOGIC, PHARMACEUTICAL AND NUTRITIONAL PRODUCTS (U.S. CLS. 1, 5, 6, 10, 26 AND 46). FIRST USE 5-20-2009; IN COMMERCE 5-20-2009.

3,785,759. CLABBER GIRL CORPORATION, TERRE HAUTE, IN. SN 77-648,255. PUB. 4-28-2009, FILED 1-13-2009.

INNOVAFRESH

THE MARK CONSISTS OF STANDARD CHARACTERS WITHOUT CLAIM TO ANY PARTICULAR FONT, STYLE, SIZE, OR COLOR.

FOR ENCAPSULATED FOOD PRESERVATIVES FOR USE IN THE MANUFACTURE OF FOODSTUFFS (U.S. CLS. 1, 5, 6, 10, 26 AND 46).

FIRST USE 2-28-2009; IN COMMERCE 2-28-2009.

3,785,674. INDEPENDENT STAVE COMPANY, INC., LEBANON, MO. SN 77-611,890. PUB. 8-4-2009, FILED 11-11-2008.

TRŪ / TAN

THE MARK CONSISTS OF STANDARD CHARACTERS WITHOUT CLAIM TO ANY PARTICULAR FONT, STYLE, SIZE, OR COLOR.

FOR CHEMICAL PRODUCTS, NAMELY, TANNIN USED IN THE WINE-MAKING PROCESS (U.S. CLS. 1, 5, 6, 10, 26 AND 46).

FIRST USE 6-0-2009; IN COMMERCE 6-0-2009.

3,785,808. NO-TILL FARMS, INC., KALISPELL, MT. SN 77-659,940. PUB. 6-2-2009, FILED 1-30-2009.

BinBuster XP

THE MARK CONSISTS OF STANDARD CHARACTERS WITHOUT CLAIM TO ANY PARTICULAR FONT, STYLE, SIZE, OR COLOR.

FOR FOOD SUPPLEMENTS FOR AGRICULTURAL PRODUCTS AND OTHER PLANTS; PREPARATIONS FOR FORTIFYING PLANTS (U.S. CLS. 1, 5, 6, 10, 26 AND 46).

FIRST USE 5-31-2009; IN COMMERCE 5-31-2009.

CLASS 1—(Continued).

3,785,976. CYTEC TECHNOLOGY CORP., WILMINGTON, DE. SN 77-696,585. PUB. 10-27-2009, FILED 3-23-2009.

AeroPaste

THE MARK CONSISTS OF STANDARD CHARACTERS WITHOUT CLAIM TO ANY PARTICULAR FONT, STYLE, SIZE, OR COLOR.

FOR PASTE ADHESIVES, NAMELY, ADHESIVES FOR INDUSTRIAL USE (U.S. CLS. 1, 5, 6, 10, 26 AND 46).

FIRST USE 9-9-2009; IN COMMERCE 9-9-2009.

3,786,026. COBURN CHEMICALS, INC., COCKEYSVILLE, MD. SN 77-719,722. PUB. 8-25-2009, FILED 4-22-2009.

Hi Test Ice Melt

THE MARK CONSISTS OF STANDARD CHARACTERS WITHOUT CLAIM TO ANY PARTICULAR FONT, STYLE, SIZE, OR COLOR.

NO CLAIM IS MADE TO THE EXCLUSIVE RIGHT TO USE "ICE MELT", APART FROM THE MARK AS SHOWN.

FOR CHEMICAL PREPARATIONS FOR MELTING SNOW AND ICE (U.S. CLS. 1, 5, 6, 10, 26 AND 46).

FIRST USE 11-4-2009; IN COMMERCE 11-4-2009.

3,786,036. TAKARA BIO INC., OTSU CITY, SHIGA, JAPAN. SN 77-726,700. PUB. 9-15-2009, FILED 5-1-2009.

MIGHTYAMP

THE MARK CONSISTS OF STANDARD CHARACTERS WITHOUT CLAIM TO ANY PARTICULAR FONT, STYLE, SIZE, OR COLOR.

FOR REAGENTS FOR SCIENTIFIC RESEARCH USE (U.S. CLS. 1, 5, 6, 10, 26 AND 46).

FIRST USE 5-18-2009; IN COMMERCE 5-18-2009.

CLASS 1—(Continued).

3,786,213. COGNIS FRANCE, SAINT MARTORY, FRANCE. SN 78-376,850. PUB. 9-1-2009, FILED 3-2-2004.

MYOXINOL

THE MARK CONSISTS OF STANDARD CHARACTERS WITHOUT CLAIM TO ANY PARTICULAR FONT, STYLE, SIZE, OR COLOR.

PRIORITY CLAIMED UNDER SEC. 44(D) ON FRANCE APPLICATION NO. 033256907, FILED 11-14-2003, REG. NO. 033256907, DATED 12-19-2003, EXPIRES 11-13-2013.

FOR BOTANICAL EXTRACTS FOR USE IN MAKING COSMETICS; ACTIVE ELEMENTS, NOT BEING ESSENTIAL OILS, OBTAINED FROM MARINE, VEGETAL, SYNTHETIC AND BIOTECHNOLOGICAL EXTRACTS AND INTENDED FOR USE IN MAKING COSMETICS AND SANITARY PREPARATIONS FOR BODY AND FACE (U.S. CLS. 1, 5, 6, 10, 26 AND 46).

FIRST USE 4-0-2004; IN COMMERCE 4-0-2004.

3,786,251. EASTMAN CHEMICAL COMPANY, KINGSPORT, TN. SN 78-736,208. PUB. 7-4-2006, FILED 10-19-2005.

EASTONE

THE MARK CONSISTS OF STANDARD CHARACTERS WITHOUT CLAIM TO ANY PARTICULAR FONT, STYLE, SIZE, OR COLOR.

FOR SYNTHETIC RESINS FOR USE IN THE MANUFACTURE OF ADHESIVES AND COATINGS IN THE NATURE OF PAINTS, LACQUERS, INKS, VARNISHES AND SEALANTS (U.S. CLS. 1, 5, 6, 10, 26 AND 46).

FIRST USE 10-9-2009; IN COMMERCE 10-9-2009.

3,786,274. NANOSTATICS, LLC, CIRCLEVILLE, OH. SN 78-842,918. PUB. 8-14-2007, FILED 3-22-2006.

GREEN SPINNING

THE MARK CONSISTS OF STANDARD CHARACTERS WITHOUT CLAIM TO ANY PARTICULAR FONT, STYLE, SIZE, OR COLOR.

CLASS 1—(Continued).

NO CLAIM IS MADE TO THE EXCLUSIVE RIGHT TO USE "SPINNING", APART FROM THE MARK AS SHOWN.

FOR POLYMERIC FIBER COMPOSITIONS OF SUB-MICRON SIZE FOR USE IN MODIFYING SURFACE FUNCTIONALITY (U.S. CLS. 1, 5, 6, 10, 26 AND 46).
FIRST USE 12-21-2009; IN COMMERCE 2-10-2010.

3,786,336. VP RACING FUELS, INC., SAN ANTONIO, TX. SN 78-970,372. PUB. 5-29-2007, FILED 9-8-2006.

WORLD LEADER IN RACING
FUELS

THE MARK CONSISTS OF STANDARD CHARACTERS WITHOUT CLAIM TO ANY PARTICULAR FONT, STYLE, SIZE, OR COLOR.

FOR CHEMICAL ADDITIVES FOR MOTOR OIL; DETERGENT ADDITIVES FOR USE WITH MOTOR OIL; CHEMICAL ADDITIVES FOR FUEL TREATMENT, NAMELY, OCTANE BOOSTER, CHEMICAL FUEL ADDITIVES (U.S. CLS. 1, 5, 6, 10, 26 AND 46).

FIRST USE 12-1-2007; IN COMMERCE 12-1-2007.

CLASS 2—PAINTS

3,785,439. INTENZE PRODUCTS, INC., ROCHELLE PARK, NJ. SN 77-485,003. PUB. 11-25-2008, FILED 5-28-2008.

ZUPER BLACK

THE MARK CONSISTS OF STANDARD CHARACTERS WITHOUT CLAIM TO ANY PARTICULAR FONT, STYLE, SIZE, OR COLOR.

NO CLAIM IS MADE TO THE EXCLUSIVE RIGHT TO USE "BLACK", APART FROM THE MARK AS SHOWN.

FOR TATTOO PIGMENTS, TATTOO COLORS, TATTOO INKS (U.S. CLS. 6, 11 AND 16).

FIRST USE 5-9-2008; IN COMMERCE 5-9-2008.

CLASS 2—(Continued).

3,785,994. SUPERIOR OPTICAL LABS, INC., OCEAN SPRINGS, MS. SN 77-704,144. PUB. 8-25-2009, FILED 4-1-2009.

exilar
plus

THE MARK CONSISTS OF THE STYLIZED WORDS "EXILAR PLUS".

FOR ANTI-REFLECTIVE OPTICAL COATINGS FOR OPHTHALMIC LENSES, SPECTACLE LENSES, PLASTIC SPECTACLE LENSES, MINERAL SPECTACLE LENSES, CORRECTIVE SPECTACLE LENSES, PROGRESSIVE SPECTACLE LENSES, SUNGLASS LENSES, POLARIZED SPECTACLE LENSES, TINTED SPECTACLE LENSES, LIGHT-SENSITIVE SPECTACLE LENSES, PHOTOCHROMIC SPECTACLE LENSES, TREATED SPECTACLE LENSES, COATED SPECTACLE LENSES, SEMI-FINISHED SPECTACLE LENSES, SPECTACLE LENS BLANKS, AND FOR SEMI-FINISHED COATED SPECTACLE BLANKS (U.S. CLS. 6, 11 AND 16).

FIRST USE 1-1-2009; IN COMMERCE 1-1-2009.

3,785,995. SUPERIOR OPTICAL LABS, INC., OCEAN SPRINGS, MS. SN 77-704,165. PUB. 8-25-2009, FILED 4-1-2009.

exilar

THE MARK CONSISTS OF THE STYLIZED WORD "EXILAR".

FOR ANTI-REFLECTIVE OPTICAL COATINGS FOR OPHTHALMIC LENSES, SPECTACLE LENSES, PLASTIC SPECTACLE LENSES, MINERAL SPECTACLE LENSES, CORRECTIVE SPECTACLE LENSES, PROGRESSIVE SPECTACLE LENSES, SUNGLASS LENSES, POLARIZED SPECTACLE LENSES, TINTED SPECTACLE LENSES, LIGHT-SENSITIVE SPECTACLE LENSES, PHOTOCHROMIC SPECTACLE LENSES, TREATED SPECTACLE LENSES, COATED SPECTACLE LENSES, SEMI-FINISHED SPECTACLE LENSES, SPECTACLE LENS BLANKS, AND FOR SEMI-FINISHED COATED SPECTACLE BLANKS (U.S. CLS. 6, 11 AND 16).

FIRST USE 1-1-2009; IN COMMERCE 1-1-2009.

CLASS 2—(Continued).

3,786,130. PTC HOLDINGS LIMITED, KWUN TONG, KOW-
LOON, HONG KONG. SN 77-763,243. PUB. 11-3-2009,
FILED 6-18-2009.

PTC Professional Toner Cartridge

THE MARK CONSISTS OF STANDARD CHARACTERS
WITHOUT CLAIM TO ANY PARTICULAR FONT, STYLE,
SIZE, OR COLOR.

NO CLAIM IS MADE TO THE EXCLUSIVE RIGHT TO
USE "PROFESSIONAL TONER CARTRIDGE", APART
FROM THE MARK AS SHOWN.

FOR INK JET CARTRIDGES; TONER CARTRIDGES
(U.S. CLS. 6, 11 AND 16).

FIRST USE 9-29-2009; IN COMMERCE 1-7-2010.

**CLASS 3—COSMETICS AND CLEANING PRE-
PARATIONS**

3,785,087. SCHOTT, RICHARD N., MURFREESBORO, TN.
SN 76-691,562. PUB. 6-16-2009, FILED 7-25-2008.

DR. NATE'S NATURALS

THE MARK CONSISTS OF STANDARD CHARACTERS
WITHOUT CLAIM TO ANY PARTICULAR FONT, STYLE,
SIZE, OR COLOR.

NO CLAIM IS MADE TO THE EXCLUSIVE RIGHT TO
USE "NATURALS", APART FROM THE MARK AS SHOWN.

THE NAME "DR. NATE'S" IDENTIFIES A LIVING
INDIVIDUAL WHOSE CONSENT IS OF RECORD.

FOR TOOTHPASTE (U.S. CLS. 1, 4, 6, 50, 51 AND 52).

FIRST USE 3-1-2009; IN COMMERCE 3-22-2009.

3,785,106. TOM'S OF MAINE, INC., KENNEBUNK, ME. SN
76-979,052. PUB. 12-4-2007, FILED 1-26-2004.

NATURALLY, IT WORKS

THE MARK CONSISTS OF STANDARD CHARACTERS
WITHOUT CLAIM TO ANY PARTICULAR FONT, STYLE,
SIZE, OR COLOR.

FOR ORAL CARE PRODUCTS, NAMELY, TOOTH-
PASTES AND NON-MEDICATED MOUTHWASHES;
SKIN CARE PRODUCTS, NAMELY, PERSONAL DEO-
DORANTS, BAR AND LIQUID SOAPS FOR HANDS,
FACE AND BODY (U.S. CLS. 1, 4, 6, 50, 51 AND 52).

FIRST USE 9-30-2003; IN COMMERCE 1-6-2004.

CLASS 3—(Continued).

3,785,185. IBG HOLDINGS, INC., ALTADENA, CA. SN 77-
229,874. PUB. 4-15-2008, FILED 7-14-2007.

EMO

THE MARK CONSISTS OF STANDARD CHARACTERS
WITHOUT CLAIM TO ANY PARTICULAR FONT, STYLE,
SIZE, OR COLOR.

THE WORDING "EMO" HAS NO MEANING IN A
FOREIGN LANGUAGE.

FOR COSMETICS (U.S. CLS. 1, 4, 6, 50, 51 AND 52).

FIRST USE 1-1-2008; IN COMMERCE 1-1-2008.

3,785,238. ROCKLINE INDUSTRIES, INC., SHEBOYGAN,
WI. SN 77-324,910. PUB. 6-24-2008, FILED 11-8-2007.

LITTLE STEPS

THE MARK CONSISTS OF STANDARD CHARACTERS
WITHOUT CLAIM TO ANY PARTICULAR FONT, STYLE,
SIZE, OR COLOR.

FOR CLEANING CLOTHS AND DISPOSABLE WIPES
IMPREGNATED WITH CLEANING CHEMICALS FOR
PERSONAL USE; BABY WIPES; PRE-MOISTENED BABY
WIPES; DISPOSABLE WIPES AND TOWELETTES IM-
PREGNATED WITH CHEMICALS OR COMPOUNDS
FOR PERSONAL HYGIENIC USE; PRE-MOISTENED
COSMETIC WIPES FOR PERSONAL HYGIENE,
NAMELY, WET WIPES, MAKE-UP REMOVER WIPES
AND MOIST TOILET WIPES AND TISSUE; DRY WATER
ACTIVATED DISPOSABLE WIPES IMPREGNATED
WITH CHEMICALS OR COMPOUNDS FOR PERSONAL
HYGIENE; PRE-MOISTENED COSMETIC TOWEL-
ETTES; PRE-MOISTENED COSMETIC WIPES AND TO-
WELETTES (U.S. CLS. 1, 4, 6, 50, 51 AND 52).

FIRST USE 8-31-2009; IN COMMERCE 8-31-2009.

3,785,250. THE TRUSTEE OF THE STUART FAMILY
TRUST, A TRUST COMPRISING RON CURTIS A UNI-
TED STATES CITIZEN, NEW YORK, NY. SN 77-332,111.
PUB. 7-1-2008, FILED 11-16-2007.



JILLSTUART

OWNER OF U.S. REG. NOS. 1,928,255, 2,805,256, AND
2,808,987.

CLASS 3—(Continued).

THE NAME "JILL STUART" IDENTIFIES A LIVING INDIVIDUAL WHOSE CONSENT IS OF RECORD.

THE MARK CONSISTS OF THE WORD "JILL" IN SCRIPT FORM SUPERIMPOSED OVER THE WORDS "JILL STUART".

FOR PERFUME; COLOGNE (U.S. CLS. 1, 4, 6, 50, 51 AND 52).

FIRST USE 12-31-2008; IN COMMERCE 12-31-2008.

CLASS 3—(Continued).

3,785,300. WILLIAMS, NICOLE S, DECATUR, GA. SN 77-376,087. PUB. 4-28-2009, FILED 1-19-2008.

BUHTER UP by Nicky

THE MARK CONSISTS OF STANDARD CHARACTERS WITHOUT CLAIM TO ANY PARTICULAR FONT, STYLE, SIZE, OR COLOR.

FOR AROMATHERAPY BODY CARE PRODUCTS, NAMELY, BODY LOTION, SHOWER GEL, CUTICLE CREAM, SHAMPOO, CONDITIONER, NON-MEDICATED LIP BALM, SOAP, BODY POLISH, BODY AND FOOT SCRUB AND NON-MEDICATED FOOT CREAM; BEAUTY CREAMS FOR BODY CARE; BODY AND BEAUTY CARE COSMETICS; BODY CREAM SOAP; BODY CREAMS; BODY DEODORANTS; BODY LOTIONS; BODY MASKS; BODY MILK; BODY OILS; BODY POWDER; BODY SCRUB; BODY SPRAY USED AS A PERSONAL DEODORANT AND AS FRAGRANCE; BODY SPRAYS; BODY SPRAYS, NAMELY, WATER IN ATOMIZED CONTAINERS USED TO PRODUCE A COOLING EFFECT; BODY WASHES; COSMETIC OLIVE OIL FOR THE FACE AND BODY; DEODORANTS FOR BODY CARE; FACE AND BODY BEAUTY CREAMS; LIQUID SOAPS FOR HANDS, FACE AND BODY; LOTIONS FOR FACE AND BODY CARE; NON-MEDICATED BODY SOAKS; SCENTED BODY LOTIONS AND CREAMS; SCENTED BODY SPRAY; SKIN AND BODY TOPICAL LOTIONS, CREAMS AND OILS FOR COSMETIC USE; SKIN CARE PREPARATION, NAMELY, BODY POLISH; SKIN CARE PREPARATIONS, NAMELY, BODY BALM; SOAPS FOR BODY CARE; TONING LOTION, FOR THE FACE, BODY AND HANDS; SCENTED FABRIC REFRESHER SPRAY; SCENTED LINEN SPRAYS; SCENTED LINEN WATER; SCENTED OILS USED TO PRODUCE AROMAS WHEN HEATED; SCENTED ROOM SPRAYS; SCENTED STICKS FOR ADDING SCENT TO A FLOWER BOUQUET OR FLOWERING POT PLANT (U.S. CLS. 1, 4, 6, 50, 51 AND 52).

FIRST USE 1-0-2008; IN COMMERCE 1-0-2008.

3,785,290. CHRISTIAN CASEY LLC, NEW YORK, NY. SN 77-368,603. PUB. 5-27-2008, FILED 1-10-2008.

I AM KING SEAN JOHN

THE MARK CONSISTS OF STANDARD CHARACTERS WITHOUT CLAIM TO ANY PARTICULAR FONT, STYLE, SIZE, OR COLOR.

OWNER OF U.S. REG. NOS. 2,409,545, 2,778,092, AND OTHERS.

THE NAME "SEAN JOHN" IDENTIFIES A LIVING INDIVIDUAL WHOSE CONSENT IS OF RECORD.

FOR NON-MEDICATED SKIN CARE PREPARATIONS; NON-MEDICATED TOILETRIES; SHOWER AND BATH GEL; BODY WASHES; DEODORANT FOR PERSONAL USE (U.S. CLS. 1, 4, 6, 50, 51 AND 52).

FIRST USE 11-30-2009; IN COMMERCE 11-30-2009.

3,785,293. CHRISTIAN CASEY LLC, NEW YORK, NY. SN 77-370,526. PUB. 5-27-2008, FILED 1-14-2008.

I AM KING

THE MARK CONSISTS OF STANDARD CHARACTERS WITHOUT CLAIM TO ANY PARTICULAR FONT, STYLE, SIZE, OR COLOR.

FOR NON-MEDICATED SKIN CARE PREPARATIONS; NON-MEDICATED TOILETRIES; SHOWER AND BATH GEL; BODY WASHES; DEODORANT FOR PERSONAL USE (U.S. CLS. 1, 4, 6, 50, 51 AND 52).

FIRST USE 11-30-2009; IN COMMERCE 11-30-2009.

3,785,320. VAFIADIS, DEAN C., DBA NEW YORK SMILE INSTITUTE, NEW YORK, NY. SN 77-390,188. PUB. 12-2-2008, FILED 2-6-2008.

DR. DEAN

THE MARK CONSISTS OF STANDARD CHARACTERS WITHOUT CLAIM TO ANY PARTICULAR FONT, STYLE, SIZE, OR COLOR.

OWNER OF U.S. REG. NOS. 3,044,108 AND 3,142,739. THE NAME "DR. DEAN" IDENTIFIES A LIVING INDIVIDUAL WHOSE CONSENT IS OF RECORD.

FOR TOOTHPASTE (U.S. CLS. 1, 4, 6, 50, 51 AND 52). FIRST USE 8-31-2009; IN COMMERCE 1-1-2010.

CLASS 3—(Continued).

3,785,376. NEW YORK COLLEGE OF HEALTH PROFESSIONS, SYOSSET, NY. SN 77-439,360. PUB. 9-2-2008, FILED 4-3-2008.

DRY BREEZES

THE MARK CONSISTS OF STANDARD CHARACTERS WITHOUT CLAIM TO ANY PARTICULAR FONT, STYLE, SIZE, OR COLOR.

FOR AROMATHERAPY INHALER SOLD FILLED WITH AROMATHERAPY PREPARATION CONTAINING ESSENTIAL OILS; AROMATHERAPY SPRAYS OR AROMA VAPOR FOR MOOD ENHANCEMENT AND THERAPEUTIC USE IN DECORATIVE PLUSH CHARACTER APPARATUSES AND SCENTED DECORATIVE APPARATUSES (U.S. CLS. 1, 4, 6, 50, 51 AND 52).

FIRST USE 7-20-2009; IN COMMERCE 7-20-2009.

CLASS 3—(Continued).

3,785,424. HARAJUKU LOVERS, LLC, BEVERLY HILLS, CA. SN 77-474,428. PUB. 4-14-2009, FILED 5-14-2008.



THE NON-LATIN CHARACTERS IN THE MARK TRANSLITERATE TO TENSHI, AND THIS MEANS ANGEL IN ENGLISH, AND TO TEN AND THIS MEANS HEAVEN IN ENGLISH.

FOR FRAGRANCES (U.S. CLS. 1, 4, 6, 50, 51 AND 52). FIRST USE 9-15-2008; IN COMMERCE 9-15-2008.

3,785,400. PRL USA HOLDINGS, INC., WILMINGTON, DE. SN 77-459,218. PUB. 7-22-2008, FILED 4-28-2008.

CHAPS EST. 1978 WEEKEND

THE MARK CONSISTS OF STANDARD CHARACTERS WITHOUT CLAIM TO ANY PARTICULAR FONT, STYLE, SIZE, OR COLOR.

OWNER OF U.S. REG. NO. 3,358,110.

NO CLAIM IS MADE TO THE EXCLUSIVE RIGHT TO USE "EST. 1978", APART FROM THE MARK AS SHOWN.

FOR AFTER-SHAVE PREPARATION (U.S. CLS. 1, 4, 6, 50, 51 AND 52).

FIRST USE 3-1-2010; IN COMMERCE 3-1-2010.

3,785,491. BRITTON BELL, DBA BRITTON'S UNIQUE BOUTIQUE, NEW BERLIN, WI. SN 77-510,793. PUB. 12-9-2008, FILED 6-29-2008.



NO CLAIM IS MADE TO THE EXCLUSIVE RIGHT TO USE "BOUTIQUE", APART FROM THE MARK AS SHOWN. THE COLOR(S) COBALT BLUE, EMERALD GREEN IS/ARE CLAIMED AS A FEATURE OF THE MARK.

THE MARK CONSISTS OF THE PROPRIETARY NAME OF THE PRODUCTS AND CONSISTS OF STYLIZED WORDS IN COBALT BLUE COLOR, "BRITTON'S UNIQUE BOUTIQUE" IN A CONVEX CURVE OVERLYING PRO-

CLASS 3—(Continued).

PRIETARY ORIGINAL ARTISTIC RENDITION OF A BUTTERFLY, IN EMERALD GREEN COLOR, UTILIZING THE FIRST LETTERS OF EACH WORD IN THE COMPANY NAME, "B" "U" "B"; OVERLYING THE STYLIZED VERSION OF THE COMBINATION OF THE WORD(S) AND PART(S) OF THE WORD(S), "SCENT" AND "SENSITIVES", IN COBALT BLUE COLOR, OVERLYING THREE HORIZONTAL STRAIGHT LINES, IN EMERALD GREEN COLOR, THEREFORE IT HAS SIGNIFICANCE, AS APPLIED TO THE GOODS/SERVICES.

FOR AFTERSHAVE PREPARATIONS; AROMATHERAPY INHALER SOLD FILLED WITH AROMATHERAPY ESSENTIAL OILS; AROMATHERAPY PILLOWS COMPRISING POTPOURRI IN FABRIC CONTAINERS; AROMATHERAPY PILLOWS THAT MAY BE USED TO FRESHEN CLOTHING OR LAY OVER THE EYES; BABY HAIR CONDITIONER; BABY LOTION; BABY OIL; BABY OILS; BABY POWDERS; BABY SHAMPOO; BATH AND SHOWER GELS AND SALTS NOT FOR MEDICAL PURPOSES; BATH CREAM; BATH FIZZIES; BATH LOTION; BATH OILS AND BATH SALTS; BATH POWDER; BATH SALTS; BATH SOAPS IN LIQUID, SOLID OR GEL FORM; BODY BUTTER; BODY LOTION; BODY LOTIONS; BODY OILS; BODY POWDER; BODY SCRUB; BODY SPRAY USED AS A PERSONAL DEODORANT AND AS FRAGRANCE; BODY WASHES; BUBBLE BATH; CLEANSING CREAMS; COLOGNES, PERFUMES AND COSMETICS; COSMETIC CREAMS FOR SKIN CARE; COSMETIC PREPARATIONS FOR BODY CARE; COSMETIC PREPARATIONS FOR SKIN RENEWAL; CUTICLE CREAM; DEODORANT FOR PERSONAL USE; DEODORANTS FOR BODY CARE; DEODORIZERS FOR PETS; ESSENTIAL OILS FOR HOUSEHOLD USE; ESSENTIAL OILS FOR PERSONAL USE; EXFOLIANT CREAMS; EYE CREAM; EYE LOTIONS; FACE AND BODY CREAMS; FACE AND BODY LOTIONS; FOAM BATH; FRAGRANCE EMITTING WICKS FOR ROOM FRAGRANCE; FRAGRANCES AND PERFUMERY; FRAGRANCES FOR AUTOMOBILES; FRAGRANCES FOR PERSONAL USE; HAIR CONDITIONERS FOR BABIES; HAIR EMOLLIENTS; HAIR SHAMPOOS AND CONDITIONERS; HAND CLEANING PREPARATIONS; HAND CREAMS; HAND LOTIONS; HAND SOAPS; INCENSE STICKS; LIP BALM; LIP CREAM; LIQUID BATH SOAPS; LIQUID PERFUMES; LIQUID SOAPS FOR HANDS, FACE AND BODY; LOTIONS FOR FACE AND BODY CARE; MASSAGE CREAMS; MASSAGE OILS; MINERAL SALT IN THE NATURE OF BATH SALTS NOT FOR MEDICAL PURPOSES; MOISTURIZING CREAMS; NAIL CREAM; NATURAL ESSENTIAL OILS; NATURAL MINERAL MAKE-UP; NIGHT CREAM; NON-MEDICATED ACNE TREATMENT PREPARATIONS; NON-MEDICATED ANTI-AGING SERUM; NON-MEDICATED BATH PREPARATIONS; NON-MEDICATED BATH SALTS; NON-MEDICATED BODY SOAKS; NON-MEDICATED DIAPER RASH OINTMENTS AND LOTIONS; NON-MEDICATED FOOT CREAM; NON-MEDICATED FOOT LOTIONS; NON-MEDICATED LIP CARE PREPARATIONS; NON-MEDICATED PREPARATIONS ALL FOR THE CARE OF SKIN, HAIR AND SCALP; NON-MEDICATED SKIN CARE PREPARATION, NAMELY, BODY MIST; NON-MEDICATED SKIN CARE PREPARATIONS, NAMELY, CREAMS, LOTIONS, GELS, TONERS, CLEANSERS AND PEELS; NON-MEDICATED SKIN CREAMS; NON-MEDICATED STIMULATING LOTIONS FOR THE SKIN; NON-MEDICATED SUN CARE PREPARATIONS; OILS FOR COSMETIC PURPOSES; OILS FOR PERFUMES AND SCENTS; PERFUMED CREAMS; PERFUMED POWDERS; PERFUMED SOAPS; PERFUMERY; PERFUMES, AFTERSHAVES AND COLOGNES; PERFUMING SACHETS; PERSONAL DEODORANTS; PET CARE KITS COMPRISING SHAMPOO, CONDITIONER, BODY SPRAY; PET FRAGRANCES; POTPOURRI; PRE-SCENTED STRIPS AND CARDS FOR

CLASS 3—(Continued).

SAMPLING FRAGRANCES; PRE-SHAVE CREAMS; ROOM FRAGRANCE REFILLS FOR NON-ELECTRIC ROOM FRAGRANCE DISPENSERS; SCENTED BODY LOTIONS AND CREAMS; SCENTED BODY SPRAY; SCENTED LINEN SPRAYS; SCENTED OILS USED TO PRODUCE AROMAS WHEN HEATED; SCENTED PINE CONES; SCENTED ROOM SPRAYS; SHAMPOO-CONDITIONERS; SHAMPOOS FOR BABIES; SHAVING PREPARATIONS; SHOWER AND BATH FOAM; SHOWER AND BATH GEL; SHOWER CREAMS; SKIN AND BODY TOPICAL LOTIONS, CREAMS AND OILS FOR COSMETIC USE; SKIN CARE PREPARATIONS, NAMELY, BODY BALM; SKIN CLEANSERS; SKIN CREAMS IN LIQUID AND IN SOLID FORM; SKIN EMOLLIENTS; SKIN LOTIONS; SKIN MASKS; SKIN MOISTURIZER; SKIN TONERS; SOAPS FOR BODY CARE; SOAPS FOR PERSONAL USE; SUN CARE LOTIONS; SUN CREAMS; TOPICAL SKIN SPRAYS FOR COSMETIC PURPOSES; WRINKLE-MINIMIZING COSMETIC PREPARATIONS FOR TOPICAL FACIAL USE (U.S. CLS. 1, 4, 6, 50, 51 AND 52).

FIRST USE 2-10-2007; IN COMMERCE 9-1-2007.

3,785,494. FANTASTIC CARE SDN. BHD., KUALA LUMPUR, MALAYSIA. SN 77-511,038. PUB. 5-19-2009, FILED 6-30-2008.



NO CLAIM IS MADE TO THE EXCLUSIVE RIGHT TO USE "CARE", APART FROM THE MARK AS SHOWN.

THE MARK CONSISTS OF THE STYLIZED WORDING "WHITE CARE" ABOVE THE DESIGN OF A WOMAN'S FACE, SHOULDERS AND ARMS, THE DESIGN OF A GOAT BENEATH THE WOMAN, AND THE DESIGN OF LEAVES, STEMS, AND FLOWERS ON THE BOTTOM PORTION OF THE DESIGN.

FOR TOILETRIES PRODUCTS IN THE NATURE OF BODY CARE PRODUCTS, NAMELY, SHOWER CREAM, BODY SHAMPOO AND SOAPS, BODY LOTION, HAIR CARE PRODUCTS, NAMELY, SHAMPOOS, CONDITIONERS, HAIR CREAM, HAIR GELS, BEAUTY SERUMS FOR COSMETIC PURPOSE, HAIR TONICS, HAIR LOSS AND GROWTH PRODUCTS IN THE NATURE OF NON-MEDICATED HAIR RESTORATION LOTIONS, HAIR DYES; SKIN LOTIONS, SKIN MOISTURIZER, BEAUTY SOAPS (U.S. CLS. 1, 4, 6, 50, 51 AND 52).

FIRST USE 2-8-2010; IN COMMERCE 2-8-2010.

CLASS 3—(Continued).

3,785,495. FANTASTIC CARE SDN. BHD., KUALA LUMPUR, MALAYSIA. SN 77-511,044. PUB. 5-19-2009, FILED 6-30-2008.



NO CLAIM IS MADE TO THE EXCLUSIVE RIGHT TO USE "HIGH QUALITY", "CARE", "SHOWER CREAM" AND "MOISTURIZING WHITENING & FIRMING ENRICHED WITH GOAT'S MILK, PEGAGA AND LICORICE FOR DRY SKIN UV PROTECTION 550ML", APART FROM THE MARK AS SHOWN.

THE MARK CONSISTS OF THE STYLIZED WORDING "HIGH QUALITY WHITE CARE" ABOVE THE DESIGN OF A WOMAN'S FACE, SHOULDERS AND ARMS, THE DESIGN OF A GOAT BENEATH THE WOMAN, AND THE DESIGN OF LEAVES, STEMS, AND FLOWERS ON THE BOTTOM PORTION OF THE DESIGN. THE STYLIZED WORDING "SHOWER CREAM 2 X MOISTURISING WHITENING & FIRMING ENRICHED WITH GOAT'S MILK, PEGAGA AND LICORICE FOR DRY SKIN UV PROTECTION 550ML" APPEARS BELOW THE WOMAN, GOAT AND FLOWER DESIGN. THE DESIGN OF A HORIZONTAL LINE APPEARS BELOW THE WORDING "FIRMING" AND ABOVE THE WORDING "ENRICHED WITH". THE WORDING "UV PROTECTION" IS SURROUNDED BY AN OVAL CARRIER.

FOR TOILETRIES PRODUCTS IN THE NATURE OF BODY CARE PRODUCTS, NAMELY, SHOWER CREAM (U.S. CLS. 1, 4, 6, 50, 51 AND 52).

FIRST USE 2-8-2010; IN COMMERCE 2-8-2010.

3,785,547. LJ LARocca, INC., STUDIO CITY, CA. SN 77-529,700. PUB. 12-9-2008, FILED 7-23-2008.

Rocca Bowwow

THE MARK CONSISTS OF STANDARD CHARACTERS WITHOUT CLAIM TO ANY PARTICULAR FONT, STYLE, SIZE, OR COLOR.

THE ENGLISH TRANSLATION OF THE WORD "ROCCA" IN THE MARK IS FORTRESS.

FOR PET CARE KITS COMPRISING BODY SPRAY (U.S. CLS. 1, 4, 6, 50, 51 AND 52).

FIRST USE 2-10-2010; IN COMMERCE 2-10-2010.

CLASS 3—(Continued).

3,785,566. L'OREAL, PARIS, FRANCE. SN 77-536,853. PUB. 12-9-2008, FILED 8-1-2008.

RING IT UP

THE MARK CONSISTS OF STANDARD CHARACTERS WITHOUT CLAIM TO ANY PARTICULAR FONT, STYLE, SIZE, OR COLOR.

FOR HAIR STYLING PREPARATION (U.S. CLS. 1, 4, 6, 50, 51 AND 52).

FIRST USE 12-0-2008; IN COMMERCE 12-0-2008.

3,785,606. SHISEIDO COMPANY LTD., TOKYO, JAPAN. SN 77-564,355. PUB. 5-26-2009, FILED 9-8-2008.

Flawless, Radiant Coverage Foundation

THE MARK CONSISTS OF STANDARD CHARACTERS WITHOUT CLAIM TO ANY PARTICULAR FONT, STYLE, SIZE, OR COLOR.

NO CLAIM IS MADE TO THE EXCLUSIVE RIGHT TO USE "COVERAGE FOUNDATION", APART FROM THE MARK AS SHOWN.

FOR MAKE-UP, NAMELY, FOUNDATION (U.S. CLS. 1, 4, 6, 50, 51 AND 52).

FIRST USE 8-0-2009; IN COMMERCE 8-0-2009.

3,785,616. ACOSTA, CARMINDY, NEW YORK, NY. SN 77-573,036. PUB. 5-19-2009, FILED 9-18-2008.

CARMINDY

THE MARK CONSISTS OF STANDARD CHARACTERS WITHOUT CLAIM TO ANY PARTICULAR FONT, STYLE, SIZE, OR COLOR.

FOR COSMETICS FOR FACE AND BODY (U.S. CLS. 1, 4, 6, 50, 51 AND 52).

FIRST USE 10-1-2009; IN COMMERCE 10-1-2009.

CLASS 3—(Continued).

3,785,683. PHYSICIANS FORMULA, INC., AZUSA, CA. SN 77-617,381. PUB. 10-20-2009, FILED 11-19-2008.

ECO-AROMA THERAPY

THE MARK CONSISTS OF STANDARD CHARACTERS WITHOUT CLAIM TO ANY PARTICULAR FONT, STYLE, SIZE, OR COLOR.

NO CLAIM IS MADE TO THE EXCLUSIVE RIGHT TO USE "THERAPY", APART FROM THE MARK AS SHOWN. FOR COSMETICS, NAMELY, COSMETICS CONTAINING AN INGREDIENT BLEND (U.S. CLS. 1, 4, 6, 50, 51 AND 52).

FIRST USE 5-14-2009; IN COMMERCE 5-14-2009.

3,785,697. L'OREAL, PARIS, FRANCE. SN 77-624,489. PUB. 5-19-2009, FILED 12-2-2008.

TELESCOPIC EXPLOSION

THE MARK CONSISTS OF STANDARD CHARACTERS WITHOUT CLAIM TO ANY PARTICULAR FONT, STYLE, SIZE, OR COLOR.

OWNER OF U.S. REG. NO. 3,261,444. FOR MASCARAS (U.S. CLS. 1, 4, 6, 50, 51 AND 52). FIRST USE 9-0-2009; IN COMMERCE 9-0-2009.

3,785,698. DESIGNER SKIN, LLC, INDIANAPOLIS, IN. SN 77-625,571. PUB. 6-9-2009, FILED 12-3-2008.

APHRODISIAC

THE MARK CONSISTS OF STANDARD CHARACTERS WITHOUT CLAIM TO ANY PARTICULAR FONT, STYLE, SIZE, OR COLOR.

FOR NON-MEDICATED INDOOR AND OUTDOOR TANNING PREPARATIONS DISTRIBUTED AND MARKETED FOR SALE AND USE IN INDOOR TANNING SALONS (U.S. CLS. 1, 4, 6, 50, 51 AND 52). FIRST USE 11-1-2009; IN COMMERCE 11-1-2009.

CLASS 3—(Continued).

3,785,733. ADVANCED BEAUTY SYSTEMS, INC., DALLAS, TX. SN 77-637,326. PUB. 10-27-2009, FILED 12-19-2008.

MIDNIGHT GARDEN

THE MARK CONSISTS OF STANDARD CHARACTERS WITHOUT CLAIM TO ANY PARTICULAR FONT, STYLE, SIZE, OR COLOR.

FOR NON-MEDICATED SKIN CARE PREPARATIONS, NAMELY, SHOWER GEL, BODY LOTION, BODY CREAM, AND BODY MIST; ANTIBACTERIAL SKIN SOAP (U.S. CLS. 1, 4, 6, 50, 51 AND 52).

FIRST USE 1-0-2009; IN COMMERCE 1-0-2009.

3,785,782. STRANGE INVISIBLE PERFUMES, LLC, BEVERLY HILLS, CA. SN 77-655,432. PUB. 11-10-2009, FILED 1-23-2009.

AQUARIAN ROSES

THE MARK CONSISTS OF STANDARD CHARACTERS WITHOUT CLAIM TO ANY PARTICULAR FONT, STYLE, SIZE, OR COLOR.

NO CLAIM IS MADE TO THE EXCLUSIVE RIGHT TO USE "ROSES", APART FROM THE MARK AS SHOWN. FOR FRAGRANCES AND PERFUMERY (U.S. CLS. 1, 4, 6, 50, 51 AND 52).

FIRST USE 2-9-2009; IN COMMERCE 2-9-2009.

3,785,839. BOECKHOLT, JOSEPH A., PRAIRIE VILLAGE, KS. SN 77-664,160. PUB. 6-2-2009, FILED 2-5-2009.

THE COLOR(S) GREEN IS/ARE CLAIMED AS A FEATURE OF THE MARK.

THE MARK CONSISTS OF A UNIQUE HIGHLY CONDENSED SAN-SERIF FONT WITH STRONG VERTICAL LINEAR ELEMENTS. ENTIRE MARK IS REPRODUCED IN GREEN.

FOR PERFUMES AND COLOGNES (U.S. CLS. 1, 4, 6, 50, 51 AND 52). FIRST USE 1-1-1940; IN COMMERCE 12-12-2009.

CLASS 3—(Continued).

3,785,843. PHILOSOPHY, INC., PHOENIX, AZ. SN 77-664,766.
PUB. 6-30-2009, FILED 2-6-2009.

TAN TINI

THE MARK CONSISTS OF STANDARD CHARACTERS WITHOUT CLAIM TO ANY PARTICULAR FONT, STYLE, SIZE, OR COLOR.

FOR HAIR CARE PREPARATIONS; NON-MEDICATED BATH PREPARATIONS; SHOWER AND BATH GEL (U.S. CLS. 1, 4, 6, 50, 51 AND 52).

FIRST USE 6-12-2009; IN COMMERCE 6-12-2009.

CLASS 3—(Continued).

3,785,924. COTY US LLC, NEW YORK, NY. SN 77-680,195.
PUB. 6-23-2009, FILED 2-27-2009.

JOVAN SATISFACTION

THE MARK CONSISTS OF STANDARD CHARACTERS WITHOUT CLAIM TO ANY PARTICULAR FONT, STYLE, SIZE, OR COLOR.

FOR PERFUMERY, COLOGNE, EAU DE TOILETTES, SOAPS, DEODORANTS (U.S. CLS. 1, 4, 6, 50, 51 AND 52).

FIRST USE 12-15-2009; IN COMMERCE 12-15-2009.

3,785,847. G.I. SKINCARE, LLC, NEW YORK, NY. SN 77-665,333. PUB. 6-16-2009, FILED 2-6-2009.

DR. GERALD IMBER

THE MARK CONSISTS OF STANDARD CHARACTERS WITHOUT CLAIM TO ANY PARTICULAR FONT, STYLE, SIZE, OR COLOR.

THE NAME "DR. GERALD IMBER" IDENTIFIES A LIVING INDIVIDUAL WHOSE CONSENT IS OF RECORD. FOR NON-MEDICATED SKIN CARE PREPARATIONS (U.S. CLS. 1, 4, 6, 50, 51 AND 52).

FIRST USE 9-18-2009; IN COMMERCE 9-18-2009.

3,785,932. VICTORIA'S SECRET STORES BRAND MANAGEMENT, INC., REYNOLDSBURG, OH. SN 77-683,301. PUB. 6-30-2009, FILED 3-4-2009.

3,785,914. HENKEL CONSUMER GOODS INC., SCOTTS-DALE, AZ. SN 77-678,321. PUB. 7-21-2009, FILED 2-25-2009.

SOFT SCRUB TOTAL BATH & BOWL

THE MARK CONSISTS OF STANDARD CHARACTERS WITHOUT CLAIM TO ANY PARTICULAR FONT, STYLE, SIZE, OR COLOR.

OWNER OF U.S. REG. NOS. 3,328,732 AND 3,468,770. NO CLAIM IS MADE TO THE EXCLUSIVE RIGHT TO USE "SCRUB" AND "BATH & BOWL", APART FROM THE MARK AS SHOWN.

FOR ALL-PURPOSE CLEANERS; TOILET BOWL DETERGENTS (U.S. CLS. 1, 4, 6, 50, 51 AND 52).
FIRST USE 12-8-2009; IN COMMERCE 12-8-2009.

AIRBRUSH FX

THE MARK CONSISTS OF STANDARD CHARACTERS WITHOUT CLAIM TO ANY PARTICULAR FONT, STYLE, SIZE, OR COLOR.

FOR FACE PRIMER (U.S. CLS. 1, 4, 6, 50, 51 AND 52).
FIRST USE 7-30-2009; IN COMMERCE 7-30-2009.

CLASS 3—(Continued).

3,786,031. AYCAYIA, LLC, TAMPA, FL. SN 77-724,166. PUB. 9-8-2009, FILED 4-28-2009.

CLASS 3—(Continued).

3,786,056. NORMAN, MICHELLE, LA JOLLA, CA. SN 77-735,194. PUB. 9-22-2009, FILED 5-12-2009.



Puregoddess

THE MARK CONSISTS OF SIX MERMAIDS IN A CIRCLE DESIGN.

FOR AFTER-SUN LOTIONS; AROMATHERAPY BODY CARE PRODUCTS, NAMELY, BODY LOTION, SHOWER GEL, CUTICLE CREAM, SHAMPOO, CONDITIONER, NON-MEDICATED LIP BALM, SOAP, BODY POLISH, BODY AND FOOT SCRUB AND NON-MEDICATED FOOT CREAM; BAR SOAP; BATH AND SHOWER GELS AND SALTS NOT FOR MEDICAL PURPOSES; BATH CREAM; BATH GEL; BATH GELS; BATH LOTION; BATH SOAPS; BATH SOAPS IN LIQUID, SOLID OR GEL FORM; BATHING LOTIONS; BEAUTY CREAMS; BEAUTY CREAMS FOR BODY CARE; BEAUTY LOTIONS; BODY BUTTER; BODY CREAM; BODY CREAM SOAP; BODY CREAMS; BODY LOTION; BODY LOTIONS; BODY SCRUB; COCOA BUTTER FOR COSMETIC PURPOSES; FACE AND BODY BEAUTY CREAMS; FACE AND BODY CREAMS; FACE AND BODY LOTIONS; FACE MILK AND LOTIONS; FACIAL SCRUBS; HAIR SHAMPOO; HAIR SHAMPOOS AND CONDITIONERS; HAND LOTIONS; LIP BALM; LIP BALM; LIQUID BATH SOAPS; LIQUID SOAP; LIQUID SOAPS; LIQUID SOAPS FOR HANDS, FACE AND BODY; LOTIONS FOR FACE AND BODY CARE; MASSAGE CREAMS; MOISTURIZING CREAMS; NON-MEDICATED LIP BALM THAT DOES NOT CONTAIN BEESWAX; SCENTED BODY LOTIONS AND CREAMS; SHAMPOOS; SHEA BUTTER FOR COSMETIC PURPOSES; SHOWER AND BATH GEL; SHOWER GEL; SHOWER GELS; SKIN AND BODY TOPICAL LOTIONS, CREAMS AND OILS FOR COSMETIC USE; SKIN CARE PREPARATIONS, NAMELY, BODY BALM; SKIN CLEANSING LOTION; SKIN CREAM; SKIN CREAMS; SKIN CREAMS IN LIQUID AND IN SOLID FORM; SKIN CREAMS IN LIQUID AND SOLID; SKIN CREAMS IN LIQUID AND SOLID FORM; SKIN LOTION; SKIN LOTIONS; SKIN SOAP; SOAPS FOR BODY CARE; SOAPS FOR PERSONAL USE; SUN CARE LOTIONS; SUN TAN GEL; SUN TAN LOTION; SUN-BLOCK LOTIONS; SUN-TANNING OILS AND LOTIONS; SUNSCREEN CREAM; SUNSCREEN CREAMS; TANNING AND AFTER-SUN MILKS, GELS AND OILS (U.S. CLS. 1, 4, 6, 50, 51 AND 52).

FIRST USE 3-25-2009; IN COMMERCE 12-30-2009.

THE MARK CONSISTS OF STANDARD CHARACTERS WITHOUT CLAIM TO ANY PARTICULAR FONT, STYLE, SIZE, OR COLOR.

OWNER OF U.S. REG. NO. 3,573,675.

FOR NON-MEDICATED SKIN CARE PREPARATIONS, NAMELY, CREAMS, LOTIONS, GELS, TONERS, CLEANSERS, FACE CLEANSERS, BODY CLEANSERS AND PEELS, BODY MIST, BODY FRAGRANCE, BODY LOTION, BODY CREAMS, BODY SPRAY, NAIL POLISH, LIPSTICK, LIP GLOSS, LIP BALM, FOUNDATION MAKE-UP, BODY POWDER, FACE POWDER, BRONZER, TANNING LOTION, EYESHADOW, BLUSH, EYELINER, SUNSCREEN CREAM, SUN TAN LOTION, SKIN GELS AND LOTIONS FOR ACCELERATING, ENHANCING OR EXTENDING TANS, NON-MEDICATED ACNE TREATMENT PREPARATION, COSMETICS (U.S. CLS. 1, 4, 6, 50, 51 AND 52).

FIRST USE 8-24-2009; IN COMMERCE 8-24-2009.

CLASS 3—(Continued).

3,786,087. ALAN D WIDGEROW, IRVINE, CA. SN 77-749,986.
PUB. 10-13-2009, FILED 6-2-2009.

Moducoll

THE MARK CONSISTS OF STANDARD CHARACTERS WITHOUT CLAIM TO ANY PARTICULAR FONT, STYLE, SIZE, OR COLOR.

FOR AGE RETARDANT LOTION; AGE SPOT REDUCING CREAMS; ANTI-AGING CREAM; ANTI-WRINKLE CREAM; ANTI-WRINKLE CREAMS; BEAUTY LOTIONS; BODY LOTION; CLEANSING CREAMS; COSMETIC CREAMS; COSMETIC CREAMS FOR SKIN CARE; COSMETIC PREPARATIONS; COSMETIC PREPARATIONS FOR BODY CARE; COSMETIC PREPARATIONS FOR SKIN RENEWAL; COSMETIC PREPARATIONS, NAMELY, FIRING CREAMS; COSMETIC PREPARATIONS, NAMELY, FIRING LOTIONS; COSMETIC SUN-PROTECTING PREPARATIONS; COSMETICS AND COSMETIC PREPARATIONS; EYE LOTIONS; FACE AND BODY LOTIONS; FACE CREAMS FOR COSMETIC USE; HAND CREAM; LOTIONS FOR COSMETIC PURPOSES; LOTIONS FOR FACE AND BODY CARE; LOTIONS FOR SCAR CONTROL AND ANTIAGING OF THE SKIN; NON-MEDICATED PREPARATIONS ALL FOR THE CARE OF SKIN, HAIR AND SCALP; NON-MEDICATED SKIN CARE PREPARATIONS; NON-MEDICATED SKIN CARE PREPARATIONS, NAMELY, CREAMS, LOTIONS, GELS, TONERS, CLEANERS AND PEELS; SKIN AND BODY TOPICAL LOTIONS, CREAMS AND OILS FOR COSMETIC USE; SKIN CLEANSERS; SKIN CONDITIONERS; SKIN CONDITIONING CREAMS FOR COSMETIC PURPOSES; SKIN CREAM; SKIN CREAMS; SKIN EMOLLIENTS; SKIN FRESHENERS; SKIN LOTION; SKIN LOTIONS; SKIN MOISTURIZER; SKIN TEXTURIZERS; SKIN TONERS; TONING LOTION, FOR THE FACE, BODY AND HANDS; WRINKLE REMOVING SKIN CARE PREPARATIONS (U.S. CLS. 1, 4, 6, 50, 51 AND 52).

FIRST USE 1-3-2010; IN COMMERCE 1-3-2010.

3,786,089. SIMPLE SERENITY SPA & WELLNESS, LLC, EL DORADO HILLS, CA. SN 77-751,460. PUB. 10-13-2009, FILED 6-3-2009.



NO CLAIM IS MADE TO THE EXCLUSIVE RIGHT TO USE "SKIN CARE", APART FROM THE MARK AS SHOWN.

CLASS 3—(Continued).

THE MARK CONSISTS OF WORDING "CELLZ +" WITH THE WORDING "SKIN CARE" UNDERNEATH. THE WORDS "CELLZ" AND "SKIN" ARE OVERLAYING A DESIGN ELEMENT OF A PAINT SWIRL.

FOR ANTI-AGING CREAMS; ANTI-AGING MOISTURIZER; COSMETIC CREAMS FOR SKIN CARE; EXFOLIANT CREAMS; FACE AND BODY LOTIONS; FACIAL CLEANSERS; SKIN CLEANSERS (U.S. CLS. 1, 4, 6, 50, 51 AND 52).

FIRST USE 10-0-2009; IN COMMERCE 10-0-2009.

3,786,100. CHURCH & DWIGHT CO., INC., PRINCETON, NJ. SN 77-755,089. PUB. 10-20-2009, FILED 6-9-2009.

OXICLEAN

THE MARK CONSISTS OF STANDARD CHARACTERS WITHOUT CLAIM TO ANY PARTICULAR FONT, STYLE, SIZE, OR COLOR.

OWNER OF U.S. REG. NOS. 2,430,077, 3,028,707, AND 3,440,531.

FOR HOUSEHOLD CLEANING PRODUCTS, NAMELY, STAIN REMOVERS, SHOWER, TUB AND TILE CLEANERS AND TOILET CLEANERS, NAMELY, TOILET BOWL DETERGENTS; GENERAL ALL PURPOSE CLEANING PREPARATIONS (U.S. CLS. 1, 4, 6, 50, 51 AND 52).

FIRST USE 2-28-2009; IN COMMERCE 2-28-2009.

3,786,102. CHURCH & DWIGHT CO., INC., PRINCETON, NJ. SN 77-755,299. PUB. 10-20-2009, FILED 6-9-2009.



OWNER OF U.S. REG. NOS. 2,430,077, 3,028,707, AND 3,440,531.

NO CLAIM IS MADE TO THE EXCLUSIVE RIGHT TO USE "CLEAN", APART FROM THE MARK AS SHOWN.

THE MARK CONSISTS OF "OXI CLEAN" (STACKED WORDS).

FOR HOUSEHOLD CLEANING PRODUCTS, NAMELY, STAIN REMOVERS, SHOWER, TUB AND TILE CLEANERS AND TOILET CLEANERS, NAMELY, TOILET BOWL DETERGENTS; GENERAL ALL PURPOSE CLEANING PREPARATIONS (U.S. CLS. 1, 4, 6, 50, 51 AND 52).

FIRST USE 2-28-2009; IN COMMERCE 2-28-2008.

CLASS 3—(Continued).

3,786,159. ARAMIS INC., NEW YORK, NY. SN 77-819,796. PUB. 12-1-2009, FILED 9-3-2009.

MAX LS

THE MARK CONSISTS OF THE WRITTEN ELEMENTS "MAX" AND "LS" WITH 4 SQUARES BETWEEN THE TWO WRITTEN ELEMENTS.

FOR COSMETICS; NON-MEDICATED SKIN CARE PREPARATIONS (U.S. CLS. 1, 4, 6, 50, 51 AND 52). FIRST USE 12-21-2009; IN COMMERCE 12-21-2009.

3,786,204. BATH & BODY WORKS BRAND MANAGEMENT, INC., REYNOLDSBURG, OH. SN 77-979,148. PUB. 7-22-2008, FILED 6-5-2007.

FAR EAST ESCAPE

THE MARK CONSISTS OF STANDARD CHARACTERS WITHOUT CLAIM TO ANY PARTICULAR FONT, STYLE, SIZE, OR COLOR.

FOR PERSONAL CARE PRODUCTS, NAMELY, AFTER SHAVE, AFTER SHAVE BALM, AGE SPOT LIGHTENER, ANTIPERSPIRANT, AROMATIC SHOWER STEAM CREAM, ASTRINGENT FOR THE FACE, ASTRINGENT FOR THE SKIN, BATH BEADS, BATH CREAM, BATH CUBES, BATH FIZZIES, BATH FOAM, BATH MILK, BATH OIL, BATH SALTS, NON-MEDICATED BATH SOAKS, BLEMISH CORRECTOR, NAMELY, FACIAL CONCEALER, BLEMISH CONCEALER STICK, NON-MEDICATED BODY BALM, BODY SOAP BAR, BODY BUTTER, BODY CREAM, BODY ESSENCE FRAGRANCE SPRAY, BODY GEL, BODY GLITTER, BODY LOTION, BODY LUSTER SPRAY LOTION, BODY MASK, FRAGRANT BODY MIST, BODY OIL, BODY PAINT, BODY POWDER, BODY SCRUB, BODY SMOOTHER, BODY SOAP, FRAGRANT BODY SPLASH, BODY WASH, BUBBLE BATH, BUFFING BAR, COLOGNE, CREAM BODY WASH, CREAM CLEANSER FOR THE SKIN, CUTICLE CREAM, CUTICLE CREAM STICK, CUTICLE OIL PEN, PERSONAL DEODORANT, ESSENTIAL OILS, EXFOLIATOR FOR THE FEET, EYE SUN BLOCK, EYE CREAM, EYE GEL, GEL EYE MASK, NON-MEDICATED EYE REPAIR CREAM, NON-MEDICATED COSMETIC EYE TREATMENT PREPARATION, NON-MEDICATED FACE BALM, FACE SUN BLOCK, FACE CLEANSER, FACE CREAM, FACE GEL, FACE LOTION, FACE MASK, FACE MIST, FACE MOISTURIZER, FACE POLISHER, FACE POWDER, FACE SCRUB, FACE SOAP, FACE WASH, IMPREGNATED FACIAL CLEANSING CLOTHS, FIRMING LOTION TREATMENT FOR THE SKIN, FOAM BATH, FOOT CREAM, FOOT LOTION, FOOT POWDER, FOOT SCRUB, FOOT SOAK, FOOT SPRAY, GEL FACE WASH, GLYCERIN SOAP, HAIR CONDITIONER, HAIR DETANGLER, HAIR DYE, HAIR GEL, HAIR GLITTER, HAIR INHIBITOR LOTION, HAIR MASCARA, HAIR MIST, HAIR POMADE, HAIR RECONSTRUCTOR, HAIR REMOVING CREAM, HAIR REPAIR CREAM, HAIR RINSE, HAIR SHAMPOO, HAIR SHINE SERUM HAIR SPRAY, HAIR STRAIGHTENER,

CLASS 3—(Continued).

HAIR STYLING MOUSSE, HAND BALM, HAND CLEANSING SPRAY, HAND CREAM, HAND EXFOLIATOR, HAND LOTION, HAND RENEWER, HAND SOAP, HAND WASH, LEG BRONZER, LEG REFRESHER, NON-MEDICATED FACIAL LINE PREVENTION CONCENTRATE, NON-MEDICATED FACIAL LINE PREVENTION SERUM, NON-MEDICATED FACIAL LINE REDUCING CONCENTRATE, NON-MEDICATED FACIAL LINE REDUCING SERUM, LIP BALM, LIP BLOCK, LIP GLOSS, LIP PAINT, LIP PROTECTOR, LIP SHINE, LIP TINT, NON-MEDICATED LIP TREATMENT PREPARATION, MASSAGE CREAM, MASSAGE LOTION, MASSAGE OIL, NON-MEDICATED MINERAL BATH BEADS, OILS AND SALTS, MOOD ENHANCING MASSAGE OINTMENT, MOOD ENHANCING FRAGRANCE MIST, MOOD ENHANCING SKIN CREAM, NAIL CORRECTOR PEN, NAIL POLISH, NAIL POLISH REMOVER, NAIL STENCILS, NIGHT EYE CREAM, NIGHT NOURISHING CREAM, OIL BLOTTING SHEETS FOR THE SKIN, FRAGRANCE OIL SPRAY, NON-MEDICATED PENETRATING RUB, PERFUME, PERFUME OILS, PILLOW FRAGRANCE MIST, POST SUN TANNING LOTION FOR THE BODY, POTPOURRI, POWDER FOR THE FEET, PRE-SUNTANNING LOTION FOR THE BODY, PULSE POINT FRAGRANCE CREAM, NON-MEDICATED PULSE POINT FRAGRANCE THERAPY OILS, PUMICE STONES FOR PERSONAL USE, REFILLS FOR ELECTRIC ROOM FRAGRANCE DISPENSERS, ROOM FRAGRANCE SPRAY, SACHETS, SALT SCRUB, SEA SALT EXFOLIATOR, SELF TANNING PREPARATION, SHAVING CREAM, SHEA BUTTER HAND CREAM, SHEA BUTTER TREATMENT STICK, SHOWER CREAM, SHOWER FOAM, SHOWER GEL, SHOWER BODY AND FACIAL SCRUB, SKIN BRONZING CREAM, PRE-MOISTENED SKIN CLEANSING WIPES, SKIN CREAM, SKIN EXFOLIATOR, SKIN MATTIFIER, SKIN MOISTURIZER, SKIN POLISHER, SKIN SCRUB, NON-MEDICATED SKIN SERUM, SMOOTHING OIL, SOAP, STYLING FOAM, SUGAR SCRUB, SUN SCREEN, SUN BLOCK, FOR THE BODY, SUN BLOCK FOR THE FACE, SUNLESS TANNING CREAM, SUNLESS TANNING LOTION FOR THE BODY, SUNLESS TANNING LOTION FOR THE FACE, SUNTAN LOTION FOR THE BODY, SUNTAN LOTION FOR THE FACE, TALCUM POWDER, UNDER EYE PATCHES FOR COSMETIC PURPOSES, NON-MEDICATED VAPOR OINTMENT FOR COSMETIC PURPOSES (U.S. CLS. 1, 4, 6, 50, 51 AND 52). FIRST USE 1-0-2008; IN COMMERCE 1-0-2008.

3,786,226. WILLIN LLC, LAS VEGAS, NV. SN 78-635,594. PUB. 12-2-2008, FILED 5-23-2005.

EUPHORIA

THE MARK CONSISTS OF STANDARD CHARACTERS WITHOUT CLAIM TO ANY PARTICULAR FONT, STYLE, SIZE, OR COLOR.

OWNER OF U.S. REG. NOS. 2,768,506 AND 2,768,507. FOR NON-MEDICATED SKIN CARE LOTIONS; SKIN CARE PRODUCTS, NAMELY, NON-MEDICATED SKIN SERUM, LOTIONS AND SKIN CARE PROTECTIVE PREPARATIONS; PERSONAL HYGIENE PRODUCTS, NAMELY, SOAPS AND SKIN CLEANSING SOLUTIONS, PERFUMES; TOILET WATER; COLOGNE (U.S. CLS. 1, 4, 6, 50, 51 AND 52).

FIRST USE 12-31-1994; IN COMMERCE 12-31-1994.

CLASS 3—(Continued).

3,786,285. SIMPLICITY PRODUCTS INTERNATIONAL, INC., LOS ANGELES, CA. SN 78-854,527. PUB. 1-2-2007, FILED 4-5-2006.

SIMPLICITY

THE MARK CONSISTS OF STANDARD CHARACTERS WITHOUT CLAIM TO ANY PARTICULAR FONT, STYLE, SIZE, OR COLOR.

FOR CLEANING PRODUCTS FOR HOUSEHOLD USE, NAMELY, LIQUID DISHWASHER SOAP, POWDERED DISHWASHER SOAP, POWDERED OXYGEN BLEACH, LIQUID OXYGEN BLEACH, GLASS CLEANER, ALL PURPOSE CLEANER, SPOT REMOVER, DISPOSABLE WIPES IMPREGNATED WITH CHEMICALS OR COMPOUNDS FOR HOUSEHOLD USE, WOOD CLEANER, LIQUID LAUNDRY DETERGENT FOR BABY USE (U.S. CLS. 1, 4, 6, 50, 51 AND 52).

FIRST USE 0-0-2009; IN COMMERCE 0-0-2009.

3,786,309. ACOSTA, CARMINDY, NEW YORK, NY. SN 78-894,283. PUB. 6-19-2007, FILED 5-26-2006.

5 MINUTE FACE

THE MARK CONSISTS OF STANDARD CHARACTERS WITHOUT CLAIM TO ANY PARTICULAR FONT, STYLE, SIZE, OR COLOR.

NO CLAIM IS MADE TO THE EXCLUSIVE RIGHT TO USE "FACE", APART FROM THE MARK AS SHOWN.

FOR COSMETICS (U.S. CLS. 1, 4, 6, 50, 51 AND 52).

FIRST USE 10-1-2009; IN COMMERCE 10-1-2009.

3,786,320. MIRKA ABRASIVES, INC., TWINSBURG, OH. SN 78-921,985. PUB. 7-31-2007, FILED 7-3-2006.

BLACK LINE

THE MARK CONSISTS OF STANDARD CHARACTERS WITHOUT CLAIM TO ANY PARTICULAR FONT, STYLE, SIZE, OR COLOR.

FOR ABRASIVES, NAMELY, COATED ABRASIVES IN THE FORM OF DISCS, SHEETS, STRIPS AND ROLLS, NON-WOVEN ABRASIVES IN THE FORM OF DISCS, SHEETS, STRIPS, AND ROLLS, FLEXIBLE ABRASIVES, ABRASIVE CLOTH, ABRASIVE PAPER, ABRASIVE SHEETS, ABRASIVE STRIPS, AND ABRASIVE ROLLS (U.S. CLS. 1, 4, 6, 50, 51 AND 52).

FIRST USE 11-4-2006; IN COMMERCE 11-4-2006.

CLASS 3—(Continued).

3,786,321. MIRKA ABRASIVES, INC., TWINSBURG, OH. SN 78-921,991. PUB. 7-31-2007, FILED 7-3-2006.



FOR ABRASIVES, NAMELY, COATED ABRASIVES IN THE FORM OF DISCS, SHEETS, STRIPS, AND ROLLS AND NON-WOVEN ABRASIVES IN THE FORM OF DISCS, SHEETS, STRIPS, AND ROLLS, FLEXIBLE ABRASIVES, ABRASIVE CLOTH, ABRASIVE PAPER, ABRASIVE SHEETS (U.S. CLS. 1, 4, 6, 50, 51 AND 52).

FIRST USE 11-4-2006; IN COMMERCE 11-4-2006.

CLASS 4—LUBRICANTS AND FUELS

3,785,586. ADVANCED REFINING CONCEPTS, LLC, RENO, NV. SN 77-548,154. PUB. 8-4-2009, FILED 8-15-2008.

CLEARREFINING

THE MARK CONSISTS OF STANDARD CHARACTERS WITHOUT CLAIM TO ANY PARTICULAR FONT, STYLE, SIZE, OR COLOR.

FOR LIQUEFIED NATURAL GAS (U.S. CLS. 1, 6 AND 15).

FIRST USE 2-12-2010; IN COMMERCE 2-12-2010.

3,785,933. THE SHERWIN-WILLIAMS COMPANY, CLEVELAND, OH. SN 77-683,873. PUB. 6-30-2009, FILED 3-5-2009.

GETS IT MOVIN'

THE MARK CONSISTS OF STANDARD CHARACTERS WITHOUT CLAIM TO ANY PARTICULAR FONT, STYLE, SIZE, OR COLOR.

FOR ALL PURPOSE LUBRICANTS (U.S. CLS. 1, 6 AND 15).

FIRST USE 6-24-2009; IN COMMERCE 6-24-2009.

CLASS 4—(Continued).

3,786,270. RENEWAFUEL, LLC, MINNEAPOLIS, MN. SN 78-836,757. PUB. 6-2-2009, FILED 3-14-2006.

RENEWAFUEL

THE MARK CONSISTS OF STANDARD CHARACTERS WITHOUT CLAIM TO ANY PARTICULAR FONT, STYLE, SIZE, OR COLOR.

FOR RENEWABLE BIOMASS-BASED SOLID FUELS FOR USE IN INDUSTRIAL AND INSTITUTIONAL SOLID-FUEL BOILERS AND PROCESS HEATERS; RENEWABLE COMPOSITE BIOMASS SOLID FUEL PELLETS FOR USE IN INDUSTRIAL AND INSTITUTIONAL SOLID-FUEL BOILERS AND PROCESS HEATERS; RENEWABLE BIOMASS FEEDSTOCK IN THE NATURE OF PELLETS OF COMPRESSED FIBER MANUFACTURED FROM A PLANT CROP TO BE USED AS FUEL IN INDUSTRIAL AND INSTITUTIONAL SOLID-FUEL BOILERS AND PROCESS HEATERS (U.S. CLS. 1, 6 AND 15).
FIRST USE 3-14-2007; IN COMMERCE 3-14-2007.

CLASS 5—PHARMACEUTICALS

3,785,074. AUXILIUM US HOLDINGS, LLC., WILMINGTON, DE. SN 76-665,957. PUB. 8-28-2007, FILED 9-13-2006.

XIAFLEX

THE MARK CONSISTS OF STANDARD CHARACTERS WITHOUT CLAIM TO ANY PARTICULAR FONT, STYLE, SIZE, OR COLOR.

FOR PHARMACEUTICAL PREPARATIONS, NAMELY, COLLAGENASE ENZYME USED TO TREAT FIBROPROLIFERATIVE DISEASE CONDITIONS SUCH AS DUPUYTREN'S CONTRACTURE, PEYRONIE'S DISEASE AND FROZEN SHOULDER SYNDROME ALSO KNOWN AS ADHESIVE CAPSULITIS (U.S. CLS. 6, 18, 44, 46, 51 AND 52).
FIRST USE 3-4-2010; IN COMMERCE 3-4-2010.

3,785,102. MEAD JOHNSON & COMPANY, EVANSVILLE, IN. SN 76-696,896. PUB. 10-20-2009, FILED 4-16-2009.

TRIPLE HEALTH GUARD

THE MARK CONSISTS OF STANDARD CHARACTERS WITHOUT CLAIM TO ANY PARTICULAR FONT, STYLE, SIZE, OR COLOR.

CLASS 5—(Continued).

NO CLAIM IS MADE TO THE EXCLUSIVE RIGHT TO USE "HEALTH", APART FROM THE MARK AS SHOWN.

FOR INFANT FORMULAS FOR SOLE SOURCE NUTRITION OR NUTRITIONAL SUPPLEMENTATION, ESPECIALLY INFANT FORMULAS FOR SOLE SOURCE NUTRITION OR NUTRITIONAL SUPPLEMENTATION (U.S. CLS. 6, 18, 44, 46, 51 AND 52).
FIRST USE 4-0-2009; IN COMMERCE 4-0-2009.

3,785,121. HYMAN ENTERPRISES LLC, LENOX, MA. SN 77-043,849. PUB. 6-12-2007, FILED 11-14-2006.

ULTRASIMPLE DIET

THE MARK CONSISTS OF STANDARD CHARACTERS WITHOUT CLAIM TO ANY PARTICULAR FONT, STYLE, SIZE, OR COLOR.

NO CLAIM IS MADE TO THE EXCLUSIVE RIGHT TO USE "DIET", APART FROM THE MARK AS SHOWN.
FOR VITAMIN AND MINERAL SUPPLEMENTS (U.S. CLS. 6, 18, 44, 46, 51 AND 52).
FIRST USE 2-10-2010; IN COMMERCE 2-10-2010.

3,785,143. PFIZER INC, NEW YORK, NY. SN 77-137,362. PUB. 8-28-2007, FILED 3-22-2007.

MIRGELIC

THE MARK CONSISTS OF STANDARD CHARACTERS WITHOUT CLAIM TO ANY PARTICULAR FONT, STYLE, SIZE, OR COLOR.

FOR PHARMACEUTICAL PREPARATIONS FOR THE TREATMENT OF PAIN (U.S. CLS. 6, 18, 44, 46, 51 AND 52).
FIRST USE 3-3-2010; IN COMMERCE 3-3-2010.

CLASS 5—(Continued).

3,785,144. PFIZER INC, NEW YORK, NY. SN 77-137,366. PUB. 8-28-2007, FILED 3-22-2007.

AQUESSA

THE MARK CONSISTS OF STANDARD CHARACTERS WITHOUT CLAIM TO ANY PARTICULAR FONT, STYLE, SIZE, OR COLOR.

FOR PHARMACEUTICAL PREPARATIONS FOR THE TREATMENT OF PAIN (U.S. CLS. 6, 18, 44, 46, 51 AND 52).
FIRST USE 2-23-2010; IN COMMERCE 2-23-2010.

3,785,145. HYY (BVI) LIMITED, KOWLOON, HONG KONG. SN 77-142,202. PUB. 11-13-2007, FILED 3-28-2007.



THE MARK CONSISTS OF A BROKEN CAPSULE WITH ITS CONTENTS BEING POURED INTO A POOL OF WATER CONTAINING CHINESE HERBS.

FOR CHINESE HERBAL PREPARATIONS, NAMELY, MEDICINAL HERBS IN DRIED OR PRESERVED FORM; MEDICINAL PREPARATIONS, NAMELY, SPORTS ENDURANCE PREPARATIONS; NUTRITIONAL SUPPLEMENTS; DIETETIC FOODS ADAPTED FOR MEDICAL USE; DIETARY SUPPLEMENTS FOR HUMANS AND ANIMALS; HEALTH FOOD SUPPLEMENTS; DIETETIC FOODS ADAPTED FOR MEDICAL USE FOR USE IN THE PROMOTION AND SUPPORT OF BODILY SYSTEMS, NAMELY, THE IMMUNE SYSTEM, LIVER, BRAIN, HEART, LUNG, KIDNEY AND PROSTATE, WITH ANTI-OXIDANT AND ANTI-AGING PROPERTIES, VITAL ENERGY REPLENISHING PROPERTIES, BLOOD CIRCULATION MAINTAINING PROPERTIES, FAT ABSORPTION REGULATING PROPERTIES, STAMINA, VITALITY AND FATIGUE REDUCING PROPERTIES (U.S. CLS. 6, 18, 44, 46, 51 AND 52).
FIRST USE 1-9-2009; IN COMMERCE 1-9-2009.

CLASS 5—(Continued).

3,785,219. PFIZER INC, NEW YORK, NY. SN 77-292,618. PUB. 2-26-2008, FILED 10-1-2007.

XEDGE

THE MARK CONSISTS OF STANDARD CHARACTERS WITHOUT CLAIM TO ANY PARTICULAR FONT, STYLE, SIZE, OR COLOR.

FOR PHARMACEUTICAL PREPARATIONS FOR THE TREATMENT OF PAIN (U.S. CLS. 6, 18, 44, 46, 51 AND 52).
FIRST USE 2-23-2010; IN COMMERCE 2-23-2010.

3,785,231. PHARMACHEM LABORATORIES, INC, KEARNY, NJ. SN 77-308,318. PUB. 12-9-2008, FILED 10-19-2007.

DIET SPICE

THE MARK CONSISTS OF STANDARD CHARACTERS WITHOUT CLAIM TO ANY PARTICULAR FONT, STYLE, SIZE, OR COLOR.

NO CLAIM IS MADE TO THE EXCLUSIVE RIGHT TO USE "DIET", APART FROM THE MARK AS SHOWN. FOR INGREDIENT IN DIETARY AND NUTRITIONAL SUPPLEMENT, NAMELY, BOTANICAL EXTRACTS; DIETARY AND NUTRITIONAL SUPPLEMENTS (U.S. CLS. 6, 18, 44, 46, 51 AND 52).
FIRST USE 8-24-2008; IN COMMERCE 8-24-2008.

3,785,303. BF SUMA PHARMACEUTICALS INC., SAN GABRIEL, CA. SN 77-378,961. PUB. 12-23-2008, FILED 1-23-2008.

ProstatRelax

THE MARK CONSISTS OF STANDARD CHARACTERS WITHOUT CLAIM TO ANY PARTICULAR FONT, STYLE, SIZE, OR COLOR.

FOR DIETARY FOOD SUPPLEMENTS (U.S. CLS. 6, 18, 44, 46, 51 AND 52).
FIRST USE 1-1-2007; IN COMMERCE 4-18-2008.

CLASS 5—(Continued).

3,785,304. BF SUMA PHARMACEUTICALS INC., SAN GABRIEL, CA. SN 77-378,973. PUB. 12-23-2008, FILED 1-23-2008.

GluGoGone

THE MARK CONSISTS OF STANDARD CHARACTERS WITHOUT CLAIM TO ANY PARTICULAR FONT, STYLE, SIZE, OR COLOR.

THE WORD "GLUGOGONE" HAS NO MEANING IN A FOREIGN LANGUAGE.

FOR DIETARY FOOD SUPPLEMENTS (U.S. CLS. 6, 18, 44, 46, 51 AND 52).

FIRST USE 1-1-2007; IN COMMERCE 3-1-2008.

CLASS 5—(Continued).

3,785,378. TRIARCO INDUSTRIES, INC., WAYNE, NJ. SN 77-441,844. PUB. 7-8-2008, FILED 4-7-2008.

BLASTING CAPS

THE MARK CONSISTS OF STANDARD CHARACTERS WITHOUT CLAIM TO ANY PARTICULAR FONT, STYLE, SIZE, OR COLOR.

FOR VITAMINS, MINERAL SUPPLEMENTS, NUTRITIONAL AND DIETARY SUPPLEMENTS (U.S. CLS. 6, 18, 44, 46, 51 AND 52).

FIRST USE 4-7-2008; IN COMMERCE 4-7-2008.

3,785,353. OMP, INC., LONG BEACH, CA. SN 77-417,283. PUB. 12-30-2008, FILED 3-10-2008.

CLENZIDERM M.D. ACNE THERAPEUTIC SYSTEM

THE MARK CONSISTS OF STANDARD CHARACTERS WITHOUT CLAIM TO ANY PARTICULAR FONT, STYLE, SIZE, OR COLOR.

OWNER OF U.S. REG. NO. 3,410,886.

NO CLAIM IS MADE TO THE EXCLUSIVE RIGHT TO USE "M.D. ACNE THERAPEUTIC SYSTEM", APART FROM THE MARK AS SHOWN.

FOR ACNE TREATMENT PREPARATIONS (U.S. CLS. 6, 18, 44, 46, 51 AND 52).

FIRST USE 7-0-2008; IN COMMERCE 7-0-2008.

3,785,382. INTRAVERA WORLDWIDE, INC., GLENDALE, CA. SN 77-443,032. PUB. 4-21-2009, FILED 4-8-2008.

INTRAVERA

THE MARK CONSISTS OF STANDARD CHARACTERS WITHOUT CLAIM TO ANY PARTICULAR FONT, STYLE, SIZE, OR COLOR.

FOR PHARMACEUTICAL PRODUCTS FOR TREATMENT OF MENTAL HEALTH, INCLUDING MEMORY LOSS (U.S. CLS. 6, 18, 44, 46, 51 AND 52).

FIRST USE 11-26-2008; IN COMMERCE 11-26-2008.

3,785,368. WATKINS INCORPORATED, WINONA, MN. SN 77-427,110. PUB. 7-29-2008, FILED 3-20-2008.

IMMUNERGY

THE MARK CONSISTS OF STANDARD CHARACTERS WITHOUT CLAIM TO ANY PARTICULAR FONT, STYLE, SIZE, OR COLOR.

FOR DIETARY SUPPLEMENTS (U.S. CLS. 6, 18, 44, 46, 51 AND 52).

FIRST USE 3-10-2010; IN COMMERCE 3-10-2010.

3,785,406. TRIARCO INDUSTRIES, INC., WAYNE, NJ. SN 77-459,650. PUB. 7-8-2008, FILED 4-28-2008.

PACberry

THE MARK CONSISTS OF STANDARD CHARACTERS WITHOUT CLAIM TO ANY PARTICULAR FONT, STYLE, SIZE, OR COLOR.

FOR VITAMINS, MINERAL SUPPLEMENTS, NUTRITIONAL AND DIETARY SUPPLEMENTS (U.S. CLS. 6, 18, 44, 46, 51 AND 52).

FIRST USE 4-28-2008; IN COMMERCE 4-28-2008.

CLASS 5—(Continued).

3,785,521. JOHNSON & JOHNSON, NEW BRUNSWICK, NJ. SN 77-521,356. PUB. 12-9-2008, FILED 7-14-2008.

**EFFECTIVE ALLERGY RELIEF
WHEN YOU NEED IT**

THE MARK CONSISTS OF STANDARD CHARACTERS WITHOUT CLAIM TO ANY PARTICULAR FONT, STYLE, SIZE, OR COLOR.

OWNER OF U.S. REG. NOS. 3,709,849 AND 3,710,334. FOR PHARMACEUTICAL PREPARATIONS, NAMELY, PHARMACEUTICAL PREPARATIONS FOR THE TREATMENT OF SINUS CONDITIONS AND ANTI-ALLERGIC PREPARATIONS; ANTIHISTAMINES; DECONGESTANTS (U.S. CLS. 6, 18, 44, 46, 51 AND 52). FIRST USE 3-0-2009; IN COMMERCE 3-0-2009.

3,785,526. SMITH'S NUTRITION PRODUCTS INC., LAS VEGAS, NV. SN 77-521,668. PUB. 5-12-2009, FILED 7-14-2008.

THE DRINK OF LIFE

THE MARK CONSISTS OF STANDARD CHARACTERS WITHOUT CLAIM TO ANY PARTICULAR FONT, STYLE, SIZE, OR COLOR.

FOR HOLISTIC DIETARY SUPPLEMENTAL DRINKS (U.S. CLS. 6, 18, 44, 46, 51 AND 52). FIRST USE 8-1-2008; IN COMMERCE 8-1-2008.

3,785,625. BAYER AKTIENGESELLSCHAFT, LEVERKUSEN-BAYERWERK, FED REP GERMANY. SN 77-581,274. PUB. 4-28-2009, FILED 9-29-2008.

FFAST

THE MARK CONSISTS OF STANDARD CHARACTERS WITHOUT CLAIM TO ANY PARTICULAR FONT, STYLE, SIZE, OR COLOR.

OWNER OF U.S. REG. NOS. 2,625,378 AND 2,970,982. FOR INSECTICIDES (U.S. CLS. 6, 18, 44, 46, 51 AND 52). FIRST USE 9-30-2002; IN COMMERCE 9-30-2002.

CLASS 5—(Continued).

3,785,650. MILLIKEN & COMPANY, SPARTANBURG, SC. SN 77-600,886. PUB. 7-7-2009, FILED 10-27-2008.

ACTIVE FLUID MANAGEMENT

THE MARK CONSISTS OF STANDARD CHARACTERS WITHOUT CLAIM TO ANY PARTICULAR FONT, STYLE, SIZE, OR COLOR.

NO CLAIM IS MADE TO THE EXCLUSIVE RIGHT TO USE "FLUID MANAGEMENT", APART FROM THE MARK AS SHOWN.

FOR WOUND DRESSINGS (U.S. CLS. 6, 18, 44, 46, 51 AND 52).

FIRST USE 10-16-2008; IN COMMERCE 10-16-2008.

3,785,662. JOHNSON & JOHNSON, NEW BRUNSWICK, NJ. SN 77-606,642. PUB. 3-24-2009, FILED 11-4-2008.



OWNER OF U.S. REG. NOS. 54,124, 2,798,877, AND OTHERS.

THE MARK CONSISTS OF THE WORD "K-Y" OVER THE WORD "INTENSE" DISPLAYED ON TOP OF A BOTTLE CENTERED WITHIN THE DEPICTION OF A FLOWER.

FOR NON-MEDICATED TOPICAL PREPARATIONS, NAMELY, GELS FOR ENHANCING SEXUAL AROUSAL (U.S. CLS. 6, 18, 44, 46, 51 AND 52).

FIRST USE 1-29-2009; IN COMMERCE 1-29-2009.

3,785,755. SCHLOTTERBECK & FOSS COMPANY, PORTLAND, ME. SN 77-646,559. PUB. 12-1-2009, FILED 1-9-2009.

UBUNTU

THE MARK CONSISTS OF STANDARD CHARACTERS WITHOUT CLAIM TO ANY PARTICULAR FONT, STYLE, SIZE, OR COLOR.

CLASS 5—(Continued).

THE FOREIGN WORDING IN THE MARK TRANSLATES INTO ENGLISH AS HUMANITY.

FOR HYDRATION AND NUTRITION PRODUCTS FOR NON-HUMAN ANIMALS, NAMELY, NUTRITIONAL HYDRATING GEL FOR ANIMALS, NUTRITIONAL ADDITIVES TO HYDRATING GEL FOR ANIMALS FOR MEDICAL PURPOSES, FOR REHYDRATION, NUTRITION AND THE DELIVERY OF PHARMACEUTICAL PREPARATIONS (U.S. CLS. 6, 18, 44, 46, 51 AND 52).

FIRST USE 12-16-2009; IN COMMERCE 1-27-2010.

3,785,761. NATURE'S WAY PRODUCTS, INC., GREEN BAY, WI. SN 77-648,417. PUB. 11-3-2009, FILED 1-13-2009.

CRANRX

THE MARK CONSISTS OF STANDARD CHARACTERS WITHOUT CLAIM TO ANY PARTICULAR FONT, STYLE, SIZE, OR COLOR.

FOR DIETARY SUPPLEMENTS (U.S. CLS. 6, 18, 44, 46, 51 AND 52).

FIRST USE 3-2-2009; IN COMMERCE 3-2-2009.

3,785,825. FOSTER AND SMITH, INC., RHINELANDER, WI. SN 77-661,634. PUB. 6-2-2009, FILED 2-2-2009.

CRAN HEALTH

THE MARK CONSISTS OF STANDARD CHARACTERS WITHOUT CLAIM TO ANY PARTICULAR FONT, STYLE, SIZE, OR COLOR.

NO CLAIM IS MADE TO THE EXCLUSIVE RIGHT TO USE "HEALTH", APART FROM THE MARK AS SHOWN.

FOR DIETARY SUPPLEMENT FOR ANIMALS (U.S. CLS. 6, 18, 44, 46, 51 AND 52).

FIRST USE 12-15-2009; IN COMMERCE 12-15-2009.

CLASS 5—(Continued).

3,785,873. I PLAY, INC., ASHEVILLE, NC. SN 77-668,913. PUB. 6-2-2009, FILED 2-12-2009.



THE MARK CONSISTS OF A STYLIZED SLEEPING SPROUT NESTLED IN AND PARTIALLY SURROUNDED BY THE TWO HALVES OF A POD RESTING ON TWO SMALL FAUX FEET.

FOR BREAST-NURSING PADS; MEDICATED PRE-MOISTENED WIPES; AND SANITIZING WIPES (U.S. CLS. 6, 18, 44, 46, 51 AND 52).

FIRST USE 8-1-2009; IN COMMERCE 8-1-2009.

3,785,879. COSRICH GROUP, INC., SUN VALLEY, CA. SN 77-669,226. PUB. 6-9-2009, FILED 2-12-2009.

HEARTGR8

THE MARK CONSISTS OF STANDARD CHARACTERS WITHOUT CLAIM TO ANY PARTICULAR FONT, STYLE, SIZE, OR COLOR.

FOR HERBAL SUPPLEMENTS (U.S. CLS. 6, 18, 44, 46, 51 AND 52).

FIRST USE 6-1-2008; IN COMMERCE 8-1-2008.

3,785,888. NUTRABOLICS, INC., RICHMOND, BC, CANADA. SN 77-671,654. PUB. 6-16-2009, FILED 2-17-2009.

AMINOCELL

THE MARK CONSISTS OF STANDARD CHARACTERS WITHOUT CLAIM TO ANY PARTICULAR FONT, STYLE, SIZE, OR COLOR.

FOR DIETARY AND NUTRITIONAL SUPPLEMENTS; VITAMINS (U.S. CLS. 6, 18, 44, 46, 51 AND 52).

FIRST USE 4-15-2009; IN COMMERCE 4-15-2009.

CLASS 5—(Continued).

3,785,901. NOVARTIS AG, BASEL, SWITZERLAND. SN 77-675,030. PUB. 6-16-2009, FILED 2-20-2009.

AFINITOR

THE MARK CONSISTS OF STANDARD CHARACTERS WITHOUT CLAIM TO ANY PARTICULAR FONT, STYLE, SIZE, OR COLOR.

OWNER OF U.S. REG. NO. 3,216,047.
FOR PHARMACEUTICAL PREPARATIONS FOR THE TREATMENT OF NEPHROLOGY (U.S. CLS. 6, 18, 44, 46, 51 AND 52).

FIRST USE 3-30-2009; IN COMMERCE 3-30-2009.

3,785,902. JARROW FORMULAS, INC., LOS ANGELES, CA. SN 77-675,161. PUB. 5-26-2009, FILED 2-20-2009.

YUM-YUM ZYMES

THE MARK CONSISTS OF STANDARD CHARACTERS WITHOUT CLAIM TO ANY PARTICULAR FONT, STYLE, SIZE, OR COLOR.

FOR DIETARY AND NUTRITIONAL SUPPLEMENTS (U.S. CLS. 6, 18, 44, 46, 51 AND 52).

FIRST USE 8-31-2009; IN COMMERCE 8-31-2009.

3,785,904. SANTEGRA INC., HOLMDEL, NJ. SN 77-675,439. PUB. 6-23-2009, FILED 2-22-2009.

SANTEGRA

THE MARK CONSISTS OF STANDARD CHARACTERS WITHOUT CLAIM TO ANY PARTICULAR FONT, STYLE, SIZE, OR COLOR.

THE WORDING "SANTEGRA" HAS NO MEANING IN A FOREIGN LANGUAGE.

FOR DIETARY SUPPLEMENTS FOR HUMAN CONSUMPTION, NAMELY, NUTRITIONAL, VITAMIN, HERBAL AND MINERAL SUPPLEMENTS (U.S. CLS. 6, 18, 44, 46, 51 AND 52).

FIRST USE 1-17-2007; IN COMMERCE 8-26-2009.

CLASS 5—(Continued).

3,785,909. OSTEOTECH, INC., EATONTOWN, NJ. SN 77-676,623. PUB. 6-16-2009, FILED 2-23-2009.

FACETLINX

THE MARK CONSISTS OF STANDARD CHARACTERS WITHOUT CLAIM TO ANY PARTICULAR FONT, STYLE, SIZE, OR COLOR.

FOR ALLOGRAFT MATERIAL, NAMELY, HUMAN BONE AND TISSUE FOR SURGICAL IMPLANTS (U.S. CLS. 6, 18, 44, 46, 51 AND 52).

FIRST USE 8-12-2009; IN COMMERCE 8-12-2009.

3,785,916. SIGNAL INVESTMENT & MANAGEMENT CO., WILMINGTON, DE. SN 77-678,744. PUB. 11-24-2009, FILED 2-26-2009.

DEXATRIM MAX SLIM PACKS

THE MARK CONSISTS OF STANDARD CHARACTERS WITHOUT CLAIM TO ANY PARTICULAR FONT, STYLE, SIZE, OR COLOR.

OWNER OF U.S. REG. NOS. 1,068,862, 3,231,335, AND OTHERS.

NO CLAIM IS MADE TO THE EXCLUSIVE RIGHT TO USE "PACKS", APART FROM THE MARK AS SHOWN.

FOR FOOD, NUTRITIONAL AND DIETARY SUPPLEMENTS (U.S. CLS. 6, 18, 44, 46, 51 AND 52).

FIRST USE 6-0-2009; IN COMMERCE 6-0-2009.

3,785,930. THE PROCTER & GAMBLE COMPANY, CINCINNATI, OH. SN 77-682,383. PUB. 6-9-2009, FILED 3-3-2009.

DAYQUIL MUCUS CONTROL

THE MARK CONSISTS OF STANDARD CHARACTERS WITHOUT CLAIM TO ANY PARTICULAR FONT, STYLE, SIZE, OR COLOR.

OWNER OF U.S. REG. NOS. 1,110,362 AND 1,687,000.

NO CLAIM IS MADE TO THE EXCLUSIVE RIGHT TO USE "MUCUS CONTROL", APART FROM THE MARK AS SHOWN.

FOR EXPECTORANTS (U.S. CLS. 6, 18, 44, 46, 51 AND 52).

FIRST USE 7-1-2009; IN COMMERCE 7-1-2009.

CLASS 5—(Continued).

3,785,974. CALDWELL CONSUMER HEALTH, LLC, DBA REVIVE PERSONAL PRODUCTS COMPANY, MADISON, NJ. SN 77-695,451. PUB. 7-21-2009, FILED 3-20-2009.

OPTIONS CONCEPTROL

THE MARK CONSISTS OF STANDARD CHARACTERS WITHOUT CLAIM TO ANY PARTICULAR FONT, STYLE, SIZE, OR COLOR.

OWNER OF U.S. REG. NOS. 1,502,774 AND 1,609,550. FOR BIRTH CONTROL PREPARATION, NAMELY, SPERMICIDES AND CONTRACEPTIVE GEL (U.S. CLS. 6, 18, 44, 46, 51 AND 52).
FIRST USE 1-22-2010; IN COMMERCE 1-22-2010.

3,785,977. LIL' DRUG STORE PRODUCTS, INC., CEDAR RAPIDS, IA. SN 77-697,053. PUB. 6-2-2009, FILED 3-23-2009.



OWNER OF U.S. REG. NOS. 1,296,316, 1,296,318, AND 1,934,934.

NO CLAIM IS MADE TO THE EXCLUSIVE RIGHT TO USE "DRUG STORE", APART FROM THE MARK AS SHOWN.

THE COLOR(S) YELLOW AND BLACK IS/ARE CLAIMED AS A FEATURE OF THE MARK.

THE MARK CONSISTS OF THE STYLIZED WORDING "LIL' DRUG STORE" IN BLACK, WITH A YELLOW BACKGROUND, AND A DOUBLE-LINED BLACK BORDER. THE COLOR WHITE APPEARING IN THE MARK REPRESENTS BACKGROUND AREAS THAT ARE NOT PART OF THE MARK.

FOR NON-PRESCRIPTION DRUG ITEMS, NAMELY, ANALGESICS, PREPARATIONS FOR TREATING COLDS AND FLU, NASAL SPRAY PREPARATIONS, ANTACIDS, DIETARY AND NUTRITIONAL SUPPLEMENTS, AND SLEEP AIDS, NAMELY, SLEEPING PILLS AND TABLETS (U.S. CLS. 6, 18, 44, 46, 51 AND 52).
FIRST USE 4-0-2009; IN COMMERCE 4-0-2009.

CLASS 5—(Continued).

3,786,044. HUNGRY FISH MEDIA, LLC, CAMBRIDGE, MA. SN 77-731,130. PUB. 10-6-2009, FILED 5-7-2009.

FORCE FACTOR

THE MARK CONSISTS OF STANDARD CHARACTERS WITHOUT CLAIM TO ANY PARTICULAR FONT, STYLE, SIZE, OR COLOR.

FOR VITAMIN AND MINERAL SUPPLEMENTS; VITAMIN SUPPLEMENTS (U.S. CLS. 6, 18, 44, 46, 51 AND 52).

FIRST USE 4-10-2009; IN COMMERCE 4-10-2009.

3,786,085. ADVANCED VISION RESEARCH, INC., WOBURN, MA. SN 77-749,216. PUB. 9-8-2009, FILED 6-1-2009.

THERATEARS XTRA

THE MARK CONSISTS OF STANDARD CHARACTERS WITHOUT CLAIM TO ANY PARTICULAR FONT, STYLE, SIZE, OR COLOR.

OWNER OF U.S. REG. NOS. 2,041,112, 2,770,188, AND 3,181,614.

FOR EYE DROPS (U.S. CLS. 6, 18, 44, 46, 51 AND 52).
FIRST USE 2-23-2010; IN COMMERCE 2-23-2010.

3,786,119. COLLEGIUM PHARMACEUTICAL, INC., CUMBERLAND, RI. SN 77-759,789. PUB. 10-27-2009, FILED 6-15-2009.

BENZEFOAM

THE MARK CONSISTS OF STANDARD CHARACTERS WITHOUT CLAIM TO ANY PARTICULAR FONT, STYLE, SIZE, OR COLOR.

FOR PHARMACEUTICAL PREPARATIONS FOR DERMATOLOGICAL USE (U.S. CLS. 6, 18, 44, 46, 51 AND 52).
FIRST USE 9-25-2009; IN COMMERCE 9-25-2009.

CLASS 5—(Continued).

3,786,127. COUNTRY LIFE, LLC, HAUPPAUGE, NY. SN 77-761,744. PUB. 11-3-2009, FILED 6-17-2009.

STRESS SHIELD

THE MARK CONSISTS OF STANDARD CHARACTERS WITHOUT CLAIM TO ANY PARTICULAR FONT, STYLE, SIZE, OR COLOR.

NO CLAIM IS MADE TO THE EXCLUSIVE RIGHT TO USE "STRESS", APART FROM THE MARK AS SHOWN, FOR DIETARY AND NUTRITIONAL SUPPLEMENTS (U.S. CLS. 6, 18, 44, 46, 51 AND 52).

FIRST USE 11-10-2009; IN COMMERCE 11-10-2009.

3,786,189. THE BINDING SITE, LTD., BIRMINGHAM, ENGLAND. SN 77-979,024. PUB. 5-12-2009, FILED 12-15-2008.



OWNER OF U.S. REG. NO. 2,534,974.

THE COLOR(S) YELLOW, BLACK, WHITE AND GRAY IS/ARE CLAIMED AS A FEATURE OF THE MARK.

THE MARK CONSISTS OF THE WORD "FREELITE" IN YELLOW LETTERS OUTLINED IN BLACK AND A DESIGN ELEMENT CONSISTING OF SEVERAL LINKED TUBES IN VARIOUS SHADES OF GRAY OUTLINED IN BLACK WITH TWO OF THE TUBES CONTAINING A CHEVRON DESIGN IN BLACK AND YELLOW AND AN OVAL OUTLINED IN BLACK IN THE CENTER OF WHICH IS A TUBULAR SHAPED OBJECT WITH A YELLOW AND BLACK CHEVRON IN THE CENTER OF THE TUBULAR SHAPED OBJECT AND A WHITE STRIPE IN THE UPPER LEFT HAND CORNER SEPARATING ONE TUBULAR SHAPE FROM THE PARTIAL APPEARANCE OF ANOTHER TUBULAR SHAPE. THE REMAINING WHITE IN THE MARK IS BACKGROUND ONLY AND IS NOT INTENDED AS A FEATURE OF THE MARK.

FOR CALIBRATING SOLUTIONS, DILUENTS, CONTROL SAMPLES, REAGENTS, ANTIBODIES, ANTIGEN SUBSTRATES, CONJUGATES, STOPPING SOLUTIONS, IMMUNOFLOURESCENCE REAGENTS, HISTOLOGY REAGENTS, ENZYME IMMUNOASSAY REAGENTS AND GENERAL PURPOSE REAGENTS FOR MEDICAL AND VETERINARY DIAGNOSTIC AND CLINICAL USE; AND DIAGNOSTIC AND IMMUNOLOGICAL TEST KITS CONSISTING OF REAGENTS, CONTROLS, BUFFERS, CALIBRATORS, DILUENTS, ANTIBODIES, ANTIGEN SUBSTRATES, CONJUGATES, STOPPING SOLUTIONS, ANTISERA AND/OR DROPPER BOTTLES, ALL FOR USE IN MEASURING THE CONCENTRATION OF PROTEINS, ANTIBODIES, ANTIGENS AND OTHER SUBSTANCES IN BLOOD, OTHER BODY FLUIDS AND BODY TISSUES, OR EXTRACTS THEREOF, FOR USE IN THE DIAGNOSIS, TREATMENT, CURE, PREVENTION OR MITIGATION OF DISEASES AND OTHER CONDITIONS IN HUMANS AND ANIMALS (U.S. CLS. 6, 18, 44, 46, 51 AND 52).

FIRST USE 9-7-2009; IN COMMERCE 9-11-2009.

CLASS 5—(Continued).

3,786,214. SPROUT FOODS, INC., NEW YORK, NY. SN 78-497,966. PUB. 10-11-2005, FILED 10-11-2004.

SPROUT

THE MARK CONSISTS OF STANDARD CHARACTERS WITHOUT CLAIM TO ANY PARTICULAR FONT, STYLE, SIZE, OR COLOR.

FOR BABY FOOD; FOOD PUREES, CEREALS AND BISCUITS FOR FEEDING BABIES; ORGANIC BABY FOOD; FIRST, SECOND AND THIRD STAGE BABY FOODS (U.S. CLS. 6, 18, 44, 46, 51 AND 52).

FIRST USE 12-15-2008; IN COMMERCE 12-15-2008.

3,786,220. SCI INTERNATIONAL INC., FREDERICK, MD. SN 78-559,014. PUB. 11-7-2006, FILED 2-2-2005.

U-CHECK

THE MARK CONSISTS OF STANDARD CHARACTERS WITHOUT CLAIM TO ANY PARTICULAR FONT, STYLE, SIZE, OR COLOR.

FOR PREGNANCY TEST KITS FOR HOME USE (U.S. CLS. 6, 18, 44, 46, 51 AND 52).

FIRST USE 11-1-2009; IN COMMERCE 11-1-2009.

CLASS 5—(Continued).

3,786,248. SPROUT FOODS, INC., NEW YORK, NY. SN 78-171,298. PUB. 6-13-2006, FILED 9-21-2005.



THE COLOR(S) GREEN, LIGHT GREEN, YELLOW GREEN, KELLY GREEN IS/ARE CLAIMED AS A FEATURE OF THE MARK.

THE MARK CONSISTS OF THE WORD "SPROUT" IN GREEN, WITH A 4-LEAF CLOVER SHAPE RAISED TO THE RIGHT, IN 4 COLORS, GREEN, LIGHT GREEN, YELLOW GREEN AND KELLY GREEN.

FOR BABY FOOD; FOOD PUREES, CEREALS AND BISCUITS FOR FEEDING BABIES; ORGANIC BABY FOOD; FIRST, SECOND AND THIRD STAGE BABY FOODS (U.S. CLS. 6, 18, 44, 46, 51 AND 52).

FIRST USE 12-15-2008; IN COMMERCE 12-15-2008.

3,786,263. VITAL PHARMACEUTICALS, INC., DAVIE, FL. SN 78-806,246. PUB. 9-26-2006, FILED 2-3-2006.

LIQRUSH

THE MARK CONSISTS OF STANDARD CHARACTERS WITHOUT CLAIM TO ANY PARTICULAR FONT, STYLE, SIZE, OR COLOR.

FOR NUTRITIONAL SUPPLEMENTS IN PILL FORM (U.S. CLS. 6, 18, 44, 46, 51 AND 52).

FIRST USE 12-10-2009; IN COMMERCE 12-10-2009.

3,786,306. MERCK SHARP & DOHME CORP., WHITEHOUSE STATION, NJ. SN 78-891,543. PUB. 12-5-2006, FILED 5-24-2006.

TREDAPTA

THE MARK CONSISTS OF STANDARD CHARACTERS WITHOUT CLAIM TO ANY PARTICULAR FONT, STYLE, SIZE, OR COLOR.

FOR PHARMACEUTICAL PREPARATIONS FOR THE TREATMENT OF CARDIOVASCULAR DISEASES AND DISORDERS (U.S. CLS. 6, 18, 44, 46, 51 AND 52).

FIRST USE 2-16-2010; IN COMMERCE 2-16-2010.

CLASS 5—(Continued).

3,786,307. MERCK SHARP & DOHME CORP., WHITEHOUSE, NJ. SN 78-891,549. PUB. 12-5-2006, FILED 5-24-2006.

TREDAPTIVE

THE MARK CONSISTS OF STANDARD CHARACTERS WITHOUT CLAIM TO ANY PARTICULAR FONT, STYLE, SIZE, OR COLOR.

FOR PHARMACEUTICAL PREPARATIONS FOR THE TREATMENT OF CARDIOVASCULAR DISEASES AND DISORDERS (U.S. CLS. 6, 18, 44, 46, 51 AND 52).

FIRST USE 2-16-2010; IN COMMERCE 2-16-2010.

3,786,308. MERCK SHARP & DOHME CORP., WHITEHOUSE STATION, NJ. SN 78-891,556. PUB. 12-5-2006, FILED 5-24-2006.

IMPROLIP

THE MARK CONSISTS OF STANDARD CHARACTERS WITHOUT CLAIM TO ANY PARTICULAR FONT, STYLE, SIZE, OR COLOR.

FOR PHARMACEUTICAL PREPARATIONS FOR THE TREATMENT OF CARDIOVASCULAR DISEASES AND DISORDERS (U.S. CLS. 6, 18, 44, 46, 51 AND 52).

FIRST USE 2-16-2010; IN COMMERCE 2-16-2010.

3,786,333. JOHNSON & JOHNSON, NEW BRUNSWICK, NJ. SN 78-957,242. PUB. 12-12-2006, FILED 8-22-2006.

STRONGER THAN PAIN

THE MARK CONSISTS OF STANDARD CHARACTERS WITHOUT CLAIM TO ANY PARTICULAR FONT, STYLE, SIZE, OR COLOR.

FOR ANALGESIC PREPARATION, ADHESIVE PATCHES CONTAINING ANALGESIC PREPARATIONS FOR PAIN RELIEF (U.S. CLS. 6, 18, 44, 46, 51 AND 52).

FIRST USE 11-8-2009; IN COMMERCE 11-8-2009.

CLASS 5—(Continued).

3,786,343. NEUROGESX, INC., SAN MATEO, CA. SN 78-981,310. PUB. 6-19-2007, FILED 4-17-2006.

NEUROGESX

THE MARK CONSISTS OF STANDARD CHARACTERS WITHOUT CLAIM TO ANY PARTICULAR FONT, STYLE, SIZE, OR COLOR.

FOR TRANSDERMAL PATCHES CONTAINING PHARMACEUTICAL PREPARATIONS TO TREAT PAIN; PHARMACEUTICAL PREPARATIONS FOR USE IN PAIN TREATMENT; ANALGESICS; TOPICAL ANESTHETICS (U.S. CLS. 6, 18, 44, 46, 51 AND 52).

FIRST USE 6-11-2009; IN COMMERCE 6-11-2009.

3,786,349. AGILE THERAPEUTICS, INC., WEST CONSHOHOCKEN, PA. SN 78-981,362. PUB. 12-16-2008, FILED 3-28-2001.

AGILE THERAPEUTICS

NO CLAIM IS MADE TO THE EXCLUSIVE RIGHT TO USE "THERAPEUTICS", APART FROM THE MARK AS SHOWN.

FOR TRANSDERMAL DRUG DELIVERY DEVICE, NAMELY, TRANSDERMAL PATCHES CONTAINING HORMONES AND OTHER THERAPEUTICS FOR USE IN CONTRACEPTION (U.S. CLS. 6, 18, 44, 46, 51 AND 52).

FIRST USE 6-20-2005; IN COMMERCE 6-20-2005.

CLASS 6—METAL GOODS

3,785,070. PILEPRO, LLC, RAPID CITY, SD. SN 76-659,385. PUB. 11-21-2006, FILED 5-1-2006.

MARINER

THE MARK CONSISTS OF STANDARD CHARACTERS WITHOUT CLAIM TO ANY PARTICULAR FONT, STYLE, SIZE, OR COLOR.

FOR METAL SHEET PILES; METAL SHEET PILE SECTIONS; METAL BEAMS USED IN SHEET PILING AND METAL SHEET PILE CONNECTORS (U.S. CLS. 2, 12, 13, 14, 23, 25 AND 50).

FIRST USE 7-31-2009; IN COMMERCE 7-31-2009.

CLASS 6—(Continued).

3,785,073. SCHAEFFER INDUSTRIES, MIRA LOMA, CA. SN 76-664,253. PUB. 3-20-2007, FILED 8-7-2006.

AMERISTRUT

THE MARK CONSISTS OF STANDARD CHARACTERS WITHOUT CLAIM TO ANY PARTICULAR FONT, STYLE, SIZE, OR COLOR.

FOR METAL FRAMING CHANNEL (U.S. CLS. 2, 12, 13, 14, 23, 25 AND 50).

FIRST USE 12-31-2007; IN COMMERCE 12-31-2007.

3,785,113. CORBIN RUSSWIN, INC., BERLIN, CT. SN 77-015,023. PUB. 5-29-2007, FILED 10-5-2006.

ACCESS 600

THE MARK CONSISTS OF STANDARD CHARACTERS WITHOUT CLAIM TO ANY PARTICULAR FONT, STYLE, SIZE, OR COLOR.

OWNER OF U.S. REG. NO. 3,149,501.

NO CLAIM IS MADE TO THE EXCLUSIVE RIGHT TO USE "ACCESS", APART FROM THE MARK AS SHOWN.

FOR MORTISE AND BORED METAL LOCKS; METAL ESCUTCHEONS FOR PROTECTING A LOCK CYLINDER; METAL EXIT DEVICES IN THE NATURE OF METAL LATCHES, LOCKS AND PUSHBAR AND TOUCHBAR OPERATORS THAT SECURE DOORS BUT ALLOW FOR INGRESS AND EGRESS TO FACILITIES (U.S. CLS. 2, 12, 13, 14, 23, 25 AND 50).

FIRST USE 6-2-2008; IN COMMERCE 6-2-2008.

3,785,288. LINCOLN GLOBAL, INC., CITY OF INDUSTRY, CA. SN 77-368,466. PUB. 5-27-2008, FILED 1-10-2008.

L-58

THE MARK CONSISTS OF STANDARD CHARACTERS WITHOUT CLAIM TO ANY PARTICULAR FONT, STYLE, SIZE, OR COLOR.

OWNER OF U.S. REG. NOS. 1,916,249, 1,916,255, AND 1,919,439.

FOR METAL WELDING WIRE (U.S. CLS. 2, 12, 13, 14, 23, 25 AND 50).

FIRST USE 11-30-2008; IN COMMERCE 11-30-2008.

CLASS 6—(Continued).

3,785,289. LINCOLN GLOBAL, INC., CITY OF INDUSTRY, CA. SN 77-368,469. PUB. 5-27-2008, FILED 1-10-2008.

L-59

THE MARK CONSISTS OF STANDARD CHARACTERS WITHOUT CLAIM TO ANY PARTICULAR FONT, STYLE, SIZE, OR COLOR.

OWNER OF U.S. REG. NOS. 1,916,249, 1,916,255, AND 1,919,439.

FOR METAL WELDING WIRE (U.S. CLS. 2, 12, 13, 14, 23, 25 AND 50).

FIRST USE 11-30-2008; IN COMMERCE 11-30-2008.

CLASS 6—(Continued).

3,785,872. EPOCH DESIGN, LLC, REDMOND, WA. SN 77-668,654. PUB. 6-9-2009, FILED 2-11-2009.

Package Master

THE MARK CONSISTS OF STANDARD CHARACTERS WITHOUT CLAIM TO ANY PARTICULAR FONT, STYLE, SIZE, OR COLOR.

NO CLAIM IS MADE TO THE EXCLUSIVE RIGHT TO USE "PACKAGE", APART FROM THE MARK AS SHOWN, FOR METAL MAILBOXES (U.S. CLS. 2, 12, 13, 14, 23, 25 AND 50).

FIRST USE 9-3-2009; IN COMMERCE 9-3-2009.

3,785,369. CIMBERIO VALVE CO. INC., MALVERN, PA. SN 77-428,350. PUB. 7-21-2009, FILED 3-21-2008.

FASTLOCK

THE MARK CONSISTS OF STANDARD CHARACTERS WITHOUT CLAIM TO ANY PARTICULAR FONT, STYLE, SIZE, OR COLOR.

FOR METAL PIPE FITTINGS (U.S. CLS. 2, 12, 13, 14, 23, 25 AND 50).

FIRST USE 7-14-2009; IN COMMERCE 9-18-2009.

3,786,037. POWERS FASTENERS, INC., BREWSTER, NY. SN 77-727,188. PUB. 7-14-2009, FILED 5-1-2009.

SNAKE+

THE MARK CONSISTS OF STANDARD CHARACTERS WITHOUT CLAIM TO ANY PARTICULAR FONT, STYLE, SIZE, OR COLOR.

OWNER OF U.S. REG. NO. 3,626,563. FOR THREADED METAL FASTENER FOR CONCRETE (U.S. CLS. 2, 12, 13, 14, 23, 25 AND 50).

FIRST USE 5-19-2008; IN COMMERCE 5-19-2008.

3,785,704. SEMCO INCORPORATED, COLUMBIA, MO. SN 77-628,837. PUB. 7-14-2009, FILED 12-8-2008.

VELOCITY

THE MARK CONSISTS OF STANDARD CHARACTERS WITHOUT CLAIM TO ANY PARTICULAR FONT, STYLE, SIZE, OR COLOR.

FOR METAL DUCTS AND PARTS THEREFOR FOR VENTILATING, AIR CONDITIONING, WARM AIR HEATING AND EXHAUST SYSTEMS (U.S. CLS. 2, 12, 13, 14, 23, 25 AND 50).

FIRST USE 1-5-2009; IN COMMERCE 1-5-2009.

3,786,062. GEE, PATRICK, WHITEHALL, MI. SN 77-738,864. PUB. 9-29-2009, FILED 5-17-2009.

SHELF BRUTE

THE MARK CONSISTS OF STANDARD CHARACTERS WITHOUT CLAIM TO ANY PARTICULAR FONT, STYLE, SIZE, OR COLOR.

NO CLAIM IS MADE TO THE EXCLUSIVE RIGHT TO USE "SHELF", APART FROM THE MARK AS SHOWN, FOR STEEL SHELF BRACKETS USED FOR STORAGE (U.S. CLS. 2, 12, 13, 14, 23, 25 AND 50).

FIRST USE 12-6-2009; IN COMMERCE 12-6-2009.

CLASS 6—(Continued).

3,786,337. ESTERLINE TECHNOLOGIES CORPORATION, BELLEVUE, WA. SN 78-973,346. PUB. 10-30-2007, FILED 9-13-2006.



The logo for Esterline features the word "Esterline" in a bold, sans-serif font. To the right of the text is a square icon containing a stylized gear or mechanical component with a circular element in the center.

OWNER OF U.S. REG. NOS. 1,905,295, 2,594,288, AND OTHERS.

FOR METAL INSTALLATION, CUSHIONING, AND SUPPORT DEVICES FOR FLUID CONDUITS AND ELECTRIC CONDUCTORS, NAMELY, SUPPORT BLOCKS, CLAMPS, FLUID AND ELECTRIC LINE SUPPORTS, BRACKETS AND SHIMS; HARDWARE, NAMELY, BRACKETS, COUPLINGS, TERMINAL BLOCK COVERS AND FAIR LEADS, ALL GOODS CONTAINING METAL; METAL AND ELASTOMERIC CLAMPS AND METAL AND ELASTOMERIC SUPPORT BLOCKS FOR WIRING AND TUBING INSTALLATIONS; STAINLESS STEEL INSULATION FOR LAND-BASED AND NUCLEAR POWER PLANTS (U.S. CLS. 2, 12, 13, 14, 23, 25 AND 50).

FIRST USE 6-0-2004; IN COMMERCE 6-0-2004.

CLASS 7—MACHINERY

3,785,237. THE TORO COMPANY, BLOOMINGTON, MN. SN 77-324,802. PUB. 10-6-2009, FILED 11-8-2007.

PRO FORCE

THE MARK CONSISTS OF STANDARD CHARACTERS WITHOUT CLAIM TO ANY PARTICULAR FONT, STYLE, SIZE, OR COLOR.

OWNER OF U.S. REG. NOS. 2,416,389, 2,934,165, AND 3,280,518.

FOR MACHINES FOR TURF, GROUNDS AND LAWN MAINTENANCE, NAMELY, POWER BLOWER/VACUUMS FOR CLEARING DEBRIS, LEAVES AND GRASS CUTTINGS FROM GOLF COURSES, ATHLETIC FIELDS, PARKS AND OTHER LARGE AREAS OF TURF (U.S. CLS. 13, 19, 21, 23, 31, 34 AND 35).

FIRST USE 10-0-2008; IN COMMERCE 10-0-2008.

CLASS 7—(Continued).

3,785,294. EMERSON ELECTRIC CO., ST. LOUIS, MO. SN 77-370,945. PUB. 5-27-2008, FILED 1-14-2008.

QWIK LOCK

THE MARK CONSISTS OF STANDARD CHARACTERS WITHOUT CLAIM TO ANY PARTICULAR FONT, STYLE, SIZE, OR COLOR.

FOR FILTERS FOR VACUUM CLEANERS (U.S. CLS. 13, 19, 21, 23, 31, 34 AND 35).

FIRST USE 11-0-2009; IN COMMERCE 11-0-2009.

3,785,473. PRODEN ENTERPRISES INC., ST-LAURENT, QC, CANADA. SN 77-502,825. PUB. 11-11-2008, FILED 6-19-2008.

TrimSaver

THE MARK CONSISTS OF STANDARD CHARACTERS WITHOUT CLAIM TO ANY PARTICULAR FONT, STYLE, SIZE, OR COLOR.

FOR MACHINE PART IN THE NATURE OF A DEVICE INSTALLED ON A ROTATIVE PRESS TO PRODUCE CORRUGATED BOXES (U.S. CLS. 13, 19, 21, 23, 31, 34 AND 35).

FIRST USE 9-0-2008; IN COMMERCE 9-0-2008.

3,785,488. CHAMPION POWER EQUIPMENT, INC., DBA CHAMPION POWER EQUIPMENT, SANTA FE SPRINGS, CA. SN 77-509,806. PUB. 11-25-2008, FILED 6-27-2008.

CATEGORY 5

THE MARK CONSISTS OF STANDARD CHARACTERS WITHOUT CLAIM TO ANY PARTICULAR FONT, STYLE, SIZE, OR COLOR.

FOR DC GENERATORS; ELECTRICITY GENERATORS; ENGINES AND MOTORS FOR THE GENERATION OF ELECTRICITY; GENERATORS OF ELECTRICITY; INTERNAL COMBUSTION ENGINES FOR POWER GENERATION; MULTI-PURPOSE HIGH PRESSURE WASHERS (U.S. CLS. 13, 19, 21, 23, 31, 34 AND 35).

FIRST USE 12-15-2009; IN COMMERCE 12-15-2009.

CLASS 7—(Continued).

3,785,516. DYNABRADE, INC., CLARENCE, NY. SN 77-518,238. PUB. 5-19-2009, FILED 7-9-2008.

DYNABRITE

THE MARK CONSISTS OF STANDARD CHARACTERS WITHOUT CLAIM TO ANY PARTICULAR FONT, STYLE, SIZE, OR COLOR.

OWNER OF U.S. REG. NOS. 1,448,068, 2,225,626, AND OTHERS.

FOR NON-WOVEN NYLON ABRASIVES, NAMELY, ABRASIVE BELTS, DISKS, AND WHEELS FOR USE WITH PORTABLE POWER TOOLS (U.S. CLS. 13, 19, 21, 23, 31, 34 AND 35).

FIRST USE 12-1-2008; IN COMMERCE 12-1-2008.

3,785,520. ARENGO 309 (PTY) LIMITED, PRIMROSE, GERMISTON, SOUTH AFRICA. SN 77-520,909. PUB. 5-26-2009, FILED 7-13-2008.

SUPERBUG

THE MARK CONSISTS OF STANDARD CHARACTERS WITHOUT CLAIM TO ANY PARTICULAR FONT, STYLE, SIZE, OR COLOR.

FOR MACHINES AND MACHINE TOOLS, NAMELY, AUTOMATIC SWIMMING POOL CLEANERS AND PARTS THEREFOR; AUTOMATIC SWIMMING POOL SWEEPERS; DEVICES FOR SWIMMING POOLS, NAMELY, SWIMMING POOL VACUUMS AND SWIMMING POOL VACUUM HOSES; AND STRUCTURAL COMPONENT PARTS OF ALL THE AFORESAID GOODS (U.S. CLS. 13, 19, 21, 23, 31, 34 AND 35).

FIRST USE 9-0-2009; IN COMMERCE 9-0-2009.

3,785,541. AQUATRON INC., DELRAY BEACH, FL. SN 77-528,438. PUB. 11-11-2008, FILED 7-22-2008.

AQUACONTROL

THE MARK CONSISTS OF STANDARD CHARACTERS WITHOUT CLAIM TO ANY PARTICULAR FONT, STYLE, SIZE, OR COLOR.

FOR AUTOMATIC SWIMMING POOL CLEANERS AND PARTS THEREFOR (U.S. CLS. 13, 19, 21, 23, 31, 34 AND 35).

FIRST USE 10-20-2009; IN COMMERCE 10-20-2009.

CLASS 7—(Continued).

3,785,560. REAY, GAVIN, LONDON SW151DQ, UNITED KINGDOM. SN 77-534,904. PUB. 6-2-2009, FILED 7-30-2008.

STIRR A REVOLUTION IN YOUR PAN

THE MARK CONSISTS OF STANDARD CHARACTERS WITHOUT CLAIM TO ANY PARTICULAR FONT, STYLE, SIZE, OR COLOR.

FOR KITCHEN MACHINES FOR FOOD PREPARATION, NAMELY, ELECTRIC MIXERS (U.S. CLS. 13, 19, 21, 23, 31, 34 AND 35).

FIRST USE 7-31-2008; IN COMMERCE 7-31-2008.

3,785,592. THE TIMKEN COMPANY, CANTON, OH. SN 77-554,615. PUB. 1-13-2009, FILED 8-25-2008.

ECOTURN

THE MARK CONSISTS OF STANDARD CHARACTERS WITHOUT CLAIM TO ANY PARTICULAR FONT, STYLE, SIZE, OR COLOR.

FOR SEALS FOR RAILROAD BEARINGS (U.S. CLS. 13, 19, 21, 23, 31, 34 AND 35).

FIRST USE 9-0-2008; IN COMMERCE 9-0-2009.

3,785,741. TENNANT COMPANY, GOLDEN VALLEY, MN. SN 77-640,837. PUB. 5-19-2009, FILED 12-29-2008.



NO CLAIM IS MADE TO THE EXCLUSIVE RIGHT TO USE "GREEN MACHINES" AND "COMPANY", APART FROM THE MARK AS SHOWN.

THE COLOR(S) YELLOW-GREEN, DARK GREEN AND GRAY IS/ARE CLAIMED AS A FEATURE OF THE MARK.

THE MARK CONSISTS OF THE WORD "GREEN" IN YELLOW-GREEN STYLIZED LETTERS ON A DARK GREEN OVAL BACKGROUND, THE WORD "MACHINES" IN DARK GREEN STYLIZED LETTERS ON A YELLOW-GREEN OVAL BACKGROUND, ALL ABOVE A YELLOW-GREEN SMALL BRUSH AND DARK GREEN LARGER BRUSH AND THE WORDS "FROM TENNANT COMPANY" IN GRAY LETTERS.

FOR STREET SWEEPERS (U.S. CLS. 13, 19, 21, 23, 31, 34 AND 35).

FIRST USE 2-28-2009; IN COMMERCE 2-28-2009.

CLASS 7—(Continued).

3,785,942. E-Z GROUT CORPORATION, WATERFORD, OH. SN 77-685,598. PUB. 7-14-2009, FILED 3-6-2009.

HOG CRUSHER

THE MARK CONSISTS OF STANDARD CHARACTERS WITHOUT CLAIM TO ANY PARTICULAR FONT, STYLE, SIZE, OR COLOR.

OWNER OF U.S. REG. NOS. 2,874,810, 2,987,588, AND 2,989,672.

NO CLAIM IS MADE TO THE EXCLUSIVE RIGHT TO USE "CRUSHER", APART FROM THE MARK AS SHOWN. FOR POWER OPERATED TOOLS, NAMELY, PORTABLE MACHINES FOR REDUCING THE SIZE OF PIECES OF PAVEMENT, CONCRETE BLOCKS AND OTHER MASONRY MATERIALS (U.S. CLS. 13, 19, 21, 23, 31, 34 AND 35).

FIRST USE 6-8-2009; IN COMMERCE 6-8-2009.

3,785,962. BLOOM INC., DBA BLOOM MANUFACTURING INC., INDEPENDENCE, IA. SN 77-692,050. PUB. 7-21-2009, FILED 3-16-2009.

DUET-SAFE

THE MARK CONSISTS OF STANDARD CHARACTERS WITHOUT CLAIM TO ANY PARTICULAR FONT, STYLE, SIZE, OR COLOR.

FOR BRAKING SYSTEMS FOR WINCHES (U.S. CLS. 13, 19, 21, 23, 31, 34 AND 35).

FIRST USE 12-19-2009; IN COMMERCE 12-19-2009.

3,785,983. KOIKE ARONSON, INC., ARCADE, NY. SN 77-699,855. PUB. 7-28-2009, FILED 3-26-2009.

PLATE-PRO EXTREME

THE MARK CONSISTS OF STANDARD CHARACTERS WITHOUT CLAIM TO ANY PARTICULAR FONT, STYLE, SIZE, OR COLOR.

OWNER OF U.S. REG. NO. 2,602,330. FOR COMPUTER NUMERICALLY CONTROLLED (CNC) CUTTING MACHINES, NAMELY, CNC MACHINES FOR CUTTING AND SHAPING METAL (U.S. CLS. 13, 19, 21, 23, 31, 34 AND 35).

FIRST USE 10-0-2009; IN COMMERCE 10-0-2009.

CLASS 7—(Continued).

3,786,019. NORTHERN TOOL & EQUIPMENT COMPANY, INC., BURNSVILLE, MN. SN 77-716,575. PUB. 8-18-2009, FILED 4-17-2009.

NORTRAC

THE MARK CONSISTS OF STANDARD CHARACTERS WITHOUT CLAIM TO ANY PARTICULAR FONT, STYLE, SIZE, OR COLOR.

FOR MACHINE PARTS, NAMELY, CYLINDERS; ENGINE CYLINDERS (U.S. CLS. 13, 19, 21, 23, 31, 34 AND 35).

FIRST USE 7-31-2009; IN COMMERCE 7-31-2009.

3,786,038. NATIONAL PRESORT, INC., DALLAS, TX. SN 77-728,058. PUB. 9-15-2009, FILED 5-4-2009.

OMNISORT

THE MARK CONSISTS OF STANDARD CHARACTERS WITHOUT CLAIM TO ANY PARTICULAR FONT, STYLE, SIZE, OR COLOR.

FOR MACHINE FOR SORTING PACKAGES, DOCUMENT, MAIL (U.S. CLS. 13, 19, 21, 23, 31, 34 AND 35).

FIRST USE 2-10-2010; IN COMMERCE 2-10-2010.

3,786,058. VITA-MIX CORPORATION, CLEVELAND, OH. SN 77-735,619. PUB. 10-6-2009, FILED 5-13-2009.

THE QUIET ONE

THE MARK CONSISTS OF STANDARD CHARACTERS WITHOUT CLAIM TO ANY PARTICULAR FONT, STYLE, SIZE, OR COLOR.

FOR ELECTRIC FOOD PROCESSORS (U.S. CLS. 13, 19, 21, 23, 31, 34 AND 35).

FIRST USE 12-0-2009; IN COMMERCE 12-0-2009.

CLASS 7—(Continued).

3,786,068. ECO-SNOW SYSTEMS LLC, LIVERMORE, CA. SN 77-741,222. PUB. 10-20-2009, FILED 5-20-2009.

NANOSNOW

THE MARK CONSISTS OF STANDARD CHARACTERS WITHOUT CLAIM TO ANY PARTICULAR FONT, STYLE, SIZE, OR COLOR.

FOR CARBON DIOXIDE BASED CRYOGENIC AEROSOL CLEANING EQUIPMENT INCLUDING NOZZLES, FILTERS, GAS DELIVERY AND BLENDING COMPONENTS AND RELATED HARDWARE FOR PRECISION SPRAY CLEANING A SURFACE TO REMOVE UNWANTED MATTER AND CONTAMINANTS (U.S. CLS. 13, 19, 21, 23, 31, 34 AND 35).

FIRST USE 2-1-2010; IN COMMERCE 2-1-2010.

3,786,114. PRIME GLOBAL PRODUCTS, INC., WOODSTOCK, GA. SN 77-759,382. PUB. 11-3-2009, FILED 6-15-2009.



THE MARK CONSISTS OF THE WORD MARK "FREEMAN" WITH THE TOP LINE OF THE "F" IN "FREEMAN" EXTENDING OUT INTO A LINE OVER THE MARK "FREEMAN" AND A LINE EXTENDING UNDERNEATH THE "R" TO THE "N" IN "FREEMAN".

FOR AIR POWERED TOOLS, NAMELY, NAIL GUNS, STAPLERS, AND PLIERS (U.S. CLS. 13, 19, 21, 23, 31, 34 AND 35).

FIRST USE 7-27-2009; IN COMMERCE 7-27-2009.

3,786,115. PRIME GLOBAL PRODUCTS, INC., WOODSTOCK, GA. SN 77-759,385. PUB. 11-3-2009, FILED 6-15-2009.

FREEMAN

THE MARK CONSISTS OF STANDARD CHARACTERS WITHOUT CLAIM TO ANY PARTICULAR FONT, STYLE, SIZE, OR COLOR.

FOR AIR POWERED TOOLS, NAMELY, NAIL GUNS, STAPLERS, AND PLIERS (U.S. CLS. 13, 19, 21, 23, 31, 34 AND 35).

FIRST USE 7-27-2009; IN COMMERCE 7-27-2009.

CLASS 7—(Continued).

3,786,170. BLUESTEM BRANDS, INC., EDEN PRAIRIE, MN. SN 77-978,834. PUB. 7-21-2009, FILED 10-24-2008.

TESTMARK

THE MARK CONSISTS OF STANDARD CHARACTERS WITHOUT CLAIM TO ANY PARTICULAR FONT, STYLE, SIZE, OR COLOR.

FOR POWER TOOLS AND ACCESSORIES, NAMELY, DRILLS, SAWS, SCREWDRIVERS, NAILERS, SANDERS, POLISHERS, IMPACT WRENCHES, DRILL KITS, COMPRISING POWER DRILL, DRILL BITS AND DRILL ACCESSORIES, DRILL ACCESSORY KITS COMPRISING DRILL BITS, SCREWDRIVER BITS, SOCKETS, NUT DRIVERS, WOOD SPADE BITS, GRINDING BITS, STEEL BRUSHES, CHAMFERS, AND CONNECTORS, AIR TOOL KITS, AIR COMPRESSORS, ELECTRIC POWER GENERATORS, MULTI-PURPOSE HIGH PRESSURE WASHERS, MOTOR STARTERS, TILLERS, GRASS TRIMMERS; REEL LAWN MOWERS (U.S. CLS. 13, 19, 21, 23, 31, 34 AND 35).

FIRST USE 8-18-2009; IN COMMERCE 8-18-2009.

CLASS 8—HAND TOOLS

3,785,063. MARFIONE, ANTHONY, BRADFORD, PA. SN 76-644,596. PUB. 5-9-2006, FILED 8-8-2005.

ELEMENT

THE MARK CONSISTS OF STANDARD CHARACTERS WITHOUT CLAIM TO ANY PARTICULAR FONT, STYLE, SIZE, OR COLOR.

FOR CUTLERY, NAMELY, KNIVES (U.S. CLS. 23, 28 AND 44).

FIRST USE 6-0-2009; IN COMMERCE 6-0-2009.

3,785,324. POSITEC GROUP LIMITED, HONG KONG ADM. REGION, CHINA. SN 77-391,964. PUB. 11-10-2009, FILED 2-8-2008.

JAWHORSE

THE COLOR(S) RED AND BLACK IS/ARE CLAIMED AS A FEATURE OF THE MARK.

THE MARK CONSISTS OF "JAWHORSE" IN STYLIZED FORMAT, WITH THE LETTER "O" APPEARING IN THE COLOR RED AND IN A DIFFERENT PROPORTION FROM THE REMAINING LETTERS, AS IF COMPRESSED FROM THE LEFT AND RIGHT SIDES BY THE ADJACENT LETTERS, WITH THE REMAINING LETTERS APPEARING IN THE COLOR BLACK.

FOR HAND TOOLS, NAMELY, VICES (U.S. CLS. 23, 28 AND 44).

FIRST USE 7-30-2008; IN COMMERCE 7-30-2008.

CLASS 8—(Continued).

3,785,553. ROBINS, MICHAEL D., RESEDA, CA. AND BRANDES, DIANE M., RESEDA, CA. SN 77-532,263. PUB. 12-30-2008, FILED 7-27-2008.

Baby Jimmy

THE MARK CONSISTS OF STANDARD CHARACTERS WITHOUT CLAIM TO ANY PARTICULAR FONT, STYLE, SIZE, OR COLOR.

NO CLAIM IS MADE TO THE EXCLUSIVE RIGHT TO USE "JIMMY", APART FROM THE MARK AS SHOWN.

FOR HAND TOOL, NAMELY, A DOOR UNLOCKING TOOL (U.S. CLS. 23, 28 AND 44).

FIRST USE 1-1-2009; IN COMMERCE 1-1-2010.

CLASS 8—(Continued).

3,785,875. I PLAY, INC., ASHEVILLE, NC. SN 77-668,951. PUB. 6-2-2009, FILED 2-12-2009.

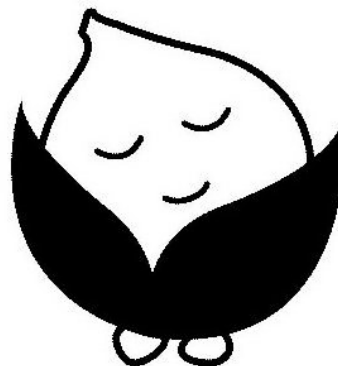

THE MARK CONSISTS OF A STYLIZED SLEEPING SPROUT NESTLED IN AND PARTIALLY SURROUNDED BY THE TWO HALVES OF A POD RESTING ON TWO SMALL FAUX FEET.

FOR BIODEGRADABLE CUTLERY; BIODEGRADABLE CUTLERY, NAMELY, FORKS AND SPOONS; AND CUTLERY (U.S. CLS. 23, 28 AND 44).

FIRST USE 8-1-2009; IN COMMERCE 8-1-2009.

3,785,770. THE ONTARIO KNIFE COMPANY, FRANKLINVILLE, NY. SN 77-651,324. PUB. 5-5-2009, FILED 1-16-2009.

AFGHAN

THE MARK CONSISTS OF STANDARD CHARACTERS WITHOUT CLAIM TO ANY PARTICULAR FONT, STYLE, SIZE, OR COLOR.

FOR KNIVES, NAMELY, MILITARY KNIVES, HUNTING KNIVES AND FISHING KNIVES (U.S. CLS. 23, 28 AND 44).

FIRST USE 11-1-2009; IN COMMERCE 11-1-2009.

3,785,906. KLEIN TOOLS, INC., LINCOLNSHIRE, IL. SN 77-675,858. PUB. 6-16-2009, FILED 2-23-2009.

10-FOLD

THE MARK CONSISTS OF STANDARD CHARACTERS WITHOUT CLAIM TO ANY PARTICULAR FONT, STYLE, SIZE, OR COLOR.

FOR HAND TOOLS, NAMELY, SCREWDRIVERS (U.S. CLS. 23, 28 AND 44).

FIRST USE 12-11-2009; IN COMMERCE 12-11-2009.

CLASS 9—ELECTRICAL AND SCIENTIFIC APPARATUS

CLASS 9—(Continued).

3,785,082. BLUESONIC USA INC., HENDERSON, NV. SN 76-685,400. PUB. 3-10-2009, FILED 12-31-2007.

AMSONIC

THE MARK CONSISTS OF STANDARD CHARACTERS WITHOUT CLAIM TO ANY PARTICULAR FONT, STYLE, SIZE, OR COLOR.

FOR DIGITAL HIGH DEFINITION DVD PLAYERS; COMPACT DISC PLAYERS; AUDIO DISC RECORDERS AND PLAYERS; COMPACT DISC PLAYER WITH MAGAZINE FOR HOLDING AND PLAYING MULTIPLE DISCS AND HARD DISC DRIVE MEMORY FOR TEMPORARILY STORING DISC CONTENT FOR EASIER ACCESS; DIGITAL VIDEO DISC RECORDERS AND PLAYERS; PORTABLE COMPACT DISC PLAYERS; PORTABLE AUDIO DISC PLAYERS; DIGITAL AUDIO RECORDERS AND PLAYERS; COMBINATION DISC PLAYERS WHICH PLAY BOTH VIDEO DISCS AND COMPACT OR OTHER AUDIO DISCS; VIDEO DISC PLAYERS CAPABLE OF STORING AND AUTOMATICALLY LOADING AND PLAYING MULTIPLE DISCS; ELECTRONIC UNIT FOR CONTROLLING VIDEO DISC PLAYERS ACTUATED BY INSERTION OF CURRENCY, NAMELY, JUKE BOXES; STEREO EQUALIZERS; STEREO AND SURROUND SOUND AMPLIFIERS; STEREO AND SURROUND SOUND RECEIVERS; STEREO AND HIGH DEFINITION TELEVISION TUNERS; RECORD TURNTABLES; LOUD SPEAKERS; LOUDSPEAKERS FOR USE IN CARS AND BOATS; LOUD SPEAKER SYSTEMS SOLD SEPARATELY OR TOGETHER AS A UNIT COMPRISED OF WOOFERS, TWEETERS, OR MID-RANGE SPEAKER CONES CONTAINED IN A CABINET; SPEAKERS FOR PERSONAL COMPUTERS; OUTDOOR AND ILLUMINATED LOUDSPEAKERS; REMOTE CONTROLLERS FOR AUDIO DISC PLAYERS, VIDEO DISC PLAYERS, TELEVISIONS; MICROPHONES; WIRELESS MICROPHONES; MICROPHONE RECEIVERS; CONNECTION BOXES FOR MULTIPLE MICROPHONES; HEADPHONES; HIGH DEFINITION LCD (LIQUID CRYSTAL DISPLAY) MONITOR TELEVISIONS; HIGH DEFINITION LCD (LIQUID CRYSTAL DISPLAY) FLAT PANEL TELEVISION AND DISPLAY MONITORS; VIDEO AMPLIFIERS; VIDEO TUNERS; COMBINATION RADIO AND AUDIO PLAYERS FOR USE IN CARS AND BOATS; VIDEO MONITORS FOR USE IN VEHICLES; TWEETERS; POWERED TWEETERS; WOOFERS; POWERED SUBWOOFERS; SUBWOOFERS; AUDIO DYNAMIC EXPANDERS; AUDIO DUAL AMP BALANCERS; AUDIO FOUR CHANNEL SWITCHING BOXES; AUDIO NOISE SUPPRESSOR; AUDIO ELECTRONIC CROSSOVERS; ELECTRICAL ADAPTORS AND ELECTRICAL POWER EXTENSION CORDS FOR USE IN CONNECTING AUDIO AND VIDEO PRODUCTS; RADIO PAGERS; WIRELESS STEREO HANDS-FREE CAR KIT COMPRISED OF HEADPHONES AND SPEAKERPHONE; WIRELESS HEADSETS AND HEADPHONES FOR USE WITH CELLULAR TELEPHONES, COMPACT DISC PLAYERS, COMPUTERS AND COMPUTER GAME EQUIPMENT, AND CORDLESS TELEPHONES; PERSONAL DIGITAL ASSISTANTS, SPEAKERPHONES, STEREO RECEIVERS, TELEPHONES, TELEPHONE TERMINALS, TWO-WAY RADIOS, VIDEO TELEPHONES, VIDEO GAME MACHINES FOR USE WITH TELEVISIONS, VIDEO TELECONFERENCING TELEPHONES, AUDIO TELECONFERENCING TELEPHONES, VISUAL DATA TELEPHONE TERMINALS, INPUT-OUTPUT VOICE SCANNERS FOR ANALOG OR DIGITAL VOICE TRANSMISSIONS; CELLULAR TELEPHONES; CORDLESS PHONES; ELECTRIC AND ELECTRONIC INSTRUMENTS FOR PROVIDING INFORMATION REGARDING MAPS, NAVIGATION, TRAFFIC, WEATHER, INTERESTING LOCATIONS AND INSTRUMENTS TO BE USED FOR TRACKING AND TRACING VEHICLES, NAMELY, VEHICLE LOCATING AND TRACKING SYS-

CLASS 9—(Continued).

TEMS COMPRISED OF COMPUTERS, COMPUTER SOFTWARE, TRANSCEIVERS, TRANSPONDERS, GLOBAL POSITIONING SATELLITE RECEIVERS AND ANTENNAS; COLOR IMAGE LARGE-SCALE DISPLAY APPARATUS FOR DISPLAYING VIDEO IN LARGE PUBLIC AREAS, STADIUMS AND HALLS; CABLE TELEVISION SYSTEMS COMPRISED DIGITAL SET TOP BOXES; ELECTRIC OPTICAL DISPLAY BOARDS; SURVEILLANCE CAMERAS; CLOSED-CIRCUIT VIDEO EQUIPMENT SYSTEMS COMPRISED CAMERAS, RECORDER AND MONITOR; ELECTRIC AND ELECTRONIC VIDEO SURVEILLANCE CAMERAS; TELEVISION CAMERAS; VIDEO SWITCHERS FOR EDITING CINEMA OR COMMERCIAL VIDEO IMAGES; WIRELESS CAMERAS; WIRELESS CAMERA USED FOR MONITORING PURPOSES; VIDEO SIGNAL CONVERTER FOR NETWORK CAMERAS; RECORDING SOFTWARE EXCLUSIVELY USED FOR NETWORK CAMERAS; NETWORK CAMERA CONTROLLERS; COMMUNICATIONS SERVERS FOR NETWORK CAMERAS; CONVERTIBLE CAMERAS (U.S. CLS. 21, 23, 26, 36 AND 38).

FIRST USE 11-2-2009; IN COMMERCE 11-2-2009.

3,785,108. GTECH RHODE ISLAND CORPORATION, PROVIDENCE, RI. SN 77-005,413. PUB. 11-6-2007, FILED 9-22-2006.

IMAGINE

THE MARK CONSISTS OF STANDARD CHARACTERS WITHOUT CLAIM TO ANY PARTICULAR FONT, STYLE, SIZE, OR COLOR.

FOR LOTTERY GAME TERMINALS AND RELATED SOFTWARE, NAMELY, LOTTERY GAME SOFTWARE (U.S. CLS. 21, 23, 26, 36 AND 38).

FIRST USE 10-15-2009; IN COMMERCE 10-15-2009.

3,785,122. OPHTHONIX, INC., VISTA, CA. SN 77-055,071. PUB. 9-8-2009, FILED 12-1-2006.



OWNER OF U.S. REG. NO. 3,188,278.
NO CLAIM IS MADE TO THE EXCLUSIVE RIGHT TO USE "HIGH RESOLUTION LENSES", APART FROM THE MARK AS SHOWN.

THE MARK CONSISTS OF THE STYLIZED WORD "IZON" (WITH AN INVERTED "I") WITH THE WORDS "HIGH RESOLUTION LENSES" UNDERNEATH IN A STYLIZED FONT.

FOR EYEGLASSES; PRESCRIPTION SUNGLASS LENSES; EYEGLASS LENSES (U.S. CLS. 21, 23, 26, 36 AND 38).

FIRST USE 10-0-2006; IN COMMERCE 10-0-2006.

CLASS 9—(Continued).

3,785,123. IGT, RENO, NV. SN 77-061,325. PUB. 10-30-2007, FILED 12-11-2006.

DRAGON'S GATE

THE MARK CONSISTS OF STANDARD CHARACTERS WITHOUT CLAIM TO ANY PARTICULAR FONT, STYLE, SIZE, OR COLOR.

FOR GAMING MACHINES, NAMELY, DEVICES THAT ACCEPT A WAGER (U.S. CLS. 21, 23, 26, 36 AND 38).

FIRST USE 9-30-2009; IN COMMERCE 9-30-2009.

3,785,134. TRULITE, INC., HOUSTON, TX. SN 77-100,859. PUB. 2-12-2008, FILED 2-6-2007.

HYDROCELL

THE MARK CONSISTS OF STANDARD CHARACTERS WITHOUT CLAIM TO ANY PARTICULAR FONT, STYLE, SIZE, OR COLOR.

FOR HYDROGEN GENERATION POWER CARTRIDGE USING A CHEMICAL HYDRIDE FOR USE IN POWERING FUEL CELLS (U.S. CLS. 21, 23, 26, 36 AND 38).

FIRST USE 7-18-2006; IN COMMERCE 7-18-2006.

3,785,135. COOLIGY, INC., MOUNTAIN VIEW, CA. SN 77-103,903. PUB. 6-17-2008, FILED 2-9-2007.

COOLIGY

THE MARK CONSISTS OF STANDARD CHARACTERS WITHOUT CLAIM TO ANY PARTICULAR FONT, STYLE, SIZE, OR COLOR.

FOR FLUID COOLING SYSTEMS COMPRISED OF A COLLECTOR, RADIATOR, PUMP AND FLUID CHANNELS SPECIFICALLY ADAPTED FOR ELECTRONICS AND ELECTRICAL COMPONENTS (U.S. CLS. 21, 23, 26, 36 AND 38).

FIRST USE 10-31-2005; IN COMMERCE 10-31-2005.

CLASS 9—(Continued).

3,785,137. MARK MILES CONSULTING INC., SAN FRANCISCO, CA. SN 77-121,608. PUB. 5-20-2008, FILED 3-2-2007.

Multispace

THE MARK CONSISTS OF STANDARD CHARACTERS WITHOUT CLAIM TO ANY PARTICULAR FONT, STYLE, SIZE, OR COLOR.

THE WORDING "MULTISPACE" HAS NO MEANING IN A FOREIGN LANGUAGE.

FOR MULTIMEDIA FILES, BOTH DOWNLOADABLE AND RECORDED ON MAGNETIC MEDIA, CONTAINING DIGITAL IMMERSIVE CONTENT IN THE NATURE OF ARTWORK, TEXT, AUDIO, AND VIDEO FOR USE WITH VIRTUAL REALITY SOFTWARE USED TO CREATE A VIRTUAL REALITY ENVIRONMENT IN A ROOM; SOFTWARE FOR THE PRODUCTION OF THE DIGITAL IMMERSIVE CONTENT IN THE NATURE OF AUDIO AND VIDEO RECORDINGS; AND COMPUTER HARDWARE THAT CAN BE USED TO RENDER THE DIGITAL IMMERSIVE CONTENT (U.S. CLS. 21, 23, 26, 36 AND 38).

FIRST USE 10-27-2005; IN COMMERCE 9-3-2007.

3,785,146. ELECTRIC VISUAL EVOLUTION, LLC, SAN CLAMENTE, CA. SN 77-142,721. PUB. 9-1-2009, FILED 3-28-2007.

EG2

THE MARK CONSISTS OF STANDARD CHARACTERS WITHOUT CLAIM TO ANY PARTICULAR FONT, STYLE, SIZE, OR COLOR.

FOR GOGGLES AND CASES THEREFOR (U.S. CLS. 21, 23, 26, 36 AND 38).

FIRST USE 9-21-2007; IN COMMERCE 9-21-2007.

3,785,150. DIGITENNA, LLC, OOSTBURG, WI. SN 77-156,436. PUB. 9-15-2009, FILED 4-13-2007.

The New Standard In Reception

THE MARK CONSISTS OF STANDARD CHARACTERS WITHOUT CLAIM TO ANY PARTICULAR FONT, STYLE, SIZE, OR COLOR.

FOR ANTENNAS; ANTENNAS FOR RADIO AND TELEVISION; ELECTRONIC COMBINERS FOR CONNECTING ANTENNAS AND RECEIVERS (U.S. CLS. 21, 23, 26, 36 AND 38).

FIRST USE 6-11-2008; IN COMMERCE 6-11-2008.

CLASS 9—(Continued).

3,785,159. ADVANCEDLO SYSTEMS INC., VANCOUVER, BC, CANADA. SN 77-182,799. PUB. 6-2-2009, FILED 5-16-2007.

udpXG

THE MARK CONSISTS OF STANDARD CHARACTERS WITHOUT CLAIM TO ANY PARTICULAR FONT, STYLE, SIZE, OR COLOR.

FOR COMPUTER SOFTWARE AND HARDWARE FOR ACCELERATING ETHERNET COMMUNICATION PROTOCOLS IN EMBEDDED SYSTEMS BY OFFLOADING PACKET PROCESSING (U.S. CLS. 21, 23, 26, 36 AND 38). FIRST USE 9-6-2006; IN COMMERCE 9-6-2006.

3,785,191. MERU NETWORKS, INC., SUNNYVALE, CA. SN 77-236,579. PUB. 5-20-2008, FILED 7-23-2007.

MERU

THE MARK CONSISTS OF STANDARD CHARACTERS WITHOUT CLAIM TO ANY PARTICULAR FONT, STYLE, SIZE, OR COLOR.

OWNER OF U.S. REG. NO. 3,063,250.
FOR HARDWARE AND SOFTWARE FOR OPERATING AND MANAGING WIRELESS NETWORKS AND VOIP COMMUNICATIONS SYSTEMS, NAMELY, ACCESS POINTS, CONTROLLERS, AND SOFTWARE FOR IMPLEMENTING AND MANAGING SECURITY FOR WIRELESS AND VOIP ACCESS (U.S. CLS. 21, 23, 26, 36 AND 38).

FIRST USE 2-28-2002; IN COMMERCE 11-30-2003.

3,785,196. MITSUBISHI ELECTRIC CORPORATION, CHIYODA-KU, TOKYO, JAPAN. SN 77-240,408. PUB. 1-1-2008, FILED 7-27-2007.



THE COLOR(S) BLUE, GREEN, RED AND BLACK IS/ARE CLAIMED AS A FEATURE OF THE MARK.

THE MARK CONSISTS OF THREE CIRCLES ARRANGED VERTICALLY, WITH THE TOP CIRCLE IN BLUE, THE MIDDLE CIRCLE IN GREEN, AND THE BOTTOM CIRCLE IN RED. THE WORD "RESOLIA" IS IN BLACK.

FOR LARGE SCREEN VIDEO DISPLAYS; IMAGE DISPLAY PANELS AND SCREENS; DISPLAY MONITORS FOR COMPUTERS (U.S. CLS. 21, 23, 26, 36 AND 38).

FIRST USE 12-17-2008; IN COMMERCE 2-3-2010.

CLASS 9—(Continued).

3,785,228. CAPCOM U.S.A., INC., SAN MATEO, CA. SN 77-298,807. PUB. 3-25-2008, FILED 10-8-2007.

DARK VOID

THE MARK CONSISTS OF STANDARD CHARACTERS WITHOUT CLAIM TO ANY PARTICULAR FONT, STYLE, SIZE, OR COLOR.

FOR COMPUTER GAME SOFTWARE, COMPUTER GAME CARTRIDGES, COMPUTER GAME CASSETTES, COMPUTER GAMES PRE-RECORDED ON CD-ROMS AND DVD-ROMS, COMPUTER GAME TAPES, VIDEO GAME CARTRIDGES, SOFTWARE FOR ARCADE-TYPE VIDEO GAMES, DOWNLOADABLE GAME SOFTWARE, DOWNLOADABLE COMPUTER GAMES, DOWNLOADABLE INTERNET GAMES, DOWNLOADABLE GAME SOFTWARE FOR PLAYING ON MOBILE PHONES, DOWNLOADABLE MOBILE TELEPHONE TONES, DOWNLOADABLE DIGITAL MUSIC PROVIDED FROM THE INTERNET; PRE-RECORDED AUDIO DISKS, CD-ROMS AND DVD-ROMS FEATURING GAMES, MUSIC, ANIMATED CARTOONS AND ACTION/ADVENTURE ENTERTAINMENT MOVIES; DOWNLOADABLE RING TONES, IMAGES, MOVING IMAGES AND MUSIC FOR MOBILE PHONES; DOWNLOADABLE SCREEN SAVER SOFTWARE AND WALLPAPER SOFTWARE FOR MOBILE PHONES (U.S. CLS. 21, 23, 26, 36 AND 38).

FIRST USE 1-18-2010; IN COMMERCE 1-18-2010.

3,785,230. SOUNDTAG, INC., BRAINTREE, MA. SN 77-307,240. PUB. 4-8-2008, FILED 10-18-2007.

PRIORITAG

THE MARK CONSISTS OF STANDARD CHARACTERS WITHOUT CLAIM TO ANY PARTICULAR FONT, STYLE, SIZE, OR COLOR.

FOR ELECTRONIC APPARATUS FOR RETRIEVING PACKAGES OR OBJECTS, NAMELY, A HANDHELD ELECTRONIC INTERROGATION UNIT FOR TRANSMITTING AN RF INTERROGATION SIGNAL TO ACTIVATE A TAG PHYSICALLY ASSOCIATED WITH A PACKAGE OR OBJECT, AND A TAG FOR TRANSMITTING BOTH HUMAN SENSIBLE AND RF SIGNALS IN RESPONSE TO THE RF INTERROGATION SIGNAL (U.S. CLS. 21, 23, 26, 36 AND 38).

FIRST USE 5-15-2009; IN COMMERCE 5-15-2009.

CLASS 9—(Continued).

3,785,242. PRADO, ALEJANDRO, FOREST HILLS, NY. SN 77-327,798. PUB. 10-21-2008, FILED 11-13-2007.

CLASS 9—(Continued).

3,785,252. TAYBILL, INC, GLENDALE, OR. SN 77-336,456. PUB. 6-3-2008, FILED 11-26-2007.

TargetScore!



THE MARK CONSISTS OF STANDARD CHARACTERS WITHOUT CLAIM TO ANY PARTICULAR FONT, STYLE, SIZE, OR COLOR.

FOR EDUCATIONAL SOFTWARE FEATURING INSTRUCTION IN K-12 ACADEMIC SUBJECTS, NAMELY, VOCABULARY, READING, WRITING, GRAMMAR, MATH, GEOGRAPHY, HISTORY, SCIENCE, AND MUSIC; COMPUTER TEST PREPARATION SOFTWARE FEATURING CONTENT FOR STANDARDIZED TESTS FOR K-12 EDUCATIONAL EXAMS, COLLEGE ENTRANCE EXAMS, AND GRADUATE SCHOOL EXAMS, INCLUDING THE SUBJECTS OF VOCABULARY, WRITING, READING, GRAMMAR, MATH, AND TEST-TAKING STRATEGIES, NAMELY, ATTITUDE, READING HINTS, CALCULATION HINTS, AND PACING; EDUCATIONAL SOFTWARE FEATURING LEARNING STRATEGIES AND CURRICULUM DESIGN, NAMELY, MOTIVATION AND MASTERY LESSONS AND DESIGN TOOLS FOR TEACHERS AND HOME SCHOOLING PARENTS; COMPUTER SOFTWARE USED FOR THE ASSESSMENT OF SCHOOL TEST PERFORMANCE; COMPUTER SOFTWARE FEATURING CURRICULUM DESIGN LESSONS AND TOOLS, NAMELY, PREPARED LEARNING PATHS, AND LEARNING MOTIVATION AND FEEDBACK SYSTEMS FOR TEACHERS AND HOME SCHOOLING PARENTS; PRE-RECORDED CDS, VIDEO TAPES, LASER DISKS, AND DVDS FEATURING INFORMATION AND INSTRUCTION ON K-12 ACADEMIC SUBJECTS, NAMELY, VOCABULARY, READING, WRITING, GRAMMAR, MATH, GEOGRAPHY, HISTORY, SCIENCE, AND MUSIC (U.S. CLS. 21, 23, 26, 36 AND 38).

FIRST USE 11-1-2007; IN COMMERCE 11-1-2007.

3,785,267. CRAFTFORD-LASERSTAR TECHNOLOGIES CORPORATION, RIVERSIDE, RI. SN 77-348,600. PUB. 5-13-2008, FILED 12-11-2007.

NO CLAIM IS MADE TO THE EXCLUSIVE RIGHT TO USE "PORTAL", APART FROM THE MARK AS SHOWN.

THE COLOR(S) RED, BLACK, AND WHITE IS/ARE CLAIMED AS A FEATURE OF THE MARK.

THE MARK CONSISTS OF THE WORD "PORTAL" IN RED CAPITAL LETTERS NEXT TO THE WORD "AXIS"; THE WORD "AXIS" IS IN WHITE CAPITAL LETTERS ON A BLACK BACKGROUND WITH AN ENLARGED, STYLIZED "X" IN RED, FOR THE "X" IN "AXIS".

THE WORDING "AXIS" HAS NO MEANING IN A FOREIGN LANGUAGE.

FOR SOFTWARE APPLICATIONS FOR THE SETTING UP AND CONFIGURATION OF COMPUTER NETWORKS, NAMELY, WEB PORTALS, SHARED ONLINE FILE SYSTEMS, AND SOCIALLY CONNECTED BUSINESS VIRTUAL WORKSPACES FOR INDIVIDUAL AND CORPORATE USAGE, THAT ENABLE PEOPLE AND COMPANIES TO COLLABORATE ON THE CREATION AND DEVELOPMENT OF DOCUMENTS AND PROJECTS (U.S. CLS. 21, 23, 26, 36 AND 38).

FIRST USE 7-12-2007; IN COMMERCE 1-12-2008.



THE MARK CONSISTS OF THE WORD "IWELD" WHICH INCORPORATES A STYLIZED LETTER "I".

FOR A BENCHTOP LASER WELDING DEVICE FOR USE IN THE JEWELRY, DENTAL, MEDICAL, MICRO-INDUSTRIAL, TOOL AND DIE, AND INDUSTRIAL TRADES (U.S. CLS. 21, 23, 26, 36 AND 38).

FIRST USE 2-21-2008; IN COMMERCE 2-21-2008.

CLASS 9—(Continued).

3,785,268. WEBER, PAUL, GOLD BEACH, OR. AND WEBER, JANICE, GOLD BEACH, OR. SN 77-352,387. PUB. 12-2-2008, FILED 12-14-2007.

BUSINESS TEAM

THE MARK CONSISTS OF STANDARD CHARACTERS WITHOUT CLAIM TO ANY PARTICULAR FONT, STYLE, SIZE, OR COLOR.

NO CLAIM IS MADE TO THE EXCLUSIVE RIGHT TO USE "BUSINESS", APART FROM THE MARK AS SHOWN.

FOR COMPUTER SOFTWARE FOR PROVIDING INSTRUCTION TO ASSIST WITH LIFE MANAGEMENT, TEAM MANAGEMENT, MEETING MANAGEMENT, AND THE INTEGRATION OF IDEAS, INDIVIDUALS, AND GROUPS WITHIN THE ENVIRONMENT OF AN ORGANIZATION BY ALLOWING FOR MEETING AND EVENT SCHEDULING, CONDUCTING AND MAINTAINING THE MEETINGS WITHOUT THE AID OF A FACILITATOR, MANAGING CALENDARS, MANAGING AND DELEGATING TASKS, RECORDING NOTES, GENERATING A FULL REPORT AT THE CONCLUSION OF MEETINGS, AND EVALUATING THE QUALITY OF THE MEETINGS (U.S. CLS. 21, 23, 26, 36 AND 38).

FIRST USE 2-22-2010; IN COMMERCE 2-22-2010.

3,785,269. HITACHI AMERICA, LTD., TARRYTOWN, NY. SN 77-352,936. PUB. 5-6-2008, FILED 12-14-2007.

REEL 120

THE MARK CONSISTS OF STANDARD CHARACTERS WITHOUT CLAIM TO ANY PARTICULAR FONT, STYLE, SIZE, OR COLOR.

FOR APPARATUS FOR TRANSMITTING AND REPRODUCING IMAGES, NAMELY, TELEVISION MONITORS PARTS THEREFOR; MICROPROCESSORS AND SOFTWARE, NAMELY, TO CONTROL AND IMPROVE VIDEO EQUIPMENT AND VIDEO QUALITY (U.S. CLS. 21, 23, 26, 36 AND 38).

FIRST USE 8-11-2009; IN COMMERCE 8-11-2009.

CLASS 9—(Continued).

3,785,272. TECHNOVARE SYSTEMS, INC., COSTA MESA, CA. SN 77-354,119. PUB. 12-2-2008, FILED 12-17-2007.

TECHNOVARE

THE MARK CONSISTS OF STANDARD CHARACTERS WITHOUT CLAIM TO ANY PARTICULAR FONT, STYLE, SIZE, OR COLOR.

FOR ELECTRONIC EQUIPMENT, NAMELY, NETWORK MEDIA PLAYERS, NETWORK MEDIA ENCODERS, NETWORK MEDIA SERVERS, SET TOP BOXES; COMPUTER HARDWARE, INTEGRATED CIRCUITS AND SEMICONDUCTORS FOR NETWORK MEDIA PLAYERS, NETWORK MEDIA ENCODERS, NETWORK MEDIA SERVERS, AND SET TOP BOXES; COMPUTER SOFTWARE FOR CONTROLLING AND USING NETWORK MEDIA PLAYERS, NETWORK MEDIA ENCODERS, NETWORK MEDIA SERVERS, AND SET TOP BOXES; COMPUTER SOFTWARE EMBEDDED OR CONTAINED IN COMPUTER HARDWARE FOR CONTROLLING AND USING NETWORK MEDIA PLAYERS, NETWORK MEDIA ENCODERS, NETWORK MEDIA SERVERS, AND SET TOP BOXES; COMPUTER SOFTWARE FOR CONTROLLING AND USING INTEGRATED CIRCUITS FOR NETWORK MEDIA PLAYERS, NETWORK MEDIA ENCODERS, NETWORK MEDIA SERVERS, AND SET TOP BOXES; COMPUTER SOFTWARE EMBEDDED OR CONTAINED IN COMPUTER HARDWARE FOR CONTROLLING AND USING INTEGRATED CIRCUITS FOR NETWORK MEDIA PLAYERS, NETWORK MEDIA ENCODERS, NETWORK MEDIA SERVERS, AND SET TOP BOXES (U.S. CLS. 21, 23, 26, 36 AND 38).

FIRST USE 1-0-2005; IN COMMERCE 1-0-2005.

3,785,283. STAIRLIGHTING SYSTEM, LLC, NORTH EAST, MD. SN 77-367,013. PUB. 11-4-2008, FILED 1-8-2008.



NO CLAIM IS MADE TO THE EXCLUSIVE RIGHT TO USE "STAIR LIGHTING SYSTEM LLC", APART FROM THE MARK AS SHOWN.

THE MARK CONSISTS OF THE WORDS "STAIRLIGHTING SYSTEM LLC" IN STYLIZED FORM, PLUS A DEPICTION OF THREE BEAMS OF LIGHT EMANATING FROM A RECTANGULAR SOURCE.

FOR LOW VOLTAGE LIGHTING PRODUCTS FOR INDOOR/OUTDOOR USE, NAMELY, ELECTRIC LIGHT SWITCHES, LIGHTING CONTROL PANELS, LIGHT EMITTING DIODES (LEDS), LED LIGHT CONTROLS, POWER SUPPLIES FOR LIGHTS, AND ELECTRONIC REGULATING AND CONTROL DEVICES FOR THE OPERATION OF LIGHT EMITTING DIODES (U.S. CLS. 21, 23, 26, 36 AND 38).

FIRST USE 3-15-2008; IN COMMERCE 3-15-2008.

CLASS 9—(Continued).

3,785,305. TEKNOCREATIONS, ALBUQUERQUE, NM. SN 77-379,640. PUB. 4-29-2008, FILED 1-24-2008.

TekCase

THE MARK CONSISTS OF STANDARD CHARACTERS WITHOUT CLAIM TO ANY PARTICULAR FONT, STYLE, SIZE, OR COLOR.

FOR BATTERY CHARGE DEVICES (U.S. CLS. 21, 23, 26, 36 AND 38).

FIRST USE 5-8-2009; IN COMMERCE 5-8-2009.

3,785,319. SOKKIA COMPANY, LIMITED, KANAGAWA, JAPAN. SN 77-389,832. PUB. 12-30-2008, FILED 2-6-2008.

LX

THE MARK CONSISTS OF STANDARD CHARACTERS WITHOUT CLAIM TO ANY PARTICULAR FONT, STYLE, SIZE, OR COLOR.

FOR MEASURING AND SURVEYING INSTRUMENTS AND APPARATUS, NAMELY, NON-MEDICAL LINE LASER DEVICES FOR PROJECTING A VISIBLE LINE ON WALLS OF CONSTRUCTION SITES (U.S. CLS. 21, 23, 26, 36 AND 38).

FIRST USE 6-30-2008; IN COMMERCE 3-30-2009.

3,785,332. BEFUN BILGI TEKNOLOJILERI A.S., MENLO PARK, CA. SN 77-401,775. PUB. 7-22-2008, FILED 2-20-2008.

BEFUNKY

THE MARK CONSISTS OF STANDARD CHARACTERS WITHOUT CLAIM TO ANY PARTICULAR FONT, STYLE, SIZE, OR COLOR.

FOR COMPUTER SOFTWARE FOR UPLOADING, EXCHANGING, SHARING, VIEWING, MANIPULATING, ENHANCING, EDITING, MANAGING, INDEXING, CATALOGUING, SORTING, STORING, PRINTING, CREATING CARTOON ENHANCEMENTS FROM, AND CREATING CUSTOM PRINTED PRODUCTS FROM, PHOTOS AND VIDEOS (U.S. CLS. 21, 23, 26, 36 AND 38).

FIRST USE 1-1-2010; IN COMMERCE 1-1-2010.

CLASS 9—(Continued).

3,785,335. APPLIED BIOSYSTEMS, LLC, FOSTER CITY, CA. SN 77-404,413. PUB. 12-16-2008, FILED 2-22-2008.

COPYCALLER

THE MARK CONSISTS OF STANDARD CHARACTERS WITHOUT CLAIM TO ANY PARTICULAR FONT, STYLE, SIZE, OR COLOR.

FOR COMPUTER SOFTWARE USED FOR COLLECTION, STORAGE, ORGANIZATION, ANALYSIS, INTEGRATION AND COMMUNICATION OF SCIENTIFIC DATA, USED IN GENETIC ANALYSIS, LIFE SCIENCE RESEARCH, HUMAN IDENTIFICATION AND BIOTECHNOLOGY FIELDS (U.S. CLS. 21, 23, 26, 36 AND 38).

FIRST USE 3-10-2009; IN COMMERCE 3-10-2009.

3,785,349. ZAPPOS.COM, INC., HENDERSON, NV. SN 77-414,630. PUB. 1-6-2009, FILED 3-6-2008.

ZIRCONIUM

THE MARK CONSISTS OF STANDARD CHARACTERS WITHOUT CLAIM TO ANY PARTICULAR FONT, STYLE, SIZE, OR COLOR.

FOR EARPHONES; DIGITAL PHOTO FRAMES (U.S. CLS. 21, 23, 26, 36 AND 38).

FIRST USE 11-13-2008; IN COMMERCE 11-13-2008.

3,785,356. TRUE VALUE COMPANY, CHICAGO, IL. SN 77-424,133. PUB. 12-2-2008, FILED 3-17-2008.



OWNER OF U.S. REG. NOS. 1,249,555 AND 1,561,687.
FOR ELECTRIC DOOR OPENERS, NAMELY, GARAGE DOOR OPENERS; LEVELS, NAMELY, PLUMB BOBS; INSTRUMENTS FOR MEASURING LENGTH; BATTERIES; BATTERY ACCESSORIES, NAMELY, BATTERY CABLES, BATTERY CHARGE DEVICES AND BATTERY PACKS (U.S. CLS. 21, 23, 26, 36 AND 38).

FIRST USE 10-0-2005; IN COMMERCE 10-0-2005.

CLASS 9—(Continued).

3,785,364. EDISON NATION HOLDINGS, LLC, CHARLOTTE, NC. SN 77-426,789. PUB. 2-17-2009, FILED 3-19-2008.

CLASS 9—(Continued).

3,785,379. CAPCOM ENTERTAINMENT, INC., SAN MATEO, CA. SN 77-442,138. PUB. 6-24-2008, FILED 4-7-2008.

EVERYDAY EDISONS

THE MARK CONSISTS OF STANDARD CHARACTERS WITHOUT CLAIM TO ANY PARTICULAR FONT, STYLE, SIZE, OR COLOR.

OWNER OF U.S. REG. NOS. 3,331,354, 3,382,931, AND OTHERS.

FOR CONSUMER PRODUCTS IN THE FIELD OF ELECTRONICS, NAMELY, POWER CORD ORGANIZERS COMPRISED OF STRAPS USED FOR BINDING POWER CORDS (U.S. CLS. 21, 23, 26, 36 AND 38).

FIRST USE 2-18-2010; IN COMMERCE 2-18-2010.

SPYBORGS

THE MARK CONSISTS OF STANDARD CHARACTERS WITHOUT CLAIM TO ANY PARTICULAR FONT, STYLE, SIZE, OR COLOR.

FOR COMPUTER GAME SOFTWARE, COMPUTER GAME CARTRIDGES, COMPUTER GAME CASSETTES, COMPUTER GAMES PRE-RECORDED ON CD-ROMS AND DVD-ROMS, COMPUTER GAME TAPES, VIDEO GAME CARTRIDGES, SOFTWARE FOR ARCADE-TYPE VIDEO GAMES, DOWNLOADABLE GAME SOFTWARE, DOWNLOADABLE COMPUTER GAMES, DOWNLOADABLE INTERNET GAMES, DOWNLOADABLE GAME SOFTWARE FOR PLAYING ON MOBILE PHONES, DOWNLOADABLE MOBILE TELEPHONE TONES, DOWNLOADABLE DIGITAL MUSIC PROVIDED FROM THE INTERNET; PRE-RECORDED AUDIO DISKS, CD-ROMS AND DVD-ROMS FEATURING GAMES, MUSIC, ANIMATED CARTOONS AND ACTION/ADVENTURE ENTERTAINMENT MOVIES; DOWNLOADABLE RING TONES, IMAGES, MOVING IMAGES AND MUSIC FOR MOBILE PHONES; DOWNLOADABLE SCREEN SAVER SOFTWARE AND WALLPAPER SOFTWARE FOR MOBILE PHONES (U.S. CLS. 21, 23, 26, 36 AND 38).

FIRST USE 9-22-2009; IN COMMERCE 9-22-2009.

3,785,374. OFFICE DEPOT (M) SDN. BHD., SELANGOR DARUL EHSAN, MALAYSIA. SN 77-432,801. PUB. 2-24-2009, FILED 3-27-2008.

3,785,397. ARTEMIS SOLUTIONS GROUP, LLC, FREELAND, WA. SN 77-457,203. PUB. 11-4-2008, FILED 4-24-2008.



THE NAME(S), PORTRAIT(S), AND/OR SIGNATURE(S) SHOWN IN THE MARK DOES NOT IDENTIFY A PARTICULAR LIVING INDIVIDUAL.

FOR ELECTRIC, AUDIOVISUAL TEACHING APPARATUS, NAMELY, ELECTRIC AUDIO PLAYBACK UNITS; SIGNAL BELLS; CALCULATING MACHINES; EYEGGLASS CASES; CASH REGISTERS; TIME CLOCKS; ELECTRONIC NOTICE BOARDS; EYEGGLASS FRAMES; PROJECTION APPARATUS, NAMELY, PROJECTION SCREENS; SPECTACLE FRAMES; TIME RECORDING APPARATUS; VIDEO SCREENS (U.S. CLS. 21, 23, 26, 36 AND 38).

FIRST USE 1-16-2003; IN COMMERCE 1-16-2003.

EMEDYX

THE MARK CONSISTS OF STANDARD CHARACTERS WITHOUT CLAIM TO ANY PARTICULAR FONT, STYLE, SIZE, OR COLOR.

FOR MEDICAL PROVIDER/FIRST RESPONDER IDENTIFICATION AND PATIENT VERIFICATION SMART CARD SYSTEM COMPRISED OF COMPUTER HARDWARE, SMART CARD AND BIOMETRIC READERS, SMART CARD TERMINALS, ENCODED AND ENCRYPTED SMART CARDS, AND COMPUTER SOFTWARE ALL FOR THE PURPOSE OF STORING PHYSICIAN, MEDICAL FACILITY, AND FIRST RESPONDER INFORMATION AND INDIVIDUAL'S PERSONAL MEDICAL INFORMATION AND READING OR UPDATING INFORMATION FROM A LOCAL OR REMOTE DATABASE (U.S. CLS. 21, 23, 26, 36 AND 38).

FIRST USE 3-1-2009; IN COMMERCE 6-15-2009.

CLASS 9—(Continued).

3,785,402. WORLD WRESTLING ENTERTAINMENT, INC., STAMFORD, CT. SN 77-459,356. PUB. 3-17-2009, FILED 4-28-2008.

CLASS 9—(Continued).

3,785,451. BRYCE, ERROL BRADSHAW, KEENE, TX. SN 77-492,281. PUB. 4-21-2009, FILED 6-5-2008.

ONE NIGHT STAND

THE MARK CONSISTS OF STANDARD CHARACTERS WITHOUT CLAIM TO ANY PARTICULAR FONT, STYLE, SIZE, OR COLOR.

OWNER OF U.S. REG. NO. 3,446,487.

FOR DOWNLOADABLE RING TONES, GRAPHICS AND MUSIC VIA A GLOBAL COMPUTER NETWORK AND WIRELESS DEVICES; VIDEO AND COMPUTER GAME TAPES, VIDEO AND COMPUTER GAME DISCS, VIDEO AND COMPUTER GAME CASSETTES, VIDEO AND COMPUTER GAME CARTRIDGES, VIDEO AND COMPUTER GAME CD-ROMS, VIDEO OUTPUT GAME MACHINES FOR USE WITH TELEVISIONS, ALL FEATURING SPORTS ENTERTAINMENT; VIDEO AND COMPUTER GAME SOFTWARE ALL IN THE NATURE OF SPORTS ENTERTAINMENT; PRE-RECORDED COMPACT DISCS, PRE-RECORDED VIDEO TAPES, PRE-RECORDED VIDEO CASSETTE TAPES, PRE-RECORDED DVDS AND PRE-RECORDED AUDIO CASSETTES, ALL FEATURING SPORTS ENTERTAINMENT; COIN-FED AMUSEMENT GAMING MACHINES ALL FEATURING SPORTS ENTERTAINMENT; INTERACTIVE VIDEO GAME PROGRAMS AND COMPUTER GAME CARTRIDGES ALL FEATURING SPORTS ENTERTAINMENT (U.S. CLS. 21, 23, 26, 36 AND 38).

FIRST USE 7-30-2005; IN COMMERCE 7-30-2005.

New Steps

THE COLOR(S) BURGUNDY RED AND BLACK IS/ARE CLAIMED AS A FEATURE OF THE MARK.

THE MARK CONSISTS OF A STYLIZED WRITING OF THE WORDS "NEW STEPS" WITH BURGUNDY RED USED TO ACCENT THE HIGHLIGHT OF THE NAME AND BLACK LINING.

FOR DIGITAL MEDIA, NAMELY, CDS AND DVDS FEATURING INFORMATION IN THE FIELD OF THERAPEUTIC LIFESTYLE CHANGES FOR THE PROMOTION OF COMPLETE HEALTH (U.S. CLS. 21, 23, 26, 36 AND 38).

FIRST USE 1-11-2010; IN COMMERCE 1-13-2010.

3,785,428. ANN WILLIAMS GROUP LLC, BLOOMFIELD HILLS, MI. SN 77-476,619. PUB. 12-9-2008, FILED 5-16-2008.

3,785,455. U.S. VISION, INC., GLENDORA, NJ. SN 77-494,548. PUB. 11-4-2008, FILED 6-9-2008.

TALKATOO**GET NOTICED ... FOR LESS**

THE MARK CONSISTS OF STANDARD CHARACTERS WITHOUT CLAIM TO ANY PARTICULAR FONT, STYLE, SIZE, OR COLOR.

FOR SOUND RECORDING APPARATUS AND AUDIO PLAYBACK UNIT THAT MAY BE WORN AS JEWELRY OR A FASHION ACCESSORY (U.S. CLS. 21, 23, 26, 36 AND 38).

FIRST USE 2-14-2010; IN COMMERCE 2-14-2010.

THE MARK CONSISTS OF STANDARD CHARACTERS WITHOUT CLAIM TO ANY PARTICULAR FONT, STYLE, SIZE, OR COLOR.

FOR EYEGLASS CASES; EYEGLASS FRAMES; EYEGLASSES; EYEWEAR; EYEWEAR ACCESSORIES, NAMELY, STRAPS, NECK CORDS AND HEAD STRAPS WHICH RESTRAIN EYEWEAR FROM MOVEMENT ON A WEARER; SUNGLASSES (U.S. CLS. 21, 23, 26, 36 AND 38).

FIRST USE 9-1-2008; IN COMMERCE 9-1-2008.

CLASS 9—(Continued).

3,785,456. TRADERISING CORPORATION, ARLINGTON, VA. SN 77-495,165. PUB. 11-4-2008, FILED 6-10-2008.



THE MARK CONSISTS OF A STYLIZED BULL AND THE WORD "TRADERISING" IN WHICH THE FIRST LETTER "I" IS SHOWN AS A RECTANGLE CONNECTED TO A VERTICAL LINE.

FOR COMPUTER SOFTWARE FOR USE IN ANALYZING FINANCIAL DATA AND DEVELOPING STRATEGIES FOR TRADING FINANCIAL SECURITIES FOR USE IN THE FIELDS OF FINANCE AND FINANCIAL MARKETS (U.S. CLS. 21, 23, 26, 36 AND 38).

FIRST USE 7-16-2008; IN COMMERCE 12-28-2009.

CLASS 9—(Continued).

3,785,464. GN BIOSYSTEMS, INC., HAYWARD, CA. SN 77-498,378. PUB. 8-25-2009, FILED 6-13-2008.

XZ

THE MARK CONSISTS OF STANDARD CHARACTERS WITHOUT CLAIM TO ANY PARTICULAR FONT, STYLE, SIZE, OR COLOR.

FOR MICROFLUIDIC PLATES HAVING MULTI-WELL ARRAYS THAT CAN BE USED IN CHEMICAL ANALYSIS, BIOLOGICAL ANALYSIS OR PATTERNING FOR MEDICAL AND SCIENTIFIC RESEARCH PURPOSES (U.S. CLS. 21, 23, 26, 36 AND 38).

FIRST USE 3-5-2009; IN COMMERCE 3-5-2009.

3,785,457. TRADERISING CORPORATION, ARLINGTON, VA. SN 77-495,167. PUB. 11-4-2008, FILED 6-10-2008.

Traderising

THE MARK CONSISTS OF STANDARD CHARACTERS WITHOUT CLAIM TO ANY PARTICULAR FONT, STYLE, SIZE, OR COLOR.

FOR COMPUTER SOFTWARE FOR USE IN ANALYZING FINANCIAL DATA AND DEVELOPING STRATEGIES FOR TRADING FINANCIAL SECURITIES FOR USE IN THE FIELDS OF FINANCE AND FINANCIAL MARKETS (U.S. CLS. 21, 23, 26, 36 AND 38).

FIRST USE 7-16-2008; IN COMMERCE 12-28-2009.

3,785,472. LEIGHTON, DANIEL, HACIENDA HEIGHTS, CA. SN 77-502,120. PUB. 4-28-2009, FILED 6-18-2008.

SmartLabTools

THE MARK CONSISTS OF STANDARD CHARACTERS WITHOUT CLAIM TO ANY PARTICULAR FONT, STYLE, SIZE, OR COLOR.

NO CLAIM IS MADE TO THE EXCLUSIVE RIGHT TO USE "TOOLS", APART FROM THE MARK AS SHOWN.

FOR COMPUTER SOFTWARE, NAMELY, INTERACTIVE PDF TEMPLATES FOR PERFORMING VARIOUS CALCULATIONS AND GENERATING SIMPLE FORMS FOR USE IN THE CLINICAL LABORATORY FIELD AND MEDICAL PROFESSION (U.S. CLS. 21, 23, 26, 36 AND 38).

FIRST USE 9-0-2007; IN COMMERCE 9-0-2007.

3,785,458. I-TEC ELECTRONICS INC., MIAMI, FL. SN 77-495,261. PUB. 12-30-2008, FILED 6-10-2008.

JAMZ

THE MARK CONSISTS OF STANDARD CHARACTERS WITHOUT CLAIM TO ANY PARTICULAR FONT, STYLE, SIZE, OR COLOR.

FOR EARPHONES; HEADPHONES; HEADSETS FOR USE WITH ELECTRONIC MUSIC PLAYERS (U.S. CLS. 21, 23, 26, 36 AND 38).

FIRST USE 10-21-2009; IN COMMERCE 10-21-2009.

3,785,502. FULHAM CO., INC., HAWTHORNE, CA. SN 77-513,442. PUB. 11-25-2008, FILED 7-2-2008.

SINEHORSE

THE MARK CONSISTS OF STANDARD CHARACTERS WITHOUT CLAIM TO ANY PARTICULAR FONT, STYLE, SIZE, OR COLOR.

FOR ELECTRICAL AND ELECTRONIC LIGHTING BALLASTS (U.S. CLS. 21, 23, 26, 36 AND 38).

FIRST USE 8-1-2009; IN COMMERCE 8-1-2009.

CLASS 9—(Continued).

3,785,508. NEW SCALE TECHNOLOGIES, INC., VICTOR, NY. SN 77-515,780. PUB. 10-6-2009, FILED 7-7-2008.

TRACKER

THE MARK CONSISTS OF STANDARD CHARACTERS WITHOUT CLAIM TO ANY PARTICULAR FONT, STYLE, SIZE, OR COLOR.

FOR ROTARY AND LINEAR POSITION SENSORS (U.S. CLS. 21, 23, 26, 36 AND 38).

FIRST USE 11-11-2008; IN COMMERCE 11-11-2008.

3,785,536. GERALD KAMPEL, TAUFKIRCHEN, FED REP GERMANY. SN 77-527,339. PUB. 6-23-2009, FILED 7-21-2008.



RESCUEVOX

OWNER OF U.S. REG. NOS. 2,148,872 AND 3,187,620. THE MARK CONSISTS OF THE CREATED WORD "RESCUEVOX" WITH STYLIZED FLAMES EMANATING FROM THE "V".

FOR TRANSCEIVERS FOR USE IN LOCATING AND RE-ORIENTING PARTIES (U.S. CLS. 21, 23, 26, 36 AND 38).

FIRST USE 8-21-2009; IN COMMERCE 8-21-2009.

3,785,537. CPAWRITER, INC., MARINE CITY, MI. SN 77-527,369. PUB. 5-19-2009, FILED 7-21-2008.

GOVWRITER

THE MARK CONSISTS OF STANDARD CHARACTERS WITHOUT CLAIM TO ANY PARTICULAR FONT, STYLE, SIZE, OR COLOR.

FOR COMPUTER SOFTWARE FOR USE BY FINANCIAL PROFESSIONALS ENGAGED IN GOVERNMENTAL AUDITS AND BY GOVERNMENTAL ENTITIES FOR USE IN THE GENERATION OF GOVERNMENTAL FINANCIAL STATEMENTS AND TRIAL BALANCE DATA SHEETS, AND INSTRUCTION AND TRAINING MATERIALS SOLD AS A UNIT THEREWITH (U.S. CLS. 21, 23, 26, 36 AND 38).

FIRST USE 8-0-2008; IN COMMERCE 8-0-2008.

CLASS 9—(Continued).

3,785,538. CPAWRITER, INC., MARINE CITY, MI. SN 77-527,383. PUB. 5-19-2009, FILED 7-21-2008.

CPAWRITER

THE MARK CONSISTS OF STANDARD CHARACTERS WITHOUT CLAIM TO ANY PARTICULAR FONT, STYLE, SIZE, OR COLOR.

FOR COMPUTER SOFTWARE FOR USE BY FINANCIAL PROFESSIONALS FOR USE IN THE GENERATION OF FINANCIAL STATEMENTS AND TRIAL BALANCE DATA SHEETS, AND INSTRUCTION AND TRAINING MATERIALS SOLD AS A UNIT THEREWITH (U.S. CLS. 21, 23, 26, 36 AND 38).

FIRST USE 12-0-2007; IN COMMERCE 12-0-2007.

3,785,545. ANAKAM, INC., SAN DIEGO, CA. SN 77-529,342. PUB. 12-16-2008, FILED 7-23-2008.

ANAKAM.VPC

THE MARK CONSISTS OF STANDARD CHARACTERS WITHOUT CLAIM TO ANY PARTICULAR FONT, STYLE, SIZE, OR COLOR.

OWNER OF U.S. REG. NO. 3,333,602. FOR COMPUTER SOFTWARE FOR CONTROLLING AND MANAGING ACCESS TO SERVER APPLICATIONS (U.S. CLS. 21, 23, 26, 36 AND 38).

FIRST USE 6-18-2008; IN COMMERCE 6-18-2008.

3,785,546. CENTRAL TEXAS INDUSTRIES, HOUSTON, TX. SN 77-529,474. PUB. 12-16-2008, FILED 7-23-2008.



THE MARK CONSISTS OF A BULLDOG ATTACHED TO A CHAIN AND BITTING ON A LIGHTNING BOLT.

FOR VOLTAGE SURGE PROTECTORS (U.S. CLS. 21, 23, 26, 36 AND 38).

FIRST USE 1-4-2008; IN COMMERCE 1-4-2008.

CLASS 9—(Continued).

3,785,548. UNIVERSAL ELECTRONICS INC., CYPRESS, CA. SN 77-530,306. PUB. 7-7-2009, FILED 7-24-2008.

XSIGHT

THE MARK CONSISTS OF STANDARD CHARACTERS WITHOUT CLAIM TO ANY PARTICULAR FONT, STYLE, SIZE, OR COLOR.

FOR REMOTE CONTROL UNITS FOR REMOTELY CONTROLLED ELECTRICAL EQUIPMENT, NAMELY, TELEVISIONS, VIDEO CASSETTE RECORDERS, DIGITAL VIDEO RECORDERS, CABLE BOXES, STEREO EQUIPMENT, SATELLITE DISHES, COMPUTERS, LIGHTING AND FANS (U.S. CLS. 21, 23, 26, 36 AND 38).
FIRST USE 11-0-2008; IN COMMERCE 11-0-2008.

3,785,549. MICARD, L.L.C., SCOTTSDALE, AZ. SN 77-530,394. PUB. 6-16-2009, FILED 7-24-2008.

MI CARD

THE MARK CONSISTS OF STANDARD CHARACTERS WITHOUT CLAIM TO ANY PARTICULAR FONT, STYLE, SIZE, OR COLOR.

NO CLAIM IS MADE TO THE EXCLUSIVE RIGHT TO USE "CARD", APART FROM THE MARK AS SHOWN.

FOR MAGNETICALLY ENCODED PLASTIC CARDS CONTAINING PERSONALIZED MEDICAL INFORMATION ON THE FRONT AND BACK FACES OF THE CARD (U.S. CLS. 21, 23, 26, 36 AND 38).

FIRST USE 12-5-2008; IN COMMERCE 12-5-2008.

3,785,550. MICARD, L.L.C., SCOTTSDALE, AZ. SN 77-530,414. PUB. 6-9-2009, FILED 7-24-2008.

MICARD

THE MARK CONSISTS OF STANDARD CHARACTERS WITHOUT CLAIM TO ANY PARTICULAR FONT, STYLE, SIZE, OR COLOR.

FOR MAGNETICALLY ENCODED PLASTIC CARDS CONTAINING PERSONALIZED MEDICAL INFORMATION ON THE FRONT AND BACK FACES OF THE CARD (U.S. CLS. 21, 23, 26, 36 AND 38).

FIRST USE 12-5-2008; IN COMMERCE 12-5-2008.

CLASS 9—(Continued).

3,785,558. HS TM, LLC, NEWARK, DE. SN 77-534,122. PUB. 8-4-2009, FILED 7-29-2008.

MAXI-GARD

THE MARK CONSISTS OF STANDARD CHARACTERS WITHOUT CLAIM TO ANY PARTICULAR FONT, STYLE, SIZE, OR COLOR.

FOR PROTECTIVE EYEWEAR, NAMELY, EYE SHIELD MASKS, GLASSES AND GOGGLES FOR DENTAL, MEDICAL AND HEALTHCARE PROFESSIONALS (U.S. CLS. 21, 23, 26, 36 AND 38).

FIRST USE 12-31-2008; IN COMMERCE 12-31-2008.

3,785,565. U.S. VISION, INC., GLENDORA, NJ. SN 77-536,714. PUB. 11-4-2008, FILED 8-1-2008.

MAX COLE.

THE MARK CONSISTS OF STANDARD CHARACTERS WITHOUT CLAIM TO ANY PARTICULAR FONT, STYLE, SIZE, OR COLOR.

THE NAME "MAX COLE" SHOWN IN THE MARK DOES NOT IDENTIFY A PARTICULAR LIVING INDIVIDUAL.

FOR EYEGLASS CASES; EYEGLASSES; EYEWEAR; EYEWEAR ACCESSORIES, NAMELY, STRAPS, NECK CORDS AND HEAD STRAPS WHICH RESTRAIN EYEWEAR FROM MOVEMENT ON A WEARER; SUNGLASSES (U.S. CLS. 21, 23, 26, 36 AND 38).

FIRST USE 11-1-2008; IN COMMERCE 11-1-2008.

3,785,581. IMOTIONS - EMOTION TECHNOLOGY A/S, COPENHAGEN, DENMARK. SN 77-547,042. PUB. 10-27-2009, FILED 8-14-2008.

ATTENTION TOOL

THE MARK CONSISTS OF STANDARD CHARACTERS WITHOUT CLAIM TO ANY PARTICULAR FONT, STYLE, SIZE, OR COLOR.

NO CLAIM IS MADE TO THE EXCLUSIVE RIGHT TO USE "TOOL", APART FROM THE MARK AS SHOWN.

FOR COMPUTER SOFTWARE FOR ANALYZING HOW CONSUMERS PERCEIVE ADVERTISEMENTS, PRODUCT PACKAGING, AND MARKETING MATERIALS (U.S. CLS. 21, 23, 26, 36 AND 38).

FIRST USE 9-15-2009; IN COMMERCE 9-15-2009.

CLASS 9—(Continued).

3,785,594. KONAMI GAMING, INC., LAS VEGAS, NV. SN 77-555,461. PUB. 10-21-2008, FILED 8-25-2008.

4-5-5-5-4

THE MARK CONSISTS OF STANDARD CHARACTERS WITHOUT CLAIM TO ANY PARTICULAR FONT, STYLE, SIZE, OR COLOR.

FOR ELECTRONIC GAME PROGRAMS; GAMING EQUIPMENT, NAMELY, SLOT MACHINES WITH OR WITHOUT VIDEO OUTPUT; GAMING MACHINES; MACHINES FOR PLAYING GAMES OF CHANCE; SLOT MACHINES (U.S. CLS. 21, 23, 26, 36 AND 38).

FIRST USE 12-3-2008; IN COMMERCE 12-3-2008.

CLASS 9—(Continued).

3,785,610. KNOWLES, BEYONCE, BEVERLY HILLS, CA. SN 77-567,464. PUB. 6-2-2009, FILED 9-11-2008.

SASHA FIERCE

THE MARK CONSISTS OF STANDARD CHARACTERS WITHOUT CLAIM TO ANY PARTICULAR FONT, STYLE, SIZE, OR COLOR.

THE NAME(S), PORTRAIT(S), AND/OR SIGNATURE(S) SHOWN IN THE MARK DOES NOT IDENTIFY A PARTICULAR LIVING INDIVIDUAL.

FOR DVDS, CDS, AUDIO CASSETTES FEATURING MUSIC, MUSICAL PERFORMANCES, DRAMATIC PERFORMANCES (U.S. CLS. 21, 23, 26, 36 AND 38).

FIRST USE 11-18-2008; IN COMMERCE 11-18-2008.

3,785,602. VSEE LAB INC, DBA VSEE LAB INC, SAN JOSE, CA. SN 77-559,592. PUB. 1-20-2009, FILED 8-31-2008.

It's good to see

THE MARK CONSISTS OF STANDARD CHARACTERS WITHOUT CLAIM TO ANY PARTICULAR FONT, STYLE, SIZE, OR COLOR.

FOR COMMUNICATIONS SOFTWARE FOR CONNECTING PEOPLE AND OBJECTS (U.S. CLS. 21, 23, 26, 36 AND 38).

FIRST USE 11-14-2008; IN COMMERCE 11-14-2008.

3,785,627. DANIEL LANOIS, TORONTO, CANADA. SN 77-582,606. PUB. 5-12-2009, FILED 9-30-2008.

RED FLOOR RECORDS

THE MARK CONSISTS OF STANDARD CHARACTERS WITHOUT CLAIM TO ANY PARTICULAR FONT, STYLE, SIZE, OR COLOR.

NO CLAIM IS MADE TO THE EXCLUSIVE RIGHT TO USE "RECORDS", APART FROM THE MARK AS SHOWN.

FOR MUSICAL SOUND RECORDINGS; MUSICAL VIDEO RECORDINGS (U.S. CLS. 21, 23, 26, 36 AND 38).

FIRST USE 12-0-2007; IN COMMERCE 12-0-2007.

3,785,609. DISNEY ENTERPRISES, INC., BURBANK, CA. SN 77-567,068. PUB. 6-23-2009, FILED 9-10-2008.

CAROLWOOD RECORDS

THE MARK CONSISTS OF STANDARD CHARACTERS WITHOUT CLAIM TO ANY PARTICULAR FONT, STYLE, SIZE, OR COLOR.

NO CLAIM IS MADE TO THE EXCLUSIVE RIGHT TO USE "RECORDS", APART FROM THE MARK AS SHOWN.

THE NAME "CAROL WOOD" DOES NOT IDENTIFY THAT OF A LIVING INDIVIDUAL.

FOR SOUND RECORDINGS FEATURING MUSIC (U.S. CLS. 21, 23, 26, 36 AND 38).

FIRST USE 11-0-2008; IN COMMERCE 11-0-2008.

3,785,628. CLAY, JASON, PISCATAWAY, NJ. SN 77-583,049. PUB. 2-17-2009, FILED 10-1-2008.

BEYOND ORIGINAL

THE MARK CONSISTS OF STANDARD CHARACTERS WITHOUT CLAIM TO ANY PARTICULAR FONT, STYLE, SIZE, OR COLOR.

FOR COMPUTER SOFTWARE FOR INFORMATION TECHNOLOGY TRAINING; DIGITAL MATERIALS, NAMELY, CDS, DVDS, DOWNLOADABLE AUDIO FILES FEATURING INFORMATION TECHNOLOGY TRAINING; DOWNLOADABLE COMPUTER SOFTWARE FOR INFORMATION TECHNOLOGY TRAINING (U.S. CLS. 21, 23, 26, 36 AND 38).

FIRST USE 8-29-2008; IN COMMERCE 12-1-2008.

CLASS 9—(Continued).

3,785,637. YAHOO! INC., SUNNYVALE, CA. SN 77-591,453.
PUB. 5-5-2009, FILED 10-13-2008.

APT FROM YAHOO!

THE MARK CONSISTS OF STANDARD CHARACTERS WITHOUT CLAIM TO ANY PARTICULAR FONT, STYLE, SIZE, OR COLOR.

OWNER OF U.S. REG. NOS. 2,040,222, 2,403,227, AND OTHERS.

FOR COMPUTER SOFTWARE FOR MANAGING ONLINE ADVERTISING AND MARKETING (U.S. CLS. 21, 23, 26, 36 AND 38).

FIRST USE 9-24-2008; IN COMMERCE 9-24-2008.

CLASS 9—(Continued).

3,785,656. PEN-LINK, LTD., LINCOLN, NE. SN 77-603,225.
PUB. 3-17-2009, FILED 10-29-2008.



THE MARK CONSISTS OF AN "X" FORMED WITH DOUBLE LINES SUPERIMPOSED ON THREE SHADED CONCENTRIC CIRCLES AND A HUMAN FIGURE WITHIN ADDITIONAL SHADED CONCENTRIC CIRCLES SUPERIMPOSED ON THE "X" FOLLOWED BY THE WORD "NET".

FOR COMPUTER PROGRAM FOR ANALYSIS OF TELEPHONE USAGE TO DETERMINE POSSIBLE CRIMINAL ACTIVITY (U.S. CLS. 21, 23, 26, 36 AND 38).

FIRST USE 8-1-2008; IN COMMERCE 2-1-2010.

3,785,641. AIBELIVE CO., LTD., TAIPEI CITY, TAIWAN. SN 77-593,665. PUB. 10-13-2009, FILED 10-15-2008.



THE MARK CONSISTS OF THE STYLIZED LETTERS "AI", WITH A DESIGN WITH A SHAPE OF A MUSIC NOTE STEMMING FROM THE LETTER "A".

FOR PRERECORDED COMPUTER PROGRAM DISKS FOR USE IN DATABASE MANAGEMENT, DESK COMPUTERS, NOTEBOOK COMPUTERS, MEMORY DEVICE FOR STORING COMPUTER DATA, PALMTOP COMPUTERS, COMPUTER PROGRAMS FOR USE IN DATABASE MANAGEMENT, PRERECORDED COMPUTER PROGRAMS FOR USE IN DATABASE MANAGEMENT, COMPUTER SOFTWARE FOR USE IN VOICE RECOGNITION AND EXECUTING VOICE COMMANDS, VOICE CONTROL SOFTWARE FOR USE IN VOICE RECOGNITION AND EXECUTING VOICE COMMAND, TELEPHONE EQUIPMENT, NAMELY, CALLER IDENTIFICATION BOXES FUNCTIONAL VIA VOICE COMMANDS, PERSONAL DIGITAL ASSISTANTS, COMPUTER COMMUNICATION ASSISTANTS, NAMELY, PERSONAL DIGITAL COMPUTER COMMUNICATION ASSISTANTS FUNCTIONAL VIA VOICE COMMAND, DOWNLOADABLE MUSIC VIA THE INTERNET, PORTABLE FLASH MEMORIES, VIDEO GAME SOFTWARE, PORTABLE MULTIMEDIA PLAYERS, NAMELY, MP3 AND MP4 PLAYER, PLAYERS FOR PLAYING AUDIO AND OR VIDEO; VOICE CONTROL SOFTWARE IN A DEVICE FOR USE IN VOICE RECOGNITION AND EXECUTING VOICE COMMANDS TO OPERATE THE DEVICE (U.S. CLS. 21, 23, 26, 36 AND 38).

FIRST USE 10-1-2009; IN COMMERCE 10-1-2009.

3,785,666. SELA PRODUCTS, LLC, EDMOND, OK. SN 77-609,018. PUB. 9-29-2009, FILED 11-6-2008.

ZAX

THE MARK CONSISTS OF STANDARD CHARACTERS WITHOUT CLAIM TO ANY PARTICULAR FONT, STYLE, SIZE, OR COLOR.

FOR CUSTOM AUDIO/VIDEO INSTALLATION AND ACCESSORY ITEMS, NAMELY, LOUDSPEAKERS, LOUDSPEAKER ENCLOSURES, LOUDSPEAKER SYSTEMS, LEVEL INDICATORS FOR USE IN CUSTOM AUDIO/VIDEO INSTALLATION, CUSTOM AUDIO/VIDEO INSTALLATION AND ACCESSORY ITEMS, NAMELY, CABLE CONNECTORS AND ADAPTORS, AUDIO INTERCONNECT AND ADAPTER CABLES, VIDEO INTERCONNECT AND ADAPTER CABLES, SPEAKER WIRE, COAXIAL CABLE, COMMUNICATION CABLE, OPTICAL CABLE, COMPUTER CABLE, ELECTRICAL CABLE, SIGNAL SPLITTERS, ELECTRICAL AND SIGNAL GROUNDING DEVICES, COAXIAL CABLE BOOTS, COAXIAL CABLE CLIPS, SATELLITE MULTI-SWITCHES, VOLTAGE SURGE PROTECTORS AND SUPPRESSORS, AUDIO/VIDEO SELECTORS, AUDIO/VIDEO DISTRIBUTION DEVICES, AUDIO/VIDEO MULTI-ZONE CONTROLLERS, MODULAR WALL JACKS AND WALL SWITCH PLATES, VOLUME CONTROLS, SPEAKER SWITCHERS, INFRARED CONTROLS, INFRARED RECEIVERS AND EMITTERS, INFRARED REPEATERS AND EXTENDERS, RADIO FREQUENCY CONTROLS, AUDIO/VIDEO RECEIVERS AND TUNERS, SIGNAL MODULATORS, COMPUTER HUBS AND ROUTERS, AMPLIFIERS, PREAMPLIFIERS, SATELLITE DISTRIBUTION AMPLIFIERS, HEADPHONES, REMOTE CONTROLS FOR AUDIO/VIDEO AND HOME AUTOMATION DEVICES, PLASMA DISPLAYS, LCD DISPLAYS, TELEVISIONS, TELEVISION ANTENNAS, TRIPODS, ELECTRIC LIGHT DIMMERS AND HOME AUTOMATION CONTROL MODULES, AUDIO/VIDEO/HOME AUTOMATION TOUCH PADS AND PANELS (U.S. CLS. 21, 23, 26, 36 AND 38).

FIRST USE 9-9-2009; IN COMMERCE 9-9-2009.

CLASS 9—(Continued).

3,785,668. BULLETPROOF ELECTRONICS, INC., BRADENTON, FL. SN 77-609,559. PUB. 10-6-2009, FILED 11-7-2008.

HEISTPROOF

THE MARK CONSISTS OF STANDARD CHARACTERS WITHOUT CLAIM TO ANY PARTICULAR FONT, STYLE, SIZE, OR COLOR.

FOR THEFT PROTECTION SYSTEMS COMPRISING OF RADIO FREQUENCY IDENTIFICATION (RFID), NAMELY, TAGS, TAG READERS AND TRANSPONDERS; GLOBAL POSITIONING SYSTEM (GPS), CELL PHONE AND ANTENNAS TO BE PLACED IN A VEHICLE (U.S. CLS. 21, 23, 26, 36 AND 38).

FIRST USE 2-2-2009; IN COMMERCE 2-2-2009.

3,785,673. TRANSMISSION DEVELOPERS INC., TORONTO, CANADA. SN 77-611,429. PUB. 4-7-2009, FILED 11-10-2008.

MAINE EXPRESS

THE MARK CONSISTS OF STANDARD CHARACTERS WITHOUT CLAIM TO ANY PARTICULAR FONT, STYLE, SIZE, OR COLOR.

NO CLAIM IS MADE TO THE EXCLUSIVE RIGHT TO USE "MAINE", APART FROM THE MARK AS SHOWN.

FOR ELECTRICITY TRANSMISSION LINE, NAMELY, POWER-LINE TRANSMISSION APPARATUS (U.S. CLS. 21, 23, 26, 36 AND 38).

FIRST USE 3-1-2009; IN COMMERCE 3-1-2009.

3,785,678. HARRIS PUBLICATIONS, INC., NEW YORK, NY. SN 77-613,674. PUB. 5-19-2009, FILED 11-13-2008.

XXL Mobile

THE MARK CONSISTS OF STANDARD CHARACTERS WITHOUT CLAIM TO ANY PARTICULAR FONT, STYLE, SIZE, OR COLOR.

OWNER OF U.S. REG. NO. 2,105,347.

NO CLAIM IS MADE TO THE EXCLUSIVE RIGHT TO USE "MOBILE", APART FROM THE MARK AS SHOWN.

CLASS 9—(Continued).

THE WORDING "XXL" HAS NO MEANING IN A FOREIGN LANGUAGE.

FOR DOWNLOADABLE GRAPHICS, SCREEN IMAGES, PICTURES, BANNERS, ANIMATIONS, GAMES, SOFTWARE APPLICATIONS THAT ALLOW MESSAGES, INFORMATION, IMAGES, SOUNDS OR OTHER DATA TO BE SENT FROM AND RECEIVED BY DIGITAL DATA STORAGE OR COMMUNICATION DEVICES, SHORT MESSAGE SERVICE (SMS), MOBILE TV AND MULTI MEDIA MESSAGING SERVICE (MMS) ALERTS OR APPLICATIONS, AND RING BACK MESSAGES VIA THE INTERNET AND WIRELESS DEVICES (U.S. CLS. 21, 23, 26, 36 AND 38).

FIRST USE 12-11-2009; IN COMMERCE 12-11-2009.

3,785,681. CARROT MEDICAL, LLC, NEWTON, MA. SN 77-616,054. PUB. 5-26-2009, FILED 11-17-2008.

CARROT MEDICAL

THE MARK CONSISTS OF STANDARD CHARACTERS WITHOUT CLAIM TO ANY PARTICULAR FONT, STYLE, SIZE, OR COLOR.

NO CLAIM IS MADE TO THE EXCLUSIVE RIGHT TO USE "MEDICAL", APART FROM THE MARK AS SHOWN.

FOR AUDIO-VISUAL SYSTEMS CONSISTING OF VIDEO MONITORS, TOUCH-SCREEN CONTROL MONITORS, GESTURE-BASED CONTROL DEVICES, WIRELESS HEADSETS AND A CENTRAL PROCESSING UNIT THAT ALLOW USERS TO COLLECT AND RECORD VISUAL DATA OF MEDICAL PROCEDURES FROM MULTIPLE, INDEPENDENT SOURCES INTO A CENTRAL PROCESSOR, SELECT AND CONSOLIDATE CERTAIN IMAGES FOR VIEWING ON A SINGLE DISPLAY MONITOR AND MANAGE THE PRESENTATION OF THIS DATA THROUGH THE USE OF TOUCH-PANEL, GESTURE-BASED OR VOICE-RECOGNITION CONTROLS (U.S. CLS. 21, 23, 26, 36 AND 38).

FIRST USE 4-30-2009; IN COMMERCE 4-30-2009.

3,785,682. TOSHIBA INTERNATIONAL CORPORATION, HOUSTON, TX. SN 77-616,361. PUB. 9-29-2009, FILED 11-18-2008.

REMOTRADAR

THE MARK CONSISTS OF STANDARD CHARACTERS WITHOUT CLAIM TO ANY PARTICULAR FONT, STYLE, SIZE, OR COLOR.

FOR COMPUTER SOFTWARE FOR MONITORING AND MANAGING POWER FOR UNINTERRUPTIBLE POWER SUPPLY SYSTEMS (U.S. CLS. 21, 23, 26, 36 AND 38).

FIRST USE 7-0-2009; IN COMMERCE 7-0-2009.

CLASS 9—(Continued).

3,785,710. HIT PLAY LLC, VERONA, NJ. SN 77-629,323. PUB. 9-15-2009, FILED 12-9-2008.

HITPLAY

THE MARK CONSISTS OF STANDARD CHARACTERS WITHOUT CLAIM TO ANY PARTICULAR FONT, STYLE, SIZE, OR COLOR.

FOR PRE-RECORDED CDS AND DVDS FEATURING MUSIC, AND DIGITAL MUSIC DOWNLOADS FROM THE INTERNET (U.S. CLS. 21, 23, 26, 36 AND 38).

FIRST USE 2-2-2010; IN COMMERCE 2-2-2010.

3,785,728. BACCUS GLOBAL LLC, DEERFIELD BEACH, FL. SN 77-634,620. PUB. 7-7-2009, FILED 12-16-2008.



THE MARK CONSISTS OF THE STYLIZED TEXT "ONE-TOUCH" WITH A CIRCLE AND A HAND ON THE RIGHT. THE HAND HAS A FINGER TOUCHING THE CIRCLE.

FOR MICRO PROCESSOR WITHIN A BATTERY CHARGER USED TO ANALYZE THE TYPE OF BATTERY, ANALYZE THE AMOUNT OF VOLTAGE LEFT, ANALYZE THE TYPES OF AMPS ARE NEEDED, AND ANALYZE WHEN TO SHUT OFF TO FLOAT MODE OR MAINTAIN MODE (U.S. CLS. 21, 23, 26, 36 AND 38).

FIRST USE 4-1-2009; IN COMMERCE 4-1-2009.

3,785,739. SAMSUNG ELECTRONICS CO., LTD., SUWON-SI, GYEONGGI-DO, REPUBLIC OF KOREA. SN 77-639,856. PUB. 3-10-2009, FILED 12-24-2008.

FREEFORM

THE MARK CONSISTS OF STANDARD CHARACTERS WITHOUT CLAIM TO ANY PARTICULAR FONT, STYLE, SIZE, OR COLOR.

FOR MOBILE PHONES; SMART PHONES (U.S. CLS. 21, 23, 26, 36 AND 38).

FIRST USE 11-9-2009; IN COMMERCE 11-9-2009.

CLASS 9—(Continued).

3,785,740. WU, QINCHAO, GUANGDONG, CHINA. SN 77-640,105. PUB. 8-18-2009, FILED 12-26-2008.



THE MARK CONSISTS OF A CIRCLE CONTAINING STYLIZED LETTER "M", WHICH CONSISTS OF TWO QUADRILATERALS, IN WHICH THE LEFT SIDE IS SOLID, THE RIGHT WIDE CONTAINS VERTICAL STRIPES, AND THE TWO QUADRILATERALS TOUCH IN THE CENTER, ALL SHOWN TO THE LEFT OF THE WORD "BARKA", SHOWN IN STYLIZED FONT.

THE WORDING "BARKA" HAS NO MEANING IN A FOREIGN LANGUAGE.

FOR LOUD SPEAKERS; LOUD SPEAKER SYSTEMS; COMPONENTS FOR LOUD SPEAKERS, NAMELY, LOUD SPEAKER TUBES, CABINETS FOR LOUD SPEAKERS, MONITOR APPARATUSES FOR LOUD SPEAKERS, ELECTRICAL COMPONENTS FOR LOUD SPEAKERS, NAMELY, ELECTRICAL CIRCUIT BOARDS, AND ELECTRO-ACOUSTIC ASSEMBLIES; MICROPHONES; SOUND TRANSMITTING APPARATUSES; EARPHONES AND HEADPHONES; DELAY STEREO MIXERS; AND ELECTRONIC SOUND PICKUPS FOR GUITARS AND BASSES (U.S. CLS. 21, 23, 26, 36 AND 38).

FIRST USE 12-9-2008; IN COMMERCE 6-1-2009.

3,785,753. WARD, RAMONE, BABYLON, NY. SN 77-645,442. PUB. 5-5-2009, FILED 1-8-2009.

COACH GUARD

THE MARK CONSISTS OF STANDARD CHARACTERS WITHOUT CLAIM TO ANY PARTICULAR FONT, STYLE, SIZE, OR COLOR.

FOR COMMUNICATIONS HEADSETS FOR USE WITH COMMUNICATION RADIOS, INTERCOM SYSTEMS, OR OTHER COMMUNICATIONS NETWORK TRANSCIEVERS; HEADSETS FOR TELEPHONES; MICROPHONE BOOM POLE; MICROPHONE MODULES; MICROPHONES (U.S. CLS. 21, 23, 26, 36 AND 38).

FIRST USE 6-14-2009; IN COMMERCE 6-14-2009.

CLASS 9—(Continued).

3,785,766. RAULAND-BORG CORPORATION, MT. PROSPECT, IL. SN 77-649,203. PUB. 5-26-2009, FILED 1-14-2009.

VOCIA

THE MARK CONSISTS OF STANDARD CHARACTERS WITHOUT CLAIM TO ANY PARTICULAR FONT, STYLE, SIZE, OR COLOR.

THE ENGLISH TRANSLATION OF "VOCIA" IN THE MARK IS VOICE.

FOR NETWORK BASED PAGING AND BACKGROUND MUSIC SYSTEM WITH LIFE SAFETY AND MISSION CRITICAL PAGING CAPABILITIES, COMPRISING COMPUTER HARDWARE AND SOFTWARE THEREFORE (U.S. CLS. 21, 23, 26, 36 AND 38).

FIRST USE 6-0-2009; IN COMMERCE 2-1-2010.

3,785,785. GENERAL DYNAMICS C4 SYSTEMS, INC., SCOTTSDALE, AZ. SN 77-656,514. PUB. 5-12-2009, FILED 1-26-2009.

Bird Dog

THE MARK CONSISTS OF STANDARD CHARACTERS WITHOUT CLAIM TO ANY PARTICULAR FONT, STYLE, SIZE, OR COLOR.

FOR COMPUTER HARDWARE AND SOFTWARE SYSTEM FOR TRACKING OBJECTS USING GPS DATA, COMPRISED OF HANDHELD RADIO UNIT AND COMPUTER STATION, AND CUSTOMIZED SOFTWARE APPLICATION FOR TRACKING LOCATION (U.S. CLS. 21, 23, 26, 36 AND 38).

FIRST USE 6-30-2009; IN COMMERCE 6-30-2009.

3,785,791. SEMTECH CORPORATION, CAMARILLO, CA. SN 77-657,478. PUB. 5-19-2009, FILED 1-27-2009.

ToPSync

THE MARK CONSISTS OF STANDARD CHARACTERS WITHOUT CLAIM TO ANY PARTICULAR FONT, STYLE, SIZE, OR COLOR.

FOR SEMICONDUCTORS FOR CLOCK SYNCHRONIZATION, COMPLIANT WITH STANDARDS DEFINED FOR SYNCHRONOUS OPTICAL NETWORK (SONET) AND SYNCHRONOUS DIGITAL HIERARCHY (SDH) (U.S. CLS. 21, 23, 26, 36 AND 38).

FIRST USE 1-29-2010; IN COMMERCE 1-29-2010.

CLASS 9—(Continued).

3,785,799. YOTOGA, LLC, WASHINGTON, DC. SN 77-658,809. PUB. 5-19-2009, FILED 1-28-2009.

YOTOGA

THE MARK CONSISTS OF STANDARD CHARACTERS WITHOUT CLAIM TO ANY PARTICULAR FONT, STYLE, SIZE, OR COLOR.

FOR COMPUTER SOFTWARE FOR DATABASE MANAGEMENT, TALENT ACQUISITION, TRACKING AND REPORTING, TALENT MANAGEMENT AND SUCCESSION PLANNING (U.S. CLS. 21, 23, 26, 36 AND 38).

FIRST USE 6-8-2008; IN COMMERCE 9-3-2008.

3,785,811. USA WIRELESS SOLUTIONS, WOOD DALE, IL. SN 77-660,207. PUB. 5-26-2009, FILED 1-30-2009.



THE MARK CONSISTS OF A LEAF, AN ARC SURROUNDING PART OF THE LEAF AND A STAR AT ONE END OF THE ARC.

FOR CARRYING CASES FOR CELL PHONES; PROTECTIVE CARRYING CASES FOR PORTABLE MUSIC PLAYERS, NAMELY, MP3 PLAYERS; PROTECTIVE CARRYING CASES SPECIALLY ADAPTED FOR GLOBAL POSITIONING SYSTEM (GPS) APPARATUS; PROTECTIVE CARRYING CASES SPECIALLY ADAPTED FOR PERSONAL DIGITAL ASSISTANTS (PDA); PROTECTIVE COVERS AND CASES FOR CELL PHONES, LAPTOPS AND PORTABLE MEDIA PLAYERS (U.S. CLS. 21, 23, 26, 36 AND 38).

FIRST USE 9-0-2009; IN COMMERCE 9-0-2009.

CLASS 9—(Continued).

3,785,812. AG LEADER TECHNOLOGY, INC., AMES, IA. SN 77-660,357. PUB. 5-26-2009, FILED 1-30-2009.

OPTRX

THE MARK CONSISTS OF STANDARD CHARACTERS WITHOUT CLAIM TO ANY PARTICULAR FONT, STYLE, SIZE, OR COLOR.

FOR ELECTRONIC DETECTORS FOR OBSERVING AND MEASURING THE INFRARED SPECTRUM, NAMELY, INFRARED DETECTORS; ELECTRONIC PLANT MOISTURE SENSOR; ELECTRONIC REGULATING AND CONTROL DEVICES FOR THE OPERATION OF LIGHT EMITTING DIODES; INFRARED DETECTORS FOR USE IN MILITARY, LAW ENFORCEMENT, CIVIL, SCIENTIFIC AND INDUSTRIAL APPLICATIONS; LIDAR; PHOTOELECTRIC SENSORS; PORTABLE DETECTION AND IDENTIFICATION INSTRUMENTS USING LIGHT SOURCES AND LIGHT DETECTORS FOR DETECTING AND IDENTIFYING CHEMICAL AND BIOLOGICAL SUBSTANCES NOT FOR MEDICAL PURPOSES; PROXIMITY SENSORS; SENSORS FOR THE DETERMINATION OF TEMPERATURES, POSITIONS AND DISTANCES; VEHICLE MOUNTED GPS SENSOR FOR DETERMINING THE RATE OF MOTION FOR A VEHICLE (U.S. CLS. 21, 23, 26, 36 AND 38).

FIRST USE 6-8-2009; IN COMMERCE 6-10-2009.

3,785,816. VIDEO GAMING TECHNOLOGIES, INC., BRENTWOOD, TN. SN 77-660,859. PUB. 5-19-2009, FILED 1-31-2009.

CHARMED LIFE

THE MARK CONSISTS OF STANDARD CHARACTERS WITHOUT CLAIM TO ANY PARTICULAR FONT, STYLE, SIZE, OR COLOR.

FOR COMPUTER SOFTWARE AND FIRMWARE FOR GAMES OF CHANCE ON ANY COMPUTERIZED PLATFORM, INCLUDING DEDICATED GAMING CONSOLES, VIDEO BASED SLOT MACHINES, REEL BASED SLOT MACHINES, AND VIDEO LOTTERY TERMINALS; GAMING DEVICES, NAMELY, GAMING MACHINES, SLOT MACHINES, BINGO MACHINES, WITH OR WITHOUT VIDEO OUTPUT (U.S. CLS. 21, 23, 26, 36 AND 38).

FIRST USE 6-0-2009; IN COMMERCE 6-0-2009.

CLASS 9—(Continued).

3,785,819. ABEL INDUSTRIES (CANADA) LTD., PITT MEADOWS, BC, CANADA. SN 77-661,351. PUB. 8-25-2009, FILED 2-2-2009.

Abel Industries

THE MARK CONSISTS OF STANDARD CHARACTERS WITHOUT CLAIM TO ANY PARTICULAR FONT, STYLE, SIZE, OR COLOR.

NO CLAIM IS MADE TO THE EXCLUSIVE RIGHT TO USE "INDUSTRIES", APART FROM THE MARK AS SHOWN.

FOR CHROMATOGRAPHY APPARATUS FOR LABORATORY USE (U.S. CLS. 21, 23, 26, 36 AND 38).

FIRST USE 9-18-1997; IN COMMERCE 9-18-1997.

3,785,820. GLOBAL GAMING GROUP INC., LAS VEGAS, NV. SN 77-661,553. PUB. 5-26-2009, FILED 2-2-2009.

The Money Bunch

THE MARK CONSISTS OF STANDARD CHARACTERS WITHOUT CLAIM TO ANY PARTICULAR FONT, STYLE, SIZE, OR COLOR.

FOR GAMING EQUIPMENT, NAMELY, SLOT MACHINES, WITH OR WITHOUT VIDEO OUTPUT (U.S. CLS. 21, 23, 26, 36 AND 38).

FIRST USE 6-1-2008; IN COMMERCE 6-1-2008.

3,785,829. MOTOROLA, INC., SCHAUMBURG, IL. SN 77-662,427. PUB. 5-26-2009, FILED 2-3-2009.

KARMA

THE MARK CONSISTS OF STANDARD CHARACTERS WITHOUT CLAIM TO ANY PARTICULAR FONT, STYLE, SIZE, OR COLOR.

FOR CELLULAR PHONES; CELLULAR PHONES WITH ELECTRONIC MESSAGING CAPABILITIES; CELLULAR PHONES WITH DIGITAL CAMERA AND VIDEO CAMERA CAPABILITIES; CELLULAR PHONES WITH NAVIGATION AND GLOBAL POSITIONING (GPS) CAPABILITIES; WIRELESS COMMUNICATION DEVICES FEATURING VOICE, DATA AND IMAGE TRANSMISSION (U.S. CLS. 21, 23, 26, 36 AND 38).

FIRST USE 6-12-2009; IN COMMERCE 6-12-2009.

CLASS 9—(Continued).

3,785,836. NEWBOLD CORPORATION, ROCKY MOUNT, VA. SN 77-663,954. PUB. 6-2-2009, FILED 2-5-2009.

KioskWorks

THE MARK CONSISTS OF STANDARD CHARACTERS WITHOUT CLAIM TO ANY PARTICULAR FONT, STYLE, SIZE, OR COLOR.

OWNER OF U.S. REG. NOS. 2,678,979 AND 3,178,430. FOR COMPUTER SOFTWARE FOR CONTROLLING AND MANAGING PATIENT MEDICAL INFORMATION; COMPUTER SOFTWARE FOR CONTROLLING SELF-SERVICE TERMINALS (U.S. CLS. 21, 23, 26, 36 AND 38). FIRST USE 11-0-2009; IN COMMERCE 1-22-2010.

3,785,840. MS ELECTRONICS LLC, OVERLAND PARK, KS. SN 77-664,444. PUB. 5-26-2009, FILED 2-5-2009.

ROCK SOLID

THE MARK CONSISTS OF STANDARD CHARACTERS WITHOUT CLAIM TO ANY PARTICULAR FONT, STYLE, SIZE, OR COLOR.

FOR AUDIO SPEAKERS (U.S. CLS. 21, 23, 26, 36 AND 38). FIRST USE 12-7-2009; IN COMMERCE 12-7-2009.

3,785,842. SPARK MOBILE, LLC, TAMPA, FL. SN 77-664,609. PUB. 6-2-2009, FILED 2-5-2009.

TOUR WRIST

THE MARK CONSISTS OF STANDARD CHARACTERS WITHOUT CLAIM TO ANY PARTICULAR FONT, STYLE, SIZE, OR COLOR.

FOR COMPUTER APPLICATION SOFTWARE FOR MOBILE PHONES (U.S. CLS. 21, 23, 26, 36 AND 38). FIRST USE 11-16-2009; IN COMMERCE 11-16-2009.

CLASS 9—(Continued).

3,785,844. LEUPOLD & STEVENS, INC., BEAVERTON, OR. SN 77-665,084. PUB. 6-9-2009, FILED 2-6-2009.

4-PLEX

THE MARK CONSISTS OF STANDARD CHARACTERS WITHOUT CLAIM TO ANY PARTICULAR FONT, STYLE, SIZE, OR COLOR.

OWNER OF U.S. REG. NOS. 1,636,774, 3,203,106, AND OTHERS.

FOR TELESCOPIC SIGHTS, OPTICAL LENS SCOPES; OPTICAL LENS SIGHTS FOR FIREARMS; OPTICAL LENS SCOPE COMPONENT, NAMELY, A RETICLE (U.S. CLS. 21, 23, 26, 36 AND 38).

FIRST USE 10-9-2009; IN COMMERCE 10-9-2009.

3,785,868. OAKLEY, INC., FOOTHILL RANCH, CA. SN 77-668,227. PUB. 6-9-2009, FILED 2-11-2009.



THE MARK CONSISTS OF AN ELLIPSOID "O" BROKEN INTO A GEOMETRIC PATTERN OF BLACK AND WHITE SHAPES.

FOR PROTECTIVE EYEWEAR, NAMELY, SPECTACLES, PRESCRIPTION EYEWEAR, ANTI GLARE GLASSES AND SUNGLASSES AND THEIR PARTS AND ACCESSORIES, NAMELY, REPLACEMENT LENSES, FRAMES, EARSTEMS, AND NOSE PIECES; CASES SPECIALLY ADAPTED FOR SPECTACLES AND SUNGLASSES AND THEIR PARTS AND ACCESSORIES (U.S. CLS. 21, 23, 26, 36 AND 38).

FIRST USE 5-5-2009; IN COMMERCE 5-5-2009.

CLASS 9—(Continued).

3,785,881. UNILUX, INC., SADDLE BROOK, NJ. SN 77-669,533. PUB. 6-9-2009, FILED 2-12-2009.

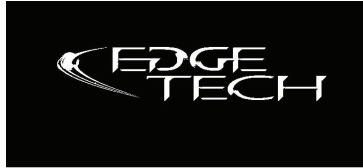

NO CLAIM IS MADE TO THE EXCLUSIVE RIGHT TO USE "TECH", APART FROM THE MARK AS SHOWN.

THE MARK CONSISTS OF THE STYLIZED WORDS "EDGE TECH" WITH A DESIGN OF A SPHERE WITH THREE CURVED LINES GOING THROUGH IT ALL CONTAINED WITHIN A RECTANGULAR DESIGN.

FOR COMPUTER SOFTWARE TO MONITOR AND CONTROL FACTORY MANUFACTURING PROCESSES; SOFTWARE FOR MONITORING AND CONTROLLING COMMUNICATION BETWEEN COMPUTERS AND AUTOMATED MACHINE SYSTEMS (U.S. CLS. 21, 23, 26, 36 AND 38).

FIRST USE 1-8-2009; IN COMMERCE 1-8-2009.

3,785,894. OLYMPUS CORPORATION, TOKYO, JAPAN. SN 77-674,557. PUB. 6-9-2009, FILED 2-20-2009.

SureView

THE MARK CONSISTS OF STANDARD CHARACTERS WITHOUT CLAIM TO ANY PARTICULAR FONT, STYLE, SIZE, OR COLOR.

FOR NONDESTRUCTIVE TESTING INSTRUMENTS, NAMELY, ULTRASONIC FLAW DETECTORS (U.S. CLS. 21, 23, 26, 36 AND 38).

FIRST USE 9-16-2009; IN COMMERCE 9-16-2009.

CLASS 9—(Continued).

3,785,895. OLYMPUS CORPORATION, TOKYO, JAPAN. SN 77-674,561. PUB. 6-9-2009, FILED 2-20-2009.

ClearWave

THE MARK CONSISTS OF STANDARD CHARACTERS WITHOUT CLAIM TO ANY PARTICULAR FONT, STYLE, SIZE, OR COLOR.

FOR NONDESTRUCTIVE TESTING INSTRUMENTS, NAMELY, ULTRASONIC FLAW DETECTORS (U.S. CLS. 21, 23, 26, 36 AND 38).

FIRST USE 9-16-2009; IN COMMERCE 9-16-2009.

3,785,899. NAVIGATORMD, INC., KNOXVILLE, TN. SN 77-674,916. PUB. 6-16-2009, FILED 2-20-2009.

DESIGN180

THE MARK CONSISTS OF STANDARD CHARACTERS WITHOUT CLAIM TO ANY PARTICULAR FONT, STYLE, SIZE, OR COLOR.

FOR COMPUTER PROGRAMS FOR INSURANCE PLANNING AND ANALYSIS (U.S. CLS. 21, 23, 26, 36 AND 38).

FIRST USE 5-29-2008; IN COMMERCE 5-29-2008.

3,785,928. ALTAPIC LLC, NEWARK, DE. SN 77-681,856. PUB. 6-23-2009, FILED 3-2-2009.

AXIRAL

THE COLOR(S) PENTONE 375U IS/ARE CLAIMED AS A FEATURE OF THE MARK.

CLASS 9—(Continued).

THE MARK CONSISTS OF THE COLOR PENTONE 375U APPLIES ONLY TO THE LETTERS "AXIRAL".

FOR CONSUMER ELECTRONIC PRODUCTS, NAMELY, AUDIO AMPLIFIERS, AUDIO RECEIVERS, ELECTRICAL AUDIO AND SPEAKER CABLES AND CONNECTORS, HOME THEATER SYSTEMS, AUDIO DECODERS, VIDEO DECODERS, SPEAKERS, POWER CONVERSION DEVICES, POWER CONVERTERS, AND POWER INVERTERS; ELECTRONIC CARDS FOR PROCESSING IMAGES; ELECTRONIC IMAGING APPARATUS IN THE FIELD OF IRIDOLOGY, SCLEROLOGY, RAYID AND EYOLOGY NOT FOR MEDICAL USE; ELECTRONIC SOUND MIXING, PROCESSING AND SYNTHESIZING APPARATUS; ELECTRONIC TIMERS; PORTABLE AND HANDHELD DIGITAL ELECTRONIC DEVICES FOR RECORDING, ORGANIZING, TRANSMITTING, MANIPULATING, AND REVIEWING TEXT, DATA, IMAGE, AND AUDIO FILES; TIME CLOCKS (U.S. CLS. 21, 23, 26, 36 AND 38).

FIRST USE 11-2-2009; IN COMMERCE 12-19-2009.

3,785,937. BOLAND, DEL PRICE, NAPERVILLE, IL. SN 77-684,108. PUB. 7-7-2009, FILED 3-5-2009.



NO CLAIM IS MADE TO THE EXCLUSIVE RIGHT TO USE "RECORDS", APART FROM THE MARK AS SHOWN. THE COLOR(S) BLACK, WHITE, RED, YELLOW, BLUE, GREEN AND GOLD IS/ARE CLAIMED AS A FEATURE OF THE MARK.

THE MARK CONSISTS OF THE LETTERS "B" (RED WITH BLACK OUTLINE) AND "D" (BLUE WITH BLACK OUTLINE) FORMING THE GLASSES ON A CHARACTER'S FACE, BLACK LETTERS "M" AND "N" FORMING THE HAIR, WHITE LETTERS SPELLING "RECORDS" FORMING THE TEETH SET IN A WIDE RED MOUTH WITH A BLACK OUTLINE ON YELLOW FACE WITH WHITE EYES AND BLACK PUPILS ALL SET ON A GREEN BACKGROUND WITH A BLACK FRAME.

FOR AUDIO DISCS FEATURING ORIGINAL MUSIC (U.S. CLS. 21, 23, 26, 36 AND 38).

FIRST USE 12-1-2009; IN COMMERCE 12-1-2009.

CLASS 9—(Continued).

3,785,956. NORCROSS CORPORATION, NEWTON, MA. SN 77-690,445. PUB. 9-1-2009, FILED 3-13-2009.

VISCSENSE

THE MARK CONSISTS OF STANDARD CHARACTERS WITHOUT CLAIM TO ANY PARTICULAR FONT, STYLE, SIZE, OR COLOR.

FOR VISCOMETERS (U.S. CLS. 21, 23, 26, 36 AND 38). FIRST USE 10-0-2009; IN COMMERCE 10-0-2009.

3,785,959. VALOR COMMUNICATION, INC., CITY OF INDUSTRY, CA. SN 77-691,842. PUB. 7-14-2009, FILED 3-16-2009.

ASMYNA

THE MARK CONSISTS OF STANDARD CHARACTERS WITHOUT CLAIM TO ANY PARTICULAR FONT, STYLE, SIZE, OR COLOR.

FOR CELL PHONE ACCESSORIES, NAMELY, CELL PHONE BATTERIES, CELL PHONE BATTERY CHARGERS, HANDS FREE KITS, CELL PHONE CASE, CELL PHONE BACKPLATE AND FACE PLATE (U.S. CLS. 21, 23, 26, 36 AND 38).

FIRST USE 1-2-2010; IN COMMERCE 1-2-2010.

3,785,972. BRAD ROSS, NEW YORK, NY. SN 77-694,442. PUB. 7-21-2009, FILED 3-19-2009.

WHO'S NEW?

THE MARK CONSISTS OF STANDARD CHARACTERS WITHOUT CLAIM TO ANY PARTICULAR FONT, STYLE, SIZE, OR COLOR.

FOR INTERACTIVE MULTIMEDIA GAME PROGRAMS AND DOWNLOADABLE GAME SOFTWARE FOR INDIVIDUAL OR NETWORK USERS TO PLAY ON PHONES, COMPUTERS, SLOT MACHINES AND OTHER ELECTRONIC GAME FORMATS (U.S. CLS. 21, 23, 26, 36 AND 38).

FIRST USE 9-23-2009; IN COMMERCE 1-5-2010.

CLASS 9—(Continued).

3,785,984. KARSTEN MANUFACTURING CORPORATION, PHOENIX, AZ. SN 77-699,977. PUB. 6-30-2009, FILED 3-26-2009.

PLAY YOUR BEST

THE MARK CONSISTS OF STANDARD CHARACTERS WITHOUT CLAIM TO ANY PARTICULAR FONT, STYLE, SIZE, OR COLOR.

OWNER OF U.S. REG. NOS. 2,476,383, 2,853,525, AND 3,268,236.

FOR MESSENGER BAGS ESPECIALLY ADAPTED FOR HOLDING LAPTOP COMPUTERS (U.S. CLS. 21, 23, 26, 36 AND 38).

FIRST USE 9-2-2009; IN COMMERCE 9-2-2009.

CLASS 9—(Continued).

3,786,018. GATEWAY GAMING, PIEDMONT, SC. SN 77-716,350. PUB. 8-25-2009, FILED 4-17-2009.

PAYDIRT

THE MARK CONSISTS OF STANDARD CHARACTERS WITHOUT CLAIM TO ANY PARTICULAR FONT, STYLE, SIZE, OR COLOR.

FOR GAMING EQUIPMENT, NAMELY, GAMING MACHINES (U.S. CLS. 21, 23, 26, 36 AND 38).

FIRST USE 6-1-2007; IN COMMERCE 6-1-2007.

3,786,003. NOKIA CORPORATION, FI-02150 ESPOO, FINLAND. SN 77-708,682. PUB. 8-4-2009, FILED 4-7-2009.

SHADE

THE MARK CONSISTS OF STANDARD CHARACTERS WITHOUT CLAIM TO ANY PARTICULAR FONT, STYLE, SIZE, OR COLOR.

FOR MOBILE TELEPHONES; ACCESSORIES AND REPLACEMENT PARTS FOR MOBILE TELEPHONES, NAMELY, HEADSETS, AUDIO AND POWER ADAPTER CABLES, AUDIO SPEAKERS, BATTERIES, BATTERY CHARGERS, CAR CHARGERS FOR MOBILE TELEPHONES, CARRYING CASES FOR MOBILE TELEPHONES, DATA CABLES, GLOBAL POSITION SYSTEM MODULES, HOLDERS FOR MOBILE TELEPHONES AND STANDS FOR MOBILE TELEPHONES, MEMORY CARDS, POWER SUPPLIES, AND TELEPHONE CABLES; COMPONENT PARTS OF MOBILE TELEPHONES, NAMELY, ALARM CLOCKS, CALCULATORS, DIGITAL CAMERAS, ELECTRONIC ADDRESS BOOKS AND CALENDARS, FM RADIO TUNERS, ELECTRONIC FOREIGN CURRENCY CONVERTERS, GLOBAL POSITIONING SYSTEMS, MUSIC AND VIDEO PLAYERS, AND SOUND AND VIDEO RECORDERS (U.S. CLS. 21, 23, 26, 36 AND 38).

FIRST USE 10-1-2009; IN COMMERCE 10-1-2009.

3,786,040. OPENPEAK INC., BOCA RATON, FL. SN 77-728,529. PUB. 9-15-2009, FILED 5-4-2009.

PROFRAME

THE MARK CONSISTS OF STANDARD CHARACTERS WITHOUT CLAIM TO ANY PARTICULAR FONT, STYLE, SIZE, OR COLOR.

OWNER OF U.S. REG. NO. 3,655,407.

FOR TELEPHONE APPARATUS, NAMELY, A TELEPHONE AND A TELEPHONE SYSTEM COMPRISED OF A HANDSET AND A CONSOLE UNIT ENABLING USER-TO-USER COMMUNICATIONS, NAMELY, THE TRANSMISSION FOR VOICE, DATA, AND VIDEO COMMUNICATIONS OVER BOTH WIRE AND WIRELESS TELECOMMUNICATION NETWORKS (U.S. CLS. 21, 23, 26, 36 AND 38).

FIRST USE 11-1-2009; IN COMMERCE 11-1-2009.

CLASS 9—(Continued).

3,786,053. SILERGY CORP., GEORGE TOWN, G.C., CAYMAN ISLANDS. SN 77-733,707. PUB. 9-29-2009, FILED 5-11-2009.

SILERGY

THE MARK CONSISTS OF STANDARD CHARACTERS WITHOUT CLAIM TO ANY PARTICULAR FONT, STYLE, SIZE, OR COLOR.

FOR BATTERY POWER SUPPLIES FOR MEDICAL VENTILATORS; CHIP CARRIERS, NAMELY, SEMICONDUCTOR CHIP HOUSINGS; CONSUMER ELECTRONIC PRODUCTS, NAMELY, AUDIO AMPLIFIERS, AUDIO SPEAKERS, AUDIO RECEIVERS, ELECTRICAL AUDIO AND SPEAKER CABLES AND CONNECTORS, HOME THEATER SYSTEMS, AUDIO DECODERS, VIDEO DECODERS, SPEAKERS, POWER CONVERSION DEVICES, POWER CONVERTERS, AND POWER INVERTERS; DC/AC POWER CONVERTERS; ELECTRONIC CONTROLLERS FOR USE WITH POWER CONVERTERS; ELECTRONIC CONTROLLERS USED TO REDUCE POWER CONSUMPTION; ELECTRONIC POWER SUPPLIES FOR DRIVING ELECTRIC MOTORS; HIGH-FREQUENCY SWITCHING POWER SUPPLIES; LOW PASS INDUCTOR FILTER USED IN HIGH POWER ELECTRICAL APPLICATIONS; POWER AMPLIFIERS; POWER CONTROLLERS; POWER SUPPLIES; POWER SUPPLY CONNECTORS AND ADAPTORS FOR USE WITH PORTABLE ELECTRONIC DEVICES; POWER SWITCHES; POWER TRANSFORMERS FOR AMPLIFICATION; RENEWABLE BATTERY SYSTEM TO PROVIDE BACKUP POWER; SEMICONDUCTOR CHIPS; SEMICONDUCTOR DEVICES; SEMICONDUCTOR POWER ELEMENTS; SEMICONDUCTORS; TELECOMMUNICATIONS EQUIPMENT AND SOFTWARE, NAMELY, FIBER-OPTIC TRANSCEIVERS, FIBER OPTIC REPEATERS, CONVERTERS AND OPTIMIZERS, WAVE DIVISION MULTIPLEXERS, FREE-SPACE OPTICS TRANSMISSION SYSTEMS, SWITCHES INCLUDING ETHERNET SWITCHES AND ROUTERS, FIBER-TO-THE-HOME AND ETHERNET-OVER-VDSL ACCESS AGGREGATORS, TERMINATORS AND REPEATERS, AND REMOTE PRESENCE MANAGEMENT PRODUCTS, NAMELY, SWITCHES, AND CONSOLE, ALARM, SENSOR AND POWER MANAGEMENT DEVICES; VERY LARGE SCALE INTEGRATION (VLSI) SEMICONDUCTOR INTEGRATED CIRCUITS; VOLTAGE REGULATORS FOR ELECTRIC POWER; VOLTAGE STABILIZING POWER SUPPLY (U.S. CLS. 21, 23, 26, 36 AND 38).

FIRST USE 2-7-2008; IN COMMERCE 2-7-2008.

CLASS 9—(Continued).

3,786,073. RICHARD W. BROWN LLC, DBA SILICON VALLEY GLOBAL LLC, MONTE SERENO, CA. SN 77-744,744. PUB. 10-6-2009, FILED 5-26-2009.

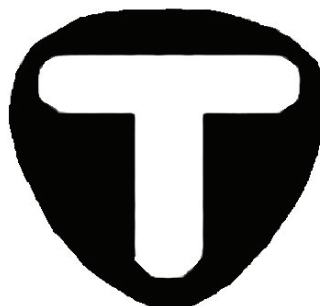

THE MARK CONSISTS OF THE LETTER "T" INSIDE A SHIELD-SHAPED STRUCTURE.

FOR MP3 PLAYERS; MEDIA PLAYERS; PORTABLE LISTENING DEVICES, NAMELY, MP3 PLAYERS; PORTABLE MEDIA PLAYERS; SPEAKERS FOR OUTPUTTING SOUND FROM A MEDIA PLAYER OR PORTABLE LISTENING DEVICE (U.S. CLS. 21, 23, 26, 36 AND 38).

FIRST USE 10-31-2009; IN COMMERCE 10-31-2009.

3,786,074. ELSON, DAVID, SANTA CLARA, CA. SN 77-744,809. PUB. 10-13-2009, FILED 5-26-2009.

GREATALPHA PRODUCTIONS

THE MARK CONSISTS OF STANDARD CHARACTERS WITHOUT CLAIM TO ANY PARTICULAR FONT, STYLE, SIZE, OR COLOR.

NO CLAIM IS MADE TO THE EXCLUSIVE RIGHT TO USE "PRODUCTIONS", APART FROM THE MARK AS SHOWN.

FOR A SERIES OF SOUND RECORDINGS EMBODIED ON PHONORECORDS, NAMELY, VINYL DISCS, CASSETTE TAPES, DIGITAL COMPACT DISCS, ENHANCED CDS, DVDS, VIDEO DISCS, AND DIGITAL MEDIA FILES, ALL FEATURING MUSIC ENTERTAINMENT (U.S. CLS. 21, 23, 26, 36 AND 38).

FIRST USE 9-21-2009; IN COMMERCE 9-21-2009.

CLASS 9—(Continued).

3,786,083. SOLIDFX, LLC, FOXBORO, MA. SN 77-748,911.
PUB. 10-20-2009, FILED 6-1-2009.

SOLIDFX

THE MARK CONSISTS OF STANDARD CHARACTERS WITHOUT CLAIM TO ANY PARTICULAR FONT, STYLE, SIZE, OR COLOR.

FOR PORTABLE ELECTRONIC DEVICE COMPRISING COMPUTER HARDWARE AND SOFTWARE FOR RECEIVING AND READING ELECTRONICALLY DISPLAYED TEXT AND IMAGES (U.S. CLS. 21, 23, 26, 36 AND 38).

FIRST USE 7-0-2009; IN COMMERCE 7-0-2009.



3,786,088. LUTRON ELECTRONICS CO., INC., COOPERSBURG, PA. SN 77-750,315. PUB. 10-20-2009, FILED 6-2-2009.

PICO

THE MARK CONSISTS OF STANDARD CHARACTERS WITHOUT CLAIM TO ANY PARTICULAR FONT, STYLE, SIZE, OR COLOR.

FOR ELECTRIC LIGHT DIMMERS (U.S. CLS. 21, 23, 26, 36 AND 38).

FIRST USE 1-8-2009; IN COMMERCE 5-7-2009.



3,786,091. SPIEGEL, MARGARET S., PORT WASHINGTON, NY. SN 77-752,241. PUB. 10-20-2009, FILED 6-4-2009.

stretcheeHeads

THE MARK CONSISTS OF STANDARD CHARACTERS WITHOUT CLAIM TO ANY PARTICULAR FONT, STYLE, SIZE, OR COLOR.

OWNER OF U.S. REG. NO. 2,820,315.
FOR MULTI-SPORT HELMET COVERS (U.S. CLS. 21, 23, 26, 36 AND 38).

FIRST USE 2-8-2010; IN COMMERCE 2-8-2010.

CLASS 9—(Continued).

3,786,097. N-TONIC, INC., PASADENA, CA. SN 77-754,371.
PUB. 10-20-2009, FILED 6-8-2009.

SNAGGLEFIND

THE MARK CONSISTS OF STANDARD CHARACTERS WITHOUT CLAIM TO ANY PARTICULAR FONT, STYLE, SIZE, OR COLOR.

FOR COMPUTER SOFTWARE TO ENABLE THE TRANSMISSION OF PHOTOGRAPHS TO MOBILE TELEPHONES; ELECTRONIC GAME SOFTWARE FOR WIRELESS DEVICES; GAME SOFTWARE (U.S. CLS. 21, 23, 26, 36 AND 38).

FIRST USE 1-25-2010; IN COMMERCE 1-25-2010.



3,786,099. ZHONGSHAN HIGHYES ELECTRONICS, CO., LTD., DBA KINGNEED, SHAXI ZHONGSHAN, CHINA. SN 77-754,974. PUB. 10-27-2009, FILED 6-9-2009.

NOWBIBLE

THE MARK CONSISTS OF STANDARD CHARACTERS WITHOUT CLAIM TO ANY PARTICULAR FONT, STYLE, SIZE, OR COLOR.

FOR PORTABLE HANDHELD DIGITAL ELECTRONIC DEVICES FOR ORGANIZING, TRANSMITTING, MANIPULATING, RECORDING, AND REVIEWING TEXT, DATA, AUDIO, AND VIDEO FILES OF DIFFERENT FORMATS; ELECTRONIC DEVICES, NAMELY, ELECTRONIC BIBLES IN THE FORM OF PERSONAL DIGITAL ASSISTANTS CONTAINING PRELOADED SOFTWARE FEATURING FULL VERSIONS OF THE HOLY BIBLE AND BIBLE STORIES IN TEXT, AUDIO, AND BOTH TEXT AND AUDIO; PORTABLE LISTENING AND VIEWING DEVICES, NAMELY, MP3, MP4, AND DIGITAL AUDIO AND VIDEO PLAYERS WITH AND WITHOUT EXTERNAL MEMORY CAPABILITIES; PRE-RECORDED AUDIO DISCS FEATURING FULL VERSIONS OF THE HOLY BIBLE AND BIBLE STORIES; COMPUTER HARDWARE AND COMPUTER SOFTWARE PROGRAMS FOR THE INTEGRATION OF TEXT, AUDIO, GRAPHICS, STILL IMAGES, AND VIDEO INTO INTERACTIVE MULTIMEDIA APPLICATIONS; AND CDS, DVDS, AND DOWNLOADABLE DIGITAL AUDIO AND VIDEO FILES FEATURING FULL VERSIONS OF THE HOLY BIBLE AND BIBLE STORIES (U.S. CLS. 21, 23, 26, 36 AND 38).

FIRST USE 8-31-2009; IN COMMERCE 8-31-2009.

CLASS 9—(Continued).

3,786,113. NEXT LEVEL SECURITY SYSTEMS, INC., CARLSBAD, CA. SN 77-758,939. PUB. 11-3-2009, FILED 6-12-2009.

Next Level Security Systems

THE MARK CONSISTS OF STANDARD CHARACTERS WITHOUT CLAIM TO ANY PARTICULAR FONT, STYLE, SIZE, OR COLOR.

NO CLAIM IS MADE TO THE EXCLUSIVE RIGHT TO USE "SECURITY SYSTEMS", APART FROM THE MARK AS SHOWN.

FOR BUILDING SECURITY SYSTEMS COMPRISING SOFTWARE AND HARDWARE FOR PROVIDING PICTURE, VIDEO, ALARM STATUS, BUILDING PLANS, AND OTHER INFORMATION TO A REMOTE STATION (U.S. CLS. 21, 23, 26, 36 AND 38).

FIRST USE 1-25-2010; IN COMMERCE 1-26-2010.

3,786,125. YUPAO CHEN, AKA DICK CHEN, SAN JOSE, CA. SN 77-761,158. PUB. 11-3-2009, FILED 6-16-2009.

AG2

THE MARK CONSISTS OF STANDARD CHARACTERS WITHOUT CLAIM TO ANY PARTICULAR FONT, STYLE, SIZE, OR COLOR.

FOR ANTI-GLARE FILTERS FOR TELEVISIONS AND COMPUTER MONITORS; CLEAR PROTECTIVE COVERS SPECIALLY ADAPTED FOR PERSONAL ELECTRONIC DEVICES (U.S. CLS. 21, 23, 26, 36 AND 38).

FIRST USE 11-1-2009; IN COMMERCE 11-1-2009.

CLASS 9—(Continued).

3,786,129. YINUGO, LLC, DBA YINUGO, LLC, SIMPSONVILLE, SC. SN 77-762,614. PUB. 11-10-2009, FILED 6-18-2009.

Yinugo

THE MARK CONSISTS OF STANDARD CHARACTERS WITHOUT CLAIM TO ANY PARTICULAR FONT, STYLE, SIZE, OR COLOR.

FOR ABDOMINAL BELT CONTAINING BUILT-IN SPEAKERS FOR PURPOSES OF TRANSMITTING MUSIC/SOUNDS/EDUCATIONAL MATERIAL TO A FETUS AND A BUILT-IN POCKETS IN WHICH TO CARRY AUDIO TRANSMITTERS; BAGS AND CASES SPECIALLY ADAPTED FOR HOLDING OR CARRYING PORTABLE TELEPHONES AND TELEPHONE EQUIPMENT AND ACCESSORIES; BATTERY CASES; BEEPER CARRYING CASES; CAMERA CASES; CARRYING CASES AND CONTAINERS FOR CONTACT LENSES; CARRYING CASES FOR CELL PHONES; CARRYING CASES FOR MOBILE COMPUTERS; CARRYING CASES FOR RADIO PAGERS; CARRYING CASES SPECIALLY ADAPTED FOR POCKET CALCULATORS AND CELL-PHONES; CASES FOR CHILDREN'S EYE GLASSES; CASES FOR CONTACT LENSES; CASES FOR DISKETTES AND COMPACT DISKS; CASES FOR ELECTRONIC DIARIES; CASES FOR MOBILE PHONES; CASES FOR PHOTOGRAPHIC APPARATUS; CASES FOR POCKET CALCULATORS; CASES FOR SPECTACLES AND SUNGLASSES; CASES FOR SPECTACLES, FOR PINCENEZ AND FOR CONTACT LENSES; CASES FOR TELEPHONES; CASINGS AND CASING PARTS FOR ELECTRICAL EQUIPMENT, NAMELY, HOUSING FOR SWITCHING APPARATUS; CD CASES; COMPACT DISC CASES; COMPUTER CARRYING CASES; CONTACT LENS CASES; DVD CASES; ENTRY/EXIT SECURITY PORTAL COMPRISED OF AN ELECTRONIC PASSAGEWAY EQUIPPED WITH BIOMETRIC DEVICES FOR IDENTIFICATION VERIFICATION AND DETECTION OF IMPERMISSIBLE ITEMS BEING CARRIED THROUGH; EYE GLASS CASES; EYEGLASS CASES; EYEWEAR CASES; LABELS CARRYING MAGNETICALLY, OPTICALLY, OR ELECTRONICALLY RECORDED OR ENCODED INFORMATION; LAPTOP CARRYING CASES; NOTEBOOK COMPUTER CARRYING CASES; PLASTIC AND CARDBOARD CASES FOR STORING RECORD ALBUMS; PLASTIC CASE USED AS A SECURITY DEVICE FOR PROTECTING AND SECURING DVDS AND OTHER MAGNETIC AND ELECTRONIC MEDIA FROM THEFT; PLASTIC CASES SPECIALLY ADAPTED HOLDING COMPACT DISCS, DVDS AND OTHER ELECTRONIC MEDIA; PROTECTIVE CARRYING CASES FOR PORTABLE MUSIC PLAYERS, NAMELY, MP3 PLAYERS; PROTECTIVE CARRYING CASES SPECIALLY ADAPTED FOR GLOBAL POSITIONING SYSTEM (GPS) APPARATUS; PROTECTIVE CARRYING CASES SPECIALLY ADAPTED FOR PERSONAL DIGITAL ASSISTANTS (PDA); PROTECTIVE CARRYING CASES SPECIALLY ADAPTED FOR VIDEO GAME CONSOLES FOR USE WITH AN EXTERNAL DISPLAY SCREEN OR MONITOR; PROTECTIVE COVERS AND CASES FOR CELL PHONES, LAPTOPS AND PORTABLE MEDIA PLAYERS; ROLLING CASES ESPECIALLY ADAPTED FOR HOLDING LAPTOPS AND NOTEBOOK COMPUTERS; SHIELD CASES FOR MAGNETIC DISKS; SPECIALTY HOLSTER FOR CARRYING EXTERNAL HARD DRIVES, MUSIC AND VIDEO PLAYERS, GPS SYSTEMS, CELL PHONES, PERSONAL DIGITAL ASSISTANTS, PAGERS OR ANY PORTABLE ELECTRONIC DEVICES; SPECTACLE CASES; SPECTACLES, FRAMES AND CASES; VIBRATING ALARM INCORPORATED INTO PLASTIC MEDICATION CASES SOLD EMPTY AS A REMINDER TO TAKE MEDICATION (U.S. CLS. 21, 23, 26, 36 AND 38).

FIRST USE 6-30-2009; IN COMMERCE 6-30-2009.

CLASS 9—(Continued).

3,786,132. MARY PULLIG SCHATZ M.D., NASHVILLE, TN.
SN 77-765,784. PUB. 11-10-2009, FILED 6-23-2009.

YOGAMD

THE MARK CONSISTS OF STANDARD CHARACTERS WITHOUT CLAIM TO ANY PARTICULAR FONT, STYLE, SIZE, OR COLOR.
FOR COMPUTER APPLICATION SOFTWARE FOR MOBILE PHONES (U.S. CLS. 21, 23, 26, 36 AND 38).
FIRST USE 12-30-2009; IN COMMERCE 12-30-2009.

3,786,133. MARY PULLIG SCHATZ M.D., NASHVILLE, TN.
SN 77-766,221. PUB. 11-10-2009, FILED 6-23-2009.

YOGALERT

THE MARK CONSISTS OF STANDARD CHARACTERS WITHOUT CLAIM TO ANY PARTICULAR FONT, STYLE, SIZE, OR COLOR.
FOR COMPUTER APPLICATION SOFTWARE FOR MOBILE PHONES (U.S. CLS. 21, 23, 26, 36 AND 38).
FIRST USE 12-30-2009; IN COMMERCE 12-30-2009.

3,786,140. ACCELL CORPORATION, FREMONT, CA. SN 77-769,802. PUB. 11-24-2009, FILED 6-28-2009.

AVGrip

THE MARK CONSISTS OF STANDARD CHARACTERS WITHOUT CLAIM TO ANY PARTICULAR FONT, STYLE, SIZE, OR COLOR.
FOR CABLE CONNECTORS; CABLES AND FIBRES FOR THE TRANSMISSION OF SOUNDS AND IMAGES (U.S. CLS. 21, 23, 26, 36 AND 38).
FIRST USE 7-29-2009; IN COMMERCE 9-23-2009.

CLASS 9—(Continued).

3,786,147. CONTRACTORS REGISTER, INC., JEFFERSON VALLEY, NY. SN 77-773,415. PUB. 11-24-2009, FILED 7-2-2009.

SYNCWARE

THE MARK CONSISTS OF STANDARD CHARACTERS WITHOUT CLAIM TO ANY PARTICULAR FONT, STYLE, SIZE, OR COLOR.
FOR SOFTWARE AND DOWNLOADABLE SOFTWARE FOR USE BY ARCHITECTS, ENGINEERS, CONTRACTORS, DEVELOPERS AND OTHER DESIGN AND BUILD PROFESSIONALS IN FACILITATING ONLINE COMMUNICATIONS AND SHARING DESIGN AND CONSTRUCTION DOCUMENTS AND FILES, IN THE FIELD OF RESIDENTIAL AND COMMERCIAL DESIGN AND CONSTRUCTION (U.S. CLS. 21, 23, 26, 36 AND 38).
FIRST USE 8-0-2009; IN COMMERCE 8-0-2009.

3,786,150. RED.COM, INC., LAKE FOREST, CA. SN 77-775,015. PUB. 12-1-2009, FILED 7-6-2009.

REDUNDEAD

THE MARK CONSISTS OF STANDARD CHARACTERS WITHOUT CLAIM TO ANY PARTICULAR FONT, STYLE, SIZE, OR COLOR.
FOR COMPUTER SOFTWARE FOR THE RECOVERY OF COMPUTER DATA (U.S. CLS. 21, 23, 26, 36 AND 38).
FIRST USE 6-24-2009; IN COMMERCE 6-24-2009.

3,786,153. SUNNY MERCHANDISE CORP., VERNON, CA. SN 77-781,078. PUB. 12-1-2009, FILED 7-14-2009.

LOUIS·V

THE MARK CONSISTS OF STANDARD CHARACTERS WITHOUT CLAIM TO ANY PARTICULAR FONT, STYLE, SIZE, OR COLOR.
FOR CASES FOR SPECTACLES AND SUNGLASSES; EYEWEAR; OPTICAL FRAMES; READING GLASSES; SKI GOGGLES; SUNGLASSES (U.S. CLS. 21, 23, 26, 36 AND 38).
FIRST USE 1-4-2010; IN COMMERCE 1-4-2010.

CLASS 9—(Continued).

3,786,164. AUDYSSEY LABORATORIES, INC., LOS ANGELES, CA. SN 77-978,352. PUB. 11-25-2008, FILED 6-6-2007.

AUDYSSEY EQUALIZED

THE MARK CONSISTS OF STANDARD CHARACTERS WITHOUT CLAIM TO ANY PARTICULAR FONT, STYLE, SIZE, OR COLOR.

OWNER OF U.S. REG. NO. 1,702,989.

NO CLAIM IS MADE TO THE EXCLUSIVE RIGHT TO USE "EQUALIZED", APART FROM THE MARK AS SHOWN.

FOR SOFTWARE FOR ACOUSTIC CORRECTION, NAMELY, SOFTWARE TO CONTROL AND IMPROVE AUDIO EQUIPMENT SOUND QUALITY; CD PLAYERS; AM/FM RADIOS; DIGITAL MUSIC PLAYERS (U.S. CLS. 21, 23, 26, 36 AND 38).

FIRST USE 7-9-2007; IN COMMERCE 10-12-2007.

3,786,165. GRACIE, RORION, SANTA BARBARA, CA. SN 77-978,575. PUB. 3-24-2009, FILED 2-7-2007.

THE GRACIE CHALLENGE

THE MARK CONSISTS OF STANDARD CHARACTERS WITHOUT CLAIM TO ANY PARTICULAR FONT, STYLE, SIZE, OR COLOR.

OWNER OF U.S. REG. NOS. 1,570,322, 2,997,282, AND OTHERS.

FOR PRERECORDED DVD'S FEATURING ENTERTAINMENT, INSTRUCTIONAL AND TRAINING PROGRAMS IN THE ART OF JIU-JITSU, MARTIAL ARTS, NON-LETHAL MARTIAL ARTS TECHNIQUES, SELF-DEFENSE, ATTACK PREVENTION, SEXUAL ASSAULT PREVENTION, PHYSICAL ATTACK ESCAPE TECHNIQUES, PERSONAL SAFETY, PHYSICAL EXERCISE AND EDUCATION, AND PHYSICAL FITNESS (U.S. CLS. 21, 23, 26, 36 AND 38).

FIRST USE 4-15-2009; IN COMMERCE 4-15-2009.

3,786,172. DISNEY ENTERPRISES, INC., BURBANK, CA. SN 77-978,849. PUB. 4-21-2009, FILED 10-12-2007.

CAMP ROCK

THE MARK CONSISTS OF STANDARD CHARACTERS WITHOUT CLAIM TO ANY PARTICULAR FONT, STYLE, SIZE, OR COLOR.

OWNER OF U.S. REG. NO. 3,577,426.

CLASS 9—(Continued).

SEC. 2(F).

FOR AUDIO AND VISUAL RECORDINGS FEATURING LIVE ACTION ENTERTAINMENT FOR CHILDREN, TELEVISION SHOWS, MUSIC, STORIES, GAMES, AND ACTIVITIES IN THE NATURE OF ENTERTAINMENT FOR CHILDREN; VIDEO GAME DISCS AND SOFTWARE FEATURING MUSIC, GAMES, AND ACTIVITIES FOR CHILDREN; CONSUMER ELECTRONICS, NAMELY, MP3 PLAYERS AND PERSONAL STEREOS; SUNGLASSES (U.S. CLS. 21, 23, 26, 36 AND 38).

FIRST USE 12-28-2009; IN COMMERCE 12-28-2009.

3,786,195. BOLAÑOS, ROBERTO GOMEZ, MEXICO, D.F., MEXICO. SN 77-979,065. PUB. 11-4-2008, FILED 3-27-2008.



THE COLOR(S) YELLOW, BROWN, ORANGE AND BLACK IS/ARE CLAIMED AS A FEATURE OF THE MARK.

THE MARK CONSISTS OF THE COLOR YELLOW APPEARS IN THE WORDING "EL CHAVO". THE COLOR BROWN OUTLINES THIS WORDING. THE COLOR ORANGE APPEARS AS THE BACKGROUND FOR THE YELLOW AND BROWN WORDING. THE COLOR BLACK APPEARS AS SHADING ON THE RIGHT HAND SIDE OF THE MARK.

THE FOREIGN WORDING IN THE MARK TRANSLATES INTO ENGLISH AS "THE BOY".

FOR KARAOKE PLAYERS, RADIOS, RADIOS INCORPORATING CLOCKS, DVD'S FEATURING TELEVISION SHOWS AND MOVIES FOR CHILDREN'S ENTERTAINMENT, DVD PLAYERS, TELEVISIONS, TELEPHONES, PREPAID TELEPHONE CALLING CARDS, MAGNETICALLY ENCODED, DIGITAL CAMERAS, MP3 AND MP4 PLAYERS, MP3 AND MP4 RECORDINGS FEATURING TELEVISION SHOWS AND MOVIES FOR CHILDREN'S ENTERTAINMENT, CHILDREN'S VIDEO TAPES, COMPUTER PROGRAMS FOR VIDEO AND COMPUTER GAMES, DIGITAL MEDIA, NAMELY, PRE-RECORDED VIDEO CASSETTES, DIGITAL VIDEO DISCS, DIGITAL VERSATILE DISCS, DOWNLOADABLE AUDIO AND VIDEO RECORDINGS, AND HIGH DEFINITION DIGITAL DISKS FEATURING TELEVISION SHOWS AND MOVIES FOR FAMILY ENTERTAINMENT, PRE-RECORDED CDS, VIDEO TAPES, LASER DISKS AND DVDS FEATURING ANIMATION (U.S. CLS. 21, 23, 26, 36 AND 38).

FIRST USE 10-21-2006; IN COMMERCE 5-24-2008.

CLASS 9—(Continued).

3,786,212. CAMBRIDGE SILICON RADIO LIMITED, CAMBRIDGE CB40WH, UNITED KINGDOM. SN 78-334,453. PUB. 9-19-2006, FILED 12-1-2003.

CLASS 9—(Continued).

3,786,239. ATTAP TECHNOLOGIES, INC., NEW YORK, NY. SN 78-695,506. PUB. 11-28-2006, FILED 8-18-2005.

Plug-n-Go

LIFEIO

THE MARK CONSISTS OF STANDARD CHARACTERS WITHOUT CLAIM TO ANY PARTICULAR FONT, STYLE, SIZE, OR COLOR.

FOR SEMI-CONDUCTOR CHIPS AND CHIP SETS COMPRISING A PLURALITY OF SEMICONDUCTOR CHIPS (U.S. CLS. 21, 23, 26, 36 AND 38). FIRST USE 11-19-2003; IN COMMERCE 10-28-2004.

THE MARK CONSISTS OF STANDARD CHARACTERS WITHOUT CLAIM TO ANY PARTICULAR FONT, STYLE, SIZE, OR COLOR.

FOR COMPUTER SOFTWARE FOR ORGANIZING PERSONAL INFORMATION, BRAND PREFERENCES, AND PAST PURCHASE INFORMATION ON CUSTOMERS FOR RETAIL STORES AND COMPUTER ECOMMERCE SOFTWARE THAT ALLOWS USERS TO PERFORM ELECTRONIC BUSINESS TRANSACTIONS VIA A GLOBAL COMPUTER NETWORK (U.S. CLS. 21, 23, 26, 36 AND 38). FIRST USE 8-0-2004; IN COMMERCE 1-0-2005.

3,786,233. AMPHENOL-TUCHEL ELECTRONICS GMBH, HEILBRONN 74080, FED REP GERMANY. SN 78-671,628. PUB. 4-14-2009, FILED 7-15-2005.

3,786,246. ROCKWELL COLLINS SIMULATION AND TRAINING SOLUTIONS LLC, CEDAR RAPIDS, IA. SN 78-714,971. PUB. 12-12-2006, FILED 9-16-2005.

eco|mate

ENVIRONMENT CREATION TOOL

PRIORITY CLAIMED UNDER SEC. 44(D) ON FED REP GERMANY APPLICATION NO. 30501819.1/0, FILED 1-17-2005, REG. NO. 30501819, DATED 2-22-2005, EXPIRES 1-31-2015.

FOR ELECTRIC COUPLINGS; ELECTRIC COUPLERS FOR DATA PROCESSING DEVICES; ELECTRIC PLUGS, ELECTRIC SOCKETS AND OTHER CONTACTS FOR ELECTRIC CONNECTORS; MICROPROCESSORS; CONNECTORS FOR ELECTRIC LINES; ELECTRICAL CABLES FOR USE IN CONNECTIONS; ELECTRIC SWITCHES; ENCODED ELECTRONIC TAGS FOR USE IN THE FIELD OF PASSIVE LABELING, TRACING OR TRACKING OF GOODS (U.S. CLS. 21, 23, 26, 36 AND 38). FIRST USE 1-9-2008; IN COMMERCE 1-9-2008.

THE MARK CONSISTS OF STANDARD CHARACTERS WITHOUT CLAIM TO ANY PARTICULAR FONT, STYLE, SIZE, OR COLOR.

NO CLAIM IS MADE TO THE EXCLUSIVE RIGHT TO USE "CREATION TOOL", APART FROM THE MARK AS SHOWN.

FOR COMPUTER MODELING DEVICE COMPRISING COMPUTER HARDWARE AND SOFTWARE, FOR THE CREATION, MODIFICATION, AND VERIFICATION OF VISUAL DATABASES (U.S. CLS. 21, 23, 26, 36 AND 38). FIRST USE 3-8-2010; IN COMMERCE 3-8-2010.

CLASS 9—(Continued).

3,786,275. CARL ZEISS AG, OBERKOCHEN, FED REP GERMANY. SN 78-843,125. PUB. 3-31-2009, FILED 3-22-2006.

π WEB

FOR DATA MANAGEMENT SOFTWARE USED TO ANALYZE, EVALUATE, MONITOR, RECORD AND GRAPHICALLY DISPLAY ALL TYPES OF QUALITY AND PROCESS DATA FROM PRODUCTION SITES, AROUND THE WORLD, IN THE TECHNICAL, ELECTRONIC, PLASTIC, FOOD, AUTOMOTIVE AND OTHER INDUSTRIES (U.S. CLS. 21, 23, 26, 36 AND 38).

FIRST USE 8-0-2009; IN COMMERCE 8-0-2009.

3,786,286. IGT, RENO, NV. SN 78-857,519. PUB. 11-28-2006, FILED 4-10-2006.

ANCIENT GOLD

THE MARK CONSISTS OF STANDARD CHARACTERS WITHOUT CLAIM TO ANY PARTICULAR FONT, STYLE, SIZE, OR COLOR.

FOR GAMING MACHINES, NAMELY, DEVICES WHICH ACCEPT A WAGER (U.S. CLS. 21, 23, 26, 36 AND 38).

FIRST USE 11-8-2005; IN COMMERCE 11-8-2005.

3,786,290. STRIX SYSTEMS, INC., NEWBURY PARK, CA. SN 78-860,446. PUB. 11-28-2006, FILED 4-12-2006.

Strix DMA

THE MARK CONSISTS OF STANDARD CHARACTERS WITHOUT CLAIM TO ANY PARTICULAR FONT, STYLE, SIZE, OR COLOR.

OWNER OF U.S. REG. NOS. 2,835,797, 2,987,369, AND 3,090,988.

FOR COMPUTER HARDWARE AND SOFTWARE ENABLING WIRELESS ACCESS TO A COMPUTER-BASED INFORMATION NETWORK; COMPUTER HARDWARE FOR USE IN A WIRELESS NETWORK; COMPUTER SOFTWARE FOR USE IN CREATING, MAINTAINING AND MANAGING A WIRELESS NETWORK (U.S. CLS. 21, 23, 26, 36 AND 38).

FIRST USE 4-17-2006; IN COMMERCE 4-17-2006.

CLASS 9—(Continued).

3,786,291. STRIX SYSTEMS, INC., NEWBURY PARK, CA. SN 78-860,447. PUB. 11-28-2006, FILED 4-12-2006.

Strix HPMA

THE MARK CONSISTS OF STANDARD CHARACTERS WITHOUT CLAIM TO ANY PARTICULAR FONT, STYLE, SIZE, OR COLOR.

OWNER OF U.S. REG. NOS. 2,835,797, 2,987,369, AND 3,090,988.

FOR COMPUTER HARDWARE AND SOFTWARE ENABLING WIRELESS ACCESS TO A COMPUTER-BASED INFORMATION NETWORK; COMPUTER HARDWARE FOR USE IN A WIRELESS NETWORK; COMPUTER SOFTWARE FOR USE IN CREATING, MAINTAINING AND MANAGING A WIRELESS NETWORK (U.S. CLS. 21, 23, 26, 36 AND 38).

FIRST USE 4-17-2006; IN COMMERCE 4-17-2006.

3,786,292. STRIX SYSTEMS, INC., NEWBURY PARK, CA. SN 78-860,448. PUB. 11-28-2006, FILED 4-12-2006.

Strix SMFR

THE MARK CONSISTS OF STANDARD CHARACTERS WITHOUT CLAIM TO ANY PARTICULAR FONT, STYLE, SIZE, OR COLOR.

OWNER OF U.S. REG. NOS. 2,835,797, 2,987,369, AND 3,090,988.

FOR COMPUTER HARDWARE AND SOFTWARE ENABLING WIRELESS ACCESS TO A COMPUTER-BASED INFORMATION NETWORK; COMPUTER HARDWARE FOR USE IN A WIRELESS NETWORK; COMPUTER SOFTWARE FOR USE IN CREATING, MAINTAINING AND MANAGING A WIRELESS NETWORK (U.S. CLS. 21, 23, 26, 36 AND 38).

FIRST USE 4-17-2006; IN COMMERCE 4-17-2006.

3,786,297. CLEVER DEVICES LTD., PLAINVIEW, NY. SN 78-881,397. PUB. 12-19-2006, FILED 5-11-2006.

CLEVER DEVICES

THE MARK CONSISTS OF STANDARD CHARACTERS WITHOUT CLAIM TO ANY PARTICULAR FONT, STYLE, SIZE, OR COLOR.

CLASS 9—(Continued).

NO CLAIM IS MADE TO THE EXCLUSIVE RIGHT TO USE "DEVICES", APART FROM THE MARK AS SHOWN.

FOR COMPUTER HARDWARE AND APPLICATION SOFTWARE FOR USE IN DISPATCHING, ROUTING, SCHEDULING, ON-TIME PERFORMANCE REPORTING, LOCATION TRACKING, VEHICLE INSPECTION MONITORING, OPERATOR/DRIVER PERFORMANCE AND BEHAVIOR MONITORING, WORK STATUS REPORTING, COMMUNICATIONS, UPLOADING AND DOWNLOADING OF DATA BETWEEN SERVER AND REMOTE UNITS, AND MANAGEMENT REPORTING IN THE FIELD OF MASS TRANSIT SYSTEMS (U.S. CLS. 21, 23, 26, 36 AND 38).

FIRST USE 0-0-1997; IN COMMERCE 0-0-1997.

3,786,314. UMG RECORDINGS, INC., SANTA MONICA, CA. SN 78-912,374. PUB. 7-3-2007, FILED 6-20-2006.

A&M RECORDS

THE MARK CONSISTS OF STANDARD CHARACTERS WITHOUT CLAIM TO ANY PARTICULAR FONT, STYLE, SIZE, OR COLOR.

OWNER OF U.S. REG. NO. 838,810.

NO CLAIM IS MADE TO THE EXCLUSIVE RIGHT TO USE "RECORDS", APART FROM THE MARK AS SHOWN.

FOR PRE-RECORDED AUDIO TAPES, DISCS AND CASSETTES, VIDEO TAPES, DISCS AND CASSETTES, DIGITAL AUDIO AND AUDIO VIDEO TAPES AND DISCS, CDS, DVDS, LASER DISCS, AND PHONOGRAPH RECORDS FEATURING MUSIC AND ENTERTAINMENT; THEATRICAL AND MUSICAL SOUND AND VIDEO RECORDINGS; VIRTUAL REALITY GAME SOFTWARE; DOWNLOADABLE RING TONES, MUSIC, MP3S, GRAPHICS, GAMES, IMAGES AND VIDEOS FOR WIRELESS COMMUNICATION DEVICES; COMPUTER GAME SOFTWARE, TAPES, CARTRIDGES AND CASSETTES; VIDEO GAME SOFTWARE, TAPES, CARTRIDGES AND CASSETTES (U.S. CLS. 21, 23, 26, 36 AND 38).

FIRST USE 9-1-1962; IN COMMERCE 9-1-1962.

3,786,326. APPLANIX CORPORATION, RICHMOND HILL, ONTARIO, CANADA. SN 78-944,913. PUB. 8-26-2008, FILED 8-4-2006.

GEOIMAGE

THE MARK CONSISTS OF STANDARD CHARACTERS WITHOUT CLAIM TO ANY PARTICULAR FONT, STYLE, SIZE, OR COLOR.

CLASS 9—(Continued).

PRIORITY CLAIMED UNDER SEC. 44(D) ON CANADA APPLICATION NO. 1311803, FILED 8-4-2006.

FOR COMPUTER SOFTWARE FOR USE IN OPERATION OF AN AERIAL 360° DODECAHEDRON CAMERA SYSTEM, COMPUTER SOFTWARE FOR USE IN GEOREFERENCING, NAMELY, THE UTILIZATION OF GEOREFERENCE INFORMATION AND GPS SIGNALS TO DETERMINE THE POSITION AND ORIENTATION OF A STATIONARY OR MOVING OBJECT OR VEHICLE ON THE EARTH'S SURFACE, AND COMPUTER SOFTWARE FOR USE IN THE CALIBRATION AND INTEGRATION OF LAND AND AIRBORNE IMAGERY, UTILIZING POSITION AND ORIENTATION ESTIMATION AND PHOTOGRAMMETRY, LIDAR, HYPER AND MULTI-SPECTRAL IMAGERY (U.S. CLS. 21, 23, 26, 36 AND 38).

FIRST USE 12-10-2008; IN COMMERCE 12-10-2008.

3,786,327. TELETRACKING TECHNOLOGIES, INC., PITTSBURGH, PA. SN 78-946,064. PUB. 4-1-2008, FILED 8-7-2006.

BEDTRACKING MOBILE

THE MARK CONSISTS OF STANDARD CHARACTERS WITHOUT CLAIM TO ANY PARTICULAR FONT, STYLE, SIZE, OR COLOR.

OWNER OF U.S. REG. NO. 1,860,092.

NO CLAIM IS MADE TO THE EXCLUSIVE RIGHT TO USE "MOBILE", APART FROM THE MARK AS SHOWN.

FOR COMPUTER SOFTWARE IN THE FORM OF A COMPUTER INTERFACE FOR PROVIDING PATIENT TURNOVER INFORMATION TO HOSPITALS (U.S. CLS. 21, 23, 26, 36 AND 38).

FIRST USE 1-31-2006; IN COMMERCE 5-31-2006.

3,786,331. IBIS BIOSCIENCES, INC., CARLSBAD, CA. SN 78-951,835. PUB. 6-19-2007, FILED 8-14-2006.

T5000

THE MARK CONSISTS OF STANDARD CHARACTERS WITHOUT CLAIM TO ANY PARTICULAR FONT, STYLE, SIZE, OR COLOR.

FOR SCIENTIFIC APPARATUS AND INSTRUMENTS, NAMELY, LABORATORY APPARATUS AND INSTRUMENTS, NAMELY, SEQUENCERS, SPECTROMETERS, SENSORS AND COMPUTERS, FOR ANALYSIS OF NUCLEIC ACID SEQUENCES, NUCLEIC ACIDS, GENETIC MATERIALS, INFECTIOUS AGENTS AND/OR PATHOGENS; LABORATORY APPARATUS AND INSTRUMENTS FOR IDENTIFICATION OF NUCLEIC ACID SEQUENCES, NUCLEIC ACIDS, GENETIC MATERIALS, INFECTIOUS AGENTS AND/OR PATHOGENS; SENSORS FOR ANALYSIS OF NUCLEIC ACID SEQUENCES, NUCLEIC ACIDS, GENETIC MATERIALS, INFECTIOUS AGENTS AND/OR PATHOGENS; SENSORS FOR IDENTIFICATION OF NUCLEIC ACID SEQUENCES, NUCLEIC ACIDS, GENETIC MATERIALS, INFECTIOUS AGENTS AND/OR PATHOGENS; BIOSENSOR SYSTEMS CONSISTING OF SENSORS AND IN-

CLASS 9—(Continued).

STRUMENTS FOR ANALYSIS OF NUCLEIC ACID SEQUENCES, NUCLEIC ACIDS, GENETIC MATERIALS, INFECTIOUS AGENTS AND/OR PATHOGENS, AND PARTS THEREFOR; BIOSENSOR SYSTEMS CONSISTING OF SENSORS AND INSTRUMENTS FOR IDENTIFICATION OF NUCLEIC ACID SEQUENCES, NUCLEIC ACIDS, GENETIC MATERIALS, INFECTIOUS AGENTS AND/OR PATHOGENS, AND PARTS THEREFOR; TEST AND COLLECTION KITS CONSISTING OF COLLECTION APPARATUS AND LABORATORY DEVICES, NAMELY, CONTAINERS, WELLS, PLATES AND WELL PLATES, FOR ANALYSIS OF NUCLEIC ACID SEQUENCES, NUCLEIC ACIDS, GENETIC MATERIALS, INFECTIOUS AGENTS AND/OR PATHOGENS; TEST AND COLLECTION KITS COMPOSED OF COLLECTION APPARATUS AND LABORATORY DEVICES, NAMELY, CONTAINERS, WELLS, PLATES AND WELL PLATES, FOR IDENTIFICATION OF NUCLEIC ACID SEQUENCES, NUCLEIC ACIDS, GENETIC MATERIALS, INFECTIOUS AGENTS AND/OR PATHOGENS; COMPUTER SOFTWARE AND HARDWARE FOR ANALYSIS OF NUCLEIC ACID SEQUENCES, NUCLEIC ACIDS, GENETIC MATERIALS, INFECTIOUS AGENTS AND/OR PATHOGENS; COMPUTER SOFTWARE AND HARDWARE FOR IDENTIFICATION OF NUCLEIC ACID SEQUENCES, NUCLEIC ACIDS, GENETIC MATERIALS, INFECTIOUS AGENTS AND/OR PATHOGENS (U.S. CLS. 21, 23, 26, 36 AND 38).

FIRST USE 11-30-2006; IN COMMERCE 9-30-2007.

3,786,338. AZTEK NETWORKS, INC., BOULDER, CO. SN 78-974,187. PUB. 6-2-2009, FILED 9-14-2006.

aztek 
NETWORKS

NO CLAIM IS MADE TO THE EXCLUSIVE RIGHT TO USE "NETWORKS", APART FROM THE MARK AS SHOWN.

FOR COMPUTER HARDWARE AND SOFTWARE FOR ENABLING VOICE OVER INTERNET PROTOCOL (VOIP), IP MULTIMEDIA SUBSYSTEM (IMS) AND EMERGENCY CALL SERVICES IN THE FIELD OF TELECOMMUNICATIONS; AUTOMATIC SWITCHING DEVICES FOR TELECOMMUNICATIONS (U.S. CLS. 21, 23, 26, 36 AND 38).

FIRST USE 11-30-2006; IN COMMERCE 6-20-2007.

CLASS 10—MEDICAL APPARATUS

3,785,181. DESIGNS FOR VISION, INC., RONKONKOMA, NY. SN 77-213,767. PUB. 12-2-2008, FILED 6-22-2007.

TWIN BEAM

THE MARK CONSISTS OF STANDARD CHARACTERS WITHOUT CLAIM TO ANY PARTICULAR FONT, STYLE, SIZE, OR COLOR.

CLASS 10—(Continued).

NO CLAIM IS MADE TO THE EXCLUSIVE RIGHT TO USE "BEAM", APART FROM THE MARK AS SHOWN.

FOR HEADLIGHTS FOR DENTAL AND SURGICAL USE (U.S. CLS. 26, 39 AND 44).

FIRST USE 9-16-2007; IN COMMERCE 1-17-2008.

3,785,187. SMITHS MEDICAL INTERNATIONAL LIMITED, ASHFORD, KENT, UNITED KINGDOM. SN 77-232,750. PUB. 2-5-2008, FILED 7-18-2007.

UniPerc

THE MARK CONSISTS OF STANDARD CHARACTERS WITHOUT CLAIM TO ANY PARTICULAR FONT, STYLE, SIZE, OR COLOR.

FOR TRACHEOSTOMY TUBE AND TRACHEOSTOMY KITS COMPRISING TUBE, DILATOR, INTRODUCER, GUIDEWIRE AND FORCEPS (U.S. CLS. 26, 39 AND 44).

FIRST USE 2-3-2010; IN COMMERCE 2-3-2010.

3,785,218. BAXTER INTERNATIONAL INC., DEERFIELD, IL. SN 77-291,872. PUB. 1-6-2009, FILED 9-28-2007.

VITALSHIELD

THE MARK CONSISTS OF STANDARD CHARACTERS WITHOUT CLAIM TO ANY PARTICULAR FONT, STYLE, SIZE, OR COLOR.

FOR ANTIMICROBIAL COATING FOR COMPONENTS USED FOR INFUSION THERAPY, SOLD APPLIED TO INFUSION THERAPY DEVICES FOR ADMINISTERING MEDICATIONS AND INTRAVENOUS FLUIDS (U.S. CLS. 26, 39 AND 44).

FIRST USE 2-22-2008; IN COMMERCE 2-22-2008.

3,785,259. MEDILAB RESEARCH + TRADING GMBH & CO., ESTENFELD, FED REP GERMANY. SN 77-340,434. PUB. 10-14-2008, FILED 11-29-2007.

POWER SKIN

THE MARK CONSISTS OF STANDARD CHARACTERS WITHOUT CLAIM TO ANY PARTICULAR FONT, STYLE, SIZE, OR COLOR.

CLASS 10—(Continued).

NO CLAIM IS MADE TO THE EXCLUSIVE RIGHT TO USE "SKIN", APART FROM THE MARK AS SHOWN.

FOR APPARATUS AND INSTRUMENTS FOR COSMETIC AND MEDICAL TREATMENTS, NAMELY, THERAPEUTIC APPARATUS AND PROBES FOR APPLYING CONTROLLED LEVELS OF ENERGY STIMULUS TO THE BODY FOR MEDICAL AND AESTHETIC SKIN TREATMENTS (U.S. CLS. 26, 39 AND 44).

FIRST USE 3-0-2008; IN COMMERCE 3-0-2008.

3,785,282. THERMOGENESIS CORPORATION, RANCHO CORDOVA, CA. SN 77-367,000. PUB. 5-20-2008, FILED 1-8-2008.

MARROWXPRESS

THE MARK CONSISTS OF STANDARD CHARACTERS WITHOUT CLAIM TO ANY PARTICULAR FONT, STYLE, SIZE, OR COLOR.

FOR MEDICAL DEVICES AND EQUIPMENT, NAMELY, A DEVICE TO HARVEST CELLS FROM BLOOD OR BONE MARROW (U.S. CLS. 26, 39 AND 44).

FIRST USE 3-0-2008; IN COMMERCE 3-0-2008.

3,785,351. DANZEY, W. PATRICK, AVON PARK, FL. SN 77-415,772. PUB. 7-29-2008, FILED 3-7-2008.

AXIAL TRAC

THE MARK CONSISTS OF STANDARD CHARACTERS WITHOUT CLAIM TO ANY PARTICULAR FONT, STYLE, SIZE, OR COLOR.

FOR PATIENT TREATMENT TABLES (U.S. CLS. 26, 39 AND 44).

FIRST USE 11-24-2009; IN COMMERCE 11-24-2009.

3,785,475. PERLSTEIN, ELIZABETH, HUNTINGTON, NY. SN 77-503,721. PUB. 6-2-2009, FILED 6-20-2008.

JETT STEP

THE MARK CONSISTS OF STANDARD CHARACTERS WITHOUT CLAIM TO ANY PARTICULAR FONT, STYLE, SIZE, OR COLOR.

CLASS 10—(Continued).

NO CLAIM IS MADE TO THE EXCLUSIVE RIGHT TO USE "STEP", APART FROM THE MARK AS SHOWN.

FOR FOOT REST FOR MEDICAL OR THERAPEUTIC PURPOSES, NAMELY, A FOOT REST FOR ADAPTING TO A FOUR-LEGGED CHAIR TO PROVIDE OR ASSIST A SPECIAL-NEEDS CHILD OR OTHER INDIVIDUAL THAT SITS IN THE FOUR-LEGGED CHAIR WITH SUPPORT FOR THEIR FEET WITHOUT THE SPECIAL-NEEDS CHILD OR OTHER INDIVIDUAL BEING ABLE TO KICK THE FOOT REST AWAY FROM THE FOUR-LEGGED CHAIR SO AS TO IMPROVE OF THE POSTURE AND ATTENTION SPAN OF THE SPECIAL-NEEDS CHILD OR OTHER INDIVIDUAL, THAT MIGHT OTHERWISE BE CAUSED OR AGGRAVATED BY THE FEET OF THE SPECIAL-NEEDS CHILD OR OTHER INDIVIDUAL BEING UNSUPPORTED (U.S. CLS. 26, 39 AND 44).

FIRST USE 1-16-2009; IN COMMERCE 1-16-2009.

3,785,477. XYLOS CORPORATION, LANGHORNE, PA. SN 77-503,994. PUB. 7-7-2009, FILED 6-20-2008.

MTA

THE MARK CONSISTS OF STANDARD CHARACTERS WITHOUT CLAIM TO ANY PARTICULAR FONT, STYLE, SIZE, OR COLOR.

FOR SURGICAL IMPLANTABLE DEVICES, NAMELY, SURGICAL IMPLANTS COMPRISING ARTIFICIAL MATERIAL, EXCLUDING DENTAL IMPLANTS (U.S. CLS. 26, 39 AND 44).

FIRST USE 1-25-2010; IN COMMERCE 1-25-2010.

3,785,478. XYLOS CORPORATION, LANGHORNE, PA. SN 77-504,006. PUB. 11-11-2008, FILED 6-20-2008.

SECURIAN

THE MARK CONSISTS OF STANDARD CHARACTERS WITHOUT CLAIM TO ANY PARTICULAR FONT, STYLE, SIZE, OR COLOR.

FOR SURGICAL IMPLANTABLE DEVICES, NAMELY, SURGICAL IMPLANTS COMPRISING ARTIFICIAL MATERIAL (U.S. CLS. 26, 39 AND 44).

FIRST USE 1-25-2010; IN COMMERCE 1-25-2010.

CLASS 10—(Continued).

3,785,557. MERLYN ASSOCIATES, INC., TUSTIN, CA. SN 77-533,590. PUB. 10-20-2009, FILED 7-29-2008.

MERLYN MEDICAL

THE MARK CONSISTS OF STANDARD CHARACTERS WITHOUT CLAIM TO ANY PARTICULAR FONT, STYLE, SIZE, OR COLOR.

NO CLAIM IS MADE TO THE EXCLUSIVE RIGHT TO USE "MEDICAL", APART FROM THE MARK AS SHOWN. FOR RESPIRATORY MASKS FOR MEDICAL PURPOSES (U.S. CLS. 26, 39 AND 44).

FIRST USE 6-20-2006; IN COMMERCE 6-20-2006.

3,785,572. NOLARO24, LLC, MIDDLEBURY, CT. SN 77-540,932. PUB. 5-19-2009, FILED 8-6-2008.



THE MARK CONSISTS OF A STYLIZED FOOT WITH SWIRLING LINES COMING OFF OF THE FOOT AND FORMING AN OVAL CARRIER. THE WORDING "RX24" IN STYLIZED FONT APPEARS INSIDE THE OVAL CARRIER. THE WORDING "WHATSMYFOOTTYPE.COM" APPEARS IN STYLIZED FONT BENEATH THE FOOT. THERE IS A WAVY HORIZONTAL LINE ON BOTH SIDES OF THE OVAL CARRIER.

FOR ORTHOTICS FOR FEET (U.S. CLS. 26, 39 AND 44).

FIRST USE 12-31-2009; IN COMMERCE 12-31-2009.

3,785,660. ATRICURE, INC., WEST CHESTER, OH. SN 77-604,810. PUB. 5-12-2009, FILED 10-31-2008.

CRY01

THE MARK CONSISTS OF STANDARD CHARACTERS WITHOUT CLAIM TO ANY PARTICULAR FONT, STYLE, SIZE, OR COLOR.

FOR SURGICAL INSTRUMENTS, NAMELY, DISPOSABLE HANDHELD CRYOGENIC PROBES FOR CARDIAC ABLATION, AND ACCESSORIES THEREFOR, NAMELY, BENDING TOOLS AND SHEATHS (U.S. CLS. 26, 39 AND 44).

FIRST USE 3-25-2009; IN COMMERCE 3-25-2009.

CLASS 10—(Continued).

3,785,776. HOLOGIC, INC., BEDFORD, MA. SN 77-653,234. PUB. 6-2-2009, FILED 1-21-2009.

THS

THE MARK CONSISTS OF STANDARD CHARACTERS WITHOUT CLAIM TO ANY PARTICULAR FONT, STYLE, SIZE, OR COLOR.

FOR HYSTEROSCOPIC VIDEO SYSTEM COMPRISED OF A HYSTEROSCOPE AND ASSOCIATED SHEATH, A COMPACT LED LIGHT SOURCE, A CAMERA HEAD, AND AN LED MONITOR WITH AN INTEGRATED CAMERA CONTROL UNIT ALL HOUSED IN A LIGHT-WEIGHT CARRYING CASE (U.S. CLS. 26, 39 AND 44).

FIRST USE 9-25-2009; IN COMMERCE 9-25-2009.

3,785,801. NEWPORT MEDICAL INSTRUMENTS, INC., COSTA MESA, CA. SN 77-659,368. PUB. 5-26-2009, FILED 1-29-2009.

Newport HT70

THE MARK CONSISTS OF STANDARD CHARACTERS WITHOUT CLAIM TO ANY PARTICULAR FONT, STYLE, SIZE, OR COLOR.

OWNER OF U.S. REG. NOS. 2,274,257, 2,709,301, AND OTHERS.

FOR MEDICAL INSTRUMENTS, NAMELY, VENTILATORS (U.S. CLS. 26, 39 AND 44).

FIRST USE 11-16-2009; IN COMMERCE 11-16-2009.

3,785,802. NEWPORT MEDICAL INSTRUMENTS, INC., COSTA MESA, CA. SN 77-659,383. PUB. 5-26-2009, FILED 1-29-2009.

HT70

THE MARK CONSISTS OF STANDARD CHARACTERS WITHOUT CLAIM TO ANY PARTICULAR FONT, STYLE, SIZE, OR COLOR.

OWNER OF U.S. REG. NOS. 2,274,257, 2,709,301, AND OTHERS.

FOR MEDICAL INSTRUMENTS, NAMELY, VENTILATORS (U.S. CLS. 26, 39 AND 44).

FIRST USE 11-16-2009; IN COMMERCE 11-16-2009.

CLASS 10—(Continued).

3,785,860. VOXELOGIX CORPORATION, SAN ANTONIO, TX. SN 77-667,204. PUB. 6-2-2009, FILED 2-10-2009.

FirstSmile

THE MARK CONSISTS OF STANDARD CHARACTERS WITHOUT CLAIM TO ANY PARTICULAR FONT, STYLE, SIZE, OR COLOR.

FOR DENTAL FIXTURES, NAMELY, PREFABRICATED PARTS FOR CROWNS, BRIDGES AND PONTICS; DENTAL IMPLANTS; DENTAL PROSTHESES (U.S. CLS. 26, 39 AND 44).

FIRST USE 2-24-2010; IN COMMERCE 2-24-2010.

CLASS 10—(Continued).

3,785,965. CNOGA MEDICAL LTD., OR AKIVA, ISRAEL. SN 77-692,401. PUB. 6-9-2009, FILED 3-17-2009.

MANOXIMETER

THE MARK CONSISTS OF STANDARD CHARACTERS WITHOUT CLAIM TO ANY PARTICULAR FONT, STYLE, SIZE, OR COLOR.

FOR SURGICAL AND MEDICAL APPARATUS AND INSTRUMENTS, NAMELY, NON-INVASIVE SENSORS FOR MEASURING PHYSIOLOGICAL PARAMETERS IN THE NATURE OF BLOOD PRESSURE, HEARTBEAT AND PULSE (U.S. CLS. 26, 39 AND 44).

FIRST USE 8-1-2007; IN COMMERCE 1-1-2009.

3,785,864. CNOGA MEDICAL LTD., OR AKIVA, ISRAEL. SN 77-667,849. PUB. 6-9-2009, FILED 2-11-2009.

TensorTip

THE MARK CONSISTS OF STANDARD CHARACTERS WITHOUT CLAIM TO ANY PARTICULAR FONT, STYLE, SIZE, OR COLOR.

FOR SURGICAL AND MEDICAL APPARATUS AND INSTRUMENTS, NAMELY, NON-INVASIVE SENSORS FOR MEASURING PHYSIOLOGICAL PARAMETERS IN THE NATURE OF BLOOD PRESSURE, HEARTBEAT AND PULSE (U.S. CLS. 26, 39 AND 44).

FIRST USE 8-1-2007; IN COMMERCE 1-1-2009.

3,786,023. ROHO, INC., BELLEVILLE, IL. SN 77-717,760. PUB. 9-15-2009, FILED 4-20-2009.

HYBRID ELITE

THE MARK CONSISTS OF STANDARD CHARACTERS WITHOUT CLAIM TO ANY PARTICULAR FONT, STYLE, SIZE, OR COLOR.

OWNER OF U.S. REG. NO. 2,958,197.
NO CLAIM IS MADE TO THE EXCLUSIVE RIGHT TO USE "HYBRID", APART FROM THE MARK AS SHOWN.
FOR WHEELCHAIR CUSHIONS FOR MEDICAL PURPOSES (U.S. CLS. 26, 39 AND 44).

FIRST USE 12-11-2009; IN COMMERCE 12-11-2009.

3,785,946. LFP IP, LLC, BEVERLY HILLS, CA. SN 77-686,989. PUB. 6-30-2009, FILED 3-10-2009.

IN LIKE FLYNT

THE MARK CONSISTS OF STANDARD CHARACTERS WITHOUT CLAIM TO ANY PARTICULAR FONT, STYLE, SIZE, OR COLOR.

THE NAME "LARRY C FLYNT" IDENTIFIES A LIVING INDIVIDUAL WHOSE CONSENT IS OF RECORD.

FOR ADULT SEXUAL STIMULATION AIDS, NAMELY, ARTIFICIAL VAGINA FOR USE AS AN AID TO MASTURBATION AND COPULATION (U.S. CLS. 26, 39 AND 44).

FIRST USE 6-19-2009; IN COMMERCE 6-19-2009.

3,786,055. EXTRAORTHO INC., MEMPHIS, TN. SN 77-735,149. PUB. 9-22-2009, FILED 5-12-2009.

EXTRAORTHO

THE MARK CONSISTS OF STANDARD CHARACTERS WITHOUT CLAIM TO ANY PARTICULAR FONT, STYLE, SIZE, OR COLOR.

FOR MEDICAL AND SURGICAL APPARATUS AND INSTRUMENTS, NAMELY, INTERNAL AND EXTERNAL JOINT DISTRACTION FIXATION DEVICES USED TO POSITION PATIENT'S LIMBS (U.S. CLS. 26, 39 AND 44).

FIRST USE 12-24-2009; IN COMMERCE 12-24-2009.

CLASS 10—(Continued).

3,786,057. EXTRAORTHO INC., MEMPHIS, TN. SN 77-735,219. PUB. 9-22-2009, FILED 5-12-2009.

XTRAFIX

THE MARK CONSISTS OF STANDARD CHARACTERS WITHOUT CLAIM TO ANY PARTICULAR FONT, STYLE, SIZE, OR COLOR.

FOR MEDICAL AND SURGICAL APPARATUS AND INSTRUMENTS, NAMELY, EXTERNAL JOINT DISTRACTION FIXATION DEVICES USED TO POSITION PATIENT'S LIMBS (U.S. CLS. 26, 39 AND 44).
FIRST USE 12-24-2009; IN COMMERCE 12-24-2009.

3,786,059. OPTISCAN BIOMEDICAL CORPORATION, HAYWARD, CA. SN 77-738,076. PUB. 11-3-2009, FILED 5-15-2009.

OPTISCANNER

THE MARK CONSISTS OF STANDARD CHARACTERS WITHOUT CLAIM TO ANY PARTICULAR FONT, STYLE, SIZE, OR COLOR.

FOR MEDICAL DEVICES, NAMELY, MONITORS TO DETERMINE THE CONCENTRATION OF GLUCOSE AND OTHER CONSTITUENTS IN THE HUMAN BODY, AND DISPOSABLE CARTRIDGES FOR USE THEREWITH (U.S. CLS. 26, 39 AND 44).
FIRST USE 11-13-2009; IN COMMERCE 11-13-2009.

3,786,123. PULSE VETERINARY TECHNOLOGIES, LLC, ALPHARETTA, GA. SN 77-760,490. PUB. 11-3-2009, FILED 6-16-2009.

PULSEVET

THE MARK CONSISTS OF STANDARD CHARACTERS WITHOUT CLAIM TO ANY PARTICULAR FONT, STYLE, SIZE, OR COLOR.

FOR VETERINARY APPARATUS AND INSTRUMENTS FOR THE TREATMENT OF MUSCULOSKELETAL DISORDERS (U.S. CLS. 26, 39 AND 44).
FIRST USE 11-0-2009; IN COMMERCE 11-0-2009.

CLASS 10—(Continued).

3,786,124. PULSE VETERINARY TECHNOLOGIES, LLC, ALPHARETTA, GA. SN 77-760,492. PUB. 11-10-2009, FILED 6-16-2009.

PULSE VETERINARY TECHNOLOGIES

THE MARK CONSISTS OF STANDARD CHARACTERS WITHOUT CLAIM TO ANY PARTICULAR FONT, STYLE, SIZE, OR COLOR.

NO CLAIM IS MADE TO THE EXCLUSIVE RIGHT TO USE "VETERINARY TECHNOLOGIES", APART FROM THE MARK AS SHOWN.

FOR VETERINARY APPARATUS AND INSTRUMENTS FOR THE TREATMENT OF MUSCULOSKELETAL DISORDERS (U.S. CLS. 26, 39 AND 44).
FIRST USE 11-0-2009; IN COMMERCE 11-0-2009.

3,786,259. CORINDUS LTD., HAIFA, ISRAEL. SN 78-785,567. PUB. 2-27-2007, FILED 1-5-2006.

CORPATH

THE MARK CONSISTS OF STANDARD CHARACTERS WITHOUT CLAIM TO ANY PARTICULAR FONT, STYLE, SIZE, OR COLOR.

FOR WORKSTATIONS COMPRISING TOUCH SCREEN CONTROL CONSOLES, JOYSTICKS, AND RADIATION BARRIERS, USED TO GUIDE AND CONTROL MECHANICAL TRANSMISSION MODULES IN THE REMOTE CARDIAC CATHETERIZATION PROCESS; BEDSIDE UNITS, NAMELY, ELECTROMECHANICAL DEVICES USED TO MECHANICALLY MANEUVER CATHETER DEVICES SUCH AS GUIDE WIRES AND STENT SYSTEMS IN THE REMOTE CARDIAC CATHETERIZATION PROCESS (U.S. CLS. 26, 39 AND 44).
FIRST USE 9-23-2009; IN COMMERCE 2-24-2010.

CLASS 11—ENVIRONMENTAL CONTROL APPARATUS

CLASS 11—(Continued).

3,785,084. KELIX HEAT TRANSFER SYSTEMS, LLC, TULSA, OK. SN 76-689,617. PUB. 5-5-2009, FILED 5-14-2008.

THERMACOUPLE

THE MARK CONSISTS OF STANDARD CHARACTERS WITHOUT CLAIM TO ANY PARTICULAR FONT, STYLE, SIZE, OR COLOR.

FOR HEAT TRANSFER EQUIPMENT FOR INSTALLATION WITHIN GEOLOGICAL ENVIRONMENTS, SUCH AS THE EARTH, LAKES AND PONDS, AND INCLUDING COAXIAL-FLOW HEAT TRANSFER SYSTEMS AND STRUCTURES COMPRISED OF A THERMALLY-CONDUCTIVE OUTER TUBE STRUCTURE COAXIALLY ARRANGED ABOUT AN INNER TUBE STRUCTURE AND PROVIDED WITH A CAP STRUCTURE, SO AS TO SEAL OFF THE INNER AND OUTER TUBE STRUCTURES AND PROVIDE AN INNER FLOW CHANNEL THAT EXTENDS DOWN THE INNER TUBE STRUCTURE AND TRANSITIONS INTO AN OUTER FLOW CHANNEL BETWEEN THE INNER AND OUTER TUBE STRUCTURES, AND ALONG WHICH AQUEOUS-BASED HEAT TRANSFER FLUID FLOWS, AND HEAT ENERGY IS TRANSFERRED BETWEEN THE AQUEOUS-BASED HEAT TRANSFER FLUID AND THE GEOLOGICAL ENVIRONMENT ALONG THE LENGTH OF THE OUTER FLOW CHANNEL (U.S. CLS. 13, 21, 23, 31 AND 34).

FIRST USE 5-1-2009; IN COMMERCE 5-1-2009.

3,785,142. LUMMUS TECHNOLOGY INC., BLOOMFIELD, NJ. SN 77-136,510. PUB. 4-29-2008, FILED 3-21-2007.

**LUMMUS ADVANCED
BREECH-LOCK EXCHANGER**

THE MARK CONSISTS OF STANDARD CHARACTERS WITHOUT CLAIM TO ANY PARTICULAR FONT, STYLE, SIZE, OR COLOR.

OWNER OF U.S. REG. NOS. 530,898 AND 924,846.

NO CLAIM IS MADE TO THE EXCLUSIVE RIGHT TO USE "EXCHANGER", APART FROM THE MARK AS SHOWN.

FOR HEAT EXCHANGERS, AND COMPONENT PARTS THEREOF (U.S. CLS. 13, 21, 23, 31 AND 34).

FIRST USE 3-12-2008; IN COMMERCE 3-12-2008.

CLASS 11—(Continued).

3,785,197. LF, LLC, WILMINGTON, DE. SN 77-245,047. PUB. 12-11-2007, FILED 8-2-2007.



The logo for 'Bright Effects' features the word 'Bright' in a serif font above the word 'Effects' in a cursive script. The text is enclosed within a dashed oval shape.

FOR FLUORESCENT LIGHT TUBES (U.S. CLS. 13, 21, 23, 31 AND 34).

FIRST USE 12-0-2004; IN COMMERCE 12-0-2004.

3,785,271. AIRINSPEACE B.V., DELFT, NETHERLANDS. SN 77-353,506. PUB. 5-27-2008, FILED 12-17-2007.

AIRINSPEACE

THE MARK CONSISTS OF STANDARD CHARACTERS WITHOUT CLAIM TO ANY PARTICULAR FONT, STYLE, SIZE, OR COLOR.

OWNER OF U.S. REG. NO. 2,963,069.

FOR AIR PURIFICATION UNITS; AIR DECONTAMINATION UNITS; AIR FILTRATION UNITS; DEVICES FOR REMOVING ODORS FROM AIR, NAMELY, AIR PURIFICATION UNITS; AIR TREATMENT UNITS THAT REDUCE MICROBIOLOGICAL CONTAMINATION; AIR BIOPROTECTION UNITS; ROOM AIR PURIFICATION UNITS; MOBILE AIR TREATMENT UNITS; AIR PURIFYING UNITS FOR REMOVING VOLATILE ORGANIC COMPOUNDS; UNITS FOR CLEANING, FILTERING, PURIFYING AND/OR REMOVING ODORS FROM AIR IN BUILDINGS, OFFICES, ROOMS, AND CONFINED SPACES; AIR PURIFYING UNITS FOR MEDICAL, NON-MEDICAL, AND COMMERCIAL USES; AIR TREATMENT UNITS FOR CLEAN ROOM AND PHARMACEUTICAL MANUFACTURING APPLICATIONS (U.S. CLS. 13, 21, 23, 31 AND 34).

FIRST USE 6-0-2001; IN COMMERCE 10-16-2008.

3,785,284. STAIRLIGHTING SYSTEM, LLC, NORTH EAST, MD. SN 77-367,023. PUB. 11-4-2008, FILED 1-8-2008.



The logo for 'The Stairlighting Kit' features the words 'The Stairlighting Kit' in a serif font. Below the text is a stylized graphic of a staircase with a light beam shining down from above.

NO CLAIM IS MADE TO THE EXCLUSIVE RIGHT TO USE "THE STAIRLIGHTING KIT", APART FROM THE MARK AS SHOWN.

CLASS 11—(Continued).

THE MARK CONSISTS OF THE WORDS "THE STAIR-LIGHTING KIT" IN STYLIZED FORM, PLUS A DEPICTION OF THREE BEAMS OF LIGHT.

FOR LOW VOLTAGE LIGHTING PRODUCTS FOR INDOOR/OUTDOOR USE, NAMELY, LIGHT BULBS, ELECTRIC LIGHT FIXTURES, AND ELECTRIC NIGHT LIGHTS (U.S. CLS. 13, 21, 23, 31 AND 34).

FIRST USE 3-15-2008; IN COMMERCE 3-15-2008.

3,785,295. LIU, YUAN, VANCOUVER, BC, CANADA. SN 77-373,483. PUB. 5-27-2008, FILED 1-16-2008.

ORGANOBLUB

THE MARK CONSISTS OF STANDARD CHARACTERS WITHOUT CLAIM TO ANY PARTICULAR FONT, STYLE, SIZE, OR COLOR.

FOR LIGHTING APPARATUS, NAMELY, LIGHT BULBS (U.S. CLS. 13, 21, 23, 31 AND 34).

FIRST USE 10-1-2009; IN COMMERCE 10-1-2009.

3,785,340. AQUACLEANA TOILET & BIDET, LLC, SKY VALLEY, CA. SN 77-408,064. PUB. 1-13-2009, FILED 2-27-2008.

AQUACLEANA

THE MARK CONSISTS OF STANDARD CHARACTERS WITHOUT CLAIM TO ANY PARTICULAR FONT, STYLE, SIZE, OR COLOR.

FOR TOILETS AND PARTS AND ACCESSORIES RELATED THERETO, NAMELY, TOILET BOWLS, TOILET STOOL UNITS WITH A WASHING WATER SQUIRTER, TOILET SEATS, TOILET BOWLS, TOILET BOWLS EQUIPPED WITH WASHING WATER SQUIRTER, TOILET SEATS FOR HEATING, WASHING AND DRYING BODY PARTS, TOILET TANKS AND STRUCTURAL PARTS THEREFOR, TOILET TANK ASSEMBLIES COMPRISED OF TOILET TANK BOWLS FOR FLUSHING TOILET TANKS, TOILETS AND REMOTE CONTROLS FOR USE WITH TOILETS, SOLD TOGETHER AS A UNIT, TANKS, NAMELY, CISTERN TANKS FOR TOILETS, FIXED SPOUTS USED DIRECTLY IN TOILETS, PLUMBING FIXTURES, NAMELY, SHOWER HEAD SPRAYERS FOR USE WITH TOILETS, HANDLES FOR FLUSHING TOILET WATER, AND, CONTROL VALVES FOR TOILET FLUSHING WATER (U.S. CLS. 13, 21, 23, 31 AND 34).

FIRST USE 4-0-2008; IN COMMERCE 11-11-2009.

CLASS 11—(Continued).

3,785,343. TRUE VALUE COMPANY, CHICAGO, IL. SN 77-409,579. PUB. 12-2-2008, FILED 2-29-2008.



FOR LIGHTING FIXTURES, NAMELY, WORK LIGHTS (U.S. CLS. 13, 21, 23, 31 AND 34).

FIRST USE 10-0-2006; IN COMMERCE 10-0-2006.

3,785,399. DISPLAY PRODUCTS INC., EL SEGUNDO, CA. SN 77-458,524. PUB. 9-16-2008, FILED 4-25-2008.

LED WashGraze

THE MARK CONSISTS OF STANDARD CHARACTERS WITHOUT CLAIM TO ANY PARTICULAR FONT, STYLE, SIZE, OR COLOR.

NO CLAIM IS MADE TO THE EXCLUSIVE RIGHT TO USE "LED", APART FROM THE MARK AS SHOWN.

FOR LED (LIGHT EMITTING DIODES) LIGHTING FIXTURES FOR USE IN DISPLAY, COMMERCIAL, INDUSTRIAL, RESIDENTIAL, AND ARCHITECTURAL ACCENT LIGHTING APPLICATIONS; LED LIGHTING FIXTURES FOR INDOOR AND OUTDOOR LIGHTING APPLICATIONS (U.S. CLS. 13, 21, 23, 31 AND 34).

FIRST USE 5-15-2008; IN COMMERCE 5-16-2008.

3,785,405. MESTEK, INC., WESTFIELD, MA. SN 77-459,640. PUB. 6-16-2009, FILED 4-28-2008.



THE MARK CONSISTS OF STYLIZED WORDS "GARAGEGUY" ADJACENT TO A HOUSE.

FOR GAS FIRED HEATERS FOR HOUSEHOLD AND INDUSTRIAL USE, AND GAS FIRED SPACE HEATERS (U.S. CLS. 13, 21, 23, 31 AND 34).

FIRST USE 5-29-2009; IN COMMERCE 8-7-2009.

CLASS 11—(Continued).

3,785,551. SPRITE INDUSTRIES, INC., CORONA, CA. SN 77-530,849. PUB. 5-26-2009, FILED 7-24-2008.

ECO SAVER

THE MARK CONSISTS OF STANDARD CHARACTERS WITHOUT CLAIM TO ANY PARTICULAR FONT, STYLE, SIZE, OR COLOR.

NO CLAIM IS MADE TO THE EXCLUSIVE RIGHT TO USE "ECO", APART FROM THE MARK AS SHOWN.

FOR SHOWER HEADS AND SHOWER FILTERS (U.S. CLS. 13, 21, 23, 31 AND 34).

FIRST USE 1-15-2008; IN COMMERCE 9-15-2008.

3,785,604. ORECK HOLDINGS, LLC, NASHVILLE, TN. SN 77-561,466. PUB. 6-16-2009, FILED 9-3-2008.

HEATWISE

THE MARK CONSISTS OF STANDARD CHARACTERS WITHOUT CLAIM TO ANY PARTICULAR FONT, STYLE, SIZE, OR COLOR.

FOR PORTABLE ELECTRIC HEATERS; ELECTRIC SPACE HEATERS (U.S. CLS. 13, 21, 23, 31 AND 34).

FIRST USE 11-8-2008; IN COMMERCE 11-8-2008.

3,785,690. DREWERY, GIG, GARY, TX. SN 77-621,903. PUB. 4-7-2009, FILED 11-25-2008.

Quick Set Service Master

THE MARK CONSISTS OF STANDARD CHARACTERS WITHOUT CLAIM TO ANY PARTICULAR FONT, STYLE, SIZE, OR COLOR.

FOR ENVIRONMENTAL CONTROL APPARATUS, NAMELY, PARTICLE ACTIVATORS FOR USE IN SOIL REMEDIATION, DRINKING WATER TREATMENT, MUNICIPAL AND INDUSTRIAL WASTEWATER TREATMENT (U.S. CLS. 13, 21, 23, 31 AND 34).

FIRST USE 10-1-2008; IN COMMERCE 10-15-2008.

CLASS 11—(Continued).

3,785,727. SAMUEL HEATH & SONS PLC, BIRMINGHAM, UNITED KINGDOM. SN 77-633,725. PUB. 6-16-2009, FILED 12-16-2008.

XIARA

THE MARK CONSISTS OF STANDARD CHARACTERS WITHOUT CLAIM TO ANY PARTICULAR FONT, STYLE, SIZE, OR COLOR.

FOR APPARATUS FOR WATER SUPPLY AND SANITARY PURPOSES, NAMELY, BATHTUBS, BIDETS, FAUCETS, SINKS, SHOWERS, TOILETS, SHOWER HEADS, TOILET SEATS, AND STRUCTURAL PARTS FOR THE FOREGOING; BATHROOM PLUMBING FITTINGS AND FIXTURES, NAMELY, FAUCETS, TAPS, BIBBS, COCKS, VALVES, LIFT RODS, PIPES BEING PARTS OF SANITARY FACILITIES; AND COMPRESSION PLUMBING FITTINGS, NAMELY, COUPLERS AND COLLARS (U.S. CLS. 13, 21, 23, 31 AND 34).

FIRST USE 12-31-2008; IN COMMERCE 9-30-2009.

3,785,834. BLUE RIDGE ATLANTIC, INC., OAKBORO, NC. SN 77-663,109. PUB. 6-9-2009, FILED 2-4-2009.

Rainigator

THE MARK CONSISTS OF STANDARD CHARACTERS WITHOUT CLAIM TO ANY PARTICULAR FONT, STYLE, SIZE, OR COLOR.

FOR AGRICULTURAL AND LANDSCAPING IRRIGATION UNITS DESIGNED TO COLLECT, STORE AND DISTRIBUTE RAINWATER FOR IRRIGATION PURPOSES FROM ABOVE OR BELOW GROUND STORAGE TANKS AND WHICH INCLUDE WATER FILTERS, WATER PUMPS, WATER TREATMENT FILTERS, SEDIMENT STRAINERS AND ULTRAVIOLET LIGHT (UV) DISINFECTION CHAMBERS SOLD AS A SINGLE UNIT (U.S. CLS. 13, 21, 23, 31 AND 34).

FIRST USE 2-2-2009; IN COMMERCE 3-31-2009.

CLASS 11—(Continued).

3,785,897. RETHINK LIGHTING, INC., RALEIGH, NC. SN 77-674,813. PUB. 6-23-2009, FILED 2-20-2009.

ILLUMINATING TRUE SUSTAINABILITY

THE MARK CONSISTS OF STANDARD CHARACTERS WITHOUT CLAIM TO ANY PARTICULAR FONT, STYLE, SIZE, OR COLOR.

FOR LED (LIGHT EMITTING DIODES) LIGHTING FIXTURES (U.S. CLS. 13, 21, 23, 31 AND 34).

FIRST USE 8-31-2009; IN COMMERCE 8-31-2009.

3,786,042. VECTAIR SYSTEMS LTD, BASINGSTOKE, HAMPSHIRE, UNITED KINGDOM. SN 77-729,975. PUB. 9-22-2009, FILED 5-6-2009.

SFX INTUIS

THE MARK CONSISTS OF STANDARD CHARACTERS WITHOUT CLAIM TO ANY PARTICULAR FONT, STYLE, SIZE, OR COLOR.

FOR AUTOMATIC HYGIENE SYSTEMS, NAMELY, AUTOMATIC AEROSOL DISPENSERS FOR AIR FRESHENING; ODOR CONTROL DISPENSERS, NAMELY, DISPENSING UNITS FOR AIR FRESHENERS; LARGE SPACE AIR FRESHENING DISPENSERS USING PRE-IMPREGNATED FRAGRANCE CARTRIDGES; AUTOMATIC CHEMICAL DOSING DISPENSERS OR DRIP DISPENSERS FOR URINALS AND TOILETS (U.S. CLS. 13, 21, 23, 31 AND 34).

FIRST USE 4-8-2009; IN COMMERCE 10-5-2009.

3,786,077. INTEX RECREATION CORP., LONG BEACH, CA. SN 77-746,279. PUB. 10-13-2009, FILED 5-28-2009.

LAWN BRITE

THE MARK CONSISTS OF STANDARD CHARACTERS WITHOUT CLAIM TO ANY PARTICULAR FONT, STYLE, SIZE, OR COLOR.

FOR LIGHTING APPARATUS, NAMELY, OUTDOOR SOLAR POWERED LIGHTING UNITS (U.S. CLS. 13, 21, 23, 31 AND 34).

FIRST USE 5-31-2009; IN COMMERCE 6-7-2009.

CLASS 11—(Continued).

3,786,221. EVERBRITE LLC, GREENFIELD, WI. SN 78-588,796. PUB. 7-14-2009, FILED 3-16-2005.

MedLux

THE MARK CONSISTS OF STANDARD CHARACTERS WITHOUT CLAIM TO ANY PARTICULAR FONT, STYLE, SIZE, OR COLOR.

FOR ELECTRIC LIGHTING FIXTURES, NAMELY, ILLUMINATED GRAPHICAL PANELS USING LEDS, LIGHT FIXTURES USING LEDS FOR ROOM TASK ILLUMINATION, ALL FIXTURES NOT SOLD OR DISTRIBUTED TO DERMATOLOGISTS, DERMATOLOGY OFFICES, AND COSMETIC/PLASTIC SURGERY OFFICES (U.S. CLS. 13, 21, 23, 31 AND 34).

FIRST USE 9-8-2004; IN COMMERCE 10-8-2004.

3,786,296. SUNFLOWER CORPORATION, LONGMONT, CO. SN 78-880,525. PUB. 12-19-2006, FILED 5-10-2006.

SUNDOLIER

THE MARK CONSISTS OF STANDARD CHARACTERS WITHOUT CLAIM TO ANY PARTICULAR FONT, STYLE, SIZE, OR COLOR.

FOR ACTIVE DAYLIGHTING SYSTEM, NAMELY, ROOF MOUNTED MOVEABLE MODULE WITH REFLECTORS AND MIRRORS THAT IS ELECTRICALLY OR SOLAR POWERED, THAT ROTATE TO TRACK AND FOLLOW THE SUN IN ORDER TO COLLECT AND GUIDE DAYLIGHT FROM THE SUN THROUGH TUBES AND DUCTS TO DISTRIBUTE THE DAYLIGHT UNIFORMLY ACROSS INTERIOR CEILING MOUNTED LIGHT FIXTURES INSIDE OF COMMERCIAL BUILDINGS, PUBLIC BUILDINGS AND RESIDENTIAL BUILDINGS (U.S. CLS. 13, 21, 23, 31 AND 34).

FIRST USE 11-16-2006; IN COMMERCE 8-26-2009.

CLASS 12—VEHICLES

CLASS 12—(Continued).

3,785,139. CROWN EQUIPMENT CORPORATION, NEW BREMEN, OH. SN 77-126,911. PUB. 4-1-2008, FILED 3-9-2007.

INTRINSIC STABILITY SYSTEM

THE MARK CONSISTS OF STANDARD CHARACTERS WITHOUT CLAIM TO ANY PARTICULAR FONT, STYLE, SIZE, OR COLOR.

NO CLAIM IS MADE TO THE EXCLUSIVE RIGHT TO USE "STABILITY SYSTEM", APART FROM THE MARK AS SHOWN.

FOR MONITORING AND CONTROL SYSTEMS SOLD AS INTEGRAL COMPONENTS OF MATERIAL LIFTING, TRANSPORTING AND HANDLING EQUIPMENT, NAMELY, POWER PROPELLED POWER LIFT TRUCKS, AND FORK LIFT TRUCKS (U.S. CLS. 19, 21, 23, 31, 35 AND 44).

FIRST USE 4-0-2009; IN COMMERCE 4-0-2009.

3,785,140. CROWN EQUIPMENT CORPORATION, NEW BREMEN, OH. SN 77-132,299. PUB. 4-1-2008, FILED 3-15-2007.

TECHNOVATION

THE MARK CONSISTS OF STANDARD CHARACTERS WITHOUT CLAIM TO ANY PARTICULAR FONT, STYLE, SIZE, OR COLOR.

FOR SYSTEM MONITORING SENSORS, CONTROLS, SWITCHES AND COMMUNICATION COMPONENTS, DIAGNOSTIC, MAINTENANCE AND SERVICE SYSTEMS, MASTS, HANDLES AND HANDLE CONTROLS, SEATS, OPERATOR WORK AREAS, SHOCK ABSORBING SYSTEMS, BRAKE SYSTEMS AND MOTORS, SOLD AS INTEGRAL COMPONENTS OF MATERIAL LIFTING, TRANSPORTING AND HANDLING EQUIPMENT, NAMELY, POWER PROPELLED POWER LIFT TRUCKS AND PALLET TRUCKS, TOWING TRACTORS, FORK LIFT TRUCKS, PLATFORM LIFT TRUCKS, SPECIAL APPLICATION LIFT TRUCKS AND STOCK PICKER TRUCKS (U.S. CLS. 19, 21, 23, 31, 35 AND 44).

FIRST USE 4-0-2009; IN COMMERCE 4-0-2009.

CLASS 12—(Continued).

3,785,243. DETROIT DIESEL CORPORATION, DETROIT, MI. SN 77-328,297. PUB. 4-22-2008, FILED 11-13-2007.

DD13

THE MARK CONSISTS OF STANDARD CHARACTERS WITHOUT CLAIM TO ANY PARTICULAR FONT, STYLE, SIZE, OR COLOR.

FOR DIESEL ENGINES FOR USE IN TRUCKS AND BUSES (U.S. CLS. 19, 21, 23, 31, 35 AND 44).

FIRST USE 5-0-2009; IN COMMERCE 5-0-2009.

3,785,346. KUMHO TIRE CO., INC., SEOUL, REPUBLIC OF KOREA. SN 77-413,392. PUB. 12-23-2008, FILED 3-5-2008.

ECO SOLUS

THE MARK CONSISTS OF STANDARD CHARACTERS WITHOUT CLAIM TO ANY PARTICULAR FONT, STYLE, SIZE, OR COLOR.

OWNER OF U.S. REG. NO. 3,352,869.

FOR TIRES; TIRES FOR LAND VEHICLES (U.S. CLS. 19, 21, 23, 31, 35 AND 44).

FIRST USE 8-0-2009; IN COMMERCE 8-0-2009.

3,785,437. EXACT MARKETING, INC., LINDON, UT. SN 77-483,019. PUB. 1-13-2009, FILED 5-23-2008.

DURASOFT POLYMER

THE MARK CONSISTS OF STANDARD CHARACTERS WITHOUT CLAIM TO ANY PARTICULAR FONT, STYLE, SIZE, OR COLOR.

NO CLAIM IS MADE TO THE EXCLUSIVE RIGHT TO USE "POLYMER", APART FROM THE MARK AS SHOWN.

FOR BAR TAPE FOR BICYCLES (U.S. CLS. 19, 21, 23, 31, 35 AND 44).

FIRST USE 3-31-2009; IN COMMERCE 3-31-2009.

CLASS 12—(Continued).

3,785,534. SENZEYE INDUSTRIES, LLC, EAST GREENWICH, RI. SN 77-526,903. PUB. 6-9-2009, FILED 7-21-2008.

GAMMA RAY

THE MARK CONSISTS OF STANDARD CHARACTERS WITHOUT CLAIM TO ANY PARTICULAR FONT, STYLE, SIZE, OR COLOR.

FOR MOTORCYCLE AND MOTOR SCOOTER PARTS, NAMELY, KICKSTANDS, REAR VIEW MIRRORS, SEATS, MOTORCYCLE AND FOOT PEGS, STORAGE BINS FOR ATTACHING TO MOTORCYCLES AND MOTOR SCOOTERS (U.S. CLS. 19, 21, 23, 31, 35 AND 44). FIRST USE 4-1-2009; IN COMMERCE 4-1-2009.

3,785,685. GIANT MANUFACTURING CO., LTD., TACHIA, TAICHUNG HSIEN, TAIWAN. SN 77-618,660. PUB. 6-2-2009, FILED 11-20-2008.

MOMENTUM

THE MARK CONSISTS OF STANDARD CHARACTERS WITHOUT CLAIM TO ANY PARTICULAR FONT, STYLE, SIZE, OR COLOR.

FOR BICYCLES, COLLAPSIBLE BICYCLES, ELECTRIC BICYCLES AND ELECTRIC COLLAPSIBLE BICYCLES, AND STRUCTURAL PARTS THEREOF; PARTS FOR BICYCLES, NAMELY, FRAMES, HANDLEBARS, HANDLEBAR STEMS, DERAILLEURS, GEARS, SADDLES, SADDLE COVERS, SADDLE BAGS, SEAT POSTS, SEAT TUBES, PEDALS, CRANKS, TIRES, WHEELS, INNER TUBES, SPOKES, PUMPS, FORKS, CARGO AND LUGGAGE CARRIERS, BICYCLE MUDGUARDS, CHAINS, CHAIN-GUARDS, WHEEL HUBS, BRAKES, HANDLE BAR CONTROL LEVERS, SHIFT LEVERS, TOE STRAPS AND CLIPS, LUGGAGE RACKS ADAPTED FOR BICYCLES, BICYCLE BELLS, BICYCLE STOP STANDS, REARVIEW MIRRORS, TIRE PATCHES, BABY CARRIAGES, BICYCLE CANTEN RACKS, ADHESIVE RUBBER PATCHES FOR REPAIRING TUBES OR TIRES, TIRE INFLATORS, TIRE RETREADING CAPS, TREAD USED TO RETREAD TIRES, BICYCLE HOLDERS FOR VEHICLES, BAGS ADAPTED FOR BICYCLES, BICYCLE HANDLE-BAR GRIP COVERS, TRAILERS, BASKETS ADAPTED FOR BICYCLES, BICYCLE PROTECTIVE WHEELS, WHEEL COVER, BICYCLE SHOCK ABSORBERS, AND OTHER ACCESSORIES FOR BICYCLES, NAMELY, WATER BOTTLE CAGES (U.S. CLS. 19, 21, 23, 31, 35 AND 44). FIRST USE 7-16-2009; IN COMMERCE 12-1-2009.

CLASS 12—(Continued).

3,785,805. BAREFOOT MOTORS, LLC, ASHLAND, OR. SN 77-659,610. PUB. 5-26-2009, FILED 1-29-2009.

EARTH UTILITY VEHICLE

THE MARK CONSISTS OF STANDARD CHARACTERS WITHOUT CLAIM TO ANY PARTICULAR FONT, STYLE, SIZE, OR COLOR.

NO CLAIM IS MADE TO THE EXCLUSIVE RIGHT TO USE "UTILITY VEHICLE", APART FROM THE MARK AS SHOWN.

FOR ATVS (ALL TERRAIN VEHICLES); ELECTRIC LAND VEHICLES, NAMELY, ENVIRONMENTALLY FRIENDLY LAND VEHICLES, ALL TERRAIN VEHICLES, ALL TERRAIN UTILITY VEHICLES, AND LOW-EMISSIONS VEHICLES AND OFF-ROAD VEHICLES; LAND VEHICLES; LAND VEHICLES, NAMELY, ENVIRONMENTALLY FRIENDLY LAND VEHICLES, ALL TERRAIN VEHICLES, ALL TERRAIN UTILITY VEHICLES, ELECTRIC LAND VEHICLES, AND LOW-EMISSIONS VEHICLES AND OFF-ROAD VEHICLES; SPORTS UTILITY VEHICLES (U.S. CLS. 19, 21, 23, 31, 35 AND 44). FIRST USE 5-17-2007; IN COMMERCE 6-25-2009.

3,785,939. WABASH NATIONAL L.P., LAFAYETTE, IN. SN 77-685,287. PUB. 7-28-2009, FILED 3-6-2009.

DURAPLATE AEROSKIRT

THE MARK CONSISTS OF STANDARD CHARACTERS WITHOUT CLAIM TO ANY PARTICULAR FONT, STYLE, SIZE, OR COLOR.

OWNER OF U.S. REG. NOS. 2,177,280, 3,010,104, AND OTHERS.

FOR AERODYNAMIC FAIRINGS FOR VEHICLES (U.S. CLS. 19, 21, 23, 31, 35 AND 44). FIRST USE 3-31-2009; IN COMMERCE 3-31-2009.

3,786,012. MIDWEST MOTORCYCLE SUPPLY DISTRIBUTORS CORP., PEVELY, MO. SN 77-712,363. PUB. 8-11-2009, FILED 4-13-2009.

GERONIMO

THE MARK CONSISTS OF STANDARD CHARACTERS WITHOUT CLAIM TO ANY PARTICULAR FONT, STYLE, SIZE, OR COLOR.

FOR MOTORCYCLE ENGINES, AND STRUCTURAL PARTS THEREFOR (U.S. CLS. 19, 21, 23, 31, 35 AND 44). FIRST USE 6-10-2009; IN COMMERCE 6-10-2009.

CLASS 12—(Continued).

3,786,024. DYNACRAFT BSC, INC., AMERICAN CANYON, CA. SN 77-717,975. PUB. 8-25-2009, FILED 4-20-2009.

SWEETHEART

THE MARK CONSISTS OF STANDARD CHARACTERS WITHOUT CLAIM TO ANY PARTICULAR FONT, STYLE, SIZE, OR COLOR.

FOR BICYCLES (U.S. CLS. 19, 21, 23, 31, 35 AND 44).
FIRST USE 1-11-2010; IN COMMERCE 1-11-2010.

CLASS 12—(Continued).

3,786,137. POLARIS INDUSTRIES INC., MEDINA, MN. SN 77-768,444. PUB. 11-10-2009, FILED 6-25-2009.

TAKE LIFE FOR A RIDE

THE MARK CONSISTS OF STANDARD CHARACTERS WITHOUT CLAIM TO ANY PARTICULAR FONT, STYLE, SIZE, OR COLOR.

FOR ELECTRIC LOW-SPEED AND RECREATIONAL VEHICLES, NAMELY, GOLF CARTS, GOLF CARS, AND 4-WHEELED LAND VEHICLES FOR USE IN PRIMARILY CLOSED COMMUNITIES (U.S. CLS. 19, 21, 23, 31, 35 AND 44).

FIRST USE 5-0-2009; IN COMMERCE 5-0-2009.

3,786,157. COKER TIRE COMPANY, CHATTANOOGA, TN. SN 77-803,130. PUB. 11-17-2009, FILED 8-12-2009.

STAHL SPORT

THE MARK CONSISTS OF STANDARD CHARACTERS WITHOUT CLAIM TO ANY PARTICULAR FONT, STYLE, SIZE, OR COLOR.

NO CLAIM IS MADE TO THE EXCLUSIVE RIGHT TO USE "SPORT", APART FROM THE MARK AS SHOWN.

THE ENGLISH TRANSLATION OF THE GERMAN WORD "STAHL" IS STEEL.

FOR TIRES FOR AUTOMOBILES AND TRUCKS (U.S. CLS. 19, 21, 23, 31, 35 AND 44).

FIRST USE 11-25-2009; IN COMMERCE 11-25-2009.

3,786,229. RANCOURT, JACQUES, SAINT-THERÈSE, QUEBEC, CANADA. SN 78-656,853. PUB. 10-24-2006, FILED 6-23-2005.



OWNER OF CANADA REG. NO. TMA663990, DATED 5-10-2006, EXPIRES 5-10-2021.

THE MARK CONSISTS, IN PART, OF THE WORD "NEMO", WITHIN THE DESIGN OF TWO CONCENTRIC SHADED RECTANGLES, WITH THE LETTER "O" SHOWN LARGER THAN THE OTHER LETTERS, AND DESIGN.

FOR ELECTRIC AUTOMOBILES, ELECTRIC MOTORCYCLES, AND ELECTRIC ALL-TERRAIN VEHICLES (U.S. CLS. 19, 21, 23, 31, 35 AND 44).

FIRST USE 3-0-2006; IN COMMERCE 3-0-2006.

3,786,136. JANASHAK, ROBERT J., BURBANK, CA. SN 77-767,531. PUB. 11-10-2009, FILED 6-24-2009.



THE COLOR(S) RED, GREEN, ORANGE, YELLOW, WHITE, BLACK AND GRAY IS/ARE CLAIMED AS A FEATURE OF THE MARK.

THE MARK CONSISTS OF AN ALLIGATOR, IN VARYING SHADES OF GREEN, HEAD IN 3/4 PROFILE HOLDING A BICYCLE. ONE HAND GRASPING THE FRONT BICYCLE WHEEL, THE OTHER HAND GRASPING THE REAR BICYCLE WHEEL, THE ALLIGATOR'S HEAD IS BETWEEN THE TWO WHEELS. THE ALLIGATOR'S TAIL ENCOMPASSING THE FRONT AND REAR WHEELS. THE ALLIGATOR AND THE BICYCLE ARE CENTERED IN AN OVAL WITH VARYING SHADES OF RED, THE LIGHTEST SHADE TOWARDS THE CENTER, DARKENING RED TOWARDS THE OUTER EDGES OF THE OVAL. THE OUTLINE OF THE OVAL IS BLACK. THE WORDS TAIL-GATOR ARE POSITIONED HORIZONTALLY ABOVE THE ALLIGATOR'S TAIL IN STYLIZED LETTERING. THE WORDS "TAIL" AND "GATOR" ARE SEPARATED BY A HYPHEN.

FOR BICYCLE RACKS FOR VEHICLES (U.S. CLS. 19, 21, 23, 31, 35 AND 44).

FIRST USE 9-23-2009; IN COMMERCE 9-23-2009.

CLASS 13—FIREARMS

3,785,177. GANDER MOUNTAIN COMPANY, ST. PAUL, MN. SN 77-208,341. PUB. 12-4-2007, FILED 6-18-2007.

GANDER MTN.

THE MARK CONSISTS OF STANDARD CHARACTERS WITHOUT CLAIM TO ANY PARTICULAR FONT, STYLE, SIZE, OR COLOR.

OWNER OF U.S. REG. NOS. 1,335,489, 2,864,302, AND OTHERS.

FOR GUN CASES; TRIPODS AND STANDS FOR FIREARMS; SLING STRAPS FOR FIREARMS; AMMUNITION FOR FIREARMS (U.S. CLS. 2 AND 9).

FIRST USE 12-31-2005; IN COMMERCE 12-31-2005.

3,785,966. SECURITY EQUIPMENT CORPORATION, FENTON, MO. SN 77-692,843. PUB. 7-28-2009, FILED 3-17-2009.



NO CLAIM IS MADE TO THE EXCLUSIVE RIGHT TO USE "DEFENCE I.D.", APART FROM THE MARK AS SHOWN.

THE COLOR(S) PURPLE AND BLACK IS/ARE CLAIMED AS A FEATURE OF THE MARK.

THE MARK CONSISTS OF THE WORDS "DEFENCE I.D." IN ALL CAPS PLACED OVER A PURPLE CIRCULAR SPRAY DESIGN. THE COLOR BLACK IS USED AS OUTLINING FOR THE WORDING. THE COLOR GRAY IN THE DRAWING REPRESENTS SHADING THAT IS NOT PART OF THE MARK. THE COLOR WHITE IN THE DRAWING REPRESENTS A TRANSPARENT BACKGROUND AND TRANSPARENT AREAS THAT ARE NOT PART OF THE MARK.

FOR SELF-DEFENSE PRODUCTS, NAMELY, DYE SPRAY WEAPONS (U.S. CLS. 2 AND 9).

FIRST USE 1-22-2010; IN COMMERCE 1-22-2010.

CLASS 13—(Continued).

3,786,112. HERO-GEAR, LLC, WINCHESTER, TN. SN 77-758,364. PUB. 10-27-2009, FILED 6-12-2009.

HERO GUNS

THE MARK CONSISTS OF STANDARD CHARACTERS WITHOUT CLAIM TO ANY PARTICULAR FONT, STYLE, SIZE, OR COLOR.

NO CLAIM IS MADE TO THE EXCLUSIVE RIGHT TO USE "GUNS", APART FROM THE MARK AS SHOWN.

FOR FIREARMS (U.S. CLS. 2 AND 9).

FIRST USE 7-27-2009; IN COMMERCE 7-27-2009.

3,786,281. FORJAS TAURUS S/A, RIO GRANDE DO SUL, BRAZIL. SN 78-851,849. PUB. 12-30-2008, FILED 3-31-2006.

TAURUS GAUCHO

THE MARK CONSISTS OF STANDARD CHARACTERS WITHOUT CLAIM TO ANY PARTICULAR FONT, STYLE, SIZE, OR COLOR.

OWNER OF U.S. REG. NOS. 1,762,727, 2,257,591, AND OTHERS.

FOR FIREARMS (U.S. CLS. 2 AND 9).

FIRST USE 4-1-2006; IN COMMERCE 4-1-2006.

CLASS 14—JEWELRY

3,785,090. CAROL DAUPLAISE, LTD., NEW YORK, NY. SN 76-693,876. PUB. 3-31-2009, FILED 10-29-2008.

CAROL DAUPLAISE PRIVATE COLLECTION

THE MARK CONSISTS OF STANDARD CHARACTERS WITHOUT CLAIM TO ANY PARTICULAR FONT, STYLE, SIZE, OR COLOR.

NO CLAIM IS MADE TO THE EXCLUSIVE RIGHT TO USE "PRIVATE COLLECTION", APART FROM THE MARK AS SHOWN.

THE NAME "CAROL DAUPLAISE" IDENTIFIES A LIVING INDIVIDUAL WHOSE CONSENT IS OF RECORD.

FOR JEWELRY, NAMELY, BRACELETS, NECKLACES, EARRINGS, PINS, RINGS, AND JEWELRY FOR HAIR (U.S. CLS. 2, 27, 28 AND 50).

FIRST USE 12-0-2008; IN COMMERCE 12-0-2008.

CLASS 14—(Continued).

3,785,103. GIVONE, LAURIE, PURCHASE, NY. AND GIVONE, ROBERT, PURCHASE, NY. SN 76-697,367. PUB. 9-22-2009, FILED 5-13-2009.

I BELIEVE IN CAPITALISM

THE MARK CONSISTS OF STANDARD CHARACTERS WITHOUT CLAIM TO ANY PARTICULAR FONT, STYLE, SIZE, OR COLOR.
FOR JEWELRY, NAMELY, BRACELETS (U.S. CLS. 2, 27, 28 AND 50).
FIRST USE 6-25-2009; IN COMMERCE 6-25-2009.

3,785,169. CHENELIA, DOMINIC, SAN DIEGO, CA. SN 77-201,905. PUB. 11-27-2007, FILED 6-8-2007.

HAPPY HOUR

THE MARK CONSISTS OF STANDARD CHARACTERS WITHOUT CLAIM TO ANY PARTICULAR FONT, STYLE, SIZE, OR COLOR.
FOR WATCH BANDS AND STRAPS; WATCH BOXES; WATCH CASES; WATCH CLASPS; WATCH POUCHES; WATCHES (U.S. CLS. 2, 27, 28 AND 50).
FIRST USE 2-12-2010; IN COMMERCE 2-12-2010.

3,785,188. THE AVALANCHE GROUP, LLC, NEW YORK, NY. SN 77-233,425. PUB. 1-1-2008, FILED 7-19-2007.



WINTOUR

THE MARK CONSISTS OF THE LETTER "W" DEPICTED FOUR TIMES IN A PATTERN ABOVE THE WORD "WINTOUR".
FOR WATCHES; JEWELRY (U.S. CLS. 2, 27, 28 AND 50).
FIRST USE 4-1-2009; IN COMMERCE 6-1-2009.

CLASS 14—(Continued).

3,785,189. THE AVALANCHE GROUP, LLC, NEW YORK, NY. SN 77-233,445. PUB. 1-1-2008, FILED 7-19-2007.



THE MARK CONSISTS OF THE LETTER "W" DEPICTED FOUR TIMES IN A PATTERN.
FOR JEWELRY; WATCHES (U.S. CLS. 2, 27, 28 AND 50).
FIRST USE 4-1-2009; IN COMMERCE 6-1-2009.

3,785,276. SELECT JEWELRY INC., LONG ISLAND CITY, NY. SN 77-358,126. PUB. 4-22-2008, FILED 12-21-2007.

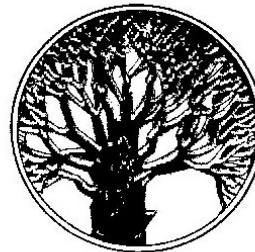

FOR GOLD JEWELRY, NAMELY, RINGS, BRACELETS, PENDANTS, EARRINGS, NECKLACES, BROOCHES, PINS AND CUFFLINKS (U.S. CLS. 2, 27, 28 AND 50).
FIRST USE 8-0-2008; IN COMMERCE 8-0-2008.

CLASS 14—(Continued).

3,785,542. MOVADO LLC, WILMINGTON, DE. SN 77-528,532.
PUB. 12-16-2008, FILED 7-22-2008.

MOVADO

THE MARK CONSISTS OF STANDARD CHARACTERS WITHOUT CLAIM TO ANY PARTICULAR FONT, STYLE, SIZE, OR COLOR.

OWNER OF U.S. REG. NOS. 1,294,171 AND 3,120,578.
FOR HOROLOGICAL AND CHRONOMETRIC INSTRUMENTS (U.S. CLS. 2, 27, 28 AND 50).
FIRST USE 3-0-1927; IN COMMERCE 3-0-1927.

3,785,543. MOVADO LLC, WILMINGTON, DE. SN 77-528,563.
PUB. 12-16-2008, FILED 7-22-2008.

SUB-SEA

THE MARK CONSISTS OF STANDARD CHARACTERS WITHOUT CLAIM TO ANY PARTICULAR FONT, STYLE, SIZE, OR COLOR.

FOR HOROLOGICAL AND CHRONOMETRIC INSTRUMENTS (U.S. CLS. 2, 27, 28 AND 50).
FIRST USE 4-0-2009; IN COMMERCE 4-0-2009.

3,785,597. QUALITY COLOR DESIGN INC, NEW YORK, NY.
SN 77-556,328. PUB. 1-20-2009, FILED 8-26-2008.

QC

THE MARK CONSISTS OF STANDARD CHARACTERS WITHOUT CLAIM TO ANY PARTICULAR FONT, STYLE, SIZE, OR COLOR.

OWNER OF U.S. REG. NO. 2,432,489.
FOR BRACELETS; EARRINGS; GEMSTONES; JEWELRY; PENDANTS; PRECIOUS GEMSTONES; RINGS (U.S. CLS. 2, 27, 28 AND 50).
FIRST USE 7-1-2009; IN COMMERCE 7-1-2009.

CLASS 14—(Continued).

3,785,631. KENNY, HOLLY A, DBA ELSIE KAYE GLASSWORKS, WESTBOROUGH, MA. SN 77-584,709. PUB. 6-23-2009, FILED 10-2-2008.

Elsie Kaye Glassworks

THE MARK CONSISTS OF STANDARD CHARACTERS WITHOUT CLAIM TO ANY PARTICULAR FONT, STYLE, SIZE, OR COLOR.

NO CLAIM IS MADE TO THE EXCLUSIVE RIGHT TO USE "GLASSWORKS", APART FROM THE MARK AS SHOWN.

THE NAME(S), PORTRAIT(S), AND/OR SIGNATURE(S) SHOWN IN THE MARK DOES NOT IDENTIFY A PARTICULAR LIVING INDIVIDUAL.

FOR BEADS FOR USE IN THE MANUFACTURE OF JEWELRY; BRACELETS; BROOCHES; CHARMS; GEMSTONE JEWELRY; IDENTIFICATION BRACELETS; JEWELRY; JEWELRY FOR THE HEAD; JEWELRY WATCHES; LAPEL PINS; PINS BEING JEWELRY; WATCHES AND JEWELRY (U.S. CLS. 2, 27, 28 AND 50).
FIRST USE 10-15-2008; IN COMMERCE 11-15-2008.

3,785,754. BELLE STAR PRODUCTIONS, INC., GLENDALE, AZ. SN 77-646,427. PUB. 5-5-2009, FILED 1-9-2009.

two:peas

THE MARK CONSISTS OF THE WORDING "TWO:PEAS" IN STYLIZED FONT.

FOR JEWELRY (U.S. CLS. 2, 27, 28 AND 50).
FIRST USE 7-28-2009; IN COMMERCE 8-2-2009.

3,785,767. CROREY, DAVID J., CLINTON TOWNSHIP, MI.
SN 77-649,383. PUB. 11-10-2009, FILED 1-14-2009.

MY FRIENDSHIP BRACELET MAKER

THE MARK CONSISTS OF STANDARD CHARACTERS WITHOUT CLAIM TO ANY PARTICULAR FONT, STYLE, SIZE, OR COLOR.

NO CLAIM IS MADE TO THE EXCLUSIVE RIGHT TO USE "FRIENDSHIP BRACELET MAKER", APART FROM THE MARK AS SHOWN.

FOR JEWELRY MAKING KITS (U.S. CLS. 2, 27, 28 AND 50).
FIRST USE 10-0-2009; IN COMMERCE 10-0-2009.

CLASS 14—(Continued).

3,785,832. MCCLUNG, JR., JACK ALLEN, ASH FORK, AZ.
SN 77-662,626. PUB. 5-26-2009, FILED 2-3-2009.



THE MARK CONSISTS OF STYLIZED CRESCENT MOON.

FOR JEWELRY (U.S. CLS. 2, 27, 28 AND 50).
FIRST USE 2-14-2010; IN COMMERCE 2-14-2010.

CLASS 14—(Continued).

3,786,020. MJ WILMAN INC., LOS ANGELES, CA. SN 77-716,623. PUB. 8-25-2009, FILED 4-17-2009.

Forever-Match-Set

THE MARK CONSISTS OF STANDARD CHARACTERS WITHOUT CLAIM TO ANY PARTICULAR FONT, STYLE, SIZE, OR COLOR.

FOR JEWELRY (U.S. CLS. 2, 27, 28 AND 50).
FIRST USE 4-1-2009; IN COMMERCE 4-1-2009.

3,785,952. GARY RICH, DENTON, TX. SN 77-687,749. PUB. 7-14-2009, FILED 3-10-2009.

Permission Bracelets

THE MARK CONSISTS OF STANDARD CHARACTERS WITHOUT CLAIM TO ANY PARTICULAR FONT, STYLE, SIZE, OR COLOR.

NO CLAIM IS MADE TO THE EXCLUSIVE RIGHT TO USE "BRACELETS", APART FROM THE MARK AS SHOWN.

FOR BRACELETS; NECKLACES (U.S. CLS. 2, 27, 28 AND 50).

FIRST USE 2-14-2004; IN COMMERCE 9-1-2008.

3,786,054. HARDING, CHRISTINE, MISSION VIEJO, CA. SN 77-734,324. PUB. 9-22-2009, FILED 5-11-2009.

Fortunes To Live By

THE MARK CONSISTS OF STANDARD CHARACTERS WITHOUT CLAIM TO ANY PARTICULAR FONT, STYLE, SIZE, OR COLOR.

FOR NECKLACES (U.S. CLS. 2, 27, 28 AND 50).
FIRST USE 10-26-2009; IN COMMERCE 12-4-2009.

3,785,971. TOSYALI INTERNATIONAL INC., TUSCALOOSA, AL. SN 77-694,106. PUB. 5-26-2009, FILED 3-18-2009.

180°

THE MARK CONSISTS OF STANDARD CHARACTERS WITHOUT CLAIM TO ANY PARTICULAR FONT, STYLE, SIZE, OR COLOR.

FOR JEWELRY (U.S. CLS. 2, 27, 28 AND 50).
FIRST USE 6-0-2009; IN COMMERCE 6-0-2009.

3,786,154. ROGERS SPORTS MANAGEMENT GROUP, INC., FINDLAY, OH. SN 77-781,341. PUB. 10-20-2009, FILED 7-15-2009.

WAYLAID

THE MARK CONSISTS OF STANDARD CHARACTERS WITHOUT CLAIM TO ANY PARTICULAR FONT, STYLE, SIZE, OR COLOR.

FOR JEWELRY (U.S. CLS. 2, 27, 28 AND 50).
FIRST USE 6-24-2009; IN COMMERCE 6-24-2009.

CLASS 14—(Continued).

3,786,219. VISANT HOLDING CORPORATION, ARMONK, NY. SN 78-557,733. PUB. 1-2-2007, FILED 2-1-2005.



THE MARK CONSISTS OF A STYLIZED LETTER "V" ATOP A CRESCENT SHAPE, WITH THE LITERAL ELEMENT BENEATH THE CRESCENT.

THE FOREIGN WORDING IN THE MARK TRANSLATES INTO ENGLISH AS AIMING.

FOR JEWELRY, NAMELY, AFFINITY RINGS AND AFFINITY JEWELRY; COMMEMORATIVE STATUARY CUPS MADE OF PRECIOUS METAL AND PRECIOUS METAL TROPHIES (U.S. CLS. 2, 27, 28 AND 50).

FIRST USE 12-0-2005; IN COMMERCE 12-0-2005.

CLASS 15—(Continued).

3,785,460. THINGS 4 STRINGS, LLC, WEST ORANGE, NJ. SN 77-495,913. PUB. 11-11-2008, FILED 6-11-2008.

Cellophant

THE MARK CONSISTS OF STANDARD CHARACTERS WITHOUT CLAIM TO ANY PARTICULAR FONT, STYLE, SIZE, OR COLOR.

FOR VIOLIN BOW HOLD TEACHING DEVICES (U.S. CLS. 2, 21 AND 36).

FIRST USE 8-16-2009; IN COMMERCE 8-16-2009.

3,785,510. ALFONSO ANNECCHIARICO, MONTEMIETTO, ITALY. SN 77-516,946. PUB. 12-2-2008, FILED 7-8-2008.

FROM OUR HANDS TO YOUR HANDS

CLASS 15—MUSICAL INSTRUMENTS

3,785,068. BALDWIN PIANO, INC., NASHVILLE, TN. SN 76-656,816. PUB. 11-28-2006, FILED 3-17-2006.

THE MARK CONSISTS OF STANDARD CHARACTERS WITHOUT CLAIM TO ANY PARTICULAR FONT, STYLE, SIZE, OR COLOR.

FOR MUSICAL INSTRUMENT STRINGS (U.S. CLS. 2, 21 AND 36).

FIRST USE 9-1-2009; IN COMMERCE 9-1-2009.

MIRACLE

CLASS 16—PAPER GOODS AND PRINTED MATTER

3,785,058. LUCASFILM LTD., SAN FRANCISCO, CA. SN 76-324,153. PUB. 10-23-2007, FILED 10-11-2001.

STAR WARS THE BOUNTY HUNTERS

THE MARK CONSISTS OF STANDARD CHARACTERS WITHOUT CLAIM TO ANY PARTICULAR FONT, STYLE, SIZE, OR COLOR.

FOR ELECTRONIC MUSICAL INSTRUMENTS, NAMELY, ELECTRONIC KEYBOARD INSTRUMENTS AND PRINTED AND ELECTRONIC TEACHING MATERIALS IN THE FIELD OF PIANO LESSONS AND OPERATING MANUALS SUPPLIED AS A UNIT (U.S. CLS. 2, 21 AND 36).

FIRST USE 1-1-1990; IN COMMERCE 1-1-1990.

FOR COMIC BOOKS (U.S. CLS. 2, 5, 22, 23, 29, 37, 38 AND 50).

FIRST USE 8-0-1999; IN COMMERCE 8-0-1999.

CLASS 16—(Continued).

3,785,089. JADE, LLC, NEEDHAM, MA. SN 76-692,931. PUB. 9-29-2009, FILED 9-17-2008.

DORIE WITT

THE MARK CONSISTS OF STANDARD CHARACTERS WITHOUT CLAIM TO ANY PARTICULAR FONT, STYLE, SIZE, OR COLOR.

THE NAME "DORIE WITT " IS THE NAME OF A FANCIFUL CHARACTER AND DOES NOT IDENTIFY A PARTICULAR LIVING INDIVIDUAL.

FOR PUBLICATIONS IN THE NATURE OF FICTIONAL NOVELS AND INSTRUCTIONAL AND EDUCATIONAL BOOKS FOR YOUNG ADULTS IN THE FIELD OF SOCIAL PROBLEMS (U.S. CLS. 2, 5, 22, 23, 29, 37, 38 AND 50).

FIRST USE 8-23-2009; IN COMMERCE 8-23-2009.

3,785,095. GROUP PUBLISHING, INC., LOVELAND, CO. SN 76-695,217. PUB. 5-5-2009, FILED 1-9-2009.

ULTIMATE DIRECTOR GO-TO GUIDE

THE MARK CONSISTS OF STANDARD CHARACTERS WITHOUT CLAIM TO ANY PARTICULAR FONT, STYLE, SIZE, OR COLOR.

NO CLAIM IS MADE TO THE EXCLUSIVE RIGHT TO USE "ULTIMATE DIRECTOR" AND "GUIDE", APART FROM THE MARK AS SHOWN.

FOR SERIES OF GUIDES AND MANUALS FEATURING CHRISTIAN EDUCATIONAL INFORMATION THAT ARE SOLD AS PART OF A MINISTRY KIT OR SEPARATELY TO BE USED IN CHURCHES AND OTHER CHRISTIAN EDUCATIONAL SETTINGS (U.S. CLS. 2, 5, 22, 23, 29, 37, 38 AND 50).

FIRST USE 11-30-2008; IN COMMERCE 12-31-2008.

3,785,099. ATLANTA NATIONAL LEAGUE BASEBALL CLUB, INC., ATLANTA, GA. SN 76-695,258. PUB. 5-5-2009, FILED 1-12-2009.

GWINNETT BRAVES

THE MARK CONSISTS OF STANDARD CHARACTERS WITHOUT CLAIM TO ANY PARTICULAR FONT, STYLE, SIZE, OR COLOR.

OWNER OF U.S. REG. NOS. 1,561,774, 1,596,052, AND OTHERS.

NO CLAIM IS MADE TO THE EXCLUSIVE RIGHT TO USE "GWINNETT", APART FROM THE MARK AS SHOWN.

FOR PAPER GOODS AND PRINTED MATTER, NAMELY, TRADING CARDS, POSTERS, STICKERS, DECALS, BUMPER STICKERS, SCORE BOOKS, SCORECARDS, PRINTED BASEBALL GAME PROGRAMS, MAGAZINES AND BOOKS FEATURING BASEBALL, NEWSLETTERS, BROCHURES AND PAMPHLETS FEATURING BASEBALL, SCRAPBOOKS, AUTOGRAPH BOOKS, CALENDARS, PENS, PENCILS (U.S. CLS. 2, 5, 22, 23, 29, 37, 38 AND 50).

FIRST USE 4-1-2009; IN COMMERCE 4-1-2009.

CLASS 16—(Continued).

3,785,100. GROUP PUBLISHING, INC., LOVELAND, CO. SN 76-695,547. PUB. 5-5-2009, FILED 2-2-2009.

GROUP 'S BUZZ

THE MARK CONSISTS OF STANDARD CHARACTERS WITHOUT CLAIM TO ANY PARTICULAR FONT, STYLE, SIZE, OR COLOR.

OWNER OF U.S. REG. NOS. 1,312,301, 3,411,987, AND OTHERS.

FOR MINISTRY KIT COMPOSED PRIMARILY OF PRINTED GUIDES AND ACTIVITY CARDS ALL FEATURING CHRISTIAN RELIGIOUS CURRICULUM AND DISTRIBUTING PRE-RECORDED AUDIO RECORDINGS AND EDUCATIONAL MATERIALS IN CONNECTION THEREWITH SOLD AS A UNIT; AND ACTIVITY CARDS FEATURING CHRISTIAN RELIGIOUS CURRICULUM SOLD SEPARATELY (U.S. CLS. 2, 5, 22, 23, 29, 37, 38 AND 50).

FIRST USE 12-31-2008; IN COMMERCE 6-30-2009.

3,785,129. PENNY-FARTHING PRESS, INC., HOUSTON, TX. SN 77-079,058. PUB. 8-21-2007, FILED 1-9-2007.

ANNE STEELYARD

THE MARK CONSISTS OF STANDARD CHARACTERS WITHOUT CLAIM TO ANY PARTICULAR FONT, STYLE, SIZE, OR COLOR.

THE NAME(S), PORTRAIT(S), AND/OR SIGNATURE(S) SHOWN IN THE MARK DOES NOT IDENTIFY A PARTICULAR LIVING INDIVIDUAL.

FOR SERIES OF FICTION BOOKS (U.S. CLS. 2, 5, 22, 23, 29, 37, 38 AND 50).

FIRST USE 1-13-2010; IN COMMERCE 1-13-2010.

3,785,141. BRISTOL-MYERS SQUIBB COMPANY, NEW YORK, NY. SN 77-134,259. PUB. 3-18-2008, FILED 3-19-2007.

OH, YES I CAN!

THE MARK CONSISTS OF STANDARD CHARACTERS WITHOUT CLAIM TO ANY PARTICULAR FONT, STYLE, SIZE, OR COLOR.

FOR PRINTED MATTER, NAMELY, PAMPHLETS AND BROCHURES RELATING TO HUMAN PHARMACEUTICALS (U.S. CLS. 2, 5, 22, 23, 29, 37, 38 AND 50).

FIRST USE 6-0-2008; IN COMMERCE 6-0-2008.

CLASS 16—(Continued).

3,785,157. ELUSEV, LLC, SALT LAKE CITY, UT. SN 77-176,567. PUB. 12-2-2008, FILED 5-9-2007.

ELUSEV

THE MARK CONSISTS OF STANDARD CHARACTERS WITHOUT CLAIM TO ANY PARTICULAR FONT, STYLE, SIZE, OR COLOR.

FOR STICKERS, DECALS, DECALCOMANIA, PLASTIC DECALS AND DECAL TRANSFERS; PRINTED ARTWORK FOR APPLICATION TO MOTOR VEHICLES; STICKERS AND DECALS FOR APPLICATION TO MOTOR VEHICLES AND ACCESSORIES THEREOF, AND STICKERS AND DECALS FOR APPLICATION TO SPORTS EQUIPMENT (U.S. CLS. 2, 5, 22, 23, 29, 37, 38 AND 50).

FIRST USE 3-13-2008; IN COMMERCE 3-13-2008.

3,785,322. INKTREE, INC., CHARLOTTESVILLE, VA. SN 77-391,190. PUB. 7-15-2008, FILED 2-7-2008.

ISEPACK

THE MARK CONSISTS OF STANDARD CHARACTERS WITHOUT CLAIM TO ANY PARTICULAR FONT, STYLE, SIZE, OR COLOR.

FOR PACKAGING CONTAINERS OF PAPER AND PAPER CONTAINERS COMPRISED OF PAPER AND PLASTIC MATERIALS DESIGNED TO LESSEN ADVERSE EFFECTS ON THE ENVIRONMENT (U.S. CLS. 2, 5, 22, 23, 29, 37, 38 AND 50).

FIRST USE 2-4-2009; IN COMMERCE 2-4-2009.

CLASS 16—(Continued).

3,785,417. THE KINSEY INSTITUTE FOR RESEARCH IN SEX, GENDER, AND REPRODUCTION, INC., BLOOMINGTON, IN. SN 77-473,236. PUB. 11-25-2008, FILED 5-13-2008.

KINSEY CONFIDENTIAL

THE MARK CONSISTS OF STANDARD CHARACTERS WITHOUT CLAIM TO ANY PARTICULAR FONT, STYLE, SIZE, OR COLOR.

FOR EDUCATIONAL AND ENTERTAINMENT PUBLICATIONS, NAMELY, ARTICLES, RESEARCH STUDIES, REPORTS, LETTERS, PRINTED INTERVIEW DOCUMENTS, PHOTOS, TEXTBOOKS, POSTERS, POSTCARDS IN THE FIELD OF HUMAN SEXUALITY, MEDICINE, PSYCHOLOGY, NEUROSCIENCE, BIOLOGY, GENDER STUDIES, SOCIOLOGY, HUMAN DEVELOPMENT, AND SOCIAL PSYCHOLOGY (U.S. CLS. 2, 5, 22, 23, 29, 37, 38 AND 50).

FIRST USE 0-0-2007; IN COMMERCE 0-0-2007.

3,785,418. THE KINSEY INSTITUTE FOR RESEARCH IN SEX, GENDER, AND REPRODUCTION, INC., BLOOMINGTON, IN. SN 77-473,304. PUB. 11-25-2008, FILED 5-13-2008.

THE KINSEY INSTITUTE FOR RESEARCH IN SEX, GENDER, AND REPRODUCTION

THE MARK CONSISTS OF STANDARD CHARACTERS WITHOUT CLAIM TO ANY PARTICULAR FONT, STYLE, SIZE, OR COLOR.

NO CLAIM IS MADE TO THE EXCLUSIVE RIGHT TO USE "INSTITUTE FOR RESEARCH IN SEX, GENDER, AND REPRODUCTION", APART FROM THE MARK AS SHOWN.

FOR EDUCATIONAL AND ENTERTAINMENT PUBLICATIONS, NAMELY, ARTICLES, RESEARCH STUDIES, REPORTS, LETTERS, PRINTED INTERVIEW DOCUMENTS, PHOTOS, TEXTBOOKS, POSTERS, POSTCARDS IN THE FIELD OF HUMAN SEXUALITY, PSYCHOLOGY, NEUROSCIENCE, BIOLOGY, GENDER STUDIES, SOCIOLOGY, HUMAN DEVELOPMENT, AND SOCIAL PSYCHOLOGY (U.S. CLS. 2, 5, 22, 23, 29, 37, 38 AND 50).

FIRST USE 0-0-1997; IN COMMERCE 0-0-1997.

CLASS 16—(Continued).

3,785,419. THE KINSEY INSTITUTE FOR RESEARCH IN SEX, GENDER, AND REPRODUCTION, INC., BLOOMINGTON, IN. SN 77-473,379. PUB. 11-25-2008, FILED 5-13-2008.

THE KINSEY INSTITUTE

THE MARK CONSISTS OF STANDARD CHARACTERS WITHOUT CLAIM TO ANY PARTICULAR FONT, STYLE, SIZE, OR COLOR.

NO CLAIM IS MADE TO THE EXCLUSIVE RIGHT TO USE "INSTITUTE", APART FROM THE MARK AS SHOWN.

FOR EDUCATIONAL AND ENTERTAINMENT PUBLICATIONS, NAMELY, ARTICLES, RESEARCH STUDIES, REPORTS, LETTERS, PRINTED INTERVIEW DOCUMENTS, PHOTOS, TEXTBOOKS, POSTERS, POSTCARDS IN THE FIELD OF HUMAN SEXUALITY, PSYCHOLOGY, NEUROSCIENCE, BIOLOGY, GENDER STUDIES, SOCIOLOGY, HUMAN DEVELOPMENT, AND SOCIAL PSYCHOLOGY (U.S. CLS. 2, 5, 22, 23, 29, 37, 38 AND 50).

FIRST USE 0-0-1983; IN COMMERCE 0-0-1983.

3,785,459. ANDREWS MCMEEL PUBLISHING, LLC, KANSAS CITY, MO. SN 77-495,503. PUB. 9-22-2009, FILED 6-10-2008.

ANIMOTION

THE MARK CONSISTS OF STANDARD CHARACTERS WITHOUT CLAIM TO ANY PARTICULAR FONT, STYLE, SIZE, OR COLOR.

FOR VIEWER FOR VIEWING PRINTED MEDIA WITH ELEMENTS THAT CONVEY MOVEMENT THROUGH NON-ELECTRICAL OPTICAL ILLUSIONS WHERE SUCH MEDIA AND VIEWER ARE SOLD AS A COMPONENT OF A GREETING CARD, BOOK, OR CALENDAR (U.S. CLS. 2, 5, 22, 23, 29, 37, 38 AND 50).

FIRST USE 6-15-2008; IN COMMERCE 9-16-2008.

CLASS 16—(Continued).

3,785,499. KRUGER INC., MONTREAL, CANADA. SN 77-512,053. PUB. 4-28-2009, FILED 7-1-2008.

GREENWHITE

THE MARK CONSISTS OF STANDARD CHARACTERS WITHOUT CLAIM TO ANY PARTICULAR FONT, STYLE, SIZE, OR COLOR.

FOR CORRUGATED CARDBOARD PACKAGING PRODUCTS TO BE USED INSIDE CONTAINERS, NAMELY, WHITE TOP LINERBOARD MAINLY USED IN THE PRODUCTION OF CORRUGATED CARDBOARD BOXES (U.S. CLS. 2, 5, 22, 23, 29, 37, 38 AND 50).

FIRST USE 2-18-2008; IN COMMERCE 2-18-2008.

3,785,624. ASSOCIATION FOR RESEARCH AND ENLIGHTENMENT, INC., VIRGINIA BEACH, VA. SN 77-578,817. PUB. 9-15-2009, FILED 9-25-2008.



NO CLAIM IS MADE TO THE EXCLUSIVE RIGHT TO USE "PRESS", APART FROM THE MARK AS SHOWN.

THE MARK CONSISTS OF THE WORDS "4TH DIMENSION" INSIDE AND AT THE TOP OF AN OVAL BORDER, WITH THE WORD "PRESS" AT THE BOTTOM OF THE OVAL BORDER; A SHADED OVAL WITH SUN RAYS IS INSIDE OVAL BORDER.

FOR BOOKS AND BROCHURES IN THE FIELDS OF SPIRITUALITY, INTUITION, PSYCHIC ABILITIES, PSYCHIC FUNCTIONING, ANCIENT MYSTERIES, PHILOSOPHY, COMPARATIVE RELIGIOUS STUDIES, AND PERSONAL AND SPIRITUAL DEVELOPMENT (U.S. CLS. 2, 5, 22, 23, 29, 37, 38 AND 50).

FIRST USE 1-1-2009; IN COMMERCE 1-1-2009.

CLASS 16—(Continued).

3,785,636. THE SMEAD MANUFACTURING COMPANY, HASTINGS, MN. SN 77-589,320. PUB. 2-17-2009, FILED 10-9-2008.



THE MARK CONSISTS OF TWO WINGNUT SHAPE DESIGNS PLACED PERPENDICULAR TO EACH OTHER. THE MARK CONSISTS OF A REPEATED PATTERN OF THE DRAWING ON THE GOODS. THE DRAWING IS A SINGLE REPETITION OF THIS DESIGN.

FOR OFFICE AND ORGANIZATIONAL SUPPLIES, NAMELY, FILE FOLDERS, FILE POCKETS, DOCUMENT FOLDERS IN THE FORM OF WALLETS AND EXPANDING FILES; FOLDERS; HANGING FOLDERS (U.S. CLS. 2, 5, 22, 23, 29, 37, 38 AND 50).

FIRST USE 3-0-2009; IN COMMERCE 3-0-2009.

3,785,658. FOOQUEENS, INC., JOHNSTON, IA. SN 77-603,299. PUB. 6-16-2009, FILED 10-29-2008.

GIFTGLOSS

THE MARK CONSISTS OF STANDARD CHARACTERS WITHOUT CLAIM TO ANY PARTICULAR FONT, STYLE, SIZE, OR COLOR.

FOR MATERIALS FOR WRAPPING AND PACKAGING, NAMELY, POLYPROPYLENE FILM AND PVC FILM USED AS GIFT PACKAGING (U.S. CLS. 2, 5, 22, 23, 29, 37, 38 AND 50).

FIRST USE 8-11-2009; IN COMMERCE 8-11-2009.

CLASS 16—(Continued).

3,785,687. BENJAMIN JOHN COLEMAN, PAWTUCKET, RI. SN 77-621,224. PUB. 4-7-2009, FILED 11-25-2008.

Origami Bonsai

THE MARK CONSISTS OF STANDARD CHARACTERS WITHOUT CLAIM TO ANY PARTICULAR FONT, STYLE, SIZE, OR COLOR.

NO CLAIM IS MADE TO THE EXCLUSIVE RIGHT TO USE "ORIGAMI", APART FROM THE MARK AS SHOWN. FOR CRAFT PAPER (U.S. CLS. 2, 5, 22, 23, 29, 37, 38 AND 50).

FIRST USE 2-4-2010; IN COMMERCE 2-4-2010.

3,785,744. WASIAK, MICHAEL, D., TOWSON, MD. SN 77-642,172. PUB. 4-21-2009, FILED 12-31-2008.

What's your bubble?

THE MARK CONSISTS OF STANDARD CHARACTERS WITHOUT CLAIM TO ANY PARTICULAR FONT, STYLE, SIZE, OR COLOR.

FOR BUMPER STICKERS; CALENDARS; DECALS; DESK CALENDARS; STICKERS; STICKERS AND TRANSFERS; VINYL LETTERS AND NUMBERS FOR USE IN MAKING VEHICLE WINDOW DECALS; WALL CALENDARS; VINYL TRANSFERS (U.S. CLS. 2, 5, 22, 23, 29, 37, 38 AND 50).

FIRST USE 1-1-2009; IN COMMERCE 11-20-2009.

3,785,823. D & K GROUP, INC., ELK GROVE VILLAGE, IL. SN 77-661,602. PUB. 10-27-2009, FILED 2-2-2009.

EXPRESSION

THE MARK CONSISTS OF STANDARD CHARACTERS WITHOUT CLAIM TO ANY PARTICULAR FONT, STYLE, SIZE, OR COLOR.

OWNER OF U.S. REG. NO. 2,606,849.

FOR LAMINATING MACHINES FOR NON-INDUSTRIAL USE IN COMMERCIAL AND ACADEMIC ESTABLISHMENTS, OFFICES AND HOMES (U.S. CLS. 2, 5, 22, 23, 29, 37, 38 AND 50).

FIRST USE 2-0-2000; IN COMMERCE 2-0-2000.

CLASS 16—(Continued).

3,785,871. CASSEN, MELODY V., NEW YORK, NY. SN 77-668,617. PUB. 6-16-2009, FILED 2-11-2009.

Melody V.

THE MARK CONSISTS OF STANDARD CHARACTERS WITHOUT CLAIM TO ANY PARTICULAR FONT, STYLE, SIZE, OR COLOR.

FOR BLANK JOURNAL BOOKS; BLANK OR PARTIALLY PRINTED POSTCARDS; BLANK PAPER NOTEBOOKS; BLANK WRITING JOURNALS; CALENDARS; CALENDARS AND DIARIES; FABRIC GIFT BAGS; GREETING CARDS; NOTEBOOKS; PAPER GIFT BAGS; PAPER NOTEBOOKS; POSTCARDS AND GREETING CARDS; PRINTED CALENDARS; WIRE-BOUND NOTEBOOKS (U.S. CLS. 2, 5, 22, 23, 29, 37, 38 AND 50).

FIRST USE 12-8-2009; IN COMMERCE 2-12-2010.

3,785,981. E. & R. WHARTON, LLC, PERRYSBURG, OH. SN 77-698,709. PUB. 8-18-2009, FILED 3-25-2009.

CREATEABLE LEARNING CONCEPTS

THE MARK CONSISTS OF STANDARD CHARACTERS WITHOUT CLAIM TO ANY PARTICULAR FONT, STYLE, SIZE, OR COLOR.

FOR DRAWING TEMPLATES (U.S. CLS. 2, 5, 22, 23, 29, 37, 38 AND 50).

FIRST USE 5-28-2009; IN COMMERCE 5-28-2009.

3,786,072. LEANIN' TREE INC., BOULDER, CO. SN 77-744,526. PUB. 10-6-2009, FILED 5-26-2009.

REAL WOMEN...REAL FUNNY!

THE MARK CONSISTS OF STANDARD CHARACTERS WITHOUT CLAIM TO ANY PARTICULAR FONT, STYLE, SIZE, OR COLOR.

FOR GREETING CARDS (U.S. CLS. 2, 5, 22, 23, 29, 37, 38 AND 50).

FIRST USE 1-1-2010; IN COMMERCE 1-1-2010.

CLASS 16—(Continued).

3,786,080. TYBOOK INC., KANSAS CITY, KS. SN 77-747,254. PUB. 10-6-2009, FILED 5-29-2009.

INDESTRUCTIBLES

THE MARK CONSISTS OF STANDARD CHARACTERS WITHOUT CLAIM TO ANY PARTICULAR FONT, STYLE, SIZE, OR COLOR.

FOR BABY BOOKS; CHILDREN'S ACTIVITY BOOKS; CHILDREN'S BOOKS; CHILDREN'S INTERACTIVE EDUCATIONAL BOOKS; PICTURE BOOKS; STORY BOOKS (U.S. CLS. 2, 5, 22, 23, 29, 37, 38 AND 50).

FIRST USE 5-30-2009; IN COMMERCE 6-1-2009.

3,786,095. VP CONSULTANTS, INC., OSPREY, FL. SN 77-753,233. PUB. 10-27-2009, FILED 6-5-2009.

Global Autism Treatment & Education Way

THE MARK CONSISTS OF STANDARD CHARACTERS WITHOUT CLAIM TO ANY PARTICULAR FONT, STYLE, SIZE, OR COLOR.

NO CLAIM IS MADE TO THE EXCLUSIVE RIGHT TO USE "GLOBAL AUTISM TREATMENT & EDUCATION", APART FROM THE MARK AS SHOWN.

FOR PRINTED INSTRUCTIONAL, EDUCATIONAL, AND TEACHING MATERIALS IN THE FIELD OF HEALTHY NUTRITION AND LIFESTYLE FOR AUTISM (U.S. CLS. 2, 5, 22, 23, 29, 37, 38 AND 50).

FIRST USE 10-16-2009; IN COMMERCE 10-16-2009.

CLASS 16—(Continued).

3,786,096. BOXOFVISION, LLC, BEVERLY HILLS, CA. SN 77-753,437. PUB. 10-20-2009, FILED 6-5-2009.



THE MARK CONSISTS OF A LARGE CAPITAL LETTER "B" FOLLOWED BY LOWER CASE LETTERS "O" AND "V" WITH THE "O" OVER THE "V".

FOR PRINTED MATTER, NAMELY, BOOKS IN THE FIELD OF MUSIC, ENTERTAINMENT AND BIOGRAPHIES (U.S. CLS. 2, 5, 22, 23, 29, 37, 38 AND 50).

FIRST USE 8-1-2009; IN COMMERCE 8-1-2009.

3,786,107. BARDIN & MARSEE PUBLISHING, BIRMINGHAM, AL. SN 77-756,597. PUB. 10-27-2009, FILED 6-10-2009.



NO CLAIM IS MADE TO THE EXCLUSIVE RIGHT TO USE "BIBLE", APART FROM THE MARK AS SHOWN.

THE MARK CONSISTS OF THE WORDING "WATERPROOF BIBLE" WITH THE LETTER "A" AS A CIRCULAR DROPLET DESIGN.

FOR SERIES OF PRINTED PUBLICATIONS, NAMELY, A SERIES OF BIBLES AND BIBLE STUDY MATERIALS (U.S. CLS. 2, 5, 22, 23, 29, 37, 38 AND 50).

FIRST USE 7-20-2009; IN COMMERCE 7-20-2009.

3,786,131. SCHOLASTIC INC., NEW YORK, NY. SN 77-763,781. PUB. 11-3-2009, FILED 6-19-2009.

PERFECTLY PRINCESS

THE MARK CONSISTS OF STANDARD CHARACTERS WITHOUT CLAIM TO ANY PARTICULAR FONT, STYLE, SIZE, OR COLOR.

FOR A SERIES OF BOOKS FOR CHILDREN (U.S. CLS. 2, 5, 22, 23, 29, 37, 38 AND 50).

FIRST USE 1-1-2010; IN COMMERCE 1-1-2010.

CLASS 16—(Continued).

3,786,184. DISNEY ENTERPRISES, INC., BURBANK, CA. SN 77-978,987. PUB. 4-28-2009, FILED 10-12-2007.

CAMP ROCK

THE MARK CONSISTS OF STANDARD CHARACTERS WITHOUT CLAIM TO ANY PARTICULAR FONT, STYLE, SIZE, OR COLOR.

OWNER OF U.S. REG. NO. 3,577,426.

SEC. 2(F).

FOR BOOKMARKS; CALENDARS; DECORATIVE PAPER CENTERPIECES; GREETING CARDS; PAPER PARTY DECORATIONS; PAPER NAPKINS; PAPER PARTY BAGS; POSTERS; PRINTED INVITATIONS; STICKERS; ADDRESS BOOKS; AUTOGRAPH BOOKS; A SERIES OF FICTION BOOKS; BOOKS FEATURING STORIES, GAMES AND ACTIVITIES FOR CHILDREN; CHILDREN'S ACTIVITY BOOKS; COLORING BOOKS; DIARIES; PHOTOGRAPH ALBUMS; BALL POINT PENS; DRY ERASE WRITING BOARDS AND WRITING SURFACES; FELT PENS; MEMO PADS; NOTEBOOKS; PENCILS; PEN AND PENCIL CASES AND BOXES; PENS (U.S. CLS. 2, 5, 22, 23, 29, 37, 38 AND 50).

FIRST USE 12-30-2009; IN COMMERCE 12-30-2009.

3,786,201. PSYCHOLOGICAL ASSESSMENT RESOURCES, INC., LUTZ, FL. SN 77-979,128. PUB. 12-9-2008, FILED 7-11-2008.



THE MARK CONSISTS OF STANDARD CHARACTERS WITHOUT CLAIM TO ANY PARTICULAR FONT, STYLE, SIZE, OR COLOR.

FOR PSYCHOLOGICAL TEST MATERIALS, NAMELY, PRINTED TESTS, PRINTED INSTRUCTIONAL MANUALS AND PRINTED SCORING SHEETS IN THE FIELD OF PSYCHOLOGICAL EVALUATION (U.S. CLS. 2, 5, 22, 23, 29, 37, 38 AND 50).

FIRST USE 2-5-2010; IN COMMERCE 2-5-2010.

3,786,223. HENKEL AG & CO. KGAA, DUESSELDORF, FED REP GERMANY. SN 78-610,110. PUB. 7-17-2007, FILED 4-15-2005.



OWNER OF U.S. REG. NOS. 981,467 AND 2,674,230.

CLASS 16—(Continued).

THE COLOR(S) RED AND WHITE IS/ARE CLAIMED AS A FEATURE OF THE MARK.

THE COLOR RED IS USED FOR THE WORD "HENKEL" AND FOR THE OVAL SURROUNDING THE WORD. THE COLOR WHITE APPEARS INSIDE THE OVAL, AND AS BACKGROUND FOR THE WORDING.

SEC. 2(F).

FOR HOUSE MARK FOR A LINE OF HOUSEHOLD ADHESIVES; HOUSE MARK FOR A LINE OF SCHOOL, CRAFT AND ART SUPPLIES, NAMELY, ADHESIVE TAPES FOR STATIONERY PURPOSES, ADHESIVES FOR DO-IT-YOURSELF AND HOUSEHOLD PURPOSES, GLUES; ADHESIVE TAPES AND ADHESIVE TAPE DISPENSERS FOR HOUSEHOLD AND STATIONERY USE, CORRECTING TAPE FOR DOCUMENTS (U.S. CLS. 2, 5, 22, 23, 29, 37, 38 AND 50).

FIRST USE 5-31-2005; IN COMMERCE 5-31-2005.

3,786,238. PAYTON, PAUL MAX, SAN FRANCISCO, CA. SN 78-692,410. PUB. 12-12-2006, FILED 8-15-2005.

PIXTILE

THE MARK CONSISTS OF STANDARD CHARACTERS WITHOUT CLAIM TO ANY PARTICULAR FONT, STYLE, SIZE, OR COLOR.

FOR CALENDARS (U.S. CLS. 2, 5, 22, 23, 29, 37, 38 AND 50).

FIRST USE 12-1-2009; IN COMMERCE 12-1-2009.

3,786,244. COONS, SUSAN A., NORTH BEND, OR. SN 78-710,354. PUB. 5-23-2006, FILED 9-9-2005.

The Lighthouse Mouse

THE MARK CONSISTS OF STANDARD CHARACTERS WITHOUT CLAIM TO ANY PARTICULAR FONT, STYLE, SIZE, OR COLOR.

FOR CHILDREN'S BOOKS (U.S. CLS. 2, 5, 22, 23, 29, 37, 38 AND 50).

FIRST USE 1-8-2007; IN COMMERCE 10-6-2009.

CLASS 16—(Continued).

3,786,268. BARCROFT, SUSAN, BARRINGTON, IL. SN 78-836,336. PUB. 7-3-2007, FILED 3-14-2006.

THE LORD'S LIBRARY

THE MARK CONSISTS OF STANDARD CHARACTERS WITHOUT CLAIM TO ANY PARTICULAR FONT, STYLE, SIZE, OR COLOR.

NO CLAIM IS MADE TO THE EXCLUSIVE RIGHT TO USE "LIBRARY", APART FROM THE MARK AS SHOWN.

FOR PRINTED PUBLICATIONS, NAMELY, BOOKS IN THE FIELD OF RELIGION, NOTE CARDS, AND MINI BOOKS AND BOOKLETS IN THE FIELD OF RELIGION (U.S. CLS. 2, 5, 22, 23, 29, 37, 38 AND 50).

FIRST USE 12-31-2007; IN COMMERCE 12-31-2007.

3,786,294. PACANA, GENEVIEVE D., GLENDALE, CA. SN 78-874,952. PUB. 12-5-2006, FILED 5-3-2006.

rollbox

THE MARK CONSISTS OF STANDARD CHARACTERS WITHOUT CLAIM TO ANY PARTICULAR FONT, STYLE, SIZE, OR COLOR.

FOR PAPER AND CARDBOARD; PAPER BOXES; PAPER CONTAINERS; PAPER LABELS; PAPER STATIONERY; PRINTED PAPER LABELS (U.S. CLS. 2, 5, 22, 23, 29, 37, 38 AND 50).

FIRST USE 8-1-2009; IN COMMERCE 8-1-2009.

3,786,340. RUDNICK, ARNOLD H., SHERMAN OAKS, CA. SN 78-981,213. PUB. 8-8-2006, FILED 12-9-2005.

E. S. PETE

THE MARK CONSISTS OF STANDARD CHARACTERS WITHOUT CLAIM TO ANY PARTICULAR FONT, STYLE, SIZE, OR COLOR.

THE NAME "E.S. PETE" DOES NOT IDENTIFY A LIVING INDIVIDUAL.

FOR CHILDREN'S BOOKS FEATURING PARANORMAL SUBJECTS, NAMELY, EXTRASENSORY PERCEPTION AND PARAPSYCHOLOGY; SERIES OF FICTION BOOKS IN THE FIELD OF PARANORMAL SUBJECTS, NAMELY, EXTRASENSORY PERCEPTION AND PARAPSYCHOLOGY (U.S. CLS. 2, 5, 22, 23, 29, 37, 38 AND 50).

FIRST USE 11-8-2005; IN COMMERCE 9-12-2008.

CLASS 17—RUBBER GOODS

3,785,104. NATIONAL CRAFT INDUSTRIES, INC., LIN KO HSIAN, TAIPEI, TAIWAN. SN 76-697,766. PUB. 10-20-2009, FILED 6-5-2009.

NCI

FOR WATER DISTRIBUTION SYSTEMS COMPRISING NON-METAL TUBING AND TUBING COUPLINGS, NAMELY, FITTINGS, MANIFOLDS, AND VALVES FOR JOINING AND TERMINATING THE TUBING, AND INSULATION TOOLS THEREFOR, SOLD AS A UNIT; WATER DISTRIBUTION SYSTEMS COMPRISING COMPOSITE TUBING CONSISTING PRIMARILY OF NON-METAL TUBING AND TUBING COUPLINGS, NAMELY, FITTINGS, MANIFOLDS, AND VALVES FOR JOINING AND TERMINATING THE TUBING, AND INSTALLATION TOOLS THEREFOR, SOLD AS A UNIT (U.S. CLS. 1, 5, 12, 13, 35 AND 50).

FIRST USE 7-2-2009; IN COMMERCE 7-2-2009.

3,785,205. PEM AMERICA, INC., NEW YORK, NY. SN 77-256,806. PUB. 1-22-2008, FILED 8-16-2007.

ARCTIC SHIELD

THE MARK CONSISTS OF STANDARD CHARACTERS WITHOUT CLAIM TO ANY PARTICULAR FONT, STYLE, SIZE, OR COLOR.

FOR SYNTHETIC FILLING MATERIALS FOR BEDDING GOODS, NAMELY, STUFFING COMPOSED OF POLYESTER, POLYETHYLENE, RUBBER OR PLASTIC FOR DECORATIVE PILLOWS, CUSHIONS, COMFORTERS, DUVETS, BLANKETS, THROWS, COVERLETS, FIBER BEDS AND MATTRESS PADS (U.S. CLS. 1, 5, 12, 13, 35 AND 50).

FIRST USE 7-20-2008; IN COMMERCE 7-20-2008.

3,785,214. J.G. STAREW INNOVATIVE SOLUTIONS, L.L.C., TOMAHAWK, WI. SN 77-279,041. PUB. 9-15-2009, FILED 9-13-2007.

EZ Route

NO CLAIM IS MADE TO THE EXCLUSIVE RIGHT TO USE "EASY ROUTE", APART FROM THE MARK AS SHOWN.

CLASS 17—(Continued).

THE MARK CONSISTS OF A STYLIZED TEXT OF THE WORDS "EZ ROUTE" WITH AN UNDERLINE THAT CURVES UP NEXT TO THE "E" IN "ROUTE".

FOR MULTI-PASSAGE PLASTIC CONDUIT FOR PLUMBING USES IN ASSOCIATION WITH DOMESTIC WATER SUPPLY APPLICATIONS; MULTI-PASSAGE PLASTIC CONDUIT USED IN HYDRONIC IN-FLOOR HEATING SYSTEMS (U.S. CLS. 1, 5, 12, 13, 35 AND 50).

FIRST USE 8-1-2007; IN COMMERCE 8-1-2007.

3,785,569. LAUREN MANUFACTURING COMPANY, NEW PHILADELPHIA, OH. SN 77-538,794. PUB. 6-23-2009, FILED 8-4-2008.

IDEA

THE MARK CONSISTS OF STANDARD CHARACTERS WITHOUT CLAIM TO ANY PARTICULAR FONT, STYLE, SIZE, OR COLOR.

FOR FLEXIBLE NON-METALLIC TWO-COMPONENT DOOR SEALS WITH A HARDER MOUNTING BODY AND A SOFTER SEALING BODY (U.S. CLS. 1, 5, 12, 13, 35 AND 50).

FIRST USE 4-30-2009; IN COMMERCE 4-30-2009.

3,785,651. GATOR HOSE LLC, TULSA, OK. SN 77-601,389. PUB. 3-31-2009, FILED 10-27-2008.



NO CLAIM IS MADE TO THE EXCLUSIVE RIGHT TO USE "HOSE", APART FROM THE MARK AS SHOWN.

THE MARK CONSISTS OF THE WORDS "GATOR HOSE" WITH THE DESIGN OF AN ALLIGATOR APPEARING BETWEEN THE TWO WORDS.

FOR INDUSTRIAL HOSES MADE OF RUBBER AND COMPOSITE MATERIALS FOR USE IN MINING, OIL-FIELD, CHEMICAL, MARINE, AND CONSTRUCTION VEHICLE INDUSTRIES (U.S. CLS. 1, 5, 12, 13, 35 AND 50).

FIRST USE 12-11-2009; IN COMMERCE 12-11-2009.

CLASS 17—(Continued).

3,785,742. BLRP, L.L.C., BANGOR, MI. SN 77-641,289. PUB. 4-28-2009, FILED 12-30-2008.

VERSAPOLY

THE MARK CONSISTS OF STANDARD CHARACTERS WITHOUT CLAIM TO ANY PARTICULAR FONT, STYLE, SIZE, OR COLOR.

FOR LOW FRICTION POLYMER LAMINATES FOR USE IN THE MANUFACTURE OF RAIL CAR COVER SLIDE GATES, CONVEYOR BELT SLIDE PLATES, COAL CAR LINERS, STORAGE TANKS, COATING DRUMS, VIBRATORY CONVEYOR PANS, HORIZONTAL MOTION CONVEYOR PANS, THROUGH-PUT TUBES, TRANSITION CHUTES, FORMING TUBES AND COLLARS (U.S. CLS. 1, 5, 12, 13, 35 AND 50).

FIRST USE 7-31-2009; IN COMMERCE 7-31-2009.

3,785,953. CRYOVAC, INC., ELMWOOD PARK, NJ. SN 77-688,648. PUB. 7-14-2009, FILED 3-11-2009.

MULTI-SEAL

THE MARK CONSISTS OF STANDARD CHARACTERS WITHOUT CLAIM TO ANY PARTICULAR FONT, STYLE, SIZE, OR COLOR.

FOR PLASTIC FILMS FOR PACKAGING FOR FOOD (U.S. CLS. 1, 5, 12, 13, 35 AND 50).

FIRST USE 12-23-2009; IN COMMERCE 12-23-2009.

3,786,255. SHURTAPE TECHNOLOGIES, LLC, HICKORY, NC. SN 78-769,451. PUB. 7-11-2006, FILED 12-8-2005.

SHURCLEAR

THE MARK CONSISTS OF STANDARD CHARACTERS WITHOUT CLAIM TO ANY PARTICULAR FONT, STYLE, SIZE, OR COLOR.

OWNER OF U.S. REG. NOS. 623,323, 2,310,146, AND 2,595,476.

FOR PRESSURE SENSITIVE ADHESIVE TAPE FOR INDUSTRIAL AND COMMERCIAL USE (U.S. CLS. 1, 5, 12, 13, 35 AND 50).

FIRST USE 12-0-2009; IN COMMERCE 12-0-2009.

CLASS 17—(Continued).

3,786,347. IBCO SRL, ST. MICHAEL, BARBADOS. SN 78-981,357. PUB. 9-22-2009, FILED 4-4-2006.

TITANIUM

THE MARK CONSISTS OF STANDARD CHARACTERS WITHOUT CLAIM TO ANY PARTICULAR FONT, STYLE, SIZE, OR COLOR.

FOR FLEXIBLE PLASTIC MEMBRANES FOR CONSTRUCTION APPLICATIONS, NAMELY, ROOFING UNDERLAYMENT (U.S. CLS. 1, 5, 12, 13, 35 AND 50).

FIRST USE 10-31-2002; IN COMMERCE 10-31-2002.

CLASS 18—LEATHER GOODS

3,785,072. JAH INNOVATIONS INC., ATLANTA, GA. SN 76-660,350. PUB. 9-4-2007, FILED 5-22-2006.

FORBIDDEN CASE

NO CLAIM IS MADE TO THE EXCLUSIVE RIGHT TO USE "CASE", APART FROM THE MARK AS SHOWN.

THE MARK CONSISTS OF STANDARD CHARACTERS WITHOUT CLAIM TO ANY PARTICULAR FONT STYLE, SIZE, OR COLOR.

FOR LEATHER SOLD IN BULK; LEATHER AND IMITATION LEATHER TRAVELING BAGS AND TRUNKS; LUGGAGE, NAMELY, SHOE TRAVEL CARRYING CASE (U.S. CLS. 1, 2, 3, 22 AND 41).

FIRST USE 10-1-2009; IN COMMERCE 10-1-2009.

3,785,261. V. FAUCHEUX, LLC, LOS ANGELES, CA. SN 77-341,394. PUB. 11-4-2008, FILED 11-30-2007.

VONNY

THE MARK CONSISTS OF STANDARD CHARACTERS WITHOUT CLAIM TO ANY PARTICULAR FONT, STYLE, SIZE, OR COLOR.

FOR BAGS, NAMELY, ALL-PURPOSE CARRYING BAGS AND TRAVEL BAGS; ALL-PURPOSE SPORT BAGS; HOLDALLS; WALLETS; MULTI-PURPOSE PURSES; HANDBAGS; OVERNIGHT BAGS; TRAVELING BAGS; BEACH BAGS; SHOPPING BAGS NOT MADE OF PAPER, NAMELY, TEXTILE SHOPPING BAGS; MARKET TOTES, NAMELY, TOTE BAGS; WINE BOTTLE BAGS WITH HANDLES FOR CARRYING OR HOLDING WINE; TOTE BAGS; SHOULDER BAGS; COSMETIC CASES SOLD EMPTY; DUFFEL BAGS; FANNY PACKS; BABY CARE BAGS SOLD EMPTY AND DIAPER BAGS (U.S. CLS. 1, 2, 3, 22 AND 41).

FIRST USE 8-14-2009; IN COMMERCE 8-14-2009.

CLASS 18—(Continued).

3,785,286. D'ANDREA, NICOLE L., LINCOLN, RI. SN 77-367,774. PUB. 5-27-2008, FILED 1-9-2008.

D'ANDREA

THE MARK CONSISTS OF STANDARD CHARACTERS WITHOUT CLAIM TO ANY PARTICULAR FONT, STYLE, SIZE, OR COLOR.

FOR HANDBAGS (U.S. CLS. 1, 2, 3, 22 AND 41).
FIRST USE 1-4-2010; IN COMMERCE 1-4-2010.

3,785,463. WILLIAM SCOTT CARTER, NORWALK, CT. SN 77-497,488. PUB. 4-28-2009, FILED 6-12-2008.

TAGWRAP

THE MARK CONSISTS OF STANDARD CHARACTERS WITHOUT CLAIM TO ANY PARTICULAR FONT, STYLE, SIZE, OR COLOR.

FOR CUSTOMER IDENTIFICATION CARD HOLDER FOR ENCLOSING ONE OR MORE SUCH CARDS, NAMELY, CARD CASES, WHICH ARE MADE OUT OF RUBBER, PAPER, CARDBOARD, PAPERBOARD, LEATHER, FAUX LEATHER, VINYL, SUEDE, PLASTIC, CLOSED CELL FOAM, CANVAS, CLOTH, RIBBONS, SATIN, SHEET METAL AND PVC (U.S. CLS. 1, 2, 3, 22 AND 41).

FIRST USE 6-1-2009; IN COMMERCE 6-1-2009.

3,785,654. TAYMOUR, HILLARY A., ROLLING HILLS ESTATES, CA. SN 77-602,334. PUB. 3-17-2009, FILED 10-28-2008.

COLLINA STRADA

THE MARK CONSISTS OF STANDARD CHARACTERS WITHOUT CLAIM TO ANY PARTICULAR FONT, STYLE, SIZE, OR COLOR.

THE FOREIGN WORDING IN THE MARK TRANSLATES INTO ENGLISH AS HILL STREET.

FOR HANDBAGS, PURSES AND WALLETS (U.S. CLS. 1, 2, 3, 22 AND 41).

FIRST USE 7-30-2009; IN COMMERCE 7-30-2009.

CLASS 18—(Continued).

3,785,693. BARK, HOP AND MEOW, INC., DBA MY DOG COLLARS, COLUMBIA, MO. SN 77-623,044. PUB. 5-12-2009, FILED 11-27-2008.



NO CLAIM IS MADE TO THE EXCLUSIVE RIGHT TO USE "DOG COLLARS.COM", APART FROM THE MARK AS SHOWN.

THE COLOR(S) GREEN, PINK AND BLACK IS/ARE CLAIMED AS A FEATURE OF THE MARK.

THE MARK CONSISTS OF A DOG WITH A BLACK BODY AND A GREEN COLLAR, FOLLOWED BY THE PHRASE, "MY DOG COLLARS.COM" IN PINK.

FOR COLLARS FOR PETS; DOG COLLARS; DOG COLLARS AND LEADS (U.S. CLS. 1, 2, 3, 22 AND 41).
FIRST USE 4-14-2009; IN COMMERCE 5-18-2009.

3,785,696. SHANNON GREENFIELD, LAS VEGAS, NV. SN 77-624,252. PUB. 6-9-2009, FILED 12-1-2008.



THE COLOR(S) BLACK, WHITE, GOLD, GREEN, VIOLET AND BLUE IS/ARE CLAIMED AS A FEATURE OF THE MARK.

THE MARK CONSISTS OF A BLACK SQUARE THAT CONTAINS IN WHITE LETTERS "WAL", AN ADJACENT GOLD RECTANGLE THAT CONTAINS A WHITE LETTER "L", AN ADJACENT GREEN RECTANGLE THAT CONTAINS A WHITE LETTER "O", AN ADJACENT VIOLET RECTANGLE THAT CONTAINS A WHITE LETTER "T" AND AN ADJACENT BLUE RECTANGLE THAT CONTAINS A WHITE LETTER "S".

FOR BACKPACKS, BOOK BAGS, SPORTS BAGS, BUM BAGS, WALLETS AND HANDBAGS; HANDBAGS, PURSES AND WALLETS; LEATHER BAGS AND WALLETS; LEATHER BAGS, SUITCASES AND WALLETS; PURSES AND WALLETS; WALLETS; WALLETS AND WALLET INSERTS; WALLETS MADE OF LEATHER OR OTHER MATERIALS; WALLETS WITH CARD COMPARTMENTS (U.S. CLS. 1, 2, 3, 22 AND 41).

FIRST USE 4-1-2007; IN COMMERCE 12-11-2009.

CLASS 18—(Continued).

3,786,000. ZERDOUN, BRUNO, MIAMI, FL. SN 77-707,266.
PUB. 8-11-2009, FILED 4-6-2009.

Comsi-Comsa

THE MARK CONSISTS OF STANDARD CHARACTERS WITHOUT CLAIM TO ANY PARTICULAR FONT, STYLE, SIZE, OR COLOR.

THE WORDING "COMSI COMSA" IS THE PHONETIC EQUIVALENT OF THE FRENCH WORDING COMME CI, COMME CA, WHICH IS TRANSLATED INTO ENGLISH AS SO-SO.

FOR HANDBAGS (U.S. CLS. 1, 2, 3, 22 AND 41).
FIRST USE 8-15-2009; IN COMMERCE 8-15-2009.

3,786,081. ETHEL RUDOLPH, SAFETY HARBOR, FL. SN 77-747,868. PUB. 10-20-2009, FILED 5-29-2009.

DawggieGoPak

THE MARK CONSISTS OF STANDARD CHARACTERS WITHOUT CLAIM TO ANY PARTICULAR FONT, STYLE, SIZE, OR COLOR.

FOR PET ACCESSORIES, NAMELY, SPECIALLY DESIGNED HAND BAGS FOR HOLDING SMALL ITEMS SUCH AS KEYS, CREDIT CARDS, MONEY, WALLETS AND DISPOSABLE BAGS FOR DISPOSING OF PET WASTE (U.S. CLS. 1, 2, 3, 22 AND 41).

FIRST USE 1-6-2010; IN COMMERCE 1-6-2010.

3,786,161. UNITED STATES POSTAL SERVICE, WASHINGTON, DC. SN 77-977,610. PUB. 10-30-2007, FILED 1-29-2007.

AIR MAIL

THE MARK CONSISTS OF STANDARD CHARACTERS WITHOUT CLAIM TO ANY PARTICULAR FONT, STYLE, SIZE, OR COLOR.

FOR HANDBAGS, WALLETS, PURSES, LUGGAGE TAGS (U.S. CLS. 1, 2, 3, 22 AND 41).
FIRST USE 2-0-2008; IN COMMERCE 2-0-2008.

CLASS 18—(Continued).

3,786,250. IROQUOIS HOLDING COMPANY, NASHVILLE, TN. SN 78-730,723. PUB. 12-19-2006, FILED 10-11-2005.

LOVE HANDLES

THE MARK CONSISTS OF STANDARD CHARACTERS WITHOUT CLAIM TO ANY PARTICULAR FONT, STYLE, SIZE, OR COLOR.

FOR LUGGAGE AND STRAPS FOR LUGGAGE (U.S. CLS. 1, 2, 3, 22 AND 41).

FIRST USE 3-12-2010; IN COMMERCE 3-12-2010.

3,786,276. WORLDWISE INC., SAN RAFAEL, CA. SN 78-843,632. PUB. 12-12-2006, FILED 3-22-2006.

CATNIP ATTRACTION SYSTEM

THE MARK CONSISTS OF STANDARD CHARACTERS WITHOUT CLAIM TO ANY PARTICULAR FONT, STYLE, SIZE, OR COLOR.

NO CLAIM IS MADE TO THE EXCLUSIVE RIGHT TO USE "CATNIP" AND "SYSTEM", APART FROM THE MARK AS SHOWN.

FOR CAT SCRATCHING PADS (U.S. CLS. 1, 2, 3, 22 AND 41).

FIRST USE 6-29-2006; IN COMMERCE 6-29-2006.

3,786,344. STANLEY LOGISTICS, L.L.C., NEW BRITAIN, CT. SN 78-981,327. PUB. 5-15-2007, FILED 4-26-2006.

FATMAX XTREME

THE MARK CONSISTS OF STANDARD CHARACTERS WITHOUT CLAIM TO ANY PARTICULAR FONT, STYLE, SIZE, OR COLOR.

OWNER OF U.S. REG. NO. 2,525,588.

FOR CARRY-ALL BAGS, NAMELY, SOFT-SIDED STORAGE BAGS, TOOL BAGS SOLD EMPTY, AND TOOL POUCHES SOLD EMPTY (U.S. CLS. 1, 2, 3, 22 AND 41).

FIRST USE 10-1-2006; IN COMMERCE 10-1-2006.

CLASS 19—NON-METALLIC BUILDING MATERIALS

CLASS 19—(Continued).

3,785,292. MASONITE INTERNATIONAL CORPORATION, MISSISSAUGA, CANADA. SN 77-370,513. PUB. 12-9-2008, FILED 1-14-2008.

WOODBIDGE

THE MARK CONSISTS OF STANDARD CHARACTERS WITHOUT CLAIM TO ANY PARTICULAR FONT, STYLE, SIZE, OR COLOR.

FOR DOOR LITES, SIDE LITES, TRANSOM LITES, ALL IN THE NATURE OF GLASS AND PLASTIC PANELS FOR DOORS AND DOOR AREAS; DECORATIVE GLASS FOR BUILDING USE (U.S. CLS. 1, 12, 33 AND 50).

FIRST USE 6-1-2002; IN COMMERCE 2-24-2010.

3,785,326. NEWBAY MEDIA LLC, NEW YORK, NY. SN 77-393,429. PUB. 12-30-2008, FILED 2-11-2008.



THE MARK CONSISTS OF AN IMAGE OF A MAN PLAYING A GUITAR.

FOR PLAQUES MADE OF PRIMARILY ENGRAVED AND CUT STONE (U.S. CLS. 1, 12, 33 AND 50).

FIRST USE 9-13-2008; IN COMMERCE 9-13-2008.

3,785,486. COSENTINO, S.A., MACAEL (ALMERIA), SPAIN. SN 77-509,228. PUB. 6-23-2009, FILED 6-26-2008.



OWNER OF U.S. REG. NOS. 2,331,597, 3,335,331, AND OTHERS.

THE COLOR(S) RED, BLACK, GREY AND WHITE IS/ARE CLAIMED AS A FEATURE OF THE MARK.

THE MARK CONSISTS OF A RECTANGULAR DESIGN. ON THE FAR RIGHT HAND SIDE OF THE RECTANGU-

CLASS 19—(Continued).

LAR DESIGN IS A RED SQUARE DESIGN. THE WORDING "SILESTONE BY COSENTINO" IS ENCLOSED WITHIN THE RECTANGULAR DESIGN, AND A STYLIZED "S" IS ENCLOSED WITHIN THE SQUARE DESIGN, WHICH IS IN TURN ENCLOSED WITHIN THE RECTANGULAR DESIGN. THE WORDING "SILESTONE" IS IN BLACK; THE BORDER OF THE RECTANGULAR DESIGN AND THE WORDING "BY COSENTINO" ARE IN GREY; AND THE LETTER "S", AS WELL AS THE BACKGROUND OF THE RECTANGULAR DESIGN, ARE IN WHITE.

FOR NON-METALLIC BUILDING MATERIALS, NAMELY, AGGLOMERATION STONES (U.S. CLS. 1, 12, 33 AND 50).

FIRST USE 4-0-2000; IN COMMERCE 4-0-2000.

3,785,599. OLDCASTLE ARCHITECTURAL, INC., ATLANTA, GA. SN 77-558,681. PUB. 12-30-2008, FILED 8-29-2008.

STRATUS

THE MARK CONSISTS OF STANDARD CHARACTERS WITHOUT CLAIM TO ANY PARTICULAR FONT, STYLE, SIZE, OR COLOR.

FOR CONCRETE EDGERS USED IN CONNECTION WITH LANDSCAPING AND HARDSCAPES (U.S. CLS. 1, 12, 33 AND 50).

FIRST USE 4-1-2009; IN COMMERCE 4-1-2009.

3,785,619. JOHN MOORE SERVICES INC., HOUSTON, TX. SN 77-574,655. PUB. 4-14-2009, FILED 9-19-2008.

THERMALOCK

THE MARK CONSISTS OF STANDARD CHARACTERS WITHOUT CLAIM TO ANY PARTICULAR FONT, STYLE, SIZE, OR COLOR.

FOR VINYL WINDOWS (U.S. CLS. 1, 12, 33 AND 50).

FIRST USE 1-25-2009; IN COMMERCE 1-25-2009.

CLASS 19—(Continued).

3,785,669. CEVN CORP., SOMERSET, NJ. SN 77-609,570. PUB. 6-9-2009, FILED 11-7-2008.

CEVN

THE MARK CONSISTS OF STANDARD CHARACTERS WITHOUT CLAIM TO ANY PARTICULAR FONT, STYLE, SIZE, OR COLOR.

FOR REINFORCED CELLULAR POLY-VINYL CHLORIDE DECK BOARDS (U.S. CLS. 1, 12, 33 AND 50). FIRST USE 9-17-2009; IN COMMERCE 9-17-2009.

3,785,998. MAGNESITAS NAVARRAS S.A., ZUBIRI (NAVARRA), SPAIN. SN 77-705,988. PUB. 8-4-2009, FILED 4-3-2009.

COLDMAG

THE MARK CONSISTS OF STANDARD CHARACTERS WITHOUT CLAIM TO ANY PARTICULAR FONT, STYLE, SIZE, OR COLOR.

FOR MAGNESITE REFRACTORIES MATERIALS (U.S. CLS. 1, 12, 33 AND 50). FIRST USE 10-14-2009; IN COMMERCE 10-14-2009.

3,786,051. KRONOTEX U.S.A. HOLDINGS, INC., BARNWELL, SC. SN 77-733,464. PUB. 10-27-2009, FILED 5-11-2009.



NO CLAIM IS MADE TO THE EXCLUSIVE RIGHT TO USE "VIBRANT FINISH" AND "ENHANCED COLOR TONES", APART FROM THE MARK AS SHOWN.

THE MARK CONSISTS OF AN ASYMMETRICAL STARBURST WITH THE STYLIZED WORDS "VIBRANT FINISH" AND "ENHANCED COLOR TONES" DISPLAYED IN THE CENTER OF THE STARBURST.

FOR LAMINATE FLOORING (U.S. CLS. 1, 12, 33 AND 50). FIRST USE 7-1-2009; IN COMMERCE 7-1-2009.

CLASS 20—FURNITURE AND ARTICLES NOT OTHERWISE CLASSIFIED

3,785,167. GROUP LACASSE INC., ST-PIE, CANADA. SN 77-200,012. PUB. 11-11-2008, FILED 6-7-2007.

ONYX

THE MARK CONSISTS OF STANDARD CHARACTERS WITHOUT CLAIM TO ANY PARTICULAR FONT, STYLE, SIZE, OR COLOR.

PRIORITY CLAIMED UNDER SEC. 44(D) ON CANADA APPLICATION NO. 1327436, FILED 12-8-2006, REG. NO. TMA706151, DATED 1-30-2008, EXPIRES 1-30-2023.

FOR OFFICE FURNITURE (U.S. CLS. 2, 13, 22, 25, 32 AND 50).

FIRST USE 0-0-1991; IN COMMERCE 0-0-1991.

3,785,203. STANDARD CAR TRUCK COMPANY, PARK RIDGE, IL. SN 77-254,407. PUB. 6-24-2008, FILED 8-14-2007.

STA-PUT

THE MARK CONSISTS OF STANDARD CHARACTERS WITHOUT CLAIM TO ANY PARTICULAR FONT, STYLE, SIZE, OR COLOR.

FOR PLASTIC PARTS, NAMELY, FASTENERS, CLASPS, BRACKETS, RESTRAINTS, AND CHOCKS USED TO SECURE PRODUCTS TRANSPORTED BY RAILROAD CARS (U.S. CLS. 2, 13, 22, 25, 32 AND 50).

FIRST USE 2-1-2010; IN COMMERCE 2-1-2010.

3,785,318. I CARE SLEEP, LLC, HIGH POINT, NC. SN 77-389,708. PUB. 4-28-2009, FILED 2-6-2008.

PEACE AND QUIET PILLOW

THE MARK CONSISTS OF STANDARD CHARACTERS WITHOUT CLAIM TO ANY PARTICULAR FONT, STYLE, SIZE, OR COLOR.

NO CLAIM IS MADE TO THE EXCLUSIVE RIGHT TO USE "PILLOW", APART FROM THE MARK AS SHOWN. FOR PILLOWS (U.S. CLS. 2, 13, 22, 25, 32 AND 50). FIRST USE 11-29-2007; IN COMMERCE 11-29-2007.

CLASS 20—(Continued).

3,785,355. FAROUKI, INGRID T., DBA DESIGNS BY INGRID. SPRINGFIELD, MO. SN 77-421,402. PUB. 5-5-2009, FILED 3-13-2008.

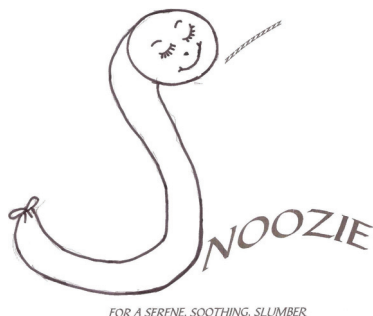

THE MARK CONSISTS OF FIRST LETTER IN "SNOOZIE" IS AN "S" WITH A SLEEPY FACE.

FOR HEAD SUPPORTING PILLOWS; NECK SUPPORT CUSHIONS; NECK-SUPPORTING PILLOWS (U.S. CLS. 2, 13, 22, 25, 32 AND 50).

FIRST USE 3-31-2008; IN COMMERCE 3-31-2008.

CLASS 20—(Continued).

3,785,359. MOOD AUSTRALIA PTY LTD, LEICHHARDT NSW 2040, AUSTRALIA. SN 77-424,227. PUB. 6-2-2009, FILED 3-17-2008.

MOOD

THE MARK CONSISTS OF STANDARD CHARACTERS WITHOUT CLAIM TO ANY PARTICULAR FONT, STYLE, SIZE, OR COLOR.

FOR ANIMAL HORN AND ANTLERS; STAG ANTLERS; ANIMAL HORN, UNWORKED OR SEMI-WORKED; BONE HANDLES FOR FURNITURE, DOORS, CABINETS, CUPBOARDS, BOXES AND DRAWERS, HORN HANDLES FOR FURNITURE, DOORS, CABINETS, CUPBOARDS, BOXES AND DRAWERS; NON-METAL CABINET HARDWARE, NAMELY, NON-METAL HANDLES, NON-METAL CLOSURES AND STOPPERS FOR BOTTLES AND CONTAINERS; NON-METAL DOOR FITTINGS, FURNITURE FITTINGS AND WINDOW FITTINGS; BOTTLE CAPS, NOT OF METAL (U.S. CLS. 2, 13, 22, 25, 32 AND 50).

FIRST USE 1-0-2000; IN COMMERCE 5-29-2005.

3,785,443. MIDWEST HALLOWELL DISTRIBUTORS, INC., CLEVELAND, OH. SN 77-488,471. PUB. 11-4-2008, FILED 6-2-2008.

INTERIOR/MEDART

THE MARK CONSISTS OF STANDARD CHARACTERS WITHOUT CLAIM TO ANY PARTICULAR FONT, STYLE, SIZE, OR COLOR.

FOR LOCKERS (U.S. CLS. 2, 13, 22, 25, 32 AND 50).

FIRST USE 4-1-2009; IN COMMERCE 4-1-2009.

3,785,357. TRUE VALUE COMPANY, CHICAGO, IL. SN 77-424,160. PUB. 12-2-2008, FILED 3-17-2008.



OWNER OF U.S. REG. NOS. 1,249,555 AND 1,561,687. FOR NON-METAL TOOL BOXES; NON-METAL CLAMPS (U.S. CLS. 2, 13, 22, 25, 32 AND 50). FIRST USE 3-0-2007; IN COMMERCE 3-0-2007.

3,785,450. MILLER, DRAYTON GRANVILLE, MOBILE, AL. SN 77-491,156. PUB. 5-19-2009, FILED 6-4-2008.

ThermoPod

THE MARK CONSISTS OF STANDARD CHARACTERS WITHOUT CLAIM TO ANY PARTICULAR FONT, STYLE, SIZE, OR COLOR.

FOR NON-METAL, BIODEGRADABLE INSULATED SHIPPING CONTAINERS AND MAILERS FOR MAINTAINING THE TEMPERATURE OF THE CONTENTS (U.S. CLS. 2, 13, 22, 25, 32 AND 50).

FIRST USE 8-11-2009; IN COMMERCE 8-11-2009.

CLASS 20—(Continued).

3,785,529. BELIEVELAND, LTD, MARIETTA, GA. SN 77-522,529. PUB. 6-9-2009, FILED 7-15-2008.

BELIEVELAND

THE MARK CONSISTS OF STANDARD CHARACTERS WITHOUT CLAIM TO ANY PARTICULAR FONT, STYLE, SIZE, OR COLOR.

OWNER OF U.S. REG. NO. 3,450,139.
FOR PLASTIC SIGNBOARDS; WINDOW CLINGS, NAMELY, VINYL APPLIQUES FOR ATTACHMENT TO WINDOWS; PLASTIC KEY CHAINS; PLASTIC PENNANTS; PLASTIC BANNERS; PLASTIC HOLIDAY ORNAMENTS (U.S. CLS. 2, 13, 22, 25, 32 AND 50).
FIRST USE 1-5-2008; IN COMMERCE 1-5-2008.

3,785,694. HNI TECHNOLOGIES INC., MUSCATINE, IA. SN 77-623,613. PUB. 6-2-2009, FILED 12-1-2008.

SILEA

THE MARK CONSISTS OF STANDARD CHARACTERS WITHOUT CLAIM TO ANY PARTICULAR FONT, STYLE, SIZE, OR COLOR.

THE WORDING "SILEA" HAS NO MEANING IN A FOREIGN LANGUAGE.

FOR FURNITURE; OFFICE FURNITURE; OFFICE FURNITURE SYSTEMS COMPRISED PRIMARILY OF MOVABLE AND FREE-STANDING OFFICE FURNITURE PARTITIONS, DESKS, TABLES, DRAWERS, CABINETS, OFFICE FURNITURE PARTITIONS WITH SURFACE FINISH OPTIONS ALLOWING FOR USE OF SAME AS MARKING BOARDS, TACK BOARDS, AND PAPER MANAGEMENT TOOL BOARDS, STORAGE RACKS, FILING CABINETS, AND SHELVING; OFFICE WORKSTATIONS HAVING MULTI-USE WORK SURFACES FOR USE IN A WIDE VARIETY OF FIELDS (U.S. CLS. 2, 13, 22, 25, 32 AND 50).
FIRST USE 9-9-2009; IN COMMERCE 9-9-2009.

3,785,722. IBC GROUP, INC., FT. LAUDERDALE, FL. SN 77-632,737. PUB. 12-1-2009, FILED 12-14-2008.



International Bedding

NO CLAIM IS MADE TO THE EXCLUSIVE RIGHT TO USE "BEDDING", APART FROM THE MARK AS SHOWN.
THE MARK CONSISTS OF "IB" INSIDE A CIRCLE ABOVE "INTERNATIONAL BEDDING".

CLASS 20—(Continued).

SEC. 2(F) AS TO "INTERNATIONAL BEDDING".
FOR SLEEP PRODUCTS, NAMELY, MATTRESSES, SPRING MATTRESSES, BOX SPRINGS AND MATTRESS FOUNDATIONS (U.S. CLS. 2, 13, 22, 25, 32 AND 50).
FIRST USE 2-28-2007; IN COMMERCE 2-28-2007.

3,785,779. DREAMWELL, LTD., LAS VEGAS, NV. SN 77-654,781. PUB. 5-19-2009, FILED 1-22-2009.

TRANSFLEXION

THE MARK CONSISTS OF STANDARD CHARACTERS WITHOUT CLAIM TO ANY PARTICULAR FONT, STYLE, SIZE, OR COLOR.

FOR FOAM SOLD AS AN INTEGRAL COMPONENT OF MATTRESSES (U.S. CLS. 2, 13, 22, 25, 32 AND 50).
FIRST USE 1-31-2009; IN COMMERCE 1-31-2009.

3,785,938. AMERICAN QUEEN LUXURY FURNISHINGS GROUP INC., SALT LAKE CITY, UT. SN 77-684,850. PUB. 7-7-2009, FILED 3-5-2009.

Queen Lanry

THE MARK CONSISTS OF THE WORD "QUEENLANRY" IS AN INVENTED WORD AND HAS NO MEANING OR SIGNIFICANCE IN THE RELEVANT TRADE OR IN ANY LANGUAGES.

FOR FURNITURE; MIRRORS; SOFAS (U.S. CLS. 2, 13, 22, 25, 32 AND 50).
FIRST USE 11-8-2008; IN COMMERCE 7-25-2009.

3,785,964. ROCKETT, JOHN, CORONA, CA. SN 77-692,265. PUB. 7-21-2009, FILED 3-16-2009.

STADIUMBACK

THE MARK CONSISTS OF STANDARD CHARACTERS WITHOUT CLAIM TO ANY PARTICULAR FONT, STYLE, SIZE, OR COLOR.

FOR PORTABLE AND FLEXIBLE POLYPROPYLENE SEAT BACK FOR USE AS A BACK SUPPORT TO BLEACHERS AND BENCH SEATS (U.S. CLS. 2, 13, 22, 25, 32 AND 50).
FIRST USE 12-1-2009; IN COMMERCE 12-1-2009.

CLASS 20—(Continued).

3,786,043. SIENHUA GROUP (NORTH AMERICA) INC., DBA DI ARMERIA EQUIPMENT, MARIETTA, GA. SN 77-730,668. PUB. 10-13-2009, FILED 5-6-2009.

THE GUN CHAIR

THE MARK CONSISTS OF STANDARD CHARACTERS WITHOUT CLAIM TO ANY PARTICULAR FONT, STYLE, SIZE, OR COLOR.

FOR PORTABLE GUN RACK (U.S. CLS. 2, 13, 22, 25, 32 AND 50).

FIRST USE 8-1-2009; IN COMMERCE 8-1-2009.

3,786,101. HANDY STORE FIXTURES, DBA NU SHELF, NEWARK, NJ. SN 77-755,235. PUB. 10-20-2009, FILED 6-9-2009.



NO CLAIM IS MADE TO THE EXCLUSIVE RIGHT TO USE "SHELF", APART FROM THE MARK AS SHOWN.

THE COLOR(S) GREEN, HUNTER GREEN IS/ARE CLAIMED AS A FEATURE OF THE MARK.

THE MARK CONSISTS OF "NU" IN A GREEN COLOR, "SHELF" IN A HUNTER GREEN COLOR. FADED GREEN UNDERNEATH THE LINE EXTENDING FROM THE LETTER "U" IN "NU" AND MORE FADED GREEN UNDERNEATH THE LINE EXTENDING FROM THE LETTER "N" IN "NU", THE COLORS OF THE LINES EXTENDING FROM BOTH "N" AND "U" START FROM GREEN THEN GET DARKER AS THE LONG EXTENDS.

FOR METAL SHELVING; SHELVES; SHELVING AND COMPONENT PARTS THEREOF, NAMELY, SHELVES AND BRACKETS SOLD AS A UNIT (U.S. CLS. 2, 13, 22, 25, 32 AND 50).

FIRST USE 6-11-2009; IN COMMERCE 6-11-2009.

3,786,128. C. J. THEOBALD III, LOUISVILLE, KY. SN 77-761,926. PUB. 11-3-2009, FILED 6-17-2009.

AD-PAD

THE MARK CONSISTS OF STANDARD CHARACTERS WITHOUT CLAIM TO ANY PARTICULAR FONT, STYLE, SIZE, OR COLOR.

FOR DISPLAY BOARDS; DISPLAY STANDS; NON-METAL HOLDERS FOR SIGNS (U.S. CLS. 2, 13, 22, 25, 32 AND 50).

FIRST USE 9-18-2009; IN COMMERCE 9-18-2009.

CLASS 20—(Continued).

3,786,289. NEWELL OPERATING COMPANY, ATLANTA, GA. SN 78-860,084. PUB. 12-5-2006, FILED 4-12-2006.

RESEMBLANCE

THE MARK CONSISTS OF STANDARD CHARACTERS WITHOUT CLAIM TO ANY PARTICULAR FONT, STYLE, SIZE, OR COLOR.

FOR INDOOR WINDOW BLINDS, MADE OF WOOD (U.S. CLS. 2, 13, 22, 25, 32 AND 50).

FIRST USE 7-31-2006; IN COMMERCE 7-31-2006.

3,786,325. LOS ANGELES POLICE REVOLVER AND ATHLETIC CLUB, LOS ANGELES, CA. SN 78-939,393. PUB. 2-26-2008, FILED 7-27-2006.



OWNER OF U.S. REG. NOS. 3,038,631 AND 3,047,180. NO CLAIM IS MADE TO THE EXCLUSIVE RIGHT TO USE "LOS ANGELES", APART FROM THE MARK AS SHOWN.

THE MARK CONSISTS OF A BADGE DESIGN WITH "POLICE OFFICER" IN THE UPPER PORTION AND WITH "LOS ANGELES POLICE" IN THE LOWER PORTION.

FOR MIRRORS, PICTURE FRAMES, WOOD AND PLASTIC BOXES, PILLOWS, FURNITURE AND HOUSEWARES, NAMELY, WALL PLAQUES, DECORATIVE BOXES, STATUES, AND FIGURINES (U.S. CLS. 2, 13, 22, 25, 32 AND 50).

FIRST USE 0-0-2004; IN COMMERCE 0-0-2004.

CLASS 21—HOUSEWARES AND GLASS

CLASS 21—(Continued).

3,785,116. KOHL'S ILLINOIS, INC., AURORA, IL. SN 77-020,031. PUB. 5-22-2007, FILED 10-12-2006.

THE BIG ONE

THE MARK CONSISTS OF STANDARD CHARACTERS WITHOUT CLAIM TO ANY PARTICULAR FONT, STYLE, SIZE, OR COLOR.

OWNER OF U.S. REG. NOS. 2,657,917, 2,811,148, AND OTHERS.

FOR COOKWARE, NAMELY, POTS AND PANS; BAKEWARE, NAMELY, BAKING DISHES, PANS, AND CONTAINERS; GLASS KITCHEN STORAGE CONTAINERS; KITCHEN UTENSILS, NAMELY, SPATULAS AND TURNERS; DRINKING GLASSES; BEVERAGEWARE (U.S. CLS. 2, 13, 23, 29, 30, 33, 40 AND 50).

FIRST USE 0-0-2009; IN COMMERCE 0-0-2009.

3,785,296. LIU, YUAN, VANCOUVER, BC, CANADA. SN 77-373,542. PUB. 5-27-2008, FILED 1-16-2008.

EUROCRYSTAL

THE MARK CONSISTS OF STANDARD CHARACTERS WITHOUT CLAIM TO ANY PARTICULAR FONT, STYLE, SIZE, OR COLOR.

FOR BEVERAGE GLASSWARE MADE OF CRYSTAL (U.S. CLS. 2, 13, 23, 29, 30, 33, 40 AND 50).

FIRST USE 10-1-2007; IN COMMERCE 10-1-2007.

3,785,363. EDISON NATION HOLDINGS, LLC, CHARLOTTE, NC. SN 77-426,779. PUB. 2-17-2009, FILED 3-19-2008.

EVERYDAY EDISONS

THE MARK CONSISTS OF STANDARD CHARACTERS WITHOUT CLAIM TO ANY PARTICULAR FONT, STYLE, SIZE, OR COLOR.

OWNER OF U.S. REG. NOS. 3,303,820, 3,382,931, AND OTHERS.

FOR CONSUMER PRODUCTS IN THE FIELD OF KITCHENWARES, NAMELY, SERVING TRAYS NOT OF PRECIOUS METAL AND HOUSEHOLD CONTAINERS FOR FOOD; CONSUMER PRODUCTS IN THE FIELD OF KITCHENWARES, NAMELY, BOWLS; CONSUMER PRODUCTS IN THE FIELD OF KITCHENWARES, NAMELY, CUTTING BOARDS (U.S. CLS. 2, 13, 23, 29, 30, 33, 40 AND 50).

FIRST USE 2-18-2010; IN COMMERCE 2-18-2010.

CLASS 21—(Continued).

3,785,447. GARY CRITHFIELD, SPOKANE VALLEY, WA. SN 77-489,964. PUB. 4-28-2009, FILED 6-3-2008.

CHEF LOCKE

THE MARK CONSISTS OF STANDARD CHARACTERS WITHOUT CLAIM TO ANY PARTICULAR FONT, STYLE, SIZE, OR COLOR.

THE NAME "CHEF LOCKE" DOES NOT IDENTIFY A LIVING INDIVIDUAL.

FOR FOOD PREPARATION PLANKS, NAMELY, WOOD PLANKS FOR USE IN GRILLING (U.S. CLS. 2, 13, 23, 29, 30, 33, 40 AND 50).

FIRST USE 8-14-2008; IN COMMERCE 8-14-2008.

3,785,528. BELIEVELAND LTD., MARIETTA, GA. SN 77-522,500. PUB. 6-9-2009, FILED 7-15-2008.

BELIEVELAND

THE MARK CONSISTS OF STANDARD CHARACTERS WITHOUT CLAIM TO ANY PARTICULAR FONT, STYLE, SIZE, OR COLOR.

OWNER OF U.S. REG. NO. 3,450,139.
FOR CUPS; MUGS; COFFEE MUGS; TRAVEL MUGS; BOTTLES SOLD EMPTY; SPORTS BOTTLES SOLD EMPTY; BEVERAGE GLASSWARE (U.S. CLS. 2, 13, 23, 29, 30, 33, 40 AND 50).

FIRST USE 8-19-2008; IN COMMERCE 8-19-2008.

3,785,579. KENNIK INNOVATIONS, L.L.C., FORT DODGE, IA. SN 77-545,842. PUB. 12-30-2008, FILED 8-13-2008.

EZLID

THE MARK CONSISTS OF STANDARD CHARACTERS WITHOUT CLAIM TO ANY PARTICULAR FONT, STYLE, SIZE, OR COLOR.

FOR FOOD SERVICE EQUIPMENT, NAMELY, LID DISPENSERS FOR USE IN GENERAL COMMERCIAL AND HOSPITALITY FACILITIES (U.S. CLS. 2, 13, 23, 29, 30, 33, 40 AND 50).

FIRST USE 3-8-2007; IN COMMERCE 3-8-2007.

CLASS 21—(Continued).

3,785,738. ALLSTAR MARKETING GROUP, LLC, HAWTHORNE, NY. SN 77-639,755. PUB. 11-3-2009, FILED 12-24-2008.

PERFECT BROWNIE

THE MARK CONSISTS OF STANDARD CHARACTERS WITHOUT CLAIM TO ANY PARTICULAR FONT, STYLE, SIZE, OR COLOR.

NO CLAIM IS MADE TO THE EXCLUSIVE RIGHT TO USE "BROWNIE", APART FROM THE MARK AS SHOWN.

FOR BAKING PANS (U.S. CLS. 2, 13, 23, 29, 30, 33, 40 AND 50).

FIRST USE 7-7-2009; IN COMMERCE 7-7-2009.

CLASS 21—(Continued).

3,785,857. TAKEYA USA CORPORATION, HUNTINGTON BEACH, CA. SN 77-667,168. PUB. 6-16-2009, FILED 2-10-2009.

TAKEYA

THE MARK CONSISTS OF STANDARD CHARACTERS WITHOUT CLAIM TO ANY PARTICULAR FONT, STYLE, SIZE, OR COLOR.

THE ENGLISH TRANSLATION OF "TAKEYA" IN THE MARK IS BAMBOO VALLEY.

FOR ALL PURPOSE CONTAINERS FOR HOUSEHOLD AND KITCHEN USE (U.S. CLS. 2, 13, 23, 29, 30, 33, 40 AND 50).

FIRST USE 1-15-2010; IN COMMERCE 1-15-2010.

3,785,745. BERKSHIRE CORPORATION, GREAT BARRINGTON, MA. SN 77-642,185. PUB. 6-9-2009, FILED 12-31-2008.

ECOCLEAN

THE MARK CONSISTS OF STANDARD CHARACTERS WITHOUT CLAIM TO ANY PARTICULAR FONT, STYLE, SIZE, OR COLOR.

FOR NON-WOVEN FABRIC WIPES FOR USE IN CONTROLLED ENVIRONMENTS IN THE NATURE OF LABORATORIES AND CLEAN ROOMS; NON-WOVEN DISPOSABLE FABRIC WIPES NOT IMPREGNATED WITH CHEMICAL OR COMPOUNDS (U.S. CLS. 2, 13, 23, 29, 30, 33, 40 AND 50).

FIRST USE 5-18-2009; IN COMMERCE 5-18-2009.

3,785,923. HANDI-FOIL CORPORATION, WHEELING, IL. SN 77-679,765. PUB. 6-23-2009, FILED 2-27-2009.

PANS FOR ALL SEASONS

THE MARK CONSISTS OF STANDARD CHARACTERS WITHOUT CLAIM TO ANY PARTICULAR FONT, STYLE, SIZE, OR COLOR.

NO CLAIM IS MADE TO THE EXCLUSIVE RIGHT TO USE "PANS", APART FROM THE MARK AS SHOWN.

FOR NON-ELECTRIC ALUMINUM AND ROASTING PANS, CONTAINERS FORMED OF ALUMINUM FOIL WITH PLASTIC LIDS FOR HOUSEHOLD USE, PANS FORMED OF ALUMINUM FOIL WITH WIRE HANDLES, AND PANS FORMED OF ALUMINUM FOIL (U.S. CLS. 2, 13, 23, 29, 30, 33, 40 AND 50).

FIRST USE 10-5-2009; IN COMMERCE 10-5-2009.

3,785,783. HARPER BRUSH WORKS, INC., FAIRFIELD, IA. SN 77-655,605. PUB. 5-19-2009, FILED 1-23-2009.

**MAKING OUR ENVIRONMENT A
PRIORITY**

THE MARK CONSISTS OF STANDARD CHARACTERS WITHOUT CLAIM TO ANY PARTICULAR FONT, STYLE, SIZE, OR COLOR.

FOR MOPS, BROOMS, SCRUBBING BRUSHES AND CLEANING CLOTHS (U.S. CLS. 2, 13, 23, 29, 30, 33, 40 AND 50).

FIRST USE 11-2-2009; IN COMMERCE 11-2-2009.

3,786,005. UNITED GENERAL SUPPLY CO., INC., HOUSTON, TX. SN 77-710,056. PUB. 9-15-2009, FILED 4-8-2009.

COUNTRY COOLER

THE MARK CONSISTS OF STANDARD CHARACTERS WITHOUT CLAIM TO ANY PARTICULAR FONT, STYLE, SIZE, OR COLOR.

NO CLAIM IS MADE TO THE EXCLUSIVE RIGHT TO USE "COOLER", APART FROM THE MARK AS SHOWN.

FOR PORTABLE COOLERS (U.S. CLS. 2, 13, 23, 29, 30, 33, 40 AND 50).

FIRST USE 2-8-2010; IN COMMERCE 2-8-2010.

CLASS 21—(Continued).

3,786,048. TUPPERWARE PRODUCTS S.A., FRIBOURG CH-1700, SWITZERLAND. SN 77-732,220. PUB. 10-20-2009, FILED 5-8-2009.

BEAUTY FEMME

THE MARK CONSISTS OF STANDARD CHARACTERS WITHOUT CLAIM TO ANY PARTICULAR FONT, STYLE, SIZE, OR COLOR.

NO CLAIM IS MADE TO THE EXCLUSIVE RIGHT TO USE "BEAUTY", APART FROM THE MARK AS SHOWN.

THE ENGLISH TRANSLATION OF THE WORD "FEMME" IN THE MARK IS WOMAN.

FOR FACIAL BRUSHES (U.S. CLS. 2, 13, 23, 29, 30, 33, 40 AND 50).

FIRST USE 5-7-2009; IN COMMERCE 5-7-2009.

3,786,118. CHURCH & DWIGHT CO., INC., PRINCETON, NJ. SN 77-759,524. PUB. 10-20-2009, FILED 6-15-2009.

MY WAY!

THE MARK CONSISTS OF STANDARD CHARACTERS WITHOUT CLAIM TO ANY PARTICULAR FONT, STYLE, SIZE, OR COLOR.

FOR TOOTHBRUSHES (U.S. CLS. 2, 13, 23, 29, 30, 33, 40 AND 50).

FIRST USE 6-18-2009; IN COMMERCE 2-1-2010.

3,786,236. BORYUNG MEDIENCE CO., LTD., SEOUL, REPUBLIC OF KOREA. SN 78-685,506. PUB. 12-12-2006, FILED 8-4-2005.

B&B

FOR POWDER COMPACTS NOT OF PRECIOUS METAL SOLD EMPTY; SOAP BOXES; COMBS; TOILET BRUSHES; TOOTHBRUSHES; BRUSHES FOR CLEANING COMMON HOUSEHOLD CONTAINERS; PITCHERS NOT OF PRECIOUS METAL; BOWLS NOT OF PRECIOUS METAL; DISHES NOT OF PRECIOUS METAL; GLASS CUPS; PLASTIC CUPS; MESS TINS; MUGS NOT OF PRECIOUS METAL; TRAYS NOT OF PRECIOUS METAL; CHOPSTICKS; BUCKETS; BASINS; PORTABLE BABY BATHS TUBS; BOTTLES FOR BEVERAGES, SOLD EMPTY (U.S. CLS. 2, 13, 23, 29, 30, 33, 40 AND 50).

FIRST USE 10-25-2009; IN COMMERCE 10-25-2009.

CLASS 21—(Continued).

3,786,242. GAIA GINO AKSESUAR TASARIM ANONIM SIRKETI, 34367 ISTANBUL, TURKEY. SN 78-705,343. PUB. 4-14-2009, FILED 9-1-2005.

GAIA & GINO

THE MARK CONSISTS OF THE STYLIZED DEPICTION OF THE WORDS "GAIA & GINO".

FOR CAKEHOLDERS NOT OF PRECIOUS METAL; DINNERWARE; DRINKING GLASSES; PLATES; SALT AND PEPPER MILLS; VASES; BEVERAGE GLASSWARE; CANDLESTICKS NOT OF PRECIOUS METAL; COFFEE CUPS; COFFEE SERVICES NOT OF PRECIOUS METAL; CUPS; DECANTERS; FIGURINES OF CHINA, CRYSTAL, EARTHENWARE, GLASS, AND PORCELAIN; MUGS; PET FEEDING DISHES (U.S. CLS. 2, 13, 23, 29, 30, 33, 40 AND 50).

FIRST USE 9-1-2004; IN COMMERCE 9-1-2004.

CLASS 22—CORDAGE AND FIBERS

3,785,358. TRUE VALUE COMPANY, CHICAGO, IL. SN 77-424,177. PUB. 12-2-2008, FILED 3-17-2008.



OWNER OF U.S. REG. NOS. 1,249,555 AND 1,561,687.

FOR NON-METAL TIE DOWNS; TIE DOWN STRAPS; TOWING ACCESSORIES, NAMELY, TOW ROPES FOR AUTOMOBILES AND TOWING STRAPS (U.S. CLS. 1, 2, 7, 19, 22, 42 AND 50).

FIRST USE 10-0-2004; IN COMMERCE 10-0-2004.

3,785,587. MOHAWK BRANDS, INC., CALHOUN, GA. SN 77-548,159. PUB. 12-23-2008, FILED 8-15-2008.

ULTRAstrand ULTRASoft

THE MARK CONSISTS OF STANDARD CHARACTERS WITHOUT CLAIM TO ANY PARTICULAR FONT, STYLE, SIZE, OR COLOR.

OWNER OF U.S. REG. NO. 2,931,710.

FOR SYNTHETIC FIBERS AND FILAMENTS FOR USE IN THE MANUFACTURE OF FABRICS, TEXTILES, YARNS, AND CARPETS (U.S. CLS. 1, 2, 7, 19, 22, 42 AND 50).

FIRST USE 10-12-2009; IN COMMERCE 10-12-2009.

CLASS 23—YARNS AND THREADS

CLASS 23—(Continued).

3,785,605. BERROCO, INC., UXBRIDGE, MA. SN 77-562,544.
PUB. 8-25-2009, FILED 9-4-2008.

LATITUDE

THE MARK CONSISTS OF STANDARD CHARACTERS WITHOUT CLAIM TO ANY PARTICULAR FONT, STYLE, SIZE, OR COLOR.
FOR YARN (U.S. CL. 43).
FIRST USE 11-11-2008; IN COMMERCE 11-11-2008.

3,786,034. J. & P. COATS, LIMITED, GLASGOW, SCOTLAND, UNITED KINGDOM. SN 77-725,085. PUB. 8-18-2009, FILED 4-29-2009.



OWNER OF U.S. REG. NO. 2,612,358.
THE MARK CONSISTS OF THE WORD "GEDIFRA" TO THE RIGHT OF A CIRCULAR SHAPE THAT CONTAINS LINES THAT ARE CROSSED.
FOR YARNS FOR KNITTING, SEWING AND CROCHETING (U.S. CL. 43).
FIRST USE 7-31-2009; IN COMMERCE 7-31-2009.

3,786,148. STOLLER, DEBORAH S, BROOKLYN, NY. SN 77-773,551. PUB. 11-24-2009, FILED 7-2-2009.

Stitch Nation by Debbie Stoller

THE MARK CONSISTS OF STANDARD CHARACTERS WITHOUT CLAIM TO ANY PARTICULAR FONT, STYLE, SIZE, OR COLOR.
FOR KNITTING YARN (U.S. CL. 43).
FIRST USE 12-1-2009; IN COMMERCE 12-26-2009.

CLASS 24—FABRICS**CLASS 24—(Continued).**

3,785,453. THE HUGHES GROUP, COLUMBIA, MD. SN 77-494,052. PUB. 5-26-2009, FILED 6-9-2008.

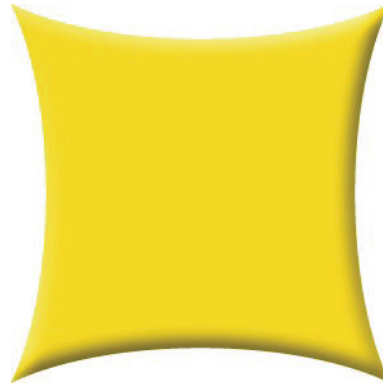

THE COLOR(S) YELLOW IS/ARE CLAIMED AS A FEATURE OF THE MARK.

THE MARK CONSISTS OF A GENERALLY RECTANGULAR IMAGE HAVING SIDES CURVED INWARDLY TOWARD THE IMAGE CENTER, THE IMAGE BEING YELLOWISH-GOLD IN COLOR WITH SHADING AT TWO OF ITS SIDES.

FOR TEXTILE SIGNAGE PANELS FOR USE WITH PORTABLE DISPLAY SYSTEMS FOR USE IN SALES, MARKETING, INFORMATIONAL, TRADE SHOW, AND EDUCATIONAL DISPLAYS (U.S. CLS. 42 AND 50).
FIRST USE 1-1-2007; IN COMMERCE 4-1-2009.

3,785,887. EUROW & O'REILLY CORPORATION, CAMARILLO, CA. SN 77-670,675. PUB. 6-9-2009, FILED 2-13-2009.



THE COLOR(S) BLACK, DARK GREEN, LIGHT GREEN AND WHITE IS/ARE CLAIMED AS A FEATURE OF THE MARK.

THE MARK CONSISTS OF THE COLOR BLACK APPEARING AS THE BACKGROUND COLOR OF A RECTANGLE SHAPED BOX IN WHICH THE STYLIZED, CAPITAL LETTERS "ECO" AND "EOC" APPEAR CENTERED WITH THE LETTERS "EOC" APPEARING DIRECTLY BENEATH THE LETTERS "ECO", WHEREIN THE LETTER "E" IN "ECO" APPEARS AS DARK GREEN, THE LETTER "C" APPEARS AS LIGHT GREEN, THE LETTER "O" APPEARS AS WHITE, AND THE LETTER "E" IN "EOC" APPEARS AS WHITE, THE LETTER "O" APPEARS AS DARK GREEN AND THE LETTER "C" APPEARS AS LIGHT GREEN.

FOR KITCHEN TOWELS; TOWELS (U.S. CLS. 42 AND 50).
FIRST USE 3-22-2009; IN COMMERCE 6-23-2009.

CLASS 24—(Continued).

3,785,957. BEACON LOOMS, INC., TEANECK, NJ. SN 77-690,805. PUB. 10-13-2009, FILED 3-13-2009.

DUVERLET

THE MARK CONSISTS OF STANDARD CHARACTERS WITHOUT CLAIM TO ANY PARTICULAR FONT, STYLE, SIZE, OR COLOR.

FOR BED COVERS (U.S. CLS. 42 AND 50).
FIRST USE 9-15-2009; IN COMMERCE 9-15-2009.

3,785,985. KARSTEN MANUFACTURING CORPORATION, PHOENIX, AZ. SN 77-699,994. PUB. 6-30-2009, FILED 3-26-2009.

PLAY YOUR BEST

THE MARK CONSISTS OF STANDARD CHARACTERS WITHOUT CLAIM TO ANY PARTICULAR FONT, STYLE, SIZE, OR COLOR.

OWNER OF U.S. REG. NOS. 2,476,383, 2,853,525, AND 3,268,236.

FOR GOLF TOWELS (U.S. CLS. 42 AND 50).
FIRST USE 9-3-2009; IN COMMERCE 9-3-2009.

3,786,271. YACHT CLUB ENTERPRISES, LTD., BLUFFTON, SC. SN 78-836,790. PUB. 6-26-2007, FILED 3-14-2006.



OWNER OF U.S. REG. NOS. 3,522,591, 3,522,593, AND OTHERS.

THE SIGNIFICANCE OF THE DESIGN ELEMENT OF THE MARK IS THAT THE INTERNATIONAL SIGNALING FLAGS TRANSLATE INTO THE WORDING "YACHT CLUB".

FOR TOWELS, BED SHEETS AND BED BLANKETS (U.S. CLS. 42 AND 50).

FIRST USE 1-29-2010; IN COMMERCE 1-29-2010.

CLASS 25—CLOTHING

CLASS 25—(Continued).

3,785,067. DAVISON, CLIFTON O., FORT COLLINS, CO. SN 76-649,353. PUB. 11-28-2006, FILED 10-28-2005.

TORO DE TEJAS

THE MARK CONSISTS OF STANDARD CHARACTERS WITHOUT CLAIM TO ANY PARTICULAR FONT, STYLE, SIZE, OR COLOR.

NO CLAIM IS MADE TO THE EXCLUSIVE RIGHT TO USE "TEJAS", APART FROM THE MARK AS SHOWN.

THE FOREIGN WORDING IN THE MARK TRANSLATES INTO ENGLISH AS BULL FROM TEXAS.

FOR CLOTHING, NAMELY, BELTS, HATS, CAPS, TOPS, PANTS, AND JACKETS (U.S. CLS. 22 AND 39).
FIRST USE 12-17-2009; IN COMMERCE 12-17-2009.

3,785,088. BREWER, JO ANN, GREENVILLE, NC. SN 76-691,648. PUB. 3-17-2009, FILED 7-28-2008.



FOR CLOTHING ENSEMBLES CONSISTING OF DRESSES, SHIRTS AND PANTS, AND ACCOMPANYING HAIR BOWS AND HAIR RIBBONS, SOLD AS A UNIT (U.S. CLS. 22 AND 39).

FIRST USE 7-1-2008; IN COMMERCE 7-1-2008.

3,785,097. ATLANTA NATIONAL LEAGUE BASEBALL CLUB, INC., ATLANTA, GA. SN 76-695,256. PUB. 5-5-2009, FILED 1-12-2009.

GWINNETT BRAVES

THE MARK CONSISTS OF STANDARD CHARACTERS WITHOUT CLAIM TO ANY PARTICULAR FONT, STYLE, SIZE, OR COLOR.

OWNER OF U.S. REG. NOS. 845,032, 3,327,473, AND OTHERS.

NO CLAIM IS MADE TO THE EXCLUSIVE RIGHT TO USE "GWINNETT", APART FROM THE MARK AS SHOWN.

FOR CLOTHING, NAMELY, CAPS, HATS, VISORS, SHIRTS, T-SHIRTS, TANK TOPS, SHORTS, BASEBALL UNIFORMS, JERSEYS, SWEATSHIRTS, JACKETS, INFANT WEAR (U.S. CLS. 22 AND 39).

FIRST USE 5-0-2008; IN COMMERCE 5-0-2008.

CLASS 25—(Continued).

3,785,101. KEMP, RUSSELL, NEW YORK, NY. SN 76-696,333.
PUB. 7-14-2009, FILED 3-16-2009.

FASHION EASE

THE MARK CONSISTS OF STANDARD CHARACTERS WITHOUT CLAIM TO ANY PARTICULAR FONT, STYLE, SIZE, OR COLOR.

FOR WOMEN'S CLOTHING, NAMELY, DRESSES, PANTS SUITS, JUMPSUITS, SKIRTS TOPS, BLOUSES, SHORTS, JACKETS AND LINGERIE (U.S. CLS. 22 AND 39).

FIRST USE 8-20-2009; IN COMMERCE 8-20-2009.

CLASS 25—(Continued).

3,785,155. MARVEL CHARACTERS, INC., MANHATTAN BEACH, CA. SN 77-169,074. PUB. 4-29-2008, FILED 4-30-2007.

THE MIGHTY THOR

THE MARK CONSISTS OF STANDARD CHARACTERS WITHOUT CLAIM TO ANY PARTICULAR FONT, STYLE, SIZE, OR COLOR.

OWNER OF U.S. REG. NOS. 890,918, 958,186, AND 2,933,886.

FOR T-SHIRTS; HATS (U.S. CLS. 22 AND 39).

FIRST USE 10-31-2008; IN COMMERCE 10-31-2008.

3,785,171. HARDKORE, INC., CHEYENNE, WY. SN 77-205,314. PUB. 11-27-2007, FILED 6-13-2007.

HARDKORE GEAR

THE MARK CONSISTS OF STANDARD CHARACTERS WITHOUT CLAIM TO ANY PARTICULAR FONT, STYLE, SIZE, OR COLOR.

NO CLAIM IS MADE TO THE EXCLUSIVE RIGHT TO USE "GEAR", APART FROM THE MARK AS SHOWN.

FOR CLOTHING, NAMELY, SHIRTS, HATS, AND JACKETS, EXCLUDING ALL HUNTING RELATED PRODUCTS AND HUNTING CLOTHING (U.S. CLS. 22 AND 39).

FIRST USE 3-6-2008; IN COMMERCE 3-6-2008.

3,785,173. APOSTLES OF COMEDY, LLC, NASHVILLE, TN. SN 77-206,500. PUB. 12-4-2007, FILED 6-14-2007.

APOSTLES OF COMEDY

THE MARK CONSISTS OF STANDARD CHARACTERS WITHOUT CLAIM TO ANY PARTICULAR FONT, STYLE, SIZE, OR COLOR.

FOR CLOTHING, NAMELY, SHIRTS, SWEATSHIRTS, JERSEYS; HEADWEAR (U.S. CLS. 22 AND 39).

FIRST USE 11-13-2008; IN COMMERCE 11-13-2008.

3,785,130. WINKLER, STEPHEN M, MARIETTA, GA. SN 77-083,083. PUB. 1-1-2008, FILED 1-15-2007.



NO CLAIM IS MADE TO THE EXCLUSIVE RIGHT TO USE "SNEAKER", APART FROM THE MARK AS SHOWN.

THE MARK CONSISTS OF A STYLIZED HEAD WEARING A CAP WITH THE WORDING "SNEAKER JUNKIE" APPEARING ON THE CAP AND BELOW THE HEAD DESIGN.

FOR DENIMS; HAT BANDS; HATS; INSOLES; JOGGING PANTS; JOGGING SUITS; LADIES' SUITS; MEN'S SUITS; POLO SHIRTS; SHOE DOWELS; SHOES SOLES FOR REPAIR; SHORT-SLEEVED AND LONG-SLEEVED T-SHIRTS; SLEEP SHIRTS; SWEAT PANTS; SWEAT SHIRTS; T-SHIRTS; TONGUE OR PULLSTRAP FOR SHOES AND BOOTS; TRACK PANTS; TRACK SUITS; WATERPROOF JACKETS AND PANTS (U.S. CLS. 22 AND 39).

FIRST USE 3-24-2008; IN COMMERCE 4-27-2008.

CLASS 25—(Continued).

3,785,176. BOELTER, KYLE M., HUNTINGDON VALLEY, PA. SN 77-207,531. PUB. 5-20-2008, FILED 6-15-2007.

**THE MOTHER NURTURE
COLLECTION**

THE MARK CONSISTS OF STANDARD CHARACTERS WITHOUT CLAIM TO ANY PARTICULAR FONT, STYLE, SIZE, OR COLOR.

OWNER OF U.S. REG. NO. 3,609,370.

NO CLAIM IS MADE TO THE EXCLUSIVE RIGHT TO USE "COLLECTION", APART FROM THE MARK AS SHOWN.

FOR CLOTHING, NAMELY, WOMEN'S T-SHIRTS, SWEATSHIRTS, SHIRTS, TOPS, JACKETS, BASEBALL HATS AND BABY BIBS (U.S. CLS. 22 AND 39).

FIRST USE 8-24-2007; IN COMMERCE 7-29-2009.

3,785,200. OUTDOOR ENVY, LLC, SMITHS STATION, AL. SN 77-249,580. PUB. 6-10-2008, FILED 8-7-2007.



FOR CLOTHING, NAMELY, SHIRTS, JACKETS AND HATS (U.S. CLS. 22 AND 39).

FIRST USE 7-4-2006; IN COMMERCE 10-2-2007.

3,785,206. PEI LICENSING, INC., MIAMI, FL. SN 77-257,474. PUB. 4-29-2008, FILED 8-16-2007.



OWNER OF U.S. REG. NOS. 1,348,121 AND 1,443,640.

CLASS 25—(Continued).

THE MARK CONSISTS OF A SERIES OF THREE DESIGN ELEMENTS PLACED IN A HORIZONTAL ROW, THE FIRST TWO COMPRISED OF FOUR DOTS FORMING A SQUARE AND THE THIRD COMPRISING THREE DOTS FORMING THE LEFT AND UPPER PORTION OF A SQUARE AND A SQUARE DESIGN IN THE LOWER RIGHT HAND CORNER ALONG WITH THE WORDS "AXIS MODERN COAST" IN STYLIZED LETTERS.

FOR CLOTHING, NAMELY, KNIT AND WOVEN SHIRTS, WOVEN SHIRTS, SHIRTS, PANTS, SHORTS (U.S. CLS. 22 AND 39).

FIRST USE 1-31-2008; IN COMMERCE 1-31-2008.

3,785,207. S.B.S TEKSTIL SANAYI VE TICARET ANONIM SIRKETI, ISTANBUL, TURKEY. SN 77-258,409. PUB. 7-8-2008, FILED 8-17-2007.

SBS SHIRTBYSHIRT

THE MARK CONSISTS OF STANDARD CHARACTERS WITHOUT CLAIM TO ANY PARTICULAR FONT, STYLE, SIZE, OR COLOR.

FOR CLOTHING, NAMELY, TROUSERS, JACKETS, OVERCOATS, COATS, SKIRTS, SUITS, JERSEYS, WAISTCOATS, SHIRTS, T-SHIRTS, SWEATSHIRTS, DRESSES, BERMUDA SHORTS, SHORTS, PAJAMAS, PULLOVERS, JEANS, TRACKSUITS, RAINWEAR, BEACHWEAR, BATHING SUITS, SWIMMING SUITS; ARTICLES OF CLOTHING MADE FROM COTTON DENIM, NAMELY, TROUSERS, SHIRTS, T-SHIRTS; ARTICLES OF CLOTHING MADE FROM KNITTED FABRICS, NAMELY, TROUSERS, SHIRTS, T-SHIRTS; UNDERCLOTHING, NAMELY, BOXER SHORTS, BRASIERES, BRIEFS, PANTS; FOOTWEAR, NAMELY, SHOES EXCLUDING ORTHOPEDIC SHOES, SANDALS, WATERPROOF BOOTS, WALKING BOOTS, BOOTIES, SPORTING SHOES, SLIPPERS; SHOE PARTS, NAMELY, HEELPIECES, INSOLES FOR FOOTWEAR, FOOTWEAR UPPERS; HEADGEAR, NAMELY, CAPS, SKULL CAPS, SPORTS CAPS, HATS, BERETS; GLOVES, SOCKS, STOCKINGS, BELTS, CAMISOLES, SARONGS, SCARVES, NECK SCARVES, SHAWLS, COLLARS, MUFFLERS, NECKTIES, TIES, SUSPENDER BELTS (U.S. CLS. 22 AND 39).

FIRST USE 3-1-2010; IN COMMERCE 3-1-2010.

CLASS 25—(Continued).

3,785,215. HER ROYAL HIGHNESS PRINCESS SIRIVANNAVARI NARIRATANA, BANGKOK, THAILAND. SN 77-279,430. PUB. 10-14-2008, FILED 9-14-2007.



THE MARK CONSISTS OF THE STYLIZED LETTERS "S'HOMME".

FOR MEN'S APPAREL, NAMELY, SHIRTS, T-SHIRTS, PANTS, TROUSERS, UNDERWEAR, SCARVES, HATS, AND FOOTWEAR (U.S. CLS. 22 AND 39).

FIRST USE 5-22-2008; IN COMMERCE 5-22-2008.

CLASS 25—(Continued).

3,785,279. MCIVER, MICHEIL, UPPER MARLBORO, MD. SN 77-362,028. PUB. 5-20-2008, FILED 12-31-2007.



THE MARK CONSISTS OF THREE MASKS WITH CROWNS, INITIALS "D" AND "V" IN THE MIDDLE, AND DESIGN IN BACKGROUND.

FOR SOCKS; PANTS; SHIRTS; DRESSES; HATS; JACKETS; JEANS; COATS; SHORTS; BLOUSES; SKIRTS; UNDERWEAR; TIES; SLIPPERS; PAJAMAS; SWEATERS; SUITS; SWIM TRUNKS; BATHING SUITS; ATHLETIC UNIFORMS; SCHOOL UNIFORMS; UNIFORMS (U.S. CLS. 22 AND 39).

FIRST USE 9-7-1986; IN COMMERCE 9-7-1986.

3,785,317. JOHNSON, KENT, CARLSBAD, CA. SN 77-388,246. PUB. 6-17-2008, FILED 2-4-2008.

3,785,233. ZAPPOS.COM, INC., HENDERSON, NV. SN 77-312,496. PUB. 7-1-2008, FILED 10-24-2007.

ROMANTIC SOLES

THE MARK CONSISTS OF STANDARD CHARACTERS WITHOUT CLAIM TO ANY PARTICULAR FONT, STYLE, SIZE, OR COLOR.

NO CLAIM IS MADE TO THE EXCLUSIVE RIGHT TO USE "SOLES", APART FROM THE MARK AS SHOWN.

FOR SHOES; FOOTWEAR (U.S. CLS. 22 AND 39).

FIRST USE 9-26-2008; IN COMMERCE 9-26-2008.



THE MARK CONSISTS OF AN ARTISTIC DEPICTION OF A SIDE VIEW OF AN EYE WITH THE WORDS "GLAZED OVER" UNDERNEATH THE DEPICTION OF THE EYE.

FOR BASEBALL CAPS, BEANIES, BOARD SHORTS, DRESSES, SHORT SLEEVED OR LONG SLEEVED T-SHIRTS, SWEAT SHIRTS, SHIRTS (U.S. CLS. 22 AND 39).

FIRST USE 9-1-2009; IN COMMERCE 9-1-2009.

CLASS 25—(Continued).

3,785,370. SATENSTEIN JOSHUA, MONTREAL, QUEBEC.
SN 77-428,498. PUB. 8-5-2008, FILED 3-21-2008.

EcoUniform

THE MARK CONSISTS OF STANDARD CHARACTERS WITHOUT CLAIM TO ANY PARTICULAR FONT, STYLE, SIZE, OR COLOR.

FOR ATHLETIC UNIFORMS; MARTIAL ARTS UNIFORMS; SCHOOL UNIFORMS; UNIFORMS; TRACK PANTS; WATERPROOF JACKETS AND PANTS; WIND PANTS; YOGA PANTS; CAPRI PANTS; CARGO PANTS; DENIMS; JOGGING PANTS; LOUNGE PANTS; NURSE PANTS; PANTS; SKI PANTS; SNOW PANTS; SNOWBOARD PANTS; STRETCH PANTS; SWEAT PANTS; CAMP SHIRTS; DRESS SHIRTS; GOLF SHIRTS; HOODED SWEAT SHIRTS; KNIT SHIRTS; LONG-SLEEVED SHIRTS; NIGHT SHIRTS; OPEN-NECKED SHIRTS; POLO SHIRTS; RUGBY SHIRTS; SHIRTS; SHIRTS FOR SUITS; SHORT-SLEEVED OR LONG-SLEEVED T-SHIRTS; SHORT-SLEEVED SHIRTS; SLEEP SHIRTS; SPORTS SHIRTS; SPORTS SHIRTS WITH SHORT SLEEVES; SWEAT SHIRTS; T-SHIRTS; TEE SHIRTS; TRIATHLON CLOTHING, NAMELY, TRIATHLON TIGHTS, TRIATHLON SHORTS, TRIATHLON SINGLET, TRIATHLON SHIRTS, TRIATHLON SUITS; WIND SHIRTS; YOGA SHIRTS; JEANS; DRESS SUITS; DRESSES; DRESSING GOWNS; EVENING DRESSES; NURSE DRESSES; SKIRTS AND DRESSES; WOMEN'S CEREMONIAL DRESSES; BASEBALL CAPS; CAPS; SWIM CAPS; BOW TIES; TIES; BELTS; BELTS OF TEXTILE; FABRIC BELTS; SKIRT SUITS; SKIRTS; SKORTS; FLEECE VESTS; HUNTING VESTS; LONG SLEEVED VESTS; MEN AND WOMEN JACKETS, COATS, TROUSERS, VESTS; VESTS; WIND VESTS; CARDIGANS; COATS; COATS FOR MEN AND WOMEN; COATS MADE OF COTTON; COATS OF DENIM; LAB COATS; RAIN COATS; SPORT COATS; SUIT COATS; TRENCH COATS; WIND COATS; DENIM JACKETS; DOWN JACKETS; JACKETS; RAIN JACKETS; REVERSIBLE JACKETS; SKI JACKETS; SPORTS JACKETS; SWEAT JACKETS; TRACK JACKETS; WIND RESISTANT JACKETS; WIND-JACKETS; BATHING SUITS; GYM SUITS; JOGGING SUITS; JUDO SUITS; KARATE SUITS; LADIES' SUITS; MEN'S SUITS; MEN'S SUITS; WOMEN'S SUITS; SKI SUITS; SNOW BOARDING SUITS; SUITS; SWEAT SUITS; TRACK SUITS; TRAINING SUITS; UNION SUITS; VESTED SUITS; ANKLE SOCKS; ANKLETS; MEN'S SOCKS; SOCKS; SOCKS AND STOCKINGS; THERMAL SOCKS; CHEF'S HATS; HATS; CREW-NECK SWEATERS; MOCK TURTLE-NECK SWEATERS; SWEATERS; TURTLENECK SWEATERS; V-NECK SWEATERS; FLEECE PULLOVERS; FLEECE SHORTS; LEOTARDS AND TIGHTS FOR WOMEN, MEN AND CHILDREN OF NYLON, COTTON OR OTHER TEXTILE FIBERS; FINISHED TEXTILE LININGS FOR GARMENTS; TEXTILE DIAPERS; ATHLETIC FOOTWEAR; FOOTWEAR; FOOTWEAR, NAMELY, WORK BOOTS; GLOVES; GYM SHORTS; JOGGING OUTFITS; INFANT AND TODDLER ONE PIECE CLOTHING; INFANT WEAR; ONE PIECE GARMENT FOR INFANTS AND TODDLERS; BABY BOTTOMS; BABY TOPS; WORK SHOES AND BOOTS; WORKING OVERALLS; NURSE OVERALLS; SCRUBS NOT FOR MEDICAL PURPOSES; CHOIR ROBES; ROBES (U.S. CLS. 22 AND 39).
FIRST USE 11-18-2009; IN COMMERCE 11-18-2009.

CLASS 25—(Continued).

3,785,377. MUHAMMAD, SABURUDIN, EL MONTE, CA. SN
77-440,037. PUB. 8-19-2008, FILED 4-4-2008.

THE MARK CONSISTS OF AN ABSTRACT DESIGN ABOVE THE STYLIZED TEXT "ESBE".

FOR T-SHIRTS, SWEATERS, HATS, JACKETS, SHOES (U.S. CLS. 22 AND 39).

FIRST USE 8-25-2007; IN COMMERCE 1-10-2008.

3,785,393. PANIZ INC., NEW YORK, NY. SN 77-451,146. PUB.
9-9-2008, FILED 4-17-2008.

LILY & KATE

THE MARK CONSISTS OF STANDARD CHARACTERS WITHOUT CLAIM TO ANY PARTICULAR FONT, STYLE, SIZE, OR COLOR.

FOR LADIES' SUITS; WOMEN JACKETS, COATS, TROUSERS, VESTS, WOMEN'S SUITS; DRESSES; SKIRTS AND DRESSES (U.S. CLS. 22 AND 39).

FIRST USE 1-15-2009; IN COMMERCE 1-15-2009.

3,785,395. KISS THE GIRL CLOTHING COMPANY LLC,
SCOTTSDALE, AZ. SN 77-455,152. PUB. 2-17-2009, FILED 4-
22-2008.

Kiss the Girl Clothing

THE MARK CONSISTS OF STANDARD CHARACTERS WITHOUT CLAIM TO ANY PARTICULAR FONT, STYLE, SIZE, OR COLOR.

CLASS 25—(Continued).

NO CLAIM IS MADE TO THE EXCLUSIVE RIGHT TO USE "CLOTHING", APART FROM THE MARK AS SHOWN.

FOR TEE SHIRTS, HOODED SWEAT SHIRTS, THERMAL SHIRTS, SHORT-SLEEVED OR LONG-SLEEVED TEE SHIRTS, SLEEP SHIRTS, PAJAMAS, HATS, SCARVES, SWEATPANTS, BELTS, SWEAT SHIRTS, SWEAT SHORTS, PANTS, JACKETS, SHOES, BOOTS, SOCKS, FOOTWEAR, BATHROBES, TANK TOPS, BATHING SUITS, HEADWEAR, NECKWEAR, UNDERWEAR, CAMISOLES, SLIPPERS, WRAPS, VESTS, DRESSES, GOWNS, FLIP FLOPS, DENIM JACKETS, COATS, BLOUSES, CARDIGANS, LEGGINGS, SLEEP SHORTS, JUMPSUITS, SWIM WEAR, AND LINGERIE (U.S. CLS. 22 AND 39).

FIRST USE 8-15-2008; IN COMMERCE 8-15-2008.

3,785,396. GREENE TOYS, LLC, NEW YORK, NY. SN 77-455,456. PUB. 9-23-2008, FILED 4-23-2008.

FLOPALONGS

THE MARK CONSISTS OF STANDARD CHARACTERS WITHOUT CLAIM TO ANY PARTICULAR FONT, STYLE, SIZE, OR COLOR.

FOR TOPS (U.S. CLS. 22 AND 39).

FIRST USE 1-8-2010; IN COMMERCE 1-8-2010.

3,785,398. MARC D. SOREL, RUMFORD, RI. AND RACHEL NOAH, RUMFORD, RI. SN 77-457,922. PUB. 9-23-2008, FILED 4-25-2008.

HAPPYNESS

THE MARK CONSISTS OF STANDARD CHARACTERS WITHOUT CLAIM TO ANY PARTICULAR FONT, STYLE, SIZE, OR COLOR.

FOR CLOTHING, NAMELY, T-SHIRTS, SWEATSHIRTS, SHIRTS, PANTS, SHORTS, UNDERWEAR, PAJAMAS, JACKETS, SCARVES, MITTENS; FOOTWEAR, NAMELY, SOCKS; AND HEADGEAR, NAMELY, HATS (U.S. CLS. 22 AND 39).

FIRST USE 4-6-2009; IN COMMERCE 4-6-2009.

CLASS 25—(Continued).

3,785,431. ROTHMAN, EDWARD, HALEIWA, HI. SN 77-476,886. PUB. 10-14-2008, FILED 5-16-2008.

PIT PROVEN

THE MARK CONSISTS OF THE WORDS "PIT PROVEN" IN STYLIZED FONT.

FOR CLOTHING, NAMELY, SWIMWEAR, SHIRTS, SHORTS, SWEAT SHIRTS, SWEAT PANTS, JACKETS, KNIT SHIRTS, WOVEN SHIRTS, SPORT SHIRTS, T-SHIRTS, TANK TOPS, HATS, VISORS, BEACH COVER UPS, SLIPPERS, AND SANDALS (U.S. CLS. 22 AND 39).

FIRST USE 1-1-2000; IN COMMERCE 1-1-2000.

3,785,432. KIGHT II, NATHAN M., DBA SOULUSA INTERNATIONALE, TAKOMA PARK, MD. SN 77-477,326. PUB. 5-19-2009, FILED 5-17-2008.

SOULUSA

THE MARK CONSISTS OF STANDARD CHARACTERS WITHOUT CLAIM TO ANY PARTICULAR FONT, STYLE, SIZE, OR COLOR.

FOR (BASED ON USE IN COMMERCE) SHIRTS; PANTS; SHOES; SOCKS (U.S. CLS. 22 AND 39).

FIRST USE 10-17-1998; IN COMMERCE 10-17-1998.

CLASS 25—(Continued).

3,785,435. FOLEY, SHARON, MARIE, STILLWATER, MN. SN 77-479,067. PUB. 12-2-2008, FILED 5-20-2008.

GET YOUR BODY MOVING

THE MARK CONSISTS OF STANDARD CHARACTERS WITHOUT CLAIM TO ANY PARTICULAR FONT, STYLE, SIZE, OR COLOR.

FOR A-SHIRTS; BUTTON-FRONT ALOHA SHIRTS; CAMP SHIRTS; DRESS SHIRTS; GOLF SHIRTS; HOODED SWEAT SHIRTS; KNIT SHIRTS; LONG-SLEEVED SHIRTS; MOISTURE-WICKING SPORTS SHIRTS; NIGHT SHIRTS; OPEN-NECKED SHIRTS; PIQUE SHIRTS; POLO SHIRTS; RUGBY SHIRTS; SHIRT FRONTS; SHIRT YOKES; SHIRTS; SHIRTS FOR SUITS; SHORT-SLEEVED OR LONG-SLEEVED T-SHIRTS; SHORT-SLEEVED SHIRTS; SLEEP SHIRTS; SPORT SHIRTS; SPORTS SHIRTS WITH SHORT SLEEVES; SWEAT SHIRTS; T-SHIRTS; TRIATHLON CLOTHING, NAMELY, TRIATHLON TIGHTS, TRIATHLON SHORTS, TRIATHLON SINGLET, TRIATHLON SHIRTS AND TRIATHLON SUITS; WIND SHIRTS; YOGA SHIRTS; CHEF'S HATS; FUR HATS; HAT BANDS; HATS; HEADGEAR, NAMELY, HATS AND CAPS; PAPER HATS FOR USE AS CLOTHING ITEMS; SEDGE HATS (SUGEGASA); SMALL HATS; TOBOGGAN HATS, PANTS AND CAPS; WOOLLY HATS; BERMUDA SHORTS; BOARD SHORTS; BOXER SHORTS; FLEECE SHORTS; GYM SHORTS; PANTIES, SHORTS AND BRIEFS; RUGBY SHORTS; SHORT OVERCOAT FOR KIMONO (HAORI); SHORT PETTICOATS; SHORT SETS; SHORT TROUSERS; SHORTS; SLIDING SHORTS; SWEAT SHORTS; UNDERWEAR, NAMELY, BOY SHORTS; WALKING SHORTS; CAP VISORS; CAPS WITH VISORS; SUN VISORS; VISORS; BATHING COSTUMES FOR WOMEN; BATHING SUITS FOR MEN; BUSTLE HOLDER BANDS FOR OBI (OBIAGE); BUSTLES FOR OBI-KNOTS (OBIAGE-SHIN); CLEATS FOR ATTACHMENT TO SPORTS SHOES; CLOTH BIBS FOR ADULT DINERS; CLOTH BIBS FOR USE BY SENIOR CITIZENS OR PHYSICALLY OR MENTALLY-CHALLENGED PERSONS; CLOTHING FOR WEAR IN JUDO PRACTICES; CLOTHING FOR WEAR IN WRESTLING GAMES; COATS FOR MEN AND WOMEN; COSTUMES FOR USE IN ROLE-PLAYING GAMES; DETACHABLE NECK-PIECES FOR KIMONOS (HANERI); FINISHED TEXTILE LININGS FOR GARMENTS; FOOTWEAR FOR MEN; FOOTWEAR FOR MEN AND WOMEN; FOOTWEAR FOR TRACK AND FIELD ATHLETICS; FOOTWEAR FOR WOMEN; FOOTWEAR NOT FOR SPORTS; GLOVES FOR PERSONAL HAND CONDITIONING USE; HEEL PIECES FOR SHOES; HIP-GUARDS ESPECIALLY MADE FOR FISHING; INSOLES; LEOTARDS AND TIGHTS FOR WOMEN, MEN AND CHILDREN OF NYLON, COTTON OR OTHER TEXTILE FIBERS; MEN'S AND WOMEN'S JACKETS, COATS, TROUSERS, VESTS; MEN'S SOCKS; MEN'S SUITS; WOMEN'S SUITS; METAL FITTINGS FOR JAPANESE STYLE WOODEN CLOGS; ONE PIECE GARMENT FOR INFANTS AND TODDLERS; PARTS OF CLOTHING, NAMELY, GUSSETS FOR TIGHTS, GUSSETS FOR STOCKINGS, GUSSETS FOR BATHING SUITS, GUSSETS FOR UNDERWEAR, GUSSETS FOR LEOTARDS AND GUSSETS FOR FOOTLETS; PLEATED SKIRTS FOR FORMAL KIMONOS (HAKAMA); PROTECTIVE METAL MEMBERS FOR SHOES AND BOOTS; RUBBER SOLES FOR JIKATABI; SASH BANDS FOR KIMONO (OBI); SCRUBS NOT FOR MEDICAL PURPOSES; SHOE INSERTS FOR PRIMARILY NON-ORTHOPEDIC PURPOSES; SHOES SOLES FOR REPAIR; SKI SUITS FOR COMPETITION; SOLES FOR JAPANESE STYLE SANDALS; SPORTS JERSEYS AND BRECCHES FOR SPORTS; STRAPS FOR BRAS; STRING FASTENERS FOR HAORI (HAORI-HIMO); SUSPENDER BELTS FOR MEN; SUSPENDER BELTS FOR WOMEN; SWIM WEAR FOR GENTLEMEN AND LADIES; SWIMWEAR; TIGHTENING-UP STRINGS FOR KIMONOS (DATEJIME); TIPS FOR FOOTWEAR; TOE STRAPS

CLASS 25—(Continued).

FOR JAPANESE STYLE SANDALS; TOE STRAPS FOR JAPANESE STYLE WOODEN CLOGS; TONGUE OR PULLSTRAP FOR SHOES AND BOOTS; TROUSERS FOR SWEATING; UNDERSHIRTS FOR KIMONOS (JUBAN); UNDERSHIRTS FOR KIMONOS (KOSHIMAKI); UPPERS FOR JAPANESE STYLE SANDALS; UPPERS OF WOVEN RATTAN FOR JAPANESE STYLE SANDALS; WAIST STRINGS FOR KIMONOS (KOSHIHIMO); WET SUITS FOR WATER-SKIING AND SUB-AQUA; WRAP BELTS FOR KIMONOS (DATEMAKI); WOMEN'S CEREMONIAL DRESSES; WOMEN'S SHOES; WOMEN'S UNDERWEAR; CHILDREN'S CLOTH EATING BIBS; CHILDREN'S HEADWEAR; CHILDREN'S AND INFANTS' CLOTH BIBS; BASEBALL CAPS; BATHING CAPS; CAPS; FITTED SWIMMING COSTUMES WITH BRA CUPS; GOLF CAPS; KNITTED CAPS; SHOWER CAPS; SKULL CAPS; SWIM CAPS; SWIM TRUNKS; SWIM WEAR; SWIMMING CAPS; SWIMMING COSTUMES; SWIMMING TRUNKS; TOE CAPS; GOLF CLEATS; GOLF SHOES; GOLF SPIKES; GOLF TROUSERS; BALLOON PANTS; CAPRI PANTS; CARGO PANTS; DENIMS; JOGGING PANTS; LEATHER PANTS; LOUNGE PANTS; MOISTURE-WICKING SPORTS PANTS; NON-DISPOSABLE CLOTH TRAINING PANTS; NURSE PANTS; PANTS; PETTI-PANTS; SKI PANTS; SNOW PANTS; SNOWBOARD PANTS; SPORTS PANTS; STRETCH PANTS; SWEAT PANTS; TAP PANTS; TRACK PANTS; WATERPROOF JACKETS AND PANTS; WIND PANTS; YOGA PANTS; CREWNECK SWEATERS; MOCK TURTLE-NECK SWEATERS; SWEATERS; TURTLE-NECK SWEATERS; V-NECK SWEATERS; TENNIS SHOES; TENNIS WEAR; SKIRT SUITS; SKIRTS; SKIRTS AND DRESSES; BRIDESMAID DRESSES; DRESS SHIELDS; DRESS SUITS; DRESSES; DRESSES MADE FROM SKINS; DRESSING GOWNS; EVENING DRESSES; NURSE DRESSES; WEDDING DRESSES; BANDANAS; BASEBALL SHOES; BELTS; BIBS NOT OF CLOTH OR PAPER; CLOTH BIBS; CLOTH DIAPERS; CLOTHING, NAMELY, ARM WARMERS; CLOTHING, NAMELY, FOLK COSTUMES; CLOTHING, NAMELY, HAND-WARMERS; CLOTHING, NAMELY, KNEE WARMERS; CLOTHING, NAMELY, NECK TUBES; CLOTHING, NAMELY, THOBES; CLOTHING, NAMELY, WRAP-AROUNDS; CORSETS; DUSTERS; FABRIC SOLD AS AN INTEGRAL COMPONENT OF FINISHED CLOTHING ITEMS, NAMELY, SHIRTS, PANTS AND SHORTS; FIGURE SKATING CLOTHING, NAMELY, SHIRTS, SKIRTS AND PANTS; FOULARDS; HOODS; INFANT AND TODDLER ONE PIECE CLOTHING; INFANT CLOTH DIAPERS; JERSEYS; LEATHER BELTS; MANTLES; MUFFLERS; PERSPIRATION ABSORBENT UNDERWEAR CLOTHING; SHIFTS; SHOULDER WRAPS; SWADDLING CLOTHES; TIES; TOPS; UNDERARM CLOTHING SHIELDS; WRAPS; FOOTBALL BOOTS AND STUDBS THEREFOR; FOOTBALL SHOES; SOCCER BOOTS; SOCCER SHOES; AFTER SKI BOOTS; APRESKI SHOES; HEAD WEAR; INFANT WEAR; SKI AND SNOWBOARD SHOES AND PARTS THEREOF; SKI BIBS; SKI BOOT BAGS; SKI BOOTS; SKI GLOVES; SKI JACKETS; SKI MASKS; SKI SUITS; SKI TROUSERS; SKI WEAR; SKIING SHOES; SURF WEAR; BED JACKETS; DENIM JACKETS; DOWN JACKETS; FISHERMEN'S JACKETS; FUR COATS AND JACKETS; FUR JACKETS; HEAVY JACKETS; JACKET LINERS; JACKETS; LEATHER JACKETS; LIGHT-REFLECTING JACKETS; LONG JACKETS; PADDED JACKETS; PADDING JACKETS; RAIN JACKETS; RAINPROOF JACKETS; REVERSIBLE JACKETS; SHELL JACKETS; SLEEVED OR SLEEVELESS JACKETS; SMOKING JACKETS; SPORTS JACKETS; STUFF JACKETS; SUEDE JACKETS; SWEAT JACKETS; TRACK JACKETS; WIND RESISTANT JACKETS; WIND-JACKETS; ANKLE BOOTS; BOOTS; CLIMBING BOOTS; FITTED SHOE OR BOOT COVERING TO PROTECT THE SHOES OR BOOT FROM WATER OR OTHER DAMAGE; FOOTWEAR, NAMELY, WORK

CLASS 25—(Continued).

BOOTS; HIKING BOOTS; HORSE-RIDING BOOTS; HUNTING BOOT BAGS; INFANTS' SHOES AND BOOTS; LACE BOOTS; LADIES' BOOTS; MOTORCYCLIST BOOTS; MOUNTAINEERING BOOTS; RAIN BOOTS; RIDING BOOTS; SNOW BOOTS; SNOWBOARD BOOTS; WINTER BOOTS; WORK SHOES AND BOOTS; LONG SLEEVED VESTS; SUN SLEEVES; BATHING SUITS; BODY SUITS; DRY SUITS; FLIGHT SUITS; GYM SUITS; JOGGING SUITS; JUDO SUITS; KARATE SUITS; LADIES' SUITS; ONE-PIECE PLAY SUITS; PLAY SUITS; RAIN SUITS; SNOW BOARDING SUITS; SNOW SUITS; SUIT COATS; SUITS; SUITS OF LEATHER; SWEAT SUITS; TRACK SUITS; TRAINING SUITS; UNION SUITS; VESTED SUITS; WARM UP SUITS; WET SUIT GLOVES; WET SUITS; ZOOT SUITS; HEADBANDS AGAINST SWEATING; STOCKINGS; SWEAT BANDS; TIGHTS; SINGLETS; HOODED PULLOVERS; OVER COATS; OVER-TROUSERS; LONG UNDERWEAR; BABY TOPS; BASELAYER TOPS; CROP TOPS; HALTER TOPS; MUSCLE TOPS; RUGBY TOPS; TANK TOPS; TOP COATS; TUBE TOPS (U.S. CLS. 22 AND 39).

FIRST USE 5-28-2009; IN COMMERCE 5-28-2009.

3,785,444. RUSSO J. MICHAEL, RICHMOND HILL, CANADA. SN 77-488,651. PUB. 11-25-2008, FILED 6-2-2008.

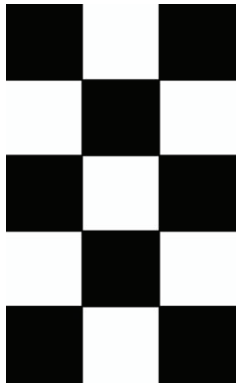

THE MARK CONSISTS OF A RECTANGULAR CHECKERED IMAGE CONSISTING OF 15 SQUARES, 3 ACROSS AND 5 DOWN TOTALING FIFTEEN SQUARES.

FOR SPORTSWEAR, NAMELY, BASEBALL CAPS, BELTS, BOMBER JACKETS, CANVAS SHOES, CAPRI PANTS, CAPS WITH VISORS, CARGO PANTS, DENIMS, DRESS SHIRTS, GOLF SHIRTS, HEAVY JACKETS, HOODED SWEAT SHIRTS, JACKETS, JOGGING PANTS, KNIT SHIRTS, KNITTED CAPS, LEATHER JACKETS, LEATHER SHOES, LONG-SLEEVED SHIRTS, MOISTURE-WICKING SPORTS SHIRTS, OPEN-NECKED SHIRTS, PIQUE SHIRTS, POLO SHIRTS, RAIN JACKETS, RAINPROOF JACKETS, REVERSIBLE JACKETS, RUGBY SHIRTS, SHELL JACKETS, SKI JACKETS, SPORTS JACKETS, SPORTS SHIRTS, SPORTS SHIRTS WITH SHORT SLEEVES, SUEDE JACKETS, SWEAT JACKETS, SWEAT SHIRTS, T-SHIRTS, WATERPROOF JACKETS AND PANTS, WIND RESISTANT JACKETS, AND WIND-JACKETS (U.S. CLS. 22 AND 39).

FIRST USE 5-5-2008; IN COMMERCE 7-9-2008.

CLASS 25—(Continued).

3,785,462. KARMAN, INC., AURORA, CO. SN 77-497,165. PUB. 11-4-2008, FILED 6-12-2008.

WEAR YOUR METAL OUT

THE MARK CONSISTS OF STANDARD CHARACTERS WITHOUT CLAIM TO ANY PARTICULAR FONT, STYLE, SIZE, OR COLOR.

FOR CLOTHING, NAMELY, SHIRTS, KNIT AND WOVEN SHIRTS, BLOUSES, JEANS, PANTS, SHORTS, SKIRTS, DRESSES, SWEATERS, SWEATSHIRTS, T-SHIRTS, JACKETS, COATS, HATS, BELTS, CAPS, SOCKS, FOOTWEAR AND HEADWEAR (U.S. CLS. 22 AND 39).

FIRST USE 1-14-2010; IN COMMERCE 1-14-2010.

3,785,469. ACI INTERNATIONAL, LOS ANGELES, CA. SN 77-500,499. PUB. 11-18-2008, FILED 6-17-2008.

ULTRA FOAM

THE MARK CONSISTS OF STANDARD CHARACTERS WITHOUT CLAIM TO ANY PARTICULAR FONT, STYLE, SIZE, OR COLOR.

NO CLAIM IS MADE TO THE EXCLUSIVE RIGHT TO USE "FOAM", APART FROM THE MARK AS SHOWN.

FOR FOOTWEAR (U.S. CLS. 22 AND 39).

FIRST USE 3-16-2010; IN COMMERCE 3-16-2010.

3,785,483. BADAPP, INCORPORATED, HOUSTON, TX. SN 77-508,415. PUB. 12-30-2008, FILED 6-26-2008.

Badapp

THE MARK CONSISTS OF STANDARD CHARACTERS WITHOUT CLAIM TO ANY PARTICULAR FONT, STYLE, SIZE, OR COLOR.

FOR BATHING SUITS; HATS; HOODED SWEAT SHIRTS; SHIRTS; SHOES; SHORTS (U.S. CLS. 22 AND 39).

FIRST USE 3-1-2010; IN COMMERCE 3-23-2010.

CLASS 25—(Continued).

3,785,485. DOBBS, VAN A., ARAB, AL. SN 77-509,150. PUB. 11-18-2008, FILED 6-26-2008.

RAMP TRAMP

THE MARK CONSISTS OF STANDARD CHARACTERS WITHOUT CLAIM TO ANY PARTICULAR FONT, STYLE, SIZE, OR COLOR.

FOR CLOTHING, NAMELY, TEE SHIRTS, SHIRTS, CAPS, VISORS, HATS, DEW RAGS, VESTS (U.S. CLS. 22 AND 39).

FIRST USE 1-1-2009; IN COMMERCE 1-1-2009.

3,785,500. HSN LP, ST. PETERSBURG, FL. SN 77-512,091. PUB. 2-10-2009, FILED 7-1-2008.

CURATIONS

THE MARK CONSISTS OF STANDARD CHARACTERS WITHOUT CLAIM TO ANY PARTICULAR FONT, STYLE, SIZE, OR COLOR.

FOR APPAREL, NAMELY, BLOUSES, KNIT TOPS, SWEATERS, PANTS, JEANS, SKIRTS, COATS, VESTS, CAPES, T-SHIRTS, SHORTS, DRESSES, JACKETS, BLAZERS; FOOTWEAR (U.S. CLS. 22 AND 39).

FIRST USE 3-25-2009; IN COMMERCE 3-25-2009.

3,785,509. HEARST COMMUNICATIONS, INC., NEW YORK, NY. SN 77-516,651. PUB. 12-2-2008, FILED 7-8-2008.

COUNTRY LIVING

THE MARK CONSISTS OF STANDARD CHARACTERS WITHOUT CLAIM TO ANY PARTICULAR FONT, STYLE, SIZE, OR COLOR.

OWNER OF U.S. REG. NOS. 2,442,089, 3,021,452, AND OTHERS.

FOR APRONS (U.S. CLS. 22 AND 39).

FIRST USE 11-1-2009; IN COMMERCE 11-1-2009.

CLASS 25—(Continued).

3,785,533. PATRICK HOLDINGS, LACONIA, NH. SN 77-526,503. PUB. 12-9-2008, FILED 7-18-2008.

KOOL 2 DROOL

THE MARK CONSISTS OF STANDARD CHARACTERS WITHOUT CLAIM TO ANY PARTICULAR FONT, STYLE, SIZE, OR COLOR.

FOR BIBS NOT OF CLOTH OR PAPER; CHILDREN'S AND INFANTS' CLOTH BIBS; HATS; INFANT AND TODDLER ONE PIECE CLOTHING; INFANT DIAPER COVERS; PANTS; SHOES; SNEAKERS; SOCKS; T-SHIRTS (U.S. CLS. 22 AND 39).

FIRST USE 8-20-2008; IN COMMERCE 3-11-2009.

3,785,535. S&K GARMENTS, INC., NEW YORK, NY. SN 77-526,975. PUB. 6-9-2009, FILED 7-21-2008.

BEYOND VINTAGE

THE MARK CONSISTS OF STANDARD CHARACTERS WITHOUT CLAIM TO ANY PARTICULAR FONT, STYLE, SIZE, OR COLOR.

NO CLAIM IS MADE TO THE EXCLUSIVE RIGHT TO USE "VINTAGE", APART FROM THE MARK AS SHOWN.

FOR CLOTHING, NAMELY, TOPS, SKIRTS, DRESSES, BLOUSES, SHIRTS, PANTS, SHORTS, SWIMWEAR, HOSIERY, JACKETS, SWEATERS, AND COATS (U.S. CLS. 22 AND 39).

FIRST USE 9-1-2008; IN COMMERCE 1-1-2009.

3,785,575. MOSS, JOHN, JR., FONTANA, CA. SN 77-542,758. PUB. 6-9-2009, FILED 8-8-2008.

LEGIONARY APPAREL

THE MARK CONSISTS OF STANDARD CHARACTERS WITHOUT CLAIM TO ANY PARTICULAR FONT, STYLE, SIZE, OR COLOR.

CLASS 25—(Continued).

NO CLAIM IS MADE TO THE EXCLUSIVE RIGHT TO USE "APPAREL", APART FROM THE MARK AS SHOWN.

FOR CLOTHING, NAMELY, T-SHIRTS, SHIRTS WITH COLLARS, BASEBALL CAPS, SLIPPERS, SANDALS, WRISTBANDS, HEADBANDS, BELTS, HEAD VISORS, SCARVES, SWEAT SHIRTS, SWEAT PANTS, SHOES, BEANIES, SOCKS, VESTS, JACKETS, COATS, SHIRT TIES, BATH ROBES, HOUSE JACKETS, HATS, BLOUSES, SHORTS, TANK TOPS, PAJAMAS, ONE PIECE GARMENT FOR INFANTS AND TODDLERS, SHAWLS, GLOVES, BONNETS, CLOTH BIBS, MITTENS, GAUCHOS, SLACKS, SKIRTS, DRESSES, SUSPENDERS, LEG WARMERS, SPORT JERSEY, LEGGINGS, STOCKINGS, LEOTARDS, HOODED SWEAT SHIRTS, HOODED JACKETS, CAMISOLES, BOXERS, BOXER BRIEFS, PANTIES, BRAS, NIGHTGOWNS, HIKING BOOTS, ATHLETIC TOPS, ATHLETIC TANK TOPS, TENNIS SHOES, SNEAKERS, BASEBALL JACKETS, SWEAT SHIRT, JACKETS, BOOTS, ASCOTS, PONCHOS, SHORTS, SCRUBS NOT FOR MEDICAL PURPOSES, LAB COATS, CREWNECK SHIRTS, TURTLENECK SHIRTS, HEADWRAPS, BANDANA (U.S. CLS. 22 AND 39).

FIRST USE 7-11-2009; IN COMMERCE 7-11-2009.

3,785,584. SMITHLINE, RICKY, NEW YORK, NY. SN 77-548,045. PUB. 8-11-2009, FILED 8-15-2008.

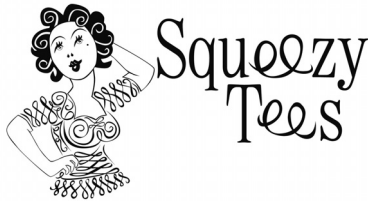

NO CLAIM IS MADE TO THE EXCLUSIVE RIGHT TO USE "TEES", APART FROM THE MARK AS SHOWN.

THE MARK CONSISTS OF A DEPICTION OF A WOMAN'S HEAD AND TORSO AND THE WORDING "SQUEEZY TEES" NEXT TO THE PICTURE.

FOR CLOTHING, NAMELY, TEE SHIRTS, TOPS, DRESSES, SKIRTS, PANTS, SHORTS, CAPRIS (U.S. CLS. 22 AND 39).

FIRST USE 3-27-2009; IN COMMERCE 3-27-2009.

3,785,588. ALTERNACARE SERVICES, INC., SPRING HILL, FL. SN 77-548,942. PUB. 3-17-2009, FILED 8-17-2008.



THE MARK CONSISTS OF A MAN PEERING OVER AN OBJECT FROM BEHIND FACING FORWARD EXPOSING HIS FACE ONLY FROM THE TOP OF HIS NOSE UP TO THE

CLASS 25—(Continued).

WIDE BRIM OF THE BLACK HAT HE IS WEARING. THE CHARACTERISTICS OF THE EXPOSED FACE OF THE MAN INCLUDE HIS UPPER NOSE, TWO EYES WHICH ARE SLIGHTLY SQUINTED WITH THE PUPILS LOOKING TO THE MAN'S EXTREME RIGHT, THIN EYE BROWS AND SMALL EAR LOBES APPEARING FROM UNDER THE HAT. UNDER THE OBJECT FROM WHICH THE MAN IS PEERING IS THE SINGLE WORD "CLOAKER" IN BLACK, BOLD, BLOCK LETTERS. THE ENTIRE LOGO IS IN BLACK AND WHITE.

FOR SCIENTIFIC AND TECHNOLOGICAL APPAREL, NAMELY, SHIRTS, PANTS, JACKETS, FOOTWEAR, HATS AND CAPS, UNIFORMS (U.S. CLS. 22 AND 39).

FIRST USE 9-27-2008; IN COMMERCE 11-30-2008.

3,785,618. DECKERS OUTDOOR CORPORATION, GOLETA, CA. SN 77-574,517. PUB. 6-23-2009, FILED 9-19-2008.

MOZO

THE MARK CONSISTS OF STANDARD CHARACTERS WITHOUT CLAIM TO ANY PARTICULAR FONT, STYLE, SIZE, OR COLOR.

THE ENGLISH TRANSLATION OF "MOZO" IN THE MARK IS YOUNG BOY.

FOR SOCKS (U.S. CLS. 22 AND 39).

FIRST USE 10-7-2008; IN COMMERCE 10-7-2008.

3,785,626. DISHMAN, KRISHEENA C., HERMITAGE, TN. SN 77-582,552. PUB. 8-4-2009, FILED 9-30-2008.

FAB3

THE MARK CONSISTS OF STANDARD CHARACTERS WITHOUT CLAIM TO ANY PARTICULAR FONT, STYLE, SIZE, OR COLOR.

FOR CLOTHING, NAMELY, TOPS, BLOUSES, AND T-SHIRTS (U.S. CLS. 22 AND 39).

FIRST USE 11-10-2009; IN COMMERCE 11-10-2009.

CLASS 25—(Continued).

3,785,643. STUDIO DAD, LLC, MEDINA, OH. SN 77-596,727. PUB. 5-5-2009, FILED 10-21-2008.

STUDIO DAD

THE MARK CONSISTS OF STANDARD CHARACTERS WITHOUT CLAIM TO ANY PARTICULAR FONT, STYLE, SIZE, OR COLOR.

NO CLAIM IS MADE TO THE EXCLUSIVE RIGHT TO USE "STUDIO", APART FROM THE MARK AS SHOWN.

FOR CLOTHING, NAMELY, SHIRTS, T-SHIRTS, SWEATSHIRTS, PANTS; HEADGEAR, NAMELY, HATS AND CAPS (U.S. CLS. 22 AND 39).

FIRST USE 12-28-2008; IN COMMERCE 12-28-2008.

CLASS 25—(Continued).

3,785,686. SHOOK, WILLIAM B., TAMPA, FL. AND KAST, ELLEN, TAMPA, FL. SN 77-620,099. PUB. 3-31-2009, FILED 11-21-2008.

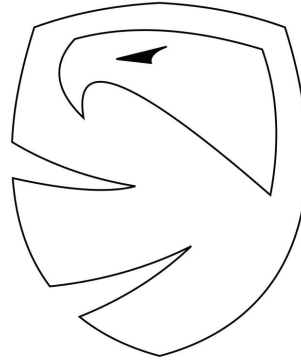

THE MARK CONSISTS OF THE STYLIZED HEAD OF AN EAGLE IN A CREST.

FOR CLOTHING, NAMELY, CYCLISTS' JERSEYS; HATS; SHIRTS; SHORTS; SOCKS; SWEAT SHIRTS; T-SHIRTS (U.S. CLS. 22 AND 39).

FIRST USE 9-4-2008; IN COMMERCE 9-4-2008.

3,785,723. HARVEY BALL SMILE LIMITED, SHINAGAWA-KU TOKYO, JAPAN. SN 77-632,791. PUB. 6-2-2009, FILED 12-14-2008.



THE MARK CONSISTS OF A SMILEY FACE DEPICTING TWO VERTICAL SHADED OVALS REPRESENTING EYES, EACH WITH AN UNSHADED CIRCLE AT THE TOP, AND A SHADED AND UNSHADED SMILE BELOW, WITH SHORT LINES DEPICTING CORNERS OF THE SMILE.

FOR CAPS; COATS; FOOTWEAR; GLOVES; HATS; NECKTIES; PAJAMAS; PANTS; SCARVES; SHIRTS; SHORTS; SKIRTS; SOCKS AND STOCKINGS; SWEATERS; SWIMSUITS; T-SHIRTS; TROUSERS; UNDERWEAR (U.S. CLS. 22 AND 39).

FIRST USE 2-27-2009; IN COMMERCE 2-27-2009.

3,785,665. T.S. ROBERTS, PONTE VEDRA BEACH, FL. SN 77-609,003. PUB. 3-24-2009, FILED 11-6-2008.

FORE EVER

THE MARK CONSISTS OF STANDARD CHARACTERS WITHOUT CLAIM TO ANY PARTICULAR FONT, STYLE, SIZE, OR COLOR.

FOR BELTS; CAPS; PANTS; SHORT-SLEEVED OR LONG-SLEEVED T-SHIRTS; SHORT-SLEEVED SHIRTS; SHORTS; TOPS; WEARABLE GARMENTS AND CLOTHING, NAMELY, SHIRTS (U.S. CLS. 22 AND 39).

FIRST USE 11-21-2009; IN COMMERCE 11-21-2009.

CLASS 25—(Continued).

3,785,724. HARVEY BALL SMILE LIMITED, SHINAGAWA-KU TOKYO, JAPAN. SN 77-632,793. PUB. 6-2-2009, FILED 12-14-2008.



THE MARK CONSISTS OF SMILEY FACE DEPICTING TWO VERTICAL PARTIALLY UNSHADED AND SHADED OVALS REPRESENTING EYES, A SHADED VERTICAL OVAL REPRESENTING A NOSE, AND A SHADED AND UNSHADED SMILE WITH CORNERS.

FOR CAPS; COATS; FOOTWEAR; GLOVES; HATS; NECKTIES; PAJAMAS; PANTS; SCARVES; SHIRTS; SHORTS; SKIRTS; SOCKS AND STOCKINGS; SWEATERS; SWIMSUITS; T-SHIRTS; TROUSERS; UNDERWEAR (U.S. CLS. 22 AND 39).

FIRST USE 2-27-2009; IN COMMERCE 2-27-2009.



3,785,725. HARVEY BALL SMILE LIMITED, SHINAGAWA-KU TOKYO, JAPAN. SN 77-632,795. PUB. 6-2-2009, FILED 12-14-2008.



THE MARK CONSISTS OF A SMILEY FACE DEPICTING THE LENS PORTION OF SUNGLASSES THAT ARE PARTIALLY SHADED AND UNSHADED, WITH A SMILE WITH CORNERS AND A LIP BELOW.

FOR CAPS; COATS; FOOTWEAR; GLOVES; HATS; NECKTIES; PAJAMAS; PANTS; SCARVES; SHIRTS; SHORTS; SKIRTS; SOCKS AND STOCKINGS; SWEATERS; SWIMSUITS; T-SHIRTS; TROUSERS; UNDERWEAR (U.S. CLS. 22 AND 39).

FIRST USE 2-27-2009; IN COMMERCE 2-27-2009.

CLASS 25—(Continued).

3,785,726. HARVEY BALL SMILE LIMITED, SHINAGAWA-KU TOKYO, JAPAN. SN 77-632,797. PUB. 6-2-2009, FILED 12-14-2008.



THE MARK CONSISTS OF A SMILEY FACE WITH SHADED SUNGLASSES WITHOUT HANDLES, IN AN UNSHADED FRAME, WITH A SMILE BELOW.

FOR CAPS; COATS; FOOTWEAR; GLOVES; HATS; NECKTIES; PAJAMAS; PANTS; SCARVES; SHIRTS; SHORTS; SKIRTS; SOCKS AND STOCKINGS; SWEATERS; SWIMSUITS; T-SHIRTS; TROUSERS; UNDERWEAR (U.S. CLS. 22 AND 39).

FIRST USE 2-27-2009; IN COMMERCE 2-27-2009.



3,785,730. ANTAGONIST, INC., SAN DIEGO, CA. SN 77-637,052. PUB. 5-5-2009, FILED 12-19-2008.

ANTAGONIST

THE MARK CONSISTS OF STANDARD CHARACTERS WITHOUT CLAIM TO ANY PARTICULAR FONT, STYLE, SIZE, OR COLOR.

FOR BOARD SHORTS; GYM SHORTS; HEADBANDS AGAINST SWEATING; RASH GUARDS; SHORTS; SPORTS SHIRTS; SWEAT SHIRTS; T-SHIRTS (U.S. CLS. 22 AND 39).

FIRST USE 5-1-2009; IN COMMERCE 11-1-2009.

CLASS 25—(Continued).

3,785,751. BITON, CORINA, MIAMI BEACH, FL. SN 77-645,089. PUB. 7-7-2009, FILED 1-7-2009.



THE MARK CONSISTS OF A CIRCULAR DESIGN CONSISTING OF A SOLID CIRCLE IN THE MIDDLE AND TWO OTHER CONCENTRIC INCOMPLETE CIRCLES AROUND THE SOLID CIRCLE.

FOR CLOTHING, NAMELY, ATHLETIC WEAR WITH UV PROTECTION, NAMELY, SHIRTS, SHORTS, PANTS, HEAD BANDS, BEACH COVER-UPS (U.S. CLS. 22 AND 39).

FIRST USE 4-15-2009; IN COMMERCE 4-15-2009.

3,785,765. GORDON, TRENSE LASHAY, RICEBORO, GA. SN 77-648,837. PUB. 6-23-2009, FILED 1-13-2009.



NO CLAIM IS MADE TO THE EXCLUSIVE RIGHT TO USE "DESIGNS", APART FROM THE MARK AS SHOWN.

THE COLOR(S) BLACK, WHITE, AND RED IS/ARE CLAIMED AS A FEATURE OF THE MARK.

THE MARK CONSISTS OF THE WORDING "LA SHAY'S DESIGNS" IN BLACK TO THE LEFT OF THE DESIGN OF A SWAN WITH A BLACK BODY AND WHITE WINGS WITHIN A BLACK CARRIER CIRCLE WITH A SINGLE LINE OF RED BORDERING THE BOTTOM PORTION OF THE CIRCLE.

FOR PANTS, CAPRI PANTS, JEANS, LEGGINGS, PANT SUITS, SKIRT SUITS, SKIRTS AND DRESSES, MINI-SKIRTS, JEAN SKIRTS, HALTER DRESSES, STRAPLESS DRESSES, SHIRTS, BODY SHIRTS, DRESS SHIRTS, HOODED SWEAT SHIRTS, KNITS SHIRTS, LONG-SLEEVED SHIRTS, NIGHT SHIRTS, OPEN-NECKED SHIRTS, POLO SHIRTS, JACKETS, HALTER TOPS, STRAPLESS SHIRTS, AND HATS FOR WOMEN AND TEENAGE GIRLS (U.S. CLS. 22 AND 39).

FIRST USE 10-25-2008; IN COMMERCE 5-1-2009.

CLASS 25—(Continued).

3,785,810. JAFFERSON, INC., IRVING, TX. SN 77-660,050. PUB. 8-25-2009, FILED 1-30-2009.

COWGIRL WEST

THE MARK CONSISTS OF STANDARD CHARACTERS WITHOUT CLAIM TO ANY PARTICULAR FONT, STYLE, SIZE, OR COLOR.

FOR BELTS (U.S. CLS. 22 AND 39).
FIRST USE 2-3-2009; IN COMMERCE 2-3-2009.

3,785,824. 4490673 CANADA INC., VERDUN, QUEBEC, CANADA. SN 77-661,604. PUB. 10-20-2009, FILED 2-2-2009.



THE MARK CONSISTS OF THE LETTER "W" IMPRINTED ON A SOLID BLOTCH DESIGN PLACED TO THE LEFT OF THE TERM "WAR" IN LOWER-CASE LETTERING. THE TERM "HEAD" APPEARS IN LOWER-CASE LETTERING DIRECTLY BELOW THE TERM "WAR".

FOR HEADWEAR, NAMELY, HATS, CAPS AND TOQUES; CLOTHING, NAMELY, T-SHIRTS, SWEATERS, JACKETS, AND SHORTS (U.S. CLS. 22 AND 39).

FIRST USE 12-1-2009; IN COMMERCE 12-1-2009.

3,785,833. EQ & I, LOS ANGELES, CA. SN 77-662,827. PUB. 6-2-2009, FILED 2-4-2009.

BODY POLICY

THE MARK CONSISTS OF STANDARD CHARACTERS WITHOUT CLAIM TO ANY PARTICULAR FONT, STYLE, SIZE, OR COLOR.

FOR CLOTHING, NAMELY, SHIRTS, T-SHIRTS, DRESSES, SKIRTS, PANTS, JACKETS, BLAZERS, COATS, SHORTS, SWEATERS, UNDERWEAR, AND STOCKINGS (U.S. CLS. 22 AND 39).

FIRST USE 12-15-2009; IN COMMERCE 12-15-2009.

CLASS 25—(Continued).

3,785,841. THOMPSON, TED A., WOODINVILLE, WA. SN 77-664,477. PUB. 6-2-2009, FILED 2-5-2009.

ONE LESS

THE MARK CONSISTS OF STANDARD CHARACTERS WITHOUT CLAIM TO ANY PARTICULAR FONT, STYLE, SIZE, OR COLOR.

FOR CLOTHING, NAMELY, T-SHIRTS (U.S. CLS. 22 AND 39).

FIRST USE 5-0-2009; IN COMMERCE 5-0-2009.

CLASS 25—(Continued).

3,785,886. 7 DIAMONDS CLOTHING CO. INC., TUSTIN, CA. SN 77-670,293. PUB. 6-9-2009, FILED 2-13-2009.

VARIOUS ARTISTS

THE MARK CONSISTS OF STANDARD CHARACTERS WITHOUT CLAIM TO ANY PARTICULAR FONT, STYLE, SIZE, OR COLOR.

FOR CLOTHING FOR MEN, WOMEN, BOYS, AND GIRLS, NAMELY, JEANS, PANTS, SHIRTS, T-SHIRTS, SWEATERS, SHORTS, SKIRTS, SKORTS, BLOUSES, TANK TOPS, HATS, NECKTIES, SCARVES, FOOTWEAR, COATS, SUITS, DRESSES, UNDERWEAR, HOSIERY, FUR-TRIMMED COATS, VESTS, DRESSES, ROBES, BEACH AND SWIMMING COVER-UPS, TENNIS AND GOLF DRESSES, WARM-UP SUITS, RAINWEAR, CAPES, PONCHOS, SHAWLS, WALKING SHORTS, TANK TOPS, JUMP SUITS, GLOVES, SPORTS JACKETS, BELTS, TIGHTS, RAINCOATS, SHOES, BOOTS, SLIPPERS, BLAZERS, BRAS, AND NIGHTGOWNS (U.S. CLS. 22 AND 39).

FIRST USE 12-1-2009; IN COMMERCE 12-1-2009.

3,785,903. CARMELINA ESTEVEZ, TEANECK, NJ. SN 77-675,398. PUB. 6-23-2009, FILED 2-21-2009.

Race OR Die

THE MARK CONSISTS OF STANDARD CHARACTERS WITHOUT CLAIM TO ANY PARTICULAR FONT, STYLE, SIZE, OR COLOR.

FOR SHIRTS, PANTS, JACKETS, SWEATER, SHOES, BELTS (U.S. CLS. 22 AND 39).

FIRST USE 10-15-2009; IN COMMERCE 2-1-2010.

3,785,850. MAHROUG, ERWIN, POORTUGAAL, NETHERLANDS. SN 77-665,745. PUB. 6-2-2009, FILED 2-7-2009.

STREET SCIENTISTS

THE MARK CONSISTS OF STANDARD CHARACTERS WITHOUT CLAIM TO ANY PARTICULAR FONT, STYLE, SIZE, OR COLOR.

FOR ATHLETIC APPAREL, NAMELY, SHIRTS, PANTS, JACKETS, FOOTWEAR, HATS AND CAPS, ATHLETIC UNIFORMS; ATHLETIC SHOES; BASEBALL CAPS; CAPS; DANCE SHOES; DENIM JACKETS; HEADGEAR, NAMELY, SPIN CAPS, CAPS AND HATS; JACKETS; JACKETS AND SOCKS; JEANS; MEN'S AND WOMEN'S JACKETS, COATS, TROUSERS, VESTS; PANTS; RUNNING SHOES; SHIRTS; SHOES; SHORT-SLEEVED OR LONG-SLEEVED T-SHIRTS; SHORT-SLEEVED SHIRTS; SWEAT PANTS; SWEAT SHIRTS; T-SHIRTS; TEE SHIRTS (U.S. CLS. 22 AND 39).

FIRST USE 11-18-2009; IN COMMERCE 12-4-2009.

3,785,919. GOSS,RADFORD LEE, AKA BIG ISLAND MAFIA, HILO, HI. SN 77-679,336. PUB. 7-14-2009, FILED 2-26-2009.

BIG ISLAND MAFIA

THE MARK CONSISTS OF STANDARD CHARACTERS WITHOUT CLAIM TO ANY PARTICULAR FONT, STYLE, SIZE, OR COLOR.

NO CLAIM IS MADE TO THE EXCLUSIVE RIGHT TO USE "BIG ISLAND", APART FROM THE MARK AS SHOWN.

FOR SHIRTS, T-SHIRTS, JACKETS, HATS, BEANIES, BANDANAS, JOGGING OUTFITS, SWIMWEAR, PANTS AND CAPS (U.S. CLS. 22 AND 39).

FIRST USE 4-2-2009; IN COMMERCE 11-2-2009.

CLASS 25—(Continued).

3,785,920. GAUYAN, KRISTOFFERSON, JACKSONVILLE, FL. SN 77-679,430. PUB. 6-23-2009, FILED 2-26-2009.



THE MARK CONSISTS OF THE STYLIZED TEXT "I" INSIDE A SQUARE. AT THE BOTTOM THERE IS THE STYLIZED TEXT "INKULTURE".

FOR BEANIES; BELTS; BIKINIS; DRESSES; HATS; JACKETS; JERSEYS; PANTS; SHIRTS; SHOES; SHORTS; SKIRTS; SOCKS; SWEATERS; SWIMWEAR; TANK TOPS; UNDERWEAR (U.S. CLS. 22 AND 39).

FIRST USE 9-1-2009; IN COMMERCE 1-1-2010.

3,785,921. PLATFORM, INC., TA FAITH&HUSTLE, SEATTLE, WA. SN 77-679,493. PUB. 7-21-2009, FILED 2-26-2009.

**Faith &
Hustle**

THE MARK CONSISTS OF STANDARD CHARACTERS WITHOUT CLAIM TO ANY PARTICULAR FONT, STYLE, SIZE, OR COLOR.

FOR ATHLETIC APPAREL, NAMELY, SHIRTS, PANTS, JACKETS, FOOTWEAR, HATS AND CAPS, ATHLETIC UNIFORMS (U.S. CLS. 22 AND 39).

FIRST USE 12-1-2008; IN COMMERCE 12-1-2008.

3,785,941. EDDIE BAUER LICENSING SERVICES LLC, BELLEVUE, WA. SN 77-685,512. PUB. 6-16-2009, FILED 3-6-2009.

SNOWLINE

THE MARK CONSISTS OF STANDARD CHARACTERS WITHOUT CLAIM TO ANY PARTICULAR FONT, STYLE, SIZE, OR COLOR.

FOR COATS; JACKETS (U.S. CLS. 22 AND 39).
FIRST USE 0-0-1996; IN COMMERCE 0-0-1996.

CLASS 25—(Continued).

3,785,944. BRAVADO INTERNATIONAL GROUP MERCHANDISING SERVICES, INC., NEW YORK, NY. SN 77-685,705. PUB. 6-2-2009, FILED 3-6-2009.

ELECTRIC CIRCUS

THE MARK CONSISTS OF STANDARD CHARACTERS WITHOUT CLAIM TO ANY PARTICULAR FONT, STYLE, SIZE, OR COLOR.

FOR T-SHIRTS AND SHIRTS (U.S. CLS. 22 AND 39).
FIRST USE 5-31-2009; IN COMMERCE 5-31-2009.

3,785,947. KILOGRAM INC, DBA KILOGRAM INC, NEW YORK, NY. SN 77-687,484. PUB. 10-27-2009, FILED 3-10-2009.

kilogram

THE MARK CONSISTS OF THE STYLIZED WORD "KILOGRAM" IN LOWER CASE LETTERS ONLY IN BATIK REGULAR FONT.

FOR DENIMS (U.S. CLS. 22 AND 39).
FIRST USE 5-1-2009; IN COMMERCE 7-6-2009.

3,785,970. EN THEOS, INC., MARION, IA. SN 77-694,000. PUB. 11-10-2009, FILED 3-18-2009.

1M4

THE MARK CONSISTS OF STANDARD CHARACTERS WITHOUT CLAIM TO ANY PARTICULAR FONT, STYLE, SIZE, OR COLOR.

OWNER OF U.S. REG. NOS. 3,435,471 AND 3,435,474.
FOR SHORT-SLEEVED OR LONG-SLEEVED T-SHIRTS (U.S. CLS. 22 AND 39).
FIRST USE 8-11-2009; IN COMMERCE 8-11-2009.

CLASS 25—(Continued).

3,785,987. AI GUO LIN, JINJIANG CITY, FUJIAN, CHINA.
SN 77-700,526. PUB. 10-27-2009, FILED 3-27-2009.



THE MARK CONSISTS OF THE STYLIZED LETTERS "FF" FORMING A CHEVRON DESIGN.

FOR BELTS; BOOTS; COATS; FOOTWEAR; HATS; JACKETS; JEANS; SHIRTS; SHOES; SHORTS; SKIRTS; SLIPPERS; SOCKS; SUITS (U.S. CLS. 22 AND 39).

FIRST USE 10-1-2009; IN COMMERCE 10-1-2009.

3,786,002. ERMENEGILDO ZEGNA CORPORATION, ENGLEWOOD, NJ. SN 77-708,574. PUB. 9-8-2009, FILED 4-7-2009.

TINDARI

THE MARK CONSISTS OF STANDARD CHARACTERS WITHOUT CLAIM TO ANY PARTICULAR FONT, STYLE, SIZE, OR COLOR.

THE WORDING "TINDARI" HAS NO MEANING IN A FOREIGN LANGUAGE.

FOR MEN'S CLOTHING, NAMELY, SUITS, JACKETS, PANTS, SHIRTS, TIES (U.S. CLS. 22 AND 39).

FIRST USE 11-0-2009; IN COMMERCE 11-0-2009.

CLASS 25—(Continued).

3,786,007. CUTTER & BUCK INC., SEATTLE, WA. SN 77-711,114. PUB. 8-11-2009, FILED 4-9-2009.



THE MARK CONSISTS OF A DESIGN OF A PAIR OF ANTLERS ATTACHED TO A SHIELD SHAPE.

FOR CLOTHING, NAMELY, SHIRTS, POLO SHIRTS, KNIT SHIRTS, JACKETS, SWEAT SHIRTS, WIND RESISTANT JACKETS (U.S. CLS. 22 AND 39).

FIRST USE 1-0-2008; IN COMMERCE 6-0-2008.

3,786,013. JCBT GLOBAL, FALLBROOK, CA. SN 77-712,435. PUB. 8-11-2009, FILED 4-13-2009.



NO CLAIM IS MADE TO THE EXCLUSIVE RIGHT TO USE "GLOBAL", APART FROM THE MARK AS SHOWN.

THE STIPPLING IS FOR SHADING PURPOSES ONLY.

THE MARK CONSISTS OF THE STYLIZED TEXT "JCBT GLOBAL" WITH A GLOBE ON TOP OF THE "J".

FOR CAPS; PANTS; SHIRTS; SHORTS; SWEAT SHIRTS; T-SHIRTS (U.S. CLS. 22 AND 39).

FIRST USE 3-9-2009; IN COMMERCE 3-9-2009.

3,786,041. RED ARME, LLC, NEW YORK, NY. SN 77-729,904. PUB. 10-6-2009, FILED 5-5-2009.



THE COLOR(S) WHITE, BLACK, AND RED IS/ARE CLAIMED AS A FEATURE OF THE MARK.

CLASS 25—(Continued).

THE MARK CONSISTS OF THE LETTERS "RED ARME" IN THE COLOR WHITE, A RED DOT IN THE AFOREMENTIONED LETTER "D", AND A BLACK BACKGROUND.
FOR T-SHIRTS (U.S. CLS. 22 AND 39).
FIRST USE 9-15-2009; IN COMMERCE 9-15-2009.

3,786,061. KUTZNER, DAMIAN, IRVINE, CA. SN 77-738,494.
PUB. 11-10-2009, FILED 5-15-2009.

Labeled Insane

THE MARK CONSISTS OF STANDARD CHARACTERS WITHOUT CLAIM TO ANY PARTICULAR FONT, STYLE, SIZE, OR COLOR.
FOR CLOTHING, NAMELY, SHIRTS, JERSEYS, BOXING SHORTS, SHORTS, AND HATS FOR MIXED MARTIAL ARTS FIGHTERS AND MUSIC BANDS (U.S. CLS. 22 AND 39).
FIRST USE 2-1-2006; IN COMMERCE 2-1-2006.

3,786,111. T-SHIRT INTERNATIONAL, INC., CULLODEN, WV. SN 77-757,981. PUB. 10-27-2009, FILED 6-12-2009.

TROPIC BLUE

THE MARK CONSISTS OF STANDARD CHARACTERS WITHOUT CLAIM TO ANY PARTICULAR FONT, STYLE, SIZE, OR COLOR.
NO CLAIM IS MADE TO THE EXCLUSIVE RIGHT TO USE "BLUE", APART FROM THE MARK AS SHOWN.
FOR T-SHIRTS; WEARABLE GARMENTS AND CLOTHING, NAMELY, SHIRTS (U.S. CLS. 22 AND 39).
FIRST USE 2-17-2010; IN COMMERCE 2-17-2010.

3,786,121. BLACK HALO PRODUCTIONS, LOS ANGELES, CA. SN 77-760,082. PUB. 11-3-2009, FILED 6-15-2009.

BLACK HALO

OWNER OF U.S. REG. NO. 3,173,022.

CLASS 25—(Continued).

THE MARK CONSISTS OF THE STYLIZED WORDS "BLACK HALO". THE LETTER "A" IN THE WORDS "BLACK" AND "HALO" APPEAR IN THE GREEK UPPER LETTER LAMBDA.
FOR CLOTHING, NAMELY, TOPS, BLOUSES, SHIRTS, TUNICS, DRESSES, PANTS, TROUSERS, SLACKS, SHORTS, JUMPSUITS, AND ROMPERS (U.S. CLS. 22 AND 39).
FIRST USE 10-6-2004. THE MARK WAS FIRST USED ANYWHERE IN A DIFFERENT FORM OTHER THAN THAT SOUGHT TO BE REGISTERED AT LEAST AS EARLY AS 12/31/2000.; IN COMMERCE 10-6-2004. THE MARK WAS FIRST USED IN COMMERCE IN A DIFFERENT FORM OTHER THAN THAT SOUGHT TO BE REGISTERED AT LEAST AS EARLY AS 06/08/2001..

3,786,122. BLACK HALO PRODUCTIONS, LOS ANGELES, CA. SN 77-760,099. PUB. 10-27-2009, FILED 6-15-2009.



THE MARK CONSISTS OF THE STYLIZED LETTERS "BH" WITH A PARALLEL LINE RUNNING THROUGH THE MIDDLE OF BOTH LETTERS.
FOR CLOTHING, NAMELY, TOPS, BLOUSES, SHIRTS, TUNICS, DRESSES, PANTS, TROUSERS, SLACKS, SHORTS, JUMPSUITS, AND ROMPERS (U.S. CLS. 22 AND 39).
FIRST USE 1-28-2010; IN COMMERCE 1-28-2010.

3,786,141. VICTORIA'S SECRET STORES BRAND MANAGEMENT, INC., REYNOLDSBURG, OH. SN 77-772,079. PUB. 10-20-2009, FILED 7-1-2009.

SEAM NO MORE

THE MARK CONSISTS OF STANDARD CHARACTERS WITHOUT CLAIM TO ANY PARTICULAR FONT, STYLE, SIZE, OR COLOR.
FOR BODY SHAPERS (U.S. CLS. 22 AND 39).
FIRST USE 1-25-2010; IN COMMERCE 1-25-2010.

CLASS 25—(Continued).

3,786,142. VICTORIA'S SECRET STORES BRAND MANAGEMENT, INC., REYNOLDSBURG, OH. SN 77-772,090. PUB. 10-20-2009, FILED 7-1-2009.

CLASS 25—(Continued).

3,786,145. VICTORIA'S SECRET STORES BRAND MANAGEMENT, INC., REYNOLDSBURG, OH. SN 77-772,142. PUB. 11-24-2009, FILED 7-1-2009.

BETTER ON TOP

THE MARK CONSISTS OF STANDARD CHARACTERS WITHOUT CLAIM TO ANY PARTICULAR FONT, STYLE, SIZE, OR COLOR.

FOR BODY SHAPERS (U.S. CLS. 22 AND 39).
FIRST USE 1-25-2010; IN COMMERCE 1-25-2010.

POWER FIGURE

THE MARK CONSISTS OF STANDARD CHARACTERS WITHOUT CLAIM TO ANY PARTICULAR FONT, STYLE, SIZE, OR COLOR.

FOR BODY SHAPERS (U.S. CLS. 22 AND 39).
FIRST USE 1-25-2010; IN COMMERCE 1-25-2010.

3,786,143. VICTORIA'S SECRET STORES BRAND MANAGEMENT, INC., REYNOLDSBURG, OH. SN 77-772,107. PUB. 10-20-2009, FILED 7-1-2009.

3,786,146. NAIGAI CO., LTD., TOKYO, JAPAN. SN 77-773,189. PUB. 12-1-2009, FILED 7-2-2009.

CHEEK-A-BOO

THE MARK CONSISTS OF STANDARD CHARACTERS WITHOUT CLAIM TO ANY PARTICULAR FONT, STYLE, SIZE, OR COLOR.

FOR BODY SHAPERS (U.S. CLS. 22 AND 39).
FIRST USE 1-25-2010; IN COMMERCE 1-25-2010.

NAIGAI

THE MARK CONSISTS OF STANDARD CHARACTERS WITHOUT CLAIM TO ANY PARTICULAR FONT, STYLE, SIZE, OR COLOR.

FOR SOCKS AND STOCKINGS (U.S. CLS. 22 AND 39).
FIRST USE 5-20-1980; IN COMMERCE 8-29-2009.

3,786,144. VICTORIA'S SECRET STORES BRAND MANAGEMENT, INC., REYNOLDSBURG, OH. SN 77-772,115. PUB. 11-24-2009, FILED 7-1-2009.

3,786,156. ROYAL MAX ENTERPRISES INC., BROOKLYN, NY. SN 77-801,550. PUB. 12-1-2009, FILED 8-11-2009.

BOLD HOLD

THE MARK CONSISTS OF STANDARD CHARACTERS WITHOUT CLAIM TO ANY PARTICULAR FONT, STYLE, SIZE, OR COLOR.

FOR BODY SHAPERS (U.S. CLS. 22 AND 39).
FIRST USE 1-25-2010; IN COMMERCE 1-25-2010.

SULTANS AND KINGS

THE MARK CONSISTS OF STANDARD CHARACTERS WITHOUT CLAIM TO ANY PARTICULAR FONT, STYLE, SIZE, OR COLOR.

FOR CAPS; HATS; MIXED MARTIAL ARTS SUITS; SHIRTS; SHORTS; SPORTS BRAS; SWEAT BANDS; SWEAT JACKETS; SWEAT PANTS; SWEAT SHIRTS; SWEAT SHORTS; T-SHIRTS (U.S. CLS. 22 AND 39).
FIRST USE 1-11-2010; IN COMMERCE 1-11-2010.

CLASS 25—(Continued).

3,786,169. MILLER INTERNATIONAL, INC., DENVER, CO.
SN 77-978,808. PUB. 12-2-2008, FILED 1-30-2008.

MILLER RANCH

THE MARK CONSISTS OF STANDARD CHARACTERS
WITHOUT CLAIM TO ANY PARTICULAR FONT, STYLE,
SIZE, OR COLOR.
FOR SHIRTS; JACKETS; VESTS (U.S. CLS. 22 AND 39).
FIRST USE 1-27-2009; IN COMMERCE 1-27-2009.

3,786,191. WRANGLER APPAREL CORP., WILMINGTON,
DE. SN 77-979,041. PUB. 3-18-2008, FILED 9-6-2007.



OWNER OF U.S. REG. NOS. 809,323, 2,575,862, AND
OTHERS.
THE MARK CONSISTS OF THE WORD "WRANGLER",
STYLIZED.
FOR CLOTHING, NAMELY, T-SHIRTS (U.S. CLS. 22
AND 39).
FIRST USE 4-10-2000; IN COMMERCE 4-11-2000.

3,786,193. WARRIOR SPORTS, INC., WARREN, MI. SN 77-
979,060. PUB. 5-26-2009, FILED 8-25-2008.

THE MEANS TO DOMINATE

THE MARK CONSISTS OF STANDARD CHARACTERS
WITHOUT CLAIM TO ANY PARTICULAR FONT, STYLE,
SIZE, OR COLOR.
FOR TEE SHIRTS, NAMELY, SHORT SLEEVE SHIRTS,
LONG SLEEVE SHIRTS, SHORTS (U.S. CLS. 22 AND 39).
FIRST USE 4-0-2002; IN COMMERCE 4-0-2002.

CLASS 25—(Continued).

3,786,197. UNDER ARMOUR, INC., BALTIMORE, MD. SN
77-979,094. PUB. 3-31-2009, FILED 9-12-2008.

RECHARGE

THE MARK CONSISTS OF STANDARD CHARACTERS
WITHOUT CLAIM TO ANY PARTICULAR FONT, STYLE,
SIZE, OR COLOR.
FOR CLOTHING, NAMELY, SHIRTS, LONG-SLEEVED
SHIRTS, MOISTURE-WICKING SPORTS SHIRTS, BODY
SUITS, T-SHIRTS, PANTS, LEGGINGS, SOCKS (U.S.
CLS. 22 AND 39).
FIRST USE 6-29-2009; IN COMMERCE 6-29-2009.

3,786,209. CLEATS LLC, MARLBOROUGH, MA. SN 78-
234,446. PUB. 8-26-2008, FILED 4-7-2003.

**CHAMP SCORPION
STINGER**

OWNER OF U.S. REG. NO. 1,327,086.
FOR SPIKES AND CLEATS FOR GOLF SHOES (U.S.
CLS. 22 AND 39).
FIRST USE 9-30-2003; IN COMMERCE 9-30-2003.

3,786,211. FAMILY DOLLAR STORES OF MICHIGAN, INC.,
MATTHEWS, NC. SN 78-328,932. PUB. 12-19-2006, FILED
11-17-2003.

URBAN LEGENDS

THE MARK CONSISTS OF STANDARD CHARACTERS
WITHOUT CLAIM TO ANY PARTICULAR FONT, STYLE,
SIZE, OR COLOR.
FOR CLOTHING, NAMELY, TOPS AND SHIRTS (U.S.
CLS. 22 AND 39).
FIRST USE 2-1-2010; IN COMMERCE 2-1-2010.

CLASS 25—(Continued).

3,786,231. MONARCH PRODUCTIONS, LLC, CALHOUN, GA. SN 78-662,062. PUB. 12-12-2006, FILED 6-30-2005.

WINGS OF NATURE

THE MARK CONSISTS OF STANDARD CHARACTERS WITHOUT CLAIM TO ANY PARTICULAR FONT, STYLE, SIZE, OR COLOR.

FOR CLOTHING, NAMELY, SHIRTS (U.S. CLS. 22 AND 39).

FIRST USE 3-4-2010; IN COMMERCE 3-4-2010.

3,786,272. EMERY, ROBERT, PHOENIX, AZ. SN 78-836,823. PUB. 11-13-2007, FILED 3-14-2006.

ERROR

THE MARK CONSISTS OF STANDARD CHARACTERS WITHOUT CLAIM TO ANY PARTICULAR FONT, STYLE, SIZE, OR COLOR.

FOR CLOTHING, NAMELY, SHIRTS (U.S. CLS. 22 AND 39).

FIRST USE 2-3-2010; IN COMMERCE 2-3-2010.

3,786,293. HOODLOVE LIMITED LIABILITY COMPANY, EAST ORANGE, NJ. SN 78-861,589. PUB. 11-28-2006, FILED 4-14-2006.

HOOD LOVE

THE MARK CONSISTS OF STANDARD CHARACTERS WITHOUT CLAIM TO ANY PARTICULAR FONT, STYLE, SIZE, OR COLOR.

FOR BASEBALL CAPS; CAPS; HATS; HEADWEAR; SHIRTS; SHORT-SLEEVED OR LONG-SLEEVED T-SHIRTS; SWEAT SHIRTS; T-SHIRTS; TOPS (U.S. CLS. 22 AND 39).

FIRST USE 4-0-2006; IN COMMERCE 4-0-2007.

CLASS 25—(Continued).

3,786,295. NINJAI GANG, LLC, KAILUA, HI. SN 78-879,256. PUB. 12-5-2006, FILED 5-8-2006.



THE MARK CONSISTS OF A STYLIZED DEPICTION OF A MONKEY WITH THE TORSO OF A HUMAN, WEARING A CROWN ON ITS HEAD AND HOLDING AN ISLAND IN ITS HAND, WITH ITS TAIL ELONGATED AND FORMING A CIRCLE AROUND THE MONKEY.

FOR SHIRTS, SHORTS AND TOPS (U.S. CLS. 22 AND 39).

FIRST USE 2-19-2010; IN COMMERCE 2-19-2010.

3,786,305. THUMB WORLD PRODUCTIONS LLC, NEW YORK, NY. SN 78-891,038. PUB. 1-2-2007, FILED 5-24-2006.

T-WIZ

THE MARK CONSISTS OF STANDARD CHARACTERS WITHOUT CLAIM TO ANY PARTICULAR FONT, STYLE, SIZE, OR COLOR.

FOR MEN'S, WOMEN'S AND CHILDREN'S CLOTHING, NAMELY, T-SHIRTS AND SWEATSHIRTS (U.S. CLS. 22 AND 39).

FIRST USE 7-11-2007; IN COMMERCE 7-11-2007.

3,786,322. JOHNSON, MICHAEL, MILL VALLEY, CA. SN 78-924,854. PUB. 4-17-2007, FILED 7-7-2006.

MICHAEL JOHNSON PERFORMANCE

THE MARK CONSISTS OF STANDARD CHARACTERS WITHOUT CLAIM TO ANY PARTICULAR FONT, STYLE, SIZE, OR COLOR.

NO CLAIM IS MADE TO THE EXCLUSIVE RIGHT TO USE "PERFORMANCE", APART FROM THE MARK AS SHOWN.

CLASS 25—(Continued).

THE NAME "MICHAEL JOHNSON" IDENTIFIES A LIVING INDIVIDUAL WHOSE CONSENT IS OF RECORD.

FOR SPORTS APPAREL, NAMELY, UNIFORMS, BATHING SUITS, SWIM TRUNKS, SHIRTS, GOLF SHIRTS, T-SHIRTS, JERSEYS, PULLOVERS, TANK TOPS, BICYCLE GLOVES, SWEATBANDS, JACKETS, LEG WARMERS, LEOTARDS, UNITARDS, TIGHTS, SHORTS, PANTS, TRACK SUITS, WARM UP SUITS, SWEAT SHIRTS, SWEAT PANTS, LEGGINGS, TENNIS SKIRTS, SPORTS BRAS, SOCKS, SKI WEAR, ATHLETIC FOOTWEAR AND HEADWEAR (U.S. CLS. 22 AND 39).
FIRST USE 4-30-2009; IN COMMERCE 4-30-2009.

3,786,330. VARCANO WORLDWIDE LIMITED, KOWLOON, HONG KONG. SN 78-949,044. PUB. 4-1-2008, FILED 8-10-2006.



THE ENGLISH TRANSLATION OF THE CHINESE CHARACTER IN THE MARK IS "FIRE".

"THE NON-LATIN CHARACTER(S) IN THE MARK TRANSLITERATES INTO "YAN"

FOR CLOTHING, NAMELY, JACKETS, TROUSERS, UNDERWEAR, SWIMMING SUITS, T-SHIRTS, RAIN COATS, THEATRICAL COSTUMES, SHOES, HATS, SOCKS, GLOVES, NECKERCHIEFS, TIES, AND BELTS; LEATHER CLOTHING, NAMELY, LEATHER COATS, LEATHER JACKETS, AND LEATHER PANTS; AND CHILD CLOTHES, NAMELY, SHORTS, SHIRTS, JUMPERS, AND OVERALLS (U.S. CLS. 22 AND 39).
FIRST USE 12-1-2006; IN COMMERCE 12-1-2006.

CLASS 26—FANCY GOODS

CLASS 26—(Continued).

3,785,892. PORTLAND BEAU COMPANY LLC, PORTLAND, OR. SN 77-673,119. PUB. 6-16-2009, FILED 2-18-2009.

ECOBEAU

THE MARK CONSISTS OF STANDARD CHARACTERS WITHOUT CLAIM TO ANY PARTICULAR FONT, STYLE, SIZE, OR COLOR.

FOR RIBBONS; DECORATIVE RIBBONS; RIBBONS FOR GIFT WRAPPING; BOWS FOR GIFT WRAPPING; REUSABLE AND RECYCLABLE RIBBONS; REUSABLE AND RECYCLABLE BOWS FOR GIFT WRAPPING (U.S. CLS. 37, 39, 40, 42 AND 50).

FIRST USE 11-0-2009; IN COMMERCE 11-0-2009.

CLASS 27—FLOOR COVERINGS

3,785,617. MOHAWK BRANDS, INC., CALHOUN, DE. SN 77-573,101. PUB. 12-23-2008, FILED 9-18-2008.

SMART OPTIONS

THE MARK CONSISTS OF STANDARD CHARACTERS WITHOUT CLAIM TO ANY PARTICULAR FONT, STYLE, SIZE, OR COLOR.

OWNER OF U.S. REG. NOS. 2,352,756, 2,940,828, AND OTHERS.

FOR CARPETS (U.S. CLS. 19, 20, 37, 42 AND 50).

FIRST USE 1-10-2009; IN COMMERCE 1-10-2009.

3,786,090. MOUNTVILLE MILLS, INC., LAGRANGE, GA. SN 77-751,782. PUB. 10-20-2009, FILED 6-4-2009.

ENVIRO PLUS

THE MARK CONSISTS OF STANDARD CHARACTERS WITHOUT CLAIM TO ANY PARTICULAR FONT, STYLE, SIZE, OR COLOR.

FOR DOOR MATS AND FLOOR MATS (U.S. CLS. 19, 20, 37, 42 AND 50).

FIRST USE 10-0-2009; IN COMMERCE 10-0-2009.

CLASS 28—TOYS AND SPORTING GOODS

CLASS 28—(Continued).

3,785,076. BOWLING, MICHAEL, TUCSON, AZ. SN 76-669,817. PUB. 6-10-2008, FILED 12-1-2006.

ELVEN WOODS

THE MARK CONSISTS OF STANDARD CHARACTERS WITHOUT CLAIM TO ANY PARTICULAR FONT, STYLE, SIZE, OR COLOR.

FOR DICE (U.S. CLS. 22, 23, 38 AND 50).
FIRST USE 12-0-2009; IN COMMERCE 12-0-2009.

3,785,096. ATLANTA NATIONAL LEAGUE BASEBALL CLUB, INC., ATLANTA, GA. SN 76-695,255. PUB. 5-5-2009, FILED 1-12-2009.

GWINNETT BRAVES

THE MARK CONSISTS OF STANDARD CHARACTERS WITHOUT CLAIM TO ANY PARTICULAR FONT, STYLE, SIZE, OR COLOR.

OWNER OF U.S. REG. NOS. 1,561,774, 1,620,113, AND OTHERS.

NO CLAIM IS MADE TO THE EXCLUSIVE RIGHT TO USE "GWINNETT", APART FROM THE MARK AS SHOWN.

FOR TOYS AND SPORTING GOODS, NAMELY, STUFFED TOYS, PLUSH TOYS, SOFT SCULPTURE FOAM TOYS, FOAM NOVELTY ITEMS, NAMELY, FOAM FINGERS, MINIATURE BASEBALL BATS, MINI BATTING HELMET REPLICAS, MINIATURE TOY BASEBALLS, BASEBALLS, BASEBALL BATS (U.S. CLS. 22, 23, 38 AND 50).

FIRST USE 12-0-2008; IN COMMERCE 12-0-2008.

3,785,158. INGE'S CHRISTMAS DECOR GMBH, NEUSTADT B. COBURG, FED REP GERMANY. SN 77-177,611. PUB. 6-9-2009, FILED 5-10-2007.



NO CLAIM IS MADE TO THE EXCLUSIVE RIGHT TO USE "COMPANY", APART FROM THE MARK AS SHOWN.

THE COLOR(S) RED AND BLUE IS/ARE CLAIMED AS A FEATURE OF THE MARK.

THE MARK CONSISTS OF "SANTA KLAUS" IN RED LETTERS APPEARING ABOVE "& COMPANY" IN BLUE LETTERS ALL INSIDE A BLUE COLORED BANNER OUTLINED IN BLUE.

FOR HAND-CRAFTED OBJECTS OF ART, IN THE FORM OF GERMAN, OLD-WORLD STYLE, HAND-PAINTED CHRISTMAS TREE DECORATIONS, MADE OF POLY RESINS, PORCELAIN, TERRA COTTA, OR GLASS (U.S. CLS. 22, 23, 38 AND 50).

FIRST USE 1-15-2006; IN COMMERCE 1-15-2006.

CLASS 28—(Continued).

3,785,174. GEBHART, DOUGLAS A., MARGATE, FL. SN 77-206,770. PUB. 11-20-2007, FILED 6-14-2007.



FOR DICE; DICE GAMES (U.S. CLS. 22, 23, 38 AND 50).

FIRST USE 5-21-2007; IN COMMERCE 2-26-2009.

3,785,190. MCCABE, TERRILL, CARLSBAD, CA. SN 77-233,616. PUB. 6-24-2008, FILED 7-19-2007.

THE EVOLUTION CONTINUES

THE MARK CONSISTS OF STANDARD CHARACTERS WITHOUT CLAIM TO ANY PARTICULAR FONT, STYLE, SIZE, OR COLOR.

FOR GOLF CLUBS AND GOLF CLUB ACCESSORIES, NAMELY, GOLF CLUBS, GOLF CLUB GRIPS, GOLF PUTTER HEADS, REPAIR TOOLS FOR GROUND MARKS CAUSED BY GOLF BALLS IN THE NATURE OF GOLF DIVOT REPAIR TOOLS (U.S. CLS. 22, 23, 38 AND 50).

FIRST USE 12-24-2009; IN COMMERCE 12-24-2009.

3,785,222. MATTEL, INC., EL SEGUNDO, CA. SN 77-293,581. PUB. 1-13-2009, FILED 10-2-2007.

TRAPJAW

THE MARK CONSISTS OF STANDARD CHARACTERS WITHOUT CLAIM TO ANY PARTICULAR FONT, STYLE, SIZE, OR COLOR.

FOR TOY ACTION FIGURES AND ACCESSORIES THEREFOR (U.S. CLS. 22, 23, 38 AND 50).

FIRST USE 2-16-2010; IN COMMERCE 2-16-2010.

CLASS 28—(Continued).

3,785,264. MAXIMA MANUFACTURING COMPANY MEINEL VERWALTUNGES GMBH & CO. KG, GERETSRIED, FED REP GERMANY. SN 77-344,016. PUB. 4-22-2008, FILED 12-4-2007.

MAXIMA HV

THE MARK CONSISTS OF STANDARD CHARACTERS WITHOUT CLAIM TO ANY PARTICULAR FONT, STYLE, SIZE, OR COLOR.

FOR FISHING LINES (U.S. CLS. 22, 23, 38 AND 50).
FIRST USE 3-20-2009; IN COMMERCE 3-20-2009.

3,785,298. JAMES GAMES INC., SANTA ANA, CA. SN 77-374,608. PUB. 12-16-2008, FILED 1-17-2008.

SPINGALI

THE MARK CONSISTS OF STANDARD CHARACTERS WITHOUT CLAIM TO ANY PARTICULAR FONT, STYLE, SIZE, OR COLOR.

FOR TOYS AND GAMES, NAMELY, BOARD GAMES, EQUIPMENT AND ACCESSORIES SOLD AS A UNIT FOR PLAYING FOR BOARD GAMES (U.S. CLS. 22, 23, 38 AND 50).

FIRST USE 11-18-2009; IN COMMERCE 11-18-2009.

3,785,299. REHAB UNITED SPORTS MEDICINE & PHYSICAL THERAPY, INC., SAN DIEGO, CA. SN 77-375,398. PUB. 6-24-2008, FILED 1-18-2008.



VERT FLEX
WEDGE

NO CLAIM IS MADE TO THE EXCLUSIVE RIGHT TO USE "WEDGE", APART FROM THE MARK AS SHOWN.

THE MARK CONSISTS OF A PARTIAL GEOMETRIC DESIGN SURROUNDING THE LETTER "A".

FOR EXERCISE EQUIPMENT, NAMELY, APPARATUS FOR STRETCHING AND STRENGTHENING EXTREMITIES (U.S. CLS. 22, 23, 38 AND 50).

FIRST USE 12-1-2008; IN COMMERCE 6-15-2009.

CLASS 28—(Continued).

3,785,408. KINGMAN INTERNATIONAL CORPORATION, BALDWIN PARK, CA. SN 77-461,265. PUB. 9-23-2008, FILED 4-29-2008.

HIGHLITE

THE MARK CONSISTS OF STANDARD CHARACTERS WITHOUT CLAIM TO ANY PARTICULAR FONT, STYLE, SIZE, OR COLOR.

FOR FACE MASKS FOR USE IN PAINTBALL COMPETITIONS (U.S. CLS. 22, 23, 38 AND 50).

FIRST USE 1-19-2010; IN COMMERCE 1-19-2010.

3,785,649. SIBLING THRIVALRY, LLC, HOMEWOOD, IL. SN 77-600,812. PUB. 7-28-2009, FILED 10-27-2008.



THE COLOR(S) BROWN, BLACK, WHITE AND RED IS/ ARE CLAIMED AS A FEATURE OF THE MARK.

THE MARK CONSISTS OF FOUR CHILDREN WITH VARYING SHADES OF BROWN SKIN, WEARING BLACK AND WHITE SHIRTS. THEY ARE IN FRONT OF A BLACK AND WHITE UNIVERSITY BUILDING WITH PILLARS. THE TEXT, "SIBLING COLLEGE" IS IN RED WITH A BLACK AND WHITE OUTLINE.

FOR CARD GAMES (U.S. CLS. 22, 23, 38 AND 50).
FIRST USE 1-17-2009; IN COMMERCE 1-17-2009.

CLASS 28—(Continued).

3,785,667. DOTSON, ELISE C., MCDONOUGH, GA. SN 77-609,129. PUB. 3-24-2009, FILED 11-6-2008.

BRUSH BOO-BOO

THE MARK CONSISTS OF STANDARD CHARACTERS WITHOUT CLAIM TO ANY PARTICULAR FONT, STYLE, SIZE, OR COLOR.

FOR PUPPETS (U.S. CLS. 22, 23, 38 AND 50).
FIRST USE 2-4-2010; IN COMMERCE 2-4-2010.

3,785,750. TIPPMANN SPORTS, LLC, BUFFALO GROVE, IL. SN 77-644,133. PUB. 11-3-2009, FILED 1-6-2009.

FLEXVALVE

THE MARK CONSISTS OF STANDARD CHARACTERS WITHOUT CLAIM TO ANY PARTICULAR FONT, STYLE, SIZE, OR COLOR.

FOR PAINTBALL GUNS AND PARTS THEREFOR (U.S. CLS. 22, 23, 38 AND 50).
FIRST USE 10-0-2009; IN COMMERCE 11-0-2009.

3,785,777. WEIR, JOE A., CHARDON, OH. SN 77-653,634. PUB. 5-5-2009, FILED 1-21-2009.

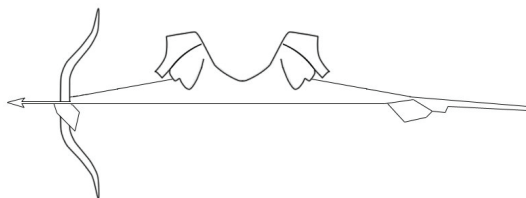

THE MARK CONSISTS OF TWO PROFILE SILHOUETTES OF HEADS, WEARING BRIMMED HATS, SPLITTING CENTER, ONE FACING LEFT, ONE FACING RIGHT. FROM THE NOSE OF EACH HEAD EXTENDS AN ANGLED LINE, HEADED DOWN AT A SLIGHT SLOPE. ON THE LEFT-HAND SIDE IS A BOW AND ARROW, APPEARING TO BE HELD BY THE LEFT-SIDE HEAD. ON THE RIGHT-HAND SIDE IS A RIFLE, APPEARING TO BE HELD BY THE RIGHT-SIDE HEAD. BELOW THE HEADS IS A HORIZONTAL LINE THAT EXTENDS BETWEEN THE BASE OF THE BOW AND THE BASE OF THE RIFLE, CONNECTING THE TWO.

FOR HUNTING STANDS; TREE STANDS FOR HUNTING (U.S. CLS. 22, 23, 38 AND 50).
FIRST USE 2-1-2009; IN COMMERCE 6-1-2009.

CLASS 28—(Continued).

3,785,809. BALANCE 360, L.L.C., SPRINGFIELD, MO. SN 77-660,015. PUB. 5-26-2009, FILED 1-30-2009.

BALANCE 360

THE MARK CONSISTS OF STANDARD CHARACTERS WITHOUT CLAIM TO ANY PARTICULAR FONT, STYLE, SIZE, OR COLOR.

NO CLAIM IS MADE TO THE EXCLUSIVE RIGHT TO USE "BALANCE", APART FROM THE MARK AS SHOWN. FOR BALANCE BOARDS (U.S. CLS. 22, 23, 38 AND 50).
FIRST USE 2-17-2010; IN COMMERCE 2-17-2010.

3,785,877. GLOBAL INTERNATIONAL ENTERPRISE CO., LTD, HUNG HOM KOWLOON, HONG KONG. SN 77-669,052. PUB. 6-9-2009, FILED 2-12-2009.

GREEN YOUR TREE

THE MARK CONSISTS OF STANDARD CHARACTERS WITHOUT CLAIM TO ANY PARTICULAR FONT, STYLE, SIZE, OR COLOR.

FOR CHRISTMAS TREE ORNAMENTS AND DECORATIONS (U.S. CLS. 22, 23, 38 AND 50).
FIRST USE 2-20-2010; IN COMMERCE 2-20-2010.

3,785,948. PAUL, CURTIS, WASHINGTON, DC. SN 77-687,509. PUB. 7-7-2009, FILED 3-10-2009.

XIACON

THE MARK CONSISTS OF STANDARD CHARACTERS WITHOUT CLAIM TO ANY PARTICULAR FONT, STYLE, SIZE, OR COLOR.

FOR EQUIPMENT FOR USE IN PLAYING A BOARD GAME, NAMELY, GAME PLAYING PIECES (U.S. CLS. 22, 23, 38 AND 50).
FIRST USE 7-17-2009; IN COMMERCE 10-23-2009.

CLASS 28—(Continued).

3,785,955. HASBRO, INC., PAWTUCKET, RI. SN 77-689,786.
PUB. 7-14-2009, FILED 3-12-2009.

REAL SURPRISES BABY

THE MARK CONSISTS OF STANDARD CHARACTERS WITHOUT CLAIM TO ANY PARTICULAR FONT, STYLE, SIZE, OR COLOR.

NO CLAIM IS MADE TO THE EXCLUSIVE RIGHT TO USE "BABY", APART FROM THE MARK AS SHOWN.

FOR DOLL ACCESSORIES; DOLL CLOTHING; DOLLS (U.S. CLS. 22, 23, 38 AND 50).

FIRST USE 6-5-2009; IN COMMERCE 6-5-2009.

CLASS 28—(Continued).

3,786,008. MIKEN SPORTS, LLC, CALEDONIA, MN. SN 77-711,575. PUB. 7-14-2009, FILED 4-10-2009.

VICIOUS

THE MARK CONSISTS OF STANDARD CHARACTERS WITHOUT CLAIM TO ANY PARTICULAR FONT, STYLE, SIZE, OR COLOR.

FOR SPORTING GOODS, NAMELY, SOFTBALL BATS (U.S. CLS. 22, 23, 38 AND 50).

FIRST USE 2-0-2009; IN COMMERCE 2-0-2009.

3,785,961. WOODWAY USA, INC., WAUKESHA, WI. SN 77-691,926. PUB. 7-14-2009, FILED 3-16-2009.

CURVE

THE MARK CONSISTS OF STANDARD CHARACTERS WITHOUT CLAIM TO ANY PARTICULAR FONT, STYLE, SIZE, OR COLOR.

FOR EXERCISE TREADMILLS (U.S. CLS. 22, 23, 38 AND 50).

FIRST USE 1-0-2010; IN COMMERCE 1-0-2010.

3,786,065. PEACOCK NINE LLC, CHICAGO, IL. SN 77-739,813. PUB. 9-29-2009, FILED 5-18-2009.

Frostywood

THE MARK CONSISTS OF STANDARD CHARACTERS WITHOUT CLAIM TO ANY PARTICULAR FONT, STYLE, SIZE, OR COLOR.

FOR SKATEBOARD DECKS (U.S. CLS. 22, 23, 38 AND 50).

FIRST USE 10-31-2008; IN COMMERCE 2-2-2010.

3,786,001. PRETTY UGLY LLC, EDISON, NJ. AND HORVATH, DAVID, EDISON, NJ. AND KIM, SUN-MIN, EDISON, NJ. SN 77-707,855. PUB. 6-23-2009, FILED 4-6-2009.

MYNUS

THE MARK CONSISTS OF STANDARD CHARACTERS WITHOUT CLAIM TO ANY PARTICULAR FONT, STYLE, SIZE, OR COLOR.

FOR STUFFED AND PLUSH TOYS (U.S. CLS. 22, 23, 38 AND 50).

FIRST USE 2-1-2010; IN COMMERCE 2-1-2010.

3,786,098. BIG FISH AMERICA, LLC, BEMIDJI, MN. SN 77-754,684. PUB. 10-20-2009, FILED 6-8-2009.

Macho Minnow

THE MARK CONSISTS OF STANDARD CHARACTERS WITHOUT CLAIM TO ANY PARTICULAR FONT, STYLE, SIZE, OR COLOR.

NO CLAIM IS MADE TO THE EXCLUSIVE RIGHT TO USE "MINNOW", APART FROM THE MARK AS SHOWN.

FOR FISHING TACKLE (U.S. CLS. 22, 23, 38 AND 50).

FIRST USE 7-15-2009; IN COMMERCE 7-15-2009.

CLASS 28—(Continued).

3,786,134. SENARIO LLC, WOODSTOCK, IL. SN 77-766,313.
PUB. 11-10-2009, FILED 6-23-2009.

Zibits

THE MARK CONSISTS OF STANDARD CHARACTERS WITHOUT CLAIM TO ANY PARTICULAR FONT, STYLE, SIZE, OR COLOR.

FOR MINIATURE TOY ROBOT (U.S. CLS. 22, 23, 38 AND 50).

FIRST USE 10-13-2009; IN COMMERCE 10-13-2009.

3,786,155. KARSTEN MANUFACTURING CORPORATION, PHOENIX, AZ. SN 77-791,228. PUB. 10-27-2009, FILED 7-28-2009.

PING I15

THE MARK CONSISTS OF STANDARD CHARACTERS WITHOUT CLAIM TO ANY PARTICULAR FONT, STYLE, SIZE, OR COLOR.

OWNER OF U.S. REG. NOS. 704,552, 3,171,985, AND OTHERS.

FOR GOLF CLUBS (U.S. CLS. 22, 23, 38 AND 50).

FIRST USE 7-21-2009; IN COMMERCE 7-21-2009.

3,786,179. SMITH, JULIE, AVONDALE ESTATES, GA. AND SAXON, JUAN, BIRMINGHAM, AL. SN 77-978,969. PUB. 10-14-2008, FILED 2-5-2008.

JUJUME

THE MARK CONSISTS OF STANDARD CHARACTERS WITHOUT CLAIM TO ANY PARTICULAR FONT, STYLE, SIZE, OR COLOR.

FOR PUZZLES AND GAMES, NAMELY, JIGSAW PUZZLES (U.S. CLS. 22, 23, 38 AND 50).

FIRST USE 4-13-2009; IN COMMERCE 11-2-2009.

CLASS 28—(Continued).

3,786,182. MGA ENTERTAINMENT, INC., VAN NUYS, CA. SN 77-978,983. PUB. 4-21-2009, FILED 12-24-2008.

BFC INK.

THE MARK CONSISTS OF STANDARD CHARACTERS WITHOUT CLAIM TO ANY PARTICULAR FONT, STYLE, SIZE, OR COLOR.

FOR TOYS, GAMES AND PLAYTHINGS, NAMELY, DOLLS, DOLL CLOTHING, DOLL ACCESSORIES (U.S. CLS. 22, 23, 38 AND 50).

FIRST USE 12-31-2008; IN COMMERCE 5-12-2009.

3,786,183. MGA ENTERTAINMENT, INC., VAN NUYS, CA. SN 77-978,984. PUB. 4-21-2009, FILED 12-24-2008.



THE MARK CONSISTS OF LITERAL ELEMENT SUPERIMPOSED ON FLOWERED SHIELD DESIGN.

FOR TOYS, GAMES AND PLAYTHINGS, NAMELY, DOLLS, DOLL CLOTHING, DOLL ACCESSORIES (U.S. CLS. 22, 23, 38 AND 50).

FIRST USE 12-30-2008; IN COMMERCE 5-12-2009.

3,786,190. ALLURE PET PRODUCTS, LLC, TOTOWA, NJ. SN 77-979,033. PUB. 10-6-2009, FILED 4-22-2009.

TUFFUT TECHNOLOGY

THE MARK CONSISTS OF STANDARD CHARACTERS WITHOUT CLAIM TO ANY PARTICULAR FONT, STYLE, SIZE, OR COLOR.

NO CLAIM IS MADE TO THE EXCLUSIVE RIGHT TO USE "TECHNOLOGY", APART FROM THE MARK AS SHOWN.

FOR GAMES, TOYS, AND PLAYTHINGS, NAMELY, PET TOYS, STUFFED TOYS, PULL TOYS, SQUEEZE TOYS, RECREATIONAL BALLS FOR GAMES (U.S. CLS. 22, 23, 38 AND 50).

FIRST USE 3-0-2009; IN COMMERCE 8-0-2009.

CLASS 28—(Continued).

3,786,217. SCARBOROUGH, DANE, MALIBU, CA. SN 78-542,046. PUB. 10-6-2009, FILED 1-4-2005.

UBERSTIX

THE MARK CONSISTS OF STANDARD CHARACTERS WITHOUT CLAIM TO ANY PARTICULAR FONT, STYLE, SIZE, OR COLOR.

OWNER OF U.S. REG. NOS. 3,336,127 AND 3,550,095.

FOR CONSTRUCTION TOYS, NAMELY, KITS THAT INCLUDE PLASTIC CONNECTOR ELEMENTS THAT ENABLE USERS TO CONSTRUCT CARS, BOATS, AIRPLANES, AND THE LIKE, USING COMMON ITEMS SUCH AS DRINKING STRAWS, COCKTAIL STRAWS, FROZEN CONFECTION STICKS, PAPER CLIPS, WATER BOTTLES, AND OTHER COMMON HOUSEHOLD ITEMS; AND SNOW BOARDS (U.S. CLS. 22, 23, 38 AND 50).

FIRST USE 7-26-2004; IN COMMERCE 7-26-2004.

3,786,240. SINGER, JONATHAN I., CINCINNATI, OH. SN 78-698,148. PUB. 1-30-2007, FILED 8-23-2005.

IttyYums

THE MARK CONSISTS OF STANDARD CHARACTERS WITHOUT CLAIM TO ANY PARTICULAR FONT, STYLE, SIZE, OR COLOR.

FOR BOARD GAMES; CARD GAMES; EQUIPMENT SOLD AS A UNIT FOR PLAYING BOARD GAMES (U.S. CLS. 22, 23, 38 AND 50).

FIRST USE 2-5-2010; IN COMMERCE 2-5-2010.

CLASS 28—(Continued).

3,786,280. KOVISS SPORTS CO., LTD., GYUNGGI-DO, REPUBLIC OF KOREA. AND LEE, SUNG-EUN, SEOUL, REPUBLIC OF KOREA. AND LEE, HYUNG-CHOON, SEOUL, REPUBLIC OF KOREA. SN 78-850,423. PUB. 6-17-2008, FILED 3-30-2006.



NO CLAIM IS MADE TO THE EXCLUSIVE RIGHT TO USE "TEE" OR "GOLF", APART FROM THE MARK AS SHOWN.

THE COLOR(S) GREEN AND BLACK IS/ARE CLAIMED AS A FEATURE OF THE MARK.

THE MARK CONSISTS OF A STYLIZED COMBINATION OF THE LETTERS "KG" IN BLACK AND GREEN, AND THE WORDING "VS TEE" AND "KOVISS GOLF" IN BLACK.

FOR METAL CLOCKWORK TOYS, PLASTIC CHARACTER TOYS, QUILTS, GOLF BAGS, GOLF BALLS, GOLF GLOVES, GOLF CLUBS, CADDIE BAGS FOR GOLF CLUBS, GOLF CLUB BAGS, NON-MOTORIZED GOLF CARTS, GOLF TEES, DIVOT REPAIR TOOLS (U.S. CLS. 22, 23, 38 AND 50).

FIRST USE 12-1-2002; IN COMMERCE 12-1-2002.

3,786,324. COMPANY B, INC., KALISPELL, MT. SN 78-935,043. PUB. 7-10-2007, FILED 7-21-2006.



NO CLAIM IS MADE TO THE EXCLUSIVE RIGHT TO USE "TROUT", APART FROM THE MARK AS SHOWN.

THE MARK CONSISTS OF AN IMAGE WITH THE WORDS "TROUT" AND "SLAYER" SURROUNDING AN ARTIFICIAL DRY FISHING FLY, WITH THE WORDS SET INSIDE TWO DARK HORIZONTAL LINES.

FOR FISHING RODS; FISHING FLIES; AND FISHING FLY BOXES (U.S. CLS. 22, 23, 38 AND 50).

FIRST USE 4-30-2008; IN COMMERCE 4-30-2008.

CLASS 29—MEATS AND PROCESSED FOODS

3,785,066. MARQUEZ BROTHERS INTERNATIONAL, INC., SAN JOSE, CA. SN 76-646,016. PUB. 7-25-2006, FILED 9-1-2005.

LA TOÑA

THE MARK CONSISTS OF STANDARD CHARACTERS WITHOUT CLAIM TO ANY PARTICULAR FONT, STYLE, SIZE, OR COLOR.

CLASS 29—(Continued).

THE NAME(S), PORTRAIT(S), AND/OR SIGNATURE(S) SHOWN IN THE MARK DOES NOT IDENTIFY A PARTICULAR LIVING INDIVIDUAL.

FOR CANNED FRUITS, DRIED BEANS (U.S. CL. 46).
FIRST USE 10-9-2009; IN COMMERCE 10-9-2009.

3,785,195. VENTURA FOODS, LLC, BREA, CA. SN 77-240,057.
PUB. 11-6-2007, FILED 7-26-2007.

NTRANS

THE MARK CONSISTS OF STANDARD CHARACTERS WITHOUT CLAIM TO ANY PARTICULAR FONT, STYLE, SIZE, OR COLOR.

FOR SHORTENING (U.S. CL. 46).
FIRST USE 4-0-2007; IN COMMERCE 4-0-2007.

3,785,209. UGS URLA GIDA VE TARIM URUNLERI SANAYI VE TICARET LIMITED SIRKETI, IZMIR, TURKEY. SN 77-259,774. PUB. 2-12-2008, FILED 8-20-2007.

Mor Tane

THE MARK CONSISTS OF STANDARD CHARACTERS WITHOUT CLAIM TO ANY PARTICULAR FONT, STYLE, SIZE, OR COLOR.

THE ENGLISH TRANSLATION OF "MOR TANE" IS PURPLE PIECE.

FOR PROCESSED OLIVES; TINNED OLIVES; PROCESSED OLIVE PUREE; PRESERVED, DRIED AND COOKED OLIVES; CANNED PROCESSED OLIVES; OLIVE OIL; OLIVE PASTES (U.S. CL. 46).

FIRST USE 10-31-2009; IN COMMERCE 10-31-2009.

3,785,235. QUANTUM FOODS, LLC, BOLINGBROOK, IL. SN 77-322,620. PUB. 3-11-2008, FILED 11-6-2007.

BUTCHER'S FINEST

THE MARK CONSISTS OF STANDARD CHARACTERS WITHOUT CLAIM TO ANY PARTICULAR FONT, STYLE, SIZE, OR COLOR.

CLASS 29—(Continued).

NO CLAIM IS MADE TO THE EXCLUSIVE RIGHT TO USE "FINEST", APART FROM THE MARK AS SHOWN.

FOR PROCESSED MEATS, BEEF, PORK, POULTRY AND SEAFOOD SOLD IN PORTIONS; FULLY COOKED ENTREES CONSISTING PRIMARILY OF MEAT, BEEF, PORK, POULTRY OR SEAFOOD (U.S. CL. 46).

FIRST USE 8-1-2009; IN COMMERCE 8-1-2009.

3,785,256. RICHMOND WHOLESALE MEAT CO., RICHMOND, CA. SN 77-339,025. PUB. 4-1-2008, FILED 11-28-2007.

GINA GALLINA

THE MARK CONSISTS OF STANDARD CHARACTERS WITHOUT CLAIM TO ANY PARTICULAR FONT, STYLE, SIZE, OR COLOR.

THE NAME "GINA GALLINA" DOES NOT IDENTIFY A LIVING INDIVIDUAL.

FOR CHICKEN AND CHICKEN PARTS (U.S. CL. 46).
FIRST USE 3-14-2008; IN COMMERCE 3-14-2008.

3,785,260. F.W. BRYCE, INC., GLOUCESTER, MA. SN 77-340,995. PUB. 4-29-2008, FILED 11-30-2007.

YOUR TRUSTED SOURCE FOR QUALITY SEAFOOD SINCE 1947

THE MARK CONSISTS OF STANDARD CHARACTERS WITHOUT CLAIM TO ANY PARTICULAR FONT, STYLE, SIZE, OR COLOR.

NO CLAIM IS MADE TO THE EXCLUSIVE RIGHT TO USE "SEAFOOD SINCE 1947", APART FROM THE MARK AS SHOWN.

FOR SEAFOOD (U.S. CL. 46).
FIRST USE 4-0-2008; IN COMMERCE 4-0-2008.

3,785,321. ARTHUR SCHUMAN, INC., FAIRFIELD, NJ. SN 77-390,596. PUB. 9-16-2008, FILED 2-6-2008.

GRAN CELLO

THE MARK CONSISTS OF STANDARD CHARACTERS WITHOUT CLAIM TO ANY PARTICULAR FONT, STYLE, SIZE, OR COLOR.

OWNER OF U.S. REG. NOS. 2,210,610, 3,181,462, AND OTHERS.

CLASS 29—(Continued).

THE ENGLISH TRANSLATION OF THE WORD "GRAN" IN THE MARK IS "GREAT".
FOR CHEESE (U.S. CL. 46).
FIRST USE 2-19-2010; IN COMMERCE 2-19-2010.

CLASS 29—(Continued).

3,785,544. SARA WEINREB, MONSEY, NY. SN 77-528,713.
PUB. 12-16-2008, FILED 7-22-2008.

3,785,441. J&B WHOLESALE DISTRIBUTING, INC., ST. MICHAEL, MN. SN 77-485,413. PUB. 11-10-2009, FILED 5-28-2008.



MIDWEST PRIDE TENDER SELECTIONS

THE MARK CONSISTS OF STANDARD CHARACTERS WITHOUT CLAIM TO ANY PARTICULAR FONT, STYLE, SIZE, OR COLOR.

OWNER OF U.S. REG. NOS. 1,857,805, 2,156,770, AND OTHERS.

NO CLAIM IS MADE TO THE EXCLUSIVE RIGHT TO USE "MIDWEST" AND "TENDER SELECTIONS", APART FROM THE MARK AS SHOWN.

FOR MEAT PRODUCTS, NAMELY, BEEF AND PORK (U.S. CL. 46).

FIRST USE 2-15-2010; IN COMMERCE 2-15-2010.

THE MARK CONSISTS OF A GREEN AND YELLOW FREE FORM FIGURE APPEARING TO BE RUNNING ON A LIGHT PURPLE MAT. THE ARMS OF THE FIGURE ARE COMPRISED OF A YELLOW AND BLACK TAPE MEASURE. THE WORD "GRAB" IS STYLIZED MEDIUM PURPLE LETTERING AND THE STYLIZED NUMBER "1" IS OUTLINED IN MEDIUM PURPLE WITH WHITE INTERIOR.

FOR PROTEIN BASED, NUTRIENT-DENSE SNACK BARS; SOY-BASED FOOD BARS (U.S. CL. 46).

FIRST USE 12-26-2008; IN COMMERCE 12-26-2008.

3,785,493. SLIZ, KEN, SAN ANTONIO, TX. SN 77-510,970.
PUB. 11-25-2008, FILED 6-30-2008.

3,785,574. TYSON FOODS, INC., SPRINGDALE, AR. SN 77-542,215. PUB. 12-16-2008, FILED 8-8-2008.

NEW AGE

SLOW COOKER CREATIONS

THE MARK CONSISTS OF STANDARD CHARACTERS WITHOUT CLAIM TO ANY PARTICULAR FONT, STYLE, SIZE, OR COLOR.

FOR FROZEN VEGETABLES AND FRUITS (U.S. CL. 46).

FIRST USE 12-18-2009; IN COMMERCE 12-18-2009.

THE MARK CONSISTS OF STANDARD CHARACTERS WITHOUT CLAIM TO ANY PARTICULAR FONT, STYLE, SIZE, OR COLOR.

OWNER OF U.S. REG. NO. 3,463,546.

NO CLAIM IS MADE TO THE EXCLUSIVE RIGHT TO USE "SLOW COOKER", APART FROM THE MARK AS SHOWN.

FOR BEEF; PORK (U.S. CL. 46).

FIRST USE 2-13-2009; IN COMMERCE 2-13-2009.

CLASS 29—(Continued).

3,785,737. HARBOR SEAFOOD, INC., NEW HYDE PARK, NY. SN 77-639,057. PUB. 5-12-2009, FILED 12-23-2008.



NO CLAIM IS MADE TO THE EXCLUSIVE RIGHT TO USE "INC.", APART FROM THE MARK AS SHOWN. THE COLOR(S) BLUE AND WHITE IS/ARE CLAIMED AS A FEATURE OF THE MARK.

THE MARK CONSISTS OF A DESIGN OF A SWORDFISH IN WHITE ABOVE THE WORDING "OCEAN VENTURE INC." IN WHITE, ALL ON A BLUE BACKGROUND.

FOR FROZEN SEAFOOD (U.S. CL. 46).
FIRST USE 4-0-2009; IN COMMERCE 4-0-2009.

3,785,950. DEL MONTE CORPORATION, SAN FRANCISCO, CA. SN 77-687,606. PUB. 6-9-2009, FILED 3-10-2009.

DEL MONTE QUALITY SUPERFRUIT

THE MARK CONSISTS OF STANDARD CHARACTERS WITHOUT CLAIM TO ANY PARTICULAR FONT, STYLE, SIZE, OR COLOR.

OWNER OF U.S. REG. NOS. 881,339, 3,573,799, AND OTHERS.

NO CLAIM IS MADE TO THE EXCLUSIVE RIGHT TO USE "QUALITY SUPERFRUIT", APART FROM THE MARK AS SHOWN.

THE ENGLISH TRANSLATION OF "DEL MONTE" IS "FROM THE MOUNTAIN".

FOR PROCESSED FRUIT (U.S. CL. 46).
FIRST USE 9-21-2008; IN COMMERCE 9-21-2008.

3,786,022. MARKET FINDERS BROKERAGE, INC., SOUTH ORANGE, NJ. SN 77-717,307. PUB. 8-25-2009, FILED 4-20-2009.

MAMAMANCINI'S

THE MARK CONSISTS OF STANDARD CHARACTERS WITHOUT CLAIM TO ANY PARTICULAR FONT, STYLE, SIZE, OR COLOR.

THE NAME(S), PORTRAIT(S), AND/OR SIGNATURE(S) SHOWN IN THE MARK DOES NOT IDENTIFY A PARTICULAR LIVING INDIVIDUAL.

FOR PREPARED ITALIAN-STYLE ENTREÉS FEATURING MEATS, NAMELY, BEEF, POULTRY AND LAMB, AND MEATBALLS MADE THEREFROM, IN A SAUCE (U.S. CL. 46).

FIRST USE 3-19-2006; IN COMMERCE 3-19-2006.

CLASS 29—(Continued).

3,786,203. JONMOR INVESTMENTS, INC., WILMINGTON, DE. SN 77-979,137. PUB. 12-2-2008, FILED 7-20-2007.



OWNER OF U.S. REG. NOS. 1,054,792 AND 1,747,277.

THE NAME(S), PORTRAIT(S), AND/OR SIGNATURE(S) SHOWN IN THE MARK DOES NOT IDENTIFY A PARTICULAR LIVING INDIVIDUAL.

THE COLOR(S) RED, GOLD, BLACK AND CREAM IS/ARE CLAIMED AS A FEATURE OF THE MARK.

THE MARK CONSISTS OF A RED OVAL SEAL OUTLINED IN GOLD AND BLACK. AT THE TOP OF THE OVAL SEAL ARE THE WORDS "JOHN MORRELL" IN SMALL, GOLD-COLORED, BLOCK PRINT. IN THE MIDDLE OF THE OVAL SEAL IS THE WORD "BISTROT" IN LARGE, CREAM-COLORED SCRIPT, OUTLINED IN BLACK. THE COLOR RED WITHIN THE OVAL CONTRASTS BETWEEN A BRIGHT RED AT THE CENTER AND FADES INTO A DEEPER RED AT THE BORDERS OF THE OVAL.

FOR SAUSAGES, HOT DOGS (U.S. CL. 46).
FIRST USE 1-0-2008; IN COMMERCE 1-0-2008.

3,786,266. PATCUD INVESTMENTS, INC., WILMINGTON, DE. SN 78-818,729. PUB. 11-14-2006, FILED 2-20-2006.



NO CLAIM IS MADE TO THE EXCLUSIVE RIGHT TO USE "BACON", APART FROM THE MARK AS SHOWN.

THE COLOR(S) RED, WHITE AND BLACK IS/ARE CLAIMED AS A FEATURE OF THE MARK.

THE MARK IS A DESIGN MARK COMPRISING THE WORD "BACON" OVER A RIBBON. THE "O" IN THE WORD "BACON" IS HEART SHAPED. THE WORDS "LOVER'S CLUB" ARE IMPOSED ON THE RIBBON. THE LETTERS B, A, C, AND N OF THE WORD "BACON" ARE BLACK. THE HEART SHAPE AND RIBBON ARE RED, AND THE WORDS "LOVER'S CLUB" ON THE RIBBON ARE WHITE.

FOR BACON (U.S. CL. 46).
FIRST USE 12-28-2009; IN COMMERCE 12-28-2009.

CLASS 30—STAPLE FOODS

CLASS 30—(Continued).

3,785,280. SNAKE RIVER ROASTING COMPANY, JACKSON, WY. SN 77-365,550. PUB. 6-9-2009, FILED 1-7-2008.



The logo for Snake River Roasting Co. features the words "Snake River" in a cursive script above the word "ROASTING" in a bold, serif font. Below "ROASTING" is "Co." in a smaller cursive font. A stylized coffee bean is integrated into the letter "O" of "ROASTING".

NO CLAIM IS MADE TO THE EXCLUSIVE RIGHT TO USE "SNAKE RIVER ROASTING CO.", APART FROM THE MARK AS SHOWN.

THE MARK CONSISTS OF THE WORDS "SNAKE RIVER" ACROSS THE TOP, FOLLOWED BY THE WORD "ROASTING" IN WHICH THE LETTER "O" IS IN THE SHAPE OF A COFFEE BEAN AND THE ABBREVIATION FOR COMPANY ("CO.") ON THE THIRD LINE.

FOR BEVERAGES MADE OF COFFEE; BEVERAGES MADE OF TEA; COFFEE; COFFEE BEANS; GROUND COFFEE BEANS; PREPARED COFFEE AND COFFEE-BASED BEVERAGES; ROASTED COFFEE BEANS; TEA (U.S. CL. 46).

FIRST USE 10-1-2007; IN COMMERCE 1-2-2008.

CLASS 30—(Continued).

3,785,328. DONGWON F&B CO., LTD., SEOUL, REPUBLIC OF KOREA. SN 77-394,437. PUB. 11-25-2008, FILED 2-12-2008.



NO CLAIM IS MADE TO THE EXCLUSIVE RIGHT TO USE "TEA", APART FROM THE MARK AS SHOWN.

THE COLOR(S) GREEN, WHITE AND BLACK IS/ARE CLAIMED AS A FEATURE OF THE MARK.

THE MARK CONSISTS OF THE WORDING "T2U" AND "TEA TO YOU" WITHIN A BLACK SQUARE WITH A GREEN LEAF FEATURE ASSOCIATED WITH THE LETTER "U". ADDITIONAL GREEN LEAF FEATURES ARE LOCATED ABOVE AND BELOW THE MARK. THE ALPHANUMERIC "T2U" IS WHITE WITH GREEN BORDERS AND THE SQUARE HAS AN OFFSET GREEN BORDER. THE WORDING "TEA TO YOU" IS IN WHITE.

FOR TEA-BASED BEVERAGES WITH FRUIT FLAVORING, TEA, NAMELY, GREEN TEA (U.S. CL. 46).

FIRST USE 11-18-2008; IN COMMERCE 11-18-2008.

3,785,339. MARS, INCORPORATED, MCLEAN, VA. SN 77-407,793. PUB. 5-26-2009, FILED 2-27-2008.

3,785,314. CLOUD TOP, AKA CLOUD TOP LLC, AKA CLOUD TOP YOGURT, PASADENA, CA. SN 77-386,871. PUB. 6-2-2009, FILED 2-1-2008.

CLOUD TOP

THE MARK CONSISTS OF STANDARD CHARACTERS WITHOUT CLAIM TO ANY PARTICULAR FONT, STYLE, SIZE, OR COLOR.

FOR FROZEN YOGURT AND FROZEN YOGURT BASED DESSERTS (U.S. CL. 46).

FIRST USE 9-11-2008; IN COMMERCE 9-24-2009.



OWNER OF U.S. REG. NOS. 2,012,056, 3,261,619, AND OTHERS.

NO CLAIM IS MADE TO THE EXCLUSIVE RIGHT TO USE THE PICTORIAL REPRESENTATION OF THE CANDY, APART FROM THE MARK AS SHOWN.

FOR CONFECTIONERY PRODUCTS, NAMELY, CANDY (U.S. CL. 46).

FIRST USE 6-30-2008; IN COMMERCE 6-30-2008.

CLASS 30—(Continued).

3,785,410. KING W. SMITH, SACRAMENTO, CA. SN 77-461,323. PUB. 5-5-2009, FILED 4-29-2008.



NO CLAIM IS MADE TO THE EXCLUSIVE RIGHT TO USE "MUFFINS", APART FROM THE MARK AS SHOWN.

THE COLOR(S) BROWN, BLACK, AND WHITE IS/ARE CLAIMED AS A FEATURE OF THE MARK.

THE COLOR BLACK APPEARS IN THE OUTLINE AND DETAILS OF THE CHEF'S HAT, THE GORILLA, THE LOWER PORTION OF THE MUFFIN, IN THE SPRINKLES ON UPPER PORTION OF THE MUFFIN, AND IN THE WORDING "MIGHTY KONG MUFFINS". THE COLOR WHITE APPEARS IN SHADED PORTIONS OF THE CHEF'S HAT AND GORILLA. THE COLOR BROWN APPEARS IN THE TOP PART OF THE MUFFIN.

FOR BAKERY GOODS, NAMELY, MUFFINS AND SCONES (U.S. CL. 46).

FIRST USE 12-4-2001; IN COMMERCE 8-1-2002.

CLASS 30—(Continued).

3,785,446. PALETERIA Y NEVERIA GUANATOS, INC., DBA GUANATOS ICE CREAM, CONCORD, CA. SN 77-489,763. PUB. 12-2-2008, FILED 6-3-2008.



NO CLAIM IS MADE TO THE EXCLUSIVE RIGHT TO USE "ICE CREAM", APART FROM THE MARK AS SHOWN.

THE COLOR(S) WHITE, GREEN, BLACK, YELLOW IS/ARE CLAIMED AS A FEATURE OF THE MARK.

THE MARK CONSISTS OF A WHITE POPSICLE SHAPE, WITH YELLOW ON THE LEFT AND GREEN ON THE RIGHT IN A RECTANGULAR WAVE SHAPE WITH WHITE WASHING ON THE TOP AND BOTTOM, AND THE WORD "GUANATOS" IN BLACK LETTERING HIGHLIGHTED BY GREEN ON THE LEFT AND YELLOW ON THE RIGHT, AND THE WORDS "ICE CREAM" IN BLACK BELOW.

FOR EDIBLE FRUIT ICES; FROZEN DESSERT CONSISTING OF FRUIT AND CREAM OR CREAM SUBSTITUTES; FRUIT ICE; FRUIT ICE BAR; FRUIT ICES; ICE CREAM; ICE CREAM DRINKS; ICE CREAMS; ICE MILK BARS; ICE-CREAM; ICE-CREAM CAKES; ITALIAN ICE (U.S. CL. 46).

FIRST USE 1-1-2007; IN COMMERCE 1-1-2007.

3,785,425. DANIEL S. SINCLAIR, JR., MANDEVILLE, LA. SN 77-474,442. PUB. 3-24-2009, FILED 5-14-2008.

KUSH

THE MARK CONSISTS OF STANDARD CHARACTERS WITHOUT CLAIM TO ANY PARTICULAR FONT, STYLE, SIZE, OR COLOR.

OWNER OF U.S. REG. NO. 3,177,919.

FOR COFFEE AND COFFEE BEANS (U.S. CL. 46).

FIRST USE 9-21-2009; IN COMMERCE 9-21-2009.

3,785,503. MARGARITA FARMS, LLC, HOLUALOA, HI. SN 77-514,311. PUB. 3-17-2009, FILED 7-3-2008.

MARGARITA FARMS

THE MARK CONSISTS OF STANDARD CHARACTERS WITHOUT CLAIM TO ANY PARTICULAR FONT, STYLE, SIZE, OR COLOR.

NO CLAIM IS MADE TO THE EXCLUSIVE RIGHT TO USE "FARMS", APART FROM THE MARK AS SHOWN.

FOR COFFEE (U.S. CL. 46).

FIRST USE 6-0-2008; IN COMMERCE 6-0-2008.

CLASS 30—(Continued).

3,785,515. KRAFT FOODS GLOBAL BRANDS LLC, NORTH-FIELD, IL. SN 77-518,140. PUB. 11-11-2008, FILED 7-9-2008.

CRACKERFULS

THE MARK CONSISTS OF STANDARD CHARACTERS WITHOUT CLAIM TO ANY PARTICULAR FONT, STYLE, SIZE, OR COLOR.

FOR CRACKER AND CHEESE COMBINATIONS (U.S. CL. 46).

FIRST USE 6-20-2009; IN COMMERCE 6-20-2009.

CLASS 30—(Continued).

A GOLD SQUARE BORDER. OUTSIDE OF THE SQUARE, THERE IS A RED BACKGROUND WITH LIGHT RED WAVY LINES GIVING THE APPEARANCE OF WOOD GRAIN. BELOW THE SQUARE, WITHIN THE WOOD GRAIN, THE WORDING "DELICIOUS BITE" APPEARS IN WHITE WITH BLACK OUTLINE. OUTSIDE OF THESE ELEMENTS, THERE IS A SERIES OF CONCENTRIC RECTANGULAR BORDERS. MOVING FROM INWARD TO OUTWARD, THE BORDERS ARE GOLD JUST BEYOND THE WOOD GRAIN, BLACK, WHITE, AND RED.

FOR BREAD AND PASTRY (U.S. CL. 46).
FIRST USE 10-1-2009; IN COMMERCE 10-1-2009.

3,785,869. ATEECO, INC., SHENANDOAH, PA. SN 77-668,279. PUB. 6-9-2009, FILED 2-11-2009.

3,785,786. DELICIOUS BITE LLC, DBA DELICIOUS BITE LLC, WEST CHESTER, PA. SN 77-656,706. PUB. 11-3-2009, FILED 1-26-2009.

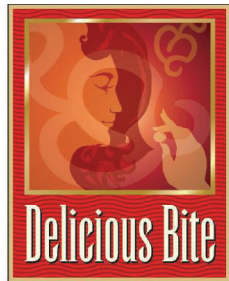

We Make Each Bite a
Special Moment!

THE MARK CONSISTS OF STANDARD CHARACTERS WITHOUT CLAIM TO ANY PARTICULAR FONT, STYLE, SIZE, OR COLOR.

FOR PIEROGIES (U.S. CL. 46).

FIRST USE 2-8-2010; IN COMMERCE 2-8-2010.

3,785,878. MCNEIL NUTRITIONALS, LLC, FORT WASHINGTON, PA. SN 77-669,053. PUB. 6-9-2009, FILED 2-12-2009.

NO CLAIM IS MADE TO THE EXCLUSIVE RIGHT TO USE "DELICIOUS BITE", APART FROM THE MARK AS SHOWN.

THE COLOR(S) RED, ORANGE, GOLD, WHITE, AND BLACK IS/ARE CLAIMED AS A FEATURE OF THE MARK.

THE MARK CONSISTS OF A RECTANGULAR DESIGN ELEMENT CONTAINING THE WORDS "DELICIOUS BITE" ABOVE SEPARATE WORDING CONSISTING OF "WE MAKE EACH BITE A SPECIAL MOMENT". THE LATTER WORDING IS NOT IN SPECIAL FORM, BUT IS SIMPLY ORANGE. THE RECTANGULAR DESIGN FEATURES A SQUARE CONTAINING SEMI-TRANSPARENT DESIGNS OF A PERSON'S FACE IN PROFILE, A HAND HOLDING A PIECE OF FOOD NEAR THE PERSON'S MOUTH, AND REPEATING BACKGROUND DESIGNS OF HEART-SHAPED LEAVES AND VINES, ALL ON A DEEP RED BACKGROUND. THE FACE, HAND, AND FOOD ARE ORANGE. THE HEART-SHAPED LEAVES ARE ALSO ORANGE. THE BACKGROUND IS RED. WHERE DIFFERENT ELEMENTS OVERLAP, THE DESIGNS SHIFT COLORS FROM RED TO ORANGE AND VICE VERSA, GIVING A TRANSPARENT LOOK. THESE DESIGNS APPEAR WITHIN

NICE TO SWEET YOU

THE MARK CONSISTS OF STANDARD CHARACTERS WITHOUT CLAIM TO ANY PARTICULAR FONT, STYLE, SIZE, OR COLOR.

FOR NON-CALORIC SWEETENER, NAMELY, A SUGAR SUBSTITUTE (U.S. CL. 46).

FIRST USE 4-1-2009; IN COMMERCE 4-1-2009.

CLASS 30—(Continued).

3,785,912. HELADOS VALLARTA, INC., FRESNO, CA. SN 77-677,982. PUB. 6-23-2009, FILED 2-25-2009.

ICESATIONS

THE MARK CONSISTS OF STANDARD CHARACTERS WITHOUT CLAIM TO ANY PARTICULAR FONT, STYLE, SIZE, OR COLOR.

FOR FROZEN CONFECTIONERY; FROZEN CONFECTIONS; FROZEN CONFECTIONS, NAMELY, FREEZER POPS; FROZEN DESSERT CONSISTING OF FRUIT AND CREAM OR CREAM SUBSTITUTES (U.S. CL. 46).

FIRST USE 2-2-2009; IN COMMERCE 2-2-2009.

3,785,913. HELADOS VALLARTA, INC., FRESNO, CA. SN 77-678,030. PUB. 6-30-2009, FILED 2-25-2009.



THE STIPPLING IS FOR SHADING PURPOSES. THE MARK CONSISTS OF AN ESKIMO HOLDING TWO FROZEN CONFECTIONS.

FOR FROZEN CONFECTIONERY; FROZEN CONFECTIONS; FROZEN CONFECTIONS, NAMELY, FREEZER POPS; FROZEN DESSERT CONSISTING OF FRUIT AND CREAM OR CREAM SUBSTITUTES (U.S. CL. 46).

FIRST USE 2-2-2009; IN COMMERCE 2-2-2009.

CLASS 30—(Continued).

3,785,940. GENERAL MILLS IP HOLDINGS II, LLC, MINNEAPOLIS, MN. SN 77-685,392. PUB. 7-7-2009, FILED 3-6-2009.

FUEL. WIN. EVOLVE.

THE MARK CONSISTS OF STANDARD CHARACTERS WITHOUT CLAIM TO ANY PARTICULAR FONT, STYLE, SIZE, OR COLOR.

FOR PROCESSED CEREAL-BASED FOOD TO BE USED AS A BREAKFAST FOOD, SNACK FOOD OR INGREDIENT FOR MAKING OTHER FOODS (U.S. CL. 46).

FIRST USE 4-30-2009; IN COMMERCE 4-30-2009.

3,785,988. H.C. BRILL COMPANY, INC., TUCKER, GA. SN 77-700,816. PUB. 7-14-2009, FILED 3-27-2009.

SWEET'N SHINE

THE MARK CONSISTS OF STANDARD CHARACTERS WITHOUT CLAIM TO ANY PARTICULAR FONT, STYLE, SIZE, OR COLOR.

FOR GLAZES, NOT FOR RETAIL CONSUMER SALE, FOR DONUTS AND BAKERY GOODS (U.S. CL. 46).

FIRST USE 10-30-2009; IN COMMERCE 2-1-2010.

3,786,033. NEW ALBERTSON'S, INC., EDEN PRAIRIE, MN. SN 77-724,967. PUB. 9-8-2009, FILED 4-29-2009.

GOOD DAY

THE MARK CONSISTS OF STANDARD CHARACTERS WITHOUT CLAIM TO ANY PARTICULAR FONT, STYLE, SIZE, OR COLOR.

OWNER OF U.S. REG. NOS. 827,274, 1,062,358, AND 1,619,325.

FOR BREAKFAST CEREALS; READY TO EAT, CEREAL DERIVED FOOD BARS (U.S. CL. 46).

FIRST USE 1-10-2009; IN COMMERCE 1-10-2009.

CLASS 30—(Continued).

3,786,050. ANITA FOOD S.A., LIMA, PERU. SN 77-733,204.
PUB. 9-22-2009, FILED 5-9-2009.

ANITA

THE MARK CONSISTS OF STANDARD CHARACTERS WITHOUT CLAIM TO ANY PARTICULAR FONT, STYLE, SIZE, OR COLOR.
THE WORDING "ANITA" HAS NO MEANING IN A FOREIGN LANGUAGE.
FOR PASTA (U.S. CL. 46).
FIRST USE 10-13-2007; IN COMMERCE 2-2-2010.

CLASS 30—(Continued).

3,786,174. TREVINO, LEOBARDO, HIDALGO, TX. SN 77-978,942. PUB. 4-21-2009, FILED 12-6-2008.

SISTERS

THE MARK CONSISTS OF STANDARD CHARACTERS WITHOUT CLAIM TO ANY PARTICULAR FONT, STYLE, SIZE, OR COLOR.
FOR COFFEE; SALAD DRESSINGS (U.S. CL. 46).
FIRST USE 11-6-2009; IN COMMERCE 11-6-2009.

3,786,069. KAUFFMAN, KELLI, PACIFIC PALISADES, CA. SN 77-742,561. PUB. 10-6-2009, FILED 5-21-2009.

KUKEES

THE MARK CONSISTS OF STANDARD CHARACTERS WITHOUT CLAIM TO ANY PARTICULAR FONT, STYLE, SIZE, OR COLOR.
FOR COOKIES (U.S. CL. 46).
FIRST USE 7-1-2009; IN COMMERCE 8-1-2009.

3,786,093. ROSEN PERFECT FOODS, INC., ORLANDO, FL. SN 77-752,751. PUB. 10-13-2009, FILED 6-5-2009.

ROSEN'S PERFECT PIZZA

THE MARK CONSISTS OF STANDARD CHARACTERS WITHOUT CLAIM TO ANY PARTICULAR FONT, STYLE, SIZE, OR COLOR.
NO CLAIM IS MADE TO THE EXCLUSIVE RIGHT TO USE "PIZZA", APART FROM THE MARK AS SHOWN.
THE NAME(S), PORTRAIT(S), AND/OR SIGNATURE(S) SHOWN IN THE MARK IDENTIFIES HARRIS "ROSEN", WHOSE CONSENT(S) TO REGISTER IS MADE OF RECORD.
FOR FRESH PIZZA, PREPARED FROZEN PIZZA AND KITS COMPRISED OF INGREDIENTS FOR PREPARING PIZZA (U.S. CL. 46).
FIRST USE 7-10-2009; IN COMMERCE 7-10-2009.

3,786,186. ALDI INC., BATAVIA, IL. SN 77-979,001. PUB. 4-21-2009, FILED 10-29-2008.

CRAZY CANDY CO.

THE MARK CONSISTS OF STANDARD CHARACTERS WITHOUT CLAIM TO ANY PARTICULAR FONT, STYLE, SIZE, OR COLOR.
NO CLAIM IS MADE TO THE EXCLUSIVE RIGHT TO USE "CANDY CO.", APART FROM THE MARK AS SHOWN.
FOR CONFECTIONARY ITEMS, NAMELY, CANDY, GUMMY CANDIES, PEPPERMINT CANDIES, CANDY MINTS, SUGARLESS CANDIES, LICORICE (U.S. CL. 46).
FIRST USE 11-19-2009; IN COMMERCE 11-19-2009.

3,786,194. THE PILLSBURY COMPANY, LLC, MINNEAPOLIS, MN. SN 77-979,063. PUB. 11-4-2008, FILED 6-11-2008.

WARMTH IN A MODERN WORLD

THE MARK CONSISTS OF STANDARD CHARACTERS WITHOUT CLAIM TO ANY PARTICULAR FONT, STYLE, SIZE, OR COLOR.
FOR REFRIGERATED AND FROZEN DOUGH; FROZEN BAKERY PRODUCTS (U.S. CL. 46).
FIRST USE 5-28-2009; IN COMMERCE 5-28-2009.

CLASS 30—(Continued).

3,786,207. GANS, KIM, MINNEAPOLIS, MN. SN 77-979,197.
PUB. 6-16-2009, FILED 9-12-2008.

SWEET FLOUR

THE MARK CONSISTS OF STANDARD CHARACTERS WITHOUT CLAIM TO ANY PARTICULAR FONT, STYLE, SIZE, OR COLOR.
FOR BAKERY GOODS (U.S. CL. 46).
FIRST USE 3-23-2009; IN COMMERCE 3-23-2009.

3,786,210. TATE & LYLE INGREDIENTS AMERICAS INC.,
DECATUR, IL. SN 78-272,266. PUB. 11-6-2007, FILED 7-9-
2003.

Staley

OWNER OF U.S. REG. NOS. 788,810, 1,025,550, AND OTHERS.
SEC. 2(F).
FOR EDIBLE CARBOHYDRATES, NAMELY, STARCHES, CORN SYRUPS; EDIBLE VEGETABLE PROTEINS AND EDIBLE DERIVATIVES THEREOF, NAMELY, CORN GLUTEN (U.S. CL. 46).
FIRST USE 12-11-2009; IN COMMERCE 12-11-2009.

3,786,227. LIN, TIANXIANG, ZHONGSHAN, GUANGDONG,
CHINA. SN 78-647,798. PUB. 2-21-2006, FILED 6-10-2005.

福香園
FUXIANGYUAN

THE MARK CONSISTS OF THE WORD "FUXIANGYUAN" AND THREE CHINESE CHARACTERS.

THE NON-LATIN CHARACTER(S) IN THE MARK TRANSLITERATES INTO "FU"; "XIANG"; "YUAN", AND THIS MEANS BLESSING; FRAGRANT; GARDEN IN ENGLISH.

FOR COFFEE; TEA; ROCK SUGAR; SWEETMEATS; HONEY; BISCUITS; MOON CAKES; OATMEAL; NOODLES; RICE FLOUR; POPCORN; POWDERS FOR ICE CREAM; COOKING SALT; SOYA SAUCE; VINEGAR; MUSTARD; SPICES; YEAST (U.S. CL. 46).
FIRST USE 3-0-2001; IN COMMERCE 8-0-2001.

CLASS 30—(Continued).

3,786,302. GRUPO CONSULTIVO DE SERVICIOS MEXICANOS, S.A. DE C.V., MONTERREY N.L. C.P., MEXICO. SN 78-884,330. PUB. 1-16-2007, FILED 5-16-2006.

The logo for 'andatti café' features a stylized, swirling graphic above the word 'andatti' in a bold, lowercase sans-serif font, with 'café' in a smaller, lowercase script font below it.

NO CLAIM IS MADE TO THE EXCLUSIVE RIGHT TO USE "CAFE", APART FROM THE MARK AS SHOWN.
FOR COFFEE; COFFEE BEVERAGES WITH MILK; COFFEE-BASED BEVERAGES (U.S. CL. 46).
FIRST USE 12-12-2005; IN COMMERCE 3-23-2010.

CLASS 31—NATURAL AGRICULTURAL PRODUCTS

3,785,115. HAYES, RICARDO, ST. LOUIS, MO. SN 77-019,941.
PUB. 6-17-2008, FILED 10-12-2006.

SNICKY SNAKS

THE MARK CONSISTS OF STANDARD CHARACTERS WITHOUT CLAIM TO ANY PARTICULAR FONT, STYLE, SIZE, OR COLOR.

NO CLAIM IS MADE TO THE EXCLUSIVE RIGHT TO USE "SNACKS", APART FROM THE MARK AS SHOWN.
FOR DOG TREATS (U.S. CLS. 1 AND 46).
FIRST USE 1-30-2008; IN COMMERCE 1-30-2008.

3,785,184. CAROLINA NURSERIES, INC., MONCKS CORNER, SC. SN 77-228,083. PUB. 1-6-2009, FILED 7-12-2007.

FIZZ

THE MARK CONSISTS OF STANDARD CHARACTERS WITHOUT CLAIM TO ANY PARTICULAR FONT, STYLE, SIZE, OR COLOR.

FOR LIVING PLANTS, NAMELY, ARGYRANTHEMUMS (U.S. CLS. 1 AND 46).
FIRST USE 2-21-2008; IN COMMERCE 2-21-2008.

CLASS 31—(Continued).

3,785,391. MM USA, FULLERTON, CA. SN 77-447,826. PUB. 9-9-2008, FILED 4-14-2008.

FROM FARM TO STORE IN TWENTY-FOUR

THE MARK CONSISTS OF STANDARD CHARACTERS WITHOUT CLAIM TO ANY PARTICULAR FONT, STYLE, SIZE, OR COLOR.

FOR FRESH FRUIT AND VEGETABLES; FRUITS, NAMELY, CITRUS, APPLES, PEARS AND GRAPES (U.S. CLS. 1 AND 46).

FIRST USE 5-27-2008; IN COMMERCE 5-27-2008.

3,785,632. LEDEBOER SEEDS LLC, AURORA, OR. SN 77-587,482. PUB. 3-3-2009, FILED 10-7-2008.



THE MARK CONSISTS OF A BALL OF YARN WITH TWO KNITTING NEEDLES WITH "NATURAL" ON THE LEFT SIDE AND "KNIT" ON THE RIGHT SIDE OF THE BALL OF YARN.

FOR GRASS SEED; GRASS SEEDS (U.S. CLS. 1 AND 46).

FIRST USE 9-2-2009; IN COMMERCE 9-2-2009.

3,785,706. PROVEN WINNERS NORTH AMERICA LLC, CAMPBELL, CA. SN 77-629,169. PUB. 6-9-2009, FILED 12-9-2008.

PRETTY MUCH PICASSO

THE MARK CONSISTS OF STANDARD CHARACTERS WITHOUT CLAIM TO ANY PARTICULAR FONT, STYLE, SIZE, OR COLOR.

FOR LIVING PLANTS, OTHER THAN CALLA LILY, AFRICAN VIOLET, ROSE PLANTS, BALCANYEL, FESCUE, CAULIFLOWER, PEPPER, SQUASH, AND FIELD CORN (U.S. CLS. 1 AND 46).

FIRST USE 2-23-2010; IN COMMERCE 2-23-2010.

CLASS 31—(Continued).

3,785,707. PROVEN WINNERS NORTH AMERICA LLC, CAMPBELL, CA. SN 77-629,174. PUB. 6-9-2009, FILED 12-9-2008.

AUGUSTA

THE MARK CONSISTS OF STANDARD CHARACTERS WITHOUT CLAIM TO ANY PARTICULAR FONT, STYLE, SIZE, OR COLOR.

FOR LIVING PLANTS, OTHER THAN WHEAT, SILVERBELL AND SNOWDROP TREES, MANGOS, POTATOES, BLUEBERRIES, AND RYE GRASS (U.S. CLS. 1 AND 46).

FIRST USE 2-23-2010; IN COMMERCE 2-23-2010.

3,785,708. PROVEN WINNERS NORTH AMERICA LLC, CAMPBELL, CA. SN 77-629,200. PUB. 6-9-2009, FILED 12-9-2008.

LUCIA

THE MARK CONSISTS OF STANDARD CHARACTERS WITHOUT CLAIM TO ANY PARTICULAR FONT, STYLE, SIZE, OR COLOR.

FOR LIVING PLANTS, OTHER THAN ALFALFA, BARLEY, COMMON WHEAT, DURUM WHEAT, FIELD CORN, KENTUCKY BLUEGRASS, ORCHARD GRASS, SUGAR BEET, WINTER RAPE, CUCUMBER, LETTUCE, PEPPERS, TOMATOES, IRIS, BEANS, AND YAMS (U.S. CLS. 1 AND 46).

FIRST USE 2-23-2010; IN COMMERCE 2-23-2010.

3,785,709. PROVEN WINNERS NORTH AMERICA LLC, CAMPBELL, CA. SN 77-629,210. PUB. 6-9-2009, FILED 12-9-2008.

SNOW PRINCESS

THE MARK CONSISTS OF STANDARD CHARACTERS WITHOUT CLAIM TO ANY PARTICULAR FONT, STYLE, SIZE, OR COLOR.

FOR LIVING PLANTS, OTHER THAN PEACH TREES, GLADIOLUS, AND PEAS (U.S. CLS. 1 AND 46).

FIRST USE 2-23-2010; IN COMMERCE 2-23-2010.

CLASS 31—(Continued).

3,785,736. PROVEN WINNERS NORTH AMERICA LLC, CAMPBELL, CA. SN 77-639,027. PUB. 6-9-2009, FILED 12-23-2008.

ILLUSION

THE MARK CONSISTS OF STANDARD CHARACTERS WITHOUT CLAIM TO ANY PARTICULAR FONT, STYLE, SIZE, OR COLOR.

FOR LIVING PLANTS, OTHER THAN CHRYSANTHEMUMS, SPATHIPHYLLUM, AND IMPATIENS (U.S. CLS. 1 AND 46).

FIRST USE 2-23-2010; IN COMMERCE 2-23-2010.

CLASS 31—(Continued).

3,785,822. THREE DOG BAKERY, INC., KANSAS CITY, MO. SN 77-661,600. PUB. 5-26-2009, FILED 2-2-2009.

BITTY BITES

THE MARK CONSISTS OF STANDARD CHARACTERS WITHOUT CLAIM TO ANY PARTICULAR FONT, STYLE, SIZE, OR COLOR.

OWNER OF U.S. REG. NOS. 2,467,206 AND 2,471,083. NO CLAIM IS MADE TO THE EXCLUSIVE RIGHT TO USE "BITES", APART FROM THE MARK AS SHOWN. SEC. 2(F) AS TO "BITTY".

FOR PET TREATS (U.S. CLS. 1 AND 46). FIRST USE 3-0-2009; IN COMMERCE 3-0-2009.

3,785,775. F. M. BROWN'S SONS, INC., SINKING SPRING, PA. SN 77-653,126. PUB. 5-12-2009, FILED 1-21-2009.

GARDEN CHIC

THE MARK CONSISTS OF STANDARD CHARACTERS WITHOUT CLAIM TO ANY PARTICULAR FONT, STYLE, SIZE, OR COLOR.

NO CLAIM IS MADE TO THE EXCLUSIVE RIGHT TO USE "GARDEN", APART FROM THE MARK AS SHOWN. FOR BIRD FOOD; BIRD SEED; WILDLIFE SEED MIXTURES (U.S. CLS. 1 AND 46).

FIRST USE 11-30-2009; IN COMMERCE 11-30-2009.

3,786,049. MCCAULEY BROTHERS, INC., VERSAILLES, KY. SN 77-732,346. PUB. 9-22-2009, FILED 5-8-2009.

PRIMAGE RM

THE MARK CONSISTS OF STANDARD CHARACTERS WITHOUT CLAIM TO ANY PARTICULAR FONT, STYLE, SIZE, OR COLOR.

FOR EQUINE FEED (U.S. CLS. 1 AND 46). FIRST USE 2-9-2010; IN COMMERCE 2-9-2010.

CLASS 32—LIGHT BEVERAGES

3,785,821. THREE DOG BAKERY, INC., KANSAS CITY, MO. SN 77-661,568. PUB. 5-26-2009, FILED 2-2-2009.

GRACIE'S GARDEN

THE MARK CONSISTS OF STANDARD CHARACTERS WITHOUT CLAIM TO ANY PARTICULAR FONT, STYLE, SIZE, OR COLOR.

FOR PET TREATS (U.S. CLS. 1 AND 46). FIRST USE 4-0-2009; IN COMMERCE 4-0-2009.

3,785,109. SPIRITS OF NEW MERCED, LLC, NORTHRIDGE, CA. SN 77-005,591. PUB. 8-28-2007, FILED 9-22-2006.

BULLRIDER

THE MARK CONSISTS OF STANDARD CHARACTERS WITHOUT CLAIM TO ANY PARTICULAR FONT, STYLE, SIZE, OR COLOR.

FOR BEER (U.S. CLS. 45, 46 AND 48). FIRST USE 2-20-2008; IN COMMERCE 2-28-2008.

CLASS 32—(Continued).

3,785,114. WINERY EXCHANGE, INC., NOVATO, CA. SN 77-015,295. PUB. 9-18-2007, FILED 10-5-2006.

TAP ROOM NO. 21

THE MARK CONSISTS OF STANDARD CHARACTERS WITHOUT CLAIM TO ANY PARTICULAR FONT, STYLE, SIZE, OR COLOR.

FOR BEER (U.S. CLS. 45, 46 AND 48).

FIRST USE 3-0-2007; IN COMMERCE 3-0-2007.

3,785,175. LANGLAIS, MICHEL, WATER MILL, NY. SN 77-206,982. PUB. 11-20-2007, FILED 6-15-2007.

DIABOLO MENTHE

THE MARK CONSISTS OF STANDARD CHARACTERS WITHOUT CLAIM TO ANY PARTICULAR FONT, STYLE, SIZE, OR COLOR.

NO CLAIM IS MADE TO THE EXCLUSIVE RIGHT TO USE "MENTHE", APART FROM THE MARK AS SHOWN.

THE ENGLISH TRANSLATION OF THE WORD "MENTHE" IN THE MARK IS MINT.

FOR NON-ALCOHOLIC MINT-FLAVORED CARBONATED BEVERAGE (U.S. CLS. 45, 46 AND 48).

FIRST USE 2-12-2010; IN COMMERCE 2-12-2010.

3,785,291. PARAMOUNT INTERNATIONAL EXPORT, LTD., LOS ANGELES, CA. SN 77-370,112. PUB. 12-9-2008, FILED 1-11-2008.

FIJI GREEN

THE MARK CONSISTS OF STANDARD CHARACTERS WITHOUT CLAIM TO ANY PARTICULAR FONT, STYLE, SIZE, OR COLOR.

OWNER OF U.S. REG. NOS. 3,282,520, 3,381,795, AND 3,385,371.

NO CLAIM IS MADE TO THE EXCLUSIVE RIGHT TO USE "GREEN", APART FROM THE MARK AS SHOWN.

FOR BOTTLED ARTESIAN WATER; BOTTLED DRINKING WATER; DRINKING WATER (U.S. CLS. 45, 46 AND 48).

FIRST USE 4-8-2008; IN COMMERCE 4-8-2008.

CLASS 32—(Continued).

3,785,837. NORTHERN UNITED BREWING COMPANY, LLC, ANN ARBOR, MI. SN 77-664,009. PUB. 6-23-2009, FILED 2-5-2009.

JOLLY PUMPKIN ARTISAN ALES

THE MARK CONSISTS OF STANDARD CHARACTERS WITHOUT CLAIM TO ANY PARTICULAR FONT, STYLE, SIZE, OR COLOR.

NO CLAIM IS MADE TO THE EXCLUSIVE RIGHT TO USE "ARTISAN ALES", APART FROM THE MARK AS SHOWN.

FOR BEER, ALE, LAGER, STOUT AND PORTER (U.S. CLS. 45, 46 AND 48).

FIRST USE 7-0-2004; IN COMMERCE 7-0-2004.

3,785,848. EXCLUSIVE ENERGY CO., LLC, DOVE CANYON, CA. SN 77-665,334. PUB. 9-1-2009, FILED 2-6-2009.



NO CLAIM IS MADE TO THE EXCLUSIVE RIGHT TO USE "ENERGY", APART FROM THE MARK AS SHOWN.

THE MARK CONSISTS OF THE WORD "EXCLUSIVE" IN STYLIZED LETTERING, AND THE WORD "ENERGY" IN A DIFFERENT STYLIZED LETTERING.

FOR NON-ALCOHOLIC BEVERAGES, NAMELY, ENERGY DRINKS (U.S. CLS. 45, 46 AND 48).

FIRST USE 7-7-2009; IN COMMERCE 7-7-2009.

3,785,854. HERO/WHITEWAVE, LLC, BROOMFIELD, CO. SN 77-666,930. PUB. 6-9-2009, FILED 2-10-2009.

A NEW WAY TO EAT FRUIT

THE MARK CONSISTS OF STANDARD CHARACTERS WITHOUT CLAIM TO ANY PARTICULAR FONT, STYLE, SIZE, OR COLOR.

FOR FRUIT JUICES; FRUIT NECTARS; NON-ALCOHOLIC FRUIT JUICE BEVERAGES (U.S. CLS. 45, 46 AND 48).

FIRST USE 11-0-2006; IN COMMERCE 11-0-2009.

CLASS 32—(Continued).

3,785,867. VINTAGE FOOD CORP., BROOKLYN, NY. SN 77-668,152. PUB. 6-16-2009, FILED 2-11-2009.

VINTAQUA

THE MARK CONSISTS OF STANDARD CHARACTERS WITHOUT CLAIM TO ANY PARTICULAR FONT, STYLE, SIZE, OR COLOR.

FOR MINERAL WATER; SPRING WATER (U.S. CLS. 45, 46 AND 48).

FIRST USE 4-15-2009; IN COMMERCE 4-15-2009.

CLASS 32—(Continued).

3,786,004. BJ'S RESTAURANTS, INC., HUNTINGTON BEACH, CA. SN 77-709,116. PUB. 7-21-2009, FILED 4-7-2009.

HEFELIGHTZEN

THE MARK CONSISTS OF STANDARD CHARACTERS WITHOUT CLAIM TO ANY PARTICULAR FONT, STYLE, SIZE, OR COLOR.

THE WORDING "HEFELIGHTZEN" HAS NO MEANING IN A FOREIGN LANGUAGE.

FOR BEER (U.S. CLS. 45, 46 AND 48).

FIRST USE 6-24-2009; IN COMMERCE 6-24-2009.

3,785,905. WILLIAMS TONY A., BESSEMER, AL. SN 77-675,542. PUB. 6-16-2009, FILED 2-22-2009.

stimulus water

THE MARK CONSISTS OF STANDARD CHARACTERS WITHOUT CLAIM TO ANY PARTICULAR FONT, STYLE, SIZE, OR COLOR.

NO CLAIM IS MADE TO THE EXCLUSIVE RIGHT TO USE "WATER", APART FROM THE MARK AS SHOWN.

FOR DISTILLED DRINKING WATER (U.S. CLS. 45, 46 AND 48).

FIRST USE 2-1-2009; IN COMMERCE 1-4-2010.

3,786,017. MONAVIE, LLC, SOUTH JORDAN, UT. SN 77-715,792. PUB. 8-18-2009, FILED 4-16-2009.

EMV

THE MARK CONSISTS OF STANDARD CHARACTERS WITHOUT CLAIM TO ANY PARTICULAR FONT, STYLE, SIZE, OR COLOR.

FOR JUICE, NAMELY, FRUIT JUICES; ENERGY DRINKS (U.S. CLS. 45, 46 AND 48).

FIRST USE 6-13-2009; IN COMMERCE 6-13-2009.

3,785,917. US PREMIUM BEVERAGES, LLC, SAN LUIS OBISPO, CA. SN 77-678,897. PUB. 6-30-2009, FILED 2-26-2009.

TONGUE TWISTERZ

THE MARK CONSISTS OF STANDARD CHARACTERS WITHOUT CLAIM TO ANY PARTICULAR FONT, STYLE, SIZE, OR COLOR.

FOR FLAVORED WATERS; FRUIT JUICES; FRUIT-FLAVORED BEVERAGES; SOFT DRINKS (U.S. CLS. 45, 46 AND 48).

FIRST USE 3-1-2010; IN COMMERCE 3-1-2010.

3,786,021. MONAVIE, LLC, SOUTH JORDAN, UT. SN 77-716,771. PUB. 8-18-2009, FILED 4-17-2009.



THE MARK CONSISTS OF A STYLIZED "E" WITH A STYLIZED AND SUPERSCRIPED "MV".

FOR JUICE, NAMELY, FRUIT JUICES; ENERGY DRINKS (U.S. CLS. 45, 46 AND 48).

FIRST USE 6-13-2009; IN COMMERCE 6-13-2009.

CLASS 32—(Continued).

3,786,092. TEJADA ABREU, ROBERTO E., WEST HENRIETTA, NY. SN 77-752,709. PUB. 10-27-2009, FILED 6-5-2009.



THE COLOR(S) ORANGE, LIGHT ORANGE, WHITE, YELLOW, AND DARK ORANGE IS/ARE CLAIMED AS A FEATURE OF THE MARK.

THE MARK CONSISTS OF THE COLOR(S) ORANGE, LIGHT ORANGE, WHITE, YELLOW, AND DARK ORANGE, AS SHOWN IN THE SYRUP DROP WITH THE COLOR LIGHT ORANGE APPEARING IN THE WORDING "NESUGAR".

FOR AROMATIZED BEVERAGES BASED ON FRUIT, PROTEIN, CORDIAL, SUGAR AND OTHER FLUID NUTRIENTS, NAMELY, CARBOHYDRATES DRINKS FOR USE AS A FOOD FILLERS; AROMATIZED BEVERAGES BASED ON FRUIT, PROTEIN, CORDIAL, SUGAR AND OTHER FLUID NUTRIENTS, NAMELY, PROTEIN DRINKS FOR USE AS A FOOD FILLERS AND NOT FOR USE AS A MEAL REPLACEMENT; CONCENTRATES, SYRUPS OR POWDERS USED IN THE PREPARATION OF SOFT DRINKS; MALT SYRUP FOR BEVERAGES; NON-ALCOHOLIC HONEY-BASED BEVERAGES; SYRUP FOR MAKING LEMONADE; SYRUP SUBSTITUTES FOR MAKING BEVERAGES; SYRUPS FOR BEVERAGES; SYRUPS FOR MAKING BEVERAGES; SYRUPS FOR MAKING FLAVOURED MINERAL WATERS; SYRUPS FOR MAKING NON-ALCOHOLIC BEVERAGES; SYRUPS FOR MAKING SOFT DRINKS; SYRUPS FOR MAKING WHEY-BASED BEVERAGES (U.S. CLS. 45, 46 AND 48).

FIRST USE 6-5-2009; IN COMMERCE 8-1-2009.

3,786,230. FISH & RICHARDSON P.C., BOSTON, MA. SN 78-657,979. PUB. 11-14-2006, FILED 6-24-2005.

THE KING OF ENERGY

THE MARK CONSISTS OF STANDARD CHARACTERS WITHOUT CLAIM TO ANY PARTICULAR FONT, STYLE, SIZE, OR COLOR.

FOR NON-ALCOHOLIC BEVERAGES, NAMELY, ENERGY DRINKS (U.S. CLS. 45, 46 AND 48).

FIRST USE 12-27-2005; IN COMMERCE 12-27-2005.

CLASS 32—(Continued).

3,786,261. RUSH BEVERAGE COMPANY, BLUE ISLAND, IL. SN 78-800,553. PUB. 8-4-2009, FILED 1-26-2006.

APPLE RUSH

THE MARK CONSISTS OF STANDARD CHARACTERS WITHOUT CLAIM TO ANY PARTICULAR FONT, STYLE, SIZE, OR COLOR.

OWNER OF U.S. REG. NO. 3,187,940.

NO CLAIM IS MADE TO THE EXCLUSIVE RIGHT TO USE "APPLE", APART FROM THE MARK AS SHOWN.

FOR NON-ALCOHOLIC SPARKLING FRUIT-BASED BEVERAGES (U.S. CLS. 45, 46 AND 48).

FIRST USE 10-13-2006; IN COMMERCE 10-13-2006.

3,786,339. NORTON, JOSEPH J., BRIGHTON, MI. SN 78-977,943. PUB. 12-4-2007, FILED 11-19-2004.



OWNER OF U.S. REG. NO. 2,202,350.
SEC. 2(F) AS TO BUG JUICE.

FOR FRUIT FLAVORED BEVERAGES (U.S. CLS. 45, 46 AND 48).

FIRST USE 1-1-1990; IN COMMERCE 1-1-1990.

CLASS 33—WINES AND SPIRITS

CLASS 33—(Continued).

3,785,086. PATRON SPIRITS INTERNATIONAL AG, 8200 SCHAFFHAUSEN, SWITZERLAND. SN 76-690,926. PUB. 4-14-2009, FILED 6-26-2008.

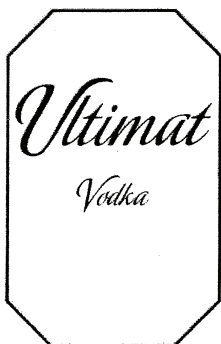

OWNER OF U.S. REG. NO. 3,157,736.
NO CLAIM IS MADE TO THE EXCLUSIVE RIGHT TO USE "VODKA", APART FROM THE MARK AS SHOWN.
THE MARK CONSISTS OF A VERTICALLY ELONGATED CONTAINING THE WORD "ULTIMAT" ABOVE THE WORD "VODKA" IN STYLIZED FONT.
FOR ALCOHOLIC BEVERAGES, EXCEPT BEERS; DISTILLED SPIRITS; AND VODKA (U.S. CLS. 47 AND 49).
FIRST USE 11-0-2009; IN COMMERCE 11-0-2007.

3,785,107. NEW CLAIRVAUX VINEYARD, LLC, CHICO, CA. SN 77-001,391. PUB. 6-19-2007, FILED 9-18-2006.

**NEW CLAIRVAUX ABBOT'S
RESERVE**

THE MARK CONSISTS OF STANDARD CHARACTERS WITHOUT CLAIM TO ANY PARTICULAR FONT, STYLE, SIZE, OR COLOR.
OWNER OF U.S. REG. NO. 3,119,731.
NO CLAIM IS MADE TO THE EXCLUSIVE RIGHT TO USE "RESERVE", APART FROM THE MARK AS SHOWN.
THE FOREIGN WORDING IN THE MARK TRANSLATES INTO ENGLISH AS "CLEAR VALLEY".
FOR WINE (U.S. CLS. 47 AND 49).
FIRST USE 3-7-2010; IN COMMERCE 3-7-2010.

CLASS 33—(Continued).

3,785,156. TC SPECIALTY BRANDS, LLC, HENDERSON, NV. SN 77-173,784. PUB. 10-23-2007, FILED 5-5-2007.

SEXY RITA

THE MARK CONSISTS OF STANDARD CHARACTERS WITHOUT CLAIM TO ANY PARTICULAR FONT, STYLE, SIZE, OR COLOR.
FOR TEQUILA (U.S. CLS. 47 AND 49).
FIRST USE 1-1-2009; IN COMMERCE 9-16-2009.

3,785,210. SLG PRODUCTIONS, INC., NEW YORK, NY. SN 77-261,578. PUB. 6-2-2009, FILED 8-22-2007.



NO CLAIM IS MADE TO THE EXCLUSIVE RIGHT TO USE "SAKE" AND THE NON-LATIN CHARACTERS WHICH TRANSLITERATE TO "ICHIBAN SAKE" WHICH MEANS "BEST SAKE" OR "NUMBER ONE" SAKE IN ENGLISH, APART FROM THE MARK AS SHOWN.
THE MARK CONSISTS OF JAPANESE LETTERING/"SAMURAI LOVE SAKE"/CROSS, CIRCLE AND ARROW LOGO WITH JAPANESE LETTERS IN CIRCLE/"A DRINK TO PLEASURE".
THE NON-LATIN CHARACTER(S) IN THE MARK TRANSLITERATES INTO "ICHIBAN SAKE" AND "AI", AND THIS MEANS "BEST SAKE" OR "NUMBER ONE SAKE" AND "LOVE" IN ENGLISH.
FOR SAKE (U.S. CLS. 47 AND 49).
FIRST USE 12-21-2009; IN COMMERCE 12-21-2009.

3,785,211. CARAMBA TEQUILA, INC., PASADENA, CA. SN 77-269,952. PUB. 7-14-2009, FILED 8-31-2007.

CARAMBA

THE MARK CONSISTS OF STANDARD CHARACTERS WITHOUT CLAIM TO ANY PARTICULAR FONT, STYLE, SIZE, OR COLOR.
FOR TEQUILA (U.S. CLS. 47 AND 49).
FIRST USE 3-1-2009; IN COMMERCE 3-1-2009.

CLASS 33—(Continued).

3,785,504. U4RIK VODKA, EL CAJON, CA. SN 77-514,723.
PUB. 4-28-2009, FILED 7-3-2008.

U4RIK Vodka

THE MARK CONSISTS OF STANDARD CHARACTERS WITHOUT CLAIM TO ANY PARTICULAR FONT, STYLE, SIZE, OR COLOR.

NO CLAIM IS MADE TO THE EXCLUSIVE RIGHT TO USE "VODKA", APART FROM THE MARK AS SHOWN.

FOR VODKA (U.S. CLS. 47 AND 49).
FIRST USE 7-1-2008; IN COMMERCE 7-1-2008.

CLASS 33—(Continued).

3,785,573. LUCASFILM LTD., SAN FRANCISCO, CA. SN 77-541,957. PUB. 5-19-2009, FILED 8-7-2008.

SKYWALKER VINEYARDS

THE MARK CONSISTS OF STANDARD CHARACTERS WITHOUT CLAIM TO ANY PARTICULAR FONT, STYLE, SIZE, OR COLOR.

OWNER OF U.S. REG. NOS. 1,862,555, 2,729,615, AND OTHERS.

NO CLAIM IS MADE TO THE EXCLUSIVE RIGHT TO USE "VINEYARDS", APART FROM THE MARK AS SHOWN.

FOR WINES (U.S. CLS. 47 AND 49).
FIRST USE 12-0-2009; IN COMMERCE 12-0-2009.

3,785,512. CANTINE GIACOMO MONTRESOR S.P.A., VERONA, ITALY. SN 77-517,586. PUB. 12-2-2008, FILED 7-9-2008.

VILLA MAFFEI

THE MARK CONSISTS OF STANDARD CHARACTERS WITHOUT CLAIM TO ANY PARTICULAR FONT, STYLE, SIZE, OR COLOR.

FOR WINES, SPIRITS AND LIQUORS (U.S. CLS. 47 AND 49).

FIRST USE 10-3-2003; IN COMMERCE 10-3-2003.

3,785,578. JADE LIQUEURS, LLC, PRAIRIEVILLE, LA. SN 77-545,408. PUB. 12-30-2008, FILED 8-12-2008.

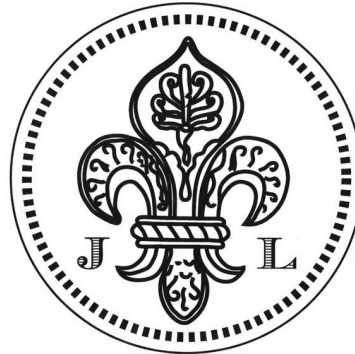

THE MARK CONSISTS OF A FLEUR DE LYS DESIGN WITH FLOURISHES SET WITHIN AN INNER DOTTED CIRCLE WHICH IS SET WITHIN AN OUTER SOLID CIRCLE.

FOR ABSINTHE (U.S. CLS. 47 AND 49).
FIRST USE 5-16-2005; IN COMMERCE 5-16-2005.

3,785,564. JASON COURT, DBA EVIDENCE WINES, NAPA, CA. SN 77-536,604. PUB. 12-23-2008, FILED 7-31-2008.

Evidence Wines

THE MARK CONSISTS OF STANDARD CHARACTERS WITHOUT CLAIM TO ANY PARTICULAR FONT, STYLE, SIZE, OR COLOR.

NO CLAIM IS MADE TO THE EXCLUSIVE RIGHT TO USE "WINES", APART FROM THE MARK AS SHOWN.

FOR APERITIF WINES; GRAPE WINE; PORT WINES; RED WINE; RED WINES; TABLE WINES; WHITE WINE; WINE; WINES; WINES AND FORTIFIED WINES; WINES AND LIQUEURS; WINES AND SPARKLING WINES (U.S. CLS. 47 AND 49).

FIRST USE 3-2-2009; IN COMMERCE 3-2-2009.

3,785,702. KELLEY FOX WINES LLC, PORTLAND, OR. SN 77-627,167. PUB. 11-17-2009, FILED 12-5-2008.



Kelley Fox Wines

NO CLAIM IS MADE TO THE EXCLUSIVE RIGHT TO USE "WINES", APART FROM THE MARK AS SHOWN.

CLASS 33—(Continued).

THE NAME(S), PORTRAIT(S), AND/OR SIGNATURE(S) SHOWN IN THE MARK IDENTIFIES "KELLEY FOX", WHOSE CONSENT(S) TO REGISTER IS MADE OF RECORD.

THE MARK CONSISTS OF THE STYLIZED WORDS "KELLEY FOX WINES". ABOVE THE STYLIZED WORDS IS AN IMAGE OF AN INSECT INSIDE A SHIELD.
FOR WINES (U.S. CLS. 47 AND 49).
FIRST USE 3-9-2009; IN COMMERCE 3-9-2009.

CLASS 33—(Continued).

3,785,831. PRODUCTOS REGIONALES DE ATOTONILCO SA DE CV, ATOTONILCO, MEXICO. SN 77-662,472. PUB. 5-26-2009, FILED 2-3-2009.

TRES CULTURAS

3,785,762. WASSAIL, LLC, DBA MAINE MEAD WORKS, PORTLAND, ME. SN 77-648,539. PUB. 4-28-2009, FILED 1-13-2009.

THE MARK CONSISTS OF STANDARD CHARACTERS WITHOUT CLAIM TO ANY PARTICULAR FONT, STYLE, SIZE, OR COLOR.

THE ENGLISH TRANSLATION OF "TRES CULTURAS" IN THE MARK IS THREE CULTURES.
FOR TEQUILA (U.S. CLS. 47 AND 49).
FIRST USE 12-18-2009; IN COMMERCE 12-18-2009.

HONEYMAKER

THE MARK CONSISTS OF STANDARD CHARACTERS WITHOUT CLAIM TO ANY PARTICULAR FONT, STYLE, SIZE, OR COLOR.

FOR MEAD (U.S. CLS. 47 AND 49).
FIRST USE 11-21-2008; IN COMMERCE 3-28-2009.

3,785,885. NORTHERN UNITED BREWING COMPANY, LLC, ANN ARBOR, MI. SN 77-670,233. PUB. 6-2-2009, FILED 2-13-2009.

BONAFIDE

3,785,827. SAN BARTOLO FARMS, INC., EL MIRAGE, AZ. SN 77-661,724. PUB. 5-26-2009, FILED 2-2-2009.

THE MARK CONSISTS OF STANDARD CHARACTERS WITHOUT CLAIM TO ANY PARTICULAR FONT, STYLE, SIZE, OR COLOR.

FOR WINE (U.S. CLS. 47 AND 49).
FIRST USE 6-1-2009; IN COMMERCE 6-1-2009.

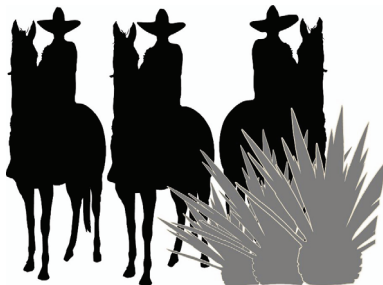

THE MARK CONSISTS OF THREE RIDERS ON HORSEBACK AND THREE AGAVE CACTUS PLANTS.

FOR TEQUILA; AGAVE-BASED ALCOHOLIC BEVERAGES (U.S. CLS. 47 AND 49).
FIRST USE 5-0-2007; IN COMMERCE 5-0-2007.

3,785,958. MARNA INCORPORATED, DBA REFERENT VODKA, SAINT PAUL, MN. SN 77-691,313. PUB. 9-8-2009, FILED 3-15-2009.

REFERENT

THE MARK CONSISTS OF THE WORD "REFERENT" STYLIZED IN DESDEMONA FONT AND SPELLED OUT IN ALL CAPITAL LETTERS.

FOR VODKA (U.S. CLS. 47 AND 49).
FIRST USE 4-19-2009; IN COMMERCE 6-2-2009.

CLASS 33—(Continued).

3,785,996. THE ARGENTO WINE COMPANY LIMITED, LONDON, UNITED KINGDOM. SN 77-704,485. PUB. 9-29-2009, FILED 4-1-2009.

ARGENTO THE REAL ARGENTINA

THE MARK CONSISTS OF STANDARD CHARACTERS WITHOUT CLAIM TO ANY PARTICULAR FONT, STYLE, SIZE, OR COLOR.

OWNER OF ERPN CMNTY TM OFC REG. NO. 6015648, DATED 4-1-2008, EXPIRES 6-19-2017.

NO CLAIM IS MADE TO THE EXCLUSIVE RIGHT TO USE "ARGENTINA", APART FROM THE MARK AS SHOWN.

THE ENGLISH TRANSLATION OF "ARGENTO" IN THE MARK IS SILVER.

FOR WINES; WINES (U.S. CLS. 47 AND 49).
FIRST USE 2-23-2009; IN COMMERCE 2-23-2009.

3,786,011. LION, MARKUS, BREISACH, FED REP GERMANY. SN 77-712,119. PUB. 8-11-2009, FILED 4-12-2009.

DUPLAIS

THE MARK CONSISTS OF STANDARD CHARACTERS WITHOUT CLAIM TO ANY PARTICULAR FONT, STYLE, SIZE, OR COLOR.

FOR SPIRITS (U.S. CLS. 47 AND 49).

FIRST USE 10-31-2008; IN COMMERCE 10-31-2008.

3,786,046. DIAGEO NORTH AMERICA, INC., NORWALK, CT. SN 77-731,608. PUB. 8-25-2009, FILED 5-7-2009.

REVEL IN THE UNEXPECTED

THE MARK CONSISTS OF STANDARD CHARACTERS WITHOUT CLAIM TO ANY PARTICULAR FONT, STYLE, SIZE, OR COLOR.

FOR ALCOHOLIC BEVERAGES EXCEPT BEERS (U.S. CLS. 47 AND 49).

FIRST USE 11-21-2009; IN COMMERCE 11-21-2009.

CLASS 33—(Continued).

3,786,086. PASSION WORLD WINES, DBA LLC, BERNARDINA BEACH, FL. SN 77-749,715. PUB. 10-27-2009, FILED 6-2-2009.

PASSION

THE MARK CONSISTS OF STANDARD CHARACTERS WITHOUT CLAIM TO ANY PARTICULAR FONT, STYLE, SIZE, OR COLOR.

FOR WINE (U.S. CLS. 47 AND 49).

FIRST USE 9-3-2009; IN COMMERCE 9-3-2009.

3,786,104. BECKER, TINA, NAPA, CA. AND BECKER, DAVID, NAPA, CA. SN 77-755,735. PUB. 10-20-2009, FILED 6-9-2009.

ACRE

THE MARK CONSISTS OF STANDARD CHARACTERS WITHOUT CLAIM TO ANY PARTICULAR FONT, STYLE, SIZE, OR COLOR.

OWNER OF U.S. REG. NOS. 3,413,306 AND 3,419,620.

FOR WINES (U.S. CLS. 47 AND 49).

FIRST USE 2-19-2010; IN COMMERCE 2-19-2010.

3,786,139. MITCHELL, JOHN S., RUTHERFORD, CA. SN 77-769,076. PUB. 11-17-2009, FILED 6-26-2009.

FOUR CAIRN

THE MARK CONSISTS OF STANDARD CHARACTERS WITHOUT CLAIM TO ANY PARTICULAR FONT, STYLE, SIZE, OR COLOR.

FOR WINES (U.S. CLS. 47 AND 49).

FIRST USE 6-18-2009; IN COMMERCE 6-18-2009.

CLASS 34—SMOKERS' ARTICLES

CLASS 34—(Continued).

3,785,828. REYNOLDS INNOVATIONS INC., WINSTON-SALEM, NC. SN 77-662,225. PUB. 11-24-2009, FILED 2-3-2009.

BREAK FREE

THE MARK CONSISTS OF STANDARD CHARACTERS WITHOUT CLAIM TO ANY PARTICULAR FONT, STYLE, SIZE, OR COLOR.

FOR CIGARETTES; SMOKELESS TOBACCO (U.S. CLS. 2, 8, 9 AND 17).
FIRST USE 12-14-2009; IN COMMERCE 12-14-2009.

3,785,896. K. HANSOTIA & CO., INC., MIAMI, FL. SN 77-674,724. PUB. 6-16-2009, FILED 2-20-2009.

ROGUE WARRIOR

THE MARK CONSISTS OF STANDARD CHARACTERS WITHOUT CLAIM TO ANY PARTICULAR FONT, STYLE, SIZE, OR COLOR.

FOR CIGARS (U.S. CLS. 2, 8, 9 AND 17).
FIRST USE 10-15-2009; IN COMMERCE 10-15-2009.

3,786,317. NHA, INC., BRISTOL, PA. SN 78-916,612. PUB. 2-6-2007, FILED 6-26-2006.

ENTOURAGE

THE MARK CONSISTS OF STANDARD CHARACTERS WITHOUT CLAIM TO ANY PARTICULAR FONT, STYLE, SIZE, OR COLOR.

FOR CIGAR TUBES; CIGARILLOS; CIGARS; HAND-ROLLING TOBACCO; LIGHTERS FOR SMOKERS; NON-ELECTRIC CIGAR LIGHTERS NOT OF PRECIOUS METAL; ROLL YOUR OWN TOBACCO; ROLLING TOBACCO; SMOKING TOBACCO; TOBACCO (U.S. CLS. 2, 8, 9 AND 17).
FIRST USE 12-29-2009; IN COMMERCE 1-4-2010.

SERVICE MARKS

CLASS 35—ADVERTISING AND BUSINESS

CLASS 35—(Continued).

3,785,083. KLEIN, DYANN, EASTHAMPTON, NY. SN 76-686,314. PUB. 8-5-2008, FILED 1-30-2008.

PROPS FROM YESTERDAY

THE MARK CONSISTS OF STANDARD CHARACTERS WITHOUT CLAIM TO ANY PARTICULAR FONT, STYLE, SIZE, OR COLOR.

NO CLAIM IS MADE TO THE EXCLUSIVE RIGHT TO USE "PROPS", APART FROM THE MARK AS SHOWN.
FOR RETAIL STORE SERVICES FOR THE FURNITURE OF CELEBRITIES AND THE PROPS FROM ENTERTAINMENT PRODUCTIONS (U.S. CLS. 100, 101 AND 102).
FIRST USE 0-0-1980; IN COMMERCE 0-0-1980.

3,785,110. AVFUEL CORPORATION, ANN ARBOR, MI. SN 77-006,639. PUB. 12-4-2007, FILED 9-25-2006.

AVGIRL

THE MARK CONSISTS OF STANDARD CHARACTERS WITHOUT CLAIM TO ANY PARTICULAR FONT, STYLE, SIZE, OR COLOR.

FOR PROMOTING PUBLIC AWARENESS OF AND INTEREST IN THE HISTORY AND FIELD OF AVIATION; PROVIDING BUSINESS INFORMATION IN THE AVIATION INDUSTRY FIELD (U.S. CLS. 100, 101 AND 102).
FIRST USE 3-1-2010; IN COMMERCE 3-1-2010.

3,785,111. FLOWERS COMMUNICATIONS GROUP, CHICAGO, IL. SN 77-008,838. PUB. 5-15-2007, FILED 9-27-2006.

ETHNIC FUSION

THE MARK CONSISTS OF STANDARD CHARACTERS WITHOUT CLAIM TO ANY PARTICULAR FONT, STYLE, SIZE, OR COLOR.

FOR PROMOTION AND MARKETING SERVICES AND RELATED CONSULTING (U.S. CLS. 100, 101 AND 102).
FIRST USE 5-29-2009; IN COMMERCE 5-29-2009.

CLASS 35—(Continued).

3,785,118. KEEP IT PUSHIN, INC., INGLEWOOD, CA. SN 77-038,712. PUB. 7-10-2007, FILED 11-7-2006.

KEEP IT PUSHIN, INC.

THE MARK CONSISTS OF STANDARD CHARACTERS WITHOUT CLAIM TO ANY PARTICULAR FONT, STYLE, SIZE, OR COLOR.

NO CLAIM IS MADE TO THE EXCLUSIVE RIGHT TO USE "INC.", APART FROM THE MARK AS SHOWN. FOR ADVERTISING AND PUBLICITY SERVICES (U.S. CLS. 100, 101 AND 102).

FIRST USE 1-1-2008; IN COMMERCE 1-1-2008.

3,785,153. STUDIO SB, LLC, SANTA BARBARA, CA. SN 77-161,768. PUB. 4-29-2008, FILED 4-20-2007.

ITZMAGIC STUDIO

THE MARK CONSISTS OF STANDARD CHARACTERS WITHOUT CLAIM TO ANY PARTICULAR FONT, STYLE, SIZE, OR COLOR.

NO CLAIM IS MADE TO THE EXCLUSIVE RIGHT TO USE "STUDIO", APART FROM THE MARK AS SHOWN.

FOR RETAIL SERVICES, NAMELY, MAIL ORDER SERVICES, FEATURING WALLETS, MEN'S AND WOMEN'S LUGGAGE AND OFFICE ACCESSORIES, AND CAR SEAT ACCESSORIES (U.S. CLS. 100, 101 AND 102).

FIRST USE 4-16-2009; IN COMMERCE 4-16-2009.

3,785,172. MARKO SWAN, GLENDALE, CA. SN 77-205,997. PUB. 12-2-2008, FILED 6-14-2007.

REX HAVOC

THE MARK CONSISTS OF STANDARD CHARACTERS WITHOUT CLAIM TO ANY PARTICULAR FONT, STYLE, SIZE, OR COLOR.

THE NAME "REX HAVOC" DOES NOT IDENTIFY A LIVING INDIVIDUAL.

FOR PROMOTING THE SALE OF WINE BY OTHERS BY MEANS OF ADVERTISEMENTS WITH A WESTERN CHARACTER ON A WEBSITE (U.S. CLS. 100, 101 AND 102).

FIRST USE 2-1-2010; IN COMMERCE 2-1-2010.

CLASS 35—(Continued).

3,785,182. KINGLAND SYSTEMS CORPORATION, CLEAR LAKE, IA. SN 77-214,699. PUB. 4-28-2009, FILED 6-25-2007.

360 DATA

THE MARK CONSISTS OF STANDARD CHARACTERS WITHOUT CLAIM TO ANY PARTICULAR FONT, STYLE, SIZE, OR COLOR.

NO CLAIM IS MADE TO THE EXCLUSIVE RIGHT TO USE "DATA", APART FROM THE MARK AS SHOWN.

FOR PROVIDING TO SUBSCRIBERS AN ON-LINE COMPUTER GLOBAL DATABASE IN THE FIELD OF BUSINESS ENTITY AND SECURITIES INFORMATION WHICH IDENTIFIES ORGANIZATIONS, COMPANIES, GOVERNMENT ENTITIES AND OTHER LEGALLY-ORGANIZED ENTITIES AND THEIR ORGANIZATIONAL STRUCTURE, PUBLICLY-TRADED SECURITIES ISSUED IN THOSE GEOGRAPHIC AREAS OF THE WORLD IN WHICH THE ENTITIES CONDUCT BUSINESS, AND THE RELATIONSHIPS BETWEEN THE ENTITIES AND THEIR SECURITIES, IN A SCALABLE SYSTEM FOR MANAGING AND EXPANDING THE DATA AND WHICH PERMITS SUBSCRIBERS TO CONTRIBUTE VERIFIED DATA BACK INTO THE DATABASE FOR ALL SUBSCRIBER USE (U.S. CLS. 100, 101 AND 102).

FIRST USE 1-10-2009; IN COMMERCE 1-10-2009.

3,785,202. QWIK-COOK, INC., DBA HOME TRENDS, ROCHESTER, NY. SN 77-250,276. PUB. 6-10-2008, FILED 8-8-2007.

QCI Direct

THE MARK CONSISTS OF STANDARD CHARACTERS WITHOUT CLAIM TO ANY PARTICULAR FONT, STYLE, SIZE, OR COLOR.

NO CLAIM IS MADE TO THE EXCLUSIVE RIGHT TO USE "DIRECT", APART FROM THE MARK AS SHOWN.

FOR CATALOG ORDERING SERVICE FEATURING, NAMELY, HOME CLEANING AND MAINTENANCE SUPPLIES; MAIL ORDER CATALOG SERVICES FEATURING, NAMELY, HOME CLEANING AND MAINTENANCE SUPPLIES; MAIL ORDER SERVICES FEATURING, NAMELY, HOME CLEANING AND MAINTENANCE SUPPLIES; ON-LINE RETAIL STORE SERVICES FEATURING, NAMELY, HOME CLEANING AND MAINTENANCE SUPPLIES; RETAIL OUTLETS FEATURING, NAMELY, HOME CLEANING AND MAINTENANCE SUPPLIES (U.S. CLS. 100, 101 AND 102).

FIRST USE 6-15-2008; IN COMMERCE 6-15-2008.

CLASS 35—(Continued).

3,785,239. MIHIR MODY, HOUSTON, TX. SN 77-325,014.
PUB. 11-4-2008, FILED 11-8-2007.

MODIA

THE MARK CONSISTS OF STANDARD CHARACTERS WITHOUT CLAIM TO ANY PARTICULAR FONT, STYLE, SIZE, OR COLOR.

THE WORDING "MODIA" HAS NO MEANING IN A FOREIGN LANGUAGE.

FOR RETAIL STORE SERVICES AND ON-LINE RETAIL STORE SERVICES FEATURING FURNITURE (U.S. CLS. 100, 101 AND 102).

FIRST USE 11-10-2007; IN COMMERCE 11-10-2007.

3,785,255. SOCIETY FOR PEDIATRIC RADIOLOGY, RESTON, VA. SN 77-337,818. PUB. 12-30-2008, FILED 11-27-2007.



THE COLOR(S) ORANGE, YELLOW, BLACK, WHITE, LIGHT BLUE AND CAUCASIAN FLESH TONES IS/ARE CLAIMED AS A FEATURE OF THE MARK.

THE MARK CONSISTS OF THE COLORS ORANGE, YELLOW, BLACK AND WHITE APPEARING ON A BUTTERFLY SITTING ON A CHILD'S HAND IN CAUCASIAN FLESH TONES ON A LIGHT BLUE BACKGROUND BEHIND THE HAND AND EXTENDING HALFWAY BEHIND THE BUTTERFLY.

FOR PROMOTING AWARENESS OF THE NEED FOR SAFETY IN THE FIELD OF RADIOLOGY FOR CHILDREN, SUCH AWARENESS BEING PROMOTED TO PROFESSIONALS IN THE SAME FIELD (U.S. CLS. 100, 101 AND 102).

FIRST USE 1-22-2008; IN COMMERCE 1-22-2008.

CLASS 35—(Continued).

3,785,308. FARIENT ADVISORS, LLC, SAN MARINO, CA. SN 77-383,658. PUB. 6-2-2009, FILED 1-29-2008.

EXECUTIVE TOP SHEET

THE MARK CONSISTS OF STANDARD CHARACTERS WITHOUT CLAIM TO ANY PARTICULAR FONT, STYLE, SIZE, OR COLOR.

NO CLAIM IS MADE TO THE EXCLUSIVE RIGHT TO USE "EXECUTIVE", APART FROM THE MARK AS SHOWN.

FOR DATA SERVICES INVOLVING EXECUTIVE COMPENSATION, NAMELY, DATA COMPILING AND ANALYZING RELATING TO EXECUTIVE PERFORMANCE AND EXECUTIVE COMPENSATION (U.S. CLS. 100, 101 AND 102).

FIRST USE 7-31-2009; IN COMMERCE 7-31-2009.

3,785,311. PEX CONNECTION, INC., OKLAHOMA CITY, OK. SN 77-385,846. PUB. 12-16-2008, FILED 1-31-2008.

RACEHORSEPLACE.COM

THE MARK CONSISTS OF STANDARD CHARACTERS WITHOUT CLAIM TO ANY PARTICULAR FONT, STYLE, SIZE, OR COLOR.

FOR PROVIDING SPACE AT A WEB SITE FOR THE ADVERTISEMENT OF THE GOODS AND SERVICES OF OTHERS RELATED TO HORSES; PROVIDING A WEB SITE AT WHICH USERS CAN OFFER HORSE-RELATED GOODS FOR SALE AND BUY HORSE-RELATED GOODS OFFERED BY OTHERS (U.S. CLS. 100, 101 AND 102).

FIRST USE 9-15-2008; IN COMMERCE 9-15-2008.

3,785,315. MIKKEN ENTERPRISES WORLDWIDE, LLC, FARMINGTON HILLS, MI. SN 77-387,178. PUB. 5-20-2008, FILED 2-2-2008.

GLOVOLOGY

THE MARK CONSISTS OF STANDARD CHARACTERS WITHOUT CLAIM TO ANY PARTICULAR FONT, STYLE, SIZE, OR COLOR.

FOR ON-LINE RETAIL STORE SERVICES FEATURING CONDOMS AND CARRYING CASES, STORAGE DEVICES, POCKET HOLDERS, AND TOTE BAGS THEREFOR, BODY AND SPA PRODUCTS INCLUDING CANDLES, AND NOVELTY ITEM (U.S. CLS. 100, 101 AND 102).

FIRST USE 2-19-2010; IN COMMERCE 2-19-2010.

CLASS 35—(Continued).

3,785,316. MIKKEN ENTERPRISES WORLDWIDE, LLC, FARMINGTON HILLS, MI. SN 77-387,181. PUB. 5-20-2008, FILED 2-2-2008.

GLOVOLOGY GIRL

THE MARK CONSISTS OF STANDARD CHARACTERS WITHOUT CLAIM TO ANY PARTICULAR FONT, STYLE, SIZE, OR COLOR.

FOR ON-LINE RETAIL STORE SERVICES FEATURING CONDOMS AND CARRYING CASES, STORAGE DEVICES, POCKET HOLDERS, AND TOTE BAGS THEREFOR, BODY AND SPA PRODUCTS INCLUDING CANDLES, AND NOVELTY ITEMS (U.S. CLS. 100, 101 AND 102).

FIRST USE 2-19-2010; IN COMMERCE 2-19-2010.

3,785,327. REPUTATION NETWORKS, INC., OAKLAND, CA. SN 77-393,789. PUB. 7-1-2008, FILED 2-11-2008.

WORKSCORE

THE MARK CONSISTS OF STANDARD CHARACTERS WITHOUT CLAIM TO ANY PARTICULAR FONT, STYLE, SIZE, OR COLOR.

FOR ADVERTISING AND BUSINESS SERVICES, NAMELY, PROVIDING USER-DEFINED INFORMATION AND PERSONAL RATINGS REGARDING EMPLOYMENT AND WORKPLACE ENVIRONMENTS VIA THE GLOBAL INFORMATION COMPUTER NETWORK (U.S. CLS. 100, 101 AND 102).

FIRST USE 9-0-2009; IN COMMERCE 9-0-2009.

3,785,389. SEMINOLE TRIBE OF FLORIDA, HOLLYWOOD, FL. SN 77-447,318. PUB. 7-1-2008, FILED 4-14-2008.

WILD CARD

THE MARK CONSISTS OF STANDARD CHARACTERS WITHOUT CLAIM TO ANY PARTICULAR FONT, STYLE, SIZE, OR COLOR.

FOR CUSTOMER LOYALTY SERVICES AND CUSTOMER CLUB SERVICES, FOR COMMERCIAL, PROMOTIONAL AND/OR ADVERTISING PURPOSES; CUSTOMER LOYALTY SERVICES, NAMELY, INCENTIVE AWARD PROGRAMS DESIGNED TO REWARD CASINO PLAYERS AND CUSTOMERS FOR FREQUENT PATRONAGE (U.S. CLS. 100, 101 AND 102).

FIRST USE 4-0-2008; IN COMMERCE 4-0-2008.

CLASS 35—(Continued).

3,785,409. KING W. SMITH, SACRAMENTO, CA. SN 77-461,320. PUB. 5-5-2009, FILED 4-29-2008.



**MIGHTY KONG
MUFFINS**

NO CLAIM IS MADE TO THE EXCLUSIVE RIGHT TO USE "MUFFINS", APART FROM THE MARK AS SHOWN.

THE COLOR(S) BROWN, BLACK, AND WHITE IS/ARE CLAIMED AS A FEATURE OF THE MARK.

THE COLOR BLACK APPEARS IN THE OUTLINE AND DETAILS OF THE CHEF'S HAT, THE GORILLA, THE LOWER PORTION OF THE MUFFIN, IN THE SPRINKLES ON UPPER PORTION OF THE MUFFIN, AND IN THE WORDING "MIGHTY KONG MUFFINS". THE COLOR WHITE APPEARS IN SHADED PORTIONS OF THE CHEF'S HAT AND GORILLA. THE COLOR BROWN APPEARS IN THE TOP PART OF THE MUFFIN.

FOR RETAIL AND ONLINE RETAIL BAKERY STORE (U.S. CLS. 100, 101 AND 102).

FIRST USE 12-4-2001; IN COMMERCE 6-30-2008.

3,785,411. DOCUMENTARY CHANNEL, INC., NASHVILLE, TN. SN 77-465,811. PUB. 10-6-2009, FILED 5-5-2008.

DOCUMENTARY CHANNEL

THE MARK CONSISTS OF STANDARD CHARACTERS WITHOUT CLAIM TO ANY PARTICULAR FONT, STYLE, SIZE, OR COLOR.

OWNER OF U.S. REG. NOS. 2,200,786 AND 3,476,672. SEC. 2(F).

FOR ONLINE RETAIL STORE SERVICES FEATURING DOCUMENTARY MOVIES AND FILMS AND MERCHANDISE RELATED TO DOCUMENTARY MOVIES AND FILMS (U.S. CLS. 100, 101 AND 102).

FIRST USE 8-28-2008; IN COMMERCE 8-28-2008.

CLASS 35—(Continued).

3,785,489. THE GORDIAN GROUP, INC., MAULDIN, SC. SN 77-510,100. PUB. 11-25-2008, FILED 6-27-2008.

JOC UNIVERSITY

THE MARK CONSISTS OF STANDARD CHARACTERS WITHOUT CLAIM TO ANY PARTICULAR FONT, STYLE, SIZE, OR COLOR.

NO CLAIM IS MADE TO THE EXCLUSIVE RIGHT TO USE "JOC", APART FROM THE MARK AS SHOWN.

FOR PROCUREMENT SERVICES FOR ENGINEERING, CONSTRUCTION, FACILITY REPAIR AND FACILITY MODERNIZATION, FOR OTHERS (U.S. CLS. 100, 101 AND 102).

FIRST USE 12-18-2009; IN COMMERCE 12-18-2009.

3,785,496. CUSTOM PRINTING COMPANY, NORTH LITTLE ROCK, AR. SN 77-511,481. PUB. 11-18-2008, FILED 6-30-2008.

GetNtheGame.com

THE MARK CONSISTS OF STANDARD CHARACTERS WITHOUT CLAIM TO ANY PARTICULAR FONT, STYLE, SIZE, OR COLOR.

FOR CONDUCTING ONLINE BUSINESS AND MARKET RESEARCH SURVEYS FOR ORGANIZERS OF SPORTING EVENTS, FESTIVALS, CONCERTS, AND CHARITY EVENTS (U.S. CLS. 100, 101 AND 102).

FIRST USE 10-31-2006; IN COMMERCE 10-31-2006.

CLASS 35—(Continued).

3,785,498. FRAKIE, INC., DBA LINEA LUXE, COCONUT GROVE, FL. SN 77-511,889. PUB. 12-9-2008, FILED 6-30-2008.

LINEA LUXE LIFESTYLE

THE MARK CONSISTS OF STANDARD CHARACTERS WITHOUT CLAIM TO ANY PARTICULAR FONT, STYLE, SIZE, OR COLOR.

FOR ONLINE RETAIL STORE SERVICES FEATURING WIDE VARIETY OF CONSUMER GOODS OF OTHERS, HOME ACCESSORIES, HOUSE WARES, ROOM DÉCOR, KITCHENWARE, KITCHEN UTENSILS, KITCHEN ACCESSORIES, BEDROOM AND BATHROOM LINENS AND ACCESSORIES, HOUSEHOLD LINENS, TABLE LINENS, TEXTILE AND TEXTILE GOODS, BEDSPREADS, BEDDING, TOWELS, BLANKETS, PLACE-MATS, FABRIC PLACE MATS, DISHWARE, GLASSWARE, CANDLES, SACHETS, ROOM FRAGRANCE, GIFTS, JEWELRY, CLOCKS, PICTURE FRAMES, CLOTHING, SHAWLS, WRAPS, FASHION ACCESSORIES, HANDBAGS, BAGS, PURSES, SMALL LEATHER GOODS, GENERAL CONSUMER MERCHANDISE, FOOD, GOURMET GOODS, BABY CLOTHES, BABY BLANKETS, BABY GIFTS, BABY-RELATED PRODUCTS, BABY GOODS, TOYS AND HOME GIFT ITEMS, BUBBLE BATH, BATH SALTS, BEAUTY PRODUCTS, COSMETICS, SOAPS, AND SKIN CARE PRODUCTS (U.S. CLS. 100, 101 AND 102).

FIRST USE 7-20-2009; IN COMMERCE 7-20-2009.

3,785,556. CAR WASH ENTERPRISES, INC., SEATTLE, WA. SN 77-533,545. PUB. 12-16-2008, FILED 7-29-2008.

WASH GREEN

THE MARK CONSISTS OF STANDARD CHARACTERS WITHOUT CLAIM TO ANY PARTICULAR FONT, STYLE, SIZE, OR COLOR.

OWNER OF U.S. REG. NO. 3,440,088.

FOR PUBLIC ADVOCACY TO PROMOTE AWARENESS OF USING ENVIRONMENTALLY RESPONSIBLE CAR WASHES; PROMOTION, ADVERTISING AND MARKETING OF ENVIRONMENTALLY RESPONSIBLE CAR WASHES (U.S. CLS. 100, 101 AND 102).

FIRST USE 1-0-2010; IN COMMERCE 1-0-2010.

CLASS 35—(Continued).

3,785,563. AMERICAN PUBLIC POWER ASSOCIATION, WASHINGTON, DC. SN 77-536,091. PUB. 6-2-2009, FILED 7-31-2008.



CAREERS
In Public Power

NO CLAIM IS MADE TO THE EXCLUSIVE RIGHT TO USE "CAREERS IN PUBLIC POWER", APART FROM THE MARK AS SHOWN.

THE MARK CONSISTS OF A DESIGN OF ELECTRIC WIRES LINKED TO A CITY IN THE RIGHT HAND OF A FLEXED ARM ABOVE THE WORDS "CAREERS IN PUBLIC POWER".

FOR PROVIDING JOB SEEKERS INFORMATION REGARDING EMPLOYMENT OPPORTUNITIES IN THE FIELD OF PUBLICLY OWNED ELECTRICITY GENERATION FACILITIES (U.S. CLS. 100, 101 AND 102).
FIRST USE 6-23-2008; IN COMMERCE 6-23-2008.

3,785,598. HURON CONSULTING GROUP INC., CHICAGO, IL. SN 77-556,497. PUB. 11-10-2009, FILED 8-27-2008.

BOOST-IRB

THE MARK CONSISTS OF STANDARD CHARACTERS WITHOUT CLAIM TO ANY PARTICULAR FONT, STYLE, SIZE, OR COLOR.

FOR CONSULTING SERVICES IN THE FIELD OF MANAGEMENT OF COMMITTEES DESIGNATED TO APPROVE, MONITOR AND REVIEW BIOMEDICAL AND BEHAVIORAL RESEARCH INVOLVING HUMANS (U.S. CLS. 100, 101 AND 102).
FIRST USE 7-16-2008; IN COMMERCE 10-20-2008.

CLASS 35—(Continued).

3,785,607. ROSEWOOD HOTELS AND RESORTS, LLC, DALLAS, TX. SN 77-565,308. PUB. 9-8-2009, FILED 9-9-2008.

VERDES

THE MARK CONSISTS OF STANDARD CHARACTERS WITHOUT CLAIM TO ANY PARTICULAR FONT, STYLE, SIZE, OR COLOR.

THE ENGLISH TRANSLATION OF "VERDES" IN THE MARK IS GREEN.

FOR HOTEL MANAGEMENT PROGRAM FOR OPERATION OF HOTELS FOR OTHERS WITH AN ENVIRONMENTALLY RESPONSIBLE PHILOSOPHY AND BUSINESS PRACTICE (U.S. CLS. 100, 101 AND 102).
FIRST USE 1-0-2008; IN COMMERCE 1-0-2008.

3,785,608. REFILL MANAGER, LLC, NEW YORK, NY. SN 77-566,872. PUB. 6-9-2009, FILED 9-10-2008.

Refill300

THE MARK CONSISTS OF STANDARD CHARACTERS WITHOUT CLAIM TO ANY PARTICULAR FONT, STYLE, SIZE, OR COLOR.

FOR PROVIDING PRESCRIPTION REFILL APPROVAL SERVICES TO OTHERS OVER AN ON-LINE WEBSITE, NAMELY, FACILITATING TRANSACTIONS BETWEEN PATIENTS, DOCTORS, AND PHARMACIES OVER AN ON-LINE WEBSITE THROUGH WHICH PATIENTS SUBMIT REQUESTS TO DOCTORS TO REFILL PRESCRIPTIONS AND DOCTORS RECEIVE NOTIFICATIONS OF THE PATIENT REQUESTS FOR REFILLS AND CAN APPROVE SUCH REQUESTS AND FORWARD REFILL PRESCRIPTIONS TO A PHARMACY OF THE PATIENT'S CHOOSING (U.S. CLS. 100, 101 AND 102).
FIRST USE 2-23-2010; IN COMMERCE 2-23-2010.

3,785,611. VCFO HOLDINGS, INC., AUSTIN, TX. SN 77-569,719. PUB. 8-18-2009, FILED 9-15-2008.

VRECRUITING

THE MARK CONSISTS OF STANDARD CHARACTERS WITHOUT CLAIM TO ANY PARTICULAR FONT, STYLE, SIZE, OR COLOR.

FOR EMPLOYMENT RECRUITING SERVICES (U.S. CLS. 100, 101 AND 102).
FIRST USE 7-30-2008; IN COMMERCE 10-15-2008.

CLASS 35—(Continued).

3,785,613. TOMMY R. HARDY, DULUTH, GA. SN 77-571,425.
PUB. 5-5-2009, FILED 9-16-2008.



OWNER OF U.S. REG. NO. 3,287,877.
THE COLOR(S) WHITE, GREEN, BLUE, AND ORANGE IS/ARE CLAIMED AS A FEATURE OF THE MARK.
THE MARK CONSISTS OF THE LETTER "V" CENTERED WITHIN THE OUTLINE OF A SPEECH BUBBLE, BOTH IN GREEN, WITH A WHITE BACKGROUND INSIDE THE BUBBLE, FOLLOWED BY THE LETTER "V" CENTERED WITHIN AN EYE, WITH THE OUTLINE AND CENTER OF THE EYE IN BLUE AND THE "V" APPEARING AS WHITE WITHIN THE BLUE SOLID OF THE EYE CENTER, WITH A WHITE BACKGROUND INSIDE THE EYE DESIGN, AND FOLLOWED BY THE LETTER "F" CENTERED WITHIN THE OUTLINE OF A SQUARE, BOTH IN ORANGE, WITH A WHITE BACKGROUND INSIDE THE SQUARE.

FOR ADVERTISING AND PUBLICITY SERVICES, NAMELY, PROMOTING THE GOODS, SERVICES, BRAND IDENTITY AND COMMERCIAL INFORMATION AND NEWS OF THIRD PARTIES THROUGH PRINT, AUDIO, VIDEO, DIGITAL AND ON-LINE MEDIUM; ADVERTISING SERVICES, NAMELY, CREATING CORPORATE AND BRAND IDENTITY FOR OTHERS; CONCEPT AND BRAND DEVELOPMENT IN THE AREA OF STRATEGIC BUSINESS AND CONSUMER INSIGHTS IN THE FIELD OF CONSUMER GOODS AND SERVICES; SERVICES RELATING TO THE ANALYSIS, EVALUATION, CREATION AND BRAND ESTABLISHMENT OF TRADEMARKS, TRADE NAMES AND DOMAIN NAMES (U.S. CLS. 100, 101 AND 102).
FIRST USE 8-8-2008; IN COMMERCE 10-2-2008.

3,785,614. CLIMATE CULTURE, LLC, NEW YORK, NY. SN 77-572,343. PUB. 10-20-2009, FILED 9-17-2008.



NO CLAIM IS MADE TO THE EXCLUSIVE RIGHT TO USE "AMERICA'S GREENEST CAMPUS", APART FROM THE MARK AS SHOWN.

THE COLOR(S) BLUE, DARK BLUE, LIGHT BLUE, LIGHT GREEN, GREEN IS/ARE CLAIMED AS A FEATURE OF THE MARK.

THE MARK CONSISTS OF A CIRCLE, WITH BACKGROUND SHADING OF LIGHT BLUE AND OUTLINED IN BLUE, LOCATED ON THE LEFT SIDE, WITH A DARK

CLASS 35—(Continued).

BLUE SHADED PICTURE OF A PERSON WITH THEIR LEFT ARM RAISED OVER THEIR HEAD HOLDING A FLORESCENT LIGHTBULB IN THE LEFT HAND INSIDE OF THE CIRCLE AND THE WORDS "AMERICA'S GREENEST CAMPUS" ON THE RIGHT SIDE, STACKED ON TOP OF EACH OTHER, WITH THE FOLLOWING COLORS ATTACHED TO THE WORDS: "AMERICA'S" IN BLUE, "GREENEST" IN LIGHT GREEN AND "CAMPUS" IN GREEN. THE WHITE BEHIND THE MARK IS BACKGROUND AREA WHICH IS NOT A PART OF THE MARK.
FOR PROMOTING THE INTERESTS OF PEOPLE CONCERNED WITH HEALTH, COMMUNITY AND ENVIRONMENTAL SUSTAINABILITY ISSUES (U.S. CLS. 100, 101 AND 102).

FIRST USE 10-1-2009; IN COMMERCE 10-1-2009.

3,785,620. JDHUNTR.COM, LOS ANGELES, CA. SN 77-575,728. PUB. 9-22-2009, FILED 9-22-2008.



NO CLAIM IS MADE TO THE EXCLUSIVE RIGHT TO USE "RESOURCES FOR THE LEGAL PROFESSIONAL" AND ".COM", APART FROM THE MARK AS SHOWN.

THE STIPPLING IS FOR SHADING PURPOSES ONLY.

THE MARK CONSISTS OF A BULLEYES WITH A HORIZONTAL AND VERTICAL LINE GOING THROUGH IT AND PLACED IN FRONT OF AND NEXT TO THE STYLIZED TEXT OF THE WORDING "JDHUNTR.COM RESOURCES FOR THE LEGAL PROFESSIONAL". THE ".COM" IS PLACED VERTICALLY ON TOP OF THE DOT AT THE END OF THE STYLIZED WORDING. THE HORIZONTAL LINE IN THE BULLSEYE RUNS BELOW THE WORDING "JDHUNTR.COM".

FOR PROVIDING AN ON-LINE SEARCHABLE DATABASE FEATURING CLASSIFIED AD LISTINGS AND EMPLOYMENT OPPORTUNITIES FOR LAW PROFESSIONALS (U.S. CLS. 100, 101 AND 102).

FIRST USE 3-2-2009; IN COMMERCE 3-2-2009.

3,785,633. THOMAS, LORRIE, SANTA BARBARA, CA. SN 77-587,978. PUB. 3-3-2009, FILED 10-8-2008.

Web Marketing Therapy

THE MARK CONSISTS OF STANDARD CHARACTERS WITHOUT CLAIM TO ANY PARTICULAR FONT, STYLE, SIZE, OR COLOR.

NO CLAIM IS MADE TO THE EXCLUSIVE RIGHT TO USE "WEB MARKETING", APART FROM THE MARK AS SHOWN.

FOR MARKETING CONSULTING; BUSINESS MARKETING CONSULTING SERVICES; BUSINESS MARKETING SERVICES; MARKET RESEARCH CONSULTATION (U.S. CLS. 100, 101 AND 102).

FIRST USE 3-15-2009; IN COMMERCE 3-15-2009.

CLASS 35—(Continued).

3,785,635. MCLANE COMPANY, INC., TEMPLE, TX. SN 77-588,550. PUB. 3-3-2009, FILED 10-8-2008.

FRESH ON THE GO

THE MARK CONSISTS OF STANDARD CHARACTERS WITHOUT CLAIM TO ANY PARTICULAR FONT, STYLE, SIZE, OR COLOR.

FOR DISTRIBUTORSHIP SERVICES IN THE FIELD OF FOOD, FOODSERVICE AND NON-FOOD GROCERY ITEMS; LOGISTICS MANAGEMENT IN THE FIELD OF FOOD, FOODSERVICE AND NON-FOOD GROCERY ITEMS; RETAIL SERVICES SUPPORT IN THE NATURE OF BUSINESS CONSULTATION AND ADVICE (U.S. CLS. 100, 101 AND 102).

FIRST USE 1-28-2009; IN COMMERCE 1-28-2009.

3,785,679. MICHIGAN ECONOMIC DEVELOPMENT CORPORATION, LANSING, MI. SN 77-614,401. PUB. 4-21-2009, FILED 11-14-2008.

GREEN JOBS FOR BLUE WATERS

THE MARK CONSISTS OF STANDARD CHARACTERS WITHOUT CLAIM TO ANY PARTICULAR FONT, STYLE, SIZE, OR COLOR.

NO CLAIM IS MADE TO THE EXCLUSIVE RIGHT TO USE "GREEN JOBS", APART FROM THE MARK AS SHOWN.

FOR PROMOTING ECONOMIC DEVELOPMENT IN THE STATE OF MICHIGAN (U.S. CLS. 100, 101 AND 102).

FIRST USE 4-22-2009; IN COMMERCE 4-22-2009.

3,785,699. T-MOBILE USA, INC., BELLEVUE, WA. SN 77-626,049. PUB. 5-5-2009, FILED 12-3-2008.

SHOT OF A LIFETIME

THE MARK CONSISTS OF STANDARD CHARACTERS WITHOUT CLAIM TO ANY PARTICULAR FONT, STYLE, SIZE, OR COLOR.

FOR ARRANGING AND CONDUCTING A PROMOTIONAL CONTEST FOR OTHERS HELD IN CONJUNCTION WITH PROFESSIONAL SPORTING EVENTS AND THEIR BROADCAST (U.S. CLS. 100, 101 AND 102).

FIRST USE 2-13-2009; IN COMMERCE 2-13-2009.

CLASS 35—(Continued).

3,785,701. MICHIGAN ECONOMIC DEVELOPMENT CORPORATION, LANSING, MI. SN 77-626,596. PUB. 4-21-2009, FILED 12-4-2008.



NO CLAIM IS MADE TO THE EXCLUSIVE RIGHT TO USE "GREEN JOBS" AND "INITIATIVE", APART FROM THE MARK AS SHOWN.

THE COLOR(S) GREEN, BLUE AND BLACK IS/ARE CLAIMED AS A FEATURE OF THE MARK.

THE MARK CONSISTS OF THE WORDS "GREEN JOBS FOR BLUE WATERS INITIATIVE" IN BLACK SURROUNDED BY A GREEN AND BLUE ARROW THAT FORMS AN OVAL.

FOR PROMOTING ECONOMIC DEVELOPMENT IN THE STATE OF MICHIGAN (U.S. CLS. 100, 101 AND 102).

FIRST USE 4-22-2009; IN COMMERCE 4-22-2009.

3,785,705. RECREATIONAL EQUIPMENT, INC., SUMNER, WA. SN 77-628,973. PUB. 4-7-2009, FILED 12-8-2008.

**LOVING THE OUTDOORS.
SHARING THE LOVE.**

THE MARK CONSISTS OF STANDARD CHARACTERS WITHOUT CLAIM TO ANY PARTICULAR FONT, STYLE, SIZE, OR COLOR.

FOR RETAIL STORE SERVICES, MAIL ORDER RETAIL SERVICES, AND ON-LINE RETAIL STORE SERVICES, ALL FOR OUTDOOR, SPORTING, FITNESS AND TRAVEL EQUIPMENT, CLOTHING, FOOTWEAR, ACCESSORIES, ELECTRONICS AND PUBLICATIONS (U.S. CLS. 100, 101 AND 102).

FIRST USE 10-0-2009; IN COMMERCE 10-0-2009.

3,785,716. AMERICAN EXPRESS MARKETING & DEVELOPMENT CORP., NEW YORK, NY. SN 77-630,410. PUB. 7-14-2009, FILED 12-10-2008.

EVERYDAY ENTERTAINMENT

THE MARK CONSISTS OF STANDARD CHARACTERS WITHOUT CLAIM TO ANY PARTICULAR FONT, STYLE, SIZE, OR COLOR.

CLASS 35—(Continued).

NO CLAIM IS MADE TO THE EXCLUSIVE RIGHT TO USE "ENTERTAINMENT", APART FROM THE MARK AS SHOWN.

FOR PROMOTING THE USE OF CHARGE CARD AND CREDIT CARD ACCOUNTS THROUGH THE ADMINISTRATION OF INCENTIVE AWARD PROGRAMS IN ORDER TO ATTRACT MORE BUSINESS TO MERCHANTS (U.S. CLS. 100, 101 AND 102).

FIRST USE 1-0-2009; IN COMMERCE 1-0-2009.

CLASS 35—(Continued).

3,785,719. AMERICAN EXPRESS MARKETING & DEVELOPMENT CORP., NEW YORK, NY. SN 77-630,485. PUB. 7-14-2009, FILED 12-10-2008.

PUT IT ON THE CARD

THE MARK CONSISTS OF STANDARD CHARACTERS WITHOUT CLAIM TO ANY PARTICULAR FONT, STYLE, SIZE, OR COLOR.

NO CLAIM IS MADE TO THE EXCLUSIVE RIGHT TO USE "CARD", APART FROM THE MARK AS SHOWN.

FOR PROMOTING THE USE OF CHARGE CARD AND CREDIT CARD ACCOUNTS THROUGH THE ADMINISTRATION OF INCENTIVE AWARD PROGRAMS IN ORDER TO ATTRACT MORE BUSINESS TO MERCHANTS (U.S. CLS. 100, 101 AND 102).

FIRST USE 1-0-2009; IN COMMERCE 1-0-2009.

3,785,717. AMERICAN EXPRESS MARKETING & DEVELOPMENT CORP., NEW YORK, NY. SN 77-630,471. PUB. 7-14-2009, FILED 12-10-2008.

FAMILY FUN AND GAMES

THE MARK CONSISTS OF STANDARD CHARACTERS WITHOUT CLAIM TO ANY PARTICULAR FONT, STYLE, SIZE, OR COLOR.

FOR PROMOTING THE USE OF CHARGE CARD AND CREDIT CARD ACCOUNTS THROUGH THE ADMINISTRATION OF INCENTIVE AWARD PROGRAMS IN ORDER TO ATTRACT MORE BUSINESS TO MERCHANTS (U.S. CLS. 100, 101 AND 102).

FIRST USE 1-0-2009; IN COMMERCE 1-0-2009.

3,785,748. MOTORSPORTS MANAGEMENT, INC., DBA MOTORSPORTS SOLUTIONS, FT. MYERS, FL. SN 77-643,934. PUB. 4-28-2009, FILED 1-6-2009.

WORK HARD RIDE HARD

THE MARK CONSISTS OF STANDARD CHARACTERS WITHOUT CLAIM TO ANY PARTICULAR FONT, STYLE, SIZE, OR COLOR.

FOR WHOLESALE AND RETAIL DISTRIBUTORSHIP SERVICES IN THE FIELD OF MOTORCYCLES; BUSINESS CONSULTING SERVICES IN THE FIELD OF MOTORCYCLES (U.S. CLS. 100, 101 AND 102).

FIRST USE 8-19-2009; IN COMMERCE 8-19-2009.

3,785,718. AMERICAN EXPRESS MARKETING & DEVELOPMENT CORP., NEW YORK, NY. SN 77-630,479. PUB. 7-14-2009, FILED 12-10-2008.

3,785,757. ARIS HORTICULTURE, INC., BARBERTON, OH. SN 77-647,460. PUB. 10-20-2009, FILED 1-12-2009.

HOME IS WHERE THE SPEND IS

THE MARK CONSISTS OF STANDARD CHARACTERS WITHOUT CLAIM TO ANY PARTICULAR FONT, STYLE, SIZE, OR COLOR.

NO CLAIM IS MADE TO THE EXCLUSIVE RIGHT TO USE "SPEND", APART FROM THE MARK AS SHOWN.

FOR PROMOTING THE USE OF CHARGE CARD AND CREDIT CARD ACCOUNTS THROUGH THE ADMINISTRATION OF INCENTIVE AWARD PROGRAMS IN ORDER TO ATTRACT MORE BUSINESS TO MERCHANTS (U.S. CLS. 100, 101 AND 102).

FIRST USE 1-0-2009; IN COMMERCE 1-0-2009.

ARIS HORTICULTURAL SERVICES

THE MARK CONSISTS OF STANDARD CHARACTERS WITHOUT CLAIM TO ANY PARTICULAR FONT, STYLE, SIZE, OR COLOR.

NO CLAIM IS MADE TO THE EXCLUSIVE RIGHT TO USE "HORTICULTURAL SERVICES", APART FROM THE MARK AS SHOWN.

FOR SALES PROMOTION SERVICES FOR THIRD PARTIES IN THE FIELD OF HORTICULTURE (U.S. CLS. 100, 101 AND 102).

FIRST USE 4-1-2009; IN COMMERCE 4-1-2009.

CLASS 35—(Continued).

3,785,784. OMAHA STEAKS INTERNATIONAL, INC., OMAHA, NE. SN 77-656,295. PUB. 5-12-2009, FILED 1-26-2009.

GIVE. SAVOR. CELEBRATE.

THE MARK CONSISTS OF STANDARD CHARACTERS WITHOUT CLAIM TO ANY PARTICULAR FONT, STYLE, SIZE, OR COLOR.

FOR MAIL ORDER SERVICES FEATURING FOOD AND FOOD RELATED GOODS; ON-LINE RETAIL STORE SERVICES FEATURING FOOD AND FOOD RELATED GOODS; RETAIL STORE SERVICES FEATURING FOOD AND FOOD RELATED GOODS (U.S. CLS. 100, 101 AND 102).

FIRST USE 3-31-2009; IN COMMERCE 3-31-2009.

3,785,790. OAKLIEF, PAT, CHICAGO, IL. SN 77-657,476. PUB. 6-9-2009, FILED 1-27-2009.

AMIGRAM

THE MARK CONSISTS OF STANDARD CHARACTERS WITHOUT CLAIM TO ANY PARTICULAR FONT, STYLE, SIZE, OR COLOR.

FOR PROVIDING AN ON-LINE DIRECTORY INFORMATION SERVICE FEATURING INFORMATION REGARDING AND IN THE NATURE OF FAMILY LIFE, GENERAL INTEREST, CLASSIFIEDS, VIRTUAL COMMUNITY, SOCIAL NETWORKING, PHOTO SHARING, AND TRANSMISSION OF PHOTOGRAPHIC IMAGES; PROMOTING THE GOODS AND SERVICES OF OTHERS OVER THE INTERNET; PROVIDING ON-LINE COMPUTER DATABASES AND ON-LINE SEARCHABLE DATABASES IN THE FIELD OF CLASSIFIED AD LISTINGS (U.S. CLS. 100, 101 AND 102).

FIRST USE 9-30-2009; IN COMMERCE 9-30-2009.

3,785,800. ENERGY CORPORATION, NEW ORLEANS, LA. SN 77-659,355. PUB. 6-2-2009, FILED 1-29-2009.

ENERGY ANSWERS

THE MARK CONSISTS OF STANDARD CHARACTERS WITHOUT CLAIM TO ANY PARTICULAR FONT, STYLE, SIZE, OR COLOR.

CLASS 35—(Continued).

OWNER OF U.S. REG. NOS. 2,387,356, 3,287,484, AND 3,289,605.

FOR EDUCATIONAL SERVICES, NAMELY, PROVIDING ON-LINE INFORMATION IN THE FIELD OF ENERGY CONSERVATION, ENERGY USAGE, AND ENERGY EFFICIENCY (U.S. CLS. 100, 101 AND 102).

FIRST USE 7-13-2009; IN COMMERCE 7-13-2009.

3,785,814. WORLD MARKET CENTER VENTURE, LLC, LAS VEGAS, NV. SN 77-660,551. PUB. 6-30-2009, FILED 1-30-2009.



OWNER OF U.S. REG. NOS. 3,435,484 AND 3,435,486. NO CLAIM IS MADE TO THE EXCLUSIVE RIGHT TO USE "DESIGN", APART FROM THE MARK AS SHOWN.

THE MARK CONSISTS OF THE STYLIZED WORDS "DESIGN SALON" OVER THE LETTERS "LVDC".

FOR ARRANGING, ORGANIZING, PROMOTING AND CONDUCTING TRADE EXHIBITIONS, TRADE CONVENTIONS, TRADE SHOWS AND TRADE FAIRS IN THE FIELDS OF HOME, OFFICE AND HOSPITALITY FURNISHINGS; ADVERTISING AND MARKETING OF TRADE SHOWROOMS AND RELATED SHOWROOM FACILITIES AND SERVICES TO MANUFACTURERS OF GOODS IN THE FIELDS OF HOME, OFFICE AND HOSPITALITY FURNISHINGS; ADVERTISING AND MARKETING OF TRADE SHOWROOMS FOR DISPLAY AND EXHIBITION OF GOODS OF MANUFACTURERS IN THE FIELDS OF HOME, OFFICE AND HOSPITALITY FURNISHINGS TO RETAILERS OF HOME, OFFICE AND HOSPITALITY FURNISHINGS; RETAIL STORE SERVICES FEATURING A WIDE VARIETY OF CONSUMER GOODS OF OTHERS (U.S. CLS. 100, 101 AND 102).

FIRST USE 12-9-2009; IN COMMERCE 12-9-2009.

3,785,835. T & G CREW LLC, NEW YORK, NY. SN 77-663,110. PUB. 6-9-2009, FILED 2-4-2009.

STYLO NY

THE MARK CONSISTS OF STANDARD CHARACTERS WITHOUT CLAIM TO ANY PARTICULAR FONT, STYLE, SIZE, OR COLOR.

NO CLAIM IS MADE TO THE EXCLUSIVE RIGHT TO USE "NY", APART FROM THE MARK AS SHOWN.

FOR PROVIDING A WEBSITE TO ASSIST CLIENTS IN FINDING AND LOCATING HAIR DRESSERS AND COSMETOLOGISTS AND IN SCHEDULING HAIRDRESSING AND COSMETOLOGY APPOINTMENTS (U.S. CLS. 100, 101 AND 102).

FIRST USE 6-1-2009; IN COMMERCE 6-1-2009.

CLASS 35—(Continued).

3,785,851. LOCKMAN, KIA, MIDDLETOWN, DE. AND CONNALLY, SEAN B., MIDDLETOWN, DE. SN 77-665,923. PUB. 6-9-2009, FILED 2-9-2009.

CLASS 35—(Continued).

3,785,891. 4-C ECONOMIC DEVELOPMENT AUTHORITY, BECKLEY, WV. SN 77-672,471. PUB. 6-9-2009, FILED 2-18-2009.

LOC-CON

FOLLOW THE RIVER...

THE MARK CONSISTS OF STANDARD CHARACTERS WITHOUT CLAIM TO ANY PARTICULAR FONT, STYLE, SIZE, OR COLOR.

FOR BUSINESS MANAGEMENT (U.S. CLS. 100, 101 AND 102).

FIRST USE 1-20-2010; IN COMMERCE 1-20-2010.

THE MARK CONSISTS OF STANDARD CHARACTERS WITHOUT CLAIM TO ANY PARTICULAR FONT, STYLE, SIZE, OR COLOR.

FOR PROMOTING RECREATION AND TOURISM IN THE NEW RIVER GORGE AREA OF WEST VIRGINIA (U.S. CLS. 100, 101 AND 102).

FIRST USE 2-5-2010; IN COMMERCE 2-5-2010.

3,785,861. COLLEGE OF DIPLOMATES OF THE AMERICAN BOARD OF ORTHODONTICS, INC., ST. CHARLES, MO. SN 77-667,252. PUB. 6-9-2009, FILED 2-10-2009.

3,785,898. WATKIN OPTICAL ON-LINE, LLC, HENDERSON, NV. SN 77-674,874. PUB. 6-23-2009, FILED 2-20-2009.

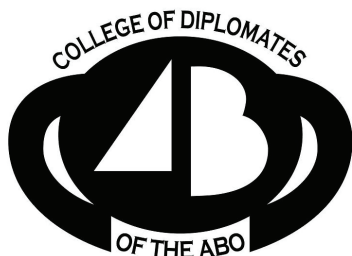

Yogurt Rocks

OWNER OF U.S. REG. NOS. 2,544,369 AND 2,775,388.

NO CLAIM IS MADE TO THE EXCLUSIVE RIGHT TO USE "COLLEGE OF DIPLOMATES", APART FROM THE MARK AS SHOWN.

THE MARK CONSISTS OF THE WORDING "COLLEGE OF DIPLOMATES OF THE ABO" AND THE HIGHLY STYLIZED LETTERS "CDABO".

FOR ASSOCIATION SERVICES, NAMELY, PROMOTING THE INTERESTS OF MEMBERS IN THE FIELD OF ORTHODONTICS (U.S. CLS. 100, 101 AND 102).

FIRST USE 6-1-2009; IN COMMERCE 6-1-2009.

THE MARK CONSISTS OF STANDARD CHARACTERS WITHOUT CLAIM TO ANY PARTICULAR FONT, STYLE, SIZE, OR COLOR.

NO CLAIM IS MADE TO THE EXCLUSIVE RIGHT TO USE "YOGURT", APART FROM THE MARK AS SHOWN.

FOR RETAIL STORES FEATURING SELF SERVE FROZEN YOGURT, FROZEN YOGURT TOPPINGS, FROZEN BEVERAGES, PACKAGED AND FRESH CHOCOLATE (U.S. CLS. 100, 101 AND 102).

FIRST USE 11-19-2009; IN COMMERCE 11-19-2009.

CLASS 35—(Continued).

3,785,911. EDDIE BAUER LICENSING SERVICES LLC, BELLEVUE, WA. SN 77-677,804. PUB. 6-16-2009, FILED 2-25-2009.

BORN OUT THERE

THE MARK CONSISTS OF STANDARD CHARACTERS WITHOUT CLAIM TO ANY PARTICULAR FONT, STYLE, SIZE, OR COLOR.

FOR CATALOG ORDERING SERVICE FEATURING CLOTHING, BACKPACKS, OUTERWEAR, GLOVES, SUNGLASSES, SLIPPERS, PAJAMAS, BAGS, CAMERA BAGS, LUGGAGE, TRAVEL ITEMS, PET PRODUCTS, OUTDOOR GEAR, BEDDING, PILLOWS, COMFORTERS, BLANKETS, SHOES, HATS, SCARVES, JEWELRY, WATCHES, UMBRELLAS, FLASHLIGHTS, MULTITools, CAMPING EQUIPMENT, CLIMBING EQUIPMENT, PICNIC COOLERS, WATER BOTTLES, FIRST AID KITS AND SURVIVAL KITS; RETAIL STORE AND ON-LINE RETAIL STORE SERVICES FEATURING CLOTHING, BACKPACKS, OUTERWEAR, GLOVES, SUNGLASSES, SLIPPERS, PAJAMAS, BAGS, CAMERA BAGS, LUGGAGE, TRAVEL ITEMS, PET PRODUCTS, OUTDOOR GEAR, BEDDING, PILLOWS, COMFORTERS, BLANKETS, SHOES, HATS, SCARVES, JEWELRY, WATCHES, UMBRELLAS, FLASHLIGHTS, MULTITools, CAMPING EQUIPMENT, CLIMBING EQUIPMENT, PICNIC COOLERS, WATER BOTTLES, FIRST AID KITS AND SURVIVAL KITS (U.S. CLS. 100, 101 AND 102).

FIRST USE 2-24-2010; IN COMMERCE 2-24-2010.

3,785,918. HOLY MEASURES, LLC, CHICAGO, IL. SN 77-679,242. PUB. 9-1-2009, FILED 2-26-2009.

HOLY MEASURES

THE MARK CONSISTS OF STANDARD CHARACTERS WITHOUT CLAIM TO ANY PARTICULAR FONT, STYLE, SIZE, OR COLOR.

FOR PROMOTING AND CONDUCTING THE SALE FOR OTHERS OF DOWNLOADABLE DIGITAL SHEET MUSIC BY PROVIDING A WEB SITE AT WHICH COMPOSERS CAN OFFER DIGITAL SHEET MUSIC FOR SALE TO THE GENERAL PUBLIC (U.S. CLS. 100, 101 AND 102).

FIRST USE 9-1-2008; IN COMMERCE 10-27-2009.

CLASS 35—(Continued).

3,785,922. VOX MEDICA, INC., PHILADELPHIA, PA. SN 77-679,606. PUB. 7-7-2009, FILED 2-27-2009.

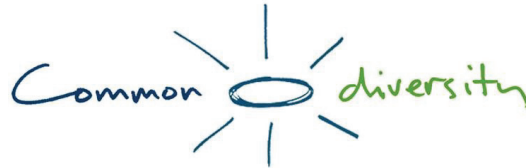

THE COLOR(S) BLUE AND GREEN IS/ARE CLAIMED AS A FEATURE OF THE MARK.

THE MARK CONSISTS OF THE TERM "COMMON" IN BLUE FONT, AND THE TERM "DIVERSITY" IN GREEN FONT, ARE BISECTED BY A BLUE CIRCULAR OBJECT WITH THREE RADIATING LINES ON EACH OF TOP AND BOTTOM GIVING THE IMPRESSION OF THE SUN.

FOR ADVERTISING SERVICES, NAMELY, CREATING CORPORATE LOGOS AND CORPORATE AND BRAND IDENTITY FOR OTHERS; MARKET RESEARCH SERVICES; CONDUCTING MARKETING STUDIES AND MARKETING SURVEYS FOR OTHERS; BUSINESS MARKETING CONSULTING SERVICES; CONDUCTING FOCUS GROUP MARKET STUDIES; DATA PROCESSING SERVICES, NAMELY, DATA COLLECTION, DATA INTERPRETATION AND DATA ANALYSIS SERVICES IN THE FIELD OF MARKETING; STRATEGIC BUSINESS PLANNING; BUSINESS MARKETING INFORMATION INTEGRATION SERVICES; AND PREPARING AUDIO-VISUAL, ELECTRONIC AND PRINT MATERIALS AND PRESENTATIONS FOR USE IN ADVERTISING (U.S. CLS. 100, 101 AND 102).

FIRST USE 6-27-2008; IN COMMERCE 6-27-2008.

3,785,969. NATIONAL ASSOCIATION OF SCHOOL NURSES, INCORPORATED, SILVER SPRINGS, MD. SN 77-693,957. PUB. 7-21-2009, FILED 3-18-2009.

VOICES OF MENINGITIS

THE MARK CONSISTS OF STANDARD CHARACTERS WITHOUT CLAIM TO ANY PARTICULAR FONT, STYLE, SIZE, OR COLOR.

NO CLAIM IS MADE TO THE EXCLUSIVE RIGHT TO USE "MENINGITIS", APART FROM THE MARK AS SHOWN.

FOR PROMOTING PUBLIC AWARENESS OF THE PUBLIC, INCLUDING HEALTH CARE PROFESSIONALS, AS TO THE FACTS, RISKS AND SERIOUSNESS OF MENINGOCOCCAL DISEASE, ESPECIALLY AMONG PRETEENS AND TEENS, AND THE IMPORTANCE OF IMMUNIZATION AND OTHER PREVENTATIVE MEASURES (U.S. CLS. 100, 101 AND 102).

FIRST USE 8-24-2009; IN COMMERCE 8-24-2009.

CLASS 35—(Continued).

3,785,975. FASHION SEAL CORPORATION, LAS VEGAS, NV. SN 77-695,671. PUB. 7-21-2009, FILED 3-20-2009.

Growing a Responsible, Educated, and Engaged Network

THE MARK CONSISTS OF STANDARD CHARACTERS WITHOUT CLAIM TO ANY PARTICULAR FONT, STYLE, SIZE, OR COLOR.

FOR ADVERTISING SERVICES RELATED TO IN-HOUSE ENVIRONMENTAL PROGRAM (U.S. CLS. 100, 101 AND 102).

FIRST USE 6-0-2009; IN COMMERCE 6-0-2009.

3,785,997. XS MEDICAL SUPPLY, INC., DAYTONA BEACH, FL. SN 77-704,961. PUB. 11-10-2009, FILED 4-2-2009.

xsmedicalsupply

THE MARK CONSISTS OF STANDARD CHARACTERS WITHOUT CLAIM TO ANY PARTICULAR FONT, STYLE, SIZE, OR COLOR.

FOR ONLINE STORE SERVICES FEATURING WHOLESALE MEDICAL AND SURGICAL EQUIPMENT AND PRODUCTS OF OTHERS (U.S. CLS. 100, 101 AND 102).

FIRST USE 7-10-2009; IN COMMERCE 8-17-2009.

3,786,067. I MEDIAREACH, LLC, WINTER SPRINGS, FL. SN 77-740,850. PUB. 9-29-2009, FILED 5-20-2009.

IMEDIAREACH

THE MARK CONSISTS OF STANDARD CHARACTERS WITHOUT CLAIM TO ANY PARTICULAR FONT, STYLE, SIZE, OR COLOR.

FOR MARKETING AND ADVERTISING SERVICES FOR OTHERS, NAMELY, DISSEMINATION OF ADVERTISEMENTS VIA WIRELESS COMMUNICATION NETWORKS AND OTHER TRADITIONAL MEDIA CHANNELS (U.S. CLS. 100, 101 AND 102).

FIRST USE 3-10-2009; IN COMMERCE 8-13-2009.

CLASS 35—(Continued).

3,786,071. YOUR MARKETING DEPT., INC., LINCOLN, NE. SN 77-743,926. PUB. 9-15-2009, FILED 5-25-2009.

Marketing Express

THE MARK CONSISTS OF STANDARD CHARACTERS WITHOUT CLAIM TO ANY PARTICULAR FONT, STYLE, SIZE, OR COLOR.

NO CLAIM IS MADE TO THE EXCLUSIVE RIGHT TO USE "MARKETING", APART FROM THE MARK AS SHOWN.

FOR ADVERTISING AND MARKETING SERVICES, NAMELY, PROMOTING THE GOODS AND SERVICES OF OTHERS; ADVERTISING SERVICES, NAMELY, CREATING CORPORATE AND BRAND IDENTITY FOR OTHERS; ADVERTISING SERVICES, NAMELY, CREATING CORPORATE LOGOS FOR OTHERS; ADVERTISING SERVICES, PUBLIC RELATIONS AND MARKETING SERVICES, NAMELY, PROMOTING AND MARKETING THE GOODS AND SERVICES OF OTHERS THROUGH ALL PUBLIC COMMUNICATION MEANS; DESIGN OF ADVERTISING FLYERS FOR OTHERS; DESIGN OF ADVERTISING MATERIALS FOR OTHERS; FRANCHISING, NAMELY, OFFERING TECHNICAL ASSISTANCE IN THE ESTABLISHMENT AND/OR OPERATION OF A BUSINESS THAT OFFERS ADVERTISING, MARKETING AND PROMOTIONAL PRODUCTS AND SERVICES TO THE SMALL BUSINESS COMMUNITY; RETAIL STORE SERVICES FEATURING ADVERTISING, MARKETING AND PROMOTIONAL PRODUCTS (U.S. CLS. 100, 101 AND 102).

FIRST USE 11-1-2009; IN COMMERCE 11-1-2009.

3,786,075. YBRAVO.COM, LLC, LIVERMORE, CA. SN 77-744,831. PUB. 10-6-2009, FILED 5-26-2009.

SIMPLY PROFESSIONAL

THE MARK CONSISTS OF STANDARD CHARACTERS WITHOUT CLAIM TO ANY PARTICULAR FONT, STYLE, SIZE, OR COLOR.

FOR ON-LINE RETAIL STORE SERVICES FEATURING OUTDOOR POWER EQUIPMENT (U.S. CLS. 100, 101 AND 102).

FIRST USE 6-26-2009; IN COMMERCE 6-26-2009.

CLASS 35—(Continued).

3,786,084. WILLIAM ABRAMS, EAST LANSING, MI. SN 77-749,145. PUB. 7-28-2009, FILED 6-1-2009.

VIRTUAL SPORTS GROUP

THE MARK CONSISTS OF STANDARD CHARACTERS WITHOUT CLAIM TO ANY PARTICULAR FONT, STYLE, SIZE, OR COLOR.

NO CLAIM IS MADE TO THE EXCLUSIVE RIGHT TO USE "SPORTS GROUP", APART FROM THE MARK AS SHOWN.

FOR PROFESSIONAL SERVICES FOR PROCURING CONTRACTS FOR SPORTS PERSONNEL, NAMELY, ATHLETES, COACHES AND SPORTSCASTERS (U.S. CLS. 100, 101 AND 102).

FIRST USE 3-3-2009; IN COMMERCE 3-3-2009.

3,786,103. HALLUM, INC, DBA HALLUM STORES, FLAG-STAFF, AZ. SN 77-755,670. PUB. 10-27-2009, FILED 6-9-2009.

SWIFT TRAVEL CENTERS

THE MARK CONSISTS OF STANDARD CHARACTERS WITHOUT CLAIM TO ANY PARTICULAR FONT, STYLE, SIZE, OR COLOR.

NO CLAIM IS MADE TO THE EXCLUSIVE RIGHT TO USE "TRAVEL CENTERS", APART FROM THE MARK AS SHOWN.

FOR RETAIL STORE SERVICES FEATURING CONVENIENCE STORE ITEMS AND GASOLINE (U.S. CLS. 100, 101 AND 102).

FIRST USE 2-1-2010; IN COMMERCE 2-1-2010.

3,786,109. MODVELOP PARTNERS, AUSTIN, TX. SN 77-757,356. PUB. 11-3-2009, FILED 6-11-2009.

BIDMODO

THE MARK CONSISTS OF STANDARD CHARACTERS WITHOUT CLAIM TO ANY PARTICULAR FONT, STYLE, SIZE, OR COLOR.

FOR PROVIDING A WEB SITE WHEREBY BUYERS OF GOODS OR SERVICES LOCATE AND RECEIVE QUOTATIONS FROM MULTIPLE COMPETITIVE SOURCES AND SELLERS OF GOODS OR SERVICES IDENTIFY AND BID ON MULTIPLE NEW SALES OPPORTUNITIES (U.S. CLS. 100, 101 AND 102).

FIRST USE 11-19-2009; IN COMMERCE 11-19-2009.

CLASS 35—(Continued).

3,786,126. I MEDIAREACH, LLC, WINTER SPRINGS, FL. SN 77-761,639. PUB. 10-6-2009, FILED 6-17-2009.



NO CLAIM IS MADE TO THE EXCLUSIVE RIGHT TO USE "MOBILE MARKETS", APART FROM THE MARK AS SHOWN.

THE MARK CONSISTS OF THE WORDS "IMEDIAREACH REACHING MOBILE MARKETS", WITH THE DESIGN OF A BALL DOTTING THE FIRST LETTER "I" AND TWO ARCHED, STREAMING LINES EXTENDING FROM THE BALL ENDING AT A DESIGN OF A STYLIZED STICK FIGURE.

FOR MARKETING AND ADVERTISING SERVICES FOR OTHERS, NAMELY, DISSEMINATION OF ADVERTISEMENTS VIA WIRELESS COMMUNICATION NETWORKS AND OTHER TRADITIONAL MEDIA CHANNELS (U.S. CLS. 100, 101 AND 102).

FIRST USE 5-7-2009; IN COMMERCE 8-13-2009.

3,786,188. EXCHANGE SOLUTIONS, INC., WALTHAM, MA. SN 77-979,003. PUB. 11-4-2008, FILED 6-8-2008.

GiveGet

THE MARK CONSISTS OF STANDARD CHARACTERS WITHOUT CLAIM TO ANY PARTICULAR FONT, STYLE, SIZE, OR COLOR.

FOR ADMINISTRATION, BILLING AND RECONCILIATION OF ACCOUNTS ON BEHALF OF OTHERS; ADVERTISING AND MARKETING; ADVERTISING AND PROMOTIONAL SERVICES; ADVERTISING, MARKETING AND PROMOTION SERVICES; AN INTERACTIVE WEB SITE FOR USERS TO REVIEW AND RATE INTERNET CONTENT, PEOPLE, COMPANIES, PRODUCTS AND/OR SERVICES UTILIZING A SOFTWARE APPLICATION TO AWARD POINTS WHEREBY WEB SITE USERS ARE ELIGIBLE TO EXCHANGE POINTS EARNED FOR PROMOTIONAL ITEMS CONSISTING; OF COUPONS, REBATES, DISCOUNTS OR SPECIAL OFFERINGS ON GOODS AND/OR SERVICE PROVIDED BY WEB SITE SPONSORS; ARRANGING OF CONTRACTUAL SERVICES WITH THIRD PARTIES; BOOKKEEPING; BOOKKEEPING FOR ELECTRONIC FUNDS TRANSFER; BUSINESS ADMINISTRATION AND OFFICE WORK; BUSINESS ADVICE AND INFORMATION; BUSINESS CONSULTING AND BUSINESS INFORMATION FOR ENTERPRISES; BUSINESS INFORMATION AND INQUIRIES; BUSINESS INFORMATION MANAGEMENT; BUSINESS MANAGEMENT; BUSINESS RECORDS MANAGEMENT; BUSINESS RESEARCH; BUSINESS SERVICES, NAMELY, PROVIDING COMPUTER DATABASES REGARDING THE PURCHASE AND SALE OF A WIDE VARIETY OF PRODUCTS AND SERVICES OF OTHERS; COMMERCIAL ADMINISTRATION OF THE LICENSING OF THE GOODS AND SERVICES OF OTHERS; COMPARISON SHOPPING SERVICES; COMPUTERIZED ON-LINE ORDERING FEATURING GENERAL MERCHANDISE AND GENERAL CONSUMER GOODS; CONSUMER LOYALTY SERVICES FOR COMMERCIAL, PROMOTIONAL, AND/OR ADVERTISING PURPOSES, NAMELY, ADMINISTRATION

CLASS 35—(Continued).

OF FREQUENT FLYER PROGRAM THAT ALLOWS MEMBERS TO REDEEM MILES FOR POINTS OR AWARDS OFFERED BY OTHER LOYALTY PROGRAMS; CUSTOMER LOYALTY SERVICES AND CUSTOMER CLUB SERVICES, FOR COMMERCIAL, PROMOTIONAL AND/OR ADVERTISING PURPOSES; CUSTOMER RELATIONSHIP MANAGEMENT; DATABASE MANAGEMENT; ELECTRONIC COMMERCE SERVICES, NAMELY, PROVIDING INFORMATION ABOUT PRODUCTS VIA TELECOMMUNICATION NETWORKS FOR ADVERTISING AND SALES PURPOSES; EXCHANGE SERVICES, NAMELY, BARTERING OF GOODS FOR OTHERS; FINANCIAL RECORDS MANAGEMENT; GENERAL INFORMATION CLEARING HOUSE; GOODS OR SERVICES PRICE QUOTATIONS; INVOICING; MANAGEMENT OF CUSTOMER APPRECIATION PROGRAMS OF OTHERS; MARKET RESEARCH; NEGOTIATION AND CONCLUSION OF COMMERCIAL TRANSACTIONS FOR THIRD PARTIES VIA TELECOMMUNICATION SYSTEMS; NEGOTIATION AND SETTLEMENT OF COMMERCIAL TRANSACTIONS FOR THIRD PARTIES; ON-LINE ADVERTISING AND MARKETING SERVICES; ON-LINE ADVERTISING ON COMPUTER COMMUNICATION NETWORKS; OPERATING ON-LINE MARKETPLACES FOR SELLERS OF GOODS AND/OR SERVICES; PROMOTING THE GOODS AND SERVICES OF OTHERS BY MEANS OF OPERATING AN ON-LINE SHOPPING MALL WITH LINKS TO THE RETAIL WEB SITES OF OTHERS; PROMOTING THE GOODS AND SERVICES OF OTHERS THROUGH ON-LINE ORDERING AND CATALOGING OF THOSE GOODS AND SERVICES; PROMOTING THE GOODS AND SERVICES OF OTHERS VIA A GLOBAL COMPUTER NETWORK; PROMOTING THE SALE OF CREDIT CARD ACCOUNTS THROUGH THE ADMINISTRATION OF INCENTIVE AWARD PROGRAMS; PROVIDING A WEB SITE AT WHICH USERS CAN OFFER GOODS FOR SALE AND BUY GOODS OFFERED BY OTHERS; PROVIDING A WEB SITE WHERE USERS CAN POST RATINGS, REVIEWS AND RECOMMENDATIONS ON PRODUCTS AND SERVICES; PROVIDING A WEB SITE WHICH FEATURES ADVERTISEMENTS FOR THE GOODS AND SERVICES OF OTHERS ON A GLOBAL COMPUTER NETWORK; PROVIDING AN ON-LINE COMPUTER DATABASE IN THE FIELD OF LOCATING PRODUCTS, DESCRIBING PRODUCTS, RATING PRODUCTS, PRICING PRODUCTS AND COMPARING PRICES OF PRODUCTS; PROVIDING AN ON-LINE COMPUTER WEB SITE THAT PROVIDES COMMERCIAL FINANCIAL TRANSACTION DATA, ACCOUNT MANAGEMENT, FINANCIAL REPORTING, ACCOUNTING FEATURES AND RELATED REFERENCE INFORMATION; PROVIDING CONSUMER PRODUCT INFORMATION VIA THE INTERNET; PROVISION OF A WEB SITE FEATURING INFORMATION ON SHOPPING (U.S. CLS. 100, 101 AND 102).

FIRST USE 7-24-2007; IN COMMERCE 7-24-2007.

3,786,298. CLEVER DEVICES LTD., PLAINVIEW, NY. SN 78-881,406. PUB. 12-19-2006, FILED 5-11-2006.

CLEVER DEVICES

THE MARK CONSISTS OF STANDARD CHARACTERS WITHOUT CLAIM TO ANY PARTICULAR FONT, STYLE, SIZE, OR COLOR.

CLASS 35—(Continued).

NO CLAIM IS MADE TO THE EXCLUSIVE RIGHT TO USE "DEVICES", APART FROM THE MARK AS SHOWN.

FOR BUSINESS CONSULTATION SERVICES IN THE FIELD OF MASS TRANSIT SYSTEMS TO IMPROVE SECURITY, SAFETY AND SERVICE, REDUCE OPERATIONAL COSTS, MAXIMIZE PRODUCTIVITY, INCREASE RIDERSHIP AND ACCESSIBILITY (U.S. CLS. 100, 101 AND 102).

FIRST USE 0-0-1997; IN COMMERCE 0-0-1997.

3,786,342. MEDICAL PROTECTIVE COMPANY, THE, FORT WAYNE, IN. SN 78-981,218. PUB. 10-23-2007, FILED 12-30-2005.



NO CLAIM IS MADE TO THE EXCLUSIVE RIGHT TO USE "MEDICAL" AND "SINCE 1899", APART FROM THE MARK AS SHOWN.

FOR INSURANCE OPERATIONS SERVICES, NAMELY, INSURANCE MARKETING CONSULTATION AND INSURANCE ACCOUNTING SERVICES (U.S. CLS. 100, 101 AND 102).

FIRST USE 0-0-2005; IN COMMERCE 0-0-2005.

CLASS 36—INSURANCE AND FINANCIAL

3,785,065. OPEN FIELD CAPITAL LLC, NEW YORK, NY. SN 76-645,492. PUB. 12-12-2006, FILED 8-24-2005.

OPEN FIELD CAPITAL

THE MARK CONSISTS OF STANDARD CHARACTERS WITHOUT CLAIM TO ANY PARTICULAR FONT, STYLE, SIZE, OR COLOR.

NO CLAIM IS MADE TO THE EXCLUSIVE RIGHT TO USE "CAPITAL", APART FROM THE MARK AS SHOWN.

FOR INVESTMENT ADVISORY SERVICES; VENTURE CAPITAL SERVICES, NAMELY, BUYING AND SELLING OF SECURITIES IN EMERGING COMPANIES (U.S. CLS. 100, 101 AND 102).

FIRST USE 11-1-2005; IN COMMERCE 11-1-2005.

3,785,078. MALKIN HOLDINGS LLC, NEW YORK, NY. SN 76-677,215. PUB. 4-22-2008, FILED 5-21-2007.

MALKIN HOLDINGS

THE MARK CONSISTS OF STANDARD CHARACTERS WITHOUT CLAIM TO ANY PARTICULAR FONT, STYLE, SIZE, OR COLOR.

CLASS 36—(Continued).

NO CLAIM IS MADE TO THE EXCLUSIVE RIGHT TO USE "HOLDINGS", APART FROM THE MARK AS SHOWN.
FOR INVESTMENT MANAGEMENT SERVICES (U.S. CLS. 100, 101 AND 102).
FIRST USE 9-21-2009; IN COMMERCE 9-21-2009.

CLASS 36—(Continued).

3,785,285. CORNERSTONE BANK, WATONGA, OK. SN 77-367,351. PUB. 5-27-2008, FILED 1-9-2008.

GREEN 4 GREEN

THE MARK CONSISTS OF STANDARD CHARACTERS WITHOUT CLAIM TO ANY PARTICULAR FONT, STYLE, SIZE, OR COLOR.
FOR BANKING SERVICES (U.S. CLS. 100, 101 AND 102).
FIRST USE 2-3-2010; IN COMMERCE 2-3-2010.

3,785,247. THE TRAVELERS INDEMNITY COMPANY, HARTFORD, CT. SN 77-331,649. PUB. 11-18-2008, FILED 11-16-2007.

Advantage 500M for Public Companies

THE MARK CONSISTS OF STANDARD CHARACTERS WITHOUT CLAIM TO ANY PARTICULAR FONT, STYLE, SIZE, OR COLOR.
NO CLAIM IS MADE TO THE EXCLUSIVE RIGHT TO USE "500M FOR PUBLIC COMPANIES", APART FROM THE MARK AS SHOWN.
FOR PROPERTY AND CASUALTY INSURANCE UNDERWRITING SERVICES (U.S. CLS. 100, 101 AND 102).
FIRST USE 11-5-2007; IN COMMERCE 11-5-2007.

3,785,310. THE PNC FINANCIAL SERVICES GROUP, INC., PITTSBURGH, PA. SN 77-385,635. PUB. 12-23-2008, FILED 1-31-2008.

VIRTUAL WALLET

THE MARK CONSISTS OF STANDARD CHARACTERS WITHOUT CLAIM TO ANY PARTICULAR FONT, STYLE, SIZE, OR COLOR.
NO CLAIM IS MADE TO THE EXCLUSIVE RIGHT TO USE "VIRTUAL", APART FROM THE MARK AS SHOWN.
FOR BANKING SERVICES; ON-LINE BANKING SERVICES; BILL PAYMENT SERVICES PROVIDED THROUGH A WEBSITE (U.S. CLS. 100, 101 AND 102).
FIRST USE 7-21-2008; IN COMMERCE 7-21-2008.

3,785,275. ARTIO GLOBAL INVESTORS INC., NEW YORK, NY. SN 77-357,988. PUB. 5-13-2008, FILED 12-21-2007.

3,785,360. BB&T CORPORATION, WINSTON-SALEM, NC. SN 77-424,915. PUB. 3-31-2009, FILED 3-18-2008.

ARTIO

THE MARK CONSISTS OF STANDARD CHARACTERS WITHOUT CLAIM TO ANY PARTICULAR FONT, STYLE, SIZE, OR COLOR.
FOR FINANCIAL AND INVESTMENT SERVICES, NAMELY, ASSET MANAGEMENT SERVICES, PORTFOLIO MANAGEMENT, INVESTMENT FUND SERVICES, PRIVATE EQUITY INVESTMENT SERVICES, HEDGE FUND INVESTMENT SERVICES; INVESTMENT ADVISORY SERVICES, INVESTMENT MANAGEMENT SERVICES (U.S. CLS. 100, 101 AND 102).
FIRST USE 6-15-2008; IN COMMERCE 6-15-2008.

EARNINGS² CHECKING

NO CLAIM IS MADE TO THE EXCLUSIVE RIGHT TO USE "EARNINGS" OR "CHECKING", APART FROM THE MARK AS SHOWN.
FOR BANKING SERVICES, NAMELY, COLLATERALIZED ACCOUNT SERVICES, CHECKING ACCOUNT SERVICES, CREDIT AND DEBIT CARD SERVICES, AND OVERDRAFT PROTECTION SERVICES; AND FINANCIAL SERVICES, NAMELY, MONTHLY ACCOUNT ANALYSIS AND CONSULTING SERVICES (U.S. CLS. 100, 101 AND 102).
FIRST USE 5-1-2008; IN COMMERCE 5-1-2008.

CLASS 36—(Continued).

3,785,365. THE PNC FINANCIAL SERVICES GROUP, INC., PITTSBURGH, PA. SN 77-426,973. PUB. 12-23-2008, FILED 3-20-2008.



OWNER OF U.S. REG. NOS. 1,416,898, 2,980,693, AND OTHERS.

NO CLAIM IS MADE TO THE EXCLUSIVE RIGHT TO USE "VIRTUAL", APART FROM THE MARK AS SHOWN.

THE MARK CONSISTS OF A DESIGN ELEMENT LOCATED TO THE LEFT OF THE WORDS "VIRTUAL WALLET". THE WORDS "BY PNC LEADING THE WAY" ARE LOCATED BELOW THE WORD "WALLET".

FOR BANKING SERVICES; ON-LINE BANKING SERVICES; BILL PAYMENT SERVICES PROVIDED THROUGH A WEBSITE (U.S. CLS. 100, 101 AND 102).

FIRST USE 7-21-2008; IN COMMERCE 7-21-2008.

3,785,366. THE PNC FINANCIAL SERVICES GROUP, INC., PITTSBURGH, PA. SN 77-426,991. PUB. 12-23-2008, FILED 3-20-2008.



OWNER OF U.S. REG. NOS. 1,416,898, 2,980,693, AND OTHERS.

NO CLAIM IS MADE TO THE EXCLUSIVE RIGHT TO USE "VIRTUAL", APART FROM THE MARK AS SHOWN.

THE MARK CONSISTS OF A DESIGN ELEMENT LOCATED TO THE LEFT OF THE WORDS "VIRTUAL WALLET". THE WORDS "BY PNC" ARE LOCATED BELOW THE WORD "WALLET".

FOR BANKING SERVICES; ON-LINE BANKING SERVICES; BILL PAYMENT SERVICES PROVIDED THROUGH A WEBSITE (U.S. CLS. 100, 101 AND 102).

FIRST USE 7-21-2008; IN COMMERCE 7-21-2008.

3,785,367. LIPPINCOTT, LLC, NARBERTH, PA. SN 77-427,003. PUB. 7-15-2008, FILED 3-20-2008.

ENTERTAIN THE POSSIBILITIES

THE MARK CONSISTS OF STANDARD CHARACTERS WITHOUT CLAIM TO ANY PARTICULAR FONT, STYLE, SIZE, OR COLOR.

FOR CHARITABLE FUNDRAISING SERVICES (U.S. CLS. 100, 101 AND 102).

FIRST USE 12-24-2008; IN COMMERCE 12-24-2008.

CLASS 36—(Continued).

3,785,372. BANK OF AMERICA, NATIONAL ASSOCIATION, CHARLOTTE, NC. SN 77-428,774. PUB. 12-2-2008, FILED 3-21-2008.

FIRST REPUBLIC

THE MARK CONSISTS OF STANDARD CHARACTERS WITHOUT CLAIM TO ANY PARTICULAR FONT, STYLE, SIZE, OR COLOR.

OWNER OF U.S. REG. NOS. 2,699,808, 3,185,144, AND OTHERS.

FOR CREDIT CARD SERVICES; DEBIT CARD SERVICES; COMMERCIAL AND CONSUMER LENDING, LEASING, AND FINANCING; TRUST, ESTATE, AND FIDUCIARY MANAGEMENT, PLANNING, AND CONSULTING; INVESTMENT SERVICES, NAMELY, PROVIDING INVESTMENT ANALYSIS, CONSULTATION, PLANNING, MANAGEMENT, ADVISORY, BROKERAGE, BANKING, AND RESEARCH SERVICES WITH RESPECT TO STOCKS, MUTUAL FUNDS, SECURITIES, BONDS, COMMODITIES, REAL ESTATE AND OTHER INSTRUMENTS OF INVESTMENT; PROVIDING SECURE FINANCIAL TRANSACTIONS IN THE NATURE OF ELECTRONIC CASH TRANSACTIONS, ELECTRONIC CREDIT CARD TRANSACTIONS, ELECTRONIC DEBIT TRANSACTIONS, ELECTRONIC CHECK PROCESSING TRANSACTIONS AND ELECTRONIC TRANSMISSION OF BILL PAYMENT DATA VIA A GLOBAL COMPUTER NETWORK; FINANCIAL PLANNING AND INVESTMENT ADVISORY SERVICES; FINANCIAL PLANNING CONSULTATION; AUTOMATED TELLER MACHINE SERVICES; SAFETY DEPOSIT BOX SERVICES (U.S. CLS. 100, 101 AND 102).

FIRST USE 12-0-2002; IN COMMERCE 12-0-2002.

3,785,388. HARTFORD FIRE INSURANCE COMPANY, HARTFORD, CT. SN 77-445,996. PUB. 12-9-2008, FILED 4-11-2008.

HARTFORD LEADERS FOUNDATION

THE MARK CONSISTS OF STANDARD CHARACTERS WITHOUT CLAIM TO ANY PARTICULAR FONT, STYLE, SIZE, OR COLOR.

OWNER OF U.S. REG. NOS. 2,432,862, 2,908,820, AND OTHERS.

NO CLAIM IS MADE TO THE EXCLUSIVE RIGHT TO USE "FOUNDATION", APART FROM THE MARK AS SHOWN.

SEC. 2(F) AS TO HARTFORD.

FOR LIFE INSURANCE AND ANNUITY UNDERWRITING SERVICES, FINANCIAL ASSET MANAGEMENT SERVICES, INVESTMENT ADVISORY SERVICES (U.S. CLS. 100, 101 AND 102).

FIRST USE 5-1-2008; IN COMMERCE 5-1-2008.

CLASS 36—(Continued).

3,785,416. CUMMINS-ALLISON CORP., MT. PROSPECT, IL.
SN 77-471,691. PUB. 7-14-2009, FILED 5-12-2008.

CARE FREE COIN

THE MARK CONSISTS OF STANDARD CHARACTERS WITHOUT CLAIM TO ANY PARTICULAR FONT, STYLE, SIZE, OR COLOR.

NO CLAIM IS MADE TO THE EXCLUSIVE RIGHT TO USE "COIN", APART FROM THE MARK AS SHOWN.

FOR COIN PROCESSING SERVICES, NAMELY, PROVIDING AND ADMINISTERING OPERATION OF SELF-SERVICE KIOSKS FOR AUTOMATED COIN COUNTING, SORTING AND CONVERTING SERVICES FOR RETAIL MERCHANTS, FINANCIAL INSTITUTIONS, GAMING FACILITIES, OR SERVICE PROVIDERS (U.S. CLS. 100, 101 AND 102).

FIRST USE 1-27-2010; IN COMMERCE 1-27-2010.

3,785,448. PRODUCERS EDGE, INC., CASA GRANDE, AZ.
SN 77-489,993. PUB. 11-11-2008, FILED 6-3-2008.



NO CLAIM IS MADE TO THE EXCLUSIVE RIGHT TO USE "PRODUCERS", APART FROM THE MARK AS SHOWN.

THE COLOR(S) BLUE PANTONE DS 203-4 C AND PROCESS BLACK IS/ARE CLAIMED AS A FEATURE OF THE MARK.

THE MARK CONSISTS OF BLACK AND BLUE SYMBOL WITH BLACK ON TOP AND BLUE AT THE BOTTOM, BLUE FOR THE WORD "PRODUCERS" AND BLACK FOR THE WORD "EDGE".

FOR INSURANCE AGENCY AND BROKERAGE (U.S. CLS. 100, 101 AND 102).

FIRST USE 1-1-2005; IN COMMERCE 1-1-2005.

3,785,466. MUNDER CAPITAL MANAGEMENT, BIRMINGHAM, MI. SN 77-499,607. PUB. 10-27-2009, FILED 6-16-2008.



OWNER OF U.S. REG. NOS. 2,382,741, 2,810,030, AND OTHERS.

NO CLAIM IS MADE TO THE EXCLUSIVE RIGHT TO USE "CAPITAL MANAGEMENT", APART FROM THE MARK AS SHOWN.

CLASS 36—(Continued).

THE MARK CONSISTS OF A COLUMN DESIGN ADJACENT TO THE WORDS "MUNDER CAPITAL MANAGEMENT".

FOR FINANCIAL ANALYSIS AND CONSULTATION; FINANCIAL CLEARING HOUSES; FINANCIAL EXCHANGE; FINANCIAL FORECASTING; FINANCIAL INFORMATION PROVIDED BY ELECTRONIC MEANS; FINANCIAL INVESTMENT IN THE FIELD OF SECURITIES; FINANCIAL MANAGEMENT; FINANCIAL PLANNING; FINANCIAL PORTFOLIO MANAGEMENT; FINANCIAL RESEARCH; INVESTMENT ADVICE; INVESTMENT CLUBS; FUND INVESTMENT CONSULTATION; INVESTMENT CONSULTATION; AND INVESTMENT OF FUNDS OF OTHERS (U.S. CLS. 100, 101 AND 102).

FIRST USE 9-30-2008; IN COMMERCE 9-30-2008.

3,785,505. PAUL, JONATHAN A., DBA SAILHAWK, SAN DIEGO, CA. SN 77-515,016. PUB. 12-2-2008, FILED 7-3-2008.

SAILHAWK

THE MARK CONSISTS OF STANDARD CHARACTERS WITHOUT CLAIM TO ANY PARTICULAR FONT, STYLE, SIZE, OR COLOR.

FOR REAL ESTATE BROKERAGE; REAL ESTATE INVESTMENT; REAL ESTATE MANAGEMENT (U.S. CLS. 100, 101 AND 102).

FIRST USE 3-24-2010; IN COMMERCE 3-24-2010.

3,785,513. VERACITY PAYMENT SOLUTIONS, INC., ATLANTA, GA. SN 77-517,745. PUB. 12-2-2008, FILED 7-9-2008.

BEQUEST

THE MARK CONSISTS OF STANDARD CHARACTERS WITHOUT CLAIM TO ANY PARTICULAR FONT, STYLE, SIZE, OR COLOR.

FOR PROVIDING CREDIT PROCESSING SERVICES, NAMELY, POINT-OF-SALE VALUE-ADDED PAYMENT PROCESSING SERVICES; PROVIDING VENDOR CONTRIBUTION TO CHARITABLE GRANT ACCOUNT FROM PAYMENT PROCESSING FEES; COLLECTING AND ADMINISTERING OF GRANT FUND DONATIONS FROM PAYMENT PROCESSING SERVICES; ELECTRONIC CASH TRANSACTIONS; PROVIDING ELECTRONIC PROCESSING AND MANAGEMENT OF GRANT FUNDS VIA A GLOBAL COMPUTER NETWORK; CHARGE CARD AND CREDIT CARD SERVICES; CREDIT CARD PAYMENT PROCESSING SERVICES; CREDIT AND CASH CARD SERVICES; CREDIT AND DEBIT CARD SERVICES; CREDIT CARD AND PAYMENT CARD SERVICES; CREDIT CARD TRANSACTION PROCESSING SERVICES; ELECTRONIC CREDIT CARD TRANSACTIONS; ELECTRONIC DEBIT TRANSACTIONS; ELECTRONIC PROCESSING OF INSURANCE CLAIMS

CLASS 36—(Continued).

AND PAYMENT DATA; ELECTRONIC TRANSFER OF FUNDS; FINANCIAL TRANSACTION SERVICES, NAMELY, PROVIDING SECURE COMMERCIAL TRANSACTIONS AND PAYMENT OPTIONS USING A MOBILE DEVICE AT A POINT OF SALE; FUND RAISING SERVICES, NAMELY, SHARING PROFITS FROM THE SALE OF SOCIALLY RESPONSIBLE PRODUCTS WITH NOT-FOR-PROFIT ORGANIZATIONS, SCHOOLS, AND CIVIC GROUPS; PROVIDING ELECTRONIC PROCESSING OF ACH AND CREDIT CARD TRANSACTIONS AND ELECTRONIC PAYMENTS VIA A GLOBAL COMPUTER NETWORK; PROVIDING ELECTRONIC PROCESSING OF CREDIT CARD TRANSACTIONS AND ELECTRONIC PAYMENTS VIA A GLOBAL COMPUTER NETWORK; PROVIDING ELECTRONIC PROCESSING OF ELECTRONIC FUNDS TRANSFER, ACH, CREDIT CARD, DEBIT CARD, ELECTRONIC CHECK AND ELECTRONIC PAYMENTS; PROVIDING GRANTS TO FINANCIALLY CHALLENGED FOR USE IN PAYING FOR MERCHANT SERVICES AND GOODS (U.S. CLS. 100, 101 AND 102).

FIRST USE 8-24-2009; IN COMMERCE 8-24-2009.

3,785,577. BANKERS LIFE AND CASUALTY COMPANY, CHICAGO, IL. SN 77-545,120. PUB. 6-2-2009, FILED 8-12-2008.

GrowthPoint

THE MARK CONSISTS OF STANDARD CHARACTERS WITHOUT CLAIM TO ANY PARTICULAR FONT, STYLE, SIZE, OR COLOR.

FOR UNDERWRITING AND ADMINISTRATION OF INDEXED EQUITY ANNUITY PRODUCTS (U.S. CLS. 100, 101 AND 102).

FIRST USE 10-6-2008; IN COMMERCE 10-6-2008.

3,785,585. WEALTHSTONE, INC., COLUMBUS, OH. SN 77-548,118. PUB. 7-21-2009, FILED 8-15-2008.

FIND IT HERE

THE MARK CONSISTS OF STANDARD CHARACTERS WITHOUT CLAIM TO ANY PARTICULAR FONT, STYLE, SIZE, OR COLOR.

FOR BUSINESS AND PERSONAL FINANCIAL CONSULTING SERVICES, NAMELY, FINANCIAL PLANNING, INVESTMENT PLANNING AND PORTFOLIO MANAGEMENT, ASSET MANAGEMENT, TAX PLANNING, AND BUSINESS STRATEGIES (U.S. CLS. 100, 101 AND 102).

FIRST USE 12-15-2008; IN COMMERCE 12-15-2008.

CLASS 36—(Continued).

3,785,622. CHINATRUST COMMERCIAL BANK, LTD., TAIPEI, TAIWAN. SN 77-577,140. PUB. 6-30-2009, FILED 9-23-2008.



Bank Utrust
松柏銀行

OWNER OF U.S. REG. NO. 2,762,230.

NO CLAIM IS MADE TO THE EXCLUSIVE RIGHT TO USE "BANK", APART FROM THE MARK AS SHOWN.

THE COLOR(S) RED, WHITE AND GREEN IS/ARE CLAIMED AS A FEATURE OF THE MARK.

THE MARK CONSISTS OF THE WORDING "BANK UTRUST" IN GREEN ABOVE FOUR CHINESE CHARACTERS ALSO IN GREEN, NEXT TO A RED CIRCLE WITH THE WORDING "WE ARE FAMILY" IN WHITE AND A PAIR OF BRACKETS IN GREEN.

THE NON-LATIN CHARACTER(S) IN THE MARK TRANSLITERATE INTO SONG, BO, YIN AND HANG, AND THIS MEANS A PINE, A CYPRESS, SILVER; RELATING TO MONEY OR CURRENCY, AND A LINE; A TRADE, PROFESSION, OR LINE OF BUSINESS IN ENGLISH.

FOR BANKING SERVICES; FINANCIAL GUARANTEE AND SURETY; CREDIT AND LOAN SERVICES; STUDENT LOAN SERVICES; CREDIT CARD SERVICES; FINANCIAL RESEARCH; INVESTMENT ADVISORY AND MANAGEMENT SERVICES; TRUSTESHIP REPRESENTATIVES; INSURANCE UNDERWRITING SERVICES FOR ALL TYPES OF INSURANCE; ON-LINE BANKING SERVICES; INSURANCE SERVICES, NAMELY, UNDERWRITING SERVICES FOR ALL TYPES OF INSURANCE PROVIDED ON-LINE; ELECTRONIC DEBIT TRANSACTIONS; PAYMENT PROCESSING SERVICES, NAMELY, CREDIT CARD AND DEBIT CARD TRANSACTION PROCESSING SERVICES (U.S. CLS. 100, 101 AND 102).

FIRST USE 12-30-2009; IN COMMERCE 12-30-2009.

3,785,640. QUANTITATIVE SERVICES GROUP LLC, NAPERVILLE, IL. SN 77-593,225. PUB. 3-3-2009, FILED 10-15-2008.

QSG EDGE

THE MARK CONSISTS OF STANDARD CHARACTERS WITHOUT CLAIM TO ANY PARTICULAR FONT, STYLE, SIZE, OR COLOR.

FOR FINANCIAL SERVICES, NAMELY, STOCK SELECTION AND INVESTMENT STRATEGY (U.S. CLS. 100, 101 AND 102).

FIRST USE 6-8-2009; IN COMMERCE 6-8-2009.

CLASS 36—(Continued).

3,785,645. COOPER, MARIE LOUISE, SAN DIEGO, CA. SN 77-598,610. PUB. 3-10-2009, FILED 10-22-2008.

THE-HOW-TO-LADY

THE MARK CONSISTS OF STANDARD CHARACTERS WITHOUT CLAIM TO ANY PARTICULAR FONT, STYLE, SIZE, OR COLOR.

FOR CHARITABLE FUND RAISING (U.S. CLS. 100, 101 AND 102).

FIRST USE 1-1-2008; IN COMMERCE 1-1-2008.

3,785,652. MASTERS, DARRELL, CINCINNATI, OH. SN 77-601,627. PUB. 10-27-2009, FILED 10-27-2008.

**Kenwood Financial
Group...where Main Street
invests.**

THE MARK CONSISTS OF STANDARD CHARACTERS WITHOUT CLAIM TO ANY PARTICULAR FONT, STYLE, SIZE, OR COLOR.

NO CLAIM IS MADE TO THE EXCLUSIVE RIGHT TO USE "KENWOOD FINANCIAL GROUP", APART FROM THE MARK AS SHOWN.

FOR BROKERAGE IN THE FIELD OF TERM LIFE INSURANCE, UNIVERSAL LIFE INSURANCE, WHOLE LIFE INSURANCE, VARIABLE LIFE INSURANCE, INDEXED LIFE INSURANCE, FIXED ANNUITIES, VARIABLE ANNUITIES, INDEX ANNUITIES, LONG TERM CARE INSURANCE, LIFE SETTLEMENTS, DISABILITY INSURANCE, HEALTH INSURANCE, MUTUAL FUNDS, EXCHANGE TRADED FUNDS, STOCKS, CORPORATE BONDS, GOVERNMENT BONDS, MUNICIPAL BONDS, OPTIONS, FUTURES FUNDS, COMMODITIES, COMMODITY INDEXES, MARKET INDEXES, AMERICAN DEPOSITORY RECEIPTS, PUBLIC AND NON-PUBLIC REAL ESTATE INVESTMENT TRUSTS, UNIT INVESTMENT TRUSTS, OIL AND GAS PARTNERSHIPS; FINANCIAL AND INVESTMENT SERVICES, NAMELY, MANAGEMENT AND BROKERAGE IN THE FIELDS OF STOCKS, BONDS, OPTIONS, COMMODITIES, FUTURES AND OTHER SECURITIES, AND THE INVESTMENT OF FUNDS OF OTHERS; FINANCIAL PLANNING; FINANCIAL PLANNING AND INVESTMENT ADVISORY SERVICES; INSURANCE BROKERAGE IN THE FIELD OF LIFE, ACCIDENT/DISABILITY, HEALTH, LONG TERM CARE, ANNUITIES; INSURANCE CONSULTATION; INVESTMENT CONSULTATION (U.S. CLS. 100, 101 AND 102).

FIRST USE 1-21-2010; IN COMMERCE 1-21-2010.

CLASS 36—(Continued).

3,785,680. SCBT, N.A., USING THE MARK IN COMMERCE THROUGH ITS OPERATING DIVISION, NCBT, COLUMBIA, SC. SN 77-615,543. PUB. 8-18-2009, FILED 11-17-2008.

**WE BELIEVE IN NORTH
CAROLINA**

THE MARK CONSISTS OF STANDARD CHARACTERS WITHOUT CLAIM TO ANY PARTICULAR FONT, STYLE, SIZE, OR COLOR.

FOR BANKING AND FINANCIAL SERVICES, NAMELY, PROVIDING BANK ACCOUNT INFORMATION BY TELEPHONE, MAIL, COMPUTER, AND A GLOBAL COMPUTER NETWORK; CHECKING, SAVINGS, AND CD ACCOUNT SERVICES; CREDIT AND DEBIT CARDS; SAFETY DEPOSIT BOX SERVICES; LOAN FINANCING SERVICES; MORTGAGE BANKING, BROKERAGE AND LENDING; FUNDS INVESTMENT, INVESTMENT BROKERAGE, INVESTMENT MANAGEMENT (U.S. CLS. 100, 101 AND 102).

FIRST USE 2-1-2009; IN COMMERCE 2-1-2009.

3,785,703. FEARSOME FIVESOME, LC, DBA MEDSTAR FUNDING, AUSTIN, TX. SN 77-627,753. PUB. 4-14-2009, FILED 12-5-2008.



NO CLAIM IS MADE TO THE EXCLUSIVE RIGHT TO USE "FUNDING", APART FROM THE MARK AS SHOWN.

THE COLOR(S) BLUE, GREEN AND WHITE IS/ARE CLAIMED AS A FEATURE OF THE MARK.

THE MARK CONSISTS OF A WHITE RECTANGLE, OUTLINED IN BLUE, WITHIN THE RECTANGLE ARE THE LETTERS "MEDST R FUNDING" IN BLUE. BETWEEN THE LETTERS "T" AND "R" IS A WHITE STAR, OUTLINED IN GREEN, WITH A SOLID GREEN STAR IN THE MIDDLE.

FOR MEDICAL ACCOUNTS RECEIVABLE FINANCING, NAMELY, THE PURCHASE OF RECEIVABLES SECURED BY ASSIGNMENT FROM MEDICAL PROVIDERS AND SUBSEQUENT RESELL OF THE RECEIVABLES TO THIRD PARTIES (U.S. CLS. 100, 101 AND 102).

FIRST USE 2-1-2010; IN COMMERCE 2-1-2010.

3,785,792. AUTOMOBILE CLUB OF SOUTHERN CALIFORNIA, COSTA MESA, CA. SN 77-657,613. PUB. 5-19-2009, FILED 1-27-2009.

**Auto Club Power Sports
Insurance**

THE MARK CONSISTS OF STANDARD CHARACTERS WITHOUT CLAIM TO ANY PARTICULAR FONT, STYLE, SIZE, OR COLOR.

CLASS 36—(Continued).

OWNER OF U.S. REG. NOS. 1,672,774, 3,260,081, AND OTHERS.

NO CLAIM IS MADE TO THE EXCLUSIVE RIGHT TO USE "POWER SPORTS INSURANCE", APART FROM THE MARK AS SHOWN.

SEC. 2(F) AS TO "AUTO CLUB".

FOR INSURANCE BROKERAGE; INSURANCE AGENCIES; INSURANCE UNDERWRITING AND INSURANCE CLAIMS PROCESSING, NAMELY, PROPERTY AND CASUALTY INSURANCE RELATING TO AUTOMOBILES, MOTORCYCLES, RECREATIONAL VEHICLES, PERSONAL WATERCRAFT, AND BOATS; INSURANCE SERVICES, NAMELY, WRITING PROPERTY AND CASUALTY INSURANCE (U.S. CLS. 100, 101 AND 102).

FIRST USE 5-1-2009; IN COMMERCE 5-1-2009.

3,785,815. ROUNDSTONE PROPERTIES INC., DANVILLE, CA. SN 77-660,637. PUB. 5-19-2009, FILED 1-30-2009.



NO CLAIM IS MADE TO THE EXCLUSIVE RIGHT TO USE "PROPERTIES INC", APART FROM THE MARK AS SHOWN.

THE STIPPLING IS FOR SHADING PURPOSES ONLY.

THE MARK CONSISTS OF THE STYLIZED TEXT "ROUNDSTONE PROPERTIES INC." WITH A CLOVER ON THE LEFT INSIDE A CIRCLE.

FOR REAL ESTATE BROKERAGE (U.S. CLS. 100, 101 AND 102).

FIRST USE 8-30-2009; IN COMMERCE 10-31-2009.

3,785,893. PROJECT EVERGREEN FOUNDATION, INC., NEW PRAGUE, MN. SN 77-673,171. PUB. 6-16-2009, FILED 2-18-2009.

BUCK IT UP FOR MILITARY FAMILIES

THE MARK CONSISTS OF STANDARD CHARACTERS WITHOUT CLAIM TO ANY PARTICULAR FONT, STYLE, SIZE, OR COLOR.

NO CLAIM IS MADE TO THE EXCLUSIVE RIGHT TO USE "MILITARY FAMILIES", APART FROM THE MARK AS SHOWN.

FOR CHARITABLE FUND RAISING (U.S. CLS. 100, 101 AND 102).

FIRST USE 1-1-2009; IN COMMERCE 1-1-2009.

CLASS 36—(Continued).

3,785,925. C. V. STARR & CO., INC., NEW YORK, NY. SN 77-680,362. PUB. 6-2-2009, FILED 2-27-2009.

STARRLINK

THE MARK CONSISTS OF STANDARD CHARACTERS WITHOUT CLAIM TO ANY PARTICULAR FONT, STYLE, SIZE, OR COLOR.

OWNER OF U.S. REG. NOS. 2,877,409, 3,587,775, AND OTHERS.

FOR AVIATION INSURANCE UNDERWRITING AND AGENCY SERVICES (U.S. CLS. 100, 101 AND 102).

FIRST USE 4-30-2009; IN COMMERCE 4-30-2009.

3,785,926. WASATCH PREFERRED, LLC, DRAPER, UT. SN 77-680,507. PUB. 6-23-2009, FILED 2-27-2009.



THE MARK CONSISTS OF A STYLIZED "W" WITH A "P" CONNECTED TO EACH END WITH THE ONE ON THE LEFT FACING BACKWARDS AND THE ONE ON THE RIGHT FACING FORWARD, ALL OF WHICH IS CENTERED IN TWO CONCENTRIC CIRCLES.

FOR INSURANCE BROKERAGE (U.S. CLS. 100, 101 AND 102).

FIRST USE 7-21-2009; IN COMMERCE 7-21-2009.

3,785,929. RELIANCE STANDARD LIFE INSURANCE COMPANY, PHILADELPHIA, PA. SN 77-682,362. PUB. 7-7-2009, FILED 3-3-2009.

RSL ADVANTEDGE

THE MARK CONSISTS OF STANDARD CHARACTERS WITHOUT CLAIM TO ANY PARTICULAR FONT, STYLE, SIZE, OR COLOR.

CLASS 36—(Continued).

OWNER OF U.S. REG. NOS. 1,617,943, 1,743,530, AND 3,068,776.
FOR INSURANCE AND FINANCIAL SERVICES, NAMELY, ACCIDENT AND HEALTH INSURANCE UNDERWRITING (U.S. CLS. 100, 101 AND 102).
FIRST USE 6-18-2009; IN COMMERCE 6-18-2009.

CLASS 36—(Continued).

3,786,009. YARD HOUSE USA, INC., IRVINE, CA. SN 77-711,917. PUB. 8-11-2009, FILED 4-10-2009.

3,785,934. AMERICAN FIDELITY ASSURANCE COMPANY, OKLAHOMA CITY, OK. SN 77-683,967. PUB. 6-16-2009, FILED 3-5-2009.



AFENROLL

NO CLAIM IS MADE TO THE EXCLUSIVE RIGHT TO USE "AMERICA", APART FROM THE MARK AS SHOWN. THE MARK CONSISTS OF THE WORDS "ROUND IT UP AMERICA", A PENNY, AND AN ARROW.
FOR CHARITABLE FUND RAISING SERVICES (U.S. CLS. 100, 101 AND 102).
FIRST USE 7-0-2009; IN COMMERCE 7-0-2009.

THE MARK CONSISTS OF STANDARD CHARACTERS WITHOUT CLAIM TO ANY PARTICULAR FONT, STYLE, SIZE, OR COLOR.
FOR INSURANCE SERVICES, NAMELY, ON-LINE AND OFF-LINE ENROLLMENT SERVICES FOR INSURANCE PRODUCTS (U.S. CLS. 100, 101 AND 102).
FIRST USE 2-2-2010; IN COMMERCE 2-2-2010.

3,786,014. GRASSMERE PARTNERS, LLC, KANSAS CITY, MO. SN 77-712,543. PUB. 9-15-2009, FILED 4-13-2009.

3,785,999. YARD HOUSE USA, INC., IRVINE, CA. SN 77-706,873. PUB. 8-11-2009, FILED 4-3-2009.

GRASSMERE PARTNERS

ROUND IT UP AMERICA

THE MARK CONSISTS OF STANDARD CHARACTERS WITHOUT CLAIM TO ANY PARTICULAR FONT, STYLE, SIZE, OR COLOR.
NO CLAIM IS MADE TO THE EXCLUSIVE RIGHT TO USE "PARTNERS", APART FROM THE MARK AS SHOWN. FOR FINANCIAL AND INVESTMENT SERVICES, NAMELY, INVESTMENT OF FUNDS FOR OTHERS AND INVESTMENT ADVISORY, CONSULTATION, MANAGEMENT AND BROKERAGE SERVICES; INVESTMENT SERVICES, NAMELY, ASSET ACQUISITION, CONSULTATION, DEVELOPMENT AND MANAGEMENT SERVICES; FINANCING AND LOAN SERVICES; VENTURE CAPITAL SERVICES, NAMELY, PROVIDING FINANCING TO EMERGING, START-UP AND ESTABLISHED COMPANIES; ACQUISITION AND LEASING OR RENTING OF REAL ESTATE; REAL ESTATE INVESTMENT SERVICES (U.S. CLS. 100, 101 AND 102).
FIRST USE 9-19-2009; IN COMMERCE 9-19-2009.

THE MARK CONSISTS OF STANDARD CHARACTERS WITHOUT CLAIM TO ANY PARTICULAR FONT, STYLE, SIZE, OR COLOR.
NO CLAIM IS MADE TO THE EXCLUSIVE RIGHT TO USE "AMERICA", APART FROM THE MARK AS SHOWN. FOR CHARITABLE FUND RAISING SERVICES (U.S. CLS. 100, 101 AND 102).
FIRST USE 7-0-2009; IN COMMERCE 7-0-2009.

CLASS 36—(Continued).

3,786,135. GENZYME CORPORATION, CAMBRIDGE, MA. SN 77-766,763. PUB. 9-29-2009, FILED 6-24-2009.

GRIP

THE MARK CONSISTS OF STANDARD CHARACTERS WITHOUT CLAIM TO ANY PARTICULAR FONT, STYLE, SIZE, OR COLOR.

FOR PROVIDING GRANTS TO RESEARCHERS, CLINICIANS AND FELLOWS IN THE FIELD OF NEPHROLOGY (U.S. CLS. 100, 101 AND 102).

FIRST USE 1-10-2010; IN COMMERCE 1-10-2010.

3,786,138. VISION SERVICE PLAN, DBA VSP, RANCHO CORDOVA, CA. SN 77-768,684. PUB. 10-27-2009, FILED 6-25-2009.



OWNER OF U.S. REG. NOS. 2,324,613 AND 3,410,088. THE COLOR(S) DARK BLUE, LIGHT BLUE AND GREEN IS/ARE CLAIMED AS A FEATURE OF THE MARK.

THE COLOR GREEN APPEARS IN THE TOP CIRCLE OF THE MARK. THE COLOR LIGHT BLUE APPEARS IN THE CIRCLE UNDER THE GREEN CIRCLE. THE COLOR DARK BLUE APPEARS IN THE WORDING "VSP VISION SANA. VIDA SANA."

THE ENGLISH TRANSLATION OF "VISION SANA." "VIDA SANA." IN THE MARK IS HEALTHY VISION. HEALTHY LIFE.

FOR ADMINISTERING PREPAID PREFERRED PROVIDER VISION CARE PLANS (U.S. CLS. 100, 101 AND 102).

FIRST USE 6-29-2009; IN COMMERCE 6-29-2009.

CLASS 36—(Continued).

3,786,151. SPIRIS, INC., LAFAYETTE, IN. SN 77-775,540. PUB. 12-1-2009, FILED 7-7-2009.

Inspired to listen. Trusted to perform.

THE MARK CONSISTS OF STANDARD CHARACTERS WITHOUT CLAIM TO ANY PARTICULAR FONT, STYLE, SIZE, OR COLOR.

FOR INSURANCE CONSULTATION AND FINANCIAL CONSULTATION; INSURANCE SERVICES, NAMELY, UNDERWRITING AND BROKERAGE OF PROPERTY, PRODUCT LIABILITY, AVIATION, CASUALTY, HEALTH, LIFE, WORKERS COMPENSATION, AND PROFESSIONAL LIABILITY INSURANCE; INSURANCE AGENCY AND BROKERAGE; FINANCIAL SERVICES, NAMELY, FINANCIAL RISK MANAGEMENT CONSULTING SERVICES, FINANCIAL CONSULTING SERVICES, FINANCIAL EVALUATION FOR INSURANCE PURPOSES, AND FINANCIAL ANALYSIS; AND SECURITIES SERVICES, NAMELY, SECURITIES BROKERAGE SERVICES (U.S. CLS. 100, 101 AND 102).

FIRST USE 11-4-2009; IN COMMERCE 11-4-2009.

3,786,160. CPP HOLDINGS LIMITED, YORK, UNITED KINGDOM. SN 77-975,706. PUB. 5-19-2009, FILED 12-12-2006.

CPP

THE MARK CONSISTS OF STANDARD CHARACTERS WITHOUT CLAIM TO ANY PARTICULAR FONT, STYLE, SIZE, OR COLOR.

FOR PROVISION OF FINANCIAL SERVICES, NAMELY, CREDIT CARD RELATED SERVICES, NAMELY, EMERGENCY LOAN ASSISTANCE IN THE NATURE OF TEMPORARY LOANS FOR HOTEL BILL PAYMENT AND TRAVEL TICKET REPLACEMENT, COMMUNICATION COSTS AND DOCUMENT REPLACEMENT COSTS FOLLOWING LOSS OF PLASTIC CARDS; PROVIDING PERSONAL FINANCIAL INFORMATION BY MAIL AND ELECTRONIC MEANS; PROVIDING CREDIT BUREAU DATA TO CONSUMERS; PROVIDING EXTENDED WARRANTY SERVICES ON A WIDE RANGE OF CONSUMER PRODUCTS, NAMELY, NEW MANUFACTURED CONSUMER PRODUCTS WITH A U.S. MANUFACTURER'S WARRANTY OF AT LEAST 90 DAYS AND A SALE PRICE OF \$5,000 OR LESS, EXCLUDING MOTORIZED VEHICLES, CONSUMABLES AND PERISHABLES; PROVIDING A COMPREHENSIVE PROTECTION PLAN FOR THE PRODUCTS OF OTHERS IN THE NATURE OF PRICE AND REPAIR REIMBURSEMENT, NAMELY, REIMBURSEMENT OF POST-PURCHASE PRICE REDUCTIONS, PARTIAL REIMBURSEMENT OF PRODUCT REPAIR COSTS, AND GUARANTEE OF PRODUCT RETURNS (U.S. CLS. 100, 101 AND 102).

FIRST USE 2-1-2004; IN COMMERCE 2-1-2004.

CLASS 36—(Continued).

3,786,198. JIFFY LUBE INTERNATIONAL, INC, HOUSTON, TX. SN 77-979,096. PUB. 4-28-2009, FILED 6-23-2008.

JIFFY LUBE FLEET CARD

THE MARK CONSISTS OF STANDARD CHARACTERS WITHOUT CLAIM TO ANY PARTICULAR FONT, STYLE, SIZE, OR COLOR.

OWNER OF U.S. REG. NOS. 1,384,672, 3,496,989, AND OTHERS.

NO CLAIM IS MADE TO THE EXCLUSIVE RIGHT TO USE "FLEET CARD", APART FROM THE MARK AS SHOWN.

FOR CREDIT CARD SERVICES (U.S. CLS. 100, 101 AND 102).

FIRST USE 4-1-2008; IN COMMERCE 4-1-2008.

3,786,208. VERIZON TRADEMARK SERVICES LLC, ARLINGTON, VA. SN 78-195,852. PUB. 5-27-2008, FILED 12-18-2002.

VERIZON READS

NO CLAIM IS MADE TO THE EXCLUSIVE RIGHT TO USE "READS", APART FROM THE MARK AS SHOWN.

FOR CHARITABLE FUNDRAISING SERVICES, NAMELY, RAISING MONEY FOR LOCAL COMMUNITY LITERACY PROGRAMS (U.S. CLS. 100, 101 AND 102).

FIRST USE 0-0-2000; IN COMMERCE 0-0-2000.

3,786,252. ONE CARD, NV, CURACAO, NETHERLD ANTILLES. SN 78-736,741. PUB. 12-12-2006, FILED 10-19-2005.

THE ONE WORLD CARD

THE MARK CONSISTS OF STANDARD CHARACTERS WITHOUT CLAIM TO ANY PARTICULAR FONT, STYLE, SIZE, OR COLOR.

NO CLAIM IS MADE TO THE EXCLUSIVE RIGHT TO USE "CARD", APART FROM THE MARK AS SHOWN.

FOR CREDIT CARD SERVICES, NAMELY, PROVIDING PREPAID CREDIT CARD ACCOUNTS OBTAINED ONLINE IN WHICH USERS DEPOSIT FUNDS IN UNITED STATES OR FOREIGN CURRENCY VIA THE INTERNET OR BY MOBILE PHONE (U.S. CLS. 100, 101 AND 102).

FIRST USE 3-3-2010; IN COMMERCE 3-3-2010.

CLASS 36—(Continued).

3,786,257. BRISTOL-MYERS SQUIBB COMPANY, NEW YORK, NY. SN 78-782,110. PUB. 12-19-2006, FILED 12-29-2005.

DESTINATION ACCESS

THE MARK CONSISTS OF STANDARD CHARACTERS WITHOUT CLAIM TO ANY PARTICULAR FONT, STYLE, SIZE, OR COLOR.

FOR FINANCIAL SERVICES, NAMELY, PROVIDING FINANCIAL PAYMENT ASSISTANCE TO OTHERS IN RESPECT OF HEALTH INSURANCE COVERAGE FOR PHARMACEUTICALS (U.S. CLS. 100, 101 AND 102).

FIRST USE 9-30-2007; IN COMMERCE 9-30-2007.

3,786,269. C. V. STARR & CO., INC., NEW YORK, NY. SN 78-836,346. PUB. 11-21-2006, FILED 3-14-2006.

STARR MARINE AGENCY

THE MARK CONSISTS OF STANDARD CHARACTERS WITHOUT CLAIM TO ANY PARTICULAR FONT, STYLE, SIZE, OR COLOR.

OWNER OF U.S. REG. NOS. 1,570,227, 2,926,969, AND OTHERS.

NO CLAIM IS MADE TO THE EXCLUSIVE RIGHT TO USE "MARINE AGENCY", APART FROM THE MARK AS SHOWN.

FOR PROPERTY AND CASUALTY INSURANCE UNDERWRITING AND AGENCY SERVICES (U.S. CLS. 100, 101 AND 102).

FIRST USE 2-9-2010; IN COMMERCE 2-9-2010.

3,786,316. HEARTLAND PAYMENT SYSTEMS, INC., PRINCETON, NJ. SN 78-913,582. PUB. 2-27-2007, FILED 6-21-2006.

MERCHANT BILL OF RIGHTS

THE MARK CONSISTS OF STANDARD CHARACTERS WITHOUT CLAIM TO ANY PARTICULAR FONT, STYLE, SIZE, OR COLOR.

CLASS 36—(Continued).

NO CLAIM IS MADE TO THE EXCLUSIVE RIGHT TO USE "MERCHANT", APART FROM THE MARK AS SHOWN.

FOR INFORMATION SERVICES, NAMELY, FINANCIAL INFORMATION PROVIDED BY ELECTRONIC MEANS; FINANCIAL ASSESSMENT AND RISK MANAGEMENT SERVICES FOR OTHERS IN THE FIELD OF ELECTRONIC PAYMENTS (U.S. CLS. 100, 101 AND 102).
FIRST USE 9-0-2006; IN COMMERCE 9-0-2006.

CLASS 37—(Continued).

NO CLAIM IS MADE TO THE EXCLUSIVE RIGHT TO USE "MANHATTAN", APART FROM THE MARK AS SHOWN.

FOR REAL ESTATE DEVELOPMENT (U.S. CLS. 100, 103 AND 106).
FIRST USE 10-15-2008; IN COMMERCE 10-15-2008.

CLASS 37—CONSTRUCTION AND REPAIR

3,785,069. WINGLER, GERRY, SIOUX FALLS, SD. SN 76-657,296. PUB. 11-21-2006, FILED 3-27-2006.

3,785,198. COINMACH CORPORATION, PLAINVIEW, NY. SN 77-246,455. PUB. 5-5-2009, FILED 8-3-2007.

CLOTHES CLINIC

THE MARK CONSISTS OF STANDARD CHARACTERS WITHOUT CLAIM TO ANY PARTICULAR FONT, STYLE, SIZE, OR COLOR.

NO CLAIM IS MADE TO THE EXCLUSIVE RIGHT TO USE "CLOTHES", APART FROM THE MARK AS SHOWN.
FOR DRY CLEANING SERVICES (U.S. CLS. 100, 103 AND 106).

FIRST USE 2-10-2010; IN COMMERCE 2-10-2010.

AIR VALET

THE MARK CONSISTS OF STANDARD CHARACTERS WITHOUT CLAIM TO ANY PARTICULAR FONT, STYLE, SIZE, OR COLOR.

NO CLAIM IS MADE TO THE EXCLUSIVE RIGHT TO USE "AIR", APART FROM THE MARK AS SHOWN.

FOR INSTALLATION, SERVICING AND REPAIR OF COIN OR CREDIT CARD ACTIVATED TIRE INFLATION MACHINES, VACUUM MACHINES FOR THE INSIDE OF VEHICLES AND WATER DISPENSING MACHINES FOR SERVICING VEHICLE ENGINES, NAMELY, MAINTAINING ENGINE COMPONENTS; OPERATION, NAMELY, THE RENTAL, INSTALLATION AND MAINTENANCE, OF COIN OR CREDIT CARD ACTIVATED TIRE INFLATION MACHINES, VACUUM MACHINES FOR THE INSIDE OF VEHICLES AND WATER DISPENSING MACHINES FOR SERVICING VEHICLE ENGINES, NAMELY, MAINTAINING ENGINE COMPONENTS (U.S. CLS. 100, 103 AND 106).

FIRST USE 11-7-2007; IN COMMERCE 11-7-2007.

3,785,120. ISURVEY AS, BILLINGSTAD, NORWAY. SN 77-043,785. PUB. 6-17-2008, FILED 11-14-2006.

ISURVEY

THE MARK CONSISTS OF STANDARD CHARACTERS WITHOUT CLAIM TO ANY PARTICULAR FONT, STYLE, SIZE, OR COLOR.

FOR SUB-SEA STRUCTURES INSTALLATION; RISER INSTALLATION; MARINE CONSTRUCTION SUPPORT SERVICES, NAMELY, CABLE TRENCHING, CABLE INSTALLATION (U.S. CLS. 100, 103 AND 106).

FIRST USE 8-1-2004; IN COMMERCE 6-1-2008.

3,785,199. KRATOS DEFENSE & SECURITY SOLUTIONS, INC., SAN DIEGO, CA. SN 77-248,436. PUB. 5-19-2009, FILED 8-6-2007.

KRATOS DEFENSE & SECURITY SOLUTIONS

3,785,180. SPECIAL K PROPERTIES, LLC, MANHATTAN BEACH, CA. SN 77-210,213. PUB. 6-23-2009, FILED 6-19-2007.

MANHATTAN SANCTUARY

THE MARK CONSISTS OF STANDARD CHARACTERS WITHOUT CLAIM TO ANY PARTICULAR FONT, STYLE, SIZE, OR COLOR.

THE MARK CONSISTS OF STANDARD CHARACTERS WITHOUT CLAIM TO ANY PARTICULAR FONT, STYLE, SIZE, OR COLOR.

NO CLAIM IS MADE TO THE EXCLUSIVE RIGHT TO USE "SECURITY", APART FROM THE MARK AS SHOWN.
FOR INSTALLATION OF SECURITY SYSTEMS (U.S. CLS. 100, 103 AND 106).

FIRST USE 2-4-2010; IN COMMERCE 2-4-2010.

CLASS 37—(Continued).

3,785,234. FIRST ENERGY FIRST LLC, HOLLY, MI. SN 77-319,382. PUB. 11-18-2008, FILED 11-1-2007.

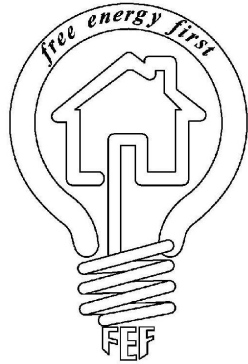

NO CLAIM IS MADE TO THE EXCLUSIVE RIGHT TO USE "FREE ENERGY", APART FROM THE MARK AS SHOWN.

THE MARK CONSISTS OF A STYLIZED LIGHTBLUB DESIGN WITH A STYLIZED HOUSE DESIGN CONTAINED WITHIN THE INTERIOR SPACE OF THE LIGHTBULB DESIGN, WITH THE PHRASE "FIRST ENERGY FIRST" BEING LOCATED ALONG THE TOP PORTION OF THE STYLIZED LIGHTBULB DESIGN AND THE LETTERS "FEF" BEING LOCATED AT THE BOTTOM OF THE STYLIZED LIGHT BLUB DESIGN.

FOR HVAC CONTRACTOR SERVICES (U.S. CLS. 100, 103 AND 106).

FIRST USE 10-16-2009; IN COMMERCE 10-16-2009.

3,785,248. CIVIX-M-R, LLC, SARASOTA, FL. SN 77-331,741. PUB. 4-22-2008, FILED 11-16-2007.

MEDEPLEX

THE MARK CONSISTS OF STANDARD CHARACTERS WITHOUT CLAIM TO ANY PARTICULAR FONT, STYLE, SIZE, OR COLOR.

FOR LAND DEVELOPMENT SERVICES, NAMELY, THE PLANNING, LAYING OUT, AND CONSTRUCTING OF MEDICAL OFFICES, COMPLEXES, AND FACILITIES (U.S. CLS. 100, 103 AND 106).

FIRST USE 1-26-2010; IN COMMERCE 1-26-2010.

CLASS 37—(Continued).

3,785,720. TRUGREEN LIMITED PARTNERSHIP, MEMPHIS, TN. SN 77-630,539. PUB. 3-24-2009, FILED 12-10-2008.

TruPerformance

THE MARK CONSISTS OF STANDARD CHARACTERS WITHOUT CLAIM TO ANY PARTICULAR FONT, STYLE, SIZE, OR COLOR.

FOR INTEGRATED PEST MANAGEMENT SERVICES OTHER THAN FOR AGRICULTURAL PURPOSES (U.S. CLS. 100, 103 AND 106).

FIRST USE 2-1-2009; IN COMMERCE 2-1-2009.

3,785,721. TRUGREEN LIMITED PARTNERSHIP, MEMPHIS, TN. SN 77-630,563. PUB. 3-24-2009, FILED 12-10-2008.

TruBlend

THE MARK CONSISTS OF STANDARD CHARACTERS WITHOUT CLAIM TO ANY PARTICULAR FONT, STYLE, SIZE, OR COLOR.

FOR INTEGRATED PEST MANAGEMENT SERVICES OTHER THAN FOR AGRICULTURAL PURPOSES (U.S. CLS. 100, 103 AND 106).

FIRST USE 2-1-2009; IN COMMERCE 2-1-2009.

3,785,813. CLEAN HARBORS CATALYST TECHNOLOGIES, LLC, PASADENA, TX. SN 77-660,528. PUB. 5-26-2009, FILED 1-30-2009.



THE MARK CONSISTS OF THE WORD "ARC" IN A DOUBLE-BANDED ARC.

FOR INSTALLATION OF TRAY ASSEMBLIES USED TO SEPARATE COMPONENTS IN REACTORS AND DISTILLATION COLUMNS TO SEPARATE CATALYST BEDS IN THE PETROCHEMICAL AND CHEMICAL INDUSTRIES (U.S. CLS. 100, 103 AND 106).

FIRST USE 2-3-2009; IN COMMERCE 2-3-2009.

CLASS 37—(Continued).

3,786,254. CLOCKWORK IP, LLC, SARASOTA, FL. SN 78-768,289. PUB. 1-2-2007, FILED 12-7-2005.

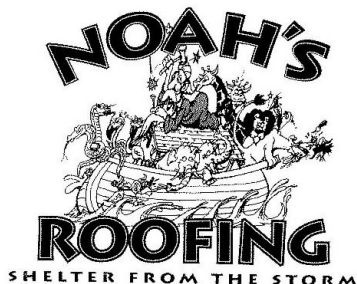

NO CLAIM IS MADE TO THE EXCLUSIVE RIGHT TO USE "ROOFING", APART FROM THE MARK AS SHOWN. THE STIPPLING IS FOR SHADING PURPOSES ONLY. THE MARK CONSISTS OF A VARIETY OF ANIMALS ON A BOAT.
FOR RESIDENTIAL ROOFING SERVICES (U.S. CLS. 100, 103 AND 106).
FIRST USE 5-8-2007; IN COMMERCE 5-8-2007.

CLASS 37—(Continued).

3,786,283. DORMA PROPERTIES, INC., WILMINGTON, DE. SN 78-854,123. PUB. 12-18-2007, FILED 4-5-2006.

CRANE

THE MARK CONSISTS OF STANDARD CHARACTERS WITHOUT CLAIM TO ANY PARTICULAR FONT, STYLE, SIZE, OR COLOR.

FOR MAINTENANCE, SERVICING, AND INSTALLATION OF REVOLVING DOORS (U.S. CLS. 100, 103 AND 106).

FIRST USE 2-0-2000; IN COMMERCE 2-0-2000.

3,786,278. K. HOV IP, II, INC., RED BANK, NJ. SN 78-849,105. PUB. 12-12-2006, FILED 3-29-2006.



OWNER OF U.S. REG. NOS. 1,519,167, 1,519,168, AND 2,815,805.

NO CLAIM IS MADE TO THE EXCLUSIVE RIGHT TO USE "ENTERPRISES INC.", APART FROM THE MARK AS SHOWN.

FOR REAL ESTATE DEVELOPMENT AND RESIDENTIAL REAL ESTATE BUILDING CONSTRUCTION; REAL ESTATE SITE SELECTION; CONSTRUCTION SERVICES, NAMELY, PLANNING, LAYING OUT AND CUSTOM CONSTRUCTION OF RESIDENTIAL BUILDINGS; CONSTRUCTION MANAGEMENT SUPERVISION; AND LAND DEVELOPMENT SERVICES, NAMELY, PLANNING AND LAYING OUT OF RESIDENTIAL OR COMMERCIAL COMMUNITIES (U.S. CLS. 100, 103 AND 106).

FIRST USE 2-28-2010; IN COMMERCE 2-28-2010.

CLASS 38—COMMUNICATION

3,785,133. HOME BOX OFFICE, INC., NEW YORK, NY. SN 77-099,347. PUB. 7-15-2008, FILED 2-5-2007.

SERIES PASS

THE MARK CONSISTS OF STANDARD CHARACTERS WITHOUT CLAIM TO ANY PARTICULAR FONT, STYLE, SIZE, OR COLOR.

FOR VIDEO ON DEMAND CABLE TELEVISION TRANSMISSION SERVICES FEATURING AUTOMATIC DOWNLOADING OF PROGRAMMING CONTENT; ELECTRONIC TRANSMISSION OF TEXT, DATA, AUDIO AND VIDEO VIA CABLE, WIRELESS COMMUNICATIONS NETWORKS AND THE INTERNET (U.S. CLS. 100, 101 AND 104).

FIRST USE 2-18-2010; IN COMMERCE 2-18-2010.

CLASS 38—(Continued).

3,785,204. CLOUDTRADE LLC, LIVONIA, MI. SN 77-254,769.
PUB. 7-1-2008, FILED 8-14-2007.

CLOUDTRADE

THE MARK CONSISTS OF STANDARD CHARACTERS WITHOUT CLAIM TO ANY PARTICULAR FONT, STYLE, SIZE, OR COLOR.

FOR ELECTRONIC TRANSMISSION OF AUDIO AND VIDEO FILES VIA COMMUNICATIONS NETWORKS; PROVIDING ELECTRONIC BULLETIN BOARDS, AND CHAT ROOMS VIA COMMUNICATIONS NETWORKS FOR THE TRANSMISSION OF MESSAGES AMONG USERS IN THE FIELD OF GENERAL INTEREST; ELECTRONIC TRANSMISSION OF DIGITAL FILES, NAMELY, FILE SHARING VIA COMMUNICATIONS NETWORKS (U.S. CLS. 100, 101 AND 104).

FIRST USE 1-1-2010; IN COMMERCE 1-1-2010.

3,785,297. FORD MOTOR COMPANY, DEARBORN, MI. SN 77-374,329. PUB. 5-20-2008, FILED 1-17-2008.

911 ASSIST

THE MARK CONSISTS OF STANDARD CHARACTERS WITHOUT CLAIM TO ANY PARTICULAR FONT, STYLE, SIZE, OR COLOR.

NO CLAIM IS MADE TO THE EXCLUSIVE RIGHT TO USE "911", APART FROM THE MARK AS SHOWN.

FOR ELECTRONIC TRANSMISSION OF EMERGENCY SIGNALS VIA A TELECOMMUNICATIONS NETWORK FOR SUMMONING EMERGENCY PERSONNEL (U.S. CLS. 100, 101 AND 104).

FIRST USE 9-30-2008; IN COMMERCE 9-30-2008.

3,785,348. VIVENDI, PARIS, FRANCE. SN 77-414,233. PUB. 3-3-2009, FILED 3-5-2008.

VIVENDI ENTERTAINMENT

THE MARK CONSISTS OF STANDARD CHARACTERS WITHOUT CLAIM TO ANY PARTICULAR FONT, STYLE, SIZE, OR COLOR.

OWNER OF U.S. REG. NO. 2,766,054.

CLASS 38—(Continued).

NO CLAIM IS MADE TO THE EXCLUSIVE RIGHT TO USE "ENTERTAINMENT", APART FROM THE MARK AS SHOWN.

FOR BROADCAST OF CABLE TELEVISION PROGRAMS; BROADCASTING PROGRAMS VIA A GLOBAL COMPUTER NETWORK; CABLE RADIO BROADCASTING AND TRANSMISSION; CABLE, NETWORK AND SATELLITE TELEVISION BROADCASTING AND TRANSMISSION SERVICES; TRANSMITTING STREAMED SOUND AND AUDIO-VISUAL RECORDINGS VIA THE INTERNET; STREAMING OF AUDIO AND VIDEO MATERIAL ON THE INTERNET; DIGITAL AND ELECTRONIC TRANSMISSION OF VOICE, DATA, SOUND, IMAGES, AUDIO, VIDEO, SIGNALS, MESSAGES AND INFORMATION; VIDEO-ON-DEMAND TRANSMISSION SERVICES; PROVIDING ON-LINE CHAT ROOMS AND FORUMS AND ELECTRONIC BULLETIN BOARDS FOR TRANSMISSION OF MESSAGES AMONG USERS CONCERNING MUSIC AND ENTERTAINMENT; PROVIDING WIRELESS TRANSMISSION OF UPLOADABLE AND DOWNLOADABLE RING TONES, VOICE, MUSIC, MP3S, GRAPHICS, GAMES, IMAGES, VIDEOS, INFORMATION AND NEWS VIA A GLOBAL COMPUTER NETWORK TO WIRELESS MOBILE COMMUNICATION DEVICES; SENDING AND RECEIVING VOICE AND TEXT MESSAGES BETWEEN WIRELESS COMMUNICATION DEVICES; AND PROVIDING WIRELESS BROADBAND COMMUNICATIONS SERVICES THROUGH WHICH CONSUMERS TRANSMIT POLLING AND VOTING INFORMATION VIA WIRELESS COMMUNICATION DEVICES (U.S. CLS. 100, 101 AND 104).

FIRST USE 1-31-2008; IN COMMERCE 1-31-2008.

3,785,595. AMERICAN LEBANESE SYRIAN ASSOCIATED CHARITIES, INC., MEMPHIS, TN. SN 77-555,594. PUB. 7-14-2009, FILED 8-26-2008.



OWNER OF U.S. REG. NO. 3,412,165.

THE MARK CONSISTS OF THE WORD "ONCOPEDIA", IN STYLIZED LETTERS, WHERE THE SECOND LETTER "O" IS A GLOBE DESIGN WHICH HAS EYES AND HAS ARMS THAT ARE HOLDING A LAPTOP COMPUTER.

FOR PROVIDING AN ONLINE FORUM FOR TRANSMISSION OF MESSAGES AMONG COMPUTER USERS, NAMELY, AN EDUCATIONAL, RESEARCH AND INFORMATION FORUM FOR PHYSICIANS AND OTHER HEALTHCARE PROFESSIONALS WHO PROVIDE CARE TO CHILDREN WITH CANCER WORLDWIDE (U.S. CLS. 100, 101 AND 104).

FIRST USE 6-4-2007; IN COMMERCE 6-4-2007.

CLASS 38—(Continued).

3,785,695. POPSCREEN, INC., HOUSTON, TX. SN 77-623,754.
PUB. 9-8-2009, FILED 12-1-2008.

POPSCREEN

THE MARK CONSISTS OF STANDARD CHARACTERS WITHOUT CLAIM TO ANY PARTICULAR FONT, STYLE, SIZE, OR COLOR.

FOR PROVIDING AN ON-LINE FORUM FOR THE POSTING BY COMPUTER USERS OF VIDEOS IN THE FIELD OF GENERAL INTEREST AND THE TRANSMISSION OF MESSAGES AMONG COMPUTER USERS CONCERNING SUCH VIDEOS (U.S. CLS. 100, 101 AND 104).

FIRST USE 9-1-2009; IN COMMERCE 9-1-2009.

3,785,760. TELECOMMUNICATION SYSTEMS, INC., ANNAPOLIS, MD. SN 77-648,298. PUB. 5-12-2009, FILED 1-13-2009.

VOIP VERIFY

THE MARK CONSISTS OF STANDARD CHARACTERS WITHOUT CLAIM TO ANY PARTICULAR FONT, STYLE, SIZE, OR COLOR.

OWNER OF U.S. REG. NO. 3,527,898.

NO CLAIM IS MADE TO THE EXCLUSIVE RIGHT TO USE "VOIP", APART FROM THE MARK AS SHOWN.

SEC. 2(F).

FOR TELECOMMUNICATION SERVICES, NAMELY, AUTOMATICALLY DETERMINING DURING THE OPERATION OF INTERNET-BASED TELECOMMUNICATION SERVICES WHETHER EMERGENCY NUMBERS ARE IN SERVICE (U.S. CLS. 100, 101 AND 104).

FIRST USE 6-27-2005; IN COMMERCE 6-27-2005.

CLASS 38—(Continued).

3,785,882. MYTEXTSPIRATIONALS, LLC, EAGLE, ID. SN 77-669,633. PUB. 4-28-2009, FILED 2-12-2009.



THE COLOR(S) BLACK, WHITE AND PURPLE IS/ARE CLAIMED AS A FEATURE OF THE MARK.

THE MARK CONSISTS OF THE COLORS BLACK, WHITE, AND PURPLE, WITH THE COLOR BLACK APPEARING IN THE OUTLINE OF A STYLIZED STICK-FIGURE CHILD, THE CHILD'S SMILE, AND IN A HEART-SHAPED DESIGN IN THE CHILD'S HAND, THE COLOR PURPLE APPEARING IN THE BODY OF THE CHILD, AND THE COLOR WHITE APPEARING IN THE BACKGROUND.

FOR TEXT AND NUMERIC WIRELESS DIGITAL MESSAGING SERVICES (U.S. CLS. 100, 101 AND 104).

FIRST USE 5-1-2009; IN COMMERCE 5-1-2009.

3,786,015. MAIZE, INC., SPANISH FORK, UT. SN 77-712,777.
PUB. 9-1-2009, FILED 4-13-2009.

SCREAM TEXT

THE MARK CONSISTS OF STANDARD CHARACTERS WITHOUT CLAIM TO ANY PARTICULAR FONT, STYLE, SIZE, OR COLOR.

NO CLAIM IS MADE TO THE EXCLUSIVE RIGHT TO USE "TEXT", APART FROM THE MARK AS SHOWN.

FOR ELECTRONIC TRANSMISSION OF TELEPHONE TEXT MESSAGES WHICH PROVIDE CLUES IN GAMES IN HAUNTED THEME BUILDING ATTRACTIONS, ON A RECREATIONAL FARM, IN SCAVENGER HUNTS ON A RECREATIONAL FARM, AND IN CORN MAZES AS PARTICIPANTS FIND THEIR WAY THROUGH THE MAZE (U.S. CLS. 100, 101 AND 104).

FIRST USE 3-31-2009; IN COMMERCE 3-31-2009.

CLASS 38—(Continued).

3,786,047. J2 GLOBAL COMMUNICATIONS, INC., HOLLYWOOD, CA. SN 77-731,855. PUB. 9-22-2009, FILED 5-7-2009.

A RADICALLY BETTER PHONE
NUMBER

THE MARK CONSISTS OF STANDARD CHARACTERS WITHOUT CLAIM TO ANY PARTICULAR FONT, STYLE, SIZE, OR COLOR.

FOR TELECOMMUNICATION SERVICES, NAMELY, PERSONAL COMMUNICATION SERVICES; DATA TRANSMISSION AND RECEPTION SERVICES VIA TELECOMMUNICATION MEANS; ELECTRONIC EXCHANGE OF VOICE, DATA, AND GRAPHICS ACCESSIBLE VIA COMPUTER AND TELECOMMUNICATION NETWORKS; LOCAL AND LONG DISTANCE TRANSMISSION OF VOICE, DATA, GRAPHICS VIA COMPUTER AND TELECOMMUNICATIONS NETWORKS; INSTANT MESSAGING SERVICES; VOICE OVER IP (VOIP) SERVICES; VIDEO AND AUDIO CONFERENCING SERVICES CONDUCTED VIA THE WEB, TELEPHONE, AND MOBILE DEVICES; COMMUNICATIONS BY COMPUTER TERMINALS; MOBILE TELEPHONE COMMUNICATION SERVICES; WIRELESS BROADBAND COMMUNICATION SERVICES (U.S. CLS. 100, 101 AND 104).

FIRST USE 1-15-2010; IN COMMERCE 1-15-2010.

CLASS 38—(Continued).

3,786,311. ITRON, INC., LIBERTY LAKE, WA. SN 78-903,265. PUB. 12-12-2006, FILED 6-7-2006.

OPENWAY

THE MARK CONSISTS OF STANDARD CHARACTERS WITHOUT CLAIM TO ANY PARTICULAR FONT, STYLE, SIZE, OR COLOR.

FOR RADIO, PUBLIC AND PRIVATE IP-BASED COMMUNICATION; ELECTRONIC DELIVERY AND TRANSMISSION OF MESSAGES, DATA AND INFORMATION VIA THE INTERNET, INTRANETS, EXTRANETS, RADIO FREQUENCY NETWORKS, WIRELESS NETWORKS, AND TELEPHONE LINES; ELECTRONIC DELIVERY AND TRANSMISSION OF MESSAGES, ENERGY CONSUMPTION AND EVENT INFORMATION; AND RADIO COMMUNICATION ALL FOR USE IN THE UTILITY, POWER AND ENERGY INDUSTRIES (U.S. CLS. 100, 101 AND 104).

FIRST USE 10-17-2006; IN COMMERCE 12-20-2007.

CLASS 39—TRANSPORTATION AND STORAGE

3,785,080. DENUNZIO, DUSTIN J., SOMERVILLE, MA. SN 76-684,584. PUB. 4-21-2009, FILED 12-3-2007.

ICON SECURE STORAGE

NO CLAIM IS MADE TO THE EXCLUSIVE RIGHT TO USE "SECURE STORAGE", APART FROM THE MARK AS SHOWN.

FOR PROVIDING SELF STORAGE FACILITIES FOR OTHERS (U.S. CLS. 100 AND 105).

FIRST USE 10-0-2008; IN COMMERCE 10-0-2008.

3,786,256. HARRIS, FREDERICK J., NAALEHU, HI. SN 78-775,211. PUB. 12-26-2006, FILED 12-16-2005.

InfoPod

THE MARK CONSISTS OF STANDARD CHARACTERS WITHOUT CLAIM TO ANY PARTICULAR FONT, STYLE, SIZE, OR COLOR.

FOR PROVIDING ACCESS BY ADVERTISERS AND END USER CONSUMERS, TO A UNIFORM NETWORK OF INTERNET MASTER CHANNELS BY MECHANICAL, BROADBAND, NARROWBAND, ELECTRONIC, WIRELESS, FIXED WIRELESS, WIRE LINE AND TELECOMMUNICATION SATELLITES FOR THE PURPOSE OF SENDING AND RECEIVING AUDIO, VIDEO, GRAPHICAL AND TEXTUAL INFORMATION ON A GLOBAL COMPUTER NETWORK (U.S. CLS. 100, 101 AND 104).

FIRST USE 1-1-2009; IN COMMERCE 1-1-2010.

3,785,160. METROPOLITAN TRANSPORTATION AUTHORITY, NEW YORK, NY. SN 77-185,901. PUB. 12-16-2008, FILED 5-21-2007.

Take the Train to the Game

THE MARK CONSISTS OF STANDARD CHARACTERS WITHOUT CLAIM TO ANY PARTICULAR FONT, STYLE, SIZE, OR COLOR.

FOR TRANSPORTATION SERVICES, NAMELY, TRANSPORTATION OF PASSENGERS BY SUBWAY AND RAILROAD TO AND FROM SPORTING EVENTS (U.S. CLS. 100 AND 105).

FIRST USE 4-0-2009; IN COMMERCE 4-0-2009.

CLASS 39—(Continued).

3,785,170. MN AIRLINES, LLC, MENDOTA HEIGHTS, MN. SN 77-204,820. PUB. 11-27-2007, FILED 6-13-2007.

UFLY

THE MARK CONSISTS OF STANDARD CHARACTERS WITHOUT CLAIM TO ANY PARTICULAR FONT, STYLE, SIZE, OR COLOR.

FOR AIR TRANSPORTATION SERVICES FEATURING A FREQUENT FLYER INCENTIVE PROGRAM AND CUSTOMER LOYALTY PROGRAM (U.S. CLS. 100 AND 105).

FIRST USE 7-17-2007; IN COMMERCE 7-17-2007.

3,785,194. ANUVA VINOS LLC, WILMINGTON, DE. SN 77-239,919. PUB. 6-10-2008, FILED 7-26-2007.

ANUVA

THE MARK CONSISTS OF STANDARD CHARACTERS WITHOUT CLAIM TO ANY PARTICULAR FONT, STYLE, SIZE, OR COLOR.

THE NAME "ANUVA" DOES NOT IDENTIFY A LIVING INDIVIDUAL.

THE WORDING "ANUVA" HAS NO MEANING IN A FOREIGN LANGUAGE.

FOR WINE CLUB SERVICES FEATURING PERIODIC SHIPMENTS OF WINE TO MEMBERS (U.S. CLS. 100 AND 105).

FIRST USE 12-1-2007; IN COMMERCE 12-1-2007.

3,785,277. GATEWAY ENERGY SERVICES CORPORATION, MONTEBELLO, NY. SN 77-359,031. PUB. 11-3-2009, FILED 12-24-2007.

GATEWAY ENERGY SERVICES

THE MARK CONSISTS OF STANDARD CHARACTERS WITHOUT CLAIM TO ANY PARTICULAR FONT, STYLE, SIZE, OR COLOR.

NO CLAIM IS MADE TO THE EXCLUSIVE RIGHT TO USE "ENERGY SERVICES", APART FROM THE MARK AS SHOWN.

FOR TRANSPORTATION AND DELIVERY OF ENERGY, NAMELY, NATURAL GAS AND ELECTRICITY (U.S. CLS. 100 AND 105).

FIRST USE 0-0-2008; IN COMMERCE 0-0-2008.

CLASS 39—(Continued).

3,785,433. MARQUEZ INVESTMENTS, CHIPLEY, FL. SN 77-477,759. PUB. 11-4-2008, FILED 5-19-2008.

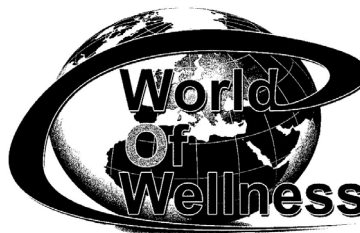

THE STIPPLING IS FOR SHADING PURPOSES ONLY. THE MARK CONSISTS OF THE STYLIZED WORDS "WORLD OF WELLNESS". THE MARK INCORPORATES THE WORDS WRAPPED AROUND AN IMAGE OF A GLOBE.

FOR TRAVEL INFORMATION SERVICES, NAMELY, PROVIDING A WEB SITE FEATURING MEDICAL TRAVEL INFORMATION FOR MAKING TRANSPORTATION RESERVATIONS AND BOOKINGS FOR TRAVEL IN THE U.S. AND TO OTHER COUNTRIES IN ORDER TO OBTAIN HEALTH CARE (U.S. CLS. 100 AND 105).

FIRST USE 9-1-2008; IN COMMERCE 10-1-2008.

3,785,646. STREAMLINE DYNAMICS, INC., FALLBROOK, CA. SN 77-599,068. PUB. 1-13-2009, FILED 10-23-2008.

STREAMLINE dynamics

THE MARK CONSISTS OF STANDARD CHARACTERS WITHOUT CLAIM TO ANY PARTICULAR FONT, STYLE, SIZE, OR COLOR.

FOR WAREHOUSING SERVICES, NAMELY, STORAGE, DISTRIBUTION, PICK-UP, PACKING, AND SHIPPING OF PETROLEUM PRODUCTS (U.S. CLS. 100 AND 105).

FIRST USE 4-6-2009; IN COMMERCE 10-20-2009.

3,786,010. PROVEEDORES Y SOLUCIONES DAC S.A., SAN JOSE, COSTA RICA. SN 77-711,976. PUB. 8-18-2009, FILED 4-11-2009.



NO CLAIM IS MADE TO THE EXCLUSIVE RIGHT TO USE "RENT A CAR", APART FROM THE MARK AS SHOWN.

THE COLOR(S) RED AND WHITE IS/ARE CLAIMED AS A FEATURE OF THE MARK.

CLASS 39—(Continued).

THE MARK CONSISTS OF A RED RECTANGLE WITH THE LITERAL MATTER "ECONOMY RENT A CAR" IN WHITE LETTERING AND A WHITE SPEED BAR DESIGN ELEMENT COMPRISING A WHITE RECTANGLE AND THREE WHITE VERTICAL BARS.

FOR CAR RENTAL; CAR RENTAL, GARAGE AND PARKING SPACE RENTAL; RENTAL CAR RESERVATION; RENTAL OF CARS; RENTAL OF VEHICLES; VEHICLE RENTAL; CAR LEASING; VEHICLE LEASING (U.S. CLS. 100 AND 105).

FIRST USE 12-23-2009; IN COMMERCE 12-23-2009.

3,786,106. MERGENTHALER TRANSFER & STORAGE CO., HELENA, MT. SN 77-756,591. PUB. 10-27-2009, FILED 6-10-2009.

SIM

THE MARK CONSISTS OF STANDARD CHARACTERS WITHOUT CLAIM TO ANY PARTICULAR FONT, STYLE, SIZE, OR COLOR.

FOR TRANSPORT SERVICES, NAMELY, DRIVING MOVING VANS LOADED BY THE CUSTOMER FROM ONE LOCATION TO ANOTHER (U.S. CLS. 100 AND 105).

FIRST USE 8-7-2009; IN COMMERCE 8-7-2009.

3,786,108. MERGENTHALER TRANSFER & STORAGE CO., HELENA, MT. SN 77-756,631. PUB. 10-27-2009, FILED 6-10-2009.

SIMPLE INEXPENSIVE MOVE

THE MARK CONSISTS OF STANDARD CHARACTERS WITHOUT CLAIM TO ANY PARTICULAR FONT, STYLE, SIZE, OR COLOR.

NO CLAIM IS MADE TO THE EXCLUSIVE RIGHT TO USE "MOVE", APART FROM THE MARK AS SHOWN.

FOR TRANSPORT SERVICES, NAMELY, DRIVING MOVING VANS LOADED BY THE CUSTOMER FROM ONE LOCATION TO ANOTHER (U.S. CLS. 100 AND 105).

FIRST USE 8-7-2009; IN COMMERCE 8-7-2009.

CLASS 40—MATERIAL TREATMENT

CLASS 40—(Continued).

3,785,747. FENNELL, MICHAEL, NAPA, CA. SN 77-643,268. PUB. 5-19-2009, FILED 1-5-2009.

NAPA WINE STUDIOS

THE MARK CONSISTS OF STANDARD CHARACTERS WITHOUT CLAIM TO ANY PARTICULAR FONT, STYLE, SIZE, OR COLOR.

NO CLAIM IS MADE TO THE EXCLUSIVE RIGHT TO USE "NAPA WINE", APART FROM THE MARK AS SHOWN.

FOR PROVIDING FACILITIES AT WHICH CUSTOMERS CAN PRODUCE WINE IN NAPA COUNTY, CALIFORNIA (U.S. CLS. 100, 103 AND 106).

FIRST USE 1-21-2010; IN COMMERCE 1-21-2010.

3,786,199. NPC, INC., CLAYSBURG, PA. SN 77-979,106. PUB. 7-21-2009, FILED 3-18-2009.

CONFIDOC

THE MARK CONSISTS OF STANDARD CHARACTERS WITHOUT CLAIM TO ANY PARTICULAR FONT, STYLE, SIZE, OR COLOR.

FOR PRINTING SERVICES (U.S. CLS. 100, 103 AND 106).

FIRST USE 4-27-2009; IN COMMERCE 4-27-2009.

CLASS 41—EDUCATION AND ENTERTAINMENT

3,785,064. CVPH MEDICAL CENTER, PLATTSBURGH, NY. SN 76-644,917. PUB. 11-7-2006, FILED 8-15-2005.

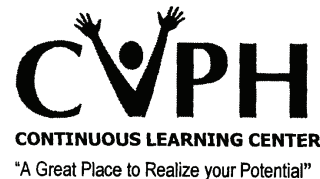
CONTINUOUS LEARNING CENTER
"A Great Place to Realize your Potential"

NO CLAIM IS MADE TO THE EXCLUSIVE RIGHT TO USE "CONTINUOUS LEARNING CENTER", APART FROM THE MARK AS SHOWN.

FOR PROVIDING FORMAL AND INFORMAL CONTINUING EDUCATION SERVICES, MAINLY COURSES IN THE FIELDS OF MEDICINE, EMPLOYEE ORIENTATION AND WORKPLACE ISSUES (U.S. CLS. 100, 101 AND 107).

FIRST USE 1-1-2010; IN COMMERCE 1-1-2010.

CLASS 41—(Continued).

3,785,081. THE WEATHER CHANNEL, INC., ATLANTA, GA. SN 76-684,939. PUB. 12-9-2008, FILED 12-14-2007.

WHEN WEATHER CHANGED HISTORY

THE MARK CONSISTS OF STANDARD CHARACTERS WITHOUT CLAIM TO ANY PARTICULAR FONT, STYLE, SIZE, OR COLOR.

FOR TELEVISION, INTERNET, AND VIDEO PROGRAMMING SERVICES (U.S. CLS. 100, 101 AND 107).
FIRST USE 1-6-2008; IN COMMERCE 11-4-2008.

3,785,098. ATLANTA NATIONAL LEAGUE BASEBALL CLUB, INC., ATLANTA, GA. SN 76-695,257. PUB. 5-5-2009, FILED 1-12-2009.

GWINNETT BRAVES

THE MARK CONSISTS OF STANDARD CHARACTERS WITHOUT CLAIM TO ANY PARTICULAR FONT, STYLE, SIZE, OR COLOR.

OWNER OF U.S. REG. NOS. 829,308, 1,484,697, AND OTHERS.

NO CLAIM IS MADE TO THE EXCLUSIVE RIGHT TO USE "GWINNETT", APART FROM THE MARK AS SHOWN.

FOR ENTERTAINMENT SERVICES, NAMELY, BASEBALL GAMES, COMPETITIONS, TOURNAMENTS AND EXHIBITIONS RENDERED LIVE AND THROUGH BROADCAST MEDIA INCLUDING TELEVISION, RADIO, SATELLITE, WIRELESS, AUDIO AND VIDEO MEDIA, TELEPHONE, FIBER OPTICS, WIRELESS FIDELITY AND OTHER ELECTRONIC MEDIA AND VIA A GLOBAL COMPUTER NETWORK OR A COMMERCIAL ON-LINE SERVICE, MOBILE TELEPHONE OR OTHER ELECTRONIC OR DIGITAL COMMUNICATIONS NETWORK OR DEVICE; INFORMATION SERVICES, NAMELY, PROVIDING INFORMATION IN THE FIELD OF SPORTS, ENTERTAINMENT AND RELATED TOPICS, AND PROVIDING FOR INFORMATIONAL MESSAGES RELATING THERETO; ORGANIZING COMMUNITY SPORTING EVENTS; LIVE PERFORMANCES BY COSTUMED CHARACTERS AND PERFORMANCES FEATURING COSTUMED OR CARTOON CHARACTERS EXHIBITED OVER TELEVISION, SATELLITE AND VIDEO MEDIA; PROVIDING FACILITIES FOR SPORTS EVENTS, TOURNAMENTS, COMPETITIONS, EXHIBITIONS, AND ENTERTAINMENT, INCLUDING PROVIDING SUCH EVENTS FOR PUBLIC EXHIBITION AND TELEVISION AND RADIO BROADCAST AND OTHER MEDIA DISTRIBUTION, AND PROVIDING OTHER CUSTOMARY STADIUM SERVICES, NAMELY, RENTAL OF STADIUM FACILITIES AND PROVIDING FACILITIES FOR STADIUM TOURS AND CONCERTS; WEB SITE FEATURING SPORTS, ENTERTAINMENT AND RELATED TOPICS; FAN CLUBS; FESTIVALS FEATURING A VARIETY OF SPORTS AND ENTERTAINMENT ACTIVITIES; PUBLISHING OF ELECTRONIC PUBLICATIONS; PROVIDING ON-LINE NEWSLETTERS IN THE FIELD OF BASEBALL; ENTERTAINMENT SERVICES IN THE NATURE OF PROMOTING BASEBALL, BASEBALL GAMES, BASEBALL EXHIBITIONS AND BASEBALL HISTORY (U.S. CLS. 100, 101 AND 107).

FIRST USE 11-10-2008; IN COMMERCE 11-10-2008.

CLASS 41—(Continued).

3,785,125. DISNEY ENTERPRISES, INC., BURBANK, CA. SN 77-069,946. PUB. 12-11-2007, FILED 12-21-2006.

JUNGLE JUNCTION

THE MARK CONSISTS OF STANDARD CHARACTERS WITHOUT CLAIM TO ANY PARTICULAR FONT, STYLE, SIZE, OR COLOR.

FOR ENTERTAINMENT SERVICES IN THE NATURE OF PRODUCTION AND DISTRIBUTION OF TELEVISION SHOW PROGRAMS FEATURING ANIMATED SERIES BY MEANS OF AND FOR CABLE TELEVISION, SATELLITE-DELIVERED AND TELEVISION BROADCASTING; ENTERTAINMENT SERVICES, NAMELY, PROVIDING INFORMATION IN THE FIELD OF ENTERTAINMENT RELATING TO TELEVISION SHOW PROGRAMS AND FAMILY ENTERTAINMENT VIA A GLOBAL COMMUNICATIONS NETWORK; ENTERTAINMENT SERVICES, NAMELY, PROVIDING A WEBSITE FEATURING INFORMATION IN THE FIELD OF ENTERTAINMENT RELATING TO TELEVISION SHOW PROGRAMS AND FAMILY ENTERTAINMENT VIA A GLOBAL COMMUNICATIONS NETWORK (U.S. CLS. 100, 101 AND 107).

FIRST USE 10-0-2009; IN COMMERCE 10-0-2009.

3,785,147. OLMSTEAD HEALTH CARE SERVICES, LLC, ALBUQUERQUE, NM. SN 77-142,990. PUB. 11-13-2007, FILED 3-28-2007.

LEVART

THE MARK CONSISTS OF STANDARD CHARACTERS WITHOUT CLAIM TO ANY PARTICULAR FONT, STYLE, SIZE, OR COLOR.

FOR EDUCATIONAL SERVICES, NAMELY, CONDUCTING AND PROVIDING SEMINARS, CLASSES, CONFERENCES, AND WORKSHOPS IN THE FIELDS OF TRAVEL HEALTH AND PANDEMIC PLANNING (U.S. CLS. 100, 101 AND 107).

FIRST USE 6-0-2008; IN COMMERCE 6-0-2008.

3,785,201. MAGIC LU PROMOCOES E EVENTOS, LTDA., BARUERI, SAO PAULO, BRAZIL. SN 77-250,151. PUB. 5-6-2008, FILED 8-8-2007.

LUCIANA GIMENEZ SHOW

THE MARK CONSISTS OF STANDARD CHARACTERS WITHOUT CLAIM TO ANY PARTICULAR FONT, STYLE, SIZE, OR COLOR.

NO CLAIM IS MADE TO THE EXCLUSIVE RIGHT TO USE "SHOW", APART FROM THE MARK AS SHOWN.

CLASS 41—(Continued).

THE NAME(S), PORTRAIT(S), AND/OR SIGNATURE(S) SHOWN IN THE MARK IDENTIFIES "LUCIANA GIMENEZ MORAD", WHOSE CONSENT(S) TO REGISTER IS MADE OF RECORD.

FOR ENTERTAINMENT SERVICES IN THE NATURE OF TELEVISION AND RADIO PROGRAMS IN THE FIELD OF FASHION, MUSIC, ENTERTAINMENT, INTERVIEWS AND NEWS COMMENTS (U.S. CLS. 100, 101 AND 107).

FIRST USE 1-15-2001; IN COMMERCE 12-17-2009.

3,785,212. RONALD M. SOHR, DBA EDUCATION CONCEPTS INTERNATIONAL CORPORATION, NASHVILLE, TN. SN 77-277,793. PUB. 3-4-2008, FILED 9-12-2007.

Tutoring Unlimited

THE MARK CONSISTS OF STANDARD CHARACTERS WITHOUT CLAIM TO ANY PARTICULAR FONT, STYLE, SIZE, OR COLOR.

NO CLAIM IS MADE TO THE EXCLUSIVE RIGHT TO USE "TUTORING", APART FROM THE MARK AS SHOWN.

FOR EDUCATION SERVICES, NAMELY, PROVIDING CLASSES, SEMINARS, WORKSHOPS, TUTORING, AND MENTORING IN THE FIELD OF MIDDLE AND HIGH SCHOOL REFORM (U.S. CLS. 100, 101 AND 107).

FIRST USE 9-1-2007; IN COMMERCE 9-1-2007.

3,785,221. THE AMERICAN OUTDOORSMAN, INC., KANSAS CITY, MO. SN 77-293,246. PUB. 8-4-2009, FILED 10-1-2007.

THE AMERICAN OUTDOORSMAN

THE MARK CONSISTS OF STANDARD CHARACTERS WITHOUT CLAIM TO ANY PARTICULAR FONT, STYLE, SIZE, OR COLOR.

OWNER OF U.S. REG. NOS. 2,619,480, 2,646,583, AND 2,650,644.
SEC. 2(F).

FOR ENTERTAINMENT SERVICES, NAMELY, PROVIDING AN ONGOING SYNDICATED RADIO PROGRAM IN THE FIELD OF HUNTING AND FISHING ACTIVITIES (U.S. CLS. 100, 101 AND 107).

FIRST USE 1-1-2010; IN COMMERCE 1-1-2010.

CLASS 41—(Continued).

3,785,223. WEIGHT WATCHERS INTERNATIONAL, INC., NEW YORK, NY. SN 77-294,333. PUB. 3-25-2008, FILED 10-2-2007.

WEIGHT WATCHERS STOP DIETING START LIVING

THE MARK CONSISTS OF STANDARD CHARACTERS WITHOUT CLAIM TO ANY PARTICULAR FONT, STYLE, SIZE, OR COLOR.

OWNER OF U.S. REG. NOS. 847,199, 3,057,759, AND OTHERS.

FOR CONDUCTING SEMINARS, LECTURES AND WORKSHOPS IN THE FIELDS OF WEIGHT LOSS, WEIGHT CONTROL AND NUTRITION (U.S. CLS. 100, 101 AND 107).

FIRST USE 1-1-2008; IN COMMERCE 1-1-2008.

3,785,278. FUNTACTIX, INC., TEL AVIV 68012, ISRAEL. SN 77-360,940. PUB. 5-13-2008, FILED 12-28-2007.

MOONDO

THE MARK CONSISTS OF STANDARD CHARACTERS WITHOUT CLAIM TO ANY PARTICULAR FONT, STYLE, SIZE, OR COLOR.

FOR ENTERTAINMENT SERVICES, NAMELY, PROVIDING ON-LINE COMPUTER GAMES; PROVIDING A COMPUTER GAME THAT MAY BE ACCESSED NETWORK-WIDE BY NETWORK USERS (U.S. CLS. 100, 101 AND 107).

FIRST USE 2-1-2008; IN COMMERCE 2-1-2008.

3,785,302. ALICE RENELLE BRACEGIRDLE, VICTORIA, BC, CANADA. SN 77-377,163. PUB. 9-2-2008, FILED 1-22-2008.

Bellyfit

THE MARK CONSISTS OF STANDARD CHARACTERS WITHOUT CLAIM TO ANY PARTICULAR FONT, STYLE, SIZE, OR COLOR.

CLASS 41—(Continued).

OWNER OF CANADA REG. NO. TMA699438, DATED 10-25-2007. EXPIRES 10-25-2021.

FOR (BASED ON 44(E)) PROVIDING BELLY DANCE PHYSICAL FITNESS CONDITIONING CLASSES FOR WOMEN; (BASED ON 1(A) USE IN COMMERCE) PROVIDING GROUP PHYSICAL FITNESS CONDITIONING CLASSES; PROVIDING WORKSHOPS, INSTRUCTOR TRAINING COURSES AND CONFERENCES IN THE FIELD OF CULTURAL DANCE FUSION FITNESS FOR WOMEN; PROVIDING MUSICAL EVENTS, NAMELY, LIVE PERFORMANCES BY A DISK JOCKEY AND LIVE PERFORMANCES BY A MUSICAL BAND; PERFORMANCES, NAMELY, ENTERTAINMENT IN THE NATURE OF LIVE DANCE PERFORMANCES; PROVIDING ON-LINE, NON-DOWNLOADABLE PUBLICATIONS IN THE NATURE OF NEWSLETTERS AND ARTICLES IN THE FIELD OF WOMEN'S HEALTH AND WELLNESS (U.S. CLS. 100, 101 AND 107).

FIRST USE 1-1-2005; IN COMMERCE 8-21-2009.

3,785,306. ST. JUDE MEDICAL, INC., ST. PAUL, MN. SN 77-381,243. PUB. 6-17-2008, FILED 1-25-2008.

MORE CONTROL. LESS RISK.

THE MARK CONSISTS OF STANDARD CHARACTERS WITHOUT CLAIM TO ANY PARTICULAR FONT, STYLE, SIZE, OR COLOR.

FOR EDUCATIONAL SERVICES, NAMELY, PROVIDING TRAINING, WORKSHOPS, SEMINARS, DEMONSTRATIONS, AND INSTRUCTION CONCERNING THE USE OF MEDICAL HARDWARE AND SOFTWARE (U.S. CLS. 100, 101 AND 107).

FIRST USE 5-15-2008; IN COMMERCE 5-15-2008.

3,785,333. RANI HANCOCK, BROOKLYN, NY. AND CAMUS CELLI, BROOKLYN, NY. SN 77-403,504. PUB. 7-15-2008, FILED 2-22-2008.

VEL RECORDS

THE MARK CONSISTS OF STANDARD CHARACTERS WITHOUT CLAIM TO ANY PARTICULAR FONT, STYLE, SIZE, OR COLOR.

NO CLAIM IS MADE TO THE EXCLUSIVE RIGHT TO USE "RECORDS", APART FROM THE MARK AS SHOWN.

FOR ENTERTAINMENT SERVICES, NAMELY, MUSICAL SOUND RECORDING PRODUCTION AND AUDIO-VISUAL RECORDING PRODUCTION; MUSIC PUBLISHING SERVICES; ENTERTAINMENT SERVICES, NAMELY, PROVIDING A WEB SITE FEATURING PRE-RECORDED MUSIC, MUSICAL PERFORMANCES AND VIDEO CLIPS, PHOTOGRAPHS, NEWS AND OTHER MULTIMEDIA MATERIALS CONCERNING A RECORD LABEL, MUSICAL ENTERTAINMENT, MUSICAL GROUPS AND SOLO RECORDINGS ARTISTS (U.S. CLS. 100, 101 AND 107).

FIRST USE 8-0-2007; IN COMMERCE 8-0-2007.

CLASS 41—(Continued).

3,785,341. NIELSEN BUSINESS MEDIA, INC., NEW YORK, NY. SN 77-408,237. PUB. 6-10-2008, FILED 2-28-2008.

FIRST IN HOLLYWOOD

THE MARK CONSISTS OF STANDARD CHARACTERS WITHOUT CLAIM TO ANY PARTICULAR FONT, STYLE, SIZE, OR COLOR.

NO CLAIM IS MADE TO THE EXCLUSIVE RIGHT TO USE "HOLLYWOOD", APART FROM THE MARK AS SHOWN.

FOR PROVIDING INFORMATION IN THE FIELD OF FILM, TELEVISION, MUSIC AND ENTERTAINMENT VIA THE INTERNET (U.S. CLS. 100, 101 AND 107).

FIRST USE 4-28-2008; IN COMMERCE 4-28-2008.

3,785,344. BLUEPRINT GROWTH INSTITUTE, INC., OVERLAND PARK, KS. SN 77-412,173. PUB. 12-2-2008, FILED 3-4-2008.

BLUEPRINT QUARTERLY

THE MARK CONSISTS OF STANDARD CHARACTERS WITHOUT CLAIM TO ANY PARTICULAR FONT, STYLE, SIZE, OR COLOR.

OWNER OF U.S. REG. NO. 3,154,747.

NO CLAIM IS MADE TO THE EXCLUSIVE RIGHT TO USE "QUARTERLY", APART FROM THE MARK AS SHOWN.

FOR PROVIDING ON-LINE PUBLICATIONS IN THE NATURE OF ELECTRONIC NEWSLETTERS IN THE FIELD OF BUSINESS MANAGEMENT AND FINANCIAL SERVICES (U.S. CLS. 100, 101 AND 107).

FIRST USE 4-30-2008; IN COMMERCE 4-30-2008.

3,785,361. SEMMEL, NEIL S., BEAR, DE. SN 77-424,955. PUB. 3-3-2009, FILED 3-18-2008.

MARSHMAN

THE MARK CONSISTS OF STANDARD CHARACTERS WITHOUT CLAIM TO ANY PARTICULAR FONT, STYLE, SIZE, OR COLOR.

FOR ORGANIZING COMMUNITY SPORTING AND CULTURAL EVENTS, INCLUDING TRIATHLONS (U.S. CLS. 100, 101 AND 107).

FIRST USE 3-4-2008; IN COMMERCE 3-4-2008.

CLASS 41—(Continued).

3,785,362. BOSTON FOUNDATION, INC., BOSTON, MA. SN 77-426,656. PUB. 7-7-2009, FILED 3-19-2008.

HUB OF INNOVATION

THE MARK CONSISTS OF STANDARD CHARACTERS WITHOUT CLAIM TO ANY PARTICULAR FONT, STYLE, SIZE, OR COLOR.

NO CLAIM IS MADE TO THE EXCLUSIVE RIGHT TO USE "INNOVATION", APART FROM THE MARK AS SHOWN.

FOR PROVIDING ON-LINE PUBLICATIONS, NAMELY, ON-LINE REPORTS AND NEWSLETTERS FEATURING INFORMATION ON THE PAST, PRESENT, AND FUTURE CONDITIONS, CHANGES, AND INNOVATIONS IN CIVIC HEALTH, CULTURAL LIFE AND THE ARTS, EDUCATION, ENVIRONMENT, HOUSING, PUBLIC SAFETY, TECHNOLOGY, TRANSPORTATION, ECONOMY, AND PUBLIC HEALTH IN BOSTON AND RELATED GEOGRAPHIC REGIONS (U.S. CLS. 100, 101 AND 107).

FIRST USE 2-28-2004; IN COMMERCE 2-28-2004.

3,785,383. BOURNE, ROBERT, BONITA SPRINGS, FL. SN 77-443,978. PUB. 3-3-2009, FILED 4-9-2008.

ON THE TEE WITH BOBBYB

THE MARK CONSISTS OF STANDARD CHARACTERS WITHOUT CLAIM TO ANY PARTICULAR FONT, STYLE, SIZE, OR COLOR.

FOR EDUCATIONAL SERVICES IN THE NATURE OF GOLF INSTRUCTION AND DISTRIBUTION OF INSTRUCTIONAL MATERIALS IN CONNECTION THEREWITH (U.S. CLS. 100, 101 AND 107).

FIRST USE 10-30-2009; IN COMMERCE 10-30-2009.

3,785,385. WYLIE, MICHAEL T., TUCSON, AZ. SN 77-444,845. PUB. 11-18-2008, FILED 4-10-2008.

Space Frog

THE MARK CONSISTS OF STANDARD CHARACTERS WITHOUT CLAIM TO ANY PARTICULAR FONT, STYLE, SIZE, OR COLOR.

CLASS 41—(Continued).

NO CLAIM IS MADE TO THE EXCLUSIVE RIGHT TO USE "FROG", APART FROM THE MARK AS SHOWN.

FOR PROVIDING LIVE COSTUMED CHARACTER PERFORMANCES FOR HOSPITALS AND CARE CENTERS FOR UPLIFT AND SUPPORT OF PATIENTS, AND FOR EDUCATIONAL AND MOTIVATIONAL PROMOTION OF RESPECT FOR ONE'S SELF AND FOR OTHERS, RESPONSIBILITY FOR ONE'S OWN ACTIONS, AND THE RIGHTS OF CHILDREN TO EDUCATION AND LEARNING, AND PROVIDING LIVE COSTUMED CHARACTER PERFORMANCES FOR SCHOOLS FOR LEARNING MOTIVATION, NUTRITION EDUCATION, PERSONAL IMPROVEMENT, PERSONAL SAFETY CONSCIOUSNESS, FIRE SAFETY CONSCIOUSNESS, AND FOR EDUCATIONAL AND MOTIVATIONAL PROMOTION OF THE RESPECT FOR ONE'S SELF AND FOR OTHERS, RESPONSIBILITY FOR ONE'S OWN ACTIONS, AND THE RIGHTS OF CHILDREN TO EDUCATION AND LEARNING (U.S. CLS. 100, 101 AND 107).

FIRST USE 9-15-2006; IN COMMERCE 9-15-2006.

3,785,390. TIME INC., NEW YORK, NY. SN 77-447,615. PUB. 12-23-2008, FILED 4-14-2008.

LIFE

THE MARK CONSISTS OF STANDARD CHARACTERS WITHOUT CLAIM TO ANY PARTICULAR FONT, STYLE, SIZE, OR COLOR.

OWNER OF U.S. REG. NOS. 1,320,664, 2,738,548, AND OTHERS.

FOR ENTERTAINMENT SERVICES, NAMELY, PROVIDING A WEB SITE FEATURING PHOTOGRAPHIC, VIDEO AND PROSE PRESENTATIONS FEATURING SUBJECTS IN THE FIELDS OF NEWS, ENTERTAINMENT, SPORTS, CELEBRITIES, TRAVEL, ANIMALS, HISTORICAL FIGURES AND EVENTS, POPULAR CULTURE, HUMAN INTEREST STORIES AND TOPICS OF GENERAL INTEREST; ONLINE PUBLISHING OF ELECTRONIC PUBLICATIONS FEATURING PHOTOGRAPHIC IMAGES, VIDEO FILES AND TEXT; PROVIDING AN ONLINE COMPUTER DATABASE OF PHOTOGRAPHIC IMAGES, VIDEO AND TEXT IN THE FIELDS OF NEWS, ENTERTAINMENT, SPORTS, CELEBRITIES, TRAVEL, ANIMALS, HISTORICAL FIGURES AND EVENTS, POPULAR CULTURE, HUMAN INTEREST STORIES AND TOPICS OF GENERAL INTEREST; ON-LINE LIBRARY SERVICES, NAMELY, PROVIDING ELECTRONIC LIBRARY SERVICES WHICH FEATURE PHOTOGRAPHS, PICTURES AND VIDEOS VIA AN ON-LINE COMPUTER NETWORK (U.S. CLS. 100, 101 AND 107).

FIRST USE 10-29-2009; IN COMMERCE 10-29-2009.

CLASS 41—(Continued).

3,785,401. WORLD WRESTLING ENTERTAINMENT, INC., STAMFORD, CT. SN 77-459,347. PUB. 3-17-2009, FILED 4-28-2008.

ONE NIGHT STAND

THE MARK CONSISTS OF STANDARD CHARACTERS WITHOUT CLAIM TO ANY PARTICULAR FONT, STYLE, SIZE, OR COLOR.

OWNER OF U.S. REG. NO. 3,319,727.
FOR ENTERTAINMENT SERVICES, NAMELY, THE PRODUCTION AND EXHIBITION OF PROFESSIONAL WRESTLING EVENTS RENDERED LIVE AND THROUGH THE MEDIA OF TELEVISION; PROVIDING WRESTLING NEWS AND INFORMATION VIA A GLOBAL COMPUTER NETWORK (U.S. CLS. 100, 101 AND 107).

FIRST USE 6-12-2005; IN COMMERCE 6-12-2005.

3,785,403. ORIENTAL HEALING ARTS ASSOCIATION, PLAISTOW, NH. SN 77-459,455. PUB. 3-17-2009, FILED 4-28-2008.

SENIOR SAFE TAI CHI

THE MARK CONSISTS OF STANDARD CHARACTERS WITHOUT CLAIM TO ANY PARTICULAR FONT, STYLE, SIZE, OR COLOR.

NO CLAIM IS MADE TO THE EXCLUSIVE RIGHT TO USE "SENIOR" AND "TAI CHI", APART FROM THE MARK AS SHOWN.

FOR PROVIDING INSTRUCTION IN TAI CHI (U.S. CLS. 100, 101 AND 107).

FIRST USE 7-8-2009; IN COMMERCE 7-8-2009.

3,785,404. ORIENTAL HEALING ARTS ASSOCIATION, PLAISTOW, NH. SN 77-459,483. PUB. 3-17-2009, FILED 4-28-2008.

SENIOR FRIENDLY TAI CHI

THE MARK CONSISTS OF STANDARD CHARACTERS WITHOUT CLAIM TO ANY PARTICULAR FONT, STYLE, SIZE, OR COLOR.

NO CLAIM IS MADE TO THE EXCLUSIVE RIGHT TO USE "SENIOR" AND "TAI CHI", APART FROM THE MARK AS SHOWN.

FOR PROVIDING INSTRUCTION IN TAI CHI (U.S. CLS. 100, 101 AND 107).

FIRST USE 7-8-2009; IN COMMERCE 7-8-2009.

CLASS 41—(Continued).

3,785,415. FRANKLIN, CANDICE, NEW YORK, NY. SN 77-469,570. PUB. 10-14-2008, FILED 5-8-2008.

Jazz Ain't Dead

THE MARK CONSISTS OF STANDARD CHARACTERS WITHOUT CLAIM TO ANY PARTICULAR FONT, STYLE, SIZE, OR COLOR.

FOR ENTERTAINMENT SERVICES IN THE NATURE OF LIVE MUSICAL PERFORMANCES (U.S. CLS. 100, 101 AND 107).

FIRST USE 4-5-2008; IN COMMERCE 5-20-2008.

3,785,430. UNIVERSAL CITY STUDIOS LLLP, UNIVERSAL CITY, CA. SN 77-476,791. PUB. 12-2-2008, FILED 5-16-2008.

HOLLYWOOD RIP RIDE ROCKIT

THE MARK CONSISTS OF STANDARD CHARACTERS WITHOUT CLAIM TO ANY PARTICULAR FONT, STYLE, SIZE, OR COLOR.

NO CLAIM IS MADE TO THE EXCLUSIVE RIGHT TO USE "HOLLYWOOD", APART FROM THE MARK AS SHOWN.

FOR AMUSEMENT PARK SERVICES (U.S. CLS. 100, 101 AND 107).

FIRST USE 8-15-2009; IN COMMERCE 8-15-2009.

3,785,436. KEITH D. BARDWELL, HARVEY, IL. SN 77-480,788. PUB. 10-21-2008, FILED 5-21-2008.

KB Right Direction

THE MARK CONSISTS OF STANDARD CHARACTERS WITHOUT CLAIM TO ANY PARTICULAR FONT, STYLE, SIZE, OR COLOR.

FOR MULTIMEDIA ENTERTAINMENT SERVICES IN THE NATURE OF RECORDING, PRODUCTION AND POST-PRODUCTION SERVICES IN THE FIELDS OF MUSIC, VIDEO, AND FILMS (U.S. CLS. 100, 101 AND 107).

FIRST USE 9-1-2009; IN COMMERCE 11-6-2009.

CLASS 41—(Continued).

3,785,440. VELOCITY INTERNATIONAL, INC., PITTSBURGH, PA. SN 77-485,325. PUB. 5-12-2009, FILED 5-28-2008.

FIRST SPIN

THE MARK CONSISTS OF STANDARD CHARACTERS WITHOUT CLAIM TO ANY PARTICULAR FONT, STYLE, SIZE, OR COLOR.

FOR ENTERTAINMENT SERVICES, NAMELY, PROVIDING A DIGITAL THEATER ENVIRONMENT IN PRIVATE CLUBS, RESTAURANTS, HOTEL BANQUET FACILITIES, CONVENTION CENTER BANQUET FACILITIES, THEATERS, AND OTHER PUBLIC VENUES (U.S. CLS. 100, 101 AND 107).

FIRST USE 5-2-2008; IN COMMERCE 5-2-2008.

3,785,442. KRISTINE A. KEVORKIAN, ENCINO, CA. SN 77-486,741. PUB. 11-4-2008, FILED 5-29-2008.

ECOLOGICAL GRIEF

THE MARK CONSISTS OF STANDARD CHARACTERS WITHOUT CLAIM TO ANY PARTICULAR FONT, STYLE, SIZE, OR COLOR.

NO CLAIM IS MADE TO THE EXCLUSIVE RIGHT TO USE "GRIEF", APART FROM THE MARK AS SHOWN.

FOR EDUCATIONAL SERVICES, NAMELY, PROVIDING EDUCATIONAL WORKSHOPS AND SEMINARS IN THE FIELDS OF GRIEF RELATED TO ENVIRONMENTAL LOSS AND DESTRUCTION (U.S. CLS. 100, 101 AND 107).

FIRST USE 3-1-2002; IN COMMERCE 2-11-2010.

3,785,465. GAMELOFT S.A., PARIS, FRANCE. SN 77-498,792. PUB. 3-3-2009, FILED 6-13-2008.



OWNER OF U.S. REG. NOS. 2,474,984, 2,519,947, AND OTHERS.

THE COLOR(S) YELLOW AND ORANGE IS/ARE CLAIMED AS A FEATURE OF THE MARK.

CLASS 41—(Continued).

THE MARK CONSISTS OF THE COLORS YELLOW AND ORANGE, WITH THE COLOR YELLOW AT THE TOP OF THE WORDING IN "GAMELOFT" GRADUATING TO ORANGE AND DARK ORANGE TO THE BOTTOM OF THE WORD.

FOR PROVIDING AN ONLINE COMPUTER DATABASE IN THE FIELDS OF COMPUTER GAMES, MOVIES, MUSIC, SPORTS AND ENTERTAINMENT; PROVIDING A WEB SITE FEATURING INFORMATION ABOUT COMPUTER AND VIDEO GAMES, MOVIES, MUSIC, SPORTS AND ENTERTAINMENT; AND ENTERTAINMENT SERVICES, NAMELY, PROVIDING ONLINE COMPUTER GAMES; AND ARRANGING COMPETITIONS AND GAMES RELATING TO EDUCATION AND ENTERTAINMENT (U.S. CLS. 100, 101 AND 107).

FIRST USE 6-0-2008; IN COMMERCE 6-0-2008.

3,785,484. CROWD FUSION, INC., PURCHASE, NY. SN 77-509,019. PUB. 9-15-2009, FILED 6-26-2008.

OBSESSABLE

THE MARK CONSISTS OF STANDARD CHARACTERS WITHOUT CLAIM TO ANY PARTICULAR FONT, STYLE, SIZE, OR COLOR.

FOR PUBLISHING SERVICES, NAMELY, BOOK PUBLISHING, MAGAZINE PUBLISHING, BOOK AND REVIEW PUBLISHING, DESKTOP PUBLISHING FOR OTHERS; ON-LINE PUBLICATION IN THE NATURE OF BLOGS, JOURNALS, MAGAZINES AND REVIEWS IN THE FIELD OF PERSONAL TECHNOLOGY; ELECTRONIC PUBLISHING SERVICES, NAMELY, PUBLICATIONS OF TEXT AND GRAPHIC WORKS OF OTHERS ON-LINE FEATURING BLOGS, DATABASES, NEWS, TOOLS, SURVEYS, AND PROFILES REGARDING PERSONAL TECHNOLOGY; ON-LINE JOURNALS AND BLOGS IN THE FIELD OF PERSONAL TECHNOLOGY (U.S. CLS. 100, 101 AND 107).

FIRST USE 9-24-2008; IN COMMERCE 9-24-2008.

3,785,497. OUTLOOK RESOURCE COMPANY, PINK HILL, NC. SN 77-511,810. PUB. 11-25-2008, FILED 6-30-2008.

FRIENDS OF TOBACCO

THE MARK CONSISTS OF STANDARD CHARACTERS WITHOUT CLAIM TO ANY PARTICULAR FONT, STYLE, SIZE, OR COLOR.

NO CLAIM IS MADE TO THE EXCLUSIVE RIGHT TO USE "TOBACCO", APART FROM THE MARK AS SHOWN.

FOR EDUCATIONAL PROGRAMS AND SEMINARS RELATING TO THE ECONOMIC IMPORTANCE OF TOBACCO AND THE TOBACCO INDUSTRY IN THE UNITED STATES (U.S. CLS. 100, 101 AND 107).

FIRST USE 2-10-2010; IN COMMERCE 2-10-2010.

CLASS 41—(Continued).

3,785,501. SONY PICTURES TELEVISION INC., CULVER CITY, CA. SN 77-512,342. PUB. 11-25-2008, FILED 7-1-2008.

CINEMACTIVE

THE MARK CONSISTS OF STANDARD CHARACTERS WITHOUT CLAIM TO ANY PARTICULAR FONT, STYLE, SIZE, OR COLOR.

FOR ENTERTAINMENT SERVICES IN THE NATURE OF PRODUCTION OF A SERIES OF ENTERTAINMENT PROGRAMS BASED ON MOVIE AND TELEVISION TRIVIA, DISTRIBUTED VIA TELEVISION, THE INTERNET WIRELESS MOBILE DEVICES (U.S. CLS. 100, 101 AND 107).

FIRST USE 4-22-2009; IN COMMERCE 4-22-2009.

CLASS 41—(Continued).

3,785,531. HENDRIX, HARVILLE, NEW YORK, NY. SN 77-523,958. PUB. 12-9-2008, FILED 7-16-2008.

DialogFirst

THE MARK CONSISTS OF STANDARD CHARACTERS WITHOUT CLAIM TO ANY PARTICULAR FONT, STYLE, SIZE, OR COLOR.

FOR EDUCATIONAL SERVICES, NAMELY, CONDUCTING LIVE, TELEPHONE AND ON-LINE COURSES OF INSTRUCTION AND WORKSHOPS IN THE FIELDS OF LEADERSHIP, EXECUTIVE AND PERSONAL LIFE COACHING, BUSINESS CONSULTATION, BUSINESS MANAGEMENT AND CONFLICT RESOLUTION; EDUCATIONAL SERVICES, NAMELY, THE OFFERING OF LIVE, TELEPHONE AND ON-LINE CERTIFICATION OF COACHES, CONSULTANTS, MANAGERS AND INSTRUCTORS IN THE FIELDS OF LEADERSHIP, EXECUTIVE AND PERSONAL LIFE COACHING, BUSINESS CONSULTATION, BUSINESS MANAGEMENT AND CONFLICT RESOLUTION (U.S. CLS. 100, 101 AND 107).

FIRST USE 1-29-2009; IN COMMERCE 1-29-2009.

3,785,518. MARTHA HEINEMAN PIEPER, CHICAGO, IL. AND WILLIAM J. PIEPER, CHICAGO, IL. SN 77-518,770. PUB. 5-26-2009, FILED 7-10-2008.

INNER HUMANISM

THE MARK CONSISTS OF STANDARD CHARACTERS WITHOUT CLAIM TO ANY PARTICULAR FONT, STYLE, SIZE, OR COLOR.

FOR EDUCATIONAL RESEARCH AND ARRANGING AND CONDUCTING EDUCATIONAL CONFERENCES, CLASSES, SEMINARS AND WORKSHOPS IN THE FIELD OF PSYCHOLOGY AND PHILOSOPHY OF MIND, AND DISTRIBUTION OF PRINTED MATERIALS IN CONNECTION THEREWITH (U.S. CLS. 100, 101 AND 107).

FIRST USE 12-0-2008; IN COMMERCE 12-0-2008.

3,785,593. FUNDACION ALAS, PANAMA CITY, PANAMA. SN 77-555,098. PUB. 6-9-2009, FILED 8-25-2008.



THE MARK CONSISTS OF TWO HANDS FORMING THE SHAPE OF A BIRD, UNDERNEATH APPEARS THE STYLIZED WORD IN CURSIVE LETTERS "ALAS"; A RECTANGLE ENCLOSES THE TWO HANDS AND WORDING.

THE ENGLISH TRANSLATION OF "ALAS" IS WINGS. FOR ORGANIZING AND ARRANGING CONCERTS AND CULTURAL EVENTS, NAMELY, MUSICAL SHOWS, MUSICAL PERFORMANCES BY ARTISTS (U.S. CLS. 100, 101 AND 107).

FIRST USE 12-12-2006; IN COMMERCE 12-12-2006.

CLASS 41—(Continued).

3,785,623. NEWSTETTER, MARK A., SAN FRANCISCO, CA. SN 77-578,229. PUB. 11-3-2009, FILED 9-24-2008.

Fretography

THE MARK CONSISTS OF STANDARD CHARACTERS WITHOUT CLAIM TO ANY PARTICULAR FONT, STYLE, SIZE, OR COLOR.

FOR TEACHING IN THE FIELD OF MUSIC (U.S. CLS. 100, 101 AND 107).
FIRST USE 6-3-2009; IN COMMERCE 6-3-2009.

3,785,639. MAANAVI, JENNIFER, NEW YORK, NY. SN 77-592,884. PUB. 7-7-2009, FILED 10-15-2008.

Mat 57

THE MARK CONSISTS OF STANDARD CHARACTERS WITHOUT CLAIM TO ANY PARTICULAR FONT, STYLE, SIZE, OR COLOR.

NO CLAIM IS MADE TO THE EXCLUSIVE RIGHT TO USE "MAT", APART FROM THE MARK AS SHOWN.

FOR PHYSICAL FITNESS INSTRUCTION AND HEALTH CLUB SERVICES, NAMELY, PROVIDING INSTRUCTION AND EQUIPMENT IN THE FIELDS OF PHYSICAL EXERCISE (U.S. CLS. 100, 101 AND 107).
FIRST USE 2-1-2007; IN COMMERCE 2-1-2007.

3,785,644. GREEN, ERIC L., HAMDEN, CT. SN 77-596,908. PUB. 3-24-2009, FILED 10-21-2008.

Tax Genius, LLC

THE MARK CONSISTS OF STANDARD CHARACTERS WITHOUT CLAIM TO ANY PARTICULAR FONT, STYLE, SIZE, OR COLOR.

NO CLAIM IS MADE TO THE EXCLUSIVE RIGHT TO USE "TAX" AND "LLC", APART FROM THE MARK AS SHOWN.

FOR CONTINUING EDUCATION SERVICES, NAMELY, PROVIDING LIVE AND ON-LINE CONTINUING PROFESSIONAL EDUCATION SEMINARS IN THE LEGAL, MEDICAL, ACCOUNTING, AND REAL ESTATE FIELDS (U.S. CLS. 100, 101 AND 107).
FIRST USE 8-1-2009; IN COMMERCE 8-1-2009.

CLASS 41—(Continued).

3,785,689. TRUESLANT, INC., NEW YORK, NY. SN 77-621,869. PUB. 4-14-2009, FILED 11-25-2008.

TRUE / SLANT

THE MARK CONSISTS OF STANDARD CHARACTERS WITHOUT CLAIM TO ANY PARTICULAR FONT, STYLE, SIZE, OR COLOR.

FOR NEWS REPORTING SERVICES IN THE FIELD OF CURRENT EVENTS AND PROVISION OF CURRENT EVENTS NEWS ON-LINE; PROVIDING AN INTERNET NEWS PORTAL FEATURING LINKS TO NEWS STORIES AND ARTICLES IN THE FIELD OF CURRENT EVENTS; PROVIDING INFORMATION, NEWS AND COMMENTARY IN THE FIELD OF CURRENT EVENTS (U.S. CLS. 100, 101 AND 107).
FIRST USE 4-10-2009; IN COMMERCE 4-10-2009.

3,785,691. TRUESLANT, INC., NEW YORK, NY. SN 77-622,019. PUB. 4-14-2009, FILED 11-25-2008.

T / S

THE MARK CONSISTS OF STANDARD CHARACTERS WITHOUT CLAIM TO ANY PARTICULAR FONT, STYLE, SIZE, OR COLOR.

FOR NEWS REPORTING SERVICES IN THE FIELD OF CURRENT EVENTS AND PROVISION OF CURRENT EVENTS NEWS ON-LINE; PROVIDING AN INTERNET NEWS PORTAL FEATURING LINKS TO NEWS STORIES AND ARTICLES IN THE FIELD OF CURRENT EVENTS; PROVIDING INFORMATION, NEWS AND COMMENTARY IN THE FIELD OF CURRENT EVENTS (U.S. CLS. 100, 101 AND 107).
FIRST USE 4-10-2009; IN COMMERCE 4-10-2009.

3,785,749. KAPLAN, SHEILA L., BROOKLYN, NY. SN 77-643,964. PUB. 5-19-2009, FILED 1-6-2009.

MALE TALES

THE MARK CONSISTS OF STANDARD CHARACTERS WITHOUT CLAIM TO ANY PARTICULAR FONT, STYLE, SIZE, OR COLOR.

CLASS 41—(Continued).

NO CLAIM IS MADE TO THE EXCLUSIVE RIGHT TO USE "MALE", APART FROM THE MARK AS SHOWN.

FOR COMPUTER SERVICES, NAMELY, PROVIDING ONLINE PERIODIC NEWSLETTERS THAT CONTAIN STORIES ABOUT MEN AS TOLD BY WOMEN, ABOUT WOMEN AS TOLD BY MEN, OR ABOUT MEN AS TOLD BY MEN (U.S. CLS. 100, 101 AND 107).

FIRST USE 2-28-2009; IN COMMERCE 2-28-2009.

3,785,758. PENTON BUSINESS MEDIA, INC., NEW YORK, NY. SN 77-647,577. PUB. 5-26-2009, FILED 1-12-2009.



tdcompare
by Transmission & Distribution World

OWNER OF U.S. REG. NOS. 1,864,721 AND 3,426,085. THE COLOR(S) RED, BLUE, WHITE AND GRAY IS/ARE CLAIMED AS A FEATURE OF THE MARK.

THE MARK CONSISTS OF THE LETTERS "TD" IN THE COLOR RED FOLLOWED BY THE WORD "COMPARE" IN THE COLOR BLUE, WITH THE WORDS "BY TRANSMISSION & DISTRIBUTION WORLD" BELOW IN THE COLOR WHITE WITHIN A GRAY RECTANGULAR SHAPE.

SEC. 2(F) AS TO "TRANSMISSION & DISTRIBUTION". FOR PROVIDING ONLINE PUBLICATIONS IN THE NATURE OF MAGAZINES AND GUIDES IN THE FIELD OF THE POWER DELIVERY INDUSTRY; PROVIDING ONLINE BUYING GUIDES IN THE FIELD OF THE POWER DELIVERY INDUSTRY (U.S. CLS. 100, 101 AND 107).

FIRST USE 9-0-2009; IN COMMERCE 9-0-2009.

3,785,769. PER4MANCE PLUS, LLC, ORLANDO, FL. SN 77-651,060. PUB. 5-5-2009, FILED 1-16-2009.

THE FOOD TO BODY FUEL DRIVE

THE MARK CONSISTS OF STANDARD CHARACTERS WITHOUT CLAIM TO ANY PARTICULAR FONT, STYLE, SIZE, OR COLOR.

FOR EDUCATION SERVICES, NAMELY, PROVIDING LIVE AND ON-LINE CLASSES, SEMINARS, CONFERENCES, AND WORKSHOPS IN THE FIELD OF HEALTH AND WEIGHT MANAGEMENT FOCUSING ON ENHANCED SPORTS PERFORMANCE AND DISTRIBUTION OF COURSE MATERIAL IN CONNECTION THEREWITH; EDUCATIONAL AND ENTERTAINMENT SERVICES, NAMELY, A CONTINUING PROGRAM ABOUT HEALTH AND WEIGHT MANAGEMENT FOCUSING ON ENHANCED SPORTS PERFORMANCE ACCESSIBLE BY RADIO, TELEVISION, SATELLITE, AUDIO, VIDEO AND COMPUTER NETWORKS; EDUCATIONAL AND ENTERTAINMENT SERVICES, NAMELY, PROVIDING MOTIVATIONAL AND EDUCATIONAL SPEAKERS; EDUCATIONAL AND ENTERTAINMENT SERVICES, NAMELY, PROVIDING MOTIVATIONAL AND EDUCATIONAL SPEAKERS IN THE FIELD OF SELF- AND PERSONAL IMPROVEMENT; EDUCATIONAL AND ENTERTAINMENT SERVICES, NAMELY, PROVIDING MOTIVATIONAL SPEAKING SERVICES IN THE FIELD OF HEALTH AND WEIGHT MANAGEMENT FOCUSING ON ENHANCED SPORTS PERFORMANCE; EDUCATIONAL SERVICES, NAMELY, CONDUCTING INFORMAL ON-

CLASS 41—(Continued).

LINE PROGRAMS IN THE FIELDS OF HEALTH AND WEIGHT MANAGEMENT FOCUSING ON ENHANCED SPORTS PERFORMANCE, AND PRINTABLE MATERIALS DISTRIBUTED THEREWITH; EDUCATIONAL SERVICES, NAMELY, CONDUCTING INFORMAL PROGRAMS IN THE FIELDS OF HEALTH AND WEIGHT MANAGEMENT FOCUSING ON ENHANCED SPORTS PERFORMANCE, USING ON-LINE ACTIVITIES AND INTERACTIVE EXHIBITS, AND PRINTABLE MATERIALS DISTRIBUTED THEREWITH; EDUCATIONAL SERVICES, NAMELY, CONDUCTING ON-LINE EXHIBITIONS AND DISPLAYS AND INTERACTIVE EXHIBITS IN THE FIELD OF HEALTH AND WEIGHT MANAGEMENT FOCUSING ON ENHANCED SPORTS PERFORMANCE; EDUCATIONAL SERVICES, NAMELY, CONDUCTING WORKOUTS, WORKSHOPS, PRESENTATIONS, RETREATS, AND PERSONAL TRAINING IN THE FIELD OF HEALTH AND WEIGHT MANAGEMENT AND DISTRIBUTION OF COURSE MATERIAL IN CONNECTION THEREWITH; EDUCATIONAL SERVICES, NAMELY, DEVELOPING, ARRANGING, AND CONDUCTING EDUCATIONAL CONFERENCES AND PROGRAMS AND PROVIDING COURSES OF INSTRUCTION IN THE FIELD OF HEALTH AND WEIGHT MANAGEMENT FOCUSING ON ENHANCED SPORTS PERFORMANCE; EDUCATIONAL SERVICES, NAMELY, PROVIDING SEMINARS, LECTURES, TELESEMINARS, CLASSES, TELECLASSES, WORKSHOPS, AND DISTRIBUTING COURSE MATERIALS, NAMELY, DVDS, IN CONNECTION THEREWITH, IN THE FIELDS OF HEALTH AND WEIGHT MANAGEMENT; EDUCATIONAL SERVICES, NAMELY, CONDUCTING SEMINARS, LECTURES, TELESEMINARS, TELECLASSES, AND WORKSHOPS IN THE FIELD OF HEALTH AND WEIGHT MANAGEMENT (U.S. CLS. 100, 101 AND 107).

FIRST USE 12-7-2008; IN COMMERCE 12-7-2008.

3,785,771. CALIFORNIA STATE LOTTERY, SACRAMENTO, CA. SN 77-651,417. PUB. 5-5-2009, FILED 1-16-2009.

LUCKY PENNY

THE MARK CONSISTS OF STANDARD CHARACTERS WITHOUT CLAIM TO ANY PARTICULAR FONT, STYLE, SIZE, OR COLOR.

FOR ONGOING SEGMENT OF A GAME SHOW BROADCAST VIA TELEVISION AND ELECTRONIC COMMUNICATION NETWORKS (U.S. CLS. 100, 101 AND 107).

FIRST USE 1-17-2009; IN COMMERCE 1-17-2009.

3,785,778. DORRANI, ANDY, AKA FARZAD ANDY DORRANI, LAS VEGAS, NV. SN 77-654,397. PUB. 7-28-2009, FILED 1-22-2009.

VEGASCONCIERGE.COM

THE MARK CONSISTS OF STANDARD CHARACTERS WITHOUT CLAIM TO ANY PARTICULAR FONT, STYLE, SIZE, OR COLOR.

CLASS 41—(Continued).

OWNER OF U.S. REG. NO. 3,552,303.

FOR ARRANGING AND CONDUCTING NIGHTCLUB ENTERTAINMENT EVENTS (U.S. CLS. 100, 101 AND 107).

FIRST USE 4-29-2002; IN COMMERCE 5-5-2008.

3,785,787. AOL LLC, DULLES, VA. SN 77-656,780. PUB. 5-19-2009, FILED 1-26-2009.

VEONOVELAS

THE MARK CONSISTS OF STANDARD CHARACTERS WITHOUT CLAIM TO ANY PARTICULAR FONT, STYLE, SIZE, OR COLOR.

THE WORD "VEO" IN SPANISH IS THE FIRST PERSON SINGULAR OF THE ENGLISH WORD WATCH, AND THE ENGLISH TRANSLATION OF "NOVELAS" IS NOVELS.

FOR PROVIDING INFORMATION IN THE FIELD OF SOAP OPERAS VIA A COMPUTER NETWORK (U.S. CLS. 100, 101 AND 107).

FIRST USE 7-0-2009; IN COMMERCE 7-0-2009.

3,785,793. PICTURE ME HAPPY, EDGEWOOD, KY. SN 77-657,914. PUB. 6-2-2009, FILED 1-27-2009.



THE COLOR(S) BLACK, BLUE, GREEN, ORANGE, RED AND WHITE IS/ARE CLAIMED AS A FEATURE OF THE MARK.

THE MARK CONSISTS OF A SMALL BLUE STAR IN THE UPPER LEFT, A LARGE BLUE STAR ATTACHED TO THE LEFT LOWER CORNER OF A RAINBOW CONSISTING OF ORANGE, YELLOW, GREEN AND BLUE STRIPES. THE RAINBOW IS ATTACHED AT THE RIGHT END TO A BLACK CAMERA WITH FLASH ATTACHMENT WITH A RED BUTTON AND YELLOW SMILEY FACE ON THE FRONT, WITH FACIAL FEATURES DELINEATED IN BLACK. A SMALL BLUE STAR IS LOCATED BESIDE THE UPPER RIGHT CORNER OF THE CAMERA AND ANOTHER BLUE STAR IS BENEATH THE SMALL STAR. "PICTURE ME HAPPY" IS WRITTEN IN BLUE ABOVE THE IMAGE.

FOR CHARITABLE SERVICES, NAMELY, PROVIDING ARTS AND CRAFTS TO SEVERELY ILL HOSPITALIZED CHILDREN (U.S. CLS. 100, 101 AND 107).

FIRST USE 1-1-2009; IN COMMERCE 1-1-2009.

CLASS 41—(Continued).

3,785,806. BOYS & GIRLS CLUBS OF GREATER DALLAS, INC., DALLAS, TX. SN 77-659,629. PUB. 5-26-2009, FILED 1-29-2009.

**Help a kid out.**

THE MARK CONSISTS OF A DOOR SLIGHTLY AJAR WITH THE WORDS "HELP A KID OUT" TO THE RIGHT OF THE DOOR.

FOR PROVIDING EDUCATIONAL MENTORING SERVICES AND PROGRAMS IN THE FIELD OF THE ARTS, HEALTH, FITNESS, SOCIAL, EDUCATIONAL, VOCATIONAL, CHARACTER AND LEADERSHIP DEVELOPMENT (U.S. CLS. 100, 101 AND 107).

FIRST USE 8-18-2009; IN COMMERCE 8-18-2009.

3,785,807. KALEI HOGAN, LOGAN, UT. SN 77-659,669. PUB. 6-2-2009, FILED 1-29-2009.

KALEI HOGAN

THE MARK CONSISTS OF STANDARD CHARACTERS WITHOUT CLAIM TO ANY PARTICULAR FONT, STYLE, SIZE, OR COLOR.

THE NAME(S), PORTRAIT(S), AND/OR SIGNATURE(S) SHOWN IN THE MARK IDENTIFIES "KALEI HOGAN", WHOSE CONSENT(S) TO REGISTER IS MADE OF RECORD.

FOR ENTERTAINMENT SERVICES, NAMELY, LIVE PERFORMANCES, PERSONAL APPEARANCES AS WELL AS TELEVISION AND RADIO PERFORMANCES BY A MUSICAL ARTIST; ENTERTAINMENT, NAMELY, PRODUCTION OF LIVE THEATRICAL SHOWS, LIVE MUSICAL SHOWS, CONCERTS AND RADIO AND TELEVISION PROGRAMS; VIDEO AND MULTIMEDIA VIDEO PRODUCTION; AUDIO AND VIDEO RECORDING SERVICES; PRODUCTION OF VIDEO AND AUDIO RECORDINGS ON CASSETTES, DVDS, COMPACT DISCS, RECORDS AND IN DIGITAL FORMAT, FEATURING MUSIC; ENTERTAINMENT SERVICES, NAMELY, PROVIDING PRERECORDED MUSIC AND VIDEOS FEATURING MUSIC ONLINE VIA A GLOBAL COMPUTER NETWORK; PROVIDING A WEBSITE FEATURING INFORMATION ON A MUSICAL ARTIST, NAMELY, INFORMATION REGARDING PERFORMANCES, RECORDS, APPEARANCES AND BIOGRAPHICAL INFORMATION ONLINE VIA A GLOBAL COMPUTER NETWORK; MUSIC PUBLISHING SERVICES (U.S. CLS. 100, 101 AND 107).

FIRST USE 1-26-2010; IN COMMERCE 1-26-2010.

CLASS 41—(Continued).

3,785,826. VIP CONNECTION, LLC, NEW YORK, NY. SN 77-661,687. PUB. 10-20-2009, FILED 2-2-2009.

VIPCONNECTION

THE MARK CONSISTS OF STANDARD CHARACTERS WITHOUT CLAIM TO ANY PARTICULAR FONT, STYLE, SIZE, OR COLOR.

FOR ARRANGING AND CONDUCTING NIGHTCLUB ENTERTAINMENT EVENTS; ARRANGING AND CONDUCTING NIGHTCLUB PARTIES (U.S. CLS. 100, 101 AND 107).

FIRST USE 5-0-2009; IN COMMERCE 5-0-2009.

3,785,852. TRUE SPIRIT TRIO, CLARKSVILLE, TN. SN 77-666,104. PUB. 6-9-2009, FILED 2-9-2009.

True Spirit Trio

THE MARK CONSISTS OF STANDARD CHARACTERS WITHOUT CLAIM TO ANY PARTICULAR FONT, STYLE, SIZE, OR COLOR.

NO CLAIM IS MADE TO THE EXCLUSIVE RIGHT TO USE "TRIO", APART FROM THE MARK AS SHOWN.

FOR ENTERTAINMENT IN THE NATURE OF LIVE PERFORMANCES BY A FEMALE GOSPEL TRIO (U.S. CLS. 100, 101 AND 107).

FIRST USE 1-13-2004; IN COMMERCE 7-1-2009.

3,785,855. PITTSBURGH MERCY HEALTH SYSTEM, INC., PITTSBURGH, PA. SN 77-667,144. PUB. 6-9-2009, FILED 2-10-2009.



**PITTSBURGH
MERCY**
A HERITAGE OF HOPE

NO CLAIM IS MADE TO THE EXCLUSIVE RIGHT TO USE "PITTSBURGH", APART FROM THE MARK AS SHOWN.

CLASS 41—(Continued).

THE MARK CONSISTS OF A STYLIZED HEART FORMED BY TWO HANDS ABOVE THE WORDING "PITTSBURGH MERCY A HERITAGE OF HOPE".

FOR EDUCATIONAL SERVICES, NAMELY, COMMUNITY-ORIENTED PROGRAMMING IN THE NATURE OF CLASSES AND WORKSHOPS IN THE FIELD OF WELLNESS (U.S. CLS. 100, 101 AND 107).

FIRST USE 2-11-2009; IN COMMERCE 2-11-2009.

3,785,859. PITTSBURGH MERCY HEALTH SYSTEM, INC., PITTSBURGH, PA. SN 77-667,178. PUB. 6-9-2009, FILED 2-10-2009.



**PITTSBURGH
MERCY**

NO CLAIM IS MADE TO THE EXCLUSIVE RIGHT TO USE "PITTSBURGH", APART FROM THE MARK AS SHOWN.

THE MARK CONSISTS OF A STYLIZED HEART FORMED BY TWO HANDS ABOVE THE WORDING "PITTSBURGH MERCY".

FOR EDUCATIONAL SERVICES, NAMELY, COMMUNITY-ORIENTED PROGRAMMING IN THE NATURE OF CLASSES AND WORKSHOPS IN THE FIELD OF WELLNESS (U.S. CLS. 100, 101 AND 107).

FIRST USE 2-11-2009; IN COMMERCE 2-11-2009.

3,785,880. CHURCHILL DOWNS INCORPORATED, LOUISVILLE, KY. SN 77-669,404. PUB. 6-9-2009, FILED 2-12-2009.



THE MARK CONSISTS OF A DESIGN OF A PROFILE OF A HORSE'S HEAD WITH A ROSE IN THE HORSE'S MOUTH.

FOR ARRANGING OF CONTESTS RELATING TO HORSE RACING (U.S. CLS. 100, 101 AND 107).

FIRST USE 1-10-2009; IN COMMERCE 1-10-2009.

CLASS 41—(Continued).

3,785,884. SIRIUS XM RADIO INC., NEW YORK, NY. SN 77-669,976. PUB. 5-26-2009, FILED 2-13-2009.

CLASS 41—(Continued).

3,785,890. TAMIR LINHART SOCCER TRAINING LLC, MCLEAN, VA. SN 77-672,204. PUB. 6-9-2009, FILED 2-17-2009.

THE POWER ALLEY

THE MARK CONSISTS OF STANDARD CHARACTERS WITHOUT CLAIM TO ANY PARTICULAR FONT, STYLE, SIZE, OR COLOR.

FOR ENTERTAINMENT SERVICES, NAMELY, PROVIDING AUDIO PROGRAMS FEATURING SPORTS, TALK, NEWS, AND DATA VIA SATELLITE AND VIA A GLOBAL COMMUNICATIONS NETWORK (U.S. CLS. 100, 101 AND 107).

FIRST USE 2-16-2009; IN COMMERCE 2-16-2009.

SOCCEROBIX

THE MARK CONSISTS OF STANDARD CHARACTERS WITHOUT CLAIM TO ANY PARTICULAR FONT, STYLE, SIZE, OR COLOR.

FOR EXERCISE CLASSES (U.S. CLS. 100, 101 AND 107).

FIRST USE 2-24-2010; IN COMMERCE 2-24-2010.

3,785,889. WORLD CHAMPION SPORTS GROUP, INC., BEAR, DE. SN 77-671,726. PUB. 8-18-2009, FILED 2-17-2009.

3,785,915. KAPLAN, SHEILA, BROOKLYN, NY. SN 77-678,683. PUB. 5-19-2009, FILED 2-26-2009.



NO CLAIM IS MADE TO THE EXCLUSIVE RIGHT TO USE "SPORTS GROUP", APART FROM THE MARK AS SHOWN.

THE MARK CONSISTS OF THREE LINES OF THE LITERAL ELEMENT, THE FIRST LINE IS "WORLD CHAMPION" (BOLDED AND THE LARGEST FONT), THE SECOND LINE OF THE LITERAL ELEMENT IS "SPORTS GROUP" (BOLDED, SMALLER FONT THEN THE FIRST LINE), THE THIRD LINE IS "BEYOND YOUR POTENTIAL" (NOT BOLDED, ITALICIZED IN QUOTATIONS, SAME FONT AS 2ND LINE). BETWEEN THE FIRST LINE AND THIRD LINE IS A DOUBLE FADED REVERSE CHECK MARK. THE CHECK MARK ON TOP IS SMALLER AND DARKER THAN THE CHECK MARK ON THE BOTTOM, WHICH IS LARGER AND MORE FADED. THE DOUBLE CHECK MARK EXTENDS FROM BELOW THE "W" IN "WORLD CHAMPION", TO THE LEFT OF SPORTS GROUP AND ABOVE THE "BE" IN BEYOND YOUR POTENTIAL AND EXTENDS TO THE LEFT OF THE ENTIRE LITERAL ELEMENT.

FOR SPORT CAMPS (U.S. CLS. 100, 101 AND 107).
FIRST USE 7-13-2009; IN COMMERCE 7-13-2009.



NO CLAIM IS MADE TO THE EXCLUSIVE RIGHT TO USE "MALE", APART FROM THE MARK AS SHOWN.

THE COLOR(S) GRAY, BLACK AND WHITE IS/ARE CLAIMED AS A FEATURE OF THE MARK.

THE MARK CONSISTS OF THE WORDS "MALE TALES" ENCLOSED WITHIN AN ELLIPTICAL OUTLINE HAVING A KEY RING AT ONE END THEREOF WITH TWO KEYS WITHIN THE OUTLINE. THE WORDS "MALE TALES" ARE IN BLACK. THE ELLIPTICAL BACKGROUND IS LIGHT GRAY WITH BLACK AND GRAY OUTLINES, ONE KEY IS DARK GRAY AND BLACK, THE OTHER KEY IS LIGHT GRAY AND BLACK, AND THE KEY RING IS DARK GRAY AND BLACK.

FOR COMPUTER SERVICES, NAMELY, PROVIDING ONLINE PERIODIC NEWSLETTERS THAT CONTAIN STORIES ABOUT MEN AS TOLD BY WOMEN, ABOUT WOMEN AS TOLD BY MEN, OR ABOUT MEN AS TOLD BY MEN (U.S. CLS. 100, 101 AND 107).

FIRST USE 2-28-2009; IN COMMERCE 2-28-2009.

CLASS 41—(Continued).

3,785,927. PHIL WALDREP EVANGELISTIC ASSOCIATION, TRINITY, AL. SN 77-681,396. PUB. 9-22-2009, FILED 3-2-2009.

LIVING WITH JOY WITH PHIL
WALDREP

THE MARK CONSISTS OF STANDARD CHARACTERS WITHOUT CLAIM TO ANY PARTICULAR FONT, STYLE, SIZE, OR COLOR.

OWNER OF U.S. REG. NO. 2,193,313.

THE NAME(S), PORTRAIT(S), AND/OR SIGNATURE(S) SHOWN IN THE MARK IDENTIFIES "PHIL WALDREP", WHOSE CONSENT(S) TO REGISTER IS MADE OF RECORD.

FOR EDUCATIONAL AND ENTERTAINMENT SERVICES, NAMELY, CONTINUING CHRISTIAN PROGRAMMING ACCESSIBLE BY RADIO (U.S. CLS. 100, 101 AND 107).

FIRST USE 10-5-2009; IN COMMERCE 10-5-2009.

CLASS 41—(Continued).

NO CLAIM IS MADE TO THE EXCLUSIVE RIGHT TO USE "SPORTS FEDERATION", APART FROM THE MARK AS SHOWN.

FOR ORGANISATION OF SPORTS COMPETITIONS (U.S. CLS. 100, 101 AND 107).

FIRST USE 4-1-2009; IN COMMERCE 6-1-2009.

3,785,963. HOUBEN, LIGIA, MIAMI, FL. SN 77-692,214. PUB. 7-21-2009, FILED 3-16-2009.

LOS ONCE PRINCIPIOS DE
TRANSFORMACION

THE MARK CONSISTS OF STANDARD CHARACTERS WITHOUT CLAIM TO ANY PARTICULAR FONT, STYLE, SIZE, OR COLOR.

THE ENGLISH TRANSLATION OF "LOS ONCE PRINCIPIOS DE TRANSFORMACION" IN THE MARK IS THE ELEVEN PRINCIPLES OF TRANSFORMATION.

FOR EDUCATIONAL SERVICES, NAMELY, CONDUCTING CLASSES, SEMINARS, AND WORKSHOPS IN THE FIELD OF LIFE TRANSITIONS AND DISTRIBUTION OF COURSE MATERIAL IN CONNECTION THEREWITH (U.S. CLS. 100, 101 AND 107).

FIRST USE 6-18-2009; IN COMMERCE 6-18-2009.

3,785,945. THE TRUSTEES OF THE SUZANNE C. SAPERSTEIN LIVING TRUST, CULVER CITY, CA. SN 77-686,807. PUB. 7-7-2009, FILED 3-9-2009.

BALLIAMOS

THE MARK CONSISTS OF STANDARD CHARACTERS WITHOUT CLAIM TO ANY PARTICULAR FONT, STYLE, SIZE, OR COLOR.

THE ENGLISH TRANSLATION OF "BALLIAMOS" IN THE MARK IS "WE DANCE".

FOR DANCE STUDIOS; EDUCATIONAL SERVICES, NAMELY, PROVIDING CLASSES AND INSTRUCTION IN THE FIELD OF DANCE (U.S. CLS. 100, 101 AND 107).

FIRST USE 6-4-2009; IN COMMERCE 6-4-2009.

3,785,967. HOUBEN, LIGIA, MIAMI, FL. SN 77-693,136. PUB. 7-21-2009, FILED 3-17-2009.

The Eleven Principles of
Transformation

THE MARK CONSISTS OF STANDARD CHARACTERS WITHOUT CLAIM TO ANY PARTICULAR FONT, STYLE, SIZE, OR COLOR.

FOR EDUCATIONAL SERVICES, NAMELY, CONDUCTING CLASSES, SEMINARS, AND WORKSHOPS IN THE FIELD OF LIFE TRANSITIONS AND DISTRIBUTION OF COURSE MATERIAL IN CONNECTION THEREWITH (U.S. CLS. 100, 101 AND 107).

FIRST USE 11-11-2009; IN COMMERCE 11-11-2009.

3,785,960. PLAY UNIVERSAL SOFTBALL FEDERATION, INC., FRANKLIN PARK, IL. SN 77-691,866. PUB. 7-14-2009, FILED 3-16-2009.

Play Universal Sports
Federation

THE MARK CONSISTS OF STANDARD CHARACTERS WITHOUT CLAIM TO ANY PARTICULAR FONT, STYLE, SIZE, OR COLOR.

OWNER OF U.S. REG. NO. 3,450,835.

CLASS 41—(Continued).

3,785,973. GREEN AWARDS, LLC, FAIRFIELD, CT. SN 77-694,679. PUB. 7-21-2009, FILED 3-19-2009.



THE COLOR(S) LIGHT GREEN AND DARK GREEN IS/ARE CLAIMED AS A FEATURE OF THE MARK.

THE MARK CONSISTS OF THE WORDING "B.GREEN" WHERE THE LETTER "B" IS DARK GREEN AND THE WORDING ".GREEN" IS LIGHT GREEN.

FOR PROVIDING RECOGNITION AND INCENTIVES BY THE WAY OF AWARDS AND CONTESTS TO DEMONSTRATE EXCELLENCE IN THE FIELD OF ENVIRONMENTALLY-RESPONSIBLE MARKETING PROGRAMS AND CAMPAIGNS (U.S. CLS. 100, 101 AND 107).

FIRST USE 7-0-2008; IN COMMERCE 7-0-2008.

3,785,990. VIEWOLUX PHOTOGRAPHY, LLC, MENDHAM, NJ. SN 77-702,913. PUB. 7-28-2009, FILED 3-31-2009.



NO CLAIM IS MADE TO THE EXCLUSIVE RIGHT TO USE "PHOTOGRAPHY", APART FROM THE MARK AS SHOWN.

THE MARK CONSISTS OF THE WORDING "VIEWOLUX PHOTOGRAPHY" THE WORD "VIEWOLUX" IN LARGER LETTERING SHOWN ABOVE THE WORD "PHOTOGRAPHY" IN SMALLER LETTERING. THE LETTER "V" IS PRESENTED IN LARGER FONT. AT THE TOP OF THE LEFT SIDE OF THE "V" IS A STICK FIGURE OF A HUMAN FACE LOOKING AT A DEPICTION OF A CAMERA ON THE TOP OF THE RIGHT SIDE OF THE "V".

FOR PHOTOGRAPHIC SERVICES, NAMELY, PHOTOGRAPHIC CAPTURE (U.S. CLS. 100, 101 AND 107).

FIRST USE 2-19-2010; IN COMMERCE 2-19-2010.

3,785,991. AOL INC., DULLES, VA. SN 77-703,187. PUB. 8-18-2009, FILED 3-31-2009.

SCI FI SQUAD

THE MARK CONSISTS OF STANDARD CHARACTERS WITHOUT CLAIM TO ANY PARTICULAR FONT, STYLE, SIZE, OR COLOR.

CLASS 41—(Continued).

OWNER OF U.S. REG. NO. 3,259,920.

NO CLAIM IS MADE TO THE EXCLUSIVE RIGHT TO USE "SCI FI", APART FROM THE MARK AS SHOWN.

FOR ENTERTAINMENT SERVICES, NAMELY, PROVIDING WEBSITES FEATURING INFORMATION IN THE FIELD OF TELEVISION, AND ON-LINE JOURNALS IN THE NATURE OF BLOGS IN THE FIELD OF TELEVISION (U.S. CLS. 100, 101 AND 107).

FIRST USE 6-0-2009; IN COMMERCE 6-0-2009.

3,785,992. AOL INC., DULLES, VA. SN 77-703,189. PUB. 8-18-2009, FILED 3-31-2009.

HORROR SQUAD

THE MARK CONSISTS OF STANDARD CHARACTERS WITHOUT CLAIM TO ANY PARTICULAR FONT, STYLE, SIZE, OR COLOR.

OWNER OF U.S. REG. NO. 3,259,920.

NO CLAIM IS MADE TO THE EXCLUSIVE RIGHT TO USE "HORROR", APART FROM THE MARK AS SHOWN.

FOR ENTERTAINMENT SERVICES, NAMELY, PROVIDING WEBSITES FEATURING INFORMATION IN THE FIELD OF TELEVISION, AND ON-LINE JOURNALS IN THE NATURE OF BLOGS IN THE FIELD OF TELEVISION (U.S. CLS. 100, 101 AND 107).

FIRST USE 6-0-2009; IN COMMERCE 6-0-2009.

3,786,027. AMERICAN EXPRESS MARKETING & DEVELOPMENT CORP., NEW YORK, NY. SN 77-720,642. PUB. 11-3-2009, FILED 4-23-2009.

HOME COOK SUPERSTAR SEARCH

THE MARK CONSISTS OF STANDARD CHARACTERS WITHOUT CLAIM TO ANY PARTICULAR FONT, STYLE, SIZE, OR COLOR.

NO CLAIM IS MADE TO THE EXCLUSIVE RIGHT TO USE "HOME COOK" AND "SEARCH", APART FROM THE MARK AS SHOWN.

FOR ENTERTAINMENT SERVICES, NAMELY, CONDUCTING CONTESTS (U.S. CLS. 100, 101 AND 107).

FIRST USE 8-1-2009; IN COMMERCE 8-1-2009.

CLASS 41—(Continued).

3,786,028. CB TM LLC, MISSION VIEJO, CA. SN 77-721,965. PUB. 11-3-2009, FILED 4-24-2009.

COLDWELL BANKER ON LOCATION

THE MARK CONSISTS OF STANDARD CHARACTERS WITHOUT CLAIM TO ANY PARTICULAR FONT, STYLE, SIZE, OR COLOR.

OWNER OF U.S. REG. NOS. 2,453,334, 2,576,448, AND OTHERS.

FOR EDUCATIONAL AND ENTERTAINMENT SERVICES, NAMELY, PROVIDING ONGOING WEBCASTS AND PODCASTS IN THE FIELD OF REAL ESTATE (U.S. CLS. 100, 101 AND 107).

FIRST USE 5-5-2009; IN COMMERCE 5-5-2009.

3,786,029. HAPPYFEET LEGENDS INTERNATIONAL, LENEXA, KS. SN 77-722,758. PUB. 11-17-2009, FILED 4-27-2009.



THE COLOR(S) RED, YELLOW, BLACK, WHITE, GREEN IS/ARE CLAIMED AS A FEATURE OF THE MARK.

THE MARK CONSISTS OF THE BLACK OUTLINE OF A SOCCER BALL WITH A BLACK SMILING MOUTH AND TWO EYES, AND THREE POLYGONS ON THE EDGE WITH A RED RIGHT FOOT WITH BLACK BORDER AND YELLOW LEFT FOOT WITH BLACK BORDER MAKING UP A STYLIZED CHARACTER. BELOW THE CHARACTER IS THE WORD "HAPPYFEET" IN BLACK WITH THE "HAPPY" ELEMENT IN BOLD FACE, THE WORD ELEMENT IS UNDERLINED IN BLACK AND BELOW THE UNDERLINE APPEARS THE WORD ELEMENT "LEGENDS" IN RED. THIS WORD ELEMENT IS SLIGHTLY ARCHED WITH THE MIDDLE LETTERS OF THE WORD BEING HIGHER IN PLACEMENT THAN THE END LETTERS. BELOW THE WORLD ELEMENT "LEGENDS" APPEARS A WREATH OF GREEN LEAVES WITH A BLACK BORDERED SHIELD WITH RED CENTER SUPERIMPOSED ON THE CENTER OF THE WREATH. THE SHIELD HAS A BLACK AND WHITE BALL IN THE CENTER OF THE RED FIELD.

FOR ENTERTAINMENT IN THE NATURE OF SOCCER GAMES; ORGANIZING SPORTING EVENTS, NAMELY, SOCCER LEAGUES; SOCCER CAMPS; SOCCER INSTRUCTION (U.S. CLS. 100, 101 AND 107).

FIRST USE 11-1-2009; IN COMMERCE 11-1-2009.

CLASS 41—(Continued).

3,786,045. HOLDINGS ACQUISITION COMPANY LP, CHICAGO, IL. SN 77-731,302. PUB. 11-24-2009, FILED 5-7-2009.



NO CLAIM IS MADE TO THE EXCLUSIVE RIGHT TO USE "CASINO", APART FROM THE MARK AS SHOWN.

THE MARK CONSISTS OF THE TEXT "RIVERS CASINO" WITH THE WORD "RIVERS" UNDERLINED.

FOR CASINOS (U.S. CLS. 100, 101 AND 107).

FIRST USE 8-9-2009; IN COMMERCE 8-9-2009.

3,786,070. WILSON, BETH, MOUNTAIN VIEW, CA. SN 77-743,006. PUB. 9-29-2009, FILED 5-22-2009.

THE SISTERHOOD GENE

THE MARK CONSISTS OF STANDARD CHARACTERS WITHOUT CLAIM TO ANY PARTICULAR FONT, STYLE, SIZE, OR COLOR.

FOR EDUCATIONAL SERVICES, NAMELY, CONDUCTING LECTURES, WORKSHOPS AND SEMINARS IN THE FIELD OF PERSONAL GROWTH, SELF IMPROVEMENT, MOTIVATION, EMPOWERMENT AND THE POWER OF SOCIAL CHANGE AND DISTRIBUTION OF TRAINING MATERIAL IN CONNECTION THEREWITH (U.S. CLS. 100, 101 AND 107).

FIRST USE 2-28-2010; IN COMMERCE 2-28-2010.

3,786,167. ALIGN TECHNOLOGY, INC., SANTA CLARA, CA. SN 77-978,731. PUB. 11-27-2007, FILED 1-30-2007.

ALIGNTECH

THE MARK CONSISTS OF STANDARD CHARACTERS WITHOUT CLAIM TO ANY PARTICULAR FONT, STYLE, SIZE, OR COLOR.

OWNER OF U.S. REG. NO. 3,181,043.

FOR TRAINING IN THE FIELDS OF DENTISTRY AND ORTHODONTIA (U.S. CLS. 100, 101 AND 107).

FIRST USE 2-29-2008; IN COMMERCE 2-29-2008.

CLASS 41—(Continued).

3,786,176. THE RAY CHARLES FOUNDATION, LOS ANGELES, CA. SN 77-978,956. PUB. 10-30-2007, FILED 12-11-2006.



THE MARK CONSISTS OF A CARICATURE OF DECEASED SINGER RAY CHARLES FEATURING THE LAPELS OF A SUIT JACKET, THE BREAST OF A DRESS SHIRT, A BOW TIE, AND THE FACE OF RAY CHARLES WEARING SUNGLASSES.

FOR ENTERTAINMENT SERVICES, CONCERTS, MOVIES, SHOWS, PLAYS AND MUSICAL PERFORMANCES BROADCAST OVER TELEVISION, SATELLITE, AUDIO, AND VIDEO MEDIA; PROVIDING A WEBSITE AND AN ONLINE INTERACTIVE COMPUTER DATABASE IN THE FIELDS OF ENTERTAINMENT, SOUND AND MUSIC VIDEO RECORDINGS, MOVIES AND SHOWS (U.S. CLS. 100, 101 AND 107).

FIRST USE 0-0-2002; IN COMMERCE 0-0-2002.

3,786,224. CRUZ, RICHARD, PINE HILL, NJ. SN 78-623,153. PUB. 1-24-2006, FILED 5-4-2005.

STREET BALL MAGIC

THE MARK CONSISTS OF STANDARD CHARACTERS WITHOUT CLAIM TO ANY PARTICULAR FONT, STYLE, SIZE, OR COLOR.

NO CLAIM IS MADE TO THE EXCLUSIVE RIGHT TO USE "STREETBALL", APART FROM THE MARK AS SHOWN.

FOR EDUCATIONAL AND ENTERTAINMENT SERVICES, NAMELY, CONDUCTING AND ARRANGING SPORTS CLINICS AND COACHES CLINICS AND SPORTING EVENTS (U.S. CLS. 100, 101 AND 107).

FIRST USE 8-15-2009; IN COMMERCE 8-15-2009.

CLASS 41—(Continued).

3,786,241. JETBLUE AIRWAYS CORPORATION, FOREST HILLS, NY. SN 78-702,572. PUB. 12-5-2006, FILED 8-29-2005.

JETBLUE

THE MARK CONSISTS OF STANDARD CHARACTERS WITHOUT CLAIM TO ANY PARTICULAR FONT, STYLE, SIZE, OR COLOR.

OWNER OF U.S. REG. NOS. 2,449,988, 2,896,785, AND OTHERS.

FOR PROVIDING ON-LINE, MAGAZINES AND JOURNALS IN THE FIELDS OF TRANSPORTATION AND TRAVEL (U.S. CLS. 100, 101 AND 107).

FIRST USE 7-30-2009; IN COMMERCE 7-30-2009.

3,786,243. MARS, MICK, WEST HOLLYWOOD, CA. SN 78-708,597. PUB. 12-12-2006, FILED 9-7-2005.

MICK MARS

THE MARK CONSISTS OF STANDARD CHARACTERS WITHOUT CLAIM TO ANY PARTICULAR FONT, STYLE, SIZE, OR COLOR.

FOR ENTERTAINMENT SERVICES, NAMELY, PROVIDING A WEB SITE FEATURING INFORMATION RELATING TO LIVE PERFORMANCES, MUSICAL AND VIDEO RECORDINGS, AND PHOTOGRAPHS (U.S. CLS. 100, 101 AND 107).

FIRST USE 9-1-2005; IN COMMERCE 9-1-2005.

3,786,253. MELISSA A. YOUNG, ATLANTA, GA. SN 78-749,119. PUB. 11-7-2006, FILED 11-8-2005.

SugaShack Music

THE MARK CONSISTS OF STANDARD CHARACTERS WITHOUT CLAIM TO ANY PARTICULAR FONT, STYLE, SIZE, OR COLOR.

NO CLAIM IS MADE TO THE EXCLUSIVE RIGHT TO USE "MUSIC", APART FROM THE MARK AS SHOWN.

FOR MUSIC PRODUCTION (U.S. CLS. 100, 101 AND 107).

FIRST USE 8-25-2000; IN COMMERCE 11-1-2003.

CLASS 41—(Continued).

3,786,258. WILCOX, KELLY KAY, AKA KELLY TRAVERS, SANTA BARBARA, CA. SN 78-783,703. PUB. 1-13-2009, FILED 1-2-2006.



THE MARK CONSISTS OF GRAPHIC IMAGE OF THE LETTER "C" WITH THE FORM OF A PERSON SITTING IN THE LETTER AND PAINTING.

FOR ANIMATION PRODUCTION SERVICES; PUBLISHING AND DISTRIBUTION OF BOOKS, REVIEWS AND OTHER PRINTED MATTER AS WELL AS RELATED ELECTRONIC DATA CARRIERS; SPECIAL EFFECTS ANIMATION SERVICES FOR FILM AND VIDEO (U.S. CLS. 100, 101 AND 107).

FIRST USE 5-15-2004; IN COMMERCE 5-15-2004.

3,786,282. WIZ KOREA CO., LTD., GYEONGGI-DO, REPUBLIC OF KOREA. SN 78-853,708. PUB. 11-25-2008, FILED 4-4-2006.



NO CLAIM IS MADE TO THE EXCLUSIVE RIGHT TO USE "GENUINE PLAY SCHOOL", APART FROM THE MARK AS SHOWN.

THE COLOR(S) BLUE, YELLOW, GREEN, PINK, PURPLE, RED, ORANGE, BLACK, TAN, AND WHITE IS/ARE CLAIMED AS A FEATURE OF THE MARK.

THE MARK CONSISTS OF THE REPRESENTATION OF A CHILD WITH A BLUE WIZARD HAT AND AN ORANGE STAR THAT IS OUTLINED IN YELLOW, HAS A PINK NOSE WITH TWO WHITE DOTS, A RED MOUTH, PINK CHEEKS, BLACK EYES AND EYEBROWS, ORANGE HAIR, TAN SKIN ON ITS FACE AND HANDS; THE CHILD IS WEARING A BLUE DRESS WITH PINK, ORANGE AND RED STARS; THE CHILD IS WEARING PINK SHOES WITH WHITE SHADING AND IS HOLDING A CANE WITH BLUE STRIPES WITH STARS OF YELLOW, ORANGE, RED AND PINK LEADING FROM THE END OF THE CANE TO AN ARBITRARY DESIGN. THE ARBITRARY DESIGN AS THE END OF THE STARS COMING FROM THE CANE AND IN THE CENTER OF THE CHILD'S DRESS CONSISTS OF A PURPLE BACKGROUND CIRCLE THAT IS OUTLINED BY A LIGHT BLUE CIRCLE; THE LIGHT BLUE CIRCLE IS OUTLINED IN WHITE AND SURROUNDED BY A TWO-

CLASS 41—(Continued).

TONE BLUE STRIPED BROKEN CIRCLE WITH A CURVED PIECE FLOATING ABOVE THE OPEN SECTION, AND IN THE CENTER OF THE PURPLE CIRCLE APPEARS THE WORD "WIZ" WITH THE "W" IN YELLOW, THE "I" IN GREEN, THE "Z" IN RED, BELOW "WIZ" IS THE WORD "ISLAND" WHICH IS IN WHITE WITH ORANGE AND RED STARS UNDERNEATH IT, THE WORDS "GENUINE PLAY SCHOOL" ARE IN WHITE AND APPEARS ARCHING ABOVE A GENIE LAMP THAT IS IN BLUE WITH RED AND ORANGE STARS COMING OUT OF THE END OF IT.

FOR PUBLICATION OF TEXTS; PUBLICATION OF BOOKS; PUBLICATION OF ON-LINE ELECTRONIC BOOKS AND MAGAZINES OF OTHERS FEATURING WORD RECOGNITION, READING STORIES, ARITHMETIC; PROVIDING NON-DOWNLOADABLE ON-LINE ELECTRONIC PUBLICATIONS IN THE NATURE OF BOOKS, MAGAZINES, AND PAMPHLETS IN THE FIELD OF WORD RECOGNITION, READING STORIES, ARITHMETIC; DIGITAL IMAGING SERVICES; TEACHING SERVICES, NAMELY, TEACHING AT PRE-SCHOOL; EDUCATIONAL EXAMINATION INFORMATION ABOUT EDUCATION; PROVIDING COURSES OF INSTRUCTION TO CHILDREN AT THE INFANT AND PRE-SCHOOL LEVEL; ORGANIZATION OF EXHIBITIONS FOR CULTURAL OR EDUCATIONAL PURPOSES; PROVIDING EDUCATION CLASSES IN THE FIELD OF GENERAL EDUCATION FOR KINDERGARTEN STUDENTS; EDUCATION SERVICES, NAMELY, PROVIDING COURSES IN THE NATURE OF CLASSES, SEMINARS, WORKSHOPS IN THE FIELD OF TELECOMMUNICATION; PHYSICAL EDUCATION (U.S. CLS. 100, 101 AND 107).

FIRST USE 4-1-2006; IN COMMERCE 4-1-2006.

3,786,284. HERLANDS, LEE, BEACHWOOD, OH. SN 78-854,234. PUB. 12-5-2006, FILED 4-5-2006.

7th Inning Comedy Stretch

THE MARK CONSISTS OF STANDARD CHARACTERS WITHOUT CLAIM TO ANY PARTICULAR FONT, STYLE, SIZE, OR COLOR.

NO CLAIM IS MADE TO THE EXCLUSIVE RIGHT TO USE "COMEDY", APART FROM THE MARK AS SHOWN.

FOR ENTERTAINMENT IN THE NATURE OF COMEDY PERFORMANCES DURING ATHLETIC PROGRAMS (U.S. CLS. 100, 101 AND 107).

FIRST USE 7-0-2005; IN COMMERCE 7-0-2005.

CLASS 41—(Continued).

3,786,287. COMMON SENSE MEDIA, SAN FRANCISCO, CA.
SN 78-858,146. PUB. 11-21-2006, FILED 4-10-2006.

SANITY, NOT CENSORSHIP

THE MARK CONSISTS OF STANDARD CHARACTERS WITHOUT CLAIM TO ANY PARTICULAR FONT, STYLE, SIZE, OR COLOR.

FOR EDUCATIONAL SERVICES, NAMELY, PROVIDING SEMINARS AND WORKSHOPS IN THE FIELD OF CHILDREN, FAMILIES, AND ENTERTAINMENT MEDIA; EDUCATIONAL SERVICES, NAMELY, CONDUCTING ON-LINE EXHIBITIONS AND DISPLAYS AND INTERACTIVE EXHIBITS IN THE FIELD OF CHILDREN, FAMILIES, AND ENTERTAINMENT MEDIA; PROVIDING A WEBSITE FEATURING INFORMATION, ADVICE, ANALYSIS, MONITORING, RATINGS AND REVIEWS IN THE FIELD OF ENTERTAINMENT MEDIA; PROVIDING INFORMATION IN THE FORM OF REVIEWS AND RATINGS OF ENTERTAINMENT MEDIA; PROVIDING ONLINE INFORMATION REGARDING ENTERTAINMENT AND THE MEDIA (U.S. CLS. 100, 101 AND 107).

FIRST USE 9-16-2008; IN COMMERCE 9-16-2008.

3,786,304. BENSRUN, INC., BURBANK, CA. SN 78-888,468.
PUB. 12-26-2006, FILED 5-20-2006.

DUMB LUCK FILMS

THE MARK CONSISTS OF STANDARD CHARACTERS WITHOUT CLAIM TO ANY PARTICULAR FONT, STYLE, SIZE, OR COLOR.

NO CLAIM IS MADE TO THE EXCLUSIVE RIGHT TO USE "FILMS", APART FROM THE MARK AS SHOWN.

FOR PRODUCTION AND DISTRIBUTION OF MOTION PICTURE FILMS, TELEVISION PROGRAMS AND DIRECT VIDEO (U.S. CLS. 100, 101 AND 107).

FIRST USE 2-8-2010; IN COMMERCE 2-8-2010.

3,786,315. UMG RECORDINGS, INC., SANTA MONICA, CA.
SN 78-912,377. PUB. 7-3-2007, FILED 6-20-2006.

A&M RECORDS

THE MARK CONSISTS OF STANDARD CHARACTERS WITHOUT CLAIM TO ANY PARTICULAR FONT, STYLE, SIZE, OR COLOR.

OWNER OF U.S. REG. NO. 838,810.

CLASS 41—(Continued).

NO CLAIM IS MADE TO THE EXCLUSIVE RIGHT TO USE "RECORDS", APART FROM THE MARK AS SHOWN.

FOR PRODUCTION OF TELEVISION AND RADIO PROGRAMS; DISTRIBUTION OF TELEVISION AND RADIO PROGRAMS FOR OTHERS; PRODUCTION AND PUBLISHING OF MUSIC; FAN CLUBS; DEVELOPMENT AND DISSEMINATION OF EDUCATIONAL MATERIALS OF OTHERS IN THE FIELD OF MUSIC AND ENTERTAINMENT; RADIO ENTERTAINMENT PRODUCTION; AUDIO AND SOUND RECORDING AND PRODUCTION; RECORD PRODUCTION; VIDEOTAPE PRODUCTION; PRODUCTION AND DISTRIBUTION OF MOTION PICTURE FILMS; TELEVISION PROGRAM SYNDICATION; ENTERTAINMENT IN THE NATURE OF ONGOING TELEVISION PROGRAMS IN THE FIELD OF MUSIC AND ENTERTAINMENT; ENTERTAINMENT, NAMELY, A CONTINUING MUSIC AND ENTERTAINMENT SHOW DISTRIBUTED OVER TELEVISION, SATELLITE, AUDIO, AND VIDEO MEDIA; PUBLICATION OF BOOKS AND MAGAZINES; ENTERTAINMENT IN THE NATURE OF ONGOING RADIO PROGRAMS; ENTERTAINMENT IN THE NATURE OF LIVE CONCERTS AND PERFORMANCES BY MUSICAL ARTISTS AND GROUPS; ENTERTAINMENT SERVICES, NAMELY, PERSONAL APPEARANCES BY MUSICAL GROUPS, MUSICAL ARTISTS AND CELEBRITIES; ENTERTAINMENT SERVICES IN THE NATURE OF MUSIC RENDERED BY MUSICAL ARTISTS THROUGH THE MEDIUM OF TELEVISION, RADIO AND RECORDING; ENTERTAINMENT SERVICES, NAMELY, PRODUCTION OF TELEVISION SHOWS, SPORTS EVENTS, FASHION SHOWS, GAME SHOWS, MUSIC SHOWS, AWARD SHOWS AND COMEDY SHOWS BEFORE LIVE AUDIENCES WHICH ARE ALL BROADCAST LIVE OR TAPED FOR LATER BROADCAST; ENTERTAINMENT SERVICES, NAMELY, PROVIDING A WEB SITE FEATURING MUSICAL PERFORMANCES, MUSICAL VIDEOS, RELATED FILM CLIPS, PHOTOGRAPHS, AND OTHER MULTIMEDIA MATERIALS; ENTERTAINMENT SERVICES, NAMELY, PROVIDING ON-LINE REVIEWS OF MUSIC, MUSICAL ARTISTS AND MUSIC VIDEOS; ENTERTAINMENT SERVICES, NAMELY, PROVIDING PRERECORDED MUSIC, INFORMATION IN THE FIELD OF MUSIC, AND COMMENTARY AND ARTICLES ABOUT MUSIC, ALL ON-LINE VIA A GLOBAL COMPUTER NETWORK; ENTERTAINMENT SERVICES, NAMELY, LIVE, TELEVISED AND MOVIE APPEARANCES BY A PROFESSIONAL ENTERTAINER; CONDUCTING ENTERTAINMENT EXHIBITIONS IN THE NATURE OF MUSIC FESTIVALS; ENTERTAINMENT SERVICES, NAMELY, CONDUCTING EXHIBITIONS IN THE FIELD OF MUSIC AND THE ARTS; ORGANIZING EXHIBITIONS FOR ENTERTAINMENT PURPOSES FEATURING MUSIC AND THE ARTS; AND PUBLISHING OF WEB MAGAZINES (U.S. CLS. 100, 101 AND 107).

FIRST USE 9-1-1962; IN COMMERCE 9-1-1962.

3,786,334. DIRECTV, INC., EL SEGUNDO, CA. SN 78-963,203.
PUB. 4-17-2007, FILED 8-29-2006.

GAME LOUNGE

THE MARK CONSISTS OF STANDARD CHARACTERS WITHOUT CLAIM TO ANY PARTICULAR FONT, STYLE, SIZE, OR COLOR.

CLASS 41—(Continued).

NO CLAIM IS MADE TO THE EXCLUSIVE RIGHT TO USE GAME, APART FROM THE MARK AS SHOWN.

FOR ENTERTAINMENT SERVICES, NAMELY, PROVIDING ON-LINE COMPUTER GAMES; PROVIDING A COMPUTER GAME THAT MAY BE ACCESSED NETWORK-WIDE BY NETWORK USERS; PROVIDING ON-LINE PUBLICATIONS IN THE NATURE OF ONLINE NEWSLETTERS IN THE FIELD OF GAMING (U.S. CLS. 100, 101 AND 107).

FIRST USE 5-31-2008; IN COMMERCE 5-31-2008.

3,786,335. B & D, INC., NASHVILLE, TN. SN 78-966,947. PUB. 2-13-2007, FILED 9-5-2006.

PLAY SOMETHING COUNTRY

THE MARK CONSISTS OF STANDARD CHARACTERS WITHOUT CLAIM TO ANY PARTICULAR FONT, STYLE, SIZE, OR COLOR.

FOR PROVIDING A WEBSITE FEATURING PRERECORDED MUSICAL CLIPS, PHOTOGRAPHS, NEWS, REVIEWS AND OTHER MULTIMEDIA ARTICLES IN CONNECTION WITH A MUSICAL GROUP (U.S. CLS. 100, 101 AND 107).

FIRST USE 5-0-2008; IN COMMERCE 5-0-2008.

3,786,346. TIBCO SOFTWARE INC., PALO ALTO, CA. SN 78-981,355. PUB. 5-29-2007, FILED 1-18-2006.

THE POWER TO PREDICT

THE MARK CONSISTS OF STANDARD CHARACTERS WITHOUT CLAIM TO ANY PARTICULAR FONT, STYLE, SIZE, OR COLOR.

FOR EDUCATIONAL SERVICES, NAMELY, PROVIDING CLASSES, SEMINARS, CONFERENCES, AND WORKSHOPS IN THE FIELD OF COMPUTER SOFTWARE (U.S. CLS. 100, 101 AND 107).

FIRST USE 12-18-2009; IN COMMERCE 12-18-2009.

CLASS 42—SCIENTIFIC AND COMPUTER SERVICES**CLASS 42—(Continued).**

3,785,077. JOSEFEK, KIRT L., FRAMINGHAM, MA. SN 76-670,000. PUB. 7-3-2007, FILED 12-6-2006.



The logo for 'healthcore' features the word 'healthcore' in a lowercase, bold, sans-serif font. The letter 'o' in 'core' is replaced by a solid black circle.

FOR DESIGN FOR OTHERS OF HEALTH AND WELLNESS AID PRODUCTS, NAMELY, PRESHAPED CUSHIONS, CONTOURED PILLOWS, HOT/COLD COMPRESS WRAPS (U.S. CLS. 100 AND 101).

FIRST USE 12-6-2006; IN COMMERCE 1-4-2010.

3,785,112. SYNCUP, INC., DANVILLE, CA. SN 77-012,646. PUB. 5-13-2008, FILED 10-3-2006.



The logo for 'SyncUp' features a large, stylized 'S' on the left, followed by the word 'SyncUp' in a bold, sans-serif font. Below 'SyncUp' is the tagline 'SyncUp Your World.' in a smaller, lighter font.

NO CLAIM IS MADE TO THE EXCLUSIVE RIGHT TO USE "SYNC UP", APART FROM THE MARK AS SHOWN.

THE MARK CONSISTS OF THE WORDING "SYNCUP SYNCUP YOUR WORLD" AND AN "S" DESIGN TO ITS LEFT.

FOR ONLINE, NON-DOWNLOADABLE COMPUTER SOFTWARE FOR STORING, CONVEYING, AND UPDATING CONTACT INFORMATION; PROVIDING A WEBSITE FOR USE IN ADDING AND SYNCHRONIZING USERS AND CONTACT INFORMATION WITH ONLINE COMPUTER SOFTWARE USED IN THE STORING, CONVEYING, AND UPDATING OF CONTACT INFORMATION; PROVIDING A WEBSITE FOR STORING, SEARCHING, REQUESTING, CONVEYING AND UPDATING CONTACT INFORMATION, CONTACT DATA, AND CONTACT INSTRUCTIONS; PROVIDING TEMPORARY USE OF ONLINE, NON-DOWNLOADABLE COMPUTER SOFTWARE TO ADD AND SYNCHRONIZE USERS AND CONTACT INFORMATION AT A WEBSITE ON A GLOBAL COMPUTER NETWORK; PROVIDING TEMPORARY USE OF ONLINE, NON-DOWNLOADABLE COMPUTER SOFTWARE FOR STORING, SEARCHING, REQUESTING, CONVEYING AND UPDATING CONTACT INFORMATION, CONTACT DATA, AND CONTACT INSTRUCTIONS, AT A WEBSITE ON A GLOBAL COMPUTER NETWORK (U.S. CLS. 100 AND 101).

FIRST USE 5-10-2009; IN COMMERCE 5-10-2009.

CLASS 42—(Continued).

3,785,151. TAWARAYA LIMITED, CHARLESTOWN, ST. CHRIST-NEVIS. SN 77-157,768. PUB. 4-8-2008, FILED 4-16-2007.

MARC NEWSON

THE MARK CONSISTS OF STANDARD CHARACTERS WITHOUT CLAIM TO ANY PARTICULAR FONT, STYLE, SIZE, OR COLOR.

"THE NAME(S), PORTRAIT(S), AND/OR SIGNATURE(S) SHOWN IN THE MARK IDENTIFIES A LIVING INDIVIDUAL, WHOSE CONSENT(S) TO REGISTER IS SUBMITTED."

FOR SCIENTIFIC SERVICES, NAMELY, ENGINEERING IN THE NATURE OF DESIGN, DESIGN CONSULTANCY AND SCIENTIFIC RESEARCH IN THE FIELD OF AUTOMOBILES, MOTOR VEHICLES, LAND CRAFT, AIRCRAFT AND SEA CRAFT; INDUSTRIAL ANALYSIS; PRODUCT RESEARCH IN THE FIELD OF ENGINEERING; DESIGN, DESIGN CONSULTANCY AND RESEARCH IN THE FIELD OF FURNITURE, TIME PIECES, INTERIOR DESIGN AND LUGGAGE DESIGN (U.S. CLS. 100 AND 101).

FIRST USE 12-31-1999; IN COMMERCE 12-31-1999.

3,785,232. ORE PHARMACEUTICALS INC., CAMBRIDGE, MA. SN 77-308,650. PUB. 4-21-2009, FILED 10-19-2007.

ORE PHARMACEUTICALS

THE MARK CONSISTS OF STANDARD CHARACTERS WITHOUT CLAIM TO ANY PARTICULAR FONT, STYLE, SIZE, OR COLOR.

NO CLAIM IS MADE TO THE EXCLUSIVE RIGHT TO USE "PHARMACEUTICALS", APART FROM THE MARK AS SHOWN.

FOR PHARMACEUTICAL PRODUCT EVALUATION, RESEARCH AND DEVELOPMENT (U.S. CLS. 100 AND 101).

FIRST USE 12-18-2007; IN COMMERCE 12-18-2007.

CLASS 42—(Continued).

3,785,245. INMOTION MUSCULOSKELETAL INSTITUTE, MEMPHIS, TN. SN 77-331,508. PUB. 4-29-2008, FILED 11-16-2007.

INMOTION

THE MARK CONSISTS OF STANDARD CHARACTERS WITHOUT CLAIM TO ANY PARTICULAR FONT, STYLE, SIZE, OR COLOR.

FOR MEDICAL AND SCIENTIFIC RESEARCH IN THE FIELD OF ORTHOPEDICS AND MUSCULOSKELETAL BIOTECHNOLOGY (U.S. CLS. 100 AND 101).

FIRST USE 1-25-2010; IN COMMERCE 1-25-2010.

3,785,373. AMERICAN FOUNDATION FOR THE BLIND, INC., NEW YORK, NY. SN 77-431,786. PUB. 8-5-2008, FILED 3-26-2008.

HELEN

THE MARK CONSISTS OF STANDARD CHARACTERS WITHOUT CLAIM TO ANY PARTICULAR FONT, STYLE, SIZE, OR COLOR.

FOR PROVIDING DOWNLOADABLE SOFTWARE FOR USE IN RATING THE ACCESSIBILITY OF INTERNET WEBSITES FOR THE VISUALLY IMPAIRED (U.S. CLS. 100 AND 101).

FIRST USE 6-12-2008; IN COMMERCE 6-12-2008.

CLASS 42—(Continued).

3,785,384. PHARMIDEAS USA, INC., AMHERST, NY. SN 77-443,980. PUB. 5-5-2009, FILED 4-9-2008.



THE MARK CONSISTS OF A STYLIZED LETTER "P" WITH A SYMBOL OF A LIGHT BULB ABOVE IT.

FOR MEDICAL AND SCIENTIFIC RESEARCH, NAMELY, CONDUCTING CLINICAL TRIALS, CONSISTING OF GATHERING OF CLINICAL TRIAL DATA AND ANALYSIS OF SUCH DATA (U.S. CLS. 100 AND 101).

FIRST USE 8-30-1999; IN COMMERCE 8-30-1999.

CLASS 42—(Continued).

3,785,413. SMART ERP SOLUTIONS, INC., DBA SMART ERP SOLUTIONS, PLEASANTON, CA. SN 77-468,073. PUB. 10-21-2008, FILED 5-7-2008.

SmartERP

THE MARK CONSISTS OF STANDARD CHARACTERS WITHOUT CLAIM TO ANY PARTICULAR FONT, STYLE, SIZE, OR COLOR.

SEC. 2(F).

FOR CONSULTATION SERVICES IN THE FIELDS OF SELECTION, IMPLEMENTATION AND USE OF COMPUTER HARDWARE AND SOFTWARE SYSTEMS FOR OTHERS; CONSULTING SERVICES IN THE FIELD OF DESIGN, SELECTION, IMPLEMENTATION AND USE OF COMPUTER HARDWARE AND SOFTWARE SYSTEMS FOR OTHERS; CONSULTING SERVICES IN THE FIELD OF IDENTIFICATION, SUPPORT, AND IMPLEMENTATION OF COMPUTER-BASED INFORMATION SYSTEMS FOR BUSINESSES; DESIGN, DEVELOPMENT AND IMPLEMENTATION OF SOFTWARE (U.S. CLS. 100 AND 101).

FIRST USE 1-1-2007; IN COMMERCE 1-1-2007.

3,785,394. MERCHANTS INFORMATION SOLUTIONS, INC., PHOENIX, AZ. SN 77-452,025. PUB. 9-9-2008, FILED 4-18-2008.

HR TRAC

THE MARK CONSISTS OF STANDARD CHARACTERS WITHOUT CLAIM TO ANY PARTICULAR FONT, STYLE, SIZE, OR COLOR.

NO CLAIM IS MADE TO THE EXCLUSIVE RIGHT TO USE "HR", APART FROM THE MARK AS SHOWN.

FOR APPLICATION SERVICE PROVIDER (ASP) SERVICES FOR OTHERS, NAMELY, HOSTING AND PROVIDING USE OF ONLINE NON-DOWNLOADABLE SOFTWARE FOR USE IN PERSONNEL RECRUITING, BEHAVIORAL, PSYCHOLOGICAL AND INTEGRITY TESTING AND EVALUATION, AND MANAGEMENT (U.S. CLS. 100 AND 101).

FIRST USE 5-29-2008; IN COMMERCE 5-29-2008.

3,785,414. AMERICAN SOCIETY FOR QUALITY, INC., MILWAUKEE, WI. SN 77-468,547. PUB. 10-7-2008, FILED 5-7-2008.

THESRO

THE MARK CONSISTS OF STANDARD CHARACTERS WITHOUT CLAIM TO ANY PARTICULAR FONT, STYLE, SIZE, OR COLOR.

FOR PROVIDING AN ONLINE DATABASE FEATURING INFORMATION IN THE FIELD OF QUALITY CONTROL MATTERS (U.S. CLS. 100 AND 101).

FIRST USE 5-4-2008; IN COMMERCE 5-4-2008.

CLASS 42—(Continued).

3,785,426. IMULUS, BOULDER, CO. SN 77-475,201. PUB. 6-23-2009, FILED 5-15-2008.

Stacks

THE MARK CONSISTS OF STANDARD CHARACTERS WITHOUT CLAIM TO ANY PARTICULAR FONT, STYLE, SIZE, OR COLOR.

FOR PROVIDING ON-LINE NON-DOWNLOADABLE SOFTWARE FOR PROJECT MANAGEMENT AND COLLABORATION, NAMELY, THE ASSIGNMENT, VISUALIZATION AND REPORTING OF SPECIFIC TASKS FILTERED BY CATEGORIES AND/OR INDIVIDUALS (U.S. CLS. 100 AND 101).

FIRST USE 1-1-2008; IN COMMERCE 2-1-2010.

3,785,474. VALUECLICK, INC., WESTLAKE VILLAGE, CA. SN 77-502,842. PUB. 6-16-2009, FILED 6-19-2008.



NO CLAIM IS MADE TO THE EXCLUSIVE RIGHT TO USE "MEDIA", APART FROM THE MARK AS SHOWN.

THE MARK CONSISTS OF THREE HEXAGONS WITH THE LETTERS "AD" IN THE CENTER OF AND "RX" AND "MEDIA" NEXT TO THE BOTTOM HEXAGON.

FOR PROVIDING TEMPORARY USE OF ONLINE NON-DOWNLOADABLE SOFTWARE THAT FACILITATES TRACKING AND ANALYZING ACTIVITIES OF WEB USERS FOR BUSINESS MANAGEMENT AND ADVERTISING PURPOSES (U.S. CLS. 100 AND 101).

FIRST USE 9-15-2008; IN COMMERCE 9-15-2008.

CLASS 42—(Continued).

3,785,487. QRI GROUP, LLC, HOUSTON, TX. SN 77-509,774. PUB. 5-26-2009, FILED 6-27-2008.

LEADING RESERVOIRS

THE MARK CONSISTS OF STANDARD CHARACTERS WITHOUT CLAIM TO ANY PARTICULAR FONT, STYLE, SIZE, OR COLOR.

NO CLAIM IS MADE TO THE EXCLUSIVE RIGHT TO USE "RESERVOIRS", APART FROM THE MARK AS SHOWN.

FOR EXPERT SERVICES IN THE FIELD OF EFFICIENT EXTRACTION OF HYDROCARBON RESOURCES, NAMELY, PROVIDING CONSULTING SERVICES TO OTHERS IN THE NATURE OF COMPILING AND ANALYZING CRITICAL INFORMATION COVERING OIL AND GAS RESERVOIRS, NAMELY, FORMATION PROPERTIES, GEOLOGIC ATTRIBUTES, PRODUCTION HISTORIES, WELL DESIGN DETAILS AND PRODUCTION FACILITIES FORMATION, AND UTILIZING RESERVOIR MANAGEMENT METRICS, ANALYTICAL TOOLS, AND KNOWLEDGE MANAGEMENT INSTRUMENTS TO GUIDE THE DIAGNOSTIC AND IMPLEMENTATION PHASES OF OPTIMIZING THE EFFICIENT EXTRACTION OF HYDROCARBON RESOURCES FROM RESERVOIRS OF OTHERS (U.S. CLS. 100 AND 101).

FIRST USE 2-17-2010; IN COMMERCE 2-17-2010.

3,785,490. MCGOWIN, CHRISTOPHER LEE, NEW ORLEANS, LA. SN 77-510,792. PUB. 11-18-2008, FILED 6-29-2008.

SHIPYARD

THE MARK CONSISTS OF STANDARD CHARACTERS WITHOUT CLAIM TO ANY PARTICULAR FONT, STYLE, SIZE, OR COLOR.

FOR GRAPHIC DESIGN (U.S. CLS. 100 AND 101).

FIRST USE 6-29-2008; IN COMMERCE 6-29-2008.

CLASS 42—(Continued).

3,785,514. FREDRIKSON & BYRON, P.A., MINNEAPOLIS, MN. SN 77-517,997. PUB. 4-21-2009, FILED 7-9-2008.

AIM TO SUSTAIN

THE MARK CONSISTS OF STANDARD CHARACTERS WITHOUT CLAIM TO ANY PARTICULAR FONT, STYLE, SIZE, OR COLOR.

FOR ENVIRONMENTAL SERVICES, NAMELY, DEVELOPING AND IMPLEMENTING ENVIRONMENTALLY-CONSCIOUS WORKPLACE STRATEGIES AND CONSERVATION INITIATIVES IN THE NATURE OF ENVIRONMENTAL ASSESSMENT, COMPLIANCE, AND PLANNING; PROVIDING TECHNICAL INFORMATION REGARDING ENVIRONMENTALLY-CONSCIOUS WORKPLACE STRATEGIES AND CONSERVATION INITIATIVES IN THE NATURE OF ENVIRONMENTAL ASSESSMENT, COMPLIANCE AND PLANNING (U.S. CLS. 100 AND 101).

FIRST USE 6-30-2008; IN COMMERCE 6-30-2008.

3,785,523. PIONEER DRILLING COMPANY, SAN ANTONIO, TX. SN 77-521,377. PUB. 5-26-2009, FILED 7-14-2008.

PENKOTA WIRELINE

THE MARK CONSISTS OF STANDARD CHARACTERS WITHOUT CLAIM TO ANY PARTICULAR FONT, STYLE, SIZE, OR COLOR.

NO CLAIM IS MADE TO THE EXCLUSIVE RIGHT TO USE "WIRELINE", APART FROM THE MARK AS SHOWN.

FOR WIRELINING FOR OIL AND GAS WELLS; OIL AND GAS WELL LOGGING AND TESTING (U.S. CLS. 100 AND 101).

FIRST USE 3-3-2008; IN COMMERCE 3-3-2008.

3,785,524. PIONEER DRILLING COMPANY, SAN ANTONIO, TX. SN 77-521,381. PUB. 6-9-2009, FILED 7-14-2008.

PIONEER LOG-TECH

THE MARK CONSISTS OF STANDARD CHARACTERS WITHOUT CLAIM TO ANY PARTICULAR FONT, STYLE, SIZE, OR COLOR.

OWNER OF U.S. REG. NO. 3,217,824.

FOR WIRELINING FOR OIL AND GAS WELLS; OIL AND GAS WELL LOGGING AND TESTING (U.S. CLS. 100 AND 101).

FIRST USE 3-3-2008; IN COMMERCE 3-3-2008.

CLASS 42—(Continued).

3,785,525. PIONEER DRILLING COMPANY, SAN ANTONIO, TX. SN 77-521,382. PUB. 5-26-2009, FILED 7-14-2008.

COMPETITION WIRELINE

THE MARK CONSISTS OF STANDARD CHARACTERS WITHOUT CLAIM TO ANY PARTICULAR FONT, STYLE, SIZE, OR COLOR.

NO CLAIM IS MADE TO THE EXCLUSIVE RIGHT TO USE "WIRELINE", APART FROM THE MARK AS SHOWN.

FOR WIRELINING FOR OIL AND GAS WELLS; OIL AND GAS WELL LOGGING AND TESTING (U.S. CLS. 100 AND 101).

FIRST USE 3-3-2008; IN COMMERCE 3-3-2008.

3,785,568. DOCTATIONS, INC., GARDEN CITY, NY. SN 77-538,339. PUB. 6-2-2009, FILED 8-4-2008.

**WiPP Web Integrated
Physician Practice**

THE MARK CONSISTS OF STANDARD CHARACTERS WITHOUT CLAIM TO ANY PARTICULAR FONT, STYLE, SIZE, OR COLOR.

NO CLAIM IS MADE TO THE EXCLUSIVE RIGHT TO USE "WEB INTEGRATED PHYSICIAN PRACTICE", APART FROM THE MARK AS SHOWN.

FOR APPLICATION SERVICE PROVIDER (ASP) FEATURING SOFTWARE FOR USE IN INTEGRATING PHYSICIANS IN GEOGRAPHICALLY DISTINCT OFFICES INTO A SINGLE GROUP USING MODERN WEB TECHNOLOGIES; PROVIDING A WEB SITE FOR USE BY PHYSICIANS TO GENERATE, MANAGE AND EXCHANGE MEDICAL INFORMATION AND DOCUMENTS REGARDLESS OF MEDICAL ORGANIZATION OR GEOGRAPHIC LOCATION; PROVIDING ON-LINE NON-DOWNLOADABLE SOFTWARE FOR INTEGRATING PHYSICIANS IN GEOGRAPHICALLY DISTINCT OFFICES INTO A SINGLE GROUP USING MODERN WEB TECHNOLOGIES; PROVIDING TEMPORARY USE OF ON-LINE NON-DOWNLOADABLE SOFTWARE FOR INTEGRATING PHYSICIANS IN GEOGRAPHICALLY DISTINCT OFFICES INTO A SINGLE GROUP USING MODERN WEB TECHNOLOGIES (U.S. CLS. 100 AND 101).

FIRST USE 2-24-2010; IN COMMERCE 2-24-2010.

CLASS 42—(Continued).

3,785,570. DXTERITY DIAGNOSTICS INC., MANAHTTAN BEACH, CA. SN 77-540,239. PUB. 6-23-2009, FILED 8-6-2008.



NO CLAIM IS MADE TO THE EXCLUSIVE RIGHT TO USE "DIAGNOSTICS", APART FROM THE MARK AS SHOWN.

THE MARK CONSISTS OF THE STYLIZED TEXT "DXTERITY DIAGNOSTICS" WITH A DNA HELIX COMPOSING THE "X" IN THE TERM "DXTERITY".

FOR PRODUCT DEVELOPMENT, NAMELY, DEVELOPMENT OF MOLECULAR DIAGNOSTIC TESTS (U.S. CLS. 100 AND 101).

FIRST USE 6-1-2006; IN COMMERCE 6-1-2006.

3,785,583. MECS, INC., CHESTERFIELD, MO. SN 77-547,537. PUB. 7-21-2009, FILED 8-14-2008.

DYNAWAVE

THE MARK CONSISTS OF STANDARD CHARACTERS WITHOUT CLAIM TO ANY PARTICULAR FONT, STYLE, SIZE, OR COLOR.

OWNER OF U.S. REG. NO. 2,004,373.

FOR DESIGN AND ENGINEERING OF GAS TREATMENT SYSTEMS; DESIGN AND ENGINEERING OF GAS AND LIQUID TREATMENT SYSTEMS (U.S. CLS. 100 AND 101).

FIRST USE 7-15-1988; IN COMMERCE 7-15-1988.

3,785,589. BIG ELITE INCORPORATED, ORLANDO, FL. SN 77-549,798. PUB. 6-30-2009, FILED 8-18-2008.



THE MARK CONSISTS OF A STYLIZED LETTER "B" AND "E" WITH A STAR IN BETWEEN.

FOR HOSTING AN ONLINE WEBSITE FEATURING A SPORTS SOCIAL NETWORKING WEBSITE (U.S. CLS. 100 AND 101).

FIRST USE 12-7-2009; IN COMMERCE 12-7-2009.

CLASS 42—(Continued).

3,785,600. TRUMEDIA NETWORKS, INC., BOSTON, MA. SN 77-558,934. PUB. 8-4-2009, FILED 8-29-2008.

TRUFAN.COM

THE MARK CONSISTS OF STANDARD CHARACTERS WITHOUT CLAIM TO ANY PARTICULAR FONT, STYLE, SIZE, OR COLOR.

FOR COMPUTER SERVICES, NAMELY, CREATING AN ON-LINE COMMUNITY FEATURING A NATIONAL NETWORK OF SPORTS FAN COMMUNITIES AND CREATING AN ONLINE COMMUNITY FOR REGISTERED USERS TO ENGAGE IN SOCIAL NETWORKING (U.S. CLS. 100 AND 101).

FIRST USE 3-23-2010; IN COMMERCE 3-23-2010.

3,785,648. LUNARTRANS, LLC, AKA NEXT GIANT LEAP, DEADWOOD, SD. SN 77-600,601. PUB. 3-17-2009, FILED 10-25-2008.

Next Giant Leap

THE MARK CONSISTS OF STANDARD CHARACTERS WITHOUT CLAIM TO ANY PARTICULAR FONT, STYLE, SIZE, OR COLOR.

FOR TECHNOLOGY CONSULTATION AND RESEARCH IN THE FIELD OF AEROSPACE ENGINEERING (U.S. CLS. 100 AND 101).

FIRST USE 12-18-2008; IN COMMERCE 12-18-2008.

3,785,653. STUDYBLUE, INC., MIDDLETON, WI. SN 77-602,317. PUB. 6-23-2009, FILED 10-28-2008.

STUDYBLUE

THE MARK CONSISTS OF STANDARD CHARACTERS WITHOUT CLAIM TO ANY PARTICULAR FONT, STYLE, SIZE, OR COLOR.

FOR COMPUTER SERVICES, NAMELY, CREATING AN ON-LINE COMMUNITY FOR REGISTERED USERS TO ENGAGE IN SOCIAL NETWORKING AND PARTICIPATE IN CHAT ROOMS AND BLOGS CENTERED AROUND TEXTBOOKS AND EDUCATION (U.S. CLS. 100 AND 101).

FIRST USE 11-6-2008; IN COMMERCE 11-6-2008.

CLASS 42—(Continued).

3,785,657. OUTCOMES HEALTH INFORMATION SOLUTIONS, LLC, CHARLOTTESVILLE, VA. SN 77-603,297. PUB. 9-29-2009, FILED 10-29-2008.

ECO-SCALING

THE MARK CONSISTS OF STANDARD CHARACTERS WITHOUT CLAIM TO ANY PARTICULAR FONT, STYLE, SIZE, OR COLOR.

FOR INFORMATION MANAGEMENT SERVICES, NAMELY, PROVIDING A WEBSITE FEATURING ONLINE NON-DOWNLOADABLE SOFTWARE FOR AUDITING, ANALYZING AND MANAGING PATIENT MEDICAL INFORMATION (U.S. CLS. 100 AND 101).

FIRST USE 2-0-2008; IN COMMERCE 2-0-2008.

3,785,659. XEL PHARMACEUTICALS, INC., DRAPER, UT. SN 77-604,551. PUB. 5-19-2009, FILED 10-30-2008.

XEL PHARMACEUTICALS

THE MARK CONSISTS OF STANDARD CHARACTERS WITHOUT CLAIM TO ANY PARTICULAR FONT, STYLE, SIZE, OR COLOR.

OWNER OF U.S. REG. NOS. 2,845,260, 2,860,543, AND 2,970,981.

NO CLAIM IS MADE TO THE EXCLUSIVE RIGHT TO USE "PHARMACEUTICALS", APART FROM THE MARK AS SHOWN.

FOR RESEARCH AND DEVELOPMENT OF DRUG DELIVERY SYSTEMS (U.S. CLS. 100 AND 101).

FIRST USE 1-0-2008; IN COMMERCE 6-0-2008.

3,785,675. LIQUIDUS MARKETING, INC., CHICAGO, IL. SN 77-613,260. PUB. 5-19-2009, FILED 11-12-2008.



The logo features a square icon with rounded corners containing three horizontal wavy lines. To the right of the icon, the word "liquidus" is written in a lowercase, sans-serif font. Below "liquidus", the words "On Demand Marketing" are written in a smaller, lowercase, sans-serif font.

NO CLAIM IS MADE TO THE EXCLUSIVE RIGHT TO USE "ON DEMAND MARKETING", APART FROM THE MARK AS SHOWN.

CLASS 42—(Continued).

THE MARK CONSISTS OF THE TERM "LIQUIDUS" ABOVE THE TERMS "ON DEMAND MARKETING" AND ADJACENT TO A DESIGN OF A SQUARE WITH ROUNDED CORNERS AND WITH THREE IDENTICAL WAVY LINES EXTENDING FROM THE CENTER OF THE SQUARE AND BEYOND THE RIGHT SIDE OF THE SQUARE.

FOR PROVIDING TEMPORARY USE OF ONLINE NON-DOWNLOADABLE COMPUTER SOFTWARE IN THE FIELD OF MARKETING FOR CREATING CUSTOMIZED VIDEO AND MULTI-MEDIA ADVERTISEMENTS FOR BROADCAST ON THE INTERNET AND ON CABLE TELEVISION (U.S. CLS. 100 AND 101).

FIRST USE 1-31-2003; IN COMMERCE 1-31-2003.

3,785,676. LIQUIDUS MARKETING, INC., CHICAGO, IL. SN 77-613,274. PUB. 5-19-2009, FILED 11-12-2008.



The logo features a square icon with rounded corners containing three horizontal wavy lines. To the right of the icon, the word "liquidus" is written in a lowercase, sans-serif font. Below "liquidus", the word "videolink" is written in a larger, lowercase, sans-serif font.

NO CLAIM IS MADE TO THE EXCLUSIVE RIGHT TO USE "VIDEOLINK", APART FROM THE MARK AS SHOWN.

THE MARK CONSISTS OF THE TERM "LIQUIDUS" ABOVE THE TERM "VIDEOLINK" AND ADJACENT TO A DESIGN OF A SQUARE WITH ROUNDED CORNERS AND WITH THREE IDENTICAL WAVY LINES EXTENDING FROM THE CENTER OF THE SQUARE AND BEYOND THE RIGHT SIDE OF THE SQUARE.

FOR PROVIDING TEMPORARY USE OF ONLINE NON-DOWNLOADABLE COMPUTER SOFTWARE IN THE FIELD OF MARKETING FOR CREATING CUSTOMIZED VIDEO AND MULTI-MEDIA ADVERTISEMENTS FOR BROADCAST ON THE INTERNET AND ON CABLE TELEVISION (U.S. CLS. 100 AND 101).

FIRST USE 10-31-2007; IN COMMERCE 10-31-2007.

3,785,677. LIQUIDUS MARKETING, INC., CHICAGO, IL. SN 77-613,284. PUB. 5-19-2009, FILED 11-12-2008.

SPOTSENSE

THE MARK CONSISTS OF STANDARD CHARACTERS WITHOUT CLAIM TO ANY PARTICULAR FONT, STYLE, SIZE, OR COLOR.

FOR PROVIDING TEMPORARY USE OF ONLINE NON-DOWNLOADABLE COMPUTER SOFTWARE IN THE FIELD OF MARKETING FOR CREATING CUSTOMIZED VIDEO AND MULTI-MEDIA ADVERTISEMENTS FOR BROADCAST ON THE INTERNET AND CABLE TELEVISION (U.S. CLS. 100 AND 101).

FIRST USE 1-31-2006; IN COMMERCE 1-31-2006.

CLASS 42—(Continued).

3,785,711. LIQUENT INC., HORSHAM, PA. SN 77-629,616. PUB. 4-14-2009, FILED 12-9-2008.

LIQUENT PUBLISHPERFECT

THE MARK CONSISTS OF STANDARD CHARACTERS WITHOUT CLAIM TO ANY PARTICULAR FONT, STYLE, SIZE, OR COLOR.

OWNER OF U.S. REG. NOS. 2,646,889, 2,788,509, AND OTHERS.

FOR PROVIDING A WEBSITE FEATURING NON-DOWNLOADABLE COMPUTER SOFTWARE USED IN DOCUMENT ASSEMBLY AND PUBLISHING, IN MANAGING WRITTEN AND GRAPHIC CONTENT, IN COMPILING AND MANAGING INFORMATION USED IN REGULATORY SUBMISSIONS, AND IN MAKING ELECTRONIC DOCUMENT SUBMISSIONS (U.S. CLS. 100 AND 101).

FIRST USE 2-9-2009; IN COMMERCE 2-9-2009.

3,785,731. OVERTONE, INC., SAN FRANCISCO, CA. SN 77-637,150. PUB. 5-26-2009, FILED 12-19-2008.

OPEN MIC

THE MARK CONSISTS OF STANDARD CHARACTERS WITHOUT CLAIM TO ANY PARTICULAR FONT, STYLE, SIZE, OR COLOR.

FOR CUSTOM DESIGN OF COMPUTER SOFTWARE FOR OTHERS FOR FINDING, CLASSIFYING AND STRUCTURING INFORMATION PERTAINING TO SOCIAL MEDIA, CUSTOMER EXPERIENCE, CUSTOMER SENTIMENT AND CUSTOMER FEEDBACK FOR USE BY BUSINESSES; PROVIDING TEMPORARY USE OF ON-LINE NON-DOWNLOADABLE SOFTWARE FOR EXTRACTING, ORGANIZING, AND ANALYZING DATA, FOR PREPARING REPORTS TO BUSINESSES IN THE FIELD OF SOCIAL MEDIA, CUSTOMER EXPERIENCE, CUSTOMER SENTIMENT AND CUSTOMER FEEDBACK ANALYTICS; DATABASE DEVELOPMENT; COMPUTER SERVICES, NAMELY, DESIGNING AND IMPLEMENTING WEBSITES OF OTHERS FEATURING WEB-BASED COLLECTION TECHNOLOGY (U.S. CLS. 100 AND 101).

FIRST USE 1-26-2009; IN COMMERCE 4-3-2009.

CLASS 42—(Continued).

3,785,734. KNIGHT ROSE PRODUCTIONS, LLC, DBA KNIGHT ROSE PRODUCTIONS, TRUMANSBURG, NY. SN 77-637,687. PUB. 4-21-2009, FILED 12-22-2008.

Lunchtaker

THE MARK CONSISTS OF STANDARD CHARACTERS WITHOUT CLAIM TO ANY PARTICULAR FONT, STYLE, SIZE, OR COLOR.

FOR COMPUTER SERVICES IN THE NATURE OF CUSTOMIZED WEB PAGES FEATURING USER-DEFINED INFORMATION, PERSONAL PROFILES AND INFORMATION; COMPUTER SERVICES, NAMELY, HOSTING AND MAINTAINING AN ON-LINE WEB SITE FOR OTHERS TO USE TO MANAGE AND FACILITATE HEALTHY EATING, MEAL PREPARATION, MEAL PLANNING, AND SHARE INFORMATION REGARDING HEALTHY EATING AND MEAL PREPARATION AND PLANNING (U.S. CLS. 100 AND 101).

FIRST USE 1-14-2008; IN COMMERCE 1-3-2009.

3,785,746. SPORTSIPLAY, LLC, KENNESAW, GA. SN 77-642,325. PUB. 4-21-2009, FILED 12-31-2008.

TAKING AMATEUR ATHLETES BEYOND THE GAME

THE MARK CONSISTS OF STANDARD CHARACTERS WITHOUT CLAIM TO ANY PARTICULAR FONT, STYLE, SIZE, OR COLOR.

FOR COMPUTER SERVICES IN THE NATURE OF CUSTOMIZED WEB PAGES FEATURING USER-DEFINED INFORMATION, PERSONAL PROFILES AND INFORMATION; COMPUTER SERVICES, NAMELY, HOSTING AND MAINTAINING AN ON-LINE WEB SITE FOR OTHERS TO POST INFORMATION, PHOTOS, AND VIDEOS; COMPUTER SERVICES, NAMELY, HOSTING ON-LINE WEB FACILITIES FOR OTHERS FOR ORGANIZING AND CONDUCTING ONLINE MEETINGS, GATHERINGS, AND INTERACTIVE DISCUSSIONS; HOSTING AN ON-LINE COMMUNITY WEB SITE FEATURING SPORTS INFORMATION, TEAM AND LEAGUE MANAGEMENT, AND INDIVIDUAL PROFILES; PROVIDING A WEB SITE FEATURING TECHNOLOGY THAT ENABLES INTERNET USERS TO CREATE, BOOKMARK, ANNOTATE, AND PUBLICLY SHARE DATA; PROVIDING A WEB SITE FEATURING TECHNOLOGY THAT ENABLES USERS TO CONNECT WITH OTHER PEOPLE IN THEIR NEIGHBORHOOD OR CITY FOR ANY NUMBER OF USER-SPECIFIED REASONS, INCLUDING PROVIDING A SERVICE OR ORGANIZING AN EVENT; PROVIDING A WEB SITE FEATURING TEMPORARY USE OF NON-DOWNLOADABLE SOFTWARE ALLOWING WEB SITE USERS TO UPLOAD, POST AND DISPLAY ONLINE VIDEOS FOR SHARING WITH OTHERS FOR ENTERTAINMENT PURPOSES; PROVIDING A WEB SITE THAT GIVES COMPUTER USERS THE ABILITY TO UPLOAD AND SHARE USER-GENERATED VIDEOS, ESSAYS AND ARTICLES ON A WIDE VARIETY OF TOPICS AND SUBJECTS; PROVIDING A WEB SITE THAT GIVES COMPUTER USERS THE ABILITY TO UPLOAD, EXCHANGE AND SHARE PHOTOS, VIDEOS AND VIDEO LOGS (U.S. CLS. 100 AND 101).

FIRST USE 7-15-2007; IN COMMERCE 7-15-2007.

CLASS 42—(Continued).

3,785,756. DYAX CORP., CAMBRIDGE, MA. SN 77-647,127.
PUB. 9-8-2009, FILED 1-10-2009.

FULFILLING THE PROMISE OF
DISCOVERY

THE MARK CONSISTS OF STANDARD CHARACTERS WITHOUT CLAIM TO ANY PARTICULAR FONT, STYLE, SIZE, OR COLOR.

FOR PROVIDING INFORMATION IN THE FIELD OF MEDICAL AND SCIENTIFIC RESEARCH; PROVIDING MEDICAL AND SCIENTIFIC RESEARCH INFORMATION IN THE FIELD OF PHARMACEUTICALS AND CLINICAL TRIALS; PROVIDING A WEB SITE FEATURING MEDICAL AND SCIENTIFIC RESEARCH INFORMATION ON PHAGES AND PHAGE DISPLAY; PROVIDING A WEB SITE FEATURING INFORMATION ON DRUG DISCOVERY (U.S. CLS. 100 AND 101).

FIRST USE 2-16-2010; IN COMMERCE 2-16-2010.

3,785,780. S. W. BAKER & ASSOCIATES, WAYZATA, MN. SN 77-654,997. PUB. 5-12-2009, FILED 1-23-2009.

BRANDVIS

THE MARK CONSISTS OF STANDARD CHARACTERS WITHOUT CLAIM TO ANY PARTICULAR FONT, STYLE, SIZE, OR COLOR.

FOR GRAPHIC DESIGN SERVICES (U.S. CLS. 100 AND 101).

FIRST USE 11-13-2009; IN COMMERCE 11-13-2009.

CLASS 42—(Continued).

3,785,830. TRADERPLANET.COM, LLC, WESLEY CHAPEL, FL. SN 77-662,445. PUB. 6-30-2009, FILED 2-3-2009.

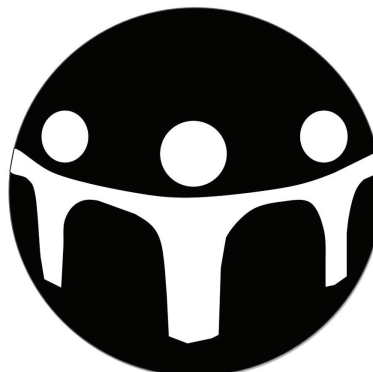

THE MARK CONSISTS OF SPHERE WITH THREE PEOPLE HOLDING HANDS.

FOR COMPUTER SERVICES, NAMELY, HOSTING ONLINE WEB FACILITIES FOR OTHERS FOR ORGANIZING AND CONDUCTING ONLINE MEETINGS, INTERACTIVE DISCUSSIONS; COMPUTER SERVICES IN THE NATURE OF CUSTOMIZED WEB PAGES FOR FINANCE AND INVESTING INDUSTRY FEATURING USER-DEFINED INFORMATION, PERSONAL PROFILES AND INFORMATION (U.S. CLS. 100 AND 101).

FIRST USE 6-18-2008; IN COMMERCE 6-18-2008.

3,785,863. HENDERSON ENGINEERS, INC., LENEXA, KS. SN 77-667,514. PUB. 7-28-2009, FILED 2-10-2009.

Concept 520

THE MARK CONSISTS OF STANDARD CHARACTERS WITHOUT CLAIM TO ANY PARTICULAR FONT, STYLE, SIZE, OR COLOR.

NO CLAIM IS MADE TO THE EXCLUSIVE RIGHT TO USE "CONCEPT", APART FROM THE MARK AS SHOWN.

FOR ENGINEERING SERVICES, NAMELY, ENGINEERING FOR THE SUSTAINABLE BUILDING SOLUTIONS (U.S. CLS. 100 AND 101).

FIRST USE 9-1-2009; IN COMMERCE 9-1-2009.

CLASS 42—(Continued).

3,785,908. AMIRSYS, INC., SALT LAKE CITY, UT. SN 77-676,473. PUB. 6-16-2009, FILED 2-23-2009.

IMMUNOQUERY CUSTOM SYNC

THE MARK CONSISTS OF STANDARD CHARACTERS WITHOUT CLAIM TO ANY PARTICULAR FONT, STYLE, SIZE, OR COLOR.

OWNER OF U.S. REG. NO. 2,479,600.

NO CLAIM IS MADE TO THE EXCLUSIVE RIGHT TO USE "CUSTOM SYNC", APART FROM THE MARK AS SHOWN.

FOR PROVIDING ACCESS TO ONLINE NON-DOWNLOADABLE SOFTWARE FEATURING MEDICAL RESEARCH AND DIAGNOSTIC INFORMATION, DIAGNOSTIC TOOLS AND ORDERING TOOLS IN THE FIELD OF PATHOLOGY (U.S. CLS. 100 AND 101).
FIRST USE 7-22-2009; IN COMMERCE 7-22-2009.

3,785,943. ACUCELA INC., BOTHELL, WA. SN 77-685,690. PUB. 7-7-2009, FILED 3-6-2009.

FOCUSED ON YOUR VISION

THE MARK CONSISTS OF STANDARD CHARACTERS WITHOUT CLAIM TO ANY PARTICULAR FONT, STYLE, SIZE, OR COLOR.

FOR PHARMACEUTICAL DRUG DEVELOPMENT SERVICES IN THE FIELD OF EYE DISEASES (U.S. CLS. 100 AND 101).

FIRST USE 4-23-2009; IN COMMERCE 4-23-2009.

3,785,979. INSULASTICS, INC., PORTLAND, OR. SN 77-697,866. PUB. 7-21-2009, FILED 3-24-2009.

INSULASTICS

THE MARK CONSISTS OF STANDARD CHARACTERS WITHOUT CLAIM TO ANY PARTICULAR FONT, STYLE, SIZE, OR COLOR.

FOR CONSULTING SERVICES RELATING TO THE DEVELOPMENT OF RECYCLED MATERIAL PRODUCTS (U.S. CLS. 100 AND 101).

FIRST USE 9-1-2007; IN COMMERCE 9-1-2007.

CLASS 42—(Continued).

3,785,980. HOLY MEASURES, LLC, CHICAGO, IL. SN 77-698,515. PUB. 8-11-2009, FILED 3-25-2009.

HOLYMEASURES.COM

THE MARK CONSISTS OF STANDARD CHARACTERS WITHOUT CLAIM TO ANY PARTICULAR FONT, STYLE, SIZE, OR COLOR.

FOR COMPUTER SERVICES, NAMELY, PROVIDING SEARCH ENGINES FOR OBTAINING DATA ON A GLOBAL COMPUTER NETWORK, NAMELY, DIGITAL FILES IN THE NATURE OF DIGITAL SHEET MUSIC; PROVIDING TEMPORARY USE OF ON-LINE NON-DOWNLOADABLE SOFTWARE FOR USE IN SEARCHING FOR DOWNLOADABLE DIGITAL FILES IN THE NATURE OF DIGITAL SHEET MUSIC (U.S. CLS. 100 AND 101).

FIRST USE 10-27-2009; IN COMMERCE 10-27-2009.

3,785,989. UCB PHARMA, S.A., 1070 BRUSSELS, BELGIUM. SN 77-700,908. PUB. 7-28-2009, FILED 3-27-2009.

XYZAL Xpressions

THE MARK CONSISTS OF STANDARD CHARACTERS WITHOUT CLAIM TO ANY PARTICULAR FONT, STYLE, SIZE, OR COLOR.

FOR PROVIDING AN INTERACTIVE WEB SITE THAT ENABLES PATIENTS TO ENTER, ACCESS, TRACK, MONITOR AND GENERATE INFORMATION ABOUT THEIR ALLERGY SYMPTOMS VIA INTERACTIVE CONTROLS AND THEN PRINT REPORTS THEREON FOR DISCUSSIONS WITH THEIR DOCTORS (U.S. CLS. 100 AND 101).

FIRST USE 1-0-2010; IN COMMERCE 1-0-2010.

3,786,006. NOELWERKS, INC., STEVENS POINT, WI. SN 77-710,407. PUB. 8-18-2009, FILED 4-9-2009.

MYASSIST

THE MARK CONSISTS OF STANDARD CHARACTERS WITHOUT CLAIM TO ANY PARTICULAR FONT, STYLE, SIZE, OR COLOR.

FOR PROVIDING INFORMATION AT THE SPECIFIC REQUEST OF END-USERS BY MEANS OF TELEPHONE OR GLOBAL COMPUTER NETWORKS (U.S. CLS. 100 AND 101).

FIRST USE 4-2-2009; IN COMMERCE 4-2-2009.

CLASS 42—(Continued).

3,786,025. ACK 6 INC., PHOENIX, AZ. SN 77-719,102. PUB. 8-25-2009, FILED 4-21-2009.

EMBEDDED PRODUCTIVITY

THE MARK CONSISTS OF STANDARD CHARACTERS WITHOUT CLAIM TO ANY PARTICULAR FONT, STYLE, SIZE, OR COLOR.

FOR CONSULTING SERVICES IN THE FIELD OF DESIGN, SELECTION, IMPLEMENTATION AND USE OF COMPUTER HARDWARE AND SOFTWARE SYSTEMS FOR OTHERS; DESIGN AND DEVELOPMENT OF COMPUTER HARDWARE AND SOFTWARE; ELECTRONIC AND ELECTRICAL SYSTEMS DESIGN SERVICES (U.S. CLS. 100 AND 101).

FIRST USE 11-17-2009; IN COMMERCE 11-17-2009.

3,786,032. MORTON, CARI RISA, TALLAHASSEE, FL. SN 77-724,739. PUB. 9-8-2009, FILED 4-29-2009.

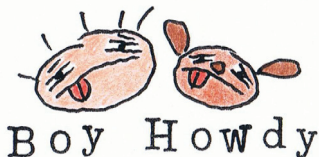

THE COLOR(S) BLACK, RED, TAN, DARK BROWN, BROWN AND WHITE IS/ARE CLAIMED AS A FEATURE OF THE MARK.

THE MARK CONSISTS OF THE TERMS "BOY HOWDY" BELOW THE HEAD OF A BOY AND THE HEAD OF A DOG, BOTH THE DOG AND THE BOY HAVE THEIR TONGUES OUT; THE COLOR BLACK APPEARS IN THE WORDING "BOY HOWDY" AND IN THE BOY AND DOG; THE COLOR RED APPEARS IN THE BOY'S TONGUE AND THE DOG'S TONGUE; THE COLOR TAN APPEARS IN THE BOY'S FACE; THE COLOR DARK BROWN APPEARS IN THE DOG'S EARS AND ON THE DOG'S NOSE; THE COLOR BROWN APPEARS IN THE DOG'S FACE; THE COLOR WHITE APPEARS IN THE FACE OF THE BOY AND DOG.

FOR GRAPHIC ILLUSTRATION SERVICES FOR OTHERS; GRAPHIC ILLUSTRATION SERVICES FOR OTHERS, NAMELY, ILLUSTRATION OF GREETING CARDS, DECALS, BUMPER STICKERS, STATIONERY, MAGAZINES AND NEWSPAPERS FOR OTHERS (U.S. CLS. 100 AND 101).

FIRST USE 11-1-2009; IN COMMERCE 11-1-2009.

CLASS 42—(Continued).

3,786,105. GAMING LABORATORIES INTERNATIONAL, LLC, LAKEWOOD, NJ. SN 77-756,209. PUB. 10-27-2009, FILED 6-10-2009.

GLILINK

THE MARK CONSISTS OF STANDARD CHARACTERS WITHOUT CLAIM TO ANY PARTICULAR FONT, STYLE, SIZE, OR COLOR.

OWNER OF U.S. REG. NOS. 2,800,298 AND 2,979,833. FOR REMOTE TESTING AND APPROVAL SERVICES, NAMELY, THE REMOTE TESTING OF ELECTRONIC GAMING AND LOTTERY DEVICES, CASINO GAMES, ELECTRONIC BINGO, GAMING AND PARIMUTUEL SYSTEMS AND ASSOCIATED EQUIPMENT FOR APPROVAL ON BEHALF OF DOMESTIC AND INTERNATIONAL GOVERNMENT GAMING AND LOTTERY REGULATORY AGENCIES (U.S. CLS. 100 AND 101).

FIRST USE 9-1-2009; IN COMMERCE 9-1-2009.

3,786,166. XAVIANT, LLC, CUMMING, GA. SN 77-978,727. PUB. 3-3-2009, FILED 9-22-2008.

YOU WILL FEEL EVERYTHING

THE MARK CONSISTS OF STANDARD CHARACTERS WITHOUT CLAIM TO ANY PARTICULAR FONT, STYLE, SIZE, OR COLOR.

FOR DESIGN AND DEVELOPMENT FOR OTHERS OF COMPUTER SOFTWARE (U.S. CLS. 100 AND 101).

FIRST USE 12-14-2008; IN COMMERCE 12-14-2008.

3,786,264. DEALERTRACK, INC., LAKE SUCCESS, NY. SN 78-814,104. PUB. 5-8-2007, FILED 2-14-2006.

IDEAL INVENTORY MODEL

THE MARK CONSISTS OF STANDARD CHARACTERS WITHOUT CLAIM TO ANY PARTICULAR FONT, STYLE, SIZE, OR COLOR.

CLASS 42—(Continued).

NO CLAIM IS MADE TO THE EXCLUSIVE RIGHT TO USE "INVENTORY MODEL", APART FROM THE MARK AS SHOWN.

FOR PROVIDING TEMPORARY ON-LINE USE OF NON-DOWNLOADABLE COMPUTER SOFTWARE FOR USE IN AUTOMOTIVE DEALERSHIP FACILITY MANAGEMENT, FOR MANAGEMENT OF VEHICLE INVENTORY FOR NEW AND USED AUTOMOBILES, FOR VEHICLE APPRAISAL, FOR MANAGEMENT OF ON-LINE AUCTIONS AND WHOLESALE VEHICLE PURCHASING AND SALES, FOR MANAGEMENT OF AUTOMOBILE REPAIR AND PARTS INVENTORY CONTROL, FOR MANAGEMENT OF DETAIL AND BODY SHOPS, FOR SALES PROCESSING, FINANCING, INSURANCE AND WARRANTY OF VEHICLES, FOR CUSTOMER RELATIONSHIP MANAGEMENT, FOR MANAGEMENT OF ADVERTISING, MARKETING, AND CALL CENTER SERVICES, FOR BUSINESS AND SALES TRAINING SERVICES, AND FOR POINT OF SALE DOCUMENTATION IN THE AUTOMOTIVE INDUSTRY (U.S. CLS. 100 AND 101).

FIRST USE 10-1-2009; IN COMMERCE 10-1-2009.

3,786,310. LEGAL AID OF WESTERN MISSOURI, KANSAS CITY, MO. SN 78-898,543. PUB. 1-16-2007, FILED 6-1-2006.

GOOD HAMMER

THE MARK CONSISTS OF STANDARD CHARACTERS WITHOUT CLAIM TO ANY PARTICULAR FONT, STYLE, SIZE, OR COLOR.

FOR LEGAL SERVICES (U.S. CLS. 100 AND 101).
FIRST USE 11-1-2007; IN COMMERCE 11-1-2007.

3,786,312. ITRON, INC., SPOKANE, WA. SN 78-903,299. PUB. 11-28-2006, FILED 6-7-2006.

OPENWAY

THE MARK CONSISTS OF STANDARD CHARACTERS WITHOUT CLAIM TO ANY PARTICULAR FONT, STYLE, SIZE, OR COLOR.

FOR COMPUTER RELATED SERVICES AND CONSULTING FOR THE UTILITY, POWER AND ENERGY INDUSTRIES, NAMELY, COMPUTER-RELATED CONSULTING FOR THE DESIGN, IMPLEMENTATION, AND MAINTENANCE OF INTEGRATED COMMUNICATIONS NETWORKS AND DATA COLLECTION COMPUTER AND COMMUNICATION NETWORK SYSTEMS FOR DATA COLLECTION APPLICATIONS, NAMELY, AUTOMATED METER READING, DEMAND RESPONSE, DATA PRESENTATION, IN-HOME CONTROL, REMOTE AND TWO-WAY COMMUNICATIONS BETWEEN NETWORKS AND UTILITY METERS, VIA THE INTERNET, INTRANETS, EXTRANETS, RADIO FREQUENCY NETWORKS, WIRELESS NETWORKS, AND TELEPHONE LINES, ALL FOR USE IN THE UTILITY, POWER AND ENERGY INDUSTRIES; TECHNICAL SUPPORT, NAMELY, MONITORING OF NETWORK SYSTEMS FOR THE UTILITY, POWER AND

CLASS 42—(Continued).

ENERGY INDUSTRIES AND TROUBLESHOOTING OF COMPUTER SOFTWARE PROBLEMS VIA TELEPHONE, IN PERSON, AND OVER THE INTERNET; PROVIDING TEMPORARY USE OF ON-LINE NON-DOWNLOADABLE SOFTWARE FOR USE OF AND ACCESS TO INTEGRATED COMMUNICATIONS NETWORKS, DATA COLLECTION COMPUTER AND COMMUNICATION NETWORK SYSTEMS, COMPUTER OPERATING SOFTWARE, AND COMPUTER SOFTWARE FOR DATA COLLECTION APPLICATIONS, NAMELY, AUTOMATED METER READING, REMOTE AND TWO-WAY COMMUNICATIONS BETWEEN NETWORKS AND UTILITY METERS, VIA THE INTERNET, INTRANETS, EXTRANETS, RADIO FREQUENCY NETWORKS, WIRELESS NETWORKS, AND TELEPHONE, ALL FOR USE IN THE UTILITY, POWER AND ENERGY INDUSTRIES; PROVIDING TEMPORARY USE OF ON-LINE NON-DOWNLOADABLE SOFTWARE FOR ENABLING UTILITIES AND ENERGY PROVIDERS TO GATHER UTILITY, ELECTRICITY, NATURAL GAS USAGE DATA TO SUPPORT TIME-BASED RATES AND ENABLE CONSUMERS AND BUSINESSES TO MAKE CHOICES ABOUT UTILITY, POWER AND ENERGY USAGE IN RESPONSE TO MARKET AND PRICE SIGNALS, AS WELL AS SYSTEM CONDITIONS; PROVIDING TEMPORARY USE OF ON-LINE NON-DOWNLOADABLE SOFTWARE FOR PROVIDING ALERTS OF UTILITY, POWER OUTAGES, AND POWER RESTORATION; PROVIDING TEMPORARY USE OF ON-LINE NON-DOWNLOADABLE SOFTWARE FOR PROVIDING CONSUMERS AND BUSINESSES WITH ACCESS TO THEIR USAGE DATA AND REMOTE DISCONNECTION AND RECONNECTION OF UTILITY SERVICES; PROVIDING TEMPORARY USE OF ON-LINE NON-DOWNLOADABLE SOFTWARE FOR CONNECTIVITY TO AND MANAGEMENT OF IN-HOME DEVICES SUCH AS THERMOSTATS, WATER HEATERS, POOL HEATERS, DIRECTLY OR VIA IN-HOME GATEWAY(S) SO THAT USE OF THOSE DEVICES CAN BE ALTERED AS CONDITIONS WARRANT; PROVIDING TEMPORARY USE OF ON-LINE NON-DOWNLOADABLE COMMUNICATION SOFTWARE FOR USE IN THE UTILITY, POWER AND ENERGY INDUSTRIES; PROVIDING TEMPORARY USE OF ON-LINE NON-DOWNLOADABLE SOFTWARE FOR DATA COLLECTION APPLICATIONS, NAMELY, AUTOMATED METER READING, DISTRIBUTION AUTOMATION, TWO-WAY COMMUNICATIONS BETWEEN NETWORKS AND UTILITY METERS, AND DEMAND SIDE MANAGEMENT APPLICATIONS VIA THE INTERNET, INTRANETS, EXTRANETS, RADIO FREQUENCY NETWORKS, WIRELESS NETWORKS, TELEPHONE LINES, AND INTEGRATED COMMUNICATIONS NETWORKS, NAMELY, PUBLIC SWITCHED TELEPHONE NETWORKS, PRIVATE NETWORKS, PUBLIC NETWORKS, AND CELLULAR NETWORKS, ALL FOR USE IN THE UTILITY, POWER AND ENERGY INDUSTRIES; PROVIDING TEMPORARY USE OF ON-LINE NON-DOWNLOADABLE COMPUTER OPERATING SOFTWARE FOR DATA COLLECTION AND REMOTE PROGRAMMING APPLICATIONS, NAMELY, TWO-WAY AUTOMATED METER READING, DISTRIBUTION AUTOMATION, REMOTE COMMUNICATIONS BETWEEN NETWORKS AND BETWEEN AND AMONG UTILITY METERS, AND DEMAND SIDE MANAGEMENT APPLICATIONS VIA THE INTERNET, INTRANETS, EXTRANETS, RADIO FREQUENCY NETWORKS, WIRELESS NETWORKS, TELEPHONE LINES, AND INTEGRATED COMMUNICATIONS NETWORKS, NAMELY, PUBLIC SWITCHED TELEPHONE NETWORKS, IP-BASED PUBLIC NETWORKS, PRIVATE NETWORKS, BROADBAND OVER POWERLINE NETWORKS, PUBLIC NETWORKS AND CELLULAR NETWORKS FOR ENERGY DATA, AND OTHER UTILITY METER MONITORING POINTS (U.S. CLS. 100 AND 101).

FIRST USE 10-17-2006; IN COMMERCE 12-20-2007.

CLASS 43—HOTEL AND RESTAURANT SERVICES

CLASS 43—(Continued).

3,785,061. MAMBO SEAFOOD #1, INC., HOUSTON, TX. SN 76-480,309. PUB. 7-22-2003, FILED 1-6-2003.

MAMBO MICHELADA

FOR RESTAURANT SERVICES (U.S. CLS. 100 AND 101).
FIRST USE 11-30-2001; IN COMMERCE 11-30-2001.

3,785,166. PIZZERIA UNO CORPORATION, WILMINGTON, DE. SN 77-199,373. PUB. 12-11-2007, FILED 6-6-2007.

UNO CHICAGO GRILL UNO MAS LOUNGE

THE MARK CONSISTS OF STANDARD CHARACTERS WITHOUT CLAIM TO ANY PARTICULAR FONT, STYLE, SIZE, OR COLOR.

OWNER OF U.S. REG. NOS. 1,846,019 AND 3,257,139.
NO CLAIM IS MADE TO THE EXCLUSIVE RIGHT TO USE "CHICAGO GRILL" AND "LOUNGE", APART FROM THE MARK AS SHOWN.

THE FOREIGN WORDING IN THE MARK TRANSLATES INTO ENGLISH AS ONE AND ONE MORE.

FOR RESTAURANT AND BAR SERVICES (U.S. CLS. 100 AND 101).

FIRST USE 7-1-2008; IN COMMERCE 7-1-2008.

3,785,168. FORBES, DAVID C, KIRKLAND, WA. SN 77-200,454. PUB. 11-27-2007, FILED 6-7-2007.

subs 4 u

THE MARK CONSISTS OF STANDARD CHARACTERS WITHOUT CLAIM TO ANY PARTICULAR FONT, STYLE, SIZE, OR COLOR.

NO CLAIM IS MADE TO THE EXCLUSIVE RIGHT TO USE "SUBS", APART FROM THE MARK AS SHOWN.

FOR CAFE-RESTAURANTS; CARRY-OUT RESTAURANTS; DELICATESSENS; FAST-FOOD RESTAURANTS; FAST-FOOD RESTAURANTS AND SNACKBARS (U.S. CLS. 100 AND 101).

FIRST USE 1-19-2010; IN COMMERCE 1-19-2010.

CLASS 43—(Continued).

3,785,244. NADAMISA, INC., WINDSOR, CANADA. SN 77-330,390. PUB. 11-18-2008, FILED 11-15-2007.

SmoothieO

THE MARK CONSISTS OF STANDARD CHARACTERS WITHOUT CLAIM TO ANY PARTICULAR FONT, STYLE, SIZE, OR COLOR.

FOR RESTAURANT SERVICES (U.S. CLS. 100 AND 101).

FIRST USE 4-0-2008; IN COMMERCE 4-0-2008.

3,785,350. THOMAS AND KING, INC., LEXINGTON, KY. SN 77-415,093. PUB. 11-25-2008, FILED 3-6-2008.



OWNER OF U.S. REG. NOS. 3,411,155 AND 3,475,527.
NO CLAIM IS MADE TO THE EXCLUSIVE RIGHT TO USE "PERFECT PORTIONS", APART FROM THE MARK AS SHOWN.

FOR RESTAURANT SERVICES (U.S. CLS. 100 AND 101).

FIRST USE 2-20-2008; IN COMMERCE 2-20-2008.

3,785,554. SIERRA LODGINGS, INC., GLENDALE, CA. SN 77-532,546. PUB. 6-23-2009, FILED 7-28-2008.



NO CLAIM IS MADE TO THE EXCLUSIVE RIGHT TO USE "SUITES", "CONVENTION CENTER" AND "VILLAS ORLANDO", APART FROM THE MARK AS SHOWN.

THE COLOR(S) ORANGE AND BLUE IS/ARE CLAIMED AS A FEATURE OF THE MARK.

CLASS 43—(Continued).

THE MARK CONSISTS OF THE FANCIFUL DESIGN OF AN ORANGE FLOWER. THE STYLIZED WORDING "THE CARIBE" IN THE COLOR BLUE IMMEDIATELY BELOW THE FLOWER DESIGN. THE STYLIZED WORDING "SUITES", "CONVENTION CENTER", "VILLAS" IN THE COLOR BLUE BELOW THE WORDING "THE CARIBE", THE STYLIZED WORDING "ORLANDO" IN THE COLOR ORANGE BELOW ALL OTHER ELEMENTS IN THE MARK.

FOR RESORT HOTELS; CONVENTION CENTERS, NAMELY, PROVIDING CONVENTION FACILITIES (U.S. CLS. 100 AND 101).

FIRST USE 1-1-2009; IN COMMERCE 1-1-2009.

3,785,571. CALISTRO CALIFORNIA BISTRO #1, LLC, SCOTTSDALE, AZ. SN 77-540,865. PUB. 6-16-2009, FILED 8-6-2008.

CALISTRO

THE MARK CONSISTS OF STANDARD CHARACTERS WITHOUT CLAIM TO ANY PARTICULAR FONT, STYLE, SIZE, OR COLOR.

FOR RESTAURANT, BAR, CAFÉ AND CATERING SERVICES (U.S. CLS. 100 AND 101).

FIRST USE 6-0-2009; IN COMMERCE 8-3-2009.

3,785,788. HHH HOLDINGS, LLC, LAS VEGAS, NV. SN 77-657,037. PUB. 5-12-2009, FILED 1-26-2009.

UNION

THE MARK CONSISTS OF STANDARD CHARACTERS WITHOUT CLAIM TO ANY PARTICULAR FONT, STYLE, SIZE, OR COLOR.

FOR BAR AND RESTAURANT SERVICES (U.S. CLS. 100 AND 101).

FIRST USE 12-16-2009; IN COMMERCE 12-16-2009.

CLASS 43—(Continued).

3,785,798. WORLD MARKET CENTER VENTURE, LLC, LAS VEGAS, NV. SN 77-658,339. PUB. 6-16-2009, FILED 1-28-2009.

DESIGN SALON

THE MARK CONSISTS OF STANDARD CHARACTERS WITHOUT CLAIM TO ANY PARTICULAR FONT, STYLE, SIZE, OR COLOR.

NO CLAIM IS MADE TO THE EXCLUSIVE RIGHT TO USE "DESIGN", APART FROM THE MARK AS SHOWN.

FOR PROVIDING SHOWROOM, CONFERENCE, EXHIBITION AND MEETING FACILITIES (U.S. CLS. 100 AND 101).

FIRST USE 12-9-2009; IN COMMERCE 12-9-2009.

3,785,838. MY COMPANY 4, INC., ATLANTA, GA. SN 77-664,101. PUB. 6-2-2009, FILED 2-5-2009.

FUEGOMUNDO

THE MARK CONSISTS OF STANDARD CHARACTERS WITHOUT CLAIM TO ANY PARTICULAR FONT, STYLE, SIZE, OR COLOR.

THE ENGLISH TRANSLATION OF "FUEGO" IS FIRE AND "MUNDO" IS WORLD.

FOR RESTAURANT SERVICES (U.S. CLS. 100 AND 101).

FIRST USE 6-5-2009; IN COMMERCE 6-5-2009.

3,785,907. AOL INC., DULLES, VA. SN 77-676,414. PUB. 6-9-2009, FILED 2-23-2009.

KITCHENDAILY

THE MARK CONSISTS OF STANDARD CHARACTERS WITHOUT CLAIM TO ANY PARTICULAR FONT, STYLE, SIZE, OR COLOR.

FOR PROVIDING INFORMATION IN THE FIELDS OF FOOD PREPARATION, RECIPES, AND COOKING (U.S. CLS. 100 AND 101).

FIRST USE 2-23-2010; IN COMMERCE 2-23-2010.

CLASS 43—(Continued).

3,786,052. SECURITY ATLANTIC LEASING, LLC, PHILADELPHIA, PA. SN 77-733,530. PUB. 9-22-2009, FILED 5-11-2009.

Gourmetro

THE MARK CONSISTS OF STANDARD CHARACTERS WITHOUT CLAIM TO ANY PARTICULAR FONT, STYLE, SIZE, OR COLOR.

FOR CATERING SERVICES FOR THE PROVISION OF FOOD AND BEVERAGES TO INDIVIDUALS, BUSINESS ENTITIES AND INSTITUTIONS (U.S. CLS. 100 AND 101).
FIRST USE 9-4-2009; IN COMMERCE 9-4-2009.

3,786,082. THE EXPRESS CAFE & BAKERY, LLC, SAVANNAH, GA. SN 77-748,605. PUB. 10-13-2009, FILED 6-1-2009.

GOOSE FEATHERS

THE MARK CONSISTS OF STANDARD CHARACTERS WITHOUT CLAIM TO ANY PARTICULAR FONT, STYLE, SIZE, OR COLOR.

FOR CAFE AND RESTAURANT SERVICES (U.S. CLS. 100 AND 101).
FIRST USE 1-4-2010; IN COMMERCE 1-4-2010.

3,786,110. LANDRESS, CARY, SAN DIEGO, CA. SN 77-757,853. PUB. 11-3-2009, FILED 6-11-2009.

KEEP IT IN SAN DIEGO

THE MARK CONSISTS OF STANDARD CHARACTERS WITHOUT CLAIM TO ANY PARTICULAR FONT, STYLE, SIZE, OR COLOR.

NO CLAIM IS MADE TO THE EXCLUSIVE RIGHT TO USE "SAN DIEGO", APART FROM THE MARK AS SHOWN.

FOR PROVIDING PERSONALIZED INFORMATION TO HOTELS, CORPORATIONS, ASSOCIATIONS AND INDIVIDUAL GROUPS ABOUT HOTELS AND TEMPORARY ACCOMMODATIONS IN SAN DIEGO, CALIFORNIA (U.S. CLS. 100 AND 101).
FIRST USE 6-15-2009; IN COMMERCE 6-15-2009.

CLASS 43—(Continued).

3,786,245. THE RONALD REAGAN PRESIDENTIAL LIBRARY FOUNDATION, SIMI VALLEY, CA. SN 78-714,203. PUB. 11-28-2006, FILED 9-15-2005.



NO CLAIM IS MADE TO THE EXCLUSIVE RIGHT TO USE "PUB", APART FROM THE MARK AS SHOWN.

THE NAME(S), PORTRAIT(S), AND/OR SIGNATURE(S) SHOWN IN THE MARK IDENTIFIES "RONALD REAGAN", WHOSE CONSENT(S) TO REGISTER IS SUBMITTED.

THE MARK CONSISTS OF THE WORDS "THE RONALD REAGAN" IN STYLIZED FORM OVER A SHIELD WITH A HERALDIC-LIKE DESIGN, WITH THE WORD "REAGAN" JUST UNDER THE DESIGN AND THE WORD "PUB" AT THE BOTTOM.

FOR PUB (U.S. CLS. 100 AND 101).
FIRST USE 12-31-2005; IN COMMERCE 12-31-2005.

3,786,319. ROMANELLI, MICHAEL, PINE BROOK, NJ. SN 78-921,823. PUB. 5-20-2008, FILED 7-3-2006.

TIFF'S

THE MARK CONSISTS OF STANDARD CHARACTERS WITHOUT CLAIM TO ANY PARTICULAR FONT, STYLE, SIZE, OR COLOR.

THE NAME "TIFF" DOES NOT IDENTIFY A LIVING INDIVIDUAL.

FOR RESTAURANT AND BAR SERVICES; RESTAURANT SERVICES; RESTAURANTS (U.S. CLS. 100 AND 101).

FIRST USE 1-1-2007; IN COMMERCE 1-1-2007.

CLASS 44—MEDICAL, BEAUTY AND AGRICULTURAL SERVICES

CLASS 44—(Continued).

3,785,183. PANATTU, BASIL VARKEY, GLENDALE, CA. SN 77-219,783. PUB. 12-11-2007, FILED 6-30-2007.



FOR LAWN MOWING SERVICES (U.S. CLS. 100 AND 101).
FIRST USE 3-11-2009; IN COMMERCE 3-11-2009.

3,785,186. PANATTU, BASIL VARKEY, DBA EARTH SQUAD, GLENDALE, CA. SN 77-230,850. PUB. 12-11-2007, FILED 7-16-2007.

to protect and conserve

THE MARK CONSISTS OF STANDARD CHARACTERS WITHOUT CLAIM TO ANY PARTICULAR FONT, STYLE, SIZE, OR COLOR.

FOR LAWN MOWING SERVICES (U.S. CLS. 100 AND 101).
FIRST USE 3-11-2009; IN COMMERCE 3-11-2009.

3,785,224. WEIGHT WATCHERS INTERNATIONAL, INC., NEW YORK, NY. SN 77-294,343. PUB. 3-25-2008, FILED 10-2-2007.

WEIGHT WATCHERS STOP
DIETING START LIVING

THE MARK CONSISTS OF STANDARD CHARACTERS WITHOUT CLAIM TO ANY PARTICULAR FONT, STYLE, SIZE, OR COLOR.

CLASS 44—(Continued).

OWNER OF U.S. REG. NOS. 847,199, 3,057,759, AND OTHERS.

FOR PROVIDING WEIGHT REDUCTION PLANNING, TREATMENT AND SUPERVISION THROUGH WEIGHT REDUCTION PROGRAMS FEATURING COUNSELING AND DIET PLANS; PROVIDING ADVICE, CONSULTATION AND INFORMATION IN THE FIELD OF WEIGHT CONTROL AND NUTRITION (U.S. CLS. 100 AND 101).
FIRST USE 1-1-2008; IN COMMERCE 1-1-2008.

3,785,257. UBM MEDICA LLC, JERSEY CITY, NJ. SN 77-339,210. PUB. 6-16-2009, FILED 11-28-2007.

PATIENT-WISE

THE MARK CONSISTS OF STANDARD CHARACTERS WITHOUT CLAIM TO ANY PARTICULAR FONT, STYLE, SIZE, OR COLOR.

FOR PROVIDING NEWS AND INFORMATION IN THE FIELDS OF HEALTHCARE AND MEDICINE VIA A NON-DOWNLOADABLE ELECTRONIC NEWSLETTER (U.S. CLS. 100 AND 101).

FIRST USE 1-29-2009; IN COMMERCE 1-29-2009.

3,785,266. AMERISTAR CASINOS, INC., LAS VEGAS, NV. SN 77-346,892. PUB. 5-6-2008, FILED 12-7-2007.

ARA

THE MARK CONSISTS OF STANDARD CHARACTERS WITHOUT CLAIM TO ANY PARTICULAR FONT, STYLE, SIZE, OR COLOR.

FOR HEALTH SPA AND DAY SPA SERVICES OFFERED AS PART OF A CASINO ESTABLISHMENT, NAMELY, HYDROTHERAPY, FACIALS, MANICURES, PEDICURES, BEAUTY CARE SERVICES, AND BEAUTY CARE FOR THE FACE AND BODY; PROVIDING HEALTH AND DAY SPA, SAUNA, STEAM ROOM, HOT TUB, BATH AND WHIRLPOOL BATH FACILITIES AS PART OF A CASINO ESTABLISHMENT; AND PROVIDING INFORMATION AS PART OF A CASINO ESTABLISHMENT IN THE FIELDS OF HYDROTHERAPY, FACIALS, MANICURES, PEDICURES, BEAUTY CARE SERVICES AND BEAUTY CARE FOR THE FACE AND BODY (U.S. CLS. 100 AND 101).

FIRST USE 5-5-2008; IN COMMERCE 5-5-2008.

CLASS 44—(Continued).

3,785,307. COVENANT HEALTH, KNOXVILLE, TN. SN 77-383,353. PUB. 6-24-2008, FILED 1-29-2008.



OWNER OF U.S. REG. NOS. 2,091,306 AND 3,057,330.
NO CLAIM IS MADE TO THE EXCLUSIVE RIGHT TO USE "MEDICAL CENTER" AND "HEALTH", APART FROM THE MARK AS SHOWN.

THE MARK CONSISTS OF A STYLIZED CROSS WITH A STYLIZED MOUNTAIN RANGE AND STYLIZED SUN IN THE CENTER. THE STYLIZED CROSS IS NOT DISPLAYED IN THE COLOR RED OR A COLORABLE IMITATION THEREOF. UNDER THE DESIGN ELEMENT IS THE WORDING "LECONTE MEDICAL CENTER", UNDERLINED. UNDER THAT WORDING IS THE WORDING "COVENANT HEALTH", WITH A STYLIZED LETTER "O". THERE IS A PERIOD AFTER THE WORD "HEALTH."

FOR MEDICAL SERVICES (U.S. CLS. 100 AND 101).
FIRST USE 2-14-2010; IN COMMERCE 2-14-2010.

3,785,511. BUHLER, CRAIG F., KAYSVILLE, UT. SN 77-517,221. PUB. 12-2-2008, FILED 7-8-2008.



THE MARK CONSISTS OF STANDARD CHARACTERS WITHOUT CLAIM TO ANY PARTICULAR FONT, STYLE, SIZE, OR COLOR.

FOR CHIROPRACTIC AND PHYSICAL THERAPY SERVICES (U.S. CLS. 100 AND 101).
FIRST USE 11-14-2008; IN COMMERCE 11-14-2008.

CLASS 44—(Continued).

3,785,532. PROMETHEUS LABORATORIES INC., SAN DIEGO, CA. SN 77-525,225. PUB. 12-9-2008, FILED 7-17-2008.

FROM INFORMATION TO INSIGHT

THE MARK CONSISTS OF STANDARD CHARACTERS WITHOUT CLAIM TO ANY PARTICULAR FONT, STYLE, SIZE, OR COLOR.

FOR MEDICAL DIAGNOSTIC TESTING, MONITORING AND REPORTING SERVICES; HEALTH CARE SERVICES, NAMELY, PROVIDING A DATABASE IN THE FIELD OF DISEASE MANAGEMENT AND PATHOLOGY INFORMATION AND FEATURING INPUTTING AND COLLECTION OF DATA AND INFORMATION ALL FOR TREATMENT AND DIAGNOSTIC PURPOSES; MEDICAL INFORMATION, NAMELY, CONSUMER-AUTHORIZED CLINICAL LABORATORY TESTING SERVICES THAT REPORT RESULTS DIRECTLY TO THE PATIENT; AND PROVIDING MEDICAL INFORMATION (U.S. CLS. 100 AND 101).

FIRST USE 10-0-2007; IN COMMERCE 10-0-2007.

3,785,590. UHS OF DELAWARE, INC., KING OF PRUSSIA, PA. SN 77-550,635. PUB. 6-2-2009, FILED 8-19-2008.



OWNER OF U.S. REG. NOS. 3,441,149 AND 3,496,950.
NO CLAIM IS MADE TO THE EXCLUSIVE RIGHT TO USE "THE WOMEN'S CENTER" AND "HOSPITAL", APART FROM THE MARK AS SHOWN.

THE MARK CONSISTS OF THE WORDING "THE WOMEN'S CENTER AT CENTENNIAL HILLS HOSPITAL" WITH A BUTTERFLY IMAGE TO THE RIGHT OF THE WORDING.

SEC. 2(F) AS TO "CENTENNIAL HILLS".
FOR MEDICAL AND HEALTH CARE SERVICES (U.S. CLS. 100 AND 101).

FIRST USE 8-19-2008; IN COMMERCE 2-18-2010.

3,785,603. CLARIAN HEALTH PARTNERS, INC., INDIANAPOLIS, IN. SN 77-561,163. PUB. 6-9-2009, FILED 9-3-2008.

HEALTHY RESULTS

THE MARK CONSISTS OF STANDARD CHARACTERS WITHOUT CLAIM TO ANY PARTICULAR FONT, STYLE, SIZE, OR COLOR.

OWNER OF U.S. REG. NOS. 3,389,596 AND 3,408,542.

CLASS 44—(Continued).

NO CLAIM IS MADE TO THE EXCLUSIVE RIGHT TO USE "HEALTHY", APART FROM THE MARK AS SHOWN.

FOR PROVIDING HEALTH INFORMATION AND ASSISTANCE IN THE NATURE OF PROVIDING HEALTH RISK APPRAISALS; HEALTH COACHING RELATING TO LOWERING BLOOD PRESSURE, LOSING WEIGHT, LOWERING CHOLESTEROL, QUITTING SMOKING, CONTROLLING BLOOD SUGARS, BEGINNING AN EXERCISE PROGRAM AND CONTROLLING ASTHMA; CONSULTING ON BEHAVIORAL HEALTH RISKS; PROVIDING BIOMETRIC SCREENINGS; ADMINISTERING DISEASE MANAGEMENT PROGRAMS; MEDICAL CONSULTATIONS RELATING TO CANCER, DEPRESSION, DIABETES, FITNESS, HEART DISEASE, NUTRITION, OSTEOPOROSIS, STRESS MANAGEMENT, WEIGHT MANAGEMENT, CONFLICT RESOLUTION, BEHAVIOR CHANGE, TOBACCO USE, DOMESTIC VIOLENCE, SUBSTANCE ABUSE, AND MATERNAL AND BABY SERVICES (U.S. CLS. 100 AND 101).

FIRST USE 10-31-2007; IN COMMERCE 10-31-2007.

3,785,700. MOELLEKEN, BRENT R.W., BEVERLY HILLS, CA. SN 77-626,426. PUB. 5-5-2009, FILED 12-4-2008.

LALA GRAFT

THE MARK CONSISTS OF STANDARD CHARACTERS WITHOUT CLAIM TO ANY PARTICULAR FONT, STYLE, SIZE, OR COLOR.

NO CLAIM IS MADE TO THE EXCLUSIVE RIGHT TO USE "GRAFT", APART FROM THE MARK AS SHOWN.

FOR PLASTIC SURGERY (U.S. CLS. 100 AND 101).

FIRST USE 6-1-2008; IN COMMERCE 6-1-2008.

3,785,732. NEXTCARE, INC., MESA, AZ. SN 77-637,227. PUB. 5-26-2009, FILED 12-19-2008.

WAHOO

THE MARK CONSISTS OF STANDARD CHARACTERS WITHOUT CLAIM TO ANY PARTICULAR FONT, STYLE, SIZE, OR COLOR.

FOR PROVIDING ONLINE CHECK-IN FOR URGENT CARE AND FAMILY MEDICAL SERVICES INVOLVING THE GATHERING AND EVALUATING OF A PATIENT'S MEDICAL INFORMATION AND CONDITION (U.S. CLS. 100 AND 101).

FIRST USE 3-31-2009; IN COMMERCE 3-31-2009.

CLASS 44—(Continued).

3,785,789. LAVALLEY, WILLIAM, AUSTIN, TX. SN 77-657,103. PUB. 5-12-2009, FILED 1-27-2009.

Patient-centered, evidence-based, outcome-driven.

THE MARK CONSISTS OF STANDARD CHARACTERS WITHOUT CLAIM TO ANY PARTICULAR FONT, STYLE, SIZE, OR COLOR.

FOR PROVIDING HEALTH INFORMATION (U.S. CLS. 100 AND 101).

FIRST USE 8-11-2008; IN COMMERCE 8-11-2008.

3,785,794. ABBOTT BIOTECHNOLOGY LTD., HAMILTON, BERMUDA. SN 77-658,240. PUB. 5-19-2009, FILED 1-28-2009.

MyHUMIRA CLEAR COMMITMENT

THE MARK CONSISTS OF STANDARD CHARACTERS WITHOUT CLAIM TO ANY PARTICULAR FONT, STYLE, SIZE, OR COLOR.

OWNER OF U.S. REG. NO. 2,725,934.

FOR HEALTH INFORMATION SERVICES, NAMELY, PROVIDING INFORMATION ABOUT AND SELF-MANAGEMENT SKILLS FOR PSORIASIS AND PSORIATIC ARTHRITIS PATIENTS (U.S. CLS. 100 AND 101).

FIRST USE 1-28-2010; IN COMMERCE 1-28-2010.

3,785,818. KCI LICENSING, INC., SAN ANTONIO, TX. SN 77-661,085. PUB. 5-12-2009, FILED 2-2-2009.



OWNER OF U.S. REG. NOS. 1,572,615, 3,260,702, AND OTHERS.

CLASS 44—(Continued).

THE MARK CONSISTS OF A STAFF ENTWINED BY TWO CURVED LINES AND TOPPED BY A GLOBE WITH THE CONTINENTS OUTLINED, WITH THE LETTERS "KCI" ACROSS THE MIDDLE OF THE GLOBE DESIGN, AND WITH TWO SETS OF THREE CURVED BARS BENDING BACKWARDS, BEHIND THE GLOBE DESIGN.

FOR PROVIDING INFORMATION RELATED TO ADVANCED WOUND CARE, NEGATIVE PRESSURE WOUND THERAPY, AND THERAPEUTIC SUPPORT SYSTEMS (U.S. CLS. 100 AND 101).

FIRST USE 2-0-2009; IN COMMERCE 2-0-2009.

3,785,853. PAWLINKS, LLC, NEW YORK, NY. SN 77-666,339. PUB. 6-16-2009, FILED 2-9-2009.



THE COLOR(S) BLUE AND ORANGE IS/ARE CLAIMED AS A FEATURE OF THE MARK.

THE MARK CONSISTS OF A BLUE PAW PRINT INTERLOCKED WITH AN ORANGE PAW PRINT NEXT TO THE WORD "PAWLINKS". THE LETTERS "P", "A" AND "W" APPEAR IN BLUE AND THE LETTERS "L", "I", "N", "K", AND "S" APPEAR IN ORANGE.

FOR PROVIDING ONLINE INFORMATION FOR PET OWNERS AND PET-RELATED BUSINESSES, ASSOCIATIONS AND NOT-FOR-PROFIT ORGANIZATIONS IN THE FIELD OF PETS, RELATING TO BREEDING, SELECTION OF PETS, GROOMING, FEEDING AND NUTRITION; PROVIDING ONLINE PET LIFE MANAGEMENT CONSULTATION FOR PET OWNERS AND PET-RELATED BUSINESSES, ASSOCIATIONS AND NOT-FOR-PROFIT ORGANIZATIONS, NAMELY, ANIMAL BREEDING, SELECTION OF PETS, PET GROOMING, PET FEEDING AND PET NUTRITION (U.S. CLS. 100 AND 101).

FIRST USE 3-1-2010; IN COMMERCE 3-1-2010.

3,785,856. PITTSBURGH MERCY HEALTH SYSTEM, INC., PITTSBURGH, PA. SN 77-667,156. PUB. 6-9-2009, FILED 2-10-2009.



**PITTSBURGH
MERCY**
A HERITAGE OF HOPE

NO CLAIM IS MADE TO THE EXCLUSIVE RIGHT TO USE "PITTSBURGH", APART FROM THE MARK AS SHOWN.

CLASS 44—(Continued).

THE MARK CONSISTS OF A STYLIZED HEART FORMED BY TWO HANDS ABOVE THE WORDING "PITTSBURGH MERCY A HERITAGE OF HOPE".

FOR HEALTH CARE SERVICES; HEALTH CARE SERVICES, NAMELY, INPATIENT AND OUTPATIENT MEDICAL TREATMENT, MEDICAL COUNSELING, AND PROGRAMMING IN THE NATURE OF SOCIOLOGICAL MEDICAL COUNSELING SERVICES; PROVIDING MENTAL HEALTH THERAPEUTIC SERVICES, NAMELY, MENTAL RETARDATION COUNSELING, THERAPY FOR VICTIMS OF SEXUAL ABUSE, MENTAL HEALTH THERAPY, AND DRUG, ALCOHOL, AND SUBSTANCE ABUSE AND ADDICTION THERAPY; PROVIDING MEDICAL AND PSYCHOLOGICAL COUNSELING FOR VICTIMS OF CHILD ABUSE (U.S. CLS. 100 AND 101).

FIRST USE 2-11-2009; IN COMMERCE 2-11-2009.

3,785,858. PITTSBURGH MERCY HEALTH SYSTEM, INC., PITTSBURGH, PA. SN 77-667,169. PUB. 6-9-2009, FILED 2-10-2009.



THE MARK CONSISTS OF A STYLIZED HEART FORMED BY TWO HANDS.

FOR HEALTH CARE SERVICES; HEALTH CARE SERVICES, NAMELY, INPATIENT AND OUTPATIENT MEDICAL TREATMENT, MEDICAL COUNSELING, AND PROGRAMMING IN THE NATURE OF SOCIOLOGICAL MEDICAL COUNSELING SERVICES; PROVIDING MENTAL HEALTH THERAPEUTIC SERVICES, NAMELY, MENTAL RETARDATION COUNSELING, THERAPY FOR VICTIMS OF SEXUAL ABUSE, MENTAL HEALTH THERAPY, AND DRUG, ALCOHOL, AND SUBSTANCE ABUSE AND ADDICTION THERAPY; PROVIDING MEDICAL AND PSYCHOLOGICAL COUNSELING FOR VICTIMS OF CHILD ABUSE (U.S. CLS. 100 AND 101).

FIRST USE 2-11-2009; IN COMMERCE 2-11-2009.

CLASS 44—(Continued).

3,785,910. TOJ ENTERPRISES, LLC, NEW YORK, NY. SN 77-677,254. PUB. 6-23-2009, FILED 2-24-2009.

Skinny In The City

THE MARK CONSISTS OF STANDARD CHARACTERS WITHOUT CLAIM TO ANY PARTICULAR FONT, STYLE, SIZE, OR COLOR.

FOR COUNSELING SERVICES IN THE FIELDS OF HEALTH, NUTRITION AND LIFESTYLE WELLNESS; PROVIDING A WEB SITE FEATURING INFORMATION ON HEALTH AND NUTRITION (U.S. CLS. 100 AND 101).
FIRST USE 1-11-2010; IN COMMERCE 1-11-2010.

3,785,935. FOUNDATIONS DEVELOPMENTAL HOUSE, CHANDLER, AZ. SN 77-684,044. PUB. 6-30-2009, FILED 3-5-2009.

Speech-EZ

THE MARK CONSISTS OF STANDARD CHARACTERS WITHOUT CLAIM TO ANY PARTICULAR FONT, STYLE, SIZE, OR COLOR.

FOR SPEECH AND LANGUAGE PATHOLOGY THERAPY SERVICES FOR CHILDREN DIAGNOSED WITH CHILDHOOD APRAXIA OF SPEECH (CAS) (U.S. CLS. 100 AND 101).

FIRST USE 4-15-2009; IN COMMERCE 5-15-2009.

3,785,982. BEYOND THE CLINIC, P.C., MILWAUKIE, OR. SN 77-699,392. PUB. 7-28-2009, FILED 3-25-2009.

BEYOND THE CLINIC

THE MARK CONSISTS OF STANDARD CHARACTERS WITHOUT CLAIM TO ANY PARTICULAR FONT, STYLE, SIZE, OR COLOR.

NO CLAIM IS MADE TO THE EXCLUSIVE RIGHT TO USE "CLINIC", APART FROM THE MARK AS SHOWN.

FOR PHYSICAL REHABILITATION; PHYSICAL THERAPY; PHYSICAL THERAPY EVALUATION, IDENTIFICATION, AND MANAGEMENT OF MOVEMENT DYSFUNCTION TO RESTORE, MAINTAIN, AND PROMOTE OPTIMAL PHYSICAL FUNCTION PREVENTING THE ONSET, SYMPTOMS AND PROGRESSION OF IMPAIRMENTS, FUNCTIONAL LIMITATIONS, AND DISABILITIES RESULTING FROM DISEASE, DISORDERS, CONDITIONS, OR INJURIES (U.S. CLS. 100 AND 101).

FIRST USE 4-16-2009; IN COMMERCE 4-16-2009.

CLASS 44—(Continued).

3,786,094. VP CONSULTANTS, INC, OSPREY, FL. SN 77-753,170. PUB. 10-27-2009, FILED 6-5-2009.

Support Autism Global Education

THE MARK CONSISTS OF STANDARD CHARACTERS WITHOUT CLAIM TO ANY PARTICULAR FONT, STYLE, SIZE, OR COLOR.

NO CLAIM IS MADE TO THE EXCLUSIVE RIGHT TO USE "GLOBAL AUTISM EDUCATION", APART FROM THE MARK AS SHOWN.

FOR COUNSELING SERVICES IN THE FIELDS OF HEALTH, NUTRITION AND LIFESTYLE WELLNESS (U.S. CLS. 100 AND 101).

FIRST USE 6-5-2009; IN COMMERCE 1-12-2010.

3,786,149. WEIMER SKIN CLINIC, P.A., DBA WEIMER SKIN CLINIC, P.A., MYRTLE BEACH, SC. SN 77-774,380. PUB. 11-24-2009, FILED 7-5-2009.



NO CLAIM IS MADE TO THE EXCLUSIVE RIGHT TO USE "SKIN CLINIC, P.A." AND THE PICTORIAL REPRESENTATION OF SOUTH CAROLINA, APART FROM THE MARK AS SHOWN.

THE COLOR(S) BLUE, METALLIC GOLD, BLACK AND WHITE IS/ARE CLAIMED AS A FEATURE OF THE MARK.

THE MARK CONSISTS OF THE WORDS "WEIMER SKIN CLINIC, P.A." WHEREIN THE LETTER "W" IS STYLIZED FROM CROSSED, WHITE, BENDING PALM TREE SHAPES, LOCATED WITHIN THE BLUE COLORED MAP OF THE STATE OF SOUTH CAROLINA. THE STYLIZED LETTER "I" IS FORMED BY A WHITE, 5 POINTED STAR AS THE DOT, LOCATED NEAR THE GEOGRAPHIC LOCATION OF MYRTLE BEACH, SC. THE BODY OF THE LETTER "I" IS OTHERWISE A GOLD CURSIVE CHARACTER. STYLIZED LETTERS "SC" ARE FORMED BY WHITE CRESCENT MOON SHAPES COMBINED. THE WHITE, STYLIZED "W" AND "SC" ARE THEMSELVES NARROWLY OUTLINED IN BLACK. THE LETTERS FORMING "...EIMER ...KIN ...LINIC, P.A." ARE GOLD CURSIVE CHARACTERS.

FOR MEDICAL CLINICS (U.S. CLS. 100 AND 101).

FIRST USE 7-16-2009; IN COMMERCE 8-6-2009.

CLASS 45—PERSONAL AND LEGAL SERVICES

CLASS 45—(Continued).

3,785,225. STANDARD PARKING CORPORATION, CHICAGO, IL. SN 77-295,455. PUB. 2-19-2008, FILED 10-3-2007.



SP PLUS

THE MARK CONSISTS OF A CIRCLE WITH TWO ROADS COMING TOGETHER INSIDE OF THE CIRCLE, TO THE RIGHT OF THE CIRCLE THE WORDS "SP PLUS".

FOR SECURITY SERVICES, NAMELY, SECURITY GUARD SERVICES, MONITORING SECURITY SYSTEMS, BACKGROUND INVESTIGATIONS, CIVIL AND CRIMINAL INVESTIGATIONS AND RESEARCH SERVICES; CONSULTING SERVICES, NAMELY, CONCERNING THE DEVELOPMENT OF SITE SPECIFIC SAFETY AND SECURITY PLANS CONSISTING OF SECURITY, GUARDS, PATROLLING SERVICES, BURGLAR AND SECURITY ALARMS, ACCESS CONTROL, SECURITY CAMERAS AND SECURITY MONITORING SERVICES (U.S. CLS. 100 AND 101).

FIRST USE 1-20-2010; IN COMMERCE 1-20-2010.

3,785,229. ALARM.COM INCORPORATED, MCCLEAN, VA. SN 77-307,104. PUB. 9-9-2008, FILED 10-18-2007.

UP & ABOUT

THE MARK CONSISTS OF STANDARD CHARACTERS WITHOUT CLAIM TO ANY PARTICULAR FONT, STYLE, SIZE, OR COLOR.

FOR FEATURE OF SECURITY MONITORING SERVICES, NAMELY, ELECTRONIC TRACKING AND REPORTING ON ACTIVITY OR INACTIVITY OF PERSONS AND RESIDENTIAL SECURITY SYSTEMS (U.S. CLS. 100 AND 101).

FIRST USE 7-0-2007; IN COMMERCE 7-0-2007.

CLASS 45—(Continued).

3,785,270. DEMARAY, LINDA, ARVADA, CO. SN 77-352,990. PUB. 11-11-2008, FILED 12-14-2007.

CHAIR OF GENESIS

THE MARK CONSISTS OF STANDARD CHARACTERS WITHOUT CLAIM TO ANY PARTICULAR FONT, STYLE, SIZE, OR COLOR.

FOR PROVIDING SPIRITUAL REHABILITATION SERVICES, NAMELY, PROVISION OF IN-PERSON SPIRITUAL AND HARMONY-RESTORING ENERGY SERVICES (U.S. CLS. 100 AND 101).

FIRST USE 2-0-2008; IN COMMERCE 2-0-2008.

3,785,539. PILGRIM TELEPHONE, INC., LEXINGTON, MA. SN 77-527,628. PUB. 12-9-2008, FILED 7-21-2008.

CONNECTIONS

THE MARK CONSISTS OF STANDARD CHARACTERS WITHOUT CLAIM TO ANY PARTICULAR FONT, STYLE, SIZE, OR COLOR.

FOR DATING SERVICES; MATCHMAKING SERVICES (U.S. CLS. 100 AND 101).

FIRST USE 2-11-2010; IN COMMERCE 2-11-2010.

3,785,978. CHOUNG, ANDREW, SAN FRANCISCO, CA. SN 77-697,205. PUB. 7-21-2009, FILED 3-23-2009.

ECHELAW

THE MARK CONSISTS OF STANDARD CHARACTERS WITHOUT CLAIM TO ANY PARTICULAR FONT, STYLE, SIZE, OR COLOR.

FOR LEGAL SERVICES (U.S. CLS. 100 AND 101).

FIRST USE 1-1-2009; IN COMMERCE 2-3-2010.

CLASS 45—(Continued).

3,786,158. SPARK NETWORKS LIMITED, BEVERLY HILLS, CA. SN 77-813,490. PUB. 11-3-2009, FILED 8-26-2009.

CLASS 45—(Continued).

3,786,277. CAROL TUTTLE ENTERPRISES, L.L.C., DRAPER, UT. SN 78-844,937. PUB. 6-24-2008, FILED 3-23-2006.

JDATE MOBILE

ENERGY PROFILING

THE MARK CONSISTS OF STANDARD CHARACTERS WITHOUT CLAIM TO ANY PARTICULAR FONT, STYLE, SIZE, OR COLOR.

FOR CONSULTATION SERVICES IN THE AREA OF SELF-HELP AND IMPROVEMENT, SPIRITUAL HEALING AND CLOTHES SHOPPING; PERSONALITY TESTING SERVICES TO ASSESS PERSONALITY AND CHARACTER AND ADVISING INDIVIDUALS REGARDING THE SAME (U.S. CLS. 100 AND 101).
FIRST USE 12-0-2004; IN COMMERCE 12-0-2004.

3,786,301. HELIX CONSULTING, LLC, MOUNT KISCO, NY. SN 78-882,687. PUB. 6-23-2009, FILED 5-12-2006.

THE MARK CONSISTS OF STANDARD CHARACTERS WITHOUT CLAIM TO ANY PARTICULAR FONT, STYLE, SIZE, OR COLOR.

OWNER OF U.S. REG. NOS. 2,420,967, 3,278,992, AND OTHERS.

NO CLAIM IS MADE TO THE EXCLUSIVE RIGHT TO USE "MOBILE", APART FROM THE MARK AS SHOWN.

FOR PERSONAL INTRODUCTION SERVICES FOR THE PURPOSE OF MAKING ACQUAINTANCES, FRIENDSHIP, AND LONG TERM RELATIONSHIPS ACCESSED VIA ELECTRONIC COMMUNICATION NETWORK FROM MOBILE TELEPHONES, CELLULAR TELEPHONES, PERSONAL DIGITAL ASSISTANTS AND OTHER PORTABLE WIRELESS ELECTRONIC DEVICES (U.S. CLS. 100 AND 101).
FIRST USE 12-9-2009; IN COMMERCE 12-9-2009.

360° MEDIATORS

THE MARK CONSISTS OF STANDARD CHARACTERS WITHOUT CLAIM TO ANY PARTICULAR FONT, STYLE, SIZE, OR COLOR.

NO CLAIM IS MADE TO THE EXCLUSIVE RIGHT TO USE "MEDIATORS", APART FROM THE MARK AS SHOWN.

FOR MEDIATION SERVICES (U.S. CLS. 100 AND 101).
FIRST USE 9-0-2009; IN COMMERCE 9-0-2009.

* * * * *

PRIOR UNITED STATES CLASSIFICATION

APPLICATION IN ONE CLASS

COLLECTIVE MEMBERSHIP MARKS

CERTIFICATION MARKS

CLASS 200—COLLECTIVE MEMBERSHIP

CLASS B—SERVICES

3,785,265. ASSOCIATION OF CERTIFIED INDEPENDENT ENTREPRENEURS, MORENO VALLEY, CA. SN 77-345,072. PUB. 10-21-2008, FILED 12-5-2007.

3,785,060. INTERNATIONAL FOUNDATION OF EMPLOYEE BENEFIT PLANS, INC., BROOKFIELD, WI. SN 76-454,894. PUB. 10-16-2007, FILED 9-27-2002.

CIE

CMS

THE MARK CONSISTS OF STANDARD CHARACTERS WITHOUT CLAIM TO ANY PARTICULAR FONT, STYLE, SIZE, OR COLOR.

FOR INDICATING MEMBERSHIP IN AN ORGANIZATION OF ENTREPRENEURS (U.S. CL. 200).
FIRST USE 1-15-2009; IN COMMERCE 1-15-2009.

THE CERTIFICATION MARK, AS INTENDED TO BE USED BY AUTHORIZED PERSONS, IS INTENDED TO CERTIFY THAT SUCH PERSONS HAVE MET THE CERTIFIER'S EDUCATIONAL REQUIREMENTS IN THE FIELD OF COMPENSATION MANAGEMENT.

FOR ADMINISTRATION OF EMPLOYEE BENEFIT PLANS, NAMELY, COMPENSATION MANAGEMENT (U.S. CL. B).
FIRST USE 1-0-2003; IN COMMERCE 1-0-2003.

* * * * *

SUPPLEMENTAL REGISTER

These registrations are not subject to opposition.

SECTION 1.— INTERNATIONAL CLASSIFICATION

The short titles associated below with the international class numbers are terms designed merely for quick identification and are not an official part of the international classification. The full names of international classes are given in section 6.1 of the trademark rules of practice.

The designation "U.S. Cl." appearing in this section refers to the U.S. class in effect prior to Sep. 1, 1973 rather than the international class which applies to applications filed on or after that date. For adoption of international classification see notice in the OFFICIAL GAZETTE of Jun. 26, 1973 (911 O.G. TM 210).

Application in more than one class

3,786,353. BONIDE PRODUCTS, INC., ORISKANY, NY. SN 76-676,754. FILED P.R. 5-14-2007; AM. S.R. 3-25-2010.

GARDEN NATURALS

CLASS 1—CHEMICALS

FOR FERTILIZERS FOR DOMESTIC USE (U.S. CLS. 1, 5, 6, 10, 26 AND 46).
FIRST USE 2-28-2007; IN COMMERCE 2-28-2007.

CLASS 5—PHARMACEUTICALS

FOR PESTICIDES AND INSECTICIDES, FOR DOMESTIC USE (U.S. CLS. 6, 18, 44, 46, 51 AND 52).
FIRST USE 2-28-2007; IN COMMERCE 2-28-2007.

3,786,368. PWB HEALTH LIMITED, DUMBARTON, G82 3PW, UNITED KINGDOM. SN 77-463,397. FILED P.R. 5-1-2008; AM. S.R. 9-21-2009.

The logo for "breastlight" features the word in a lowercase, sans-serif font. The letters "breast" are in a reddish-pink color, and "light" is in a purple color.

OWNER OF ERPN CMNTY TM OFC REG. NO. 006912794, DATED 8-21-2009, EXPIRES 4-30-2018.
THE COLOR(S) PINK AND PURPLE IS/ARE CLAIMED AS A FEATURE OF THE MARK.

THE MARK CONSISTS OF THE STYLIZED WORD "BREASTLIGHT" WITH THE COLOR PINK APPEARING IN THE WORD "BREAST" AND THE COLOR PURPLE APPEARING IN THE WORD "LIGHT".

CLASS 5—PHARMACEUTICALS

FOR WATER-BASED PERSONAL LUBRICANTS (U.S. CLS. 6, 18, 44, 46, 51 AND 52).

CLASS 10—MEDICAL APPARATUS

FOR ELECTRICAL AND ELECTRONIC APPARATUS FOR CARRYING OUT SELF-EXAMINATION OF THE HUMAN BODY TO IDENTIFY ABNORMALITIES IN BODY TISSUE FOR MEDICAL PURPOSES, NAMELY, A LIGHT EMITTING DEVICE FOR THE PURPOSE OF SELF-EXAMINATION OF BREASTS FOR MEDICAL PURPOSES; APPARATUS FOR CARRYING OUT SELF-EXAMINATION OF THE HUMAN BODY FOR MEDICAL PURPOSES, NAMELY, A LIGHT EMITTING DEVICE FOR THE PURPOSE OF SELF-EXAMINATION OF BREASTS (U.S. CLS. 26, 39 AND 44).

3,786,374. BROWARD COUNTY COMMUNITY DEVELOPMENT INC., DBA BROWARD HOUSING SOLUTIONS, FORT LAUDERDALE, FL. SN 77-561,141. FILED 9-3-2008.

Broward Housing Solutions

THE MARK CONSISTS OF STANDARD CHARACTERS WITHOUT CLAIM TO ANY PARTICULAR FONT, STYLE, SIZE, OR COLOR.

CLASS 36—INSURANCE AND FINANCIAL

FOR HOUSING AGENCIES; REAL ESTATE RENTAL SERVICES, NAMELY, RENTAL OF RESIDENTIAL HOUSING (U.S. CLS. 100, 101 AND 102).
FIRST USE 0-0-2004; IN COMMERCE 0-0-2004.

CLASS 37—CONSTRUCTION AND REPAIR

FOR HOUSING SERVICES, NAMELY, DEVELOPMENT OF REAL PROPERTY, NAMELY, REPAIR, IMPROVEMENT, AND NEW CONSTRUCTION; HOUSING SERVICES, NAMELY, REPAIR, IMPROVEMENT, AND CONSTRUCTION OF RESIDENTIAL REAL PROPERTY (U.S. CLS. 100, 103 AND 106).
FIRST USE 0-0-2004; IN COMMERCE 0-0-2004.

3,786,377. OPEN SOCIETY INSTITUTE, NEW YORK, NY. SN 77-588,694. FILED P.R. 10-8-2008; AM. S.R. 2-18-2010.

CIVIC JUSTICE CORPS

THE MARK CONSISTS OF STANDARD CHARACTERS WITHOUT CLAIM TO ANY PARTICULAR FONT, STYLE, SIZE, OR COLOR.

CLASS 16—PAPER GOODS AND PRINTED MATTER

FOR PRINTED PUBLICATIONS AND EDUCATIONAL COURSE MATERIALS, NAMELY, HANDOUTS, WORKBOOKS, ALL IN THE FIELDS OF ACADEMIC, TECHNICAL AND CITIZENSHIP TRAINING FOR ADULTS AND YOUTH TO PROMOTE ACTIVE CITIZENSHIP AND CAREER DEVELOPMENT, ENVIRONMENTAL SUSTAINABILITY, BETTER NEIGHBORHOODS AND IMPROVED CRIMINAL JUSTICE SYSTEMS (U.S. CLS. 2, 5, 22, 23, 29, 37, 38 AND 50).

FIRST USE 0-0-2007; IN COMMERCE 0-0-2007.

CLASS 35—ADVERTISING AND BUSINESS

FOR PROVIDING COMMUNITY OUTREACH AND COMMUNITY SERVICE ACTIVITIES, NAMELY, ORGANIZING AND CONDUCTING VOLUNTEER PROGRAMS AND COMMUNITY SERVICE PROJECTS AND ORGANIZING YOUTH GROUPS TO UNDERTAKE PROJECTS TO PROMOTE ACTIVE CITIZENSHIP, CAREER DEVELOPMENT, ENVIRONMENTAL SUSTAINABILITY, BETTER NEIGHBORHOODS AND IMPROVED CRIMINAL JUSTICE SYSTEMS; PROVIDING INFORMATION AND NEWS RESOURCES VIA A GLOBAL COMMUNICATIONS NETWORK IN THE FIELD OF CAREER DEVELOPMENT (U.S. CLS. 100, 101 AND 102).

FIRST USE 0-0-2007; IN COMMERCE 0-0-2007.

CLASS 41—EDUCATION AND ENTERTAINMENT

FOR PROVIDING ACADEMIC, TECHNICAL AND CITIZENSHIP EDUCATION TRAINING AND EDUCATIONAL SERVICES TO ADULTS AND YOUTH, NAMELY, CLASSES, SEMINARS, CONFERENCES, WORKSHOPS IN THE FIELDS OF ACTIVE CITIZENSHIP, CAREER DEVELOPMENT, ENVIRONMENTAL SUSTAINABILITY, BETTER NEIGHBORHOODS AND IMPROVED CRIMINAL JUSTICE SYSTEMS (U.S. CLS. 100, 101 AND 107).

FIRST USE 0-0-2007; IN COMMERCE 0-0-2007.

3,786,379. TRANSPERFECT TRANSLATIONS INTERNATIONAL INC., NEW YORK, NY. SN 77-593,060. FILED P.R. 10-15-2008; AM. S.R. 2-17-2010.

TRIAL INTERACTIVE

THE MARK CONSISTS OF STANDARD CHARACTERS WITHOUT CLAIM TO ANY PARTICULAR FONT, STYLE, SIZE, OR COLOR.

CLASS 35—ADVERTISING AND BUSINESS

FOR BUSINESS ADMINISTRATIVE SERVICES, NAMELY, RECORDS MANAGEMENT PROVIDED VIA THE INTERNET, DOCUMENT INDEXING AND PROCESSING ALL IN THE FIELD OF CLINICAL TRIALS (U.S. CLS. 100, 101 AND 102).

FIRST USE 6-30-2008; IN COMMERCE 6-30-2008.

CLASS 39—TRANSPORTATION AND STORAGE

FOR STORAGE SERVICES FOR ARCHIVING DATABASES, IMAGES AND OTHER ELECTRONIC DATA (U.S. CLS. 100 AND 105).

FIRST USE 6-30-2008; IN COMMERCE 6-30-2008.

CLASS 40—MATERIAL TREATMENT

FOR DIGITAL COMPRESSION OF COMPUTER DATA; ELECTRONIC IMAGING, SCANNING AND DIGITIZING OF DOCUMENTS (U.S. CLS. 100, 103 AND 106).

FIRST USE 6-30-2008; IN COMMERCE 6-30-2008.

CLASS 42—SCIENTIFIC AND COMPUTER SERVICES

FOR PROVIDING TEMPORARY USE TO OTHERS OF ON LINE NON-DOWNLOADABLE SOFTWARE FOR UPLOAD, STORAGE, EXCHANGE AND REVIEW OF SECURED DOCUMENTS (U.S. CLS. 100 AND 101).

FIRST USE 6-30-2008; IN COMMERCE 6-30-2008.

3,786,382. SKY BLUE TECHNOLOGIES, INC., LAFAYETTE, IN. SN 77-596,833. FILED P.R. 10-21-2008; AM. S.R. 2-15-2010.

Radio Bookmark

THE MARK CONSISTS OF STANDARD CHARACTERS WITHOUT CLAIM TO ANY PARTICULAR FONT, STYLE, SIZE, OR COLOR.

CLASS 9—ELECTRICAL AND SCIENTIFIC APPARATUS

FOR SMALL ELECTRONIC PORTABLE DEVICE IN THE NATURE OF A FOB-LIKE MECHANISM FOR PERSONALIZED ONLINE INDEXING OF RADIO PROGRAMS (U.S. CLS. 21, 23, 26, 36 AND 38).

FIRST USE 9-20-2006; IN COMMERCE 4-11-2007.

CLASS 41—EDUCATION AND ENTERTAINMENT

FOR PROVIDING AN INTERNET WEBSITE PORTAL FEATURING LINKS TO RADIO PROGRAMS IN THE FIELDS OF CURRENT EVENT NEWS, MUSIC, AND EDUCATION (U.S. CLS. 100, 101 AND 107).

FIRST USE 9-20-2006; IN COMMERCE 4-11-2007.

CLASS 42—SCIENTIFIC AND COMPUTER SERVICES

FOR COMPUTER SERVICES, NAMELY, CREATING PERSONALIZED INDEXES OF RADIO PROGRAMS AVAILABLE ON GLOBAL COMPUTER NETWORKS (U.S. CLS. 100 AND 101).

FIRST USE 9-20-2006; IN COMMERCE 4-11-2007.

3,786,389. NEUMANN COLLEGE, ASTON, PA. SN 77-615,475.
FILED P.R. 11-17-2008; AM. S.R. 3-16-2010.

INSTITUTE FOR SPORT,
SPIRITUALITY AND CHARACTER
DEVELOPMENT

THE MARK CONSISTS OF STANDARD CHARACTERS WITHOUT CLAIM TO ANY PARTICULAR FONT, STYLE, SIZE, OR COLOR.

CLASS 9—ELECTRICAL AND SCIENTIFIC APPARATUS

FOR PROVIDING DOWNLOADABLE PUBLICATIONS VIA A WEBSITE, NAMELY, BROCHURES, REPORTS, AND SCHOLARLY PAPERS, ALL IN THE FIELD OF INTEGRATION OF CHARACTER DEVELOPMENT AND SPIRITUALITY THROUGH SPORTS (U.S. CLS. 21, 23, 26, 36 AND 38).

FIRST USE 4-1-2008; IN COMMERCE 4-1-2008.

CLASS 41—EDUCATION AND ENTERTAINMENT

FOR EDUCATIONAL SERVICES, NAMELY, CONDUCTING CLASSES AT THE UNDERGRADUATE AND GRADUATE LEVELS, PROVIDING SYMPOSIA AND SUMMER CAMPS IN THE FIELD OF PROMOTING THE SPIRITUAL, ETHICAL AND PSYCHOLOGICAL DIMENSIONS WITHIN ATHLETICS, AND PROVIDING INFORMATION IN THE FIELD OF INTEGRATION OF CHARACTER DEVELOPMENT AND SPIRITUALITY THROUGH SPORTS VIA AN ONLINE WEBSITE (U.S. CLS. 100, 101 AND 107).

FIRST USE 4-1-2008; IN COMMERCE 4-1-2008.

3,786,393. INNER LIGHT DESIGN, INC., DBA THE NEW GREEN ECONOMY, NEDERLAND, CO. SN 77-625,144.
FILED P.R. 12-2-2008; AM. S.R. 3-29-2010.

The New Green
ECONOMY

THE COLOR(S) GRAY AND GREEN IS/ARE CLAIMED AS A FEATURE OF THE MARK.

THE MARK CONSISTS OF THE WORDS "THE NEW GREEN" IN ITC BERKELEY OLDSTYLE STANDARD BOLD FONT. THE LETTERS "T," "N" AND "G" AT THE BEGINNING OF EACH WORD ARE CAPITALIZED. THE WORDS "THE NEW GREEN" ARE IN A GRAY COLOR; THEY APPEAR JUST ABOVE, AND ARE EQUAL IN WIDTH TO, THE WORD "ECONOMY". THE WORD "ECONOMY" IS IN DUTCH801 RM BT FONT; IT IS IN ALL CAPS, AND IS OF A GREEN COLOR.

CLASS 35—ADVERTISING AND BUSINESS

FOR ADVERTISING AND PUBLICITY SERVICES, NAMELY, PROMOTING THE GOODS, SERVICES, BRAND IDENTITY AND COMMERCIAL INFORMATION AND NEWS OF THIRD PARTIES THROUGH PRINT, AUDIO, VIDEO, DIGITAL AND ON-LINE MEDIUM; PROVIDING CONSUMER INFORMATION AND RELATED NEWS IN THE FIELDS OF BUSINESS AND ECONOMICS WITH A FOCUS ON SUSTAINABILITY PRINCIPLES AND PRACTICES ACROSS MULTIPLE INDUSTRIES; ADVERTISING AND DIRECTORY SERVICES, NAMELY, PROMOTING THE GOODS AND SERVICES OF OTHERS BY PROVIDING A WEB PAGE FEATURING LINKS TO THE WEBSITES OF OTHERS (U.S. CLS. 100, 101 AND 102).

FIRST USE 11-18-2008; IN COMMERCE 11-18-2008.

CLASS 41—EDUCATION AND ENTERTAINMENT

FOR ON-LINE JOURNALS, NAMELY, BLOGS AND ARTICLES FEATURING CONTENT RELATED TO SUSTAINABLY ORIENTED PRODUCTS, SERVICES, NEWS, AND ECONOMIC POLICIES (U.S. CLS. 100, 101 AND 107).

FIRST USE 11-18-2008; IN COMMERCE 11-18-2008.

CLASS 42—SCIENTIFIC AND COMPUTER SERVICES

FOR HOSTING AN ONLINE WEBSITE FEATURING NEWS AND INFORMATION ON RENEWABLE ENERGY, SUSTAINABILITY AND ECONOMICS (U.S. CLS. 100 AND 101).

FIRST USE 11-18-2008; IN COMMERCE 11-18-2008.

3,786,404. GIULIANI S.P.A., MILANO, ITALY. SN 77-650,561.
FILED P.R. 1-15-2009; AM. S.R. 9-25-2009.

GIULIANI

THE MARK CONSISTS OF STANDARD CHARACTERS WITHOUT CLAIM TO ANY PARTICULAR FONT, STYLE, SIZE, OR COLOR.

OWNER OF ITALY REG. NO. 999836, DATED 3-23-2006, EXPIRES 2-16-2012.

CLASS 5—PHARMACEUTICALS

FOR PHARMACEUTICAL, MEDICINAL AND DIETETIC PRODUCTS, NAMELY, ANTACIDS, ANTIFLATULANTS, APPETITE SUPPRESSANTS, BEE POLLEN FOR USE AS DIETARY FOOD SUPPLEMENTS, CHOLESTEROL REDUCERS, MEDICATED COMPRESSES, MEAL REPLACEMENT AND DIETARY SUPPLEMENT DRINK MIXES, MEAL REPLACEMENT DRINKS, MEAL REPLACEMENT POWDERS, NUTRITIONAL DRINK MIX FOR USE AS A MEAL REPLACEMENT, NUTRITIONAL SUPPLEMENTS, DIETARY DRINK MIX FOR USE AS A MEAL REPLACEMENT, FOOD SUPPLEMENTS, DIETARY SUPPLEMENTS, DIETARY FOODS SUPPLEMENTS, FOOD FOR DIABETICS, FOR INFANTS, FOR MEDICALLY RESTRICTED DIETS, GASTRO-INTESTINAL TREATMENT PREPARATIONS, MEDICATED HAIR CARE PREPARATIONS, HAIR GROWTH STIMULANTS, HEMORRHOID TREATMENT PREPARATIONS, HEMORRHOIDAL OINTMENTS, HERB TEAS FOR MEDICINAL PURPOSES, HERBAL SUPPLEMENTS, HERBAL TEAS FOR MEDICINAL PURPOSES, LAXATIVES, LECITHIN FOR USE AS DIETARY SUPPLEMENT, MINERAL AND VITAMIN SUPPLEMENTS (U.S. CLS. 6, 18, 44, 46, 51 AND 52).

CLASS 32—LIGHT BEVERAGES

FOR MINERAL AND AERATED WATERS AND OTHER NON-ALCOHOLIC DRINKS, NAMELY, LOW CALORIE SOFT DRINKS, SPORTS DRINKS, FRUIT DRINKS, FRUIT FLAVORED SOFT DRINKS, FRUIT JUICES, FRUIT JUICE CONCENTRATES, AERATED FRUIT JUICES, FRUIT NECTARS, FRUIT-BASED SOFT DRINKS FLAVORED WITH TEA, LEMONADE, TOMATO JUICE, VEGETABLE JUICE; CONCENTRATES, SYRUPS OR POWDERS USED IN THE PREPARATIONS OF SOFT DRINKS, ESSENCES FOR THE PREPARATION OF MINERAL WATERS, ESSENCES FOR USE IN MAKING SOFT DRINKS, SYRUPS FOR MAKING SOFT DRINKS, SYRUPS FOR MAKING LEMONADE (U.S. CLS. 45, 46 AND 48).

3,786,406. THE SPORTSMAN'S GUIDE, INC., SOUTH ST. PAUL, MN. SN 77-668,362. FILED P.R. 2-11-2009; AM. S.R. 3-5-2010.

GUIDE GEAR FIELD TESTED SINCE 1977

THE MARK CONSISTS OF STANDARD CHARACTERS WITHOUT CLAIM TO ANY PARTICULAR FONT, STYLE, SIZE, OR COLOR.

OWNER OF U.S. REG. NOS. 2,398,567, 2,523,057, AND OTHERS.

NO CLAIM IS MADE TO THE EXCLUSIVE RIGHT TO USE "GEAR FIELD TESTED SINCE 1977", APART FROM THE MARK AS SHOWN.

CLASS 6—METAL GOODS

FOR METAL GOODS, NAMELY, GAZEBOS; AND METAL PORTABLE HOUSES WITH SCREENS (U.S. CLS. 2, 12, 13, 14, 23, 25 AND 50).

FIRST USE 6-0-2007; IN COMMERCE 6-0-2007.

CLASS 12—VEHICLES

FOR NON-MOTORIZED CARTS (U.S. CLS. 19, 21, 23, 31, 35 AND 44).

FIRST USE 6-0-2007; IN COMMERCE 6-0-2007.

3,786,409. THE SPORTSMAN'S GUIDE, INC., SOUTH ST. PAUL, MN. SN 77-683,117. FILED P.R. 3-4-2009; AM. S.R. 3-3-2010.

GUIDE GEAR

THE MARK CONSISTS OF STANDARD CHARACTERS WITHOUT CLAIM TO ANY PARTICULAR FONT, STYLE, SIZE, OR COLOR.

OWNER OF U.S. REG. NOS. 2,398,567, 3,236,303, AND OTHERS.

NO CLAIM IS MADE TO THE EXCLUSIVE RIGHT TO USE "GEAR", APART FROM THE MARK AS SHOWN.

CLASS 6—METAL GOODS

FOR METAL GOODS, NAMELY, GAZEBOS; AND METAL PORTABLE HOUSES WITH SCREENS (U.S. CLS. 2, 12, 13, 14, 23, 25 AND 50).

FIRST USE 6-0-2007; IN COMMERCE 6-0-2007.

CLASS 12—VEHICLES

FOR NON-MOTORIZED CARTS (U.S. CLS. 19, 21, 23, 31, 35 AND 44).

FIRST USE 6-0-2007; IN COMMERCE 6-0-2007.

3,786,411. JANET MOORE COMMUNICATIONS, INC., AKA JANET MOORE INTERNATIONAL, HOUSTON, TX. SN 77-701,661. FILED P.R. 3-29-2009; AM. S.R. 3-12-2010.

Global Rainmaking

THE MARK CONSISTS OF STANDARD CHARACTERS WITHOUT CLAIM TO ANY PARTICULAR FONT, STYLE, SIZE, OR COLOR.

CLASS 35—ADVERTISING AND BUSINESS

FOR ADVERTISING AND PROMOTION SERVICES AND RELATED CONSULTING; ADVICE IN THE FIELD OF BUSINESS MANAGEMENT AND MARKETING; ARRANGING AND CONDUCTING BUSINESS CONFERENCES; ASSISTANCE, ADVISORY SERVICES AND CONSULTANCY WITH REGARD TO BUSINESS PLANNING, BUSINESS ANALYSIS, BUSINESS MANAGEMENT, AND BUSINESS ORGANIZATION; BRAND IMAGERY CONSULTING SERVICES; BUSINESS ADVISORY SERVICES, CONSULTANCY AND INFORMATION; BUSINESS CONSULTATION SERVICES; BUSINESS INFORMATION IN THE FIELD OF BUSINESS DEVELOPMENT AND CLIENT DEVELOPMENT; BUSINESS MANAGEMENT CONSULTING AND ADVISORY SERVICES; BUSINESS MARKETING CONSULTING SERVICES; CONCEPT AND BRAND DEVELOPMENT IN THE FIELD OF PROFESSIONAL SERVICE PROVIDERS WHO WANT TO WORK INTERNATIONALLY; CONSULTANCY SERVICES REGARDING BUSINESS STRATEGIES; CONSULTING SERVICES IN BUSINESS LEADERSHIP DEVELOPMENT AND BUSINESS MANAGEMENT; CONSULTING SERVICES RELATING TO PUBLICITY; CORPORATE IMAGE CONSULTING SERVICES; CREATIVE MARKETING DESIGN SERVICES; DEVELOPMENT OF MARKETING STRATEGIES AND CONCEPTS; DIRECT MARKETING CONSULTING SERVICES; MARKETING CONSULTING; PROVIDING INFORMATION ABOUT THE CORPORATE WORLD, CORPORATE CULTURE, AND THE CORPORATE SECTOR; PROVIDING MARKETING AND PROMOTION OF SPECIAL EVENTS; PUBLICITY CONSULTATION; SALES PROMOTION SERVICES (U.S. CLS. 100, 101 AND 102).

FIRST USE 10-4-2007; IN COMMERCE 10-4-2007.

CLASS 41—EDUCATION AND ENTERTAINMENT

FOR ARRANGING OF SEMINARS; ARRANGING PROFESSIONAL WORKSHOP AND TRAINING COURSES; BUSINESS TRAINING; CONDUCTING WORKSHOPS AND SEMINARS IN BUSINESS DEVELOPMENT AND CLIENT DEVELOPMENT; CONTINUING EDUCATION SERVICES, NAMELY, PROVIDING LIVE AND ON-LINE CONTINUING PROFESSIONAL EDUCATION SEMINARS IN THE FIELD OF BUSINESS DEVELOPMENT AND CLIENT DEVELOPMENT; EDUCATION IN THE FIELD OF BUSINESS DEVELOPMENT AND CLIENT DEVELOPMENT RENDERED THROUGH VIDEO CONFERENCE; EDUCATION IN THE FIELDS OF BUSINESS DEVELOPMENT AND CLIENT DEVELOPMENT RENDERED THROUGH CORRESPONDENCE COURSES; EDUCATION SERVICES, NAMELY, MENTORING IN THE FIELD OF BUSINESS DEVELOPMENT AND CLIENT DEVELOPMENT; EDUCATION SERVICES, NAMELY, ONE-ON-ONE MENTORING IN THE FIELDS OF BUSINESS DEVELOPMENT AND CLIENT DEVELOPMENT; EDUCATION SERVICES, NAMELY, PROVIDING LIVE AND ON-LINE CLASSES, CONFERENCES, SEMINARS AND WORKSHOPS IN THE FIELD OF BUSINESS DEVELOPMENT AND CLIENT DEVELOPMENT; EDUCATION SERVICES, NAMELY, PROVIDING CLASSES, CONFERENCES, SEMINARS AND WORKSHOPS IN THE FIELDS OF BUSINESS DEVELOPMENT AND CLIENT DEVELOPMENT; EDUCATIONAL AND ENTERTAINMENT SERVICES, NAMELY, PROVIDING MOTIVATIONAL SPEAKING SERVICES IN THE FIELD OF BUSINESS DEVELOPMENT AND CLIENT DEVELOPMENT; EDUCATIONAL SERVICES, NAMELY, CONDUCTING INFORMAL ON-LINE PROGRAMS IN THE FIELDS OF BUSINESS DEVELOPMENT AND CLIENT DEVELOPMENT, AND PRINTABLE MATERIALS DISTRIBUTED THEREWITH; EDUCATIONAL SERVICES, NAMELY, CONDUCTING INFORMAL PROGRAMS IN THE FIELDS OF BUSINESS DEVELOPMENT AND CLIENT DEVELOPMENT, USING ON-LINE ACTIVITIES AND INTERACTIVE EXHIBITS, AND PRINTABLE MATERIALS DISTRIBUTED THEREWITH; EDUCATIONAL SERVICES, NAMELY, CONDUCTING PROGRAMS IN THE FIELD OF BUSINESS DEVELOPMENT AND CLIENT DEVELOPMENT; EDUCATIONAL SERVICES, NAMELY, CONDUCTING CLASSES, CONFERENCES, SEMINARS AND WORKSHOPS IN THE FIELD OF BUSINESS DEVELOPMENT

AND CLIENT DEVELOPMENT AND DISTRIBUTION OF COURSE MATERIAL IN CONNECTION THEREWITH; EDUCATIONAL SERVICES, NAMELY, CONDUCTING CLASSES, CONFERENCES, SEMINARS AND WORKSHOPS IN THE FIELD OF BUSINESS DEVELOPMENT AND CLIENT DEVELOPMENT AND DISTRIBUTION OF TRAINING MATERIAL IN CONNECTION THEREWITH; EDUCATIONAL SERVICES, NAMELY, PROVIDING CLASSES, CONFERENCES, SEMINARS AND WORKSHOPS IN THE FIELDS OF BUSINESS DEVELOPMENT AND CLIENT DEVELOPMENT; EDUCATIONAL SERVICES, NAMELY, CONDUCTING CLASSES, CONFERENCES, SEMINARS AND WORKSHOPS IN THE FIELD OF BUSINESS DEVELOPMENT AND CLIENT DEVELOPMENT; INSTRUCTION IN THE FIELD OF BUSINESS DEVELOPMENT AND CLIENT DEVELOPMENT; ON-LINE PUBLICATION OF NEWSLETTERS, ARTICLES AND TRAINING MATERIALS ABOUT BUSINESS DEVELOPMENT AND CLIENT DEVELOPMENT; PERSONAL COACHING SERVICES IN THE FIELD OF BUSINESS DEVELOPMENT AND CLIENT DEVELOPMENT; PROVIDING ON-LINE PUBLICATIONS IN THE NATURE OF NEWSLETTERS, ARTICLES AND TRAINING MATERIALS IN THE FIELD OF BUSINESS DEVELOPMENT AND CLIENT DEVELOPMENT; PROVIDING ON-LINE TRAINING NEWSLETTERS, ARTICLES, MATERIALS, CLASSES, CONFERENCES, SEMINARS AND WORKSHOPS IN THE FIELD OF BUSINESS DEVELOPMENT AND CLIENT DEVELOPMENT; PUBLIC SECTOR BUSINESS TRAINING; PUBLICATION OF NEWSLETTERS, ARTICLES AND TRAINING MATERIALS ABOUT BUSINESS DEVELOPMENT AND CLIENT DEVELOPMENT; TEACHING IN THE FIELD OF BUSINESS DEVELOPMENT AND CLIENT DEVELOPMENT; TRAINING COURSES IN STRATEGIC PLANNING RELATING TO ADVERTISING, PROMOTION, MARKETING AND BUSINESS (U.S. CLS. 100, 101 AND 107).

FIRST USE 10-4-2007; IN COMMERCE 10-4-2007.

3,786,413. URBAN AGENT TEAM, LLC, BOISE, ID. SN 77-703,598. FILED P.R. 3-31-2009; AM. S.R. 3-10-2010.

URBAN AGENT TEAM

THE MARK CONSISTS OF STANDARD CHARACTERS WITHOUT CLAIM TO ANY PARTICULAR FONT, STYLE, SIZE, OR COLOR.

CLASS 35—ADVERTISING AND BUSINESS

FOR REAL ESTATE ADVERTISING SERVICES; REAL ESTATE MARKETING SERVICES IN THE FIELD OF CONDOMINIUMS, APARTMENTS AND HOMES (U.S. CLS. 100, 101 AND 102).

FIRST USE 5-31-2007; IN COMMERCE 5-31-2007.

CLASS 36—INSURANCE AND FINANCIAL

FOR COMMERCIAL AND RESIDENTIAL REAL ESTATE AGENCY SERVICES; REAL ESTATE BROKERAGE; REAL ESTATE MANAGEMENT (U.S. CLS. 100, 101 AND 102).

FIRST USE 12-8-2008; IN COMMERCE 12-8-2008.

3,786,415. ARA SAFETY (US) INC., NEW YORK, NY. SN 77-712,812. FILED P.R. 4-13-2009; AM. S.R. 3-10-2010.

ZERO COMBUSTION

THE MARK CONSISTS OF STANDARD CHARACTERS WITHOUT CLAIM TO ANY PARTICULAR FONT, STYLE, SIZE, OR COLOR.

CLASS 1—CHEMICALS

FOR FIRE RETARDANT CHEMICALS; FIRE RETARDANT COMPOSITIONS FOR COMMERCIAL AND DOMESTIC USE; CHEMICAL AGENT FOR FIREPROOFING FABRICS, WOOD, PAPER, AND CARDBOARD; CHEMICAL SPRAYS USED TO FIREPROOF HOUSEHOLD UPHOLSTERY, CLOTHING, AND DECORATIVE ACCESSORIES (U.S. CLS. 1, 5, 6, 10, 26 AND 46).

FIRST USE 10-0-2005; IN COMMERCE 10-0-2005.

CLASS 40—MATERIAL TREATMENT

FOR FIREPROOFING OF WOOD, PAPER, CARDBOARD, CLOTHS, HOUSEHOLD UPHOLSTERY, CLOTHING, DECORATIVE ACCESSORIES; APPLYING FIRE RETARDANT PAINTS AND COATINGS TO BUILDING MATERIALS (U.S. CLS. 100, 103 AND 106).

FIRST USE 10-0-2005; IN COMMERCE 10-0-2005.

3,786,426. CLUSTER RESOURCES, INC., PROVO, UT. SN 77-741,795. FILED P.R. 5-21-2009; AM. S.R. 2-26-2010.

ADAPTIVE COMPUTING

THE MARK CONSISTS OF STANDARD CHARACTERS WITHOUT CLAIM TO ANY PARTICULAR FONT, STYLE, SIZE, OR COLOR.

NO CLAIM IS MADE TO THE EXCLUSIVE RIGHT TO USE "COMPUTING", APART FROM THE MARK AS SHOWN.

CLASS 9—ELECTRICAL AND SCIENTIFIC APPARATUS

FOR UNIFIED INTELLIGENT AUTOMATION SOFTWARE TOOLS THAT PROVIDE INTELLIGENT POLICY-BASED GOVERNANCE AND RESOURCE MANAGEMENT CAPABILITIES FOR POOLS OF COMPUTING AND OTHER INFORMATION-TECHNOLOGY RESOURCES, NAMELY, A CLUSTER OF COMPUTERS, A GROUP OF COMPUTER CLUSTERS KNOWN AS A GRID OR GRIDS, COMMERCIAL ENTERPRISE AND HIGH-PERFORMANCE COMPUTING DATA CENTERS, DYNAMIC, ON-DEMAND OR VIRTUALIZED INFRASTRUCTURE AND DATA CENTERS, UTILITY-BASED COMPUTING SYSTEMS, HIGH-PERFORMANCE COMPUTING SYSTEMS, NETWORKED COMPUTERS, HETEROGENEOUS ENVIRONMENTS, AND HYBRID OPERATING SYSTEM ENVIRONMENTS, IN THE NATURE OF DOWNLOADABLE COMPUTER SOFTWARE THAT PROVIDES A SINGLE, SECURE INTERFACE TO

ALL OF THE ASSOCIATED COMPUTING RESOURCES FOR INTELLIGENT POLICY-BASED GOVERNANCE, WORKLOAD SCHEDULING, RESOURCE AND ENERGY MONITORING, CONTROL, MANAGEMENT AND PROVISIONING BY ADMINISTRATORS, MANAGERS, AND END USERS IN THE NATURE OF AUTOMATED ALLOCATION OF COMPUTING RESOURCES, ANALYSIS OF COMPUTING RESOURCE AVAILABILITY AND STATUS INFORMATION, INSTALLATION OF SOFTWARE AND PROVISIONING OPERATING SYSTEM CHANGES, POWER MANAGEMENT, SOFTWARE UPGRADES MANAGEMENT, ACCOUNTING AND USAGE MANAGEMENT FOR REPORTING AND BILLING, THIRD-PARTY APPLICATION INTEGRATION MANAGEMENT, WORKLOAD POLICY MANAGEMENT, AND JOB SCHEDULING FOR BOTH BATCH AND INTERACTIVE JOBS; DOWNLOADABLE COMPUTER SOFTWARE FOR AUTOMATED GOVERNANCE, MONITORING, MANAGING, PROFILING, AND INDICATING AVAILABLE COMPUTING AND ASSOCIATED RESOURCES, NAMELY, FOR INTELLIGENT AUTOMATION AND MANAGEMENT OF MULTIPLE RESOURCES, SCHEDULING, OPERATING SYSTEM PROVISIONING, POWER MANAGEMENT, AND COMPUTING RESOURCE POLICY IMPLEMENTATION THAT ENABLES ADMINISTRATORS, MANAGERS, AND END USERS TO AUTOMATE, CONTROL, AND UTILIZE MULTIPLE COMPUTING RESOURCES ACROSS COMPUTER CLUSTERS AND GRIDS, HETEROGENEOUS COMPUTERS, HYBRID OPERATING SYSTEM ENVIRONMENTS, HIGH-PERFORMANCE COMPUTING ENVIRONMENTS, AND COMPUTING NETWORKS AND FOR PROVIDING DATA ON A CLUSTER, GRID OR GRIDS, ON-DEMAND DATA CENTER, HIGH-PERFORMANCE COMPUTING ENVIRONMENT, AND COMPUTING NETWORKS; DOWNLOADABLE COMPUTER SOFTWARE FOR STATISTICAL DIAGNOSTIC AND PERFORMANCE MONITORING, NAMELY, ANALYSIS OF UTILIZATION OF COMPUTING RESOURCES, ANALYSIS OF EFFICIENCY OF USE OF COMPUTER RESOURCES, ANALYSIS OF OPTIMIZATION OF COMPUTING RESOURCES, ANALYSIS OF FAIR SHARING OF COMPUTING RESOURCES, ANALYSIS OF LOAD BALANCING OF COMPUTER SYSTEMS, ANALYSIS OF HYBRID OPERATING SYSTEM ENVIRONMENTS, AND ANALYSIS OF POWER CONSUMPTION IN COMPUTE ENVIRONMENTS BY ORGANIZATIONS, ENTITIES, INDIVIDUALS, CLASSIFICATIONS OF QUALITY OF SERVICE, QUEUES, AND COMPUTING NODES; DOWNLOADABLE COMPUTER SOFTWARE FOR PROVIDING A QUALITY OF SERVICE FOR SUBMITTED JOBS AND FOR SCHEDULING GUARANTEES AND JOB RESERVATIONS FOR USERS, GROUPS, CLASSES, ACCOUNTS, AND LEVELS OF QUALITY OF SERVICE; DOWNLOADABLE COMPUTER SOFTWARE FOR COMMAND-LINE AND GRAPHICAL RESOURCE AND WORKLOAD SIMULATION, INCLUDING SIMULATION OF SIMULTANEOUS INSTANCES TO EXPLORE THE EFFECTS OF CONFIGURATIONS AND POLICIES ON CLUSTERS, GRIDS, HIGH-PERFORMANCE COMPUTING ENVIRONMENTS, ON-DEMAND DATA CENTERS, OR NETWORKED COMPUTERS; DOWNLOADABLE COMPUTER SOFTWARE FOR DYNAMIC COMMAND-LINE AND GRAPHICAL MANAGEMENT OF COMPUTING RESOURCES, NAMELY, MANAGEMENT OF SOFTWARE LICENSES WITHIN A SINGLE COMPUTER ADMINISTRATIVE DOMAIN OR ACROSS MULTIPLE HETEROGENEOUS COMPUTER ADMINISTRATIVE DOMAINS, HYBRID OPERATING SYSTEM ENVIRONMENTS, FILE SPACES, NETWORK-ATTACHED STORAGE MEDIA, TAPE DRIVES, PROCESSORS, MEMORY, DISKS, NETWORK BANDWIDTH, AND OTHER HARDWARE RESOURCES; DOWNLOADABLE COMPUTER SOFTWARE FOR INTERFACE WITH AND COLLECTION OF END-USER COMMANDS FOR JOB, QUEUE, OPERATING SYSTEM, POWER CONSUMPTION, AND SYSTEM MANAGEMENT, FOR INTERNAL DIAGNOSTIC AND LOGGING FACILITIES, AND FOR INTEGRATION OF PROVISIONING MANAGERS, BILLING SYSTEMS, IDENTITY AND SECURITY MANAGERS AND DATABASES, AND TRANSLATION OF RESOURCE MANAGER JOB SUBMISSIONS; DOWNLOADABLE COMPUTER SOFTWARE FOR PEER-TO-PEER COLLABORATION OF MULTIPLE INSTANCES TO PROVIDE DOMAIN-SPECIFIC POLICIES AND TO PROVIDE NATIVE RESOURCE MANAGEMENT SUPPORT (U.S. CLS. 21, 23, 26, 36 AND 38).

FIRST USE 8-5-2009; IN COMMERCE 8-5-2009.

CLASS 42—SCIENTIFIC AND COMPUTER SERVICES

FOR TECHNICAL SUPPORT SERVICES AND COMPUTER SERVICES, NAMELY, MONITORING AND MANAGING NETWORK SYSTEMS; COMPUTER SOFTWARE CONSULTATION, AND MAINTENANCE AND UPGRADING COMPUTER SOFTWARE, AND TECHNICAL SUPPORT SERVICES, NAMELY, TROUBLESHOOTING OF COMPUTER SOFTWARE PROBLEMS FOR COMPUTER SOFTWARE DISTRIBUTED BY DOWNLOAD OR OTHER METHODS FOR AUTOMATING, GOVERNING, MANAGING, SCHEDULING, SIMULATING, PERFORMANCE MONITORING, POWER AND ENERGY MANAGEMENT, OPERATING SYSTEM PROVISIONING, AND ACCOUNTING FOR SINGLE AND MULTIPLE DISTRIBUTED ENVIRONMENTS, NAMELY, GROUPS OF INTERCONNECTED COMPUTERS AND ASSOCIATED RESOURCES KNOWN AS CLUSTERS, GROUPS OF CLUSTERS KNOWN AS A GRID OR GRIDS, COMMERCIAL ENTERPRISE AND HIGH-PERFORMANCE COMPUTING DATA CENTERS, DYNAMIC, ADAPTIVE, ON-DEMAND OR VIRTUALIZED INFRASTRUCTURE AND DATA CENTERS, UTILITY-BASED COMPUTING SYSTEMS, HIGH-PERFORMANCE COMPUTING ENVIRONMENTS, AND NETWORKED COMPUTERS (U.S. CLS. 100 AND 101).

FIRST USE 8-5-2009; IN COMMERCE 8-5-2009.

3,786,455. HARLAND CLARKE CORP., SAN ANTONIO, TX. SN 77-822,065. FILED P.R. 9-8-2009; AM. S.R. 3-8-2010.

BUSINESS SOLUTIONS

THE MARK CONSISTS OF STANDARD CHARACTERS WITHOUT CLAIM TO ANY PARTICULAR FONT, STYLE, SIZE, OR COLOR.

CLASS 16—PAPER GOODS AND PRINTED MATTER

FOR BANK CHECKS AND ACCESSORIES, NAMELY, CHECKBOOK COVERS, CHECKBOOK REGISTERS, ADDRESS LABELS, RUBBER STAMPS, PRINTED DEPOSIT ENVELOPES, PERSONAL ORGANIZERS, PRINTED DEPOSIT TICKETS AND SLIPS, ENVELOPES, AND PENS (U.S. CLS. 2, 5, 22, 23, 29, 37, 38 AND 50).

FIRST USE 3-31-2009; IN COMMERCE 3-31-2009.

CLASS 22—CORDAGE AND FIBERS

FOR BANK DEPOSIT BAGS (U.S. CLS. 1, 2, 7, 19, 22, 42 AND 50).

FIRST USE 3-31-2009; IN COMMERCE 3-31-2009.

CLASS 35—ADVERTISING AND BUSINESS

FOR MAIL ORDER SERVICES IN THE FIELD OF BANK CHECKS AND ACCESSORIES, NAMELY, CHECKBOOK COVERS, CHECKBOOK REGISTERS, ADDRESS LABELS, RUBBER STAMPS, PRINTED DEPOSIT ENVELOPES, PERSONAL ORGANIZERS, PRINTED DEPOSIT TICKETS AND SLIPS, ENVELOPES, AND PENS; RETAIL CATALOG ORDERING, ONLINE ORDERING AND PHONE ORDERING SERVICES FEATURING CHECKS AND ACCESSORIES, NAMELY, CHECKBOOK COVERS, CHECKBOOK REGISTERS, ADDRESS LABELS, RUBBER STAMPS, PRINTED DEPOSIT ENVELOPES, PERSONAL ORGANIZERS, PRINTED DEPOSIT TICKETS AND SLIPS, ENVELOPES, AND PENS (U.S. CLS. 100, 101 AND 102).

FIRST USE 3-31-2009; IN COMMERCE 3-31-2009.

3,786,467. VIRTUAL WORLD TECHNOLOGIES, INC., VALDOSTA, GA. SN 77-850,635. FILED P.R. 10-16-2009; AM. S.R. 3-22-2010.

VIRTUAL WORLD TECHNOLOGIES

THE MARK CONSISTS OF STANDARD CHARACTERS WITHOUT CLAIM TO ANY PARTICULAR FONT, STYLE, SIZE, OR COLOR.

CLASS 9—ELECTRICAL AND SCIENTIFIC APPARATUS

FOR APPARATUS FOR RECORDING TRANSMISSION AND REPRODUCTION OF IMAGES; BLANK MAGNETIC DATA CARRIERS; APPARATUS FOR RECORDING DATA; CENTRAL PROCESSING UNITS FOR PROCESSING DATA, AND COMPUTER HARDWARE (U.S. CLS. 21, 23, 26, 36 AND 38).

FIRST USE 2-1-1995; IN COMMERCE 2-1-1995.

CLASS 42—SCIENTIFIC AND COMPUTER SERVICES

FOR DESIGN AND DEVELOPMENT OF COMPUTER HARDWARE AND SOFTWARE; RECORDING DATA FOR OTHERS ON OPTICAL, DIGITAL AND MAGNETIC MEDIA FOR ELECTRONIC STORAGE (U.S. CLS. 100 AND 101).

FIRST USE 2-1-1995; IN COMMERCE 2-1-1995.

3,786,472. EVERET MILNER, GLENDALE, CA. SN 77-878,593. FILED P.R. 11-23-2009; AM. S.R. 3-12-2010.

YOURSCHOOLWORK

THE MARK CONSISTS OF STANDARD CHARACTERS WITHOUT CLAIM TO ANY PARTICULAR FONT, STYLE, SIZE, OR COLOR.

CLASS 41—EDUCATION AND ENTERTAINMENT

FOR EDUCATION SERVICES, NAMELY, MAINTAINING A WEB-BASED ENVIRONMENT TO PROVIDE HOMEWORK AND CLASSWORK RESOURCES TO STUDENTS BASED ON TEACHER LESSON PLANS (U.S. CLS. 100, 101 AND 107).

FIRST USE 2-6-2006; IN COMMERCE 2-6-2006.

CLASS 42—SCIENTIFIC AND COMPUTER SERVICES

FOR COMPUTER SERVICES, NAMELY, PROVIDING AN ONLINE PORTAL FEATURING NON-DOWNLOADABLE SOFTWARE TO FACILITATE COMMUNICATION BETWEEN SCHOOLS AND PARENTS REGARDING A STUDENT'S SCHOOLWORK (U.S. CLS. 100 AND 101).

FIRST USE 2-6-2006; IN COMMERCE 2-6-2006.

CLASS 37—CONSTRUCTION AND REPAIR

FOR REFURBISHMENT OF CUSTOMER EQUIPMENT AND SYSTEMS, NAMELY, REPAIR OF COMPUTER AND REPAIR OF COMPUTER SYSTEM NETWORKS; ENVIRONMENTAL WASTE DISPOSAL OF CUSTOMER EQUIPMENT AND SYSTEMS FOR OTHERS; INSTALLATION AND REPAIR OF CONSUMER ELECTRONICS, PHOTOGRAPHIC EQUIPMENT, VIDEO EQUIPMENT, AUDIO EQUIPMENT, TELECOMMUNICATION EQUIPMENT AND COMPUTER HARDWARE; UPGRADING OF COMPUTER HARDWARE (U.S. CLS. 100, 103 AND 106).

FIRST USE 4-0-2006; IN COMMERCE 4-0-2006.

3,786,490. DECISIONONE CORPORATION, DEVON, PA. SN 78-920,745. FILED P.R. 6-30-2006; AM. S.R. 2-22-2010.

LOCAL. RELIABLE. COST EFFECTIVE.

THE MARK CONSISTS OF STANDARD CHARACTERS WITHOUT CLAIM TO ANY PARTICULAR FONT, STYLE, SIZE, OR COLOR.

CLASS 35—ADVERTISING AND BUSINESS

FOR INVENTORY MANAGEMENT SERVICES IN THE FIELD OF PHOTOGRAPHIC EQUIPMENT, VIDEO EQUIPMENT, AUDIO EQUIPMENT, TELECOMMUNICATION EQUIPMENT AND COMPUTER HARDWARE AND SOFTWARE; LOGISTICS DEPOT SERVICES IN THE NATURE OF TRANSPORTATION LOGISTIC SERVICES, NAMELY, PLANNING AND SCHEDULING SHIPMENTS FOR USERS OF TRANSPORTATION SERVICES; INVENTORY TRACKING, NAMELY, TRACKING OF INVENTORY PACKAGE SHIPMENTS; ONLINE SERVICES, NAMELY, INVENTORY MONITORING FOR CUSTOMER COMPUTER EQUIPMENT AND COMPUTER SYSTEMS; ORDER FULFILLMENT SERVICES IN THE FIELDS OF CONSUMER ELECTRONICS, SOFTWARE, PHOTOGRAPHIC EQUIPMENT, VIDEO EQUIPMENT, AUDIO EQUIPMENT, SOFTWARE APPLICATIONS, TELECOMMUNICATION EQUIPMENT, COMPUTER HARDWARE, SOFTWARE, COMPUTERS AND RELATED PERIPHERALS AND PARTS; ARRANGING FOR OTHERS THE REPAIR AND REPLACEMENT OF CONSUMER ELECTRONIC GOODS; MANAGEMENT OF TELEPHONE CALL CENTERS FOR OTHERS ON THE TOPICS OF CONSUMER ELECTRONICS, SOFTWARE, PHOTOGRAPHIC EQUIPMENT, VIDEO EQUIPMENT, AUDIO EQUIPMENT, SOFTWARE APPLICATIONS, TELECOMMUNICATION EQUIPMENT, COMPUTER HARDWARE, SOFTWARE, COMPUTERS AND RELATED PERIPHERALS AND PARTS (U.S. CLS. 100, 101 AND 102).

FIRST USE 4-0-2006; IN COMMERCE 4-0-2006.

CLASS 39—TRANSPORTATION AND STORAGE

FOR WAREHOUSING SERVICES; SUPPLY CHAIN, LOGISTICS AND REVERSE LOGISTICS SERVICES, NAMELY, STORAGE, TRANSPORTATION AND DELIVERY OF DOCUMENTS, PACKAGES, RAW MATERIALS, AND OTHER FREIGHT FOR OTHERS BY AIR, RAIL, SHIP OR TRUCK (U.S. CLS. 100 AND 105).

FIRST USE 4-0-2006; IN COMMERCE 4-0-2006.

CLASS 42—SCIENTIFIC AND COMPUTER SERVICES

FOR INSTALLATION OF COMPUTER SOFTWARE; CONSUMER PRODUCT SAFETY TESTING FOR OTHERS; UPDATING OF DATA BASE CONFIGURATIONS; COMPUTER CONSULTATION IN THE FIELD OF COMPUTER SECURITY CONFIGURATION AND SETUP; TECHNICAL SUPPORT, NAMELY, MONITORING OF NETWORK SYSTEMS; TECHNICAL SUPPORT, NAMELY, PROVIDING BACK-UP COMPUTER PROGRAMS AND FACILITIES; TECHNICAL SUPPORT SERVICES, NAMELY, TROUBLESHOOTING OF COMPUTER HARDWARE AND SOFTWARE PROBLEMS; COMPUTER CONSULTATION IN THE FIELD OF CONFIGURING AND RECONFIGURING AND DE-INSTALLING COMPUTER SOFTWARE, COMPUTER SET-UP, DISPOSAL, DATA MIGRATION; COMPUTER DIAGNOSTIC SERVICES; DIAGNOSTIC SERVICE SIN THE FIELD OF CONSUMER ELECTRONICS, SOFTWARE, PHOTOGRAPHIC EQUIPMENT, VIDEO EQUIPMENT, AUDIO EQUIPMENT, SOFTWARE APPLICATIONS, TELECOMMUNICATION EQUIPMENT, COMPUTER HARDWARE, SOFTWARE, COMPUTERS AND RELATED PERIPHERALS AND PARTS; COMPUTER PROJECT MANAGEMENT SERVICES; COMPUTER SERVICES, NAMELY, DATA RECOVERY SERVICES; COMPUTER DISASTER RECOVERY PLANNING (U.S. CLS. 100 AND 101).

FIRST USE 4-0-2006; IN COMMERCE 4-0-2006.

* * * * *

SECTION 2.— INTERNATIONAL CLASSIFICATION

The short titles associated below with the international class numbers are terms designed merely for quick identification and are not an official part of the international classification. The full names of international classes are given in section 6.1 of the trademark rules of practice.

The designation "U.S. Cl." appearing in this section refers to the U.S. class in effect prior to Sep. 1, 1973 rather than the international class which applies to applications filed on or after that date. For adoption of international classification see notice in the OFFICIAL GAZETTE of Jun. 26, 1973 (911 O.G. TM 210).

Application in one class

CLASS 1—CHEMICALS

3,786,465. TRUOX, INC., MCCLELLAN, CA. SN 77-841,019. FILED P.R. 10-5-2009; AM. S.R. 2-16-2010.

RWI Reduction Technology

THE MARK CONSISTS OF STANDARD CHARACTERS WITHOUT CLAIM TO ANY PARTICULAR FONT, STYLE, SIZE, OR COLOR.

NO CLAIM IS MADE TO THE EXCLUSIVE RIGHT TO USE "TECHNOLOGY", APART FROM THE MARK AS SHOWN.

FOR CHEMICALS FOR USE IN THE DECONTAMINATION OF POLLUTED SITES; WATER PURIFYING CHEMICALS FOR SWIMMING POOLS; WATER TREATMENT CHEMICALS FOR USE IN SWIMMING POOLS AND SPAS (U.S. CLS. 1, 5, 6, 10, 26 AND 46).

FIRST USE 10-5-2009; IN COMMERCE 2-8-2010.

CLASS 2—PAINTS

3,786,371. PRINT RECOVERY CONCEPTS, INC., STANDISH, ME. SN 77-502,004. FILED P.R. 6-18-2008; AM. S.R. 3-2-2010.

SoyPrint

THE MARK CONSISTS OF THE WORDS "SOYPRINT" AS ONE WORD, WITH AN UPPERCASE "S" AND "P". FOR INK CARTRIDGES FOR PRINTERS (U.S. CLS. 6, 11 AND 16).

FIRST USE 7-1-2009; IN COMMERCE 7-1-2009.

CLASS 2—(Continued).

3,786,459. KAMA GLOBAL LLC, ALPHARETTA, GA. SN 77-831,995. FILED P.R. 9-22-2009; AM. S.R. 2-2-2010.

ICE GRIP

THE MARK CONSISTS OF STANDARD CHARACTERS WITHOUT CLAIM TO ANY PARTICULAR FONT, STYLE, SIZE, OR COLOR.

FOR COATINGS IN THE NATURE OF ANTI-SLIP PREPARATIONS APPLIED TO VEHICLE ROOFS TO GRIP ICE FROM SLIPPING OFF (U.S. CLS. 6, 11 AND 16).

FIRST USE 2-1-2010; IN COMMERCE 2-1-2010.

CLASS 3—COSMETICS AND CLEANING PREPARATIONS

3,786,474. A.V.W. INC., DBA MAX PROFESSIONAL, FT LAUDERDALE, FL. SN 77-884,560. FILED P.R. 12-2-2009; AM. S.R. 3-15-2010.

Gun Wash

THE MARK CONSISTS OF STANDARD CHARACTERS WITHOUT CLAIM TO ANY PARTICULAR FONT, STYLE, SIZE, OR COLOR.

NO CLAIM IS MADE TO THE EXCLUSIVE RIGHT TO USE "WASH", APART FROM THE MARK AS SHOWN.

FOR CLEANER FOR USE ON GUNS (U.S. CLS. 1, 4, 6, 50, 51 AND 52).

FIRST USE 5-18-2009; IN COMMERCE 7-11-2009.

CLASS 5—PHARMACEUTICALS

CLASS 5—(Continued).

3,786,383. T.R.P. COMPANY, INC., RENO, NV. SN 77-597,459.
FILED P.R. 10-21-2008; AM. S.R. 2-15-2010.

EARACHE RELIEF

THE MARK CONSISTS OF STANDARD CHARACTERS WITHOUT CLAIM TO ANY PARTICULAR FONT, STYLE, SIZE, OR COLOR.

NO CLAIM IS MADE TO THE EXCLUSIVE RIGHT TO USE "EARACHE", APART FROM THE MARK AS SHOWN. FOR HOMEOPATHIC PHARMACEUTICALS FOR TREATING EARACHE IN PEOPLE (U.S. CLS. 6, 18, 44, 46, 51 AND 52).

FIRST USE 1-15-2010; IN COMMERCE 1-15-2010.

3,786,384. T.R.P. COMPANY, INC., RENO, NV. SN 77-597,527.
FILED P.R. 10-21-2008; AM. S.R. 2-15-2010.

ASTHMA RELIEF

THE MARK CONSISTS OF STANDARD CHARACTERS WITHOUT CLAIM TO ANY PARTICULAR FONT, STYLE, SIZE, OR COLOR.

NO CLAIM IS MADE TO THE EXCLUSIVE RIGHT TO USE "ASTHMA", APART FROM THE MARK AS SHOWN. FOR HOMEOPATHIC PHARMACEUTICALS FOR TREATING THE SYMPTOMS OF ASTHMA IN PEOPLE (U.S. CLS. 6, 18, 44, 46, 51 AND 52).

FIRST USE 1-31-2010; IN COMMERCE 1-31-2010.

3,786,407. PRIMARY INVESTMENTS GROUP LIMITED,
ROAD TOWN, TORTOLA, BR.VIRGIN ISLANDS. SN 77-
671,984. FILED P.R. 2-17-2009; AM. S.R. 11-4-2009.

ULTIMATE FIBER CLEANSE

THE MARK CONSISTS OF STANDARD CHARACTERS WITHOUT CLAIM TO ANY PARTICULAR FONT, STYLE, SIZE, OR COLOR.

OWNER OF U.S. REG. NOS. 2,023,228, 3,552,951, AND 3,593,867.

NO CLAIM IS MADE TO THE EXCLUSIVE RIGHT TO USE "FIBER CLEANSE", APART FROM THE MARK AS SHOWN.

FOR DIETARY SUPPLEMENTS; FOOD SUPPLEMENTS; HERBAL SUPPLEMENTS; NUTRITIONAL SUPPLEMENTS; VITAMIN SUPPLEMENTS; MINERAL SUPPLEMENTS; MULTI-VITAMIN/MINERAL SUPPLEMENTS (U.S. CLS. 6, 18, 44, 46, 51 AND 52).

FIRST USE 6-1-2009; IN COMMERCE 6-1-2009.

CLASS 5—(Continued).

3,786,416. WESTERN RESEARCH 3000, INC., THOUSAND OAKS, CA. SN 77-718,165. FILED P.R. 4-21-2009; AM. S.R. 1-14-2010.

**RESVERATROL-RX CLINICAL
STRENGTH SUPER ANTI-AGING
FORMULA**

THE MARK CONSISTS OF STANDARD CHARACTERS WITHOUT CLAIM TO ANY PARTICULAR FONT, STYLE, SIZE, OR COLOR.

FOR NUTRITIONAL SUPPLEMENTS CONTAINING RESVERATROL (U.S. CLS. 6, 18, 44, 46, 51 AND 52).

FIRST USE 1-8-2010; IN COMMERCE 1-8-2010.

3,786,425. DOCTOR RECOMMENDED PRODUCTS, LLC,
FEASTERVILLE, PA. SN 77-739,141. FILED P.R. 5-18-2009;
AM. S.R. 2-23-2010.

Physician Grade

THE MARK CONSISTS OF STANDARD CHARACTERS WITHOUT CLAIM TO ANY PARTICULAR FONT, STYLE, SIZE, OR COLOR.

FOR VITAMIN AND MINERAL SUPPLEMENTS (U.S. CLS. 6, 18, 44, 46, 51 AND 52).

FIRST USE 2-12-2009; IN COMMERCE 2-12-2009.

3,786,431. LAWN & GARDEN PRODUCTS, INC., FRESNO,
CA. SN 77-755,313. FILED P.R. 6-9-2009; AM. S.R. 3-8-2010.

**ALL NATURAL MITE & INSECT
CONTROL RTU**

THE MARK CONSISTS OF STANDARD CHARACTERS WITHOUT CLAIM TO ANY PARTICULAR FONT, STYLE, SIZE, OR COLOR.

FOR INSECTICIDE FOR AGRICULTURAL AND DOMESTIC USE (U.S. CLS. 6, 18, 44, 46, 51 AND 52).

FIRST USE 5-28-2008; IN COMMERCE 5-28-2008.

CLASS 5—(Continued).

3,786,477. D.O.R.C. DUTCH OPHTHALMIC RESEARCH CENTER (INTERNATIONAL) B.V., ZUIDLAND, NETHERLANDS. SN 77-887,620. FILED 12-7-2009.

MEMBRANEBLUE

THE MARK CONSISTS OF STANDARD CHARACTERS WITHOUT CLAIM TO ANY PARTICULAR FONT, STYLE, SIZE, OR COLOR.

FOR PHARMACEUTICAL PREPARATIONS, NAMELY, VISCOUS FLUID FOR APPLICATION IN EYE SURGERY, HAVING THE PROPERTY OF IMPROVING THE VISIBILITY OF CERTAIN CAPSULES OR STRUCTURES IN THE EYE AND THUS ALLOWING FOR BETTER SURGERY TECHNIQUES AND SMOOTHER SURGERY PROCEDURES (U.S. CLS. 6, 18, 44, 46, 51 AND 52).

FIRST USE 2-12-2009; IN COMMERCE 2-12-2009.

CLASS 7—MACHINERY

3,786,354. GOODWAY TECHNOLOGIES CORPORATION, STAMFORD, CT. SN 76-689,364. FILED P.R. 5-6-2008; AM. S.R. 3-10-2010.

Bucket Vac

THE MARK CONSISTS OF STANDARD CHARACTERS WITHOUT CLAIM TO ANY PARTICULAR FONT, STYLE, SIZE, OR COLOR.

FOR A VACUUM HEAD FOR CONVERTING A BUCKET INTO A VACUUM CLEANER (U.S. CLS. 13, 19, 21, 23, 31, 34 AND 35).

FIRST USE 1-1-2009; IN COMMERCE 1-1-2009.

CLASS 9—ELECTRICAL AND SCIENTIFIC APPARATUS**CLASS 9—(Continued).**

3,786,376. MERCHSOURCE LLC, FOOTHILL RANCH, CA. SN 77-581,946. FILED P.R. 9-30-2008; AM. S.R. 7-6-2009.

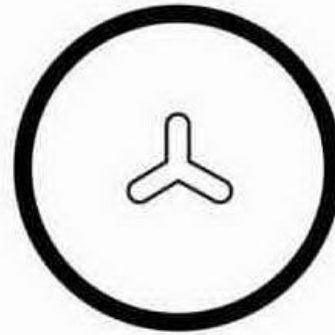

THE MARK CONSISTS OF TRADE DRESS OF AN ACTUATOR DESIGN FROM A MULTIMEDIA PLAYER CONSISTING OF A DESIGN WITH AN OVERALL TRIANGULAR SHAPE IN THE MIDDLE OF THE ACTUATOR AND A CIRCULAR SINGLE LINE BORDER DESIGN AROUND THE BORDER OF THE ACTUATOR.

FOR PORTABLE AND HANDHELD DIGITAL ELECTRONIC DEVICES FOR RECORDING, ORGANIZING, TRANSMITTING, MANIPULATING, AND REVIEWING TEXT, DATA, AUDIO AND VIDEO FILES (U.S. CLS. 21, 23, 26, 36 AND 38).

FIRST USE 8-11-2006; IN COMMERCE 8-11-2006.

3,786,378. MOJIX, INC., LOS ANGELES, CA. SN 77-591,775. FILED P.R. 10-13-2008; AM. S.R. 2-22-2010.

ENODE

THE MARK CONSISTS OF STANDARD CHARACTERS WITHOUT CLAIM TO ANY PARTICULAR FONT, STYLE, SIZE, OR COLOR.

FOR RADIO FREQUENCY IDENTIFICATION (RFID) READERS FOR USE WITH UHF PASSIVE RFID TAGS IN SUPPLY CHAIN MANAGEMENT AND ASSET TRACKING APPLICATIONS (U.S. CLS. 21, 23, 26, 36 AND 38).

FIRST USE 4-16-2008; IN COMMERCE 4-16-2008.

CLASS 9—(Continued).

3,786,388. BEALE, THEODORE, ZUG, SWITZERLAND. SN 77-612,377. FILED P.R. 11-11-2008; AM. S.R. 2-25-2010.

WARMOUSE

THE MARK CONSISTS OF STANDARD CHARACTERS WITHOUT CLAIM TO ANY PARTICULAR FONT, STYLE, SIZE, OR COLOR.

FOR INPUT DEVICES FOR COMPUTERS (U.S. CLS. 21, 23, 26, 36 AND 38).

FIRST USE 1-17-2010; IN COMMERCE 1-17-2010.

3,786,410. JOHN SCOTT HARRISON, LEAWOOD, KS. SN 77-694,045. FILED P.R. 3-18-2009; AM. S.R. 9-3-2009.

FIREPLACE BLOCKER

THE MARK CONSISTS OF STANDARD CHARACTERS WITHOUT CLAIM TO ANY PARTICULAR FONT, STYLE, SIZE, OR COLOR.

FOR FIRE BLANKETS (U.S. CLS. 21, 23, 26, 36 AND 38).

FIRST USE 9-1-2009; IN COMMERCE 9-1-2009.

3,786,441. RED CARD SYSTEMS, LLC, ST. LOUIS, MO. SN 77-768,782. FILED P.R. 6-25-2009; AM. S.R. 3-12-2010.

DOCS

THE MARK CONSISTS OF STANDARD CHARACTERS WITHOUT CLAIM TO ANY PARTICULAR FONT, STYLE, SIZE, OR COLOR.

FOR SOFTWARE FOR MANAGING THE DESIGN, STORAGE AND DISTRIBUTION OF DOCUMENTS IN THE HEALTHCARE ADMINISTRATION MARKET (U.S. CLS. 21, 23, 26, 36 AND 38).

FIRST USE 12-15-2007; IN COMMERCE 12-15-2007.

CLASS 9—(Continued).

3,786,466. PROCESS WEAVER INC, FREMONT, CA. SN 77-848,469. FILED P.R. 10-14-2009; AM. S.R. 2-17-2010.

FREIGHT AUDIT

THE MARK CONSISTS OF STANDARD CHARACTERS WITHOUT CLAIM TO ANY PARTICULAR FONT, STYLE, SIZE, OR COLOR.

FOR COMPUTER SOFTWARE FOR USE BY SHIPPERS FOR PREPARING ELECTRONIC INVOICES AND FOR DETECTING INVOICE ERRORS; COMPUTER SOFTWARE FOR USE BY SHIPPERS FOR CONVERSION OF PAPER INVOICES TO ELECTRONIC INVOICES; COMPUTER SOFTWARE FOR USE BY SHIPPERS FOR DETECTING INVOICE OVERPAYMENTS; COMPUTER SOFTWARE FOR USE BY SHIPPERS FOR ANALYZING EXPENDITURE ACCOUNTS, PREPARING BIDS AND FOR NEGOTIATING SHIPPING RATES; COMPUTER SOFTWARE FOR USE BY SHIPPERS FOR DATA MINING; COMPUTER SOFTWARE FOR USE BY SHIPPERS FOR MANAGING OUTSOURCING AND AUDIT AND PAYMENT ACTIVITIES; COMPUTER SOFTWARE FOR USE BY SHIPPERS FOR MANAGING FREIGHT PAYMENTS AND SELF-BILLING OR SELF-INVOICING; COMPUTER SOFTWARE FOR USE BY SHIPPERS FOR BID OPTIMIZATION AND ELECTRONIC ACCOUNT SETTLEMENT; ALL THE ABOVE SOFTWARE FOR USE IN THE FIELD OF FREIGHT LOGISTICS AND TRANSPORTATION (U.S. CLS. 21, 23, 26, 36 AND 38).

FIRST USE 6-30-2009; IN COMMERCE 6-30-2009.

3,786,476. ELECTRONIC ARTS INC., REDWOOD CITY, CA. SN 77-887,200. FILED P.R. 12-6-2009; AM. S.R. 3-12-2010.

SKATE

THE MARK CONSISTS OF STANDARD CHARACTERS WITHOUT CLAIM TO ANY PARTICULAR FONT, STYLE, SIZE, OR COLOR.

FOR COMPUTER GAME SOFTWARE; VIDEO GAME SOFTWARE (U.S. CLS. 21, 23, 26, 36 AND 38).

FIRST USE 9-13-2007; IN COMMERCE 9-13-2007.

CLASS 10—MEDICAL APPARATUS

CLASS 10—(Continued).

3,786,366. MASIMO CORPORATION, IRVINE, CA. SN 77-443,386. FILED P.R. 4-8-2008; AM. S.R. 8-12-2009.

ADAPTIVE PROBE OFF DETECTION

THE MARK CONSISTS OF STANDARD CHARACTERS WITHOUT CLAIM TO ANY PARTICULAR FONT, STYLE, SIZE, OR COLOR.

FOR MEDICAL DEVICES, NAMELY, PATIENT MONITORS AND PATIENT SENSORS FOR USE IN NON-INVASIVE BLOOD CONSTITUENT MONITORING (U.S. CLS. 26, 39 AND 44).

FIRST USE 9-4-2003; IN COMMERCE 9-4-2003.

CLASS 11—(Continued).

3,786,457. DIMENSION ONE SPAS, INC., VISTA, CA. SN 77-825,226. FILED P.R. 9-11-2009; AM. S.R. 2-13-2010.

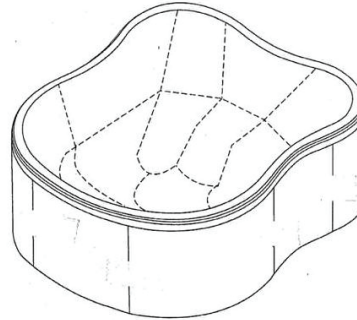
**CLASS 11—ENVIRONMENTAL CONTROL APPARATUS**

3,786,370. BAINS ULTRA INC., SAINT-NICOLAS, QUEBEC, CANADA. SN 77-501,660. FILED P.R. 6-18-2008; AM. S.R. 3-17-2009.

THE MARK CONSISTS OF THE THREE-DIMENSIONAL CONFIGURATION OF THE CURVILINEAR SPA FRAME SHAPE. THE MATTER SHOWN IN BROKEN LINES IS NOT PART OF THE MARK.

FOR SPAS IN THE NATURE OF HEATED POOLS, WHIRLPOOLS, AND HOT TUBS (U.S. CLS. 13, 21, 23, 31 AND 34).

FIRST USE 2-0-2007; IN COMMERCE 2-0-2007.

HYDRO-THERMO MASSAGE

THE MARK CONSISTS OF STANDARD CHARACTERS WITHOUT CLAIM TO ANY PARTICULAR FONT, STYLE, SIZE, OR COLOR.

PRIORITY CLAIMED UNDER SEC. 44(D) ON CANADA APPLICATION NO. 1398847, FILED 6-10-2008, REG. NO. TMA756440, DATED 1-5-2010, EXPIRES 1-5-2025.

FOR THERAPEUTIC BATHTUBS AND SHOWERS (U.S. CLS. 13, 21, 23, 31 AND 34).

3,786,458. DIMENSION ONE SPAS, INC., VISTA, CA. SN 77-825,245. FILED P.R. 9-11-2009; AM. S.R. 2-13-2010.

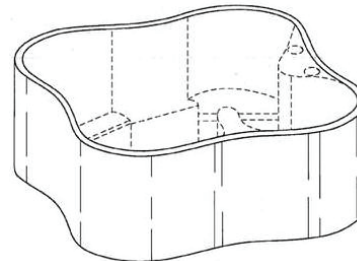

3,786,392. OTTLITE TECHNOLOGIES, INC., TAMPA, FL. SN 77-622,306. FILED P.R. 11-26-2008; AM. S.R. 3-2-2010.

OFFICE HD

THE MARK CONSISTS OF STANDARD CHARACTERS WITHOUT CLAIM TO ANY PARTICULAR FONT, STYLE, SIZE, OR COLOR.

FOR LAMPS; LIGHTING FIXTURES (U.S. CLS. 13, 21, 23, 31 AND 34).

FIRST USE 10-27-2008; IN COMMERCE 10-27-2008.

THE MARK CONSISTS OF THE THREE-DIMENSIONAL CONFIGURATION OF THE CURVILINEAR SPA FRAME SHAPE. THE MATTER SHOWN IN BROKEN LINES IS NOT PART OF THE MARK.

FOR SPAS IN THE NATURE OF HEATED POOLS, WHIRLPOOLS, HOT TUBS (U.S. CLS. 13, 21, 23, 31 AND 34).

FIRST USE 11-0-2003; IN COMMERCE 11-0-2003.

CLASS 11—(Continued).

3,786,461. THE DRYER PROS, L.L.C., PHOENIX, AZ. SN 77-835,249. FILED P.R. 9-25-2009; AM. S.R. 3-8-2010.



NO CLAIM IS MADE TO THE EXCLUSIVE RIGHT TO USE "DRYER", APART FROM THE MARK AS SHOWN.

THE MARK CONSISTS OF THE WORDS "THE DRYER PROS" IN WHITE LETTERS AGAINST A DARK BACKGROUND, WITH THE WORD "THE" POSITIONED ABOVE THE LETTER "R" IN THE WORD "DRYER"; THE DARK BACKGROUND IS A GENERALLY ELONGATED OVAL SHAPE WITH ROUNDED TOP AND BOTTOM AND FLATTENED SIDES; THE DARK BACKGROUND IS SURROUNDED BY A THIN WHITE BAND OF THE SAME SHAPE, AND THE WHITE BAND IS SURROUNDED BY A THIN DARK BAND OF THE SAME SHAPE.

FOR VEHICLE AIR DRYERS (U.S. CLS. 13, 21, 23, 31 AND 34).

FIRST USE 12-11-2009; IN COMMERCE 12-11-2009.

CLASS 12—VEHICLES

3,786,402. STAND-N-FISH, LLC, SARASOTA, FL. SN 77-645,603. FILED P.R. 1-8-2009; AM. S.R. 3-22-2010.

STANDNFISH

THE MARK CONSISTS OF STANDARD CHARACTERS WITHOUT CLAIM TO ANY PARTICULAR FONT, STYLE, SIZE, OR COLOR.

FOR STANDING SUPPORT BAR AND STABILIZER ESPECIALLY ADAPTED FOR KAYAKS THAT ATTACH TO KAYAKS SO INDIVIDUALS MAY LEAN AGAINST WHILE STANDING (U.S. CLS. 19, 21, 23, 31, 35 AND 44).
FIRST USE 3-26-2009; IN COMMERCE 8-26-2009.

CLASS 12—(Continued).

3,786,414. GROS EUGENE W., WHITE CITY, OR. SN 77-710,156. FILED P.R. 4-8-2009; AM. S.R. 2-19-2010.

I ♥ WIDE BOTTOMS

THE COLOR(S) BLACK AND RED IS/ARE CLAIMED AS A FEATURE OF THE MARK.

THE MARK CONSISTS OF "I", "WIDE" AND "BOTTOMS" ARE IN BLACK COLOR, THE HEART DESIGN BETWEEN "I" AND "WIDE" IS IN RED COLOR.

FOR ALUMINUM BOATS AND STRUCTURAL PARTS THEREFOR, NAMELY, BOAT BOTTOMS (U.S. CLS. 19, 21, 23, 31, 35 AND 44).

FIRST USE 4-1-2009; IN COMMERCE 4-1-2009.

CLASS 13—FIREARMS

3,786,399. PRECISION REFLEX, INC., NEW BRENNAN, OH. SN 77-642,384. FILED P.R. 12-31-2008; AM. S.R. 3-15-2010.

COMBAT LATCH

THE MARK CONSISTS OF STANDARD CHARACTERS WITHOUT CLAIM TO ANY PARTICULAR FONT, STYLE, SIZE, OR COLOR.

NO CLAIM IS MADE TO THE EXCLUSIVE RIGHT TO USE "LATCH", APART FROM THE MARK AS SHOWN.

FOR GUN PARTS (U.S. CLS. 2 AND 9).

FIRST USE 2-27-2008; IN COMMERCE 2-27-2008.

CLASS 14—JEWELRY

CLASS 14—(Continued).

3,786,361. DESIGNER WATCHES, NORTH LAS VEGAS, NV.
SN 77-396,946. FILED P.R. 2-14-2008; AM. S.R. 11-5-2008.

Class Watch

THE MARK CONSISTS OF STANDARD CHARACTERS WITHOUT CLAIM TO ANY PARTICULAR FONT, STYLE, SIZE, OR COLOR.

FOR CUSTOM WATCHES FEATURING THE LOGO OF A SCHOOL, GRADUATION PICTURE OR YEAR OF GRADUATION (U.S. CLS. 2, 27, 28 AND 50).

FIRST USE 11-0-1998; IN COMMERCE 11-0-1998.

3,786,473. HARUKO KINASE-LEGGETT, URBANA, IL. SN 77-881,139. FILED 11-25-2009.

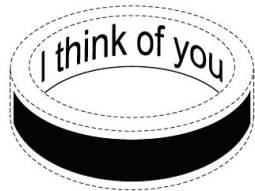

THE COLOR(S) BLACK IS/ARE CLAIMED AS A FEATURE OF THE MARK.

THE MARK CONSISTS OF THE WORDING "I THINK OF YOU" AND THE UNADORNED POLISHED METAL EXTERIOR SURFACE COMBINED WITH A BLACK BAND EXTENDING PARTIALLY AROUND THE CIRCUMFERENCE OF THE RING ARE CLAIMED AS FEATURES OF THE MARK. THE MARK CONSISTS OF THE WORDING "I THINK OF YOU" ENGRAVED ON THE INTERIOR SURFACE OF THE RING WITH THE UNADORNED POLISHED METAL SURFACE COMBINED WITH A BLACK BAND EXTENDING PARTIALLY AROUND THE OUTSIDE CIRCUMFERENCE OF THE RING. THE OUTLINE OF THE RING DEPICTED IN DOTTED LINES IN THE DRAWING IS INTENDED TO SHOW PLACEMENT OF THE MARK AND IS NOT PART OF THE MARK.

FOR JEWELRY, NAMELY, RINGS (U.S. CLS. 2, 27, 28 AND 50).

FIRST USE 10-31-2009; IN COMMERCE 10-31-2009.

CLASS 15—MUSICAL INSTRUMENTS**CLASS 15—(Continued).**

3,786,386. PROSOUND COMMUNICATIONS, INC., SAN FERNANDO, CA. SN 77-611,757. FILED P.R. 11-11-2008; AM. S.R. 2-18-2010.

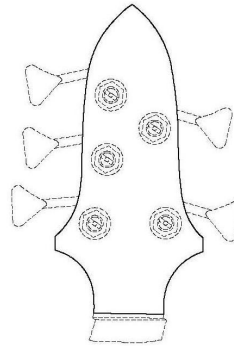

THE MARK CONSISTS OF THE DESIGN OF A GUITAR HEAD. THE DOTTED OUTLINES IN THE DRAWING, NAMELY, A PORTION OF THE GUITAR NECK, THE TUNING PEGS, AND CAPSTAN ARE NOT PART OF THE MARK BUT ARE MERELY INTENDED TO SHOW THE ENVIRONMENT OF THE MARK.

FOR ELECTRIC GUITARS (U.S. CLS. 2, 21 AND 36).
FIRST USE 12-30-2000; IN COMMERCE 12-31-2000.

CLASS 16—PAPER GOODS AND PRINTED MATTER

3,786,352. ALM MEDIA PROPERTIES, LLC, NEW YORK, NY. SN 76-552,948. FILED P.R. 10-2-2003; AM. S.R. 5-24-2004.

THE A-LIST

FOR LEGAL MAGAZINE SECTIONS IN THE NATURE OF PERIODIC REPORTS THAT RANK LAW FIRMS (U.S. CLS. 2, 5, 22, 23, 29, 37, 38 AND 50).

FIRST USE 9-0-2003; IN COMMERCE 9-0-2003.

3,786,362. KATHY DAVIS DESIGNS, INC., DBA KATHY DAVIS STUDIOS, AMBLER, PA. SN 77-415,131. FILED P.R. 3-6-2008; AM. S.R. 3-26-2010.

SCATTER JOY

THE MARK CONSISTS OF STANDARD CHARACTERS WITHOUT CLAIM TO ANY PARTICULAR FONT, STYLE, SIZE, OR COLOR.

FOR BLANK WRITING JOURNALS; BOOKMARKS (U.S. CLS. 2, 5, 22, 23, 29, 37, 38 AND 50).

FIRST USE 3-1-2009; IN COMMERCE 3-1-2009.

CLASS 16—(Continued).

3,786,395. SBE ENTERTAINMENT GROUP, LLC, LOS ANGELES, CA. SN 77-637,261. FILED P.R. 12-19-2008; AM. S.R. 3-4-2010.

SPARKLE LIKE SUNSHINE

THE MARK CONSISTS OF STANDARD CHARACTERS WITHOUT CLAIM TO ANY PARTICULAR FONT, STYLE, SIZE, OR COLOR.

FOR MERCHANDISE BAGS (U.S. CLS. 2, 5, 22, 23, 29, 37, 38 AND 50).

FIRST USE 11-1-2008; IN COMMERCE 11-1-2008.

3,786,396. SBE ENTERTAINMENT GROUP, LOS ANGELES, CA. SN 77-637,632. FILED P.R. 12-22-2008; AM. S.R. 3-4-2010.

SO LONG SWEETIE

THE MARK CONSISTS OF STANDARD CHARACTERS WITHOUT CLAIM TO ANY PARTICULAR FONT, STYLE, SIZE, OR COLOR.

FOR ENVELOPES; ENVELOPES FOR STATIONERY USE (U.S. CLS. 2, 5, 22, 23, 29, 37, 38 AND 50).

FIRST USE 11-1-2008; IN COMMERCE 11-1-2008.

3,786,449. IBASIS, INC., BURLINGTON, MA. SN 77-805,119. FILED P.R. 8-14-2009; AM. S.R. 2-3-2010.

ES

THE MARK CONSISTS OF STANDARD CHARACTERS WITHOUT CLAIM TO ANY PARTICULAR FONT, STYLE, SIZE, OR COLOR.

FOR PRE-PAID TELEPHONE CALLING CARDS, NOT MAGNETICALLY ENCODED; TELEPHONE CALLING CARDS, NOT MAGNETICALLY ENCODED (U.S. CLS. 2, 5, 22, 23, 29, 37, 38 AND 50).

FIRST USE 7-1-2009; IN COMMERCE 7-1-2009.

CLASS 16—(Continued).

3,786,451. PLAN B MEDIA LLC, DURHAM, NC. SN 77-817,101. FILED P.R. 9-1-2009; AM. S.R. 3-11-2010.

RETROFIT

THE MARK CONSISTS OF STANDARD CHARACTERS WITHOUT CLAIM TO ANY PARTICULAR FONT, STYLE, SIZE, OR COLOR.

FOR MAGAZINES IN THE FIELD OF CONSTRUCTION AND BUILDING (U.S. CLS. 2, 5, 22, 23, 29, 37, 38 AND 50).

FIRST USE 10-3-2009; IN COMMERCE 10-3-2009.

3,786,460. DECOR PRODUCTS INTERNATIONAL, INC., DONGGUAN, CHINA. SN 77-833,022. FILED P.R. 9-23-2009; AM. S.R. 1-26-2010.

Decor Products International, Inc.

THE MARK CONSISTS OF STANDARD CHARACTERS WITHOUT CLAIM TO ANY PARTICULAR FONT, STYLE, SIZE, OR COLOR.

NO CLAIM IS MADE TO THE EXCLUSIVE RIGHT TO USE "PRODUCTS" AND "INC.", APART FROM THE MARK AS SHOWN.

FOR CORRUGATED PAPER PANELS LAMINATED WITH CRAFT LINERBOARD PRIMARILY FOR LAMINATION WITH DECORATIVE OVERLAYS FOR FURTHER USE IN THE CONSTRUCTION OF WALL PARTITIONS, ROOM DIVIDERS, DESKTOPS AND TABLETOPS (U.S. CLS. 2, 5, 22, 23, 29, 37, 38 AND 50).

FIRST USE 11-23-2009; IN COMMERCE 11-23-2009.

3,786,468. COLORADO RUNNER LLC, LITTLETON, CO. SN 77-851,194. FILED P.R. 10-17-2009; AM. S.R. 3-5-2010.

Colorado Runner

THE MARK CONSISTS OF STANDARD CHARACTERS WITHOUT CLAIM TO ANY PARTICULAR FONT, STYLE, SIZE, OR COLOR.

FOR MAGAZINES IN THE FIELD OF RUNNING AND FITNESS (U.S. CLS. 2, 5, 22, 23, 29, 37, 38 AND 50).

FIRST USE 7-1-2003; IN COMMERCE 9-1-2003.

CLASS 18—LEATHER GOODS

CLASS 18—(Continued).

3,786,358. MY-BAG CARES LLC, NEW YORK, NY. SN 77-319,405. FILED P.R. 11-1-2007; AM. S.R. 3-10-2010.

MY BAG CARES

THE MARK CONSISTS OF STANDARD CHARACTERS WITHOUT CLAIM TO ANY PARTICULAR FONT, STYLE, SIZE, OR COLOR.

FOR RE-USABLE TEXTILE SHOPPING BAGS (U.S. CLS. 1, 2, 3, 22 AND 41).

FIRST USE 11-0-2008; IN COMMERCE 11-0-2008.

CLASS 19—NON-METALLIC BUILDING MATERIALS

3,786,394. MASONITE CORPORATION, TAMPA, FL. SN 77-632,940. FILED P.R. 12-15-2008; AM. S.R. 3-23-2010.

HOLLISTER

THE MARK CONSISTS OF STANDARD CHARACTERS WITHOUT CLAIM TO ANY PARTICULAR FONT, STYLE, SIZE, OR COLOR.

FOR DOORS NOT OF METAL (U.S. CLS. 1, 12, 33 AND 50).

FIRST USE 3-3-2010; IN COMMERCE 3-3-2010.

CLASS 21—HOUSEWARES AND GLASS

3,786,364. STONEWICK, INC., DALLAS, TX. SN 77-431,298. FILED P.R. 3-25-2008; AM. S.R. 3-6-2010.

PLATINUM WICK

THE MARK CONSISTS OF STANDARD CHARACTERS WITHOUT CLAIM TO ANY PARTICULAR FONT, STYLE, SIZE, OR COLOR.

NO CLAIM IS MADE TO THE EXCLUSIVE RIGHT TO USE "WICK", APART FROM THE MARK AS SHOWN.

FOR FRAGRANCE DISPENSING DEVICE, NAMELY, A CATALYTIC BURNER COMPRISED OF A POROUS NON-METALLIC WICK USED TO EMIT SCENT WHEN LIT (U.S. CLS. 2, 13, 23, 29, 30, 33, 40 AND 50).

FIRST USE 9-1-2007; IN COMMERCE 9-1-2007.

CLASS 21—(Continued).

3,786,398. MISSY ENTERPRISES, INC., STREAMWOOD, IL. SN 77-642,053. FILED P.R. 12-31-2008; AM. S.R. 3-9-2010.

The Penny Pig

THE MARK CONSISTS OF STANDARD CHARACTERS WITHOUT CLAIM TO ANY PARTICULAR FONT, STYLE, SIZE, OR COLOR.

FOR NON-METAL PIGGY BANKS, NAMELY, NON-METAL CONTAINER FOR RECEIVING AND STORING PAPER MONEY, COINS, AND OTHER SMALL ITEMS (U.S. CLS. 2, 13, 23, 29, 30, 33, 40 AND 50).

FIRST USE 2-22-2010; IN COMMERCE 2-22-2010.

3,786,403. JOHNSON & JOHNSON, INC., MADISON, FL. SN 77-648,170. FILED P.R. 1-13-2009; AM. S.R. 3-15-2010.

BETTER BEVERAGE COMPANY

THE MARK CONSISTS OF STANDARD CHARACTERS WITHOUT CLAIM TO ANY PARTICULAR FONT, STYLE, SIZE, OR COLOR.

NO CLAIM IS MADE TO THE EXCLUSIVE RIGHT TO USE "BEVERAGE COMPANY", APART FROM THE MARK AS SHOWN.

FOR BEVERAGE DISPENSERS (U.S. CLS. 2, 13, 23, 29, 30, 33, 40 AND 50).

FIRST USE 3-1-2008; IN COMMERCE 3-1-2008.

3,786,478. E&M ENGINEERING, INC, DBA FOLDTUK KITCHENWARE, RICHMOND, VA. SN 77-887,682. FILED P.R. 12-7-2009; AM. S.R. 3-10-2010.

FoldTuk

THE MARK CONSISTS OF STANDARD CHARACTERS WITHOUT CLAIM TO ANY PARTICULAR FONT, STYLE, SIZE, OR COLOR.

FOR BAKEWARE (U.S. CLS. 2, 13, 23, 29, 30, 33, 40 AND 50).

FIRST USE 3-16-2007; IN COMMERCE 3-16-2007.

CLASS 25—CLOTHING

CLASS 25—(Continued).

3,786,381. JARIN, STEPHANIE, BEVERLY HILLS, CA. SN 77-596,072. FILED P.R. 10-20-2008; AM. S.R. 2-10-2010.

MANCINI

THE MARK CONSISTS OF STANDARD CHARACTERS WITHOUT CLAIM TO ANY PARTICULAR FONT, STYLE, SIZE, OR COLOR.

THE NAME(S), PORTRAIT(S), AND/OR SIGNATURE(S) SHOWN IN THE MARK DOES NOT IDENTIFY A PARTICULAR LIVING INDIVIDUAL.

FOR FOOTWEAR (U.S. CLS. 22 AND 39).
FIRST USE 1-5-2004; IN COMMERCE 1-5-2004.

3,786,391. HAYS, GARRY, GRESHAM, OR. SN 77-617,191. FILED P.R. 11-19-2008; AM. S.R. 2-22-2010.



THE COLOR(S) BLACK, GREEN AND RED IS/ARE CLAIMED AS A FEATURE OF THE MARK.

THE MARK CONSISTS OF A WHITE DEPICTION OF THE COUNTRY OF MEXICO OUTLINED IN BLACK WITH THE WORD "MEXICO" SUPERIMPOSED OVER THE TOP OF THE MAP, WITH THE LETTERS "ME" APPEARING IN GREEN, THE LETTERS "XI" APPEARING IN OUTLINED IN BLACK WITH TRANSPARENT MIDDLES, AND THE LETTERS "CO" APPEARING IN RED.

FOR BEACH ACCESSORIES; BEACH APPAREL; BEACHWEAR, NAMELY, BEACH COVERUPS, TANK TOPS, TOPS, T-SHIRTS; HEADWEAR, NAMELY, CAPS, BANDANNAS, VISORS, HATS, HEAD SWEATBANDS; CLOTHING, NAMELY, POLO SHIRTS, SHIRTS, AND WALKING SHORTS; SWIM WEAR, NAMELY, SWIM TRUNKS, SWIM CAPS, SWIMSUITS, AND SURF WEAR; GOLF CLOTHING, NAMELY, GOLF CAPS AND GOLF SHIRTS (U.S. CLS. 22 AND 39).

FIRST USE 8-22-2008; IN COMMERCE 12-10-2008.

CLASS 25—(Continued).

3,786,408. TODD, TODD SHANNE, DBA PINKNECK UNLIMITED, MCCALL CREEK, MS. SN 77-675,561. FILED P.R. 2-22-2009; AM. S.R. 3-16-2010.

Pinkneck

THE MARK CONSISTS OF STANDARD CHARACTERS WITHOUT CLAIM TO ANY PARTICULAR FONT, STYLE, SIZE, OR COLOR.

FOR HATS; JACKETS; PANTS; SHIRTS; SHOES; SHORTS; SOCKS; SWIMWEAR; UNDERWEAR (U.S. CLS. 22 AND 39).

FIRST USE 1-19-2008; IN COMMERCE 1-20-2010.

3,786,428. MICHAEL BARTON ENTERPRISES, DUNNELON, FL. SN 77-751,890. FILED 6-4-2009.

P.O.T. PARTY PISSED OFF TAXPAYERS

THE MARK CONSISTS OF STANDARD CHARACTERS WITHOUT CLAIM TO ANY PARTICULAR FONT, STYLE, SIZE, OR COLOR.

FOR CLOTHING, NAMELY, BANDANAS, BATHING SUITS, COATS FOR MEN AND WOMEN, FOOTWEAR FOR MEN AND WOMEN, DRESSES, GYM SHORTS, GYM SUITS, HATS, HEADBANDS, JACKETS, TROUSERS, VESTS, MEN'S SUITS, WOMEN'S SUITS, MONEY BELTS, PANTS, SHOES, SHORT-SLEEVED OR LONG-SLEEVED T-SHIRTS, SHORTS, SKI BOOT BAGS, SOCKS, SKIRTS, SUN VISORS, SUSPENDERS, BELTS, SWIMSUITS, UNIFORMS, AND WAIST BELTS (U.S. CLS. 22 AND 39).

FIRST USE 4-15-1996; IN COMMERCE 4-15-1996.

CLASS 25—(Continued).

3,786,475. CORPORATE COMEDY RESOURCE, INC., SARASOTA, FL. SN 77-885,380. FILED P.R. 12-3-2009; AM. S.R. 3-11-2010.



THE COLOR(S) RED, WHITE AND BLUE IS/ARE CLAIMED AS A FEATURE OF THE MARK.

THE MARK CONSISTS OF THE FOLLOWING: THE WORD "OOPS!" IN THE COLOR BLUE, WITH RED AND WHITE STRIPES AND A BLUE ARCH WITHIN THE SECOND LETTER "O".

FOR ATHLETIC APPAREL, NAMELY, SHIRTS, PANTS, JACKETS, FOOTWEAR, HATS AND CAPS, ATHLETIC UNIFORMS; BASEBALL CAPS; CHILDREN'S AND INFANT'S APPAREL, NAMELY, JUMPERS, OVERALL SLEEPWEAR, PAJAMAS, ROMPERS AND ONE-PIECE GARMENTS; DRESS SHIRTS; FLEECE PULL-OVERS; GOLF CAPS; GOLF SHIRTS; HATS; JACKETS; JERSEYS; LONG SLEEVE PULLOVERS; SWEAT JACKETS; SWEAT PANTS; SWEAT SHIRTS; T-SHIRTS; TEE SHIRTS (U.S. CLS. 22 AND 39).

FIRST USE 1-22-2010; IN COMMERCE 1-22-2010.

3,786,486. PARAMOUNT PICTURES CORPORATION, HOLLYWOOD, CA. SN 77-904,435. FILED P.R. 1-4-2010; AM. S.R. 3-10-2010.

CALLAHAN AUTO PARTS

THE MARK CONSISTS OF STANDARD CHARACTERS WITHOUT CLAIM TO ANY PARTICULAR FONT, STYLE, SIZE, OR COLOR.

FOR APPAREL, NAMELY, T-SHIRTS (U.S. CLS. 22 AND 39).

FIRST USE 11-1-2009; IN COMMERCE 11-1-2009.

CLASS 26—FANCY GOODS**CLASS 26—(Continued).**

3,786,440. BEAUTY PLUS TRADING CO., INC., MOONACHIE, NJ. SN 77-768,463. FILED P.R. 6-25-2009; AM. S.R. 3-10-2010.

TRU INDIAN REMY

THE MARK CONSISTS OF STANDARD CHARACTERS WITHOUT CLAIM TO ANY PARTICULAR FONT, STYLE, SIZE, OR COLOR.

FOR WIGS, HAIR WEAVES, HAIR EXTENSIONS, HAIRPIECES AND ADD-IN AND ADD-ON HAIR ACCESSORIES CONSTRUCTED PRIMARILY OF SYNTHETIC AND/OR HUMAN HAIR (U.S. CLS. 37, 39, 40, 42 AND 50).

FIRST USE 9-2-2009; IN COMMERCE 10-6-2009.

CLASS 28—TOYS AND SPORTING GOODS

3,786,359. TCBC ENTERPRISES, LLC, SPRINGFIELD, VA. SN 77-383,998. FILED P.R. 1-30-2008; AM. S.R. 3-2-2010.

THE MARK CONSISTS OF STANDARD CHARACTERS WITHOUT CLAIM TO ANY PARTICULAR FONT, STYLE, SIZE, OR COLOR.

FOR TALKING AND SOUNDMAKING ELECTRONIC PRESS-DOWN TOYS (U.S. CLS. 22, 23, 38 AND 50).

FIRST USE 12-15-2009; IN COMMERCE 12-15-2009.

3,786,387. THANE INTERNATIONAL, INC., LA QUINTA, CA. SN 77-612,343. FILED P.R. 11-11-2008; AM. S.R. 9-4-2009.

3 MINUTE LEGS

THE MARK CONSISTS OF STANDARD CHARACTERS WITHOUT CLAIM TO ANY PARTICULAR FONT, STYLE, SIZE, OR COLOR.

OWNER OF U.S. REG. NO. 3,747,696.
FOR MANUALLY-OPERATED EXERCISE EQUIPMENT (U.S. CLS. 22, 23, 38 AND 50).

FIRST USE 8-11-2009; IN COMMERCE 8-11-2009.

CLASS 28—(Continued).

3,786,397. TYR SPORT, INC., HUNTINGTON BEACH, CA. SN 77-638,221. FILED P.R. 12-22-2008; AM. S.R. 3-15-2010.

STREAMLINE

THE MARK CONSISTS OF STANDARD CHARACTERS WITHOUT CLAIM TO ANY PARTICULAR FONT, STYLE, SIZE, OR COLOR.

FOR SWIM BOARDS USED FOR PROFESSIONAL TRAINING PURPOSES (U.S. CLS. 22, 23, 38 AND 50).
FIRST USE 12-26-2002; IN COMMERCE 12-26-2002.

3,786,422. HATFIELD, CRAIG, MORGANTOWN, WV. SN 77-734,155. FILED P.R. 5-11-2009; AM. S.R. 3-22-2010.

BreakAway Hooks

THE MARK CONSISTS OF STANDARD CHARACTERS WITHOUT CLAIM TO ANY PARTICULAR FONT, STYLE, SIZE, OR COLOR.

NO CLAIM IS MADE TO THE EXCLUSIVE RIGHT TO USE "HOOKS", APART FROM THE MARK AS SHOWN.
FOR FISH HOOKS (U.S. CLS. 22, 23, 38 AND 50).
FIRST USE 5-31-2009; IN COMMERCE 5-31-2009.

3,786,481. FINAL SCOOP DESIGNS, LTD., DBA READY TO PLAY GROUP LTD., R2P PET, LTD. & R2P PRODUCTS LTD., MACAU, CHINA. SN 77-888,939. FILED P.R. 12-8-2009; AM. S.R. 3-11-2010.

HIGH VIZ TECHNOLOGY

THE MARK CONSISTS OF STANDARD CHARACTERS WITHOUT CLAIM TO ANY PARTICULAR FONT, STYLE, SIZE, OR COLOR.

FOR PET TOYS (U.S. CLS. 22, 23, 38 AND 50).
FIRST USE 6-1-2007; IN COMMERCE 9-1-2007.

CLASS 29—MEATS AND PROCESSED FOODS**CLASS 29—(Continued).**

3,786,363. FOREVER CHEESE INC., LONG ISLAND CITY, NY. SN 77-427,901. FILED P.R. 3-20-2008; AM. S.R. 2-22-2010.

Aragones

THE MARK CONSISTS OF STANDARD CHARACTERS WITHOUT CLAIM TO ANY PARTICULAR FONT, STYLE, SIZE, OR COLOR.

THE ENGLISH TRANSLATION OF "ARAGONES" IN THE MARK IS "ARAGONESE".
FOR CHEESE (U.S. CL. 46).
FIRST USE 9-1-2007; IN COMMERCE 9-1-2007.

3,786,439. FRANK BRUNCKHORST CO., L.L.C., BROOKLYN, NY. SN 77-765,336. FILED P.R. 6-22-2009; AM. S.R. 3-12-2010.

**THE BEST ROAST CHICKEN.
EVER.**

THE MARK CONSISTS OF STANDARD CHARACTERS WITHOUT CLAIM TO ANY PARTICULAR FONT, STYLE, SIZE, OR COLOR.

NO CLAIM IS MADE TO THE EXCLUSIVE RIGHT TO USE "ROAST CHICKEN", APART FROM THE MARK AS SHOWN.
FOR PROCESSED MEATS (U.S. CL. 46).
FIRST USE 8-31-2009; IN COMMERCE 8-31-2009.

CLASS 30—STAPLE FOODS

3,786,372. LICKERPOPS LLC, PROVIDENCE, RI. SN 77-511,838. FILED P.R. 6-30-2008; AM. S.R. 3-5-2010.

Sipper Pops

THE MARK CONSISTS OF STANDARD CHARACTERS WITHOUT CLAIM TO ANY PARTICULAR FONT, STYLE, SIZE, OR COLOR.

NO CLAIM IS MADE TO THE EXCLUSIVE RIGHT TO USE "POPS", APART FROM THE MARK AS SHOWN.

FOR LOLLIPOPS INCORPORATING A DRINKING STRAW, NAMELY, A LOLLIPOP FEATURING, AS A PART THEREOF, A FUNCTIONAL DRINKING STRAW (U.S. CL. 46).
FIRST USE 3-1-2010; IN COMMERCE 3-1-2010.

CLASS 30—(Continued).

3,786,432. NEW YORK SWEETS BAKERY CAFE, INC., NEW YORK, NY. SN 77-757,483. FILED P.R. 6-11-2009; AM. S.R. 3-16-2010.

NEW YORK SWEETS

THE MARK CONSISTS OF STANDARD CHARACTERS WITHOUT CLAIM TO ANY PARTICULAR FONT, STYLE, SIZE, OR COLOR.

NO CLAIM IS MADE TO THE EXCLUSIVE RIGHT TO USE "SWEETS", APART FROM THE MARK AS SHOWN. FOR FINE BAKED GOODS AND DESSERTS (U.S. CL. 46).

FIRST USE 11-2-2004; IN COMMERCE 11-2-2004.

CLASS 31—NATURAL AGRICULTURAL PRODUCTS

3,786,489. OMS, INVESTMENTS, INC., LOS ANGELES, CA. SN 78-863,054. FILED P.R. 4-17-2006; AM. S.R. 2-28-2007.

HEAT-TOLERANT BLUE

THE MARK CONSISTS OF STANDARD CHARACTERS WITHOUT CLAIM TO ANY PARTICULAR FONT, STYLE, SIZE, OR COLOR.

FOR GRASS SEED (U.S. CLS. 1 AND 46).
FIRST USE 1-1-2005; IN COMMERCE 1-1-2005.

CLASS 33—WINES AND SPIRITS

3,786,360. E. & J. GALLO WINERY, MODESTO, CA. SN 77-392,172. FILED P.R. 2-8-2008; AM. S.R. 8-18-2009.

BLUSH NOIR

THE MARK CONSISTS OF STANDARD CHARACTERS WITHOUT CLAIM TO ANY PARTICULAR FONT, STYLE, SIZE, OR COLOR.

NO CLAIM IS MADE TO THE EXCLUSIVE RIGHT TO USE "BLUSH", APART FROM THE MARK AS SHOWN. FOR WINES (U.S. CLS. 47 AND 49).
FIRST USE 4-30-2008; IN COMMERCE 4-30-2008.

CLASS 33—(Continued).

3,786,448. ZIMMERMANN-GRAEFF & MULLER GMBH & CO., ZELL/MOSEL, FED REP GERMANY. SN 77-803,883. FILED P.R. 8-13-2009; AM. S.R. 2-23-2010.

ZIMMERMANN

THE MARK CONSISTS OF STANDARD CHARACTERS WITHOUT CLAIM TO ANY PARTICULAR FONT, STYLE, SIZE, OR COLOR.

OWNER OF FED REP GERMANY REG. NO. 00981309, DATED 1-1-1979, EXPIRES 6-30-2018.
OWNER OF U.S. REG. NO. 1,586,017.
FOR WINES AND SPARKLING WINES (U.S. CLS. 47 AND 49).

SERVICE MARKS**CLASS 35—ADVERTISING AND BUSINESS**

3,786,369. TRANZAP, INC., DENVER, CO. SN 77-483,852. FILED P.R. 5-27-2008; AM. S.R. 9-3-2009.

JIBXML

THE MARK CONSISTS OF STANDARD CHARACTERS WITHOUT CLAIM TO ANY PARTICULAR FONT, STYLE, SIZE, OR COLOR.

OWNER OF U.S. REG. NO. 2,777,484.
FOR COMPUTER SERVICES, NAMELY, PROVIDING A WEB SITE AND DATABASE FEATURING A STANDARDIZED FORMAT THAT AUTOMATES BUSINESS MANAGEMENT BY MONITORING, COMPILING AND DELIVERING BUSINESS, STATISTICAL AND ADMINISTRATION DATA, AND THAT AUTOMATES ACCOUNTING FOR ELECTRONIC REVENUE AND EXPENSE PROCESSING (U.S. CLS. 100, 101 AND 102).
FIRST USE 3-3-2010; IN COMMERCE 3-3-2010.

CLASS 35—(Continued).

3,786,401. WEBMASTERS PRO SHOP, DBA FOR SALE BY MEMBER, GRAND RAPIDS, MI. SN 77-645,305. FILED P.R. 1-7-2009; AM. S.R. 2-23-2010.

For Sale By Member

THE MARK CONSISTS OF STANDARD CHARACTERS WITHOUT CLAIM TO ANY PARTICULAR FONT, STYLE, SIZE, OR COLOR.

FOR PROVIDING A WEB SITE THAT FEATURES AN ON-LINE MARKET FOR USERS TO LIST OFFERED OR WANTED PERSONAL AND BUSINESS ASSETS AND SKILLS FOR HIRE, RENT, SALE OR AUCTION TRANSACTED ON THE BASIS OF PREDEFINED PERFORMANCE AND CLOSING TERMS AND CONDITIONS (U.S. CLS. 100, 101 AND 102).

FIRST USE 6-7-2009; IN COMMERCE 2-22-2010.

3,786,405. FRANS, MARK, SAN ANTONIO, TX. SN 77-651,958. FILED P.R. 1-19-2009; AM. S.R. 2-25-2010.

ALAMOTICKETS

THE MARK CONSISTS OF STANDARD CHARACTERS WITHOUT CLAIM TO ANY PARTICULAR FONT, STYLE, SIZE, OR COLOR.

FOR ONLINE AND TELEPHONE ORDERING SERVICES IN FIELD OF TICKETS TO CONCERTS, SHOWS, SPORTING EVENTS AND OTHER ENTERTAINMENT EVENTS (U.S. CLS. 100, 101 AND 102).

FIRST USE 9-11-2002; IN COMMERCE 9-11-2002.

3,786,423. PAPERG, INC., NEW HAVEN, CT. SN 77-737,116. FILED P.R. 5-14-2009; AM. S.R. 2-11-2010.

Flyerboard

THE MARK CONSISTS OF STANDARD CHARACTERS WITHOUT CLAIM TO ANY PARTICULAR FONT, STYLE, SIZE, OR COLOR.

FOR ON-LINE ADVERTISING AND MARKETING SERVICES (U.S. CLS. 100, 101 AND 102).

FIRST USE 3-16-2007; IN COMMERCE 6-18-2007.

CLASS 35—(Continued).

3,786,429. TEN WEAR INC., SANTA MONICA, CA. SN 77-753,642. FILED P.R. 6-5-2009; AM. S.R. 2-25-2010.

Varga Store

THE MARK CONSISTS OF STANDARD CHARACTERS WITHOUT CLAIM TO ANY PARTICULAR FONT, STYLE, SIZE, OR COLOR.

NO CLAIM IS MADE TO THE EXCLUSIVE RIGHT TO USE "STORE", APART FROM THE MARK AS SHOWN.

FOR RETAIL CLOTHING STORES (U.S. CLS. 100, 101 AND 102).

FIRST USE 8-24-2006; IN COMMERCE 6-30-2008.

3,786,433. STRAUSS, MADISON, WILTON MANORS, FL. SN 77-757,517. FILED P.R. 6-11-2009; AM. S.R. 3-13-2010.

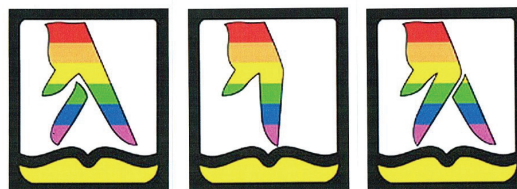

NO CLAIM IS MADE TO THE EXCLUSIVE RIGHT TO USE THE IMAGE OF THE WALKING FINGERS ON THE OPEN BOOK, APART FROM THE MARK AS SHOWN.

THE COLOR(S) RED, ORANGE, YELLOW, GREEN, BLUE, LAVENDER, BLACK, AND WHITE IS/ARE CLAIMED AS A FEATURE OF THE MARK.

THE MARK CONSISTS OF A HAND POISED OVER AN OPEN YELLOW PAGES BOOK WITH TWO FINGERS POINTING DOWNWARD. THE HAND IS DEPICTED IN THE COLORS OF THE GAY PRIDE FLAG, I.E., RED, ORANGE, YELLOW, GREEN, BLUE, AND LAVENDER MOVING FROM TOP TO BOTTOM. AN OPEN YELLOW BOOK BORDERED IN BLACK IS AT THE BOTTOM. THE INTERIOR OF THE RECTANGLES IS WHITE. THE DESIGN IS BORDERED IN BLACK. THE MARK INCLUDES MOTION OF FINGERS WALKING OVER AN OPEN BOOK. THE THREE POINTS IN THE MOTION ARE SHOWN IN THE FREEZE FRAMES.

FOR ON-LINE BUSINESS DIRECTORIES FEATURING GAY AND GAY-FRIENDLY BUSINESSES (U.S. CLS. 100, 101 AND 102).

FIRST USE 4-13-2009; IN COMMERCE 4-13-2009.

CLASS 35—(Continued).

3,786,442. ABC WINDOW CLEANING SUPPLY, INC., LAKEWOOD, CO. SN 77-771,405. FILED P.R. 6-30-2009; AM. S.R. 3-3-2010.

CLASS 35—(Continued).

3,786,469. FORT LAUDERDALE TAXI VAN CORPORATIONS, DANIA BEACH, FL. SN 77-870,418. FILED P.R. 11-11-2009; AM. S.R. 3-10-2010.

WATERFED

WWW.FORTLAUDERDALETAXI.COM

THE MARK CONSISTS OF STANDARD CHARACTERS WITHOUT CLAIM TO ANY PARTICULAR FONT, STYLE, SIZE, OR COLOR.

FOR RETAIL STORE AND ON-LINE RETAIL STORE SERVICES FEATURING WINDOW CLEANING EQUIPMENT AND SUPPLIES (U.S. CLS. 100, 101 AND 102).

FIRST USE 9-0-2006; IN COMMERCE 9-0-2006.

THE MARK CONSISTS OF STANDARD CHARACTERS WITHOUT CLAIM TO ANY PARTICULAR FONT, STYLE, SIZE, OR COLOR.

FOR ONLINE TAXI REFERRAL SERVICE PROVIDING INFORMATION ON TAXI VANS, TAXI CABS, AND AIRPORT SHUTTLES (U.S. CLS. 100, 101 AND 102).

FIRST USE 4-1-2006; IN COMMERCE 4-1-2006.

3,786,462. GRAYHAIR SOFTWARE, INC., MT. LAUREL, NJ. SN 77-837,438. FILED P.R. 9-29-2009; AM. S.R. 3-12-2010.

3,786,470. OREGON BREWING COMPANY, NEWPORT, OR. SN 77-877,192. FILED P.R. 11-20-2009; AM. S.R. 3-10-2010.

ADDRESS SCORE

MINI BEER FESTIVAL

THE MARK CONSISTS OF STANDARD CHARACTERS WITHOUT CLAIM TO ANY PARTICULAR FONT, STYLE, SIZE, OR COLOR.

FOR MAILING LIST PREPARATION AND MAINTENANCE SERVICES FEATURING THE PROVISION OF A DETAILED MAILING LIST RANKING WHICH HIGHLIGHTS DELIVERY POINT ERRORS AND UPDATED ADDRESS INFORMATION WHICH IS DERIVED FROM TEST ADDRESS FILES (U.S. CLS. 100, 101 AND 102).

FIRST USE 10-1-2009; IN COMMERCE 10-1-2009.

THE MARK CONSISTS OF STANDARD CHARACTERS WITHOUT CLAIM TO ANY PARTICULAR FONT, STYLE, SIZE, OR COLOR.

NO CLAIM IS MADE TO THE EXCLUSIVE RIGHT TO USE "BEER FESTIVAL", APART FROM THE MARK AS SHOWN.

FOR ARRANGING AND CONDUCTING ENTERTAINMENT EXHIBITIONS IN THE NATURE OF FESTIVALS FEATURING SMALL BREWERS AND THEIR BEERS (U.S. CLS. 100, 101 AND 102).

FIRST USE 9-19-2009; IN COMMERCE 9-19-2009.

3,786,464. SURVEYCLUB.COM, LLC, DENVER, CO. SN 77-840,064. FILED P.R. 10-2-2009; AM. S.R. 3-8-2010.

3,786,479. PUENTE BAGELS, INC., SAN FRANCISCO, CA. SN 77-887,967. FILED 12-7-2009.

SURVEY CLUB

MARIN BAGEL COMPANY

THE MARK CONSISTS OF STANDARD CHARACTERS WITHOUT CLAIM TO ANY PARTICULAR FONT, STYLE, SIZE, OR COLOR.

NO CLAIM IS MADE TO THE EXCLUSIVE RIGHT TO USE "SURVEY", APART FROM THE MARK AS SHOWN.

FOR PROVIDING A WEBSITE THAT ALLOWS USERS TO TAKE CONSUMER SURVEYS OFFERED BY THIRD PARTIES REGARDING THEIR GOODS AND SERVICES (U.S. CLS. 100, 101 AND 102).

FIRST USE 8-14-2007; IN COMMERCE 8-14-2007.

THE MARK CONSISTS OF STANDARD CHARACTERS WITHOUT CLAIM TO ANY PARTICULAR FONT, STYLE, SIZE, OR COLOR.

NO CLAIM IS MADE TO THE EXCLUSIVE RIGHT TO USE "COMPANY", APART FROM THE MARK AS SHOWN.

FOR WHOLESALE DISTRIBUTORSHIPS FEATURING BAKERY GOODS (U.S. CLS. 100, 101 AND 102).

FIRST USE 6-25-2009; IN COMMERCE 12-7-2009.

CLASS 35—(Continued).

3,786,485. NATIONAL ASSOCIATION OF THEATRE OWNERS, INC., WASHINGTON, DC. SN 77-894,430. FILED P.R. 12-16-2009; AM. S.R. 2-10-2010.

CINEMA BUYING GROUP

THE MARK CONSISTS OF STANDARD CHARACTERS WITHOUT CLAIM TO ANY PARTICULAR FONT, STYLE, SIZE, OR COLOR.

NO CLAIM IS MADE TO THE EXCLUSIVE RIGHT TO USE "BUYING GROUP", APART FROM THE MARK AS SHOWN.

FOR BUYING GROUP SERVICES OFFERED TO OWNERS OF MOTION PICTURE THEATERS (U.S. CLS. 100, 101 AND 102).

FIRST USE 12-1-2007; IN COMMERCE 12-1-2007.

CLASS 36—(Continued).

3,786,434. KAYLER, JENNIFER D., SAN DIEGO, CA. SN 77-760,486. FILED P.R. 6-16-2009; AM. S.R. 3-23-2010.

Help Patrick Walk

THE MARK CONSISTS OF STANDARD CHARACTERS WITHOUT CLAIM TO ANY PARTICULAR FONT, STYLE, SIZE, OR COLOR.

FOR ORGANIZING AND CONDUCTING SPECIAL EVENTS FOR CHARITABLE FUNDRAISING PURPOSES (U.S. CLS. 100, 101 AND 102).

FIRST USE 6-16-2009; IN COMMERCE 6-16-2009.

3,786,435. TOWER GROUP, INC., NEW YORK, NY. SN 77-761,903. FILED P.R. 6-17-2009; AM. S.R. 3-26-2010.

EBOP

THE MARK CONSISTS OF STANDARD CHARACTERS WITHOUT CLAIM TO ANY PARTICULAR FONT, STYLE, SIZE, OR COLOR.

FOR INSURANCE UNDERWRITING SERVICES FOR ALL TYPES OF INSURANCE (U.S. CLS. 100, 101 AND 102).

FIRST USE 3-11-2010; IN COMMERCE 3-11-2010.

CLASS 36—INSURANCE AND FINANCIAL

3,786,373. AMERICAN MORTGAGE HOLDINGS LLC, BANNOCKBURN, IL. SN 77-517,147. FILED P.R. 7-8-2008; AM. S.R. 3-2-2010.

AMERICAN MORTGAGE HOLDINGS

THE MARK CONSISTS OF STANDARD CHARACTERS WITHOUT CLAIM TO ANY PARTICULAR FONT, STYLE, SIZE, OR COLOR.

NO CLAIM IS MADE TO THE EXCLUSIVE RIGHT TO USE "MORTGAGE", APART FROM THE MARK AS SHOWN.

FOR FINANCIAL SERVICES, NAMELY, FINANCIAL ANALYSIS AND CONSULTATION OF REAL ESTATE MORTGAGES, BUYING AND SELLING NON- AND SUB-PERFORMING, SUBPRIME, AND OTHER RESIDENTIAL MORTGAGES AND OTHER RESIDENTIAL REAL ESTATE INVESTMENTS, INCLUDING REAL ESTATE; MORTGAGE BANKING SERVICES, NAMELY, ACQUISITION, SERVICING, SECURITIZATION, AND BROKERAGE OF MORTGAGE LOANS, AND VALUING MORTGAGE SERVICE RIGHTS AND MORTGAGE-BACKED SECURITIES (U.S. CLS. 100, 101 AND 102).

FIRST USE 3-2-2010; IN COMMERCE 3-2-2010.

CLASS 37—CONSTRUCTION AND REPAIR

3,786,357. A. LEECHMAN HEATING & COOLING, INC., DES MOINES, IA. SN 77-194,563. FILED P.R. 5-31-2007; AM. S.R. 2-25-2010.

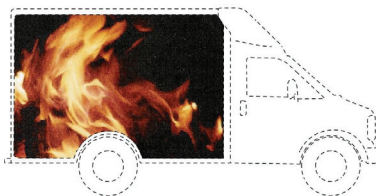

THE COLOR(S) BLACK, YELLOW, ORANGE, GRAY AND RED IS/ARE CLAIMED AS A FEATURE OF THE MARK. THE MARK CONSISTS OF THE COLORS BLACK, YEL-

CLASS 37—(Continued).

LOW, ORANGE, GRAY AND RED, WITH THE COLORS YELLOW, ORANGE AND RED APPEARING IN THE DESIGN OF FLAMES AND EMBERS AND THE COLORS BLACK AND GRAY APPEARING IN THE DESIGN OF FIRE LOGS AND IN THE BACKGROUND. THE BROKEN LINES SHOWN IN THE DRAWING ARE INTENDED ONLY TO SHOW PLACEMENT OF THE MARK ON A BOX TRUCK USED IN THE COURSE OF PERFORMING AND ADVERTISING THE SERVICES, AND ARE NOT CLAIMED AS A FEATURE OF THE MARK.

FOR HEATING AND AIR CONDITIONING CONTRACTOR SERVICES, INCLUDING INSTALLATION, REPAIR, AND MAINTENANCE SERVICES; PLUMBING CONTRACTOR SERVICES, INCLUDING INSTALLATION, REPAIR, AND MAINTENANCE SERVICES; ELECTRICAL CONTRACTOR SERVICES, INCLUDING INSTALLATION, REPAIR, AND MAINTENANCE SERVICES (U.S. CLS. 100, 103 AND 106).

FIRST USE 11-1-2003; IN COMMERCE 11-1-2003.

3,786,427. AMERICAN CONTRACTING, INC., CHARLOTTE, NC. SN 77-748,928. FILED P.R. 6-1-2009; AM. S.R. 3-5-2010.

AMERICAN CONTRACTING

THE MARK CONSISTS OF STANDARD CHARACTERS WITHOUT CLAIM TO ANY PARTICULAR FONT, STYLE, SIZE, OR COLOR.

NO CLAIM IS MADE TO THE EXCLUSIVE RIGHT TO USE "CONTRACTING", APART FROM THE MARK AS SHOWN.

FOR CONSTRUCTION AND RENOVATION SERVICES, NAMELY, THE FURNISHING AND INSTALLATION OF ACOUSTICAL CEILINGS AND ACCESS FLOOR SYSTEMS IN COMMERCIAL FACILITIES (U.S. CLS. 100, 103 AND 106).

FIRST USE 3-5-2010; IN COMMERCE 3-5-2010.

3,786,436. TECHNIQUEX, LLC, TEMPE, AZ. SN 77-761,987. FILED P.R. 6-17-2009; AM. S.R. 3-23-2010.

THE LEADER IN SPECIALTY FLOORING

THE MARK CONSISTS OF STANDARD CHARACTERS WITHOUT CLAIM TO ANY PARTICULAR FONT, STYLE, SIZE, OR COLOR.

NO CLAIM IS MADE TO THE EXCLUSIVE RIGHT TO USE "SPECIALTY FLOORING", APART FROM THE MARK AS SHOWN.

FOR APPLICATION FOR OTHERS OF PROTECTIVE COATINGS, NAMELY, EPOXIES, URETHANES, AND VINYL-ESTERS, ON FLOORS AND WALLS (U.S. CLS. 100, 103 AND 106).

FIRST USE 8-1-2007; IN COMMERCE 8-1-2007.

CLASS 37—(Continued).

3,786,444. TYRA LOPEZ, STAMFORD, CT. SN 77-774,456. FILED P.R. 7-6-2009; AM. S.R. 2-23-2010.

Heavy-Duty Green Cleaning

THE MARK CONSISTS OF STANDARD CHARACTERS WITHOUT CLAIM TO ANY PARTICULAR FONT, STYLE, SIZE, OR COLOR.

NO CLAIM IS MADE TO THE EXCLUSIVE RIGHT TO USE "CLEANING", APART FROM THE MARK AS SHOWN. FOR JANITORIAL SERVICES (U.S. CLS. 100, 103 AND 106).

FIRST USE 6-1-2009; IN COMMERCE 6-1-2009.

CLASS 38—COMMUNICATION

3,786,380. HISPANIC INFORMATION AND TELECOMMUNICATIONS NETWORK, INC., BROOKLYN, NY. SN 77-594,604. FILED P.R. 10-16-2008; AM. S.R. 2-5-2010.

CBO CONNECT

THE MARK CONSISTS OF STANDARD CHARACTERS WITHOUT CLAIM TO ANY PARTICULAR FONT, STYLE, SIZE, OR COLOR.

FOR STREAMING OF AUDIO VIDEO MATERIAL ON THE INTERNET VIA AN INTEROPERABLE COMMUNICATION SYSTEM; TELECONFERENCING AND VIDEO CONFERENCING SERVICES WITH THE USE OF STREAMING VIDEO, WIRELESS INTERNET, VOIP PHONE AND VPN (VIRTUAL PRIVATE NETWORK) OPERATING SOFTWARE (U.S. CLS. 100, 101 AND 104).

FIRST USE 4-11-2006; IN COMMERCE 4-11-2006.

3,786,417. ASHEIM, DAVID C., SAN FRANCISCO, CA. SN 77-718,914. FILED P.R. 4-21-2009; AM. S.R. 3-15-2010.

Give By Cell

THE MARK CONSISTS OF STANDARD CHARACTERS WITHOUT CLAIM TO ANY PARTICULAR FONT, STYLE, SIZE, OR COLOR.

OWNER OF U.S. REG. NOS. 3,203,485 AND 3,516,303.

CLASS 38—(Continued).

NO CLAIM IS MADE TO THE EXCLUSIVE RIGHT TO USE "BY CELL", APART FROM THE MARK AS SHOWN.

FOR TELECOMMUNICATIONS SERVICES, NAMELY, PROVIDING ELECTRONIC TRANSMISSION OF CHARITABLE DONATIONS FROM INDIVIDUALS' CELL PHONES TO NON-PROFIT ORGANIZATIONS THAT ALSO ALLOW NON-PROFIT ORGANIZATIONS TO RECEIVE DONATIONS VIA CELL PHONE (U.S. CLS. 100, 101 AND 104).

FIRST USE 5-8-2009; IN COMMERCE 7-1-2009.

3,786,471. S4 CONSULTING, INC., COLUMBUS, OH. SN 77-877,682. FILED P.R. 11-20-2009.

BusinessRelationships.com

THE MARK CONSISTS OF STANDARD CHARACTERS WITHOUT CLAIM TO ANY PARTICULAR FONT, STYLE, SIZE, OR COLOR.

FOR PROVIDING AN ONLINE COMMUNITY WEBSITE FEATURING MESSAGE BOARDS, BLOGS AND DISCUSSION GROUPS FOR SHARING INFORMATION ON HOW TO PROTECT, GROW AND RECOVER BUSINESS RELATIONSHIPS (U.S. CLS. 100, 101 AND 104).

FIRST USE 5-12-2009; IN COMMERCE 5-12-2009.

CLASS 39—TRANSPORTATION AND STORAGE

3,786,375. PLEASANT HOLIDAYS, LLC, WESTLAKE VILLAGE, CA. SN 77-561,713. FILED P.R. 9-3-2008; AM. S.R. 9-18-2009.

LowestAirFares.com

THE MARK CONSISTS OF STANDARD CHARACTERS WITHOUT CLAIM TO ANY PARTICULAR FONT, STYLE, SIZE, OR COLOR.

FOR PROVIDING AIRLINE TRANSPORTATION RESERVATIONS FOR OTHERS, INCLUDING TRANSPORTATION RESERVATIONS BASED ON SEARCHING FOR SPECIFIC TIMES, DATES, AIRPORTS, AIRLINES, AND AIRLINE CLASSES (U.S. CLS. 100 AND 105).

FIRST USE 8-19-2008; IN COMMERCE 8-19-2008.

CLASS 41—EDUCATION AND ENTERTAINMENT**CLASS 41—(Continued).**

3,786,365. ANDREW MORRISON, NEW ROCHELLE, NY. SN 77-441,189. FILED P.R. 4-7-2008; AM. S.R. 1-26-2009.

16 week challenge

THE MARK CONSISTS OF STANDARD CHARACTERS WITHOUT CLAIM TO ANY PARTICULAR FONT, STYLE, SIZE, OR COLOR.

FOR ENTERTAINMENT SERVICES, NAMELY, PRODUCTION AND DISTRIBUTION OF A GAME SHOW; ENTERTAINMENT SERVICES, NAMELY, PROVIDING A TELEVISION PROGRAM IN THE FIELD OF BUSINESS VIA A GLOBAL COMPUTER NETWORK; PRESENTATION OF LIVE SHOW PERFORMANCES; PRODUCTION OF CABLE TELEVISION PROGRAMS; PRODUCTION OF RADIO AND TELEVISION PROGRAMS (U.S. CLS. 100, 101 AND 107).

FIRST USE 2-1-2008; IN COMMERCE 2-1-2008.

3,786,385. REGENT UNIVERSITY, VIRGINIA BEACH, VA. SN 77-604,487. FILED P.R. 10-30-2008; AM. S.R. 3-1-2010.

**CENTER FOR CHRISTIAN
THOUGHT AND ACTION**

THE MARK CONSISTS OF STANDARD CHARACTERS WITHOUT CLAIM TO ANY PARTICULAR FONT, STYLE, SIZE, OR COLOR.

NO CLAIM IS MADE TO THE EXCLUSIVE RIGHT TO USE "CENTER", APART FROM THE MARK AS SHOWN.

FOR EDUCATIONAL SERVICES, NAMELY, CONDUCTING SEMINARS, WORKSHOPS, COLLOQUIUM, CONFERENCES, AND CLASSES CONCERNING CHRISTIAN-BASED PERSPECTIVES ON VARIOUS TOPICS; ON-LINE ACADEMIC LIBRARY SERVICES CONCERNING CHRISTIAN-BASED PERSPECTIVES; REFERENCE LIBRARIES OF RESOURCES CONCERNING CHRISTIAN PERSPECTIVES ON VARIOUS TOPICS (U.S. CLS. 100, 101 AND 107).

FIRST USE 2-26-2010; IN COMMERCE 2-26-2010.

3,786,390. THE NATIONAL GUITAR MUSEUM, LLC, FAIRFIELD, CT. SN 77-616,886. FILED P.R. 11-18-2008; AM. S.R. 3-9-2010.

THE NATIONAL GUITAR MUSEUM

THE MARK CONSISTS OF STANDARD CHARACTERS WITHOUT CLAIM TO ANY PARTICULAR FONT, STYLE, SIZE, OR COLOR.

CLASS 41—(Continued).

NO CLAIM IS MADE TO THE EXCLUSIVE RIGHT TO USE "GUITAR MUSEUM", APART FROM THE MARK AS SHOWN.

FOR MUSEUM SERVICES, NAMELY, PROVIDING ONLINE EXHIBITIONS FEATURING INFORMATION IN THE FIELD OF GUITARS, GUITAR DISPLAYS, GUITAR HISTORY AND CULTURE, FOR EDUCATIONAL AND ENTERTAINMENT PURPOSES; ENTERTAINMENT SERVICES, NAMELY, PRESENTING LIVE MUSIC CONCERTS AND MUSICAL PERFORMANCES (U.S. CLS. 100, 101 AND 107).

FIRST USE 1-27-2009; IN COMMERCE 10-1-2009.

CLASS 41—(Continued).

3,786,421. MARCH V ADVENTURES, SAN DIEGO, CA. SN 77-732,614. FILED P.R. 5-8-2009; AM. S.R. 12-23-2009.

SCUBA DIVER GIRLS

THE MARK CONSISTS OF STANDARD CHARACTERS WITHOUT CLAIM TO ANY PARTICULAR FONT, STYLE, SIZE, OR COLOR.

FOR EDUCATIONAL SERVICES, NAMELY, ARRANGING AND CONDUCTING CLASSES, SEMINARS, WORKSHOPS, MEETINGS, AND TRAINING SERVICES IN THE FIELD OF AQUATICS, SCUBA DIVING, SNORKELING, SAFETY, DIVING EQUIPMENT, AND OCEANOGRAPHY; ENTERTAINMENT IN THE NATURE OF SCUBA DIVING, AND SNORKELING EXHIBITIONS; MAKING RESERVATIONS AND BOOKINGS FOR SCUBA DIVING AND SNORKELING; PROVIDING INFORMATION ABOUT UNDERWATER SPORTING ACTIVITIES, EQUIPMENT, FACILITIES TRAINING VIA A GLOBAL COMPUTER NETWORK IN CLASS (U.S. CLS. 100, 101 AND 107).

FIRST USE 11-20-2008; IN COMMERCE 11-20-2008.

3,786,418. ROBINSON RADIO, INC., GLEN ALLEN, VA. SN 77-719,731. FILED P.R. 4-22-2009; AM. S.R. 1-14-2010.



The Lifestyle Show

THE MARK CONSISTS OF "THE LIFESTYLE SHOW" STYLIZED IN THE MANNER OF PLACEMENT OF THE WORDS, ONE OVER THE OTHER, WRITTEN IN DIAGONAL FASHION FROM LEFT TO RIGHT IN THE SHAPE OF A RECTANGLE.

FOR ENTERTAINMENT SERVICES, NAMELY, A RADIO SHOW CONSISTING OF A UNIQUE GUIDE TO HOME, HEALTH AND WEALTH, MADE AVAILABLE VIA BROADCAST, STREAMING MEDIA OR PODCAST (U.S. CLS. 100, 101 AND 107).

FIRST USE 2-3-2009; IN COMMERCE 2-3-2009.

3,786,424. SYSTEMS TECHNOLOGY FORUM, LTD., FREDERICKSBURG, VA. SN 77-738,886. FILED P.R. 5-17-2009; AM. S.R. 3-10-2010.

SYSTEMS TECHNOLOGY FORUM

3,786,420. JOHNSON, BRYCE, MATTHEWS, NC. SN 77-729,027. FILED P.R. 5-5-2009; AM. S.R. 3-12-2010.

SPORTS YAPP

THE MARK CONSISTS OF STANDARD CHARACTERS WITHOUT CLAIM TO ANY PARTICULAR FONT, STYLE, SIZE, OR COLOR.

NO CLAIM IS MADE TO THE EXCLUSIVE RIGHT TO USE "SPORTS", APART FROM THE MARK AS SHOWN.

FOR ENTERTAINMENT SERVICES, NAMELY, PROVIDING AN ON-GOING RADIO PROGRAM IN THE FIELD OF SPORTS; PROVIDING ENTERTAINMENT, INFORMATION, NEWS AND PROGRAMMING, ALL IN THE FIELD OF SPORTS VIA THE INTERNET (U.S. CLS. 100, 101 AND 107).

FIRST USE 2-0-2010; IN COMMERCE 2-0-2010.

THE MARK CONSISTS OF STANDARD CHARACTERS WITHOUT CLAIM TO ANY PARTICULAR FONT, STYLE, SIZE, OR COLOR.

NO CLAIM IS MADE TO THE EXCLUSIVE RIGHT TO USE "FORUM", APART FROM THE MARK AS SHOWN.

FOR EDUCATIONAL SERVICES, NAMELY, TRAINING SERVICES IN THE FIELD OF COMPUTER SOFTWARE INTEGRATION; EDUCATIONAL SERVICES, NAMELY, TRAINING SERVICES IN THE FIELD OF MATERIAL SCIENCE AND ENGINEERING; EDUCATIONAL SERVICES, NAMELY, TRAINING SERVICES IN THE USE AND MAINTENANCE OF SHIPS, AIRCRAFT, NAVAL AND AERONAUTICAL SYSTEMS AND VEHICLES, MISSILE SYSTEMS; TRAINING SERVICES IN THE USE AND MAINTENANCE OF ELECTRONIC SYSTEMS, COMPUTER SYSTEMS AND NETWORKS, COMMUNICATIONS SYSTEMS AND NETWORKS (U.S. CLS. 100, 101 AND 107).

FIRST USE 4-17-2003; IN COMMERCE 4-17-2003.

CLASS 41—(Continued).

3,786,445. MARKETING CONFIGURATIONS, INC., APOPKA, FL. SN 77-775,320. FILED P.R. 7-7-2009; AM. S.R. 3-11-2010.

Boothmanship

THE MARK CONSISTS OF STANDARD CHARACTERS WITHOUT CLAIM TO ANY PARTICULAR FONT, STYLE, SIZE, OR COLOR.

FOR EDUCATIONAL SERVICES, NAMELY, PROVIDING TRAINING ON THE MOST EFFECTIVE WAY TO OPERATE TRADE SHOW EXHIBITS, FROM ORDERING AND CONSTRUCTING TO MANAGING AND STAFFING OF THE EXHIBITS (U.S. CLS. 100, 101 AND 107).

FIRST USE 12-31-1990; IN COMMERCE 12-31-1990.

3,786,446. CREADOR PICTURES, LLC, JAMAICA, NY. SN 77-787,067. FILED P.R. 7-22-2009; AM. S.R. 1-22-2010.

AFRO LATINOS

THE MARK CONSISTS OF STANDARD CHARACTERS WITHOUT CLAIM TO ANY PARTICULAR FONT, STYLE, SIZE, OR COLOR.

FOR ENTERTAINMENT IN THE NATURE OF VISUAL AND AUDIO PERFORMANCES, AND MUSICAL VARIETY AND NEWS SHOWS; ENTERTAINMENT, NAMELY, A CONTINUING TELEVISION SERIES TRANSMITTED OVER TELEVISION, SATELLITE, AUDIO AND VIDEO MEDIA (U.S. CLS. 100, 101 AND 107).

FIRST USE 1-1-2009; IN COMMERCE 1-1-2009.

3,786,447. CONSTRUCTIVE RESOURCE, INC., LARGO, FL. SN 77-795,211. FILED P.R. 8-3-2009; AM. S.R. 3-25-2010.

SOLAR SOURCE INSTITUTE

THE MARK CONSISTS OF STANDARD CHARACTERS WITHOUT CLAIM TO ANY PARTICULAR FONT, STYLE, SIZE, OR COLOR.

NO CLAIM IS MADE TO THE EXCLUSIVE RIGHT TO USE "INSTITUTE", APART FROM THE MARK AS SHOWN.

FOR EDUCATIONAL SERVICES, NAMELY, CONDUCTING TRAINING CLASSES, SEMINARS, CONFERENCES, AND WORKSHOPS IN THE FIELD OF RENEWABLE SOLAR ENERGY, AND DISTRIBUTION OF TRAINING MATERIAL IN CONNECTION THEREWITH (U.S. CLS. 100, 101 AND 107).

FIRST USE 1-19-2009; IN COMMERCE 1-19-2009.

CLASS 41—(Continued).

3,786,450. VERSUS, L.P., PHILADELPHIA, PA. SN 77-814,488. FILED P.R. 8-27-2009; AM. S.R. 3-8-2010.

SPORTS JOBS

THE MARK CONSISTS OF STANDARD CHARACTERS WITHOUT CLAIM TO ANY PARTICULAR FONT, STYLE, SIZE, OR COLOR.

FOR ENTERTAINMENT IN THE NATURE OF ONGOING TELEVISION PROGRAMS IN THE FIELD OF SPORTS (U.S. CLS. 100, 101 AND 107).

FIRST USE 11-18-2009; IN COMMERCE 11-18-2009.

3,786,452. DNC PARKS & RESORTS AT KSC, INC., BUFFALO, NY. SN 77-817,257. FILED P.R. 9-1-2009; AM. S.R. 2-26-2010.

SHUTTLE LAUNCH EXPERIENCE

THE MARK CONSISTS OF STANDARD CHARACTERS WITHOUT CLAIM TO ANY PARTICULAR FONT, STYLE, SIZE, OR COLOR.

FOR EDUCATIONAL SERVICES, NAMELY, PROVIDING DISPLAYS, EXHIBITS, AND SIMULATIONS TEACHING GUESTS ABOUT SPACE SHUTTLE LAUNCHES (U.S. CLS. 100, 101 AND 107).

FIRST USE 5-25-2007; IN COMMERCE 5-25-2007.

3,786,453. KNOX MCLAUGHLIN GORNALL & SENNETT, P.C., ERIE, PA. SN 77-818,548. FILED P.R. 9-2-2009; AM. S.R. 2-15-2010.

Knox Tax Institute

THE MARK CONSISTS OF STANDARD CHARACTERS WITHOUT CLAIM TO ANY PARTICULAR FONT, STYLE, SIZE, OR COLOR.

NO CLAIM IS MADE TO THE EXCLUSIVE RIGHT TO USE "TAX INSTITUTE", APART FROM THE MARK AS SHOWN.

FOR EDUCATIONAL SERVICES, NAMELY, CONDUCTING CLASSES, LECTURES, WORKSHOPS AND SEMINARS IN THE FIELD OF TAXATION, TAX LAW AND ESTATE LAW AND DISTRIBUTION OF COURSE MATERIAL IN CONNECTION THEREWITH (U.S. CLS. 100, 101 AND 107).

FIRST USE 11-24-2009; IN COMMERCE 11-24-2009.

CLASS 41—(Continued).

3,786,456. LANDRUM, KEVIN, BARTLETT, TN. SN 77-823,346. FILED P.R. 9-9-2009; AM. S.R. 3-10-2010.

Mid South Home Show

THE COLOR(S) BLUE IS/ARE CLAIMED AS A FEATURE OF THE MARK.

THE MARK CONSISTS OF "MID SOUTH HOME SHOW" IS ALL THE COLOR BLUE DESIGNED IN SCRIPT MT BOLD.

FOR TELEVISION SHOW PRODUCTION (U.S. CLS. 100, 101 AND 107).

FIRST USE 3-1-2010; IN COMMERCE 3-1-2010.

3,786,463. PAIDGAMEPLAYER.COM, LLC, DENVER, CO. SN 77-840,020. FILED P.R. 10-2-2009; AM. S.R. 3-11-2010.

PAID GAME PLAYER

THE MARK CONSISTS OF STANDARD CHARACTERS WITHOUT CLAIM TO ANY PARTICULAR FONT, STYLE, SIZE, OR COLOR.

FOR PROVIDING A WEBSITE THAT ALLOWS USERS TO PLAY VIDEO GAMES OFFERED BY THIRD PARTIES AND TO PROVIDE REVIEWS REGARDING THOSE GAMES (U.S. CLS. 100, 101 AND 107).

FIRST USE 8-14-2007; IN COMMERCE 8-14-2007.

3,786,480. ELECTRONIC ARTS INC., REDWOOD CITY, CA. SN 77-887,970. FILED P.R. 12-7-2009; AM. S.R. 3-12-2010.

SKATE

THE MARK CONSISTS OF STANDARD CHARACTERS WITHOUT CLAIM TO ANY PARTICULAR FONT, STYLE, SIZE, OR COLOR.

FOR ENTERTAINMENT SERVICES, NAMELY, PROVIDING AN ON-LINE COMPUTER GAME; PROVISION OF INFORMATION RELATING TO ELECTRONIC COMPUTER GAMES PROVIDED VIA THE INTERNET (U.S. CLS. 100, 101 AND 107).

FIRST USE 9-13-2007; IN COMMERCE 9-13-2007.

CLASS 41—(Continued).

3,786,482. NACCME, LLC, MILLSTONE TOWNSHIP, NJ. SN 77-889,537. FILED P.R. 12-9-2009; AM. S.R. 3-8-2010.

PHARMACY LEARNING NETWORK

THE MARK CONSISTS OF STANDARD CHARACTERS WITHOUT CLAIM TO ANY PARTICULAR FONT, STYLE, SIZE, OR COLOR.

NO CLAIM IS MADE TO THE EXCLUSIVE RIGHT TO USE "LEARNING NETWORK", APART FROM THE MARK AS SHOWN.

FOR EDUCATIONAL SERVICES, NAMELY, CONDUCTING AND ORGANIZING CLASSES, SEMINARS, CONFERENCES AND WORKSHOPS IN THE FIELDS OF HEALTHCARE AND MEDICINE, AS WELL AS THE DISTRIBUTION OF COURSE MATERIALS IN CONNECTION THEREWITH (U.S. CLS. 100, 101 AND 107).

FIRST USE 5-9-2009; IN COMMERCE 5-9-2009.

3,786,483. GREEN, ERNEST, MONROE, MI. SN 77-890,983. FILED P.R. 12-10-2009; AM. S.R. 3-16-2010.

Michigan Hot Rod

THE MARK CONSISTS OF STANDARD CHARACTERS WITHOUT CLAIM TO ANY PARTICULAR FONT, STYLE, SIZE, OR COLOR.

NO CLAIM IS MADE TO THE EXCLUSIVE RIGHT TO USE "HOT ROD", APART FROM THE MARK AS SHOWN.

FOR ENTERTAINMENT SERVICES, NAMELY, PROVIDING A WEBSITE FEATURING ENTERTAINMENT INFORMATION AND NEWS ABOUT HOTRODS AND AUTOMOBILES (U.S. CLS. 100, 101 AND 107).

FIRST USE 6-2-2009; IN COMMERCE 6-2-2009.

3,786,484. ABYSSINIAN DEVELOPMENT CORPORATION, NEW YORK, NY. SN 77-892,784. FILED P.R. 12-14-2009; AM. S.R. 3-22-2010.

HARLEM! A SALON SERIES

THE MARK CONSISTS OF STANDARD CHARACTERS WITHOUT CLAIM TO ANY PARTICULAR FONT, STYLE, SIZE, OR COLOR.

NO CLAIM IS MADE TO THE EXCLUSIVE RIGHT TO USE "A SALON SERIES", APART FROM THE MARK AS SHOWN.

FOR ORGANIZING COMMUNITY CULTURAL EVENTS (U.S. CLS. 100, 101 AND 107).

FIRST USE 11-20-2009; IN COMMERCE 11-20-2009.

CLASS 41—(Continued).

3,786,488. UNIVERSITY COLLEGE OF CHAPMAN UNIVERSITY, ORANGE, CA. SN 77-978,877. FILED P.R. 4-7-2009; AM. S.R. 12-23-2009.

BRANDMAN UNIVERSITY

THE MARK CONSISTS OF STANDARD CHARACTERS WITHOUT CLAIM TO ANY PARTICULAR FONT, STYLE, SIZE, OR COLOR.

NO CLAIM IS MADE TO THE EXCLUSIVE RIGHT TO USE "UNIVERSITY", APART FROM THE MARK AS SHOWN.

FOR EDUCATIONAL SERVICES, NAMELY, PROVIDING LIVE AND ONLINE COURSES OF INSTRUCTION AT THE UNDERGRADUATE AND GRADUATE COLLEGE LEVEL; CONTINUING EDUCATION SERVICES, NAMELY, PROVIDING LIVE AND ON-LINE CONTINUING PROFESSIONAL EDUCATION SEMINARS IN THE FIELDS UNDERGRADUATE AND GRADUATE LEVEL DEGREE PROGRAMS AND CONTINUOUS EDUCATION CERTIFICATION PROGRAMS; ENTERTAINMENT SERVICES IN THE NATURE OF COMPETITIONS IN THE FIELDS OF ATHLETICS; ENTERTAINMENT SERVICES IN THE NATURE OF CONDUCTING EXHIBITIONS IN THE FIELDS OF LIVE MUSIC CONCERTS, FINE ART EXHIBITIONS, DANCE PERFORMANCES, THEATER PRODUCTIONS AND FILM EXHIBITIONS; ARRANGING AND CONDUCTING EDUCATIONAL CONFERENCES (U.S. CLS. 100, 101 AND 107).

FIRST USE 4-30-2009; IN COMMERCE 4-30-2009.

CLASS 42—SCIENTIFIC AND COMPUTER SERVICES

3,786,355. R-SQUARED SERVICES AND SOLUTIONS, LLC, PRINCETON JUNCTION, NJ. SN 76-693,217. FILED P.R. 9-30-2008; AM. S.R. 6-30-2009.



THE MARK CONSISTS OF STANDARD CHARACTERS WITHOUT CLAIM TO ANY PARTICULAR FONT, STYLE, SIZE, OR COLOR.

FOR PROVIDING ON-LINE NON-DOWNLOADABLE SOFTWARE FOR USE BY HEALTHCARE PROVIDERS, HOSPITAL SYSTEMS, HEALTH INSURANCE PLANS, MEDICAL DEVICE MANUFACTURERS, AND PHARMACEUTICAL MANUFACTURERS FOR THE STORAGE, PROCESSING AND ONGOING MONITORING OF FINANCIAL ARRANGEMENTS AND RELATED INFORMATION BETWEEN NON-RELATED ENTITIES FOR BUSINESS AND REGULATORY COMPLIANCE PURPOSES AND THE TRACKING AND MONITORING OF ACTIVITIES, DELIVERABLES AND PAYMENTS BETWEEN NON-RELATED ENTITIES AND HEALTHCARE PROVIDERS, HOSPITAL SYSTEMS, HEALTH INSURANCE PLANS, MEDICAL DEVICE MANUFACTURERS, AND PHARMACEUTICAL MANUFACTURERS (U.S. CLS. 100 AND 101).

FIRST USE 6-27-2007; IN COMMERCE 6-27-2007.

CLASS 42—(Continued).

3,786,419. CELL LINE GENETICS, LLC, MADISON, WI. SN 77-726,647. FILED P.R. 4-30-2009; AM. S.R. 2-3-2010.

CELL LINE GENETICS

THE MARK CONSISTS OF STANDARD CHARACTERS WITHOUT CLAIM TO ANY PARTICULAR FONT, STYLE, SIZE, OR COLOR.

NO CLAIM IS MADE TO THE EXCLUSIVE RIGHT TO USE "GENETICS", APART FROM THE MARK AS SHOWN. FOR SCIENTIFIC RESEARCH (U.S. CLS. 100 AND 101).

FIRST USE 12-31-2005; IN COMMERCE 4-1-2006.

3,786,438. ICC EVALUATION SERVICE, INC., WHITTIER, CA. SN 77-764,212. FILED P.R. 6-19-2009; AM. S.R. 3-16-2010.

SUSTAINABLE ATTRIBUTES VERIFICATION AND EVALUATION

THE MARK CONSISTS OF STANDARD CHARACTERS WITHOUT CLAIM TO ANY PARTICULAR FONT, STYLE, SIZE, OR COLOR.

NO CLAIM IS MADE TO THE EXCLUSIVE RIGHT TO USE "VERIFICATION AND EVALUATION", APART FROM THE MARK AS SHOWN.

FOR ANALYSIS, TESTING, EVALUATION AND VERIFICATION OF THE PRODUCTS, COMPONENTS, MATERIALS AND METHODS OF OTHERS FOR THE PURPOSE OF CERTIFICATION (U.S. CLS. 100 AND 101).

FIRST USE 11-14-2008; IN COMMERCE 11-14-2008.

3,786,443. SALES & MARKETING TECHNOLOGIES, LTD., ALTAMONTE SPRINGS, FL. SN 77-774,076. FILED P.R. 7-3-2009; AM. S.R. 3-12-2010.

Conversion Site

THE MARK CONSISTS OF STANDARD CHARACTERS WITHOUT CLAIM TO ANY PARTICULAR FONT, STYLE, SIZE, OR COLOR.

NO CLAIM IS MADE TO THE EXCLUSIVE RIGHT TO USE "SITE", APART FROM THE MARK AS SHOWN.

FOR WEB SITE DESIGN; DEVELOPMENT OF STANDARDIZED WEB SITES FOR OTHERS; COMPUTER SERVICES, NAMELY, SEARCH ENGINE OPTIMIZATION, COMPUTER PROGRAMMING, WEBSITE HOSTING, AND COMPUTER PROJECT MANAGEMENT (U.S. CLS. 100 AND 101).

FIRST USE 8-10-2009; IN COMMERCE 8-10-2009.

CLASS 42—(Continued).

3,786,454. SCALE COMPUTING, INC., GREENWOOD, IN. SN 77-818,553. FILED P.R. 9-2-2009; AM. S.R. 3-16-2010.



NO CLAIM IS MADE TO THE EXCLUSIVE RIGHT TO USE "COMPUTING", APART FROM THE MARK AS SHOWN.

THE MARK CONSISTS OF THE WORD "SCALE" IN STYLIZED, BOLD FONT, ABOVE THE WORD "COMPUTING" IN STYLIZED, BOLD FONT. THREE LINES OF INCREASING LENGTH APPEAR WITHIN THE "A" IN "SCALE".

FOR DEVELOPING COMPUTER HARDWARE AND SOFTWARE, PROVIDING COMPUTER HARDWARE, NAMELY, COMPUTER RENTAL FOR DATA PROTECTION AND STORAGE AND PROVIDING TEMPORARY USE OF NON-DOWNLOADABLE COMPUTER SOFTWARE FOR DATA PROTECTION AND STORAGE (U.S. CLS. 100 AND 101).

FIRST USE 10-0-2007; IN COMMERCE 10-0-2007.

CLASS 43—HOTEL AND RESTAURANT SERVICES

3,786,367. ALFREDO INTERNATIONAL, INC., ORLANDO, FL. SN 77-455,691. FILED P.R. 4-23-2008; AM. S.R. 3-22-2010.

BELLANCA WINEFLIGHTS

THE MARK CONSISTS OF STANDARD CHARACTERS WITHOUT CLAIM TO ANY PARTICULAR FONT, STYLE, SIZE, OR COLOR.

NO CLAIM IS MADE TO THE EXCLUSIVE RIGHT TO USE "WINEFLIGHTS", APART FROM THE MARK AS SHOWN.

FOR BAR AND RESTAURANT SERVICES; WINE BARS (U.S. CLS. 100 AND 101).

FIRST USE 5-0-2009; IN COMMERCE 1-0-2010.

3,786,400. JOHNSON & JOHNSON, INC., MADISON, FL. SN 77-643,936. FILED P.R. 1-6-2009; AM. S.R. 3-15-2010.

BETTER BREW COFFEE COMPANY

THE MARK CONSISTS OF STANDARD CHARACTERS WITHOUT CLAIM TO ANY PARTICULAR FONT, STYLE, SIZE, OR COLOR.

CLASS 43—(Continued).

NO CLAIM IS MADE TO THE EXCLUSIVE RIGHT TO USE "COFFEE COMPANY", APART FROM THE MARK AS SHOWN.

FOR SELF-SERVE COFFEE BAR (U.S. CLS. 100 AND 101).

FIRST USE 3-1-2008; IN COMMERCE 3-1-2008.

CLASS 44—MEDICAL, BEAUTY AND AGRICULTURAL SERVICES

3,786,356. TL MALONE ENTERPRISES, INC., MENDON 14506, NY. SN 77-186,012. FILED P.R. 5-21-2007; AM. S.R. 1-29-2010.

WEIGHT LOSS FOR WELLNESS

THE MARK CONSISTS OF STANDARD CHARACTERS WITHOUT CLAIM TO ANY PARTICULAR FONT, STYLE, SIZE, OR COLOR.

NO CLAIM IS MADE TO THE EXCLUSIVE RIGHT TO USE "WEIGHT LOSS", APART FROM THE MARK AS SHOWN.

FOR CONSULTING TO INDIVIDUALS AND COMMUNITIES ENGAGED IN GROUP WEIGHT LOSS PROGRAMS; WEIGHT REDUCTION DIET PLANNING AND SUPERVISION; HEALTH CARE SERVICES, NAMELY, WELLNESS PROGRAMS; PROVIDING ASSISTANCE, FITNESS EVALUATION AND CONSULTATION TO CORPORATE CLIENTS TO HELP THEIR EMPLOYEES MAKE HEALTH, WELLNESS AND NUTRITIONAL CHANGES IN THEIR DAILY LIVING TO IMPROVE HEALTH; PROVIDING WELLNESS SERVICES, NAMELY, PERSONAL ASSESSMENTS, PERSONALIZED ROUTINES, MAINTENANCE SCHEDULES, AND COUNSELING, SPECIFICALLY EXCLUDING MEDICAL SERVICES OR HEALTH CARE SERVICES (U.S. CLS. 100 AND 101).

FIRST USE 2-0-2007; IN COMMERCE 2-0-2007.

3,786,430. NTK ENTERPRISES, INC., PLANO, TX. SN 77-754,609. FILED P.R. 6-8-2009; AM. S.R. 2-23-2010.

VISION REJUVENATION

THE MARK CONSISTS OF STANDARD CHARACTERS WITHOUT CLAIM TO ANY PARTICULAR FONT, STYLE, SIZE, OR COLOR.

NO CLAIM IS MADE TO THE EXCLUSIVE RIGHT TO USE "VISION", APART FROM THE MARK AS SHOWN.

FOR LASER VISION CORRECTION SERVICES; LASER VISION SURGERY SERVICES (U.S. CLS. 100 AND 101).

FIRST USE 1-1-2010; IN COMMERCE 1-1-2010.

CLASS 45—(Continued).

3,786,487. C/HCA, INC., NASHVILLE, TN. SN 77-978,784. FILED P.R. 3-11-2008; AM. S.R. 7-9-2009.

CLASS 45—(Continued).

3,786,412. RESOLUTION STRATEGIES LLP, PORTLAND, OR. SN 77-702,084. FILED P.R. 3-30-2009; AM. S.R. 12-15-2009.

FIRST ONSITE

Aggressive Resolution Management

THE MARK CONSISTS OF STANDARD CHARACTERS WITHOUT CLAIM TO ANY PARTICULAR FONT, STYLE, SIZE, OR COLOR.

FOR MEDICAL CLINICS AT WORK FACILITIES; AND MEDICAL CLINICS FEATURING AMBULATORY CARE (U.S. CLS. 100 AND 101).

FIRST USE 3-31-2009; IN COMMERCE 5-12-2009.

THE MARK CONSISTS OF STANDARD CHARACTERS WITHOUT CLAIM TO ANY PARTICULAR FONT, STYLE, SIZE, OR COLOR.

FOR LEGAL SERVICES, NAMELY, PROVIDING SETTLEMENT NEGOTIATION BY IMPLEMENTING A SET OF CORE PROCESSES AS REPEATABLE BEST PRACTICES TO RESPONSIBLY EVALUATE SITUATIONS, INCLUDING RISK ASSESSMENT AND OUTCOME ANALYSIS, DETERMINING OPTIONS AND ALTERNATIVES, AND THEN DEFINING AND ENACTING A STRATEGIC SETTLEMENT PROCESS IN PARALLEL TO LITIGATION STRATEGIES (U.S. CLS. 100 AND 101).

FIRST USE 1-23-2009; IN COMMERCE 1-23-2009.

CLASS 45—PERSONAL AND LEGAL SERVICES

* * * * *

PRIOR UNITED STATES CLASSIFICATION

APPLICATION IN ONE CLASS

CERTIFICATION MARKS

CLASS B—SERVICES

3,786,437. WOUND CARE EDUCATION INSTITUTE, INC,
LAKE GENEVA, WI. SN 77-762,560. FILED 6-17-2009.

Certified Wound Care
Market Specialist

NO CLAIM IS MADE TO THE EXCLUSIVE RIGHT TO USE "CERTIFIED", APART FROM THE MARK AS SHOWN.

THE CERTIFICATION MARK, AS USED BY AUTHORIZED PERSONS, CERTIFIES THAT AN INDIVIDUAL HAS COMPLETED A SPECIFIC TRAINING COURSE AND HAS PASSED A TEST INDICATING THEIR COMPETENCY IN THE SUBJECT MATTER OF WOUND CARE.

FOR INDEPENDENT SALES REPRESENTATIVES IN THE FIELD OF MEDICINE, THAT PROVIDE IN-DEPTH KNOWLEDGE TO HEALTH CARE PROVIDERS, SPECIFICALLY IN THE FIELD OF WOUND CARE (U.S. CL. B).

FIRST USE 5-15-2009; IN COMMERCE 5-15-2009.

THE MARK CONSISTS OF STANDARD CHARACTERS WITHOUT CLAIM TO ANY PARTICULAR FONT, STYLE, SIZE, OR COLOR.

* * * * *

TRADEMARK REGISTRATIONS RENEWED

The designation "U.S. Cl." appearing in this section refers to the U.S. class in effect prior to Sep. 1, 1973 rather than the international class which applies to applications filed on or after that date. For adoption of international classification see notice in the OFFICIAL GAZETTE of Jun. 26, 1973 (911 O.G. TM 210).

131,017.	ACE. U.S. CL. 40. (INT. CL. 21). REG. 5-4-1920.	695,237.	UNI-STRAND. U.S. CL. 21. (INT. CL. 9). REG. 3-29-1960.
134,443.	SUPER-KOOL (STYLIZED). U.S. CL. 15. (INT. CL. 4). REG. 8-31-1920.	695,255.	VITALINE AND DESIGN. U.S. CL. 23. (INT. CL. 7). REG. 3-29-1960.
139,645.	THURCO (STYLIZED). U.S. CL. 23. (INT. CL. 7). REG. 2-8-1921.	695,380.	MISCELLANEOUS DESIGN. U.S. CL. 39. (INT. CLS. 10, 25 AND 26). REG. 3-29-1960.
267,288.	TECHNICOLOR. U.S. CL. 26. (INT. CL. 9). REG. 2-18-1930.	695,405.	A & E. U.S. CL. 43. (INT. CL. 23). REG. 3-29-1960.
267,316.	LIMITORQUE (STYLIZED). U.S. CL. 23. (INT. CL. 7). REG. 2-18-1930.	695,463.	QUINTUS. INT. CL. 1. (U.S. CL. 1). REG. 4-5-1960.
269,143.	WILLIAMS (STYLIZED). U.S. CL. 51. (INT. CLS. 3 AND 5). REG. 3-25-1930.	695,669.	VERILUX. U.S. CL. 34. (INT. CL. 11). REG. 4-5-1960.
273,427.	HOUSE BEAUTIFUL (STYLIZED). U.S. CL. 38. (INT. CL. 16). REG. 8-5-1930.	695,817.	KUTZIT. U.S. CL. 52. (INT. CL. 3). REG. 4-5-1960.
376,615.	GULF COAST DU-RITE ENAMEL AND DESIGN. U.S. CL. 16. (INT. CL. 2). REG. 4-2-1940.	696,098.	WHO'S WHO IN THE SOUTH AND SOUTH-WEST. U.S. CL. 38. (INT. CL. 16). REG. 4-12-1960.
379,207.	MISCELLANEOUS DESIGN. U.S. CL. 35. (INT. CLS. 7, 12 AND 17). REG. 7-9-1940.	696,100.	WHO'S WHO IN THE WEST. U.S. CL. 38. (INT. CL. 16). REG. 4-12-1960.
380,596.	HALLMARK. U.S. CL. 38. (INT. CLS. 9, 16 AND 28). REG. 8-27-1940.	696,157.	DOWNEY'S (STYLIZED). U.S. CL. 46. (INT. CL. 30). REG. 4-12-1960.
443,861.	LF (STYLIZED). U.S. CL. 21. (INT. CL. 9). REG. 3-28-1950.	697,234.	COMMODOX. U.S. CL. 102. (INT. CL. 36). REG. 5-3-1960.
515,316.	FLAGG-FLOW. U.S. CL. 13. (INT. CL. 6). REG. 9-20-1949.	697,310.	SURE-PINE. U.S. CL. 6. (INT. CL. 5). REG. 5-10-1960.
521,717.	WEBER'S (STYLIZED). U.S. CL. 46. (INT. CL. 30). REG. 3-7-1950.	698,794.	FOSECO. U.S. CL. 6. (INT. CL. 1). REG. 6-7-1960.
522,496.	THERMO KING. U.S. CL. 31. (INT. CL. 11). REG. 3-21-1950.	700,354.	LEVEL-BEST. U.S. CL. 12. (INT. CL. 19). REG. 7-5-1960.
522,618.	OLD MASTER. U.S. CL. 28. (INT. CLS. 8 AND 14). REG. 3-21-1950.	701,120.	BOL MAID. U.S. CL. 52. (INT. CL. 3). REG. 7-12-1960.
522,717.	DENTOTAPE. U.S. CL. 44. (INT. CL. 5). REG. 3-21-1950.	701,579.	PHENO SEAL. INT. CL. 1. (U.S. CL. 1). REG. 7-26-1960.
523,051.	WHEAT. U.S. CL. 21. (INT. CL. 11). REG. 3-28-1950.	702,493.	THERMOGUN. U.S. CL. 21. (INT. CL. 11). REG. 8-9-1960.
523,399.	ARMOLA. U.S. CL. 46. (INT. CL. 29). REG. 4-4-1950.	703,659.	ORIGINAL SCHLICHTE AND DESIGN. U.S. CL. 49. (INT. CL. 33). REG. 8-30-1960.
523,578.	1 ONE A DAY (STYLIZED). U.S. CL. 18. (INT. CL. 5). REG. 4-4-1950.	703,898.	MICROPITCH. U.S. CL. 23. (INT. CL. 7). REG. 9-6-1960.
523,684.	VIBRO-KING. U.S. CL. 23. (INT. CLS. 6, 7, 8, 9, 11, 12, 16, 21 AND 28). REG. 4-11-1950.	708,599.	CR-39 STANDARD CHARACTER MARK. U.S. CL. 6. (INT. CL. 1). REG. 12-20-1960.
524,085.	GOLDEN FLEECE AND DESIGN. U.S. CL. 29. (INT. CL. 21). REG. 4-18-1950.	710,213.	SEWER-RAIDER. U.S. CL. 23. (INT. CL. 7). REG. 1-24-1961.
524,366.	OXY-DRY (STYLIZED). U.S. CL. 21. (INT. CL. 9). REG. 4-25-1950.	880,111.	TOAST'EM. U.S. CL. 46. (INT. CL. 30). REG. 11-4-1969.
526,750.	HARLEY-DAVIDSON (STYLIZED). U.S. CL. 19. (INT. CLS. 7, 12, 22 AND 27). REG. 6-27-1950.	883,914.	AQUAPHASE. U.S. CL. 100. (INT. CL. 42). REG. 1-6-1970.
526,855.	CROSS. U.S. CL. 37. (INT. CL. 16). REG. 6-27-1950.	884,854.	N AND DESIGN. U.S. CLS. 6, 13, 15, 38, 52 AND 100 ONLY. (INT. CLS. 1, 3, 4, 6, 16 AND 40). REG. 1-27-1970.
527,062.	ATOMIC BALM (STYLIZED). U.S. CL. 18. (INT. CL. 5). REG. 7-4-1950.	887,886.	INTERTHERM. U.S. CL. 34. (INT. CL. 11). REG. 3-17-1970.
533,220.	M AND DESIGN. U.S. CL. 105. (INT. CL. 39). REG. 11-7-1950.	888,099.	UNITED STATES OPEN TENNIS CHAMPIONSHIPS. U.S. CL. 107. (INT. CL. 41). REG. 3-17-1970.
534,076.	CLOUD WALKER (STYLIZED). U.S. CL. 39. (INT. CL. 25). REG. 11-28-1950.	888,129.	BALL CHAIN AND DESIGN. U.S. CL. 13. (INT. CL. 6). REG. 3-24-1970.
535,954.	GOODY (STYLIZED). U.S. CL. 46. (INT. CL. 31). REG. 1-9-1951.	888,144.	CHEVRON AND DESIGN. U.S. CL. 15. (INT. CL. 4). REG. 3-24-1970.
684,651.	AEON (STYLIZED). U.S. CL. 13. (INT. CL. 20). REG. 9-8-1959.	888,229.	SUNPAK (STYLIZED). U.S. CL. 26. (INT. CL. 9). REG. 3-24-1970.
685,808.	EQ. U.S. CL. 21. (INT. CL. 9). REG. 9-29-1959.	888,360.	DUNKIN' DONUTS AND DESIGN. U.S. CL. 46. (INT. CLS. 1, 5, 29, 30, 31 AND 32). REG. 3-24-1970.
688,595.	LESONAL. U.S. CL. 16. (INT. CL. 2). REG. 11-24-1959.	888,503.	MISCELLANEOUS DESIGN. U.S. CL. 3. (INT. CL. 18). REG. 3-31-1970.
691,007.	LONE STAR AND DESIGN. U.S. CL. 46. (INT. CLS. 1, 5, 29, 30, 31 AND 32). REG. 1-5-1960.	888,527.	SPUTOLYSIN (STYLIZED). U.S. CL. 6. (INT. CL. 1). REG. 3-31-1970.
691,815.	CITIBANK. U.S. CL. 102. (INT. CL. 36). REG. 1-19-1960.	888,578.	A ARC AND DESIGN. U.S. CLS. 21 AND 35. (INT. CLS. 7, 9, 11, 12, 15 AND 17). REG. 3-31-1970.
694,624.	LEES. U.S. CL. 42. (INT. CL. 27). REG. 3-15-1960.	888,923.	EL MAR (STYLIZED). U.S. CL. 15. (INT. CL. 4). REG. 4-7-1970.
694,856.	SLIMLUX. U.S. CL. 21. (INT. CL. 11). REG. 3-22-1960.		
694,970.	THERMOLACTYL AND DESIGN. U.S. CL. 39. (INT. CLS. 10, 25 AND 26). REG. 3-22-1960.		

- 889,138. CHIANTI CLASSICO CONSORZIO VINO CHIANTICLASSICO AND DESIGN. U.S. CL. 47. (INT. CL. 33). REG. 4-7-1970.
- 890,596. FLEURS DE ROCAILLE. U.S. CL. 51. (INT. CL. 3). REG. 5-5-1970.
- 890,829. IDEAL. U.S. CLS. 21 AND 23 ONLY. (INT. CLS. 6, 7, 8, 9, 11, 12, 15, 16, 21 AND 28). REG. 5-12-1970.
- 891,625. NEW MAN (STYLIZED). U.S. CL. 39. (INT. CL. 25). REG. 5-26-1970.
- 892,363. INVERTAVOLT. U.S. CL. 21. (INT. CL. 9). REG. 6-9-1970.
- 892,625. PAR. INT. CL. 1. (U.S. CL. 1). REG. 6-16-1970.
- 892,822. MISCELLANEOUS DESIGN. U.S. CL. 23. (INT. CLS. 7 AND 8). REG. 6-16-1970.
- 895,876. TRU-OIL. U.S. CL. 16. (INT. CL. 2). REG. 8-4-1970.
- 896,160. NURSES CHRISTIAN FELLOWSHIP. U.S. CL. 100. (INT. CL. 42). REG. 8-4-1970.
- 897,506. NCF. U.S. CL. 100. (INT. CL. 42). REG. 8-25-1970.
- 897,927. SHOP RITE. U.S. CL. 45. (INT. CL. 32). REG. 9-1-1970.
- 898,856. SUPERVAN. U.S. CL. 46. (INT. CL. 30). REG. 9-15-1970.
- 901,872. POP-UPS. U.S. CL. 46. (INT. CL. 30). REG. 11-3-1970.
- 902,296. TOAST 'EM. U.S. CL. 46. (INT. CL. 30). REG. 11-10-1970.
- 903,013. FOX AND DESIGN. U.S. CL. 36. (INT. CL. 15). REG. 11-24-1970.
- 903,621. CP. U.S. CL. 105 ONLY. (INT. CL. 39). REG. 12-1-1970.
- 904,192. CRAFT LITE. U.S. CL. 21. (INT. CL. 11). REG. 12-15-1970.
- 909,557. BLACK WATCH. U.S. CL. 26. (INT. CL. 9). REG. 3-9-1971.
- 1,125,290. MISCELLANEOUS DESIGN. INT. CLS. 4 AND 21 ONLY. (U.S. CLS. 15 AND 52). REG. 9-25-1979.
- 1,125,455. LASERMARK. INT. CL. 9. (U.S. CL. 21). REG. 9-25-1979.
- 1,125,955. SWITCH-A-BRIX. INT. CL. 11. (U.S. CL. 31). REG. 10-16-1979.
- 1,127,423. ENDURAKOTE. INT. CL. 7. (U.S. CL. 23). REG. 12-11-1979.
- 1,128,440. AMERICAN SOYBEAN ASSOCIATION. INT. CL. 42. (U.S. CL. 100). REG. 12-25-1979.
- 1,128,935. BROWN AND DESIGN. INT. CL. 11. (U.S. CL. 34). REG. 1-8-1980.
- 1,130,948. BOHEMIAN KITCHEN. INT. CL. 29. (U.S. CL. 46). REG. 2-12-1980.
- 1,131,216. GB. INT. CLS. 8 AND 9. (U.S. CLS. 21 AND 23). REG. 2-26-1980.
- 1,131,700. OCUCEPT. INT. CL. 10. (U.S. CL. 44). REG. 3-11-1980.
- 1,132,015. BECKOSOL. INT. CL. 2. (U.S. CL. 16). REG. 4-1-1980.
- 1,132,059. BOVATEC. INT. CL. 5. (U.S. CL. 18). REG. 4-1-1980.
- 1,132,069. SNAPPER. INT. CL. 6. (U.S. CL. 13). REG. 4-1-1980.
- 1,132,080. ALASKAN. INT. CL. 7. (U.S. CL. 23). REG. 4-1-1980.
- 1,132,091. ULTRAKAN. INT. CL. 7. (U.S. CL. 23). REG. 4-1-1980.
- 1,132,181. GUSSCO. INT. CL. 16. (U.S. CLS. 32 AND 37). REG. 4-1-1980.
- 1,132,212. SOFT & SUPPLE. INT. CL. 17. (U.S. CL. 35). REG. 4-1-1980.
- 1,132,233. TOYOBO AND DESIGN. INT. CL. 22. (U.S. CL. 1). REG. 4-1-1980.
- 1,132,528. MISCELLANEOUS DESIGN. INT. CL. 3. (U.S. CL. 51). REG. 4-8-1980.
- 1,132,832. MISCELLANEOUS DESIGN. INT. CL. 34. (U.S. CL. 17). REG. 4-8-1980.
- 1,132,938. BELCLENE. INT. CL. 1. (U.S. CL. 6). REG. 4-15-1980.
- 1,132,991. SHUR-DRI. INT. CL. 7. (U.S. CL. 23). REG. 4-15-1980.
- 1,133,005. CRAFTOOL. INT. CL. 8. (U.S. CL. 23). REG. 4-15-1980.
- 1,133,010. STRIPAX. INT. CL. 8. (U.S. CL. 23). REG. 4-15-1980.
- 1,133,090. CAMCO. INT. CL. 15. (U.S. CL. 36). REG. 4-15-1980.
- 1,133,122. BURBERRY. INT. CL. 18. (U.S. CLS. 1, 2, 3, 22 AND 41). REG. 4-15-1980.
- 1,133,571. WHIZARD. INT. CL. 9. (U.S. CL. 39). REG. 4-22-1980.
- 1,133,886. INTERNATIONAL ASSOCIATION OF MACHINISTS AND AEROSPACE WORKERS AFFILIATED WITH AFL-CIO UNION MADE AND DESIGN. U.S. CL. A. REG. 4-22-1980.
- 1,134,021. GROHMIX. INT. CL. 9. (U.S. CL. 26). REG. 4-29-1980.
- 1,134,417. ERYC. INT. CL. 5. (U.S. CL. 18). REG. 5-6-1980.
- 1,134,464. AIMPOINT AND DESIGN. INT. CL. 9. (U.S. CL. 26). REG. 5-6-1980.
- 1,134,775. MISCELLANEOUS DESIGN. INT. CL. 30. (U.S. CL. 46). REG. 5-6-1980.
- 1,135,065. MISCELLANEOUS DESIGN. INT. CL. 11. (U.S. CL. 34). REG. 5-13-1980.
- 1,135,177. MISCELLANEOUS DESIGN. INT. CL. 22. (U.S. CL. 50). REG. 5-13-1980.
- 1,135,244. BRER RABBIT. INT. CL. 30. (U.S. CL. 46). REG. 5-13-1980.
- 1,136,056. FRANGINSERT. INT. CL. 9. (U.S. CLS. 23 AND 26). REG. 5-27-1980.
- 1,138,171. BONTZ. INT. CL. 3. (U.S. CL. 52). REG. 7-29-1980.
- 1,138,374. ULTRAKAN. INT. CL. 16. (U.S. CL. 37). REG. 8-5-1980.
- 1,138,544. FEAST. INT. CL. 1. (U.S. CL. 10). REG. 8-12-1980.
- 1,138,555. THERMAX. INT. CL. 3. (U.S. CL. 52). REG. 8-12-1980.
- 1,139,222. PROBLEM SOLVER. INT. CL. 16. (U.S. CL. 38). REG. 9-2-1980.
- 1,139,473. COMET. INT. CL. 37. (U.S. CL. 103). REG. 9-9-1980.
- 1,140,068. INNOVATION ASSOCIATES. INT. CL. 35. (U.S. CL. 101). REG. 9-30-1980.
- 1,142,666. GIRL SCOUTS AND DESIGN. INT. CL. 26. (U.S. CL. 40). REG. 12-9-1980.
- 1,146,412. B & G. INT. CL. 11. (U.S. CL. 34). REG. 1-27-1981.
- 1,147,999. MACH. INT. CL. 11. (U.S. CLS. 19 AND 34). REG. 3-3-1981.
- 1,149,205. BANK & OFFICE INTERIORS. INT. CL. 42. (U.S. CL. 101). REG. 3-24-1981.
- 1,149,209. MISS GRACE LEMON CAKE CO.. INT. CL. 42. (U.S. CLS. 100 AND 101). REG. 3-24-1981.
- 1,149,214. QUIK MART. INT. CL. 42. (U.S. CL. 101). REG. 3-24-1981.
- 1,536,036. MISCELLANEOUS DESIGN. INT. CL. 32 ONLY. (U.S. CL. 45). REG. 4-25-1989.
- 1,553,030. Z WING. INT. CL. 28. (U.S. CL. 22). REG. 8-22-1989.
- 1,556,249. MOSTLY MUFFINS. INT. CL. 42. (U.S. CLS. 100 AND 101). REG. 9-12-1989.
- 1,557,880. COLORADO SILVER. INT. CL. 14. (U.S. CL. 28). REG. 9-26-1989.
- 1,558,147. JOURNEYS AN ATTITUDE YOU CAN WEAR. INT. CLS. 25 AND 42. (U.S. CLS. 39 AND 101). REG. 9-26-1989.
- 1,558,455. TRAC 800. INT. CL. 38. (U.S. CL. 104). REG. 9-26-1989.
- 1,558,623. NORTH CAROLINA 100. INT. CL. 16. (U.S. CLS. 2, 5, 22, 23, 29, 37, 38 AND 50). REG. 9-26-1989.
- 1,559,018. DURASLOT. INT. CL. 19. (U.S. CL. 12). REG. 10-3-1989.
- 1,559,207. CHARLES SQUARE AND DESIGN. INT. CL. 35. (U.S. CL. 101). REG. 10-3-1989.
- 1,559,337. PETSMART. INT. CL. 42. (U.S. CLS. 100 AND 101). REG. 10-3-1989.
- 1,559,681. HALO CROWN. INT. CL. 10. (U.S. CL. 44). REG. 10-10-1989.
- 1,560,114. CHARLES SQUARE. INT. CL. 35. (U.S. CL. 101). REG. 10-10-1989.
- 1,560,701. OSCILLATRON. INT. CL. 10. (U.S. CL. 44). REG. 10-17-1989.
- 1,561,652. AMERICAN ACADEMY OF OPHTHALMOLOGY. U.S. CL. 200. REG. 10-17-1989.
- 1,563,604. TOSCANA. INT. CL. 30. (U.S. CL. 46). REG. 10-31-1989.
- 1,564,659. SOUTHERN CAL. INT. CL. 25. (U.S. CL. 39). REG. 11-7-1989.
- 1,565,796. ATE AND DESIGN. INT. CL. 12. (U.S. CLS. 19 AND 26). REG. 11-14-1989.
- 1,565,806. REFLECTION. INT. CL. 12. (U.S. CL. 19). REG. 11-14-1989.
- 1,566,487. MOSTLY MUFFINS AND DESIGN. INT. CL. 42. (U.S. CLS. 100 AND 101). REG. 11-14-1989.
- 1,573,184. AQUA SELECT. INT. CL. 11. (U.S. CL. 31). REG. 12-26-1989.

- 1,573,410. KOMPAKT. INT. CL. 20. (U.S. CL. 32). REG. 12-26-1989.
- 1,574,066. SUPERGLASS. INT. CL. 19. (U.S. CLS. 12 AND 33). REG. 12-26-1989.
- 1,574,578. VIDEO PROFESSOR. INT. CL. 9. (U.S. CLS. 21 AND 36). REG. 1-2-1990.
- 1,575,653. BSR. INT. CL. 41. (U.S. CL. 107). REG. 1-2-1990.
- 1,575,839. IFTF. INT. CL. 42. (U.S. CLS. 100 AND 101). REG. 1-2-1990.
- 1,579,002. SILICORE. INT. CL. 17. (U.S. CLS. 12 AND 35). REG. 1-23-1990.
- 1,579,838. PRO-CUT. INT. CL. 9. (U.S. CL. 21). REG. 1-30-1990.
- 1,579,903. INFORCER AND DESIGN. INT. CL. 9. (U.S. CL. 38). REG. 1-30-1990.
- 1,580,613. SPORTING ADVENTURES AND DESIGN. INT. CL. 39. (U.S. CLS. 100 AND 105). REG. 1-30-1990.
- 1,583,093. THE PROS. INT. CL. 42. (U.S. CLS. 100 AND 107). REG. 2-13-1990.
- 1,583,293. ULTRAM. INT. CL. 5. (U.S. CL. 18). REG. 2-20-1990.
- 1,583,987. HERTZ #1 CLUB GOLD SERVICE. INT. CL. 39. (U.S. CLS. 100 AND 105). REG. 2-20-1990.
- 1,585,508. KITCHENAID. INT. CL. 11. (U.S. CLS. 13 AND 34). REG. 3-6-1990.
- 1,586,010. ROYALE INTERNATIONAL AND DESIGN. INT. CL. 32. (U.S. CL. 45). REG. 3-6-1990.
- 1,586,107. SPECIALTY COMMUNICATIONS. INT. CLS. 37 AND 42. (U.S. CLS. 101 AND 103). REG. 3-6-1990.
- 1,586,392. TIPAQUE YELLOW. INT. CL. 2. (U.S. CLS. 6 AND 16). REG. 3-13-1990.
- 1,586,502. WILGARD. INT. CL. 6. (U.S. CL. 12). REG. 3-13-1990.
- 1,586,997. DINET-KIT. INT. CL. 30. (U.S. CL. 46). REG. 3-13-1990.
- 1,587,177. THE THOMAS M. COOLEY LAW SCHOOL IN CORDE HOMINUM EST ANIMA LEGIS. 1972 AND DESIGN. INT. CL. 41. (U.S. CL. 107). REG. 3-13-1990.
- 1,587,387. AIR SOLUTION (STYLIZED). INT. CL. 5. (U.S. CL. 6). REG. 3-20-1990.
- 1,587,435. WAGNER. INT. CL. 6 ONLY. (U.S. CLS. 2, 12, 13, 14, 23, 25 AND 50). REG. 3-20-1990.
- 1,588,303. INGRAM. INT. CL. 42. (U.S. CLS. 100 AND 101). REG. 3-20-1990.
- 1,588,426. DENIMAX. INT. CL. 1. (U.S. CL. 6). REG. 3-27-1990.
- 1,588,439. VEGE-PLEX. INT. CL. 1. (U.S. CL. 6). REG. 3-27-1990.
- 1,588,449. WORLD OF COLOR AND DESIGN. INT. CL. 2. (U.S. CL. 16). REG. 3-27-1990.
- 1,588,505. MISCELLANEOUS DESIGN. INT. CLS. 6 AND 16 ONLY. (U.S. CLS. 2, 5, 12, 13, 14, 22, 23, 25, 29, 37, 38 AND 50). REG. 3-27-1990.
- 1,588,529. M AND DESIGN. INT. CLS. 7 AND 8. (U.S. CL. 23). REG. 3-27-1990.
- 1,588,536. WALDRON. INT. CL. 7. (U.S. CL. 23). REG. 3-27-1990.
- 1,588,614. FIREX (STYLIZED). INT. CL. 9. (U.S. CLS. 21 AND 26). REG. 3-27-1990.
- 1,588,665. SALESTRACKER. INT. CL. 9. (U.S. CL. 38). REG. 3-27-1990.
- 1,588,684. CONTOUR. INT. CL. 10. (U.S. CL. 44). REG. 3-27-1990.
- 1,588,694. CLEARFLOW VALVES. INT. CL. 11. (U.S. CLS. 13 AND 23). REG. 3-27-1990.
- 1,588,702. CULLIGAN AND DESIGN. INT. CLS. 11 AND 32. (U.S. CLS. 13 AND 45). REG. 3-27-1990.
- 1,588,930. CASTLE CRATE. INT. CL. 20. (U.S. CL. 2). REG. 3-27-1990.
- 1,588,965. COLEMAN. INT. CL. 25. (U.S. CLS. 22 AND 39). REG. 3-27-1990.
- 1,589,023. GORDON AND SMITH. INT. CLS. 25 AND 28. (U.S. CLS. 22, 23, 38, 39 AND 50). REG. 3-27-1990.
- 1,589,024. GORDON & SMITH. INT. CLS. 25 AND 28. (U.S. CLS. 22, 23, 38, 39 AND 50). REG. 3-27-1990.
- 1,589,056. LONG GONE AND DESIGN. INT. CL. 25. (U.S. CL. 39). REG. 3-27-1990.
- 1,589,182. THE OLIVE GARDEN (STYLIZED). INT. CL. 30. (U.S. CL. 46). REG. 3-27-1990.
- 1,589,288. WE DROP SHIP TRAVEL. INT. CL. 35. (U.S. CL. 101). REG. 3-27-1990.
- 1,589,296. WORKING HARDER, REACHING HIGHER, DOLLARBANK. INT. CL. 36. (U.S. CL. 102). REG. 3-27-1990.
- 1,589,376. SOLUTIONEERING. INT. CL. 40. (U.S. CL. 106). REG. 3-27-1990.
- 1,589,502. CENTER FOR EFFECTIVE LIVING. INT. CL. 42. (U.S. CL. 100). REG. 3-27-1990.
- 1,589,590. SATURN YELLOW. INT. CL. 2. (U.S. CLS. 11 AND 16). REG. 4-3-1990.
- 1,589,622. DERMASOL. INT. CL. 3. (U.S. CL. 51). REG. 4-3-1990.
- 1,589,660. IMMUCOX. INT. CL. 5. (U.S. CL. 18). REG. 4-3-1990.
- 1,589,854. PEET. INT. CL. 11. (U.S. CL. 34). REG. 4-3-1990.
- 1,590,134. EDITORIAL SOLUTIONS. INT. CL. 35. (U.S. CL. 101). REG. 4-3-1990.
- 1,590,157. USAA AND DESIGN. INT. CL. 36. (U.S. CL. 102). REG. 4-3-1990.
- 1,590,197. RAZORBACKS. INT. CL. 41. (U.S. CL. 107). REG. 4-3-1990.
- 1,590,260. BEN FRANKLIN CRAFTS. INT. CL. 42. (U.S. CL. 101). REG. 4-3-1990.
- 1,590,276. SHORTY SMALL'S. INT. CL. 42. (U.S. CL. 100). REG. 4-3-1990.
- 1,590,289. SIAM. INT. CL. 42. (U.S. CLS. 100 AND 101). REG. 4-3-1990.
- 1,590,708. FRANTZ MEDICAL. INT. CL. 10. (U.S. CL. 44). REG. 4-10-1990.
- 1,590,750. TEXAS FIREFRAME. INT. CL. 11. (U.S. CL. 13). REG. 4-10-1990.
- 1,590,813. MINERS. INT. CL. 16. (U.S. CL. 38). REG. 4-10-1990.
- 1,590,982. NATIONAL PHYSIQUE COMMITTEE OF THE U.S.A.. INT. CL. 25. (U.S. CLS. 22 AND 39). REG. 4-10-1990.
- 1,591,014. MISCELLANEOUS DESIGN. INT. CL. 25. (U.S. CL. 39). REG. 4-10-1990.
- 1,591,031. G&S. INT. CLS. 25 AND 28. (U.S. CLS. 22, 23, 38, 39 AND 50). REG. 4-10-1990.
- 1,591,099. SPEED MASTER. INT. CL. 28. (U.S. CL. 22). REG. 4-10-1990.
- 1,591,236. MISCELLANEOUS DESIGN. INT. CL. 36. (U.S. CL. 102). REG. 4-10-1990.
- 1,591,479. SHARI'S. INT. CL. 42. (U.S. CL. 100). REG. 4-10-1990.
- 1,591,489. HALLOUMI. U.S. CL. A. REG. 4-10-1990.
- 1,591,541. HOUSEHOLD GOOP. INT. CL. 1. (U.S. CLS. 5 AND 6). REG. 4-17-1990.
- 1,591,582. POLY/SATIN. INT. CL. 2. (U.S. CL. 16). REG. 4-17-1990.
- 1,591,626. GEAR SHIELD. INT. CL. 4. (U.S. CL. 15). REG. 4-17-1990.
- 1,591,652. KANGAROO. INT. CL. 5. (U.S. CLS. 18 AND 46). REG. 4-17-1990.
- 1,591,656. MISCELLANEOUS DESIGN. INT. CL. 5. (U.S. CL. 18). REG. 4-17-1990.
- 1,591,693. SMC AND DESIGN. INT. CLS. 7 AND 9. (U.S. CLS. 21, 23, 26, 36 AND 38). REG. 4-17-1990.
- 1,591,704. KADIA AND DESIGN. INT. CL. 7. (U.S. CL. 23). REG. 4-17-1990.
- 1,591,842. HINGE-O-GRAB. INT. CL. 9. (U.S. CL. 26). REG. 4-17-1990.
- 1,591,874. GAMMAMED. INT. CL. 10. (U.S. CL. 44). REG. 4-17-1990.
- 1,592,094. JONES WEAR. INT. CL. 25. (U.S. CL. 39). REG. 4-17-1990.
- 1,592,107. MOTHER'S PRIDE. INT. CL. 25. (U.S. CL. 39). REG. 4-17-1990.
- 1,592,181. POWER WORMS. INT. CL. 28. (U.S. CL. 22). REG. 4-17-1990.
- 1,592,183. POWER GRUBS. INT. CL. 28. (U.S. CL. 22). REG. 4-17-1990.
- 1,592,197. FARAON AND DESIGN. INT. CLS. 29 AND 30. (U.S. CL. 46). REG. 4-17-1990.
- 1,593,026. THERMAGLAS. INT. CL. 17. (U.S. CL. 35). REG. 4-24-1990.
- 1,593,639. NOTOUCH. INT. CL. 9. (U.S. CL. 21). REG. 4-24-1990.
- 1,593,729. MOOD MATCHER. INT. CL. 3. (U.S. CL. 51). REG. 5-1-1990.
- 1,593,827. N-TECH. INT. CL. 7. (U.S. CL. 23). REG. 5-1-1990.
- 1,594,157. CHILDREN'S BOOKS IN PRINT. INT. CL. 16. (U.S. CL. 38). REG. 5-1-1990.
- 1,594,782. RADILON. INT. CL. 1. (U.S. CLS. 1, 5, 6, 10, 26 AND 46). REG. 5-8-1990.
- 1,594,883. HOBO. INT. CL. 7. (U.S. CL. 23). REG. 5-8-1990.

- 1,594,884. STUD KING AND DESIGN. INT. CL. 7. (U.S. CL. 23). REG. 5-8-1990.
- 1,595,180. IGUZZINI. INT. CL. 11. (U.S. CLS. 13, 21, 23, 31 AND 34). REG. 5-8-1990.
- 1,595,268. SAN DIEGO BUSINESS JOURNAL. INT. CL. 16. (U.S. CL. 38). REG. 5-8-1990.
- 1,595,678. IN/MAX. INT. CL. 36. (U.S. CLS. 101 AND 102). REG. 5-8-1990.
- 1,596,048. DEEP WOODS OFF!. INT. CL. 5. (U.S. CL. 6). REG. 5-15-1990.
- 1,596,057. CHOPARD (STYLIZED). INT. CL. 14 ONLY. (U.S. CL. 28). REG. 5-15-1990.
- 1,596,855. AMERICAN HARVEST WORKSHOP. INT. CL. 41. (U.S. CL. 107). REG. 5-15-1990.
- 1,596,950. KNIGHTS OF COLUMBUS. U.S. CL. 200. REG. 5-15-1990.
- 1,597,031. IMJECT. INT. CL. 1. (U.S. CL. 6). REG. 5-22-1990.
- 1,597,057. NEUTROGENA. INT. CL. 3. (U.S. CL. 51). REG. 5-22-1990.
- 1,597,208. EASIA. INT. CL. 8. (U.S. CL. 23). REG. 5-22-1990.
- 1,597,658. AQUANOR. INT. CL. 29. (U.S. CL. 46). REG. 5-22-1990.
- 1,597,793. EPBS. INT. CL. 35. (U.S. CLS. 101 AND 102). REG. 5-22-1990.
- 1,597,805. MAGELLAN. INT. CL. 36. (U.S. CLS. 101 AND 102). REG. 5-22-1990.
- 1,597,882. ABI/INFORM. INT. CL. 42. (U.S. CLS. 100 AND 101). REG. 5-22-1990.
- 1,598,201. TG AND DESIGN. INT. CL. 7. (U.S. CL. 23). REG. 5-29-1990.
- 1,599,070. MANALOX. INT. CL. 1. (U.S. CL. 6). REG. 6-5-1990.
- 1,599,215. AMS. INT. CLS. 7, 9, 37 AND 42. (U.S. CLS. 13, 19, 21, 23, 26, 31, 34, 35, 36, 38, 100, 101, 103 AND 106). REG. 6-5-1990.
- 1,599,231. PROSHUCKER. INT. CL. 7. (U.S. CL. 23). REG. 6-5-1990.
- 1,599,839. MISCELLANEOUS DESIGN. INT. CL. 35. (U.S. CL. 101). REG. 6-5-1990.
- 1,600,005. LEARNING FORUM. INT. CL. 42. (U.S. CL. 101). REG. 6-5-1990.
- 1,600,233. CRETE-NU. INT. CL. 3. (U.S. CL. 52). REG. 6-12-1990.
- 1,600,301. HOLE-N-HEAD GUARD. INT. CL. 5. (U.S. CL. 18). REG. 6-12-1990.
- 1,600,316. DELLA-SPRAY & DIP. INT. CL. 5. (U.S. CL. 18). REG. 6-12-1990.
- 1,601,126. NO NAME STEAKS. INT. CL. 29. (U.S. CL. 46). REG. 6-12-1990.
- 1,601,207. KING KRUST. INT. CL. 30. (U.S. CL. 46). REG. 6-12-1990.
- 1,601,550. LOEWS. INT. CL. 42. (U.S. CL. 100). REG. 6-12-1990.
- 1,602,140. OUTBACK. INT. CL. 12. (U.S. CL. 19). REG. 6-19-1990.
- 1,602,500. VIBREX AND DESIGN. INT. CL. 28. (U.S. CL. 22). REG. 6-19-1990.
- 1,602,903. LASER IMAGES. INT. CL. 40. (U.S. CL. 106). REG. 6-19-1990.
- 1,603,284. EMBREAK. INT. CL. 1. (U.S. CL. 6). REG. 6-26-1990.
- 1,603,353. THERASEED. INT. CL. 5. (U.S. CL. 18). REG. 6-26-1990.
- 1,603,618. SELECTAIRE. INT. CL. 11. (U.S. CL. 44). REG. 6-26-1990.
- 1,603,620. MEDIC-AID. INT. CL. 11. (U.S. CL. 13). REG. 6-26-1990.
- 1,604,060. MONARCH. INT. CL. 37. (U.S. CLS. 100, 103 AND 106). REG. 6-26-1990.
- 1,604,621. FORM MARKS (STYLIZED). INT. CL. 16. (U.S. CL. 38). REG. 7-3-1990.
- 1,604,969. PALTEM. INT. CL. 37. (U.S. CL. 103). REG. 7-3-1990.
- 1,605,024. MISCELLANEOUS DESIGN. INT. CLS. 41 AND 42. (U.S. CLS. 100 AND 107). REG. 7-3-1990.
- 1,605,437. SOLEX. INT. CL. 12. (U.S. CLS. 19 AND 33). REG. 7-10-1990.
- 1,605,646. COLLEEN'S COLLECTABLES. INT. CL. 25. (U.S. CL. 39). REG. 7-10-1990.
- 1,608,446. PHYDBACK AND DESIGN. INT. CL. 35. (U.S. CL. 101). REG. 7-31-1990.
- 1,608,786. PET LIFE-LINE. INT. CLS. 5 AND 10. (U.S. CLS. 18 AND 44). REG. 8-7-1990.
- 1,609,076. NEWELL PORCELAIN AND DESIGN. INT. CL. 17. (U.S. CL. 35). REG. 8-7-1990.
- 1,609,293. NONINO. INT. CL. 33. (U.S. CLS. 47 AND 49). REG. 8-7-1990.
- 1,609,552. ADACAP. INT. CL. 6. (U.S. CL. 13). REG. 8-14-1990.
- 1,609,995. KITTY WHITE AND DESIGN. INT. CL. 31. (U.S. CL. 1). REG. 8-14-1990.
- 1,612,966. CARR. INT. CL. 20. (U.S. CL. 32). REG. 9-11-1990.
- 1,613,037. KUT-GARD. INT. CL. 25. (U.S. CL. 39). REG. 9-11-1990.
- 1,613,084. BELL BOY. INT. CLS. 29 AND 30. (U.S. CL. 46). REG. 9-11-1990.
- 1,613,341. THE BEDDING EXPERTS. INT. CL. 42. (U.S. CL. 101). REG. 9-11-1990.
- 1,614,147. JAGUAR AND DESIGN. INT. CLS. 35, 37 AND 42. (U.S. CLS. 101 AND 103). REG. 9-18-1990.
- 1,614,300. OPTICLEAR. INT. CL. 40. (U.S. CL. 106). REG. 9-18-1990.
- 1,614,640. EXOTAP-MOLD. INT. CL. 7. (U.S. CL. 23). REG. 9-25-1990.
- 1,614,863. SCAN-IT. INT. CL. 16. (U.S. CL. 37). REG. 9-25-1990.
- 1,615,520. DRI-DYE CHECK STRIPS. INT. CL. 9. (U.S. CLS. 26 AND 44). REG. 10-2-1990.
- 1,617,312. RIDGID AND DESIGN. INT. CL. 6. (U.S. CLS. 2 AND 13). REG. 10-16-1990.
- 1,618,274. GRAFFITI GARD. INT. CL. 2. (U.S. CL. 16). REG. 10-23-1990.
- 1,618,442. MICROLACER. INT. CL. 7. (U.S. CL. 23). REG. 10-23-1990.
- 1,619,840. TALKING STONE PRESS. INT. CL. 16. (U.S. CL. 38). REG. 10-30-1990.
- 1,620,818. TMX. INT. CL. 7. (U.S. CL. 23). REG. 11-6-1990.
- 1,621,210. ROYAL SEAL. INT. CL. 17. (U.S. CLS. 13 AND 35). REG. 11-6-1990.
- 1,622,388. MILT SPARKS. INT. CL. 13. (U.S. CL. 9). REG. 11-13-1990.
- 1,623,256. STRAPBINDER. INT. CL. 6 ONLY. (U.S. CL. 14). REG. 11-20-1990.
- 1,623,355. PROSTATRON. INT. CLS. 9 AND 10. (U.S. CLS. 38 AND 44). REG. 11-20-1990.
- 1,624,287. BLACKHOLE. INT. CL. 1. (U.S. CL. 6). REG. 11-27-1990.
- 1,625,292. DALLAS SYMPHONY ORCHESTRA. INT. CL. 41. (U.S. CL. 107). REG. 11-27-1990.
- 1,626,390. AIR ROTATION. INT. CL. 42. (U.S. CLS. 100 AND 101). REG. 12-4-1990.
- 1,626,477. POLY-BOND. INT. CL. 1. (U.S. CLS. 1, 5 AND 6). REG. 12-11-1990.
- 1,627,804. FOOD TECHNOLOGY & DEVELOPMENT CENTER AND DESIGN. INT. CL. 42. (U.S. CL. 100). REG. 12-11-1990.
- 1,628,082. Q-U-V. INT. CL. 9. (U.S. CL. 26). REG. 12-18-1990.
- 1,628,534. PASHA. INT. CL. 31. (U.S. CL. 46). REG. 12-18-1990.
- 1,629,592. ZARA. INT. CL. 42. (U.S. CL. 101). REG. 12-25-1990.
- 1,629,933. COLORSTAR. INT. CL. 9. (U.S. CLS. 26 AND 38). REG. 1-1-1991.
- 1,630,506. ATTORNEY'S BRIEFCASE. INT. CL. 9. (U.S. CL. 38). REG. 1-1-1991.
- 1,630,652. ABACUS. INT. CL. 9. (U.S. CL. 38). REG. 1-8-1991.
- 1,630,876. BRIC-EDG. INT. CL. 19. (U.S. CL. 12). REG. 1-8-1991.
- 1,631,317. KAHLE. INT. CL. 7. (U.S. CL. 23). REG. 1-15-1991.
- 1,633,477. PING (STYLIZED). INT. CL. 41. (U.S. CL. 107). REG. 1-29-1991.
- 1,633,547. COMPSYCH. INT. CL. 42. (U.S. CL. 100). REG. 1-29-1991.
- 1,635,740. CASINO HOLIDAY. INT. CLS. 39 AND 42. (U.S. CLS. 100 AND 105). REG. 2-19-1991.
- 1,635,775. MOVIEWATCHER. INT. CL. 41. (U.S. CL. 107). REG. 2-19-1991.
- 1,635,924. VIKING. INT. CL. 4. (U.S. CL. 15). REG. 2-26-1991.
- 1,635,942. MOTH-TEK. INT. CL. 5. (U.S. CL. 6). REG. 2-26-1991.
- 1,636,250. PURE & NATURAL (STYLIZED). INT. CL. 29. (U.S. CL. 46). REG. 2-26-1991.
- 1,636,750. XPRO. INT. CL. 9. (U.S. CL. 26). REG. 3-5-1991.
- 1,637,332. SILVER STREAK. INT. CL. 3. (U.S. CLS. 6 AND 52). REG. 3-12-1991.
- 1,637,782. WHEN ONLY AN EXPERT WILL DO. INT. CL. 35. (U.S. CLS. 101 AND 103). REG. 3-12-1991.
- 1,638,555. FRANCO-AMERICAN AND DESIGN. INT. CL. 30. (U.S. CL. 46). REG. 3-19-1991.

- 1,638,631. BEST LINK. INT. CL. 36. (U.S. CL. 102). REG. 3-19-1991.
- 1,638,689. DATAMAX OFFICE SYSTEMS. INT. CL. 42. (U.S. CL. 101). REG. 3-19-1991.
- 1,639,355. SPECIFICATION LINE. INT. CL. 11. (U.S. CL. 31). REG. 3-26-1991.
- 1,767,843. ACCU-PREP. INT. CL. 1. (U.S. CL. 6). REG. 4-27-1993.
- 2,194,940. HEXAROSE. INT. CLS. 1 AND 3. (U.S. CLS. 1, 4, 5, 6, 10, 26, 46, 50, 51 AND 52). REG. 10-13-1998.
- 2,236,617. CHUGACH ALASKA AND DESIGN. INT. CLS. 16, 35, 36, 37, 39 AND 42 ONLY. (U.S. CLS. 2, 5, 22, 23, 29, 37, 38, 50, 100, 101, 102, 103, 105 AND 106). REG. 4-6-1999.
- 2,251,465. GRANNY'S LOVE. INT. CL. 25. (U.S. CLS. 22 AND 39). REG. 6-8-1999.
- 2,256,114. EZ#2. INT. CL. 16. (U.S. CLS. 2, 5, 22, 23, 29, 37, 38 AND 50). REG. 6-22-1999.
- 2,263,791. RAPOSEIRA. INT. CL. 33. (U.S. CLS. 47 AND 49). REG. 7-20-1999.
- 2,275,651. RTI. INT. CLS. 9, 35, 36 AND 42. (U.S. CLS. 21, 23, 26, 36, 38, 100, 101 AND 102). REG. 9-7-1999.
- 2,278,709. URANE. INT. CLS. 7, 9 AND 42. (U.S. CLS. 13, 19, 21, 23, 26, 31, 34, 35, 36, 38, 100 AND 101). REG. 9-21-1999.
- 2,279,608. TOMKATS AND DESIGN. INT. CL. 25. (U.S. CLS. 22 AND 39). REG. 9-21-1999.
- 2,279,799. HOLEY MOLEY. INT. CL. 7. (U.S. CLS. 13, 19, 21, 23, 31, 34 AND 35). REG. 9-21-1999.
- 2,280,031. HAIR SO SHINE. INT. CL. 3. (U.S. CLS. 1, 4, 6, 50, 51 AND 52). REG. 9-21-1999.
- 2,280,226. VISIONPLUS (STYLIZED). INT. CL. 9. (U.S. CLS. 21, 23, 26, 36 AND 38). REG. 9-28-1999.
- 2,280,640. CENTURY. INT. CLS. 7 AND 9. (U.S. CLS. 13, 19, 21, 23, 26, 31, 34, 35, 36 AND 38). REG. 9-28-1999.
- 2,280,658. AMERICAN FRESH. INT. CLS. 29 AND 30. (U.S. CL. 46). REG. 9-28-1999.
- 2,280,694. ALMOST LIVE!. INT. CL. 41. (U.S. CLS. 100, 101 AND 107). REG. 9-28-1999.
- 2,280,942. TIGER-GRIP. INT. CL. 8. (U.S. CLS. 23, 28 AND 44). REG. 9-28-1999.
- 2,281,106. VIROCLEAR. INT. CL. 5. (U.S. CLS. 6, 18, 44, 46, 51 AND 52). REG. 9-28-1999.
- 2,281,520. EAST SIDE RECORDS. INT. CL. 9. (U.S. CLS. 21, 23, 26, 36 AND 38). REG. 9-28-1999.
- 2,281,521. EAST SIDE STORY. INT. CL. 9. (U.S. CLS. 21, 23, 26, 36 AND 38). REG. 9-28-1999.
- 2,281,598. SOUTHERN AFRICA WILDLIFE TRUST AND DESIGN. INT. CL. 42. (U.S. CLS. 100 AND 101). REG. 9-28-1999.
- 2,281,603. QSC PHCC QUALITY SERVICE CONTRACTORS TRUST THE NATION'S BEST AND DESIGN. INT. CLS. 16, 41 AND 42. (U.S. CLS. 2, 5, 22, 23, 29, 37, 38, 50, 100, 101 AND 107). REG. 9-28-1999.
- 2,281,756. RITE AID INTERNET REFILLS WWW.RITEAID.COM AND DESIGN. INT. CL. 42. (U.S. CLS. 100 AND 101). REG. 9-28-1999.
- 2,281,992. LIP ESSENTIALS. INT. CL. 3. (U.S. CLS. 1, 4, 6, 50, 51 AND 52). REG. 9-28-1999.
- 2,281,999. BRUSHSTROKES. INT. CL. 16. (U.S. CLS. 2, 5, 22, 23, 29, 37, 38 AND 50). REG. 9-28-1999.
- 2,282,124. WEDMASTER. INT. CL. 42. (U.S. CLS. 100 AND 101). REG. 9-28-1999.
- 2,282,261. BIKE WISCONSIN. INT. CL. 35. (U.S. CLS. 100, 101 AND 102). REG. 9-28-1999.
- 2,282,321. PHOTONICS INDUSTRIES. INT. CL. 9. (U.S. CLS. 21, 23, 26, 36 AND 38). REG. 9-28-1999.
- 2,282,526. VISIBLE SOLUTIONS AND DESIGN. INT. CL. 35. (U.S. CLS. 100, 101 AND 102). REG. 10-5-1999.
- 2,282,787. SELCO (STYLIZED). INT. CLS. 7 AND 9. (U.S. CLS. 13, 19, 21, 23, 26, 31, 34, 35, 36 AND 38). REG. 10-5-1999.
- 2,283,003. MEDINTELLIGENCE. INT. CLS. 9 AND 35. (U.S. CLS. 21, 23, 26, 36, 38, 100, 101 AND 102). REG. 10-5-1999.
- 2,283,253. SPLASHGUARD II. INT. CL. 10. (U.S. CLS. 26, 39 AND 44). REG. 10-5-1999.
- 2,283,777. MISCELLANEOUS DESIGN. INT. CL. 21. (U.S. CLS. 2, 13, 23, 29, 30, 33, 40 AND 50). REG. 10-5-1999.
- 2,284,412. AIRCOOL. INT. CL. 9. (U.S. CLS. 21, 23, 26, 36 AND 38). REG. 10-12-1999.
- 2,284,502. SKYSTAR. INT. CL. 12. (U.S. CLS. 19, 21, 23, 31, 35 AND 44). REG. 10-12-1999.
- 2,284,538. HUGGY BUGGY (STYLIZED). INT. CL. 28. (U.S. CLS. 22, 23, 38 AND 50). REG. 10-12-1999.
- 2,284,867. PUBLICIS AND DESIGN. INT. CL. 35. (U.S. CLS. 100, 101 AND 102). REG. 10-12-1999.
- 2,285,270. NATIONAL AIR CARGO. INT. CL. 39. (U.S. CLS. 100 AND 105). REG. 10-12-1999.
- 2,286,564. ADDING POWER TO ENERGY. INT. CL. 42 ONLY. (U.S. CLS. 100 AND 101). REG. 10-12-1999.
- 2,286,897. COP...COPINE PARIS AND DESIGN. INT. CL. 25 ONLY. (U.S. CLS. 22 AND 39). REG. 10-19-1999.
- 2,287,833. GREEN HILLS MEMORIAL PARK AND DESIGN. INT. CL. 42. (U.S. CLS. 100 AND 101). REG. 10-19-1999.
- 2,287,873. COMPUTER MEDICS AND DESIGN. INT. CL. 37 ONLY. (U.S. CLS. 100, 103 AND 106). REG. 10-19-1999.
- 2,288,269. THE DRESSINGS FOR PEOPLE WHO MAKE THEIR OWN!. INT. CL. 30. (U.S. CL. 46). REG. 10-19-1999.
- 2,291,289. JANUS. INT. CL. 7. (U.S. CLS. 13, 19, 21, 23, 31, 34 AND 35). REG. 11-9-1999.
- 2,291,867. FAST EDGE. INT. CL. 20. (U.S. CLS. 2, 13, 22, 25, 32 AND 50). REG. 11-16-1999.
- 2,293,898. ALLEN. INT. CL. 7. (U.S. CLS. 13, 19, 21, 23, 31, 34 AND 35). REG. 11-23-1999.
- 2,294,301. AVALON. INT. CL. 17. (U.S. CLS. 1, 5, 12, 13, 35 AND 50). REG. 11-23-1999.
- 2,295,274. MALAYSIA AIRLINES AND DESIGN. INT. CL. 39. (U.S. CLS. 100 AND 105). REG. 11-30-1999.
- 2,299,184. NATURE'S. INT. CL. 1. (U.S. CLS. 1, 5, 6, 10, 26 AND 46). REG. 12-14-1999.
- 2,299,423. GEOGRAPHIC SOLUTIONS. INT. CL. 42. (U.S. CLS. 100 AND 101). REG. 12-14-1999.
- 2,300,611. RELION. INT. CL. 11. (U.S. CLS. 13, 21, 23, 31 AND 34). REG. 12-14-1999.
- 2,300,825. BIOPEIN. INT. CL. 1. (U.S. CLS. 1, 5, 6, 10, 26 AND 46). REG. 12-14-1999.
- 2,302,034. STM AND DESIGN. INT. CL. 7. (U.S. CLS. 13, 19, 21, 23, 31, 34 AND 35). REG. 12-21-1999.
- 2,302,859. MISCELLANEOUS DESIGN. INT. CL. 28. (U.S. CLS. 22, 23, 38 AND 50). REG. 12-21-1999.
- 2,304,105. AMERICANS FOR A FAIR CHANCE. INT. CL. 42 ONLY. (U.S. CLS. 100 AND 101). REG. 12-28-1999.
- 2,304,203. SNAP-N-SPLASH. INT. CL. 28. (U.S. CLS. 22, 23, 38 AND 50). REG. 12-28-1999.
- 2,304,566. HICKORY GROVE. INT. CL. 20. (U.S. CLS. 2, 13, 22, 25, 32 AND 50). REG. 12-28-1999.
- 2,304,605. SURECON. INT. CL. 9. (U.S. CLS. 21, 23, 26, 36 AND 38). REG. 12-28-1999.
- 2,305,785. CO-X-GENE TECHNOLOGY. INT. CL. 42. (U.S. CLS. 100 AND 101). REG. 1-4-2000.
- 2,306,143. CHIN-UP STRIP. INT. CL. 5. (U.S. CLS. 6, 18, 44, 46, 51 AND 52). REG. 1-4-2000.
- 2,306,567. TLJ (STYLIZED). INT. CL. 14. (U.S. CLS. 2, 27, 28 AND 50). REG. 1-4-2000.
- 2,307,024. ROVIS. INT. CL. 9. (U.S. CLS. 21, 23, 26, 36 AND 38). REG. 1-11-2000.
- 2,307,456. SPLIT-ONLINE. INT. CL. 9. (U.S. CLS. 21, 23, 26, 36 AND 38). REG. 1-11-2000.
- 2,307,457. SPLIT-DESKTOP. INT. CL. 9. (U.S. CLS. 21, 23, 26, 36 AND 38). REG. 1-11-2000.
- 2,308,019. BLANKOUT. INT. CL. 28. (U.S. CLS. 22, 23, 38 AND 50). REG. 1-11-2000.
- 2,308,370. RESOLUTE. INT. CL. 12. (U.S. CLS. 19, 21, 23, 31, 35 AND 44). REG. 1-18-2000.
- 2,308,995. TRAVEL-AIRE. INT. CL. 20. (U.S. CLS. 2, 13, 22, 25, 32 AND 50). REG. 1-18-2000.
- 2,309,002. SUNBIRD. INT. CL. 25. (U.S. CLS. 22 AND 39). REG. 1-18-2000.
- 2,310,586. THE BIRTHPLACE OF BATON ROUGE WOMAN'S HOSPITAL AND DESIGN. INT. CL. 42. (U.S. CLS. 100 AND 101). REG. 1-25-2000.
- 2,310,861. COUNTRY ESTATE AND DESIGN. INT. CL. 19. (U.S. CLS. 1, 12, 33 AND 50). REG. 1-25-2000.
- 2,313,072. POLYMER DIAGNOSTICS INC. AND DESIGN. INT. CL. 42. (U.S. CLS. 100 AND 101). REG. 2-1-2000.
- 2,313,361. KIM-LOK. INT. CL. 9. (U.S. CLS. 21, 23, 26, 36 AND 38). REG. 2-1-2000.
- 2,313,364. KIM-SNAP. INT. CL. 9. (U.S. CLS. 21, 23, 26, 36 AND 38). REG. 2-1-2000.
- 2,315,228. FWGB AND DESIGN. INT. CL. 9. (U.S. CLS. 21, 23, 26, 36 AND 38). REG. 2-8-2000.

- 2,315,261. NO DRAWING-SENSORY MARK. INT. CL. 9. (U.S. CLS. 21, 23, 26, 36 AND 38). REG. 2-8-2000.
- 2,315,276. THE LIMBAUGH INSTITUTE FOR ADVANCED CONSERVATIVE STUDIES. INT. CL. 16. (U.S. CLS. 2, 5, 22, 23, 29, 37, 38 AND 50). REG. 2-8-2000.
- 2,316,046. PA SERIES. INT. CL. 7. (U.S. CLS. 13, 19, 21, 23, 31, 34 AND 35). REG. 2-8-2000.
- 2,316,496. ACADEMIC GAMEPLAN AND DESIGN. INT. CL. 16. (U.S. CLS. 2, 5, 22, 23, 29, 37, 38 AND 50). REG. 2-8-2000.
- 2,316,933. SPRAYBOR. INT. CL. 1. (U.S. CLS. 1, 5, 6, 10, 26 AND 46). REG. 2-8-2000.
- 2,317,388. RACIAL HARMONY. INT. CL. 41. (U.S. CLS. 100, 101 AND 107). REG. 2-8-2000.
- 2,317,449. PURA AND DESIGN. INT. CL. 11. (U.S. CLS. 13, 21, 23, 31 AND 34). REG. 2-15-2000.
- 2,317,919. X-LITE AND DESIGN. INT. CL. 9. (U.S. CLS. 21, 23, 26, 36 AND 38). REG. 2-15-2000.
- 2,318,115. LEGEND. INT. CL. 10. (U.S. CLS. 26, 39 AND 44). REG. 2-15-2000.
- 2,318,708. OPTIMIZER. INT. CL. 9. (U.S. CLS. 21, 23, 26, 36 AND 38). REG. 2-15-2000.
- 2,320,052. ADVITECH. INT. CL. 1 ONLY. (U.S. CLS. 1, 5, 6, 10, 26 AND 46). REG. 2-22-2000.
- 2,320,146. DISKUS. INT. CL. 6. (U.S. CLS. 2, 12, 13, 14, 23, 25 AND 50). REG. 2-22-2000.
- 2,320,257. DALLAS AREA RAPID TRANSIT. INT. CL. 39. (U.S. CLS. 100 AND 105). REG. 2-22-2000.
- 2,320,464. YOUR RENTAL RESOURCE. INT. CLS. 35, 37, 39, 41 AND 42. (U.S. CLS. 100, 101, 102, 103, 105, 106 AND 107). REG. 2-22-2000.
- 2,320,693. PURDY AND DESIGN. INT. CL. 40 ONLY. (U.S. CLS. 100, 103 AND 106). REG. 2-22-2000.
- 2,321,406. HERTZ ISLANDER GOLD. INT. CL. 39. (U.S. CLS. 100 AND 105). REG. 2-22-2000.
- 2,322,285. HEADSIGHT. INT. CL. 9. (U.S. CLS. 21, 23, 26, 36 AND 38). REG. 2-22-2000.
- 2,322,335. VITAMINS FOR THE NEW MILLENNIUM. INT. CL. 5. (U.S. CLS. 6, 18, 44, 46, 51 AND 52). REG. 2-22-2000.
- 2,322,465. DATA HEAD. INT. CL. 28. (U.S. CLS. 22, 23, 38 AND 50). REG. 2-22-2000.
- 2,322,869. EGO. INT. CL. 14. (U.S. CLS. 2, 27, 28 AND 50). REG. 2-29-2000.
- 2,324,426. ONE ENVIRONMENT. ONE SIMPLE WAY TO CARE FOR IT. STANDARD CHARACTER MARK. INT. CLS. 36 AND 42. (U.S. CLS. 100, 101 AND 102). REG. 2-29-2000.
- 2,324,838. PIPELINER. INT. CL. 7. (U.S. CLS. 13, 19, 21, 23, 31, 34 AND 35). REG. 2-29-2000.
- 2,324,981. OTI INSIGHT. INT. CL. 9. (U.S. CLS. 21, 23, 26, 36 AND 38). REG. 2-29-2000.
- 2,325,149. MEDAIRE. INT. CLS. 16 AND 41. (U.S. CLS. 2, 5, 22, 23, 29, 37, 38, 50, 100, 101 AND 107). REG. 3-7-2000.
- 2,325,261. SURESCAN. INT. CL. 10. (U.S. CLS. 26, 39 AND 44). REG. 3-7-2000.
- 2,325,720. BOOMTOWN AND DESIGN. INT. CL. 41. (U.S. CLS. 100, 101 AND 107). REG. 3-7-2000.
- 2,326,161. THRU PUT AND DESIGN. INT. CL. 42. (U.S. CLS. 100 AND 101). REG. 3-7-2000.
- 2,326,615. WNKS. INT. CL. 38. (U.S. CLS. 100, 101 AND 104). REG. 3-7-2000.
- 2,326,618. MISCELLANEOUS DESIGN. INT. CL. 21. (U.S. CLS. 2, 13, 23, 29, 30, 33, 40 AND 50). REG. 3-7-2000.
- 2,327,316. WHOA!. INT. CL. 5. (U.S. CLS. 6, 18, 44, 46, 51 AND 52). REG. 3-7-2000.
- 2,327,341. YOUTH FRONT. INT. CLS. 9, 16 AND 25. (U.S. CLS. 2, 5, 21, 22, 23, 26, 29, 36, 37, 38, 39 AND 50). REG. 3-7-2000.
- 2,327,405. AROMA FRESH. INT. CLS. 20 AND 24. (U.S. CLS. 2, 13, 22, 25, 32, 42 AND 50). REG. 3-7-2000.
- 2,327,429. ENTERPRISE GUIDE. INT. CL. 9. (U.S. CLS. 21, 23, 26, 36 AND 38). REG. 3-7-2000.
- 2,327,494. OXSOL. INT. CL. 1. (U.S. CLS. 1, 5, 6, 10, 26 AND 46). REG. 3-14-2000.
- 2,327,739. TELOS (STYLIZED). INT. CL. 9. (U.S. CLS. 21, 23, 26, 36 AND 38). REG. 3-14-2000.
- 2,327,912. M (STYLIZED). INT. CL. 17. (U.S. CLS. 1, 5, 12, 13, 35 AND 50). REG. 3-14-2000.
- 2,327,982. MISCELLANEOUS DESIGN. INT. CL. 35. (U.S. CLS. 100, 101 AND 102). REG. 3-14-2000.
- 2,328,221. THOUGHTS TO SELL BY (STYLIZED). INT. CL. 16. (U.S. CLS. 2, 5, 22, 23, 29, 37, 38 AND 50). REG. 3-14-2000.
- 2,328,362. MISCELLANEOUS DESIGN. INT. CLS. 41 AND 42. (U.S. CLS. 100, 101 AND 107). REG. 3-14-2000.
- 2,328,373. NATURE'S OCEAN. INT. CL. 19 ONLY. (U.S. CLS. 1, 12, 33 AND 50). REG. 3-14-2000.
- 2,328,591. DECA. INT. CL. 35. (U.S. CLS. 100, 101 AND 102). REG. 3-14-2000.
- 2,328,623. MISCELLANEOUS DESIGN. INT. CL. 18. (U.S. CLS. 1, 2, 3, 22 AND 41). REG. 3-14-2000.
- 2,328,655. FOUR PIECE SUIT. INT. CL. 41. (U.S. CLS. 100, 101 AND 107). REG. 3-14-2000.
- 2,328,717. SCHOOLS ATTUNED. INT. CL. 16. (U.S. CLS. 2, 5, 22, 23, 29, 37, 38 AND 50). REG. 3-14-2000.
- 2,328,718. SCHOOLS ATTUNED. INT. CL. 41. (U.S. CLS. 100, 101 AND 107). REG. 3-14-2000.
- 2,328,817. LOGOS @ WORK AND DESIGN. INT. CL. 42. (U.S. CLS. 100 AND 101). REG. 3-14-2000.
- 2,328,887. PARAGRAPH. INT. CL. 9. (U.S. CLS. 21, 23, 26, 36 AND 38). REG. 3-14-2000.
- 2,328,899. TPD (STYLIZED). INT. CL. 42. (U.S. CLS. 100 AND 101). REG. 3-14-2000.
- 2,328,991. TRADEPOST. INT. CLS. 35 AND 38. (U.S. CLS. 100, 101, 102 AND 104). REG. 3-14-2000.
- 2,329,054. D DUARTE DESIGN AND DESIGN. INT. CL. 42. (U.S. CLS. 100 AND 101). REG. 3-14-2000.
- 2,329,074. ON THE GO! AND DESIGN. INT. CL. 42. (U.S. CLS. 100 AND 101). REG. 3-14-2000.
- 2,329,172. SAPPHIRE SERIES. INT. CL. 10. (U.S. CLS. 26, 39 AND 44). REG. 3-14-2000.
- 2,329,278. CITRALVA SUPER. INT. CLS. 1 AND 3. (U.S. CLS. 1, 4, 5, 6, 10, 26, 46, 50, 51 AND 52). REG. 3-14-2000.
- 2,329,525. KITTY KUBBYHOLE. INT. CL. 20. (U.S. CLS. 2, 13, 22, 25, 32 AND 50). REG. 3-14-2000.
- 2,329,665. DREAMMAKERS' FORUM. INT. CL. 41. (U.S. CLS. 100, 101 AND 107). REG. 3-14-2000.
- 2,329,721. THE HEALTHY MARKET AND CAFE. INT. CLS. 35 AND 42. (U.S. CLS. 100, 101 AND 102). REG. 3-14-2000.
- 2,330,047. MILLENNIUM. INT. CL. 20. (U.S. CLS. 2, 13, 22, 25, 32 AND 50). REG. 3-14-2000.
- 2,330,063. ROCK. INT. CL. 21. (U.S. CLS. 2, 13, 23, 29, 30, 33, 40 AND 50). REG. 3-14-2000.
- 2,330,151. SOFT CLEAN. INT. CL. 3. (U.S. CLS. 1, 4, 6, 50, 51 AND 52). REG. 3-14-2000.
- 2,330,156. DIGIMON. INT. CL. 28. (U.S. CLS. 22, 23, 38 AND 50). REG. 3-14-2000.
- 2,330,208. TASTRIES. INT. CL. 30. (U.S. CL. 46). REG. 3-14-2000.
- 2,330,213. MISCELLANEOUS DESIGN. INT. CL. 42. (U.S. CLS. 100 AND 101). REG. 3-14-2000.
- 2,330,533. COMFORT TENSION SEATING. INT. CL. 10. (U.S. CLS. 26, 39 AND 44). REG. 3-21-2000.
- 2,330,581. WILDTHINGS. INT. CL. 25. (U.S. CLS. 22 AND 39). REG. 3-21-2000.
- 2,330,601. MOVESOURCE. INT. CLS. 35, 36 AND 39. (U.S. CLS. 100, 101, 102 AND 105). REG. 3-21-2000.
- 2,330,648. EVAC. INT. CL. 7. (U.S. CLS. 13, 19, 21, 23, 31, 34 AND 35). REG. 3-21-2000.
- 2,330,693. NIKON. INT. CLS. 9, 16, 21 AND 28 ONLY. (U.S. CLS. 2, 5, 13, 21, 22, 23, 26, 29, 30, 33, 36, 37, 38, 40 AND 50). REG. 3-21-2000.
- 2,330,875. MISCELLANEOUS DESIGN. INT. CL. 29. (U.S. CL. 46). REG. 3-21-2000.
- 2,330,911. SHANE'S WORLD AND DESIGN. INT. CLS. 9, 16 AND 25. (U.S. CLS. 2, 5, 21, 22, 23, 26, 29, 36, 37, 38, 39 AND 50). REG. 3-21-2000.
- 2,330,955. FLEXIBLE 97. INT. CL. 36. (U.S. CLS. 100, 101 AND 102). REG. 3-21-2000.
- 2,330,988. DELTOP. INT. CL. 20. (U.S. CLS. 2, 13, 22, 25, 32 AND 50). REG. 3-21-2000.
- 2,331,047. GERITREX CORP.. INT. CL. 3. (U.S. CLS. 1, 4, 6, 50, 51 AND 52). REG. 3-21-2000.
- 2,331,126. LVS. INT. CL. 9. (U.S. CLS. 21, 23, 26, 36 AND 38). REG. 3-21-2000.
- 2,331,266. PETER PEPPER PRODUCTS. INT. CL. 35. (U.S. CLS. 100, 101 AND 102). REG. 3-21-2000.
- 2,331,343. RESOLVING CONFLICT CREATIVELY PROGRAM. INT. CL. 41. (U.S. CLS. 100, 101 AND 107). REG. 3-21-2000.
- 2,331,367. INFLUENCE SOFT-GLOSS. INT. CL. 16. (U.S. CLS. 2, 5, 22, 23, 29, 37, 38 AND 50). REG. 3-21-2000.

- 2,331,423. ALL ABOUT TRAVEL. INT. CLS. 39 AND 42. (U.S. CLS. 100, 101 AND 105). REG. 3-21-2000.
- 2,331,518. WOLF DESIGNS. INT. CL. 20. (U.S. CLS. 2, 13, 22, 25, 32 AND 50). REG. 3-21-2000.
- 2,331,545. BOATMATES. INT. CLS. 20 AND 21. (U.S. CLS. 2, 13, 22, 23, 25, 29, 30, 32, 33, 40 AND 50). REG. 3-21-2000.
- 2,331,564. NORTHERN INSTITUTIONAL FUNDS. INT. CL. 36. (U.S. CLS. 100, 101 AND 102). REG. 3-21-2000.
- 2,331,606. CANCER SURVIVAL TOOLBOX AND DESIGN. INT. CL. 9. (U.S. CLS. 21, 23, 26, 36 AND 38). REG. 3-21-2000.
- 2,331,608. COLUMBIA F L O O R I N G AND DESIGN. INT. CL. 19. (U.S. CLS. 1, 12, 33 AND 50). REG. 3-21-2000.
- 2,331,618. WHNS. INT. CL. 38. (U.S. CLS. 100, 101 AND 104). REG. 3-21-2000.
- 2,331,641. LOIS HILL. INT. CL. 8. (U.S. CLS. 23, 28 AND 44). REG. 3-21-2000.
- 2,331,642. LUCASARTS ENTERTAINMENT COMPANY. INT. CL. 9. (U.S. CLS. 21, 23, 26, 36 AND 38). REG. 3-21-2000.
- 2,331,643. LUCASARTS. INT. CL. 9. (U.S. CLS. 21, 23, 26, 36 AND 38). REG. 3-21-2000.
- 2,331,800. THERMOFLEX. INT. CL. 1. (U.S. CLS. 1, 5, 6, 10, 26 AND 46). REG. 3-21-2000.
- 2,331,970. SUNQUEST. INT. CL. 19. (U.S. CLS. 1, 12, 33 AND 50). REG. 3-21-2000.
- 2,332,063. FLUOMARINE. INT. CL. 2. (U.S. CLS. 6, 11 AND 16). REG. 3-21-2000.
- 2,332,084. SHOPGUARD AND DESIGN. INT. CL. 9. (U.S. CLS. 21, 23, 26, 36 AND 38). REG. 3-21-2000.
- 2,332,090. POWERHOUSE. INT. CL. 28. (U.S. CLS. 22, 23, 38 AND 50). REG. 3-21-2000.
- 2,332,098. THUNDER PROJECT. INT. CL. 42. (U.S. CLS. 100 AND 101). REG. 3-21-2000.
- 2,332,182. MB DC AND DESIGN. INT. CL. 42. (U.S. CLS. 100 AND 101). REG. 3-21-2000.
- 2,332,317. SMARTX. INT. CL. 9. (U.S. CLS. 21, 23, 26, 36 AND 38). REG. 3-21-2000.
- 2,332,329. SEEDS' WOOD DRESSING. INT. CL. 3. (U.S. CLS. 1, 4, 6, 50, 51 AND 52). REG. 3-21-2000.
- 2,332,335. KOOLIT. INT. CL. 1. (U.S. CLS. 1, 5, 6, 10, 26 AND 46). REG. 3-21-2000.
- 2,332,390. TIMES COMMUNITY NEWS. INT. CL. 35. (U.S. CLS. 100, 101 AND 102). REG. 3-21-2000.
- 2,332,425. LE BARON AND DESIGN. INT. CL. 35. (U.S. CLS. 100, 101 AND 102). REG. 3-21-2000.
- 2,332,434. PREPARE TO SPEAK. INT. CL. 41. (U.S. CLS. 100, 101 AND 107). REG. 3-21-2000.
- 2,332,466. DESTINATION SPA REFERRAL SERVICE. INT. CL. 35. (U.S. CLS. 100, 101 AND 102). REG. 3-21-2000.
- 2,332,514. CREATE-A-BED. INT. CL. 20. (U.S. CLS. 2, 13, 22, 25, 32 AND 50). REG. 3-21-2000.
- 2,332,518. SETAMINE. INT. CL. 2. (U.S. CLS. 6, 11 AND 16). REG. 3-21-2000.
- 2,332,536. FARMERS CARE. INT. CL. 36. (U.S. CLS. 100, 101 AND 102). REG. 3-21-2000.
- 2,332,552. CABLE SCOPE. INT. CL. 35. (U.S. CLS. 100, 101 AND 102). REG. 3-21-2000.
- 2,332,595. NEWLEAF. INT. CL. 21. (U.S. CLS. 2, 13, 23, 29, 30, 33, 40 AND 50). REG. 3-21-2000.
- 2,332,640. RAWSON AND DESIGN. INT. CLS. 25 AND 28. (U.S. CLS. 22, 23, 38, 39 AND 50). REG. 3-21-2000.
- 2,332,705. IQ SYSTEM AND DESIGN. INT. CL. 7. (U.S. CLS. 13, 19, 21, 23, 31, 34 AND 35). REG. 3-21-2000.
- 2,332,868. TARAXATONE. INT. CL. 5. (U.S. CLS. 6, 18, 44, 46, 51 AND 52). REG. 3-21-2000.
- 2,333,108. NYCE. INT. CL. 36. (U.S. CLS. 100, 101 AND 102). REG. 3-21-2000.
- 2,333,247. CRSI. INT. CL. 42. (U.S. CLS. 100 AND 101). REG. 3-21-2000.
- 2,333,291. PLANT-PROD. INT. CL. 1. (U.S. CLS. 1, 5, 6, 10, 26 AND 46). REG. 3-21-2000.
- 2,333,387. CONAIRPRO. INT. CL. 11. (U.S. CLS. 13, 21, 23, 31 AND 34). REG. 3-21-2000.
- 2,333,520. 6180. INT. CL. 9. (U.S. CLS. 21, 23, 26, 36 AND 38). REG. 3-21-2000.
- 2,333,545. WHIRLERS. INT. CL. 21. (U.S. CLS. 2, 13, 23, 29, 30, 33, 40 AND 50). REG. 3-21-2000.
- 2,333,599. INTERNATIONAL CES. INT. CL. 35. (U.S. CLS. 100, 101 AND 102). REG. 3-21-2000.
- 2,333,665. SWEETS FROM HEAVEN AND DESIGN. INT. CL. 25 ONLY. (U.S. CLS. 22 AND 39). REG. 3-21-2000.
- 2,333,771. ACTIVE DRY. INT. CL. 25. (U.S. CLS. 22 AND 39). REG. 3-21-2000.
- 2,333,807. READER'S DIGEST CHILDREN'S BOOKS. INT. CL. 16. (U.S. CLS. 2, 5, 22, 23, 29, 37, 38 AND 50). REG. 3-21-2000.
- 2,333,813. TONY BOOMBOZZ. INT. CL. 42. (U.S. CLS. 100 AND 101). REG. 3-21-2000.
- 2,333,842. GELEASE. INT. CL. 17. (U.S. CLS. 1, 5, 12, 13, 35 AND 50). REG. 3-21-2000.
- 2,334,126. AFRICAN WORLD FESTIVAL. INT. CLS. 16, 35 AND 41. (U.S. CLS. 2, 5, 22, 23, 29, 37, 38, 50, 100, 101, 102 AND 107). REG. 3-28-2000.
- 2,334,131. ABS-CBN. INT. CLS. 36 AND 38. (U.S. CLS. 100, 101, 102 AND 104). REG. 3-28-2000.
- 2,334,171. JAGUAR AND DESIGN. INT. CL. 16. (U.S. CLS. 2, 5, 22, 23, 29, 37, 38 AND 50). REG. 3-28-2000.
- 2,334,178. THE FIELDS ARE RIPE FOR HARVEST AND DESIGN. INT. CLS. 16, 36, 41 AND 42. (U.S. CLS. 2, 5, 22, 23, 29, 37, 38, 50, 100, 101, 102 AND 107). REG. 3-28-2000.
- 2,334,207. BROOKSTONE. INT. CLS. 8, 9, 10, 11, 12, 14, 18, 20, 21, 25, 27, 28 AND 35. (U.S. CLS. 1, 2, 3, 13, 19, 20, 21, 22, 23, 25, 26, 27, 28, 29, 30, 31, 32, 33, 34, 35, 36, 37, 38, 39, 40, 41, 42, 44, 50, 100, 101 AND 102). REG. 3-28-2000.
- 2,334,216. HAGEN & CO.. INT. CLS. 35, 41 AND 42. (U.S. CLS. 100, 101, 102 AND 107). REG. 3-28-2000.
- 2,334,222. CAVACOM. INT. CL. 35. (U.S. CLS. 100, 101 AND 102). REG. 3-28-2000.
- 2,334,238. MAGMA PLUS. INT. CLS. 5 AND 30. (U.S. CLS. 6, 18, 44, 46, 51 AND 52). REG. 3-28-2000.
- 2,334,249. KOKOMO'S FAMILY FUN CENTER AND DESIGN. INT. CL. 41. (U.S. CLS. 100, 101 AND 107). REG. 3-28-2000.
- 2,334,268. MISCELLANEOUS DESIGN. INT. CLS. 14, 21, 25, 27 AND 35. (U.S. CLS. 2, 13, 19, 20, 22, 23, 27, 28, 29, 30, 33, 37, 39, 40, 42, 50, 100, 101 AND 102). REG. 3-28-2000.
- 2,334,274. EV.EXT. INT. CL. 5 ONLY. (U.S. CLS. 6, 18, 44, 46, 51 AND 52 ONLY). REG. 3-28-2000.
- 2,334,279. FIRE-X GLASBORD. INT. CL. 19. (U.S. CLS. 1, 12, 33 AND 50). REG. 3-28-2000.
- 2,334,326. CARDPRO. INT. CLS. 35, 36 AND 40. (U.S. CLS. 100, 101, 102, 103 AND 106). REG. 3-28-2000.
- 2,334,340. V+ AND DESIGN. INT. CL. 9. (U.S. CLS. 21, 23, 26, 36 AND 38). REG. 3-28-2000.
- 2,334,377. PORTASOFT. INT. CL. 11. (U.S. CLS. 13, 21, 23, 31 AND 34). REG. 3-28-2000.
- 2,334,412. THE ORIGINAL IDEA PEOPLE. INT. CLS. 40 AND 42. (U.S. CLS. 100, 101, 103 AND 106). REG. 3-28-2000.
- 2,334,454. WORKONOMICS. INT. CLS. 16, 35 AND 41. (U.S. CLS. 2, 5, 22, 23, 29, 37, 38, 50, 100, 101, 102 AND 107). REG. 3-28-2000.
- 2,334,479. MISCELLANEOUS DESIGN. INT. CL. 14. (U.S. CLS. 2, 27, 28 AND 50). REG. 3-28-2000.
- 2,334,527. DURALINE. INT. CL. 2. (U.S. CLS. 6, 11 AND 16). REG. 3-28-2000.
- 2,334,579. FERRELL REED AND DESIGN. INT. CL. 25. (U.S. CLS. 22 AND 39). REG. 3-28-2000.
- 2,334,593. ALPHAVAX. INT. CL. 42. (U.S. CLS. 100 AND 101). REG. 3-28-2000.
- 2,334,644. MOTOR TRIKE. INT. CL. 12. (U.S. CLS. 19, 21, 23, 31, 35 AND 44). REG. 3-28-2000.
- 2,334,699. ULTRA GLOW. INT. CL. 3. (U.S. CLS. 1, 4, 6, 50, 51 AND 52). REG. 3-28-2000.
- 2,334,713. APD ENGINEERING AND DESIGN. INT. CL. 42. (U.S. CLS. 100 AND 101). REG. 3-28-2000.
- 2,334,810. PHONETICS. INT. CL. 9. (U.S. CLS. 21, 23, 26, 36 AND 38). REG. 3-28-2000.
- 2,334,811. AMERICAN PATCHWORK & QUILTING (STYLIZED). INT. CL. 16. (U.S. CLS. 2, 5, 22, 23, 29, 37, 38 AND 50). REG. 3-28-2000.
- 2,334,812. MISCELLANEOUS DESIGN. INT. CL. 35 ONLY. (U.S. CLS. 100, 101 AND 102). REG. 3-28-2000.
- 2,334,837. LEONARDO L 1502 AND DESIGN. INT. CL. 19. (U.S. CLS. 1, 12, 33 AND 50). REG. 3-28-2000.
- 2,334,844. PRODUCT IN A BOX. INT. CL. 28. (U.S. CLS. 22, 23, 38 AND 50). REG. 3-28-2000.
- 2,334,859. CITIES FOR CLIMATE PROTECTION. INT. CL. 42. (U.S. CLS. 100 AND 101). REG. 3-28-2000.

- 2,334,901. BELLASOL. INT. CL. 1. (U.S. CLS. 1, 5, 6, 10, 26 AND 46). REG. 3-28-2000.
- 2,334,928. MISCELLANEOUS DESIGN. INT. CL. 16. (U.S. CLS. 2, 5, 22, 23, 29, 37, 38 AND 50). REG. 3-28-2000.
- 2,334,930. MOSES & SINGER. INT. CL. 42. (U.S. CLS. 100 AND 101). REG. 3-28-2000.
- 2,334,943. LAWRENCE GROUP STANDARD CHARACTER MARK. INT. CL. 42. (U.S. CLS. 100 AND 101). REG. 3-28-2000.
- 2,334,966. OCEAN CITY LUMBER COMPANY AND DESIGN. INT. CL. 36. (U.S. CLS. 100, 101 AND 102). REG. 3-28-2000.
- 2,334,997. SCALEPHREE. INT. CL. 1. (U.S. CLS. 1, 5, 6, 10, 26 AND 46). REG. 3-28-2000.
- 2,335,000. PREMIATA. INT. CL. 25 ONLY. (U.S. CLS. 22 AND 39). REG. 3-28-2000.
- 2,335,094. ROYAL NICARAGUAN. INT. CL. 34. (U.S. CLS. 2, 8, 9 AND 17). REG. 3-28-2000.
- 2,335,109. TOWHAUL. INT. CL. 7. (U.S. CLS. 13, 19, 21, 23, 31, 34 AND 35). REG. 3-28-2000.
- 2,335,110. TOWHAUL SMITH EQUIPMENT USA AND DESIGN. INT. CL. 7. (U.S. CLS. 13, 19, 21, 23, 31, 34 AND 35). REG. 3-28-2000.
- 2,335,111. TOWHAUL BY SMITH AND DESIGN. INT. CL. 40. (U.S. CLS. 100, 103 AND 106). REG. 3-28-2000.
- 2,335,244. ACTIVEPOINT. INT. CL. 9. (U.S. CLS. 21, 23, 26, 36 AND 38). REG. 3-28-2000.
- 2,335,251. SO SMART!. INT. CL. 9. (U.S. CLS. 21, 23, 26, 36 AND 38). REG. 3-28-2000.
- 2,335,270. TRENCH FORMER AND DESIGN. INT. CLS. 6 AND 19. (U.S. CLS. 1, 2, 12, 13, 14, 23, 25, 33 AND 50). REG. 3-28-2000.
- 2,335,348. THE BRIGHT IDEAS COMPANY. INT. CL. 42. (U.S. CLS. 100 AND 101). REG. 3-28-2000.
- 2,335,384. TRIPPAK EXPRESS. INT. CL. 39. (U.S. CLS. 100 AND 105). REG. 3-28-2000.
- 2,335,385. RISING WATERS. INT. CL. 28. (U.S. CLS. 22, 23, 38 AND 50). REG. 3-28-2000.
- 2,335,390. SESAME. INT. CL. 17. (U.S. CLS. 1, 5, 12, 13, 35 AND 50). REG. 3-28-2000.
- 2,335,412. MISCELLANEOUS DESIGN. INT. CL. 1. (U.S. CLS. 1, 5, 6, 10, 26 AND 46). REG. 3-28-2000.
- 2,335,428. MRSID. INT. CL. 9. (U.S. CLS. 21, 23, 26, 36 AND 38). REG. 3-28-2000.
- 2,335,456. WINDAC. INT. CL. 9. (U.S. CLS. 21, 23, 26, 36 AND 38). REG. 3-28-2000.
- 2,335,461. NIGHT FLASHER. INT. CL. 18. (U.S. CLS. 1, 2, 3, 22 AND 41). REG. 3-28-2000.
- 2,335,468. ASK HAL. INT. CLS. 35 AND 42. (U.S. CLS. 100, 101 AND 102). REG. 3-28-2000.
- 2,335,486. TRIM LEGENDARY BEAUTY. INT. CL. 42. (U.S. CLS. 100 AND 101). REG. 3-28-2000.
- 2,335,487. TRIM CLASSIC BARBER. INT. CL. 42. (U.S. CLS. 100 AND 101). REG. 3-28-2000.
- 2,335,488. TRIM CLASSIC BARBER LEGENDARY BEAUTY AND DESIGN. INT. CL. 42. (U.S. CLS. 100 AND 101). REG. 3-28-2000.
- 2,335,493. SHEENIQUE. INT. CL. 3 ONLY. (U.S. CLS. 1, 4, 6, 50, 51 AND 52). REG. 3-28-2000.
- 2,335,496. DEVELOPMENT IN ACTION SERIES. INT. CLS. 16 AND 41. (U.S. CLS. 2, 5, 22, 23, 29, 37, 38, 50, 100, 101 AND 107). REG. 3-28-2000.
- 2,335,504. LYTE NOW AND DESIGN. INT. CL. 5. (U.S. CLS. 6, 18, 44, 46, 51 AND 52). REG. 3-28-2000.
- 2,335,508. DARK AND DESIGN. INT. CL. 1. (U.S. CLS. 1, 5, 6, 10, 26 AND 46). REG. 3-28-2000.
- 2,335,509. FAST AND DESIGN. INT. CL. 1. (U.S. CLS. 1, 5, 6, 10, 26 AND 46). REG. 3-28-2000.
- 2,335,510. SET CONTROL AND DESIGN. INT. CL. 1. (U.S. CLS. 1, 5, 6, 10, 26 AND 46). REG. 3-28-2000.
- 2,335,547. ONE TURNBERRY PLACE. INT. CL. 36. (U.S. CLS. 100, 101 AND 102). REG. 3-28-2000.
- 2,335,589. SAXON. INT. CL. 7. (U.S. CLS. 13, 19, 21, 23, 31, 34 AND 35). REG. 3-28-2000.
- 2,335,656. FISHING & HUNTING TEXAS AND DESIGN. INT. CLS. 25 AND 41. (U.S. CLS. 22, 39, 100, 101 AND 107). REG. 3-28-2000.
- 2,335,657. TYE-RITE. INT. CL. 26. (U.S. CLS. 37, 39, 40, 42 AND 50). REG. 3-28-2000.
- 2,335,719. SPLASH. INT. CL. 3. (U.S. CLS. 1, 4, 6, 50, 51 AND 52). REG. 3-28-2000.
- 2,335,759. TCI TRANS CALIFORNIA COURIER, INC (STYLIZED). INT. CL. 39. (U.S. CLS. 100 AND 105). REG. 3-28-2000.
- 2,335,767. OUR PASSION IS SLEEP BECAUSE YOUR PASSION IS LIFE. INT. CL. 20. (U.S. CLS. 2, 13, 22, 25, 32 AND 50). REG. 3-28-2000.
- 2,335,777. MELODY. INT. CL. 9. (U.S. CLS. 21, 23, 26, 36 AND 38). REG. 3-28-2000.
- 2,335,811. RENUELITE. INT. CL. 4. (U.S. CLS. 1, 6 AND 15). REG. 3-28-2000.
- 2,335,818. CROWN. INT. CL. 9. (U.S. CLS. 21, 23, 26, 36 AND 38). REG. 3-28-2000.
- 2,335,819. E-FLOW. INT. CL. 9. (U.S. CLS. 21, 23, 26, 36 AND 38). REG. 3-28-2000.
- 2,335,847. AQUAZOL. INT. CL. 2. (U.S. CLS. 6, 11 AND 16). REG. 3-28-2000.
- 2,335,851. PAULO. INT. CL. 40. (U.S. CLS. 100, 103 AND 106). REG. 3-28-2000.
- 2,335,890. MISCELLANEOUS DESIGN. INT. CL. 5. (U.S. CLS. 6, 18, 44, 46, 51 AND 52). REG. 3-28-2000.
- 2,335,900. THUNDERBIRD. INT. CL. 14. (U.S. CLS. 2, 27, 28 AND 50). REG. 3-28-2000.
- 2,335,937. BREAKTHROUGH TO LITERACY. INT. CL. 41. (U.S. CLS. 100, 101 AND 107). REG. 3-28-2000.
- 2,335,947. ELVIS. INT. CL. 9. (U.S. CLS. 21, 23, 26, 36 AND 38). REG. 3-28-2000.
- 2,335,966. DRUG CHECKER. INT. CL. 42. (U.S. CLS. 100 AND 101). REG. 3-28-2000.
- 2,336,009. PETRO-STIK. INT. CL. 9. (U.S. CLS. 21, 23, 26, 36 AND 38). REG. 3-28-2000.
- 2,336,011. AV AND DESIGN. INT. CLS. 7 AND 35 ONLY. (U.S. CLS. 13, 19, 21, 23, 31, 34, 35, 100, 101 AND 102 ONLY). REG. 3-28-2000.
- 2,336,060. EASYLYTE (STYLIZED). INT. CLS. 1, 5 AND 10. (U.S. CLS. 1, 5, 6, 10, 18, 26, 39, 44, 46, 51 AND 52). REG. 3-28-2000.
- 2,336,214. REBEL. INT. CL. 7. (U.S. CLS. 13, 19, 21, 23, 31, 34 AND 35). REG. 3-28-2000.
- 2,336,257. DORT ONLINE. INT. CL. 36. (U.S. CLS. 100, 101 AND 102). REG. 3-28-2000.
- 2,336,272. MISCELLANEOUS DESIGN. INT. CL. 25. (U.S. CLS. 22 AND 39). REG. 3-28-2000.
- 2,336,283. FLATTOP GRILL AND DESIGN. INT. CL. 42. (U.S. CLS. 100 AND 101). REG. 3-28-2000.
- 2,336,314. CASTAWAY CLUB. INT. CL. 41. (U.S. CLS. 100, 101 AND 107). REG. 3-28-2000.
- 2,336,315. SARANAC VILLAGE. INT. CL. 41. (U.S. CLS. 100, 101 AND 107). REG. 3-28-2000.
- 2,336,321. CASTAWAY CLUB. INT. CL. 42. (U.S. CLS. 100 AND 101). REG. 3-28-2000.
- 2,336,340. MISCELLANEOUS DESIGN. INT. CL. 30. (U.S. CL. 46). REG. 3-28-2000.
- 2,336,350. TROUBLEMAKER. INT. CL. 41. (U.S. CLS. 100, 101 AND 107). REG. 3-28-2000.
- 2,336,373. ELLIOT. INT. CL. 28. (U.S. CLS. 22, 23, 38 AND 50). REG. 3-28-2000.
- 2,336,380. GEM-COTE. INT. CL. 12. (U.S. CLS. 19, 21, 23, 31, 35 AND 44). REG. 3-28-2000.
- 2,336,383. ITAL GELATI LA BELLA ITALIANA AND DESIGN. INT. CL. 30. (U.S. CL. 46). REG. 3-28-2000.
- 2,336,384. JET SOLUTIONS. INT. CLS. 35, 37 AND 39. (U.S. CLS. 100, 101, 102, 103, 105 AND 106). REG. 3-28-2000.
- 2,336,400. SYNOVA. INT. CL. 42 ONLY. (U.S. CLS. 100 AND 101). REG. 3-28-2000.
- 2,336,405. ACE. INT. CL. 20. (U.S. CLS. 2, 13, 22, 25, 32 AND 50). REG. 3-28-2000.
- 2,336,416. BEYOND CASUAL. INT. CL. 25. (U.S. CLS. 22 AND 39). REG. 3-28-2000.
- 2,336,504. DIEBOTICS. INT. CL. 7. (U.S. CLS. 13, 19, 21, 23, 31, 34 AND 35). REG. 3-28-2000.
- 2,336,543. 21ST CENTURY URBAN SCHOOLS. INT. CL. 41. (U.S. CLS. 100, 101 AND 107). REG. 3-28-2000.
- 2,336,559. TILE DOC XIM AND DESIGN. INT. CL. 2. (U.S. CLS. 6, 11 AND 16). REG. 3-28-2000.
- 2,336,582. CHARLES DE VALLIERE. INT. CL. 33. (U.S. CLS. 47 AND 49). REG. 3-28-2000.
- 2,336,591. HILLSBOROUGH RIVER TOWER. INT. CL. 37. (U.S. CLS. 100, 103 AND 106). REG. 3-28-2000.
- 2,336,607. MEDIAKAT. INT. CLS. 16 AND 42. (U.S. CLS. 2, 5, 22, 23, 29, 37, 38, 50, 100 AND 101). REG. 3-28-2000.
- 2,336,614. SOULCALIBUR. INT. CLS. 9 AND 28. (U.S. CLS. 21, 22, 23, 26, 36, 38 AND 50). REG. 3-28-2000.
- 2,336,629. AUKITCHEN AND DESIGN. INT. CL. 7. (U.S. CLS. 13, 19, 21, 23, 31, 34 AND 35). REG. 3-28-2000.

- 2,336,671. BOSTON EO. INT. CL. 9. (U.S. CLS. 21, 23, 26, 36 AND 38). REG. 3-28-2000.
- 2,336,694. PLATINUM HORSE. INT. CL. 41. (U.S. CLS. 100, 101 AND 107). REG. 3-28-2000.
- 2,336,701. MISCELLANEOUS DESIGN. INT. CLS. 14 AND 25. (U.S. CLS. 2, 22, 27, 28, 39 AND 50). REG. 3-28-2000.
- 2,336,727. FRESH CHOICE. INT. CL. 2. (U.S. CLS. 6, 11 AND 16). REG. 3-28-2000.
- 2,336,736. EXTENSA. INT. CL. 11. (U.S. CLS. 13, 21, 23, 31 AND 34). REG. 3-28-2000.
- 2,336,745. WING-IT. INT. CL. 28. (U.S. CLS. 22, 23, 38 AND 50). REG. 3-28-2000.
- 2,336,749. INCODE. INT. CL. 42. (U.S. CLS. 100 AND 101). REG. 3-28-2000.
- 2,336,753. SHERLOCK. INT. CL. 9. (U.S. CLS. 21, 23, 26, 36 AND 38). REG. 3-28-2000.
- 2,336,754. REMICADE. INT. CL. 5. (U.S. CLS. 6, 18, 44, 46, 51 AND 52). REG. 3-28-2000.
- 2,336,775. CSG SCREEN EXPRESS. INT. CL. 9. (U.S. CLS. 21, 23, 26, 36 AND 38). REG. 3-28-2000.
- 2,336,828. SYSTEM 64. INT. CL. 6. (U.S. CLS. 2, 12, 13, 14, 23, 25 AND 50). REG. 3-28-2000.
- 2,336,830. GENETIX. INT. CL. 5. (U.S. CLS. 6, 18, 44, 46, 51 AND 52). REG. 3-28-2000.
- 2,336,857. MISCELLANEOUS DESIGN. INT. CL. 12. (U.S. CLS. 19, 21, 23, 31, 35 AND 44). REG. 3-28-2000.
- 2,336,877. CHIHUAHUAS. INT. CLS. 16 AND 42. (U.S. CLS. 2, 5, 22, 23, 29, 37, 38, 50, 100 AND 101). REG. 3-28-2000.
- 2,336,881. JAPAN WASHINGTON BULLETIN. INT. CL. 42. (U.S. CLS. 100 AND 101). REG. 3-28-2000.
- 2,336,893. SUPERPSYCHIC. INT. CL. 41. (U.S. CLS. 100, 101 AND 107). REG. 3-28-2000.
- 2,336,942. SAMBUCOL. INT. CL. 5. (U.S. CLS. 6, 18, 44, 46, 51 AND 52). REG. 4-4-2000.
- 2,337,058. Q AND DESIGN. INT. CL. 9. (U.S. CLS. 21, 23, 26, 36 AND 38). REG. 4-4-2000.
- 2,337,085. BWL. INT. CLS. 14, 18 AND 25 ONLY. (U.S. CLS. 1, 2, 3, 22, 27, 28, 39, 41 AND 50). REG. 4-4-2000.
- 2,337,086. BILL WALL LEATHER. INT. CLS. 14, 18 AND 25 ONLY. (U.S. CLS. 1, 2, 3, 22, 27, 28, 39, 41 AND 50). REG. 4-4-2000.
- 2,337,124. FRITZ. INT. CL. 9. (U.S. CLS. 21, 23, 26, 36 AND 38). REG. 4-4-2000.
- 2,337,242. SKYWAN. INT. CL. 9. (U.S. CLS. 21, 23, 26, 36 AND 38). REG. 4-4-2000.
- 2,337,281. CHEF'S REQUESTED FOODS AND DESIGN. INT. CL. 29. (U.S. CL. 46). REG. 4-4-2000.
- 2,337,294. INTEROX. INT. CL. 1. (U.S. CLS. 1, 5, 6, 10, 26 AND 46). REG. 4-4-2000.
- 2,337,433. MV MACULA VISION RESEARCH FOUNDATION AND DESIGN. INT. CLS. 36 AND 42. (U.S. CLS. 100, 101 AND 102). REG. 4-4-2000.
- 2,337,486. TIMES BOOKS. INT. CL. 16. (U.S. CLS. 2, 5, 22, 23, 29, 37, 38 AND 50). REG. 4-4-2000.
- 2,337,506. GLEIKE. INT. CL. 9. (U.S. CLS. 21, 23, 26, 36 AND 38). REG. 4-4-2000.
- 2,337,561. US AIRWAYS CLUB. INT. CL. 39. (U.S. CLS. 100 AND 105). REG. 4-4-2000.
- 2,337,571. REEL SHORTS AND DESIGN. INT. CL. 41. (U.S. CLS. 100, 101 AND 107). REG. 4-4-2000.
- 2,337,606. CSG SYSTEMS. INT. CL. 35. (U.S. CLS. 100, 101 AND 102). REG. 4-4-2000.
- 2,337,610. STOP CANCER. INT. CL. 36. (U.S. CLS. 100, 101 AND 102). REG. 4-4-2000.
- 2,337,633. ON ANY GIVEN SUNDAY. INT. CL. 25. (U.S. CLS. 22 AND 39). REG. 4-4-2000.
- 2,337,655. CENTERSTONE. INT. CL. 42. (U.S. CLS. 100 AND 101). REG. 4-4-2000.
- 2,337,669. MISCELLANEOUS DESIGN. INT. CL. 42. (U.S. CLS. 100 AND 101). REG. 4-4-2000.
- 2,337,678. CSG SYSTEMS. INT. CL. 9. (U.S. CLS. 21, 23, 26, 36 AND 38). REG. 4-4-2000.
- 2,337,685. MISCELLANEOUS DESIGN. INT. CL. 30. (U.S. CL. 46). REG. 4-4-2000.
- 2,337,693. CITIES FOR CLIMATE PROTECTION. INT. CL. 41. (U.S. CLS. 100, 101 AND 107). REG. 4-4-2000.
- 2,337,755. HOME MEDIA. INT. CLS. 35, 37 AND 42. (U.S. CLS. 100, 101, 102, 103 AND 106). REG. 4-4-2000.
- 2,337,758. COMFORT CLUB AND DESIGN. INT. CLS. 20 AND 35 ONLY. (U.S. CLS. 2, 13, 22, 25, 32, 50, 100, 101 AND 102). REG. 4-4-2000.
- 2,337,816. V VARICAD AND DESIGN. INT. CL. 9. (U.S. CLS. 21, 23, 26, 36 AND 38). REG. 4-4-2000.
- 2,337,829. BUCKLE DOWN. INT. CL. 28. (U.S. CLS. 22, 23, 38 AND 50). REG. 4-4-2000.
- 2,337,836. A KNOWLEDGE CORPORATION. INT. CL. 42. (U.S. CLS. 100 AND 101). REG. 4-4-2000.
- 2,337,845. RADITER. INT. CL. 1. (U.S. CLS. 1, 5, 6, 10, 26 AND 46). REG. 4-4-2000.
- 2,337,870. CABLEREP TOOLS YOU TRUST. AND DESIGN. INT. CL. 8. (U.S. CLS. 23, 28 AND 44). REG. 4-4-2000.
- 2,337,883. AMERITRUST REALTY AND DESIGN. INT. CL. 36. (U.S. CLS. 100, 101 AND 102). REG. 4-4-2000.
- 2,337,908. BUILDING BLOCKS TO READING AEIOU AND DESIGN. INT. CL. 16. (U.S. CLS. 2, 5, 22, 23, 29, 37, 38 AND 50). REG. 4-4-2000.
- 2,337,965. RECI. INT. CL. 41. (U.S. CLS. 100, 101 AND 107). REG. 4-4-2000.
- 2,337,983. ECLIPSE (STYLIZED). INT. CL. 9. (U.S. CLS. 21, 23, 26, 36 AND 38). REG. 4-4-2000.
- 2,337,985. ITIPACK AND DESIGN. INT. CL. 7. (U.S. CLS. 13, 19, 21, 23, 31, 34 AND 35). REG. 4-4-2000.
- 2,338,013. RITE LITE. INT. CL. 9. (U.S. CLS. 21, 23, 26, 36 AND 38). REG. 4-4-2000.
- 2,338,069. PATENTPOST. INT. CLS. 35 AND 38. (U.S. CLS. 100, 101, 102 AND 104). REG. 4-4-2000.
- 2,338,103. TRIPPAK EXPRESS (STYLIZED). INT. CL. 39. (U.S. CLS. 100 AND 105). REG. 4-4-2000.
- 2,338,294. KIDS GO SHOPPING AND DESIGN. INT. CL. 35. (U.S. CLS. 100, 101 AND 102). REG. 4-4-2000.
- 2,338,302. DIGEST RC. INT. CL. 5. (U.S. CLS. 6, 18, 44, 46, 51 AND 52). REG. 4-4-2000.
- 2,338,305. MISCELLANEOUS DESIGN. INT. CL. 37. (U.S. CLS. 100, 103 AND 106). REG. 4-4-2000.
- 2,338,357. REAL RESULTS. INT. CLS. 16 AND 41. (U.S. CLS. 2, 5, 22, 23, 29, 37, 38, 50, 100, 101 AND 107). REG. 4-4-2000.
- 2,338,373. E.T. JR.. INT. CL. 12. (U.S. CLS. 19, 21, 23, 31, 35 AND 44). REG. 4-4-2000.
- 2,338,499. DOMINI SOCIAL EQUITY FUND. INT. CL. 36. (U.S. CLS. 100, 101 AND 102). REG. 4-4-2000.
- 2,338,502. INSTINET. INT. CL. 36. (U.S. CLS. 100, 101 AND 102). REG. 4-4-2000.
- 2,338,527. AV AND DESIGN. INT. CLS. 1, 7, 9 AND 35. (U.S. CLS. 1, 5, 6, 10, 13, 19, 21, 23, 26, 31, 34, 35, 36, 38, 46, 100, 101 AND 102). REG. 4-4-2000.
- 2,338,528. BOOM BOX. INT. CL. 13. (U.S. CLS. 2 AND 9). REG. 4-4-2000.
- 2,338,600. HOMELINK. INT. CL. 35. (U.S. CLS. 100, 101 AND 102). REG. 4-4-2000.
- 2,338,624. N AND DESIGN. INT. CL. 37. (U.S. CLS. 100, 103 AND 106). REG. 4-4-2000.
- 2,338,646. AUDUBON. INT. CL. 9. (U.S. CLS. 21, 23, 26, 36 AND 38). REG. 4-4-2000.
- 2,338,659. ELLIOTT BAY BOOK COMPANY. INT. CL. 35. (U.S. CLS. 100, 101 AND 102). REG. 4-4-2000.
- 2,338,710. MR. BUBBLE. INT. CL. 3 ONLY. (U.S. CLS. 1, 4, 6, 50, 51 AND 52). REG. 4-4-2000.
- 2,338,745. EYEBUSTER. INT. CL. 28. (U.S. CLS. 22, 23, 38 AND 50). REG. 4-4-2000.
- 2,338,808. HUMANICS. INT. CL. 35. (U.S. CLS. 100, 101 AND 102). REG. 4-4-2000.
- 2,338,877. NOBU. INT. CL. 30. (U.S. CL. 46). REG. 4-4-2000.
- 2,338,906. CHRONICLE. INT. CL. 10. (U.S. CLS. 26, 39 AND 44). REG. 4-4-2000.
- 2,339,085. ALPHA AIR. INT. CL. 10. (U.S. CLS. 26, 39 AND 44). REG. 4-4-2000.
- 2,339,089. TWIST-SEAL. INT. CL. 10. (U.S. CLS. 26, 39 AND 44). REG. 4-4-2000.
- 2,339,092. ORIEL. INT. CLS. 35 AND 41. (U.S. CLS. 100, 101, 102 AND 107). REG. 4-4-2000.
- 2,339,103. ELEKTRON. INT. CL. 7. (U.S. CLS. 13, 19, 21, 23, 31, 34 AND 35). REG. 4-4-2000.
- 2,339,173. OPUS. INT. CL. 9. (U.S. CLS. 21, 23, 26, 36 AND 38). REG. 4-4-2000.
- 2,339,198. SATIN SMOOTH. INT. CL. 11. (U.S. CLS. 13, 21, 23, 31 AND 34). REG. 4-4-2000.
- 2,339,201. LIPOPROFILE. INT. CL. 42. (U.S. CLS. 100 AND 101). REG. 4-4-2000.
- 2,339,216. AT2000. INT. CL. 7. (U.S. CLS. 13, 19, 21, 23, 31, 34 AND 35). REG. 4-4-2000.
- 2,339,257. DEEP POCKETS. INT. CL. 20. (U.S. CLS. 2, 13, 22, 25, 32 AND 50). REG. 4-4-2000.
- 2,339,271. BONDFILM. INT. CL. 1. (U.S. CLS. 1, 5, 6, 10, 26 AND 46). REG. 4-4-2000.
- 2,339,276. DANCE DANCE REVOLUTION. INT. CL. 28. (U.S. CLS. 22, 23, 38 AND 50). REG. 4-4-2000.

- 2,339,388. FOOD EXPORT USA. INT. CL. 35. (U.S. CLS. 100, 101 AND 102). REG. 4-4-2000.
- 2,339,412. GIFTLAW. INT. CL. 9. (U.S. CLS. 21, 23, 26, 36 AND 38). REG. 4-4-2000.
- 2,339,434. QUANTERRA. INT. CL. 9. (U.S. CLS. 21, 23, 26, 36 AND 38). REG. 4-11-2000.
- 2,339,449. MISCELLANEOUS DESIGN. INT. CL. 3. (U.S. CLS. 1, 4, 6, 50, 51 AND 52). REG. 4-11-2000.
- 2,339,523. BLUIISH-GREEN AND DESIGN. INT. CL. 11. (U.S. CLS. 13, 21, 23, 31 AND 34). REG. 4-11-2000.
- 2,339,546. ESYS. INT. CLS. 1 AND 9. (U.S. CLS. 1, 5, 6, 10, 21, 23, 26, 36, 38 AND 46). REG. 4-11-2000.
- 2,339,556. DATAWAVE TECHNOLOGIES AND DESIGN. INT. CL. 9. (U.S. CLS. 21, 23, 26, 36 AND 38). REG. 4-11-2000.
- 2,339,615. MISCELLANEOUS DESIGN. INT. CL. 9. (U.S. CLS. 21, 23, 26, 36 AND 38). REG. 4-11-2000.
- 2,339,672. TWIN ELK AND DESIGN. INT. CL. 35 ONLY. (U.S. CLS. 100, 101 AND 102). REG. 4-11-2000.
- 2,339,759. POOCH BOTANIQUE AND DESIGN. INT. CL. 3. (U.S. CLS. 1, 4, 6, 50, 51 AND 52). REG. 4-11-2000.
- 2,339,763. MISCELLANEOUS DESIGN. INT. CL. 3. (U.S. CLS. 1, 4, 6, 50, 51 AND 52). REG. 4-11-2000.
- 2,339,776. AFCO AND DESIGN. INT. CLS. 35, 36 AND 37. (U.S. CLS. 100, 101, 102, 103 AND 106). REG. 4-11-2000.
- 2,339,794. HYDROCLEAR DIAMOND CLASS. INT. CL. 4. (U.S. CLS. 1, 6 AND 15). REG. 4-11-2000.
- 2,339,904. 1848 AND DESIGN. U.S. CL. 200. REG. 4-11-2000.
- 2,339,913. CANPLAST. INT. CLS. 17 AND 19. (U.S. CLS. 1, 5, 12, 13, 33, 35 AND 50). REG. 4-11-2000.
- 2,339,949. AURORA UV. INT. CL. 11. (U.S. CLS. 13, 21, 23, 31 AND 34). REG. 4-11-2000.
- 2,340,126. TIES OF DISTINCTION. INT. CL. 25. (U.S. CLS. 22 AND 39). REG. 4-11-2000.
- 2,340,144. QUICK 60+. INT. CL. 36. (U.S. CLS. 100, 101 AND 102). REG. 4-11-2000.
- 2,340,204. PLANET EARTH FOUNDATION. INT. CL. 35. (U.S. CLS. 100, 101 AND 102). REG. 4-11-2000.
- 2,340,235. PLANET EARTH MEDIA. INT. CL. 35. (U.S. CLS. 100, 101 AND 102). REG. 4-11-2000.
- 2,340,257. DECISION BASE. INT. CL. 28. (U.S. CLS. 22, 23, 38 AND 50). REG. 4-11-2000.
- 2,340,308. GUDAIR. INT. CL. 5. (U.S. CLS. 6, 18, 44, 46, 51 AND 52). REG. 4-11-2000.
- 2,340,378. CD COREY DELTA CONSTRUCTORS AN EMPLOYEE OWNED COMPANY AND DESIGN. INT. CL. 37. (U.S. CLS. 100, 103 AND 106). REG. 4-11-2000.
- 2,340,477. NATIONAL ASSOCIATION OF STATE FORESTERS FOUNDED 1920 AND DESIGN. INT. CL. 42. (U.S. CLS. 100 AND 101). REG. 4-11-2000.
- 2,340,563. VM ZINC. INT. CL. 6. (U.S. CLS. 2, 12, 13, 14, 23, 25 AND 50). REG. 4-11-2000.
- 2,340,689. IHI ENVIRONMENTAL. INT. CLS. 41 AND 42. (U.S. CLS. 100, 101 AND 107). REG. 4-11-2000.
- 2,340,759. 9 WSOC-TV AND DESIGN. INT. CL. 38. (U.S. CLS. 100, 101 AND 104). REG. 4-11-2000.
- 2,340,817. BODY- SOLID U.S.A. (STYLIZED). INT. CL. 28. (U.S. CLS. 22, 23, 38 AND 50). REG. 4-11-2000.
- 2,340,818. EZEEBOX. INT. CLS. 20 AND 21. (U.S. CLS. 2, 13, 22, 23, 25, 29, 30, 32, 33, 40 AND 50). REG. 4-11-2000.
- 2,340,844. CHARLES CHAPLIN AND DESIGN. INT. CL. 16. (U.S. CLS. 2, 5, 22, 23, 29, 37, 38 AND 50). REG. 4-11-2000.
- 2,340,856. THE JAZZ MESSENGERS THE LEGACY OF ART BLAKEY. INT. CL. 9. (U.S. CLS. 21, 23, 26, 36 AND 38). REG. 4-11-2000.
- 2,340,911. MISCELLANEOUS DESIGN. INT. CL. 36. (U.S. CLS. 100, 101 AND 102). REG. 4-11-2000.
- 2,340,978. QUICK PITCH. INT. CL. 19. (U.S. CLS. 1, 12, 33 AND 50). REG. 4-11-2000.
- 2,341,000. VOICE OF GOD RECORDINGS. INT. CLS. 9 AND 16. (U.S. CLS. 2, 5, 21, 22, 23, 26, 29, 36, 37, 38 AND 50). REG. 4-11-2000.
- 2,341,004. GO ZIPS. INT. CL. 41. (U.S. CLS. 100, 101 AND 107). REG. 4-11-2000.
- 2,341,049. MISCELLANEOUS DESIGN. INT. CLS. 41 AND 42. (U.S. CLS. 100, 101 AND 107). REG. 4-11-2000.
- 2,341,146. DOMINI SOCIAL INVESTMENTS. INT. CL. 36. (U.S. CLS. 100, 101 AND 102). REG. 4-11-2000.
- 2,341,243. DOG DAY AFTERNOON WHERE DOGS HAVE FUN! AND DESIGN. INT. CL. 42. (U.S. CLS. 100 AND 101). REG. 4-11-2000.
- 2,341,270. MISCELLANEOUS DESIGN. INT. CLS. 25, 28 AND 41. (U.S. CLS. 22, 23, 38, 39, 50, 100, 101 AND 107). REG. 4-11-2000.
- 2,341,390. CLASSIC. INT. CL. 10. (U.S. CLS. 26, 39 AND 44). REG. 4-11-2000.
- 2,341,443. SYNTEC (STYLIZED). INT. CL. 24. (U.S. CLS. 42 AND 50). REG. 4-11-2000.
- 2,341,460. SAN GABRIEL. INT. CL. 30. (U.S. CL. 46). REG. 4-11-2000.
- 2,341,506. SURFLIGHT. INT. CLS. 25 AND 28. (U.S. CLS. 22, 23, 38, 39 AND 50). REG. 4-11-2000.
- 2,341,531. EARNINGSWHISPERS. INT. CL. 36. (U.S. CLS. 100, 101 AND 102). REG. 4-11-2000.
- 2,341,583. MATSUHISA. INT. CLS. 25 AND 42. (U.S. CLS. 22, 39, 100 AND 101). REG. 4-11-2000.
- 2,341,656. STEP OUTSIDE. INT. CL. 42. (U.S. CLS. 100 AND 101). REG. 4-11-2000.
- 2,341,672. INDICHROME. INT. CL. 1 ONLY. (U.S. CLS. 1, 5, 6, 10, 26 AND 46). REG. 4-11-2000.
- 2,341,707. BMD AND DESIGN. INT. CL. 5. (U.S. CLS. 6, 18, 44, 46, 51 AND 52). REG. 4-11-2000.
- 2,341,720. SUPER STARS. INT. CL. 13. (U.S. CLS. 2 AND 9). REG. 4-11-2000.
- 2,341,770. SOS. INT. CL. 9. (U.S. CLS. 21, 23, 26, 36 AND 38). REG. 4-11-2000.
- 2,341,775. POPULAR DOGS. INT. CLS. 16 AND 42. (U.S. CLS. 2, 5, 22, 23, 29, 37, 38, 50, 100 AND 101). REG. 4-11-2000.
- 2,341,884. W & P (STYLIZED). INT. CL. 16 ONLY. (U.S. CLS. 2, 5, 22, 23, 29, 37, 38 AND 50). REG. 4-11-2000.
- 2,341,899. PEOPLE PROCESS RESULTS. INT. CL. 35. (U.S. CLS. 100, 101 AND 102). REG. 4-11-2000.
- 2,341,940. POSIES AND DESIGN. INT. CL. 28. (U.S. CLS. 22, 23, 38 AND 50). REG. 4-11-2000.
- 2,342,017. NOLAN LAW GROUP. INT. CL. 42. (U.S. CLS. 100 AND 101). REG. 4-11-2000.
- 2,342,054. BOOTS 'N JEANS. INT. CL. 42. (U.S. CLS. 100 AND 101). REG. 4-18-2000.
- 2,342,096. MSN. INT. CL. 35. (U.S. CLS. 100, 101 AND 102). REG. 4-18-2000.
- 2,342,173. VEGGIE MAGMA. INT. CLS. 5 AND 30. (U.S. CLS. 6, 18, 44, 46, 51 AND 52). REG. 4-18-2000.
- 2,342,237. DART. INT. CL. 35. (U.S. CLS. 100, 101 AND 102). REG. 4-18-2000.
- 2,342,338. MULTICAPS. INT. CL. 42. (U.S. CLS. 100 AND 101). REG. 4-18-2000.
- 2,342,491. TOP TEA AND DESIGN. INT. CL. 30. (U.S. CL. 46). REG. 4-18-2000.
- 2,342,606. TECHNOPHARM (STYLIZED). INT. CLS. 35 AND 41. (U.S. CLS. 100, 101, 102 AND 107). REG. 4-18-2000.
- 2,342,687. PUMPAC. INT. CL. 8. (U.S. CLS. 23, 28 AND 44). REG. 4-18-2000.
- 2,342,718. FARLEY'S FOOD, FUN & PUB AND DESIGN. INT. CLS. 25 AND 42. (U.S. CLS. 22, 39, 100 AND 101). REG. 4-18-2000.
- 2,342,725. MARKETFITZ. INT. CL. 35. (U.S. CLS. 100, 101 AND 102). REG. 4-18-2000.
- 2,342,735. ASRT. INT. CLS. 41 AND 42. (U.S. CLS. 100, 101 AND 107). REG. 4-18-2000.
- 2,342,736. AMERICAN SOCIETY OF RADIOLOGIC TECHNOLOGISTS. INT. CLS. 41 AND 42. (U.S. CLS. 100, 101 AND 107). REG. 4-18-2000.
- 2,342,779. LONDONDERRY FREEZER WAREHOUSE, L.L.C. AND DESIGN. INT. CL. 39. (U.S. CLS. 100 AND 105). REG. 4-18-2000.
- 2,342,813. AQUAM. INT. CL. 35. (U.S. CLS. 100, 101 AND 102). REG. 4-18-2000.
- 2,342,904. RACIAL HARMONY AND DESIGN. INT. CL. 41. (U.S. CLS. 100, 101 AND 107). REG. 4-18-2000.
- 2,343,009. CHRISTIE LEE. INT. CL. 14 ONLY. (U.S. CLS. 2, 27, 28 AND 50). REG. 4-18-2000.
- 2,343,031. THEY GIVE MAX FACTS FOR QUICK & EASY STUDY/REVIEW AND DESIGN. INT. CL. 16. (U.S. CLS. 2, 5, 22, 23, 29, 37, 38 AND 50). REG. 4-18-2000.
- 2,343,053. EYETIQUE. INT. CLS. 35 AND 42. (U.S. CLS. 100, 101 AND 102). REG. 4-18-2000.
- 2,343,089. PROVISTA. INT. CL. 30. (U.S. CL. 46). REG. 4-18-2000.
- 2,343,205. SOMETHING SILVER. INT. CL. 14. (U.S. CLS. 2, 27, 28 AND 50). REG. 4-18-2000.
- 2,343,348. NORTH CAPE PUBLICATIONS. INT. CL. 16. (U.S. CLS. 2, 5, 22, 23, 29, 37, 38 AND 50). REG. 4-18-2000.

- 2,343,371. TOTALSHIPPING. INT. CL. 39. (U.S. CLS. 100 AND 105). REG. 4-18-2000.
- 2,343,379. FIRST MATE. INT. CL. 16. (U.S. CLS. 2, 5, 22, 23, 29, 37, 38 AND 50). REG. 4-18-2000.
- 2,343,427. ST. BARTH PROPERTIES. INT. CL. 42. (U.S. CLS. 100 AND 101). REG. 4-18-2000.
- 2,343,442. SNARF'S AND DESIGN. INT. CL. 42. (U.S. CLS. 100 AND 101). REG. 4-18-2000.
- 2,343,448. BEARING SERVICE PREMIUM SERVICE, EXPERT SOLUTIONS AND DESIGN. INT. CL. 35. (U.S. CLS. 100, 101 AND 102). REG. 4-18-2000.
- 2,343,533. POWERGARD. INT. CL. 36. (U.S. CLS. 100, 101 AND 102). REG. 4-18-2000.
- 2,343,829. JUST FOR THE KIDS. INT. CL. 41. (U.S. CLS. 100, 101 AND 107). REG. 4-18-2000.
- 2,343,890. TRIVENTO. INT. CL. 33. (U.S. CLS. 47 AND 49). REG. 4-18-2000.
- 2,343,931. DISC BRAKES HAYES AND DESIGN. INT. CL. 12. (U.S. CLS. 19, 21, 23, 31, 35 AND 44). REG. 4-18-2000.
- 2,343,992. SERVO/FILL. INT. CL. 7. (U.S. CLS. 13, 19, 21, 23, 31, 34 AND 35). REG. 4-18-2000.
- 2,344,076. DIGI-BLOCK. INT. CL. 28. (U.S. CLS. 22, 23, 38 AND 50). REG. 4-18-2000.
- 2,344,140. MEN'S HEALTH. INT. CL. 42. (U.S. CLS. 100 AND 101). REG. 4-18-2000.
- 2,344,271. DEATHTRAP DUNGEON. INT. CL. 9 ONLY. (U.S. CLS. 21, 23, 26, 36 AND 38). REG. 4-25-2000.
- 2,344,277. COLORCON COATING SCHOOL. INT. CL. 41. (U.S. CLS. 100, 101 AND 107). REG. 4-25-2000.
- 2,344,299. BURLY. INT. CL. 25. (U.S. CLS. 22 AND 39). REG. 4-25-2000.
- 2,344,568. MESHACH. INT. CL. 33. (U.S. CLS. 47 AND 49). REG. 4-25-2000.
- 2,344,605. BOOK BUNGEE. INT. CL. 16. (U.S. CLS. 2, 5, 22, 23, 29, 37, 38 AND 50). REG. 4-25-2000.
- 2,344,661. UW HIFLO (STYLIZED). INT. CL. 7. (U.S. CLS. 13, 19, 21, 23, 31, 34 AND 35). REG. 4-25-2000.
- 2,344,663. RAYMOND ENKEBOLL DESIGNS. INT. CL. 20. (U.S. CLS. 2, 13, 22, 25, 32 AND 50). REG. 4-25-2000.
- 2,344,865. POCKET POWER. INT. CL. 9. (U.S. CLS. 21, 23, 26, 36 AND 38). REG. 4-25-2000.
- 2,344,902. AMERICAN PROFESSIONAL AND DESIGN. INT. CL. 28. (U.S. CLS. 22, 23, 38 AND 50). REG. 4-25-2000.
- 2,344,904. ROYAL ST PIERRE WORCESTER MA AND DESIGN. INT. CL. 28. (U.S. CLS. 22, 23, 38 AND 50). REG. 4-25-2000.
- 2,345,132. CLAP, SING AND READ. INT. CL. 41. (U.S. CLS. 100, 101 AND 107). REG. 4-25-2000.
- 2,345,148. CAGE DIAPER. INT. CL. 16. (U.S. CLS. 2, 5, 22, 23, 29, 37, 38 AND 50). REG. 4-25-2000.
- 2,345,225. DOGEARED. INT. CL. 14 ONLY. (U.S. CLS. 2, 27, 28 AND 50). REG. 4-25-2000.
- 2,345,248. EVAP FOAM NO RINSE. INT. CL. 3. (U.S. CLS. 1, 4, 6, 50, 51 AND 52). REG. 4-25-2000.
- 2,345,450. TEXAS WILD! AND DESIGN. INT. CL. 41. (U.S. CLS. 100, 101 AND 107). REG. 4-25-2000.
- 2,345,649. LONGABERGER GOLF CLUB AND DESIGN. INT. CL. 41. (U.S. CLS. 100, 101 AND 107). REG. 4-25-2000.
- 2,345,667. E=DTE. INT. CL. 42. (U.S. CLS. 100 AND 101). REG. 4-25-2000.
- 2,345,679. EARNINGSWHISPER. INT. CL. 36. (U.S. CLS. 100, 101 AND 102). REG. 4-25-2000.
- 2,345,789. MIDNIGHT READER. INT. CL. 11. (U.S. CLS. 13, 21, 23, 31 AND 34). REG. 4-25-2000.
- 2,345,874. THRESHOLD 21. INT. CLS. 16 AND 42. (U.S. CLS. 2, 5, 22, 23, 29, 37, 38, 50, 100 AND 101). REG. 4-25-2000.
- 2,345,875. T21. INT. CLS. 16 AND 42. (U.S. CLS. 2, 5, 22, 23, 29, 37, 38, 50, 100 AND 101). REG. 4-25-2000.
- 2,345,906. ASP AUTOMOTIVE SERVICE PROFESSIONALS AND DESIGN. INT. CL. 37. (U.S. CLS. 100, 103 AND 106). REG. 4-25-2000.
- 2,345,913. CLASSIC AMERICAN TROLLEYS, BY SUPREME. INT. CL. 12. (U.S. CLS. 19, 21, 23, 31, 35 AND 44). REG. 4-25-2000.
- 2,345,967. WORLD GOLF FOUNDATION. INT. CL. 42. (U.S. CLS. 100 AND 101). REG. 4-25-2000.
- 2,346,167. POTATO BONE. INT. CL. 31. (U.S. CLS. 1 AND 46). REG. 4-25-2000.
- 2,346,262. JUNIOR LEAGUE OF DALLAS (STYLIZED). INT. CL. 42. (U.S. CLS. 100 AND 101). REG. 5-2-2000.
- 2,346,342. ENZOGENOL (STYLIZED). INT. CL. 5. (U.S. CLS. 6, 18, 44, 46, 51 AND 52). REG. 5-2-2000.
- 2,346,452. LILAC FESTIVAL. INT. CL. 41. (U.S. CLS. 100, 101 AND 107). REG. 5-2-2000.
- 2,346,705. TWINKLE TRIM. INT. CL. 28. (U.S. CLS. 22, 23, 38 AND 50). REG. 5-2-2000.
- 2,346,912. POSTURE BUILDER. INT. CL. 20. (U.S. CLS. 2, 13, 22, 25, 32 AND 50). REG. 5-2-2000.
- 2,346,934. S SLEEP MULTIMEDIA INC. AND DESIGN. INT. CL. 9. (U.S. CLS. 21, 23, 26, 36 AND 38). REG. 5-2-2000.
- 2,346,978. FOOD ART CATERED AFFAIRS. INT. CL. 42. (U.S. CLS. 100 AND 101). REG. 5-2-2000.
- 2,347,174. PAUL, WEISS, RIFKIND, WHARTON & GARRISON. INT. CL. 42. (U.S. CLS. 100 AND 101). REG. 5-2-2000.
- 2,347,521. NIZORAL A-D (STYLIZED). INT. CL. 5. (U.S. CLS. 6, 18, 44, 46, 51 AND 52). REG. 5-2-2000.
- 2,347,550. WINDOW WHOOSHER. INT. CL. 21. (U.S. CLS. 2, 13, 23, 29, 30, 33, 40 AND 50). REG. 5-2-2000.
- 2,347,893. THE MEDITERRANEAN GARDEN. INT. CL. 16. (U.S. CLS. 2, 5, 22, 23, 29, 37, 38 AND 50). REG. 5-2-2000.
- 2,348,099. CHEF TONINO'S THE ITALIAN ART OF LIVING AND DESIGN. INT. CL. 29. (U.S. CL. 46). REG. 5-9-2000.
- 2,348,160. 3SB. INT. CL. 9. (U.S. CLS. 21, 23, 26, 36 AND 38). REG. 5-9-2000.
- 2,348,287. MBE. INT. CLS. 35, 38 AND 39. (U.S. CLS. 100, 101, 102, 104 AND 105). REG. 5-9-2000.
- 2,348,348. HOP BOOKS (STYLIZED). INT. CL. 16. (U.S. CLS. 2, 5, 22, 23, 29, 37, 38 AND 50). REG. 5-9-2000.
- 2,348,472. ABOUT.COM. INT. CL. 42. (U.S. CLS. 100 AND 101). REG. 5-9-2000.
- 2,348,492. MISCELLANEOUS DESIGN. INT. CL. 30. (U.S. CL. 46). REG. 5-9-2000.
- 2,348,568. SAN DIEGO CONVENTION & VISITORS BUREAU AND DESIGN. INT. CL. 35. (U.S. CLS. 100, 101 AND 102). REG. 5-9-2000.
- 2,348,658. FRIPAN (STYLIZED). INT. CL. 30. (U.S. CL. 46). REG. 5-9-2000.
- 2,348,876. MISCELLANEOUS DESIGN. INT. CLS. 10, 16 AND 41. (U.S. CLS. 2, 5, 22, 23, 26, 29, 37, 38, 39, 44, 50, 100, 101 AND 107). REG. 5-9-2000.
- 2,348,895. WOOD TRACE. INT. CL. 37. (U.S. CLS. 100, 103 AND 106). REG. 5-9-2000.
- 2,349,133. PROFESSIONAL RESOURCE NETWORK. INT. CLS. 35 AND 36. (U.S. CLS. 100, 101 AND 102). REG. 5-9-2000.
- 2,349,144. ORIGINAL EQUIPMENT SUPPLIERS ASSOCIATION. INT. CL. 42. (U.S. CLS. 100 AND 101). REG. 5-9-2000.
- 2,349,246. FLORIDA GATORS. INT. CLS. 25 AND 41. (U.S. CLS. 22, 39, 100, 101 AND 107). REG. 5-16-2000.
- 2,349,258. TGT AND DESIGN. INT. CLS. 6 AND 21. (U.S. CLS. 2, 12, 13, 14, 23, 25, 29, 30, 33, 40 AND 50). REG. 5-16-2000.
- 2,349,338. P 76 PEN AR LAN. INT. CL. 31. (U.S. CLS. 1 AND 46). REG. 5-16-2000.
- 2,349,369. SOURCE FOUR. INT. CL. 11. (U.S. CLS. 13, 21, 23, 31 AND 34). REG. 5-16-2000.
- 2,349,560. POLYPLAST. INT. CL. 2. (U.S. CLS. 6, 11 AND 16). REG. 5-16-2000.
- 2,349,656. POINTEK. INT. CL. 9. (U.S. CLS. 21, 23, 26, 36 AND 38). REG. 5-16-2000.
- 2,349,780. VIBRANT WOMAN. INT. CL. 5. (U.S. CLS. 6, 18, 44, 46, 51 AND 52). REG. 5-16-2000.
- 2,349,968. LUXPRO. INT. CL. 9. (U.S. CLS. 21, 23, 26, 36 AND 38). REG. 5-16-2000.
- 2,350,004. RIVER POINT RESORT. INT. CLS. 39 AND 42. (U.S. CLS. 100, 101 AND 105). REG. 5-16-2000.
- 2,350,170. E-FLOW (STYLIZED). INT. CL. 9. (U.S. CLS. 21, 23, 26, 36 AND 38). REG. 5-16-2000.
- 2,350,205. DAIRY XPRESS. INT. CLS. 6 AND 9. (U.S. CLS. 2, 12, 13, 14, 21, 23, 25, 26, 36, 38 AND 50). REG. 5-16-2000.
- 2,350,329. OCULAR CONCEPTS. INT. CL. 10. (U.S. CLS. 26, 39 AND 44). REG. 5-16-2000.
- 2,350,360. GO EVERYWHERE. INT. CL. 25. (U.S. CLS. 22 AND 39). REG. 5-16-2000.

- 2,350,385. INFORMATION NAVIGATOR. INT. CLS. 9 AND 16. (U.S. CLS. 2, 5, 21, 22, 23, 26, 29, 36, 37, 38 AND 50). REG. 5-16-2000.
- 2,350,658. THE BEST WAY TO PAY FOR EVERYTHING THAT MATTERS. INT. CL. 36. (U.S. CLS. 100, 101 AND 102). REG. 5-16-2000.
- 2,351,620. PRO V60. INT. CL. 5. (U.S. CLS. 6, 18, 44, 46, 51 AND 52). REG. 5-23-2000.
- 2,351,787. UBIQUITY AND DESIGN. INT. CL. 9. (U.S. CLS. 21, 23, 26, 36 AND 38). REG. 5-23-2000.
- 2,352,084. S AND DESIGN. INT. CL. 42. (U.S. CLS. 100 AND 101). REG. 5-23-2000.
- 2,352,100. COOL CLASSICS. INT. CL. 30. (U.S. CL. 46). REG. 5-23-2000.
- 2,352,160. FLEX AWAY. INT. CL. 28. (U.S. CLS. 22, 23, 38 AND 50). REG. 5-23-2000.
- 2,352,212. INDEPENDENCE JAZZ REUNION. INT. CL. 41. (U.S. CLS. 100, 101 AND 107). REG. 5-23-2000.
- 2,352,269. RACK AND PINION FENCE SYSTEM AND DESIGN. INT. CL. 7. (U.S. CLS. 13, 19, 21, 23, 31, 34 AND 35). REG. 5-23-2000.
- 2,352,479. COCONUT KIDS N FRIENDS KIDS IN A NUT SHELL AND DESIGN. INT. CL. 28. (U.S. CLS. 22, 23, 38 AND 50). REG. 5-23-2000.
- 2,352,537. FLEXIGEL. INT. CL. 5. (U.S. CLS. 6, 18, 44, 46, 51 AND 52). REG. 5-23-2000.
- 2,352,605. AQUA TRAK BLACK. INT. CLS. 9 AND 10. (U.S. CLS. 21, 23, 26, 36, 38, 39 AND 44). REG. 5-23-2000.
- 2,352,624. SUCCESS CREATIONS. INT. CL. 28. (U.S. CLS. 22, 23, 38 AND 50). REG. 5-23-2000.
- 2,352,780. JUVA. INT. CL. 42. (U.S. CLS. 100 AND 101). REG. 5-23-2000.
- 2,353,066. T AND DESIGN. INT. CLS. 9, 25 AND 28. (U.S. CLS. 21, 22, 23, 26, 36, 38, 39 AND 50). REG. 5-30-2000.
- 2,353,375. CONNTECT. INT. CLS. 1 AND 3. (U.S. CLS. 1, 4, 5, 6, 10, 26, 46, 50, 51 AND 52). REG. 5-30-2000.
- 2,353,430. VIVASTAR. INT. CL. 1. (U.S. CLS. 1, 5, 6, 10, 26 AND 46). REG. 5-30-2000.
- 2,353,464. PAXTON. INT. CL. 7. (U.S. CLS. 13, 19, 21, 23, 31, 34 AND 35). REG. 5-30-2000.
- 2,353,471. NATIONAL MOLDING. INT. CL. 26. (U.S. CLS. 37, 39, 40, 42 AND 50). REG. 5-30-2000.
- 2,353,751. EARNINGS WHISPER. INT. CL. 36. (U.S. CLS. 100, 101 AND 102). REG. 5-30-2000.
- 2,353,912. GRANGE. INT. CL. 25. (U.S. CLS. 22 AND 39). REG. 5-30-2000.
- 2,353,954. IRCOTHIX. INT. CL. 1. (U.S. CLS. 1, 5, 6, 10, 26 AND 46). REG. 5-30-2000.
- 2,354,303. FUTABA. INT. CL. 7 ONLY. (U.S. CLS. 13, 19, 21, 23, 31, 34 AND 35). REG. 6-6-2000.
- 2,354,646. HIKARI. INT. CL. 9. (U.S. CLS. 21, 23, 26, 36 AND 38). REG. 6-6-2000.
- 2,354,787. LOIS HILL. INT. CL. 3. (U.S. CLS. 1, 4, 6, 50, 51 AND 52). REG. 6-6-2000.
- 2,355,276. WALTER'S WAY. INT. CL. 35. (U.S. CLS. 100, 101 AND 102). REG. 6-6-2000.
- 2,355,578. MEGA. INT. CL. 21. (U.S. CLS. 2, 13, 23, 29, 30, 33, 40 AND 50). REG. 6-6-2000.
- 2,355,758. HOOKED ON PHONICS AND DESIGN. INT. CL. 16. (U.S. CLS. 2, 5, 22, 23, 29, 37, 38 AND 50). REG. 6-6-2000.
- 2,355,782. A-C-TECH. INT. CL. 17. (U.S. CLS. 1, 5, 12, 13, 35 AND 50). REG. 6-6-2000.
- 2,356,107. EASY GARDENER AND DESIGN. INT. CLS. 19 AND 24. (U.S. CLS. 1, 12, 33, 42 AND 50). REG. 6-6-2000.
- 2,356,234. SUPERIOR QUALITY RICE HITOMEBORE AND DESIGN. INT. CL. 30. (U.S. CL. 46). REG. 6-6-2000.
- 2,356,261. MISCELLANEOUS DESIGN. INT. CL. 28. (U.S. CLS. 22, 23, 38 AND 50). REG. 6-6-2000.
- 2,356,512. SKYHAWKS. INT. CL. 41. (U.S. CLS. 100, 101 AND 107). REG. 6-13-2000.
- 2,356,548. QUIK-DRY. INT. CL. 1. (U.S. CLS. 1, 5, 6, 10, 26 AND 46). REG. 6-13-2000.
- 2,356,549. MOOSE LEGION. INT. CL. 42. (U.S. CLS. 100 AND 101). REG. 6-13-2000.
- 2,356,622. TIME TRAVEL. INT. CL. 42. (U.S. CLS. 100 AND 101). REG. 6-13-2000.
- 2,357,226. 999. INT. CL. 5. (U.S. CLS. 6, 18, 44, 46, 51 AND 52). REG. 6-13-2000.
- 2,357,234. RANDALLS REMARKABLE. INT. CL. 35. (U.S. CLS. 100, 101 AND 102). REG. 6-13-2000.
- 2,357,433. QUICK BUSINESS DEPOSIT. INT. CL. 36. (U.S. CLS. 100, 101 AND 102). REG. 6-13-2000.
- 2,357,581. BASCHIERI & PELLAGRI (STYLIZED). INT. CL. 13. (U.S. CLS. 2 AND 9). REG. 6-13-2000.
- 2,357,734. CUTSTOP. INT. CL. 5. (U.S. CLS. 6, 18, 44, 46, 51 AND 52). REG. 6-13-2000.
- 2,357,815. MISCELLANEOUS DESIGN. INT. CLS. 25 AND 42. (U.S. CLS. 22, 39, 100 AND 101). REG. 6-13-2000.
- 2,358,030. NEOLOCK. INT. CL. 9. (U.S. CLS. 21, 23, 26, 36 AND 38). REG. 6-13-2000.
- 2,358,207. ADRENALINE. INT. CL. 14. (U.S. CLS. 2, 27, 28 AND 50). REG. 6-13-2000.
- 2,358,308. SIGNATURE. INT. CL. 5. (U.S. CLS. 6, 18, 44, 46, 51 AND 52). REG. 6-13-2000.
- 2,358,700. QUIC-PASS. INT. CL. 6. (U.S. CLS. 2, 12, 13, 14, 23, 25 AND 50). REG. 6-13-2000.
- 2,358,782. SIXPACK. INT. CL. 20. (U.S. CLS. 2, 13, 22, 25, 32 AND 50). REG. 6-13-2000.
- 2,359,124. MOOSE LODGE. INT. CL. 42. (U.S. CLS. 100 AND 101). REG. 6-20-2000.
- 2,359,300. 3RV. INT. CL. 9. (U.S. CLS. 21, 23, 26, 36 AND 38). REG. 6-20-2000.
- 2,359,301. 3RA. INT. CL. 9. (U.S. CLS. 21, 23, 26, 36 AND 38). REG. 6-20-2000.
- 2,359,331. BORDER GRILL. INT. CL. 42. (U.S. CLS. 100 AND 101). REG. 6-20-2000.
- 2,359,353. PURDY. INT. CLS. 7 AND 40. (U.S. CLS. 13, 19, 21, 23, 31, 34, 35, 100, 103 AND 106). REG. 6-20-2000.
- 2,359,445. WORK AUSTRALIA. INT. CLS. 35 AND 39. (U.S. CLS. 100, 101, 102 AND 105). REG. 6-20-2000.
- 2,359,736. US INTERACTIVE. INT. CLS. 35 AND 42. (U.S. CLS. 100, 101 AND 102). REG. 6-20-2000.
- 2,359,852. MISCELLANEOUS DESIGN. INT. CL. 5. (U.S. CLS. 6, 18, 44, 46, 51 AND 52). REG. 6-20-2000.
- 2,359,876. UNIBOR. INT. CL. 7. (U.S. CLS. 13, 19, 21, 23, 31, 34 AND 35). REG. 6-20-2000.
- 2,360,596. PROCAS. INT. CL. 9. (U.S. CLS. 21, 23, 26, 36 AND 38). REG. 6-20-2000.
- 2,360,811. SWEET EDDIE'S. INT. CLS. 30 AND 35. (U.S. CLS. 46, 100, 101 AND 102). REG. 6-20-2000.
- 2,361,033. MISCELLANEOUS DESIGN. INT. CL. 25. (U.S. CLS. 22 AND 39). REG. 6-27-2000.
- 2,361,245. MISCELLANEOUS DESIGN. INT. CLS. 5, 14, 18, 20, 21, 24, 25 AND 28 ONLY. (U.S. CLS. 1, 2, 3, 6, 13, 18, 22, 23, 25, 27, 28, 29, 30, 32, 33, 38, 39, 40, 41, 42, 44, 46, 50, 51 AND 52). REG. 6-27-2000.
- 2,361,359. 3RP. INT. CL. 9. (U.S. CLS. 21, 23, 26, 36 AND 38). REG. 6-27-2000.
- 2,361,428. QUALDO QUALDOO'S OFFICE AND DESIGN. INT. CL. 35. (U.S. CLS. 100, 101 AND 102). REG. 6-27-2000.
- 2,361,767. SHINPO AND DESIGN. INT. CL. 11. (U.S. CLS. 13, 21, 23, 31 AND 34). REG. 6-27-2000.
- 2,361,834. ROLLOMATIC. INT. CLS. 7 AND 9. (U.S. CLS. 13, 19, 21, 23, 26, 31, 34, 35, 36 AND 38). REG. 6-27-2000.
- 2,362,112. SYNPOWER. INT. CL. 4. (U.S. CLS. 1, 6 AND 15). REG. 6-27-2000.
- 2,362,332. R AND DESIGN. INT. CL. 8. (U.S. CLS. 23, 28 AND 44). REG. 6-27-2000.
- 2,362,474. HUXTABLE'S KITCHEN. INT. CL. 30. (U.S. CL. 46). REG. 6-27-2000.
- 2,362,541. SUSHISAMBA. INT. CL. 42. (U.S. CLS. 100 AND 101). REG. 6-27-2000.
- 2,363,092. TIDEPOOL. INT. CL. 11. (U.S. CLS. 13, 21, 23, 31 AND 34). REG. 6-27-2000.
- 2,363,327. PUBLIC STORAGE. INT. CLS. 16 AND 39. (U.S. CLS. 2, 5, 22, 23, 29, 37, 38, 50, 100 AND 105). REG. 6-27-2000.
- 2,363,412. TRAVELNEWSLINK. INT. CL. 38. (U.S. CLS. 100, 101 AND 104). REG. 6-27-2000.
- 2,363,506. DHA. INT. CLS. 35 AND 42. (U.S. CLS. 100, 101 AND 102). REG. 7-4-2000.
- 2,363,691. US (STYLIZED). INT. CL. 35. (U.S. CLS. 100, 101 AND 102). REG. 7-4-2000.
- 2,363,774. JOSEPH PERRIER. INT. CL. 33. (U.S. CLS. 47 AND 49). REG. 7-4-2000.
- 2,363,978. SUKUP. INT. CLS. 6 AND 7. (U.S. CLS. 2, 12, 13, 14, 19, 21, 23, 25, 31, 34, 35 AND 50). REG. 7-4-2000.
- 2,364,030. S SKILCRAFT AND DESIGN. INT. CLS. 3 AND 5. (U.S. CLS. 1, 4, 6, 18, 44, 46, 50, 51 AND 52). REG. 7-4-2000.
- 2,364,031. SKILCRAFT. INT. CLS. 3 AND 5. (U.S. CLS. 1, 4, 6, 18, 44, 46, 50, 51 AND 52). REG. 7-4-2000.

- 2,364,116. REMYLINE. INT. CL. 30. (U.S. CL. 46). REG. 7-4-2000.
- 2,364,133. CAREGROUP HEALTHCARE SYSTEM AND DESIGN. INT. CL. 42. (U.S. CLS. 100 AND 101). REG. 7-4-2000.
- 2,364,421. YAYA MARIA AND DESIGN. INT. CL. 30. (U.S. CL. 46). REG. 7-4-2000.
- 2,364,604. MISCELLANEOUS DESIGN. INT. CL. 35. (U.S. CLS. 100, 101 AND 102). REG. 7-4-2000.
- 2,365,353. SKYLINE CHILI. INT. CL. 29. (U.S. CL. 46). REG. 7-4-2000.
- 2,366,254. ITEC ENTERTAINMENT CORPORATION. INT. CL. 42. (U.S. CLS. 100 AND 101). REG. 7-11-2000.
- 2,366,396. MISTER DONUT (STYLIZED). INT. CL. 30 ONLY. (U.S. CL. 46). REG. 7-11-2000.
- 2,366,557. DURAZOL. INT. CL. 2. (U.S. CLS. 6, 11 AND 16). REG. 7-11-2000.
- 2,367,150. RETAIL VISION. INT. CL. 42. (U.S. CLS. 100 AND 101). REG. 7-11-2000.
- 2,367,185. CHARGE-ABLES. INT. CL. 9. (U.S. CLS. 21, 23, 26, 36 AND 38). REG. 7-11-2000.
- 2,367,813. FINER RECREATIONAL LIVING. INT. CL. 12. (U.S. CLS. 19, 21, 23, 31, 35 AND 44). REG. 7-18-2000.
- 2,368,212. LOADED. INT. CLS. 16 AND 42. (U.S. CLS. 2, 5, 22, 23, 29, 37, 38, 50, 100 AND 101). REG. 7-18-2000.
- 2,368,743. MIDREX. INT. CL. 11. (U.S. CLS. 13, 21, 23, 31 AND 34). REG. 7-18-2000.
- 2,368,822. UC4. INT. CL. 9. (U.S. CLS. 21, 23, 26, 36 AND 38). REG. 7-18-2000.
- 2,368,919. CLEAN & SAFE. INT. CL. 22. (U.S. CLS. 1, 2, 7, 19, 22, 42 AND 50). REG. 7-18-2000.
- 2,368,968. UVERSA PRESS. INT. CL. 41. (U.S. CLS. 100, 101 AND 107). REG. 7-18-2000.
- 2,368,981. ALLIN. INT. CL. 38 ONLY. (U.S. CLS. 100, 101 AND 104). REG. 7-18-2000.
- 2,369,691. SUBMARINOS. INT. CL. 30. (U.S. CL. 46). REG. 7-25-2000.
- 2,369,965. 3RH. INT. CL. 9. (U.S. CLS. 21, 23, 26, 36 AND 38). REG. 7-25-2000.
- 2,369,971. LETICA (STYLIZED). INT. CL. 39. (U.S. CLS. 100 AND 105). REG. 7-25-2000.
- 2,370,092. CLEAN AIR FILTER. INT. CLS. 7 AND 42. (U.S. CLS. 13, 19, 21, 23, 31, 34, 35, 100 AND 101). REG. 7-25-2000.
- 2,370,139. MISCELLANEOUS DESIGN. INT. CL. 16. (U.S. CLS. 2, 5, 22, 23, 29, 37, 38 AND 50). REG. 7-25-2000.
- 2,370,229. CURTIS (STYLIZED). INT. CL. 11. (U.S. CLS. 13, 21, 23, 31 AND 34). REG. 7-25-2000.
- 2,370,344. CARESENSE. INT. CL. 9. (U.S. CLS. 21, 23, 26, 36 AND 38). REG. 7-25-2000.
- 2,370,596. MISCELLANEOUS DESIGN. INT. CL. 42. (U.S. CLS. 100 AND 101). REG. 7-25-2000.
- 2,370,915. MARGATINI (STYLIZED). INT. CL. 33. (U.S. CLS. 47 AND 49). REG. 7-25-2000.
- 2,371,611. VICTORY. INT. CL. 12. (U.S. CLS. 19, 21, 23, 31, 35 AND 44). REG. 7-25-2000.
- 2,372,400. PIGPAK. INT. CL. 5. (U.S. CLS. 6, 18, 44, 46, 51 AND 52). REG. 8-1-2000.
- 2,372,762. CORNICHE. INT. CL. 16. (U.S. CLS. 2, 5, 22, 23, 29, 37, 38 AND 50). REG. 8-1-2000.
- 2,372,833. VINTAGEFISH. INT. CLS. 28 AND 36. (U.S. CLS. 22, 23, 38, 50, 100, 101 AND 102). REG. 8-1-2000.
- 2,372,983. FINAL DETAIL. INT. CL. 3. (U.S. CLS. 1, 4, 6, 50, 51 AND 52). REG. 8-1-2000.
- 2,372,999. LEADERLINK. INT. CL. 41. (U.S. CLS. 100, 101 AND 107). REG. 8-1-2000.
- 2,373,773. CUSTOM BY NATURE. INT. CL. 37. (U.S. CLS. 100, 103 AND 106). REG. 8-1-2000.
- 2,373,787. HERITAGE COLLECTION FROM GENERATION TO GENERATION. INT. CL. 24. (U.S. CLS. 42 AND 50). REG. 8-1-2000.
- 2,374,362. THE BLOCK AT ORANGE AND DESIGN. INT. CL. 36. (U.S. CLS. 100, 101 AND 102). REG. 8-8-2000.
- 2,374,528. LATERAL FORGIVENESS. INT. CL. 19. (U.S. CLS. 1, 12, 33 AND 50). REG. 8-8-2000.
- 2,374,578. LEGENDS IN OUR OWN MINDS. INT. CL. 41. (U.S. CLS. 100, 101 AND 107). REG. 8-8-2000.
- 2,374,678. MD VALET. INT. CL. 9. (U.S. CLS. 21, 23, 26, 36 AND 38). REG. 8-8-2000.
- 2,374,752. HARTMAN. INT. CL. 9. (U.S. CLS. 21, 23, 26, 36 AND 38). REG. 8-8-2000.
- 2,374,852. VICKERS. INT. CLS. 16 AND 36. (U.S. CLS. 2, 5, 22, 23, 29, 37, 38, 50, 100, 101 AND 102). REG. 8-8-2000.
- 2,375,714. DECKHOG. INT. CL. 7. (U.S. CLS. 13, 19, 21, 23, 31, 34 AND 35). REG. 8-8-2000.
- 2,376,099. Y DAILYLINE AND DESIGN. INT. CL. 16. (U.S. CLS. 2, 5, 22, 23, 29, 37, 38 AND 50). REG. 8-8-2000.
- 2,376,259. FIRE & RESCUE FIELD GUIDE. INT. CL. 16. (U.S. CLS. 2, 5, 22, 23, 29, 37, 38 AND 50). REG. 8-8-2000.
- 2,376,375. BRIDGEPORT BLUEFISH. INT. CL. 25. (U.S. CLS. 22 AND 39). REG. 8-15-2000.
- 2,377,248. GREATER PHOENIX CHAMBER OF COMMERCE AND DESIGN. INT. CL. 35. (U.S. CLS. 100, 101 AND 102). REG. 8-15-2000.
- 2,377,310. SILICYCLE AND DESIGN. INT. CL. 1. (U.S. CLS. 1, 5, 6, 10, 26 AND 46). REG. 8-15-2000.
- 2,377,532. MISCELLANEOUS DESIGN. INT. CLS. 35, 36, 37, 38, 41 AND 42. (U.S. CLS. 100, 101, 102, 103, 104, 106 AND 107). REG. 8-15-2000.
- 2,377,640. JEFF SAGARIN. INT. CL. 41. (U.S. CLS. 100, 101 AND 107). REG. 8-15-2000.
- 2,377,827. ISSUE. INT. CL. 3. (U.S. CLS. 1, 4, 6, 50, 51 AND 52). REG. 8-15-2000.
- 2,378,101. VERTEX STANDARD. INT. CL. 9. (U.S. CLS. 21, 23, 26, 36 AND 38). REG. 8-15-2000.
- 2,378,318. NEA VALUEBUILDER AND DESIGN. INT. CL. 36. (U.S. CLS. 100, 101 AND 102). REG. 8-22-2000.
- 2,378,319. NEA VALUEBUILDER. INT. CL. 36. (U.S. CLS. 100, 101 AND 102). REG. 8-22-2000.
- 2,378,610. ALIMED. INT. CLS. 10 AND 17. (U.S. CLS. 1, 5, 12, 13, 26, 35, 39, 44 AND 50). REG. 8-22-2000.
- 2,379,085. BASIC ESSENTIALS. INT. CL. 16. (U.S. CLS. 2, 5, 22, 23, 29, 37, 38 AND 50). REG. 8-22-2000.
- 2,379,380. ALLIANCE CREDIT UNION. INT. CL. 36. (U.S. CLS. 100, 101 AND 102). REG. 8-22-2000.
- 2,379,623. MISCELLANEOUS DESIGN. INT. CL. 42. (U.S. CLS. 100 AND 101). REG. 8-22-2000.
- 2,380,022. POWERGEL. INT. CL. 17. (U.S. CLS. 1, 5, 12, 13, 35 AND 50). REG. 8-22-2000.
- 2,380,065. MARRIOTT EXECUTIVE APARTMENTS. INT. CL. 42. (U.S. CLS. 100 AND 101). REG. 8-22-2000.
- 2,380,731. BILLTRACKER. INT. CL. 35. (U.S. CLS. 100, 101 AND 102). REG. 8-29-2000.
- 2,381,366. GREENFIX AMERICA AND DESIGN. INT. CL. 31. (U.S. CLS. 1 AND 46). REG. 8-29-2000.
- 2,381,811. MONSOON. INT. CL. 9. (U.S. CLS. 21, 23, 26, 36 AND 38). REG. 8-29-2000.
- 2,381,889. HORSE PAL. INT. CL. 21. (U.S. CLS. 2, 13, 23, 29, 30, 33, 40 AND 50). REG. 8-29-2000.
- 2,382,073. LANSKY. INT. CLS. 25 AND 35. (U.S. CLS. 22, 39, 100, 101 AND 102). REG. 9-5-2000.
- 2,382,222. EMHART. INT. CL. 7. (U.S. CLS. 13, 19, 21, 23, 31, 34 AND 35). REG. 9-5-2000.
- 2,382,225. SIMOREG DC-MASTER. INT. CLS. 7 AND 9 ONLY. (U.S. CLS. 13, 19, 21, 23, 26, 31, 34, 35, 36 AND 38). REG. 9-5-2000.
- 2,382,338. PUBLIC WORKS ONLINE. INT. CL. 42. (U.S. CLS. 100 AND 101). REG. 9-5-2000.
- 2,382,362. VINTAGE CHOICE (STYLIZED). INT. CL. 29. (U.S. CL. 46). REG. 9-5-2000.
- 2,382,430. ZA AND DESIGN. INT. CLS. 9 AND 14. (U.S. CLS. 2, 21, 23, 26, 27, 28, 36, 38 AND 50). REG. 9-5-2000.
- 2,382,499. SMARTSCRUBS.COM. INT. CL. 35. (U.S. CLS. 100, 101 AND 102). REG. 9-5-2000.
- 2,382,652. GRILL 'N GOLD. INT. CL. 29. (U.S. CL. 46). REG. 9-5-2000.
- 2,382,796. EDM TECHNOLOGIES. INT. CL. 40. (U.S. CLS. 100, 103 AND 106). REG. 9-5-2000.
- 2,383,234. 1.4SEED. INT. CL. 1. (U.S. CLS. 1, 5, 6, 10, 26 AND 46). REG. 9-5-2000.
- 2,383,902. SUCKAFREE. INT. CL. 25. (U.S. CLS. 22 AND 39). REG. 9-5-2000.
- 2,383,937. Q.BIZ. INT. CL. 38. (U.S. CLS. 100, 101 AND 104). REG. 9-5-2000.
- 2,383,950. SOUTHERN HOME. INT. CLS. 1, 3, 4, 5, 6, 8, 9, 10, 11, 16, 21, 30 AND 31. (U.S. CLS. 1, 2, 4, 5, 6, 10, 12, 13, 14, 15, 18, 21, 22, 23, 25, 26, 28, 29, 30, 31, 33, 34, 36, 37, 38, 39, 40, 44, 46, 50, 51 AND 52). REG. 9-5-2000.
- 2,383,953. LASER - PANEL. INT. CL. 11. (U.S. CLS. 13, 21, 23, 31 AND 34). REG. 9-5-2000.
- 2,383,954. LASER - PLATE. INT. CL. 11. (U.S. CLS. 13, 21, 23, 31 AND 34). REG. 9-5-2000.

- 2,384,130. BIO GUARD. INT. CL. 3. (U.S. CLS. 1, 4, 6, 50, 51 AND 52). REG. 9-5-2000.
- 2,384,334. ARTHROSE. INT. CL. 5. (U.S. CLS. 6, 18, 44, 46, 51 AND 52). REG. 9-5-2000.
- 2,384,417. AP&T AND DESIGN. INT. CL. 7. (U.S. CLS. 13, 19, 21, 23, 31, 34 AND 35). REG. 9-12-2000.
- 2,384,814. SILVERSON. INT. CL. 7. (U.S. CLS. 13, 19, 21, 23, 31, 34 AND 35). REG. 9-12-2000.
- 2,384,985. ABC-CLIO. INT. CL. 16. (U.S. CLS. 2, 5, 22, 23, 29, 37, 38 AND 50). REG. 9-12-2000.
- 2,385,023. FLYTE TYME. INT. CL. 25. (U.S. CLS. 22 AND 39). REG. 9-12-2000.
- 2,385,392. BIZWORLD. INT. CL. 41. (U.S. CLS. 100, 101 AND 107). REG. 9-12-2000.
- 2,385,437. MISCELLANEOUS DESIGN. INT. CL. 12. (U.S. CLS. 19, 21, 23, 31, 35 AND 44). REG. 9-12-2000.
- 2,385,438. VALIANT. INT. CL. 12. (U.S. CLS. 19, 21, 23, 31, 35 AND 44). REG. 9-12-2000.
- 2,385,504. HI-MAX. INT. CL. 6. (U.S. CLS. 2, 12, 13, 14, 23, 25 AND 50). REG. 9-12-2000.
- 2,385,848. FORECAST. INT. CL. 10. (U.S. CLS. 26, 39 AND 44). REG. 9-12-2000.
- 2,385,947. VISTASTAT. INT. CL. 9. (U.S. CLS. 21, 23, 26, 36 AND 38). REG. 9-12-2000.
- 2,385,948. VISTACAPTURE. INT. CL. 9. (U.S. CLS. 21, 23, 26, 36 AND 38). REG. 9-12-2000.
- 2,386,101. MILFORM. INT. CL. 20. (U.S. CLS. 2, 13, 22, 25, 32 AND 50). REG. 9-12-2000.
- 2,386,246. HOG TIES. INT. CL. 22. (U.S. CLS. 1, 2, 7, 19, 22, 42 AND 50). REG. 9-12-2000.
- 2,386,298. FLAGSHIP LOUNGE. INT. CL. 35. (U.S. CLS. 100, 101 AND 102). REG. 9-12-2000.
- 2,386,468. SEALTITE. INT. CLS. 8 AND 9. (U.S. CLS. 21, 23, 26, 28, 36, 38 AND 44). REG. 9-12-2000.
- 2,386,527. I-TEK. INT. CL. 6. (U.S. CLS. 2, 12, 13, 14, 23, 25 AND 50). REG. 9-12-2000.
- 2,386,580. HEALTHGRAM. INT. CL. 42. (U.S. CLS. 100 AND 101). REG. 9-12-2000.
- 2,386,800. PERSONAL MONEYLINE. INT. CL. 36. (U.S. CLS. 100, 101 AND 102). REG. 9-19-2000.
- 2,387,190. NITRO-SUL. INT. CL. 1. (U.S. CLS. 1, 5, 6, 10, 26 AND 46). REG. 9-19-2000.
- 2,387,276. NAPOLEON. INT. CL. 34. (U.S. CLS. 2, 8, 9 AND 17). REG. 9-19-2000.
- 2,387,373. QUALITY DOOR & HARDWARE, INC. AND DESIGN. INT. CL. 35. (U.S. CLS. 100, 101 AND 102). REG. 9-19-2000.
- 2,387,396. TRNS-PORT EXPEDITE ELECTRONIC BIDDING SYSTEM AND DESIGN. INT. CL. 9. (U.S. CLS. 21, 23, 26, 36 AND 38). REG. 9-19-2000.
- 2,387,652. TOM JENKINS' BAR-B-Q A TASTE YOU'LL NEVER FORGET... AND DESIGN. INT. CL. 42. (U.S. CLS. 100 AND 101). REG. 9-19-2000.
- 2,388,240. DESTRUCTO. INT. CLS. 25 AND 28. (U.S. CLS. 22, 23, 38, 39 AND 50). REG. 9-19-2000.
- 2,388,453. PHASEPRO. INT. CL. 9. (U.S. CLS. 21, 23, 26, 36 AND 38). REG. 9-19-2000.
- 2,388,517. INSPECT-IT 1ST. INT. CL. 42. (U.S. CLS. 100 AND 101). REG. 9-19-2000.
- 2,388,560. FIRE KING MEDIAVAULT. INT. CL. 20. (U.S. CLS. 2, 13, 22, 25, 32 AND 50). REG. 9-19-2000.
- 2,388,840. GERMAN SHEPHERDS. INT. CLS. 16 AND 42. (U.S. CLS. 2, 5, 22, 23, 29, 37, 38, 50, 100 AND 101). REG. 9-19-2000.
- 2,389,009. PACESETTER. INT. CL. 7 ONLY. (U.S. CLS. 13, 19, 21, 23, 31, 34 AND 35). REG. 9-26-2000.
- 2,389,074. HOZETYTE (STYLIZED). INT. CL. 6. (U.S. CLS. 2, 12, 13, 14, 23, 25 AND 50). REG. 9-26-2000.
- 2,389,510. TRNS-PORT SITEMANAGER CONSTRUCTION MANAGEMENT SYSTEM AND DESIGN. INT. CL. 9. (U.S. CLS. 21, 23, 26, 36 AND 38). REG. 9-26-2000.
- 2,389,549. ILLUSTRATED JUNIOR LIBRARY. INT. CL. 16. (U.S. CLS. 2, 5, 22, 23, 29, 37, 38 AND 50). REG. 9-26-2000.
- 2,389,700. M.C. DEAN. INT. CLS. 37 AND 42. (U.S. CLS. 100, 101, 103 AND 106). REG. 9-26-2000.
- 2,389,947. BACIO DIVINO. INT. CL. 33. (U.S. CLS. 47 AND 49). REG. 9-26-2000.
- 2,390,873. SECURESWITCH. INT. CL. 9. (U.S. CLS. 21, 23, 26, 36 AND 38). REG. 10-3-2000.
- 2,391,140. UL AND DESIGN. U.S. CL. A. REG. 10-3-2000.
- 2,391,252. LOVE & LOGIC. INT. CL. 16. (U.S. CLS. 2, 5, 22, 23, 29, 37, 38 AND 50). REG. 10-3-2000.
- 2,391,893. SUCCESS INSIGHTS. INT. CL. 9. (U.S. CLS. 21, 23, 26, 36 AND 38). REG. 10-3-2000.
- 2,392,040. RUMMAGE SALE KIDS GARAGE SALE! ITEMS FROM OTHER PLANETS AND DESIGN. INT. CL. 28. (U.S. CLS. 22, 23, 38 AND 50). REG. 10-3-2000.
- 2,393,222. REKHA.COM. INT. CL. 42. (U.S. CLS. 100 AND 101). REG. 10-10-2000.
- 2,393,963. CME WIRE & CABLE. INT. CL. 9. (U.S. CLS. 21, 23, 26, 36 AND 38). REG. 10-10-2000.
- 2,394,251. PASS IT ON. INT. CL. 35. (U.S. CLS. 100, 101 AND 102). REG. 10-10-2000.
- 2,394,276. MARINEKLEEN PREMIUM DIESEL AND DESIGN. INT. CL. 1. (U.S. CLS. 1, 5, 6, 10, 26 AND 46). REG. 10-10-2000.
- 2,394,310. NU SKIN 180. INT. CL. 3. (U.S. CLS. 1, 4, 6, 50, 51 AND 52). REG. 10-10-2000.
- 2,394,585. YOUR ONE STOP SHOP. INT. CLS. 35, 37 AND 42. (U.S. CLS. 100, 101, 102, 103 AND 106). REG. 10-17-2000.
- 2,394,865. Q-DEX. INT. CL. 16. (U.S. CLS. 2, 5, 22, 23, 29, 37, 38 AND 50). REG. 10-17-2000.
- 2,395,002. FINAID AND DESIGN. INT. CL. 36. (U.S. CLS. 100, 101 AND 102). REG. 10-17-2000.
- 2,395,003. MISCELLANEOUS DESIGN. INT. CL. 36. (U.S. CLS. 100, 101 AND 102). REG. 10-17-2000.
- 2,395,549. YACHTRONICS AND DESIGN. INT. CLS. 35 AND 37. (U.S. CLS. 100, 101, 102, 103 AND 106). REG. 10-17-2000.
- 2,396,643. CHA-CHA CHILI. INT. CL. 29. (U.S. CL. 46). REG. 10-24-2000.
- 2,397,170. ANCORLOY. INT. CL. 6. (U.S. CLS. 2, 12, 13, 14, 23, 25 AND 50). REG. 10-24-2000.
- 2,397,298. MISCELLANEOUS DESIGN. INT. CL. 42. (U.S. CLS. 100 AND 101). REG. 10-24-2000.
- 2,398,052. ATLANTIC GEM. INT. CL. 29. (U.S. CL. 46). REG. 10-24-2000.
- 2,398,127. IT'S THE RIGHT PRESCRIPTION. INT. CL. 35. (U.S. CLS. 100, 101 AND 102). REG. 10-24-2000.
- 2,398,312. ISLAND REPUBLIC. INT. CL. 25. (U.S. CLS. 22 AND 39). REG. 10-24-2000.
- 2,398,564. LOGIGEAR. INT. CLS. 9 AND 42. (U.S. CLS. 21, 23, 26, 36, 38, 100 AND 101). REG. 10-24-2000.
- 2,399,031. MAGNUM CUSTOM TRAILERS. INT. CL. 12. (U.S. CLS. 19, 21, 23, 31, 35 AND 44). REG. 10-31-2000.
- 2,400,057. DEARMOND. INT. CL. 15 ONLY. (U.S. CLS. 2, 21 AND 36). REG. 10-31-2000.
- 2,400,153. ANDSCAN. INT. CL. 9. (U.S. CLS. 21, 23, 26, 36 AND 38). REG. 10-31-2000.
- 2,400,154. TRECSCAN. INT. CL. 9. (U.S. CLS. 21, 23, 26, 36 AND 38). REG. 10-31-2000.
- 2,400,245. BREAST CANCER ACTION. INT. CL. 16. (U.S. CLS. 2, 5, 22, 23, 29, 37, 38 AND 50). REG. 10-31-2000.
- 2,400,955. CONSILIENCE. INT. CL. 33. (U.S. CLS. 47 AND 49). REG. 10-31-2000.
- 2,401,284. 3RU. INT. CL. 9. (U.S. CLS. 21, 23, 26, 36 AND 38). REG. 11-7-2000.
- 2,401,605. LUU NOODLE THE BEST NOODLES IN TOWN ! AND DESIGN. INT. CL. 42. (U.S. CLS. 100 AND 101). REG. 11-7-2000.
- 2,401,801. PSC AND DESIGN. INT. CL. 35. (U.S. CLS. 100, 101 AND 102). REG. 11-7-2000.
- 2,402,051. MICHELLE. INT. CL. 20. (U.S. CLS. 2, 13, 22, 25, 32 AND 50). REG. 11-7-2000.
- 2,402,440. GLOBAL ELECTRIC MOTORCARS. INT. CL. 12. (U.S. CLS. 19, 21, 23, 31, 35 AND 44). REG. 11-7-2000.
- 2,403,090. YEAST RAIDERS. INT. CL. 5. (U.S. CLS. 6, 18, 44, 46, 51 AND 52). REG. 11-14-2000.
- 2,403,313. COMPUTER HOPE. INT. CL. 42. (U.S. CLS. 100 AND 101). REG. 11-14-2000.
- 2,403,386. MISCELLANEOUS DESIGN. INT. CL. 38. (U.S. CLS. 100, 101 AND 104). REG. 11-14-2000.
- 2,403,472. RAYELCO. INT. CL. 9. (U.S. CLS. 21, 23, 26, 36 AND 38). REG. 11-14-2000.
- 2,403,683. SKADDEN. INT. CL. 42. (U.S. CLS. 100 AND 101). REG. 11-14-2000.
- 2,404,293. SAGRES. INT. CL. 12. (U.S. CLS. 19, 21, 23, 31, 35 AND 44). REG. 11-14-2000.
- 2,404,811. HYDROQSORB. INT. CL. 5. (U.S. CLS. 6, 18, 44, 46, 51 AND 52). REG. 11-14-2000.
- 2,404,858. TAMARACK CELLARS. INT. CL. 33. (U.S. CLS. 47 AND 49). REG. 11-14-2000.

- 2,404,973. LIFE TAG. INT. CL. 14. (U.S. CLS. 2, 27, 28 AND 50). REG. 11-21-2000.
- 2,405,161. TFK. INT. CL. 16. (U.S. CLS. 2, 5, 22, 23, 29, 37, 38 AND 50). REG. 11-21-2000.
- 2,405,199. CAMBRIDGE. INT. CL. 12. (U.S. CLS. 19, 21, 23, 31, 35 AND 44). REG. 11-21-2000.
- 2,405,395. MISCELLANEOUS DESIGN. INT. CL. 37. (U.S. CLS. 100, 103 AND 106). REG. 11-21-2000.
- 2,405,798. SPITFIRE. INT. CL. 9. (U.S. CLS. 21, 23, 26, 36 AND 38). REG. 11-21-2000.
- 2,406,036. SBB CFF FFS AND DESIGN. INT. CL. 14. (U.S. CLS. 2, 27, 28 AND 50). REG. 11-21-2000.
- 2,406,040. CO-OP CACHE CONSULTING AND DESIGN. INT. CL. 35. (U.S. CLS. 100, 101 AND 102). REG. 11-21-2000.
- 2,406,129. CHILD DEVELOPMENT CENTERS A FUN PLACE TO LEARN AND GROW AND DESIGN. INT. CL. 42. (U.S. CLS. 100 AND 101). REG. 11-21-2000.
- 2,406,490. DIRECT HEATCON. INT. CL. 7. (U.S. CLS. 13, 19, 21, 23, 31, 34 AND 35). REG. 11-21-2000.
- 2,406,899. Q. INTEGRITY. INT. CLS. 38 AND 42. (U.S. CLS. 100, 101 AND 104). REG. 11-21-2000.
- 2,407,516. WINDRIDGE. INT. CL. 25. (U.S. CLS. 22 AND 39). REG. 11-28-2000.
- 2,408,437. DIAMOND TEX AND DESIGN. INT. CL. 19. (U.S. CLS. 1, 12, 33 AND 50). REG. 11-28-2000.
- 2,408,652. THE DRUGSTORE AT BI-LO. INT. CL. 35. (U.S. CLS. 100, 101 AND 102). REG. 11-28-2000.
- 2,409,441. KINON. INT. CL. 1. (U.S. CLS. 1, 5, 6, 10, 26 AND 46). REG. 11-28-2000.
- 2,409,448. SPECTRALITE. INT. CL. 17. (U.S. CLS. 1, 5, 12, 13, 35 AND 50). REG. 11-28-2000.
- 2,409,952. LOSMA (STYLIZED). INT. CLS. 7 AND 11. (U.S. CLS. 13, 19, 21, 23, 31, 34 AND 35). REG. 12-5-2000.
- 2,410,314. MISCELLANEOUS DESIGN. INT. CL. 9. (U.S. CLS. 21, 23, 26, 36 AND 38). REG. 12-5-2000.
- 2,410,837. CSS. INT. CL. 41. (U.S. CLS. 100, 101 AND 107). REG. 12-5-2000.
- 2,410,839. MISCELLANEOUS DESIGN. INT. CL. 6. (U.S. CLS. 2, 12, 13, 14, 23, 25 AND 50). REG. 12-5-2000.
- 2,410,849. POW WOW. INT. CL. 25. (U.S. CLS. 22 AND 39). REG. 12-5-2000.
- 2,410,977. BI-LO CENTER. INT. CL. 16. (U.S. CLS. 2, 5, 22, 23, 29, 37, 38 AND 50). REG. 12-5-2000.
- 2,411,292. RAVENS YARD. INT. CL. 41. (U.S. CLS. 100, 101 AND 107). REG. 12-5-2000.
- 2,411,713. JETALUM. INT. CL. 6. (U.S. CLS. 2, 12, 13, 14, 23, 25 AND 50). REG. 12-12-2000.
- 2,412,066. SARANAC VILLAGE. INT. CL. 42. (U.S. CLS. 100 AND 101). REG. 12-12-2000.
- 2,412,978. WESTERN FIBER-TUFF. INT. CL. 16. (U.S. CLS. 2, 5, 22, 23, 29, 37, 38 AND 50). REG. 12-12-2000.
- 2,413,067. FLEX SEAL. INT. CL. 17. (U.S. CLS. 1, 5, 12, 13, 35 AND 50). REG. 12-12-2000.
- 2,413,212. A LEGACY TO REMEMBER. INT. CL. 16. (U.S. CLS. 2, 5, 22, 23, 29, 37, 38 AND 50). REG. 12-12-2000.
- 2,413,380. LISA. INT. CL. 41. (U.S. CLS. 100, 101 AND 107). REG. 12-19-2000.
- 2,413,673. CHARLES JONES (STYLIZED). INT. CL. 42. (U.S. CLS. 100 AND 101). REG. 12-19-2000.
- 2,413,837. TECHNICOLOR. INT. CL. 39. (U.S. CLS. 100 AND 105). REG. 12-19-2000.
- 2,414,152. GOLDILOCKS. INT. CL. 30 ONLY. (U.S. CL. 46). REG. 12-19-2000.
- 2,414,490. SANIBEL. INT. CL. 12. (U.S. CLS. 19, 21, 23, 31, 35 AND 44). REG. 12-19-2000.
- 2,414,627. ACTIVE ONLY. INT. CL. 11. (U.S. CLS. 13, 21, 23, 31 AND 34). REG. 12-19-2000.
- 2,415,353. AWARD HARDWOOD FLOORS. INT. CL. 19. (U.S. CLS. 1, 12, 33 AND 50). REG. 12-26-2000.
- 2,415,807. HENRY SCHEIN AND DESIGN. INT. CL. 36. (U.S. CLS. 100, 101 AND 102). REG. 12-26-2000.
- 2,415,867. KKIQ. INT. CL. 38. (U.S. CLS. 100, 101 AND 104). REG. 12-26-2000.
- 2,416,068. MISCELLANEOUS DESIGN. INT. CLS. 7 AND 9. (U.S. CLS. 13, 19, 21, 23, 26, 31, 34, 35, 36 AND 38). REG. 12-26-2000.
- 2,416,477. NATURE'S BASKET. INT. CL. 35. (U.S. CLS. 100, 101 AND 102). REG. 12-26-2000.
- 2,416,868. CONSOLIDATED OFFICE SYSTEMS "OFFERING YOU THE MOST COMPLETE OFFICE SUPPORT SINCE 1973". INT. CL. 35. (U.S. CLS. 100, 101 AND 102). REG. 1-2-2001.
- 2,417,379. BOSTON DENTAL. INT. CL. 42. (U.S. CLS. 100 AND 101). REG. 1-2-2001.
- 2,418,158. POSILOCK. INT. CL. 6. (U.S. CLS. 2, 12, 13, 14, 23, 25 AND 50). REG. 1-2-2001.
- 2,418,424. VS STANDARD. INT. CL. 9. (U.S. CLS. 21, 23, 26, 36 AND 38). REG. 1-2-2001.
- 2,418,712. S AND DESIGN. INT. CL. 31. (U.S. CLS. 1 AND 46). REG. 1-9-2001.
- 2,419,481. HOP BOOKS HOOKED ON PHONICS LIBRARY COLLECTION AND DESIGN. INT. CL. 16. (U.S. CLS. 2, 5, 22, 23, 29, 37, 38 AND 50). REG. 1-9-2001.
- 2,420,115. EXECUSTAFF (STYLIZED). INT. CL. 35. (U.S. CLS. 100, 101 AND 102). REG. 1-9-2001.
- 2,421,012. IQ RESORTS. INT. CL. 42. (U.S. CLS. 100 AND 101). REG. 1-16-2001.
- 2,421,420. BURHOP'S SEAFOOD AND DESIGN. INT. CL. 35. (U.S. CLS. 100, 101 AND 102). REG. 1-16-2001.
- 2,422,453. STEEN. INT. CL. 42. (U.S. CLS. 100 AND 101). REG. 1-23-2001.
- 2,422,505. TENTH PLANET PRODUCTIONS AND DESIGN. INT. CL. 41. (U.S. CLS. 100, 101 AND 107). REG. 1-23-2001.
- 2,422,687. CYBERSOFT. INT. CL. 9. (U.S. CLS. 21, 23, 26, 36 AND 38). REG. 1-23-2001.
- 2,422,712. CORE MANAGEMENT SPECIALISTS AND DESIGN. INT. CL. 12. (U.S. CLS. 19, 21, 23, 31, 35 AND 44). REG. 1-23-2001.
- 2,423,060. PANGEA. INT. CL. 42. (U.S. CLS. 100 AND 101). REG. 1-23-2001.
- 2,423,099. SECUREFX. INT. CL. 9. (U.S. CLS. 21, 23, 26, 36 AND 38). REG. 1-23-2001.
- 2,423,161. MISCELLANEOUS DESIGN. INT. CL. 29. (U.S. CL. 46). REG. 1-23-2001.
- 2,423,162. OLD CHATHAM SHEEPHERDING COMPANY. INT. CL. 29. (U.S. CL. 46). REG. 1-23-2001.
- 2,423,821. BULB HOUND. INT. CL. 8. (U.S. CLS. 23, 28 AND 44). REG. 1-23-2001.
- 2,424,132. TELLME. INT. CL. 35. (U.S. CLS. 100, 101 AND 102). REG. 1-23-2001.
- 2,424,420. ECONOBOARD. INT. CL. 16. (U.S. CLS. 2, 5, 22, 23, 29, 37, 38 AND 50). REG. 1-30-2001.
- 2,424,686. COMMODORES AND DESIGN. INT. CL. 41. (U.S. CLS. 100, 101 AND 107). REG. 1-30-2001.
- 2,424,995. HOUSE OF IMPORTS. INT. CL. 35. (U.S. CLS. 100, 101 AND 102). REG. 1-30-2001.
- 2,425,439. WIZARD. INT. CL. 7. (U.S. CLS. 13, 19, 21, 23, 31, 34 AND 35). REG. 1-30-2001.
- 2,426,036. GRP. U.S. CL. B. REG. 2-6-2001.
- 2,426,072. EPI. INT. CLS. 28, 35 AND 42. (U.S. CLS. 22, 23, 38, 50, 100, 101 AND 102). REG. 2-6-2001.
- 2,426,073. EPI AND DESIGN. INT. CLS. 28, 35 AND 42. (U.S. CLS. 22, 23, 38, 50, 100, 101 AND 102). REG. 2-6-2001.
- 2,426,304. TRACK JUDGE AND DESIGN. INT. CL. 9. (U.S. CLS. 21, 23, 26, 36 AND 38). REG. 2-6-2001.
- 2,426,658. PLAY LIKE A DOG.. INT. CL. 42. (U.S. CLS. 100 AND 101). REG. 2-6-2001.
- 2,427,103. PASTAZIOS. INT. CL. 42. (U.S. CLS. 100 AND 101). REG. 2-6-2001.
- 2,427,218. SILVERTON. INT. CL. 41. (U.S. CLS. 100, 101 AND 107). REG. 2-6-2001.
- 2,427,906. IN-SITE. INT. CL. 9. (U.S. CLS. 21, 23, 26, 36 AND 38). REG. 2-13-2001.
- 2,428,088. PERNA. INT. CL. 5. (U.S. CLS. 6, 18, 44, 46, 51 AND 52). REG. 2-13-2001.
- 2,428,476. WHACKY WORM. INT. CL. 28. (U.S. CLS. 22, 23, 38 AND 50). REG. 2-13-2001.
- 2,428,507. PYRODIGITAL. INT. CL. 13. (U.S. CLS. 2 AND 9). REG. 2-13-2001.
- 2,428,574. STAMP OF QUALITY. INT. CL. 37. (U.S. CLS. 100, 103 AND 106). REG. 2-13-2001.
- 2,428,803. FITNESS WAVE. INT. CL. 42. (U.S. CLS. 100 AND 101). REG. 2-13-2001.
- 2,429,080. SECURECRT. INT. CL. 9. (U.S. CLS. 21, 23, 26, 36 AND 38). REG. 2-20-2001.
- 2,429,125. CINNABITES. INT. CL. 30. (U.S. CL. 46). REG. 2-20-2001.
- 2,429,153. AGGTRANS. INT. CL. 39. (U.S. CLS. 100 AND 105). REG. 2-20-2001.

- 2,429,205. PERSON-CENTERED LIVING. INT. CL. 42. (U.S. CLS. 100 AND 101). REG. 2-20-2001.
- 2,429,458. MERCURY RACING. INT. CL. 25. (U.S. CLS. 22 AND 39). REG. 2-20-2001.
- 2,429,583. AKWA TEARS. INT. CL. 5. (U.S. CLS. 6, 18, 44, 46, 51 AND 52). REG. 2-20-2001.
- 2,429,584. TEARS RENEWED. INT. CL. 5. (U.S. CLS. 6, 18, 44, 46, 51 AND 52). REG. 2-20-2001.
- 2,429,669. POIPU KAI RESORT. INT. CL. 42. (U.S. CLS. 100 AND 101). REG. 2-20-2001.
- 2,429,831. TAROT: WITCH OF THE BLACK ROSE. INT. CL. 16. (U.S. CLS. 2, 5, 22, 23, 29, 37, 38 AND 50). REG. 2-20-2001.
- 2,430,010. SYMTALK. INT. CLS. 16 AND 28. (U.S. CLS. 2, 5, 22, 23, 29, 37, 38 AND 50). REG. 2-20-2001.
- 2,430,518. GARAGESALE.COM. INT. CL. 35. (U.S. CLS. 100, 101 AND 102). REG. 2-20-2001.
- 2,430,714. INTEGRAL ACCESS. INT. CL. 9. (U.S. CLS. 21, 23, 26, 36 AND 38). REG. 2-27-2001.
- 2,430,990. PATA COMPASS. INT. CL. 16. (U.S. CLS. 2, 5, 22, 23, 29, 37, 38 AND 50). REG. 2-27-2001.
- 2,431,234. MISCELLANEOUS DESIGN. INT. CL. 42. (U.S. CLS. 100 AND 101). REG. 2-27-2001.
- 2,431,397. VIEWGUARD. INT. CL. 6. (U.S. CLS. 2, 12, 13, 14, 23, 25 AND 50). REG. 2-27-2001.
- 2,432,177. AIRWASH. INT. CL. 11. (U.S. CLS. 13, 21, 23, 31 AND 34). REG. 2-27-2001.
- 2,432,276. VECTREN. INT. CL. 39. (U.S. CLS. 100 AND 105). REG. 2-27-2001.
- 2,432,280. 4U2DESIGN. INT. CL. 42. (U.S. CLS. 100 AND 101). REG. 2-27-2001.
- 2,432,505. MISCELLANEOUS DESIGN. INT. CL. 10. (U.S. CLS. 26, 39 AND 44). REG. 3-6-2001.
- 2,432,636. FF FOOD FAST AND DESIGN. INT. CL. 35. (U.S. CLS. 100, 101 AND 102). REG. 3-6-2001.
- 2,432,678. RHINO AND DESIGN. INT. CL. 9. (U.S. CLS. 21, 23, 26, 36 AND 38). REG. 3-6-2001.
- 2,432,894. TRAC-WORK. INT. CL. 37. (U.S. CLS. 100, 103 AND 106). REG. 3-6-2001.
- 2,433,003. EAST. INT. CL. 12. (U.S. CLS. 19, 21, 23, 31, 35 AND 44). REG. 3-6-2001.
- 2,433,238. OAK BEAN. INT. CL. 31. (U.S. CLS. 1 AND 46). REG. 3-6-2001.
- 2,433,475. PREPSTAR. INT. CL. 16. (U.S. CLS. 2, 5, 22, 23, 29, 37, 38 AND 50). REG. 3-6-2001.
- 2,433,569. NYIA. INT. CL. 42. (U.S. CLS. 100 AND 101). REG. 3-6-2001.
- 2,433,582. NUTRITION FOR THE SKIN AND DESIGN. INT. CL. 3. (U.S. CLS. 1, 4, 6, 50, 51 AND 52). REG. 3-6-2001.
- 2,433,595. MOSQUITO MAGNET. INT. CL. 7. (U.S. CLS. 13, 19, 21, 23, 31, 34 AND 35). REG. 3-6-2001.
- 2,433,658. SCHOLASTIC. INT. CL. 16. (U.S. CLS. 2, 5, 22, 23, 29, 37, 38 AND 50). REG. 3-6-2001.
- 2,433,770. PLATINUM PRIORITY. INT. CL. 36. (U.S. CLS. 100, 101 AND 102). REG. 3-6-2001.
- 2,433,932. AVORA. INT. CL. 22. (U.S. CLS. 1, 2, 7, 19, 22, 42 AND 50). REG. 3-6-2001.
- 2,433,949. WAY 2 SOUR. INT. CL. 30. (U.S. CL. 46). REG. 3-6-2001.
- 2,433,970. TUMI TRACER. INT. CL. 18. (U.S. CLS. 1, 2, 3, 22 AND 41). REG. 3-6-2001.
- 2,434,314. PMI AND DESIGN. INT. CL. 22. (U.S. CLS. 1, 2, 7, 19, 22, 42 AND 50). REG. 3-6-2001.
- 2,434,431. L.A. COLORS. INT. CL. 3. (U.S. CLS. 1, 4, 6, 50, 51 AND 52). REG. 3-6-2001.
- 2,434,550. JMG AND DESIGN. INT. CL. 41. (U.S. CLS. 100, 101 AND 107). REG. 3-13-2001.
- 2,434,717. PROFITABLE INVESTING. INT. CL. 36. (U.S. CLS. 100, 101 AND 102). REG. 3-13-2001.
- 2,434,859. YOYO JAM. INT. CL. 28. (U.S. CLS. 22, 23, 38 AND 50). REG. 3-13-2001.
- 2,435,330. WATER WHEEL. INT. CL. 12. (U.S. CLS. 19, 21, 23, 31, 35 AND 44). REG. 3-13-2001.
- 2,436,216. PIEDINI (STYLIZED). INT. CL. 25. (U.S. CLS. 22 AND 39). REG. 3-20-2001.
- 2,436,768. QUALITY TOOLS THAT GO TO WORK WITH YOU. INT. CL. 35. (U.S. CLS. 100, 101 AND 102). REG. 3-20-2001.
- 2,437,196. SOYTECH. INT. CL. 35. (U.S. CLS. 100, 101 AND 102). REG. 3-20-2001.
- 2,437,981. SUPERMAG. INT. CL. 7. (U.S. CLS. 13, 19, 21, 23, 31, 34 AND 35). REG. 3-27-2001.
- 2,438,298. POSILLICO AND DESIGN. INT. CL. 16. (U.S. CLS. 2, 5, 22, 23, 29, 37, 38 AND 50). REG. 3-27-2001.
- 2,438,314. HENRY ELLIOTT & COMPANY. INT. CL. 35. (U.S. CLS. 100, 101 AND 102). REG. 3-27-2001.
- 2,438,890. NORTHSTAR. INT. CL. 5. (U.S. CLS. 6, 18, 44, 46, 51 AND 52). REG. 3-27-2001.
- 2,438,981. CYBERLINK POWERDVD. INT. CL. 9. (U.S. CLS. 21, 23, 26, 36 AND 38). REG. 3-27-2001.
- 2,439,118. TEA. INT. CLS. 35 AND 36. (U.S. CLS. 100, 101 AND 102). REG. 3-27-2001.
- 2,439,236. WINDJAMMER CAPITAL INVESTORS. INT. CL. 36. (U.S. CLS. 100, 101 AND 102). REG. 3-27-2001.

* * * * *

TRADEMARK REGISTRATIONS CANCELED

The designation "U.S. Cl." appearing in this section refers to the U.S. class in effect prior to Sep. 1, 1973 rather than the international class which applies to applications filed on or after that date. For adoption of international classification see notice in the OFFICIAL GAZETTE of Jun. 26, 1973 (911 O.G. TM 210).

SECTION 7(D)

- 1,375,020. FIRSTCASH. INT. CLS. 35 AND 36. REG. 12-10-1985.
- 1,810,525. ALLSTATE TICKETING SHOWS TOURS AND DESIGN. INT. CLS. 9 AND 41. REG. 12-14-1993.
- 2,750,706. TD WATERHOUSE. INT. CL. 36. REG. 8-12-2003.
- 2,800,786. HOMEGOING AND DESIGN. INT. CL. 16. REG. 12-30-2003.
- 2,804,575. CARDSYNC. INT. CL. 36. REG. 1-13-2004.
- 2,807,773. TENSION TAKER. INT. CL. 10. REG. 1-27-2004.
- 2,823,993. JOE WEIDER'S BATTLE OF THE BICEPS. INT. CL. 25. REG. 3-16-2004.
- 2,911,418. COUNTRY LIVING GARDENER. INT. CL. 31. REG. 12-14-2004.
- 3,035,680. ASA LATE MODEL SERIES AND DESIGN. INT. CL. 41. REG. 12-27-2005.
- 3,084,021. SURREAL. INT. CL. 3. REG. 4-25-2006.
- 3,174,171. SAE INSTITUTE (STYLIZED). INT. CL. 35. REG. 11-21-2006.
- 3,288,194. KNOWLEDGETREE STANDARD CHARACTER MARK. INT. CL. 9. REG. 9-4-2007.
- 3,322,116. KATE'S HOMEMADE BUTTER FARM FRESH FROM MAINE AND DESIGN. INT. CL. 29. REG. 10-30-2007.
- 3,329,606. SENSORY TECHNOLOGY STANDARD CHARACTER MARK. INT. CL. 35. REG. 11-6-2007.
- 3,389,545. BAREFOOT AND DESIGN. INT. CL. 18. REG. 2-26-2008.
- 3,449,127. NEXNAV STANDARD CHARACTER MARK. INT. CL. 9. REG. 6-17-2008.
- 3,501,180. HI FIVE STANDARD CHARACTER MARK. INT. CL. 3. REG. 9-16-2008.
- 3,576,283. CREATE, SHARE & THINK AS ONE STANDARD CHARACTER MARK. INT. CLS. 35 AND 42. REG. 2-17-2009.
- 3,620,899. SUNGRID STANDARD CHARACTER MARK. INT. CL. 9. REG. 5-12-2009.
- 3,718,444. HELMSLEYSPEAR STANDARD CHARACTER MARK. INT. CLS. 36 AND 37. REG. 12-1-2009.
- 3,733,384. THE CRAZY LOBSTER BAR & GRILL STANDARD CHARACTER MARK. INT. CL. 43. REG. 1-5-2010.
- 3,744,241. ALAMO PAINT & DECORATING STANDARD CHARACTER MARK. INT. CL. 35. REG. 2-2-2010.
- 3,756,288. SANTA BARBARA WINE COMPANY STANDARD CHARACTER MARK. INT. CL. 33. REG. 3-2-2010.
- 1,124,251. SOUND-X. INT. CL. 9. REG. 8-21-1979.
- 1,505,898. THROUGHPUT. INT. CL. 16. REG. 9-27-1988.
- 1,530,259. SMITHFIELD'S CHICKEN 'N BAR-B-Q (STYLIZED). INT. CL. 42. REG. 3-14-1989.
- 1,545,951. TEKSTIM. INT. CL. 1. REG. 7-4-1989.
- 1,552,392. MAGNUM BLAST. INT. CL. 1. REG. 8-22-1989.
- 1,552,394. ITEK GRAPHIX AND DESIGN. INT. CLS. 1, 7, 9 AND 16. REG. 8-22-1989.
- 1,552,404. TURBO-BOOST. INT. CL. 1. REG. 8-22-1989.
- 1,552,409. UDYFIN. INT. CLS. 1 AND 2. REG. 8-22-1989.
- 1,552,414. FIBRSELE. INT. CL. 2. REG. 8-22-1989.
- 1,552,425. EASI-MECHE. INT. CL. 3. REG. 8-22-1989.
- 1,552,430. AB AND DESIGN. INT. CL. 3. REG. 8-22-1989.
- 1,552,432. L.A. LOOKS AND DESIGN. INT. CL. 3. REG. 8-22-1989.
- 1,552,439. DABAO AND DESIGN. INT. CLS. 3 AND 5. REG. 8-22-1989.
- 1,552,440. THE ROSE MARIE COLLECTION AND DESIGN. INT. CL. 3. REG. 8-22-1989.
- 1,552,451. AVAIL. INT. CL. 5. REG. 8-22-1989.
- 1,552,453. MENADOL. INT. CL. 5. REG. 8-22-1989.
- 1,552,461. GOAL MAKER. INT. CL. 5. REG. 8-22-1989.
- 1,552,471. ALPHA THERAPEUTIC CORPORATION (STYLIZED). INT. CL. 5. REG. 8-22-1989.
- 1,552,472. SURE-CRAFT. INT. CLS. 6 AND 17. REG. 8-22-1989.
- 1,552,479. MCS MINI CONTROL SYSTEM AND DESIGN. INT. CLS. 6, 9 AND 17. REG. 8-22-1989.
- 1,552,481. BEACH AND DESIGN. INT. CLS. 6 AND 20. REG. 8-22-1989.
- 1,552,482. TECHNOLOY. INT. CL. 6. REG. 8-22-1989.
- 1,552,484. PALCO. INT. CLS. 6, 8 AND 9. REG. 8-22-1989.
- 1,552,485. PALCO AND DESIGN. INT. CLS. 6, 8 AND 9. REG. 8-22-1989.
- 1,552,494. ROKTRUSS. INT. CL. 6. REG. 8-22-1989.
- 1,552,496. HISTORICAL SERIES. INT. CL. 6. REG. 8-22-1989.
- 1,552,497. TORQRITE. INT. CL. 6. REG. 8-22-1989.
- 1,552,501. CYCLO AND DESIGN. INT. CL. 7. REG. 8-22-1989.
- 1,552,503. LOCTRONIC. INT. CL. 7. REG. 8-22-1989.
- 1,552,506. US MODULAR AND DESIGN. INT. CL. 7. REG. 8-22-1989.
- 1,552,512. CAN HANDLER. INT. CL. 7. REG. 8-22-1989.
- 1,552,522. COLEMAN AND DESIGN. INT. CL. 7. REG. 8-22-1989.
- 1,552,525. CL DESIGN AND DESIGN. INT. CL. 7. REG. 8-22-1989.
- 1,552,526. MULTIPRESS. INT. CL. 7. REG. 8-22-1989.
- 1,552,530. ATLANTIDE. INT. CL. 8. REG. 8-22-1989.
- 1,552,532. MISCELLANEOUS DESIGN. INT. CLS. 8, 11 AND 21. REG. 8-22-1989.
- 1,552,540. PERCEPTION TECHNOLOGY. INT. CL. 9. REG. 8-22-1989.
- 1,552,545. GOKO. INT. CL. 9. REG. 8-22-1989.
- 1,552,549. TECPRO. INT. CL. 9. REG. 8-22-1989.
- 1,552,551. FORTE (STYLIZED). INT. CL. 9. REG. 8-22-1989.
- 1,552,554. BABY BOOMER CLASSICS AND DESIGN. INT. CL. 9. REG. 8-22-1989.
- 1,552,558. WY. INT. CL. 9. REG. 8-22-1989.
- 1,552,560. COMPU-COLOR. INT. CL. 9. REG. 8-22-1989.
- 1,552,572. ULTRA. INT. CL. 9. REG. 8-22-1989.
- 1,552,574. BEC AND DESIGN. INT. CLS. 9 AND 28. REG. 8-22-1989.
- 1,552,575. IM II. INT. CL. 9. REG. 8-22-1989.

SECTION 8

- 370,288. VITA-RICH (STYLIZED). U.S. CL. 46. REG. 8-22-1939.
- 815,737. ELECTROHOME. U.S. CL. 21. REG. 9-27-1966.
- 840,129. PROMISE. U.S. CL. 46. REG. 12-5-1967.
- 874,992. VILLAGER. U.S. CL. 12. REG. 8-19-1969.

- 1,552,580. STELLA AND DESIGN. INT. CL. 9. REG. 8-22-1989.
- 1,552,585. THINKING. INT. CLS. 9 AND 11. REG. 8-22-1989.
- 1,552,586. TANK MANAGER. INT. CL. 9. REG. 8-22-1989.
- 1,552,587. JT FAX. INT. CL. 9. REG. 8-22-1989.
- 1,552,593. INTELLI-CARD. INT. CL. 9. REG. 8-22-1989.
- 1,552,606. ULTRA-SPOT. INT. CL. 9. REG. 8-22-1989.
- 1,552,609. MCN 2000. INT. CL. 9. REG. 8-22-1989.
- 1,552,623. MICRO STAR CO., INC.. INT. CL. 9. REG. 8-22-1989.
- 1,552,629. MICROPLATE MANAGER. INT. CL. 9. REG. 8-22-1989.
- 1,552,630. TSILENT. INT. CL. 9. REG. 8-22-1989.
- 1,552,631. HELIBAR. INT. CL. 9. REG. 8-22-1989.
- 1,552,632. CHAI. INT. CL. 9. REG. 8-22-1989.
- 1,552,635. C AND DESIGN. INT. CL. 9. REG. 8-22-1989.
- 1,552,639. INNER TRADITIONS. INT. CL. 9. REG. 8-22-1989.
- 1,552,642. GAMMASCOPE. INT. CL. 9. REG. 8-22-1989.
- 1,552,647. DCD. INT. CL. 9. REG. 8-22-1989.
- 1,552,649. NARADA AND DESIGN. INT. CL. 9. REG. 8-22-1989.
- 1,552,655. AUDIO + AND DESIGN. INT. CL. 9. REG. 8-22-1989.
- 1,552,656. BIOQUANT. INT. CLS. 9 AND 10. REG. 8-22-1989.
- 1,552,660. ART-IM. INT. CL. 9. REG. 8-22-1989.
- 1,552,662. VAL-MISER. INT. CL. 9. REG. 8-22-1989.
- 1,552,663. ULTRA-MISER. INT. CL. 9. REG. 8-22-1989.
- 1,552,665. DISCUS/NWI AND DESIGN. INT. CL. 9. REG. 8-22-1989.
- 1,552,666. ADAPTSNA. INT. CL. 9. REG. 8-22-1989.
- 1,552,667. INTERFLEX AND DESIGN. INT. CL. 9. REG. 8-22-1989.
- 1,552,669. LASERPLANE. INT. CL. 9. REG. 8-22-1989.
- 1,552,675. ACCOUNTANT'S DREAM. INT. CL. 9. REG. 8-22-1989.
- 1,552,676. MED-RATE. INT. CL. 9. REG. 8-22-1989.
- 1,552,680. WESTERN ELECTRIC. INT. CL. 9. REG. 8-22-1989.
- 1,552,683. LEASE STAR AND DESIGN. INT. CLS. 9 AND 35. REG. 8-22-1989.
- 1,552,684. ADVANCED LOGIC RESEARCH, INC.. INT. CL. 9. REG. 8-22-1989.
- 1,552,685. SOLARBANDIT. INT. CL. 9. REG. 8-22-1989.
- 1,552,691. IT'S THE LAW. INT. CL. 9. REG. 8-22-1989.
- 1,552,698. T-STAR. INT. CL. 9. REG. 8-22-1989.
- 1,552,703. FILMAC. INT. CL. 9. REG. 8-22-1989.
- 1,552,704. SAVINGSPLANNER. INT. CL. 9. REG. 8-22-1989.
- 1,552,708. SUNGLASS FACTORY. INT. CL. 9. REG. 8-22-1989.
- 1,552,712. MATHSTATION. INT. CL. 9. REG. 8-22-1989.
- 1,552,713. MODAPT. INT. CL. 9. REG. 8-22-1989.
- 1,552,718. QUANTEX. INT. CL. 9. REG. 8-22-1989.
- 1,552,725. CAVITRON. INT. CL. 10. REG. 8-22-1989.
- 1,552,728. CARE AND DESIGN. INT. CL. 10. REG. 8-22-1989.
- 1,552,732. COMBICYCLE. INT. CLS. 10 AND 28. REG. 8-22-1989.
- 1,552,734. CROCKER FELS. INT. CL. 10. REG. 8-22-1989.
- 1,552,736. SASSY. INT. CL. 10. REG. 8-22-1989.
- 1,552,740. SCANPAK. INT. CL. 11. REG. 8-22-1989.
- 1,552,745. ARC DECO. INT. CL. 11. REG. 8-22-1989.
- 1,552,747. MISCELLANEOUS DESIGN. INT. CL. 11. REG. 8-22-1989.
- 1,552,750. TOILEFRESH. INT. CL. 11. REG. 8-22-1989.
- 1,552,752. REFLECTIONS. INT. CL. 11. REG. 8-22-1989.
- 1,552,753. NAV. INT. CL. 11. REG. 8-22-1989.
- 1,552,760. QUENCHMASTER. INT. CL. 11. REG. 8-22-1989.
- 1,552,761. EASY HANDLER. INT. CL. 11. REG. 8-22-1989.
- 1,552,763. HEAT PLUS AND DESIGN. INT. CL. 11. REG. 8-22-1989.
- 1,552,767. PTI AND DESIGN. INT. CL. 12. REG. 8-22-1989.
- 1,552,772. 800 VSS. INT. CL. 12. REG. 8-22-1989.
- 1,552,773. 950 VSS. INT. CL. 12. REG. 8-22-1989.
- 1,552,777. RALLIART. INT. CL. 12. REG. 8-22-1989.
- 1,552,781. ALUMITECH AND DESIGN. INT. CL. 12. REG. 8-22-1989.
- 1,552,786. STOR-IT (STYLIZED). INT. CL. 12. REG. 8-22-1989.
- 1,552,793. BILL JORDAN COMBAT GRIP. INT. CL. 13. REG. 8-22-1989.
- 1,552,795. H.S. AND DESIGN. INT. CL. 14. REG. 8-22-1989.
- 1,552,796. JN. INT. CL. 14. REG. 8-22-1989.
- 1,552,797. MIXIT. INT. CL. 14. REG. 8-22-1989.
- 1,552,804. SASA. INT. CL. 14. REG. 8-22-1989.
- 1,552,814. HAZARDOUS MATERIALS TRANSPORTATION. INT. CL. 16. REG. 8-22-1989.
- 1,552,819. RADWORKS. INT. CL. 16. REG. 8-22-1989.
- 1,552,822. GIRL STYLE. INT. CL. 16. REG. 8-22-1989.
- 1,552,831. STIKFOR. INT. CL. 16. REG. 8-22-1989.
- 1,552,834. BASE BEHAVIORAL ALTERNATIVES THRU SELF-ESTEEM AND DESIGN. INT. CL. 16. REG. 8-22-1989.
- 1,552,836. CONDOC. INT. CLS. 16 AND 41. REG. 8-22-1989.
- 1,552,840. INSIDE UPS AND DESIGN. INT. CL. 16. REG. 8-22-1989.
- 1,552,845. SUPERMEAL. INT. CL. 16. REG. 8-22-1989.
- 1,552,846. HOMENOTES AND DESIGN. INT. CL. 16. REG. 8-22-1989.
- 1,552,848. IMPRESO. INT. CL. 16. REG. 8-22-1989.
- 1,552,850. THE TREASURES YOU CAN KEEP FOREVER. INT. CL. 16. REG. 8-22-1989.
- 1,552,855. SHIP & STORE. INT. CLS. 16 AND 20. REG. 8-22-1989.
- 1,552,863. ESTEEM (STYLIZED). INT. CLS. 16 AND 21. REG. 8-22-1989.
- 1,552,866. AUTO-INKING. INT. CL. 16. REG. 8-22-1989.
- 1,552,869. INTAC. INT. CL. 16. REG. 8-22-1989.
- 1,552,874. COUGAR PADS. INT. CL. 17. REG. 8-22-1989.
- 1,552,882. WIDEBODY. INT. CL. 18. REG. 8-22-1989.
- 1,552,889. QUALITY FIRST GREATWOOD CEDAR HOMES AND DESIGN. INT. CL. 19. REG. 8-22-1989.
- 1,552,896. CERTANE. INT. CL. 19. REG. 8-22-1989.
- 1,552,898. COLONY MANOR. INT. CL. 19. REG. 8-22-1989.
- 1,552,899. MEADOWRIDGE. INT. CL. 19. REG. 8-22-1989.
- 1,552,902. BECAUSE A WINDOW IS 90 PERCENT GLASS. INT. CL. 19. REG. 8-22-1989.
- 1,552,908. ARTISTRY. INT. CL. 20. REG. 8-22-1989.
- 1,552,912. MASTER-TRAK. INT. CL. 20. REG. 8-22-1989.
- 1,552,916. AVEX (STYLIZED). INT. CL. 20. REG. 8-22-1989.
- 1,552,917. MISCELLANEOUS DESIGN. INT. CL. 20. REG. 8-22-1989.
- 1,552,919. SIDING SADDLE. INT. CL. 20. REG. 8-22-1989.
- 1,552,924. WALRUS AND DESIGN. INT. CL. 20. REG. 8-22-1989.
- 1,552,925. HOMECREST AND DESIGN. INT. CL. 20. REG. 8-22-1989.
- 1,552,935. MAGIC VENT. INT. CL. 21. REG. 8-22-1989.
- 1,552,938. SNAP-A-TRAY. INT. CL. 21. REG. 8-22-1989.
- 1,552,944. TODAY'S CLASSICS. INT. CLS. 24 AND 25. REG. 8-22-1989.
- 1,552,950. SIDEFFECTS CALIFORNIA AND DESIGN. INT. CL. 25. REG. 8-22-1989.
- 1,552,962. PALM CLUB AND DESIGN. INT. CL. 25. REG. 8-22-1989.
- 1,552,965. HIND AND DESIGN. INT. CL. 25. REG. 8-22-1989.
- 1,552,970. FUSION KIDS. INT. CL. 25. REG. 8-22-1989.
- 1,552,975. THUNDERWEAR AND DESIGN. INT. CL. 25. REG. 8-22-1989.
- 1,552,993. GRIP-TITE. INT. CL. 27. REG. 8-22-1989.
- 1,553,001. SPUTT FOR DOES. INT. CL. 28. REG. 8-22-1989.
- 1,553,011. TEKIN (STYLIZED). INT. CL. 28. REG. 8-22-1989.
- 1,553,013. IREM. INT. CL. 28. REG. 8-22-1989.
- 1,553,015. ACCELERATION SPEED PERFORMANCE ASP AND DESIGN. INT. CL. 28. REG. 8-22-1989.
- 1,553,017. PENN TOURNAMENT. INT. CL. 28. REG. 8-22-1989.
- 1,553,023. UNCLE SCAM. INT. CL. 28. REG. 8-22-1989.
- 1,553,028. COLLEGE CROWN CLASSIC SUPERGAME. INT. CL. 28. REG. 8-22-1989.
- 1,553,044. HONEYBAKED AND DESIGN. INT. CLS. 29 AND 30. REG. 8-22-1989.
- 1,553,048. SIDEWALKERS' AND DESIGN. INT. CL. 29. REG. 8-22-1989.
- 1,553,049. BROCK'S AND DESIGN. INT. CLS. 29 AND 31. REG. 8-22-1989.
- 1,553,050. TIEN-FU. INT. CL. 29. REG. 8-22-1989.

- 1,553,053. PLANTATION AND DESIGN. INT. CL. 29. REG. 8-22-1989.
- 1,553,055. FANCY FRY. INT. CL. 29. REG. 8-22-1989.
- 1,553,059. SNOKIST RED RIBBON AND DESIGN. INT. CL. 29. REG. 8-22-1989.
- 1,553,066. STERLING SILVER BEEF AND DESIGN. INT. CL. 29. REG. 8-22-1989.
- 1,553,071. PACIFIC-JADE (STYLIZED). INT. CLS. 29 AND 30. REG. 8-22-1989.
- 1,553,072. NO-KNIFE. INT. CL. 29. REG. 8-22-1989.
- 1,553,082. MOST AND DESIGN. INT. CL. 30. REG. 8-22-1989.
- 1,553,086. MICRO-READY. INT. CL. 30. REG. 8-22-1989.
- 1,553,091. MISCELLANEOUS DESIGN. INT. CL. 30. REG. 8-22-1989.
- 1,553,092. PIECES OF HEAVEN FINE CHOCOLATES AND DESIGN. INT. CL. 30. REG. 8-22-1989.
- 1,553,102. RYE TWINS (STYLIZED). INT. CL. 30. REG. 8-22-1989.
- 1,553,105. EASTER BUDDIES. INT. CL. 30. REG. 8-22-1989.
- 1,553,107. TABU E VIVRAI DI PIU AND DESIGN. INT. CL. 30. REG. 8-22-1989.
- 1,553,111. KYO-GREEN. INT. CL. 30. REG. 8-22-1989.
- 1,553,114. DAINTEE AND DESIGN. INT. CL. 30. REG. 8-22-1989.
- 1,553,118. SWEETIE. INT. CL. 30. REG. 8-22-1989.
- 1,553,119. JOEY'S "LUV IN EVERY BITE" AND DESIGN. INT. CL. 30. REG. 8-22-1989.
- 1,553,121. QUICK'S OLDE FASHION CANDY AND DESIGN. INT. CL. 30. REG. 8-22-1989.
- 1,553,135. A.P.R. AND DESIGN. INT. CL. 31. REG. 8-22-1989.
- 1,553,140. JULIAN AND DESIGN. INT. CL. 31. REG. 8-22-1989.
- 1,553,141. RIGHT (STYLIZED). INT. CL. 31. REG. 8-22-1989.
- 1,553,143. SANDSTONE AND DESIGN. INT. CL. 31. REG. 8-22-1989.
- 1,553,145. ORIGINAL ANDY BOY SINCE 1926 AND DESIGN. INT. CL. 31. REG. 8-22-1989.
- 1,553,147. LITTLE GEMS. INT. CL. 31. REG. 8-22-1989.
- 1,553,149. DUAL-LOCK. INT. CL. 32. REG. 8-22-1989.
- 1,553,150. AQUASOURCE. INT. CL. 32. REG. 8-22-1989.
- 1,553,155. GRAFFRUTTI. INT. CL. 32. REG. 8-22-1989.
- 1,553,159. CHOCOLATE SOLDIER. INT. CL. 32. REG. 8-22-1989.
- 1,553,160. FAIRLEE AND DESIGN. INT. CL. 32. REG. 8-22-1989.
- 1,553,161. CHOICE PREMIUM NATURAL AND DESIGN. INT. CL. 32. REG. 8-22-1989.
- 1,553,163. GOETZ PALE THE FAMOUS NEAR BEER NON ALCOHOLIC GOETZ ORIGINAL PALE REMAINS AMERICA'S PURE LIGHT BREW BORN IN "THE TWENTIES" TO SATISFY A NATION'S THIRST AND DESIGN. INT. CL. 32. REG. 8-22-1989.
- 1,553,166. CAVE SPRING DRINKING WATER QUALITY TASTE AND EXCELLENCE AND DESIGN. INT. CL. 32. REG. 8-22-1989.
- 1,553,168. RAZCAL AND DESIGN. INT. CL. 32. REG. 8-22-1989.
- 1,553,169. BOKU. INT. CL. 32. REG. 8-22-1989.
- 1,553,171. ORANGE JULIUS (STYLIZED). INT. CL. 32. REG. 8-22-1989.
- 1,553,177. PHILIPPINE. INT. CL. 33. REG. 8-22-1989.
- 1,553,180. VINEYARD BRANDS, INC. (STYLIZED). INT. CL. 33. REG. 8-22-1989.
- 1,553,181. DANCING CATS. INT. CL. 33. REG. 8-22-1989.
- 1,553,193. MOTIVATION MEDIA. INT. CLS. 35, 39, 41 AND 42. REG. 8-22-1989.
- 1,553,196. PHYSICIAN COMPUTER NETWORK. INT. CLS. 35 AND 41. REG. 8-22-1989.
- 1,553,197. THINK INTERNATIONAL. INT. CL. 35. REG. 8-22-1989.
- 1,553,199. AUTOVANTAGE AND DESIGN. INT. CL. 35. REG. 8-22-1989.
- 1,553,202. FINANCIAL DYNAMICS. INT. CL. 35. REG. 8-22-1989.
- 1,553,203. FINANCIAL DYNAMICS AND DESIGN. INT. CL. 35. REG. 8-22-1989.
- 1,553,206. MONITAL AND DESIGN. INT. CL. 35. REG. 8-22-1989.
- 1,553,214. ARIEL WEST AND DESIGN. INT. CL. 35. REG. 8-22-1989.
- 1,553,222. THE VILLAGE AT CORTE MADERA AND DESIGN. INT. CL. 36. REG. 8-22-1989.
- 1,553,223. TOUCH-N-GO. INT. CL. 36. REG. 8-22-1989.
- 1,553,230. SECOR AND DESIGN. INT. CL. 36. REG. 8-22-1989.
- 1,553,231. INSTANT SPACE. INT. CLS. 36 AND 39. REG. 8-22-1989.
- 1,553,235. CHECK CASHING USA AND DESIGN. INT. CL. 36. REG. 8-22-1989.
- 1,553,244. HOME BENEFICIAL LIFE. INT. CL. 36. REG. 8-22-1989.
- 1,553,245. FIRST PENNSYLVANIA. INT. CL. 36. REG. 8-22-1989.
- 1,553,248. PROJECT REMBRANDT. INT. CL. 36. REG. 8-22-1989.
- 1,553,253. WAXMAN'S. INT. CLS. 37, 40 AND 42. REG. 8-22-1989.
- 1,553,259. S (STYLIZED). INT. CL. 37. REG. 8-22-1989.
- 1,553,260. LOUISIANA DOCK. INT. CLS. 37 AND 39. REG. 8-22-1989.
- 1,553,263. ABC AUTOMOTIVE ELECTRONICS. INT. CL. 37. REG. 8-22-1989.
- 1,553,269. SENDEX. INT. CL. 38. REG. 8-22-1989.
- 1,553,272. CRUISE CALLING. INT. CL. 38. REG. 8-22-1989.
- 1,553,273. CRUISE CALLING AND DESIGN. INT. CL. 38. REG. 8-22-1989.
- 1,553,274. MAKE THE QUALITY CONNECTION. INT. CL. 38. REG. 8-22-1989.
- 1,553,277. HAWAII AND DESIGN. INT. CLS. 39 AND 42. REG. 8-22-1989.
- 1,553,284. CONVENIENT VIDEO. INT. CL. 41. REG. 8-22-1989.
- 1,553,287. EP, PROFESSIONAL ELECTRONIC PUBLISHING & COMMERCIAL ELECTRONIC PREPRESS TECHNOLOGY AND DESIGN. INT. CL. 41. REG. 8-22-1989.
- 1,553,292. THE NEAL WAY. INT. CLS. 41 AND 42. REG. 8-22-1989.
- 1,553,293. PORTA-PLAYER. INT. CL. 41. REG. 8-22-1989.
- 1,553,311. GSC. INT. CL. 42. REG. 8-22-1989.
- 1,553,312. TREND-LINES AND DESIGN. INT. CL. 42. REG. 8-22-1989.
- 1,553,317. CULTURAL CENTER FOR THE ARTS AND DESIGN. INT. CL. 42. REG. 8-22-1989.
- 1,553,320. OASIS AND DESIGN. INT. CL. 42. REG. 8-22-1989.
- 1,553,326. MISCELLANEOUS DESIGN. INT. CL. 42. REG. 8-22-1989.
- 1,553,327. UNIVERSAL STUDIOS FAN CLUB AND DESIGN. INT. CL. 42. REG. 8-22-1989.
- 1,553,331. YOUR SOFA. YOUR WAY.. INT. CL. 42. REG. 8-22-1989.
- 1,553,338. THE REDD SLED CHRISTMAS SHOP. INT. CL. 42. REG. 8-22-1989.
- 1,553,342. BREAD BARN. INT. CL. 42. REG. 8-22-1989.
- 1,553,344. RESPONSIBLE STEWARDSHIP. INT. CL. 42. REG. 8-22-1989.
- 1,553,351. IDEA AND DESIGN. U.S. CL. 200. REG. 8-22-1989.
- 1,553,354. SEAL OF QUALITY NEW YORK STATE AND DESIGN. U.S. CL. A. REG. 8-22-1989.
- 1,553,356. SHRINKFAST. INT. CL. 7. REG. 8-22-1989.
- 1,553,359. PETITE. INT. CL. 10. REG. 8-22-1989.
- 1,553,361. KOPY KIT. INT. CL. 16. REG. 8-22-1989.
- 1,553,365. GEBORENER DEUTSCHER (STYLIZED). INT. CL. 16. REG. 8-22-1989.
- 1,553,368. 39 SEASONINGS. INT. CL. 29. REG. 8-22-1989.
- 1,553,375. XTRA SPACE. INT. CL. 39. REG. 8-22-1989.
- 1,553,377. YOUNG DRIVERS OF AMERICA. INT. CL. 41. REG. 8-22-1989.
- 1,553,378. PROFESSIONAL VOICE PROGRAM. INT. CL. 42. REG. 8-22-1989.
- 1,553,379. BIG & TALL (STYLIZED). INT. CL. 42. REG. 8-22-1989.
- 1,588,505. MISCELLANEOUS DESIGN. INT. CLS. 14 AND 24 ONLY. REG. 3-27-1990.

- 1,623,256. STRAPBINDER. INT. CL. 8 ONLY. REG. 11-20-1990.
- 2,183,213. RAREWARE AND DESIGN. INT. CLS. 9 AND 28. REG. 8-25-1998.
- 2,229,496. CUPID. INT. CL. 33. REG. 3-2-1999.
- 2,236,617. CHUGACH ALASKA AND DESIGN. INT. CL. 31 ONLY. REG. 4-6-1999.
- 2,259,086. CLOUDLAND FILMWORKS, INC.. INT. CL. 41. REG. 7-6-1999.
- 2,271,282. MASTER SCENT SAUCER. INT. CL. 28. REG. 8-24-1999.
- 2,271,288. YALE. INT. CL. 24. REG. 8-24-1999.
- 2,271,291. FRIEND TO FRIEND. INT. CL. 14. REG. 8-24-1999.
- 2,271,294. INDUS. INT. CLS. 37, 41 AND 42. REG. 8-24-1999.
- 2,271,301. YANKEE SPIRITS. INT. CLS. 33 AND 42. REG. 8-24-1999.
- 2,271,304. TRIANT. INT. CLS. 9 AND 42. REG. 8-24-1999.
- 2,271,311. CYBEREUNION. INT. CL. 42. REG. 8-24-1999.
- 2,271,313. CAREPOINT 2000. INT. CL. 42. REG. 8-24-1999.
- 2,271,314. TREASURE CHESTS. INT. CL. 16. REG. 8-24-1999.
- 2,271,321. BIOMED COMM. INT. CL. 5. REG. 8-24-1999.
- 2,271,343. HONEYSWEET. INT. CL. 30. REG. 8-24-1999.
- 2,271,346. RECTICEL. INT. CL. 17. REG. 8-24-1999.
- 2,271,351. CORNER STONES. INT. CL. 19. REG. 8-24-1999.
- 2,271,357. SMART VIEWER. INT. CL. 9. REG. 8-24-1999.
- 2,271,360. V3. INT. CL. 41. REG. 8-24-1999.
- 2,271,366. STUFF'EMS. INT. CL. 30. REG. 8-24-1999.
- 2,271,368. DBS. INT. CLS. 3 AND 16. REG. 8-24-1999.
- 2,271,376. WRITTEN-POLE. INT. CL. 7. REG. 8-24-1999.
- 2,271,383. POURS REMOTE. INT. CLS. 9 AND 42. REG. 8-24-1999.
- 2,271,398. STREAMGUARD. INT. CL. 11. REG. 8-24-1999.
- 2,271,403. MONOBELT. INT. CL. 11. REG. 8-24-1999.
- 2,271,405. ROADWAY PROTECTION AUTO CLUB AND DESIGN. INT. CLS. 35, 36, 37 AND 39. REG. 8-24-1999.
- 2,271,418. CLARKE. INT. CL. 18. REG. 8-24-1999.
- 2,271,430. INTERON. INT. CLS. 7, 11, 17, 20, 37 AND 42. REG. 8-24-1999.
- 2,271,437. LIFETOUCH. INT. CL. 42. REG. 8-24-1999.
- 2,271,445. OVAL TRACK WAREHOUSE. INT. CL. 35. REG. 8-24-1999.
- 2,271,453. FORGET - ME - NOT (STYLIZED). INT. CL. 35. REG. 8-24-1999.
- 2,271,455. DEOS AND DESIGN. INT. CL. 9. REG. 8-24-1999.
- 2,271,456. DEOS. INT. CL. 9. REG. 8-24-1999.
- 2,271,498. THE MEDICAL MUTUAL GROUP AND DESIGN. INT. CL. 36. REG. 8-24-1999.
- 2,271,500. ROTEK AND DESIGN. INT. CL. 40. REG. 8-24-1999.
- 2,271,502. TECHSHOPPER. INT. CL. 42. REG. 8-24-1999.
- 2,271,503. THE PORK STORE CAFE. INT. CL. 42. REG. 8-24-1999.
- 2,271,528. BIOSCIENCE LION AG AND DESIGN. INT. CLS. 1, 9 AND 42. REG. 8-24-1999.
- 2,271,531. AMURA AND DESIGN. INT. CL. 7. REG. 8-24-1999.
- 2,271,536. SLEEPEE-TIME. INT. CL. 20. REG. 8-24-1999.
- 2,271,537. ANIMAL ARK. INT. CL. 16. REG. 8-24-1999.
- 2,271,541. PROMGMT. (STYLIZED). INT. CLS. 9, 16 AND 41. REG. 8-24-1999.
- 2,271,554. COMMERCIAL MANAGER. INT. CL. 9. REG. 8-24-1999.
- 2,271,555. PHILLY TWIST AND DESIGN. INT. CL. 35. REG. 8-24-1999.
- 2,271,573. LUMEX AND DESIGN. INT. CL. 9. REG. 8-24-1999.
- 2,271,578. PREMIER MARKETING SERVICES. INT. CL. 35. REG. 8-24-1999.
- 2,271,583. STEPHEN FULLER AND DESIGN. INT. CLS. 37 AND 42. REG. 8-24-1999.
- 2,271,588. MEADOW HOMES. INT. CLS. 36 AND 37. REG. 8-24-1999.
- 2,271,614. HI-LYSINE. INT. CL. 31. REG. 8-24-1999.
- 2,271,618. ORIGINAL PAW PLEASERS. INT. CLS. 35 AND 42. REG. 8-24-1999.
- 2,271,639. HIGHLAND SUN AND DESIGN. INT. CLS. 9, 25 AND 41. REG. 8-24-1999.
- 2,271,648. AXAPTA. INT. CL. 9. REG. 8-24-1999.
- 2,271,652. MISCELLANEOUS DESIGN. INT. CL. 41. REG. 8-24-1999.
- 2,271,653. MISCELLANEOUS DESIGN. INT. CL. 41. REG. 8-24-1999.
- 2,271,654. EXTENSIS WHERE EMPLOYEES AND BUSINESSES GROW AND DESIGN. INT. CL. 35. REG. 8-24-1999.
- 2,271,656. THE LAWRENCE GROUP. INT. CL. 42. REG. 8-24-1999.
- 2,271,667. MISCELLANEOUS DESIGN. INT. CL. 20. REG. 8-24-1999.
- 2,271,669. EMULSILAC. INT. CL. 1. REG. 8-24-1999.
- 2,271,683. TUFFMATE. INT. CL. 16. REG. 8-24-1999.
- 2,271,712. FORMULATED WITH UVX ULTRA-VIOLET INHIBITOR AND DESIGN. INT. CL. 3. REG. 8-24-1999.
- 2,271,721. CALIFORNIA MATTRESS. INT. CL. 20. REG. 8-24-1999.
- 2,271,722. DRAFTWORLDWIDE AND DESIGN. INT. CL. 35. REG. 8-24-1999.
- 2,271,725. ENB FASTLINK. INT. CL. 36. REG. 8-24-1999.
- 2,271,734. PRODUCT PLANNER. INT. CL. 9. REG. 8-24-1999.
- 2,271,744. EMPIRIANA. INT. CL. 9. REG. 8-24-1999.
- 2,271,745. FLEET ONE GOLD. INT. CL. 35. REG. 8-24-1999.
- 2,271,750. MOBIL SPEEDPASS-THE FASTEST WAY TO GET GAS. INT. CLS. 9 AND 36. REG. 8-24-1999.
- 2,271,771. MARKET CHOICE. INT. CL. 36. REG. 8-24-1999.
- 2,271,773. SPOKE-AD. INT. CL. 12. REG. 8-24-1999.
- 2,271,774. ENVIROSCAPE NEWS. INT. CL. 16. REG. 8-24-1999.
- 2,271,781. RADISSON SEVEN SEAS CRUISES. INT. CL. 39. REG. 8-24-1999.
- 2,271,790. SCOTT'S. INT. CLS. 29 AND 30. REG. 8-24-1999.
- 2,271,792. SANTA JOANA. INT. CL. 33. REG. 8-24-1999.
- 2,271,793. SWINGIN' MEDALLIONS. INT. CL. 41. REG. 8-24-1999.
- 2,271,797. ORIENTAL RUG HOSPITAL. INT. CL. 37. REG. 8-24-1999.
- 2,271,812. SAMO (MORIO). INT. CL. 29. REG. 8-24-1999.
- 2,271,820. MISCELLANEOUS DESIGN. INT. CLS. 35, 36 AND 39. REG. 8-24-1999.
- 2,271,828. TOYS "R" US. INT. CL. 41. REG. 8-24-1999.
- 2,271,844. ZAP-N-SERVE. INT. CL. 30. REG. 8-24-1999.
- 2,271,857. POWER SYSTEMS ENGINEERING, P.S. AND DESIGN. INT. CL. 42. REG. 8-24-1999.
- 2,271,869. FOR THE MOST IMPORTANT MONEY IN THE WORLD. YOURS.. INT. CL. 36. REG. 8-24-1999.
- 2,271,879. PANTASTIC. INT. CL. 21. REG. 8-24-1999.
- 2,271,880. HARRINGTON PARK PRESS. INT. CL. 16. REG. 8-24-1999.
- 2,271,889. NO-BRAINERS. INT. CL. 9. REG. 8-24-1999.
- 2,271,903. MORNINGSTAR. INT. CL. 16. REG. 8-24-1999.
- 2,271,935. HCE HOSPITALITY COMPENSATION EXCHANGE. INT. CL. 42. REG. 8-24-1999.
- 2,271,939. YOUR BEST YEAR YET. INT. CL. 41. REG. 8-24-1999.
- 2,271,942. BRAND ENGINEERING. INT. CL. 35. REG. 8-24-1999.
- 2,271,944. 2X. INT. CL. 41. REG. 8-24-1999.
- 2,271,950. IMPACT BALANCER. INT. CL. 5. REG. 8-24-1999.
- 2,271,956. K AND M ELECTRONICS, INC.. INT. CL. 9. REG. 8-24-1999.
- 2,271,984. THE SPEED ART MUSEUM AND DESIGN. INT. CL. 41. REG. 8-24-1999.
- 2,271,990. M.A.P.S.. INT. CL. 16. REG. 8-24-1999.
- 2,271,994. NIACIN B AND DESIGN. INT. CL. 42. REG. 8-24-1999.
- 2,272,006. CLEARKIL. INT. CL. 5. REG. 8-24-1999.
- 2,272,011. EZ-STRIP. INT. CL. 19. REG. 8-24-1999.
- 2,272,013. ALL CAPS. INT. CL. 25. REG. 8-24-1999.
- 2,272,016. BLANVER'S BEST. INT. CL. 1. REG. 8-24-1999.
- 2,272,020. THERMO-SURE. INT. CL. 17. REG. 8-24-1999.
- 2,272,022. PHYMATCH. INT. CL. 35. REG. 8-24-1999.
- 2,272,028. MSBL MABL AND DESIGN. INT. CL. 41. REG. 8-24-1999.

- 2,272,033. DIAMOND PUMPS AND WATER SYSTEMS. INT. CL. 7. REG. 8-24-1999.
- 2,272,053. BRUNSWICK-BALKE-COLLENDER. INT. CL. 28. REG. 8-24-1999.
- 2,272,055. SR. INT. CL. 3. REG. 8-24-1999.
- 2,272,077. NU-COURT. INT. CL. 2. REG. 8-24-1999.
- 2,272,082. ESTAVAN CRUZ. INT. CL. 34. REG. 8-24-1999.
- 2,272,095. ULTRA GLIDE. INT. CL. 10. REG. 8-24-1999.
- 2,272,097. SONO IMAGE. INT. CL. 10. REG. 8-24-1999.
- 2,272,112. KOOL-GRIP. INT. CL. 9. REG. 8-24-1999.
- 2,272,114. MODIF. INT. CL. 20. REG. 8-24-1999.
- 2,272,119. GROUP ADVANTAGE (STYLIZED). INT. CL. 36. REG. 8-24-1999.
- 2,272,133. THE OXBRIDGE GROUP AND DESIGN. INT. CL. 35. REG. 8-24-1999.
- 2,272,149. LANTREND. INT. CL. 9. REG. 8-24-1999.
- 2,272,155. DEVELOPMENTS. INT. CL. 41. REG. 8-24-1999.
- 2,272,156. RED CELL. INT. CL. 25. REG. 8-24-1999.
- 2,272,162. MAX-D. INT. CL. 10. REG. 8-24-1999.
- 2,272,171. RIB RANCH. INT. CL. 42. REG. 8-24-1999.
- 2,272,172. RIPPLES AND DESIGN. INT. CL. 25. REG. 8-24-1999.
- 2,272,173. NWH (STYLIZED). INT. CL. 42. REG. 8-24-1999.
- 2,272,181. PHAT FARM AND DESIGN. INT. CL. 25. REG. 8-24-1999.
- 2,272,184. KNOWLEDGEOPOLIS. INT. CL. 9. REG. 8-24-1999.
- 2,272,194. MISCELLANEOUS DESIGN. INT. CL. 36. REG. 8-24-1999.
- 2,272,196. RECRUITMAX. INT. CL. 9. REG. 8-24-1999.
- 2,272,208. DURAMYL. INT. CL. 1. REG. 8-24-1999.
- 2,272,212. LOUD'R. INT. CL. 9. REG. 8-24-1999.
- 2,272,233. SPIN CYCLE COIN LAUNDRY AND DESIGN. INT. CL. 37. REG. 8-24-1999.
- 2,272,238. PEERLESSPOWERED. INT. CL. 9. REG. 8-24-1999.
- 2,272,240. EXTENDED GRACE EDITION. INT. CL. 36. REG. 8-24-1999.
- 2,272,263. KID-A-PEEL (STYLIZED). INT. CL. 16. REG. 8-24-1999.
- 2,272,275. BEDS & BRITCHES, ETC.. INT. CL. 42. REG. 8-24-1999.
- 2,272,280. COMVIRTUAL (STYLIZED). INT. CL. 42. REG. 8-24-1999.
- 2,272,281. HEALTHHOUSE. INT. CL. 35. REG. 8-24-1999.
- 2,272,286. NANOGARD. INT. CL. 3. REG. 8-24-1999.
- 2,272,293. MISCELLANEOUS DESIGN. INT. CL. 21. REG. 8-24-1999.
- 2,272,298. CAPITAL FOR KNOWLEDGE. INT. CL. 36. REG. 8-24-1999.
- 2,272,308. THE CORRESPONDING VIEW. INT. CL. 16. REG. 8-24-1999.
- 2,272,315. POWERCAFE. INT. CL. 30. REG. 8-24-1999.
- 2,272,318. FRIENDSHIP GESTURES. INT. CL. 16. REG. 8-24-1999.
- 2,272,334. SKYPORT. INT. CL. 35. REG. 8-24-1999.
- 2,272,336. ROAD & TRACK. INT. CL. 28. REG. 8-24-1999.
- 2,272,338. THE SLIP. INT. CL. 41. REG. 8-24-1999.
- 2,272,339. NATURAL SCIENCES FOR THINKING ANIMALS. INT. CL. 16. REG. 8-24-1999.
- 2,272,346. WE TOP THEM ALL. INT. CL. 35. REG. 8-24-1999.
- 2,272,347. CAMPWAY'S TRUCK ACCESSORY WORLD AND DESIGN. INT. CL. 35. REG. 8-24-1999.
- 2,272,367. YEAH, WE'VE GOT THAT!. INT. CL. 35. REG. 8-24-1999.
- 2,272,376. MISCELLANEOUS DESIGN. INT. CL. 25. REG. 8-24-1999.
- 2,272,377. GUIDANT. INT. CL. 16. REG. 8-24-1999.
- 2,272,378. GUIDANT AND DESIGN. INT. CL. 16. REG. 8-24-1999.
- 2,272,387. DOUBLE HAPPINESS BRAND AND DESIGN. INT. CL. 30. REG. 8-24-1999.
- 2,272,399. MITCHELL (STYLIZED). INT. CL. 28. REG. 8-24-1999.
- 2,272,401. AMERICA'S KITCHEN. INT. CL. 30. REG. 8-24-1999.
- 2,272,404. BRIAN MOORE. INT. CLS. 35, 39 AND 42. REG. 8-24-1999.
- 2,272,406. DESERT SONLIGHT. INT. CL. 3. REG. 8-24-1999.
- 2,272,412. COWBOY BILLY'S. INT. CL. 29. REG. 8-24-1999.
- 2,272,415. HYDE PARK TOWNSMAN. INT. CL. 16. REG. 8-24-1999.
- 2,272,421. MIST OF ALOHA. INT. CL. 3. REG. 8-24-1999.
- 2,272,451. VERANDA. INT. CLS. 36 AND 37. REG. 8-24-1999.
- 2,272,456. EARTH FORCE CAPS. INT. CLS. 16, 41 AND 42. REG. 8-24-1999.
- 2,272,458. H AND DESIGN. INT. CL. 12. REG. 8-24-1999.
- 2,272,459. JJ. INT. CL. 41. REG. 8-24-1999.
- 2,272,468. MICROCORP. INT. CL. 9. REG. 8-24-1999.
- 2,272,480. DIGIPRO DIGITAL PRODUCTIONS AND DESIGN. INT. CL. 38. REG. 8-24-1999.
- 2,272,484. NETBILL. INT. CLS. 9, 35 AND 36. REG. 8-24-1999.
- 2,272,489. FUGA. INT. CL. 21. REG. 8-24-1999.
- 2,272,490. ALLEGRO. INT. CL. 21. REG. 8-24-1999.
- 2,272,494. I LOVE THIS TEAM. INT. CL. 14. REG. 8-24-1999.
- 2,272,496. THE POWER TO GET IN. INT. CL. 9. REG. 8-24-1999.
- 2,272,498. NASACO. INT. CL. 9. REG. 8-24-1999.
- 2,272,506. EDUCIZE. INT. CL. 25. REG. 8-24-1999.
- 2,272,511. JANUS OLYMPUS FUND. INT. CL. 36. REG. 8-24-1999.
- 2,272,516. PAS-5. INT. CL. 38. REG. 8-24-1999.
- 2,272,517. PAS-6. INT. CL. 38. REG. 8-24-1999.
- 2,272,528. SCIENCELINE. INT. CL. 9. REG. 8-24-1999.
- 2,272,535. KANEMITSU BAKERY THE ORIGINAL FAMOUS MOLOKAI BREAD MIX AND DESIGN. INT. CL. 30. REG. 8-24-1999.
- 2,272,536. THE ORIGINAL FAMOUS MOLOKAI SWEET BREAD THE FRIENDLY ISLE'S FINEST KANEMITSU BAKERY AND DESIGN. INT. CL. 30. REG. 8-24-1999.
- 2,272,537. THE FRIENDLY ISLE'S FINEST MOLOKAI ENRICHED BREAD AND DESIGN. INT. CL. 30. REG. 8-24-1999.
- 2,272,544. CARLY. INT. CL. 21. REG. 8-24-1999.
- 2,272,546. DISPATCHER-CS. INT. CL. 9. REG. 8-24-1999.
- 2,272,550. DIAMONDTOWN. INT. CL. 41. REG. 8-24-1999.
- 2,272,551. OPTISCAN. INT. CL. 9. REG. 8-24-1999.
- 2,272,562. EYEMAX. INT. CL. 42. REG. 8-24-1999.
- 2,272,575. LUNCH EXPRESS. INT. CL. 9. REG. 8-24-1999.
- 2,272,583. HISTORY MYSTERIES. INT. CL. 16. REG. 8-24-1999.
- 2,272,587. FREEMAN FITS AMERICA. INT. CL. 25. REG. 8-24-1999.
- 2,272,594. LOGO SOAP. INT. CL. 3. REG. 8-24-1999.
- 2,272,595. FOUR SEASONS HOUSING. INT. CL. 19. REG. 8-24-1999.
- 2,272,622. HEALTH READY. INT. CL. 36. REG. 8-24-1999.
- 2,272,623. POWER STATION. INT. CL. 41. REG. 8-24-1999.
- 2,272,644. UNIGEN. INT. CL. 9. REG. 8-24-1999.
- 2,272,646. M MERIT AND DESIGN. INT. CLS. 9 AND 41. REG. 8-24-1999.
- 2,272,654. IF YOU CAN IMAGINE IT, WE CAN HELP YOU CREATE IT. INT. CLS. 40 AND 42. REG. 8-24-1999.
- 2,272,664. BOTO. INT. CL. 26. REG. 8-24-1999.
- 2,272,667. PRO/E. INT. CL. 9. REG. 8-24-1999.
- 2,272,671. HEALTHY DIRECTIVES. INT. CL. 35. REG. 8-24-1999.
- 2,272,674. HIRE KNOWLEDGE. INT. CL. 9. REG. 8-24-1999.
- 2,272,679. INSANE DEDICATION TO PERFORMANCE. INT. CL. 25. REG. 8-24-1999.
- 2,272,686. LOUISE POMMERY AND DESIGN. INT. CL. 33. REG. 8-24-1999.
- 2,272,689. PIZZA LIKE A PRO. INT. CL. 21. REG. 8-24-1999.
- 2,272,705. INFOVIEW. INT. CL. 9. REG. 8-24-1999.
- 2,272,706. INFOTALK. INT. CL. 9. REG. 8-24-1999.
- 2,272,711. ANSWERS. INT. CL. 25. REG. 8-24-1999.
- 2,272,720. PARTNERS IN MAKING YOUR PRODUCTS BETTER. INT. CLS. 35, 40 AND 42. REG. 8-24-1999.
- 2,272,754. BRADFORD HOMESUITES...THE CURE FOR CABIN FEVER. INT. CL. 42. REG. 8-24-1999.
- 2,272,757. U-WIRE. INT. CL. 42. REG. 8-24-1999.
- 2,272,761. KOA. INT. CL. 39. REG. 8-24-1999.
- 2,272,779. ENCHANTMENT COLLECTION BY BATTAT. INT. CL. 25. REG. 8-24-1999.

- 2,272,780. WM. MOORBY SIGNATURE SERIES. INT. CL. 25. REG. 8-24-1999.
- 2,272,784. LX (STYLIZED). INT. CL. 9. REG. 8-24-1999.
- 2,272,785. TIMES SQUARE 2000 AND DESIGN. INT. CL. 33. REG. 8-24-1999.
- 2,272,786. TIMES SQUARE 2000 AND DESIGN. INT. CL. 14. REG. 8-24-1999.
- 2,272,795. SECOND STREET SECURITIES. INT. CL. 36. REG. 8-24-1999.
- 2,272,820. TYT. INT. CL. 26. REG. 8-24-1999.
- 2,272,843. ROTOVANE (STYLIZED). INT. CL. 7. REG. 8-24-1999.
- 2,272,844. GLOBOMAX. INT. CL. 42. REG. 8-24-1999.
- 2,272,850. T.A.G.I SHELF THAT'S A GOOD IDEA! AND DESIGN. INT. CL. 20. REG. 8-24-1999.
- 2,272,862. LCN. INT. CL. 42. REG. 8-24-1999.
- 2,272,881. LIFESTYLE. INT. CL. 21. REG. 8-24-1999.
- 2,272,889. XENICARE. INT. CL. 42. REG. 8-24-1999.
- 2,272,896. ULTRA-ZORB PLUS. INT. CL. 25. REG. 8-24-1999.
- 2,272,901. ULTRA-ZORB. INT. CL. 25. REG. 8-24-1999.
- 2,272,913. CHERISH AND JOY KIDSTUFF. INT. CLS. 20 AND 24. REG. 8-24-1999.
- 2,272,917. P AND DESIGN. INT. CLS. 9 AND 36. REG. 8-24-1999.
- 2,272,924. PRIME VALUE. INT. CL. 18. REG. 8-24-1999.
- 2,272,929. TAKE YOUR PARENTS TO SCHOOL DAY. INT. CL. 41. REG. 8-24-1999.
- 2,272,932. MAUI ROSE. INT. CL. 9. REG. 8-24-1999.
- 2,272,939. R RIDERS RAYLZ AND DESIGN. INT. CL. 25. REG. 8-24-1999.
- 2,272,941. THE FOR ALL KIDS FOUNDATION AND DESIGN. INT. CL. 36. REG. 8-24-1999.
- 2,272,948. CAMDEN HALL. INT. CL. 20. REG. 8-24-1999.
- 2,272,959. CREATIVE ACCENTS. INT. CL. 26. REG. 8-24-1999.
- 2,272,964. BEAR TRACKER. INT. CL. 12. REG. 8-24-1999.
- 2,272,972. EXPRES (STYLIZED). INT. CL. 14. REG. 8-24-1999.
- 2,272,973. LAWAMERICA. INT. CL. 36. REG. 8-24-1999.
- 2,272,997. THE SIGN OF THE TIMES. INT. CL. 36. REG. 8-24-1999.
- 2,272,998. CERANTO. INT. CL. 25. REG. 8-24-1999.
- 2,273,000. SEBASTIAN SAINT. INT. CL. 14. REG. 8-24-1999.
- 2,273,014. SHOPCOOL. INT. CL. 11. REG. 8-24-1999.
- 2,273,016. VANGUARD GFP. INT. CL. 9. REG. 8-24-1999.
- 2,273,017. LOTS OF TOTS. INT. CL. 41. REG. 8-24-1999.
- 2,273,030. ACTIVA. INT. CL. 9. REG. 8-24-1999.
- 2,273,043. ONE-ROUNDER. INT. CL. 3. REG. 8-24-1999.
- 2,273,048. M AND DESIGN. INT. CL. 14. REG. 8-24-1999.
- 2,273,055. EYE OF PROTECTION. INT. CL. 14. REG. 8-24-1999.
- 2,273,056. UPPER DECK AND DESIGN. INT. CL. 14. REG. 8-24-1999.
- 2,273,067. BRO'S. INT. CL. 30. REG. 8-24-1999.
- 2,273,070. PROFESSIONAL AND DESIGN. INT. CL. 3. REG. 8-24-1999.
- 2,273,072. EXCEL ARCHIVES. INT. CL. 39. REG. 8-24-1999.
- 2,273,085. THUILLIER. INT. CL. 28. REG. 8-24-1999.
- 2,273,093. A WORLD APART. INT. CL. 35. REG. 8-24-1999.
- 2,273,099. BIRDWORKS. INT. CL. 41. REG. 8-24-1999.
- 2,273,101. E-FIRST. INT. CL. 39. REG. 8-24-1999.
- 2,273,104. TOOTH TOWN. INT. CL. 42. REG. 8-24-1999.
- 2,273,114. ICD - INFORMATION CAPITAL DEVELOPMENT. INT. CLS. 35 AND 41. REG. 8-24-1999.
- 2,273,130. ARTECHE. INT. CL. 9. REG. 8-24-1999.
- 2,273,133. INSCRIPTIONS. INT. CL. 14. REG. 8-24-1999.
- 2,273,146. SUBSTANCE FREE KIDS. INT. CL. 16. REG. 8-24-1999.
- 2,273,154. SAND PUTTER. INT. CL. 28. REG. 8-24-1999.
- 2,273,164. ULTIMATE BRAKING POWER. INT. CL. 12. REG. 8-24-1999.
- 2,273,177. A SPLENDID PRODUCT. INT. CL. 31. REG. 8-24-1999.
- 2,273,182. CRISPY'N WHITE. INT. CL. 31. REG. 8-24-1999.
- 2,286,564. ADDING POWER TO ENERGY. INT. CLS. 35, 36 AND 39 ONLY. REG. 10-12-1999.
- 2,286,897. COP...COPINE PARIS AND DESIGN. INT. CLS. 3 AND 18 ONLY. REG. 10-19-1999.
- 2,320,693. PURDY AND DESIGN. INT. CL. 7 ONLY. REG. 2-22-2000.
- 2,330,693. NIKON. INT. CLS. 12, 14 AND 20 ONLY. REG. 3-21-2000.
- 2,335,000. PREMIATA. INT. CL. 18 ONLY. REG. 3-28-2000.
- 2,335,493. SHEENIQUE. INT. CLS. 16 AND 26 ONLY. REG. 3-28-2000.
- 2,336,011. AV AND DESIGN. INT. CLS. 1 AND 9 ONLY. REG. 3-28-2000.
- 2,336,400. SYNOVA. INT. CL. 41 ONLY. REG. 3-28-2000.
- 2,337,085. BWL. INT. CL. 20 ONLY. REG. 4-4-2000.
- 2,338,710. MR. BUBBLE. INT. CL. 28 ONLY. REG. 4-4-2000.
- 2,341,672. INDICHROME. INT. CL. 2 ONLY. REG. 4-11-2000.
- 2,343,009. CHRISTIE LEE. INT. CL. 26 ONLY. REG. 4-18-2000.
- 2,344,271. DEATHTRAP DUNGEON. INT. CL. 41 ONLY. REG. 4-25-2000.
- 2,345,225. DOGEARED. INT. CL. 26 ONLY. REG. 4-25-2000.
- 2,361,245. MISCELLANEOUS DESIGN. INT. CL. 11 ONLY. REG. 6-27-2000.
- 2,368,981. ALLIN. INT. CL. 40 ONLY. REG. 7-18-2000.
- 2,382,225. SIMOREG DC-MASTER. INT. CL. 42 ONLY. REG. 9-5-2000.
- 2,400,057. DEARMOND. INT. CL. 9 ONLY. REG. 10-31-2000.
- 2,414,152. GOLDDLOCKS. INT. CL. 32 ONLY. REG. 12-19-2000.
- 2,608,022. DAXX. INT. CL. 9. REG. 8-13-2002.
- 2,681,659. BREYERS AND DESIGN. INT. CL. 35. REG. 1-28-2003.
- 2,715,133. CST. INT. CLS. 1 AND 5 ONLY. REG. 5-13-2003.
- 2,727,303. CYBERGRASP. INT. CL. 9. REG. 6-17-2003.
- 2,729,361. TELLURIDE CLOTHING COMPANY. INT. CL. 18 ONLY. REG. 6-24-2003.
- 2,751,532. CARLA CARINI. INT. CL. 3. REG. 8-19-2003.
- 2,751,534. CARINISSIMA (STYLIZED). INT. CLS. 3, 18 AND 25. REG. 8-19-2003.
- 2,751,538. VIPER. INT. CL. 7. REG. 8-19-2003.
- 2,751,539. B (STYLIZED). INT. CLS. 9, 18, 25 AND 28. REG. 8-19-2003.
- 2,751,541. BPB AND DESIGN. INT. CLS. 6, 16, 17 AND 19. REG. 8-19-2003.
- 2,751,542. R RALEIGH NOTTINGHAM ENGLAND AND DESIGN. INT. CLS. 9, 14, 18 AND 25. REG. 8-19-2003.
- 2,751,545. FITNESS FOR THE LINKS. INT. CL. 41. REG. 8-19-2003.
- 2,751,546. PRE-PAK-ITS. INT. CL. 5. REG. 8-19-2003.
- 2,751,548. VOICELINK AND DESIGN. INT. CL. 38. REG. 8-19-2003.
- 2,751,555. TAMTEC. INT. CLS. 5, 10, 35 AND 40. REG. 8-19-2003.
- 2,751,561. SYMBIO LACT (STYLIZED). INT. CLS. 5, 29 AND 30. REG. 8-19-2003.
- 2,751,563. LORUS. INT. CLS. 5, 35, 40 AND 42. REG. 8-19-2003.
- 2,751,564. MISCELLANEOUS DESIGN. INT. CL. 12. REG. 8-19-2003.
- 2,751,565. AROMABABY. INT. CL. 3. REG. 8-19-2003.
- 2,751,568. MISCELLANEOUS DESIGN. INT. CL. 3. REG. 8-19-2003.
- 2,751,569. C-DILLA (STYLIZED). INT. CLS. 9, 16 AND 42. REG. 8-19-2003.
- 2,751,571. MISCELLANEOUS DESIGN. INT. CL. 12. REG. 8-19-2003.
- 2,751,573. AIRPILOTMASK. INT. CL. 10. REG. 8-19-2003.
- 2,751,574. TONIGUY.COM. INT. CL. 3. REG. 8-19-2003.
- 2,751,575. RASAR. INT. CL. 9. REG. 8-19-2003.
- 2,751,576. TOPIC (STYLIZED). INT. CLS. 5 AND 10. REG. 8-19-2003.
- 2,751,581. R.I.E.MPP AND DESIGN. INT. CLS. 7, 9, 11, 37 AND 42. REG. 8-19-2003.
- 2,751,582. FRONTLINE COMMUNICATIONS CORP.. INT. CLS. 35, 38 AND 42. REG. 8-19-2003.
- 2,751,586. ALA CARTE NETWORK. INT. CL. 43. REG. 8-19-2003.
- 2,751,587. CN EL FERROCARRIL DE AMERICA DEL NORTE (STYLIZED). INT. CLS. 9, 16, 35, 38, 39 AND 42. REG. 8-19-2003.

- 2,751,589. XDI. INT. CL. 42. REG. 8-19-2003.
 2,751,591. AVATION (STYLIZED). INT. CL. 35. REG. 8-19-2003.
 2,751,592. SHU AND DESIGN. INT. CLS. 41 AND 42. REG. 8-19-2003.
 2,751,593. RAGING SOURS. INT. CL. 30. REG. 8-19-2003.
 2,751,594. HUBBELL FAST FLEX. INT. CL. 9. REG. 8-19-2003.
 2,751,596. MISCELLANEOUS DESIGN. INT. CL. 3. REG. 8-19-2003.
 2,751,597. BACK TO BASICS. INT. CLS. 12 AND 28. REG. 8-19-2003.
 2,751,599. MONACOR. INT. CLS. 9, 11 AND 15. REG. 8-19-2003.
 2,751,600. M MONACOR AND DESIGN. INT. CLS. 9, 11 AND 15. REG. 8-19-2003.
 2,751,601. SHOEGEAR AND DESIGN. INT. CL. 9. REG. 8-19-2003.
 2,751,602. X10 AND DESIGN. INT. CL. 9. REG. 8-19-2003.
 2,751,606. COMMUNITY CENTS. INT. CL. 35. REG. 8-19-2003.
 2,751,607. JEAN PIERRE FLEURIMON (STYLIZED). INT. CLS. 3, 41 AND 42. REG. 8-19-2003.
 2,751,609. GYM JAM AND DESIGN. INT. CLS. 25 AND 41. REG. 8-19-2003.
 2,751,610. STRAW TRACK. INT. CL. 7. REG. 8-19-2003.
 2,751,612. YOUR FAVOURITES. INT. CL. 16. REG. 8-19-2003.
 2,751,613. SYMBIOS CAPITAL AND DESIGN. INT. CLS. 35, 36, 38 AND 42. REG. 8-19-2003.
 2,751,614. TRAVEL BLENDING. INT. CLS. 39 AND 41. REG. 8-19-2003.
 2,751,615. EXUSIA ENTERPRISES. INT. CL. 36. REG. 8-19-2003.
 2,751,616. O. INT. CL. 30. REG. 8-19-2003.
 2,751,617. EZ CARD. INT. CL. 9. REG. 8-19-2003.
 2,751,618. SUPPORT COURT (STYLIZED). INT. CLS. 9 AND 35. REG. 8-19-2003.
 2,751,619. OUR TECHNOLOGY SETS US APART. OUR PEOPLE SET US ABOVE.. INT. CL. 36. REG. 8-19-2003.
 2,751,620. NEW ORGANICS CO. MIND BODY SPIRIT AND DESIGN. INT. CLS. 29, 30 AND 32. REG. 8-19-2003.
 2,751,625. PHOENIX PHARMACEUTICAL, INC.. INT. CL. 5. REG. 8-19-2003.
 2,751,626. SUREFLOW. INT. CL. 9. REG. 8-19-2003.
 2,751,629. SERIOUS & FUN. INT. CL. 9. REG. 8-19-2003.
 2,751,630. CODIQUANT. INT. CL. 9. REG. 8-19-2003.
 2,751,631. EARTHAVEN. INT. CL. 9. REG. 8-19-2003.
 2,751,634. SPEED PART. INT. CL. 9. REG. 8-19-2003.
 2,751,635. FRANGI. INT. CLS. 18 AND 24. REG. 8-19-2003.
 2,751,637. AC PRIME. INT. CL. 42. REG. 8-19-2003.
 2,751,638. ACTIVATOR AND DESIGN. INT. CL. 9. REG. 8-19-2003.
 2,751,639. IASTORE.COM AND DESIGN. INT. CL. 35. REG. 8-19-2003.
 2,751,640. CALIFORNIA STREET RODS AND DESIGN. INT. CL. 40. REG. 8-19-2003.
 2,751,641. SHING'S JEWELRY & ACCESORIES AND DESIGN. INT. CL. 40. REG. 8-19-2003.
 2,751,642. FCIA SECURE ACCOUNTS. INT. CL. 36. REG. 8-19-2003.
 2,751,646. MISCELLANEOUS DESIGN. INT. CL. 3. REG. 8-19-2003.
 2,751,647. VBH (STYLIZED). INT. CL. 3. REG. 8-19-2003.
 2,751,653. CLUB EMERALD. INT. CL. 35. REG. 8-19-2003.
 2,751,654. CARD-IAC-PHONE. INT. CL. 10. REG. 8-19-2003.
 2,751,656. SCHAFER AND DESIGN. INT. CLS. 6, 9, 11 AND 20. REG. 8-19-2003.
 2,751,657. CESSAL. INT. CL. 5. REG. 8-19-2003.
 2,751,658. SOBERAL. INT. CL. 5. REG. 8-19-2003.
 2,751,662. DUNE. INT. CLS. 12, 28 AND 37. REG. 8-19-2003.
 2,751,663. FREEDOM FOR MANAGED APPLICATIONS. INT. CL. 42. REG. 8-19-2003.
 2,751,664. LINGUINATOR. INT. CL. 42. REG. 8-19-2003.
 2,751,667. MEDIORAMA. INT. CLS. 9 AND 42. REG. 8-19-2003.
 2,751,669. MISCELLANEOUS DESIGN. INT. CL. 41. REG. 8-19-2003.
 2,751,672. 20/20 SPEECH. INT. CL. 9. REG. 8-19-2003.
 2,751,674. MISCELLANEOUS DESIGN. INT. CL. 9. REG. 8-19-2003.
 2,751,675. FOX VALLEY CENTER. INT. CLS. 35 AND 36. REG. 8-19-2003.
 2,751,677. CENTURY CITY SHOPPING CENTER. INT. CLS. 35 AND 36. REG. 8-19-2003.
 2,751,678. HIDITV (STYLIZED). INT. CL. 9. REG. 8-19-2003.
 2,751,679. TFG SPORTS AND DESIGN. INT. CLS. 18, 25 AND 28. REG. 8-19-2003.
 2,751,680. AQUAPET. INT. CL. 9. REG. 8-19-2003.
 2,751,681. WAPCON. INT. CLS. 35, 38 AND 42. REG. 8-19-2003.
 2,751,682. MISCELLANEOUS DESIGN. INT. CL. 33. REG. 8-19-2003.
 2,751,686. PEAKSTONE EASSURANCE. INT. CLS. 9, 35 AND 42. REG. 8-19-2003.
 2,751,689. DEUTSCHE POST WEBTRANSFER AND DESIGN. INT. CLS. 35, 36, 38, 39, 41 AND 42. REG. 8-19-2003.
 2,751,690. TARGETED GENETICS AND DESIGN. INT. CL. 5. REG. 8-19-2003.
 2,751,692. OMNIPLUS SELECTBUS AND DESIGN. INT. CLS. 12, 36, 37 AND 39. REG. 8-19-2003.
 2,751,694. MISSEL KOMPAKT-ELEMENT WASCHTISCH AND DESIGN. INT. CLS. 6, 11 AND 17. REG. 8-19-2003.
 2,751,696. FLYING SUSHI. INT. CL. 42. REG. 8-19-2003.
 2,751,699. CRITIQUEME.COM. INT. CL. 41. REG. 8-19-2003.
 2,751,701. GLINDRA. INT. CLS. 9, 16 AND 42. REG. 8-19-2003.
 2,751,702. FULFILLMENT FUND. INT. CL. 36. REG. 8-19-2003.
 2,751,703. POWERED BY Q. INT. CLS. 35 AND 36. REG. 8-19-2003.
 2,751,704. INFORMATION AT HAND. INT. CL. 42. REG. 8-19-2003.
 2,751,705. CATWALKCAFE. INT. CLS. 25 AND 42. REG. 8-19-2003.
 2,751,707. SPACE THEIMAGINATIONSTATION AND DESIGN. INT. CL. 41. REG. 8-19-2003.
 2,751,708. KHAN SAMSUNG PRO-GAME TEAM AND DESIGN. INT. CL. 35. REG. 8-19-2003.
 2,751,710. IDENTEC SOLUTIONS. INT. CL. 9. REG. 8-19-2003.
 2,751,713. META-RATH. INT. CLS. 5, 16 AND 32. REG. 8-19-2003.
 2,751,715. OMEGA 2. INT. CL. 9. REG. 8-19-2003.
 2,751,719. CASTELLO. INT. CLS. 29 AND 30. REG. 8-19-2003.
 2,751,720. RUMBLE LASERWORKS. INT. CLS. 9 AND 40. REG. 8-19-2003.
 2,751,721. RUMBLE VARISIST. INT. CLS. 9 AND 40. REG. 8-19-2003.
 2,751,722. RUMBLE HYPERCUT. INT. CLS. 9 AND 40. REG. 8-19-2003.
 2,751,723. SAM'S AND DESIGN. INT. CL. 9. REG. 8-19-2003.
 2,751,724. NEW CHOICE SYMBOL OF QUALITY AND DESIGN. INT. CL. 29. REG. 8-19-2003.
 2,751,726. SOLISILK. INT. CL. 20. REG. 8-19-2003.
 2,751,727. CHANNEL ENGINE. INT. CL. 35. REG. 8-19-2003.
 2,751,728. COOL WORKS.COM. INT. CL. 35. REG. 8-19-2003.
 2,751,730. PARADIGM GLOBAL ADVISORS. INT. CL. 36. REG. 8-19-2003.
 2,751,731. GPTA. INT. CL. 9. REG. 8-19-2003.
 2,751,732. HI BIKE AND DESIGN. INT. CLS. 11 AND 12. REG. 8-19-2003.
 2,751,735. AUTOMATIC MEETINGS. INT. CL. 38. REG. 8-19-2003.
 2,751,737. LI'L PEACH AND DESIGN. INT. CLS. 29 AND 32. REG. 8-19-2003.
 2,751,738. MIOTEC. INT. CLS. 9, 16, 40 AND 42. REG. 8-19-2003.
 2,751,741. IQ SOLUTIONS AND DESIGN. INT. CL. 35. REG. 8-19-2003.
 2,751,742. MISCELLANEOUS DESIGN. INT. CL. 42. REG. 8-19-2003.

- 2,751,743. BUSINESS-FOR-LIFE. INT. CL. 35. REG. 8-19-2003.
- 2,751,744. PRIMA. INT. CL. 3. REG. 8-19-2003.
- 2,751,745. WHITE. INT. CL. 12. REG. 8-19-2003.
- 2,751,746. INITIATOR. INT. CL. 31. REG. 8-19-2003.
- 2,751,750. COPA. INT. CL. 3. REG. 8-19-2003.
- 2,751,752. MOVE PERKS AND DESIGN. INT. CL. 36. REG. 8-19-2003.
- 2,751,754. IMA INSTITUTE FOR MANAGEMENT ALTRAN AND DESIGN. INT. CLS. 41 AND 42. REG. 8-19-2003.
- 2,751,756. ROOF IN A BOX. INT. CLS. 6 AND 19. REG. 8-19-2003.
- 2,751,757. MISCELLANEOUS DESIGN. INT. CL. 14. REG. 8-19-2003.
- 2,751,758. DIADORA PASSIONE ITALIANA AND DESIGN. INT. CLS. 18, 25 AND 28. REG. 8-19-2003.
- 2,751,759. PASSIONE TOTALE. INT. CLS. 18, 25 AND 28. REG. 8-19-2003.
- 2,751,762. ELAREF. INT. CL. 5. REG. 8-19-2003.
- 2,751,763. SPIRAL SAW. INT. CL. 7. REG. 8-19-2003.
- 2,751,764. MISCELLANEOUS DESIGN. INT. CLS. 11, 12, 20, 21, 27 AND 28. REG. 8-19-2003.
- 2,751,766. REVOLUTION. INT. CL. 36. REG. 8-19-2003.
- 2,751,767. UNITED GOVERNMENT SERVICES. INT. CLS. 35 AND 45. REG. 8-19-2003.
- 2,751,768. O.H.P. BEACONS. INT. CL. 9. REG. 8-19-2003.
- 2,751,772. BREUSS GEMUSESFTMISCHUNG. INT. CL. 32. REG. 8-19-2003.
- 2,751,773. MARBOND. INT. CLS. 9 AND 11. REG. 8-19-2003.
- 2,751,774. MISCELLANEOUS DESIGN. INT. CLS. 9 AND 16. REG. 8-19-2003.
- 2,751,776. NM STATE AND DESIGN. INT. CL. 41. REG. 8-19-2003.
- 2,751,777. VIRBAGEN. INT. CL. 5. REG. 8-19-2003.
- 2,751,778. STYLIS. INT. CL. 9. REG. 8-19-2003.
- 2,751,779. EGERY. INT. CLS. 9, 12, 37, 38, 39, 41 AND 42. REG. 8-19-2003.
- 2,751,780. PHOTO CURE AND DESIGN. INT. CL. 5. REG. 8-19-2003.
- 2,751,781. ADMIRA. INT. CL. 35. REG. 8-19-2003.
- 2,751,783. BEAUTIFY YOUR GARDEN, SIMPLIFY YOUR LIFE. INT. CL. 19. REG. 8-19-2003.
- 2,751,784. "LA PARESSE EN DOUCE" (STYLIZED). INT. CLS. 3, 24 AND 25. REG. 8-19-2003.
- 2,751,786. POWERFUL FUTURE. INT. CLS. 7, 9, 11, 16, 35, 37 AND 42. REG. 8-19-2003.
- 2,751,787. BANC OF AMERICA SECURITIES AND DESIGN. INT. CL. 36. REG. 8-19-2003.
- 2,751,788. SWINGER. INT. CLS. 9, 35 AND 41. REG. 8-19-2003.
- 2,751,789. VLX2010. INT. CL. 9. REG. 8-19-2003.
- 2,751,790. VLXSIGHT. INT. CL. 9. REG. 8-19-2003.
- 2,751,792. SPITFIRE NUN AND DESIGN. INT. CL. 41. REG. 8-19-2003.
- 2,751,793. ASTEIO. INT. CL. 35. REG. 8-19-2003.
- 2,751,795. LEARNING LODGE AND DESIGN. INT. CL. 41. REG. 8-19-2003.
- 2,751,796. MIVAS. INT. CL. 10. REG. 8-19-2003.
- 2,751,797. NUMTEL. INT. CLS. 35 AND 36. REG. 8-19-2003.
- 2,751,798. IN DEFENSE OF GENIUS. INT. CL. 42. REG. 8-19-2003.
- 2,751,799. SKINTRONICS. INT. CLS. 3, 5 AND 38. REG. 8-19-2003.
- 2,751,800. RISO FINO AND DESIGN. INT. CL. 30. REG. 8-19-2003.
- 2,751,803. SOMEWHERE BETWEEN THE WHITE PICKET FENCE AND THE BOARDROOM. INT. CL. 41. REG. 8-19-2003.
- 2,751,808. THE FRIENDLY TUMBLER. INT. CL. 7. REG. 8-19-2003.
- 2,751,810. JUNE. INT. CLS. 35 AND 39. REG. 8-19-2003.
- 2,751,812. SMALLSCRIPT. INT. CL. 9. REG. 8-19-2003.
- 2,751,813. STERIOLOC. INT. CL. 10. REG. 8-19-2003.
- 2,751,814. V VALLI & VALLI L'ARREDOBAGNO AND DESIGN. INT. CLS. 11, 20 AND 21. REG. 8-19-2003.
- 2,751,815. KWIK KOPY PRINTING AND DESIGN. INT. CL. 16. REG. 8-19-2003.
- 2,751,816. EL CORCEL. INT. CL. 29. REG. 8-19-2003.
- 2,751,817. GEARMANAGER.COM. INT. CL. 9. REG. 8-19-2003.
- 2,751,819. MISCELLANEOUS DESIGN. INT. CL. 33. REG. 8-19-2003.
- 2,751,820. DRSPOCK AND DESIGN. INT. CL. 16. REG. 8-19-2003.
- 2,751,821. POOLIA AND DESIGN. INT. CLS. 16, 35 AND 41. REG. 8-19-2003.
- 2,751,823. HASH HOUSE A GO GO CRAIG "ANDY" BEARDSLEE AND DESIGN. INT. CL. 42. REG. 8-19-2003.
- 2,751,824. THE FAST PROGRAM. INT. CL. 41. REG. 8-19-2003.
- 2,751,827. B AND DESIGN. INT. CLS. 35 AND 36. REG. 8-19-2003.
- 2,751,828. B AND DESIGN. INT. CLS. 35 AND 36. REG. 8-19-2003.
- 2,751,830. MISCELLANEOUS DESIGN. INT. CL. 3. REG. 8-19-2003.
- 2,751,831. PRIVANZA. INT. CL. 36. REG. 8-19-2003.
- 2,751,832. TEXAS SHARPS RIFLE CO.. INT. CL. 13. REG. 8-19-2003.
- 2,751,833. ENTERPRISE MERCHANDISE & SVC. AND DESIGN. INT. CL. 35. REG. 8-19-2003.
- 2,751,836. ATLANTIS FOUNDRIES. INT. CLS. 6, 7 AND 40. REG. 8-19-2003.
- 2,751,837. APALEXO. INT. CL. 5. REG. 8-19-2003.
- 2,751,838. VINCI PARK AND DESIGN. INT. CL. 39. REG. 8-19-2003.
- 2,751,840. READ AND COLOR ME AGAIN AND AGAIN. INT. CL. 16. REG. 8-19-2003.
- 2,751,841. PACKSTAFF, LLC. INT. CL. 35. REG. 8-19-2003.
- 2,751,842. COLOR ME AGAIN AND AGAIN. INT. CL. 16. REG. 8-19-2003.
- 2,751,845. APPLICATION SERVICES LIBRARY ASL AND DESIGN. INT. CLS. 35, 38, 41 AND 42. REG. 8-19-2003.
- 2,751,846. EQUESTRIAN (STYLIZED). INT. CL. 3. REG. 8-19-2003.
- 2,751,849. B 150. INT. CLS. 12, 28 AND 37. REG. 8-19-2003.
- 2,751,850. DESIGNER ALLEY AND DESIGN. INT. CL. 25. REG. 8-19-2003.
- 2,751,851. BANA. INT. CL. 34. REG. 8-19-2003.
- 2,751,853. MISCELLANEOUS DESIGN. INT. CL. 40. REG. 8-19-2003.
- 2,751,854. BIGSKY AIRLINES. INT. CL. 39. REG. 8-19-2003.
- 2,751,855. MR. BASEBALL. INT. CL. 28. REG. 8-19-2003.
- 2,751,857. ARNOLDO MONDADORI EDITORE. INT. CLS. 9, 16, 35, 38 AND 41. REG. 8-19-2003.
- 2,751,858. PERLE MONDE. INT. CL. 18. REG. 8-19-2003.
- 2,751,859. 7 P.M.. INT. CLS. 16 AND 36. REG. 8-19-2003.
- 2,751,860. KOH-TAO AND DESIGN. INT. CLS. 9, 14 AND 25. REG. 8-19-2003.
- 2,751,862. VIBO AND DESIGN. INT. CLS. 11, 21 AND 28. REG. 8-19-2003.
- 2,751,863. RIGHTEMPLOYEE. INT. CL. 35. REG. 8-19-2003.
- 2,751,864. UNICORN. INT. CLS. 9, 35 AND 42. REG. 8-19-2003.
- 2,751,865. "ASK FOR THE ORANGE BOX" PRO-WIRE SONNY THE ORANGE BOXER... HE CONNECTS EVERY TIME. AND DESIGN. INT. CL. 9. REG. 8-19-2003.
- 2,751,866. THE BODY IMAGE CLINIC AND DESIGN. INT. CL. 42. REG. 8-19-2003.
- 2,751,867. SUPERICE AND DESIGN. INT. CLS. 3 AND 4. REG. 8-19-2003.
- 2,751,868. SCHOTT COMPONENTS (STYLIZED). INT. CLS. 9 AND 21. REG. 8-19-2003.
- 2,751,873. MISCELLANEOUS DESIGN. INT. CLS. 9 AND 25. REG. 8-19-2003.
- 2,751,880. SIEMENS KNOWLEDGE INTERCHANGE NETWORK AND DESIGN. INT. CLS. 35 AND 41. REG. 8-19-2003.
- 2,751,883. TEGENERO AND DESIGN. INT. CLS. 5, 35 AND 42. REG. 8-19-2003.

- 2,751,884. GENGAUGE. INT. CL. 9. REG. 8-19-2003.
 2,751,885. B BASEFINANCIERA.COM AND DESIGN. INT. CL. 38. REG. 8-19-2003.
 2,751,888. STAREM. INT. CL. 2. REG. 8-19-2003.
 2,751,892. CULTURE & FAMILY INSTITUTE AND DESIGN. INT. CL. 41. REG. 8-19-2003.
 2,751,893. GIGAENERGY (STYLIZED). INT. CL. 9. REG. 8-19-2003.
 2,751,894. EXTRUSION IS MORE. INT. CLS. 7, 9 AND 42. REG. 8-19-2003.
 2,751,897. SEATTLE HOME CAKES ALL YOUR FAVORITES! AND DESIGN. INT. CL. 30. REG. 8-19-2003.
 2,751,898. SEXENGINE. INT. CL. 42. REG. 8-19-2003.
 2,751,903. MISCELLANEOUS DESIGN. INT. CL. 9. REG. 8-19-2003.
 2,751,907. FORENSICS EXPLORERS. INT. CLS. 9, 35, 41 AND 42. REG. 8-19-2003.
 2,751,908. AVEAL. INT. CLS. 25 AND 28. REG. 8-19-2003.
 2,751,909. ALL AMERICAN SNACK HEAVENLY TRASH AND DESIGN. INT. CL. 30. REG. 8-19-2003.
 2,751,910. LIFE BRITE AND DESIGN. INT. CL. 11. REG. 8-19-2003.
 2,751,918. HAWKES AND DESIGN. INT. CLS. 7 AND 35. REG. 8-19-2003.
 2,751,919. ADIMA. INT. CLS. 35, 37, 39, 41 AND 42. REG. 8-19-2003.
 2,751,922. RAY'S NEW YORK BAGELS. INT. CL. 30. REG. 8-19-2003.
 2,751,923. POST EXPRESS FLYGIRLS AND DESIGN. INT. CLS. 35 AND 39. REG. 8-19-2003.
 2,751,924. LINE-ARC. INT. CL. 9. REG. 8-19-2003.
 2,751,927. EKWAL. INT. CL. 9. REG. 8-19-2003.
 2,751,928. ELASTOPLAST. INT. CLS. 5 AND 10. REG. 8-19-2003.
 2,751,932. JUKEBOX HEROES. INT. CL. 41. REG. 8-19-2003.
 2,751,933. INDIA GROCERS IG WE TRUST IN GOD AND DESIGN. INT. CL. 30. REG. 8-19-2003.
 2,751,937. MISCELLANEOUS DESIGN. INT. CL. 42. REG. 8-19-2003.
 2,751,938. MERRILL LYNCH PREFERRED BROKER PROGRAM. INT. CL. 36. REG. 8-19-2003.
 2,751,939. TEENCHAT.NET. INT. CL. 38. REG. 8-19-2003.
 2,751,940. COGNIGENPC (STYLIZED). INT. CL. 35. REG. 8-19-2003.
 2,751,941. PAGRIT. INT. CLS. 1, 5 AND 42. REG. 8-19-2003.
 2,751,942. BLUE RIDGE MOTION PICTURES AND DESIGN. INT. CL. 41. REG. 8-19-2003.
 2,751,943. NO CUT AND DESIGN. INT. CL. 10. REG. 8-19-2003.
 2,751,944. DEMI QUALT ACID (STYLIZED). INT. CL. 3. REG. 8-19-2003.
 2,751,945. NEXTEL COMPATIBLE AND DESIGN. INT. CL. 38. REG. 8-19-2003.
 2,751,949. RELATIONCHECK. INT. CLS. 9, 41 AND 42. REG. 8-19-2003.
 2,751,950. PST PRIAMUS SYSTEM TECHNOLOGIES AND DESIGN. INT. CL. 42. REG. 8-19-2003.
 2,751,953. VEST (STYLIZED). INT. CL. 10. REG. 8-19-2003.
 2,751,954. TIME TRAVELER. INT. CL. 41. REG. 8-19-2003.
 2,751,956. DECORCOTE. INT. CL. 19. REG. 8-19-2003.
 2,751,957. TWA. INT. CL. 16. REG. 8-19-2003.
 2,751,958. MISCELLANEOUS DESIGN. INT. CLS. 25 AND 28. REG. 8-19-2003.
 2,751,959. WIRELESS IT MANAGEMENT NOW. INT. CL. 9. REG. 8-19-2003.
 2,751,960. WILD THANG. INT. CLS. 25 AND 28. REG. 8-19-2003.
 2,751,963. MIRACLE HOMME LANCOME AND DESIGN. INT. CL. 3. REG. 8-19-2003.
 2,751,966. BSP REPORT MANAGEMENT SYSTEM BSP-RM (STYLIZED). INT. CL. 16. REG. 8-19-2003.
 2,751,967. BSP JOB SCHEDULING SYSTEM BSP-JS (STYLIZED). INT. CL. 16. REG. 8-19-2003.
 2,751,968. PESI (STYLIZED). INT. CLS. 9, 16 AND 41. REG. 8-19-2003.
 2,751,970. FOSTER (STYLIZED). INT. CLS. 7 AND 12. REG. 8-19-2003.
 2,751,971. PIZZA BEAR AND DESIGN. INT. CLS. 39 AND 43. REG. 8-19-2003.
 2,751,972. APLYXAR. INT. CL. 5. REG. 8-19-2003.
 2,751,973. HILLS OF GALILEE AND DESIGN. INT. CL. 3. REG. 8-19-2003.
 2,751,974. EYEDA SYSTEMS (STYLIZED). INT. CL. 9. REG. 8-19-2003.
 2,751,977. COLLO (STYLIZED). INT. CL. 25. REG. 8-19-2003.
 2,751,982. VINEYARD MUSIC. INT. CL. 41. REG. 8-19-2003.
 2,751,983. BE WISE-BE TRAINED. INT. CL. 41. REG. 8-19-2003.
 2,751,985. ALAIN TONDOWSKI. INT. CL. 25. REG. 8-19-2003.
 2,751,986. LEOPARDO AND DESIGN. INT. CL. 21. REG. 8-19-2003.
 2,751,987. COOPER. INT. CL. 29. REG. 8-19-2003.
 2,751,988. IMPERIAL MOTION BOARD THERDS AND DESIGN. INT. CL. 25. REG. 8-19-2003.
 2,751,991. MAKING GOD'S WORD STICK IN THE HEARTS OF CHILDREN. INT. CL. 16. REG. 8-19-2003.
 2,751,992. CRYSTAL FIRE. INT. CL. 14. REG. 8-19-2003.
 2,751,993. BACTOSCAN. INT. CL. 9. REG. 8-19-2003.
 2,751,995. FLORA QUEST INT. AND DESIGN. INT. CL. 31. REG. 8-19-2003.
 2,751,996. FLORA QUEST INT.. INT. CL. 31. REG. 8-19-2003.
 2,751,999. EVERLOCK AXLES AND DESIGN. INT. CL. 28. REG. 8-19-2003.
 2,752,000. MOLLY DARCY'S AND DESIGN. INT. CL. 25. REG. 8-19-2003.
 2,752,001. @ANYMAP (STYLIZED). INT. CL. 9. REG. 8-19-2003.
 2,752,002. NS. INT. CLS. 25 AND 28. REG. 8-19-2003.
 2,752,003. NEVER SUMMER. INT. CLS. 25 AND 28. REG. 8-19-2003.
 2,752,004. C 28. INT. CLS. 12, 28 AND 37. REG. 8-19-2003.
 2,752,006. PROTEKTOR AND DESIGN. INT. CL. 6. REG. 8-19-2003.
 2,752,007. GUINEVERE'S GARDEN. INT. CLS. 16 AND 35. REG. 8-19-2003.
 2,752,011. NEXT. INT. CL. 41. REG. 8-19-2003.
 2,752,013. B BANTREE AND DESIGN. INT. CL. 9. REG. 8-19-2003.
 2,752,014. NEWCOLOR (STYLIZED). INT. CL. 9. REG. 8-19-2003.
 2,752,016. N NOVODIETA AND DESIGN. INT. CLS. 5 AND 35. REG. 8-19-2003.
 2,752,017. ART BUILDS COMMUNITY! AND DESIGN. INT. CLS. 35 AND 36. REG. 8-19-2003.
 2,752,018. MISCELLANEOUS DESIGN. INT. CL. 25. REG. 8-19-2003.
 2,752,019. SMA AND DESIGN. INT. CL. 40. REG. 8-19-2003.
 2,752,022. IE INTERACTIVE EDGE AND DESIGN. INT. CL. 9. REG. 8-19-2003.
 2,752,023. IMAGINE AUDIO "IMAGINE YOUR PASSION" (STYLIZED). INT. CL. 9. REG. 8-19-2003.
 2,752,024. STANLEY CAPITAL MORTGAGE. INT. CL. 36. REG. 8-19-2003.
 2,752,026. LIQUIDCOLD. INT. CL. 1. REG. 8-19-2003.
 2,752,031. MICHELADAS MICHE MIX ESPECIAL AND DESIGN. INT. CL. 30. REG. 8-19-2003.
 2,752,038. ENGINEERED FROM THE GROUND UP. INT. CLS. 37 AND 42. REG. 8-19-2003.
 2,752,039. MEYER BROS. DAIRY. INT. CLS. 29 AND 30. REG. 8-19-2003.
 2,752,040. NATURAL GAS THE ENERGY OF BUSINESS. INT. CLS. 35 AND 39. REG. 8-19-2003.
 2,752,043. DREAM GARAGE. INT. CL. 35. REG. 8-19-2003.
 2,752,046. AGENTS OF HOPE. INT. CL. 36. REG. 8-19-2003.
 2,752,048. GO HUMANS. INT. CLS. 16, 35 AND 41. REG. 8-19-2003.
 2,752,050. OPTIMANCE. INT. CLS. 35 AND 41. REG. 8-19-2003.
 2,752,051. STAGE I (STYLIZED). INT. CL. 11. REG. 8-19-2003.
 2,752,052. EXCALIBUR MEDICAL IMAGING. INT. CL. 44. REG. 8-19-2003.
 2,752,053. NO DRAWING-SENSORY MARK. INT. CL. 5. REG. 8-19-2003.

- 2,752,055. THE BEAUTY DIET. INT. CL. 44. REG. 8-19-2003.
2,752,057. ASFORY. INT. CL. 35. REG. 8-19-2003.
2,752,058. STAGE II (STYLIZED). INT. CL. 11. REG. 8-19-2003.
2,752,059. PCR AND DESIGN. INT. CL. 42. REG. 8-19-2003.
2,752,064. INNEOV. INT. CLS. 3 AND 5. REG. 8-19-2003.
2,752,067. TOOLS FOR LIFE EDUCATION FOR EMPOWERMENT. INT. CL. 41. REG. 8-19-2003.
2,752,070. SUPRAQ. INT. CL. 10. REG. 8-19-2003.
2,752,072. BEST MILK AND DESIGN. INT. CL. 3. REG. 8-19-2003.
2,752,073. DR. RATH'S JUNIOR FORMULA. INT. CLS. 5, 30 AND 32. REG. 8-19-2003.
2,752,074. DR. RATH'S VITACOR FORMULA. INT. CLS. 5, 30 AND 32. REG. 8-19-2003.
2,752,076. SILK FLOSS AND DESIGN. INT. CL. 21. REG. 8-19-2003.
2,752,077. SHRT/CTS. INT. CL. 25. REG. 8-19-2003.
2,752,080. DIPS-KEY. INT. CL. 8. REG. 8-19-2003.
2,752,081. MAXX-BAY. INT. CL. 19. REG. 8-19-2003.
2,752,086. COLLEGEXIT.COM. INT. CLS. 35 AND 36. REG. 8-19-2003.
2,752,088. SEETOURS. INT. CLS. 3, 12, 14, 16, 18, 25, 28, 30, 32, 33, 39, 41, 42, 43 AND 44. REG. 8-19-2003.
2,752,090. ANORGANICA. INT. CLS. 35 AND 41. REG. 8-19-2003.
2,752,094. STERI. INT. CL. 10. REG. 8-19-2003.
2,752,097. REVENUE SECURITY. INT. CL. 36. REG. 8-19-2003.
2,752,098. CERTI-MED. INT. CL. 36. REG. 8-19-2003.
2,752,099. CARNAL. INT. CL. 1. REG. 8-19-2003.
2,752,104. KID CALL ALERT AND DESIGN. INT. CL. 16. REG. 8-19-2003.
2,752,109. SIMPLY PLANT. INT. CL. 31. REG. 8-19-2003.
2,752,111. MISCELLANEOUS DESIGN. INT. CL. 9. REG. 8-19-2003.
2,752,113. RE-STORATION. INT. CL. 3. REG. 8-19-2003.
2,752,114. THE ORIGINAL FLYING FLOCK. INT. CL. 28. REG. 8-19-2003.
2,752,115. TRUCKING DUCK AND DESIGN. INT. CL. 36. REG. 8-19-2003.
2,752,116. CIPI CERTIFIED INVESTIGATIVE PROFESSIONALS INC. AND DESIGN. INT. CL. 41. REG. 8-19-2003.
2,752,118. COMPENSATION DESIGN GROUP AND DESIGN. INT. CL. 35. REG. 8-19-2003.
2,752,122. STRICTLY ADDITIONS AND DESIGN. INT. CL. 37. REG. 8-19-2003.
2,752,123. STRICTLY ADDITIONS. INT. CL. 37. REG. 8-19-2003.
2,752,124. SPTD. INT. CL. 5. REG. 8-19-2003.
2,752,125. LASYNAC. INT. CL. 5. REG. 8-19-2003.
2,752,126. LASUCH (STYLIZED). INT. CL. 32. REG. 8-19-2003.
2,752,128. VERDAGIO. INT. CL. 5. REG. 8-19-2003.
2,752,130. ETS TECHNOLOGIES. INT. CL. 41. REG. 8-19-2003.
2,752,132. MCART PRO AND DESIGN. INT. CL. 42. REG. 8-19-2003.
2,752,133. GENEBACT. INT. CL. 42. REG. 8-19-2003.
2,752,135. REPAIR WIZARD AND DESIGN. INT. CL. 37. REG. 8-19-2003.
2,752,139. HPL. INT. CLS. 9, 41 AND 42. REG. 8-19-2003.
2,752,142. DECORIZE. INT. CL. 35. REG. 8-19-2003.
2,752,145. THE CROSSOVER BRIDGE. INT. CL. 35. REG. 8-19-2003.
2,752,146. VERQUIN CONFISEUR AND DESIGN. INT. CL. 30. REG. 8-19-2003.
2,752,148. CONWAY GOLD AND DESIGN. INT. CL. 34. REG. 8-19-2003.
2,752,149. MISCELLANEOUS DESIGN. INT. CL. 34. REG. 8-19-2003.
2,752,151. 700. INT. CL. 7. REG. 8-19-2003.
2,752,152. THE MARKETING WEDGE. INT. CL. 36. REG. 8-19-2003.
2,752,153. BOLCHOJ. INT. CL. 3. REG. 8-19-2003.
2,752,155. MURRAY'S JEWELRY. INT. CL. 35. REG. 8-19-2003.
2,752,157. BODYKI AND DESIGN. INT. CL. 41. REG. 8-19-2003.
2,752,158. XPOINT. INT. CL. 9. REG. 8-19-2003.
2,752,161. FANATIC. INT. CL. 3. REG. 8-19-2003.
2,752,163. WHEELSURE. INT. CL. 12. REG. 8-19-2003.
2,752,164. DOGS AFIELD AND DESIGN. INT. CL. 35. REG. 8-19-2003.
2,752,165. DOGS AFIELD. INT. CL. 35. REG. 8-19-2003.
2,752,166. GENBLEND. INT. CL. 1. REG. 8-19-2003.
2,752,170. JAZZ MANAGEMENT. INT. CL. 35. REG. 8-19-2003.
2,752,173. ECH AND DESIGN. INT. CL. 25. REG. 8-19-2003.
2,752,174. BONSAI NETWORKS AND DESIGN. INT. CL. 38. REG. 8-19-2003.
2,752,175. WEILIS AND DESIGN. INT. CL. 1. REG. 8-19-2003.
2,752,177. FONEFIX AND DESIGN. INT. CL. 37. REG. 8-19-2003.
2,752,178. TENOX COD. INT. CL. 7. REG. 8-19-2003.
2,752,180. WLUC. INT. CL. 38. REG. 8-19-2003.
2,752,184. ASHER'S ORGANIC AND DESIGN. INT. CL. 30. REG. 8-19-2003.
2,752,186. EVENSEED. INT. CL. 21. REG. 8-19-2003.
2,752,187. BOONDOGGLES. INT. CLS. 35 AND 43. REG. 8-19-2003.
2,752,189. ADE WWW.ADULTDVDEMPIRE.COM AND DESIGN. INT. CL. 35. REG. 8-19-2003.
2,752,190. AMMBIT. INT. CLS. 35 AND 41. REG. 8-19-2003.
2,752,191. THE CENTER FOR INSTITUTIONAL EFFECTIVENESS AND DESIGN. INT. CL. 41. REG. 8-19-2003.
2,752,192. THE CENTER FOR INSTITUTIONAL EFFECTIVENESS AND DESIGN. INT. CL. 35. REG. 8-19-2003.
2,752,194. HLD. INT. CL. 19. REG. 8-19-2003.
2,752,197. THE GUN TAILOR. INT. CL. 37. REG. 8-19-2003.
2,752,199. LOS DOS GRANDES DE LA SIERRA. INT. CL. 41. REG. 8-19-2003.
2,752,200. O-RINGS, INC. AND DESIGN. INT. CL. 17. REG. 8-19-2003.
2,752,201. SURROUNDER. INT. CL. 9. REG. 8-19-2003.
2,752,202. OMNIPLUS. INT. CLS. 11, 14, 16, 25 AND 28. REG. 8-19-2003.
2,752,205. RHEYRAIL. INT. CL. 9. REG. 8-19-2003.
2,752,206. ASPECTA SPIRIT AND SOLUTIONS. INT. CLS. 35, 36 AND 42. REG. 8-19-2003.
2,752,211. PRINCETON SOFTECH'S ARCHIVE. INT. CL. 9. REG. 8-19-2003.
2,752,212. BUGS STEVENS FREETOWN AUTO PARTS. INT. CL. 35. REG. 8-19-2003.
2,752,214. ACTIVE ALLIANCE. INT. CL. 42. REG. 8-19-2003.
2,752,216. RAY AND DESIGN. INT. CL. 40. REG. 8-19-2003.
2,752,219. YAMANOUCHI. INT. CL. 5. REG. 8-19-2003.
2,752,221. TIRE PRESSURE AT A GLANCE - FOR A SAFER RIDE. INT. CL. 9. REG. 8-19-2003.
2,752,222. REAL WOOD FURNITURE FINISHED YOUR WAY AND DESIGN. INT. CL. 42. REG. 8-19-2003.
2,752,224. QUALITY MILK AND DESIGN. U.S. CL. A. REG. 8-19-2003.
2,752,225. SILVER CHECK. INT. CLS. 3 AND 35. REG. 8-19-2003.
2,752,228. IDYLL (STYLIZED). INT. CL. 14. REG. 8-19-2003.
2,752,230. BODIE-HOOVER. INT. CLS. 1 AND 4. REG. 8-19-2003.
2,752,231. MES-CXX. INT. CL. 9. REG. 8-19-2003.
2,752,235. A AND DESIGN. INT. CL. 37. REG. 8-19-2003.
2,752,236. GE AND DESIGN. INT. CLS. 17 AND 19. REG. 8-19-2003.
2,752,238. PHILADELPHIA CRUISE TERMINAL AT PIER 1. INT. CLS. 39 AND 43. REG. 8-19-2003.
2,752,241. PATCO AND DESIGN. INT. CL. 39. REG. 8-19-2003.
2,752,242. MALLFORMS. INT. CLS. 6 AND 19. REG. 8-19-2003.
2,752,243. MYDYN DNS. INT. CL. 42. REG. 8-19-2003.
2,752,244. T AND DESIGN. INT. CL. 42. REG. 8-19-2003.
2,752,245. TIRO. INT. CL. 42. REG. 8-19-2003.

- 2,752,246. TIRO T AND DESIGN. INT. CL. 42. REG. 8-19-2003.
- 2,752,248. IPLAN. INT. CLS. 36 AND 44. REG. 8-19-2003.
- 2,752,249. THE VEIN DOCTOR AND DESIGN. INT. CL. 44. REG. 8-19-2003.
- 2,752,252. LAPTOP PJS. INT. CL. 9. REG. 8-19-2003.
- 2,752,260. MEAN DOG AND DESIGN. INT. CL. 9. REG. 8-19-2003.
- 2,752,264. KINDER SURPRISE. INT. CL. 30. REG. 8-19-2003.
- 2,752,267. FUELSMART. INT. CL. 35. REG. 8-19-2003.
- 2,752,269. TRITON PRESTIGE PRODUCTS. INT. CL. 30. REG. 8-19-2003.
- 2,752,272. PHOTONICSFIBER.COM. INT. CLS. 35 AND 42. REG. 8-19-2003.
- 2,752,278. NOLS AND DESIGN. INT. CL. 41. REG. 8-19-2003.
- 2,752,281. YUMMY MIAMI AND DESIGN. INT. CLS. 29 AND 35. REG. 8-19-2003.
- 2,752,282. KNOW WHAT YOU HAVE. PROTECT WHAT YOU KNOW.. INT. CLS. 36 AND 45. REG. 8-19-2003.
- 2,752,283. CRAB CRAZY!. INT. CL. 43. REG. 8-19-2003.
- 2,752,284. TEGGLASS. INT. CL. 19. REG. 8-19-2003.
- 2,752,285. LE SUMMIT (STYLIZED). INT. CL. 9. REG. 8-19-2003.
- 2,752,288. AVALON. INT. CL. 10. REG. 8-19-2003.
- 2,752,294. THE RESERVE PADDOCK. INT. CL. 33. REG. 8-19-2003.
- 2,752,297. BASE PREP REVOLUTIONARY MICROWAX AND DESIGN. INT. CL. 28. REG. 8-19-2003.
- 2,752,299. MISCELLANEOUS DESIGN. INT. CL. 42. REG. 8-19-2003.
- 2,752,300. OPTIMAX. INT. CL. 16. REG. 8-19-2003.
- 2,752,304. LIVE ABOVE IT ALL. INT. CL. 36. REG. 8-19-2003.
- 2,752,307. PLANET WOBBLE. INT. CLS. 9 AND 16. REG. 8-19-2003.
- 2,752,309. VASTAC. INT. CLS. 37 AND 42. REG. 8-19-2003.
- 2,752,311. GUNWALKER RADIO CONTROLLED MINI RFV SERIES AND DESIGN. INT. CL. 28. REG. 8-19-2003.
- 2,752,312. GUNROLLER MULTI DIRECTION RC GROUND MOVER AND DESIGN. INT. CL. 28. REG. 8-19-2003.
- 2,752,315. J (STYLIZED). INT. CLS. 32 AND 33. REG. 8-19-2003.
- 2,752,316. J AND DESIGN. INT. CLS. 32 AND 33. REG. 8-19-2003.
- 2,752,317. DEFYWIRE. INT. CL. 9. REG. 8-19-2003.
- 2,752,319. AMERICAN BEAUTY HEALTHY HARVEST. INT. CL. 30. REG. 8-19-2003.
- 2,752,323. IZA-BOA. INT. CL. 25. REG. 8-19-2003.
- 2,752,327. ESI ELECTRIC SWITCHES AND DESIGN. INT. CL. 35. REG. 8-19-2003.
- 2,752,328. EIWISS CHEMICAL CORPORATION AND DESIGN. INT. CL. 1. REG. 8-19-2003.
- 2,752,329. SAFE TAG. INT. CL. 6. REG. 8-19-2003.
- 2,752,330. YOGA BOOTY BALLET. INT. CL. 41. REG. 8-19-2003.
- 2,752,334. NON-STOP TRAINING AND DESIGN. INT. CLS. 10, 16 AND 28. REG. 8-19-2003.
- 2,752,335. SAM'S SEAFOOD. INT. CLS. 29 AND 31. REG. 8-19-2003.
- 2,752,336. NTESTER. INT. CL. 9. REG. 8-19-2003.
- 2,752,337. LIGHTWAVE EUROPE. INT. CL. 16. REG. 8-19-2003.
- 2,752,340. EPM. INT. CLS. 42 AND 45. REG. 8-19-2003.
- 2,752,341. THE ANNUITY MACHINE SYSTEM. INT. CL. 9. REG. 8-19-2003.
- 2,752,342. LORIS HEALTHCARE SYSTEM. INT. CL. 44. REG. 8-19-2003.
- 2,752,343. REMODELERS GUILD AND DESIGN. INT. CL. 37. REG. 8-19-2003.
- 2,752,345. WELLESLEY INNS & SUITES AND DESIGN. INT. CL. 43. REG. 8-19-2003.
- 2,752,347. AIROX. INT. CL. 17. REG. 8-19-2003.
- 2,752,348. G REIT AND DESIGN. INT. CLS. 35 AND 36. REG. 8-19-2003.
- 2,752,351. MISCELLANEOUS DESIGN. INT. CL. 3. REG. 8-19-2003.
- 2,752,352. WE MAKE YOU SOUND BRILLIANT. INT. CL. 41. REG. 8-19-2003.
- 2,752,355. GLOBOND. INT. CL. 35. REG. 8-19-2003.
- 2,752,356. LIGHT N POWERFUL AND DESIGN. INT. CL. 7. REG. 8-19-2003.
- 2,752,358. CLAREMONT COURIER. INT. CL. 16. REG. 8-19-2003.
- 2,752,361. TECHNANOLOGY. INT. CL. 6. REG. 8-19-2003.
- 2,752,362. MATH TRIPS. INT. CL. 16. REG. 8-19-2003.
- 2,752,364. IMMUNE CARE 64. INT. CL. 5. REG. 8-19-2003.
- 2,752,365. WORK, MIRACLES INTERMOUNTAIN HEALTH CARE A LIFETIME OF CAREER CHOICES. AND DESIGN. INT. CL. 35. REG. 8-19-2003.
- 2,752,366. WHERE YOUR DREAM JEWELS BECOME REALITY!. INT. CL. 35. REG. 8-19-2003.
- 2,752,367. WATER SNOOP. INT. CL. 9. REG. 8-19-2003.
- 2,752,368. CARSON INDUSTRIES. INT. CLS. 6, 19 AND 20. REG. 8-19-2003.
- 2,752,369. KING OF THE AIR. INT. CL. 41. REG. 8-19-2003.
- 2,752,370. A-WAY FROM PAIN AND DESIGN. INT. CL. 16. REG. 8-19-2003.
- 2,752,374. THE ARIZONA BREAD COMPANY. INT. CLS. 35 AND 43. REG. 8-19-2003.
- 2,752,377. DP AND DESIGN. INT. CLS. 16 AND 35. REG. 8-19-2003.
- 2,752,379. TALKING MINI. INT. CL. 28. REG. 8-19-2003.
- 2,752,381. RCN BUSINESS AND DESIGN. INT. CLS. 38 AND 42. REG. 8-19-2003.
- 2,752,384. FITZBRADSHAWRACING. INT. CL. 41. REG. 8-19-2003.
- 2,752,386. TOYOFLO. INT. CLS. 22 AND 23. REG. 8-19-2003.
- 2,752,388. CUSTOM CLOSETS INC. AND DESIGN. INT. CLS. 37 AND 42. REG. 8-19-2003.
- 2,752,389. PIALISH. INT. CL. 41. REG. 8-19-2003.
- 2,752,393. SILESIA. INT. CLS. 3, 29, 30, 32 AND 33. REG. 8-19-2003.
- 2,752,394. SILESIA AND DESIGN. INT. CLS. 3, 29, 30, 32 AND 33. REG. 8-19-2003.
- 2,752,395. HEAD TO TOES FOR BEAR CUBS OF ALL AGES. INT. CL. 3. REG. 8-19-2003.
- 2,752,396. HRDE. INT. CL. 35. REG. 8-19-2003.
- 2,752,398. DEI AN NBTY SUBSIDIARY AND DESIGN. INT. CL. 5. REG. 8-19-2003.
- 2,752,399. SUNNYTRIPS.COM. INT. CL. 43. REG. 8-19-2003.
- 2,752,400. SECUR-KEEPER. INT. CL. 18. REG. 8-19-2003.
- 2,752,402. F. INT. CL. 31. REG. 8-19-2003.
- 2,752,404. STYLECAM. INT. CL. 9. REG. 8-19-2003.
- 2,752,407. GLOBAL SOLUTIONS - FOR THE LIFE OF YOUR PRODUCT. INT. CLS. 35, 39, 40 AND 42. REG. 8-19-2003.
- 2,752,408. QUICK'S OLDE FASHION CANDY AND DESIGN. INT. CL. 30. REG. 8-19-2003.
- 2,752,409. COLOMBINE (STYLIZED). INT. CLS. 9 AND 16. REG. 8-19-2003.
- 2,752,410. WIZKIDS (STYLIZED). INT. CL. 16. REG. 8-19-2003.
- 2,752,411. REGIS ADVANTAGE PROGRAM. INT. CL. 41. REG. 8-19-2003.
- 2,752,412. FREEDOM ELEVEN THINGS THAT MAKE US... (STYLIZED). INT. CL. 25. REG. 8-19-2003.
- 2,752,413. ROCOCO. INT. CL. 30. REG. 8-19-2003.
- 2,752,414. AUTOCOUNT. INT. CLS. 16 AND 35. REG. 8-19-2003.
- 2,752,415. THE CHRISTMAS LIGHT COMPANY AND DESIGN. INT. CL. 37. REG. 8-19-2003.
- 2,752,418. LD LINK DEPOT (STYLIZED). INT. CL. 9. REG. 8-19-2003.
- 2,752,419. GEARS GAMES & GADGETS EXPO AND DESIGN. INT. CL. 35. REG. 8-19-2003.
- 2,752,424. LAMP DEPOT. INT. CL. 35. REG. 8-19-2003.
- 2,752,428. DATA COMM ELECTRONICS AND DESIGN. INT. CL. 9. REG. 8-19-2003.
- 2,752,429. VANTAGE POINT OF VIEW. INT. CL. 16. REG. 8-19-2003.
- 2,752,430. LETCH. INT. CL. 41. REG. 8-19-2003.

- 2,752,432. FELICITY'S BIRTHDAY TEA. INT. CL. 43. REG. 8-19-2003.
- 2,752,433. DALLAS SALADS. INT. CLS. 29 AND 30. REG. 8-19-2003.
- 2,752,434. KYBA BENEFITS. INT. CLS. 35 AND 36. REG. 8-19-2003.
- 2,752,435. KYBA BENEFITS ...KNOW YOUR BENEFIT ALTERNATIVES AND DESIGN. INT. CLS. 35 AND 36. REG. 8-19-2003.
- 2,752,437. MARIA BUENAS NOCHES (STYLIZED). INT. CL. 3. REG. 8-19-2003.
- 2,752,439. DON'T YOU MOVE, DO YOUR THING, ALL YOU NEED IS CHICKEN WING KING. INT. CL. 43. REG. 8-19-2003.
- 2,752,440. WILD MEDICINE. INT. CL. 5. REG. 8-19-2003.
- 2,752,441. BRIDGELINE QUALITY INTERNET SOLUTIONS AND DESIGN. INT. CLS. 9 AND 42. REG. 8-19-2003.
- 2,752,442. TIGERAIR AND DESIGN. INT. CL. 37. REG. 8-19-2003.
- 2,752,443. PROTX. INT. CL. 40. REG. 8-19-2003.
- 2,752,444. BARCLAY PRODUCTS LIMITED AND DESIGN. INT. CL. 11. REG. 8-19-2003.
- 2,752,447. CANNONBILT. INT. CL. 41. REG. 8-19-2003.
- 2,752,449. CLASSIC GOURMET SMALL BALE (STYLIZED). INT. CL. 31. REG. 8-19-2003.
- 2,752,452. BOBBLE KIDS. INT. CL. 20. REG. 8-19-2003.
- 2,752,454. EC PURCHASING AND DESIGN. INT. CL. 35. REG. 8-19-2003.
- 2,752,457. BATTERIES INCLUDED. INT. CLS. 35 AND 38. REG. 8-19-2003.
- 2,752,458. TOCRIS. INT. CL. 1. REG. 8-19-2003.
- 2,752,459. TREASURE CRISPS. INT. CL. 30. REG. 8-19-2003.
- 2,752,462. PREMIUM LENSES OUTSTANDING PROFITS. INT. CL. 35. REG. 8-19-2003.
- 2,752,463. GENERATION OF PRAISE. INT. CL. 41. REG. 8-19-2003.
- 2,752,464. POOCHIE PALS. INT. CLS. 18 AND 24. REG. 8-19-2003.
- 2,752,465. DRI-EDGE. INT. CL. 25. REG. 8-19-2003.
- 2,752,466. PERFORMAX PLAN BUILDER. INT. CLS. 35 AND 36. REG. 8-19-2003.
- 2,752,467. SCROLLTOONS. INT. CL. 16. REG. 8-19-2003.
- 2,752,468. RAMSEEKER. INT. CL. 35. REG. 8-19-2003.
- 2,752,469. SEC ASSOCIATES. INT. CL. 42. REG. 8-19-2003.
- 2,752,470. BRITE. INT. CL. 16. REG. 8-19-2003.
- 2,752,471. LIKWIDART. INT. CL. 16. REG. 8-19-2003.
- 2,752,474. POINT & VOTE. INT. CL. 9. REG. 8-19-2003.
- 2,752,478. URBAN INDEMAND PAY-PER-VIEW AND DESIGN. INT. CL. 41. REG. 8-19-2003.
- 2,752,479. CINEMA INDEMAND PAY-PER-VIEW AND DESIGN. INT. CL. 41. REG. 8-19-2003.
- 2,752,481. XPRESS (STYLIZED). INT. CL. 1. REG. 8-19-2003.
- 2,752,483. JOSEFINA'S BIRTHDAY TEA. INT. CL. 43. REG. 8-19-2003.
- 2,752,484. BUTTER CLASSIC. INT. CL. 31. REG. 8-19-2003.
- 2,752,487. KOA ADVANTAGE. INT. CL. 36. REG. 8-19-2003.
- 2,752,488. DO-ALL TRAPS. INT. CL. 13. REG. 8-19-2003.
- 2,752,491. OKW ORIGINAL KIDS WEAR AND DESIGN. INT. CL. 25. REG. 8-19-2003.
- 2,752,495. UNKNOWN EATER. INT. CL. 41. REG. 8-19-2003.
- 2,752,496. BIZCYCLE. INT. CL. 42. REG. 8-19-2003.
- 2,752,497. NEWS TALK 860 KPAM AND DESIGN. INT. CL. 41. REG. 8-19-2003.
- 2,752,499. "SEARCHING, FINDING, GUIDING" AND DESIGN. INT. CL. 44. REG. 8-19-2003.
- 2,752,500. SCENT STOMPER. INT. CL. 25. REG. 8-19-2003.
- 2,752,503. NYSE THE WORLD PUTS ITS STOCK IN US AND DESIGN. INT. CLS. 18, 21 AND 25. REG. 8-19-2003.
- 2,752,505. LEGENDARY GAME. INT. CL. 25. REG. 8-19-2003.
- 2,752,506. A DOSE OF THE GHOST. INT. CL. 41. REG. 8-19-2003.
- 2,752,509. SR AND DESIGN. INT. CL. 36. REG. 8-19-2003.
- 2,752,510. SCREAM TOUR. INT. CL. 41. REG. 8-19-2003.
- 2,752,511. K/P/L AND DESIGN. INT. CL. 35. REG. 8-19-2003.
- 2,752,513. PUREBED PREMIUM HORSE BEDDING AND DESIGN. INT. CL. 31. REG. 8-19-2003.
- 2,752,514. REGAL DOWNS PREMIUM HORSE BEDDING AND DESIGN. INT. CL. 31. REG. 8-19-2003.
- 2,752,516. HORN INTERACTIVE. INT. CL. 42. REG. 8-19-2003.
- 2,752,518. TCF THE COSTUME FACTORY AND DESIGN. INT. CL. 40. REG. 8-19-2003.
- 2,752,520. VIOLA. INT. CL. 19. REG. 8-19-2003.
- 2,752,521. W WELLLANE AND DESIGN. INT. CL. 7. REG. 8-19-2003.
- 2,752,522. ROTO-LOK. INT. CL. 7. REG. 8-19-2003.
- 2,752,523. BLAZE'N. INT. CL. 12. REG. 8-19-2003.
- 2,752,528. EAT'EM-UP. INT. CL. 31. REG. 8-19-2003.
- 2,752,529. MISCELLANEOUS DESIGN. INT. CL. 9. REG. 8-19-2003.
- 2,752,530. SOLEIL ROSE. INT. CL. 25. REG. 8-19-2003.
- 2,752,531. MAINLINE CONFIRMS STREP A DOTS. INT. CL. 5. REG. 8-19-2003.
- 2,752,533. PARK WEST AT SEA. INT. CL. 35. REG. 8-19-2003.
- 2,752,534. MOO'S ANGELS. INT. CL. 16. REG. 8-19-2003.
- 2,752,536. CARBS AWAY SHAKE. INT. CLS. 5 AND 29. REG. 8-19-2003.
- 2,752,537. MISCELLANEOUS DESIGN. INT. CL. 16. REG. 8-19-2003.
- 2,752,538. NORTHERN VIRGINIA DAILY. INT. CL. 16. REG. 8-19-2003.
- 2,752,539. LIFE INSURANCE BLUEPRINT. INT. CL. 36. REG. 8-19-2003.
- 2,752,540. YNB (STYLIZED). INT. CL. 36. REG. 8-19-2003.
- 2,752,541. AMERICA WORKS BECAUSE WOMEN WORK!. INT. CL. 35. REG. 8-19-2003.
- 2,752,544. IT'S COOL TO BE CONNECTED. INT. CL. 9. REG. 8-19-2003.
- 2,752,545. MISCELLANEOUS DESIGN. INT. CL. 43. REG. 8-19-2003.
- 2,752,546. DIGITHONG. INT. CL. 9. REG. 8-19-2003.
- 2,752,550. TAILORIST. INT. CL. 24. REG. 8-19-2003.
- 2,752,552. WE KNOW GIRLS. INT. CL. 35. REG. 8-19-2003.
- 2,752,553. FULACRYAL. INT. CL. 17. REG. 8-19-2003.
- 2,752,554. RESOUND AND DESIGN. INT. CL. 42. REG. 8-19-2003.
- 2,752,556. GAMEROOMGIANT.COM. INT. CL. 35. REG. 8-19-2003.
- 2,752,557. GAMEROOMGIANT. INT. CL. 35. REG. 8-19-2003.
- 2,752,559. PRIAZUL. INT. CL. 1. REG. 8-19-2003.
- 2,752,560. DOWN. INT. CL. 41. REG. 8-19-2003.
- 2,752,562. POSHING. INT. CL. 9. REG. 8-19-2003.
- 2,752,563. IDEA EXCELLENCE ACCOUNTABILITY INNOVATION DESIRE TO ENRICH LIVES AND DESIGN. INT. CL. 42. REG. 8-19-2003.
- 2,752,565. PRAESIDIUM. INT. CL. 36. REG. 8-19-2003.
- 2,752,569. RIDGEFIELD'S. INT. CL. 32. REG. 8-19-2003.
- 2,752,571. BEHOLD HIS GLORY, INC. AND DESIGN. INT. CL. 24. REG. 8-19-2003.
- 2,752,573. WASTOID. INT. CL. 41. REG. 8-19-2003.
- 2,752,576. RE:AB. INT. CL. 25. REG. 8-19-2003.
- 2,752,577. DIGITAL CONTRAST (STYLIZED). INT. CL. 35. REG. 8-19-2003.
- 2,752,578. FERAL. INT. CL. 25. REG. 8-19-2003.
- 2,752,579. THE BRIGHTSTAR DIAMOND. INT. CL. 14. REG. 8-19-2003.
- 2,752,581. STIR THE AIR. INT. CLS. 18 AND 25. REG. 8-19-2003.
- 2,752,584. AEROCD. INT. CL. 9. REG. 8-19-2003.
- 2,752,585. WIRED FOR EXCELLENCE. INT. CL. 44. REG. 8-19-2003.
- 2,752,587. ITEMSTOR. INT. CL. 9. REG. 8-19-2003.
- 2,752,593. GARDEN STATE AQUATICS. INT. CL. 35. REG. 8-19-2003.
- 2,752,599. BASICLUX RECORDS. INT. CL. 9. REG. 8-19-2003.
- 2,752,609. WHERE ALL POINTS MEET. INT. CLS. 37, 38 AND 42. REG. 8-19-2003.
- 2,752,610. SONEXIS AND DESIGN. INT. CLS. 37, 38 AND 42. REG. 8-19-2003.
- 2,752,611. SHORREXPRESS. INT. CL. 35. REG. 8-19-2003.

- 2,752,613. THE TERCET GROUP, LLC. INT. CL. 35. REG. 8-19-2003.
- 2,752,615. MALIK SIGMA PSI FRATERNITY, INC.. INT. CL. 45. REG. 8-19-2003.
- 2,752,616. MISCELLANEOUS DESIGN. INT. CL. 41. REG. 8-19-2003.
- 2,752,619. ITB. INT. CL. 42. REG. 8-19-2003.
- 2,752,623. MISCELLANEOUS DESIGN. INT. CLS. 41 AND 44. REG. 8-19-2003.
- 2,752,625. SG PRO. INT. CL. 36. REG. 8-19-2003.
- 2,752,626. "FULFILLING THE GREAT COMMISSION. MAKING YOUR VISION OUR MISSION.". INT. CL. 35. REG. 8-19-2003.
- 2,752,627. DANGER MEN GOLFING AND DESIGN. INT. CL. 28. REG. 8-19-2003.
- 2,752,635. I.T. SALES BOOT CAMP. (STYLIZED). INT. CL. 41. REG. 8-19-2003.
- 2,752,637. KISS. INT. CL. 20. REG. 8-19-2003.
- 2,752,638. KISS AND DESIGN. INT. CL. 20. REG. 8-19-2003.
- 2,752,641. TOTE-A-BALE. INT. CL. 20. REG. 8-19-2003.
- 2,752,643. LISTQWIK. INT. CL. 35. REG. 8-19-2003.
- 2,752,652. EMW. INT. CL. 41. REG. 8-19-2003.
- 2,752,654. MATCHMAN. INT. CL. 16. REG. 8-19-2003.
- 2,752,655. E-Z QUAD. INT. CL. 28. REG. 8-19-2003.
- 2,752,656. G.I. JOE. INT. CL. 28. REG. 8-19-2003.
- 2,752,657. LOOKS ON LOCATION. INT. CL. 44. REG. 8-19-2003.
- 2,752,659. DJ WRECK. INT. CL. 41. REG. 8-19-2003.
- 2,752,660. MODERN BRIDE BOSTON. INT. CL. 16. REG. 8-19-2003.
- 2,752,661. ESTARI AND DESIGN. INT. CL. 9. REG. 8-19-2003.
- 2,752,662. A PEACEFUL COMPANY (STYLIZED). INT. CL. 35. REG. 8-19-2003.
- 2,752,663. MODERN BRIDE MARYLAND. INT. CL. 16. REG. 8-19-2003.
- 2,752,664. MODERN BRIDE NEW JERSEY. INT. CL. 16. REG. 8-19-2003.
- 2,752,665. PATRICIA KENT STUDIO. INT. CL. 16. REG. 8-19-2003.
- 2,752,666. PAPERLESS RECORDER. INT. CL. 9. REG. 8-19-2003.
- 2,752,667. MODERN BRIDE WASHINGTON. INT. CL. 16. REG. 8-19-2003.
- 2,752,668. RETAIL RUNS BETTER WITH US. INT. CL. 9. REG. 8-19-2003.
- 2,752,669. ASK INDYME. INT. CL. 9. REG. 8-19-2003.
- 2,752,671. SUN ORTHODONTIC CENTER. INT. CL. 44. REG. 8-19-2003.
- 2,752,674. LIFE BALANCE FOR WEIGHT LOSS. INT. CL. 44. REG. 8-19-2003.
- 2,752,675. THE NETWORKING GUY. INT. CL. 16. REG. 8-19-2003.
- 2,752,676. TB AND DESIGN. INT. CLS. 9 AND 41. REG. 8-19-2003.
- 2,752,677. SCENTS GALORE. INT. CL. 3. REG. 8-19-2003.
- 2,752,679. PEOPLE GET THE GOVERNMENT THEY DESERVE. INT. CL. 35. REG. 8-19-2003.
- 2,752,680. ALOKSAK. INT. CL. 16. REG. 8-19-2003.
- 2,752,682. FEDERAL FULFILLMENT. INT. CL. 35. REG. 8-19-2003.
- 2,752,684. TEPPER TOPPER (STYLIZED). INT. CL. 21. REG. 8-19-2003.
- 2,752,687. PAYMER. INT. CLS. 9 AND 36. REG. 8-19-2003.
- 2,752,690. SHAMIM. INT. CL. 29. REG. 8-19-2003.
- 2,752,691. WORLDVIEW INTERACTIVE. INT. CL. 9. REG. 8-19-2003.
- 2,752,693. SINGLEHANDED. INT. CL. 9. REG. 8-19-2003.
- 2,752,697. G & S AUTO & MUFFLER. INT. CL. 37. REG. 8-19-2003.
- 2,752,698. MANEN. INT. CL. 35. REG. 8-19-2003.
- 2,752,701. CASTLE CREST. INT. CL. 29. REG. 8-19-2003.
- 2,752,702. KWELIWORKS INSTITUTE AND DESIGN. INT. CL. 41. REG. 8-19-2003.
- 2,752,703. BETTY'S PIZZA SHACK LENOX, MA AND DESIGN. INT. CL. 43. REG. 8-19-2003.
- 2,752,709. FREESTYLE JUMPROPING. INT. CL. 41. REG. 8-19-2003.
- 2,752,710. THE OTHER FACE OF LATIN AMERICA. INT. CL. 41. REG. 8-19-2003.
- 2,752,712. VEQUITY FINANCIAL GROUP. INT. CL. 36. REG. 8-19-2003.
- 2,752,715. MISCELLANEOUS DESIGN. INT. CLS. 36 AND 44. REG. 8-19-2003.
- 2,752,718. CRUSHING DAY. INT. CL. 41. REG. 8-19-2003.
- 2,752,719. FINDERS KEEPERS (STYLIZED). INT. CL. 35. REG. 8-19-2003.
- 2,752,721. MERITECH. INT. CLS. 35 AND 37. REG. 8-19-2003.
- 2,752,734. THINGS. INT. CL. 35. REG. 8-19-2003.
- 2,752,735. CONNECTED CLASSROOM CONFERENCE. INT. CL. 41. REG. 8-19-2003.
- 2,752,736. HOEG FLOWERS AND DESIGN. INT. CL. 31. REG. 8-19-2003.
- 2,752,737. ALTERED FITNESS. INT. CL. 41. REG. 8-19-2003.
- 2,752,739. DEVON (STYLIZED). INT. CL. 42. REG. 8-19-2003.
- 2,752,741. INTELLICHAISE. INT. CL. 9. REG. 8-19-2003.
- 2,752,746. LYODRY. INT. CL. 20. REG. 8-19-2003.
- 2,752,747. PICOTAG. INT. CLS. 9 AND 42. REG. 8-19-2003.
- 2,752,748. INFOGLOBE. INT. CL. 9. REG. 8-19-2003.
- 2,752,750. EL AS DE LA SIERRA. INT. CL. 41. REG. 8-19-2003.
- 2,752,755. CYPO DC-SQL. INT. CL. 9. REG. 8-19-2003.
- 2,752,756. CYPOSOFT. INT. CL. 9. REG. 8-19-2003.
- 2,752,759. TITLE SOLUTION. INT. CL. 39. REG. 8-19-2003.
- 2,752,760. COSTAMAR MONEY TRANSFER AND DESIGN. INT. CL. 36. REG. 8-19-2003.
- 2,752,763. DRUG DISCOVERY TECHNOLOGY. INT. CL. 35. REG. 8-19-2003.
- 2,752,765. GYLS AND DESIGN. INT. CL. 41. REG. 8-19-2003.
- 2,752,770. NETVISION. INT. CL. 36. REG. 8-19-2003.
- 2,752,771. KEEPSAKE 200. INT. CL. 36. REG. 8-19-2003.
- 2,752,772. KEEPSAKE SURVIVORSHIP 200. INT. CL. 36. REG. 8-19-2003.
- 2,752,773. STRIP N SLIDE. INT. CL. 3. REG. 8-19-2003.
- 2,752,774. RESTAKAV. INT. CL. 5. REG. 8-19-2003.
- 2,752,775. BACOPA BOOST. INT. CL. 5. REG. 8-19-2003.
- 2,752,776. BEAUTIFUL LOSERS. INT. CL. 41. REG. 8-19-2003.
- 2,752,781. COMDERA. INT. CL. 42. REG. 8-19-2003.
- 2,752,784. REALLUXE. INT. CL. 36. REG. 8-19-2003.
- 2,752,785. TRANSPLANTLOGIC. INT. CL. 44. REG. 8-19-2003.
- 2,752,786. HIVLOGIC. INT. CL. 44. REG. 8-19-2003.
- 2,752,789. INFERTILITYLOGIC. INT. CL. 44. REG. 8-19-2003.
- 2,752,791. DREAM JEANS. INT. CL. 5. REG. 8-19-2003.
- 2,752,792. OXYLAST. INT. CL. 10. REG. 8-19-2003.
- 2,752,793. PURACHEK. INT. CL. 10. REG. 8-19-2003.
- 2,752,794. SUPPORT ORIGINAL MUSIC. INT. CL. 41. REG. 8-19-2003.
- 2,752,795. S.O.M.. INT. CL. 41. REG. 8-19-2003.
- 2,752,797. HALBLOCK. INT. CL. 1. REG. 8-19-2003.
- 2,752,801. FAST COOL. INT. CL. 1. REG. 8-19-2003.
- 2,752,802. OHBA. INT. CL. 43. REG. 8-19-2003.
- 2,752,803. CURRALON. INT. CL. 2. REG. 8-19-2003.
- 2,752,805. CHAPIN SHEA MCNITT & CARTER A LAW CORPORATION AND DESIGN. INT. CL. 42. REG. 8-19-2003.
- 2,752,806. MISCELLANEOUS DESIGN. INT. CL. 42. REG. 8-19-2003.
- 2,752,808. CRYSTAL TAPIOCA. INT. CL. 43. REG. 8-19-2003.
- 2,752,809. CHIROTROPIC. INT. CL. 44. REG. 8-19-2003.
- 2,752,810. TRADING SPACES. INT. CL. 25. REG. 8-19-2003.
- 2,752,814. SCIENCE.DOWN TO A SCIENCE.. INT. CL. 40. REG. 8-19-2003.
- 2,752,819. HEXAPLEX. INT. CL. 1. REG. 8-19-2003.
- 2,752,822. TOTAL BUST. INT. CL. 5. REG. 8-19-2003.
- 2,752,823. MASTERMATH. INT. CL. 41. REG. 8-19-2003.
- 2,752,829. NEORX AND DESIGN. INT. CLS. 1, 5, 40 AND 42. REG. 8-19-2003.
- 2,752,830. TRICYCLE. INT. CLS. 1 AND 5. REG. 8-19-2003.
- 2,752,835. CONCORDE ACCEPTANCE CORPORATION AND DESIGN. INT. CL. 36. REG. 8-19-2003.
- 2,752,836. MATHSOFT (STYLIZED). INT. CL. 9. REG. 8-19-2003.

- 2,752,837. FLEXIBLE FUSE. INT. CL. 38. REG. 8-19-2003.
 2,752,841. SPACE/XML. INT. CL. 35. REG. 8-19-2003.
 2,752,842. SPACE. INT. CL. 35. REG. 8-19-2003.
 2,752,843. SUNFIRE. INT. CL. 4. REG. 8-19-2003.
 2,752,844. CO-OPU AND DESIGN. INT. CL. 41. REG. 8-19-2003.
 2,752,846. KITCHEN ESSENTIALS. INT. CL. 9. REG. 8-19-2003.
 2,752,849. BOCOM. INT. CL. 9. REG. 8-19-2003.
 2,752,850. PLAYJAM. AND DESIGN. INT. CLS. 9 AND 38. REG. 8-19-2003.
 2,752,853. FRANCE INSIGHTS. INT. CLS. 35, 39 AND 42. REG. 8-19-2003.
 2,752,854. DIRTYWEAR DW. INT. CL. 25. REG. 8-19-2003.
 2,752,855. OFFICEBLOC. INT. CLS. 35, 38 AND 42. REG. 8-19-2003.
 2,752,858. MUROTORTO. INT. CL. 33. REG. 8-19-2003.
 2,752,859. TPDIGITAL. INT. CLS. 40 AND 42. REG. 8-19-2003.
 2,752,860. E INTERNET EXCHANGE AND DESIGN. INT. CL. 42. REG. 8-19-2003.
 2,752,861. RODREJO. INT. CL. 33. REG. 8-19-2003.
 2,752,863. SWAROVSKI IMPERIAL DIAMOND. INT. CL. 14. REG. 8-19-2003.
 2,752,866. MISCELLANEOUS DESIGN. INT. CLS. 40 AND 42. REG. 8-19-2003.
 2,752,870. TEXDOT. INT. CL. 7. REG. 8-19-2003.
 2,752,871. REVENUE STORM THE BUSINESS RAIN-MAKERS AND DESIGN. INT. CLS. 9, 16 AND 35. REG. 8-19-2003.
 2,752,873. DESIGN EXPERT (STYLIZED). INT. CL. 9. REG. 8-19-2003.
 2,752,874. INFLEXION SCIENCE TECHNOLOGY HEALTH AND DESIGN. INT. CLS. 9 AND 42. REG. 8-19-2003.
 2,752,875. ANTLER ADVANTAGE. INT. CL. 5. REG. 8-19-2003.
 2,752,876. RECOVERINGMATES.COM. INT. CL. 45. REG. 8-19-2003.
 2,752,877. WRITE TO SUCCEED. INT. CL. 41. REG. 8-19-2003.
 2,752,878. AMERISPECHOME OWNER'S MANUAL. INT. CL. 42. REG. 8-19-2003.
 2,752,879. KID MODERN AND DESIGN. INT. CLS. 16 AND 25. REG. 8-19-2003.
 2,752,880. ARGUE. INT. CL. 28. REG. 8-19-2003.
 2,752,881. E ENLIGHTENEERING, INC. AND DESIGN. INT. CL. 35. REG. 8-19-2003.
 2,752,882. INVENTION UNIVERSITY. INT. CL. 42. REG. 8-19-2003.
 2,752,883. SUPER PRO AND DESIGN. INT. CL. 12. REG. 8-19-2003.
 2,752,886. END-THROUGH-END. INT. CL. 9. REG. 8-19-2003.
 2,752,887. IRZITUR. INT. CL. 5. REG. 8-19-2003.
 2,752,888. LIFE ACTION REVIVAL MINISTRIES AND DESIGN. INT. CL. 16. REG. 8-19-2003.
 2,752,892. ANTICAL. INT. CLS. 5 AND 30. REG. 8-19-2003.
 2,752,894. T.A.L.K. TOTALLY ACTIVE LANGUAGE FOR KIDS AND DESIGN. INT. CL. 41. REG. 8-19-2003.
 2,752,895. NETSPECTIVE WEBFILTER. INT. CLS. 9 AND 42. REG. 8-19-2003.
 2,752,896. COWABUNGA MICRO ICE CREAMERY & JAVA HUT AND DESIGN. INT. CL. 42. REG. 8-19-2003.
 2,752,898. JOYWOOD. INT. CL. 5. REG. 8-19-2003.
 2,752,900. PORTLAND BLAZERS AND DESIGN. INT. CL. 35. REG. 8-19-2003.
 2,752,903. EASYFORM. INT. CLS. 16 AND 20. REG. 8-19-2003.
 2,752,905. SAFE SEX PREVENTOR AND DESIGN. INT. CL. 10. REG. 8-19-2003.
 2,752,907. CRUSHLINK. INT. CL. 42. REG. 8-19-2003.
 2,752,910. SELECT CHOICE 401(K). INT. CL. 36. REG. 8-19-2003.
 2,752,911. DAILY KISS. INT. CL. 9. REG. 8-19-2003.
 2,752,913. CYBERSTEEL. INT. CL. 37. REG. 8-19-2003.
 2,752,916. REALTY WAREHOUSE AND DESIGN. INT. CL. 16. REG. 8-19-2003.
 2,752,917. TRAININGPRO KNOWLEDGE NOW AND DESIGN. INT. CLS. 16 AND 41. REG. 8-19-2003.
 2,752,918. A BIZ AND DESIGN. INT. CL. 35. REG. 8-19-2003.
 2,752,921. HOME GARDENER AND DESIGN. INT. CL. 8. REG. 8-19-2003.
 2,752,924. PRIMETOOLS. INT. CL. 35. REG. 8-19-2003.
 2,752,925. CLAIRIN GRAND BOIS. INT. CL. 33. REG. 8-19-2003.
 2,752,926. BEST FRIENDS COMPANY AND DESIGN. INT. CL. 12. REG. 8-19-2003.
 2,752,927. MAPS. INT. CL. 35. REG. 8-19-2003.
 2,752,928. BEST FRIENDS. INT. CL. 12. REG. 8-19-2003.
 2,752,930. ELLISON (STYLIZED). INT. CL. 9. REG. 8-19-2003.
 2,752,932. QUIK START. INT. CL. 1. REG. 8-19-2003.
 2,752,935. IOPHILUM. INT. CLS. 3 AND 5. REG. 8-19-2003.
 2,752,937. THE INTEGRATOR KIT. INT. CL. 9. REG. 8-19-2003.
 2,752,938. DIET PEPSI TWIST AND DESIGN. INT. CL. 32. REG. 8-19-2003.
 2,752,939. LITTLE PARTS OF PORCELAIN AND DESIGN. INT. CL. 28. REG. 8-19-2003.
 2,752,940. CIZAVIG. INT. CL. 5. REG. 8-19-2003.
 2,752,944. PROTOS. INT. CLS. 1, 5 AND 42. REG. 8-19-2003.
 2,752,945. AMPHONY (STYLIZED). INT. CL. 9. REG. 8-19-2003.
 2,752,946. PEPSI TWIST AND DESIGN. INT. CL. 32. REG. 8-19-2003.
 2,752,947. PEPSI TWIST AND DESIGN. INT. CL. 32. REG. 8-19-2003.
 2,752,948. Y'A BON ESPRESSO AND DESIGN. INT. CL. 43. REG. 8-19-2003.
 2,752,949. SHORTCUT LEARNING. INT. CLS. 9 AND 42. REG. 8-19-2003.
 2,752,951. VIP 1000. INT. CL. 42. REG. 8-19-2003.
 2,752,954. SKINLIGHTS FACE ILLUMINATOR MAKEUP. INT. CL. 3. REG. 8-19-2003.
 2,752,955. POWERAUDIT. INT. CL. 42. REG. 8-19-2003.
 2,752,956. COGNITIVEDATA. INT. CL. 35. REG. 8-19-2003.
 2,752,958. SONICDOME BY HEARMUFF AND DESIGN. INT. CL. 25. REG. 8-19-2003.
 2,752,960. LARIATCENTRAL. INT. CL. 9. REG. 8-19-2003.
 2,752,961. COLLABRASPSPACE REVOLUTIONARY COLLABORATION AND DESIGN. INT. CL. 9. REG. 8-19-2003.
 2,752,965. EZ ROUTEMAPS. INT. CLS. 9 AND 38. REG. 8-19-2003.
 2,752,967. DANCING ART. INT. CL. 16. REG. 8-19-2003.
 2,752,968. LTP. INT. CL. 35. REG. 8-19-2003.
 2,752,969. MOHAT. INT. CL. 9. REG. 8-19-2003.
 2,752,971. WERK 1. INT. CL. 18. REG. 8-19-2003.
 2,752,972. WERK 1. INT. CL. 28. REG. 8-19-2003.
 2,752,981. PD AND DESIGN. INT. CL. 12. REG. 8-19-2003.
 2,752,984. CARROUSEL AND DESIGN. INT. CL. 20. REG. 8-19-2003.
 2,752,986. THE WILDLIFE EXPERIENCE AND DESIGN. INT. CL. 41. REG. 8-19-2003.
 2,752,988. WOOGIE (STYLIZED). INT. CL. 25. REG. 8-19-2003.
 2,752,989. OT SCRIPTS INDUSTRIAL STRENGTH. INT. CL. 9. REG. 8-19-2003.
 2,752,991. SCHOLAR'S EDGE AND DESIGN. INT. CL. 36. REG. 8-19-2003.
 2,752,992. ALIVE PRODUCTS MARKETING AND DESIGN. INT. CL. 3. REG. 8-19-2003.
 2,752,993. AROMATIC HEALING AND DESIGN. INT. CL. 41. REG. 8-19-2003.
 2,752,994. PROMOROM AND DESIGN. INT. CL. 20. REG. 8-19-2003.
 2,752,995. EASYLITE. INT. CL. 9. REG. 8-19-2003.
 2,752,997. JOYFUL BUNNY. INT. CL. 28. REG. 8-19-2003.
 2,752,998. EL CARTEL DE NUEVO LEON. INT. CLS. 9 AND 41. REG. 8-19-2003.
 2,752,999. ATI ACCESS TECHNOLOGIES INTERNATIONAL (STYLIZED). INT. CL. 9. REG. 8-19-2003.

- 2,753,003. LIL' WRANGLERS. INT. CL. 41. REG. 8-19-2003.
 2,753,004. FOUNDATIONS FOR EFFECTIVE LEADERSHIP. INT. CL. 41. REG. 8-19-2003.
 2,753,005. KONABOLDT. INT. CL. 35. REG. 8-19-2003.
 2,753,006. MISCELLANEOUS DESIGN. INT. CL. 41. REG. 8-19-2003.
 2,753,007. GAP KIDS. INT. CL. 9. REG. 8-19-2003.
 2,753,008. ID - SUPPLY AND DESIGN. INT. CL. 42. REG. 8-19-2003.
 2,753,009. PULCINO. INT. CL. 25. REG. 8-19-2003.
 2,753,011. GS GEEKSPEED AND DESIGN. INT. CL. 38. REG. 8-19-2003.
 2,753,013. TURNING CONFLICT INTO SHARED BENEFITS. INT. CL. 35. REG. 8-19-2003.
 2,753,015. EMPIRE TELERADIOLOGY ASSOCIATES LLC. AND DESIGN. INT. CL. 42. REG. 8-19-2003.
 2,753,016. NOVA. INT. CL. 9. REG. 8-19-2003.
 2,753,020. BUTT OUT. INT. CL. 16. REG. 8-19-2003.
 2,753,021. GORILLA BOOT CAMP. INT. CL. 41. REG. 8-19-2003.
 2,753,022. ZOMEXIL. INT. CL. 5. REG. 8-19-2003.
 2,753,023. CIRGOVIA. INT. CL. 5. REG. 8-19-2003.
 2,753,024. THE FEELING IS ANATOMIC. INT. CLS. 20 AND 24. REG. 8-19-2003.
 2,753,027. O'NEAL. INT. CL. 9. REG. 8-19-2003.
 2,753,028. O'NEAL. INT. CL. 28. REG. 8-19-2003.
 2,753,030. HDX. INT. CL. 38. REG. 8-19-2003.
 2,753,031. PHOBOS. INT. CL. 9. REG. 8-19-2003.
 2,753,035. SMALL TOUCHES. INT. CL. 35. REG. 8-19-2003.
 2,753,037. VINCI USA. INT. CL. 9. REG. 8-19-2003.
 2,753,038. AFFECTIVE ADVANCED (STYLIZED). INT. CL. 5. REG. 8-19-2003.
 2,753,039. MISCELLANEOUS DESIGN. INT. CL. 16. REG. 8-19-2003.
 2,753,040. V AND DESIGN. INT. CL. 9. REG. 8-19-2003.
 2,753,041. LITE STEAM-A-SEAM. INT. CL. 26. REG. 8-19-2003.
 2,753,042. LITE STEAM-A-SEAM2. INT. CL. 26. REG. 8-19-2003.
 2,753,043. DOCKSIDE CAKES AND DESIGN. INT. CLS. 30 AND 35. REG. 8-19-2003.
 2,753,044. LEBOLE. INT. CL. 25. REG. 8-19-2003.
 2,753,045. ECODER AND DESIGN. INT. CL. 28. REG. 8-19-2003.
 2,753,046. SPEECHMATTERS LLC AND DESIGN. INT. CL. 41. REG. 8-19-2003.
 2,753,048. RESPONSERX. INT. CL. 35. REG. 8-19-2003.
 2,753,051. AVSTRIPPER. INT. CL. 9. REG. 8-19-2003.
 2,753,052. MISCELLANEOUS DESIGN. INT. CL. 5. REG. 8-19-2003.
 2,753,053. EXPERIENCESYMMETRY. INT. CL. 35. REG. 8-19-2003.
 2,753,057. GREATER BAY BANCORP GREAT BANK. GREATER PEOPLE.. INT. CL. 36. REG. 8-19-2003.
 2,753,058. ALTURAS. INT. CL. 35. REG. 8-19-2003.
 2,753,061. PURELY GOURMET. INT. CLS. 29 AND 30. REG. 8-19-2003.
 2,753,064. DIAGNOSTIC RECRUITING. INT. CL. 35. REG. 8-19-2003.
 2,753,067. TUNE IN TOKYO. INT. CL. 41. REG. 8-19-2003.
 2,753,071. DIRECTIONS. INT. CL. 41. REG. 8-19-2003.
 2,753,072. USA DATANET AND DESIGN. INT. CL. 38. REG. 8-19-2003.
 2,753,073. THEHOMELOANGROUP PUTTING IT ALL TOGETHER AND DESIGN. INT. CL. 36. REG. 8-19-2003.
 2,753,074. ILIDS AND DESIGN. INT. CL. 25. REG. 8-19-2003.
 2,753,076. RENTOKIL. INT. CL. 45. REG. 8-19-2003.
 2,753,077. LOSENTRA. INT. CL. 5. REG. 8-19-2003.
 2,753,079. ELODIUS. INT. CL. 5. REG. 8-19-2003.
 2,753,080. FLEXIANT. INT. CL. 5. REG. 8-19-2003.
 2,753,082. IRONSTONE MOSAICS (STYLIZED). INT. CL. 42. REG. 8-19-2003.
 2,753,083. HEALTHSYNCH. INT. CL. 16. REG. 8-19-2003.
 2,753,086. APSIS SPORT USA. INT. CL. 18. REG. 8-19-2003.
 2,753,088. POWDERFLAP. INT. CL. 28. REG. 8-19-2003.
 2,753,090. RAWHIDE SEARCH SOLUTIONS. INT. CLS. 35 AND 42. REG. 8-19-2003.
 2,753,091. MS. GALAXY. INT. CL. 35. REG. 8-19-2003.
 2,753,092. STRANDED NAKED AND DESIGN. INT. CL. 25. REG. 8-19-2003.
 2,753,094. SIGNOLOGIES. INT. CL. 9. REG. 8-19-2003.
 2,753,097. PLUS QUE PARFAIT. INT. CL. 3. REG. 8-19-2003.
 2,753,098. ACEIS. INT. CL. 9. REG. 8-19-2003.
 2,753,099. CANDY CORNER. INT. CL. 3. REG. 8-19-2003.
 2,753,101. PREFERRED HOSPICE. INT. CL. 44. REG. 8-19-2003.
 2,753,103. SUSPENSION OF DISBELIEF. INT. CL. 42. REG. 8-19-2003.
 2,753,104. VRAY. INT. CL. 5. REG. 8-19-2003.
 2,753,105. SIX50 AND DESIGN. INT. CL. 41. REG. 8-19-2003.
 2,753,106. HYDROFOG. INT. CL. 1. REG. 8-19-2003.
 2,753,107. INSITEIG AND DESIGN. INT. CL. 42. REG. 8-19-2003.
 2,753,108. AMERICA'S BACK. INT. CL. 41. REG. 8-19-2003.
 2,753,109. BODY IMAGE AND DESIGN. INT. CL. 3. REG. 8-19-2003.
 2,753,110. YOUR PERSONAL AIRLINE (STYLIZED). INT. CL. 39. REG. 8-19-2003.
 2,753,115. INDEPENDENT GLASS DISTRIBUTORS AND DESIGN. INT. CL. 35. REG. 8-19-2003.
 2,753,116. BULOVA (STYLIZED). INT. CL. 14. REG. 8-19-2003.
 2,753,118. CHAMELEON COLLECTION. INT. CL. 14. REG. 8-19-2003.
 2,753,121. SOLID OVATION. INT. CL. 3. REG. 8-19-2003.
 2,753,122. WHAT QUILTS FIRST?. INT. CL. 9. REG. 8-19-2003.
 2,753,123. CULTURE UP!. INT. CL. 41. REG. 8-19-2003.
 2,753,128. MARKETRON. INT. CL. 42. REG. 8-19-2003.
 2,753,130. MRS. B'S STORY TIME . . . WITH A TWIST!. INT. CL. 16. REG. 8-19-2003.
 2,753,131. MRS. B'S STORY TIME . . . WITH A TWIST!. INT. CL. 41. REG. 8-19-2003.
 2,753,133. SUMNER HARRINGTON. INT. CL. 36. REG. 8-19-2003.
 2,753,135. TUSKER TRAIL & SAFARI CO. AND DESIGN. INT. CL. 39. REG. 8-19-2003.
 2,753,136. AMELIE. INT. CL. 18. REG. 8-19-2003.
 2,753,137. SERPENTINE. INT. CL. 18. REG. 8-19-2003.
 2,753,138. K AND DESIGN. INT. CL. 29. REG. 8-19-2003.
 2,753,139. MEMORAGE. INT. CL. 16. REG. 8-19-2003.
 2,753,143. BUNKER MASTER. INT. CL. 8. REG. 8-19-2003.
 2,753,145. DVD YARN AND DESIGN. INT. CL. 9. REG. 8-19-2003.
 2,753,148. 1-POINT SUPPORT AND DESIGN. INT. CL. 42. REG. 8-19-2003.
 2,753,149. SALTWATER GRADE AND DESIGN. INT. CL. 28. REG. 8-19-2003.
 2,753,150. PIZZAMARKETPLACE.COM AND DESIGN. INT. CLS. 35 AND 38. REG. 8-19-2003.
 2,753,153. CRITICALERT. INT. CL. 38. REG. 8-19-2003.
 2,753,155. CELON'S MYTHICAL. INT. CL. 32. REG. 8-19-2003.
 2,753,156. MISCELLANEOUS DESIGN. INT. CL. 25. REG. 8-19-2003.
 2,753,158. VIERO AND DESIGN. INT. CL. 30. REG. 8-19-2003.
 2,753,159. STATICFILTER. INT. CL. 36. REG. 8-19-2003.
 2,753,160. HEALTHCORE. INT. CL. 35. REG. 8-19-2003.
 2,753,162. IN DEMAND? TRY SOUP AT HAND. INT. CL. 29. REG. 8-19-2003.
 2,753,164. COLLAFFEE. INT. CL. 30. REG. 8-19-2003.
 2,753,166. ABRA. INT. CL. 18. REG. 8-19-2003.
 2,753,167. ABRAHAM MORTGAGE AND DESIGN. INT. CL. 36. REG. 8-19-2003.
 2,753,169. QWESTAIR. INT. CL. 38. REG. 8-19-2003.
 2,753,170. AGENT 77. INT. CL. 16. REG. 8-19-2003.
 2,753,173. SEIU. INT. CL. 35. REG. 8-19-2003.
 2,753,175. ATACAMA AND DESIGN. INT. CL. 33. REG. 8-19-2003.
 2,753,178. MISCELLANEOUS DESIGN. INT. CL. 33. REG. 8-19-2003.
 2,753,181. CLEAR CREATIONS. INT. CL. 20. REG. 8-19-2003.

- 2,753,184. HOLLAH.COM. INT. CLS. 16 AND 45. REG. 8-19-2003.
- 2,753,186. MOTORCARGARAGE.COM. INT. CLS. 16 AND 25. REG. 8-19-2003.
- 2,753,187. ISLANDS IN THE PARK AND DESIGN. INT. CL. 41. REG. 8-19-2003.
- 2,753,189. MOATWARE. INT. CL. 9. REG. 8-19-2003.
- 2,753,191. CRYSTALZYME VINO-PRO. INT. CL. 1. REG. 8-19-2003.
- 2,753,192. FIZZEES. INT. CL. 5. REG. 8-19-2003.
- 2,753,193. PRO2. INT. CL. 5. REG. 8-19-2003.
- 2,753,195. AHH TOMAN. INT. CL. 20. REG. 8-19-2003.
- 2,753,196. PROFESSOR PLUM. INT. CLS. 9 AND 41. REG. 8-19-2003.
- 2,753,197. MARCHING AND CHOWDER AND DESIGN. INT. CL. 35. REG. 8-19-2003.
- 2,753,198. ESTELLE DANAN. INT. CL. 40. REG. 8-19-2003.
- 2,753,201. THERE'S A BETTER WAY TO SEE EUROPE. INT. CL. 43. REG. 8-19-2003.
- 2,753,204. ECLUSTERING. INT. CL. 35. REG. 8-19-2003.
- 2,753,206. WORKESSENTIALS. INT. CL. 41. REG. 8-19-2003.
- 2,753,210. NATURAL CONFIDENCE. INT. CL. 35. REG. 8-19-2003.
- 2,753,211. TRIMINAID (STYLIZED). INT. CL. 5. REG. 8-19-2003.
- 2,753,214. INTRUSION PREVENTION THROUGH INNOVATION. INT. CL. 9. REG. 8-19-2003.
- 2,753,216. PLATINUM PRINTING. INT. CLS. 40 AND 42. REG. 8-19-2003.
- 2,753,217. GOCH. INT. CL. 9. REG. 8-19-2003.
- 2,753,218. MAGNUS. INT. CL. 41. REG. 8-19-2003.
- 2,753,219. ELEMENTS BY ARNOLD ZIMBERG. INT. CL. 25. REG. 8-19-2003.
- 2,753,221. FOREVER FRESH (STYLIZED). INT. CL. 1. REG. 8-19-2003.
- 2,753,222. TOWER RESOURCE GROUP. INT. CLS. 35 AND 36. REG. 8-19-2003.
- 2,753,224. ROPER'S CHOICE. INT. CL. 18. REG. 8-19-2003.
- 2,753,225. SPACEMEN, INC. INT. CL. 35. REG. 8-19-2003.
- 2,753,226. INSPIRE TOWER MEMORIAL AND DESIGN. INT. CL. 36. REG. 8-19-2003.
- 2,753,227. TYPE S AND DESIGN. INT. CL. 5. REG. 8-19-2003.
- 2,753,228. LIFEPURPOSES WORK. LEAD. LIVE. ON PURPOSE. AND DESIGN. INT. CL. 41. REG. 8-19-2003.
- 2,753,230. MYCOPIA. INT. CL. 31. REG. 8-19-2003.
- 2,753,231. IT'S A GIRL. INT. CL. 32. REG. 8-19-2003.
- 2,753,233. NYTAE. INT. CL. 19. REG. 8-19-2003.
- 2,753,236. BIZ INK. INT. CL. 16. REG. 8-19-2003.
- 2,753,238. BIZ INK AND DESIGN. INT. CL. 16. REG. 8-19-2003.
- 2,753,239. SPRAY-N-FEED. INT. CL. 1. REG. 8-19-2003.
- 2,753,241. PIONEERING THE USE OF MICROTECHNOLOGY. INT. CL. 37. REG. 8-19-2003.
- 2,753,242. FLOATING BED. INT. CLS. 20 AND 22. REG. 8-19-2003.
- 2,753,244. TECHTUBE. INT. CL. 18. REG. 8-19-2003.
- 2,753,245. MISCELLANEOUS DESIGN. INT. CL. 44. REG. 8-19-2003.
- 2,753,246. SPOTTED MEATAPOTAMUS. INT. CL. 44. REG. 8-19-2003.
- 2,753,247. MISCELLANEOUS DESIGN. INT. CL. 44. REG. 8-19-2003.
- 2,753,248. MISCELLANEOUS CATAGORIUS. INT. CL. 44. REG. 8-19-2003.
- 2,753,249. MISCELLANEOUS DESIGN. INT. CL. 44. REG. 8-19-2003.
- 2,753,251. REXPOSE. INT. CL. 3. REG. 8-19-2003.
- 2,753,254. MISCELLANEOUS DESIGN. INT. CL. 39. REG. 8-19-2003.
- 2,753,255. PACTS. INT. CL. 41. REG. 8-19-2003.
- 2,753,257. MINDS THAT MOVE. INT. CL. 36. REG. 8-19-2003.
- 2,753,258. YRADS. INT. CL. 9. REG. 8-19-2003.
- 2,753,259. GENERATION+ COMPLIMENTARY SOLUTIONS. INT. CL. 5. REG. 8-19-2003.
- 2,753,262. TOTALGA AND DESIGN. INT. CLS. 35 AND 42. REG. 8-19-2003.
- 2,753,266. WRAP N TIE. INT. CL. 24. REG. 8-19-2003.
- 2,753,267. REAL TRAINING. REAL RESULTS. INT. CL. 41. REG. 8-19-2003.
- 2,753,268. MISCELLANEOUS DESIGN. INT. CL. 9. REG. 8-19-2003.
- 2,753,269. MY PERSONAL FAVORITES. INT. CL. 9. REG. 8-19-2003.
- 2,753,270. MISCELLANEOUS DESIGN. INT. CL. 9. REG. 8-19-2003.
- 2,753,271. NIGHTBUSTER. INT. CL. 11. REG. 8-19-2003.
- 2,753,272. WING DOME. INT. CL. 43. REG. 8-19-2003.
- 2,753,273. XXXTREME. INT. CL. 16. REG. 8-19-2003.
- 2,753,274. MISCELLANEOUS DESIGN. INT. CL. 9. REG. 8-19-2003.
- 2,753,275. INTERNET ESSENTIALS AND DESIGN. INT. CL. 9. REG. 8-19-2003.
- 2,753,276. AMBER ALERT NET AND DESIGN. INT. CL. 9. REG. 8-19-2003.
- 2,753,277. ! AND DESIGN. INT. CL. 9. REG. 8-19-2003.
- 2,753,279. WE'LL MOVE MOUNTAINS FOR YOUR NEXT MEETING. INT. CL. 43. REG. 8-19-2003.
- 2,753,282. AGA. INT. CL. 25. REG. 8-19-2003.
- 2,753,283. BADAVIDI. INT. CL. 14. REG. 8-19-2003.
- 2,753,284. TYPYS. INT. CL. 35. REG. 8-19-2003.
- 2,753,286. THE CREEKS AT BEECHWOOD. INT. CLS. 41 AND 43. REG. 8-19-2003.
- 2,753,287. BARSE. INT. CLS. 14 AND 18. REG. 8-19-2003.
- 2,753,288. CEOEDGE. INT. CL. 9. REG. 8-19-2003.
- 2,753,289. ALL THIS FOR LESS. INT. CL. 35. REG. 8-19-2003.
- 2,753,290. POPTION. INT. CL. 9. REG. 8-19-2003.
- 2,753,291. HARTFORD WORLD ADVANTAGE. INT. CL. 36. REG. 8-19-2003.
- 2,753,292. HARTFORD WORLD ADVANTAGE PRIVILEGE PROGRAM. INT. CL. 36. REG. 8-19-2003.
- 2,753,294. "DEBT FREE FOR LIFE" CONSUMERS FIRST AND DESIGN. INT. CL. 36. REG. 8-19-2003.
- 2,753,295. AIRCRAFT OF THE WORLD. INT. CL. 16. REG. 8-19-2003.
- 2,753,297. CAPITOL DELUXE. INT. CL. 25. REG. 8-19-2003.
- 2,753,299. POUCHET. INT. CL. 14. REG. 8-19-2003.
- 2,753,301. ACCELERATE 2K2 AND DESIGN. INT. CL. 9. REG. 8-19-2003.
- 2,753,302. MISCELLANEOUS DESIGN. INT. CL. 9. REG. 8-19-2003.
- 2,753,303. MISCELLANEOUS DESIGN. INT. CL. 9. REG. 8-19-2003.
- 2,753,304. MISCELLANEOUS DESIGN. INT. CL. 9. REG. 8-19-2003.
- 2,753,306. MY FIREWALL PLUS AND DESIGN. INT. CL. 9. REG. 8-19-2003.
- 2,753,307. MISCELLANEOUS DESIGN. INT. CL. 9. REG. 8-19-2003.
- 2,753,308. MISCELLANEOUS DESIGN. INT. CL. 9. REG. 8-19-2003.
- 2,753,311. BONE ZONE AND DESIGN. INT. CL. 25. REG. 8-19-2003.
- 2,753,313. GIVE ME FIVE. INT. CL. 25. REG. 8-19-2003.
- 2,753,315. POLAR POUCH AND DESIGN. INT. CL. 32. REG. 8-19-2003.
- 2,753,319. GURU. INT. CLS. 9 AND 16. REG. 8-19-2003.
- 2,753,323. FREEDOM FUNDING. INT. CL. 36. REG. 8-19-2003.
- 2,753,325. ROYAL DOULTON. INT. CL. 24. REG. 8-19-2003.
- 2,753,328. EYE CANDY. INT. CLS. 3, 14, 18, 25, 26 AND 35. REG. 8-19-2003.
- 2,753,331. VERSANI. INT. CL. 18. REG. 8-19-2003.
- 2,753,333. TOOLS FOR A LIFETIME. INT. CLS. 7 AND 8. REG. 8-19-2003.
- 2,753,334. CONTROL WITH COMPASSION. INT. CL. 5. REG. 8-19-2003.
- 2,753,335. BRIDEZILLA. INT. CLS. 25 AND 28. REG. 8-19-2003.
- 2,753,336. MELODY. INT. CL. 9. REG. 8-19-2003.
- 2,753,337. ZIGGY STARDUST. INT. CL. 41. REG. 8-19-2003.
- 2,753,340. THE HALE CLINIC AND DESIGN. INT. CL. 16. REG. 8-19-2003.

- 2,753,343. REACHING YOUR CONSUMER, EVERYWHERE, EVERYDAY. INT. CL. 35. REG. 8-19-2003.
- 2,753,344. PEACE PRETZELS. INT. CL. 30. REG. 8-19-2003.
- 2,753,346. GT AND DESIGN. INT. CL. 9. REG. 8-19-2003.
- 2,753,347. TICKLES. INT. CL. 14. REG. 8-19-2003.
- 2,753,348. MISCELLANEOUS DESIGN. INT. CLS. 3 AND 5. REG. 8-19-2003.
- 2,753,349. MISCELLANEOUS DESIGN. INT. CL. 7. REG. 8-19-2003.
- 2,753,350. Q-VEL. INT. CL. 5. REG. 8-19-2003.
- 2,753,356. 5 TIMES SQUARE. INT. CLS. 36 AND 37. REG. 8-19-2003.
- 2,753,359. DIRECTV PARA TODOS. INT. CLS. 9, 16, 25, 38 AND 41. REG. 8-19-2003.
- 2,753,362. SUMMIT BOATS. INT. CL. 12. REG. 8-19-2003.
- 2,753,363. ELEPHANT NOTES. INT. CL. 16. REG. 8-19-2003.
- 2,753,365. WE'RE MAKING MAGIC AT CHUCK E. CHEESE. INT. CL. 42. REG. 8-19-2003.
- 2,753,368. UGLY TRIBE. INT. CL. 25. REG. 8-19-2003.
- 2,753,369. PIERRE BEAUVAIS AND DESIGN. INT. CL. 21. REG. 8-19-2003.
- 2,753,370. TRUESHOPPING. INT. CL. 9. REG. 8-19-2003.
- 2,753,372. VTECH AND DESIGN. INT. CL. 28. REG. 8-19-2003.
- 2,753,374. CORRECT CUT. INT. CL. 9. REG. 8-19-2003.
- 2,753,375. ISOLIX. INT. CL. 9. REG. 8-19-2003.
- 2,753,376. MISCELLANEOUS DESIGN. INT. CL. 42. REG. 8-19-2003.
- 2,753,377. GERONIMO. INT. CL. 29. REG. 8-19-2003.
- 2,753,378. DEVELOPMENTAL NATURAL RESOURCES, INCORPORATED AND DESIGN. INT. CL. 1. REG. 8-19-2003.
- 2,753,379. LAW BEAT. INT. CL. 42. REG. 8-19-2003.
- 2,753,380. DERMOLASTIN. INT. CL. 5. REG. 8-19-2003.
- 2,753,381. WOMEN IN GOLF DAY AND DESIGN. INT. CLS. 36 AND 41. REG. 8-19-2003.
- 2,753,388. JASMINE. INT. CL. 28. REG. 8-19-2003.
- 2,753,389. ROSINA WACHTMEISTER. INT. CLS. 20 AND 21. REG. 8-19-2003.
- 2,753,391. STRAIGHT FORWARD. INT. CL. 10. REG. 8-19-2003.
- 2,753,396. IP SAFE. INT. CL. 9. REG. 8-19-2003.
- 2,753,398. ALLBENEFITS.COM. INT. CL. 36. REG. 8-19-2003.
- 2,753,399. TECHNOINSULIN. INT. CL. 5. REG. 8-19-2003.
- 2,753,400. GENE SWITCH. INT. CL. 3. REG. 8-19-2003.
- 2,753,403. DORITOS. INT. CLS. 29 AND 30. REG. 8-19-2003.
- 2,753,404. MIPS16. INT. CL. 9. REG. 8-19-2003.
- 2,753,405. FIELD TO TABLE. INT. CL. 30. REG. 8-19-2003.
- 2,753,407. TRAMPUTANTES. INT. CL. 9. REG. 8-19-2003.
- 2,753,408. SPECTRUM POWER. INT. CL. 12. REG. 8-19-2003.
- 2,753,409. MISCELLANEOUS DESIGN. INT. CL. 14. REG. 8-19-2003.
- 2,753,410. BOLS BLUE LIQUEUR AND DESIGN. INT. CL. 33. REG. 8-19-2003.
- 2,753,411. BOOKJAM (STYLIZED). INT. CL. 41. REG. 8-19-2003.
- 2,753,412. QUICK LASH. INT. CL. 3. REG. 8-19-2003.
- 2,753,413. JUICE LADY. INT. CL. 41. REG. 8-19-2003.
- 2,753,414. JUICE LADY. INT. CL. 9. REG. 8-19-2003.
- 2,753,418. HOLIDAY. INT. CL. 16. REG. 8-19-2003.
- 2,753,420. 21ST CENTURY LEASING (STYLIZED). INT. CLS. 35 AND 42. REG. 8-19-2003.
- 2,753,425. INDISPENSABLE. INT. CL. 16. REG. 8-19-2003.
- 2,753,426. LESS HAIR - GUARANTEED. INT. CL. 42. REG. 8-19-2003.
- 2,753,427. THE NIGHTMARE ROOM. INT. CLS. 9, 16 AND 41. REG. 8-19-2003.
- 2,753,428. MISCELLANEOUS DESIGN. INT. CLS. 9 AND 41. REG. 8-19-2003.
- 2,753,429. PLIANT TECHNOLOGIES. INT. CLS. 9 AND 42. REG. 8-19-2003.
- 2,753,430. JAIMY CHUANG. INT. CL. 20. REG. 8-19-2003.
- 2,753,432. BAIT BULLET. INT. CL. 5. REG. 8-19-2003.
- 2,753,437. COMPUSUITE AND DESIGN. INT. CLS. 38 AND 39. REG. 8-19-2003.
- 2,753,439. 360 GEAR AND DESIGN. INT. CL. 25. REG. 8-19-2003.
- 2,753,442. WONDERLIFT. INT. CL. 25. REG. 8-19-2003.
- 2,753,443. SIMPATA. INT. CLS. 36 AND 42. REG. 8-19-2003.
- 2,753,445. MAB-TOF. INT. CL. 9. REG. 8-19-2003.
- 2,753,448. ROCK MOUNTAIN. INT. CL. 41. REG. 8-19-2003.
- 2,753,452. ALTITUDE. INT. CL. 33. REG. 8-19-2003.
- 2,753,455. AS YOUR TODDLER GROWS. INT. CL. 16. REG. 8-19-2003.
- 2,753,456. SIMPATA AND DESIGN. INT. CLS. 36 AND 42. REG. 8-19-2003.
- 2,753,457. PJ PROJECTS!. INT. CL. 9. REG. 8-19-2003.
- 2,753,459. PHYTO FRESH. INT. CL. 3. REG. 8-19-2003.
- 2,753,462. GLASFLEX. INT. CL. 9. REG. 8-19-2003.
- 2,753,463. NO-NUMO. INT. CL. 10. REG. 8-19-2003.
- 2,753,464. ACTIVEM. INT. CL. 9. REG. 8-19-2003.
- 2,753,467. ESELF. INT. CL. 42. REG. 8-19-2003.
- 2,753,468. ALLEN BY ABS. INT. CL. 25. REG. 8-19-2003.
- 2,753,469. ARETECH. INT. CL. 37. REG. 8-19-2003.
- 2,753,474. COMMON SENSE GARDENER. INT. CLS. 35 AND 42. REG. 8-19-2003.
- 2,753,475. ICM CORPORATION AND DESIGN. INT. CL. 9. REG. 8-19-2003.
- 2,753,480. CH.1. INT. CL. 9. REG. 8-19-2003.
- 2,753,482. SARNA. INT. CLS. 1, 16, 17, 19, 20 AND 37. REG. 8-19-2003.
- 2,753,484. FAST BREAKAWAY PHILLY STEAKS AND DESIGN. INT. CL. 29. REG. 8-19-2003.
- 2,753,485. ZAPCENTRAL. INT. CL. 42. REG. 8-19-2003.
- 2,753,487. ASIAN GEAR. INT. CL. 25. REG. 8-19-2003.
- 2,753,488. VIRTUAL SERIAL NUMBER. INT. CL. 9. REG. 8-19-2003.
- 2,753,489. VSN. INT. CL. 9. REG. 8-19-2003.
- 2,753,493. OLLITAS. INT. CL. 33. REG. 8-19-2003.
- 2,753,494. AXT. INT. CL. 1. REG. 8-19-2003.
- 2,753,498. IDEA DIARRHEA. INT. CLS. 16 AND 25. REG. 8-19-2003.
- 2,753,501. SUMMER SANITARIUM TOUR. INT. CL. 25. REG. 8-19-2003.
- 2,753,503. WILHELMI. INT. CLS. 6 AND 19. REG. 8-19-2003.
- 2,753,506. WHEN IT COMES TO CASH FAST, NOBODY BEATS THE GIANT. INT. CL. 36. REG. 8-19-2003.
- 2,753,507. FAIRPET FAIR TRADE PET PRODUCTS. INT. CLS. 3, 21 AND 28. REG. 8-19-2003.
- 2,753,508. CHAMELEON. INT. CL. 9. REG. 8-19-2003.
- 2,753,509. SCAMPI'S S.S. SCAMPI AND DESIGN. INT. CL. 42. REG. 8-19-2003.
- 2,753,512. CHRISTIAN BUSINESS CONNECTION ...HIGHER ACCOUNTABILITY. INT. CL. 35. REG. 8-19-2003.
- 2,753,514. CAP PRO BROKERAGE SERVICES. INT. CL. 36. REG. 8-19-2003.
- 2,753,515. TZATZIKI ADONIS ATE AND DESIGN. INT. CLS. 29 AND 30. REG. 8-19-2003.
- 2,753,516. TZATZIKI ADONIS AND DESIGN. INT. CLS. 29 AND 30. REG. 8-19-2003.
- 2,753,517. LIGERAMICA. INT. CL. 19. REG. 8-19-2003.
- 2,753,520. VELOCITIS. INT. CL. 9. REG. 8-19-2003.
- 2,753,524. UNREAL II. INT. CLS. 9 AND 16. REG. 8-19-2003.
- 2,753,525. BAGEL TALK. INT. CLS. 35 AND 42. REG. 8-19-2003.
- 2,753,526. POPPY TOAST. INT. CL. 30. REG. 8-19-2003.
- 2,753,527. OUR EGGS MEAN BUSINESS. INT. CLS. 29 AND 30. REG. 8-19-2003.
- 2,753,528. WORKLIFE SOLUTIONS. INT. CL. 36. REG. 8-19-2003.
- 2,753,529. SURESYSTEMS. INT. CLS. 6, 7 AND 20. REG. 8-19-2003.
- 2,753,530. VALUE MASTER TOOL. INT. CL. 8. REG. 8-19-2003.
- 2,753,533. CLUB MED AND DESIGN. INT. CL. 28. REG. 8-19-2003.
- 2,753,534. CRYSTAL SHARKSKIN. INT. CL. 17. REG. 8-19-2003.
- 2,753,535. BED HEAD. INT. CL. 42. REG. 8-19-2003.
- 2,753,536. COOLBURN TECHNOLOGY. INT. CL. 11. REG. 8-19-2003.
- 2,753,537. FRESH DIAMOND. INT. CL. 32. REG. 8-19-2003.

- 2,753,538. LEADER ALLIANCE. INT. CLS. 16, 35 AND 41. REG. 8-19-2003.
- 2,753,539. [T]O EXPAND COSMIC CONCIIOUSNESS AND ENHANCE SPIRITUAL PERCEPTION... (PAGE1, PAR. 2) (STYLIZED). INT. CL. 18. REG. 8-19-2003.
- 2,753,543. PONTIS. INT. CLS. 9 AND 42. REG. 8-19-2003.
- 2,753,544. COLONIAL MALL. INT. CL. 36. REG. 8-19-2003.
- 2,753,548. PACKY PODA. INT. CL. 27. REG. 8-19-2003.
- 2,753,549. ECHOICE (STYLIZED). INT. CL. 35. REG. 8-19-2003.
- 2,753,552. IWP ESTATE DOOR COLLECTION. INT. CL. 19. REG. 8-19-2003.
- 2,753,553. CSA TRAVEL PROTECTION AND DESIGN. INT. CLS. 35, 36, 39 AND 42. REG. 8-19-2003.
- 2,753,557. CUSTOM CLASSROOM. INT. CL. 42. REG. 8-19-2003.
- 2,753,559. HR CIRCLE.COM AND DESIGN. INT. CL. 42. REG. 8-19-2003.
- 2,753,560. FINDMEID. INT. CL. 14. REG. 8-19-2003.
- 2,753,561. BLOCAL. INT. CL. 37. REG. 8-19-2003.
- 2,753,562. HOT IQ. INT. CL. 9. REG. 8-19-2003.
- 2,753,564. YOUR BEAR IS BORN. INT. CLS. 35 AND 41. REG. 8-19-2003.
- 2,753,567. MOORECONNECTS. INT. CLS. 35 AND 42. REG. 8-19-2003.
- 2,753,569. INTELEMATICS. INT. CLS. 39 AND 42. REG. 8-19-2003.
- 2,753,570. FANCY PANTS. INT. CL. 25. REG. 8-19-2003.
- 2,753,571. COGNISTAR. INT. CL. 41. REG. 8-19-2003.
- 2,753,573. TO SPACE. INT. CL. 25. REG. 8-19-2003.
- 2,753,574. PRICE CRASHER. INT. CL. 35. REG. 8-19-2003.
- 2,753,575. HEALTH CARE. ENLIGHTENED.. INT. CLS. 35 AND 36. REG. 8-19-2003.
- 2,753,576. DUTCH CRAFT. INT. CL. 19. REG. 8-19-2003.
- 2,753,577. PERFORMANCECARE. INT. CL. 36. REG. 8-19-2003.
- 2,753,579. SMARTBALLAST. INT. CL. 9. REG. 8-19-2003.
- 2,753,581. MERLE ASSOCIATES AND DESIGN. INT. CLS. 35 AND 42. REG. 8-19-2003.
- 2,753,584. RACERETTE. INT. CL. 25. REG. 8-19-2003.
- 2,753,586. CICERONE CAESAR AUGE DOMINI ANUSCO SIII AND DESIGN. INT. CL. 29. REG. 8-19-2003.
- 2,753,588. COUNTY CREST AND DESIGN. INT. CL. 33. REG. 8-19-2003.
- 2,753,590. IKS. INT. CL. 14. REG. 8-19-2003.
- 2,753,592. EM (STYLIZED). INT. CL. 35. REG. 8-19-2003.
- 2,753,595. PERSIST. INT. CL. 42. REG. 8-19-2003.
- 2,753,596. COOKE COMMUNICATIONS. INT. CL. 42. REG. 8-19-2003.
- 2,753,597. RHINO HYDE AND DESIGN. INT. CL. 19. REG. 8-19-2003.
- 2,753,599. ENTERNET. INT. CL. 9. REG. 8-19-2003.
- 2,753,600. AMBASSADOR REWARDS. INT. CLS. 35, 39 AND 42. REG. 8-19-2003.
- 2,753,601. NF KIDNEY FAILURE (STYLIZED). INT. CL. 31. REG. 8-19-2003.
- 2,753,603. THE VIRCOM 3 SYSTEM. INT. CLS. 35, 39, 41 AND 42. REG. 8-19-2003.
- 2,753,604. AEVUM. INT. CLS. 3, 9, 18 AND 25. REG. 8-19-2003.
- 2,753,605. STARRY NIGHT. INT. CL. 14. REG. 8-19-2003.
- 2,753,606. CYLARCOM AND DESIGN. INT. CL. 42. REG. 8-19-2003.
- 2,753,607. E-VALVE. INT. CL. 38. REG. 8-19-2003.
- 2,753,608. SAUCE BY COLOR KINETICS AND DESIGN. INT. CL. 28. REG. 8-19-2003.
- 2,753,609. SAUCE BY COLOR KINETICS AND DESIGN. INT. CL. 9. REG. 8-19-2003.
- 2,753,610. BEZEL COLLECTION. INT. CL. 25. REG. 8-19-2003.
- 2,753,611. DOO WOP CAJUNS. INT. CL. 41. REG. 8-19-2003.
- 2,753,612. HAUL ICE. INT. CL. 21. REG. 8-19-2003.
- 2,753,616. DREAMTOY AND DESIGN. INT. CLS. 28 AND 35. REG. 8-19-2003.
- 2,753,617. GRANNY'S HOT FUDGE SAUCE. INT. CL. 30. REG. 8-19-2003.
- 2,753,618. GDO AND DESIGN. INT. CLS. 7 AND 9. REG. 8-19-2003.
- 2,753,620. OMNIFLEXION. INT. CL. 9. REG. 8-19-2003.
- 2,753,621. AUDIOARTF/X. INT. CL. 9. REG. 8-19-2003.
- 2,753,622. OMNICOLUMN. INT. CL. 9. REG. 8-19-2003.
- 2,753,623. ADVANCED ORTHOPEDIC FOOTWEAR AND DESIGN. INT. CL. 10. REG. 8-19-2003.
- 2,753,624. MISCELLANEOUS DESIGN. INT. CL. 33. REG. 8-19-2003.
- 2,753,625. INFO-OPS. INT. CL. 42. REG. 8-19-2003.
- 2,753,627. AFFCO. INT. CL. 40. REG. 8-19-2003.
- 2,753,628. DUROLANE. INT. CLS. 5 AND 10. REG. 8-19-2003.
- 2,753,630. 2ND C AND DESIGN. INT. CLS. 9 AND 42. REG. 8-19-2003.
- 2,753,631. SEALAB 2021. INT. CL. 25. REG. 8-19-2003.
- 2,753,632. PRO V2. INT. CL. 25. REG. 8-19-2003.
- 2,753,634. S MADE EXCLUSIVELY FOR SPIEGEL CATALOG, INC. AND DESIGN. INT. CL. 21. REG. 8-19-2003.
- 2,753,635. VENDARIA MOVING PICTURES. MOVING PRODUCTS. AND DESIGN. INT. CLS. 35, 41 AND 42. REG. 8-19-2003.
- 2,753,636. AVATAR. INT. CL. 28. REG. 8-19-2003.
- 2,753,637. REMNANT TRUTH. INT. CL. 41. REG. 8-19-2003.
- 2,753,642. DAZZLER. INT. CL. 12. REG. 8-19-2003.
- 2,753,646. IT'S ALL U. INT. CL. 35. REG. 8-19-2003.
- 2,753,647. VELA PHARMACEUTICALS. INT. CL. 42. REG. 8-19-2003.
- 2,753,653. SHEEP IN THE BIG CITY AND DESIGN. INT. CL. 41. REG. 8-19-2003.
- 2,753,654. ELANTRA. INT. CL. 21. REG. 8-19-2003.
- 2,753,656. CRYOCARE SURGICAL SYSTEM AND DESIGN. INT. CL. 10. REG. 8-19-2003.
- 2,753,657. MYKONOS. INT. CL. 3. REG. 8-19-2003.
- 2,753,658. STUFF SKINS WE STUFFEM YOU EATEM AND DESIGN. INT. CL. 29. REG. 8-19-2003.
- 2,753,659. THANACARE. INT. CL. 35. REG. 8-19-2003.
- 2,753,660. THANACARE. INT. CL. 42. REG. 8-19-2003.
- 2,753,664. NETCIRCULAR. INT. CL. 35. REG. 8-19-2003.
- 2,753,665. RAIN-TRIP. INT. CL. 9. REG. 8-19-2003.
- 2,753,666. CHS COOPERATIVES AND DESIGN. INT. CLS. 25, 35, 36, 39, 40 AND 42. REG. 8-19-2003.
- 2,753,667. SURROUND LIGHT AND DESIGN. INT. CL. 9. REG. 8-19-2003.
- 2,753,668. SPEED/GLO. INT. CL. 12. REG. 8-19-2003.
- 2,753,671. SERANO NETWORKS. INT. CL. 9. REG. 8-19-2003.
- 2,753,672. FANSTEEL INTERCAST. INT. CL. 40. REG. 8-19-2003.
- 2,753,673. YALE UNIVERSITY GOODS. INT. CL. 35. REG. 8-19-2003.
- 2,753,676. AITHEM. INT. CLS. 9 AND 42. REG. 8-19-2003.
- 2,753,677. EDFT. INT. CL. 42. REG. 8-19-2003.
- 2,753,679. BANTAM INTERACTIVE. INT. CL. 9. REG. 8-19-2003.
- 2,753,680. IMAGIC NETWORK. INT. CL. 35. REG. 8-19-2003.
- 2,753,684. NETEXCHANGE CLIENT MOBILE. INT. CL. 36. REG. 8-19-2003.
- 2,753,690. VENTURE VUL ACCUMULATOR. INT. CL. 36. REG. 8-19-2003.
- 2,753,693. BANTAM INTERACTIVE AND DESIGN. INT. CL. 9. REG. 8-19-2003.
- 2,753,694. POWERITE. INT. CL. 22. REG. 8-19-2003.
- 2,753,697. IMAGESMART DM. INT. CL. 9. REG. 8-19-2003.
- 2,753,701. M AND DESIGN. INT. CL. 35. REG. 8-19-2003.
- 2,753,705. S-PLUS GRAPHLETS. INT. CL. 9. REG. 8-19-2003.
- 2,753,706. TRANSQ FLEX. INT. CL. 10. REG. 8-19-2003.
- 2,753,707. EMUDERME. INT. CL. 5. REG. 8-19-2003.
- 2,753,708. EMERGENCY GRAM AND DESIGN. INT. CL. 16. REG. 8-19-2003.
- 2,753,709. CARDIA DESIGNS. INT. CL. 14. REG. 8-19-2003.
- 2,753,710. GIVE YOUR KID A LITTLE CREDIT. INT. CL. 9. REG. 8-19-2003.
- 2,753,711. BX SONIC. INT. CL. 10. REG. 8-19-2003.
- 2,753,715. INSIGHTFUL INTELLIGENCE FROM DATA AND DESIGN. INT. CL. 9. REG. 8-19-2003.
- 2,753,716. [WILDLIFE:DETECTIVES]. INT. CL. 41. REG. 8-19-2003.

- 2,753,717. WHA DAT WEAR MC 180° AND DESIGN. INT. CL. 25. REG. 8-19-2003.
- 2,753,718. BUGSWIPE. INT. CL. 5. REG. 8-19-2003.
- 2,753,722. SPIDER WRAP. INT. CL. 20. REG. 8-19-2003.
- 2,753,723. HARMONIC. INT. CL. 35. REG. 8-19-2003.
- 2,753,724. NESLEMUR. INT. CL. 3. REG. 8-19-2003.
- 2,753,729. MARKET MOSAIC. INT. CL. 42. REG. 8-19-2003.
- 2,753,730. FLEETGO. INT. CL. 9. REG. 8-19-2003.
- 2,753,731. MEDIAPPOINT. INT. CL. 9. REG. 8-19-2003.
- 2,753,732. INMEETINGS. INT. CL. 38. REG. 8-19-2003.
- 2,753,733. TAPLI. INT. CL. 16. REG. 8-19-2003.
- 2,753,734. SMARTDM. INT. CL. 9. REG. 8-19-2003.
- 2,753,735. MIRACLE MAC. INT. CL. 31. REG. 8-19-2003.
- 2,753,738. GE GLOBAL ASSET PROTECTION. INT. CL. 36. REG. 8-19-2003.
- 2,753,739. MISCELLANEOUS DESIGN. INT. CL. 36. REG. 8-19-2003.
- 2,753,740. FRANK AND DESIGN. INT. CL. 25. REG. 8-19-2003.
- 2,753,741. MACROSCOPE. INT. CL. 36. REG. 8-19-2003.
- 2,753,744. ESTATE COLLECTION. INT. CL. 28. REG. 8-19-2003.
- 2,753,747. AZALEAMC. INT. CL. 9. REG. 8-19-2003.
- 2,753,755. SWISSLOG (STYLIZED). INT. CLS. 6, 7, 9, 12, 20, 35, 37, 41 AND 42. REG. 8-19-2003.
- 2,753,756. SWISSLOG. INT. CLS. 6, 7, 9, 12, 20, 35, 37, 41 AND 42. REG. 8-19-2003.
- 2,753,757. DRYCLEAN OUTLET AND DESIGN. INT. CL. 37. REG. 8-19-2003.
- 2,753,758. VICTORIAN GARDEN COLLECTION. INT. CL. 6. REG. 8-19-2003.
- 2,753,759. ITAYA NAOMI. INT. CL. 24. REG. 8-19-2003.
- 2,753,760. LIPSHOP.COM. INT. CL. 3. REG. 8-19-2003.
- 2,753,762. ESPLANADE PLACE. INT. CL. 36. REG. 8-19-2003.
- 2,753,763. MATRIX MEMORY AND DESIGN. INT. CL. 9. REG. 8-19-2003.
- 2,753,764. LOCALORINATION. INT. CL. 9. REG. 8-19-2003.
- 2,753,767. KINESTHETIC SPEAKER. INT. CL. 41. REG. 8-19-2003.
- 2,753,770. WE VIDEOTAPE YOUR MEETINGS AND TURN THEM INTO REAL WORK. INT. CL. 41. REG. 8-19-2003.
- 2,753,771. LET'S TALK VIDEO. INT. CL. 41. REG. 8-19-2003.
- 2,753,772. AVENTURA CROSSINGS. INT. CL. 36. REG. 8-19-2003.
- 2,753,773. B-TECH AND DESIGN. INT. CL. 5. REG. 8-19-2003.
- 2,753,775. POP-OUT. INT. CL. 25. REG. 8-19-2003.
- 2,753,776. YOU CAN BE SURE... IF IT'S WESTINGHOUSE. INT. CL. 11. REG. 8-19-2003.
- 2,753,777. JAY JAK-I ON THE BRAN, BABY..... GONNA TAKE CRER THE WORLD JAK-I RECORDS AND ENTERTAINMENT AND DESIGN. INT. CL. 9. REG. 8-19-2003.
- 2,753,779. FALCON FAMILY OF COMPANIES. INT. CL. 9. REG. 8-19-2003.
- 2,753,780. FORMATE AND DESIGN. INT. CL. 29. REG. 8-19-2003.
- 2,753,781. STARSPEED (STYLIZED). INT. CL. 9. REG. 8-19-2003.
- 2,753,785. LIFE MOSAIC. INT. CL. 20. REG. 8-19-2003.
- 2,753,790. ZONE OF INFLUENCE. INT. CL. 35. REG. 8-19-2003.
- 2,753,794. BM AUDIO LABS. INT. CL. 9. REG. 8-19-2003.
- 2,753,795. COVID. INT. CL. 16. REG. 8-19-2003.
- 2,753,797. CHANNEL FLEX. INT. CL. 19. REG. 8-19-2003.
- 2,753,798. STORFUSION. INT. CLS. 35 AND 39. REG. 8-19-2003.
- 2,753,804. COMEMON. INT. CL. 9. REG. 8-19-2003.
- 2,753,805. FLOOSIE (STYLIZED). INT. CL. 25. REG. 8-19-2003.
- 2,753,807. EVERYONE WANTS BROADBAND. INT. CL. 9. REG. 8-19-2003.
- 2,753,808. FORE YOUR FITNESS. INT. CL. 42. REG. 8-19-2003.
- 2,753,809. THE HEART OF TEA TREE OIL. INT. CL. 3. REG. 8-19-2003.
- 2,753,812. OLIVENOS (STYLIZED). INT. CL. 29. REG. 8-19-2003.
- 2,753,815. SNAP N' WRAP. INT. CL. 21. REG. 8-19-2003.
- 2,753,817. MAXXAN. INT. CL. 9. REG. 8-19-2003.
- 2,753,820. BRONX WWW.BRONXSHOES.COM X AND DESIGN. INT. CL. 25. REG. 8-19-2003.
- 2,753,823. LVD COBRA. INT. CLS. 7, 35 AND 42. REG. 8-19-2003.
- 2,753,824. RESOLUTION PERFORMANCE MANAGEMENT. INT. CL. 9. REG. 8-19-2003.
- 2,753,825. NOTHING ELSE CUTS IT. INT. CL. 7. REG. 8-19-2003.
- 2,753,826. TITAN POWER GAS. INT. CL. 11. REG. 8-19-2003.
- 2,753,831. EXTREME SPA AND DESIGN. INT. CL. 3. REG. 8-19-2003.
- 2,753,832. WACKADOO'S GRUB & BREW. INT. CLS. 21 AND 30. REG. 8-19-2003.
- 2,753,837. EAGLE INVERTA-TEE. INT. CL. 17. REG. 8-19-2003.
- 2,753,840. LITTLE T AND ONE TRACK MIKE. INT. CL. 41. REG. 8-19-2003.
- 2,753,841. WE'VE DISCOVERED THE DOSE RESPONSE CURVE FOR EVERY DRUG, EVERY DISEASE, IN EVERY PATIENT. INT. CL. 42. REG. 8-19-2003.
- 2,753,842. THE NEW VOICE IN COMMUNICATIONS. YOURS.. INT. CLS. 38 AND 42. REG. 8-19-2003.
- 2,753,843. THE NEW VOICE IN COMMUNICATIONS. YOURS.. INT. CL. 38. REG. 8-19-2003.
- 2,753,846. GEIGER AND DESIGN. INT. CLS. 18 AND 20. REG. 8-19-2003.
- 2,753,847. HONEYMOONELEGANCEETC.COM. INT. CL. 16. REG. 8-19-2003.
- 2,753,853. AXONLINK. INT. CL. 9. REG. 8-19-2003.
- 2,753,854. TOPPEST.COM. INT. CL. 35. REG. 8-19-2003.
- 2,753,855. THE UNIVERSAL BOX. INT. CLS. 19 AND 20. REG. 8-19-2003.
- 2,753,856. WILDSPOORT. INT. CL. 18. REG. 8-19-2003.
- 2,753,858. POWER BOXX. INT. CL. 41. REG. 8-19-2003.
- 2,753,859. I-QUIZ. INT. CL. 16. REG. 8-19-2003.
- 2,753,860. SIMPLYWELL THE JOY OF GOOD HEALTH. AND DESIGN. INT. CL. 41. REG. 8-19-2003.
- 2,753,867. PROTOCOM SECURELOGIN. INT. CL. 9. REG. 8-19-2003.
- 2,753,868. PANZER DRAGOON. INT. CL. 9. REG. 8-19-2003.
- 2,753,871. XACTION. INT. CL. 9. REG. 8-19-2003.
- 2,753,873. AWAREWEAR AND DESIGN. INT. CL. 25. REG. 8-19-2003.
- 2,753,874. EARLY AMERICANA. INT. CL. 4. REG. 8-19-2003.
- 2,753,876. CH@T. INT. CL. 14. REG. 8-19-2003.
- 2,753,880. ALTVANTAGE. INT. CL. 36. REG. 8-19-2003.
- 2,753,883. ARTIGAMI AND DESIGN. INT. CL. 16. REG. 8-19-2003.
- 2,753,885. NASDAQ EUROPE COMPOSITE INDEX. INT. CL. 36. REG. 8-19-2003.
- 2,753,891. ACEGAIN. INT. CL. 9. REG. 8-19-2003.
- 2,753,893. KOH-TAO. INT. CLS. 9, 14 AND 25. REG. 8-19-2003.
- 2,753,902. CLAW CLIP. INT. CL. 8. REG. 8-19-2003.
- 2,753,903. SOURCEDIRECT.COM AND DESIGN. INT. CL. 9. REG. 8-19-2003.
- 2,753,905. XIGMA. INT. CL. 18. REG. 8-19-2003.
- 2,753,906. FRANKENHEIM. INT. CL. 32. REG. 8-19-2003.
- 2,753,908. GIVE US THE BALL. INT. CLS. 35 AND 42. REG. 8-19-2003.
- 2,753,909. TEESAV AND DESIGN. INT. CL. 25. REG. 8-19-2003.
- 2,753,912. INTERNATIONAL WEBCONNECT. INT. CLS. 35 AND 36. REG. 8-19-2003.
- 2,753,913. FRAUDSAFE. INT. CLS. 16 AND 41. REG. 8-19-2003.
- 2,753,918. PLAY THROUGH. INT. CL. 41. REG. 8-19-2003.
- 2,753,920. KERALONG AND DESIGN. INT. CL. 3. REG. 8-19-2003.
- 2,753,921. BIO 33 AND DESIGN. INT. CL. 3. REG. 8-19-2003.
- 2,753,922. FE AND DESIGN. INT. CLS. 35 AND 41. REG. 8-19-2003.

- 2,753,923. TRULY FREE CHECKING. INT. CL. 36. REG. 8-19-2003.
- 2,753,924. RAPID ASSIST. INT. CL. 9. REG. 8-19-2003.
- 2,753,925. C3 CONTROL . CONSERVE . CONVENIENCE (STYLIZED). INT. CL. 11. REG. 8-19-2003.
- 2,753,926. MISCELLANEOUS DESIGN. INT. CL. 10. REG. 8-19-2003.
- 2,753,928. AUTEC AND DESIGN. INT. CL. 9. REG. 8-19-2003.
- 2,753,930. MAGICPULSE. INT. CL. 9. REG. 8-19-2003.
- 2,753,935. LAURIAT. INT. CL. 8. REG. 8-19-2003.
- 2,753,937. CHROME CONCEPTS. INT. CL. 12. REG. 8-19-2003.
- 2,753,938. FARM & FIRESIDE. INT. CL. 16. REG. 8-19-2003.
- 2,753,939. QUICKSTACK. INT. CL. 11. REG. 8-19-2003.
- 2,753,940. HOVOGLAS PLUS. INT. CL. 11. REG. 8-19-2003.
- 2,753,941. RELLIANT SERIES 200. INT. CL. 20. REG. 8-19-2003.
- 2,753,946. SODA PUPS. INT. CL. 32. REG. 8-19-2003.
- 2,753,947. BOB PLUNKERT & REAL COUNTRY AND DESIGN. INT. CL. 41. REG. 8-19-2003.
- 2,753,951. FLAME ART. INT. CL. 4. REG. 8-19-2003.
- 2,753,953. BUNGALO RECORDS. INT. CL. 38. REG. 8-19-2003.
- 2,753,956. REIKER AND DESIGN. INT. CL. 11. REG. 8-19-2003.
- 2,753,958. TRU-TRACER. INT. CL. 13. REG. 8-19-2003.
- 2,753,959. PRACTICE PUTTING AID AND DESIGN. INT. CL. 28. REG. 8-19-2003.
- 2,753,961. STINGRAY DR AND DESIGN. INT. CL. 10. REG. 8-19-2003.
- 2,753,962. STINGRAY DR. INT. CL. 10. REG. 8-19-2003.
- 2,753,965. ABANDONED POOLS. INT. CL. 41. REG. 8-19-2003.
- 2,753,971. A WORLD OF FLAVOR AT THE CENTER OF THE PLATE. INT. CL. 30. REG. 8-19-2003.
- 2,753,972. RELLIANT SLIDER TECHNOLOGIES AND DESIGN. INT. CL. 20. REG. 8-19-2003.
- 2,753,973. BRIGHT IMPRESSIONS COLLECTION. INT. CL. 11. REG. 8-19-2003.
- 2,753,974. OOHOL. INT. CLS. 9, 36, 38 AND 42. REG. 8-19-2003.
- 2,753,977. TREASURE COAST. INT. CL. 33. REG. 8-19-2003.
- 2,753,981. ALDERWOODS. INT. CL. 36. REG. 8-19-2003.
- 2,753,982. ALDERWOODS. INT. CLS. 39 AND 42. REG. 8-19-2003.
- 2,753,989. VARNA. INT. CL. 7. REG. 8-19-2003.
- 2,753,992. YARNBIRD INTERACTIVE STORYTELLING AND DESIGN. INT. CL. 9. REG. 8-19-2003.
- 2,753,994. ASYLUM WORKSHOP. INT. CL. 20. REG. 8-19-2003.
- 2,753,997. CAPTAIN JOE'S. INT. CL. 33. REG. 8-19-2003.
- 2,753,998. SMART PEOPLE.SMART METALS.. INT. CL. 42. REG. 8-19-2003.
- 2,754,003. VOCERA AND DESIGN. INT. CL. 9. REG. 8-19-2003.
- 2,754,005. WA (STYLIZED). INT. CL. 18. REG. 8-19-2003.
- 2,754,006. EMPATH. INT. CL. 9. REG. 8-19-2003.
- 2,754,010. MUSIC CENTER LIVE. INT. CL. 9. REG. 8-19-2003.
- 2,754,011. FULL GROUP SOLUTION. INT. CL. 36. REG. 8-19-2003.
- 2,754,013. COLUMBUS NBDL AND DESIGN. INT. CL. 25. REG. 8-19-2003.
- 2,754,015. CHAMPIONS' MARK. INT. CL. 35. REG. 8-19-2003.
- 2,754,016. CORTE VIGNA. INT. CL. 33. REG. 8-19-2003.
- 2,754,017. THALASSOKEA. INT. CL. 3. REG. 8-19-2003.
- 2,754,020. TELESPECTRUM CUSTOMER INTERACTION MANAGEMENT. INT. CL. 35. REG. 8-19-2003.
- 2,754,026. QUALNET AND DESIGN. INT. CL. 9. REG. 8-19-2003.
- 2,754,030. BS&K AND DESIGN. INT. CL. 9. REG. 8-19-2003.
- 2,754,032. RELATIVELY SPEAKING: RAISING CHILDREN THE SECOND TIME. INT. CL. 16. REG. 8-19-2003.
- 2,754,034. QUICKNC (STYLIZED). INT. CL. 9. REG. 8-19-2003.
- 2,754,035. VIDITALK (STYLIZED). INT. CL. 38. REG. 8-19-2003.
- 2,754,036. RAINBOW ART. INT. CL. 16. REG. 8-19-2003.
- 2,754,040. ALGAE TAMER. INT. CL. 5. REG. 8-19-2003.
- 2,754,041. REAL BUSINESS TOOLS. INT. CLS. 35 AND 42. REG. 8-19-2003.
- 2,754,042. M MIDLAND DESIGN INC. AND DESIGN. INT. CL. 8. REG. 8-19-2003.
- 2,754,043. SCENARIO BEAN. INT. CL. 9. REG. 8-19-2003.
- 2,754,044. YOUR TRUSTED ADVISOR. INT. CL. 42. REG. 8-19-2003.
- 2,754,045. WIDE SIDE. INT. CL. 20. REG. 8-19-2003.
- 2,754,047. TUF-BASE. INT. CL. 19. REG. 8-19-2003.
- 2,754,048. MISCELLANEOUS DESIGN. INT. CL. 25. REG. 8-19-2003.
- 2,754,049. INTERGLOBENETWORK. INT. CL. 35. REG. 8-19-2003.
- 2,754,050. CLAIRE'S GRAND RIVER WINERY. INT. CL. 35. REG. 8-19-2003.
- 2,754,054. SHAREHOLDER VIEW. INT. CL. 36. REG. 8-19-2003.
- 2,754,057. VALID. INT. CL. 1. REG. 8-19-2003.
- 2,754,058. IFLEX. INT. CL. 10. REG. 8-19-2003.
- 2,754,059. MR. BIGSTUFF. INT. CL. 30. REG. 8-19-2003.
- 2,754,060. EXTYSR WE EXTEND YOUR REACH AND DESIGN. INT. CL. 42. REG. 8-19-2003.
- 2,754,061. NEXT MEX. INT. CL. 42. REG. 8-19-2003.
- 2,754,062. TANGENT. INT. CL. 15. REG. 8-19-2003.
- 2,754,063. ALWAYS THERE. INT. CL. 20. REG. 8-19-2003.
- 2,754,064. T4. INT. CL. 16. REG. 8-19-2003.
- 2,754,065. AVANT GARDE. INT. CL. 8. REG. 8-19-2003.
- 2,754,066. VERSERA. INT. CLS. 9, 38 AND 42. REG. 8-19-2003.
- 2,754,069. HAND FORGED DOUGHNUTS AND DESIGN. INT. CL. 30. REG. 8-19-2003.
- 2,754,070. REAKT AND DESIGN. INT. CLS. 20 AND 25. REG. 8-19-2003.
- 2,754,076. PARLOR BOSS. INT. CL. 3. REG. 8-19-2003.
- 2,754,077. THERMA FRIDGE AND DESIGN. INT. CL. 11. REG. 8-19-2003.
- 2,754,081. WATERPRO AND DESIGN. INT. CL. 25. REG. 8-19-2003.
- 2,754,083. FAST FORWARD. INT. CL. 9. REG. 8-19-2003.
- 2,754,085. WINTER. INT. CL. 15. REG. 8-19-2003.
- 2,754,087. MISCELLANEOUS DESIGN. INT. CL. 20. REG. 8-19-2003.
- 2,754,088. CARMOTIVE. INT. CL. 36. REG. 8-19-2003.
- 2,754,091. BIRDTITE. INT. CL. 16. REG. 8-19-2003.
- 2,754,094. DB DECIBEL PRODUCTS AN ALLEN TELECOM COMPANY AND DESIGN. INT. CL. 9. REG. 8-19-2003.
- 2,754,096. XXX. INT. CL. 28. REG. 8-19-2003.
- 2,754,097. FOREVER CREATIVE WORLDWIDE. INT. CL. 25. REG. 8-19-2003.
- 2,754,103. FORMAL COUNTRY. INT. CL. 27. REG. 8-19-2003.
- 2,754,109. BRIGADE. INT. CL. 35. REG. 8-19-2003.
- 2,754,113. ADU. INT. CL. 14. REG. 8-19-2003.
- 2,754,116. CHEM DECON AND DESIGN. INT. CL. 11. REG. 8-19-2003.
- 2,754,120. C'EST MOI. INT. CL. 4. REG. 8-19-2003.
- 2,754,121. COLOR UNLIMITED. INT. CL. 24. REG. 8-19-2003.
- 2,754,124. TROPIC DELIGHT. INT. CL. 29. REG. 8-19-2003.
- 2,754,125. PULSE WATCH. INT. CL. 36. REG. 8-19-2003.
- 2,754,126. PERRY'S ICE CREAM IT'S THE ICE CREAM- IEST. INT. CL. 30. REG. 8-19-2003.
- 2,754,127. E-Z MEAL. INT. CL. 30. REG. 8-19-2003.
- 2,754,131. SIMPLY EASIER. INT. CL. 36. REG. 8-19-2003.
- 2,754,132. MODULITE. INT. CL. 22. REG. 8-19-2003.
- 2,754,135. BENCH-MATE. INT. CL. 20. REG. 8-19-2003.
- 2,754,143. AMDOCSENABLER. INT. CL. 9. REG. 8-19-2003.
- 2,754,144. WATER WORKS. INT. CL. 7. REG. 8-19-2003.
- 2,754,146. ZÜB (STYLIZED). INT. CL. 25. REG. 8-19-2003.
- 2,754,148. FIDDLER'S ELBOW. INT. CL. 24. REG. 8-19-2003.
- 2,754,150. SOPHIE. INT. CL. 21. REG. 8-19-2003.
- 2,754,151. ORO-TEL. INT. CL. 16. REG. 8-19-2003.

- 2,754,152. AXE APOLLO AND DESIGN. INT. CL. 3. REG. 8-19-2003.
- 2,754,154. AXE ORION AND DESIGN. INT. CL. 3. REG. 8-19-2003.
- 2,754,155. LONESTAR (STYLIZED). INT. CL. 39. REG. 8-19-2003.
- 2,754,157. DRYKEEPER. INT. CL. 25. REG. 8-19-2003.
- 2,754,158. NOBODY KNOWS THIS WORLD BETTER. INT. CLS. 16 AND 35. REG. 8-19-2003.
- 2,754,159. RF RODAN & FIELDS AND DESIGN. INT. CLS. 3 AND 5. REG. 8-19-2003.
- 2,754,160. MRS. GROSSMAN'S LIMITED EDITION. INT. CL. 16. REG. 8-19-2003.
- 2,754,161. WAY LONG WAY FUN LET 'ER RIP. INT. CL. 30. REG. 8-19-2003.
- 2,754,163. VISTA VIEW. INT. CL. 9. REG. 8-19-2003.
- 2,754,164. LANGUEDGE (STYLIZED). INT. CL. 9. REG. 8-19-2003.
- 2,754,165. VASOHEAL AND DESIGN. INT. CL. 5. REG. 8-19-2003.
- 2,754,167. STRETCH N' FRESH. INT. CL. 21. REG. 8-19-2003.
- 2,754,169. MB MBX LOGISTICS A REYES HOLDINGS COMPANY AND DESIGN. INT. CL. 39. REG. 8-19-2003.
- 2,754,172. PRO SEAL AND DESIGN. INT. CL. 11. REG. 8-19-2003.
- 2,754,174. SEEING INTO THE FUTURE. INT. CL. 9. REG. 8-19-2003.
- 2,754,175. LET GENEROSITY PREVAIL. INT. CL. 33. REG. 8-19-2003.
- 2,754,177. BIDBUCKS. INT. CL. 35. REG. 8-19-2003.
- 2,754,178. CRAZY COLORS. INT. CL. 28. REG. 8-19-2003.
- 2,754,179. ZIP BOMB. INT. CL. 30. REG. 8-19-2003.
- 2,754,180. ULTRA-FIL. INT. CL. 21. REG. 8-19-2003.
- 2,754,181. ROLL-A-HOSE. INT. CL. 17. REG. 8-19-2003.
- 2,754,182. NATURE'S LITTLE BITES. INT. CL. 30. REG. 8-19-2003.
- 2,754,183. PIZZA JR.'S. INT. CL. 30. REG. 8-19-2003.
- 2,754,184. GENUINE SONOMA JEAN COMPANY. INT. CL. 25. REG. 8-19-2003.
- 2,754,185. POCKET HEARO. INT. CL. 9. REG. 8-19-2003.
- 2,754,187. VERT. INT. CL. 43. REG. 8-19-2003.
- 2,754,188. WE BRING HEALTH TO MIND. INT. CL. 44. REG. 8-19-2003.
- 2,754,189. NATURAL RUNNER. INT. CL. 28. REG. 8-19-2003.
- 2,754,190. PROPHILE. INT. CL. 9. REG. 8-19-2003.
- 2,754,192. TIGHTY WHITEY. INT. CL. 25. REG. 8-19-2003.
- 2,754,194. YOSEMITE. INT. CL. 9. REG. 8-19-2003.
- 2,754,195. GATEWAY. INT. CL. 41. REG. 8-19-2003.
- 2,754,196. EDGE OF COLOR. INT. CL. 20. REG. 8-19-2003.
- 2,754,199. SUNNY BOY AND DESIGN. INT. CL. 25. REG. 8-19-2003.
- 2,754,200. PRIMASPORT XPLOERS. INT. CL. 25. REG. 8-19-2003.
- 2,754,203. TRUBODY. INT. CL. 3. REG. 8-19-2003.
- 2,754,205. INNERVISION. INT. CL. 44. REG. 8-19-2003.
- 2,754,206. PROCALM. INT. CL. 5. REG. 8-19-2003.
- 2,754,209. MISCELLANEOUS DESIGN. INT. CL. 16. REG. 8-19-2003.
- 2,754,210. GOLD EAST PAPER USA. INT. CL. 16. REG. 8-19-2003.
- 2,754,211. MALTED MOO. INT. CL. 30. REG. 8-19-2003.
- 2,754,212. DIAMOND QUARTZ. INT. CL. 19. REG. 8-19-2003.
- 2,754,214. HARSH ENVIRONMENT WARRANTY. INT. CL. 36. REG. 8-19-2003.
- 2,754,215. GRIME MASTER. INT. CL. 21. REG. 8-19-2003.
- 2,754,216. MICRO MOTORING. INT. CL. 28. REG. 8-19-2003.
- 2,754,222. HAIR STRATE. INT. CL. 3. REG. 8-19-2003.
- 2,754,227. CHOICE COOKIES AND DESIGN. INT. CL. 30. REG. 8-19-2003.
- 2,754,228. ALMOST CD. INT. CL. 36. REG. 8-19-2003.
- 2,754,235. MAPLE LEAF HAM SHOPPE. INT. CL. 29. REG. 8-19-2003.
- 2,754,236. AES AUGUSTA ELECTRICAL SYSTEMS. INT. CL. 37. REG. 8-19-2003.
- 2,754,238. GITCHIGOOMIE. INT. CL. 30. REG. 8-19-2003.
- 2,754,240. A DELIGHTFUL BLEND OF ART AND FRAGRANCE. INT. CL. 4. REG. 8-19-2003.
- 2,754,242. EXPOSITÉ BY MAGASCHONI (STYLIZED). INT. CL. 25. REG. 8-19-2003.
- 2,754,244. DR. HANA'S NASOPURE AND DESIGN. INT. CL. 10. REG. 8-19-2003.
- 2,754,250. GYM-DRI. INT. CL. 25. REG. 8-19-2003.
- 2,754,254. FEDEX SMART SAVERS. INT. CL. 39. REG. 8-19-2003.
- 2,754,257. AMERICAN CONQUEST. INT. CLS. 9, 16 AND 42. REG. 8-19-2003.
- 2,754,261. COLOR LITE. INT. CL. 14. REG. 8-19-2003.
- 2,754,263. TECKADEMICS. TUNED AND DESIGN. INT. CL. 25. REG. 8-19-2003.
- 2,754,264. ESSENTUM. INT. CL. 5. REG. 8-19-2003.
- 2,754,265. L AND DESIGN. INT. CL. 29. REG. 8-19-2003.
- 2,754,268. THE LANDMARKS. INT. CL. 41. REG. 8-19-2003.
- 2,754,270. DOCTORS' SELECT. INT. CL. 5. REG. 8-19-2003.
- 2,754,271. BINIKI. INT. CL. 25. REG. 8-19-2003.
- 2,754,272. THE Q INSIDE THE O. INT. CL. 41. REG. 8-19-2003.
- 2,754,275. COPPER-GLYDE. INT. CL. 4. REG. 8-19-2003.
- 2,754,277. RAGG CHICKS. INT. CL. 28. REG. 8-19-2003.
- 2,754,280. TEX STOP AND DESIGN. INT. CL. 2. REG. 8-19-2003.
- 2,754,282. WORMCAM. INT. CL. 9. REG. 8-19-2003.
- 2,754,284. THE WORLD UNDER ONE ROOF. INT. CL. 35. REG. 8-19-2003.
- 2,754,285. ROADSTER. INT. CL. 7. REG. 8-19-2003.
- 2,754,288. WACHOVIA CAPITAL RESERVE LINE. INT. CL. 36. REG. 8-19-2003.
- 2,754,290. RICHETTI BROTHERS. INT. CL. 30. REG. 8-19-2003.
- 2,754,291. TE TEAS AND DESIGN. INT. CL. 30. REG. 8-19-2003.
- 2,754,293. SLICE-A-ROOS. INT. CL. 29. REG. 8-19-2003.
- 2,754,294. BLOOD SUCKERS. INT. CL. 30. REG. 8-19-2003.
- 2,754,296. AURORA. INT. CL. 10. REG. 8-19-2003.
- 2,754,297. JOHN COUTURE NEW YORK. INT. CL. 25. REG. 8-19-2003.
- 2,754,298. LIFE IS COMPLICATED, BANKING SHOULDN'T BE. INT. CL. 36. REG. 8-19-2003.
- 2,754,299. MIDNIGHT PLEASURES JEWELRY. INT. CL. 14. REG. 8-19-2003.
- 2,754,300. DUAL-AIR. INT. CL. 25. REG. 8-19-2003.
- 2,754,303. FREEDOM TO BE YOURSELF. INT. CL. 5. REG. 8-19-2003.
- 2,754,304. HEALTH SOLUTIONS. INT. CLS. 10 AND 21. REG. 8-19-2003.
- 2,754,308. TASTE SHINES THROUGH. INT. CL. 34. REG. 8-19-2003.
- 2,754,309. BUTTERFLY GARDEN. INT. CLS. 4 AND 5. REG. 8-19-2003.
- 2,754,310. LOUISVILLE SLUGGER. INT. CL. 29. REG. 8-19-2003.
- 2,754,312. MUDD SPORT AND DESIGN. INT. CL. 25. REG. 8-19-2003.
- 2,754,315. MANOOSH AND BALOOSH. INT. CL. 28. REG. 8-19-2003.
- 2,754,317. OUTSMART. INT. CL. 41. REG. 8-19-2003.
- 2,754,318. AIRREST. INT. CL. 9. REG. 8-19-2003.
- 2,754,319. WEATTRACT. INT. CL. 42. REG. 8-19-2003.
- 2,754,320. THAT'S MY BANK. INT. CL. 36. REG. 8-19-2003.
- 2,754,322. E-PROCUREMENT@MOORE. INT. CLS. 35, 39 AND 40. REG. 8-19-2003.
- 2,754,323. QUICKLUX. INT. CL. 7. REG. 8-19-2003.
- 2,754,329. FORTECH SOLUTIONS. INT. CL. 42. REG. 8-19-2003.
- 2,754,330. RANDY O'DONNELL IS THE M@N AND DESIGN. INT. CL. 16. REG. 8-19-2003.
- 2,754,331. THE M@N AND DESIGN. INT. CL. 16. REG. 8-19-2003.
- 2,754,333. PERFECTLY PLUSH. INT. CL. 28. REG. 8-19-2003.
- 2,754,335. GREENLEAF AND DESIGN. INT. CL. 42. REG. 8-19-2003.
- 2,754,337. THE DEBT TRAP. INT. CL. 36. REG. 8-19-2003.
- 2,754,339. P.W.R.: PREFERENTIAL WEAR RATIO WEAR TECHNOLOGY. INT. CL. 42. REG. 8-19-2003.

- 2,754,340. ADVANTIS TECHNOLOGIES. INT. CL. 40. REG. 8-19-2003.
- 2,754,341. SUNHILLO CORPORATION. INT. CL. 9. REG. 8-19-2003.
- 2,754,342. DIRTY QUEEN RECORDS AND DESIGN. INT. CLS. 9, 16 AND 25. REG. 8-19-2003.
- 2,754,343. BREAKFAST ON THE RUN. INT. CL. 30. REG. 8-19-2003.
- 2,754,344. STORAGE PROFILER. INT. CL. 9. REG. 8-19-2003.
- 2,754,345. ENVIEW TECHNOLOGIES. INT. CL. 42. REG. 8-19-2003.
- 2,754,348. DERMALZONE. INT. CL. 5. REG. 8-19-2003.
- 2,754,349. DETECTION SYSTEMS DS AND DESIGN. INT. CL. 9. REG. 8-19-2003.
- 2,754,351. CARELINE. INT. CL. 5. REG. 8-19-2003.
- 2,754,352. ESW ENCLOSURE SYSTEMS WORLDWIDE. INT. CL. 40. REG. 8-19-2003.
- 2,754,355. ENTERPRISE BY TARGETVISION DATARUNNER. INT. CL. 9. REG. 8-19-2003.
- 2,754,356. WHEN LIFE DEPENDS ON MEDICAL TECHNOLOGY. INT. CL. 9. REG. 8-19-2003.
- 2,754,358. POWER RANGERS: WILD FORCE. INT. CL. 41. REG. 8-19-2003.
- 2,754,359. ARJES. INT. CL. 25. REG. 8-19-2003.
- 2,754,362. CRI. INT. CL. 1. REG. 8-19-2003.
- 2,754,365. DIAL4SNAX. INT. CL. 35. REG. 8-19-2003.
- 2,754,367. RASP. INT. CL. 6. REG. 8-19-2003.
- 2,754,369. NICK.COM BEATMIXER. INT. CL. 41. REG. 8-19-2003.
- 2,754,371. SOS AND DESIGN. INT. CLS. 41 AND 42. REG. 8-19-2003.
- 2,754,372. EVOTRA. INT. CLS. 35 AND 37. REG. 8-19-2003.
- 2,754,373. WEDDINGSTORIES. INT. CL. 42. REG. 8-19-2003.
- 2,754,374. ATS CENTER FOR ADVANCED TECHNOLOGY SOLUTIONS, INC. AND DESIGN. INT. CLS. 41 AND 42. REG. 8-19-2003.
- 2,754,376. MARATHON. INT. CL. 1. REG. 8-19-2003.
- 2,754,379. B.O.B.. INT. CL. 2. REG. 8-19-2003.
- 2,754,380. W&G. INT. CLS. 18 AND 25. REG. 8-19-2003.
- 2,754,381. "REDEFINING THE LAW". INT. CL. 42. REG. 8-19-2003.
- 2,754,382. RELEASE THE FEAR AND DESIGN. INT. CL. 41. REG. 8-19-2003.
- 2,754,384. ALTERED SKATES. INT. CL. 35. REG. 8-19-2003.
- 2,754,385. UNWIRED BY AETHER. INT. CLS. 9, 38 AND 42. REG. 8-19-2003.
- 2,754,388. ALBION ADVANCED NUTRITION (STYLISTED). INT. CLS. 1, 5 AND 40. REG. 8-19-2003.
- 2,754,389. DEEP ROOTS STRONG BRANCHES. INT. CL. 36. REG. 8-19-2003.
- 2,754,392. EBTDESIGN. INT. CL. 42. REG. 8-19-2003.
- 2,754,393. COPPERCARE. INT. CL. 1. REG. 8-19-2003.
- 2,754,395. MYCHOICE. INT. CL. 36. REG. 8-19-2003.
- 2,754,396. MAC PRINTER AND DESIGN. INT. CL. 42. REG. 8-19-2003.
- 2,754,398. CAGETECH. INT. CL. 20. REG. 8-19-2003.
- 2,754,400. GEORGIA CHEROKEES BASEBALL CLUB. INT. CL. 41. REG. 8-19-2003.
- 2,754,401. AQUAEDGE. INT. CL. 41. REG. 8-19-2003.
- 2,754,404. SHRINK YOUR PANTS. INT. CL. 41. REG. 8-19-2003.
- 2,754,406. CHEMWAND. INT. CLS. 1 AND 11. REG. 8-19-2003.
- 2,754,409. THEY'RE OFF. INT. CL. 9. REG. 8-19-2003.
- 2,754,410. POSTGUARD. INT. CL. 16. REG. 8-19-2003.
- 2,754,411. WHITEGIRL. INT. CL. 25. REG. 8-19-2003.
- 2,754,412. ENDOVASCULAR TODAY AND DESIGN. INT. CLS. 9 AND 16. REG. 8-19-2003.
- 2,754,413. TWIST & FLEX. INT. CL. 20. REG. 8-19-2003.
- 2,754,414. THERMA FRIDGE. INT. CL. 11. REG. 8-19-2003.
- 2,754,419. JESMAGIC SQUATTY CUPS. INT. CL. 28. REG. 8-19-2003.
- 2,754,420. GEOVINE GEOGRAPHIC VINEYARD INFORMATION SYSTEMS AND DESIGN. INT. CL. 42. REG. 8-19-2003.
- 2,754,423. BEARCUTS. INT. CL. 16. REG. 8-19-2003.
- 2,754,426. PACK HAPPY. INT. CL. 18. REG. 8-19-2003.
- 2,754,429. PEARL PLASTIC AND DESIGN. INT. CL. 5. REG. 8-19-2003.
- 2,754,432. SATELLITE 4000. INT. CLS. 7 AND 12. REG. 8-19-2003.
- 2,754,433. CAJUN HERITAGE. INT. CL. 30. REG. 8-19-2003.
- 2,754,434. HOME PROFESSIONAL. INT. CL. 7. REG. 8-19-2003.
- 2,754,435. F AND DESIGN. INT. CL. 25. REG. 8-19-2003.
- 2,754,440. PURE HEAT. INT. CL. 3. REG. 8-19-2003.
- 2,754,441. PRESENTATION MASTER AND DESIGN. INT. CL. 9. REG. 8-19-2003.
- 2,754,445. OCEAN TIDES. INT. CLS. 3 AND 4. REG. 8-19-2003.
- 2,754,447. THE SOUND OF MEMORIES. INT. CL. 16. REG. 8-19-2003.
- 2,754,448. AMIGO. INT. CL. 33. REG. 8-19-2003.
- 2,754,449. COGNITIVE THERAPY COMPLEX. INT. CL. 5. REG. 8-19-2003.
- 2,754,450. SECRET LISTENER. INT. CL. 28. REG. 8-19-2003.
- 2,754,451. AIRBORNE ASSAULT. INT. CL. 9. REG. 8-19-2003.
- 2,754,455. TRAXCELL. INT. CL. 42. REG. 8-19-2003.
- 2,754,456. CITRUS INFUSION. INT. CL. 3. REG. 8-19-2003.
- 2,754,458. REFRESHEN. INT. CL. 1. REG. 8-19-2003.
- 2,754,459. PROAPPLICATOR. INT. CL. 16. REG. 8-19-2003.
- 2,754,460. SILVERHERON. INT. CL. 29. REG. 8-19-2003.
- 2,754,462. INCREDIBLY ULTRA SHEER. INT. CL. 25. REG. 8-19-2003.
- 2,754,464. LA OPCION INTELIGENTE. INT. CLS. 4 AND 37. REG. 8-19-2003.
- 2,754,467. LUNAR OFFENSIVE PRESS AND DESIGN. INT. CL. 16. REG. 8-19-2003.
- 2,754,468. TARGET BUTLER. INT. CL. 28. REG. 8-19-2003.
- 2,754,469. ARCHIVE. INT. CL. 11. REG. 8-19-2003.
- 2,754,470. V-AMOUR. INT. CL. 10. REG. 8-19-2003.
- 2,754,471. WORLD OF GOOD. INT. CL. 16. REG. 8-19-2003.
- 2,754,472. KEEP OUT. INT. CL. 28. REG. 8-19-2003.
- 2,754,473. GETLEWD. INT. CL. 25. REG. 8-19-2003.
- 2,754,474. FASTLANE. INT. CL. 41. REG. 8-19-2003.
- 2,754,475. HEALTHY SNACKER. INT. CL. 5. REG. 8-19-2003.
- 2,754,476. LANDMARK INVESTMENT RESEARCH INC.. INT. CL. 36. REG. 8-19-2003.
- 2,754,477. VINNIE THE CRAZY CAR MAN. INT. CL. 35. REG. 8-19-2003.
- 2,754,478. MOTIVATOR. INT. CL. 3. REG. 8-19-2003.
- 2,754,479. DOMINATE. INT. CL. 3. REG. 8-19-2003.
- 2,754,482. THERMA-VENT. INT. CL. 11. REG. 8-19-2003.
- 2,754,483. MUCHA LUCHA. INT. CL. 41. REG. 8-19-2003.
- 2,754,488. FUSSY BOY! AND DESIGN. INT. CL. 25. REG. 8-19-2003.
- 2,754,489. TEMPO REF. INT. CL. 9. REG. 8-19-2003.
- 2,754,490. COPYCOCK. INT. CL. 16. REG. 8-19-2003.
- 2,754,491. POLYSHIELD. INT. CL. 2. REG. 8-19-2003.
- 2,754,493. TRITON GENETICS. INT. CL. 31. REG. 8-19-2003.
- 2,754,494. THE SUN IS RISING ON A NEW DAY... IMAGINE THE POSSIBILITIES. INT. CL. 35. REG. 8-19-2003.
- 2,754,498. NASPL AND DESIGN. INT. CL. 35. REG. 8-19-2003.
- 2,754,500. PURRFECT PET SITTING. INT. CL. 44. REG. 8-19-2003.
- 2,754,501. MICROCHICK. INT. CL. 30. REG. 8-19-2003.
- 2,754,504. HEADENDWARE. INT. CL. 9. REG. 8-19-2003.
- 2,754,506. MISCELLANEOUS DESIGN. INT. CLS. 25, 36, 41, 42 AND 44. REG. 8-19-2003.
- 2,754,507. BOOK PLANET. INT. CL. 35. REG. 8-19-2003.
- 2,754,508. WELCOME TO THE BLENDED ICE AGE. INT. CL. 30. REG. 8-19-2003.
- 2,754,510. DOMTAR. A DIFFERENT FEEL. INT. CLS. 16 AND 19. REG. 8-19-2003.
- 2,754,511. ENTEGRA TO YOU. INT. CL. 16. REG. 8-19-2003.
- 2,754,512. NO-BRAINER COOKBOOK. INT. CL. 16. REG. 8-19-2003.
- 2,754,513. IGENIE. INT. CL. 9. REG. 8-19-2003.
- 2,754,514. SILLY SNAKES AND LADDERS. INT. CL. 28. REG. 8-19-2003.
- 2,754,516. LUMI-DANCER. INT. CL. 11. REG. 8-19-2003.
- 2,754,519. PIVOT-IMAGE. INT. CL. 9. REG. 8-19-2003.

- 2,754,520. HARVEST ENERGY. INT. CL. 35. REG. 8-19-2003.
 2,754,522. TMC THE MOVIE CHANNEL ON DEMAND AND DESIGN. INT. CL. 41. REG. 8-19-2003.
 2,754,523. TMC THE MOVIE CHANNEL ON DEMAND AND DESIGN. INT. CL. 38. REG. 8-19-2003.
 2,754,524. BODY CHOICE. INT. CL. 5. REG. 8-19-2003.
 2,754,528. SCRUB 'N TOSS. INT. CL. 21. REG. 8-19-2003.
 2,754,530. W16. INT. CLS. 7, 12 AND 27. REG. 8-19-2003.
 2,754,531. W 8. INT. CLS. 7, 12 AND 28. REG. 8-19-2003.
 2,754,532. 800HOSTING. INT. CL. 42. REG. 8-19-2003.
 2,754,533. 1-800-HOSTING.COM. INT. CL. 42. REG. 8-19-2003.
 2,754,534. BABY GEAR REVIEW. INT. CL. 42. REG. 8-19-2003.
 2,754,535. IMAGECODE. INT. CL. 9. REG. 8-19-2003.
 2,754,536. MIGRATION. INT. CL. 42. REG. 8-19-2003.
 2,754,537. GIFTS4BOATS.COM. INT. CL. 35. REG. 8-19-2003.
 2,754,540. THEDOORCOMPANY.COM. INT. CL. 35. REG. 8-19-2003.
 2,754,543. CITY BROKERS. INT. CL. 36. REG. 8-19-2003.
 2,754,544. WHISTLE CANDY AND DESIGN. INT. CL. 30. REG. 8-19-2003.
 2,754,545. CITRUS FARMS. INT. CL. 32. REG. 8-19-2003.
 2,754,546. ELEVATOR NEWS NETWORK. INT. CL. 35. REG. 8-19-2003.
 2,754,547. TRANSFER TRACKER. INT. CL. 36. REG. 8-19-2003.
 2,754,548. PICCOLINA. INT. CL. 35. REG. 8-19-2003.
 2,754,549. THE CODING INSTITUTE. INT. CL. 41. REG. 8-19-2003.
 2,754,551. (SBM) SIMPLE BUT MENTAL. INT. CL. 25. REG. 8-19-2003.
 2,754,552. SMALLTOWNREALESTATE. INT. CL. 36. REG. 8-19-2003.
 2,754,553. TECHNOLOGY4KIDS. INT. CL. 35. REG. 8-19-2003.
 2,754,554. BARGAINS FOR THE HOME!. INT. CL. 42. REG. 8-19-2003.
 2,754,555. MUSLIM YELLOW PAGES. INT. CL. 16. REG. 8-19-2003.
 2,754,556. PREFERRED PROTECTION PLAN. INT. CL. 36. REG. 8-19-2003.
 2,754,557. HOME OPENER SOUVENIRS. INT. CL. 16. REG. 8-19-2003.
 2,754,558. NET C@LLCENTER AND DESIGN. INT. CL. 42. REG. 8-19-2003.
 2,754,560. HEALTH ROCKER. INT. CL. 10. REG. 8-19-2003.
 2,754,561. THE PORCELAIN GARDEN. INT. CL. 21. REG. 8-19-2003.
 2,754,563. RIZADAS. INT. CL. 29. REG. 8-19-2003.
 2,754,565. BERKEY. INT. CL. 11. REG. 8-19-2003.
 2,754,567. CE AND DESIGN. INT. CLS. 41 AND 42. REG. 8-19-2003.
 2,754,570. CALIFORNIA-GUJARAT SISTER STATE COMMITTEE. INT. CL. 41. REG. 8-19-2003.
 2,754,572. MISCELLANEOUS DESIGN. INT. CL. 25. REG. 8-19-2003.
 2,754,574. FARMLAND. INT. CLS. 25 AND 28. REG. 8-19-2003.
 2,754,575. NEUROSTEM. INT. CL. 42. REG. 8-19-2003.
 2,754,576. FORECAST ENGINEERING. INT. CL. 35. REG. 8-19-2003.
 2,754,577. CHARITABLE VENTURE FOUNDATION (STYLIZED). INT. CL. 36. REG. 8-19-2003.
 2,754,581. FORWARD INVESTMENT NOTES. INT. CL. 36. REG. 8-19-2003.
 2,754,583. PHAT SOUND. INT. CL. 9. REG. 8-19-2003.
 2,754,587. CURL HYDRATOR. INT. CL. 3. REG. 8-19-2003.
 2,754,589. AFFORDABLE HOMES OF AMERICA. INT. CL. 37. REG. 8-19-2003.
 2,754,590. MORTGAGE PROFESSOR. INT. CL. 16. REG. 8-19-2003.
 2,754,592. SOUTH CAROLINA EDUCATION LOTTERY. INT. CL. 41. REG. 8-19-2003.
 2,754,593. HORSESHOE CRAB RESEARCH INSTITUTE. INT. CL. 35. REG. 8-19-2003.
 2,754,594. SUB-TERRANEAN SHIFT. INT. CL. 9. REG. 8-19-2003.
 2,754,595. NORTH AMERICAN GAMING ALMANAC. INT. CL. 16. REG. 8-19-2003.
 2,754,601. NATIONALBROADCAST.COM. INT. CL. 41. REG. 8-19-2003.
 2,754,602. FESTIVAL OF HUMMINGBIRDS. INT. CL. 41. REG. 8-19-2003.
 2,754,604. CENTER FOR REPRODUCTIVE RIGHTS AND DESIGN. INT. CLS. 42 AND 44. REG. 8-19-2003.
 2,754,605. CLEAN & CLEAR. INT. CL. 11. REG. 8-19-2003.
 2,754,606. MUSICALFARE. INT. CL. 41. REG. 8-19-2003.
 2,754,607. PUPPY TUBS. INT. CL. 44. REG. 8-19-2003.
 2,754,608. DIRECT EMPLOYERS (STYLIZED). INT. CL. 35. REG. 8-19-2003.
 2,754,609. RADFORD (STYLIZED). INT. CL. 21. REG. 8-19-2003.
 2,754,612. REINING HORSE SPORTS FOUNDATION. INT. CLS. 35, 41 AND 44. REG. 8-19-2003.
 2,754,613. NAPA TAPAS. INT. CL. 29. REG. 8-19-2003.
 2,754,615. GROUP PHOTO. INT. CL. 28. REG. 8-19-2003.
 2,754,616. VASI. INT. CL. 33. REG. 8-19-2003.
 2,754,617. DAYTON PREMIER ALLOYS AND DESIGN. INT. CL. 12. REG. 8-19-2003.
 2,754,618. SHOP SPECS. INT. CL. 9. REG. 8-19-2003.
 2,754,620. DVD BUILDER. INT. CL. 9. REG. 8-19-2003.
 2,754,621. "OUR SUPERIOR PREPARATION PROCEDURES". INT. CL. 37. REG. 8-19-2003.
 2,754,626. MATCHA ESPRESSO. INT. CL. 30. REG. 8-19-2003.
 2,754,627. LEARN TO DRAW. INT. CL. 28. REG. 8-19-2003.
 2,754,628. BOSWORTH. INT. CL. 33. REG. 8-19-2003.
 2,754,632. FINANCIAL CUSTOMER RELATIONSHIP MANAGEMENT. INT. CLS. 35 AND 36. REG. 8-19-2003.
 2,754,633. CAD2PDF. INT. CL. 9. REG. 8-19-2003.
 2,754,634. TWIRL AND CURL. INT. CL. 9. REG. 8-19-2003.
 2,754,636. DEDICATED RISK MANAGEMENT LINE OF CREDIT. INT. CL. 36. REG. 8-19-2003.
 2,754,640. VITAMIN SODA. INT. CL. 32. REG. 8-19-2003.
 2,754,641. STREET GEAR FOR THE MUSIC JUNKIE. INT. CL. 9. REG. 8-19-2003.
 2,754,642. THE CLASSIC CORNICE. INT. CL. 19. REG. 8-19-2003.
 2,754,643. FIESTA HISPANA. INT. CL. 41. REG. 8-19-2003.
 2,754,646. CAPITAL ACCESS EXPO. INT. CL. 35. REG. 8-19-2003.
 2,754,647. DVCR. INT. CL. 9. REG. 8-19-2003.
 2,754,648. THE GREATER HARTFORD REVIEW. INT. CL. 16. REG. 8-19-2003.
 2,754,650. ONLINE PAYMENT COMPLIANCE SYSTEM. INT. CL. 9. REG. 8-19-2003.
 2,754,652. TECHNOLOGY FOR THE LIFE SCIENCES. INT. CLS. 16, 41 AND 42. REG. 8-19-2003.
 2,754,653. 1-800-POPCORN. INT. CL. 42. REG. 8-19-2003.
 2,754,655. NEWCOME. INT. CL. 21. REG. 8-19-2003.
 2,754,657. THICK'N CHEWY. INT. CL. 31. REG. 8-19-2003.
 2,754,660. CORO. INT. CL. 33. REG. 8-19-2003.
 2,754,663. CAMATOOLS (STYLIZED). INT. CL. 9. REG. 8-19-2003.
 2,754,664. BEST BUSINESS. INT. CL. 35. REG. 8-19-2003.
 2,754,667. ECUP. INT. CL. 10. REG. 8-19-2003.
 2,754,668. 1-800-BANKCARD (STYLIZED). INT. CL. 36. REG. 8-19-2003.
 2,754,669. NONI NASAL. INT. CL. 5. REG. 8-19-2003.
 2,754,670. CANDLES FOR GUYS. INT. CL. 4. REG. 8-19-2003.
 2,760,693. OCE IMAGE LOGIC (STYLIZED). INT. CLS. 37 AND 42 ONLY. REG. 9-9-2003.
 2,762,405. PARTYLITE AND DESIGN. INT. CL. 26 ONLY. REG. 9-9-2003.
 2,763,218. CASHMONEY AND DESIGN. INT. CLS. 16, 38 AND 39 ONLY. REG. 9-16-2003.
 2,764,598. METABOLIFE (STYLIZED). INT. CL. 25 ONLY. REG. 9-16-2003.
 2,768,598. IBU GALLERY EDITION. INT. CLS. 3, 4, 8, 24 AND 25 ONLY. REG. 9-30-2003.
 2,770,421. BATTLESHIP MISSOURI. INT. CLS. 21 AND 28 ONLY. REG. 9-30-2003.

- 2,774,562. BRUNOFRISONI (STYLIZED). INT. CLS. 9 AND 14 ONLY. REG. 10-21-2003.
- 2,778,603. QUAN CHI. INT. CL. 16 ONLY. REG. 10-28-2003.
- 2,793,555. OCE INTRA LOGIC (STYLIZED). INT. CLS. 37 AND 42 ONLY. REG. 12-16-2003.
- 2,798,095. CIGARETTE. INT. CL. 16 ONLY. REG. 12-23-2003.
- 2,817,040. PROUDLY AMERICAN. INT. CL. 4 ONLY. REG. 2-24-2004.
- 2,818,561. MISCELLANEOUS DESIGN. INT. CL. 16 ONLY. REG. 3-2-2004.
- 2,820,962. RODNEY MOORE. INT. CL. 25 ONLY. REG. 3-9-2004.
- 2,821,059. MISCELLANEOUS DESIGN. INT. CLS. 16, 42 AND 44 ONLY. REG. 3-9-2004.
- 2,821,463. MYASSISTANT. INT. CL. 35 ONLY. REG. 3-9-2004.
- 2,822,000. FAMITSU.COM. INT. CL. 35 ONLY. REG. 3-16-2004.
- 2,822,220. IMAGINK (STYLIZED). INT. CL. 9 ONLY. REG. 3-16-2004.
- 2,822,236. INTERVIA. INT. CL. 7 ONLY. REG. 3-16-2004.
- 2,822,671. DEGACRYL. INT. CLS. 2 AND 17 ONLY. REG. 3-16-2004.
- 2,823,110. GMP INSTITUTE AND DESIGN. INT. CL. 9 ONLY. REG. 3-16-2004.
- 2,823,207. PCS. INT. CL. 16 ONLY. REG. 3-16-2004.
- 2,823,598. MARC BUCHANAN. INT. CL. 3 ONLY. REG. 3-16-2004.
- 2,823,613. STEP UP. INT. CLS. 35 AND 41 ONLY. REG. 3-16-2004.
- 2,823,682. OUR BUSINESS IS TO HELP GROW YOUR BUSINESS. INT. CL. 42 ONLY. REG. 3-16-2004.
- 2,824,290. ACROS. INT. CL. 9 ONLY. REG. 3-23-2004.
- 2,824,326. OCE DOC EXEC (STYLIZED). INT. CLS. 37 AND 42 ONLY. REG. 3-23-2004.
- 2,824,327. OCE ENGINEERING EXEC (STYLIZED). INT. CLS. 37 AND 42 ONLY. REG. 3-23-2004.
- 2,824,328. OCE PRINT EXEC (STYLIZED). INT. CLS. 37 AND 42 ONLY. REG. 3-23-2004.
- 2,824,392. XERO FLOR AND DESIGN. INT. CL. 1 ONLY. REG. 3-23-2004.
- 2,824,540. MAXTOR (STYLIZED). INT. CLS. 35 AND 42 ONLY. REG. 3-23-2004.
- 2,824,649. ROSE BRAND AND DESIGN. INT. CL. 30 ONLY. REG. 3-23-2004.
- 2,825,144. VANESSA BRUNO. INT. CLS. 3, 9 AND 14 ONLY. REG. 3-23-2004.
- 2,825,349. RAINCHECK. INT. CL. 24 ONLY. REG. 3-23-2004.
- 2,825,661. ZEPTOMARK. INT. CL. 40 ONLY. REG. 3-23-2004.
- 2,826,254. THE MAILBOX BOOK COMPANY. INT. CL. 41 ONLY. REG. 3-23-2004.
- 2,826,801. DNOA SELECT. INT. CL. 35 ONLY. REG. 3-30-2004.
- 2,826,839. MISCELLANEOUS DESIGN. INT. CLS. 3, 9 AND 16 ONLY. REG. 3-30-2004.
- 2,826,976. X5. INT. CLS. 12, 14, 16, 18, 21, 24 AND 25 ONLY. REG. 3-30-2004.
- 2,827,459. CNCG AND DESIGN. INT. CL. 9 ONLY. REG. 3-30-2004.
- 2,827,778. NEXTT. INT. CL. 44 ONLY. REG. 3-30-2004.
- 2,828,526. MISCELLANEOUS DESIGN. INT. CL. 36 ONLY. REG. 3-30-2004.
- 2,828,676. CICLO. INT. CLS. 12, 25 AND 28 ONLY. REG. 3-30-2004.
- 2,828,985. PETER BEATON. INT. CLS. 9 AND 25 ONLY. REG. 4-6-2004.
- 2,829,501. PEPPERDINE UNIVERSITY FREELY YE RECEIVED FREELY GIVE 1937 AND DESIGN. INT. CL. 24 ONLY. REG. 4-6-2004.
- 2,831,267. HUGO. INT. CL. 23 ONLY. REG. 4-13-2004.
- 2,831,458. MISCELLANEOUS DESIGN. INT. CL. 25 ONLY. REG. 4-13-2004.
- 2,833,482. DELPHI. INT. CL. 12 ONLY. REG. 4-20-2004.
- 2,834,842. EYES IN. INT. CL. 41 ONLY. REG. 4-20-2004.
- 2,835,845. CNR WISDOM FOR LIFE. AND DESIGN. INT. CL. 18 ONLY. REG. 4-27-2004.
- 2,835,893. TOEJAM & EARL STANDARD CHARACTER MARK. INT. CL. 28 ONLY. REG. 4-27-2004.
- 2,837,981. ADG SPORTS. INT. CL. 28 ONLY. REG. 5-4-2004.
- 2,842,245. FLORALIFE. INT. CL. 17 ONLY. REG. 5-18-2004.
- 2,842,936. PROPERTY CLAIM SERVICES PCS AND DESIGN. INT. CL. 16 ONLY. REG. 5-18-2004.
- 2,845,545. HALL OF IDEAS. INT. CL. 42 ONLY. REG. 5-25-2004.
- 2,848,092. SHILOH APRIL 6TH 1862 MY LIFE PRESERVER G.E.D. TES OF AMERICA VENTY D. AND DESIGN. INT. CL. 25 ONLY. REG. 6-1-2004.
- 2,848,093. SHILOH APRIL 6TH 1862 MY LIFE PRESERVER G.E.D. INT. CL. 25 ONLY. REG. 6-1-2004.
- 2,878,274. MISCELLANEOUS DESIGN. INT. CLS. 3, 10 AND 11 ONLY. REG. 8-31-2004.
- 2,884,510. PRO AND DESIGN. INT. CL. 14 ONLY. REG. 9-14-2004.
- 2,897,094. ITX. INT. CL. 41 ONLY. REG. 10-26-2004.
- 2,897,578. ZUPREEM. INT. CL. 28 ONLY. REG. 10-26-2004.
- 2,900,961. LA NOUBA. INT. CLS. 14, 18 AND 24 ONLY. REG. 11-9-2004.
- 2,908,197. AVD. INT. CL. 9 ONLY. REG. 12-7-2004.
- 2,922,878. BLUE UP. INT. CLS. 9, 14, 18 AND 25 ONLY. REG. 2-1-2005.

SECTION 18

- 1,295,185. LET'S EAT AND DESIGN. INT. CL. 42. REG. 9-11-1984.
- 1,435,217. ROYAL SILK AND DESIGN. INT. CL. 3. REG. 4-7-1987.
- 1,630,075. EXPRESSIONS IN WOOD (STYLIZED). INT. CL. 20. REG. 1-1-1991.
- 1,803,765. POPULE. INT. CL. 21. REG. 11-9-1993.
- 1,810,869. JOYRIDE. INT. CLS. 25 AND 28. REG. 12-14-1993.
- 2,461,568. TRADITIONS AND DESIGN. INT. CL. 39. REG. 6-19-2001.
- 2,843,468. KAO AND DESIGN. INT. CL. 30. REG. 5-18-2004.
- 2,846,484. RUTHLESS TALENTS. INT. CL. 41. REG. 5-25-2004.
- 2,853,439. VIENCE. INT. CL. 9. REG. 6-15-2004.
- 2,876,849. LA PANTERA ROSA. INT. CL. 43. REG. 8-24-2004.
- 2,880,691. APEX. INT. CL. 9. REG. 9-7-2004.
- 2,906,417. SOPHIX. INT. CL. 9. REG. 11-30-2004.
- 2,906,809. 1-BOSTONLIMO STANDARD CHARACTER MARK. INT. CL. 39. REG. 11-30-2004.
- 2,917,663. KAO AND DESIGN. INT. CL. 32. REG. 1-11-2005.
- 2,919,301. KAO AND DESIGN. INT. CL. 29. REG. 1-18-2005.
- 2,931,221. WINNING INNINGS. INT. CL. 41. REG. 3-8-2005.
- 2,961,471. FANTASTIC FRUIT STANDARD CHARACTER MARK. INT. CL. 30. REG. 6-7-2005.
- 3,084,828. LILY ALLEN ORGANICS STANDARD CHARACTER MARK. INT. CL. 3. REG. 4-25-2006.
- 3,089,748. ENDEAVOR STANDARD CHARACTER MARK. INT. CL. 41. REG. 5-9-2006.
- 3,144,385. LILY ALLEN ORGANICS AND DESIGN. INT. CL. 3. REG. 9-19-2006.
- 3,210,804. PRO MOTION STANDARD CHARACTER MARK. INT. CL. 35. REG. 2-20-2007.
- 3,246,901. IN YOUR ELEMENT STANDARD CHARACTER MARK. INT. CL. 35. REG. 5-29-2007.
- 3,249,165. POINT GEAR STANDARD CHARACTER MARK. INT. CL. 25. REG. 6-5-2007.
- 3,250,964. POINT GEAR STANDARD CHARACTER MARK. INT. CL. 25. REG. 6-12-2007.
- 3,252,939. B C BATTLERS STANDARD CHARACTER MARK. INT. CLS. 9, 16, 21, 25, 28 AND 41. REG. 6-19-2007.
- 3,311,413. LEONARDO'S PRODUCTS STANDARD CHARACTER MARK. INT. CL. 3. REG. 10-16-2007.
- 3,368,803. HOME GROWN LACROSSE STANDARD CHARACTER MARK. INT. CL. 41. REG. 1-15-2008.
- 3,415,482. SYMMETRIC OBJECTS. INT. CL. 9. REG. 4-22-2008.
- 3,431,641. FUTURE. INT. CLS. 35 AND 42. REG. 5-20-2008.

- 3,468,168. ENZO ROSSI AND DESIGN. INT. CL. 18. REG. 7-15-2008.
- 3,545,600. COSTA RICA BLUE ZONE STANDARD CHARACTER MARK. INT. CL. 32. REG. 12-9-2008.
- 3,548,840. RENEW STANDARD CHARACTER MARK. INT. CL. 1. REG. 12-23-2008.
- 3,607,155. SOFTINOS AND DESIGN. INT. CL. 25. REG. 4-14-2009.
- 3,660,184. BLUE ZONE WATER STANDARD CHARACTER MARK. INT. CL. 32. REG. 7-28-2009.
- 3,684,658. ARMOR-TEE STANDARD CHARACTER MARK. INT. CL. 9. REG. 9-15-2009.

NUMBERS

- 2,901,490. DOUGHGIRL. INT. CL. 30. REG. 11-9-2004. RESTORED TO SN 78-151,330.
- 3,747,894. WOMEN OF COLOR STANDARD CHARACTER MARK. INT. CL. 36. REG. 2-9-2010. RESTORED TO SN 77-061,222.
- 3,752,366. FPN FRANCHISE PAYMENTS NETWORK AND DESIGN. INT. CL. 36. REG. 2-23-2010. RESTORED TO SN 78-908,713.
- 3,755,127. DRILLGUIDE STEERING TOOLS AND DESIGN. INT. CL. 9. REG. 3-2-2010. RESTORED TO SN 77-228,926.

INADVERTENTLY ISSUED REGISTRATION

* * * * *

TRADEMARK REGISTRATIONS AMENDED, CORRECTED, ETC.

The designation "U.S. Cl." appearing in this section refers to the U.S. class in effect prior to Sep. 1, 1973 rather than the international class which applies to applications filed on or after that date. For adoption of international classification see notice in the OFFICIAL GAZETTE of Jun. 26, 1973 (911 O.G. TM 210).

Any change to the registration will be indicated at the bottom of each entry under ELEMENTS AMENDED, CORRECTED OR RESTRICTED. With the exception of changes to the goods and services, additions to the registration will appear in asterisks and deletions of the registration will appear in brackets. Elements which are only changed will be listed with no punctuation. As to the goods/services statement, amendments to the goods/services will appear in asterisks and deletions will appear in brackets. In addition if any change to the goods/services occurs, the element "Goods/Services" will be listed under ELEMENTS AMENDED, CORRECTED OR RESTRICTED.

535,365. REG. 12-26-1950. CRAMER PRODUCTS, INC. (KANSAS CORPORATION) 153 WEST WARREN, GARDNER, KS, 66030, SN 71-584,323. FILED 9-1-1949. PRINCIPAL REGISTER.

ISO-QUIN

THE MARK CONSISTS OF STANDARD CHARACTERS WITHOUT CLAIM TO ANY PARTICULAR FONT, STYLE, SIZE, OR COLOR.

INT. CL. 5/U.S. CL. 18

FOR LIQUID DISINFECTANT PREPARATION, HAVING GERMICIDAL AND FUNGICIDAL PROPERTIES, FOR USE ON THE SKIN OF ATHLETES AND ALSO ON THE SURFACES OF ATHLETIC APPARATUS OR EQUIPMENT .

FIRST USE 3-1-1949; IN COMMERCE 3-1-1949.

ELEMENTS AMENDED
MARK

551,623. REG. 12-4-1951. CATERPILLAR, INC. (DELAWARE CORPORATION) 100 N.E. ADAMS ST., PEORIA, IL, 616299620, SN 71-596,777. FILED 5-3-1950. PRINCIPAL REGISTER.

CATERPILLAR

THE MARK CONSISTS OF STANDARD CHARACTERS WITHOUT CLAIM TO ANY PARTICULAR FONT, STYLE, SIZE, OR COLOR.

OWNER OF U.S. REG. NOS. 79,056, 506,258 AND OTHERS.
INT. CL. 1/U.S. CL. 6

FOR RUST INHIBITOR FLUID FOR PREVENTING FORMATION OF RUST IN THE COOLING SYSTEM OF INTERNAL COMBUSTION SYSTEMS [, AND LIQUID CHEMICAL COMPOSITION FOR SOAKING DECALCOMANIA IN ORDER TO SEPARATE THE TRANSPARENT PRINTED LAYER FROM ITS PAPER BACKING AND RENDER THE SURFACE OF SAID TRANSPARENT LAYER ADHESIVE] .

FIRST USE 12-0-1948; IN COMMERCE 12-0-1948.

ELEMENTS AMENDED
MARK

913,075. REG. 6-8-1971. CLOUD PACKAGING SOLUTIONS LLC (DELAWARE LIMITED LIABILITY COMPANY) 1938 SOUTH WOLF ROAD, DES PLAINES, IL, 60018, SN 72-364,387. FILED 7-6-1970. PRINCIPAL REGISTER.



INT. CL. 7/U.S. CL. 23

FOR PACKAGING MACHINES.

FIRST USE 5-1-1965; IN COMMERCE 5-1-1965.

ELEMENTS AMENDED
CITIZENSHIP
ASSIGNMENT/NAME CHANGE
MARK

984,625. REG. 5-21-1974. DEL MONTE CORPORATION (DELAWARE CORPORATION) P.O. BOX 193575, ONE MARKET @ THE LANDMARK, SAN FRANCISCO, CA, 941193575, SN 72-461,919. FILED 7-2-1973. PRINCIPAL REGISTER.

TASTES SO GOOD, CATS ASK FOR IT BY NAME!

THE MARK CONSISTS OF STANDARD CHARACTERS WITHOUT CLAIM TO ANY PARTICULAR FONT, STYLE, SIZE, OR COLOR.

INT. CL. 31/U.S. CL. 46

FOR CAT FOOD.

FIRST USE 6-7-1973; IN COMMERCE 6-7-1973.

ELEMENTS AMENDED
MARK

1,142,666. REG. 12-9-1980. GIRL SCOUTS OF THE UNITED STATES OF AMERICA (UNITED STATES CORPORATION) 420 FIFTH AVENUE, NEW YORK, NY, 10018, SN 73-198,874. FILED 1-2-1979. PRINCIPAL REGISTER.



Girl Scouts

OWNER OF U.S. REG. NOS. 212,451, 215,905 AND OTHERS.

THE MARK CONSISTS OF A CLOVER WITH THREE PROFILES OF A WOMAN'S FACE ALTERNATING IN BLACK AND WHITE WITHIN THE BORDERS WITH THE WORDS GIRL SCOUTS CENTERED BENEATH.

SEC. 2(F).
INT. CL. 26/U.S. CL. 40
FOR EMBROIDERED PATCH .
FIRST USE 10-25-1978; IN COMMERCE 10-25-1978.

ELEMENTS AMENDED
DESCRIPTION OF MARK
MARK

1,574,066. REG. 12-26-1989. SOUTHWALL TECHNOLOGIES INC. (DELAWARE CORPORATION) 3788 FABIAN WAY, PALO ALTO, CA, 94303, SN 73-770,121. FILED P.R. 12-19-1988; AM. S.R. 9-22-1989. SUPPLEMENTAL REGISTER.

SUPERGLASS

INT. CL. 19/U.S. CLS. 12 AND 33
FOR MULTIPANE GLAZING PANELS HAVING AN INTERMEDIATE SHEET OF HEAT REFLECTIVE METALIZED PLASTIC FILM.
FIRST USE 9-7-1988; IN COMMERCE 9-7-1988.

ELEMENTS CORRECTED
OWNER NAME

1,597,055. REG. 5-22-1990. MASTEY DE PARIS, INC. (CALIFORNIA CORPORATION) 25413 RYE CANYON ROAD, VALENCIA, CA, 91355, SN 73-814,727. FILED 7-25-1989. PRINCIPAL REGISTER.

TRAITE

THE ENGLISH TRANSLATION OF THE WORD "TRAITE" IN THE MARK IS "TREATY" AND "JOURNEY".
INT. CL. 3/U.S. CLS. 51 AND 52

FOR HAIR CARE AND CLEANING PREPARATIONS - NAMELY, NON-MEDICATED SHAMPOO.
FIRST USE 12-0-1975; IN COMMERCE 12-0-1975.

ELEMENTS AMENDED
OWNER NAME
MARK

1,605,991. REG. 7-10-1990. EDUCATION MANAGEMENT LLC (DELAWARE LIMITED LIABILITY COMPANY) 210 SIXTH AVENUE, PITTSBURGH, PA, 15222, SN 73-825,667. FILED 9-15-1989. PRINCIPAL REGISTER.

THE ART INSTITUTE OF PHILADELPHIA

NO CLAIM IS MADE TO THE EXCLUSIVE RIGHT TO USE "ART INSTITUTE", APART FROM THE MARK AS SHOWN.
SEC. 2(F).

INT. CL. 41/U.S. CL. 107
FOR EDUCATION SERVICES, NAMELY POST SECONDARY INSTRUCTION IN THE FIELDS OF VISUAL COMMUNICATION ARTS AND DESIGN; INTERIOR DESIGN; FASHION MARKETING; AND PHOTOGRAPHY.
FIRST USE 12-0-1972; IN COMMERCE 12-0-1972.

ELEMENTS AMENDED
MARK

1,673,386. REG. 1-28-1992. PYLON MANUFACTURING CORP. (DELAWARE CORPORATION) 1341 NEWPORT CENTER DRIVE WEST, DEERFIELD BEACH, FL, 33442, SN 74-155,028. FILED 4-8-1991. PRINCIPAL REGISTER.

LEXOR

INT. CL. 12/U.S. CL. 19
FOR VEHICLE WINDSHIELD WIPERS.
FIRST USE 10-25-1990; IN COMMERCE 10-25-1990.

ELEMENTS AMENDED
OWNER NAME
MARK

1,882,072. REG. 3-7-1995. EAST MANUFACTURING CORPORATION (DELAWARE CORPORATION) 1871 STATE ROUTE 44, PO BOX 277, RANDOLPH, OH, 44265, SN 74-514,364. FILED 4-19-1994. PRINCIPAL REGISTER.



OWNER OF U.S. REG. NOS. 965,404, 1,573,242 AND OTHERS.

NO CLAIM IS MADE TO THE EXCLUSIVE RIGHT TO USE "QUAD", APART FROM THE MARK AS SHOWN.

THE MARK IS THE WORDS "EAST QUAD" IN A PARALLELOGRAM.

INT. CL. 12/U.S. CL. 19

FOR SEMI-TRAILERS AND STRUCTURAL PARTS THEREFOR .

FIRST USE 3-1-1994; IN COMMERCE 3-1-1994.

ELEMENTS CORRECTED
CITIZENSHIP

2,260,442. REG. 7-13-1999. ATLANTA ATTACHMENT COMPANY (GEORGIA CORPORATION) 362 INDUSTRIAL PARK DRIVE, LAWRENCEVILLE, GA, 30046, SN 75-364,280. FILED 9-29-1997. PRINCIPAL REGISTER.

ATLANTA ATTACHMENT COMPANY

OWNER OF U.S. REG. NO. 1,203,370.
NO CLAIM IS MADE TO THE EXCLUSIVE RIGHT TO USE "ATTACHMENT COMPANY", APART FROM THE MARK AS SHOWN.

SEC. 2(F).

INT. CL. 7/U.S. CLS. 13, 19, 21, 23, 31, 34 AND 35

FOR SEWING MACHINES AND REPLACEMENT PARTS THEREFOR .

FIRST USE 3-0-1969; IN COMMERCE 3-0-1969.

ELEMENTS AMENDED
MARK
DISCLAIMER

2,268,246. REG. 8-10-1999. COMPAGNIE EUROPEENNE DU ZIRCONIUM CEZUS (FRANCE CORPORATION) 33 RUE LA FAYETTE, PARIS CEDEX 09, FRANCE, 75442, SN 75-357,613. FILED 9-16-1997. PRINCIPAL REGISTER.

CEZUS

OWNER OF FRANCE REG. NO. 1146835, DATED 8-14-1980, RENEWED AS REG. NO. 1713029, DATED 8-6-1990, EXPIRES 8-6-2000.

INT. CL. 1/U.S. CLS. 1

FOR ZIRCONIUM SALTS FOR CERAMICS MANUFACTURING.

FIRST USE 0-0-1982; IN COMMERCE 0-0-1982.

INT. CL. 6/U.S. CLS. 2, 12, 13, 14, 23, 25 AND 50

FOR ZIRCONIUM AND ZIRCONIUM ALLOYS FOR THE NUCLEAR INDUSTRY.
FIRST USE 0-0-1982; IN COMMERCE 0-0-1982.

ELEMENTS CORRECTED
OWNER NAME

2,274,331. REG. 8-31-1999. HIGH SCOPE EDUCATIONAL RESEARCH FOUNDATION (MICHIGAN NON-PROFIT CORPORATION) 600 NORTH RIVER STREET, YPSILANTI, MI, 48198, SN 75-521,880. FILED 7-15-1998. PRINCIPAL REGISTER.



OWNER OF U.S. REG. NOS. 1,461,879 AND 1,462,318.

INT. CL. 16/U.S. CLS. 2, 5, 22, 23, 29, 37, 38 AND 50

FOR PUBLICATIONS, NAMELY, MAGAZINES AND BOOKS DIRECTED TO EDUCATORS, PERTAINING TO EDUCATIONAL DEVELOPMENT.

FIRST USE 1-1-1997; IN COMMERCE 1-1-1997.

ELEMENTS AMENDED
MARK
[LINING/STIPPLING STATEMENT]

2,274,332. REG. 8-31-1999. HIGH SCOPE EDUCATIONAL RESEARCH FOUNDATION (MICHIGAN NON-PROFIT CORPORATION) 600 NORTH RIVER STREET, YPSILANTI, MI, 48198, SN 75-521,881. FILED 7-15-1998. PRINCIPAL REGISTER.



OWNER OF U.S. REG. NOS. 1,461,879 AND 1,462,318.

INT. CL. 41/U.S. CLS. 100, 101 AND 107

FOR EDUCATIONAL SERVICES, NAMELY, CONDUCTING WORKSHOPS AND SEMINARS IN THE FIELD OF EARLY CHILDHOOD AND ADOLESCENT EDUCATION.

FIRST USE 1-1-1997; IN COMMERCE 1-1-1997.

ELEMENTS AMENDED
MARK
[LINING/STIPPLING STATEMENT]

2,317,388. REG. 2-8-2000. RACIAL HARMONY (ILLINOIS NON-PROFIT CORPORATION) P. O. BOX 296, BELLEVILLE, IL, 62222, SN 75-612,728. FILED P.R. 12-28-1998; AM. S.R. 11-29-1999. SUPPLEMENTAL REGISTER.

RACIAL HARMONY

INT. CL. 41/U.S. CLS. 100, 101 AND 107

FOR EDUCATIONAL SERVICES, NAMELY CONDUCTING CLASSES, SEMINARS, CONFERENCES, AND WORKSHOPS IN THE FIELD OF RACIAL AND ETHNIC HARMONY; AND DISTRIBUTING MATERIALS IN CONNECTION THEREWITH.

FIRST USE 11-1-1992; IN COMMERCE 11-1-1992.

ELEMENTS CORRECTED
OWNER NAME
ENTITY

2,324,426. REG. 2-29-2000. EARTH SHARE (D.C. CORPORATION) 7735 OLD GEORGETOWN ROAD, BETHESDA, MD, 20814, SN 75-677,694. FILED 4-6-1999. PRINCIPAL REGISTER.

ONE ENVIRONMENT. ONE SIMPLE WAY TO CARE FOR IT.

THE MARK CONSISTS OF STANDARD CHARACTERS WITHOUT CLAIM TO ANY PARTICULAR FONT, STYLE, SIZE, OR COLOR.

INT. CL. 36/U.S. CLS. 100, 101 AND 102

FOR CHARITABLE FUNDRAISING SERVICES FOR ENVIRONMENTAL ORGANIZATIONS; PROVIDING INFORMATION CONCERNING CHARITABLE FUNDRAISING SERVICES THROUGH A GLOBAL COMMUNICATIONS NETWORK; PROVIDING TECHNICAL ASSISTANCE IN THE ESTABLISHMENT OF CHARITABLE FUNDRAISING PROGRAMS THROUGH EMPLOYEE CONTRIBUTIONS AT THE WORKPLACE; PROVIDING TECHNICAL ASSISTANCE IN THE ESTABLISHMENT OF CHARITABLE FUNDRAISING SERVICES WHICH INCLUDE THE USE OF DEDICATED TELEPHONE NUMBERS AND SITES ON COMMUNICATIONS NETWORKS.

FIRST USE 4-14-1997; IN COMMERCE 4-14-1997.

INT. CL. 42/U.S. CLS. 100 AND 101

FOR PROVIDING ENVIRONMENTAL INFORMATION SERVICES; PROMOTING THE PUBLIC AWARENESS OF THE NEED FOR ENVIRONMENTAL CONSERVATION.

FIRST USE 4-14-1997; IN COMMERCE 4-14-1997.

ELEMENTS CORRECTED
ENTITY
MARK

2,327,739. REG. 3-14-2000. TELOS CORPORATION (MARYLAND CORPORATION) 19886 ASHBURN DRIVE, ASHBURN, VA, 201472358, SN 75-422,704. FILED 1-26-1998. PRINCIPAL REGISTER.



THE ENGLISH TRANSLATION OF THE GREEK WORD "TELOS" IS "GOAL".

INT. CL. 9/U.S. CLS. 21, 23, 26, 36 AND 38

FOR COMPUTER HARDWARE AND PERIPHERALS; PORTABLE COMPUTERS; COMPUTER HARDWARE INTEGRATION EQUIPMENT; COMPUTER RUGGEDIZATION EQUIPMENT; COMPUTER WORKSTATIONS; AND COMPUTER NETWORKING PRODUCTS, NAMELY COMPUTER SERVERS, WORKSTATIONS, PERIPHERALS AND SOFTWARE SUITES FOR USE IN COMMUNICATIONS, DATA MANAGEMENT AND DATA INTEGRATION.

FIRST USE 4-0-1995; IN COMMERCE 4-0-1995.

ELEMENTS AMENDED
MARK

2,334,943. REG. 3-28-2000. LAWRENCE GROUP INC., THE (MISSOURI CORPORATION), AKA THE LAWRENCE GROUP, INCORPORATED, 319 N. 4TH STREET, SUITE 1000, ST. LOUIS, MO, 63102, SN 75-580,288. FILED 10-30-1998. PRINCIPAL REGISTER.

LAWRENCE GROUP

THE MARK CONSISTS OF STANDARD CHARACTERS WITHOUT CLAIM TO ANY PARTICULAR FONT, STYLE, SIZE, OR COLOR.

NO CLAIM IS MADE TO THE EXCLUSIVE RIGHT TO USE "GROUP", APART FROM THE MARK AS SHOWN.

INT. CL. 42/U.S. CLS. 100 AND 101

FOR ARCHITECTURAL SERVICES, INCLUDING INTERIOR ARCHITECTURE AND MASTER PLANNING, DESIGN AND DECORATING, SPACE PLANNING.

FIRST USE 12-0-1983; IN COMMERCE 2-0-1985.

ELEMENTS AMENDED
MARK

2,338,012. REG. 4-4-2000. THEORY LLC (NEW YORK LIMITED LIABILITY COMPANY) 1114 AVENUE OF THE AMERICAS, NEW YORK, NY, 10036, SN 75-631,960. FILED 2-3-1999. PRINCIPAL REGISTER.

THEORY

INT. CL. 25/U.S. CLS. 22 AND 39

FOR WEARING APPAREL, NAMELY T-SHIRTS, TOPS, SHORTS, PANTS, SKIRTS, BLOUSES, DRESSES, EVENING GOWNS, JACKETS, COATS, SUITS, VESTS, SOCKS, SCARVES AND CAPS.

FIRST USE 2-0-1997; IN COMMERCE 2-0-1997.

ELEMENTS AMENDED
ENTITY
MARK

2,340,378. REG. 4-11-2000. COREY DELTA, INC. (CALIFORNIA CORPORATION), DBA COREY DELTA CONSTRUCTORS, INC., 4931 PARK ROAD, BENICIA, CA, 94510, SN 75-587,914. FILED 11-13-1998. PRINCIPAL REGISTER.



NO CLAIM IS MADE TO THE EXCLUSIVE RIGHT TO USE "CONSTRUCTORS" AND "AN EMPLOYEE OWNED COMPANY", APART FROM THE MARK AS SHOWN.

THE MARK CONSISTS, IN PART, OF A STYLIZATION OF THE LETTERS "C" AND "D". THE COLOR(S) RED STYLIZED "C" AND "D" WITH WHITE OUTLINES. STYLIZED "COREY DELTA" IN BLACK LETTERING. RED LINE UNDERNEATH "DELTA." "AN EMPLOYEE OWNED COMPANY" IT WHITE BLOCK WITH RED BACKGROUND. IS/ARE CLAIMED AS A FEATURE OF THE MARK.

INT. CL. 37/U.S. CLS. 100, 103 AND 106
FOR INDUSTRIAL CONSTRUCTION SERVICES FOR OTHERS.

FIRST USE 0-0-1995; IN COMMERCE 0-0-1995.

ELEMENTS AMENDED
MARK
DISCLAIMER
DESCRIPTION OF MARK
[LINING/STIPPLING STATEMENT]

2,342,904. REG. 4-18-2000. RACIAL HARMONY (ILLINOIS NON-PROFIT CORPORATION) P. O. BOX 296, BELLEVILLE, IL, 62222, SN 75-612,730. FILED 12-28-1998. PRINCIPAL REGISTER.



NO CLAIM IS MADE TO THE EXCLUSIVE RIGHT TO USE "RACIAL HARMONY", APART FROM THE MARK AS SHOWN.

THE STIPPLING IN THE DESIGN IS FOR SHADING PURPOSES ONLY.

INT. CL. 41/U.S. CLS. 100, 101 AND 107
FOR EDUCATIONAL SERVICES, NAMELY CONDUCTING CLASSES, SEMINARS, CONFERENCES, AND WORKSHOPS IN THE FIELD OF RACIAL AND ETHNIC HARMONY; AND DISTRIBUTING MATERIALS IN CONNECTION THEREWITH.

FIRST USE 11-1-1992; IN COMMERCE 11-1-1992.

ELEMENTS CORRECTED
OWNER NAME
ENTITY

2,391,788. REG. 10-3-2000. HUNTER AMENITIES INTERNATIONAL LTD./LESARTICLES D'CCUEIL HUNTER INTERNATIONALELTEE (CANADA CORPORATION) 1205 CORPORATE DR, BURLINGTON, ONTARIO, CANADA, L7L 5V5, SN 74-637,782. FILED 2-24-1995. PRINCIPAL REGISTER.



PRIORITY CLAIMED UNDER SEC. 44(D) ON CANADA APPLICATION NO. 763285, FILED 9-2-1994.

INT. CL. 3/U.S. CLS. 1, 4, 6, 50, 51 AND 52

FOR SINGLE USE AMENITIES, NAMELY, HAIR SHAMPOO, BODY LOTION, HAIR CONDITIONERS, BATH GEL, LIQUID SHOWER SOAP, MOUTHWASH, COLOGNE, NON-MEDICATED LIP BALM, LAUNDRY DETERGENT, HAND SOAP, BATH SOAP, LIQUID DISHWASHING DETERGENT, BATH CRYSTALS, EYE GEL, FACIAL AND SKIN CLEANSERS, MASSAGE OILS, AND AMENITY KITS CONTAINING ONE OR MORE OF THE FOREGOING ITEMS.

FIRST USE 2-0-1995; IN COMMERCE 7-0-1995.

INT. CL. 25/U.S. CLS. 22 AND 39

FOR SINGLE USE AMENITIES, NAMELY, SHOWER CAPS.

FIRST USE 2-0-1995; IN COMMERCE 7-0-1995.

INT. CL. 26/U.S. CLS. 37, 39, 40, 42 AND 50

FOR SINGLE USE AMENITIES, NAMELY, SEWING KITS COMPRISED OF BUTTONS, NEEDLES AND THREAD.

FIRST USE 2-0-1995; IN COMMERCE 7-0-1995.

ELEMENTS AMENDED
MARK

2,412,243. REG. 12-12-2000. EAST MANUFACTURING CORP. (DELAWARE CORPORATION) 1871 STATE ROUTE 44, RANDOLPH, OH, 44265, SN 75-802,263. FILED 9-20-1999. PRINCIPAL REGISTER.

BUILDING OUR BUSINESS BY HELPING YOU BUILD YOURS

INT. CL. 40/U.S. CLS. 100, 103 AND 106

FOR MANUFACTURE OF HEAVY DUTY TRUCK TRAILERS AND TRUCKING ACCESSORIES TO ORDER AND/OR SPECIFICATION OF OTHERS.

FIRST USE 6-1-1999; IN COMMERCE 6-1-1999.

ELEMENTS CORRECTED
CITIZENSHIP

2,433,003. REG. 3-6-2001. EAST MANUFACTURING CORPORATION (DELAWARE CORPORATION) 1871 STATE ROUTE 44, RANDOLPH, OH, 44265, SN 75-755,703. FILED 7-20-1999. PRINCIPAL REGISTER.

2,585,668. REG. 6-25-2002. TEXAS CAPITAL BANCSHARES, INC. (DELAWARE CORPORATION) 2100 MCKINNEY; SUITE 1250, DALLAS, TX, 75201, SN 75-519,888. FILED 7-10-1998. PRINCIPAL REGISTER.

EAST



INT. CL. 12/U.S. CLS. 19, 21, 23, 31, 35 AND 44
 FOR TRUCK TRAILERS, SEMI-TRAILERS, DISCHARGE TRAILERS, CARGO TRAILERS, VEHICLE DUMP BODIES, DUMP TRAILERS, [DUMP CHASSIS, GARBAGE TRUCKS, SCRAP TRUCKS,] PLATFORM TRAILERS, AND STRUCTURAL PARTS THEREOF, AND TRAILER ACCESSORIES, NAMELY, STORAGE BOXES SPECIALLY FITTED FOR THE CARGO AREAS OF TRAILERS.
 FIRST USE 6-7-1999; IN COMMERCE 6-7-1999.

NO CLAIM IS MADE TO THE EXCLUSIVE RIGHT TO USE "TEXAS" OR "BANK", APART FROM THE MARK AS SHOWN.
 THE DRAWING IS LINED FOR THE COLOR(S) RED AND BLUE.
 INT. CL. 36/U.S. CLS. 100, 101 AND 102
 FOR BANKING SERVICES.
 FIRST USE 12-18-1998; IN COMMERCE 12-18-1998.

ELEMENTS CORRECTED
 CITIZENSHIP

ELEMENTS CORRECTED
 OWNER NAME

2,482,830. REG. 8-28-2001. JOHNS HOPKINS UNIVERSITY, THE (MARYLAND NON-PROFIT CORPORATION) 113 GARLAND HALL, 3400 NORTH CHARLES STREET, BALTIMORE, MD, 21218, SN 75-506,369. FILED 6-22-1998. PRINCIPAL REGISTER.

2,701,891. REG. 4-1-2003. STUDIO PEYO S.A. (SWITZERLAND CORPORATION) CHEMIN FRANK-THOMAS 36, GENEVE, SWITZERLAND, 1208, SN 76-297,866. FILED 8-10-2001. PRINCIPAL REGISTER.

ACG

SMURF

INT. CL. 9/U.S. CLS. 21, 23, 26, 36 AND 38
 FOR COMPUTER SOFTWARE FOR PROVIDING A CASE-MIX OR RISK ADJUSTMENT SYSTEM TO ASSESS AND MANAGE HEALTH CARE RESOURCE UTILIZATION AND CONSUMPTION, AND INSTRUCTION MANUALS SOLD TOGETHER AS A UNIT.
 FIRST USE 12-0-1991; IN COMMERCE 12-0-1991.

OWNER OF ERPN CMNTY TM OFC REG. NO. 1414911, DATED 1-30-2001.
 OWNER OF ERPN CMNTY TM OFC REG. NO. 686576, DATED 9-22-2000.
 OWNER OF U.S. REG. NOS. 1,209,160, 1,369,190 AND OTHERS.
 INT. CL. 9/U.S. CLS. 21, 23, 26, 36 AND 38

ELEMENTS CORRECTED
 OWNER NAME
 MARK

FOR [RADIOS, PORTABLE TAPE RECORDERS, RADIO AND CASSETTE PLAYERS, CD AND CASSETTE RECORDERS, RECORD PLAYERS, VIDEO RECORDERS, VIDEO PLAYERS, PRE-RECORDED AUDIO, VISUAL AND AUDIO-VISUAL MAGNETIC DATA CARRIERS,] VISUAL AND AUDIO-VISUAL DIGITAL DATA CARRIERS AND DVD PROGRAMS, [VINYL DISCS, AUDIO AND VIDEO COMPACT DISCS, CD-IS, CD-ROMS ALL FEATURING MUSIC, GAMES] CHILDREN'S ANIMATED PROGRAMS, CHILDREN'S ENTERTAINMENT, EDUCATIONAL AND PLAY-EDUCATIONAL PROGRAMS; [PRE-RECORDED FLOPPY DISKS, COMPUTER SOFTWARE AND DATA, NAMELY, MULTIMEDIA APPLICATIONS FEATURING CHILDREN'S ENTERTAINMENT USED ON PERSONAL COMPUTERS, VIDEO GAME MACHINE FOR USE WITH TELEVISIONS, PRIVATE USE AND IN CONNECTION WITH THE WORLD WIDE WEB AND LOCAL NETWORKS; COMPUTER GAME SOFTWARE, SOFTWARE, PROGRAMS AND DATA RECORDED ON VIDEO GAME MACHINES FOR USE WITH TELEVISION AND PRIVATE USE, AND RECORDED ON VIDEO GAME CARTRIDGES AND DOWNLOADABLE SOFTWARE, SOFTWARE MODULES AND INTERACTIVE MULTIMEDIA SOFTWARE ALL USED FOR PLAYING GAMES AND CONTAINING CHILDREN'S ENTERTAINMENT AND EDUCATION PROGRAMS AND SCREEN SAVERS; VIDEO GAME MACHINES FOR USE WITH TELEVISIONS AND FOR PRIVATE USE, AND FOR USE WITH COMPUTERS THAT CAN BE USED FOR PLAYING GAMES OVER THE WORLDWIDE WEB AND LOCAL NETWORKS, VIDEO GAME CARTRIDGES THEREFORE; MATS FOR COMPUTER MICE].
 FIRST USE ; IN COMMERCE .

2,499,251. REG. 10-23-2001. BLACK TIE MEDICAL, INC. (NEVADA CORPORATION) 1281 SUNSET CLIFFS BLVD., SAN DIEGO, CA, 92107, SN 74-641,820. FILED 3-3-1995. PRINCIPAL REGISTER.

INT. CL. 14/U.S. CLS. 2, 27, 28 AND 50

TULIP

INT. CL. 10/U.S. CLS. 26, 39 AND 44
 FOR MEDICAL EQUIPMENT, NAMELY, CANNULAS, [SYRINGES,] SUCTION ADAPTERS, AUTOCLAVE TRAYS, PERCUTANEOUS PUNCHES, TRANSFER COUPLERS, INJECTION NEEDLES, INFILTRATORS, [DISPOSAL CONTAINERS, ENDOSCOPES, ENDOSCOPIC LIGHT BOXES, ENDOSCOPIC DISSECTORS, ENDOSCOPIC LIFTERS, ENDOSCOPIC RETRACTORS, ENDOSCOPIC CAMERAS, ENDOSCOPIC MONITORS].
 FIRST USE 12-3-1987; IN COMMERCE 12-3-1987.

ELEMENTS CORRECTED
 [DISCLAIMER]

FOR [COSTUME JEWELRY AND] WATCHES FOR CHILDREN [; LEARNING WATCHES FOR CHILDREN] .

FIRST USE ; IN COMMERCE .

INT. CL. 16/U.S. CLS. 2, 5, 22, 23, 29, 37, 38 AND 50

FOR [ADHESIVE TAPE FOR OFFICE AND HOUSEHOLD PURPOSES; ADHESIVES FOR OFFICE AND HOUSEHOLD PURPOSES; ADVERTISING BOARDS OF CARDBOARD OR PAPER; PHOTOGRAPH ALBUMS, STAMP ALBUMS, STICKER ALBUMS; YEAR BOOKS; WATER COLOUR PAINTING; NAPKINS OF PAPER OR CELLULOSE; NAPKIN PANTS OF PAPER OR CELLULOSE; BABY TISSUES OF PAPER OR CELLULOSE; PAPER BAGS; BAGS OF PAPER OR PLASTIC FOR PACKAGING; BLOTTER PAPER; FOLDERS; BOOK-MARKERS; BOOKS IN THE FIELD OF CHILDREN'S BOOKS, CHILDREN'S EDUCATIONAL BOOKS, COMIC BOOKS AND CARTOONS, COLORING BOOKS, COLLECTOR BOOKS; BOTTLE PACKAGING OF CARDBOARD OR PAPER; BOTTLE WRAPPERS OF CARDBOARD OR PAPER; PEN CASES; PAPER OR CARDBOARD BOXES; CALENDARS; PAINTERS' CANVASSES; CARDBOARD; CARDBOARD ARTICLES, NAMELY, CARDBOARD BINDERS, CHILDREN'S CASES IN CARDBOARD, CARDBOARD TUBES, MERCHANDISE FLOOR DISPLAYS IN CARDBOARD; BOXES FOR STAMPS; CATALOGUES FEATURING TOYS AND GAMES, FIGURINES, BOOKS, COLLECTIONS; LITHOGRAPHS; CHROMOLITHOGRAPHS; OFFICE PAPER CLIPS; TAPES FOR BOOK BINDING; MATS OF PAPER; COMIC STRIPS; TAPES OF PAPER AND CARDS FOR RECORDING COMPUTER PROGRAMS; PAPER FOR PHOTOCOPYING APPARATUS; ENVELOPES; IRON-ON TRANSFERS, PLASTIC TRANSFERS, DRY TRANSFERS; DRAWING IMPLEMENTS; DRAWING MATERIAL, NAMELY, DRAWING TRIANGLES, DRAWING CURVES, DRAWING COMPASSES; DRAWING PAPER PADS; DRAWING PENS [; DRAWING EQUIPMENT, NAMELY, DRAWING BRUSHES, PAINTING SETS; DRAWING RULERS; DRAWING SQUARES; EMBROIDERY DESIGN PATTERNS; ENGRAVING PLATES; ENGRAVINGS; ERASING PRODUCTS, NAMELY, ERASERS; CORRECTION FLUID, CORRECTION TAPE, CORRECTION PENS; ERASABLE BOARDS; FACE TOWELS OF PAPER; PAPIER-MACHE; FLAGS OF PAPER; PLASTIC FOLDERS; FOLDERS FOR PAPERS; PRINTED FORMS; FOUNTAIN PENS; GLUES FOR OFFICE AND HOUSEHOLD PURPOSES; GRAPHIC IMAGES IN THE NATURE OF PICTURES; GRAPHIC ART REPRODUCTIONS; ADHESIVE PAPER FOR OFFICE PURPOSES; ADHESIVE TAPES FOR HOUSEHOLD AND STATIONERY USE; HANDBOOKS AND MANUALS USED FOR TOYS AND GAMES; HANDKERCHIEFS OF PAPER; HATBOXES OF CARDBOARD; CONTAINERS FOR POSTAGE STAMPS; HYGIENIC PAPER; WRITING INK; INK PEN REFILL CARTRIDGES; ENVELOPES FOR PAPERS;] PRINTED PAPER LABELS; MAGAZINES AND PERIODICALS IN THE FIELD OF CHILDREN'S AND COLLECTOR'S ENTERTAINMENT, COMIC BOOKS AND CARTOONS; [DRAWING FOLDERS FOR LETTERS; PAPER BEER MATS; MODELING CLAY; MODELING MATERIALS FOR USE BY CHILDREN; MODELING PASTE; MODELING WAX;] NEWSLETTERS AND NEWSPAPERS IN THE FIELD OF CHILDREN'S AND COLLECTOR'S ENTERTAINMENT, COMIC BOOKS AND CARTOONS; NOTEBOOKS; [HOLE PUNCHES;] PACKAGING MATERIALS, NAMELY, TOY BOXES; [PRINTING BLOCKS;] NOTEPADS AND STATIONERY; [PAINT BOXES; PAINT BRUSHES; PAINTINGS AND PICTURES FRAMED AND UNFRAMED; DRAWING PAPER, COPY PAPER, REPRODUCTION PAPER, PAPER PARTY DECORATION, PAPER TO COVER BOOKS, PAPER TRANSFERS;] PAPER CLIPS; [PASTEL CRAYONS; PENCIL BOXES; INK PEN CARTRIDGE HOLDERS; PEN WIPERS; PENCIL HOLDERS; PENCIL SHARPENERS; PENCILS; PEN HOLDERS; PENS; PHOTOGRAPHS; ILLUSTRATIONS;] PAPER AND CARDBOARD PLACARDS; [POSTERS OF PAPER OR CARDBOARD; PLACE MATS OF PAPER; PLASTIC FILM FOR PACKAGING; GIFT WRAP PAPER AND TAPE; PORTRAITS; POSTAGE STAMPS; POSTCARDS; POSTERS;] PRINTED BAGS OF PAPER; PRINTED PUBLICATIONS, NAMELY, MAGAZINES, [BOOKS,] COMIC BOOKS IN THE FIELD OF CARTOONS AND COMIC BOOKS; [PRINTED TIMETABLES; PRINTS; ART REPRODUCTIONS; PAPER TAPE; DRAFTING RULERS; SET DRAWING SQUARES; SCHOOL EQUIPMENT, NAMELY, CHALK BOARDS FOR SCHOOL AND HOME USE, EXERCISE BOOKS, SCHOOL DIARY, BOOK-

MARK, WAX PENCILS, COLORING PENCILS, SCHOOL FRIEND BOOKS; SCRAPBOOKS; SELF ADHESIVE TAPES FOR HOUSEHOLD AND STATIONERY USE; BOARDS OF PAPER OR CARDBOARD; SONG BOOKS; INKING PADS; HOLDERS FOR RUBBER STAMPS AND SEALS; HOLDERS FOR PENS AND PENCILS; OFFICE REQUISITES AND WRITING MATERIALS, NAMELY, STENCIL BOXES, STENCIL PLATES, CORRESPONDENCE STENCILS.] CORRESPONDENCE STICKERS; [TABLE CLOTHS OF PAPER; TABLE LINEN OF PAPER; TABLE NAPKINS OF PAPER; TEAR-OFF CALENDARS; GREETING CARDS, FILE CARDS, PLAYING CARDS, ANNOUNCEMENT CARDS, POSTCARDS, BUSINESS CARDS, DIPLOMA CARDS, MUSICAL GREETING CARDS, HANGING DOOR CARDS, TRADING CARDS; PRINTED TICKETS; TOILET PAPER; TOWELS OF PAPER; TRACING PAPER; VISCOSE PAPER FOR WRAPPING; DISTEMPERS; PACKAGING, NAMELY, ENVELOPES FOR LETTERS; ENVELOPES FOR BOOKS; PEN CASES; WRITING FOLDERS; WRITING PAPER AND ENVELOPES; WRITING INSTRUMENTS; WRITING REQUISITES, NAMELY, ERASERS, CORRECTING FILM AND FLUID FOR TYPE, BLOTTER PAPER AND BLOTTERS; WRITING AND DRAWING BOOKS; WRITING BOOKLETS; WRITING PAPER; TALKING CHILDREN'S BOOKS] .

FIRST USE ; IN COMMERCE .

INT. CL. 20/U.S. CLS. 2, 13, 22, 25, 32 AND 50

FOR NON-METAL KEY RINGS; PLASTIC KEY RINGS; FIGURINES AND SCULPTURES IN PLASTIC, RESIN AND PLASTER; PLASTIC MONEY BOXES; PLASTIC CAKE DECORATIONS.

FIRST USE ; IN COMMERCE .

INT. CL. 24/U.S. CLS. 42 AND 50

FOR [HANDKERCHIEFS, BED LINEN, BATH TOWELS, WASHING MITTS, TOWELS, COTTON AND SYNTHETIC FABRIC BY THE METRE, UPHOLSTERY FABRICS; COARSELY-WOVEN, UNBLEACHED LINEN] .

FIRST USE ; IN COMMERCE .

INT. CL. 25/U.S. CLS. 22 AND 39

FOR [CLOTHING FOR BABIES, NAMELY, BOOTIES, BIBS, LEGGINGS, INFANT CLOTH DIAPERS; HEADGEAR, NAMELY, HATS AND CAPS; CAPS, SCARVES, NECKERCHIEFS, SCARVES FOR MEN; GLOVES AND MITTENS; BELTS;] SOCKS AND STOCKINGS; [HEADBANDS;] LEISURE CLOTHING, NAMELY, UNDERWEAR, NIGHTWEAR, [OVERCOATS, ANORAKS,] T-SHIRTS, [PANTS, LEOTARDS,] SHORTS, SWEATERS, [PULLOVERS, TROUSERS, JEANS, SHIRTS, BLOUSES; BASEBALL CAPS, SUN VISORS; SHOES, SPORTS SHOES, SLIPPERS, BOOTS; TIES, BOW TIES; SPORT CLOTHING, NAMELY, SWIMMING SUIT, JOGGING SUIT, SWEAT PANTS, SWEAT SHORTS, TRACKSUIT; HALLOWEEN COSTUMES AND MASKS SOLD THEREWITH] .

FIRST USE ; IN COMMERCE .

INT. CL. 28/U.S. CLS. 22, 23, 38 AND 50

FOR [STAND ALONE VIDEO GAME MACHINES FOR USE ON FAIR GROUNDS; PINBALL MACHINES; BATH TOYS AND GAMES; INDOOR AND OUTDOOR GAMES, NAMELY, GAME OF DICE, BOARD GAMES AND OUTDOOR ACTIVITIES GAMES IN THE NATURE OF ROLLER SKATES, SKATE BOARDS, RIDE ON TOYS, NAMELY, TOY CYCLES, TOY GARDENING SETS, TOY HANDYMAN SETS AND PARTY GAMES FOR CHILDREN; CARDBOARD GAMES, NAMELY, CARD GAMES; EDUCATIONAL GAMES IN THE NATURE OF HANDHELD ELECTRONIC GAME UNITS; PUZZLES; JIGSAW PUZZLES; GAMES OF SKILL, WOODEN GAMES, NAMELY, PADDLE BALL GAMES, YOYOS; DOMINOES; CONSTRUCTION TOYS; BATTERY-OPERATED AND WIND-UP TOY,] MUSICAL AND SPEAKING DOLLS AND SOFT TOYS AND ACCESSORIES SOLD THEREWITH; [PUPPETS;] CAST TOY VEHICLES AND ACCESSORIES; MINIATURE TOY SETS OF CARTOON CHARACTERS; [TARGETS AND DARTS; TENNIS RACKETS FOR CHILDREN AND TENNIS BALLS; PVC BALLS, LEATHER BALLS, METALLISED INFLATABLE HELIUM BALLOONS, LATEX BALLOONS, PUNCHBALLS; SWIMMING AIDS FOR CHILDREN,

NAMELY, POOL RINGS, ARM FLOATS FOR RECREATIONAL USE; INFLATABLE BEACH ARTICLES, NAMELY, INFLATABLE BOAT, INFLATABLE BALLOONS, INFLATABLE SWIMMING POOL, INFLATABLE MATTRESSES FOR RECREATIONAL USE, INFLATABLE TOYS; CHILDREN'S PLAY CARNIVAL COSMETICS; PARTY FAVOR NOVELTIES IN THE NATURE OF SMALL TOYS; TOYS,] GAMES AND ACCESSORIES FOR BABIES AND PRE-SCHOOL CHILDREN, NAMELY, PLUSH TOYS, [RATTLES,] TOY ACTION FIGURES, MUSICAL TOYS [; TOY CANDY DISPENSERS] .

FIRST USE ; IN COMMERCE .
INT. CL. 30/U.S. CL. 46

FOR [CHEWING GUM; SWEETS, NAMELY, CHOCOLATE TRUFFLES, CANDY STICKS, CANDY BEARS, FRUIT GUMS, FRUIT PASTILLES; LOLLIPOPS; BUBBLE GUM; CONFECTIONS, NAMELY, WAFER ROLLS, ICE CREAM, ICE LOLLIES, WATER LOLLIES, FROZEN CONFECTIONS; MARSHMALLOWS; CANDY, NAMELY, JELLY SWEETS; DRY BISCUITS; BISCUITS FILLED WITH CHOCOLATE OR WITH FRUIT; BISCUITS; CHOCOLATE; CHOCOLATE BARS; FRUIT TARTS; CAKES; SWEET BREAD ROLLS; PUDDINGS, RICE PUDDINGS, CUSTARDS, CHOCOLATE MOUSSES, CHOCOLATE AND SWEET DRESSINGS; CHOCOLATE EASTER EGGS, CHOCOLATE CONFETTI; EDIBLE CAKE DECORATIONS] .

FIRST USE ; IN COMMERCE .
INT. CL. 38/U.S. CLS. 100, 101 AND 104

FOR [BROADCASTING OF RADIO AND TELEVISION PROGRAMS; TRANSMISSION OF SOUND AND IMAGES VIA SATELLITE AND VIA THE INTERNET; TELEVISION BROADCASTING] .

FIRST USE ; IN COMMERCE .
INT. CL. 41/U.S. CLS. 100, 101 AND 107

FOR [PROVIDING ONLINE COMPUTER GAMES; THEATRICAL PRODUCTIONS; MUSICAL PERFORMANCES; ARRANGING OF SPORTING EVENTS; RADIO AND] TELEVISION ENTERTAINMENT IN THE NATURE OF ONGOING CHILDREN'S ANIMATED PROGRAMS;] PRODUCTION AND RENTAL OF FILMS AND CARTOONS; LIBRARY SERVICES, NAMELY, LENDING BOOKS, COMICS AND MAGAZINES; PUBLICATION OF BOOKS, COMICS AND MAGAZINES; AMUSEMENT PARKS] .

FIRST USE ; IN COMMERCE .

ELEMENTS AMENDED
GOODS/SERVICES

2,745,409. REG. 7-29-2003. COMMONWEALTH SOAP & TOILETRIES, INC. (MASSACHUSETTS CORPORATION) 661 QUEQUECHAN ST., FALL RIVER, MA, 02721, SN 78-135,786. FILED P.R. 6-14-2002; AM. S.R. 2-10-2003. SUPPLEMENTAL REGISTER.

EGYPTIAN
COTTON

INT. CL. 3/U.S. CLS. 1, 4, 6, 50, 51 AND 52
FOR SOAPS, NAMELY BODY, SKIN, HAND, AND DEODORANT SOAPS; HAND CREAMS; GELS, NAMELY, GELS FOR SKIN AND BODY.
FIRST USE 10-1-2001; IN COMMERCE 10-1-2001.

ELEMENTS CORRECTED
OWNER NAME

2,753,845. REG. 8-19-2003. RAZOR USA LLC (DELAWARE LIMITED LIABILITY COMPANY) 16200A CARMENITA ROAD, CERRITOS, CA, 90703, SN 76-252,172. FILED 5-4-2001. PRINCIPAL REGISTER.

AIRGO

INT. CL. 28/U.S. CLS. 22, 23, 38 AND 50
FOR POGO STICKS.
FIRST USE 5-15-2001; IN COMMERCE 5-15-2001.

ELEMENTS CORRECTED
OWNER NAME

2,781,742. REG. 11-11-2003. STMICROELECTRONICS, INC. (DELAWARE CORPORATION) 1310 ELECTRONICS DRIVE, CARROLLTON, TX, 75006, SN 76-476,255. FILED 12-18-2002. PRINCIPAL REGISTER.

uPSD

INT. CL. 9/U.S. CLS. 21, 23, 26, 36 AND 38
FOR SEMICONDUCTORS, INTEGRATED CIRCUITS, MICROPROCESSORS, MICROCONTROLLERS, AND EMBEDDED MICROPROCESSORS.
FIRST USE 5-0-2002; IN COMMERCE 5-0-2002.

ELEMENTS AMENDED
MARK

2,789,452. REG. 12-2-2003. MILWAUKEE BREWERS BASEBALL CLUB (WISCONSIN LIMITED PARTNERSHIP) ONE BREWERS WAY, MILLER PARK, MILWAUKEE, WI, 5321, SN 76-355,688. FILED 1-4-2002. PRINCIPAL REGISTER.



OWNER OF U.S. REG. NOS. 1,543,238, 2,549,755 AND OTHERS.
NO CLAIM IS MADE TO THE EXCLUSIVE RIGHT TO USE "MILWAUKEE", APART FROM THE MARK AS SHOWN.
INT. CL. 9/U.S. CLS. 21, 23, 26, 36 AND 38

FOR ELECTRICAL AND SCIENTIFIC APPARATUS, NAMELY, [BINOCULARS,] CALCULATORS, ELECTRIC SWITCH PLATE COVERS; LUMINOUS SIGNS; NEON SIGNS; DECORATIVE MAGNETS; [COMPUTER SOFTWARE, NAMELY, SCREEN SAVERS,] COMPACT DISC CASES, VIDEO AND COMPUTER GAME CARTRIDGES, VIDEO AND COMPUTER GAME DISCS, [VIDEO AND COMPUTER GAME CASSETTES,] COMPUTER GAME PROGRAMS IN THE FIELD OF BASEBALL; PROTECTIVE HELMETS, CATCHERS HELMETS.
FIRST USE 11-0-1999; IN COMMERCE 11-0-1999.

ELEMENTS CORRECTED
OWNER NAME
OWNER ADDRESS

2,802,700. REG. 1-6-2004. THEORY LLC (NEW YORK LIMITED LIABILITY COMPANY) 38 GANSEVOORT STREET, NEW YORK, NY, 10014, SN 75-980,638. FILED 1-18-1999. PRINCIPAL REGISTER.

THEORY

OWNER OF U.S. REG. NO. 2,067,427.
INT. CL. 18/U.S. CLS. 1, 2, 3, 22 AND 41
FOR LEATHER GOODS, NAMELY, BELTS, HANDBAGS, [KEY CASES, WALLETS,] TOTE BAGS, [COSMETIC BAGS SOLD EMPTY,] BACKPACKS, [FANNY PACKS, DIARY AND ADDRESS BOOK COVERS, AND LUGGAGE; AND UMBRELLAS].
FIRST USE 2-0-1997; IN COMMERCE 2-0-1997.
INT. CL. 25/U.S. CLS. 22 AND 39
FOR WEARING APPAREL, NAMELY, BELTS, SLEEPWEAR, [BATHING SUITS,] STOCKINGS, LINGERIE, UNDERWEAR, WRAPS, HATS, GLOVES AND FOOTWEAR.
FIRST USE 2-0-1997; IN COMMERCE 2-0-1997.
INT. CL. 35/U.S. CLS. 100, 101 AND 102
FOR RETAIL STORE SERVICES IN THE FIELDS OF APPAREL, FOOTWEAR, BAGS AND LUGGAGE AND WATCHES AND JEWELRY.
FIRST USE 2-0-1997; IN COMMERCE 2-0-1997.

ELEMENTS CORRECTED
ENTITY

2,817,659. REG. 2-24-2004. H-D MICHIGAN, LLC (MICHIGAN LIMITED LIABILITY COMPANY) 315 W. HURON STREET, SUITE 400, ANN ARBOR, MI, 48103, SN 75-776,385. FILED 8-16-1999. PRINCIPAL REGISTER.

MOTORCLOTHES

INT. CL. 25/U.S. CLS. 22 AND 39

FOR CLOTHING, NAMELY, [BANDANAS,] BELTS, COATS, JACKETS, CAPS, HATS, HEAD WEAR, KNIT HATS, [RAIN HATS,] GLOVES, JEANS, PANTS, CHAPS, [COVERALLS,] SHORTS, SHIRTS, SWEATERS, HALTER TOPS, TANK TOPS, [CT- SHIRTS,] * T-SHIRTS * SWEATSHIRTS, SWEAT PANTS, [HOSIERY,] HEAD BANDS, LEATHER COATS, LEATHER JACKETS, LEATHER PANTS, LEATHER CHAPS, LEATHER VESTS, [NECKTIES,] NIGHTGOWNS, NIGHT SHIRTS, PAJAMAS, RAIN COATS, RAIN SUITS, [SUITS,] SCARVES, [SUSPENDERS, SWIMSUITS,] SKIRTS, [BIB OVERALLS, BABY BIBS NOT OF PAPER,] LINGERIE, UNDERWEAR, VESTS, AND WRISTBANDS; FOOTWEAR, NAMELY, SHOES AND BOOTS [; AND FOOTWEAR PARTS, NAMELY, DECORATIVE BOOT STRAPS].
FIRST USE 8-31-1990; IN COMMERCE 8-31-1990.

ELEMENTS CORRECTED
GOODS/SERVICES

2,825,362. REG. 3-23-2004. INSTITUTE FOR BUSINESS & HOME SAFETY (ILLINOIS NOT-FOR-PROFIT CORPORATION) 4775 E. FOWLER AVENUE, TAMPA, FL, 33617, SN 75-669,385. FILED 3-26-1999. PRINCIPAL REGISTER.

FORTIFIED FOR SAFER LIVING

THE MARK CONSISTS OF STANDARD CHARACTERS WITHOUT CLAIM TO ANY PARTICULAR FONT, STYLE, SIZE, OR COLOR.
THE CERTIFICATION MARK, AS INTENDED TO BE USED BY AUTHORIZED PERSONS, CERTIFIES THAT THE STRUCTURES BEARING THE MARK MEET CERTAIN MINIMUM STANDARDS OF NATURAL DISASTER RESISTANCE.
INT. CL. A /U.S. CL. A
FOR RESIDENTIAL BUILDING STRUCTURES.
FIRST USE 7-12-2001; IN COMMERCE 11-3-2002.

ELEMENTS AMENDED
MARK

2,828,526. REG. 3-30-2004. INCHCAPE SHIPPING SERVICES HOLDINGS LIMITED (UNITED KINGDOM PRIVATE LIMITED COMPANY) UNITS 6/7, LAKESIDE BUSINESS VILLAGE, FLEMING ROAD, CHAFFORD HUNDRED, ESSEX, UNITED KINGDOM, RM16 6YA, SN 78-108,627. FILED 2-13-2002. PRINCIPAL REGISTER.



PRIORITY CLAIMED UNDER SEC. 44(D) ON UNITED KINGDOM APPLICATION NO. 2278138, FILED 8-15-2001, REG. NO. 2278138, DATED 4-19-2002.

PRIORITY CLAIMED UNDER SEC. 44(D) ON UNITED KINGDOM APPLICATION NO. 2278138, FILED 8-15-2001, REG. NO. 2278138, DATED 8-15-2001.

THE MARK CONSISTS OF A DESIGN OF A GLOBE.
INT. CL. 35/U.S. CLS. 100, 101 AND 102

FOR BUSINESS MANAGEMENT; BUSINESS ADMINISTRATION; ACCOUNTING SERVICES; COST ACCOUNTING IN THE NATURE OF COST REPORTING; [INVENTORY MANAGEMENT SERVICES;] SOURCING AND BUYING SERVICES IN THE NATURE OF PROCUREMENT, NAMELY, PURCHASING GOODS AND SERVICES RELATING TO VESSELS, CARGOS AND CREWS FOR OTHERS; MARKETING SERVICES ON BEHALF OF PRINCIPALS; MARKETING RESEARCH SERVICES; IMPORT AGENCY AND EXPORT AGENCY SERVICES; ARRANGING AND COORDINATING PROVISION OF GOODS, SUPPLIES AND SUPPORT SERVICES FOR VESSEL OWNERS, CHARTERERS OR CARGO OWNERS IN THE NATURE OF PROCUREMENT, NAMELY, PURCHASING GOODS AND SERVICES RELATING TO VESSELS, CARGOS AND CREWS; LOGISTICS MANAGEMENT IN THE FIELD OF FREIGHT TRANSPORT IN THE NATURE OF PROVISIONING OF SHIPS, CREW AND PASSENGER LOGISTICS; BUSINESS SUPERVISION SERVICES; NAMELY, SUPERVISION OF PORT AND TERMINAL OPERATIONS; OPERATION OF A BUSINESS FOR OTHERS, NAMELY, OPERATING PORT TERMINALS; CUSTOMS CLEARANCE OF CARGO.

FIRST USE 7-31-2001; IN COMMERCE 7-31-2001.
INT. CL. 36/U.S. CLS. 100, 101 AND 102

FOR [INSURANCE SERVICES, NAMELY, INSURANCE BROKERAGE, INSURANCE AGENCY SERVICES, INSURANCE CONSULTATION SERVICES, INSURANCE INFORMATION AND UNDERWRITING SERVICES FOR ALL TYPES OF INSURANCE, AND RE-INSURANCE; DEBT FACTORING; AND CUSTOMS BROKERAGE].

FIRST USE 7-31-2001; IN COMMERCE 7-31-2001.
INT. CL. 39/U.S. CLS. 100 AND 105

FOR TRANSPORT BROKERAGE; SHIPPING SERVICES; NAMELY, TRANSPORTATION OF PASSENGERS AND GOODS BY LAND, SEA AND AIR; FREIGHT BROKERAGE; FREIGHT FORWARDING; FREIGHTING, NAMELY, FREIGHT TRANSPORTATION SERVICES VIA SHIPS IN THE NATURE OF ARRANGING AND MANAGING TRANSPORTATION OF CARGO AND CONTAINERS TO AND FROM PORTS ON BEHALF OF VESSEL OWNERS, CHARTERERS AND CARGO OWNERS; DELIVERY OF GOODS; NAMELY, FREIGHT TRANSPORTATION SERVICES VIA LAND, SEA AND AIR; WAREHOUSING; PACKAGING ARTICLES FOR TRANSPORTATION; [WAREHOUSE STORAGE OF GOODS; STORAGE OF GOODS IN THE NATURE OF HOLDING CARGO FOR INSPECTION OR COLLECTION PRIOR TO DELIVERY; RENTAL OF CONTAINERS FOR TRANSPORTATION OF GOODS;] FREIGHT TRANSPORT SERVICES, NAMELY, CARRIAGE OF GOODS AND CARGO FOR OTHERS BY LAND, SEA AND AIR; CARGO HANDLING SERVICES; ARRANGING SHORE EXCURSIONS FOR TOURISTS; LIGHTERAGE SERVICES.

FIRST USE 7-31-2001; IN COMMERCE 7-31-2001.

ELEMENTS AMENDED
DESCRIPTION OF MARK
OWNER NAME
OWNER ADDRESS
ENTITY
MARK

2,832,827. REG. 4-13-2004. MASONITE INTERNATIONAL CORPORATION (CANADA CORPORATION) 1600 BRITANNIA ROAD EAST, MISSISSAUGA, ONTARIO L4W 1J2, CANADA., SN 76-441,965. FILED 8-14-2002. PRINCIPAL REGISTER.

MASONITE THE BEAUTIFUL DOOR

THE MARK CONSISTS OF STANDARD CHARACTERS WITHOUT CLAIM TO ANY PARTICULAR FONT, STYLE, SIZE, OR COLOR.

OWNER OF U.S. REG. NO. 248,040.

NO CLAIM IS MADE TO THE EXCLUSIVE RIGHT TO USE "DOOR", APART FROM THE MARK AS SHOWN.

INT. CL. 6/U.S. CLS. 2, 12, 13, 14, 23, 25 AND 50
FOR METAL DOORS.

FIRST USE 9-1-2003; IN COMMERCE 12-18-2003.

INT. CL. 19/U.S. CLS. 1, 12, 33 AND 50

FOR DOORS NOT MADE OF METAL.

FIRST USE 9-1-2003; IN COMMERCE 12-18-2003.

ELEMENTS AMENDED
MARK

2,835,893. REG. 4-27-2004. KABUSHIKI KAISHA SEGA (JAPAN CORPORATION), DBA SEGA CORPORATION, 1-2-12, HANEDA, OHTA-KU, TOKYO, JAPAN., SN 76-410,399. FILED 5-21-2002. PRINCIPAL REGISTER.

TOEJAM & EARL

THE MARK CONSISTS OF STANDARD CHARACTERS WITHOUT CLAIM TO ANY PARTICULAR FONT, STYLE, SIZE, OR COLOR.

PRIORITY CLAIMED UNDER SEC. 44(D) ON JAPAN APPLICATION NO. 2002-40297, FILED 5-17-2002, REG. NO. 4658652, DATED 4-4-2003.

INT. CL. 9/U.S. CLS. 21, 23, 26, 36 AND 38

MAY 4, 2010

U.S. PATENT AND TRADEMARK OFFICE

TM 1647

FOR [VIDEO GAME SOFTWARE;] COMPUTER GAME PROGRAMS; [COMPUTER GAME DISCS;] VIDEO COMPUTER GAME PROGRAMS; [HOME VIDEO COMPUTER GAME DISCS; GAME DISCS AND CIRCUIT BOARDS CONTAINING GAME PROGRAMS FOR USE WITH HAND-HELD OR ARCADE VIDEO GAME MACHINES WITH BUILT-IN SCREENS].

FIRST USE ; IN COMMERCE .
INT. CL. 28/U.S. CLS. 22, 23, 38 AND 50

FOR [STAND ALONE VIDEO GAME MACHINES; ARCADE GAME MACHINES WITH BUILT-IN SCREENS].

FIRST USE ; IN COMMERCE .

ELEMENTS AMENDED
MARK

2,878,046. REG. 8-24-2004. E.P. HENRY CORPORATION (NEW JERSEY CORPORATION) 201 PARK AVE., P. O. BOX 615, WOODBURY, NJ, 08096, SN 76-522,827. FILED P.R. 6-16-2003; AM. S.R. 5-24-2004. SUPPLEMENTAL REGISTER.

MID-ATLANTIC HARDSCAPING

THE MARK CONSISTS OF STANDARD CHARACTERS WITHOUT CLAIM TO ANY PARTICULAR FONT, STYLE, SIZE, OR COLOR.

INT. CL. 35/U.S. CLS. 100, 101 AND 102
FOR ARRANGING AND CONDUCTING TRADE SHOWS IN THE FIELD OF LANDSCAPING.
FIRST USE 12-0-2001; IN COMMERCE 12-0-2001.

ELEMENTS AMENDED
MARK

2,839,984. REG. 5-11-2004. AMERICAN CITY BUSINESS JOURNALS, INC. (NORTH CAROLINA CORPORATION) 120 WEST MOREHEAD STREET, SUITE 400, CHARLOTTE, NC, 28202, SN 76-533,004. FILED 7-17-2003. PRINCIPAL REGISTER.

WHERE LOCAL BUSINESS COMES FIRST

INT. CL. 35/U.S. CLS. 100, 101 AND 102
FOR PROMOTING THE GOODS AND SERVICES OF OTHERS BY PREPARING AND PROVIDING ADVERTISING, MARKETING AND PROMOTIONAL MATTER TO NEWSPAPERS AND OTHER MEDIA.
FIRST USE 6-19-2003; IN COMMERCE 6-19-2003.

ELEMENTS CORRECTED
OWNER NAME

2,881,010. REG. 9-7-2004. ECO FLUIDS, INC. (TEXAS CORPORATION) 601 JEFFERSON STREET, SUITE 3770, HOUSTON, TX, 77002, SN 76-524,879. FILED 3-25-2003. PRINCIPAL REGISTER.

ecofluids



NO CLAIM IS MADE TO THE EXCLUSIVE RIGHT TO USE "ECOFLUIDS", APART FROM THE MARK AS SHOWN.

THE MARK CONSISTS OF THE TERM "ECOFLUIDS" AND THE DESIGN OF A LEAF WITH TOWER.

INT. CL. 1/U.S. CLS. 1
FOR DRILLING MUDS FOR USE IN OIL WELL DRILLING.
FIRST USE 8-14-2001; IN COMMERCE 8-14-2001.

ELEMENTS CORRECTED
OWNER NAME
OWNER ADDRESS

2,846,330. REG. 5-25-2004. PROSPERITY BANK (TEXAS STATE BANKING ASSOCIATION) 1301 N. MECHANIC, EL CAMPO, TX, 77437, SN 78-045,938. FILED 1-31-2001. PRINCIPAL REGISTER.

PROSPERITY BANCSHARES, INC.

THE MARK CONSISTS OF STANDARD CHARACTERS WITHOUT CLAIM TO ANY PARTICULAR FONT, STYLE, SIZE, OR COLOR.

NO CLAIM IS MADE TO THE EXCLUSIVE RIGHT TO USE "BANCSHARES INC", APART FROM THE MARK AS SHOWN.

INT. CL. 36/U.S. CLS. 100, 101 AND 102
FOR BANKING SERVICES.
FIRST USE 12-31-1994; IN COMMERCE 12-31-1994.

ELEMENTS AMENDED
MARK
DISCLAIMER

2,891,491. REG. 10-5-2004. SJI, INC. (MISSOURI CORPORATION) 1918 INNERBELT BUSINESS CENTER DR., ST. LOUIS, MO, 63114, SN 75-933,459. FILED 3-1-2000. PRINCIPAL REGISTER.

SJI

INT. CL. 35/U.S. CLS. 100, 101 AND 102

FOR BUSINESS MANAGEMENT CONSULTATION SERVICES; PUBLIC RELATIONS SERVICES; PROMOTIONAL SERVICES, NAMELY, THE DEVELOPMENT AND EXECUTION OF SALES AND MARKETING CAMPAIGNS FOR BUSINESSES; ASSISTANCE IN THE SALE OF GOODS AND SERVICES OF OTHERS BY TARGET MARKETING AND BRAND BUILDING THROUGH THE DISTRIBUTION OF PRINTED MATERIAL, PROMOTIONAL ITEMS, PRODUCT SAMPLES AND GIFTS; ADVERTISING SERVICES IN THE NATURE OF THE DEVELOPMENT OF ADVERTISING CAMPAIGNS FOR BUSINESSES INVOLVED IN THE SALE OF GOODS AND SERVICES TO OTHERS.

FIRST USE 5-1-2000; IN COMMERCE 5-1-2000.

ELEMENTS AMENDED
MARK

2,902,952. REG. 11-16-2004. OBERKOTTER FOUNDATION (PENNSYLVANIA NON-PROFIT CORPORATION) 1600 MARKET STREET, SUITE 3600, PHILADELPHIA, PA, 19103, SN 76-547,532. FILED 9-30-2003. PRINCIPAL REGISTER.



NO CLAIM IS MADE TO THE EXCLUSIVE RIGHT TO USE "ORAL DEAF EDUCATION", APART FROM THE MARK AS SHOWN.

THE COLOR(S) BLUE, RED, ORANGE, GREEN AND WHITE IS/ARE CLAIMED AS A FEATURE OF THE MARK.

THE MARK CONSISTS OF THE MARK IS COMPRISED OF THE WORDS ORAL DEAF EDUCATION SHOWN IN BLUE IN A STYLIZED FONT. TO THE LEFT OF THE WORDS ARE FOUR (4) COLOR BLOCKS EACH CONTAINING A DRAWING REVERSED OUT OF THE COLOR IN WHITE. THREE OF THE BLOCKS ARE APPROXIMATELY THE SAME SIZE AND STACKED ON TOP OF ONE ANOTHER. THE LARGE FOURTH BLOCK IS POSITIONED TO THE LEFT OF THE THREE. THE LARGE BLOCK IS SHOWN IN BLUE.

INT. CL. 41/U.S. CLS. 100, 101 AND 107

FOR EDUCATION SERVICES, NAMELY PROVIDING TEACHING MATERIALS AND ON-LINE INFORMATION ON THE SUBJECT OF ORAL DEAF EDUCATION. FIRST USE 0-0-1998; IN COMMERCE 0-0-1998.

ELEMENTS AMENDED
DESCRIPTION OF MARK
COLOR DESCRIPTION STATEMENT
MARK

2,918,186. REG. 1-11-2005. COSMETIC DERMATOLOGY, INC. (FLORIDA CORPORATION) 8798 NORTHWEST 15TH STREET, MIAMI, FL, 33172, SN 78-280,995. FILED 7-30-2003. PRINCIPAL REGISTER.

CREASE RELEASE

INT. CL. 3/U.S. CLS. 1, 4, 6, 50, 51 AND 52

FOR SKIN CREAM, [BODY LOTION,] [BODY SCRUB,] [SKIN LOTION,] SKIN MOISTURIZER, SKIN EMOLLIENTS, [SKIN MASKS, FACIAL MASKS, SKIN CLEANSER, SKIN TONER, EXFOLIATES,] EYE CREAM [SHAVE GEL, SUN SCREENS, AND SUN BLOCK PREPARATIONS].

FIRST USE 1-2-2004; IN COMMERCE 1-2-2004.

ELEMENTS AMENDED
GOODS/SERVICES

2,921,902. REG. 2-1-2005. DEUTSCHE TELEKOM AG (FED REP GERMANY CORPORATION) FRIEDRICH-EBERT-ALLEE 140, 53113 BONN, FED REP GERMANY., SN 76-176,993. FILED 12-7-2000. PRINCIPAL REGISTER.



PRIORITY CLAIMED UNDER SEC. 44(D) ON FED REP GERMANY APPLICATION NO. 30043206.62, FILED 6-7-2000, REG. NO. 30043206.2, DATED 10-25-2000.

INT. CL. 9/U.S. CLS. 21, 23, 26, 36 AND 38

FOR ELECTRIC, ELECTRONIC, OPTICAL, MEASURING, SIGNALING, CONTROLLING AND TEACHING APPARATUS AND INSTRUMENTS, ALL FOR USE WITH TELECOMMUNICATIONS, NAMELY, APPARATUS FOR PRODUCING SOUND, IMAGES OR DATA, NAMELY, MAGNETIC AND OPTICAL DATA CARRIERS, DATA PROCESSORS AND COMPUTERS, NAMELY, MICROCOMPUTERS, MINICOMPUTERS, COMPUTER CENTRAL PROCESSORS, COMPUTER MONITORS, COMPUTER KEYBOARDS, COMPUTER TERMINALS, COMPUTER INTERFACE BOARDS, COMPUTER MEMORIES, COMPUTER LASER PRINTERS, COMPUTER IMPACT PRINTERS, COMPUTER DOT MATRIX PRINTERS, COMPUTER OPERATING SYSTEMS, COMPUTERS AND INSTRUCTIONAL MANUALS SOLD AS A UNIT, COMPUTER INTERFACE APPARATUS, NAMELY, COMPUTER MODEMS, COMPUTER MOUSE AND MOUSE PAD, COMPUTER PERIPHERALS AND PARTS THEREOF; COMPUTER PROGRAMS AND DATABASES FOR USE IN OPERATING TELECOMMUNICATIONS AND BUSINESS MANAGEMENT SYSTEMS AND RELATED INSTRUCTIONAL MANUALS SOLD AS A UNIT; COMPUTER PROGRAMS, NAMELY, FINANCIAL ACCOUNTING SYSTEM SOFTWARE, SOFTWARE USED FOR THE PROVISION OF ONLINE INFORMATION SERVICES, NETWORK MANAGEMENT SOFTWARE, COMPUTER PROXY SOFTWARE FOR USE WITH OTHER SOFTWARE PROGRAMS, COMPUTER PROGRAMS AND SOFTWARE FOR CONTROLLING ACCESS AND ALARM MONITORING OF HOMES, APARTMENTS, BUILDINGS AND OTHER PROPERTIES, BILLING ANALYSIS SOFTWARE, AND SOFTWARE FOR NETWORK ACCESS CONTROL AND FOR CREATING AND MAINTAINING FIREWALLS; COMPUTER PROGRAMS FOR ACCESSING A GLOBAL COMPUTER NETWORK AND INTERACTIVE COMPUTER COMMUNICATIONS NETWORK; OPTICAL CABLES, OPTIC FILTERS, OPTICAL SCANNERS, OPTICAL CHARACTER READERS, OPTICAL DISCS, OPTICAL FIBERS, OPTICAL GLASS FOR SIGNAL TRANSMISSION, OPTIC TRANSMITTERS, OPTIC RECEIVERS, OPTICAL SIGNAL PROCESSING APPARATUS, OPTIC SWITCHES, OPTICAL ATTENUATORS, OPTICAL AMPLIFIERS, OPTICAL CHARACTER RECOGNITION APPARATUS, AND PARTS THEREOF; AUDIO, VIDEO AND DATA COMMUNICATIONS SYSTEMS, NAMELY, DIGITAL AND ANALOGUE SIGNAL TRANSMITTERS, RECEIVERS AND CONVERTERS, RADIO AND TELEPHONE TRANSMITTERS, RECEIVERS AND SERVERS, ANSWERING MACHINES, TELECOMMUNICATION TRANSMISSION, RECEIVING AND STORAGE APPARATUS, NAMELY, TELE-

COMMUNICATIONS TRANSMITTING SETS, DATA TRANSMITTERS, FACSIMILE MACHINES, ELECTRONIC MAIL APPARATUS FOR ELECTRONIC EXCHANGE OF DATA IMAGES AND MESSAGES, REMOTE CONTROLS AND SET-TOP UNITS FOR TELEVISION, CINEMATOGRAPHIC TELEVISION AND AMUSEMENT EQUIPMENT, NAMELY, SIGNAL DECODERS, ELECTRICAL WIRE, ELECTRICAL WIRE CONNECTORS, INTEGRATED CIRCUITS, PRINTED CIRCUITS, ELECTRIC CIRCUITS, CIRCUIT BREAKERS, PRINTED CIRCUIT BOARDS, ELECTRIC CIRCUIT BOARDS, CIRCUIT CONNECTORS, ELECTRICAL CONTROLLERS, ELECTRICAL CONVERTERS, ELECTRICAL FUSES, ELECTRIC LUMINESCENT DISPLAY PANELS, ELECTRICAL SWITCH PLATES, ELECTRIC PLUGS, ANTENNAS, ELECTRICAL CABLES, COMPUTER CABLES, COMPUTER CHIPS, SILICON CHIPS, CHRONOGRAPHS FOR USE AS SPECIALIZED TIME RECORDING APPARATUS, ELECTRIC COILS, COMPUTER BUFFERS, BLANK COMPUTER DISCS, BLANK COMPUTER FLOPPY DISKS, COMPUTER HARD DISCS, ELECTRICAL CONDUCTORS, ACOUSTIC CONDUITS, ELECTRICAL CONDUITS, FIBER OPTIC CONDUITS AND PARTS THEREOF; COMPACT DISC PLAYERS, AUDIO AND VIDEO TAPE RECORDERS, AUDIO AND VIDEO TAPE PLAYERS, AUDIO AND VIDEO CASSETTE RECORDERS, AUDIO AND VIDEO CASSETTE PLAYERS, BLANK AUDIO AND VIDEO TAPES, CASSETTES, DISCS AND MICROFICHE; AUDIO AND VIDEO TAPES, CASSETTES, DISCS AND MICROFICHE FEATURING INFORMATION CONCERNING TELECOMMUNICATIONS, AND CONCERNING PERSONAL AND BUSINESS MANAGEMENT SYSTEMS; AUDIO AND VIDEO RECORDINGS IN THE FIELD OF TELECOMMUNICATIONS, INFORMATION TECHNOLOGY, SAFETY; TELEVISION AND TELEVISION PERIPHERAL EQUIPMENT, NAMELY CAMERAS, SET BOXES, REMOTE CONTROL UNITS FOR INTERACTIVE AND NON-INTERACTIVE USE; COMPUTER MEMORY, COMPUTER PERIPHERALS AND MODEMS; VIDEO MONITORS, AUTOMATIC VENDING MACHINES AND TIMING MECHANISMS THEREOF, AND PARTS THEREOF; MACHINE READABLE, MAGNETICALLY ENCODED CARDS, NAMELY, PREPAID TELEPHONE CALLING CARDS AND CREDIT CARDS; SMART CARDS; DATA PROCESSORS AND READERS, WORD PROCESSORS, MAGNETIC CODED CARD READERS, MAGNETIC CODED CARDS, NAMELY, FIDELITY CARDS, ELECTRONIC ENCRYPTION UNITS, LASERS NOT FOR MEDICAL USE, LIGHT EMITTING DIODES, LIGHT EMITTING DIODE DISPLAYS, MICROPROCESSORS, BLANK MAGNETIC DATA CARRIERS, DEMAGNETIZERS FOR MAGNETIC TAPES, AND PARTS THEREOF; COMPUTER, DATA AND VIDEO NETWORKING AND CONFERENCING EQUIPMENT, NAMELY, TELECONFERENCING EQUIPMENT AND AUDIOVISUAL TEACHING EQUIPMENT IN THE NATURE OF OVERHEAD FILM, PHOTOGRAPHIC AND SLIDE PROJECTORS, PROJECTION SCREENS, COMPUTER BASED INFORMATION DISPLAY EQUIPMENT, NAMELY, COMPUTERS WHICH DISPLAY INFORMATION ON AN OVERHEAD SCREEN, INTERCOMS; TELEPHONES, TELEPHONE ANSWERING MACHINES, TELEPHONE TRANSMITTERS, TELEPHONE NETWORKS, TELEPHONE WIRES, TELEPRINTERS, TELETYPEWRITERS, AND PARTS THEREOF, NAMELY, CALLER IDENTIFICATION BOXES, DIALING ASSEMBLIES, TELEPHONE UNITS, AUDIO OPERATED RELAYS, AUDIO OPERATED RELAYS, AUDIO/VIDEO SIGNAL AND OPTICAL FILTERS, PROTECTORS AND AUTOMATIC SIGNALING AND CONTROL EQUIPMENT, TELEMETERS, WIRELESS AND CELLULAR TELEPHONES, RADIO PAGERS, PORTABLE COMPUTER DEVICES, NAMELY LAPTOPS, HANDHELD AND POCKET COMPUTERS, FACSIMILE TRANSMITTERS AND RECEIVERS, WIRELESS FAX MACHINES, PERSONAL COMMUNICATIONS EQUIPMENT, NAMELY, PERSONAL DIGITAL ASSISTANTS, CALCULATORS AND RELATED PERIPHERALS; SATELLITE PRO-

CESSORS, SATELLITES AND SATELLITE COMMUNICATION EARTH STATIONS BOTH STATIONARY AND MOVEABLE; AUDIO AND VIDEO RECORDINGS IN THE FIELD OF NEWS, SPORTS, ENTERTAINMENT, CULTURE, BUSINESS AND FINANCE, WEATHER AND TRAVEL; PRERECORDED COMPACT DISCS, AUDIO CASSETTE TAPES, VIDEO CASSETTE TAPES, DIGITAL AUDIO TAPES AND DIGITAL VIDEO DISCS FEATURING MUSICAL, VARIETY, NEWS AND COMEDY SHOWS; COMPUTER GAME PROGRAMS FOR CHILDREN AND ADULTS; VIDEO AND COMPUTER GAME CARTRIDGES.

FIRST USE ; IN COMMERCE .

INT. CL. 16/U.S. CLS. 2, 5, 22, 23, 29, 37, 38 AND 50

FOR PRINTED MATTER, NAMELY, TELEPHONE DIRECTORIES, BOOKS, NEWSLETTERS, PAMPHLETS, BROCHURES, MAGAZINES AND PAPERBACKS ALL IN THE FIELD OF TELECOMMUNICATIONS, PRINTED AND STAMPED PLASTIC AND CARDBOARD GREETING, BLANK, NOTE, AND INDEX CARDS; NOTE PAPER AND ENVELOPES, RUBBER STAMPS, NAME TAGS AND LABELS MADE FROM PAPER OR CARDBOARD, NOTEBOOKS, DIARIES, NOTE PAPERS, NOTE PADS, ADDRESS BOOKS, FOLDERS FOR LETTERS AND LOOSE PAPERS, CLEAR HOLE REINFORCEMENTS, STUDENT CALENDARS, STAMP ALBUMS AND PHOTO-ALBUMS; PAPER WEIGHTS, LETTER OPENERS, BLOTTER PADS; DESK TRAYS, DESK STANDS AND HOLDERS FOR HOLDING STATIONERY AND OFFICE IMPLEMENTS; PRINTED INSTRUCTIONAL AND TEACHING MATERIALS ALL IN THE FIELDS OF TELECOMMUNICATIONS, INFORMATION TECHNOLOGY, SAFETY, NEWS, SPORTS, ENTERTAINMENT, CULTURE, BUSINESS AND FINANCE, WEATHER AND TRAVEL; STATIONERY, DRAWING AND UNGRADUATED RULERS, ERASERS, STAPLERS, STAPLES, PAPER CLIPS, BOOK MARKERS, CUTOUT SAMPLES AND STENCILS; SCRATCH PICTURES, PAPER, NAMELY, BOND PAPER AND ART PAPER, PVC STICKERS, GIFT WRAP PAPER; BLACKBOARDS, CHALK STICKS, ADHESIVES FOR STATIONERY OR HOUSEHOLD PURPOSES; DRAWING AND PAINTING MATERIALS, NAMELY, PENCILS, DRAWING PENCILS, PENS, DRAWING PENS, PAINT TRAYS, PAINTING SETS FOR ARTISTS, PAINTING SETS FOR CHILDREN, CRAFT PAINT KITS, AND PENCIL CASES; NON-MAGNETICALLY ENCODED, PREPAID TELEPHONE CALLING CARDS.

FIRST USE ; IN COMMERCE .

INT. CL. 35/U.S. CLS. 100, 101 AND 102

FOR ADVERTISING AND BUSINESS MANAGEMENT, PROFESSIONAL CONSULTANCY IN THE FIELD OF DATA PROCESSING.

FIRST USE ; IN COMMERCE .

INT. CL. 36/U.S. CLS. 100, 101 AND 102

FOR INSURANCE SERVICES, NAMELY, INSURANCE BROKERAGE, INSURANCE CLAIMS PROCESSING; FINANCIAL SERVICES, NAMELY, CLEARING OF SECURE FINANCIAL TRANSACTIONS THROUGH ONLINE SERVICES; FINANCIAL ANALYSIS AND CONSULTATION, PROVIDING FINANCIAL INFORMATION, ISSUANCE OF SECURITIES, COMMERCIAL LENDING SERVICES, FINANCIAL PORTFOLIO MANAGEMENT, DISCOUNT BROKERAGE SERVICES, BROKERAGE OF SHARES AND BUSINESS VENTURES, BROKERAGE OF FUND SHARES, SECURITIES CONSULTING AND SAFE KEEPING, BROKERAGE OF PRODUCTIVE INVESTMENTS AND FUNDS; FINANCIAL SPONSORSHIP OF SPORTS, EDUCATIONAL AND ENTERTAINMENT PROGRAMS AND EVENTS; REAL ESTATE SERVICES, NAMELY BROKERAGE, MANAGEMENT, LEASING, APPRAISAL OF REAL PROPERTY; CUSTOMS BROKERAGE FOR THIRD PARTIES; MONETARY EXCHANGE; CREDIT CARD SERVICES; TELEPHONE CALLING CARD SERVICES; ELECTRONIC COMMERCE SERVICES, NAMELY, ELECTRONIC DEBIT AND CREDIT CARD PROCESSING SERVICES, FUNDS TRANSFER AND PAYMENT PROCESSING SERVICES; PROVIDING INFORMATION VIA THE TELEPHONE AND THE GLOBAL COMMUNICATIONS INFORMATION NETWORK IN THE FIELD OF BUSINESS AND FINANCE.

FIRST USE ; IN COMMERCE .

INT. CL. 38/U.S. CLS. 100, 101 AND 104

FOR TELECOMMUNICATIONS AND INFORMATION TECHNOLOGY SERVICES, NAMELY, ELECTRIC, DIGITAL, CELLULAR AND WIRELESS TRANSMISSION OF VOICE, DATA, INFORMATION, IMAGES, SIGNALS AND MESSAGES AND TRANSMISSION OF VOICE, DATA, IMAGES, AUDIO, VIDEO AND INFORMATION VIA TELEPHONE, TELEVISION AND GLOBAL COMMUNICATIONS INFORMATION NETWORKS; PROVIDING TELECOMMUNICATIONS CONNECTIONS OVER A GLOBAL COMMUNICATIONS INFORMATION NETWORK, ELECTRONIC MAIL, VOICE MAIL AND MESSAGING SERVICES, NAMELY, THE RECORDING AND STORAGE AND SUBSEQUENT TRANSMISSION OF VOICE MESSAGES BY TELEPHONE; RENTAL OF TELECOMMUNICATIONS EQUIPMENT, NAMELY, EQUIPMENT FOR ELECTRONIC ACCESS TO GLOBAL TELECOMMUNICATIONS NETWORK, EQUIPMENT FOR TRANSMITTING, RECEIVING, RECORDING AND MONITORING VOICE, DATA, INFORMATION, IMAGES, SIGNALS, MESSAGES, COMPRISED OF DATA AND WORD PROCESSORS, AND TELECOMMUNICATIONS HARDWARE AND SOFTWARE AND COMPONENTS AND PERIPHERALS THEREOF FOR USE IN THE TELECOMMUNICATIONS INDUSTRY, AND RENTAL OF EQUIPMENT FOR TRANSMITTING, RECEIVING, RECORDING AND MONITORING COMPUTER PROGRAMS FOR USE IN OPERATING AND ACCESSING TELECOMMUNICATIONS SYSTEMS; AUDIO AND VIDEO BROADCASTING FEATURING ENTERTAINMENT IN THE NATURE OF LIVE VISUAL AND AUDIO PERFORMANCES, AND MUSICAL, VARIETY, NEWS AND COMEDY SHOWS; PROVIDING MULTIPLE-USER DIAL-UP AND DEDICATED ACCESS TO THE INTERNET; PERSONAL COMMUNICATIONS SERVICES; PAGER SERVICES; ELECTRONIC MAIL SERVICES; TRANSMISSION AND BROADCAST OF AUDIO AND VIDEO PROGRAMMING; PROVIDING MULTIPLE-USER ACCESS TO A GLOBAL COMMUNICATION INFORMATION NETWORK; LEASING TELECOMMUNICATIONS EQUIPMENT, COMPONENTS, SYSTEMS AND SUPPLIES.
FIRST USE ; IN COMMERCE .

INT. CL. 39/U.S. CLS. 100 AND 105

FOR WAREHOUSE STORAGE OF GOODS; STORAGE OF GOODS RELATING TO TELECOMMUNICATIONS COMPUTERS AND OTHER INFORMATION TECHNOLOGY DEVICES; TRANSPORTATION OF GOODS BY TRUCK, SHIP, RAILWAY AND PLANE.
FIRST USE ; IN COMMERCE .

INT. CL. 41/U.S. CLS. 100, 101 AND 107

FOR EDUCATION AND INSTRUCTION, NAMELY, EDUCATIONAL SERVICES IN THE NATURE OF CLASSES AND SEMINARS IN THE FIELDS OF BUSINESS, TELECOMMUNICATIONS AND COMPUTERS, AND THE DISTRIBUTION OF COURSE MATERIALS THEREWITH; ENTERTAINMENT IN THE NATURE OF LIVE VISUAL AND AUDIO PERFORMANCES, NAMELY, MUSICAL BANDS, GYMNASTIC, DANCE, AND BALLET PERFORMANCES; ENTERTAINMENT SERVICES, NAMELY, PROVIDING MUSICAL, VARIETY, NEWS AND COMEDY SHOWS VIA A GLOBAL COMPUTER INFORMATION NETWORK; ENTERTAINMENT SERVICES, NAMELY, PROVIDING ON-LINE COMPUTER GAMES FOR CHILDREN AND ADULTS; PROVIDING ENTERTAINMENT INFORMATION AND GENERAL INFORMATION AT THE SPECIFIC REQUEST OF END-USERS BY MEANS OF TELEPHONE OR GLOBAL COMMUNICATIONS NETWORKS; ORGANIZING COMMUNITY SPORTING AND CULTURAL EVENTS; PUBLICATION OF BOOKS, MAGAZINES, JOURNALS, MANUALS, BROCHURES AND LEAFLETS ON THE SUBJECT OF TELECOMMUNICATIONS; ELECTRONIC PUBLISHING SERVICES, NAMELY, PUBLICATION OF TEXT AND GRAPHIC WORKS OF OTHERS ON TELECOMMUNICATIONS RECORDED ON CD-RIN AND CD-I; ORGANIZING FAIRS AND EXHIBITIONS IN THE FIELD OF VISUAL AND AUDIO PERFORMANCES, NAMELY, ROCK GROUP, GYMNASTIC, DANCE, AND BALLET PERFORMANCES.
FIRST USE ; IN COMMERCE .

INT. CL. 42/U.S. CLS. 100 AND 101

FOR COMPUTER PROGRAMMING SERVICES FOR OTHERS; CONSULTING IN THE FIELD OF TELECOMMUNICATION, RENTAL OF SOFTWARE AND HARDWARE FOR ONLINE ACCESS; [SERVICES OF AN INTERNET TRUST CENTER, NAMELY, ASSURANCE AND ADMINISTRATION OF DIGITAL KEYS AND/OR DIGITAL CERTIFICATES;] WEB PAGE HOSTING SERVICES; COMPUTER SERVICES, NAMELY, CREATING INDEXES OF INFORMATION AVAILABLE ON COMPUTER NETWORKS; CONSULTING AND DESIGN SERVICES IN THE FIELD OF INFORMATION TECHNOLOGY, COMPUTER PROGRAMMING, TELECOMMUNICATIONS AND GLOBAL COMMUNICATION NETWORKS; INSTALLATION, MAINTENANCE AND REPAIR OF COMPUTER SOFTWARE.
FIRST USE ; IN COMMERCE .

ELEMENTS AMENDED
GOODS/SERVICES

2,928,500. REG. 3-1-2005. PRESSPART GMBH & CO..KG (FED REP GERMANY INDIVIDUAL) AM MEILENSTEIN 8-19, MARSBERG, FED REP GERMANY, 34431, SN 76-467,244. FILED 11-6-2002. PRINCIPAL REGISTER.

PRESSPART

PRIORITY CLAIMED UNDER SEC. 44(D) ON ERPNCMNTY TM OFC APPLICATION NO. 002686186, FILED 5-6-2002, REG. NO. 002686186, DATED 7-2-2003, EXPIRES 7-2-2013.

INT. CL. 6/U.S. CLS. 2, 12, 13, 14, 23, 25 AND 50

FOR COMMON METALS AND THEIR ALLOYS, NON PRECIOUS AND BASE METALS AND ALLOYING COMPONENTS, ALL PRECISION STAMPED OR DRAWN FROM SHEET FORM, FOR USE IN FURTHER MANUFACTURE; COMMON METALS AND THEIR ALLOYS, NON PRECIOUS AND BASE METALS AND ALLOYING COMPONENTS, ALL PRECISION STAMPED OR DRAWN FROM SHEET FORM, FOR USE IN THE FURTHER MANUFACTURE OF SCIENTIFIC, ELECTRICAL, OPTICAL, MECHANICAL, SURVEYING, WEIGHING, MEASURING, SIGNALING, CHECKING AND MONITORING INSTRUMENTS AND APPARATUS; COMMON METALS AND THEIR ALLOYS, NON PRECIOUS AND BASE METALS AND ALLOYING COMPONENTS, ALL PRECISION STAMPED OR DRAWN FROM SHEET FORM, FOR USE IN THE FURTHER MANUFACTURE OF PRINTING MACHINES, WRITING MACHINES, PRINTING APPARATUS AND OFFICE MACHINES; SMALL METAL HOUSE HARDWARE AND SMALL METAL HARDWARE, NAMELY, NUTS, BOLTS, HINGES, SLIDES, HANDLES, PULLS, LOCKS, METAL CONDUITS, METAL PIPES, METAL TUBES AND METAL CONDUIT, METAL PIPE AND TUBE FITTINGS; METAL AEROSOL CONTAINERS, SOLD EMPTY.
FIRST USE ; IN COMMERCE .

ELEMENTS CORRECTED
GOODS/SERVICES
FOREIGN COUNTRY OF ORIGIN

2,932,159. REG. 3-8-2005. JET-ALLIANCE, INC. (CALIFORNIA CORPORATION) 3390 AUTO MALL DRIVE SUITE 200, WESTLAKE VILLAGE, CA, 91362, SN 78-396,499. FILED P.R. 4-5-2004; AM. S.R. 11-29-2004. SUPPLEMENTAL REGISTER.

JETALLIANCE

THE MARK CONSISTS OF STANDARD CHARACTERS WITHOUT CLAIM TO ANY PARTICULAR FONT, STYLE, SIZE, OR COLOR.

INT. CL. 36/U.S. CLS. 100, 101 AND 102

FOR FORMATION, BROKERAGE AND MANAGEMENT OF FRACTIONAL OWNERSHIP INTERESTS IN AIRCRAFT .

FIRST USE 1-24-2001; IN COMMERCE 1-24-2001.

ELEMENTS AMENDED
MARK

2,932,183. REG. 3-15-2005. DIABCELL PTY LIMITED (NEW ZEALAND LIMITED LIABILITY COMPANY) LEVEL 9 20 HUNTER STREET, SYDNEY, NSW 2001, AUSTRALIA., SN 76-068,984. FILED 6-14-2000. PRINCIPAL REGISTER.

DIABECCELL

PRIORITY CLAIMED UNDER SEC. 44(D) ON NEW ZEALAND APPLICATION NO. 605168, FILED 12-15-1999, REG. NO. 605168, DATED 12-15-1999, EXPIRES 12-15-2006.

INT. CL. 5/U.S. CLS. 6, 18, 44, 46, 51 AND 52

FOR PHARMACEUTICAL PREPARATIONS FOR USE IN THE TREATMENT OF DIABETES .

FIRST USE ; IN COMMERCE .

ELEMENTS CORRECTED
OWNER NAME
OWNER ADDRESS
CITIZENSHIP
ENTITY

2,968,340. REG. 7-12-2005. VITAMINS PLAYWEAR, LTD. (NEW YORK CORPORATION) 10 WEST 33RD STREET, SUITE 910, NEW YORK, NY, 10001, SN 78-236,727. FILED 4-11-2003. PRINCIPAL REGISTER.

MULTI VITAMINS

OWNER OF U.S. REG. NOS. 1,362,018, 2,557,079 AND OTHERS.

INT. CL. 25/U.S. CLS. 22 AND 39

FOR CHILDREN'S APPAREL, NAMELY, LAYETTES COMPRISING CAPS, BOOTIES, SLEEPWEAR, COVERALLS, BODYSUITS, SWEATERS, CREEPERS, JOG SUITS, T-SHIRTS, PANTS, CLOTH EATING BIBS .

FIRST USE 3-0-2003; IN COMMERCE 3-0-2003.

ELEMENTS CORRECTED
OWNER NAME
OWNER ADDRESS

2,969,056. REG. 7-19-2005. DEUTSCHE TELEKOM AG (FED REP GERMANY CORPORATION) FRIEDRICH-EBERT-ALLEE 140, 53113 BONN, FED REP GERMANY., SN 76-223,046. FILED 3-12-2001. PRINCIPAL REGISTER.



PRIORITY CLAIMED UNDER SEC. 44(D) ON FED REP GERMANY APPLICATION NO. 30068725.7, FILED 9-13-2000, REG. NO. 30068725, DATED 11-30-2000.

INT. CL. 9/U.S. CLS. 21, 23, 26, 36 AND 38

FOR ELECTRIC, ELECTRONIC, OPTICAL, MEASURING, SIGNALING, CONTROLLING AND TEACHING APPARATUS AND INSTRUMENTS, ALL FOR USE WITH TELECOMMUNICATIONS, NAMELY, APPARATUS FOR PRODUCING SOUND, IMAGES OR DATA, MAGNETIC AND OPTICAL DATA CARRIERS, DATA PROCESSORS AND COMPUTERS, NAMELY, MICROCOMPUTERS, MINICOMPUTERS, COMPUTER CENTRAL PROCESSORS, COMPUTER MONITORS, COMPUTER KEYBOARDS, COMPUTER TERMINALS, COMPUTER INTERFACE BOARDS, COMPUTER MEMORIES, COMPUTER LASER PRINTERS, COMPUTER IMPACT PRINTERS, COMPUTER DOT MATRIX PRINTERS, COMPUTER OPERATING SYSTEMS, COMPUTERS AND INSTRUCTIONAL MANUALS SOLD AS A UNIT, COMPUTER INTERFACE APPARATUS, NAMELY, COMPUTER MODEMS, COMPUTER MOUSE AND MOUSE PAD, COMPUTER PERIPHERALS AND PARTS THEREOF COMPUTER PROGRAMS AND DATABASES FOR USE IN OPERATING TELECOMMUNICATIONS AND BUSINESS MANAGEMENT SYSTEMS AND RELATED INSTRUCTION MANUALS SOLD AS A UNIT; OPTICAL CABLES, OPTIC FILTERS, OPTICAL SCANNERS, OPTICAL CHARACTER READERS, OPTICAL DISCS, OPTICAL FIBERS, OPTICAL GLASS FOR SIGNAL TRANSMISSION, OPTIC TRANSMITTERS, OPTIC RECEIVERS, OPTICAL SIGNAL PROCESSING APPARATUS, OPTIC SWITCHES, OPTICAL NETWORKS COMPRISING COMMUNICATION TRANSMISSION SWITCHING AND RECEPTION APPARATUS, OPTICAL ATTENUATORS, OPTICAL AMPLIFIERS, OPTICAL CHARACTER RECOGNITION APPARATUS, AND PARTS THEREOF AUDIO, VIDEO AND DATA COMMUNICATIONS SYSTEMS, NAMELY, DIGITAL AND ANALOGUE SIGNAL TRANSMITTERS, RECEIVERS AND CONVERTERS, RADIO AND TELEPHONE TRANSMITTERS, RECEIVERS AND SERVERS, STATIONARY, WIRELESS AND CELLULAR TELEPHONE SYSTEMS AND ANSWERING MACHINES, TELECOMMUNICATION TRANSMISSION, RECEIVING AND STORAGE APPARATUS, TELECOMMUNICATIONS TRANSMITTING SETS, DATA TRANSMITTERS, FACSIMILE MACHINES, ELECTRONIC MAIL APPARATUS FOR ELECTRONIC EXCHANGE OF DATA IMAGES AND MESSAGES, REMOTE CONTROLS AND SET-TOP UNITS, CINEMATOGRAPHIC TELEVISION AND AMUSEMENT EQUIPMENT, NAMELY, SIGNAL DECODERS AND INTERACTIVE AUDIO AND VIDEO EQUIPMENT TO FACILITATE INTERACTION BETWEEN CONSUMERS AND PROVIDERS OF GOODS AND SERVICES, ELECTRICAL WIRE, ELECTRICAL WIRE CONNECTORS, INTEGRATED CIRCUITS, PRINTED CIRCUITS, ELECTRIC CIRCUITS, CIRCUIT BREAKERS, PRINTED CIRCUIT BOARDS, ELECTRIC CIRCUIT BOARDS, CIRCUIT CONNECTORS, ELECTRICAL CONTROLLERS, ELECTRICAL CONVERTERS, ELECTRICAL FUSES, ELECTRIC LUMINESCENT DISPLAY PANELS, ELECTRICAL SWITCH PLATES, ELECTRIC PLUGS, ANTENNAS, ELECTRICAL CABLES, COMPUTER CABLES, COMPUTER CHIPS, SILICON CHIPS, CHRONOGRAPHS FOR USE AS SPECIALIZED TIME RECORDING APPARATUS, ELECTRIC COILS, COMPUTER BUFFERS, BLANK COMPUTER DISCS, BLANK COMPUTER FLOPPY DISKS, COMPUTER HARD DISCS, ELECTRICAL CONDUCTORS, ACOUSTIC CONDUITS, ELECTRICAL CONDUITS, FIBER OPTIC CONDUITS AND PARTS THEREOF COMPACT DISC PLAYERS, AUDIO AND VIDEO TAPE RECORDERS, AUDIO AND

VIDEO TAPE PLAYERS, AUDIO AND VIDEO CASSETTE RECORDERS, AUDIO AND VIDEO CASSETTE PLAYERS, BLANK AUDIO AND VIDEO TAPES, CASSETTES, DISCS AND MICROFICHE; AUDIO AND VIDEO TAPES, CASSETTES, DISCS AND MICROFICHE FEATURING INFORMATION CONCERNING TELECOMMUNICATIONS, PERSONAL AND BUSINESS MANAGEMENT SYSTEMS, VIDEO MONITORS, AUTOMATIC VENDING MACHINES AND TIMING MECHANISMS THEREFOR, AND PARTS THEREOF; DATA PROCESSORS AND READERS, WORD PROCESSORS, MAGNETIC CODED CARD READERS, MAGNETIC CARDS, ELECTRONIC ENCRYPTION UNITS, LASERS, LIGHT EMITTING DIODES, LIGHT EMITTING DIODE DISPLAYS, MICROPROCESSORS, BLANK MAGNETIC DATA CARRIERS, DEMAGNETIZERS FOR MAGNETIC TAPES, AND PARTS THEREOF; COMMUNICATIONS AND VIDEO TRANSMISSION SWITCHING AND RECEPTION APPARATUS; COMPUTER, DATA AND VIDEO NETWORKING AND CONFERENCING EQUIPMENT, NAMELY, TELECONFERENCING EQUIPMENT, AUDIOVISUAL TEACHING EQUIPMENT, OVERHEAD FILM, PHOTOGRAPHIC AND SLIDE PROJECTORS, PROJECTION SCREENS, COMPUTER BASED INFORMATION DISPLAY EQUIPMENT, NAMELY, COMPUTERS WHICH DISPLAY INFORMATION ON AN OVERHEAD SCREEN, INTERCOMS; TELEPHONES, TELEPHONE ANSWERING MACHINES, TELEPHONE TRANSMITTERS, TELEPHONE NETWORKS, TELEPHONE WIRES, TELEPRINTERS, TELETYPEWRITERS, AND PARTS THEREOF, NAMELY, CALLER IDENTIFICATION BOXES, RADIO TELEPHONE EQUIPMENT AND ACCESSORIES, NAMELY, CALL BOXES AND SYSTEMS, DIALING ASSEMBLIES, TELEPHONE UNITS, AUDIO OPERATED RELAYS, SIGNALING DEVICES, RECEIVING DEVICES, TERMINATION EQUIPMENT, FILTERS, PROTECTORS AND AUTOMATIC SIGNALING AND CONTROL EQUIPMENT, TELEMETERS, WIRELESS AND CELLULAR TELEPHONES, PAGERS, PAGING EQUIPMENT, PORTABLE COMPUTER DEVICES, FACSIMILE TRANSMITTERS AND RECEIVERS, WIRELESS FAX MACHINES, PERSONAL COMMUNICATIONS EQUIPMENT, NAMELY, PERSONAL DIGITAL ASSISTANTS (PDA), CALCULATORS AND RELATED PERIPHERALS; SATELLITE PROCESSORS, SATELLITES AND SATELLITE COMMUNICATION EARTH STATIONS BOTH STATIONARY AND MOVEABLE; PRERECORDED COMPACT DISCS, AUDIO CASSETTE TAPES, VIDEO CASSETTE TAPES, DIGITAL AUDIO TAPES AND DIGITAL VIDEO DISCS FEATURING MUSICAL, VARIETY, NEWS AND COMEDY SHOWS; COMPUTER GAME PROGRAMS FOR CHILDREN AND ADULTS; ELECTRONIC PUBLICATIONS, NAMELY, BOOKS, PERIODICALS, MAGAZINES, INSTRUCTION MANUALS FEATURING INFORMATION ON TELECOMMUNICATION RECORDED ON ELECTRONIC MEDIA.

FIRST USE ; IN COMMERCE .

INT. CL. 16/U.S. CLS. 2, 5, 22, 23, 29, 37, 38 AND 50

FOR PRINTED MATTER, NAMELY, PRINTED AND STAMPED PLASTIC AND CARDBOARD GREETING, BLANK, NOTE, AND INDEX CARDS, AS WELL AS BOOKS OR MAGAZINES ON TELECOMMUNICATIONS; NOTE PAPER AND ENVELOPES, STAMPS, NAME TAGS AND LABELS MADE FROM PAPER OR CARDBOARD, NOTEBOOKS, DIARIES, NOTE PAPERS, NOTE PADS, ADDRESS BOOKS, FOLDERS FOR LETTERS, FILES OR LOOSE PAPER, CLEAR HOLE REINFORCEMENTS, STUDENT CALENDARS, STAMP ALBUMS AND PHOTO-ALBUMS; PAPER WEIGHTS, LETTER OPENERS, BLOTTING PADS; DESK TRAYS, NAMELY, CASES FOR STATIONERY AND OFFICE IMPLEMENTS; PRINTED INSTRUCTIONAL AND TEACHING MATERIAL ON TELECOMMUNICATIONS; STATIONERY, NAMELY DRAWING AND UNGRADUATED RULERS, ERASERS, STAPLERS, STAPLES, PAPER CLIPS, BOOK MARKERS, CUTOUT SAMPLES AND STENCILS; TRANSPARENT PICTURE APPLICATIONS, SCRATCH PICTURES, PAPER, PVC STICKERS, PAPERBACKS, GIFT WRAP PAPER; BLACKBOARDS, CHALK STICKS, ADHESIVES FOR STATIONERY OR HOUSEHOLD PURPOSES; DRAWING AND PAINTING MATERIALS, NAMELY, PENCILS, DRAWING PENCILS, PENS, DRAWING PENS, PAINT TRAYS, PAINTING SETS FOR ARTISTS, PAINTING SETS FOR CHILDREN, CRAFT PAINT KITS, DRAWING RULERS AND PENCIL CASES.

FIRST USE ; IN COMMERCE .

INT. CL. 35/U.S. CLS. 100, 101 AND 102

FOR ADVERTISING SERVICES, NAMELY, PREPARING AND PLACING ADVERTISEMENTS FOR OTHERS, DIRECT MAIL ADVERTISING, ELECTRONIC BILLBOARD ADVERTISING, PREPARING AUDIO-VISUAL PRESENTATIONS FOR USE IN ADVERTISING; BUSINESS SERVICES, NAMELY, BUSINESS APPRAISALS, BUSINESS AUDITING, PROVIDING BUSINESS INFORMATION, NAMELY, PREPARING BUSINESS REPORTS AND CONDUCTING BUSINESS RESEARCH, ANALYSIS AND SURVEYS, BUSINESS MANAGEMENT PLANNING, BUSINESS MANAGEMENT CONSULTATION, BUSINESS MANAGEMENT SUPERVISION, CONDUCTING BUSINESS NETWORKING FOR OTHERS; RENTAL OF AUTOMATIC VENDING MACHINES; AND ORGANIZING JOB FAIRS; GENERATION OF DATA PROCESSING PROGRAMS; PROFESSIONAL CONSULTING IN THE FIELD OF DATA PROCESSING; LICENSING OF COMPUTER SOFTWARE AND HARDWARE FOR ONLINE ACTORS, FOR CONSUMER FACILITATING AND THE ADMINISTRATION OF COMPLEX NETWORK SYSTEMS.

FIRST USE ; IN COMMERCE .

INT. CL. 36/U.S. CLS. 100, 101 AND 102

FOR INSURANCE SERVICES, NAMELY, INSURANCE BROKERAGE, INSURANCE CLAIMS PROCESSING; CLEARING OF SECURE FINANCIAL TRANSACTIONS THROUGH ONLINE SERVICES; FINANCIAL AND MONETARY AFFAIRS, NAMELY FINANCIAL ANALYSIS AND CONSULTATION, FINANCIAL INFORMATION, ISSUANCE OF SECURITIES, COMMERCIAL LENDING SERVICES, FINANCIAL PORTFOLIO MANAGEMENT, DISCOUNT BROKERAGE SERVICES, BROKERAGE OF SHARES, BROKERAGE OF FUND SHARES, SECURITIES CONSULTING AND SAFE KEEPING, BROKERAGE OF PRODUCTIVE INVESTMENTS AND FUNDS; REAL ESTATE AFFAIRS, NAMELY BROKERAGE, MANAGEMENT, LEASING, APPRAISAL OF REAL PROPERTY; CUSTOMS BROKERAGE FOR THIRD PARTIES; CONSULTING SERVICES RELATING TO BANK AFFAIRS; CONSULTING SERVICES RELATING TO INSURANCE AFFAIRS, NAMELY INFORMATION AND BROKERAGE OF INSURANCES; AND MONETARY EXCHANGE.

FIRST USE ; IN COMMERCE .

INT. CL. 38/U.S. CLS. 100, 101 AND 104

FOR TELECOMMUNICATION SERVICES, NAMELY, ELECTRIC, DIGITAL, CELLULAR AND WIRELESS TRANSMISSION OF VOICE, DATA, INFORMATION, IMAGES, SIGNALS AND MESSAGES; PROVIDING TELECOMMUNICATIONS CONNECTIONS OVER A GLOBAL COMMUNICATIONS NETWORK, ELECTRONIC MAIL, VOICE MAIL AND MESSAGING SERVICES, AUDIO AND VIDEO TELECONFERENCING, RENTAL OF TELECOMMUNICATIONS EQUIPMENT, NAMELY, EQUIPMENT FOR ELECTRONIC ACCESS TO GLOBAL TELECOMMUNICATIONS NETWORK, EQUIPMENT FOR TRANSMITTING, RECEIVING, RECORDING AND MONITORING PROCESSORS, AND TELECOMMUNICATIONS HARDWARE AND SOFTWARE INCLUDING COMPONENTS AND PERIPHERALS THEREOF FOR USE IN THE TELECOMMUNICATIONS INDUSTRY, AND FOR TRANSMITTING, RECEIVING, RECORDING AND MONITORING COMPUTER PROGRAMS FOR USE IN OPERATING AND ACCESSING TELECOMMUNICATIONS SYSTEMS; AUDIO AND VIDEO BROADCASTING FEATURING ENTERTAINMENT IN THE NATURE OF LIVE VISUAL AND AUDIO PERFORMANCES, AND MUSICAL, VARIETY, NEWS AND COMEDY SHOWS; AND PROVIDING ACCESS TO COMPUTER INFORMATION NETWORKS.

FIRST USE ; IN COMMERCE .

INT. CL. 41/U.S. CLS. 100, 101 AND 107

FOR EDUCATION AND INSTRUCTION, NAMELY, EDUCATIONAL SERVICES IN THE NATURE OF CLASSES AND SEMINARS IN THE FIELDS OF BUSINESS, TELECOMMUNICATIONS AND COMPUTERS, AND THE DISTRIBUTION OF COURSE MATERIALS THEREWITH; ENTERTAINMENT IN THE NATURE OF VISUAL AND AUDIO PERFORMANCES, NAMELY, MUSICAL BAND, ROCK GROUP, GYMNASIAC, DANCE, AND BALLET PERFORMANCES; ENTERTAINMENT SERVICES, NAMELY, PROVIDING MUSICAL, VARIETY, NEWS AND COMEDY SHOWS VIA A GLOBAL COMPUTER INFORMATION NETWORK; ENTERTAINMENT SERVICES, NAMELY, PROVIDING ON-LINE COMPUTER GAMES FOR CHILDREN AND ADULTS; ORGANIZING COMMUNITY SPORTING AND CULTURAL EVENTS; PUBLICATION OF BOOKS, MAGAZINES, JOURNALS, MANUALS, BROCHURES, AND LEAFLETS ON THE SUBJECT OF TELECOMMUNICATIONS; ELECTRONIC PUBLISHING SERVICES, NAMELY, PUBLICATION OF TEXT AND GRAPHIC WORKS OF OTHERS ON TELECOMMUNICATIONS RECORDED ON ELECTRONIC MEDIA; ORGANIZING FAIRS AND EXHIBITIONS IN THE FIELD OF VISUAL AND AUDIO PERFORMANCES, NAMELY, MUSICAL BAND, ROCK GROUP, GYMNASIAC, DANCE, AND BALLET PERFORMANCES.

FIRST USE ; IN COMMERCE .

INT. CL. 42/U.S. CLS. 100 AND 101

FOR COMPUTER PROGRAMMING SERVICES FOR OTHERS; DATABASE SERVICES, NAMELY, LEASING ACCESS TIME TO A COMPUTER DATABASE IN THE FIELD OF TELECOMMUNICATION; PROVIDING AND MAINTAINING AN ONLINE COMPUTER DATABASE IN THE FIELD OF GENERAL NEWS AND INFORMATION; CONSULTING IN THE FIELD OF TELECOMMUNICATION; RENTAL OF SOFTWARE AND HARDWARE FOR ONLINE ACCESS; [SERVICES OF AN INTERNET TRUST CENTER, NAMELY, ASSURANCE AND ADMINISTRATION OF DIGITAL KEYS AND DIGITAL CERTIFICATES;] RENTAL OF DATA PROCESSING EQUIPMENT AND COMPUTERS; PROJECTING AND PLANNING SERVICES, NAMELY, DESIGN SERVICES FOR OTHERS IN THE FIELD OF TELECOMMUNICATIONS EQUIPMENT.

FIRST USE ; IN COMMERCE .

ELEMENTS AMENDED
GOODS/SERVICES

2,970,285. REG. 7-19-2005. SELLERSMFG., INC. (INDIANA CORPORATION) 601 NORTH OLD STATE ROAD 15, MILFORD, IN, 46542, SN 78-368,447. FILED 2-16-2004. PRINCIPAL REGISTER.

RUFF NECK

THE MARK CONSISTS OF STANDARD CHARACTERS WITHOUT CLAIM TO ANY PARTICULAR FONT, STYLE, SIZE, OR COLOR.

INT. CL. 12/U.S. CLS. 19, 21, 23, 31, 35 AND 44

FOR TOWING HITCHES FOR USE WITH MOTOR VEHICLES.

FIRST USE 1-2-2001; IN COMMERCE 6-15-2001.

ELEMENTS CORRECTED
OWNER NAME

2,975,016. REG. 7-26-2005. DEUTSCHE TELEKOM AG (FED REP GERMANY CORPORATION) FRIEDRICH-EBERT-ALLEE 140, 53113 BONN, FED REP GERMANY., SN 76-176,992. FILED 12-7-2000. PRINCIPAL REGISTER.



PRIORITY CLAIMED UNDER SEC. 44(D) ON FED REP GERMANY APPLICATION NO. 30043200338, FILED 6-7-2000, REG. NO. 30043200, DATED 9-7-2000.

INT. CL. 9/U.S. CLS. 21, 23, 26, 36 AND 38

FOR ELECTRIC, ELECTRONIC, OPTICAL, MEASURING, SIGNALING, CONTROLLING OR TEACHING APPARATUS AND INSTRUMENTS, ALL FOR USE WITH TELECOMMUNICATIONS, NAMELY, APPARATUS FOR PRODUCING SOUND, IMAGES OR DATA, MAGNETIC AND OPTICAL DATA CARRIERS, DATA PROCESSORS AND COMPUTERS, NAMELY, MICROCOMPUTERS, MINICOMPUTERS, COMPUTER CENTRAL PROCESSORS, COMPUTER MONITORS, COMPUTER KEYBOARDS, COMPUTER TERMINALS, COMPUTER INTERFACE BOARDS, COMPUTER MEMORIES, COMPUTER LASER PRINTERS, COMPUTER IMPACT PRINTERS, COMPUTER DOT MATRIX PRINTERS, COMPUTER OPERATING SYSTEMS, COMPUTERS AND INSTRUCTIONAL MANUALS SOLD AS A UNIT, COMPUTER INTERFACE APPARATUS, NAMELY, COMPUTER MODEMS, COMPUTER MOUSE AND MOUSE PAD, COMPUTER PERIPHERALS AND PARTS THEREOF, COMPUTER PROGRAMS AND DATA BASES FOR USE IN OPERATING TELECOMMUNICATIONS AND BUSINESS MANAGEMENT SYSTEMS AND RELATED INSTRUCTION MANUALS SOLD AS A UNIT; OPTICAL CABLES, OPTIC FILTERS, OPTICAL SCANNERS, OPTICAL CHARACTER READERS, OPTICAL DISCS, OPTICAL FIBERS, OPTICAL GLASS FOR SIGNAL TRANSMISSION, OPTIC TRANSMITTERS, OPTIC RECEIVERS, OPTICAL SIGNAL PROCESSING APPARATUS, OPTIC SWITCHES, OPTICAL NETWORKS COMPRISING COMMUNICATION TRANSMISSION SWITCHING AND RECEPTION APPARATUS, OPTICAL ATTENUATORS, OPTICAL AMPLIFIERS, OPTICAL CHARACTER RECOGNITION APPARATUS, AND PARTS THEREOF; AUDIO, VIDEO AND DATA COMMUNICATIONS SYSTEMS, NAMELY, DIGITAL AND ANALOGUE SIGNAL TRANSMITTERS, RECEIVERS AND CONVERTERS, RADIO AND TELEPHONE TRANSMITTERS, RECEIVERS AND SERVERS, STATIONARY, WIRELESS AND CELLULAR TELEPHONE SYSTEMS AND ANSWERING MACHINES, TELECOMMUNICATION TRANSMISSION, RECEIVING AND STORAGE APPARATUS, TELECOMMUNICATIONS TRANSMITTING SETS, DATA TRANSMITTERS, FACSIMILE MACHINES, ELECTRONIC MAIL APPARATUS FOR ELECTRONIC EXCHANGE OF DATA IMAGES AND MESSAGES, REMOTE CONTROLS AND SET-TOP UNITS, CINEMATOGRAPHIC TELEVISION AND AMUSEMENT EQUIPMENT, NAMELY, SIGNAL DECODERS AND INTERACTIVE AUDIO AND VIDEO EQUIPMENT TO FACILITATE INTERACTION BETWEEN CONSUMERS AND PROVIDERS OF GOODS AND SERVICES, ELECTRICAL WIRE, ELECTRICAL WIRE CONNECTORS, INTEGRATED CIRCUITS, PRINTED CIRCUITS, ELECTRIC CIRCUITS, CIRCUIT BREAKERS, PRINTED CIRCUIT BOARDS, ELECTRIC CIRCUIT BOARDS, CIRCUIT CONNECTORS, ELECTRICAL CONTROLLERS, ELECTRICAL CONVERTERS, ELECTRICAL FUSES, ELECTRIC LUMINESCENT DISPLAY PANELS, ELECTRICAL SWITCH PLATES, ELECTRIC PLUGS, ANTENNAS, ELECTRICAL CABLES, COMPUTER CABLES, COMPUTER CHIPS, SILICON CHIPS, CHRONOGRAPHS FOR USE AS SPECIALIZED TIME RECORDING APPARATUS, ELECTRIC COILS, COMPUTER BUFFERS, BLANK COMPUTER DISCS, BLANK COMPUTER FLOPPY DISKS, COMPUTER HARD DISCS, ELECTRICAL CONDUCTORS, ACOUSTIC CONDUITS, ELECTRICAL CONDUITS, FIBER OPTIC CONDUITS AND PARTS THEREOF; COMPACT DISC PLAYERS, AUDIO AND VIDEO TAPE RECORDERS, AUDIO AND VIDEO TAPE PLAYERS, AUDIO AND VIDEO CASSETTE RECORDERS, AUDIO AND VIDEO CASSETTE PLAY-

ERS, BLANK AUDIO AND VIDEO TAPES, CASSETTES, DISCS AND MICROFICHE; AUDIO AND VIDEO TAPES, CASSETTES, DISCS AND MICROFICHE FEATURING INFORMATION CONCERNING TELECOMMUNICATIONS, PERSONAL AND BUSINESS MANAGEMENT SYSTEMS; VIDEO MONITORS, AUTOMATIC VENDING MACHINES AND TIMING MECHANISMS THEREFOR, AND PARTS THEREOF; DATA PROCESSORS AND READERS, WORD PROCESSORS, MAGNETIC CODED CARD READERS, MAGNETIC CARDS, ELECTRONIC ENCRYPTION UNITS, LASERS, LIGHT EMITTING DIODES, LIGHT EMITTING DIODE DISPLAYS, MICROPROCESSORS, BLANK MAGNETIC DATA CARRIERS, DEMAGNETIZERS FOR MAGNETIC TAPES, AND PARTS THEREOF; COMMUNICATIONS AND VIDEO TRANSMISSION SWITCHING AND RECEPTION APPARATUS; COMPUTER, DATA AND VIDEO NETWORKING AND CONFERENCING EQUIPMENT, NAMELY, TELECONFERENCING EQUIPMENT, AUDIOVISUAL TEACHING EQUIPMENT, OVERHEAD FILM, PHOTOGRAPHIC AND SLIDE PROJECTORS, PROJECTION SCREENS, COMPUTER BASED INFORMATION DISPLAY EQUIPMENT, NAMELY, COMPUTERS WHICH DISPLAY INFORMATION ON AN OVERHEAD SCREEN, INTERCOMS, TELEPHONES, TELEPHONE ANSWERING MACHINES, TELEPHONE TRANSMITTERS, TELEPHONE NETWORKS, TELEPHONE WIRES, TELEPRINTERS, TELETYPENWRITERS, AND PARTS THEREOF; NAMELY, CALLER IDENTIFICATION BOXES, RADIO TELEPHONE EQUIPMENT AND ACCESSORIES, NAMELY, CALL BOXES AND SYSTEMS, DIALING ASSEMBLIES, TELEPHONE UNITS, AUDIO OPERATED RELAYS, SIGNALING DEVICES, RECEIVING DEVICES, TERMINATION EQUIPMENT, FILTERS, PROTECTORS AND AUTOMATIC SIGNALING AND CONTROL EQUIPMENT, TELEMETERS, WIRELESS AND CELLULAR TELEPHONES, PAGERS, PAGING EQUIPMENT, PORTABLE COMPUTER DEVICES, FACSIMILE TRANSMITTERS AND RECEIVERS, WIRELESS FAX MACHINES, PERSONAL COMMUNICATIONS EQUIPMENT, NAMELY, PERSONAL DIGITAL ASSISTANTS (PDA), CALCULATORS AND RELATED PERIPHERALS; SATELLITE PROCESSORS, SATELLITES AND SATELLITE COMMUNICATION EARTH STATIONS BOTH STATIONARY AND MOVEABLE; BASEBALL BATTING HELMETS; PRE-RECORDED COMPACT DISCS, AUDIO CASSETTE TAPES, VIDEO CASSETTE TAPES, DIGITAL AUDIO TAPES AND DIGITAL VIDEO DISCS FEATURING MUSICAL, VARIETY, NEWS AND COMEDY SHOWS; AND COMPUTER GAME PROGRAMS FOR CHILDREN AND ADULTS.

FIRST USE ; IN COMMERCE .

INT. CL. 16/U.S. CLS. 2, 5, 22, 23, 29, 37, 38 AND 50

FOR PRINTED MATTER, NAMELY, PRINTED AND STAMPED PLASTIC AND CARDBOARD GREETING, BLANK, NOTE, AND INDEX CARDS, AS WELL AS BOOKS OR MAGAZINES ON TELECOMMUNICATIONS; NOTE PAPER AND ENVELOPES, STAMPS, NAME TAGS AND LABELS MADE FROM PAPER OR CARDBOARD, NOTEBOOKS, DIARIES, NOTE PAPERS, NOTE PADS, ADDRESS BOOKS, FOLDERS FOR LETTERS, FILES OR LOOSE PAPER, CLEAR HOLE REINFORCEMENTS, STUDENT CALENDARS, STAMP ALBUMS AND PHOTO-ALBUMS; PAPER WEIGHTS, LETTER OPENERS, BLOTTING PADS; DESK TRAYS (CASES FOR STATIONERY AND OFFICE IMPLEMENTS); PRINTED INSTRUCTIONAL AND TEACHING MATERIAL ON TELECOMMUNICATIONS; STATIONERY, NAMELY RULERS, ERASERS, STAPLERS, STAPLES, PAPER CLIPS, BOOK MARKERS, CUTOUT SAMPLES AND STENCILS; TRANSPARENT PICTURE APPLICATIONS, SCRATCH PICTURES, PAPER, PVC STICKERS, PAPERBACKS, GIFT WRAP PAPER; BLACKBOARDS, CHALK STICKS, ADHESIVES FOR STATIONERY OR HOUSEHOLD PURPOSES; DRAWING AND PAINTING MATERIALS, PENCIL CASES, DRAWING AND PAINTING MATERIALS, NAMELY, PENCILS, DRAWING PENCILS, PENS, DRAWING PENS, PAINT TRAYS, PAINTING SETS FOR ARTISTS, PAINTING SETS FOR CHILDREN, CRAFT PAINT KITS, AND PENCIL CASES.

FIRST USE ; IN COMMERCE .

INT. CL. 35/U.S. CLS. 100, 101 AND 102

FOR ADVERTISING SERVICES, NAMELY, AND ORGANIZING JOB FAIRS; LICENSING OF COMPUTER SOFTWARE AND HARDWARE FOR ONLINE ACTORS FOR CONSUMER FACILITATING AND THE ADMINISTRATION OF COMPLEX NETWORK SYSTEMS; GENERATION OF DATA PROCESSING PROGRAMS; PROFESSIONAL CONSULTANCY IN THE FIELD OF DATA PROCESSING.

FIRST USE ; IN COMMERCE .

INT. CL. 36/U.S. CLS. 100, 101 AND 102

FOR LICENSING OF COMPUTER SOFTWARE AND HARDWARE FOR ONLINE ACTORS FOR CONSUMER FACILITATING AND THE ADMINISTRATION OF COMPLEX NETWORK SYSTEMS; CLEARING OF SECURE FINANCIAL TRANSACTIONS THROUGH ONLINE SERVICES; FINANCIAL AND MONETARY AFFAIRS, NAMELY FINANCIAL ANALYSIS AND CONSULTATION, FINANCIAL INFORMATION, ISSUANCE OF SECURITIES, COMMERCIAL LENDING SERVICES, FINANCIAL PORTFOLIO MANAGEMENT, DISCOUNT SERVICES, BROKERAGE OF SHARES, OF SETS AND BUSINESS VENTURES, BROKERAGE OF FUND SHARES, SECURITIES CONSULTING AND SAFE KEEPING, BROKERAGE OF PRODUCTIVE INVESTMENTS AND FUNDS; REAL ESTATE AFFAIRS, NAMELY BROKERAGE, MANAGEMENT, LEASING, APPRAISAL OF REAL PROPERTY; CUSTOMS BROKERAGE FOR THIRD PARTIES; CONSULTANCY SERVICES RELATING TO BANK AFFAIRS; CONSULTANCY SERVICES RELATING TO INSURANCE AFFAIRS, NAMELY INFORMATION AND BROKERAGE OF INSURANCES; AND MONETARY EXCHANGE.

FIRST USE ; IN COMMERCE .

INT. CL. 38/U.S. CLS. 100, 101 AND 104

FOR TELECOMMUNICATION SERVICES, NAMELY, ELECTRIC, DIGITAL, CELLULAR AND WIRELESS TRANSMISSION OF VOICE, DATA, INFORMATION, IMAGES, SIGNALS AND MESSAGES; PROVIDING TELECOMMUNICATIONS CONNECTIONS OVER A GLOBAL COMMUNICATIONS NETWORK, ELECTRONIC MAIL, VOICE MAIL AND MESSAGING SERVICES, AUDIO AND VIDEO TELECONFERENCING, RENTAL OF TELECOMMUNICATIONS EQUIPMENT, NAMELY, EQUIPMENT FOR ELECTRONIC ACCESS TO GLOBAL TELECOMMUNICATIONS NETWORK, EQUIPMENT FOR TRANSMITTING, RECEIVING, RECORDING AND MONITORING VOICE, DATA, INFORMATION, IMAGES, SIGNALS, MESSAGES, COMPRISED OF DATA AND WORD PROCESSORS, AND TELECOMMUNICATIONS HARDWARE AND SOFTWARE INCLUDING COMPONENTS AND PERIPHERALS THEREOF FOR USE IN THE TELECOMMUNICATIONS INDUSTRY, AND FOR TRANSMITTING, RECEIVING, RECORDING AND MONITORING COMPUTER PROGRAMS FOR USE IN OPERATING AND ACCESSING TELECOMMUNICATIONS SYSTEMS; AUDIO AND VIDEO BROADCASTING FEATURING ENTERTAINMENT IN THE NATURE OF LIVE VISUAL AND AUDIO PERFORMANCES, AND MUSICAL, VARIETY, NEWS AND COMEDY SHOWS; AND PROVIDING ACCESS TO COMPUTER INFORMATION NETWORKS.

FIRST USE ; IN COMMERCE .

INT. CL. 39/U.S. CLS. 100 AND 105

FOR WAREHOUSE STORAGE OF GOODS.

FIRST USE ; IN COMMERCE .

INT. CL. 41/U.S. CLS. 100, 101 AND 107

FOR EDUCATION IN THE NATURE CLASSES AND SEMINARS IN THE FIELDS OF BUSINESS, TELECOMMUNICATIONS AND COMPUTERS, AND THE DISTRIBUTION OF COURSE MATERIALS THEREWITH; ENTERTAINMENT IN THE NATURE OF VISUAL AND AUDIO PERFORMANCES, NAMELY, MUSICAL BAND, ROCK GROUP, GYMNASTIC, DANCE, AND BALLET PERFORMANCES; ENTERTAINMENT SERVICES, NAMELY, PROVIDING MUSICAL, VARIETY, NEWS AND COMEDY SHOWS VIA A GLOBAL COMPUTER INFORMATION NETWORK; ENTERTAINMENT SERVICES, NAMELY PROVIDING ON-LINE COMPUTER GAMES FOR CHILDREN AND ADULTS; ORGANIZATION OF COMMUNITY SPORTING AND CULTURAL EVENTS; PUBLICATION OF BOOKS, MAGAZINES, JOURNALS, MANUALS, BROCHURES, AND LEAFLETS; ORGANIZING FAIRS AND EXHIBITIONS IN THE FIELD OF VISUAL AND AUDIO PERFORMANCES, NAMELY, MUSICAL BAND, ROCK GROUP, GYMNASTIC, DANCE, AND BALLET PERFORMANCES.

FIRST USE ; IN COMMERCE .

INT. CL. 42/U.S. CLS. 100 AND 101

FOR COMPUTER PROGRAMMING SERVICES FOR OTHERS; CONSULTING IN THE FIELD OF TELECOMMUNICATION, RENTAL OF SOFTWARE AND HARDWARE FOR ONLINE ACCESS; [SERVICES OF AN INTERNET TRUST CENTER, NAMELY, ASSURANCE AND ADMINISTRATION OF DIGITAL KEYS AND/OR DIGITAL CERTIFICATES;] RENTAL OF DATA PROCESSING EQUIPMENT.

FIRST USE ; IN COMMERCE .

ELEMENTS AMENDED
GOODS/SERVICES

3,004,691. REG. 10-4-2005. THEORY LLC (NEW YORK LIMITED LIABILITY COMPANY) 38 GANSEVOORT STREET, NEW YORK, NY, 10014, SN 76-417,051. FILED 6-6-2002. PRINCIPAL REGISTER.

THEORY

OWNER OF U.S. REG. NO. 2,067,427.
INT. CL. 14/U.S. CLS. 2, 27, 28 AND 50
FOR JEWELRY, CLOCKS AND WATCHES.
FIRST USE 6-23-2003; IN COMMERCE 6-23-2003.

ELEMENTS CORRECTED
OWNER ADDRESS
ENTITY

3,048,952. REG. 1-24-2006. INFOSNAP, INC. (MARYLAND CORPORATION) SUITE 310 NORTH, 4550 MONTGOMERY AVE., BETHESDA, MD, 20814, SN 78-424,335. FILED 5-25-2004. PRINCIPAL REGISTER.



THE MARK IS NOT IN COLOR.
INT. CL. 9/U.S. CLS. 21, 23, 26, 36 AND 38
FOR DOWNLOADABLE COMPUTER SOFTWARE FOR ONLINE FORM COMPLETION AND INFORMATION DELIVERY, NAMELY, FOR DATA COLLECTION, DATABASE STORAGE, DATA EXTRACTION, AND DATA DISTRIBUTION FOR APPLICANTS, SCHOOLS, CAMPS, AND ORGANIZATIONS FOR ADMISSIONS APPLICATION AND REGISTRATION VIA A GLOBAL COMPUTER NETWORK.

FIRST USE 12-18-2000; IN COMMERCE 12-18-2000.
INT. CL. 42/U.S. CLS. 100 AND 101
FOR COMPUTER SERVICE, NAMELY, ACTING AS AN APPLICATION SERVICE PROVIDER HOSTING COMPUTER APPLICATION SOFTWARE FOR THE COLLECTION, EDITING, ORGANIZING, MODIFYING, BOOK MARKING, TRANSMISSION, STORAGE AND SHARING OF DATA AND INFORMATION FOR FORM COMPLETION FOR APPLICANTS, SCHOOLS, CAMPS, AND ORGANIZATIONS FOR ADMISSIONS APPLICATIONS AND REGISTRATION.
FIRST USE 12-18-2000; IN COMMERCE 12-18-2000.

ELEMENTS AMENDED
DESCRIPTION OF MARK

3,112,173. REG. 7-4-2006. SCHOELLER TEXTIL AG (SWITZERLAND JOINT STOCK COMPANY) BAHNHOFSTRASSE 17, CH-9475 SEVELEN, SWITZERLAND., SN 79-007,180. FILED 10-20-2004. PRINCIPAL REGISTER.

schoeller-PCM

THE MARK CONSISTS OF STANDARD CHARACTERS WITHOUT CLAIM TO ANY PARTICULAR FONT, STYLE, SIZE, OR COLOR.

OWNER OF INTERNATIONAL REGISTRATION 0838526 DATED 10-20-2004, EXPIRES 10-20-2014.

INT. CL. 17/U.S. CLS. 1, 5, 12, 13, 35 AND 50

FOR RUBBER; GUTTA-PERCHA; GUM; ASBESTOS POWDER; ASBESTOS BOARDS; ASBESTOS FELT; MICA AND GOODS MADE THEREOF, NAMELY, ELECTRICAL INSULATING MICA PRODUCTS; PLASTICS IN EXTRUDED FORM FOR USE IN MANUFACTURE; STOPPING AND INSULATING MATERIALS, NAMELY, INSULATING TILES, INSULATING PAINT, INSULATING PLASTER; FLEXIBLE NON-METALIC PIPES.

FIRST USE ; IN COMMERCE .

INT. CL. 24/U.S. CLS. 42 AND 50

FOR FABRICS AND TEXTILES, NAMELY, RAYON, RAMIE, NYLON, POLYESTER, LINEN; BED AND TABLE COVERS, NAMELY, BED SPREADS, BED SHEETS, BED LINEN .

FIRST USE ; IN COMMERCE .

INT. CL. 25/U.S. CLS. 22 AND 39

FOR CLOTHING, NAMELY, PANTS, T-SHIRTS, SWEATSHIRTS, SHORTS, SWEATERS; [FOOTWEAR;] HEADGEAR, NAMELY, CAPS, HATS.

FIRST USE ; IN COMMERCE .

ELEMENTS AMENDED
GOODS/SERVICES

3,139,392. REG. 9-5-2006. SUNRIDER CORPORATION, THE (UTAH CORPORATION), DBA SUNRIDER INTERNATIONAL, 1625 ABALONE AVENUE, TORRANCE, CA, 90501, SN 76-061,204. FILED 6-1-2000. PRINCIPAL REGISTER.

DR. CHEN'S MEN'S FORMULA

THE MARK CONSISTS OF STANDARD CHARACTERS WITHOUT CLAIM TO ANY PARTICULAR FONT, STYLE, SIZE, OR COLOR.

OWNER OF U.S. REG. NO. 2,224,955.

NO CLAIM IS MADE TO THE EXCLUSIVE RIGHT TO USE "MEN'S FORMULA", APART FROM THE MARK AS SHOWN.

THE NAME DR. CHEN IDENTIFIES A LIVING INDIVIDUAL WHOSE CONSENT IS OF RECORD.

INT. CL. 5/U.S. CLS. 6, 18, 44, 46, 51 AND 52

FOR [DIETARY] * NUTRITIONAL * SUPPLEMENTS.
FIRST USE 8-0-2000; IN COMMERCE 8-0-2000.

INT. CL. 29/U.S. CL. 46

FOR BLEND OF PROCESSED VEGETABLES, FRUITS, AND HERBS ENCLOSED IN CAPSULE FORM FOR USE AS A FOOD AND/OR FOOD BEVERAGE.

FIRST USE 8-0-2000; IN COMMERCE 8-0-2000.

ELEMENTS AMENDED
MARK

3,156,085. REG. 10-17-2006. ORTIVUS AB (SWEDEN PUBLIC LIMITED COMPANY) KARLSROVAGEN 2D, DANDERYD, SWEDEN, 182 17, SN 78-390,820. FILED 3-25-2004. PRINCIPAL REGISTER.

ORTIVUS

THE MARK CONSISTS OF STANDARD CHARACTERS WITHOUT CLAIM TO ANY PARTICULAR FONT, STYLE, SIZE, OR COLOR.

OWNER OF U.S. REG. NO. 3,003,918.
INT. CL. 42/U.S. CLS. 100 AND 101

FOR COMPUTER SOFTWARE DEVELOPMENT FOR THE PUBLIC SAFETY INDUSTRY; MAINTENANCE OF COMPUTER SOFTWARE USED BY THE PUBLIC SAFETY INDUSTRY; AND TECHNICAL SUPPORT SERVICES, NAMELY, TROUBLESHOOTING OF COMPUTER SOFTWARE PROBLEMS FOR SOFTWARE USED BY THE PUBLIC SAFETY INDUSTRY.

FIRST USE 1-1-2004; IN COMMERCE 1-1-2004.

ELEMENTS CORRECTED
OWNER NAME

3,183,596. REG. 12-12-2006. NOVARTIS AG (SWITZERLAND CORPORATION) 4002, BASEL, SWITZERLAND., SN 78-799,978. FILED 1-26-2006. PRINCIPAL REGISTER.

FOCLIVIA

THE MARK CONSISTS OF STANDARD CHARACTERS WITHOUT CLAIM TO ANY PARTICULAR FONT, STYLE, SIZE, OR COLOR.

OWNER OF SWITZERLAND REG. NO. 508138, DATED 3-12-2003.

OWNER OF U.S. REG. NO. 2,825,162.
INT. CL. 5/U.S. CLS. 6, 18, 44, 46, 51 AND 52

FOR [PHARMACEUTICAL PREPARATIONS FOR THE TREATMENT OF AND/OR PREVENTION OF DISORDERS OF THE NERVOUS SYSTEM, THE IMMUNE SYSTEM, THE CARDIO-VASCULAR SYSTEM INCLUDING DIABETES AND METABOLIC DISEASES, THE RESPIRATORY SYSTEM, THE MUSCULO-SKELETAL SYSTEM, THE GENITOURINARY SYSTEM, FOR THE TREATMENT OF INFLAMMATORY DISORDERS, FOR USE IN DERMATOLOGY, IN ONCOLOGY, IN HEMATOLOGY, IN TRANSPLANTATION, IN OPHTHALMOLOGY, FOR USE IN THE GASTROENTEROLOGICAL AREA AND THE PREVENTION AND TREATMENT OF OCULAR DISORDERS OR DISEASES; PHARMACEUTICAL PREPARATIONS TREATING BACTERIA-BASED DISEASES, ANTI-INFECTIVES, ANTI-BACTERIALS, ANTIVIRALS, ANTI-BIOTICS, ANTI-FUNGALS, AND] VACCINES.

FIRST USE ; IN COMMERCE .

ELEMENTS AMENDED
GOODS/SERVICES

3,184,087. REG. 12-12-2006. BOTTEGA DI LUNGAVITA S.R.L. (ITALY SOCIETA A RESPONSABILITA LIMITATA) VIA VERGA, 13, I-24127 BERGAMO, ITALY., SN 79-018,369. FILED 10-10-2005. PRINCIPAL REGISTER.

ARMONIE TOSCANE TUSCAN HARMONIES

OWNER OF INTERNATIONAL REGISTRATION 0870028 DATED 10-10-2005, EXPIRES 10-10-2015.

NO CLAIM IS MADE TO THE EXCLUSIVE RIGHT TO USE "TOSCANE" AND "TUSCAN", APART FROM THE MARK AS SHOWN.

THE FOREIGN WORDING IN THE MARK TRANSLATES INTO ENGLISH AS TUSCAN HARMONIES.

INT. CL. 3/U.S. CLS. 1, 4, 6, 50, 51 AND 52

FOR FACIAL CREAMS, BODY CREAMS AND BEAUTY CREAMS; SOAPS, NAMELY, SKIN SOAPS AND SOAPS FOR BODY CARE; PERFUMERY, ESSENTIAL OILS, COSMETICS, HAIR LOTIONS; DENTIFRICES; * NONE OF THE AFORESAID PREPARATIONS BEING FOR SCALP OR HAIR CARE OR WASHING *.

FIRST USE ; IN COMMERCE .

INT. CL. 5/U.S. CLS. 6, 18, 44, 46, 51 AND 52

FOR VITAMIN PHARMACEUTICAL PREPARATIONS FOR USE AS INGREDIENTS IN THE FOOD AND PHARMACEUTICAL INDUSTRY; DIETETIC PREPARATIONS, SPECIFICALLY FOOD ADAPTED FOR MEDICAL USE; FOOD SUPPLEMENTS; DISINFECTANTS FOR MEDICAL PURPOSES; * NONE OF THE AFORESAID PREPARATIONS BEING FOR SCALP OR HAIR CARE OR WASHING *.

FIRST USE ; IN COMMERCE .

ELEMENTS CORRECTED
GOODS/SERVICES

3,203,603. REG. 1-30-2007. TOLOMATIC, INC. (MINNESOTA CORPORATION) 3800 COUNTY ROAD 116, HAMEL, MN, 55340, SN 78-695,101. FILED 8-18-2005. PRINCIPAL REGISTER.

TOLOMATIC

THE MARK CONSISTS OF STANDARD CHARACTERS WITHOUT CLAIM TO ANY PARTICULAR FONT, STYLE, SIZE, OR COLOR.

OWNER OF U.S. REG. NO. 882,042.

INT. CL. 7/U.S. CLS. 13, 19, 21, 23, 31, 34 AND 35

FOR COMPONENTS OF ELECTROMECHANICAL ACTUATORS, NAMELY, ROD SCREW CYLINDERS, SCREW AND BELT DRIVEN RODLESS ACTUATORS, AND INTEGRATED SERVO MOTORS FOR USE IN INDUSTRIAL AUTOMATION MACHINERY; SERVO AND STEPPER MOTORS, CONTROLS AND DRIVES FOR USE IN INDUSTRIAL AUTOMATION MACHINERY.

FIRST USE 2-9-1968; IN COMMERCE 2-9-1968.

ELEMENTS AMENDED
MARK

FOR MECHANICAL AND PNEUMATIC POWER TRANSMITTING MECHANISMS, NAMELY, RODLESS LINEAR ACTUATORS, ROD STYLE LINEAR ACTUATORS, ROD CYLINDER LINEAR THRUSTERS; AIR-OVER-OIL INTENSIFIERS AND CYLINDERS; BRAKES FOR MACHINE TOOLS AND INDUSTRIAL APPLICATIONS; AND PNEUMATIC CLUTCHES; ALL THE AFOREMENTIONED BEING FOR USE IN MACHINES.

FIRST USE 2-9-1968; IN COMMERCE 2-9-1968.

ELEMENTS AMENDED
MARK

3,203,749. REG. 1-30-2007. AB HOLDINGS, LLC (IDAHO LIMITED LIABILITY COMPANY) 1555 SHORELINE DRIVE, 3RD FLOOR, BOISE, ID, 83702, SN 78-808,240. FILED 2-6-2006. PRINCIPAL REGISTER.

3,223,279. REG. 3-27-2007. OLIVEDA NETWORK S.L. (SPAIN LIMITED LIABILITY COMPANY) CA'A PELLET, C/PERE ESTRUCH, 9, E-07350 BINISSALEM (BALEARES), SPAIN., SN 79-019,292. FILED 9-28-2005. PRINCIPAL REGISTER.



OLIVEDA

OWNER OF U.S. REG. NO. 3,069,052.
THE MARK CONSISTS OF A JAPANESE KANJI CHARACTER.

THE NON-LATIN CHARACTER(S) IN THE MARK TRANSLITERATES INTO KIWAMI OR KYOKU, AND THIS MEANS ULTIMATE OR EXTREME IN ENGLISH.
INT. CL. 29/U.S. CL. 46

FOR MEAT, NAMELY, BEEF AND PORK CARCASSES, CUT PORTIONS OF BEEF AND PORK BOTH PACKAGED AND NON-PACKAGED, AND GROUND BEEF.

FIRST USE 7-17-2003; IN COMMERCE 7-17-2003.

ELEMENTS CORRECTED
COLORS CLAIMED STATEMENT

PRIORITY DATE OF 4-25-2005 IS CLAIMED.
OWNER OF INTERNATIONAL REGISTRATION 0872408 DATED 9-28-2005, EXPIRES 9-28-2015.

INT. CL. 29/U.S. CL. 46

FOR MEAT, FISH, POULTRY MID GAME; MEAT EXTRACTS; PRESERVED, DRIED AND COOKED FRUITS AND VEGETABLES; PRESERVED, DRIED AND COOKED OLIVES; JELLIES, JAMS, COMPOTES; EGGS, MILK; MILK PRODUCTS EXCLUDING ICE CREAM, ICE MILK AND FROZEN YOGURT; CHEESE; EDIBLE OILS AND FATS; AND EDIBLE OLIVE OIL.

FIRST USE ; IN COMMERCE .

INT. CL. 30/U.S. CL. 46

FOR COFFEE, TEA, COCOA, SUGAR, RICE, TAPIOCA, SAGO, ARTIFICIAL COFFEE; FLOUR; PREPARATIONS MADE FROM CEREALS, NAMELY CEREAL-BASED SNACK FOODS; BREAD, PASTRIES; CONFECTIONERY, NAMELY CANDY; FRUIT AND FLAVORED ICES; HONEY, TREACLE; YEAST; BAKING POWDER; SALT, MUSTARD; VINEGAR, CONDIMENTS, NAMELY SAUCES; SPICES; AND ICE.

FIRST USE ; IN COMMERCE .

INT. CL. 31/U.S. CLS. 1 AND 46

FOR AGRICULTURAL, HORTICULTURAL AND FORESTRY PRODUCTS AND GRAINS, NAMELY AGRICULTURAL GRAINS FOR PLANTING; LIVE ANIMALS; FRESH FRUITS AND VEGETABLES; FRESH OLIVES; SEEDS FOR SOWING; LIVE NATURAL PLANTS AND FLOWERS; FOODSTUFFS FOR ANIMALS; MALT FOR BREWING AND DISTILLING; FEED FOR DOMESTIC ANIMALS AND FEED FOR ANIMALS.

FIRST USE ; IN COMMERCE .

3,214,929. REG. 3-6-2007. TOLOMATIC, INC. (MINNESOTA CORPORATION) 3800 COUNTY ROAD 116, HAMEL, MN, 55340, SN 78-695,094. FILED 8-18-2005. PRINCIPAL REGISTER.

TOLOMATIC

THE MARK CONSISTS OF STANDARD CHARACTERS WITHOUT CLAIM TO ANY PARTICULAR FONT, STYLE, SIZE, OR COLOR.

OWNER OF U.S. REG. NO. 882,042.
INT. CL. 7/U.S. CLS. 13, 19, 21, 23, 31, 34 AND 35

ELEMENTS CORRECTED
[GOODS/SERVICES]
[INTERNATIONAL CLASS(ES)]

3,232,137. REG. 4-24-2007. BOLD, INC. (UTAH CORPORATION) 333 SOUTH 520 WEST, SUITE 220, LINDON, UT, 84042, SN 76-646,043. FILED 9-1-2005. PRINCIPAL REGISTER.

BLACK RHINO

THE MARK CONSISTS OF STANDARD CHARACTERS WITHOUT CLAIM TO ANY PARTICULAR FONT, STYLE, SIZE, OR COLOR.

INT. CL. 8/U.S. CLS. 23, 28 AND 44

FOR FULL LINE OF HAND TOOLS, NAMELY, BOLT CUTTERS, CABLE CUTTERS, CAULKING GUNS, CROW BARS, FENCE TOOLS IN THE NATURE OF CUTTING, HITTING, GRABBING, STRIPPING, DIGGING, PRYING AND WIRE TYING, HAMMERS, DRY-WALL HAMMERS, AND ROOFING HAMMERS, HACKSAWS, HAND SHEARS, HANDSAWS, HEX WRENCHES, ALLEN WRENCHES, MAGNETIC EXTENSION HOLDERS FOR SCREWDRIVER BITS, PLIERS, SCRAPERS, SCREWDRIVERS, SCREWDRIVER BITS FOR DRILLS, SCREW SETTERS, TIN SNIPS, UTILITY KNIVES AND BLADES, WRENCHES, TOOL BELTS, HAND-POWERED STAPLE GUNS.

FIRST USE 3-5-1999; IN COMMERCE 3-5-1999.

INT. CL. 9/U.S. CLS. 21, 23, 26, 36 AND 38

FOR EYE AND SUN GLASSES AND SAFETY GLASSES; BUBBLE LEVELS, MEASURING TAPES.

FIRST USE 10-10-1999; IN COMMERCE 10-10-1999.

INT. CL. 18/U.S. CLS. 1, 2, 3, 22 AND 41

FOR TOOL BAGS SOLD EMPTY, NAMELY POUCHES, CLIPS, AND NAIL BAGS.

FIRST USE 12-20-2001; IN COMMERCE 12-20-2001.

ELEMENTS CORRECTED
GOODS/SERVICES

3,235,057. REG. 4-24-2007. JOHNSON & JOHNSON (NEW JERSEY CORPORATION) ONE JOHNSON & JOHNSON PLAZA, NEW BRUNSWICK, NJ, 08933, SN 78-665,200. FILED 7-7-2005. PRINCIPAL REGISTER.

PEDIACARE

THE MARK CONSISTS OF STANDARD CHARACTERS WITHOUT CLAIM TO ANY PARTICULAR FONT, STYLE, SIZE, OR COLOR.

OWNER OF U.S. REG. NOS. 1,445,906 AND 2,911,609.

INT. CL. 5/U.S. CLS. 6, 18, 44, 46, 51 AND 52

FOR AIR FRESHENER; REFILLS FOR AIR FRESHENERS.

FIRST USE 8-11-2005; IN COMMERCE 8-11-2005.

INT. CL. 10/U.S. CLS. 26, 39 AND 44

FOR ELECTRIC VAPORIZER THAT EMITS MENTHOL DESIGNED TO HELP CONSUMERS MANAGE UPPER RESPIRATORY CONDITIONS.

FIRST USE 8-11-2005; IN COMMERCE 8-11-2005.

INT. CL. 11/U.S. CLS. 13, 21, 23, 31 AND 34

FOR ELECTRICAL DISPENSER FOR AIR FRESHENER AND DEODORIZER TO BE PLUGGED INTO WALL OUTLETS.

FIRST USE 8-11-2005; IN COMMERCE 8-11-2005.

ELEMENTS CORRECTED
MARK

3,252,005. REG. 6-12-2007. CONTEC MASCHINENBAU & ENTWICKLUNGSTECHNIK GMBH (FED REP GERMANY GMBH) HAUPTSTR. 146, 57518 ALSDORF, FED REP GERMANY., SN 79-023,142. FILED 12-1-2005. PRINCIPAL REGISTER.



PRIORITY DATE OF 6-3-2005 IS CLAIMED.

OWNER OF INTERNATIONAL REGISTRATION 0883019 DATED 12-1-2005, EXPIRES 12-1-2015.

INT. CL. 7/U.S. CLS. 13, 19, 21, 23, 31, 34 AND 35

FOR ELECTRICAL MACHINE TOOLS FOR SAWING, GRINDING, SHOTBLASTING, SANDBLASTING, MILLING, NAPPING, DERUSTING, DESCALING AND GROOVING, AS WELL AS FOR REMOVING OF FLOOR COVERINGS, MARKINGS, THERMOPLASTICS AND PAINTS, AND PARTS THEREFOR IN THE NATURE OF TOOLING INSERTS FOR MILLING, GRINDING, PLANING, SAWING AND POLISHING; ELECTRICAL VACUUM CLEANERS FOR REMOVING DUST IN THE FIELD OF CONSTRUCTION, AND PARTS THEREFOR IN THE NATURE OF SUCTION HOODS, HOSES, BAGS FOR COLLECTING OF DUST AND OTHER DIRT AND FILTER CARTRIDGES; * ALL THE AFORESAID GOODS NOT FOR USE FOR OR IN CONNECTION WITH THE PERSONALISATION OF DOCUMENTS OR OTHER FORMS, INCLUDING BUT NOT EXCLUSIVELY PLASTIC CARDS, PASSES OR DELIVERY NOTES, WHEREBY A VARIETY OF TECHNOLOGIES CAN BE APPLIED, INCLUDING, BUT NOT EXCLUSIVELY, LASER ENGRAVING AND/OR LASER MILLING, EMBEDDING AND/OR LASER MILLING, EMBEDDING AND/OR THE PERSONALISATION OF SMART CARDS *.

FIRST USE ; IN COMMERCE .

ELEMENTS CORRECTED
GOODS/SERVICES

3,256,819. REG. 6-26-2007. MAKO SURGICAL CORP. (DELAWARE CORPORATION) 2555 DAVIE ROAD, FORT LAUDERDALE, FL, 33317, SN 76-640,441. FILED 6-7-2005. PRINCIPAL REGISTER.



NO CLAIM IS MADE TO THE EXCLUSIVE RIGHT TO USE "SURGICAL CORP.", APART FROM THE MARK AS SHOWN.

INT. CL. 10/U.S. CLS. 26, 39 AND 44

FOR BONE IMPLANTS COMPRISED OF PROCESSED MATERIALS; ORTHOPEDIC JOINT IMPLANTS; ORTHOPEDIC SURGICAL INSTRUMENTS, APPLIANCES AND APPARATUS FOR USE IN PERFORMING ORTHOPEDIC TRANSPLANT AND IMPLANT SURGERY; AND SURGICAL ROBOTS.

FIRST USE 5-31-2006; IN COMMERCE 5-31-2006.

ELEMENTS CORRECTED
CITIZENSHIP

3,302,678. REG. 10-2-2007. SMARTRAC IP B.V. (NETHERLANDS LIMITED LIABILITY COMPANY) PARNASSUSWEG 103, NL-1077 DE AMSTERDAM, NETHERLANDS., SN 79-015,010. FILED 2-15-2005. PRINCIPAL REGISTER.

SMARTRAC

PRIORITY DATE OF 8-17-2004 IS CLAIMED.
OWNER OF INTERNATIONAL REGISTRATION 0861259
DATED 2-15-2005, EXPIRES 2-15-2015.
INT. CL. 7/U.S. CLS. 13, 19, 21, 23, 31, 34 AND 35

FOR MACHINES AND MACHINE TOOLS FOR THE ELECTRIC, ELECTRONICS AND PLASTICS INDUSTRIES, NAMELY, ADHESIVE TAPE DISPENSING MACHINES, AUTOMATIC STAMPING MACHINES, CUTTING MACHINES, ELECTRIC WELDING MACHINES, EMOSSING MACHINES AND SEMICONDUCTOR MANUFACTURING MACHINES, EXCEPT HOUSEHOLD AND KITCHEN APPLIANCES; SHAPING MACHINES, NAMELY, PUNCHING AND BENDING MACHINES; MECHANICAL TOOLS FOR PUNCHING AND BENDING MACHINES, NAMELY, BELTS, BRAKES, CLUTCHES, COMPRESSORS, MOTORS, FILTERS, CYLINDERS, BLADES, VALVES, WHEELS; MACHINES FOR THE PACKAGING OF INTEGRATED CIRCUITS, HANDLING AND ASSEMBLY MACHINES, IN PARTICULAR FOR THE PROCESSING OF MICROPARTS AND FOR MICROBONDING, FINE-WIRE WINDING MACHINES, IN PARTICULAR FOR MANUFACTURING ELECTRIC COILS AND FOR CONNECTING ELECTRONIC COMPONENTS TO COILS; COMPONENTS AND ASSEMBLIES FOR THE AFORESAID MACHINES, IN PARTICULAR SENSOR, CONTROL AND REGULATING DEVICES, MAINLY CONSISTING OF SENSORS, PROCESSORS, ACTUATORS AND OPTIONAL APPARATUS FOR IMAGE PROCESSING; * ALL THE AFORESAID PRODUCTS OTHER THAN FOR THE FIELD OF POLYURETHANE, INJECTION MOULDING AND EXTRUSION; ALL THE AFORESAID GOODS/SERVICES OTHER THAN IN THE FIELD OF MEASURING AND DETERMINING THE POSITION, ORIENTATION AND/OR MOVEMENT OF OBJECTS, PERSONS OR ANIMAL *.

FIRST USE ; IN COMMERCE .
INT. CL. 9/U.S. CLS. 21, 23, 26, 36 AND 38

FOR BLANK MAGNETIC DATA-CARRIERS; CASH REGISTERS, CALCULATORS, DATA PROCESSORS AND COMPUTERS; ELECTRIC AND ELECTRONIC COMPONENTS FOR COMPUTERS, NAMELY, MICROPROCESSORS, MICROCHIPS AND HARD DISKS; SIGNAL PROCESSORS; COMPUTER CHIPS; COMPUTER PERIPHERALS; BLANK OPTICAL AND MAGNETO-OPTICAL DATA CARRIERS; BLANK TRANSPONDER CARDS AND BLANK CHIP CARDS; READERS FOR TRANSPONDER CARDS AND CHIP CARDS; TRANSPONDERS IN THE FORM OF CONTACT OR NON-CONTACT CHIP ENCODED CARDS WITH AN INTEGRATED MICROCHIP FOR ACCESS SYSTEMS, FARE PAYMENT SYSTEMS, IDENTIFICATION APPLICATIONS AND FOR AIRLINE TICKET APPLICATIONS; TRANSPONDERS WITH AN INTEGRATED ENCODED MICROCHIP FOR ACCESS SYSTEMS, NAMELY, ELECTRONIC KEYS, FOR CASHLESS PAYMENT SYSTEMS AND FOR CUSTOMER ACQUISITION AND IDENTIFICATION; TRANSPONDERS IN THE FORM OF DISC-TYPE LABELS AND TAGS WITH AN INTEGRATED ENCODED MICROCHIP FOR PARKING SYSTEMS, NAMELY, TICKETS OR TRANSPORT TICKETS, FOR SKI PASSES IN THE LEISURE INDUSTRY, AND FOR INDUSTRIAL APPLICATIONS; TRANSPONDERS IN THE FORM OF ADHESIVE LAMINATE INLAYS WITH AN INTEGRATED ENCODED MICROCHIP FOR USE IN ACCESS SYSTEMS, FOR AUTOMATIC FARE-COLLECTION SYSTEMS, FOR IDENTIFICATION PURPOSES AND FOR AIRLINE TICKETS; TRANSPONDERS IN THE FORM OF PRE-EMBOSSSED OR PRELAMINATED ENCODED CHIP CARDS WITH AN INTEGRATED MICROCHIP FOR USE IN THE PRODUCTION OF COMBINATION CARDS FOR ACCESS SYSTEMS, AUTOMATIC FARE COLLECTION, IDENTIFICATION SYSTEMS, ELECTRONIC MONEY EXCHANGES, CASHLESS SALES SYSTEMS AND PORTABLE DATA-

BASE SYSTEMS; TRANSPONDERS IN THE FORM OF PROGRAMMED MICROCHIPS FOR IMPLANTING UNDER THE SKIN FOR IDENTIFYING ANIMALS; TRANSPONDERS IN THE FORM OF ATTACHABLE SIGNBOARDS AND TAGS WITH AN INTEGRATED ENCODED MICROCHIP FOR IDENTIFYING TREES, TELEGRAPH POLES AND THE LIKE, AND FOR USE IN THE ARTS TO IDENTIFY WORKS OF ARTS, COPIES OF ORIGINAL AND RESTORED WORKS OF ART; TRANSPONDERS IN THE FORM OF CONTACT AND NON-CONTACT PAPER LABELS AND TAGS WITH AN INTEGRATED ENCODED MICROCHIP FOR USE IN THE MANAGEMENT OF SUPPLY CHAINS, IN PRODUCTION SUPERVISION, IN LUGGAGE IDENTIFICATION, FOR USE WITH EXPRESS PARCEL SERVICES AND GOODS TRANSPORT SERVICES, AND FOR USE IN PREVENTING FRAUD AND THE IDENTIFICATION OF WORKS OF ART; TRANSPONDERS IN THE FORM OF ADHESIVE LABELS AND TAGS WITH AN INTEGRATED ENCODED MICROCHIP FOR IDENTIFYING INDUSTRIAL GAS CYLINDERS; ENCODERS AND READERS FOR BAR CODES, ELECTRONIC CARDS AND MAGNETIC ENCODED CARDS; COMPUTER MONITORS AND COMPUTER SCREENS FOR ALL THE AFORESAID GOODS, SOFTWARE APPLICATIONS, NAMELY, PRE-RECORDED COMPUTER SOFTWARE FOR USE IN THE FIELD OF RADIO FREQUENCY IDENTIFICATION FOR OPERATING THE AFORESAID GOODS; ELECTRONIC PASSPORTS AND SECURITY DOCUMENTS, NAMELY, BLANK ELECTRONIC CHIP CARDS, BLANK INTEGRATED CIRCUIT CARD, ELECTRONIC CIRCUIT CARDS, ENCODED ELECTRONIC CHIP CARDS FOR IDENTIFYING PERSONS, OBJECTS OR ANIMALS, ENCODED INTEGRATED CIRCUIT CARDS FOR IDENTIFYING PERSONS, OBJECTS OR ANIMALS, ENCODED SMART CARDS FOR IDENTIFYING PERSONS, OBJECTS OR ANIMALS, MAGNETIC CARDS AND MICROCHIP CARDS; ELECTRONIC LABELS CONTAINING PROGRAMMING FOR THE PROCESSING, TRANSMISSION AND RECEPTION OF DATA; ELECTRONIC PAYMENT DEVICES, NAMELY, ELECTRONIC AND MAGNETIC ID CARDS FOR USE IN CONNECTION WITH PAYMENT FOR GOODS AND SERVICES, AND ELECTRONIC PAYMENT TERMINALS; ALL THE AFORESAID GOODS EXCEPT LAUNDRY MACHINE VENDING CARDS; * ALL THE AFORESAID PRODUCTS OTHER THAN FOR THE FIELD OF POLYURETHANE, INJECTION MOULDING AND EXTRUSION; ALL THE AFORESAID GOODS/SERVICES OTHER THAN IN THE FIELD OF MEASURING AND DETERMINING THE POSITION, ORIENTATION AND/OR MOVEMENT OF OBJECTS, PERSONS OR ANIMAL *.

FIRST USE ; IN COMMERCE .

INT. CL. 17/U.S. CLS. 1, 5, 12, 13, 35 AND 50

FOR SEMI-FINISHED PLASTIC PRODUCTS, NAMELY, INLAYS FOR ELECTRONIC PASSPORTS, SECURITY- AND IDENTIFICATION-DOCUMENTS; PLASTICS IN THE FORM OF SHEETS AND FOILS FOR USE IN THE MANUFACTURE OF ELECTRONIC CHIP CARDS, INTEGRATED CIRCUIT CARDS, SMART CARDS, MAGNETIC CARDS AND MICROCHIP CARDS FOR USE AS CARRIER MATERIAL OR SUBSTRATE FOR ELECTRONIC COMPONENTS; PLASTICS IN THE FORM OF SHEETS AND FOILS FOR USE IN THE MANUFACTURE OF ELECTRONIC CHIP CARDS, INTEGRATED CIRCUIT CARDS, SMART CARDS, MAGNETIC CARDS AND MICROCHIP CARDS FOR USE AS CARRIER MATERIAL OR SUBSTRATE FOR TRANSPONDERS; * ALL THE AFORESAID GOODS/SERVICES OTHER THAN IN THE FIELD OF MEASURING AND DETERMINING THE POSITION, ORIENTATION AND/OR MOVEMENT OF OBJECTS, PERSONS OR ANIMALS *.

FIRST USE ; IN COMMERCE .

ELEMENTS CORRECTED
GOODS/SERVICES

3,335,373. REG. 11-13-2007. SCHMID, RALF (FED REP GERMANY INDIVIDUAL) INDUSTRIESTR. 11, 67136 FUBGÖNHEIM, FED REP GERMANY., SN 79-022,457. FILED 10-14-2005. PRINCIPAL REGISTER.



PRIORITY DATE OF 8-24-2005 IS CLAIMED. OWNER OF INTERNATIONAL REGISTRATION 0881257 DATED 10-14-2005, EXPIRES 10-14-2015.

NO CLAIM IS MADE TO THE EXCLUSIVE RIGHT TO USE "WHEELS GROUP", APART FROM THE MARK AS SHOWN.

INT. CL. 3/U.S. CLS. 1, 4, 6, 50, 51 AND 52

FOR CAR MAINTENANCE AND CLEANING PREPARATIONS.

FIRST USE ; IN COMMERCE .

INT. CL. 7/U.S. CLS. 13, 19, 21, 23, 31, 34 AND 35

FOR EXHAUST PIPES FOR VEHICLES.

FIRST USE ; IN COMMERCE .

INT. CL. 12/U.S. CLS. 19, 21, 23, 31, 35 AND 44

FOR LAND VEHICLES; VEHICLE PARTS, NAMELY, RIMS, TIRES, WHEELS, LIGHT ALLOY WHEELS, GEARSHIFT KNOBS, STEERING WHEELS, SPOILERS, LUGGAGE RACKS, HUB CAPS, SHOCK ABSORBERS; BRAKE SYSTEMS FOR VEHICLES.

FIRST USE ; IN COMMERCE .

INT. CL. 35/U.S. CLS. 100, 101 AND 102

FOR MARKETING AND ADVERTISING; BUSINESS MANAGEMENT; BUSINESS CONSULTING.

FIRST USE ; IN COMMERCE .

INT. CL. 36/U.S. CLS. 100, 101 AND 102

FOR LEASE-PURCHASE FINANCING, FINANCING SERVICES.

FIRST USE ; IN COMMERCE .

INT. CL. 39/U.S. CLS. 100 AND 105

FOR * PASSENGER * TRANSPORT [AND FREIGHT] SERVICES BY LAND, SEA AND AIR.

FIRST USE ; IN COMMERCE .

INT. CL. 40/U.S. CLS. 100, 103 AND 106

FOR MATERIAL TREATMENT FOR VEHICLES AND VEHICLE PARTS, IN PARTICULAR CUTTING, SHAPING, POLISHING, METAL COATING.

FIRST USE ; IN COMMERCE .

INT. CL. 42/U.S. CLS. 100 AND 101

FOR DESIGN AND DEVELOPMENT OF VEHICLE PARTS AND VEHICLE ACCESSORIES.

FIRST USE ; IN COMMERCE .

ELEMENTS CORRECTED
GOODS/SERVICES

3,351,606. REG. 12-11-2007. EAST MANUFACTURING CORPORATION (DELAWARE CORPORATION) 1871 STATE ROUTE 44, RANDOLPH, OH, 44265. SN 77-141,475. FILED 3-27-2007. PRINCIPAL REGISTER.

GENESIS II

THE MARK CONSISTS OF STANDARD CHARACTERS WITHOUT CLAIM TO ANY PARTICULAR FONT, STYLE, SIZE, OR COLOR.

OWNER OF U.S. REG. NO. 2,930,020.

INT. CL. 12/U.S. CLS. 19, 21, 23, 31, 35 AND 44

FOR TRUCK TRAILERS, SEMI-TRAILERS, DISCHARGE TRAILERS, CARGO TRAILERS, VEHICLE DUMP BODIES, DUMP TRAILERS, DUMP CHASSIS, GARBAGE TRUCKS, SCRAP TRUCKS, AND STRUCTURAL PARTS THEREOF.

FIRST USE 3-22-2007; IN COMMERCE 3-22-2007.

ELEMENTS CORRECTED
CITIZENSHIP

3,379,938. REG. 2-12-2008. SQUARE-H BRANDS, INC. (DELAWARE CORPORATION), DBA "SQUARE-H BRANDS", 2731 SOUTH SOTO STREET, LOS ANGELES, CA, 90023, SN 76-670,778. FILED 12-26-2006. PRINCIPAL REGISTER.

DELITE

THE MARK CONSISTS OF STANDARD CHARACTERS WITHOUT CLAIM TO ANY PARTICULAR FONT, STYLE, SIZE, OR COLOR.

INT. CL. 29/U.S. CL. 46

FOR [PORK AND BEEF MEATS AND PROCESSED MEAT PRODUCTS MADE THEREFROM, NAMELY, SMOKED BACON, SAUSAGE, AND HAM] * PORK MEATS AND PROCESSED MEAT PRODUCTS MADE THEREFROM, NAMELY, SMOKED BACON *.

FIRST USE 4-17-1995; IN COMMERCE 4-17-1995.

ELEMENTS AMENDED
GOODS/SERVICES

3,385,755. REG. 2-19-2008. CTP GMBH (FED REP GERMANY GMBH) LUDWIG-SCHÖFFEL-STRASSE 6, 86830 SCHWABMÜNCHEN, FED REP GERMANY., SN 79-034,754. FILED 10-27-2006. PRINCIPAL REGISTER.

CTP

PRIORITY DATE OF 8-11-2006 IS CLAIMED. OWNER OF INTERNATIONAL REGISTRATION 0914149 DATED 10-27-2006, EXPIRES 10-27-2016.

INT. CL. 35/U.S. CLS. 100, 101 AND 102

FOR BUSINESS MANAGEMENT, PERSONNEL MANAGEMENT, AND ORGANIZATION CONSULTANCY FOR THE PAPER INDUSTRY; ARRANGING AND CONDUCTING OF BUSINESS EXHIBITIONS AND TRADE FAIRS FOR THE PAPER INDUSTRY.

INT. CL. 42/U.S. CLS. 100 AND 101

FOR RESEARCH, DEVELOPMENT, AND CONSULTATION SERVICES, NAMELY, CHEMICAL TESTING AND ANALYSIS, ENGINEERING AND RESEARCH, INDUSTRIAL ANALYSIS AND RESEARCH, MATERIAL AND PHYSICAL TESTING AND ANALYSIS, AND TECHNOLOGICAL AND TECHNICAL CONSULTING SERVICES, ALL IN THE FIELDS OF PAPER MANUFACTURING AND PROCESSING; AND CONSULTING SERVICES IN ENVIRONMENTAL PROTECTION.

FIRST USE : IN COMMERCE .

ELEMENTS CORRECTED
CITIZENSHIP
ENTITY
MARK TYPE
[GOODS/SERVICES]
[INTERNATIONAL CLASS(ES)]

3,408,001. REG. 4-8-2008. BRACEWELL & GIULIANI LLP (TEXAS LIMITED LIABILITY PARTNERSHIP) 711 LOUISIANA STREET, SUITE 2300, HOUSTON, TX, 77002, SN 77-084,519. FILED 1-17-2007. PRINCIPAL REGISTER.

WE KNOW ENERGY

THE MARK CONSISTS OF STANDARD CHARACTERS WITHOUT CLAIM TO ANY PARTICULAR FONT, STYLE, SIZE, OR COLOR.
INT. CL. 45/U.S. CLS. 100 AND 101
FOR LEGAL SERVICES.
FIRST USE 10-20-2005; IN COMMERCE 10-20-2005.

ELEMENTS CORRECTED
ENTITY

3,410,825. REG. 4-8-2008. SOAP & GLORY LIMITED (UNITED KINGDOM LIMITED LIABILITY COMPANY) ORCHARD HOUSE, FIRST FLOOR, 167-169 KENSINGTON HIGH STREET, LONDON, UNITED KINGDOM, W8 6SH, SN 78-873,994. FILED 5-2-2006. PRINCIPAL REGISTER.



PRIORITY CLAIMED UNDER SEC. 44(D) ON UNITED KINGDOM APPLICATION NO. 2416928, FILED 3-17-2006, REG. NO. 2416928, DATED 3-17-2006, EXPIRES 3-17-2016.
INT. CL. 3/U.S. CLS. 1, 4, 6, 50, 51 AND 52

FOR COSMETICS, NAMELY, SOAPS, SHOWER GELS, MOISTURE LOTIONS, MOISTURE CREAMS, BODY SCRUBS, BATH GELS, BATH OILS, BATH CREAMS, FACIAL MOISTURIZING LOTIONS, FACE MASKS, EAU DE TOILETTE, PARFUMS AND SCENTED BODY SPRAYS.

FIRST USE 8-30-2006; IN COMMERCE 2-20-2007.

ELEMENTS CORRECTED
OWNER NAME
CITIZENSHIP
ENTITY
OWNER ADDRESS

3,421,500. REG. 5-6-2008. CASE DESIGN/REMODELING, INC. (MARYLAND CORPORATION) 4701 SANGAMORE ROAD, SUITE P40, BETHESDA, MD, 20816, SN 77-113,147. FILED 2-22-2007. PRINCIPAL REGISTER.



NO CLAIM IS MADE TO THE EXCLUSIVE RIGHT TO USE "INSTITUTE OF REMODELING", APART FROM THE MARK AS SHOWN.

THE MARK CONSISTS OF A SQUARE CONTAINING TWO OVERLAPPING HANDS AND THE WORDS "CASE INSTITUTE OF REMODELING" OUTSIDE THE SQUARE.
INT. CL. 41/U.S. CLS. 100, 101 AND 107

FOR EDUCATIONAL SERVICES, NAMELY, CONDUCTING SEMINARS, WORKSHOPS AND TRAINING IN THE NATURE OF TELECONFERENCES, WEB SEMINARS, SALES MEETINGS, LEADERSHIP SEMINARS AND WORKSHOPS IN THE CONSTRUCTION AND REMODELING INDUSTRIES.
FIRST USE 2-8-2007; IN COMMERCE 2-8-2007.

ELEMENTS AMENDED
MARK
DISCLAIMER
DESCRIPTION OF MARK

3,459,919. REG. 7-8-2008. OKI ELECTRIC INDUSTRY CO., LTD. (JAPAN CORPORATION) 7-12, TORANOMON 1-CHOME, MINATO-KU, TOKYO, JAPAN., SN 76-172,057. FILED 11-28-2000. PRINCIPAL REGISTER.

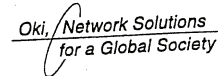

PRIORITY CLAIMED UNDER SEC. 44(D) ON JAPAN APPLICATION NO. 2000-109545, FILED 10-6-2000, REG. NO. 4542733, DATED 2-8-2002, EXPIRES 2-8-2012.

OWNER OF U.S. REG. NOS. 1,176,941, 1,314,392 AND 1,578,683.

NO CLAIM IS MADE TO THE EXCLUSIVE RIGHT TO USE "NETWORK SOLUTIONS FOR A GLOBAL SOCIETY", APART FROM THE MARK AS SHOWN.

INT. CL. 2/U.S. CLS. 6, 11 AND 16

FOR TONER, PREFILLED TONER CARTRIDGES, INK AND PREFILLED INK CARTRIDGES, ALL FOR COMPUTER PRINTERS, COPIERS AND FACSIMILE MACHINES.

FIRST USE ; IN COMMERCE .

INT. CL. 9/U.S. CLS. 21, 23, 26, 36 AND 38

FOR MEASURING APPARATUS, NAMELY, FLOWMETERS FOR USE IN MEASURING WATER FLOWING IN RIVERS; TELEPHONES; TELEPHONE SWITCHBOARDS AND EXCHANGERS; TELEVISION TRANSMITTERS; RADIO TRANSMITTERS; RADAR; FACSIMILE MACHINES; DATA PROCESSORS; COMPUTERS; COMPUTER PRINTERS; COMPUTER PERIPHERALS; COMPUTER PROGRAMS FOR USE IN INTEGRATING COMPUTER TELEPHONY IN THE FIELD OF COMPUTER NETWORKS; SEMICONDUCTORS; INTEGRATED CIRCUITS; ELECTROSTATIC COPIERS; PHOTOCOPIERS; FIRE ALARMS; CASH DISPENSERS; CASH REGISTERS.

FIRST USE ; IN COMMERCE .

INT. CL. 16/U.S. CLS. 2, 5, 22, 23, 29, 37, 38 AND 50

FOR INK RIBBONS AND PREFILLED INK RIBBON CARTRIDGES, BOTH FOR COMPUTER PRINTERS, COPIERS AND FACSIMILE MACHINES.

FIRST USE ; IN COMMERCE .

INT. CL. 36/U.S. CLS. 100, 101 AND 102

FOR ELECTRONIC PAYMENT, NAMELY, ELECTRONIC PROCESSING AND TRANSMISSION OF BILL PAYMENT DATA FOR SETTLEMENT OF BILLS FOR USERS OF DIGITAL MONEY; FINANCIAL INFORMATION PROVIDED BY ELECTRONIC MEANS.

FIRST USE ; IN COMMERCE .

INT. CL. 38/U.S. CLS. 100, 101 AND 104

FOR TELEPHONE COMMUNICATION; MOBILE TELEPHONE COMMUNICATION; NETWORK CONFERENCING SERVICES; COMMUNICATIONS BY SATELLITE; FACSIMILE TRANSMISSIONS AND COMMUNICATION; PROVIDING INFORMATION IN THE FIELD OF TELECOMMUNICATION NETWORKS; RENTAL OF TELEPHONES, FACSIMILE MACHINES AND TELECOMMUNICATION EQUIPMENT IN GENERAL.

FIRST USE ; IN COMMERCE .

INT. CL. 41/U.S. CLS. 100, 101 AND 107

FOR EDUCATIONAL SERVICES, NAMELY, TRAINING, INSTRUCTION, AND CONDUCTING SEMINARS, CONFERENCES, AND WORKSHOPS, ALL IN THE FIELDS OF COMPUTERS, COMPUTER PROGRAMS AND COMPUTER NETWORKS.

FIRST USE ; IN COMMERCE .

INT. CL. 42/U.S. CLS. 100 AND 101

FOR RESEARCH AND DEVELOPMENT FOR NEW PRODUCTS FOR OTHERS IN THE FIELDS OF TELECOMMUNICATION EQUIPMENT, COMPUTERS, COMPUTER PRINTERS, COMPUTER PERIPHERALS AND COMPUTER PROGRAMS; DESIGN FOR OTHERS IN THE FIELD OF TELECOMMUNICATION EQUIPMENT, COMPUTERS, COMPUTER PRINTERS AND COMPUTER PERIPHERALS; DESIGNING TELECOMMUNICATION NETWORKS FOR OTHERS; TECHNICAL SUPPORT SERVICES, NAMELY, TROUBLESHOOTING OF COMPUTER HARDWARE AND SOFTWARE PROBLEMS VIA TELEPHONE, ELECTRONIC MAIL AND IN PERSON; EDITING OF MANUALS IN THE FIELD OF COMPUTERS, COMPUTER PRINTERS, COMPUTER PERIPHERALS AND COMPUTER PROGRAMMING; PROVIDING TECHNICAL INFORMATION IN THE FIELDS OF TELECOMMUNICATION EQUIPMENT, COMPUTERS, COMPUTER PRINTERS, COMPUTER PERIPHERALS AND COMPUTER PROGRAMS; RENTAL OF COMPUTERS, COMPUTER PRINTERS, COMPUTER PERIPHERALS AND COMPUTER PROGRAMS; LANGUAGE TRANSLATION.

FIRST USE ; IN COMMERCE .

ELEMENTS CORRECTED
GOODS/SERVICES

3,473,595. REG. 7-22-2008. MARSILLI & CO. S.P.A. (ITALY JOINT STOCK COMPANY) VIA PER RIPALTA ARPINA, 14, CASTELLEONE (CREMONA), ITALY., SN 78-323,565. FILED 11-5-2003. PRINCIPAL REGISTER.



PRIORITY CLAIMED UNDER SEC. 44(D) ON ERPNCMNTY TM OFC APPLICATION NO. 3379716, FILED 9-30-2003, REG. NO. 003379716, DATED 5-16-2006, EXPIRES 9-30-2013.

NO CLAIM IS MADE TO THE EXCLUSIVE RIGHT TO USE "THE NEWEST PLATFORM", APART FROM THE MARK AS SHOWN.

THE STIPPLING IS A FEATURE OF THE MARK.

THE MARK CONSISTS OF THE STYLIZED LETTERS SAM, ABOVE A BAR WHICH IS PARTIALLY BLACKENED. BENEATH THE BAR IS THE TERM "SMARTAUTOMOTION". BENEATH THAT IS THE WORDING "THE NEWEST PLATFORM FROM" AND THE NAME MARSILLI.

INT. CL. 7/U.S. CLS. 13, 19, 21, 23, 31, 34 AND 35

FOR AUTOMATIC ASSEMBLY LINES FOR ASSEMBLING ELECTRO MECHANICAL AND ELECTRONIC COMPONENTS AND FOR GENERALLY MANUFACTURING GOODS TO THE SPECIFIC NEEDS OF A CUSTOMER OR MANUFACTURER COMPRISED OF PICK-UP ARMS AND GRIPS, POSITIONERS, JOINERS, FASTENING ROBOTS, SORTERS, HOLDERS, ASSEMBLERS, LOADERS AND UNLOADERS, [PELLETIZERS,] * PALLETIZERS * WELDERS, AND TAPES; AUTOMATION MODULES FOR CONVEYORS, NAMELY, LOADERS AND UNLOADERS AND CONSISTING OF COMPUTERS, CONTROLLERS, SENSORS, INPUT PERIPHERALS, OUTPUT PERIPHERALS, MEMORIES AND EFFECTORS; CONVEYORS, CONVEYORS AND PARTS THEREFORE SOLD AS A UNIT; AUTOMATION MACHINERY, NAMELY, MACHINES FOR AUTOMATICALLY CARRYING OUT A PROCESS OR PART THEREOF IN STAND-ALONE APPLICATION OR INTEGRATED IN LINES, NAMELY, MACHINES FOR ASSEMBLAGE AND CONTROL OF ELECTRO MECHANICAL AND ELECTRONIC COMPONENTS, NAMELY, MACHINES FOR PICKING UP COMPONENTS, MACHINES FOR POSITIONING COMPONENTS, MACHINES FOR JOINING COMPONENTS, MACHINES FOR INSERTING ONE COMPONENT INTO ANOTHER, MACHINES FOR FASTENING ONE COMPONENT TO ANOTHER, MACHINES FOR HOLDING TWO COMPONENTS IN A GIVEN POSITION AND MACHINES FOR SORTING COMPONENTS, MACHINES FOR WELDING COMPONENTS, MACHINES FOR SOLDERING COMPONENTS; MATERIALS HANDLING MACHINES, NAMELY, [PELLETIZERS] * PALLETIZERS *; SPECIALTY MACHINES FOR ASSEMBLING COMPONENTS, NAMELY, MACHINES FOR PICKING UP COMPONENTS, MACHINES FOR POSITIONING COMPONENTS, MACHINES FOR JOINING COMPONENTS, MACHINES FOR INSERTING ONE COMPONENT INTO ANOTHER, MACHINES FOR FASTENING ONE COMPONENT TO ANOTHER, MACHINES FOR HOLDING TWO COMPONENTS IN A GIVEN POSITION AND MACHINES FOR SORTING COMPONENTS, ALL FOR USE FOR MACHINE COMPONENTS AND ELECTRONIC COMPONENTS; ELECTRICAL WELDING MACHINES; ELECTRICAL SOLDERING MACHINES AND COMPONENTS THEREFORE SOLD AS A UNIT.

FIRST USE 9-27-2005; IN COMMERCE 9-27-2005.

ELEMENTS CORRECTED
GOODS/SERVICES

3,478,987. REG. 8-5-2008. EVONIK INDUSTRIES AG (FED REP GERMANY CORPORATION) RELLINGHAUSER STRABE 1-11, ESSEN, FED REP GERMANY, 45128, SN 77-195,922. FILED 6-1-2007. PRINCIPAL REGISTER.



OWNER OF FED REP GERMANY REG. NO. 30674165, DATED 12-2-2006, EXPIRES 12-31-2016.

THE COLOR(S) DARK PURPLE, LIGHT PURPLE, DARK GREY, LIGHT GREY, AND WHITE IS/ARE CLAIMED AS A FEATURE OF THE MARK.

THE MARK CONSISTS OF THE COLOR DARK PURPLE OUTLINED WITH LIGHT PURPLE AND DARK GREY APPEARS IN THE INTERIOR "E" SHAPED DESIGN; THE COLOR LIGHT GRAY OUTLINED WITH DARK GREY AND WHITE APPEARS IN THE EXTERIOR CIRCULAR DESIGN.

INT. CL. 16/U.S. CLS. 2, 5, 22, 23, 29, 37, 38 AND 50

FOR PAPER GOODS, NAMELY, TRANSPARENT, OPAQUE AND TRANSLUCENT FILMS FOR USE WITH INK JET COPIES AND LASER PRINTERS; ADVERTISING BOARDS OF PAPER OR CARDBOARD; ADVERTISING SIGNS OF PAPER OR CARDBOARD; ALUMINUM FOIL LAMINATED PAPER FOR PRINTING PURPOSES; ART PAPER; BABIES' DIAPERS OF PAPER; BOOK-COVER PAPER; COMPUTER PAPER; CONSTRUCTION PAPER; COPY PAPER; DIGITAL PRINTING PAPER; DIRECTORY PAPER; DRAWING PAPER; ENVELOPE PAPER; FACSIMILE TRANSMISSION PAPER; LASER PRINT PAPER; TYPEWRITER PAPER; LETTER PAPER BEING FINISHED PRODUCTS; OFFSET PAPER; PAPER FOR PHOTOCOPIERS; PAPER FOR RECORDING MACHINES; PAPER FOR USE IN THE GRAPHIC ARTS INDUSTRY; PUBLICATION PAPER; REEL PAPER FOR PRINTERS; SEMI-PROCESSED PAPER; SYNTHETIC PAPER; PAPER BOXES; PAPER BAGS; AND PAPER FOR WRAPPING AND PACKAGING; CARDBOARD GOODS, NAMELY, ADVERTISING BOARDS; BOXES, CARTONS, AND CONTAINERS; BACKING FOR BINDING BOOKS; CARRIERS FOR FOODS AND BEVERAGES; FLOOR DISPLAYS FOR MERCHANDISING PRODUCTS; HANG TAGS; MAILING TUBES; PACKAGING; CONTAINERS FOR ICE; LINERBOARD; PICTURE MOUNTS; AND PLACARDS; BOOKBINDING MATERIAL, NAMELY, BOOKBINDINGS; BOOKBINDING TAPE; BOOKBINDING WIRE; AND CLOTH FOR BOOKBINDING; PHOTOGRAPHS; STATIONERY; ADHESIVES FOR STATIONERY FOR HOUSEHOLD PURPOSES; ARTISTS' MATERIALS, NAMELY, BRUSHES; PASTELS; PENCILS; PENS; CANVAS; AND MOLDS FOR MODELING CLAY; ELECTRONIC TYPEWRITERS; TYPEWRITER RIBBONS; PRINTBALLS AND TYPEBALLS; PRINTED INSTRUCTIONAL AND TEACHING MATERIAL IN THE FIELDS OF TELECOMMUNICATIONS AND EDUCATION; OFFICE REQUISITES, NAMELY, STAPLERS; RUBBER BANDS; ENVELOPE SEALING MACHINES; ADHESIVE TAPE DISPENSERS; ADHESIVE APPLYING MACHINES FOR HOME AND OFFICE USE; AUTOMATIC ADHESIVE DISPENSERS FOR OFFICE USE; AUTOMATIC PAPER CLIP DISPENSING MACHINES FOR OFFICE OR STATIONERY USE; BINDERS; CD SHREDDERS; COLATORS; CORRECTING FLUID FOR TYPE; DOCUMENT BINDING MACHINES FOR OFFICE USE; DOCUMENT LAMINATORS FOR OFFICE USE; ELECTRIC STAPLERS FOR OFFICES; FINGER STALLS; FRANKING MACHINES; GLUE; IMPRINTERS; INK ROLLERS FOR OFFICE MACHINES; LAMINATING MACHINES FOR HOME AND OFFICE USE; LETTER INSERTER MACHINES FOR OFFICE USE; OFFICE

CHECK WRITING AND ENGRAVING MACHINES; DE-COLLATING MACHINES; HOLE PUNCHERS; LABELING MACHINES; LETTERING MACHINES; OFFICE MACHINE RIBBONS; PAPER DRILL MACHINES; TYPE COMPOSING MACHINES; EMBOSSERS; PAPER FOLDING MACHINES; PAPER SHREDDERS; PAPER FEEDING MACHINES; PROTRACTORS; PUNCHES; RUBBER BANDS; SEALS; AND SPIRAL BINDING MACHINES; PLASTIC MATERIALS FOR PACKAGING, NAMELY, PLASTIC BAGS AND PLASTIC BUBBLE PACKS; OTHER PACKAGING MATERIAL, NAMELY, ABSORBENT PADS OF PAPER AND CELLULOSE FOR USE IN FOOD PACKAGING; INDUSTRIAL PACKAGING CONTAINERS OF PAPER; PACKAGING AND CONTAINERS COMPRISED OF STARCH-BASED MATERIALS IN THE NATURE OF A PAPER SUBSTITUTE FOR FOOD, BEVERAGES AND CONSUMER PRODUCTS; PAPER CONTAINERS FOR FOOD AND BEVERAGES COMPRISED OF MATERIALS DESIGNED TO LESSEN ADVERSE EFFECTS ON THE ENVIRONMENT; PAPER POUCHES FOR PACKAGING; PAPER ENVELOPES; AND VEGETABLE PARCHMENT FOR USE IN FOOD WRAPPING, PREPARATION, PROCESSING AND PACKAGING.

FIRST USE ; IN COMMERCE .

ELEMENTS CORRECTED
FOREIGN REG. DATE

3,488,097. REG. 8-19-2008. 80STEEES.COM, INC. (PENNSYLVANIA CORPORATION) 12875 ROUTE 30, 1ST FLOOR, NORTH HUNTINGDON, PA, 15642, SN 77-372,873. FILED 1-16-2008. PRINCIPAL REGISTER.

80stees.com

THE MARK CONSISTS OF STANDARD CHARACTERS WITHOUT CLAIM TO ANY PARTICULAR FONT, STYLE, SIZE, OR COLOR.

INT. CL. 25/U.S. CLS. 22 AND 39

FOR T-SHIRTS; SWEAT SHIRTS; LONG-SLEEVED SHIRTS; BOXER SHORTS; HATS; WRISTBANDS; YOGA PANTS; GLOVES; MITTENS.

FIRST USE 5-30-2000; IN COMMERCE 5-30-2000.

INT. CL. 35/U.S. CLS. 100, 101 AND 102

FOR ON-LINE RETAIL STORE SERVICES FEATURING T-SHIRTS, SWEAT SHIRTS, LONG SLEEVED T-SHIRTS, COSTUMES, BOXER SHORTS, HATS, BELT BUCKLES, TALKING TOYS, WRISTBANDS, PATCHES, MAGNETS, KEYCHAINS, POSTERS, PLUSH, TOYS, TOTE BAGS, YOGA PANTS, PAJAMA PANTS, MESSENGER BAGS, PLAYING CARDS, LAMPS, PENS, PENS WITH AUDIO, PINS, ORNAMENTS, NOTEPADS, GLOVES, MITTENS, LUNCHBOXES, WASHCLOTHES, STEERING WHEEL COVERS, BLANKETS, TROWS, BOARD GAMES, INFLATABLE YARD DECORATIONS, CARDBOARD CUT OUTS.

FIRST USE 5-30-2000; IN COMMERCE 5-30-2000.

ELEMENTS CORRECTED
DATE OF FIRST USE
DATE OF FIRST USE IN COMMERCE

3,494,729. REG. 9-2-2008. EVONIK INDUSTRIES AG (FED REP GERMANY CORPORATION) RELLINGHAUSER STRABE 1-11, ESSEN, FED REP GERMANY, 45128, SN 77-195,880. FILED 6-1-2007. PRINCIPAL REGISTER.



OWNER OF FED REP GERMANY REG. NO. 30674165, DATED 12-2-2006, EXPIRES 12-31-2016.

THE COLOR(S) DARK PURPLE, LIGHT PURPLE, DARK GREY, LIGHT GREY, AND WHITE IS/ARE CLAIMED AS A FEATURE OF THE MARK.

THE MARK CONSISTS OF THE COLOR DARK PURPLE OUTLINED WITH LIGHT PURPLE AND DARK GREY APPEARS IN THE INTERIOR "E" SHAPED DESIGN; THE COLOR LIGHT GRAY OUTLINED WITH DARK GREY AND WHITE APPEARS IN THE EXTERIOR CIRCULAR DESIGN.

INT. CL. 11/U.S. CLS. 13, 21, 23, 31 AND 34

FOR APPARATUSES FOR LIGHTING, NAMELY, ELECTRIC LIGHTING FIXTURES AND SCONCES; ELECTRIC TORCHES FOR LIGHTING; ELECTRIC TRACK LIGHTING UNITS; FIBER OPTIC LIGHTING FIXTURES USED IN CONJUNCTION WITH ELECTRICAL ILLUMINATORS; FLUORESCENT LIGHTING TUBES; INFRARED LIGHTING FIXTURES; LANDSCAPE LIGHTING INSTALLATIONS; LIGHTING DEVICES FOR SHOWCASES; LIGHTING FIXTURES FOR USE IN PARKING DECKS AND GARAGES; LIGHTING FIXTURES FOR USE IN PARKING LOTS AND WALKWAYS; LIGHTING FIXTURES THAT INTEGRATE NATURAL DAYLIGHT AND FLUORESCENT LIGHTING; LIGHTING TRACKS; LIGHTING TUBES; PAYER LIGHTS; INDOOR AND OUTDOOR SOLAR-POWERED LIGHTING UNITS AND FIXTURES; APPARATUSES FOR HEATING, NAMELY, CHEMICALLY ACTIVATED HEATING PACKS FOR PROVIDING WARMTH TO THE BODY NOT FOR MEDICAL PURPOSES; ELECTRIC HEATING FANS; ELECTRIC RADIATORS FOR HEATING BUILDINGS; ELECTRICAL HEATING CABLES; ELECTRICAL HEATING TAPES, ELECTRICAL INDUCTION HEATING APPARATUS FOR HEATING METAL WORKPIECES; HEAT SINKS FOR USE IN HEATING AND VENTILATING APPARATUS; HEATING AND COOLING PACKS FILLED WITH CHEMICAL SUBSTANCES THAT REACT WHEN REQUIRED TO WARM OR COOL THE BODY NOT FOR MEDICAL PURPOSES; ELECTRIC AND CHEMICALLY ACTIVATED HEATING CUSHIONS NOT FOR MEDICAL PURPOSES; HEATING FURNACES FOR INDUSTRIAL PURPOSES; ELECTRIC AND CHEMICALLY ACTIVATED HEATING PADS NOT FOR MEDICAL PURPOSES; HEATING SYSTEMS COMPOSED PRIMARILY OF TUBES, PIPES AND PRE-ASSEMBLED MANIFOLDS THROUGH WHICH COLD OR LOW TEMPERATURE WATER CIRCULATES; HOT-AIR SPACE HEATING APPARATUS FOR INDUSTRIAL PURPOSES; HOT WATER SPACE HEATING APPARATUS FOR INDUSTRIAL PURPOSES; INDUCTION HEATERS FOR HEATING THERMAL INSULATED DELIVERY BAGS DESIGNED TO KEEP FOOD WARM DURING TRANSPORT; INDUSTRIAL DRYERS FOR HEATING AND DEHUMIDIFYING; CHEMICALLY ACTIVATED HEATING PACKETS FOR WARMING HANDS NOT FOR MEDICAL USE; PAVEMENT HEATING APPARATUS; PELTIER HEATING APPARATUS; PIPES FOR HEATING BOILERS; PORTABLE THERMAL SELF-HEATING POUCH FOR THE PURPOSES OF HEATING FOOD; PORTABLE THERMOELECTRIC COOLING AND HEATING UNIT FOR FOOD AND BEVERAGES; STEAM HEATING APPARATUS FOR INDUSTRIAL PURPOSES; STEAM RADIATORS FOR HEATING BUILDINGS; AND

THERMOSTATIC VALVES FOR HEATING INSTALLATIONS; APPARATUSES FOR COOKING, NAMELY, ELECTRIC COOKING OVENS; GAS COOKING OVENS; COMMERCIAL COOKING OVENS; DOMESTIC COOKING OVENS; INDUSTRIAL COOKING OVENS; LINERS FOR CONVENTIONAL OVENS IN THE NATURE OF HEAT TRANSMITTING CONTAINERS FOR PROVIDING UNIFORM HEAT AND HUMIDITY DURING COOKING; COOKING RANGES; ELECTRIC COOKING POTS; GAS STOVES; ELECTRIC STOVES; JAPANESE CHARCOAL COOKING STOVES FOR HOUSEHOLD PURPOSES; MICROWAVE OVENS; AND OIL COOKING STOVES FOR HOUSEHOLD PURPOSES; WATER SUPPLY APPARATUSES, NAMELY, ELECTRONIC GENERATORS FOR USE IN CONTROLLING THE AMOUNT OF HUMIDITY IN THE AIR BY CREATING, REMOVING OR CIRCULATING SMALL WATER PARTICLES OR WATER VAPOR IN THE AIR; REVERSE OSMOSIS WATER FILTRATION UNITS; FLOW RESTRICTORS FOR REVERSE OSMOSIS WATER PURIFICATION UNITS; GAS WATER HEATERS; HOT WATER HEATERS; HOT WATER TANKS; INDUSTRIAL WATER PURIFYING APPARATUS; MACHINES THAT GENERATES PURIFIED WATER FROM THE ATMOSPHERE AND SIMULTANEOUSLY PURIFY THE AIR; OXYGEN GENERATOR FOR PROCESSING WATER BY INCREASING OXYGEN CONTENT IN THE WATER; OZONE SANITIZERS FOR WATER; SOLAR WATER HEATERS; TAP WATER FAUCETS; TAP WATER PURIFYING DEVICES; THICKENING AND DEWATERING MACHINES FOR USE IN THE TREATMENT OF LIQUIDS INCLUDING WATER, INDUSTRIAL EFFLUENT AND SEWAGE; WASTE WATER PURIFICATION UNITS; WATER BED HEATERS; WATER COOLING TOWERS; WATER DESALINATION PLANTS; WATER DISTILLATION UNITS; WATER FAUCET SPOUTS; WATER PURIFICATION INSTALLATIONS FOR WASTE WATER AND SEWAGE CONSISTING OF CURTAINS AND TEXTILE FABRICS; WATER FILTERING UNITS FOR DOMESTIC, COMMERCIAL AND INDUSTRIAL USE; WATER FOUNTAINS; WATER IONIZERS FOR HOUSEHOLD PURPOSES; WATER PURIFICATION TANKS AND UNITS FOR DOMESTIC, COMMERCIAL AND INDUSTRIAL USE; WATER SOFTENING UNITS; CARTRIDGE FILTRATION UNITS FOR USE IN WATER TREATMENT; AND CHEMICAL AND ULTRAVIOLET WATER STERILIZATION UNITS; DRYING APPARATUSES, NAMELY, CLOTHES DRYERS; DRYERS FOR THE REMOVAL OF WATER VAPOR FROM COMPRESSED AIR AND GASES; DRYERS USED FOR THE REMOVAL OF SOLID, LIQUID AND VAPOR CONTAMINANTS FROM COMPRESSED AIR AND GASES; ELECTRIC HOT AIR HAND DRYERS; HAIR DRYERS FOR HOUSEHOLD PURPOSES; HAND HELD ELECTRIC HAIR DRYERS; INDUSTRIAL DRYERS FOR HEATING AND DEHUMIDIFYING; AND STATIONARY HAIR DRYERS FOR COMMERCIAL AND DOMESTIC USE; VENTILATING APPARATUSES, NAMELY, EXHAUST FANS; VENTILATING FANS FOR COMMERCIAL AND INDUSTRIAL USE; AND VENTILATING LOUVERS; STEAM GENERATORS; REFRIGERATING MACHINES; PARTS OF SANITARY FACILITIES, NAMELY, SANITARY PIPES FOR SANITARY PURPOSES; PURIFICATION INSTALLATIONS FOR SEWAGE, NAMELY, SEWAGE TREATMENT PLANTS; AND REACTORS FOR THE CHEMICAL INDUSTRY, NAMELY, NUCLEAR REACTORS; MACHINES FOR AIR CONDITIONING.

FIRST USE : IN COMMERCE .

ELEMENTS CORRECTED
FOREIGN REG. DATE

3,514,826. REG. 10-14-2008. EVONIK INDUSTRIES AG (FED REP GERMANY CORPORATION) RELLINGHAUSER STRABE 1-11, ESSEN, FED REP GERMANY, 45128, SN 77-195,862. FILED 6-1-2007. PRINCIPAL REGISTER.



PRIORITY CLAIMED UNDER SEC. 44(D) ON FED REP GERMANY APPLICATION NO. 30674165.2/3, FILED 12-2-2006, REG. NO. 30674165, DATED 12-2-2006, EXPIRES 12-31-2016.

THE COLOR(S) DARK PURPLE, LIGHT PURPLE, DARK GREY, LIGHT GREY, AND WHITE IS/ARE CLAIMED AS A FEATURE OF THE MARK.

THE MARK CONSISTS OF THE COLOR DARK PURPLE OUTLINED WITH LIGHT PURPLE AND DARK GREY APPEARS IN THE INTERIOR "E" SHAPED DESIGN; THE COLOR LIGHT GRAY OUTLINED WITH DARK GREY AND WHITE APPEARS IN THE EXTERIOR CIRCULAR DESIGN.

INT. CL. 9/U.S. CLS. 21, 23, 26, 36 AND 38

FOR APPARATUSES AND INSTRUMENTS USED FOR THE PURPOSE OF SCIENCE, NAMELY, GLASSWARE FOR SCIENTIFIC EXPERIMENTS IN LABORATORIES; PLATES, GLASS SLIDES OR CHIPS HAVING MULTI-WELL ARRAYS THAT CAN BE USED IN CHEMICAL ANALYSIS, BIOLOGICAL ANALYSIS OR PATTERNING; PRISMS; SATELLITES; OPTICAL MIRRORS; SENSING AND SIGNALING DEVICES FOR MEASUREMENT AND QUALITY CONTROL OF MATERIAL PROCESSING BY LASER; DEVICES FOR DETERMINING THE WATER CONTENT IN PETROLEUM PRODUCTS; FLUORESCENCE DETECTOR FOR CRIME SCENE INVESTIGATIONS; SCIENTIFIC MEASURING INSTRUMENTS, NAMELY, MEASUREMENT STANDARD DEVICES FOR NANOMETROLOGY, NAMELY, MEASURING TOOLS HAVING A PATTERN IN THE MICROMETER OR NANOMETER RANGES; APPARATUSES AND INSTRUMENTS USED FOR NAUTICAL PURPOSES, NAMELY, GLOBAL POSITIONING SYSTEMS FOR MAPPING, TRACKING AND DETERMINING LOCATIONS, DISTANCES, DIRECTIONS AND ROUTES; GYROSCOPES; MARINE DEPTH FINDERS; APPARATUSES AND INSTRUMENTS USED FOR SURVEYING PURPOSES, NAMELY, COMPASSES; COMPASS NEEDLES, LEVEL MEASURING MACHINES; LEVELING RODS; SURVEYING CHAINS; SURVEYING TRANSITS; AND SURVEYING TRIPODS; APPARATUSES AND INSTRUMENTS USED FOR PHOTOGRAPHIC PURPOSES, NAMELY, BAGS AND CASES FOR CAMERAS AND OTHER PHOTOGRAPHIC EQUIPMENT, DRYING APPARATUS FOR PHOTOGRAPHIC PRINTS, EXPOSURE METERS, PHOTOGRAPHIC CAMERAS, PHOTOGRAPHIC FILTERS, PHOTOGRAPHIC FLASH UNITS, PHOTOGRAPHIC FLASHBULBS, PHOTOGRAPHIC PROJECTORS, SLIDE TRANSPARENCIES, AND VIEWFINDERS; APPARATUSES AND INSTRUMENTS USED FOR CINEMATOGRAPHIC PURPOSES, NAMELY, CINEMATOGRAPHIC CAMERAS, CINEMATOGRAPHIC FILM, CINEMATOGRAPHIC PROJECTORS, AND SOUND RECORDING DEVICES; APPARATUSES AND INSTRUMENTS USED FOR OPTICAL PURPOSES, NAMELY, OPTICAL CABLES, BLANK OPTICAL DISCS, CABLES FOR ELECTRICAL OR OPTICAL SIGNAL TRANSMISSION, DISPERSION SHIFTED OPTICAL FIBERS, ELECTRONIC AND OPTICAL COMMUNICATIONS INSTRUMENTS AND COMPONENTS, NAMELY, OPTICAL TRANSMITTERS, OPTICAL RECEIVERS, OPTICAL DATA LINKS, OPTICAL TRANSCEIVERS; FILTERS FOR OPTICAL DEVICES; LASER EQUIPMENT DESIGNED FOR CUTTING, DRILLING, MARKING, EN-

GRAVING, SHAPING, AND TINTING OPTICAL LENSES FOR EYEGLASSES; NONLINEAR OPTICAL FIBRES; OPTICAL CHARACTER RECOGNITION APPARATUS; OPTICAL CHARACTER READERS; OPTICAL DISC DRIVES; OPTICAL DISK READERS; OPTICAL FRAMES; OPTICAL FREQUENCY METROLOGY DEVICES; OPTICAL GLASSES, OPTICAL INSPECTION DEVICES FOR INDUSTRIAL USE; OPTICAL AND TELESCOPIC LENS SIGHTS; OPTICAL LENSES; OPTICAL READERS; OPTICAL REFLECTORS; OPTICAL SCANNERS; OPTICAL SEMICONDUCTOR AMPLIFIERS, OPTICAL SHUTTERS; AND OPTICAL MIRRORS; APPARATUSES AND INSTRUMENTS USED FOR WEIGHING, NAMELY, SCALES, BALANCES AND WEIGHING PLATTERS SOLD AS A COMPONENT OF SCANNER SCALES; APPARATUSES AND INSTRUMENTS USED FOR MEASURING, NAMELY, INSTRUMENTS FOR MEASURING LENGTH, INSTRUMENTS FOR MEASURING TEMPERATURE AND HUMIDITY LEVELS IN GASES AND SOLIDS, INSTRUMENTS FOR MEASURING TWO-DIMENSIONAL DISTRIBUTION OF FORCE AND PRESSURE, INSTRUMENTS FOR MEASURING MILK QUALITY PARAMETERS, INSTRUMENTS FOR MEASURING RADIATION, INSTRUMENTS FOR MEASURING RESISTANCE, LASERS FOR MEASURING PURPOSES, LASER DOPPLER FOR MEASURING PURPOSES, GAS SENSORS FOR MEASURING GAS CONCENTRATION, ELECTRONIC BASED INSTRUMENTS FOR MEASURING ENVIRONMENTAL PARAMETERS INCLUDING HUMIDITY, MOLD, BACTERIA, AIR QUALITY AND WATER QUALITY; AUTOMOTIVE MEASURING INSTRUMENTS, NAMELY, WATER TEMPERATURE GAUGES, AIR FUEL RATIO GAUGES, BOOST GAUGES, VACUUM GAUGES AND EXHAUST GAS TEMPERATURE GAUGES; MEASURING AND CONTROL DEVICES FOR AIR CONDITIONING TECHNOLOGY; BEVELS; RAIN GAUGES, MEASURING BUCKETS AND CUPS; MEASURING DEVICES, NAMES FLUOROMETERS, DIGITIZERS, RULES, SPOONS, TAPES, POCKET CALIPERS; RHEOMETERS FOR MEASURING THE VISCOSITY AND VISCOELASTICITY OF FLUIDS; AND CONDUCTIVITY METERS; APPARATUSES AND INSTRUMENTS USED FOR SIGNALING, NAMELY, ROTATING LIGHTS; SIGNALING BUOYS; TRAFFIC LIGHT SIGNALING DEVICES; AND DEVICES FOR CHECKING FLIGHT PARAMETERS; APPARATUSES AND INSTRUMENTS USED FOR LIFE SAVING AND TEACHING, NAMELY, LIFE RAFTS, LIFE BELTS, LIFE JACKETS, LIFE NETS AND PRESERVERS, LIFE BUOYS, AND MEDICAL TEACHING MANNEQUINS; APPARATUSES AND INSTRUMENTS FOR CONDUCTING, SWITCHING, TRANSFORMING, ACCUMULATING, REGULATING OR CONTROLLING ELECTRICITY, NAMELY, ELECTRICITY CONDUITS, ELECTRICITY ADAPTERS, AND ELECTRICITY WINDING WIRES; APPARATUSES FOR RECORDING, TRANSMISSION OR REPRODUCTION OF SOUND OR IMAGES; BLANK MAGNETIC DATA CARRIERS; BLANK RECORD OPTICAL AND MAGNETIC DISCS FOR SOUND OR VIDEO RECORDING; AUTOMATIC VENDING MACHINES; MECHANISMS FOR COIN-OPERATED APPARATUSES, NAMELY, COIN CHANGERS, COIN COUNTING OR SORTING MACHINES, AND COIN ACCEPTORS FOR SEPARATING GOOD COINS FROM COUNTERFEITS; CASH REGISTERS; CALCULATING MACHINES, NAMELY, CALCULATORS; DATA PROCESSING EQUIPMENT, NAMELY, DATA PROCESSORS AND COMPUTERS; COMPUTER SOFTWARE AND FIRMWARE FOR USE IN DATABASE MANAGEMENT, USE AS A SPREADSHEET, WORD PROCESSING, PROCESS CONTROL SOFTWARE, LAB DATA MANAGEMENT SOFTWARE, BUSINESS PROCESS MANAGEMENT AND COMPUTER SOFTWARE FOR USE IN DATABASE MANAGEMENT, USE AS A SPREADSHEET OR WORD PROCESSING IN THE FIELD OF SCIENCE; COMPONENTS AND ELECTRICALLY-CONTROLLABLE LIQUIDS FOR SCREENS, NAMELY, LIQUID CRYSTAL DISPLAYS, LIQUID LEVEL SENSORS, AND LIQUID ANALYZERS; FIRE-EXTINGUISHING APPARATUSES, NAMELY, FIRE EXTINGUISHERS, FIRE-EXTIN-

GUISHERS FOR AUTOMOBILES, FIRE HYDRANTS, FIRE SPRINKLERS, AND FIRE EXTINGUISHING SYSTEMS; CONTROLS AND REGULATING APPARATUSES, NAMELY, GAS METERS, ELECTRONIC VALVE FOR CONTROLLING GAS, GAS SENSORS FOR MEASURING GAS CONCENTRATION, AND RESIDUAL GAS ANALYZERS FOR GENERATING GAS; MEASURING AND MONITORING APPARATUSES FOR GENERATING GAS, NAMELY, GAS METERS, ELECTRONIC VALVE FOR MEASURING GAS, GAS SENSOR FOR MEASURING GAS CONCENTRATION, AND GAS ANALYZERS; ELECTRICITY CONDUITS.
FIRST USE ; IN COMMERCE .

ELEMENTS CORRECTED
FOREIGN REG. DATE

3,530,817. REG. 11-11-2008. ALERE MEDICAL, INC. (CALIFORNIA CORPORATION) 10615 PROFESSIONAL CIRCLE, RENO, NV, 89521, SN 77-443,913. FILED 4-9-2008. PRINCIPAL REGISTER.



THE MARK CONSISTS OF AN ABSTRACT HEART-SHAPED FIGURE.

INT. CL. 10/U.S. CLS. 26, 39 AND 44

FOR MEDICAL MONITORING APPARATUS USED TO MONITOR AND COMMUNICATE DATA SUCH AS WEIGHT, BLOOD PRESSURE, BLOOD GLUCOSE LEVELS, OTHER BLOOD CHEMISTRY DATA, HEART RATE, EKG, COAGULATION TIME, PEAK FLOW OR OTHER MEASUREMENTS OF RESPIRATORY FUNCTION IN PATIENTS WITH CHRONIC DISEASES SUCH AS HEART DISEASE.

FIRST USE 12-13-1996; IN COMMERCE 12-13-1996.

INT. CL. 44/U.S. CLS. 100 AND 101

FOR HEALTH CARE SERVICES.

FIRST USE 12-13-1996; IN COMMERCE 12-13-1996.

ELEMENTS CORRECTED
OWNER ADDRESS
CITIZENSHIP

3,537,199. REG. 11-25-2008. ROLAND, CONRAD (FED REP GERMANY INDIVIDUAL) P.O. BOX 433, HOLUALOA, HAWAII 96725, UNITED STATES., SN 79-037,728. FILED 12-28-2006. PRINCIPAL REGISTER.

Solavita

OWNER OF INTERNATIONAL REGISTRATION 0922074 DATED 12-28-2006, EXPIRES 12-28-2016.

THE ENGLISH TRANSLATION OF THE WORD "SOLAVITA" IN THE MARK IS SINGLE LIFE.

INT. CL. 3/U.S. CLS. 1, 4, 6, 50, 51 AND 52

FOR COSMETIC PREPARATIONS FOR SKIN CARE, NAMELY, TANNING OILS, TANNING LOTIONS AND TANNING CREAMS; COSMETIC SUN-PROTECTIVE OILS AND LOTIONS; [SKIN TONERS; BATH AND SHOWER OILS, GELS, CREAMS, FOAMS AND SALTS, NOT FOR MEDICAL PURPOSES; HAIR CARE PREPARATIONS; HAIR COLORING PREPARATIONS, NAMELY, HAIR COLOR; SHAMPOOS; FOAMS AND LOTIONS NOT FOR MEDICAL PURPOSES, NAMELY, BATH FOAMS, SKIN LOTIONS AND BODY LOTIONS; NON-MEDICATED MASSAGE PREPARATIONS, NAMELY, MASSAGE OILS AND LOTIONS] * ALL THE AFOREMENTIONED GOODS FOR THE PREVENTION AND TREATMENT OF SKIN DISORDERS INCLUDING SUNBURN AND SKIN CANCER *.

FIRST USE ; IN COMMERCE .

INT. CL. 44/U.S. CLS. 100 AND 101

FOR MEDICAL SERVICES; HYGIENIC AND BEAUTY CARE FOR HUMAN BEINGS, NAMELY, SKIN EXAMS, COMPLEXION ANALYSIS, COSMETIC CONSULTATIONS, REJUVENATION PROCEDURES, LASER TREATMENTS, PHOTODYNAMIC THERAPY, FRUIT ACID PEELS AND IMMERSION THERAPY WITH PHYTOCHEMICALS, VITAMINS AND MINERALS; MASSAGE; HEALTH SPA SERVICES, NAMELY, COSMETIC BODY CARE SERVICES; TANNING SALONS; SKIN TANNING SERVICE FOR HUMANS FOR COMETIC PURPOSES, NAMELY, INDOOR TANNING BED SERVICES AND OUTDOOR FULL-BODY TANNING SERVICES.

FIRST USE ; IN COMMERCE .

ELEMENTS CORRECTED
GOODS/SERVICES

3,557,740. REG. 1-6-2009. GREENLIGHT (UNITED KINGDOM LIMITED COMPANY) 2ND FLOOR 1 WEST SMITHFIELD, LONDON EC1A 9JU, UNITED KINGDOM., SN 79-047,276. FILED 9-19-2007. PRINCIPAL REGISTER.

Quant

PRIORITY DATE OF 8-3-2007 IS CLAIMED.
OWNER OF INTERNATIONAL REGISTRATION 0946239 DATED 9-19-2007, EXPIRES 9-19-2017.
INT. CL. 9/U.S. CLS. 21, 23, 26, 36 AND 38

FOR COMPUTER PROGRAMS FOR USE AS SEARCHING DIRECTORIES, NAMELY, COMPUTER SEARCH ENGINE SOFTWARE; COMPUTER SOFTWARE TO ENABLE THE CREATION, TRACKING, AND PAY-PER-CLICK FUNCTIONALITY OF ADVERTISING AND MARKETING CREATIVES VIA THE INTERNET; COMPUTER SEARCH ENGINE OPTIMIZATION SOFTWARE FOR USE IN ADVERTISING; COMPUTER PROGRAMS FOR USE IN INSERTING ADVERTISEMENTS ON THE INTERNET IN RESPONSE TO CHARACTERISTICS OF USERS ACCESSING WEB SITES; COMPUTER PROGRAMS FOR REPORTING THE EXTENT OF ADVERTISING ACHIEVED BY THE AFORESAID PROGRAM, NAMELY, COMPUTER PROGRAMS FOR THE COMPILATION OF ADVERTISING DATA.

FIRST USE ; IN COMMERCE .

FOR COMPUTER PROGRAMMING; DUPLICATION OF COMPUTER PROGRAMS; COMPUTER SOFTWARE AND HARDWARE DESIGN AND DEVELOPMENT; INSTALLATION, UPDATING, MAINTENANCE AND REPAIR OF COMPUTER SOFTWARE; PROVIDING SEARCH ENGINES FOR THE INTERNET; CREATING AND MAINTAINING WEB SITES FOR OTHERS; HOSTING COMPUTER WEB SITES; DESIGN OF COMPUTER DATABASES; DESIGN, DRAWING AND COMMISSIONED WRITING FOR THE COMPILATION OF WEB SITES; INFORMATION RELATING TO ALL THE FOREGOING PROVIDED ON-LINE FROM A COMPUTER DATABASE OR THE INTERNET; CONSULTANCY, ADVISORY AND INFORMATION SERVICES RELATING TO THE FOREGOING.

FIRST USE ; IN COMMERCE .

ELEMENTS CORRECTED
GOODS/SERVICES

INT. CL. 35/U.S. CLS. 100, 101 AND 102

FOR MARKETING, NAMELY, ON-LINE ADVERTISING AND MARKETING SERVICES; SEARCH ENGINE MARKETING SERVICES, NAMELY, PROMOTING THE GOODS AND SERVICES OF OTHERS THROUGH SEARCH ENGINE REFERRAL TRAFFIC ANALYSIS AND REPORTING; MARKETING ADVISORY SERVICES, NAMELY, MARKETING CONSULTING; MARKETING AGENCY SERVICES, NAMELY, PROVIDING ADVERTISING AGENCY SERVICES IN THE DESIGN AND EXECUTION OF ONLINE MARKETING PROGRAMS; PROFESSIONAL CONSULTANCY RELATING TO MARKETING; PROMOTIONAL MARKETING, NAMELY, PROMOTING THE WEBSITES OF OTHERS; ADVERTISING; ADVERTISING AGENCIES; ADVERTISING AGENCY SERVICES; ADVERTISING CONSULTATION, NAMELY, PROVIDING BUSINESS ADVICE RELATING TO ADVERTISING; ON-LINE ADVERTISING ON A COMPUTER NETWORK; MULTIMEDIA ADVERTISING AND PROMOTION SERVICES, NAMELY, PROMOTING THE GOODS, SERVICES, BRAND IDENTITY AND COMMERCIAL INFORMATION AND NEWS OF THIRD PARTIES THROUGH PRINT, AUDIO, VIDEO, DIGITAL AND ON-LINE MEDIUM; ADVERTISING AND PROMOTIONAL SERVICES; PROMOTING THE GOODS AND SERVICES OF OTHERS; BUSINESS MANAGEMENT; BUSINESS ADMINISTRATION; BUSINESS INFORMATION SERVICES; ARRANGING AND CONDUCTING OF AUCTION SALES; PROVIDING AN ONLINE AUCTION EXCHANGE FOR BUYING AND SELLING ADVERTISING; ON-LINE TRADING SERVICES, NAMELY, ON-LINE TRADING SERVICES IN WHICH SELLER POSTS PRODUCTS TO BE AUCTIONED AND BIDDING IS DONE VIA THE INTERNET; ADVERTISING AGENCY SERVICES; RENTAL OF ADVERTISING SPACE ON WEB PAGES; SELLING ADVERTISING SPACE ON WEB PAGES; [PROVISION OF INFORMATION ON ADVERTISEMENT ACCESSES;] ADVERTISING RESEARCH, NAMELY, CONDUCTING MARKET RESEARCH; ADVERTISING VIA ELECTRONIC MEDIA AND SPECIFICALLY THE INTERNET; CONSUMER RESEARCH, NAMELY, AND TRACKING WEB SITES OF OTHERS TO PROVIDE DETAILS ABOUT USER CLICK TRAFFIC OR VISITS TO THE WEB SITE AND CONDUCTING ANALYSIS OF ADVERTISING RESPONSE; ADVERTISING BY TRANSMISSION OF ON-LINE PUBLICITY FOR THIRD PARTIES THROUGH ELECTRONIC COMMUNICATIONS WEBSITES; INFORMATION, ADVISORY AND CONSULTANCY SERVICES RELATING TO ALL THE AFORESAID.

FIRST USE ; IN COMMERCE .

3,567,815. REG. 1-27-2009. MONIKKER PTY LTD (AUSTRALIA COMPANY) RIALTO SOUTH TOWER, 525 COLLINS STREET., 27TH FLOOR, MELBOURNE VIC 3000, AUSTRALIA., SN 79-033,015. FILED 10-3-2006. PRINCIPAL REGISTER.

MONIKKER

THE MARK CONSISTS OF STANDARD CHARACTERS WITHOUT CLAIM TO ANY PARTICULAR FONT, STYLE, SIZE, OR COLOR.

PRIORITY DATE OF 4-4-2006 IS CLAIMED.

OWNER OF INTERNATIONAL REGISTRATION 0908819 DATED 10-3-2006, EXPIRES 10-3-2016.

INT. CL. 38/U.S. CLS. 100, 101 AND 104

FOR TELECOMMUNICATIONS SERVICES, NAMELY, TRANSMISSION OF CALL ALERT SIGNALS TO TELEPHONES AND PERSONAL COMMUNICATIONS DEVICES, PROVIDING LOCAL AND LONG DISTANCE TELECOMMUNICATIONS SERVICE WITH AUDIO AND VIDEO ADVERTISING FOR OTHERS AS A COMPONENT OF THE LOCAL AND LONG DISTANCE SERVICE; TELECOMMUNICATIONS SERVICES, NAMELY, VOICE AND DATA MESSAGING SERVICES IN THE NATURE OF ELECTRONIC VOICE MESSAGING, NAMELY, THE RECORDING AND SUBSEQUENT TRANSMISSION OF VOICE MESSAGES BY TELEPHONE AND PERSONAL COMMUNICATIONS DEVICES.

INT. CL. 41/U.S. CLS. 100, 101 AND 107

FOR ENTERTAINMENT SERVICES, NAMELY, NON-DOWNLOADABLE RINGTONES, PRE-RECORDED MUSIC, SOUND, VIDEO, GRAPHICS, PROSE AND ANIMATIONS PRESENTED TO MOBILE COMMUNICATIONS DEVICES, FIXED NETWORK COMMUNICATIONS DEVICES AND WIRELESS DEVICES VIA A GLOBAL COMPUTER NETWORK; ENTERTAINMENT SERVICES, NAMELY, PROVISION OF PRE-RECORDED MUSIC, SOUNDS, IMAGES, TEXT-BASED PROSE, GRAPHICS, ANIMATIONS OR VIDEO OVER TELECOMMUNICATIONS NETWORKS FOR USE AS RINGTONES OR CALL ALERTS, SELECTED FROM A WEBSITE FEATURING SAMPLES OF MUSIC, SOUNDS, IMAGES, TEXT-BASED PROSE, GRAPHICS, ANIMATIONS OR VIDEO.

ELEMENTS CORRECTED
MARK TYPE
[GOODS/SERVICES]
[INTERNATIONAL CLASS(ES)]

INT. CL. 42/U.S. CLS. 100 AND 101

3,575,660. REG. 2-17-2009. ALERE MEDICAL, INC. (CALIFORNIA CORPORATION) 10615 PROFESSIONAL CIRCLE, RENO, NV, 89521, SN 77-513,696. FILED 7-2-2008. PRINCIPAL REGISTER.

DAYLINK

THE MARK CONSISTS OF STANDARD CHARACTERS WITHOUT CLAIM TO ANY PARTICULAR FONT, STYLE, SIZE, OR COLOR.

INT. CL. 10/U.S. CLS. 26, 39 AND 44

FOR MEDICAL MONITORING APPARATUS USED TO MONITOR AND COMMUNICATE DATA SUCH AS WEIGHT, BLOOD PRESSURE, BLOOD GLUCOSE LEVELS, OTHER BLOOD CHEMISTRY DATA, HEART RATE, EKG, COAGULATION TIME, PEAK FLOW OR OTHER MEASUREMENTS OF RESPIRATORY FUNCTION IN PATIENTS WITH CHRONIC DISEASES SUCH AS HEART DISEASE.

FIRST USE 12-13-1996; IN COMMERCE 12-13-1996.
INT. CL. 44/U.S. CLS. 100 AND 101

FOR HEALTH CARE SERVICES.

FIRST USE 12-13-1996; IN COMMERCE 12-13-1996.

ELEMENTS CORRECTED

OWNER ADDRESS
CITIZENSHIP

3,576,189. REG. 2-17-2009. DEUTSCHE TELEKOM AG (FED REP GERMANY CORPORATION) FRIEDRICH-EBERT-ALLEE 140, BONN, FED REP GERMANY, 53113, SN 78-184,591. FILED 11-13-2002. PRINCIPAL REGISTER.



PRIORITY CLAIMED UNDER SEC. 44(D) ON FED REP GERMANY APPLICATION NO. 30224473.5/0, FILED 5-15-2002, REG. NO. 30224473, DATED 8-6-2002.

OWNER OF U.S. REG. NO. 2,367,890.

THE MARK CONSISTS OF THE FOLLOWING COLORS: THE CIRCLE AROUND THE LETTER "T" IS MAGENTA; THE LETTER "T" IN THE CIRCLE AND THE LINE FOLLOWING FROM THE LETTER "T" ARE WHITE; AND THE WORD "ZONES" IS GREY. THE APPLICANT CLAIMS THE COLORS MAGENTA, GREY AND WHITE AS A FEATURE OF THE MARK.

INT. CL. 9/U.S. CLS. 21, 23, 26, 36 AND 38

FOR ELECTRIC, ELECTRONIC, OPTICAL, MEASURING, SIGNALING, CONTROLLING AND TEACHING APPARATUS AND INSTRUMENTS, ALL FOR USE WITH TELECOMMUNICATIONS, NAMELY, APPARATUS FOR PRODUCING SOUND, IMAGES OR DATA, NAMELY, MAGNETIC AND OPTICAL DATA CARRIERS, DATA PROCESSORS AND COMPUTERS, NAMELY, MICROCOMPUTERS, MINICOMPUTERS, COMPUTER CENTRAL PROCESSORS, COMPUTER MONITORS, COMPUTER KEYBOARDS, COMPUTER TERMINALS, COMPUTER INTERFACE BOARDS, COMPUTER MEMORIES, COMPUTER LASER PRINTERS, COMPUTER IMPACT PRINTERS, COMPUTER DOT MATRIX PRINTERS, COMPUTER OPERATING SYSTEMS, COMPUTERS AND INSTRUCTIONAL MANUALS SOLD AS A UNIT, COMPUTER INTERFACE APPARATUS, NAMELY, COMPUTER MODEMS, COMPUTER MOUSE AND MOUSE PAD, COMPUTER PERIPHERALS AND PARTS THEREOF; COMPUTER PROGRAMS AND DATABASES FOR USE IN OPERAT-

ING TELECOMMUNICATIONS AND BUSINESS MANAGEMENT SYSTEMS AND RELATED INSTRUCTION MANUALS SOLD AS A UNIT; COMPUTER PROGRAMS, NAMELY, FINANCIAL ACCOUNTING SYSTEM SOFTWARE, SOFTWARE USED FOR THE PROVISION OF ONLINE INFORMATION SERVICES, NETWORK MANAGEMENT SOFTWARE, COMPUTER PROXY SOFTWARE FOR USE WITH OTHER SOFTWARE PROGRAMS, ALARM MONITORING SOFTWARE, BILLING ANALYSIS SOFTWARE, AND SOFTWARE FOR NETWORK ACCESS CONTROL, CREATING AND MAINTAINING FIREWALLS; COMPUTER PROGRAMS FOR ACCESSING A GLOBAL COMPUTER NETWORK AND INTERACTIVE COMPUTER COMMUNICATIONS NETWORK; OPTICAL CABLES, OPTIC FILTERS, OPTICAL SCANNERS, OPTICAL CHARACTER READERS, OPTICAL DISCS, OPTICAL FIBERS, OPTICAL GLASS FOR SIGNAL TRANSMISSION, OPTIC TRANSMITTERS, OPTIC RECEIVERS, OPTICAL SIGNAL PROCESSING APPARATUS, OPTIC SWITCHES, OPTICAL ATTENUATORS, OPTICAL AMPLIFIERS, OPTICAL CHARACTER RECOGNITION APPARATUS, AND PARTS THEREOF, AUDIO, VIDEO AND DATA COMMUNICATIONS SYSTEMS, NAMELY, DIGITAL AND ANALOGUE SIGNAL TRANSMITTERS, RECEIVERS AND CONVERTERS, RADIO AND TELEPHONE TRANSMITTERS, RECEIVERS AND SERVERS, ANSWERING MACHINES, TELECOMMUNICATION TRANSMISSION, RECEIVING AND STORAGE APPARATUS, NAMELY, TELECOMMUNICATIONS TRANSMITTING SETS, DATA TRANSMITTERS, FACSIMILE MACHINES, ELECTRONIC MAIL APPARATUS FOR ELECTRONIC EXCHANGE OF DATA IMAGES AND MESSAGES, REMOTE CONTROLS AND SET-TOP UNITS FOR TELEVISION, CINEMATOGRAPHIC TELEVISION AND AMUSEMENT EQUIPMENT, NAMELY, SIGNAL DECODERS, ELECTRICAL WIRE, ELECTRICAL WIRE CONNECTORS, INTEGRATED CIRCUITS, PRINTED CIRCUITS, ELECTRIC CIRCUITS, CIRCUIT BREAKERS, PRINTED CIRCUIT BOARDS, ELECTRIC CIRCUIT BOARDS, CIRCUIT CONNECTORS, ELECTRICAL CONTROLLERS, ELECTRICAL CONVERTERS, ELECTRICAL FUSES, ELECTRIC LUMINESCENT DISPLAY PANELS, ELECTRICAL SWITCH PLATES, ELECTRIC PLUGS, ANTENNAS, ELECTRICAL CABLES, COMPUTER CABLES, COMPUTER CHIPS, SILICON CHIPS, CHRONOGRAPHS FOR USE AS SPECIALIZED TIME RECORDING APPARATUS, ELECTRIC COILS, COMPUTER BUFFERS, BLANK COMPUTER DISCS, BLANK COMPUTER FLOPPY DISKS, COMPUTER HARD DISCS, ELECTRICAL CONDUCTORS, ACOUSTIC CONDUITS, ELECTRICAL CONDUITS, FIBER OPTIC CONDUITS AND PARTS THEREOF; COMPACT DISC PLAYERS, AUDIO AND VIDEO TAPE RECORDERS, AUDIO AND VIDEO TAPE PLAYERS, AUDIO AND VIDEO CASSETTE RECORDERS, AUDIO AND VIDEO CASSETTE PLAYERS, BLANK AUDIO AND VIDEO TAPES, CASSETTES, DISCS AND MICROFICHE; AUDIO AND VIDEO TAPES, CASSETTES, DISCS AND MICROFICHE FEATURING INFORMATION CONCERNING TELECOMMUNICATIONS, AND CONCERNING PERSONAL AND BUSINESS MANAGEMENT SYSTEMS; AUDIO AND VIDEO RECORDINGS IN THE FIELD OF TELECOMMUNICATIONS, INFORMATION TECHNOLOGY, AND SAFETY; TELEVISION AND TELEVISION PERIPHERAL EQUIPMENT, NAMELY CAMERAS, SET BOXES, REMOTE CONTROL UNITS FOR INTERACTIVE AND NON-INTERACTIVE USE; COMPUTER MEMORY, COMPUTER PERIPHERALS AND MODEMS; VIDEO MONITORS, AUTOMATIC VENDING MACHINES AND TIMING MECHANISMS THEREFOR, AND PARTS THEREOF; MACHINE READABLE, MAGNETICALLY ENCODED CARDS, NAMELY, TELEPHONE CALLING CARDS AND CREDIT CARDS; BLANK SMART CARDS; DATA PROCESSORS AND READERS, WORD PROCESSORS, MAGNETIC CODED CARD READERS, MAGNETIC CODED CARDS, ELECTRONIC ENCRYPTION UNITS, LASERS NOT FOR MEDICAL USE, LIGHT EMITTING DIODES, LIGHT EMITTING DIODE DISPLAYS, MICROPROCESSORS, BLANK DATA CARRIERS, DEMAGNETIZERS FOR MAGNETIC TAPES, AND PARTS THEREOF TELECONFERENCING EQUIPMENT AND AUDIOVISUAL TEACHING EQUIPMENT IN THE NATURE OF OVERHEAD FILM, PHOTOGRAPHIC AND SLIDE PROJECTORS, PROJECTION SCREENS, COMPUTER BASED INFORMATION DISPLAY EQUIPMENT, NAMELY, COMPUTERS WHICH DISPLAY INFORMATION ON AN OVERHEAD SCREEN, INTERCOMS; TELEPHONES, TELEPHONE ANSWERING MACHINES,

TELEPHONE TRANSMITTERS, TELEPHONE NETWORKS, TELEPHONE WIRES, TELEPRINTERS, TELETYPEWRITERS, AND PARTS THEREOF, NAMELY, CALLER IDENTIFICATION BOXES, DIALING ASSEMBLIES, TELEPHONE UNIT AND AUDIO OPERATED RELAYS, AUDIO OPERATED RELAYS, AUDIO/VIDEO SIGNAL AND OPTICAL FILTERS, PROTECTORS AND AUTOMATIC SIGNALING AND CONTROL EQUIPMENT, TELEMETERS, WIRELESS AND CELLULAR TELEPHONES, RADIO PAGERS, PORTABLE COMPUTER DEVICES, NAMELY LAPTOPS, HANDHELD AND POCKET COMPUTERS, FACSIMILE TRANSMITTERS AND RECEIVERS, WIRELESS FAX MACHINES, PERSONAL COMMUNICATIONS EQUIPMENT, NAMELY, PERSONAL DIGITAL ASSISTANTS, CALCULATORS AND RELATED PERIPHERALS; SATELLITE PROCESSORS, SATELLITES AND SATELLITE COMMUNICATION EARTH STATIONS BOTH STATIONARY AND MOVEABLE; AUDIO AND VIDEO RECORDINGS IN THE FIELD OF NEWS, SPORTS, ENTERTAINMENT, CULTURE, BUSINESS AND FINANCE, WEATHER AND TRAVEL; PRERECORDED COMPACT DISCS, AUDIO CASSETTE TAPES, VIDEO CASSETTE TAPES, DIGITAL AUDIO TAPES AND DIGITAL VIDEO DISCS FEATURING MUSICAL, VARIETY, NEWS AND COMEDY SHOWS; COMPUTER GAME PROGRAMS FOR CHILDREN AND ADULTS; VIDEO AND COMPUTER GAME CARTRIDGES.

FIRST USE ; IN COMMERCE .

INT. CL. 16/U.S. CLS. 2, 5, 22, 23, 29, 37, 38 AND 50

FOR PRINTED MATTER, NAMELY, TELEPHONE DIRECTORIES, BOOKS, NEWSLETTERS, PAMPHLETS, BROCHURES, MAGAZINES AND PAPERBACKS ALL IN THE FIELD OF TELECOMMUNICATIONS, PRINTED AND STAMPED PLASTIC AND CARDBOARD GREETING, BLANK, NOTE, AND INDEX CARDS; NOTE PAPER AND ENVELOPES, RUBBER STAMPS, NAME TAGS AND LABELS MADE FROM PAPER OR CARDBOARD, NOTEBOOKS, DIARIES, NOTE PAPERS, NOTE PADS, ADDRESS BOOKS, FOLDERS FOR LETTERS, FILES OR LOOSE PAPER, CLEAR HOLE REINFORCEMENTS, STUDENT CALENDARS, STAMP ALBUMS AND PHOTO-ALBUMS; PAPER WEIGHTS, LETTER OPENERS, BLOTTER PADS; DESK TRAYS, DESK STANDS AND HOLDERS FOR HOLDING STATIONERY AND OFFICE IMPLEMENTS; PRINTED INSTRUCTIONAL AND TEACHING MATERIALS ALL IN THE FIELDS OF TELECOMMUNICATIONS, INFORMATION TECHNOLOGY, SAFETY, NEWS, SPORTS, ENTERTAINMENT, CULTURE, BUSINESS AND FINANCE, WEATHER AND TRAVEL; STATIONERY, DRAWING AND UNGRADUATED RULERS, ERASERS, STAPLERS, STAPLES, PAPER CLIPS, BOOK MARKERS, CUTOUT SAMPLES AND STENCILS; SCRATCH PICTURES, PAPER, NAMELY, BOND PAPER AND ART PAPER, PVC STICKERS, GIFT WRAP PAPER; BLACKBOARDS, CHALK STICKS, ADHESIVES FOR STATIONERY OR HOUSEHOLD PURPOSES; DRAWING AND PAINTING MATERIALS, NAMELY, PENCILS, DRAWING PENCILS, PENS, DRAWING PENS, PAINT TRAYS, PAINTING SETS FOR ARTISTS, PAINTING SETS FOR CHILDREN, PAINT KITS, AND PENCIL CASES; NON-MAGNETICALLY ENCODED, PREPAID TELEPHONE CALLING CARDS.

FIRST USE ; IN COMMERCE .

INT. CL. 35/U.S. CLS. 100, 101 AND 102

FOR ADVERTISING SERVICES, NAMELY, PREPARING AND PLACING ADVERTISEMENTS FOR OTHERS PROMOTING THE GOODS AND SERVICES OF OTHERS THROUGH PRINTED ADVERTISING, PRINTED DIRECTORIES, THROUGH ENCODED MEDIA, THROUGH THE DISSEMINATION OF PROMOTIONAL MATERIALS, THROUGH DIRECT MAIL ADVERTISING, THROUGH ELECTRONIC BILLBOARD ADVERTISING, PREPARING AUDIO-VISUAL PRESENTATIONS FOR USE IN ADVERTISING; BUSINESS SERVICES, NAMELY, BUSINESS APPRAISALS, BUSINESS AUDITING, PROVIDING BUSINESS INFORMATION, NAMELY, PREPARING BUSINESS REPORTS AND CONDUCTING BUSINESS RESEARCH, ANALYSIS AND SURVEYS, BUSINESS MANAGEMENT PLANNING, BUSINESS MANAGEMENT CONSULTATION, BUSINESS MANAGEMENT SUPERVISION, CONDUCTING BUSINESS NETWORKING FOR OTHERS; BUSINESS MANAGEMENT AND CONSULTING SERVICES EXCLUDING AGRICULTURAL BUSINESS

MANAGEMENT AND CONSULTING SERVICES; BUSINESS INFORMATION SERVICES IN THE FIELD OF TELECOMMUNICATIONS, ADVERTISING, INFORMATION TECHNOLOGY, MARKETING AND RELATED FIELDS; RENTAL OF AUTOMATIC VENDING MACHINES; ORGANIZING JOB FAIRS; RENTAL OF DATA PROCESSING EQUIPMENT; PROFESSIONAL CONSULTANCY IN THE FIELD OF DATA PROCESSING; PROVIDING INFORMATION VIA THE TELEPHONE AND THE GLOBAL COMMUNICATION NETWORKS IN THE FIELD OF BUSINESS; RENTAL OF DATA PROCESSING EQUIPMENT.

FIRST USE ; IN COMMERCE .

INT. CL. 36/U.S. CLS. 100, 101 AND 102

FOR CLEARING OF SECURE FINANCIAL TRANSACTIONS THROUGH ONLINE SERVICES; FINANCIAL AND MONETARY AFFAIRS, NAMELY FINANCIAL ANALYSIS AND CONSULTATION, PROVIDING FINANCIAL INFORMATION, ISSUANCE OF SECURITIES, COMMERCIAL LENDING SERVICES, FINANCIAL PORTFOLIO MANAGEMENT, DISCOUNT BROKERAGE SERVICES, BROKERAGE OF SHARES, OF SETS AND BUSINESS VENTURES, BROKERAGE OF FUND SHARES, SECURITIES CONSULTING AND SAFE KEEPING, BROKERAGE OF PRODUCTIVE INVESTMENTS AND FUNDS; FINANCIAL SPONSORSHIP OF SPORTS, EDUCATIONAL AND ENTERTAINMENT PROGRAMS AND EVENTS; REAL ESTATE SERVICES, NAMELY BROKERAGE, MANAGEMENT, LEASING, APPRAISAL OF REAL PROPERTY; CUSTOMS BROKERAGE FOR THIRD PARTIES; MONETARY EXCHANGE; CREDIT CARD SERVICES; TELEPHONE CALLING CARD SERVICES; ELECTRONIC COMMERCE SERVICES, NAMELY, ELECTRONIC DEBIT AND CREDIT CARD PROCESSING SERVICES, FUNDS TRANSFER AND PAYMENT PROCESSING SERVICES; PROVIDING INFORMATION VIA THE TELEPHONE AND THE GLOBAL COMMUNICATION NETWORKS IN THE FIELD OF FINANCE.

FIRST USE ; IN COMMERCE .

INT. CL. 38/U.S. CLS. 100, 101 AND 104

FOR TELECOMMUNICATIONS AND INFORMATION TECHNOLOGY SERVICES, NAMELY ELECTRIC, DIGITAL, CELLULAR AND WIRELESS TRANSMISSION OF VOICE, DATA, INFORMATION, IMAGES, SIGNALS AND MESSAGES AND TRANSMISSION OF VOICE, DATA, IMAGES, AUDIO, VIDEO AND INFORMATION VIA TELEPHONE, TELEVISION AND GLOBAL COMMUNICATION NETWORKS; PROVIDING TELECOMMUNICATIONS CONNECTIONS OVER A GLOBAL COMMUNICATIONS NETWORK, ELECTRONIC MAIL, VOICE MAIL AND MESSAGING SERVICES, NAMELY, THE RECORDING AND STORAGE AND SUBSEQUENT TRANSMISSION OF VOICE MESSAGES BY TELEPHONE; RENTAL OF TELECOMMUNICATIONS EQUIPMENT, NAMELY, EQUIPMENT FOR ELECTRONIC ACCESS TO GLOBAL TELECOMMUNICATIONS NETWORK, EQUIPMENT FOR TRANSMITTING, RECEIVING, RECORDING AND MONITORING VOICE, DATA, INFORMATION, IMAGES, SIGNALS, MESSAGES, COMPRISED OF DATA AND WORD PROCESSORS, AND TELECOMMUNICATIONS HARDWARE AND SOFTWARE INCLUDING COMPONENTS AND PERIPHERALS THEREOF FOR USE IN THE TELECOMMUNICATIONS INDUSTRY, AND RENTAL OF EQUIPMENT FOR TRANSMITTING, RECEIVING, RECORDING AND MONITORING COMPUTER PROGRAMS FOR USE IN OPERATING AND ACCESSING TELECOMMUNICATIONS SYSTEMS; AUDIO AND VIDEO BROADCASTING FEATURING ENTERTAINMENT IN THE NATURE OF LIVE VISUAL AND AUDIO PERFORMANCES, AND MUSICAL, VARIETY, NEWS AND COMEDY SHOWS; PROVIDING ACCESS TO COMPUTER INFORMATION NETWORKS; PERSONAL COMMUNICATIONS SERVICES; PAGER SERVICES; ELECTRONIC MAIL SERVICES; TRANSMISSION AND BROADCAST OF AUDIO AND VIDEO PROGRAMMING; PROVIDING MULTIPLE-USER ACCESS TO A GLOBAL COMMUNICATION NETWORK; LEASING TELECOMMUNICATIONS EQUIPMENT, COMPONENTS, SYSTEMS AND SUPPLIES; CONSULTING IN THE FIELD OF TELECOMMUNICATIONS; CONSULTING IN THE FIELD OF TELECOMMUNICATIONS AND GLOBAL COMMUNICATION NETWORKS.

FIRST USE ; IN COMMERCE .

INT. CL. 39/U.S. CLS. 100 AND 105

FOR WAREHOUSE STORAGE OF GOODS; STORAGE OF GOODS RELATING TO TELECOMMUNICATIONS, COMPUTERS AND OTHER INFORMATION TECHNOLOGY DEVICES; TRANSPORTATION OF GOODS BY TRUCK, SHIP, RAILWAY AND PLANE; PROVIDING INFORMATION VIA TELEPHONE AND GLOBAL COMPUTER NETWORKS IN THE FIELD OF TRAVEL; ELECTRONIC STORAGE OF INFORMATION IN THE NATURE OF FILES AND DOCUMENTS.

FIRST USE : IN COMMERCE .

INT. CL. 41/U.S. CLS. 100, 101 AND 107

FOR EDUCATION AND INSTRUCTION, NAMELY, EDUCATIONAL SERVICES IN THE NATURE OF CLASSES AND SEMINARS IN THE FIELDS OF BUSINESS, TELECOMMUNICATIONS AND INFORMATION TECHNOLOGY, AND THE DISTRIBUTION OF COURSE MATERIALS THEREWITH; ENTERTAINMENT IN THE NATURE OF VISUAL AND AUDIO LIVE PERFORMANCES, NAMELY, MUSICAL BAND, ROCK GROUP, GYMNASTIC, DANCE, AND BALLET PERFORMANCES; ENTERTAINMENT SERVICES, NAMELY, PROVIDING ONLINE COMPUTER GAMES FOR CHILDREN AND ADULTS; PROVIDING GENERAL INFORMATION VIA TELEPHONE, TELEVISION AND GLOBAL COMMUNICATIONS NETWORKS IN THE FIELD OF ENTERTAINMENT; ORGANIZING COMMUNITY SPORTING AND CULTURAL EVENTS; PUBLICATION OF BOOKS, MAGAZINES, JOURNALS, MANUALS, BROCHURES AND LEAFLETS ON THE SUBJECT OF TELECOMMUNICATIONS; ELECTRONIC PUBLISHING SERVICES, NAMELY, PUBLICATION OF TEXT AND GRAPHIC WORKS OF OTHERS ON TELECOMMUNICATIONS RECORDED ON ELECTRONIC MEDIA; ORGANIZING FAIRS AND EXHIBITIONS IN THE FIELD OF LIVE VISUAL AND AUDIO PERFORMANCES, NAMELY, ROCK GROUP, GYMNASTIC, DANCE, AND BALLET PERFORMANCES.

FIRST USE : IN COMMERCE .

INT. CL. 42/U.S. CLS. 100 AND 101

FOR COMPUTER PROGRAMMING SERVICES FOR OTHERS; RENTAL OF SOFTWARE AND HARDWARE FOR ONLINE ACCESS; [SERVICES OF AN INTERNET TRUST CENTER, NAMELY, ASSURANCE AND ADMINISTRATION OF DIGITAL KEYS AND/OR DIGITAL CERTIFICATES;] GENERATION OF DATA PROCESSING PROGRAMS; WEB PAGE HOSTING SERVICES; COMPUTER SERVICES, NAMELY, CREATING INDEXES OF INFORMATION AVAILABLE ON COMPUTER NETWORKS; CONSULTING AND DESIGN SERVICES IN THE FIELD OF INFORMATION TECHNOLOGY, AND COMPUTER PROGRAMMING; DESIGN SERVICES IN THE FIELD OF TELECOMMUNICATIONS AND GLOBAL COMMUNICATION NETWORKS; INSTALLATION, MAINTENANCE AND REPAIR OF COMPUTER SOFTWARE.

FIRST USE : IN COMMERCE .

ELEMENTS AMENDED
GOODS/SERVICES

3,580,499. REG. 2-24-2009. DEUTSCHE TELEKOM AG (FED REP GERMANY CORPORATION) FRIEDRICH-EBERT-ALLEE 140, BONN, FED REP GERMANY, 53113, SN 78-179,124. FILED 10-28-2002. PRINCIPAL REGISTER.



PRIORITY CLAIMED UNDER SEC. 44(D) ON FED REP GERMANY APPLICATION NO. 30221215, FILED 4-29-2002, REG. NO. 30221215, DATED 7-10-2002.

OWNER OF U.S. REG. NOS. 2,367,890, 2,963,049 AND OTHERS.

NO CLAIM IS MADE TO THE EXCLUSIVE RIGHT TO USE "EMAIL", APART FROM THE MARK AS SHOWN.

THE MARK CONSISTS OF THE FOLLOWING COLORS: THE CIRCLE AROUND THE LETTER "T" IS MAGENTA; THE LETTER "T" IN A CIRCLE AND THE LINE FOLLOWING FROM THE LETTER "T" ARE WHITE; AND THE WORD "E-MAIL" IS GREY. THE APPLICANT CLAIMS COLOR AS A FEATURE OF THE MARK.

INT. CL. 9/U.S. CLS. 21, 23, 26, 36 AND 38

FOR ELECTRIC, ELECTRONIC, OPTICAL, MEASURING, SIGNALING; CONTROLLING AND TEACHING APPARATUS AND INSTRUMENTS, ALL FOR USE WITH TELECOMMUNICATIONS, NAMELY, APPARATUS FOR PRODUCING SOUND, IMAGES OR DATA, NAMELY, MAGNETIC AND OPTICAL DATA CARRIERS, DATA PROCESSORS AND COMPUTERS, NAMELY, MICROCOMPUTERS, MINICOMPUTERS, COMPUTER CENTRAL PROCESSORS, COMPUTER MONITORS, COMPUTER KEYBOARDS, COMPUTER TERMINALS, COMPUTER INTERFACE BOARDS, COMPUTER MEMORIES, COMPUTER LASER PRINTERS, COMPUTER IMPACT PRINTERS, COMPUTER DOT MATRIX PRINTERS, COMPUTER OPERATING SYSTEMS, COMPUTERS AND INSTRUCTIONAL MANUALS SOLD AS A UNIT, COMPUTER INTERFACE APPARATUS, NAMELY, COMPUTER MODEMS, COMPUTER MOUSE AND MOUSE PAD, COMPUTER PERIPHERALS AND PARTS THEREOF; COMPUTER PROGRAMS AND DATABASES FOR USE IN OPERATING TELECOMMUNICATIONS AND BUSINESS MANAGEMENT SYSTEMS AND RELATED INSTRUCTION MANUALS SOLD AS A UNIT; COMPUTER PROGRAMS, NAMELY, FINANCIAL ACCOUNTING SYSTEM SOFTWARE, SOFTWARE USED FOR THE PROVISION OF ONLINE INFORMATION SERVICES, NETWORK MANAGEMENT SOFTWARE, COMPUTER PROXY SOFTWARE FOR USE WITH OTHER SOFTWARE PROGRAMS, ALARM MONITORING SOFTWARE, BILLING ANALYSIS SOFTWARE, AND SOFTWARE FOR NETWORK ACCESS CONTROL, CREATING AND MAINTAINING FIREWALLS; COMPUTER PROGRAMS FOR ACCESSING A GLOBAL COMPUTER NETWORK AND INTERACTIVE COMPUTER COMMUNICATIONS NETWORK; OPTICAL CABLES, OPTIC FILTERS, OPTICAL SCANNERS, OPTICAL CHARACTER READERS, OPTICAL DISCS, OPTICAL FIBERS, OPTICAL GLASS FOR SIGNAL TRANSMISSION, OPTIC TRANSMITTERS, OPTIC RECEIVERS, OPTICAL SIGNAL PROCESSING APPARATUS, OPTIC SWITCHES, OPTICAL ATTENUATORS, OPTICAL AMPLIFIERS, OPTICAL CHARACTER RECOGNITION APPARATUS, AND PARTS THEREOF; AUDIO, VIDEO AND DATA COMMUNICATIONS SYSTEMS, NAMELY, DIGITAL AND ANALOGUE SIGNAL TRANSMITTERS, RECEIVERS AND CONVERTERS, RADIO AND TELEPHONE TRANSMITTERS, RECEIVERS AND SERVERS, ANSWERING MACHINES, TELECOMMUNICATION TRANSMISSION, RECEIVING AND STORAGE APPARATUS, NAMELY, TELECOMMUNICATIONS TRANSMITTING SETS, DATA TRANSMITTERS, FACSIMILE MACHINES, ELECTRONIC MAIL APPARATUS FOR ELECTRONIC EXCHANGE OF DATA IMAGES AND MESSAGES, REMOTE CONTROLS AND SET-TOP UNITS FOR TELEVISION, CINEMATOGRAPHIC TELEVISION AND AMUSEMENT EQUIPMENT, NAMELY, SIGNAL DECODERS, ELECTRICAL WIRE, ELECTRICAL WIRE CONNECTORS, INTEGRATED CIRCUITS, PRINTED CIRCUITS, ELECTRIC CIRCUITS, CIRCUIT BREAKERS,

PRINTED CIRCUIT BOARDS, ELECTRIC CIRCUIT BOARDS, CIRCUIT CONNECTORS, ELECTRICAL CONTROLLERS, ELECTRICAL CONVERTERS, ELECTRICAL FUSES, ELECTRIC LUMINESCENT DISPLAY PANELS, ELECTRICAL SWITCH PLATES, ELECTRIC PLUGS, ANTENNAS, ELECTRICAL CABLES, COMPUTER CABLES, COMPUTER CHIPS, SILICON CHIPS, CHRONOGRAPHS FOR USE AS SPECIALIZED TIME RECORDING APPARATUS, ELECTRIC COILS, COMPUTER BUFFERS, BLANK COMPUTER DISCS, BLANK COMPUTER FLOPPY DISKS, COMPUTER HARD DISCS, ELECTRICAL CONDUCTORS, ACOUSTIC CONDUITS, ELECTRICAL CONDUITS, FIBER OPTIC CONDUITS AND PARTS THEREOF; COMPACT DISC PLAYERS, AUDIO AND VIDEO TAPE RECORDERS, AUDIO AND VIDEO TAPE PLAYERS, AUDIO AND VIDEO CASSETTE RECORDERS, AUDIO AND VIDEO CASSETTE PLAYERS, BLANK AUDIO AND VIDEO TAPES, CASSETTES, DISCS AND MICROFICHE; AUDIO AND VIDEO TAPES, CASSETTES, DISCS AND MICROFICHE FEATURING INFORMATION CONCERNING TELECOMMUNICATIONS, AND CONCERNING PERSONAL AND BUSINESS MANAGEMENT SYSTEMS; AUDIO AND VIDEO RECORDINGS IN THE FIELD OF TELECOMMUNICATIONS, INFORMATION TECHNOLOGY, SAFETY; TELEVISION AND TELEVISION PERIPHERAL EQUIPMENT, NAMELY CAMERAS, SET BOXES, REMOTE CONTROL UNITS FOR INTERACTIVE AND NON-INTERACTIVE USE; COMPUTER MEMORY, COMPUTER PERIPHERALS AND MODEMS; VIDEO MONITORS, AUTOMATIC VENDING MACHINES AND TIMING MECHANISMS THEREFOR, AND PARTS THEREOF; MACHINE READABLE, MAGNETICALLY ENCODED CARDS, NAMELY, TELEPHONE CALLING CARDS AND CREDIT CARDS; BLANK SMART CARDS; DATA PROCESSORS AND READERS, WORD PROCESSORS, MAGNETIC CODED CARD READERS, ELECTRONIC ENCRYPTION UNITS, LASERS NOT FOR MEDICAL USE, LIGHT EMITTING DIODES, LIGHT EMITTING DIODE DISPLAYS, MICROPROCESSORS, BLANK DATA CARRIERS, DEMAGNETIZERS FOR MAGNETIC TAPES, AND PANS THEREOF; COMPUTER, DATA AND VIDEO NETWORKING AND CONFERENCING EQUIPMENT, NAMELY, TELECONFERENCING EQUIPMENT AND AUDIO-VISUAL TEACHING EQUIPMENT IN THE NATURE OF OVERHEAD FILM, PHOTOGRAPHIC AND SLIDE PROJECTORS, PROJECTION SCREENS, COMPUTER BASED INFORMATION DISPLAY EQUIPMENT, NAMELY, COMPUTERS WHICH DISPLAY INFORMATION ON AN OVERHEAD SCREEN, INTERCOMS; TELEPHONES, TELEPHONE ANSWERING MACHINES, TELEPHONE TRANSMITTERS, TELEPHONE NETWORKS, TELEPHONE WIRES, TELEPRINTERS, TELETYPEWRITERS, AND PARTS THEREOF, NAMELY, CALLER IDENTIFICATION BOXES, DIALING ASSEMBLIES, TELEPHONE UNITS, AUDIO OPERATED RELAYS, AUDIO OPERATED RELAYS, AUDIO/VIDEO SIGNAL AND OPTICAL FILTERS, PROTECTORS AND AUTOMATIC SIGNALING AND CONTROL EQUIPMENT, TELEMETERS, WIRELESS AND CELLULAR TELEPHONES, RADIO PAGERS, PORTABLE COMPUTER DEVICES, NAMELY LAPTOPS, HANDHELD AND POCKET COMPUTERS, FACSIMILE TRANSMITTERS AND RECEIVERS, WIRELESS FAX MACHINES, PERSONAL COMMUNICATIONS EQUIPMENT, NAMELY, PERSONAL DIGITAL ASSISTANTS (PDA), CALCULATORS AND RELATED PERIPHERALS; SATELLITE PROCESSORS, SATELLITES AND SATELLITE COMMUNICATION EARTH STATIONS BOTH STATIONARY AND MOVEABLE; AUDIO AND VIDEO RECORDINGS IN THE FIELD OF NEWS, SPORTS, ENTERTAINMENT, CULTURE, BUSINESS AND FINANCE, WEATHER AND TRAVEL; PRE-RECORDED COMPACT DISCS, AUDIO CASSETTE TAPES, VIDEO CASSETTE TAPES, DIGITAL AUDIO TAPES AND DIGITAL VIDEO DISCS FEATURING MUSICAL, VARIETY, NEWS AND COMEDY SHOWS; COMPUTER GAME PROGRAMS FOR CHILDREN AND ADULTS; VIDEO AND COMPUTER GAME CARTRIDGES.

FIRST USE ; IN COMMERCE .

FOR PRINTED MATTER, NAMELY, TELEPHONE DIRECTORIES, BOOKS, NEWSLETTERS, PAMPHLETS, BROCHURES, MAGAZINES AND PAPERBACKS ALL IN THE FIELD OF TELECOMMUNICATIONS, PRINTED AND STAMPED PLASTIC AND CARDBOARD GREETING, BLANK, NOTE, AND INDEX CARDS; NOTE PAPER AND ENVELOPES, RUBBER STAMPS, NAME TAGS AND LABELS MADE FROM PAPER OR CARDBOARD, NOTEBOOKS, DIARIES, NOTE PAPERS, NOTE PADS, ADDRESS BOOKS, FOLDERS FOR LETTERS, FILES OR LOOSE PAPER, CLEAR HOLE REINFORCEMENTS, STUDENT CALENDARS, STAMP ALBUMS AND PHOTO-ALBUMS; PAPER WEIGHTS, LETTER OPENERS, BLOTTING PADS; DESK TRAYS, DESK STANDS AND HOLDERS FOR HOLDING STATIONERY AND OFFICE IMPLEMENTS; PRINTED INSTRUCTIONAL AND TEACHING MATERIALS ALL IN THE FIELDS OF TELECOMMUNICATIONS, INFORMATION TECHNOLOGY, SAFETY, NEWS, SPORTS, ENTERTAINMENT, CULTURE, BUSINESS AND FINANCE, WEATHER AND TRAVEL; STATIONERY, DRAWING AND UNGRADUATED RULERS, ERASERS, STAPLERS, STAPLES, PAPER CLIPS, BOOK MARKERS, CUTOUT SAMPLES AND STENCILS; SCRATCH PICTURES, PAPER, NAMELY, BOND PAPER AND ART PAPER, PVC STICKERS, GIFT WRAP PAPER; BLACKBOARDS, CHALK STICKS, ADHESIVES FOR STATIONERY OR HOUSEHOLD PURPOSES; DRAWING AND PAINTING MATERIALS, NAMELY, PENCILS, DRAWING PENCILS, PENS, DRAWING PENS, PAINT TRAYS, PAINTING SETS FOR ARTISTS, PAINTING SETS FOR CHILDREN, PAINT KITS, AND PENCIL CASES; NON-MAGNETICALLY ENCODED, PREPAID TELEPHONE CALLING CARDS.

FIRST USE ; IN COMMERCE .

INT. CL. 35/U.S. CLS. 100, 101 AND 102

FOR TELEPHONE DIRECTORY SERVICES; ADVERTISING SERVICES, NAMELY, PREPARING AND PLACING ADVERTISEMENTS FOR OTHERS PROMOTING THE GOODS AND SERVICES OF OTHERS THROUGH PRINTED ADVERTISING, PRINTED DIRECTORIES, THROUGH ENCODED MEDIA, THROUGH THE DISSEMINATION OF PROMOTIONAL MATERIALS, THROUGH DIRECT MAIL ADVERTISING, THROUGH ELECTRONIC BILLBOARD ADVERTISING, PREPARING AUDIO-VISUAL PRESENTATIONS FOR USE IN ADVERTISING; BUSINESS SERVICES, NAMELY, BUSINESS APPRAISALS, BUSINESS AUDITING, PROVIDING BUSINESS INFORMATION, NAMELY, PREPARING BUSINESS REPORTS AND CONDUCTING BUSINESS RESEARCH, ANALYSIS AND SURVEYS, BUSINESS MANAGEMENT PLANNING, BUSINESS MANAGEMENT CONSULTATION, BUSINESS MANAGEMENT SUPERVISION, CONDUCTING BUSINESS NETWORKING FOR OTHERS; BUSINESS MANAGEMENT AND CONSULTING SERVICES EXCLUDING AGRICULTURAL BUSINESS MANAGEMENT AND CONSULTING SERVICES; BUSINESS INFORMATION SERVICES IN THE FIELD OF TELECOMMUNICATIONS, ADVERTISING, INFORMATION TECHNOLOGY AND MARKETING; RENTAL OF AUTOMATIC VENDING MACHINES; ORGANIZING JOB FAIRS; RENTAL OF DATA PROCESSING EQUIPMENT; PROFESSIONAL CONSULTANCY IN THE FIELD OF DATA PROCESSING; PROVIDING INFORMATION VIA THE TELEPHONE AND THE GLOBAL COMMUNICATION NETWORKS IN THE FIELD OF BUSINESS.

FIRST USE ; IN COMMERCE .

FOR INSURANCE SERVICES, NAMELY, INSURANCE BROKERAGE, INSURANCE CLAIMS PROCESSING; CLEARING OF SECURE FINANCIAL TRANSACTIONS THROUGH ONLINE SERVICES; FINANCIAL AND MONETARY AFFAIRS, NAMELY FINANCIAL ANALYSIS AND CONSULTATION, PROVIDING FINANCIAL INFORMATION, ISSUANCE OF SECURITIES, COMMERCIAL LENDING SERVICES, FINANCIAL PORTFOLIO MANAGEMENT, DISCOUNT BROKERAGE SERVICES, BROKERAGE OF SHARES, OF SETS AND BUSINESS VENTURES, BROKERAGE OF FUND SHARES, SECURITIES CONSULTING AND SAFE KEEPING, BROKERAGE OF PRODUCTIVE INVESTMENTS AND FUNDS; FINANCIAL SPONSORSHIP OF SPORTS, EDUCATIONAL AND ENTERTAINMENT PROGRAMS AND EVENTS; REAL ESTATE SERVICES, NAMELY BROKERAGE, MANAGEMENT, LEASING, APPRAISAL OF REAL PROPERTY; CUSTOMS BROKERAGE FOR THIRD PARTIES; MONETARY EXCHANGE; CREDIT CARD SERVICES; TELEPHONE CALLING CARD SERVICES; ELECTRONIC COMMERCE SERVICES, NAMELY, ELECTRONIC DEBIT AND CREDIT CARD PROCESSING SERVICES, FUNDS TRANSFER AND PAYMENT PROCESSING SERVICES; PROVIDING INFORMATION VIA THE TELEPHONE AND THE GLOBAL COMMUNICATION NETWORKS IN THE FIELD OF FINANCE.

FIRST USE ; IN COMMERCE .

FOR COMPUTER PROGRAMMING SERVICES FOR OTHERS; RENTAL OF SOFTWARE AND HARDWARE FOR ONLINE ACCESS; [SERVICES OF AN INTERNET TRUST CENTER, NAMELY, ASSURANCE AND ADMINISTRATION OF DIGITAL KEYS AND/OR DIGITAL CERTIFICATES;] GENERATION OF DATA PROCESSING PROGRAMS; WEB PAGE HOSTING SERVICES; COMPUTER SERVICES, NAMELY, CREATING INDEXES OF INFORMATION AVAILABLE ON COMPUTER NETWORKS; CONSULTING AND DESIGN SERVICES IN THE FIELDS OF INFORMATION TECHNOLOGY AND COMPUTER PROGRAMMING; DESIGN SERVICES IN THE FIELDS OF TELECOMMUNICATIONS AND GLOBAL COMMUNICATION NETWORKS; INSTALLATION, MAINTENANCE AND REPAIR OF COMPUTER SOFTWARE.

FIRST USE ; IN COMMERCE .

ELEMENTS AMENDED
GOODS/SERVICES

3,583,485. REG. 3-3-2009. EVOTEC AG (FED REP GERMANY AG) SCHNACKENBURGALLEE 114, 25252 HAMBURG, FED REP GERMANY., SN 79-039,239. FILED 3-12-2007. PRINCIPAL REGISTER.

Tomorrow's Drugs Today

PRIORITY DATE OF 9-12-2006 IS CLAIMED.

OWNER OF INTERNATIONAL REGISTRATION 0925991 DATED 3-12-2007, EXPIRES 3-12-2017.

INT. CL. 9/U.S. CLS. 21, 23, 26, 36 AND 38

FOR SCIENTIFIC APPARATUS AND INSTRUMENTS, NAMELY, SCREENING TECHNOLOGY, NAMELY, DETECTORS, INCUBATORS AND SPECTROSCOPES, MICROSCOPES, CONFOCAL MICROSCOPES, IMAGING TECHNOLOGY, NAMELY, IMAGING APPARATUS FOR BIOLOGICAL TISSUE, NAMELY, BLOOD, STEM CELLS, UMBILICAL CORDS, PLACENTAS, STEM CELLS FROM HUMAN EXFOLIATED DECIDUOUS TEEH, CELLS IN A RESEARCH LABORATORY ENVIRONMENT, AND SOFTWARE FOR VIEWING AND ANALYZING DIGITAL IMAGES, ROBOTTING SYSTEMS, NAMELY, LABORATORY ROBOTS; LASERS, NOT FOR MEDICAL USE; PIPETTES, CHIP SYSTEMS, NAMELY, SENSOR CHIPS FOR SCIENTIFIC USE, CHEMICAL APPARATUS AND INSTRUMENTS AS COMPUTER HARDWARE .

FIRST USE ; IN COMMERCE .

INT. CL. 42/U.S. CLS. 100 AND 101

FOR [SCIENTIFIC AND TECHNOLOGICAL SERVICES, NAMELY, SCIENTIFIC RESEARCH IN THE FIELD OF PHARMACEUTICALS, FOOD SUPPLEMENTS, AGRICULTURAL CHEMICALS, DIAGNOSTIC PREPARATIONS, REAGENT AND RAW MATERIAL DEVELOPMENT AND PRODUCTION, ASSAY DEVELOPMENT, SCREENING, NAMELY, DISEASE SCREENING, AND SCREENING FOR BIOLOGICAL ACTIVITY OR INTERACTION, PROFILING, NAMELY, MEDICAL PROFILING, AND ANALYSIS AND CHARACTERIZATION OF CHEMICAL COMPOUNDS WITH RESPECT TO THEIR DOSE-RESPONSIVE ACTIVITIES AND TO THEIR INTERACTION WITH THE MEMBERS OF THE SAME TARGET FAMILY, NAMELY, THE FAMILY OF SPECIFIC BIOLOGICAL MOLECULES, CHEMICAL SYNTHESIS, CHEMICAL ANALYSIS, CRYSTALLOGRAPHIC ANALYSIS, VIRTUAL SCREENING, IN THE NATURE OF EVALUATING CHEMICAL COMPOUNDS USING COMPUTER PROGRAMS, MOLECULAR MODELING, STRUCTURE-ACTIVITY-RELATIONSHIP ANALYSIS, COMPUTATIONAL CHEMISTRY; TECHNICAL RESEARCH IN THE FIELDS OF SCREENING TECHNOLOGY, MICROSCOPES, CONFOCAL MICROSCOPES, IMAGING TECHNOLOGY, ROBOTTING SYSTEMS, LASERS, LIQUID HANDLING TECHNOLOGY DISPENSERS, PIPETTES, CHIP SYSTEMS, CHEMICAL AND BIOLOGICAL SYNTHESIS AND PRODUCTION TECHNOLOGY, REACTORS, PURIFICATION TECHNOLOGY, ANALYSIS TECHNOLOGY, PHARMACEUTICAL FORMULATION TECHNOLOGY, NUCLEAR MAGNETIC RESONANCE TECHNOLOGY, X-RAY TECHNOLOGY; RESEARCH AND DEVELOPMENT

INT. CL. 38/U.S. CLS. 100, 101 AND 104

FOR TELECOMMUNICATIONS AND INFORMATION TECHNOLOGY SERVICES, NAMELY ELECTRIC, DIGITAL, CELLULAR AND WIRELESS TRANSMISSION OF VOICE, DATA, INFORMATION, IMAGES, SIGNALS AND MESSAGES AND TRANSMISSION OF VOICE, DATA, IMAGES, AUDIO, VIDEO AND INFORMATION VIA TELEPHONE, TELEVISION AND GLOBAL COMMUNICATION NETWORKS; PROVIDING TELECOMMUNICATIONS CONNECTIONS OVER A GLOBAL COMMUNICATIONS NETWORK, ELECTRONIC MAIL, VOICE MAIL AND MESSAGING SERVICES, NAMELY, THE RECORDING AND STORAGE AND SUBSEQUENT TRANSMISSION OF VOICE MESSAGES BY TELEPHONE; RENTAL OF TELECOMMUNICATIONS EQUIPMENT, NAMELY, EQUIPMENT FOR ELECTRONIC ACCESS TO GLOBAL TELECOMMUNICATIONS NETWORK, EQUIPMENT FOR TRANSMITTING, RECEIVING, RECORDING AND MONITORING VOICE, DATA, INFORMATION, IMAGES, SIGNALS, MESSAGES, COMPRISED OF DATA AND WORD PROCESSORS, AND TELECOMMUNICATIONS HARDWARE AND SOFTWARE INCLUDING COMPONENTS AND PERIPHERALS THEREOF FOR USE IN THE TELECOMMUNICATIONS INDUSTRY, AND RENTAL OF EQUIPMENT FOR TRANSMITTING, RECEIVING, RECORDING AND MONITORING COMPUTER PROGRAMS FOR USE IN OPERATING AND ACCESSING TELECOMMUNICATIONS SYSTEMS; AUDIO AND VIDEO BROADCASTING FEATURING ENTERTAINMENT IN THE NATURE OF LIVE VISUAL AND AUDIO PERFORMANCES AND MUSICAL, VARIETY, NEWS AND COMEDY SHOWS; PROVIDING ACCESS TO COMPUTER INFORMATION NETWORKS; PERSONAL COMMUNICATIONS SERVICES; PAGER SERVICES; ELECTRONIC MAIL SERVICES; TRANSMISSION AND BROADCAST OF AUDIO AND VIDEO PROGRAMMING; PROVIDING MULTIPLE-USER ACCESS TO A GLOBAL COMMUNICATION NETWORK; LEASING TELECOMMUNICATIONS EQUIPMENT, COMPONENTS, SYSTEMS AND SUPPLIES; CONSULTING IN THE FIELD OF TELECOMMUNICATION; CONSULTING IN THE FIELDS OF TELECOMMUNICATIONS AND GLOBAL COMMUNICATION NETWORKS.

FIRST USE ; IN COMMERCE .

INT. CL. 42/U.S. CLS. 100 AND 101

OF PHARMACEUTICALS, FOOD SUPPLEMENTS, AGRICULTURAL CHEMICALS, DIAGNOSTIC PREPARATIONS; INDUSTRIAL ANALYSIS AND SCIENTIFIC, PRODUCT, AND PHARMACEUTICAL RESEARCH SERVICES IN THE FIELD OF PHARMACEUTICALS, FOOD SUPPLEMENTS, DIAGNOSTIC PREPARATIONS, AGRICULTURAL CHEMICALS PREPARATIONS, REAGENT AND RAW MATERIAL DEVELOPMENT AND PRODUCTION, ASSAY DEVELOPMENT, SCREENING, NAMELY, DISEASE SCREENING, AND SCREENING FOR BIOLOGICAL ACTIVITY OR INTERACTION, PROFILING, NAMELY, MEDICAL PROFILING, AND ANALYSIS AND CHARACTERIZATION OF CHEMICAL COMPOUNDS WITH RESPECT TO THEIR DOSE-RESPONSIVE ACTIVITIES AND TO THEIR INTERACTION WITH THE MEMBERS OF THE SAME TARGET FAMILY, NAMELY, THE FAMILY OF SPECIFIC BIOLOGICAL MOLECULES, CHEMICAL SYNTHESIS, CHEMICAL ANALYSIS, CRYSTALLOGRAPHIC ANALYSIS, VIRTUAL SCREENING IN THE NATURE OF EVALUATING CHEMICAL COMPOUNDS USING COMPUTER PROGRAMS, MOLECULAR MODELING, STRUCTURE-ACTIVITY-RELATIONSHIP ANALYSIS, COMPUTATIONAL CHEMISTRY; RESEARCH AND SCIENTIFIC ADVICE IN THE FIELD OF PHARMACEUTICALS;] DESIGN AND DEVELOPMENT OF COMPUTER HARDWARE AND SOFTWARE [; RESEARCH AND DEVELOPMENT IN THE AREAS OF BIOTECHNOLOGY, PHARMACY, MEDICINE, DIAGNOSTICS AND CHEMISTRY, NAMELY, SYNTHESIS, MODIFICATIONS OR DERIVATISATION OF MOLECULES, IN PARTICULAR FOR THE CREATION OF SUBSTANCE LIBRARIES].

FIRST USE ; IN COMMERCE .
 INT. CL. 44/U.S. CLS. 100 AND 101
 FOR MEDICAL SERVICES, VETERINARY SERVICES; MEDICAL, VETERINARY, AGRICULTURAL, HORTICULTURAL ADVICE.
 FIRST USE ; IN COMMERCE .

ELEMENTS CORRECTED
 GOODS/SERVICES
 [INTERNATIONAL CLASS(ES)]

3,584,465. REG. 3-3-2009. DISNEY ENTERPRISES, INC. (DELAWARE CORPORATION) 500 SOUTH BUENA VISTA STREET, BURBANK, CA, 91521, SN 77-976,429. FILED 2-5-2007. PRINCIPAL REGISTER.

MINNIE MOUSE

THE MARK CONSISTS OF STANDARD CHARACTERS WITHOUT CLAIM TO ANY PARTICULAR FONT, STYLE, SIZE, OR COLOR.

OWNER OF U.S. REG. NOS. 3,002,502, 3,102,338 AND 3,131,283.

INT. CL. 9/U.S. CLS. 21, 23, 26, 36 AND 38
 FOR PRE-RECORDED COMPACT DISCS FEATURING MUSIC, STORIES, GAMES AND ACTIVITIES; PRE-RECORDED DIGITAL VIDEO DISCS AND DIGITAL VERSATILE DISCS FEATURING MOVIES, MUSIC, GAMES AND ANIMATED ENTERTAINMENT; CD-ROM DISCS, COMPUTER GAME PROGRAMS AND COMPUTER SOFTWARE FEATURING LEARNING ACTIVITIES, GAMES AND ENTERTAINMENT; MOTION PICTURE FILMS FEATURING ANIMATED AND LIVE-ACTION ENTERTAINMENT FOR CHILDREN; SUNGLASSES; CONSUMER ELECTRONIC GOODS, NAMELY, NON-TETHERED STILL DIGITAL CAMERAS.

FIRST USE 3-27-2008; IN COMMERCE 3-27-2008.

ELEMENTS CORRECTED
 CITIZENSHIP

3,585,343. REG. 3-10-2009. CADOGAN TATE GROUP LIMITED (UNITED KINGDOM LIMITED COMPANY (LTD.)) CADOGAN HOUSE, 239 ACTON LANE, LONDON, UNITED KINGDOM, NW107NP, SN 77-278,390. FILED 9-12-2007. PRINCIPAL REGISTER.

CADOGAN TATE

THE MARK CONSISTS OF STANDARD CHARACTERS WITHOUT CLAIM TO ANY PARTICULAR FONT, STYLE, SIZE, OR COLOR.

PRIORITY CLAIMED UNDER SEC. 44(D) ON ERP NCMNTY TM OFC APPLICATION NO. 005769328, FILED 3-19-2007, REG. NO. 003305307, DATED 4-21-2005, EXPIRES 8-8-2013.

INT. CL. 39/U.S. CLS. 100 AND 105

FOR TRANSPORT AND STORAGE OF GOODS; PACKAGING ARTICLES FOR TRANSPORTATION; JUNK REMOVAL SERVICES; FREIGHT FORWARDING SERVICES, PACKING OR WRAPPING OF GOODS TO BE STORED OR TRANSPORTED; RENTAL OF TRUCKS, VANS OR VEHICLES FOR TRANSPORTING GOODS; RENTAL OF STORAGE CONTAINERS; STORAGE OF GOODS; STORAGE OF GOODS USING CONTROLLED ENVIRONMENTS; STORAGE, PACKING AND SHIPPING OF FINE ART; RESIDENTIAL FURNITURE MOVING, MOVING VAN AND STORAGE SERVICES; WAREHOUSING AND STORAGE OF GOODS AND PERSONAL BELONGINGS; PROVIDING SELF-STORAGE FACILITIES FOR OTHERS, AND RENTAL OF WAREHOUSE AND STORAGE SPACE; DATA STORAGE SERVICES FOR BUSINESSES, NAMELY STORAGE OF BUSINESS DATA IN PAPER AND ELECTRONIC FORM AND STORAGE OF ELECTRICALLY STORED BUSINESS DATA AND DOCUMENTS.

FIRST USE 12-31-1997; IN COMMERCE 12-31-1997.

ELEMENTS CORRECTED
 FOREIGN COUNTRY OF ORIGIN
 FOREIGN REG. NO.
 FOREIGN REG. DATE
 FOREIGN REG. EXPIRATION DATE

3,591,398. REG. 3-17-2009. LITHOS BOUW B.V. (NETHERLANDS B.V.) SPACESHUTTLE 38, NL-3824 ML AMERSFOORT, NETHERLANDS., SN 79-048,731. FILED 7-13-2007. PRINCIPAL REGISTER.



PRIORITY DATE OF 7-6-2007 IS CLAIMED.
OWNER OF INTERNATIONAL REGISTRATION 0950101 DATED 7-13-2007, EXPIRES 7-13-2017.

NO CLAIM IS MADE TO THE EXCLUSIVE RIGHT TO USE "ROBUST AND FLEXIBLE", APART FROM THE MARK AS SHOWN.

THE COLOR(S) BLUE, DARK BLUE, GREEN, AND GRAY IS/ARE CLAIMED AS A FEATURE OF THE MARK.

THE MARK CONSISTS OF THE WORD "FLEXDC" ABOVE THE WORDS "ROBUST AND FLEXIBLE", AND A FOUR POINTED DESIGN ELEMENT TO THE LEFT; THE COLOR BLUE APPEARS AS THE FOUR POINTED DESIGN ELEMENT; THE COLOR DARK BLUE APPEARS AS THE OUTLINE OF THE FOUR POINTED DESIGN ELEMENT AND AS THE WORDING "FLEXDC" AND "ROBUST AND FLEXIBLE"; THE COLOR GREEN APPEARS AS THE TWO OVERTURNED EDGES OF THE FOUR POINTED DESIGN; THE COLOR GRAY APPEARS AS THE SHADOW OF THE FOUR POINTED DESIGN.

INT. CL. 6/U.S. CLS. 2, 12, 13, 14, 23, 25 AND 50

FOR COMMON METALS AND THEIR ALLOYS; METAL BUILDING MATERIALS, NAMELY, WALL PANELS, CEILING PANELS, CEILING SUPPORTS, TUBES, FRAMEWORKS, DOORS, DOOR PANELS, SOFFITS, FASCIA, METAL TRIM FOR BUILDINGS AND ROOFING TILES; SMALL ITEMS OF METAL HARDWARE, NAMELY, PULLEYS, SPRINGS, NUTS, WASHERS, THIMBLES, LOCKS AND KEYS THEREFOR, KEY BLANKS AND PADLOCKS; GOODS OF COMMON METAL NOT INCLUDED IN OTHER CLASSES, NAMELY, BARREL HOOPS OF METAL, BOXES OF COMMON METAL, RING-SHAPED FITTINGS OF METAL, PIPES, BOLTS, VALVES, CASINGS; PARTITIONS OF METAL, NAMELY, METAL PARTITION WALLS; PREFABRICATED METAL WALL PANELS AND STRUCTURAL PARTS THEREFOR, NAMELY, METAL SECTIONS, METAL CONNECTING PIECES AND METAL BUILDING ANCHORS; TRANSPORTABLE BUILDINGS OF METAL; METAL WALLS, PREFABRICATED METAL PARTITION WALLS AND METAL SYSTEM WALLS AND OTHER PREFABRICATED METAL WALLS, NAMELY, WALL PANELS OF METAL AND METAL CURTAIN WALLS; METAL FLOORS AND FLOOR PARTS, NAMELY, METAL FLOOR TILES AND METAL EXPANSION JOINTS FOR FLOORS; WINDOW SCREENS OF METAL.

FIRST USE ; IN COMMERCE .

INT. CL. 9/U.S. CLS. 21, 23, 26, 36 AND 38

FOR SCIENTIFIC, NAUTICAL, SURVEYING, PHOTOGRAPHIC, CINEMATOGRAPHIC, OPTICAL, WEIGHING, MEASURING, SIGNALING, CHECKING, SUPERVISION, LIFE-SAVING AND TEACHING APPARATUS AND INSTRUMENTS, NAMELY, LEVEL MEASURING MACHINES, SURVEYING MACHINES AND INSTRUMENTS, PHOTOGRAPHIC CAMERAS, CINEMATOGRAPHIC CAMERAS, VIDEO CAMERAS, OPTICAL LENSES, SCALES, MEASURING TAPES AND SIGNALING BUOYS; APPARATUS AND INSTRUMENTS FOR CONDUCTING, SWITCHING, TRANSFORMING, ACCUMULATING, REGULATING OR CONTROLLING ELECTRICITY, NAMELY, ELECTRICAL CONDUCTORS, ELECTRICAL SWITCHES, ELECTRICAL TRANSFORMERS, ELECTRIC ACCUMULATORS AND VOLTAGE REGULATORS FOR ELECTRIC POWER; DATA PROCESSING EQUIPMENT, NAMELY, DATA PROCESSORS; COMPUTERS; COMPUTER HARDWARE; COMPUTER PERIPHERAL DEVICES; UNINTERRUPTIBLE POWER SUPPLIES FOR COMPUTERS; INTERNAL COOLING FANS FOR COMPUTERS; POWER SUPPLIES, NAMELY, EMERGENCY POWER SUPPLIES AND UN-

INTERRUPTIBLE POWER SUPPLY SYSTEMS; TELECOMMUNICATIONS APPARATUS, NAMELY, WIRELESS ACCESS POINT (WAP) DEVICES, WIRELESS NETWORK REPEATERS, WIRELESS NETWORK EXTENDERS, AMPLIFIER FOR WIRELESS COMMUNICATIONS, ANTENNAS FOR WIRELESS COMMUNICATIONS APPARATUS AND APPARATUS FOR WIRELESS TRANSMISSION OF ACOUSTIC INFORMATION; MODEMS; SWITCHING DEVICES, NAMELY, POWER SWITCHES, COMPUTER SWITCHES AND DIFFERENTIAL SWITCHES; THE AFORESAID GOODS FOR THE EQUIPPING OF DATA CENTRES.

FIRST USE ; IN COMMERCE .

INT. CL. 19/U.S. CLS. 1, 12, 33 AND 50

FOR NON-METALLIC BUILDING MATERIALS, NAMELY, BUILDING GLASS, SEMI-WORKED WOODS, PLASTIC PIPE SUPPORTS, FLY ASH, COMPOSITE PANELS COMPOSED PRIMARILY OF NON-METAL MATERIALS, WALL BOARDS, DECKING BOARDS, WOOD BOARDS, NON-METAL BUILDING ANCHORS, NON-METAL MANDRELS AND NON-METALLIC REINFORCEMENTS FOR CONCRETE AND WOOD BUILDING CONSTRUCTION, NAMELY, PLATES, RODS AND BARS; NON-METALLIC TRANSPORTABLE BUILDINGS; MONUMENTS, NOT OF METAL, NAMELY, MONUMENTS OF STONE, CONCRETE OR MARBLE; NON-METAL DOORS; NON-METAL DOOR FRAMES; PARTITION WALLS, NOT OF METAL; PREFABRICATED WALLS PANELS NOT OF METAL AND STRUCTURAL PARTS THEREFOR, NAMELY, NON-METAL WALL SECTIONS AND NON-METAL CONNECTING PIECES; BUILDING MATERIALS NOT OF METAL WHICH WHEN COMBINED AND ASSEMBLED CONSTITUTE A PREFABRICATED DATA CENTRE, NAMELY, BUILDING GLASS, SEMI-WORKED WOODS, PLASTIC PIPE SUPPORTS, FLY ASH, COMPOSITE PANELS COMPOSED PRIMARILY OF NON-METAL MATERIALS, WALL BOARDS, DECKING BOARDS, WOOD BOARDS, NON-METAL MANDRELS AND NON-METALLIC REINFORCEMENTS FOR CONCRETE AND WOOD BUILDING CONSTRUCTION, NAMELY, PLATES, RODS AND BARS.

FIRST USE ; IN COMMERCE .

INT. CL. 35/U.S. CLS. 100, 101 AND 102

FOR MEDIATION OF AGREEMENTS REGARDING THE SALE AND PURCHASE OF GOODS, NAMELY, PROFESSIONAL BUSINESS MEDIATION IN RESPECT OF AGREEMENTS REGARDING THE PURCHASE AND SALE AND IMPORT AND EXPORT OF COMMON METALS AND THEIR ALLOYS, BUILDING MATERIALS, TRANSPORTABLE BUILDINGS, SMALL ITEMS OF METAL HARDWARE, GOODS OF COMMON METAL, METAL DOORS AND FRAMES, PARTITION WALLS, PARTS FOR BUILDING ELEMENTS, PREFABRICATED WALLS AND PARTS THEREFOR, INCLUDING SECTIONS, CONNECTING PIECES, BUILDING ANCHORS, SEMI-FINISHED PRODUCTS OF METAL, WALLS, PREFABRICATED PARTITION WALLS AND SYSTEM WALLS AND OTHER PREFABRICATED WALLS, FLOORS AND FLOOR PARTS AND SCREENS OF METAL, BUILDING MATERIALS WHICH WHEN COMBINED AND ASSEMBLED CONSTITUTE A PREFABRICATED DATA CENTRE, SCIENTIFIC, NAUTICAL, SURVEYING, PHOTOGRAPHIC, CINEMATOGRAPHIC, OPTICAL, WEIGHING, MEASURING, SIGNALING, CHECKING, SUPERVISION, LIFE-SAVING AND TEACHING APPARATUS AND INSTRUMENTS, APPARATUS AND INSTRUMENTS FOR CONDUCTING, SWITCHING, TRANSFORMING, ACCUMULATING, REGULATING OR CONTROLLING ELECTRICITY, DATA PROCESSING EQUIPMENT, COMPUTERS, COMPUTER HARDWARE, COMPUTER PERIPHERAL DEVICES, UNINTERRUPTIBLE POWER SUPPLY UNITS, IN PARTICULAR FOR COMPUTERS, COOLING FANS, BEING PARTS FOR COMPUTERS, EMERGENCY POWER APPARATUS AND INSTALLATIONS, INCLUDING UNINTERRUPTIBLE POWER SUPPLY SYSTEMS,

TELECOMMUNICATIONS APPARATUS, INCLUDING ELECTRONIC APPARATUS FOR WIRELESS COMMUNICATIONS AND WIRELESS COMPUTER NETWORKS, MODEMS AND SWITCHING DEVICES; ADVERTISING AND PUBLICITY SERVICES; SALES PROMOTION SERVICES; CONSULTANCY AND INFORMATION ON THE AFORESAID SERVICES VIA ELECTRONIC NETWORKS SUCH AS THE INTERNET, NAMELY, CONSULTATION SERVICES IN THE FIELDS OF MEDIATION OF AGREEMENTS REGARDING THE SALE AND PURCHASE OF GOODS, ADVERTISING AND PUBLICITY SERVICES AND SALES PROMOTION SERVICES.

FIRST USE ; IN COMMERCE .

INT. CL. 37/U.S. CLS. 100, 103 AND 106

FOR BUILDING CONSTRUCTION SERVICES; INSTALLATION SERVICES, NAMELY, INSTALLATION OF METAL BUILDING MATERIALS, NON-METALLIC BUILDING MATERIALS, BUILDING INSULATION, WALLS, PANELS, DOORS, WINDOWS, ELECTRICAL SYSTEMS, COMPUTER SYSTEMS AND APPLIANCES; INSTALLATION IN THE NATURE OF POSITIONING, AND REPAIR OF PROFILE SYSTEMS, SYSTEM WALLS, AND SYSTEM FLOORS IN BUILDINGS; PROVIDING INFORMATION IN THE FIELD OF BUILDING CONSTRUCTION; BUILDING CONSTRUCTION SUPERVISION AND MANAGEMENT; BUILDING CONTRACTING, NAMELY, GENERAL CONSTRUCTION CONTRACTING AND ROOFING CONTRACTING; INSTALLATION OF INSULATING MATERIALS; REPAIR AND MAINTENANCE OF BUILDING STRUCTURES AND BUILDINGS; CONSTRUCTION CONSULTANCY, NAMELY, TECHNICAL CONSTRUCTION CONSULTANCY REGARDING THE USE AND APPLICATION OF PARTS IN AND FOR BUILDING COMPONENTS, SYSTEM WALLS AND SYSTEM FLOORS; CONSTRUCTION OF DATA CENTERS, NAMELY, INSTALLATION, ASSEMBLY, POSITIONING AND COMBINING OF PREFABRICATED BUILDING MATERIALS TO FORM DATA CENTERS; INSTALLATION, MAINTENANCE AND REPAIR OF COMPUTERS, COMPUTER HARDWARE, COMPUTER PERIPHERAL DEVICES, UNINTERRUPTIBLE POWER SUPPLY UNITS FOR COMPUTERS, COOLING FANS FOR COMPUTERS, EMERGENCY POWER APPARATUS AND INSTALLATIONS, NAMELY, UNINTERRUPTIBLE POWER SUPPLY SYSTEMS, TELECOMMUNICATIONS APPARATUS, NAMELY, ELECTRONIC APPARATUS FOR WIRELESS COMMUNICATIONS AND WIRELESS COMPUTER NETWORKS, MODEMS AND SWITCHING DEVICES; TECHNICAL CONSULTANCY, NAMELY, CONSTRUCTION CONSULTANCY; PROVIDING INFORMATION ON THE AFORESAID SERVICES.

FIRST USE ; IN COMMERCE .

INT. CL. 42/U.S. CLS. 100 AND 101

FOR DESIGN AND DEVELOPMENT OF NEW PRODUCTS FOR OTHERS, NAMELY, DESIGN AND DEVELOPMENT OF BUILDING MATERIALS, TRANSPORTABLE BUILDINGS, SMALL ITEMS OF METAL HARDWARE, GOODS OF COMMON METAL, METAL DOORS AND FRAMES, PARTITION WALLS, PARTS FOR BUILDING ELEMENTS, PREFABRICATED WALLS AND PARTS THEREFOR, INCLUDING SECTIONS, CONNECTING PIECES, BUILDING ANCHORS, SEMI-FINISHED PRODUCTS OF METAL, WALLS, PREFABRICATED PARTITION WALLS AND SYSTEM WALLS AND OTHER PREFABRICATED WALLS, FLOORS AND FLOOR PARTS AND SCREENS OF METAL, BUILDING MATERIALS WHICH WHEN COMBINED AND ASSEMBLED CONSTITUTE A PREFABRICATED DATA CENTRE, SCIENTIFIC, NAUTICAL, SURVEYING, PHOTOGRAPHIC, CINEMATOGRAPHIC, OPTICAL, WEIGHING, MEASURING, SIGNALING, CHECKING, SUPERVISION, LIFE-SAVING AND TEACHING APPARATUS AND INSTRUMENTS, APPARATUS AND INSTRUMENTS FOR CONDUCTING, SWITCHING, TRANSFORMING, ACCUMULATING, REGULATING OR CONTROLLING ELECTRICITY, DATA PROCESSING EQUIPMENT, COMPUTERS, COMPUTER HARDWARE, COMPUTER PERIPHERAL DEVICES, UNINTERRUPTIBLE POWER SUPPLY UNITS, IN PARTICULAR FOR COMPUTERS, COOLING FANS, BEING PARTS FOR COMPUTERS, EMERGENCY POWER APPARATUS AND INSTALLATIONS, INCLUDING UNINTERRUPTIBLE POWER SUPPLY SYSTEMS, TELECOMMUNICATIONS APPARATUS, INCLUDING ELECTRONIC APPARATUS FOR WIRELESS COMMUNICATIONS AND WIRELESS COMPUTER NETWORKS, MODEMS AND SWITCHING DEVICES; CONSULTING IN THE FIELD OF ENGINEERING AND ARCHI-

TECTURE, NAMELY, PLANNING AND CONSULTANCY OFFERED BY ENGINEERS REGARDING BUILDING CONSTRUCTION AND TECHNICAL ASSESSMENT OF BUILDING PLANS, PROJECT STUDIES REGARDING BUILDING WORKS, AND EVALUATION OF THE RESULTS; CONSULTING IN THE FIELD OF ENGINEERING AND ARCHITECTURE, NAMELY, DESIGN AND PLANNING AND CONSULTANCY REGARDING BUILDING CONSTRUCTION AS PART OF THE DEVELOPMENT OF BUILDING PROJECTS, AND EVALUATION OF THE RESULTS; ARCHITECTURAL AND ENGINEERING SERVICES FOR BUILDING CONSTRUCTION; ENGINEERING SERVICES, NAMELY, DRAWING-UP OF EXPERT REPORTS BY ENGINEERS; TECHNICAL BUILDING CONSTRUCTION CONSULTANCY; QUALITY CONTROL FOR OTHERS, NAMELY, QUALITY CONTROL FOR BUILDING CONSTRUCTION AND BUILDING WORKS; PROVIDING QUALITY ASSURANCE SERVICES IN THE FIELD OF BUILDING CONSTRUCTION AND BUILDING WORKS; ENGINEERING; [OPERATION OF DATA CENTRES' COMPUTER SYSTEMS, NAMELY, PROVIDING, HOSTING, MANAGING, DEVELOPING, RESEARCHING, ANALYZING, REPORTING, AND MAINTAINING APPLICATIONS, SOFTWARE, WEB SITES, AND DATABASES OF OTHERS IN THE FIELDS OF BUILDING CONSTRUCTION, ENGINEERING AND ARCHITECTURE;] CONSULTANCY AND PROVIDING INFORMATION ON THE AFORESAID SERVICES VIA ELECTRONIC NETWORKS SUCH AS THE INTERNET.

FIRST USE ; IN COMMERCE .

ELEMENTS CORRECTED
GOODS/SERVICES

3,622,967. REG. 5-19-2009. BPI US HOLDING, LLC (ILLINOIS LIMITED LIABILITY COMPANY) 1 N FRANKLIN STREET, SUITE 1100, CHICAGO, IL, 60606, SN 77-605,014. FILED 10-31-2008. PRINCIPAL REGISTER.

THE MARK CONSISTS OF STANDARD CHARACTERS WITHOUT CLAIM TO ANY PARTICULAR FONT, STYLE, SIZE, OR COLOR.

INT. CL. 41/U.S. CLS. 100, 101 AND 107

FOR CAREER SERVICES, NAMELY, CAREER COACHING AND CAREER COUNSELING FOR YOUNG ADULTS; CONDUCTING WORKSHOPS FOR YOUNG ADULTS IN THE FIELD OF CAREER PLANNING.

FIRST USE 12-29-2008; IN COMMERCE 12-29-2008.

ELEMENTS CORRECTED
OWNER NAME
CITIZENSHIP

3,626,960. REG. 5-26-2009. RAPID REFILL CORP. (MINNESOTA CORPORATION) 18732 LAKE DRIVE EAST, CHANNASSEN, MN, 55317, SN 77-976,422. FILED 7-23-2007. PRINCIPAL REGISTER.

RAPID REFILL

THE MARK CONSISTS OF STANDARD CHARACTERS WITHOUT CLAIM TO ANY PARTICULAR FONT, STYLE, SIZE, OR COLOR.

OWNER OF U.S. REG. NO. 2,918,486.

NO CLAIM IS MADE TO THE EXCLUSIVE RIGHT TO USE "REFILL", APART FROM THE MARK AS SHOWN.

INT. CL. 2/U.S. CLS. 6, 11 AND 16

FOR PRINTER INK CARTRIDGES AND TONER CARTRIDGES.

FIRST USE 9-24-2007. THE MARK WAS FIRST USED ANYWHERE IN A DIFFERENT FORM OTHER THAN THAT SOUGHT TO BE REGISTERED AT LEAST AS EARLY AS 10/01/2002.; IN COMMERCE 9-24-2007.

INT. CL. 35/U.S. CLS. 100, 101 AND 102

FOR RETAIL STORE SERVICES FEATURING NEW AND RECYCLED OR REMANUFACTURED PRINTER CARTRIDGES AND TONER CARTRIDGES, PAPER, BLANK DIGITAL STORAGE MEDIA, AND SUPPLIES FOR PRINTERS, FAX MACHINES AND COPIERS.

FIRST USE 9-24-2007. THE MARK WAS FIRST USED ANYWHERE IN A DIFFERENT FORM OTHER THAN THAT SOUGHT TO BE REGISTERED AT LEAST AS EARLY AS 10/01/2002.; IN COMMERCE 9-24-2007.

INT. CL. 40/U.S. CLS. 100, 103 AND 106

FOR RECYCLING OF PRINTER CARTRIDGES AND TONER CARTRIDGES.

FIRST USE 9-24-2007. THE MARK WAS FIRST USED ANYWHERE IN A DIFFERENT FORM OTHER THAN THAT SOUGHT TO BE REGISTERED AT LEAST AS EARLY AS 10/01/2002.; IN COMMERCE 9-24-2007.

ELEMENTS CORRECTED

USE IN ANOTHER FORM STATEMENT

3,629,121. REG. 6-2-2009. DEUTSCHE TELEKOM AG (FED REP GERMANY CORPORATION) FRIEDRICH-EBERT-ALLEE 140, 53113 BONN, FED REP GERMANY., SN 76-177,036. FILED 12-7-2000. PRINCIPAL REGISTER.



PRIORITY CLAIMED UNDER SEC. 44(D) ON FED REP GERMANY APPLICATION NO. 30043201.1, FILED 6-7-2000, REG. NO. 30043201, DATED 9-7-2000.

THE LETTER "T" WITH THE SWIRL ON THE DRAWING PAGE IS THE COLOR WHITE. THE BACKGROUND OF THE CIRCLE ON THE DRAWING PAGE IS THE COLOR MAGENTA. THE WORD "INFO" ON THE DRAWING PAGE IS THE COLOR GRAY. APPLICANT HEREBY CLAIMS THE COLORS MAGENTA, GRAY AND WHITE AS FEATURES OF THE MARK.

INT. CL. 9/U.S. CLS. 21, 23, 26, 36 AND 38

FOR ELECTRIC, ELECTRONIC, OPTICAL, MEASURING, SIGNALING, CONTROLLING OR TEACHING APPARATUS AND INSTRUMENTS, ALL FOR USE WITH TELECOMMUNICATIONS, NAMELY, APPARATUS FOR PRODUCING SOUND, IMAGES OR DATA, MAGNETIC AND OPTICAL DATA CARRIERS, DATA PROCESSORS AND COMPUTERS, NAMELY, MICROCOMPUTERS, MINICOMPUTERS, COMPUTER CENTRAL PROCESSORS, COMPUTER MONITORS, COMPUTER KEYBOARDS, COMPUTER TERMINALS, COMPUTER INTERFACE BOARDS, COMPUTER MEMORIES, COMPUTER LASER PRINTERS, COMPUTER IMPACT PRINTERS, COMPUTER DOT MATRIX PRINTERS, COMPUTER OPERATING SYSTEMS, COMPUTERS AND INSTRUCTIONAL MANUALS SOLD AS A UNIT, COMPUTER INTERFACE APPARATUS, NAMELY, COMPUTER MODEMS, COMPUTER MOUSE AND MOUSE PAD, COMPUTER PERIPHERALS AND PARTS THEREOF; COMPUTER PROGRAMS AND DATA BASES FOR USE IN OPERATING TELECOMMUNICATIONS AND BUSINESS MANAGEMENT SYSTEMS AND RELATED INSTRUCTION MANUALS SOLD AS A UNIT; OPTICAL CABLES, OPTIC FILTERS, OPTICAL SCANNERS, OPTICAL CHARACTER READERS, OPTICAL DISCS, OPTICAL FIBERS, OPTICAL GLASS FOR SIGNAL TRANSMISSION, OPTIC TRANSMITTERS, OPTIC RECEIVERS, OPTICAL SIGNAL PROCESSING APPARATUS, OPTIC SWITCHES, OPTICAL NETWORKS COMPRISING COMMUNICATION TRANSMISSION SWITCHING AND RECEPTION APPARATUS, OPTICAL ATTENUATORS, OPTICAL AMPLIFIERS, OPTICAL CHARACTER RECOGNITION APPARATUS, AND PARTS THEREOF; AUDIO, VIDEO AND DATA COMMUNICATIONS SYSTEMS, NAMELY, DIGITAL AND ANALOGUE SIGNAL TRANSMITTERS, RECEIVERS AND CONVERTERS, RADIO AND TELEPHONE TRANSMITTERS, RECEIVERS AND SERVERS, STATIONARY, WIRELESS AND CELLULAR TELEPHONE SYSTEMS AND ANSWERING MACHINES, TELECOMMUNICATION TRANSMISSION, RECEIVING AND STORAGE APPARATUS, TELECOMMUNICATIONS TRANSMITTING SETS, DATA TRANSMITTERS, FACSIMILE MACHINES, ELECTRONIC MAIL APPARATUS FOR ELECTRONIC EXCHANGE OF DATA IMAGES AND MESSAGES, REMOTE CONTROLS AND SET-TOP UNITS, CINEMATOGRAPHIC TELEVISION AND AMUSEMENT EQUIPMENT, NAMELY, SIGNAL DECODERS AND INTERACTIVE AUDIO AND VIDEO EQUIPMENT TO FACILITATE INTERACTION BETWEEN CONSUMERS AND PROVIDERS OF GOODS AND SERVICES, ELECTRICAL WIRE, ELECTRICAL WIRE CONNECTORS, INTEGRATED CIRCUITS, PRINTED CIRCUITS, ELECTRIC CIRCUITS, CIRCUIT BREAKERS, PRINTED CIRCUIT BOARDS, ELECTRIC CIRCUIT BOARDS, CIRCUIT CONNECTORS, ELECTRICAL CONTROLLERS, ELECTRICAL CONVERTERS, ELECTRICAL FUSES, ELECTRIC LUMINESCENT DISPLAY PANELS, ELECTRICAL SWITCH PLATES, ELECTRIC PLUGS, ANTENNAS, ELECTRICAL CABLES, COMPUTER CABLES, COMPUTER CHIPS, SILICON CHIPS, CHRONOGRAPHS FOR USE AS SPECIALIZED TIME RECORDING APPARATUS, ELECTRIC COILS, COMPUTER BUFFERS, BLANK COMPUTER DISCS, BLANK COMPUTER FLOPPY DISKS, COMPUTER HARD DISCS, ELECTRICAL CONDUCTORS, ACOUSTIC CONDUITS, ELECTRICAL CONDUITS, FIBER OPTIC CONDUITS AND PART THEREOF; COMPACT DISC PLAYERS, AUDIO AND VIDEO TAPE RECORDERS, AUDIO AND VIDEO TAPE PLAYERS, AUDIO AND VIDEO CASSETTE RECORDERS, AUDIO AND VIDEO CASSETTE PLAYERS, BLANK AUDIO AND VIDEO TAPES, CASSETTES, DISCS AND MICROFICHE; AUDIO AND VIDEO TAPES, CASSETTES, DISCS AND MICROFICHE FEATURING INFORMATION CONCERNING TELECOMMUNICATIONS, PERSONAL AND BUSINESS MANAGEMENT SYSTEMS; VIDEO MONITORS, AUTOMATIC VENDING MACHINES AND TIMING MECHANISMS THEREFOR, AND PARTS THEREOF; DATA PROCESSORS AND READERS, WORD PROCESSORS, MAGNETIC CODED CARD READERS, MAGNETIC CARDS, ELECTRONIC ENCRYPTION UNITS, LASERS, LIGHT EMITTING DIODES, LIGHT EMITTING DIODE DISPLAYS, MICROPROCESSORS, BLANK MAGNETIC DATA CARRIERS, DEMAGNETIZERS FOR MAGNETIC TAPES, AND PARTS THEREOF; COMMUNICATIONS AND VIDEO TRANSMISSION SWITCHING AND RECEPTION APPARATUS; COMPUTER, DATA AND VIDEO NETWORKING AND CONFERENCING EQUIPMENT, NAMELY, TELECONFERENCING EQUIPMENT, AUDIOVISUAL

TEACHING EQUIPMENT, OVERHEAD FILM, PHOTOGRAPHIC AND SLIDE PROJECTORS, PROJECTION SCREENS, COMPUTER BASED INFORMATION DISPLAY EQUIPMENT, NAMELY, COMPUTERS WHICH DISPLAY INFORMATION ON AN OVERHEAD SCREEN, INTERCOMS, TELEPHONES, TELEPHONE ANSWERING MACHINES, TELEPHONE TRANSMITTERS, TELEPHONE NETWORKS, TELEPHONE WIRES, TELEPRINTERS, TELETYPEWRITERS, AND PARTS THEREOF, NAMELY, CALLER IDENTIFICATION BOXES, RADIO TELEPHONE EQUIPMENT AND ACCESSORIES, NAMELY, CALL BOXES AND SYSTEMS, DIALING ASSEMBLIES, TELEPHONE UNITS, AUDIO OPERATED RELAYS, SIGNALING DEVICES, RECEIVING DEVICES, TERMINATION EQUIPMENT, FILTERS, PROTECTORS AND AUTOMATIC SIGNALING AND CONTROL EQUIPMENT, TELEMETERS, WIRELESS AND CELLULAR TELEPHONES, PAGERS, PAGING EQUIPMENT, PORTABLE COMPUTER DEVICES, FACSIMILE TRANSMITTERS AND RECEIVERS, WIRELESS FAX MACHINES, PERSONAL COMMUNICATIONS EQUIPMENT, NAMELY, PERSONAL DIGITAL ASSISTANTS (PDA), CALCULATORS AND RELATED PERIPHERALS; SATELLITE PROCESSORS, SATELLITES AND SATELLITE COMMUNICATION EARTH STATIONS BOTH STATIONARY AND MOVEABLE; BASEBALL BATTING HELMETS; PRE-RECORDED COMPACT DISCS, AUDIO CASSETTE TAPES, VIDEO CASSETTE TAPES, DIGITAL AUDIO TAPES AND DIGITAL VIDEO DISCS FEATURING MUSICAL, VARIETY, NEWS AND COMEDY SHOWS; AND COMPUTER GAME PROGRAMS FOR CHILDREN AND ADULTS.

FIRST USE ; IN COMMERCE .

INT. CL. 16/U.S. CLS. 2, 5, 22, 23, 29, 37, 38 AND 50

FOR PRINTED MATTER, NAMELY, PRINTED AND STAMPED PLASTIC AND CARDBOARD GREETING, BLANK, NOTE, AND INDEX CARDS, AS WELL AS BOOKS OR MAGAZINES ON TELECOMMUNICATIONS; NOTE PAPER AND ENVELOPES, STAMPS, NAME TAGS AND LABELS MADE FROM PAPER OR CARDBOARD, NOTEBOOKS, DIARIES, NOTE PAPERS, NOTE PADS, ADDRESS BOOKS, FOLDERS FOR LETTERS, FILES OR LOOSE PAPER, CLEAR HOLE REINFORCEMENTS, STUDENT CALENDARS, STAMP ALBUMS AND PHOTO-ALBUMS; PAPER WEIGHTS, LETTER OPENERS, BLOTTING PADS; DESK TRAYS (CASES FOR STATIONERY AND OFFICE IMPLEMENTS); PRINTED INSTRUCTIONAL AND TEACHING MATERIAL ON TELECOMMUNICATIONS; STATIONERY, NAMELY RULERS, ERASERS, STAPLERS, STAPLES, PAPER CLIPS, BOOK MARKERS, CUTOUT SAMPLES AND STENCILS; TRANSPARENT PICTURE APPLICATIONS, SCRATCH PICTURES, PAPER, PVC STICKERS, PAPERBACKS, GIFT WRAP PAPER; BLACKBOARDS, CHALK STICKS, ADHESIVES FOR STATIONERY OR HOUSEHOLD PURPOSES; DRAWING AND PAINTING MATERIALS, PENCIL CASES.

FIRST USE ; IN COMMERCE .

INT. CL. 35/U.S. CLS. 100, 101 AND 102

FOR ADVERTISING SERVICES, NAMELY, PREPARING AND PLACING ADVERTISEMENTS FOR OTHERS, DIRECT MAIL ADVERTISING, ELECTRONIC BILLBOARD ADVERTISING, PREPARING AUDIO-VISUAL PRESENTATIONS FOR USE IN ADVERTISING; BUSINESS SERVICES, NAMELY, BUSINESS APPRAISALS, BUSINESS AUDITING, PROVIDING BUSINESS INFORMATION, NAMELY, PREPARING BUSINESS REPORTS AND CONDUCTING BUSINESS RESEARCH, ANALYSIS AND SURVEYS, BUSINESS MANAGEMENT PLANNING, BUSINESS MANAGEMENT CONSULTATION, BUSINESS MANAGEMENT SUPERVISION, CONDUCTING BUSINESS NETWORKING FOR OTHERS; RENTAL OF AUTOMATIC VENDING MACHINES; AND ORGANIZING JOB FAIRS; GENERATION OF DATA PROCESSING PROGRAMS AND PROFESSIONAL CONSULTANCY IN THE FIELD OF DATA PROCESSING; LICENSING OF COMPUTER SOFTWARE AND HARDWARE FOR ONLINE ACTORS, FOR CONSUMER FACILITATING AND THE ADMINISTRATION OF COMPLEX NETWORK SYSTEMS.

FIRST USE ; IN COMMERCE .

INT. CL. 36/U.S. CLS. 100, 101 AND 102

FOR CLEARING OF SECURE FINANCIAL TRANSACTIONS THROUGH ONLINE SERVICES; FINANCIAL AND MONETARY AFFAIRS, NAMELY FINANCIAL ANALYSIS AND CONSULTATION, FINANCIAL INFORMATION, ISSUANCE OF SECURITIES, COMMERCIAL LENDING SERVICES, FINANCIAL PORTFOLIO MANAGEMENT, DISCOUNT SERVICES, BROKERAGE OF SHARES, OF SETS AND BUSINESS VENTURES, BROKERAGE OF FUND SHARES, SECURITIES CONSULTING AND SAFE KEEPING, BROKERAGE OF PRODUCTIVE INVESTMENTS AND FUNDS; REAL ESTATE AFFAIRS, NAMELY BROKERAGE, MANAGEMENT, LEASING, APPRAISAL OF REAL PROPERTY; CUSTOMS BROKERAGE FOR THIRD PARTIES; CONSULTANCY SERVICES RELATING TO BANK AFFAIRS; CONSULTANCY SERVICES RELATING TO INSURANCE AFFAIRS, NAMELY INFORMATION AND BROKERAGE OF INSURANCES; AND MONETARY EXCHANGE.

FIRST USE ; IN COMMERCE .

INT. CL. 38/U.S. CLS. 100, 101 AND 104

FOR TELECOMMUNICATION SERVICES, NAMELY, ELECTRIC, DIGITAL, CELLULAR AND WIRELESS TRANSMISSION OF VOICE, DATA, INFORMATION, IMAGES, SIGNALS AND MESSAGES; PROVIDING TELECOMMUNICATIONS CONNECTIONS OVER A GLOBAL COMMUNICATIONS NETWORK, ELECTRONIC MAIL, VOICE MAIL AND MESSAGING SERVICES, AUDIO AND VIDEO TELECONFERENCING, RENTAL OF TELECOMMUNICATIONS EQUIPMENT, NAMELY, EQUIPMENT FOR ELECTRONIC ACCESS TO GLOBAL TELECOMMUNICATIONS NETWORK, EQUIPMENT FOR TRANSMITTING, RECEIVING, RECORDING AND MONITORING VOICE, DATA, INFORMATION, IMAGES, SIGNALS, MESSAGES, COMPRISED OF DATA AND WORD PROCESSORS, AND TELECOMMUNICATIONS HARDWARE AND SOFTWARE INCLUDING COMPONENTS AND PERIPHERALS THEREOF FOR USE IN THE TELECOMMUNICATIONS INDUSTRY, AND FOR TRANSMITTING, RECEIVING, RECORDING AND MONITORING COMPUTER PROGRAMS FOR USE IN OPERATING AND ACCESSING TELECOMMUNICATIONS SYSTEMS; AUDIO AND VIDEO BROADCASTING FEATURING ENTERTAINMENT IN THE NATURE OF LIVE VISUAL AND AUDIO PERFORMANCES, AND MUSICAL, VARIETY, NEWS AND COMEDY SHOWS; AND PROVIDING ACCESS TO COMPUTER INFORMATION NETWORKS .

FIRST USE ; IN COMMERCE .

INT. CL. 41/U.S. CLS. 100, 101 AND 107

FOR EDUCATION IN THE NATURE CLASSES AND SEMINARS IN THE FIELDS OF BUSINESS, TELECOMMUNICATIONS AND COMPUTERS, AND THE DISTRIBUTION OF COURSE MATERIALS THEREWITH; ENTERTAINMENT IN THE NATURE OF VISUAL AND AUDIO PERFORMANCES, NAMELY, MUSICAL BAND, ROCK GROUP, GYMNASIAC, DANCE, AND BALLET PERFORMANCES; ENTERTAINMENT SERVICES, NAMELY, PROVIDING MUSICAL, VARIETY, NEWS AND COMEDY SHOWS VIA A GLOBAL COMPUTER INFORMATION NETWORK; ENTERTAINMENT SERVICES, NAMELY PROVIDING ON-LINE COMPUTER GAMES FOR CHILDREN AND ADULTS; ORGANIZATION OF COMMUNITY SPORTING AND CULTURAL EVENTS; PUBLICATION OF BOOKS, MAGAZINES, JOURNALS, MANUALS, BROCHURES, AND LEAFLETS; ORGANIZING FAIRS AND EXHIBITIONS IN THE FIELD OF VISUAL AND AUDIO PERFORMANCES, NAMELY, MUSICAL BAND, ROCK GROUP, GYMNASIAC, DANCE, AND BALLET PERFORMANCES.

FIRST USE ; IN COMMERCE .

INT. CL. 42/U.S. CLS. 100 AND 101

FOR COMPUTER PROGRAMMING SERVICES FOR OTHERS; CONSULTING IN THE FIELD OF TELECOMMUNICATION, RENTAL OF SOFTWARE AND HARDWARE FOR ONLINE ACCESS; [SERVICES OF AN INTERNET TRUST CENTER, NAMELY, ASSURANCE AND ADMINISTRATION OF DIGITAL KEYS AND/OR DIGITAL CERTIFICATES;] RENTAL OF DATA PROCESSING EQUIPMENT.

FIRST USE ; IN COMMERCE .

ELEMENTS AMENDED
GOODS/SERVICES

3,629,122. REG. 6-2-2009. DEUTSCHE TELEKOM AG (FED REP GERMANY CORPORATION) FRIEDRICH-EBERT-ALLEE 140, 53113 BONN, FED REP GERMANY., SN 76-222,033. FILED 3-8-2001. PRINCIPAL REGISTER.

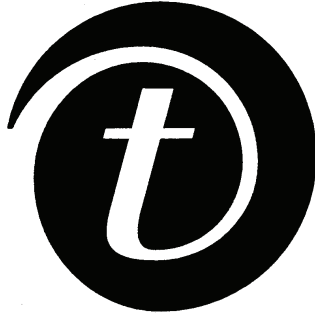

PRIORITY CLAIMED UNDER SEC. 44(D) ON FED REP GERMANY APPLICATION NO. 30067629.8, FILED 9-8-2000, REG. NO. 30067629, DATED 9-8-2000.

INT. CL. 9/U.S. CLS. 21, 23, 26, 36 AND 38

FOR ELECTRIC, ELECTRONIC, OPTICAL, MEASURING, SIGNALING, CONTROLLING AND TEACHING APPARATUS AND INSTRUMENTS, ALL FOR USE WITH TELECOMMUNICATIONS, NAMELY, APPARATUS FOR PRODUCING SOUND, IMAGES OR DATA, MAGNETIC AND OPTICAL DATA CARRIERS, DATA PROCESSORS AND COMPUTERS, NAMELY, MICROCOMPUTERS, MINICOMPUTERS, COMPUTER CENTRAL PROCESSORS, COMPUTER MONITORS, COMPUTER KEYBOARDS, COMPUTER TERMINALS, COMPUTER INTERFACE BOARDS, COMPUTER MEMORIES, COMPUTER LASER PRINTERS, COMPUTER IMPACT PRINTERS, COMPUTER DOT MATRIX PRINTERS, COMPUTER OPERATING SYSTEMS, COMPUTERS AND INSTRUCTIONAL MANUALS SOLD AS A UNIT, COMPUTER INTERFACE APPARATUS, NAMELY, COMPUTER MODEMS, COMPUTER MOUSE AND MOUSE PAD, COMPUTER PERIPHERALS AND PARTS THEREOF; COMPUTER PROGRAMS AND DATABASES FOR USE IN OPERATING TELECOMMUNICATIONS AND BUSINESS MANAGEMENT SYSTEMS AND RELATED INSTRUCTION MANUALS SOLD AS A UNIT; OPTICAL CABLES, OPTIC FILTERS, OPTICAL SCANNERS, OPTICAL CHARACTER READERS, OPTICAL DISCS, OPTICAL FIBERS, OPTICAL GLASS FOR SIGNAL TRANSMISSION, OPTIC TRANSMITTERS, OPTIC RECEIVERS, OPTICAL SIGNAL PROCESSING APPARATUS, OPTIC SWITCHES, OPTICAL NETWORKS COMPRISING COMMUNICATION TRANSMISSION SWITCHING AND RECEPTION APPARATUS, OPTICAL ATTENUATORS, OPTICAL AMPLIFIERS, OPTICAL CHARACTER RECOGNITION APPARATUS, AND PARTS THEREOF; AUDIO, VIDEO AND DATA COMMUNICATIONS SYSTEMS, NAMELY, DIGITAL AND ANALOGUE SIGNAL TRANSMITTERS, RECEIVERS AND CONVERTERS, RADIO AND TELEPHONE TRANSMITTERS, RECEIVERS AND SERVERS, STATIONARY, WIRELESS AND CELLULAR TELEPHONE SYSTEMS AND ANSWERING MACHINES, TELECOMMUNICATION TRANSMISSION, RECEIVING AND STORAGE APPARATUS, TELECOMMUNICATIONS TRANSMITTING SETS, DATA TRANSMITTERS, FACSIMILE MACHINES, ELECTRONIC MAIL APPARATUS FOR ELECTRONIC EXCHANGE OF DATA IMAGES AND MESSAGES, REMOTE CONTROLS AND SET-TOP UNITS, CINEMATOGRAPHIC TELEVISION AND AMUSEMENT EQUIPMENT, NAMELY, SIGNAL DECODERS AND INTERACTIVE AUDIO AND VIDEO EQUIPMENT TO FACILITATE INTERACTION BETWEEN CONSUMERS AND PROVIDERS OF GOODS AND SERVICES, ELECTRICAL WIRE, ELECTRICAL WIRE CONNECTORS, INTEGRATED CIRCUITS, PRINTED CIRCUITS, ELECTRIC CIRCUITS, CIRCUIT BREAKERS, PRINTED CIRCUIT BOARDS, ELECTRIC CIRCUIT BOARDS, CIRCUIT CONNECTORS, ELECTRICAL CONTROLLERS, ELECTRICAL CONVERTERS, ELECTRICAL FUSES, ELECTRIC LUMINESCENT DISPLAY PANELS, ELECTRICAL SWITCH PLATES, ELECTRIC PLUGS, ANTENNAS, ELECTRICAL CABLES, COMPU-

TER CABLES, COMPUTER CHIPS, SILICON CHIPS, CHRONOGRAPHS FOR USE AS SPECIALIZED TIME RECORDING APPARATUS, ELECTRIC COILS, COMPUTER BUFFERS, BLANK COMPUTER DISCS, BLANK COMPUTER FLOPPY DISKS, COMPUTER HARD DISCS, ELECTRICAL CONDUCTORS, ACOUSTIC CONDUITS, ELECTRICAL CONDUITS, FIBER OPTIC CONDUITS AND PARTS THEREOF; COMPACT DISC PLAYERS, AUDIO AND VIDEO TAPE RECORDERS, AUDIO AND VIDEO TAPE PLAYERS, AUDIO AND VIDEO CASSETTE RECORDERS, AUDIO AND VIDEO CASSETTE PLAYERS, BLANK AUDIO AND VIDEO TAPES, CASSETTES, DISCS AND MICROFICHE; AUDIO AND VIDEO TAPES, CASSETTES, DISCS AND MICROFICHE FEATURING INFORMATION CONCERNING TELECOMMUNICATIONS, PERSONAL AND BUSINESS MANAGEMENT SYSTEMS, VIDEO MONITORS, AUTOMATIC VENDING MACHINES AND TIMING MECHANISMS THEREFOR, AND PARTS THEREOF; DATA PROCESSORS AND READERS, WORD PROCESSORS, MAGNETIC CODED CARD READERS, MAGNETIC CARDS, ELECTRONIC ENCRYPTION UNITS, LASERS, LIGHT EMITTING DIODES, LIGHT EMITTING DIODE DISPLAYS, MICROPROCESSORS, BLANK MAGNETIC DATA CARRIERS, DEMAGNETIZERS FOR MAGNETIC TAPES, AND PARTS THEREOF COMMUNICATIONS AND VIDEO TRANSMISSION SWITCHING AND RECEPTION APPARATUS; COMPUTER, DATA AND VIDEO NETWORKING AND CONFERENCING EQUIPMENT, NAMELY, TELECONFERENCING EQUIPMENT, AUDIOVISUAL TEACHING EQUIPMENT, OVERHEAD FILM, PHOTOGRAPHIC AND SLIDE PROJECTORS, PROJECTION SCREENS, COMPUTER BASED INFORMATION DISPLAY EQUIPMENT, NAMELY, COMPUTERS WHICH DISPLAY INFORMATION ON AN OVERHEAD SCREEN, INTERCOMS; TELEPHONES, TELEPHONE ANSWERING MACHINES, TELEPHONE TRANSMITTERS, TELEPHONE NETWORKS, TELEPHONE WIRES, TELEPRINTERS, TELETYPENWRITERS, AND PARTS THEREOF, NAMELY, CALLER IDENTIFICATION BOXES, RADIO TELEPHONE EQUIPMENT AND ACCESSORIES, NAMELY, CALL BOXES AND SYSTEMS, DIALING ASSEMBLIES, TELEPHONE UNITS, AUDIO OPERATED RELAYS, SIGNALING DEVICES, RECEIVING DEVICES, TERMINATION EQUIPMENT, FILTERS, PROTECTORS AND AUTOMATIC SIGNALING AND CONTROL EQUIPMENT, TELEMETERS, WIRELESS AND CELLULAR TELEPHONES, PAGERS, PAGING EQUIPMENT, PORTABLE COMPUTER DEVICES, FACSIMILE TRANSMITTERS AND RECEIVERS, WIRELESS FAX MACHINES, PERSONAL COMMUNICATIONS EQUIPMENT, NAMELY, PERSONAL DIGITAL ASSISTANTS (PDA), CALCULATORS AND RELATED PERIPHERALS; SATELLITE PROCESSORS, SATELLITES AND SATELLITE COMMUNICATION EARTH STATIONS BOTH STATIONARY AND MOVEABLE; PRERECORDED COMPACT DISCS, AUDIO CASSETTE TAPES, VIDEO CASSETTE TAPES, DIGITAL AUDIO TAPES AND DIGITAL VIDEO DISCS FEATURING MUSICAL, VARIETY, NEWS AND COMEDY SHOWS; COMPUTER GAME PROGRAMS FOR CHILDREN AND ADULTS; ELECTRONIC PUBLICATIONS, NAMELY, BOOKS, PERIODICALS, MAGAZINES, INSTRUCTION MANUALS FEATURING INFORMATION ON TELECOMMUNICATION RECORDED ON ELECTRONIC MEDIA.

FIRST USE ; IN COMMERCE .

INT. CL. 16/U.S. CLS. 2, 5, 22, 23, 29, 37, 38 AND 50

FOR PRINTED MATTER, NAMELY, PRINTED AND STAMPED PLASTIC AND CARDBOARD GREETING, BLANK, NOTE, AND INDEX CARDS, AS WELL AS BOOKS OR MAGAZINES ON TELECOMMUNICATIONS; NOTE PAPER AND ENVELOPES, STAMPS, NAME TAGS AND LABELS MADE FROM PAPER OR CARDBOARD, NOTEBOOKS, DIARIES, NOTE PAPERS, NOTE PADS, ADDRESS BOOKS, FOLDERS FOR LETTERS, FILES OR LOOSE PAPER, CLEAR HOLE REINFORCEMENTS, STUDENT CALENDARS, STAMP ALBUMS AND PHOTO-ALBUMS; PAPER WEIGHTS, LETTER OPENERS, BLOTTING PADS; DESK TRAYS, NAMELY, CASES FOR STATIONERY AND OFFICE IMPLEMENTS; PRINTED INSTRUCTIONAL AND TEACHING MATERIAL ON TELECOMMUNICATIONS; STATIONERY, NAMELY RULERS, ERASERS, STAPLERS, STAPLES, PAPER CLIPS, BOOK MARKERS, CUTOUT SAMPLES AND STENCILS; TRANSPARENT PICTURE APPLICATIONS, SCRATCH PICTURES, PAPER, PVC STICKERS, PAPERBACKS, GIFT WRAP PAPER; BLACKBOARDS, CHALK STICKS, ADHESIVES FOR STATIONERY OR HOUSEHOLD PURPOSES; DRAWING AND PAINTING MATERIALS, PENCIL CASES.

FIRST USE ; IN COMMERCE .

INT. CL. 35/U.S. CLS. 100, 101 AND 102

FOR ADVERTISING SERVICES, NAMELY, PREPARING AND PLACING ADVERTISEMENTS FOR OTHERS, DIRECT MAIL ADVERTISING, ELECTRONIC BILLBOARD ADVERTISING, PREPARING AUDIO-VISUAL PRESENTATIONS FOR USE IN ADVERTISING; BUSINESS SERVICES, NAMELY, BUSINESS APPRAISALS, BUSINESS AUDITING, PROVIDING BUSINESS INFORMATION, NAMELY, PREPARING BUSINESS REPORTS AND CONDUCTING BUSINESS RESEARCH, ANALYSIS AND SURVEYS, BUSINESS MANAGEMENT PLANNING, BUSINESS MANAGEMENT CONSULTATION, BUSINESS MANAGEMENT SUPERVISION, CONDUCTING BUSINESS NETWORKING FOR OTHERS; RENTAL OF AUTOMATIC VENDING MACHINES; AND ORGANIZING JOB FAIRS GENERATION OF DATA PROCESSING PROGRAMS; PROFESSIONAL CONSULTING IN THE FIELD OF DATA PROCESSING.

FIRST USE ; IN COMMERCE .

INT. CL. 36/U.S. CLS. 100, 101 AND 102

FOR INSURANCE SERVICES, NAMELY, INSURANCE BROKERAGE, INSURANCE CLAIMS PROCESSING; CLEARING OF SECURE FINANCIAL TRANSACTIONS THROUGH ONLINE SERVICES; FINANCIAL AND MONETARY AFFAIRS, NAMELY, FINANCIAL ANALYSIS AND CONSULTATION, FINANCIAL INFORMATION, ISSUANCE OF SECURITIES, COMMERCIAL LENDING SERVICES, FINANCIAL PORTFOLIO MANAGEMENT, DISCOUNT SERVICES, BROKERAGE OF SHARES, OF SETS AND BUSINESS VENTURES, BROKERAGE OF FUND SHARES, SECURITIES CONSULTING AND SAFE KEEPING, BROKERAGE OF PRODUCTIVE INVESTMENTS AND FUNDS; REAL [ESTATEAFFAIRS] * ESTATE AFFAIRS *, NAMELY, BROKERAGE, MANAGEMENT, LEASING, APPRAISAL OF REAL PROPERTY; CUSTOMS BROKERAGE FOR THIRD PARTIES; CONSULTING SERVICES RELATING TO BANK AFFAIRS; CONSULTING SERVICES RELATING TO INSURANCE AFFAIRS, NAMELY, INFORMATION AND BROKERAGE OF INSURANCES; AND MONETARY EXCHANGE.

FIRST USE ; IN COMMERCE .

INT. CL. 38/U.S. CLS. 100, 101 AND 104

FOR TELECOMMUNICATION SERVICES, NAMELY, ELECTRIC, DIGITAL, CELLULAR AND WIRELESS TRANSMISSION OF VOICE, DATA, INFORMATION, IMAGES, SIGNALS AND MESSAGES; PROVIDING TELECOMMUNICATIONS CONNECTIONS OVER A GLOBAL COMMUNICATIONS NETWORK, ELECTRONIC MAIL, VOICE MAIL AND MESSAGING SERVICES, AUDIO AND VIDEO TELECONFERENCING, RENTAL OF TELECOMMUNICATIONS EQUIPMENT, NAMELY, EQUIPMENT FOR ELECTRONIC ACCESS TO GLOBAL TELECOMMUNICATIONS NETWORK, EQUIPMENT FOR TRANSMITTING, RECEIVING, RECORDING AND MONITORING VOICE, DATA, INFORMATION, IMAGES, SIGNALS, MESSAGES, COMPRISED OF DATA AND WORD PROCESSORS, AND TELECOMMUNICATIONS HARDWARE AND SOFTWARE INCLUDING COMPONENTS AND PERIPHERALS THEREOF FOR USE IN THE TELECOMMUNICATIONS INDUSTRY, AND FOR TRANSMITTING, RECEIVING, RECORDING AND MONITORING COMPUTER PROGRAMS FOR USE IN OPERATING AND ACCESSING TELECOMMUNICATIONS SYSTEMS; AUDIO AND VIDEO BROADCASTING FEATURING ENTERTAINMENT IN THE NATURE OF LIVE VISUAL AND AUDIO PERFORMANCES, AND MUSICAL, VARIETY, NEWS AND COMEDY SHOWS; AND PROVIDING ACCESS TO COMPUTER INFORMATION NETWORKS.

FIRST USE ; IN COMMERCE .

INT. CL. 39/U.S. CLS. 100 AND 105

FOR WAREHOUSE STORAGE OF GOODS; TRANSPORTATION OF GOODS BY TRUCK, SHIP, RAILWAY AND PLANE; STORAGE OF GOODS RELATING TO TELECOMMUNICATIONS, COMPUTERS AND OTHER INFORMATION TECHNOLOGY DEVICES.

FIRST USE ; IN COMMERCE .

INT. CL. 41/U.S. CLS. 100, 101 AND 107

FOR EDUCATION AND INSTRUCTION, NAMELY, EDUCATIONAL SERVICES IN THE NATURE OF CLASSES AND SEMINARS IN THE FIELDS OF BUSINESS, TELECOMMUNICATIONS AND COMPUTERS, AND THE DISTRIBUTION OF COURSE MATERIALS THEREWITH; ENTERTAINMENT IN THE NATURE OF VISUAL AND AUDIO PERFORMANCES, NAMELY, MUSICAL BAND, ROCK GROUP, GYMNAS TIC, DANCE, AND BALLET PERFORMANCES; ENTERTAINMENT SERVICES, NAMELY, PROVIDING MUSICAL, VARIETY, NEWS AND COMEDY SHOWS VIA A GLOBAL COMPUTER INFORMATION NETWORK; ENTERTAINMENT SERVICES, NAMELY, PROVIDING ON-LINE COMPUTER GAMES FOR CHILDREN AND ADULTS; ORGANIZING COMMUNITY SPORTING AND CULTURAL EVENTS; PUBLICATION OF BOOKS, MAGAZINES, JOURNALS, MANUALS, BROCHURES, AND LEAFLETS ON THE SUBJECT OF TELECOMMUNICATIONS; ELECTRONIC PUBLISHING SERVICES, NAMELY, PUBLICATION OF TEXT AND GRAPHIC WORKS OF OTHERS ON TELECOMMUNICATIONS RECORDED ON ELECTRONIC MEDIA; ORGANIZING FAIRS AND EXHIBITIONS IN THE FIELD OF VISUAL AND AUDIO PERFORMANCES, NAMELY, MUSICAL BAND, ROCK GROUP, GYMNAS TIC, DANCE, AND BALLET PERFORMANCES.

FIRST USE ; IN COMMERCE .

INT. CL. 42/U.S. CLS. 100 AND 101

FOR LICENSING OF COMPUTER SOFTWARE AND HARDWARE FOR ONLINE ACTORS, FOR CONSUMER FACILITATING AND THE ADMINISTRATION OF COMPLEX NETWORK SYSTEMS; COMPUTER PROGRAMMING SERVICES FOR OTHERS; DATABASE SERVICES, NAMELY, LEASING ACCESS TIME TO A COMPUTER DATABASE IN THE FIELD OF TELECOMMUNICATION; PROVIDING AND MAINTAINING AN ONLINE COMPUTER DATABASE IN THE FIELD OF GENERAL NEWS AND INFORMATION; CONSULTING IN THE FIELD OF TELECOMMUNICATION; RENTAL OF SOFTWARE AND HARDWARE FOR ONLINE ACCESS; [SERVICES OF AN INTERNET TRUST CENTER, NAMELY, ASSURANCE AND ADMINISTRATION OF DIGITAL KEYS AND DIGITAL CERTIFICATES;] RENTAL OF DATA PROCESSING EQUIPMENT AND COMPUTERS; PROJECTING AND PLANNING SERVICES, NAMELY, DESIGN SERVICES FOR OTHERS IN THE FIELD OF TELECOMMUNICATIONS EQUIPMENT .

FIRST USE ; IN COMMERCE .

ELEMENTS AMENDED
GOODS/SERVICES

3,647,409. REG. 6-30-2009. SCHMITT MEASUREMENT SYSTEMS, INC. (MONTANA CORPORATION) 2765 N.W. NICOLAI, PORTLAND, OR, 97210, SN 77-633,065. FILED 12-15-2008. PRINCIPAL REGISTER.

3,670,666. REG. 8-18-2009. ASOBIO S.R.L. (ITALY LIMITED LIABILITY COMPANY) VIA STENDHAL 36, 20144 MILANO, ITALY., SN 77-531,157. FILED 7-25-2008. PRINCIPAL REGISTER.

XACT

THE MARK CONSISTS OF STANDARD CHARACTERS WITHOUT CLAIM TO ANY PARTICULAR FONT, STYLE, SIZE, OR COLOR.

INT. CL. 9/U.S. CLS. 21, 23, 26, 36 AND 38

FOR ULTRASONIC MONITORING APPARATUS FOR MONITORING LIQUID FUEL LEVELS IN A TANK.

FIRST USE 7-7-2008; IN COMMERCE 7-7-2008.

ELEMENTS CORRECTED
OWNER NAME

3,664,532. REG. 8-4-2009. FASHIONOLOGY LLC (CALIFORNIA LIMITED LIABILITY COMPANY) SUITE 33, 9405 BRIGHTON WAY, BEVERLY HILLS, CA, 90210, SN 77-427,702. FILED 3-20-2008. PRINCIPAL REGISTER.

FASHIONOLOGY

THE MARK CONSISTS OF STANDARD CHARACTERS WITHOUT CLAIM TO ANY PARTICULAR FONT, STYLE, SIZE, OR COLOR.

INT. CL. 35/U.S. CLS. 100, 101 AND 102

FOR RETAIL STORE SERVICES AND WEB-BASED ON-LINE RETAIL STORE SERVICES FEATURING CLOTHING, APPAREL, FOOTWEAR, HEADWEAR, EYEWEAR, JEWELRY, BAGS; RETAIL STORE SERVICES AND WEB-BASED ON-LINE RETAIL STORE SERVICES FEATURING ACCESSORIES, NAMELY, CLOTHING ACCESSORIES, HEADWEAR ACCESSORIES, FOOTWEAR ACCESSORIES, ROOM DECOR ACCESSORIES.

FIRST USE 7-25-2008; IN COMMERCE 7-25-2008.

INT. CL. 37/U.S. CLS. 100, 103 AND 106

FOR GARMENT EMBELLISHMENT SERVICES, NAMELY, ASSISTING CHILDREN AND ADULTS WITH APPLYING BEADWORK, FABRIC, LEATHER, STONES AND GEMS, METAL, ILLUSTRATIONS, HEAT TRANSFERS AND FEATHERS TO CLOTHING, APPAREL, FOOTWEAR, HEADWEAR, EYEWEAR, JEWELRY, BAGS, AND ACCESSORIES, NAMELY, CLOTHING ACCESSORIES, HEADWEAR ACCESSORIES, FOOTWEAR ACCESSORIES, ROOM DECOR ACCESSORIES.

FIRST USE 2-22-2009; IN COMMERCE 2-22-2009.

ELEMENTS CORRECTED
ENTITY

ASOBIO,

INT. CL. 25/U.S. CLS. 22 AND 39

FOR CLOTHING, NAMELY, JERSEYS, COATS, SHIRTS, SKIRTS, TEE-SHIRTS, TROUSERS, SUITS; SWIMSUITS; MASQUERADE COSTUMES; FOOTWEAR; HEADGEAR, NAMELY, HATS, CAPS; HOSIERY; GLOVES; NECKTIES; SHAPEWEAR, NAMELY, GIRDLES; WEDDING GOWNS.

FIRST USE 10-18-2008; IN COMMERCE 1-11-2009.

ELEMENTS CORRECTED
OWNER NAME

3,690,813. REG. 9-29-2009. LLEWELLYN, GARY (UNITED STATES INDIVIDUAL) 6211 W. 30TH STREET, INDIANAPOLIS, IN, 46224, SN 77-611,595. FILED P.R. 11-11-2008; AM. S.R. 8-21-2009. SUPPLEMENTAL REGISTER.

eDentist

THE MARK CONSISTS OF STANDARD CHARACTERS WITHOUT CLAIM TO ANY PARTICULAR FONT, STYLE, SIZE, OR COLOR.

INT. CL. 35/U.S. CLS. 100, 101 AND 102

FOR ON-LINE BUSINESS DIRECTORIES FEATURING RESTAURANTS AND DENTISTS; DENTAL REFERRAL SERVICE.

FIRST USE 1-6-2003; IN COMMERCE 1-6-2003.

ELEMENTS CORRECTED
OWNER NAME

3,703,492. REG. 10-27-2009. MAYES, BRETT (UNITED STATES INDIVIDUAL) 770 NORTH MONTEREY, SUITE, GILBERT, AZ, 852333821, SN 77-664,450. FILED 2-5-2009. PRINCIPAL REGISTER.

SiGCiG

THE MARK CONSISTS OF STANDARD CHARACTERS WITHOUT CLAIM TO ANY PARTICULAR FONT, STYLE, SIZE, OR COLOR.

INT. CL. 34/U.S. CLS. 2, 8, 9 AND 17

FOR ELECTRONIC CIGARETTES FOR USE AS AN ALTERNATIVE TO TRADITIONAL CIGARETTES. FIRST USE 2-13-2009; IN COMMERCE 3-15-2009.

3,717,730. REG. 12-1-2009. INTERNATIONAL CENTER FOR LEADERSHIP IN EDUCATION (NEW YORK CORPORATION) 1587 ROUTE 146, REXFORD, NY, 12148, SN 77-631,549. FILED 12-11-2008. PRINCIPAL REGISTER.

ELEMENTS AMENDED MARK

RIGOR/RELEVANCE FRAMEWORK

3,708,662. REG. 11-10-2009. BROOKLINE COLLEGE, LLC (DELAWARE LIMITED LIABILITY COMPANY) 2111 E. HIGHLAND AVENUE, SUITE B400, PHOENIX, AZ, 85016, SN 77-727,332. FILED 5-1-2009. PRINCIPAL REGISTER.

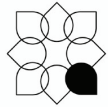

BROOKLINE COLLEGE

THE MARK CONSISTS OF STANDARD CHARACTERS WITHOUT CLAIM TO ANY PARTICULAR FONT, STYLE, SIZE, OR COLOR.

NO CLAIM IS MADE TO THE EXCLUSIVE RIGHT TO USE "FRAMEWORK", APART FROM THE MARK AS SHOWN.

INT. CL. 41/U.S. CLS. 100, 101 AND 107

FOR DEVELOPMENT AND DISSEMINATION OF EDUCATIONAL MATERIALS, NAMELY, BOOKS AND BROCHURES IN THE FIELD OF K-12 EDUCATION; EDUCATION SERVICES, NAMELY, PROVIDING CLASSES, SEMINARS, WORKSHOPS, CONFERENCES AND INFORMATION IN THE FIELD OF K-12 EDUCATION; EDUCATIONAL RESEARCH IN THE FIELD OF K-12 EDUCATION; PROVIDING ON-LINE NON-DOWNLOADABLE BOOKS, BROCHURES, TEACHING MATERIALS AND ACTIVITY GUIDES IN THE FIELD OF K-12 EDUCATION.

FIRST USE 1-1-1997; IN COMMERCE 1-1-1997.

NO CLAIM IS MADE TO THE EXCLUSIVE RIGHT TO USE "COLLEGE", APART FROM THE MARK AS SHOWN.

THE MARK CONSISTS OF A PATTERN OF TEAR DROP SHAPE IMAGES FORMING A CIRCLE WITH THE WORDS "BROOKLINE COLLEGE" UNDER THE PATTERN.

INT. CL. 41/U.S. CLS. 100, 101 AND 107

FOR EDUCATIONAL SERVICES, NAMELY, PROVIDING COURSES OF INSTRUCTION AT THE POSTSECONDARY AND PROFESSIONAL LEVEL AND DISTRIBUTION OF COURSE MATERIAL IN CONNECTION THEREWITH.

FIRST USE 6-29-2009; IN COMMERCE 6-29-2009.

ELEMENTS CORRECTED

DATE OF FIRST USE

DATE OF FIRST USE IN COMMERCE

ELEMENTS CORRECTED OWNER NAME ENTITY

3,720,030. REG. 12-1-2009. HAWAII KINE INC. (BR.VIRGIN ISLANDS CORPORATION) OMAR HODGE BUILDING, 3RD FLOOR, WICKHAMS CAY I, P.O. BOX 362 ROAD TOWN, TORTOLA, BR.VIRGIN ISLANDS,, SN 78-429,184. FILED 6-3-2004. PRINCIPAL REGISTER.

3,715,497. REG. 11-24-2009. DEUTSCHE EDELSTAHLWERKE GMBH (FED REP GERMANY GMBH) AUSTRASSE 4, 58452 WITTEN, FED REP GERMANY., SN 79-064,911. FILED 11-25-2008. PRINCIPAL REGISTER.

Corrodur

HAWAII KINE

THE MARK CONSISTS OF STANDARD CHARACTERS WITHOUT CLAIM TO ANY PARTICULAR FONT, STYLE, SIZE, OR COLOR.

PRIORITY DATE OF 7-18-2008 IS CLAIMED.

OWNER OF INTERNATIONAL REGISTRATION 0992154 DATED 11-25-2008, EXPIRES 11-25-2018.

INT. CL. 6/U.S. CLS. 2, 12, 13, 14, 23, 25 AND 50

FOR UNWROUGHT AND SEMI-WROUGHT COMMON METALS, IN PARTICULAR STEEL, STAINLESS STEEL AND BRIGHT STEEL; SEMI-FINISHED PRODUCTS OF STEEL IN THE FORM OF RODS, PLATES, SHEETS, BILLETS, BLOCKS, [WIRE,] PROFILES, RINGS [; AUXILIARY WELDING MATERIALS OF METAL] .

FIRST USE ; IN COMMERCE .

THE MARK CONSISTS OF STANDARD CHARACTERS WITHOUT CLAIM TO ANY PARTICULAR FONT, STYLE, SIZE, OR COLOR.

NO CLAIM IS MADE TO THE EXCLUSIVE RIGHT TO USE "HAWAII", APART FROM THE MARK AS SHOWN.

INT. CL. 30/U.S. CL. 46

FOR BEVERAGES, NAMELY, COFFEE.

FIRST USE 3-12-2004; IN COMMERCE 6-1-2004.

ELEMENTS CORRECTED GOODS/SERVICES

ELEMENTS CORRECTED OWNER ADDRESS

3,730,162. REG. 12-22-2009. GENERAL MILLS FOODS ASIA LIMITED (HONG KONG LIMITED LIABILITY COMPANY) THE GATEWAY, NO 25 CANTON ROAD, TST, SUITE 08-12, 23 A/F, TOWER ONE, KOWLOON, HONG KONG, MS-GA75, SN 78-961,572. FILED 8-28-2006. PRINCIPAL REGISTER.

3,740,338. REG. 1-19-2010. DISNEY ENTERPRISES, INC. (DELAWARE CORPORATION) 500 SOUTH BUENA VISTA STREET, BURBANK, CA, 91521, SN 77-099,715. FILED 2-5-2007. PRINCIPAL REGISTER.



THE NON-LATIN CHARACTER(S) IN THE MARK TRANSLITERATES INTO "WANCHAI MA TOU", AND THIS MEANS WANCHAI PIER IN ENGLISH.
INT. CL. 30/U.S. CL. 46

FOR FOOD PRODUCTS, NAMELY, FROZEN ENTREES CONSISTING PRIMARILY OF RICE OR NOODLES.

FIRST USE 4-27-2009; IN COMMERCE 4-27-2009.

ELEMENTS AMENDED
MARK

MINNIE MOUSE

THE MARK CONSISTS OF STANDARD CHARACTERS WITHOUT CLAIM TO ANY PARTICULAR FONT, STYLE, SIZE, OR COLOR.

OWNER OF U.S. REG. NOS. 3,002,502, 3,102,338 AND 3,131,283.

INT. CL. 16/U.S. CLS. 2, 5, 22, 23, 29, 37, 38 AND 50

FOR AUTOGRAPH BOOKS; BINDERS; SERIES OF FICTION BOOKS CALENDARS; PEN AND PENCIL CASES; PENCILS; STATIONERY; POSTERS; ERASERS; PENCIL SHARPENERS; WRITING PAPER; ENVELOPES; PAPER WEIGHTS; TRADING CARDS.

FIRST USE 11-11-2008; IN COMMERCE 11-11-2008.

ELEMENTS CORRECTED
CITIZENSHIP

3,741,495. REG. 1-26-2010. LG HOUSEHOLD & HEALTH CARE LTD. (REPUBLIC OF KOREA CORPORATION) 20, YOIDO-DONG, YOUNGDUNGPO-GU, SEOUL, REPUBLIC OF KOREA., SN 77-177,599. FILED 5-10-2007. PRINCIPAL REGISTER.

LacVert Ion Water Vluë+

ENERGY ESSENCE

3,732,603. REG. 12-29-2009. MARVELOUS ENTERTAINMENT INC. (JAPAN CORPORATION) 12-8, HIGASHI-SHINAGAWA 4-CHOME, SHINAGAWA-KU, TOKYO, JAPAN., SN 77-650,440. FILED 1-15-2009. PRINCIPAL REGISTER.

Steal Princess

THE MARK CONSISTS OF STANDARD CHARACTERS WITHOUT CLAIM TO ANY PARTICULAR FONT, STYLE, SIZE, OR COLOR.

INT. CL. 9/U.S. CLS. 21, 23, 26, 36 AND 38

FOR ELECTRONIC CIRCUITS AND CD-ROMS RECORDING PROGRAMS FOR HAND-HELD GAMES WITH LIQUID CRYSTAL DISPLAYS.

FIRST USE 3-0-2009; IN COMMERCE 3-0-2009.

ELEMENTS CORRECTED
OWNER ADDRESS

PRIORITY CLAIMED UNDER SEC. 44(D) ON REPUBLIC OF KOREA APPLICATION NO. 2007-0017061, FILED 3-30-2007, REG. NO. 0733970, DATED 1-14-2008.

OWNER OF U.S. REG. NO. 2,629,003.

NO CLAIM IS MADE TO THE EXCLUSIVE RIGHT TO USE "ION WATER", APART FROM THE MARK AS SHOWN.

INT. CL. 3/U.S. CLS. 1, 4, 6, 50, 51 AND 52

FOR SKIN MILK LOTION; PERFUMES; CLEANSING CREAM; BATH SOAPS; LIPSTICKS; FACIAL ESSENCE IN THE NATURE OF ESSENTIAL OILS; [HAIR SHAMPOOS;] EYE SHADOWS; TOOTHPASTE; GENERAL TOILET WATER; [HAIR COLORANTS;] HAND AND BODY SOAP IN POWDER FORM; FALSE EYELASHES; FALSE NAILS; PRE-MOISTENED COSMETIC TISSUES IMPREGNATED WITH COSMETIC LOTIONS; LIQUID SOAPS; NON-MEDICATED BATH AND BEAUTY CARE COSMETICS WITH ELECAMPANE; [HAIR RINSE; HAIR SPRAY; HAIR MOUSSE; HAIR ESSENCE IN THE NATURE OF PERFUMED OILS FOR HAIR;] SUN SCREEN LOTION; [DEPILATORY PREPARATIONS FOR HAIR; COLOR-REMOVING PREPARATIONS FOR HAIR;] FABRIC SOFTENERS FOR LAUNDRY USE; NON-MEDICATED MOUTH WASHES; NON-MEDICATED DENTAL RINSES; FOUNDATION CREAM MAKEUP; CHEEK COLORS, NAMELY, BLUSH; BLUSHERS; EYE LINER; NAIL POLISH; NOURISHING NON-MEDICATED SKIN CREAM; ANTISTATIC PREPARATIONS FOR HOUSEHOLD PURPOSES, NAMELY, ANTI-STATIC DRYER SHEETS, ANTI-STATIC SPRAY FOR CLOTHING; NAIL POLISH REMOVER; BEAUTY MASKS; BEAUTY MASK PACK COMPRISED OF FACIAL EXFOLIANT, FACIAL MOISTURIZER, AND FACIAL TONER; TOILET SOAPS; DETERGENTS PREPARED FROM PETROLEUM FOR HOUSEHOLD CLEANING USE; RINSE IN THE FORM OF DETERGENT FOR CLOTH-

ING; TOILET BOWL DETERGENTS; DISH WASHING DETERGENTS; BABY OIL; LIP GLOSS; LIP BALM; MASSAGE CREAM; BODY LOTION; [HAIR GEL;] NON-MEDICATED PROTECTIVE PREPARATIONS FOR LIPS; AFTER SHAVE LOTION; SHAVING FOAM; SHAVING CREAM; DEODORANTS FOR PERSONAL USE; AROMATICS OTHER THAN FOR MEDICAL PURPOSES, NAMELY, FRAGRANCES FOR PERSONAL USE; FUMIGATION PREPARATIONS, NAMELY, FUMIGATING INCENSES; LAVENDER OIL; ROSE OIL FOR COSMETIC PURPOSES; MINT FOR PERFUMERY; VANILLA PERFUMERY; [HAIR REMOVAL AGENT, NAMELY, HAIR REMOVING CREAM;] BATH GEL; SHOWER GEL; BODY SCRUB; MASSAGE OIL; BLEACHING AGENTS FOR LAUNDRY USE; CLEANSERS FOR LAUNDRY USE; TOOTH WHITENER; NOURISHING SKIN CREAM; LIQUID ROUGE; MASCARA; MASSAGE GEL; ENAMEL FOR MANICURE; VARNISH-REMOVING PREPARATIONS; BADIAN ESSENCE FOR COSMETIC USE; VANISHING CREAMS; BATH OIL; BATH POWDER; BABY POWDER; PERFUMED POWDER; [DANDRUFF LOTIONS, NOT FOR MEDICAL TREATMENT; DANDRUFF CREAMS, NOT FOR MEDICAL TREATMENT;] BATH SALTS, NOT FOR MEDICAL PURPOSES; COSMETIC SUN MILK; SUNSCREEN CREAMS; COSMETIC SUN OILS; COSMETIC SUN-TANNING PREPARATIONS; NAIL COLORANTS; COSMETIC SKIN FRESHENERS; EYE MAKE-UP REMOVERS; EAU DE COLOGNE; LIP PRIMERS; NON-MEDICATED LIP CONDITIONERS; COLD CREAMS; SOLID POWDER FOR COMPACTS; DEPILATORY WAX; [PERMANENT WAVE PREPARATIONS; NEUTRALIZERS FOR PERMANENT WAVING;] FACE POWDER FOR COSMETICS; POTPOURRI PERFUMES; SKIN WHITENING CREAMS; HAND CREAMS; [HAIR GLAZE; HAIR DRESSINGS; HAIR LACQUERS; HAIR LOTIONS; HAIR MOISTURIZERS; HAIR CONDITIONERS; HAIR CREAMS; HAIR TONIC;] MAKE-UP POWDER; ASTRINGENTS FOR COSMETIC PURPOSES; BODY CREAM; SKIN CLEANSING FOAMS; SKIN CLEANSING LOTIONS; LIP PENCILS; SHOWER COLOGNE; EAU DE TOILET; NON-MEDICATED TOILET WATER FOR REMOVING HORNY SUBSTANCE, NAMELY, FOR REMOVING SCALY SKIN; NON-MEDICATED CREAMS FOR REMOVING HORNY SUBSTANCE, NAMELY, FOR REMOVING SCALY SKIN; ESSENCES, NAMELY, CONCENTRATED LIQUID IN THE NATURE OF ESSENTIAL OILS FOR COSMETICS; COSMETIC PREPARATIONS FOR SLIMMING PURPOSES, NAMELY, CREAMS FOR CELLULITE REDUCTION; INCENSE STICKS; [ADHESIVES FOR AFFIXING FALSE HAIR;] COTTON STICKS FOR COSMETIC PURPOSES; ADHESIVES FOR COSMETIC PURPOSES; COTTON WOOL FOR COSMETIC PURPOSES; COSMETIC SOAPS; PAPER SOAPS; CREAM SOAPS; BODY CLEANSERS; SHAVING SOAP; SOAP FOR FOOT PERSPIRATION; DEODORANT SOAP; ALMOND SOAP; MEDICATED SOAP; BREATH FRESHENING SPRAYS; TOOTH POWDERS; FILMS IMPREGNATED WITH COSMETIC LOTIONS; COSMETIC FILMS FOR REMOVING OIL; COSMETIC PAPER FOR REMOVING OIL; DEGREASING PREPARATIONS FOR HOUSEHOLD PURPOSES; RUST REMOVING PREPARATIONS; FLOOR WAX REMOVERS; DRAINS PREPARATIONS, NAMELY, DRAIN OPENERS; GLASS CLEANING PREPARATIONS; WINDSCREEN CLEANING LIQUIDS; SHOE POLISH; POLISHING WAX; EMERY BOARDS; ABRASIVE CLOTH; TOOTH WHITENING PATCH; PREPARATIONS FOR CLEANING DENTURES.
FIRST USE ; IN COMMERCE .

ELEMENTS AMENDED
GOODS/SERVICES

3,742,338. REG. 1-26-2010. CAMZAK LLC (NEW YORK LIMITED LIABILITY COMPANY) 130 W 19TH 3C, NEW YORK, NY, 10011, SN 77-766,934. FILED 6-24-2009. PRINCIPAL REGISTER.



NO CLAIM IS MADE TO THE EXCLUSIVE RIGHT TO USE "CRAB", APART FROM THE MARK AS SHOWN.
THE MARK CONSISTS OF CRAB WITHIN A CIRCLE WITH THE WORDS "FATTY CRAB".

INT. CL. 43/U.S. CLS. 100 AND 101
FOR RESTAURANT SERVICES.
FIRST USE 9-0-2005; IN COMMERCE 9-0-2005.

ELEMENTS CORRECTED
MARK

3,747,298. REG. 2-9-2010. AMAZON TECHNOLOGIES, INC. (NEVADA CORPORATION) ATTN: TRADEMARKS, PO BOX 8102, RENO, NV, 89507, SN 77-327,634. FILED 11-12-2007. PRINCIPAL REGISTER.

OWNER OF U.S. REG. NOS. 2,738,837, 2,832,943 AND OTHERS.

THE MARK CONSISTS OF THE WORD "AMAZONMP3" WITH A "SMILE" OR CURVED ARROW BELOW THE WORD GOING FROM THE LETTER "A" TO THE LETTER "Z".

INT. CL. 38/U.S. CLS. 100, 101 AND 104

FOR TELECOMMUNICATIONS SERVICES, NAMELY, ELECTRONIC TRANSMISSION OF STREAMED AND DOWNLOADABLE AUDIO FILES VIA COMPUTER AND COMMUNICATIONS NETWORKS; TELECOMMUNICATIONS SERVICES, NAMELY, ELECTRONIC TRANSMISSION OF STREAMED VIDEO FILES VIA COMPUTER AND COMMUNICATIONS NETWORKS; PROVIDING ONLINE ELECTRONIC BULLETIN BOARDS FOR THE TRANSMISSION OF MESSAGES AMONG COMPUTER USERS CONCERNING MUSIC AND ENTERTAINMENT; WEB CASTING SERVICES; DELIVERY OF MESSAGES BY ELECTRONIC TRANSMISSION; TELECOMMUNICATIONS SERVICES, NAMELY, ELECTRONIC TRANSMISSION OF STREAMED AND DOWNLOADABLE AUDIO CONTENT FILES VIA COMPUTER AND COMMUNICATIONS NETWORKS; TELECOMMUNICATIONS SERVICES, NAMELY, ELECTRONIC TRANSMISSION OF STREAMED VIDEO AND MULTIMEDIA CONTENT FILES VIA COMPUTER AND COMMUNICATIONS NETWORKS; AUDIO BROADCASTING OF SPOKEN WORD AND MUSIC.

FIRST USE 9-25-2007; IN COMMERCE 9-25-2007.

ELEMENTS CORRECTED
MARK

3,750,386. REG. 2-16-2010. CURBGAMES, LLC (TEXAS LIMITED LIABILITY COMPANY) 11800 MIRA MESA DRIVE, AUSTIN, TX, 78732, SN 77-459,886. FILED 4-28-2008. PRINCIPAL REGISTER.

CURBGAMES

THE MARK CONSISTS OF STANDARD CHARACTERS WITHOUT CLAIM TO ANY PARTICULAR FONT, STYLE, SIZE, OR COLOR.

INT. CL. 41/U.S. CLS. 100, 101 AND 107

FOR ENTERTAINMENT SERVICES, NAMELY, A MOBILE VIDEO GAME ARCADE.

FIRST USE 4-30-2008; IN COMMERCE 4-30-2008.

ELEMENTS CORRECTED
OWNER NAME

3,752,806. REG. 2-23-2010. SCHOOLGY LLC (DELAWARE LIMITED LIABILITY COMPANY) 80 BROAD STREET, SUITE 502, NEW YORK, NY, 10004, SN 77-397,743. FILED 2-14-2008. PRINCIPAL REGISTER.

Schoolgy

THE MARK CONSISTS OF STANDARD CHARACTERS WITHOUT CLAIM TO ANY PARTICULAR FONT, STYLE, SIZE, OR COLOR.

INT. CL. 41/U.S. CLS. 100, 101 AND 107

FOR COMPUTER EDUCATION TRAINING SERVICES.

FIRST USE 7-1-2007; IN COMMERCE 2-1-2008.

ELEMENTS CORRECTED
CITIZENSHIP

3,755,447. REG. 3-2-2010. AMERICA'S COLLECTIBLES NETWORK, INC. (TENNESSEE CORPORATION) 10001 KINGSTON PK, KNOXVILLE, TN, 37922, SN 77-488,668. FILED 6-2-2008. PRINCIPAL REGISTER.

DONO DELLA

THE MARK CONSISTS OF STANDARD CHARACTERS WITHOUT CLAIM TO ANY PARTICULAR FONT, STYLE, SIZE, OR COLOR.

THE FOREIGN WORDING IN THE MARK TRANSLATES INTO ENGLISH AS "GIFT OF PEARLS"

INT. CL. 14/U.S. CLS. 2, 27, 28 AND 50

FOR PEARLS.

FIRST USE 4-0-2009; IN COMMERCE 4-0-2009.

ELEMENTS CORRECTED
MARK

3,756,091. REG. 3-2-2010. PHYSICIANS MUTUAL INSURANCE COMPANY (NEBRASKA INSURANCE COMPANY) 2600 DODGE STREET, OMAHA, NE, 68131, SN 77-724,172. FILED 4-28-2009. PRINCIPAL REGISTER.

INSURANCE FOR ALL OF US.

THE MARK CONSISTS OF STANDARD CHARACTERS WITHOUT CLAIM TO ANY PARTICULAR FONT, STYLE, SIZE, OR COLOR.

INT. CL. 36/U.S. CLS. 100, 101 AND 102

FOR INSURANCE UNDERWRITING SERVICES, NAMELY, HEALTH INSURANCE UNDERWRITING SERVICES, LONG-TERM CARE INSURANCE UNDERWRITING SERVICES, DENTAL INSURANCE UNDERWRITING SERVICES, LIFE INSURANCE UNDERWRITING SERVICES, MEDICARE SUPPLEMENT INSURANCE UNDERWRITING SERVICES; ANNUITY UNDERWRITING SERVICES.

FIRST USE 10-12-2009; IN COMMERCE 10-12-2009.

ELEMENTS AMENDED
MARK

3,756,413. REG. 3-9-2010. ANTHONY DIAZ (UNITED STATES INDIVIDUAL) 6440 SKY POINTE DRIVE, SUITE 140-424, LAS VEGAS, NV, 89131, AND LANI DIZON (UNITED STATES INDIVIDUAL) 6440 SKY POINTE DRIVE, SUITE 140-424, LAS VEGAS, NV, 89131, SN 77-024,402. FILED 10-18-2006. PRINCIPAL REGISTER.

ZENZA

THE MARK CONSISTS OF STANDARD CHARACTERS WITHOUT CLAIM TO ANY PARTICULAR FONT, STYLE, SIZE, OR COLOR.

INT. CL. 5/U.S. CLS. 6, 18, 44, 46, 51 AND 52

FOR DIETARY AND NUTRITIONAL SUPPLEMENTS; MINERAL NUTRITIONAL SUPPLEMENTS; IONIC NUTRITIONAL SUPPLEMENTS; MEDICATED PREPARATIONS AND LOTIONS FOR THE CARE OF THE SKIN AND HAIR; DIETARY SUPPLEMENT DRINKS, NUTRITIONALLY FORTIFIED BEVERAGES, POWDERED FRUIT-FLAVORED DIETARY SUPPLEMENT DRINK MIX, POWDERED NUTRITIONAL SUPPLEMENT DRINK MIX, VITAMIN FORTIFIED BEVERAGES; MEAL REPLACEMENT DRINK MIXES, MEAL REPLACEMENT BARS, MEAL REPLACEMENT DRINKS, MEAL REPLACEMENT POWDERS, MEAL REPLACEMENT SHAKES; HERBAL SUPPLEMENTS; VITAMINS, MINERAL AND NATUROPATHIC SUPPLEMENTS IN LIQUID, DROPS, TABLET, POWDER, OR CAPSULE FORM.

FIRST USE 12-5-2005; IN COMMERCE 12-5-2005.

INT. CL. 32/U.S. CLS. 45, 46 AND 48

FOR ENERGY DRINKS; FRUIT BEVERAGES, FRUIT JUICES AND DRINKS, CONCENTRATED FRUIT DRINKS, FRUIT NECTARS.

FIRST USE 12-5-2005; IN COMMERCE 12-5-2005.

ELEMENTS AMENDED
[GOODS/SERVICES]
[INTERNATIONAL CLASS(ES)]
[DATE OF FIRST USE]
[DATE OF FIRST USE IN COMMERCE]

3,757,255. REG. 3-9-2010. ASSOCIATION OF PUBLIC SAFETY COMMUNICATIONS OFFICIALS INTERNATIONAL, INC. (FLORIDA CORPORATION) 351 N. WILIAMSON BOULEVARD, DAYTONA BEACH, FL. 32114, SN 77-786,629. FILED 7-22-2009. PRINCIPAL REGISTER.

Project LOCATE

THE MARK CONSISTS OF STANDARD CHARACTERS WITHOUT CLAIM TO ANY PARTICULAR FONT, STYLE, SIZE, OR COLOR.

NO CLAIM IS MADE TO THE EXCLUSIVE RIGHT TO USE "LOCATE", APART FROM THE MARK AS SHOWN.

INT. CL. 41/U.S. CLS. 100, 101 AND 107

FOR DEVELOPMENT AND DISSEMINATION OF EDUCATIONAL MATERIALS IN THE FIELD OF PUBLIC SAFETY COMMUNICATIONS WIRELESS LOCATION DETERMINATION TECHNOLOGY FOR OTHERS.

FIRST USE 8-0-2002; IN COMMERCE 8-0-2002.

INT. CL. 42/U.S. CLS. 100 AND 101

FOR PROVIDING TECHNICAL RESEARCH AND DEVELOPMENT OF STANDARDS USED TO ASSIST PUBLIC SAFETY COMMUNICATION PROVIDERS WITH THE TECHNOLOGY, REGULATIONS AND IMPLEMENTATION OF WIRELESS LOCATION DETERMINATION TECHNOLOGY.

FIRST USE 8-0-2006; IN COMMERCE 8-0-2006.

ELEMENTS CORRECTED
OWNER NAME

3,757,786. REG. 3-9-2010. SCHECHTL MASCHINENBAU GMBH (FED REP GERMANY GMBH) VIEHHAUSERSTR. 4, 83533 EDLING, FED REP GERMANY., SN 79-067,524. FILED 3-13-2009. PRINCIPAL REGISTER.

Schechtl

THE MARK CONSISTS OF STANDARD CHARACTERS WITHOUT CLAIM TO ANY PARTICULAR FONT, STYLE, SIZE, OR COLOR.

PRIORITY DATE OF 10-14-2008 IS CLAIMED.

OWNER OF INTERNATIONAL REGISTRATION 0999519 DATED 3-13-2009, EXPIRES 3-13-2019.

INT. CL. 7/U.S. CLS. 13, 19, 21, 23, 31, 34 AND 35

FOR EDGING MACHINES; POWER TOOLS, NAMELY, BENDING TOOLS FOR BENDING METAL, SQUARING SHEARS AND ROTARY SHEARS; BENDING MACHINES AND BENDING PRESS MACHINES; SHEET METAL STACKING MACHINES FOR SQUARING SHEARS; INDUSTRIAL FOLDING MACHINES; INDUSTRIAL PROFILING MACHINES FOR ARCHITECTURAL ROOFING; PARTS FOR THE AFORESAID GOODS.

INT. CL. 9/U.S. CLS. 21, 23, 26, 36 AND 38

FOR SOFTWARE, INCLUDING SOFTWARE FOR CONTROLLING EDGING MACHINES, BENDING MACHINES AND BENDING PRESS MACHINES, FOLDING MACHINES AND PROFILING MACHINES.

INT. CL. 42/U.S. CLS. 100 AND 101

FOR COMPUTER PROGRAMMING; [ELECTRONIC DATA PROCESSING CONSULTANCY;] DESIGNING OF COMPUTER PROGRAMS FOR DATA PROCESSING, IN PARTICULAR FOR CONTROLLING EDGING MACHINES, BENDING MACHINES AND BENDING PRESS MACHINES, FOLDING MACHINES AND PROFILING MACHINES; INSTALLATION AND MAINTENANCE OF SOFTWARE.

FIRST USE ; IN COMMERCE .

ELEMENTS CORRECTED
GOODS/SERVICES

3,758,192. REG. 3-9-2010. CHARITY GLOBAL, INC. (NEW YORK NON-PROFIT CORPORATION) 200 VARICK STREET, SUITE 201, NEW YORK, NY, 10014, SN 77-380,918. FILED 1-25-2008. PRINCIPAL REGISTER.

water.

THE MARK CONSISTS OF STANDARD CHARACTERS WITHOUT CLAIM TO ANY PARTICULAR FONT, STYLE, SIZE, OR COLOR.

INT. CL. 25/U.S. CLS. 22 AND 39

FOR [BATHING SUITS, BATHROBES, BEACHWEAR, BOXER SHORTS, CAPS, COATS, DRESSING GOWNS, FOOTWEAR, GALOSHES, GYM SHORTS, JACKETS, JOGGING SUITS, KNICKERS, PONCHOS, POLO SHIRTS, SHORTS, SPORT COATS, SUITS, SUN VISORS, SWEAT PANTS, SWIM TRUNKS, SWIM WEAR, SWIMSUITS, HALTER TOPS, TOPS, TURTLENECKS, UNDERCLOTHES, UNDERGARMENTS, UNDERPANTS, UNDERSHIRTS, AND WRIST BANDS] *HATS, RAINWEAR, RAIN COATS, SWEAT SHIRTS, T-SHIRTS, SHIRTS, AND TANK TOPS*.

FIRST USE 3-1-2007; IN COMMERCE 3-1-2007.

ELEMENTS CORRECTED
GOODS/SERVICES

3,759,025. REG. 3-9-2010. RAYSPAN CORPORATION (CALIFORNIA CORPORATION) 11975 EL CAMINO REAL #301, SAN DIEGO, CA. 92130, SN 77-656,882. FILED 1-26-2009. PRINCIPAL REGISTER.

Metarray.n

THE MARK CONSISTS OF STANDARD CHARACTERS WITHOUT CLAIM TO ANY PARTICULAR FONT, STYLE, SIZE, OR COLOR.

OWNER OF U.S. REG. NO. 3,591,800.
INT. CL. 9/U.S. CLS. 21, 23, 26, 36 AND 38

FOR [AMPLIFIER FOR WIRELESS COMMUNICATIONS;] ANTENNAS FOR WIRELESS COMMUNICATIONS APPARATUS; COMPUTER HARDWARE, NAMELY, WIRELESS ACCESS POINT WAP DEVICES; DEVICES FOR WIRELESS RADIO TRANSMISSION; [HOME AND OFFICE AUTOMATION SYSTEMS COMPRISING WIRELESS AND WIRED CONTROLLERS, CONTROLLED DEVICES, AND SOFTWARE FOR LIGHTING, HVAC, SECURITY, SAFETY AND OTHER HOME AND OFFICE MONITORING AND CONTROL APPLICATIONS; INTEGRATED CIRCUITS AND INTEGRATED CIRCUIT CORES FOR USE IN WIRELESS COMMUNICATIONS AND WIRELESS COMMUNICATION EQUIPMENT AND APPARATI AND DIGITAL SIGNAL PROCESSORS DSP; MOBILE COMPUTING AND OPERATING PLATFORMS CONSISTING OF DATA TRANSCEIVERS, WIRELESS NETWORKS AND GATEWAYS FOR COLLECTION AND MANAGEMENT OF DATA; RECONFIGURABLE PROCESSORS FOR USE IN WIRELESS COMMUNICATION HANDSETS AND NETWORK EQUIPMENT IN THE FIELD OF WIDEBAND COMMUNICATIONS; TELEMATICS APPARATUS, NAMELY, WIRELESS INTERNET DEVICES WHICH PROVIDE TELEMATIC SERVICES AND HAVE A CELLULAR PHONE FUNCTION; WIRELESS COMPUTER PERIPHERALS; WIRELESS CONTROLLER TO MONITOR AND CONTROL THE FUNCTIONING OF OTHER ELECTRONIC DEVICES; WIRELESS REMOTE TEMPERATURE AND HUMIDITY MONITORS FOR BUILDING MAINTENANCE;] WIRELESS TELEPHONES; WIRELESS TELEPHONY APPARATUS.
FIRST USE 1-26-2009; IN COMMERCE 9-1-2009.

ELEMENTS AMENDED
GOODS/SERVICES

3,767,709. REG. 3-30-2010. RDF MEDIA GROUP LIMITED (UNITED KINGDOM INCORPORATED COMPANY) THE GLOUCESTER BUILDING, KENSINGTON VILLAGE, AVONMORE ROAD, LONDON, UNITED KINGDOM, W14 8RF, SN 79-070,889. FILED 6-16-2009. PRINCIPAL REGISTER.

YOJOJO

THE MARK CONSISTS OF STANDARD CHARACTERS WITHOUT CLAIM TO ANY PARTICULAR FONT, STYLE, SIZE, OR COLOR.

OWNER OF INTERNATIONAL REGISTRATION 1007623 DATED 6-16-2009, EXPIRES 6-16-2019.

THE WORDING "YOJOJO" HAS NO MEANING IN A FOREIGN LANGUAGE.

INT. CL. 9/U.S. CLS. 21, 23, 26, 36 AND 38

FOR SCIENTIFIC, NAUTICAL, SURVEYING, PHOTOGRAPHIC, CINEMATOGRAPHIC, OPTICAL, WEIGHING, MEASURING, SIGNALING, CHECKING, LIFE-SAVING AND TEACHING APPARATUS AND INSTRUMENTS, NAMELY, CAMERAS AND DIGITAL VIDEO RECORDERS; APPARATUS AND INSTRUMENTS FOR CONDUCTING, SWITCHING, TRANSFORMING, ACCUMULATING, REGULATING OR CONTROLLING ELECTRICITY, NAMELY, TRANSFORMERS, ELECTRICAL SWITCHES, AND VOLTAGE REGULATORS; APPARATUS FOR RECORDING, TRANSMISSION OR REPRODUCTION OF SOUND OR IMAGES, NAMELY, VIDEO RECORDERS, CASSETTE PLAYERS, CASSETTE RECORDERS, VIDEO PLAYERS, MUSIC AMPLIFIERS, TAPE PLAYERS, VIDEO CAMERAS, AND MUSIC RECORDING APPARATUS IN THE NATURE OF TAPE RECORDERS, CD RECORDERS, DVD RECORDERS, MP3 RECORDERS AND DIGITAL AUDIO FILE RECORDERS; MAGNETIC DATA CARRIERS, RECORDING DISCS, VIDEOS, CDS, CD ROMS, DVDS, MINI-DISKS, AUDIO, VIDEO AND AUDIO-VISUAL RECORDINGS AND CINEMATOGRAPHICAL FILMS FEATURING CHILDREN'S TELEVISION PROGRAMMES, SERIALS, MOVIES AND CARTOONS; AUDIO RECORDINGS FEATURING MUSIC; DATA PROCESSING EQUIPMENT AND COMPUTERS, NAMELY, PERSONAL COMPUTERS AND DATA PROCESSORS; COMPUTER FIRMWARE FOR USE IN DATABASE MANAGEMENT; SOFTWARE AND DOWNLOADABLE SOFTWARE IN RELATION TO CHILDREN'S GAMES AND ENTERTAINMENT; COMPACT DISCS FEATURING MUSIC; DOWNLOADABLE MUSIC VIA THE INTERNET; TELECOMMUNICATIONS APPARATUS, NAMELY, TELEPHONES, MOBILE PHONES AND CELL PHONES; COMPUTER GAMES EQUIPMENT ADAPTED FOR USE WITH TV RECEIVERS, NAMELY, JOYSTICKS AND CONSOLES; ELECTRONIC GAMES SOFTWARE, HAND HELD ELECTRONIC GAME DEVICES AND PORTABLE GAME CONSOLE DEVICES FOR USE WITH AN EXTERNAL MONITOR; APPARATUS FOR USE IN BROADCASTING, TRANSMISSION, RECEIVING, PROCESSING, REPRODUCING, ENCODING AND DECODING OF RADIO AND TELEVISION PROGRAMMES AND DATA, NAMELY, DECODER SOFTWARE, TRANSMITTERS, AND ANTENNAE; DOWNLOADABLE COMPUTER GAMES SOFTWARE; COMPUTER GAMES SOFTWARE; HANDHELD COMPUTER GAMES FOR USE WITH TELEVISION RECEIVERS; DOWNLOADABLE ELECTRONIC PUBLICATIONS AVAILABLE VIA THE INTERNET OR DATABASES IN THE NATURE OF MAGAZINES, PERIODICALS, BOOKS OR NEWSLETTERS IN THE FIELD OF CHILDREN'S ENTERTAINMENT; COMMUNICATIONS SOFTWARE USED IN CONNECTING COMPUTERS TO DATABASES AND THE INTERNET; TELECOMMUNICATIONS APPARATUS TO ENABLE CONNECTION TO DATABASES AND THE INTERNET, NAMELY, MODEMS; DOWNLOADABLE DIGITAL MUSIC AND MP3 MUSIC FILES; BINOCULARS; MAGNETS; SUNGLASSES; SUNGLASS CASES; AUTOMATIC VENDING MACHINES, NAMELY, TICKET VENDING MACHINES AND DISPENSERS PARTS AND FITTINGS FOR THE AFORESAID GOODS; * NONE OF THE FOREGOING BEING PRE-PAID CALLING CARDS *.

FIRST USE ; IN COMMERCE .

INT. CL. 16/U.S. CLS. 2, 5, 22, 23, 29, 37, 38 AND 50

FOR PRINTED PUBLICATIONS, NAMELY, FORMS AND CHARTS; BOOKS, MAGAZINES, AND JOURNALS IN THE FIELD OF CHILDREN'S ENTERTAINMENT, ART AND COOKERY; POSTERS; PHOTOGRAPHS; OFFICE AND CHILDREN'S STATIONERY; CALENDARS; GUIDE BOOKS FEATURING CHILDREN'S ENTERTAINMENT; PAPER BAGS; PRINTED SHOW PROGRAMMES RELATED TO CHILDREN'S ENTERTAINMENT; GUIDE BOOKS IN THE FIELD OF ENTERTAINMENT; BROCHURES AND LEAFLETS ABOUT THE ENTERTAINMENT INDUSTRY; PRINTED FORMS FEATURING THE SCHEDULES OF PLAYS AND TELEVISION PROGRAMMING; BOOKS FEATURING TELEVISION AND MOVIE SCRIPTS, MUSIC, AND SONG LYRICS; MUSIC SHEETS; PRINTED INSTRUCTIONAL AND TEACHING MATERIAL IN THE FIELD OF CHILDREN'S ENTERTAINMENT, ART, COOKERY,

MATHEMATICS, ENGLISH, READING AND WRITING; WRITING INSTRUMENTS, NAMELY, PENS, PENCILS, CRAYONS; ERASERS; DRAWING RULERS; PENCIL SHARPENERS; PENCIL BOXES AND CASES; PENCIL HOLDERS; PHOTOGRAPH ALBUMS; RING BINDERS; FOLDERS; NOTEBOOKS; NOTEPADS; DIARIES; CALENDARS; POSTCARDS; DRAWINGS; STICKERS; TRANSFERS; STENCILS; SEAT AND ADMISSION TICKETS FOR SPORTING, CULTURAL, EDUCATIONAL AND ARTISTIC EVENTS, MOTION PICTURES, MUSICAL CONCERTS, TELEVISION SHOWS AND OTHER ENTERTAINMENT EVENTS.
FIRST USE ; IN COMMERCE .

INT. CL. 25/U.S. CLS. 22 AND 39

FOR CLOTHING, NAMELY, T-SHIRTS, SHIRTS, TANK TOPS, JUMPERS, SWEATERS, TROUSERS, SHORTS, SKIRTS, COATS, RAINCOATS, JACKETS, DRESSES, JEANS, LEGGINGS, JOGGING SUITS, SPORTS WEAR, NAMELY, DRESS SUITS, GYM SUITS, SWEAT SUITS AND TRACK SUITS, OVERALLS, BODYSUITS, ROMPER SUITS, NIGHTWEAR, ROBES, DRESSING GOWNS, PYJAMAS, SHORTS, SLEEP SUITS, SWIMWEAR, BOOTS, SHOES, SLIPPERS, SANDALS, RUNNING SHOES, SNEAKERS, SOCKS, HOSIERY, HATS, CAPS, BERETS, SCARVES, GLOVES, MITTENS, BOOTIES, CLOTH BIBS, APRONS, UNDERWEAR, BELTS, BRACES.
FIRST USE ; IN COMMERCE .

INT. CL. 28/U.S. CLS. 22, 23, 38 AND 50

FOR GAMES, TOYS AND PLAYTHINGS, NAMELY, ACTION FIGURES AND DOLLS; BEACH AND WATER TOYS, NAMELY, BEACH BALLS, SAND TOYS, BEACH BUCKETS AND SHOVELS, AIR MATTRESSES FOR RECREATIONAL USE, FLYING DISKS, AND WATER PISTOLS; PLAYMATS FOR INFANTS WITH TOYS ATTACHED; GYMNASIAC AND SPORTING ARTICLES, NAMELY, SKITTLES; HAND-HELD ELECTRONIC GAME DEVICES AND PORTABLE GAME CONSOLE DEVICES OTHER THAN THOSE FOR USE WITH AN EXTERNAL MONITOR; ELECTRONIC TOYS AND GAMES, NAMELY, ELECTRONIC ACTION TOYS AND ELECTRONIC BOARD GAMES OTHER THAN THOSE FOR USE WITH AN EXTERNAL MONITOR; DOLLS AND DOLLS' CLOTHING; ACCESSORIES FOR DOLLS; DOLLS' HOUSES; DOLLS' FURNITURE; DOLLS' FURNITURE ACCESSORIES; TEDDY BEARS; TOY ACTION FIGURES; TOY VEHICLES; SCALE MODEL VEHICLES; TOY BUILDING STRUCTURES AND TOY VEHICLE TRACKS; SOFT TOYS, NAMELY, STUFFED ANIMALS AND STUFFED CHARACTER FIGURES; PLUSH TOYS; PLAY SETS AND PLAY CASES, NAMELY, CHESS SETS AND CHECKER SETS AND CASES THEREFOR AND CHILDREN'S BOARD GAMES RELATING TO CHILDREN'S TELEVISION PROGRAMMES; BALLOONS; PLAYING CARDS; NOVELTY JOKES AND NOVELTIES FOR PARTIES, NAMELY, TOY MASKS AND FACE MASKS, PLASTIC TOY VEHICLES, PLASTIC TOY MODELS OF FIGURES, DIE CAST VEHICLES, DIE CAST FIGURES; PUZZLES; COSTUME MASKS; DECORATIONS FOR CHRISTMAS TREES; SKATEBOARDS; ICE SKATES AND ROLLER SKATES; SKATING BOOTS WITH SKATES ATTACHED; SPORTS BAG ADAPTED FOR CARRYING SPORTS ARTICLES; GOLF GLOVES; SOFTBALL AND BASEBALLS GLOVES; PUPPETS; MARIONETTES; KITES; MARBLES; BASKET BALLS, BASEBALLS, TENNIS BALLS, SOFT BALLS, CRICKET BALLS, GOLF BALLS; BASEBALL BATS, CRICKET BATS, SOFT BALL BAT, GOLF CLUBS.
FIRST USE ; IN COMMERCE .

INT. CL. 38/U.S. CLS. 100, 101 AND 104

FOR PROVIDING ACCESS TO TELECOMMUNICATIONS NETWORKS; TELECOMMUNICATIONS SERVICES, NAMELY, PROVIDING E-MAIL SERVICES AND ACCESS TO THE INTERNET; PROVIDING USER ACCESS TO THE INTERNET; INTERNET BROADCASTING SERVICES; WEBCASTING SERVICES; INFORMATION TRANSMISSION VIA ELECTRONIC COMMUNICATION NETWORKS; TRANSMISSION OF MESSAGES, DATA AND CONTENT VIA THE INTERNET AND OTHER COMPUTER AND COMMUNICATIONS NETWORKS; PROVIDING ACCESS TO DATABASES; PROVIDING ONLINE FORUMS, CHAT ROOMS AND LIST SERVERS FOR THE TRANSMISSION OF MESSAGES, COMMENTS AND MULTIMEDIA CONTENT AMONG USERS IN THE FIELD OF ENTERTAINMENT; TRANSMISSION OF ELECTRONIC MEDIA, MULTIMEDIA CONTENT, VIDEOS, MOVIES, PICTURES, IMAGES, TEXT, PHOTOS, GAMES, USER-GENERATED CONTENT, AUDIO CONTENT, AND INFORMATION VIA THE INTERNET AND OTHER COMPUTER AND COMMUNICATIONS NETWORKS; * NONE OF THE FOREGOING BEING TELEPHONY SERVICES *.
FIRST USE ; IN COMMERCE .

INT. CL. 41/U.S. CLS. 100, 101 AND 107

FOR PROVIDING ON-LINE JOURNALS, NAMELY, BLOGS IN THE FIELD OF ENTERTAINMENT; DISTRIBUTION OF DIGITAL TELEVISION PROGRAMMING FOR OTHERS; EDUCATIONAL SERVICES, NAMELY, PROVIDING CLASSES IN THE FIELD OF ENTERTAINMENT, MATHEMATICS, ENGLISH, READING AND WRITING; ENTERTAINMENT SERVICES, NAMELY, ORGANIZING COMMUNITY AND CULTURAL EVENTS AND PUTTING ON RADIO AND STAGE SHOWS FOR CHILDREN FOR THE PURPOSE OF ENTERTAINMENT; ENTERTAINMENT SERVICES, NAMELY, PROVIDING ONLINE COMPUTER GAMES; PRODUCTION OF TELEVISION PROGRAMMES, RADIO PROGRAMMES, FILMS, AUDIO RECORDINGS, LIVE SHOWS, STAGE PLAYS AND DRAMAS, AND CONCERTS; PRESENTATION OF MUSICAL AND LIVE PERFORMANCES; SYNDICATION OF TELEVISION AND RADIO PROGRAMMING; RENTAL OF FILMS, DVDS, COMPUTER GAMES AND VIDEO GAMES; THEATRICAL, MUSICAL, TELEVISION, RADIO AND FILM ENTERTAINMENT SERVICES, NAMELY, PROVIDING CHILDREN'S ENTERTAINMENT; PROVIDING THEATRE AND CINEMA FACILITIES; PRESENTATION OF LIVE PERFORMANCES; RECORDING STUDIO SERVICES; RENTAL OF EQUIPMENT, APPARATUS AND STAGE SCENERY FOR THEATRICAL SETS OR TELEVISION STUDIOS; RENTAL OF SOUND RECORDINGS AND VIDEO RECORDINGS; PROVIDING ENTERTAINMENT INFORMATION; ENTERTAINMENT TICKET AGENCY SERVICES; PROVIDING OF TRAINING AND EDUCATION IN THE NATURE OF CLASSES, SEMINARS AND WORKSHOPS RELATING TO THEATRICAL, MUSICAL, TELEVISION, RADIO AND CINEMATIC SHOWS, TELEVISION AND RADIO ENTERTAINMENT; THEATRE PRODUCTION; PUBLICATION OF PRINTED MATTER, NAMELY, BOOKS, MAGAZINES, JOURNALS, PERIODICALS, REPORTS, MANUALS, AND TEXT; PROVIDING ONLINE ELECTRONIC NON-DOWNLOADABLE PUBLICATIONS IN THE NATURE OF BOOKS AND JOURNALS IN THE FIELD OF ENTERTAINMENT; PROVIDING NEWS INFORMATION IN THE FIELD OF ENTERTAINMENT; ENTERTAINMENT SERVICES, NAMELY, PROVIDING NON-DOWNLOADABLE DIGITAL MUSIC AND INFORMATION IN THE FIELD OF MUSIC AND ENTERTAINMENT VIA A COMPUTER DATABASE, THE INTERNET AND TELEVISION AND RADIO PROGRAMMES.
FIRST USE ; IN COMMERCE .

ELEMENTS CORRECTED
GOODS/SERVICES

* * * * *

TRADEMARK REGISTRATIONS—NEW CERTIFICATES

New Certificates issued under section 7(d) of the Trademark Act of 1946 for the unexpired term of the original registrations.

980,450. THE WHOLE EARTH. U.S. CL. 46. DEL MONTE CORPORATION, SAN FRANCISCO, CA. REG. 3-12-1974. NEW CERT. SEC. 7(D) TO SNAK KING CORP., CITY OF INDUSTRY, CA.

REG. 4-29-1997. NEW CERT. SEC. 7(D) TO CROSSBOW CONSULTING, L.P., DALLAS, TX.

1,998,068. COTTON TOPPER (STYLIZED). INT. CL. 22. A.J. GERRARD & COMPANY, DES PLAINES, IL. REG. 9-3-1996. NEW CERT. SEC. 7(D) TO L.P. BROWN COMPANY, INC., MEMPHIS, TN.

3,611,684. WEIGHT KNOW MORE STANDARD CHARACTER MARK. INT. CL. 44. WKM PARTNERS DALLAS 1 LLC, DALLAS, TX. REG. 4-28-2009. NEW CERT. SEC. 7(D) TO REGISTRANT.

2,057,087. MAKING TECHNOLOGY WORK FOR BUSINESS. INT. CL. 42. EDISON GROUP, INC., DALLAS, TX.

3,760,843. STERLING TRUST STANDARD CHARACTER MARK. INT. CL. 36. STERLING TRUST, ELYRIA, OH. REG. 3-16-2010. NEW CERT. SEC. 7(D) TO REGISTRANT.

* * * * *

INDEX OF REGISTRANTS

MAY 4, 2010

(Registered; Renewed; Canceled; Amended, Corrected, etc.; New Certificates; 12c Publications.)

The designation "U.S. Cl." appearing in this section refers to the U.S. class in effect prior to Sep. 1, 1973 rather than the international class which applies to applications filed on or after that date. For adoption of international classification see notice in the OFFICIAL GAZETTE of Jun. 26, 1973 (911 O.G. TM 210).

"EUROTERM" CLOSED JOINT-STOCK COMPANY, ARME-
NIA:
3,785,013, PUB. 2-16-2010. MULTIPLE CLASS, INT. CLS.
29, 30, 31 AND 32.

ÏD GROUP, FRANCE:
3,784,859, PUB. 4-1-2008. MULTIPLE CLASS, INT. CLS. 3,
14, 18 AND 44.

A & B COMM., INC., CHULA VISTA, CA, DBA CRAZY
GUYS COMMUNICATIONS:
3,783,406, PUB. 2-16-2010. INT. CL. 35.

A BAR AND GRILL WITH A BITE, INC., NEW ORLEANS,
LA, DBA THE CRAZY LOBSTER BAR & GRILL:
3,733,384, CANC. INT. CL. 43.

A PEACEFUL COMPANY, GUILFORD, CT:
2,752,662, CANC. INT. CL. 35.

A. BLOK BEHEER B.V., NETHERLANDS:
3,784,875, PUB. 5-19-2009. MULTIPLE CLASS, INT. CLS.
35, 41, 42 AND 44.

A. KLEBES GMBH & CO. K.G. KUNSTSTOFF- UND
METALLWARENFABRIK, ERLANGEN, FED REP GER-
MANY:
1,552,831, CANC. INT. CL. 16.

A. LEECHMAN HEATING & COOLING, INC., DES
MOINES, IA:
3,786,357, INT. CL. 37.

A.B.C. COMPOUNDING COMPANY, INC., MORROW, GA:
3,501,180, CANC. INT. CL. 3.

A.I. ROOT COMPANY, THE, MEDINA, OH:
2,335,811, REN. 3-29-10. INT. CL. 4.

A.J. BOGGS & COMPANY, OKEMOS, MI:
2,272,468, CANC. INT. CL. 9.

A.J. GERRARD & COMPANY, DES PLAINES, IL TO
ILLINOIS TOOL WORKS INC., GLENVIEW, IL:
1,623,256, CANC. INT. CL. 8.

A.J. GERRARD & COMPANY, DES PLAINES, IL TO L.P.
BROWN COMPANY, INC., MEMPHIS, TN:
1,998,068 NEW CERT. 5-4-2010. INT. CL. 22.

A.K. TECHNICAL LABORATORY INC., HANISHINA-GUN,
NAGANO-KEN, JAPAN:
2,406,490, REN. 3-30-10. INT. CL. 7.

A.M. BEST COMPANY, OLDWICK, NJ:
1,638,631, REN. 4-1-10. INT. CL. 36.

A.T.X. INTERNATIONAL, INC., LINCOLN, RI:
526,855, REN. 3-29-10. U.S. CL. 37 (INT. CL. 16).

A.V.W. INC., FT LAUDERDALE, FL, DBA MAX PROFES-
SIONAL:
3,786,474, INT. CL. 3.

A-TRONIC MGM AG, CH-8105 REGENSDORF, SWITZER-
LAND:
2,751,630, CANC. INT. CL. 9.

AAAA WORLD IMPORT-EXPORT, INC., MIAMI, FL:
3,784,526, PUB. 2-16-2010. INT. CL. 35.

AARON CLARK INDUSTRIES, REYNOLDSBURG, OH:
2,754,447, CANC. INT. CL. 16.

AB HOLDINGS, LLC, BOISE, ID:
3,203,749, COR. INT. CL. 29.
3,783,523, PUB. 2-16-2010. INT. CL. 5.
3,783,524, PUB. 2-16-2010. INT. CL. 5.
3,783,525, PUB. 2-16-2010. INT. CL. 5.
3,783,526, PUB. 2-16-2010. INT. CL. 5.
3,783,527, PUB. 2-16-2010. INT. CL. 5.

ABBOTT BIOTECHNOLOGY LTD., HAMILTON, BERMU-
DA:
3,784,305, PUB. 2-16-2010. INT. CL. 5.
3,785,794, INT. CL. 44.

ABC AUTO ALARMS, INC., ELK GROVE VILLAGE, IL:
1,553,263, CANC. INT. CL. 37.

ABC WINDOW CLEANING SUPPLY, INC., LAKEWOOD,
CO:
3,786,442, INT. CL. 35.

ABC-CLIO, INC., SANTA BARBARA, CA:
2,384,985, REN. 3-26-10. INT. CL. 16.

ABEL INDUSTRIES (CANADA) LTD., PITT MEADOWS, BC,
CANADA:
3,785,819, INT. CL. 9.

ABERCROMBIE & FITCH TRADING CO., NEW ALBANY,
OH:
3,783,586, PUB. 2-16-2010. INT. CL. 35.
3,783,648, PUB. 2-16-2010. INT. CL. 3.
3,783,649, PUB. 2-16-2010. INT. CL. 14.
3,783,650, PUB. 2-16-2010. INT. CL. 25.
3,783,651, PUB. 2-16-2010. INT. CL. 35.

ABLE PLANET, INCORPORATED, WHEAT RIDGE, CO:
3,784,833, PUB. 3-11-2008. INT. CL. 9.

ABOUT, INC., NEW YORK, NY, ABOUT.COM, INC., NEW
YORK, NY:
2,348,472, REN. 3-26-10. INT. CL. 42.

ABRAHAM MORTGAGE, LLC, TAMPA, FL:
2,753,167, CANC. INT. CL. 36.

ABS LICENSE, S.A. DE C.V., NUEVO LEON, MEXICO:
2,753,039, CANC. INT. CL. 16.

ABS-CBN INTERNATIONAL, REDWOOD CITY, CA:
2,334,131, REN. 3-29-10. MULTIPLE CLASS, INT. CLS. 36
AND 38.

ABT, INC., TROUTMAN, NC:
2,335,270, REN. 3-26-10. MULTIPLE CLASS, INT. CLS. 6
AND 19.

ABUS AUGUST BREMICKER SOHNE KG, 58300 WETTER-
VOLMARSTEIN, FED REP GERMANY:
2,320,146, REN. 3-30-10. INT. CL. 6.

ABYSSINIAN DEVELOPMENT CORPORATION, NEW
YORK, NY:
3,786,484, INT. CL. 41.

ACCELL CORPORATION, FREMONT, CA:
3,786,140, INT. CL. 9.

ACCESS DATA TECHNOLOGIES, ALPHARETTA, GA:
2,754,513, CANC. INT. CL. 9.

ACCESS INTELLIGENCE LLC, ROCKVILLE, MD:
2,754,549, CANC. INT. CL. 41.

ACCESS KIDDIE RIDES, INC., FARGO, ND:
2,754,560, CANC. INT. CL. 10.

ACCESS TECHNOLOGIES INTERNATIONAL, INC., MIL-
WAUKEE, WI:
2,752,999, CANC. INT. CL. 9.

ACCESSORIES ASSOCIATES, INC., SMITHFIELD, RI:
2,271,291, CANC. INT. CL. 14.

ACCOMMODATIONS KAUAI, INC., ANAHOLA, HI:
2,429,669, REN. 3-30-10. INT. CL. 42.

ACCUPAGE LIMITED, HAMPSHIRE GUL2 5LS, UNITED
KINGDOM:
2,751,575, CANC. INT. CL. 9.

- ACCUQUEST HEARING CENTER, INC., HOFFMAN ESTATES, IL:
3,785,555, MULTIPLE CLASS, INT. CLS. 35, 37 AND 44.
- ACCURATE CHEMICAL & SCIENTIFIC CORPORATION, WESTBURY, NY:
1,767,843. REN. 4-1-10. INT. CL. 1.
- ACCURATE ROOFING AND SIDING UNLIMITED, INC., TRENTON, NJ:
2,405,395. REN. 3-31-10. INT. CL. 37.
- ACE BED CO., LTD., SONGNAM-SHI, KYONGGI-DO, REPUBLIC OF KOREA:
2,336,405. REN. 3-27-10. INT. CL. 20.
- ACEGAIN, INC., SAN JOSE, CA:
2,753,891, CANC. INT. CL. 9.
- ACI INTERNATIONAL, LOS ANGELES, CA:
3,785,469, INT. CL. 25.
- ACK 6 INC., PHOENIX, AZ:
3,786,025, INT. CL. 42.
- ACL TRANSPORTATION SERVICES LLC, JEFFERSONVILLE, IN:
1,553,260, CANC. MULTIPLE CLASS, INT. CLS. 37 AND 39.
- ACORN MOBILITY SERVICES LIMITED, STEETON, UNITED KINGDOM:
3,784,944, PUB. 2-16-2010. INT. CL. 7.
- ACOSTA, CARMINDY, NEW YORK, NY:
3,785,616, INT. CL. 3.
3,786,309, INT. CL. 3.
- ACS MARKETING, L.P., DALLAS, TX:
2,335,384. REN. 3-30-10. INT. CL. 39.
2,338,103. REN. 3-31-10. INT. CL. 39.
- ACT, INC., IOWA CITY, IA:
2,343,829. REN. 3-30-10. INT. CL. 41.
- ACTELION PHARMACEUTICALS LTD, ALLSCHWIL, SWITZERLAND:
3,784,713, PUB. 2-16-2010. INT. CL. 5.
- ACTIVE ORGANICS, LP, LEWISVILLE, TX:
3,785,148, INT. CL. 1.
3,785,470, INT. CL. 1.
3,786,313, MULTIPLE CLASS, INT. CLS. 1 AND 3.
- ACTIVEPOINT LTD., 42101 NETANYA SOUTH, ISRAEL:
2,335,244. REN. 3-26-10. INT. CL. 9.
- ACTIVIDENTITY (AUSTRALIA) PTY LTD., FREMONT, CA:
2,753,867, CANC. INT. CL. 9.
- ACUCELA INC., BOTHELL, WA:
3,785,943, INT. CL. 42.
- ADALIS CORPORATION, VANCOUVER, WA:
2,335,390. REN. 3-29-10. INT. CL. 17.
- ADAM CORNELIUS KING, BELLEVUE, WA:
3,784,416, PUB. 2-16-2010. INT. CL. 28.
- ADAMS, BERNARD, UTOPIA, TX:
3,784,068, PUB. 2-16-2010. INT. CL. 9.
- ADDAZI, INC., LOS ANGELES, CA, DBA CONDOMANIA:
3,784,493, PUB. 2-16-2010. MULTIPLE CLASS, INT. CLS. 10 AND 35.
- ADMARK, INC., TOPEKA, KS:
1,552,845, CANC. INT. CL. 16.
- ADMINISTRATOR OF ART BLAKEY ESTATE, THE C/O TAKASHI BUHAINA BLAKEY, WEEHAWKEN, NJ:
2,340,856. REN. 3-27-10. INT. CL. 9.
- ADSERVERSONLINE, LLC, CHICAGO, IL:
2,753,290, CANC. INT. CL. 9.
- ADT SERVICES AG, SCHAFFHAUSEN, SWITZERLAND:
2,753,599, CANC. INT. CL. 9.
- ADVANCE MAGAZINE PUBLISHER, INC., NEW YORK, NY:
2,752,660, CANC. INT. CL. 16.
2,752,663, CANC. INT. CL. 16.
2,752,664, CANC. INT. CL. 16.
2,752,667, CANC. INT. CL. 16.
- ADVANCED BEAUTY SYSTEMS, INC., DALLAS, TX:
3,785,733, INT. CL. 3.
- ADVANCED CHEMISTRY & TECHNOLOGY, INC., GARDEN GROVE, CA:
2,355,782. REN. 3-31-10. INT. CL. 17.
- ADVANCED CHIROPRACTIC SERVICES, P.A., LAWRENCE, KS:
3,784,197, PUB. 2-16-2010. INT. CL. 44.
- ADVANCED CONSTRUCTION PRODUCTS, INC., TUCSON, AZ:
2,751,726, CANC. INT. CL. 20.
- ADVANCED EDUCATION SYSTEMS, LLC, LUTHERVILLE, MD:
2,752,917, CANC. MULTIPLE CLASS, INT. CLS. 16 AND 41.
- ADVANCED FOOD SYSTEMS, INC., SOMERSET, NJ:
3,783,777, PUB. 2-16-2010. INT. CL. 30.
- ADVANCED INTERNET TECHNOLOGIES, INC., FAYETTEVILLE, NC:
2,752,132, CANC. INT. CL. 42.
- ADVANCED LOGIC RESEARCH, INC., IRVINE, CA:
1,552,684, CANC. INT. CL. 9.
- ADVANCED PAINTING CONTRACTORS CO., INC., MANHATTAN BEACH, CA:
2,754,621, CANC. INT. CL. 37.
- ADVANCED REFINING CONCEPTS, LLC, RENO, NV:
3,785,586, INT. CL. 4.
- ADVANCED SEMICONDUCTOR ENGINEERING, INC., KAOSHIUNG, TAIWAN:
3,785,152, MULTIPLE CLASS, INT. CLS. 9, 40 AND 42.
- ADVANCED SOLUTIONS, INC., LOUISVILLE, KY:
2,751,983, CANC. INT. CL. 41.
- ADVANCED SPORT, INC., PHILADELPHIA, PA, ADVANCED SPORT, INC., PHILADELPHIA, PA:
2,405,199. REN. 3-31-10. INT. CL. 12.
- ADVANCED SPORTS, INC., PHILADELPHIA, PA, DBA FUJI AMERICA:
2,404,293. REN. 3-30-10. INT. CL. 12.
- ADVANCED SPORTS, INC., PHILAPHIA, PA, ADVANCED SPORTS, INC., PHILAPHIA, PA:
2,414,490. REN. 3-30-10. INT. CL. 12.
- ADVANCED VISION RESEARCH, INC., WOBURN, MA:
3,786,085, INT. CL. 5.
- ADVANCEDLO SYSTEMS INC., VANCOUVER, BC, CANADA:
3,785,159, INT. CL. 9.
- ADVANTAGE DEBT MANAGEMENT OF AMERICA, INC., CINCINNATI, OH:
3,783,992, PUB. 2-16-2010. INT. CL. 36.
- ADVANTEK, INC., EDINA, MN:
3,783,715, PUB. 2-16-2010. INT. CL. 35.
- ADVENT SOFTWARE, INC., SAN FRANCISCO, CA:
2,272,795, CANC. INT. CL. 36.
- ADVENT TELEVISION LTD, SINGAPORE:
2,751,591, CANC. INT. CL. 35.
- ADVENTURE DIVERS, INC., FT. LAUDERDALE, FL:
3,783,290, PUB. 2-16-2010. INT. CL. 35.
- ADVIRTPRO, LLC, EL CERRITO, CA, DBA ADTOLIST-COM:
3,783,858, PUB. 2-16-2010. INT. CL. 35.
- ADVITECH INC., QUEBEC, CANADA, ADVITECH SOLUTIONS INC., VANIER QUEBEC, CANADA:
2,320,052. REN. 3-26-10. INT. CL. 1.
- ADVOCARE INTERNATIONAL, L.L.C., CARROLLTON, TX:
2,753,192, CANC. INT. CL. 5.
2,753,193, CANC. INT. CL. 5.
- ADXLINK, INC., IRWINDALE, CA:
2,753,974, CANC. MULTIPLE CLASS, INT. CLS. 9, 36, 38 AND 42.
- AEROBIND INC, FORT WORTH, TX:
3,784,454, PUB. 2-16-2010. INT. CL. 16.
- AETHER SYSTEMS, INC., OWINGS MILLS, MD:
2,754,385, CANC. MULTIPLE CLASS, INT. CLS. 9, 38 AND 42.
- AF GLOENCO, INC., HOUSTON, TX:
1,553,356, CANC. INT. CL. 7.
- AFFINION PUBLISHING, INC., LAS VEGAS, NV:
1,553,199, CANC. INT. CL. 35.
- AFFLICTION HOLDINGS LLC, SEAL BEACH, CA:
3,784,792, PUB. 2-16-2010. INT. CL. 25.
3,784,795, PUB. 2-16-2010. INT. CL. 25.
3,784,802, PUB. 2-16-2010. MULTIPLE CLASS, INT. CLS. 14 AND 18.
- 3,784,803, PUB. 2-16-2010. INT. CL. 14.
3,784,805, PUB. 2-16-2010. INT. CL. 14.
3,784,810, PUB. 2-16-2010. INT. CL. 35.

AFFORDABLE TERMINAL & SUPPLY, INC., HOUSTON, TX:
2,272,212, CANC. INT. CL. 9.

AG LEADER TECHNOLOGY, INC., AMES, IA:
3,785,812, INT. CL. 9.

AGA RANGEMASTER GROUP PLC, WARWICKSHIRE CV31 3RG, UNITED KINGDOM:
3,784,866, PUB. 2-16-2010. MULTIPLE CLASS, INT. CLS. 11, 37 AND 40.

AGENT 77, MENDOTA HEIGHTS, MN:
2,753,170, CANC. INT. CL. 16.

AGGREGATE TRANSPORT CORPORATION, HANOVER, MD:
2,429,153, REN. 3-26-10. INT. CL. 39.

AGILE THERAPEUTICS, INC., WEST CONSHOCKEN, PA:
3,786,349, INT. CL. 5.

AGILITY HOLDINGS, INC., SANTA ANA, CA:
3,784,151, PUB. 2-16-2010. INT. CL. 39.

AGRI LABORATORIES, LTD., ST. JOSEPH, MO:
2,358,308, REN. 4-1-10. INT. CL. 5.

AGRI-MARK, INC., LAWRENCE, MA:
2,382,362, REN. 3-31-10. INT. CL. 29.

AHEAD, LLC, CHICAGO, IL:
3,783,646, PUB. 2-16-2010. MULTIPLE CLASS, INT. CLS. 35 AND 42.

AI GUO LIN, JINJIANG CITY, FUJIAN, CHINA:
3,785,987, INT. CL. 25.

AIBELIVE CO., LTD., TAIPEI CITY, TAIWAN:
3,785,641, INT. CL. 9.

AIDA ENGINEERING, LTD., KANAGAWA-KEN, JAPAN:
1,620,818, REN. 3-31-10. INT. CL. 7.

AIHINI, JOSEPH, NEWARK, NJ:
1,553,119, CANC. INT. CL. 30.

AIM - ARIZONA INTERNET MARKETING, LLC, CHINO VALLEY, AZ:
3,784,220, PUB. 2-16-2010. INT. CL. 9.

AIM SERVICES S.A.R.L., LUXEMBOURG, LUXEMBOURG:
3,785,021, PUB. 2-16-2010. MULTIPLE CLASS, INT. CLS. 35, 36 AND 45.

AIM-ARIZONA INTERNET MARKETING, LLC, CHINO VALLEY, AZ:
3,784,550, PUB. 2-16-2010. INT. CL. 42.

AIMREC ENTERPRISE, LLC, BALTIMORE, MD, DBA AIMREC ENTERPRISE, LLC:
3,783,612, PUB. 2-16-2010. INT. CL. 9.

AIR JAMAICA LIMITED, KINGSTON, JAMAICA:
2,753,187, CANC. INT. CL. 41.

AIR WAVES, INC., LEWIS CENTER, OH:
2,752,470, CANC. INT. CL. 16.

AIRBORNE ATHLETICS, INC., BELLE PLAINE, MN:
3,783,109, PUB. 2-16-2010. INT. CL. 28.

AIRCRAFT RUBBER MANUFACTURING, INC, REDMOND, OR:
3,784,124, PUB. 2-16-2010. INT. CL. 12.
3,784,798, PUB. 2-16-2010. INT. CL. 17.

AIRGROUP CORPORATION, BELLEVUE, WA:
2,753,254, CANC. INT. CL. 39.

AIRINSPACE B.V., DELFT, NETHERLANDS:
3,785,271, INT. CL. 11.

AIRSOFT AMERICA, INC, VERNON, CA:
3,783,267, PUB. 2-16-2010. INT. CL. 13.

AIRSPEED AVIATION, INC., OZARK, AL:
2,753,110, CANC. INT. CL. 39.

AIRTEC AG, SWITZERLAND:
3,785,014, PUB. 2-16-2010. MULTIPLE CLASS, INT. CLS. 7 AND 37.

AIRXCEL, INC., WICHITA, KS:
1,147,999, REN. 3-30-10. INT. CL. 11.

AIXTRON AG, D-52134 HERZOGENRATH, FED REP GERMANY:
2,908,197, CANC. INT. CL. 9.

AJAX TOCCO MAGNETHERMIC CORPORATION, WARREN, OH:
1,552,740, CANC. INT. CL. 11.

AJC INTERNATIONAL, INC., ATLANTA, GA:
3,784,629, PUB. 2-16-2010. INT. CL. 29.

AKIMBO AB, SALTSJO-BOO, SWEDEN:
2,751,701, CANC. MULTIPLE CLASS, INT. CLS. 9, 16 AND 42.

AKITA, INC., WILMINGTON, DE:
3,784,718, PUB. 2-16-2010. INT. CL. 36.
3,784,723, PUB. 2-16-2010. INT. CL. 36.
3,784,731, PUB. 2-16-2010. INT. CL. 36.

AKORN, INC., LAKE FOREST, IL:
2,429,583, REN. 3-26-10. INT. CL. 5.
2,429,584, REN. 3-26-10. INT. CL. 5.

AKTIEBOLAGET ELECTROLUX, SE-105 45 STOCKHOLM, SWEDEN:
2,754,323, CANC. INT. CL. 7.

AKZO NOBEL COATINGS GMBH, 70469, STUTTGART, FED REP GERMANY, SCHOWITZ, HEINRICH, STUTTGART-FEUERBACH, FED REP GERMANY, DBA CHR. LECHLER & SOHN NACHR., DBA CHR. LECHLER & SOHN NACHF.:
688,595, REN. 3-26-10. U.S. CL. 16 (INT. CL. 2).

ALABAMA CREDIT UNION, TUSCALOOSA, AL:
3,784,293, PUB. 2-16-2010. INT. CL. 36.

ALAIN TONDOWSKI SARL, 75004 PARIS, FRANCE:
2,751,985, CANC. INT. CL. 25.

ALAMO FIREWORKS, INC., SAN ANTONIO, TX:
2,338,528, REN. 3-30-10. INT. CL. 13.
2,341,720, REN. 3-30-10. INT. CL. 13.

ALAN CHARLES ROBERTS, NEW YORK, NY:
2,752,958, CANC. INT. CL. 25.

ALAN D WIDGEROW, IRVINE, CA:
3,786,087, INT. CL. 3.

ALAN LLOYD DESIGN, INC., ST. LOUIS, MO:
2,753,271, CANC. INT. CL. 11.

ALARM.COM INCORPORATED, MCCLEAN, VA:
3,785,229, INT. CL. 45.

ALBION COLOURS LIMITED, YEADON, LEEDS, UNITED KINGDOM:
2,366,557, REN. 3-27-10. INT. CL. 2.

ALBION LABORATORIES, INC., CLEARFIELD, UT:
2,754,388, CANC. MULTIPLE CLASS, INT. CLS. 1, 5 AND 40.

ALCATEL, PARIS, FRANCE:
2,753,098, CANC. INT. CL. 9.

ALCATEL LUCENT, FRANCE:
3,784,970, PUB. 2-16-2010. MULTIPLE CLASS, INT. CLS. 9, 38 AND 42.

ALCON RESEARCH, LTD., FORT WORTH, TX:
1,552,725, CANC. INT. CL. 10.

ALCON, INC., CH-6331 HUNENBERG, SWITZERLAND:
3,783,137, PUB. 2-16-2010. INT. CL. 5.

ALDERWOODS GROUP INC., CINCINNATI, OH:
2,753,981, CANC. INT. CL. 36.

ALDI INC., BATAVIA, IL:
3,786,186, INT. CL. 30.

ALERE MEDICAL, INC., RENO, NV:
3,530,817, COR. MULTIPLE CLASS, INT. CLS. 10 AND 44.
3,575,660, COR. MULTIPLE CLASS, INT. CLS. 10 AND 44.

ALEXANDER INDUSTRIES, INC., RADFORD, VA:
3,783,756, PUB. 2-16-2010. INT. CL. 13.

ALEXANDER TECHNOLOGIES EUROPE LIMITED, PETERLEE, CO. DURHAM SR8 2RL, UNITED KINGDOM:
2,318,708, REN. 4-1-10. INT. CL. 9.

ALEXANDER, ZACHARY, T, ASHBURN, VA:
2,754,392, CANC. INT. CL. 42.

ALFONSO ANNECCHIARICO, MONTEMIETTO, ITALY:
3,785,510, INT. CL. 15.

ALFREDO INTERNATIONAL, INC., ORLANDO, FL:
3,786,367, INT. CL. 43.

ALFREDO M. AMEZAGA JR., RENO, NV:
3,784,432, PUB. 2-16-2010. MULTIPLE CLASS, INT. CLS. 16 AND 45.

ALI WING, INC., NEW YORK, NY:
3,786,303, MULTIPLE CLASS, INT. CLS. 38 AND 44.

ALICE RENELLE BRACEGIRDLE, VICTORIA, BC, CANADA:
3,785,302, INT. CL. 41.

- ALIGN TECHNOLOGY, INC., SANTA CLARA, CA:
3,786,167, INT. CL. 41.
- ALIMED, INC., DEDHAM, MA:
2,378,610, REN. 3-29-10. MULTIPLE CLASS, INT. CLS. 10 AND 17.
- ALINE ARCHITECTURE, LLC, ALEXANDRIA, VA:
3,784,226, PUB. 2-16-2010. INT. CL. 42.
- ALL ABOUT TRAVEL, INC., TUCSON, AZ:
2,331,423, REN. 3-28-10. MULTIPLE CLASS, INT. CLS. 39 AND 42.
- ALL AMERICAN SNACKS, L.L.C., LINCOLN, NE:
2,751,909, CANC. INT. CL. 30.
- ALL KINDS OF MINDS, DURHAM, NC:
2,328,717, REN. 3-26-10. INT. CL. 16.
2,328,718, REN. 3-26-10. INT. CL. 41.
- ALL POINTS AUTO TRANSPORT, LP, SAN LEANDRO, CA:
3,783,287, PUB. 2-16-2010. INT. CL. 39.
- ALL STATE TOURS, INC., LAS VEGAS, NV:
1,810,525, CANC. MULTIPLE CLASS, INT. CLS. 9 AND 41.
- ALL THINGS EQUAL, INC., SANTA MONICA, CA:
2,754,615, CANC. INT. CL. 28.
- ALL TREND CORPORATION, FORT LAUDERDALE, FL:
1,552,760, CANC. INT. CL. 11.
- ALLA, RAVIKUMAR REDDY, NEW BERLIN, WI:
2,754,470, CANC. INT. CL. 10.
- ALLEGRA HOLDINGS LLC, NORTHVILLE, MI:
3,783,744, PUB. 2-16-2010. MULTIPLE CLASS, INT. CLS. 35, 40 AND 42.
- ALLEN TELECOM INC., BEACHWOOD, OH:
2,754,094, CANC. INT. CL. 9.
- ALLEN, BENJAMIN L., CHANDLER, AZ:
3,784,822, PUB. 5-19-2009. INT. CL. 35.
- ALLEN, MICHAEL W., JERSEYVILLE, IL:
3,783,377, PUB. 2-16-2010. INT. CL. 16.
- ALLEN, REGINALD, WASHINGTON, DC:
3,783,480, PUB. 2-16-2010. INT. CL. 42.
- ALLIANCE BENEFIT GROUP, INC., PITTSBURGH, PA:
2,753,398, CANC. INT. CL. 36.
- ALLIANCE CREDIT UNION, OGDEN, UT:
2,379,380, REN. 3-26-10. INT. CL. 36.
- ALLIANCE FOOD EQUIPMENT PROCESSING, LLC, NORTHVALE, NJ, RASMUSSEN, MARLIN B., SACRAMENTO, CA:
695,255, REN. 3-26-10. U.S. CL. 23 (INT. CL. 7).
- ALLIANCE SPORTS GROUP, L.P., GRAND PRAIRIE, TX:
3,783,395, PUB. 2-16-2010. MULTIPLE CLASS, INT. CLS. 8, 11 AND 28.
3,785,517, MULTIPLE CLASS, INT. CLS. 18, 20, 22 AND 25.
- ALLIED INTERNATIONAL CORPORATION OF VA, ASHBURN, VA:
2,751,593, CANC. INT. CL. 30.
- ALLIED MARINE, LLC, FORT LAUDERDALE, FL:
3,784,253, PUB. 2-16-2010. MULTIPLE CLASS, INT. CLS. 35, 36, 37, 39 AND 42.
- ALLIN CORPORATION, PITTSBURGH, PA:
2,368,981, REN. 4-1-10. INT. CL. 38.
2,368,981, CANC. INT. CL. 40.
- ALLISON, MARK A, STONY BROOK, NY:
2,753,031, CANC. INT. CL. 9.
- ALLSTAR MARKETING GROUP, LLC, HAWTHORNE, NY:
3,783,261, PUB. 2-16-2010. INT. CL. 21.
3,785,738, INT. CL. 21.
- ALLURE PET PRODUCTS, LLC, TOTOWA, NJ:
3,786,190, INT. CL. 28.
- ALM MEDIA PROPERTIES, LLC, NEW YORK, NY:
3,786,352, INT. CL. 16.
- ALMAR LTD., ROLLING HILLS ESTATES, CA:
2,340,911, REN. 3-31-10. INT. CL. 36.
- ALOYS F. DORNBRACHT GMBH & CO. KG, ISERLOHN, FED REP GERMANY:
3,785,213, MULTIPLE CLASS, INT. CLS. 6, 9, 11, 20 AND 21.
- ALPHA PHI INTERNATIONAL FRATERNITY, INCORPORATED, EVANSTON, IL, AKA ALPHA PHI SORORITY:
3,783,966, PUB. 2-16-2010. INT. CL. 18.
3,783,967, PUB. 2-16-2010. INT. CL. 25.
3,784,045, PUB. 2-16-2010. INT. CL. 21.
- ALPHA PRO TECH, INC., NOGALES, AZ:
2,339,085, REN. 3-31-10. INT. CL. 10.
2,339,089, REN. 3-27-10. INT. CL. 10.
2,352,605, REN. 3-26-10. MULTIPLE CLASS, INT. CLS. 9 AND 10.
- ALPHA THERAPEUTIC CORPORATION, LOS ANGELES, CA:
1,552,471, CANC. INT. CL. 5.
- ALPHARMA INC., BRIDGEWATER, NJ:
2,341,707, REN. 3-31-10. INT. CL. 5.
- ALPHAVAX, INC., RESEARCH TRIANGLE PARK, NC:
2,334,593, REN. 3-26-10. INT. CL. 42.
- ALTANA AG, 46483 WESEL, FED REP GERMANY:
3,785,119, MULTIPLE CLASS, INT. CLS. 1, 2, 9 AND 17.
- ALTAPIC LLC, NEWARK, DE:
3,785,928, INT. CL. 9.
- ALTERED SKATES OF AMERICA, ST. LOUIS, MO:
2,754,384, CANC. INT. CL. 35.
- ALTERNACARE SERVICES, INC., SPRING HILL, FL:
3,785,588, INT. CL. 25.
- ALTERS-DELETIS, ANGELA, SEATTLE, WA:
2,752,737, CANC. INT. CL. 41.
- ALTRAN TECHNOLOGIES, PARIS, FRANCE:
2,751,754, CANC. MULTIPLE CLASS, INT. CLS. 41 AND 42.
- ALTVANTAGE ADVISORS, L.P., NEW YORK, NY:
2,753,880, CANC. INT. CL. 36.
- ALURE HOME IMPROVEMENTS, INC., PLAINVIEW, NY:
3,784,372, PUB. 2-16-2010. INT. CL. 37.
- ALVARADO, CESAR, SAN MARCOS, CA:
2,752,235, CANC. INT. CL. 37.
- ALVEOLA KFT., H-1143 BUDAPEST, HUNGARY:
3,784,951, PUB. 1-12-2010. MULTIPLE CLASS, INT. CLS. 3 AND 8.
- ALWAYS B.B. INT'L, INC., LOS ANGELES, CA:
2,753,164, CANC. INT. CL. 30.
- ALWAYSVIEW, INC., FREMONT, CA:
3,784,498, PUB. 2-16-2010. INT. CL. 45.
3,784,529, PUB. 2-16-2010. INT. CL. 45.
- AMAZON TECHNOLOGIES, INC., RENO, NV:
3,747,298, COR. INT. CL. 38.
- AMAZONLIFE PRODUTOS E SERVICOS LTDA, RIO DE JANEIRO, BRAZIL:
3,783,144, PUB. 7-29-2008. INT. CL. 18.
- AMBITION BEVERAGES, INC., NEW YORK, NY:
3,784,183, PUB. 2-16-2010. INT. CL. 33.
- AMBROGIO E GIOVANNI FOLONARI TENUTE; SOCIETÀ AGRICOLA A RESPONSABILITÀ LIMITATA, ITALY:
3,785,003, PUB. 2-16-2010. INT. CL. 33.
- AMBRUS, SANDOR Z., TORONTO, ONTARIO, CANADA:
2,332,084, REN. 3-31-10. INT. CL. 9.
- AMC BURGERS, INC., SOUTHFIELD, MI:
3,784,317, PUB. 2-16-2010. INT. CL. 30.
- AMDOCS SOFTWARE SYSTEMS LIMITED, DUBLIN 2, IRELAND:
2,754,143, CANC. INT. CL. 9.
- AMERICA'S BACK, INC., ESTES PARK, CO:
2,753,108, CANC. INT. CL. 41.
- AMERICA'S COLLECTIBLES NETWORK, INC., KNOXVILLE, TN:
3,755,447, COR. INT. CL. 14.
- AMERICA'S HEALTH INSURANCE PLANS, INC., WASHINGTON, DC:
3,785,387, MULTIPLE CLASS, INT. CLS. 35 AND 36.
- AMERICA'S KITCHEN, INC., ALPHARETTA, GA:
2,272,401, CANC. INT. CL. 30.
- AMERICAIR CORPORATION, MISSISSAUGA, ONTARIO:
2,432,177, REN. 3-27-10. INT. CL. 11.
- AMERICAN & EFIRD MILLS INC., MT. HOLLY, NC:
695,405, REN. 3-27-10. U.S. CL. 43 (INT. CL. 23).
- AMERICAN ACADEMY OF OPHTHALMOLOGY, INC., SAN FRANCISCO, CA:
1,561,652, REN. 3-27-10. U.S. CL. 200.

AMERICAN ACADEMY OF WOUND MANAGEMENT, INC., WASHINGTON, DC:
3,784,333, PUB. 2-16-2010. U.S. CL. B.

AMERICAN AIRLINES, INC., FORT WORTH, TX:
2,386,298. REN. 3-26-10. INT. CL. 35.

AMERICAN ASSOCIATION OF CRITICAL CARE NURSES, INC., ALISO VIEJO, CA:
2,332,098. REN. 3-26-10. INT. CL. 42.

AMERICAN ASSOCIATION OF STATE HIGHWAY AND TRANSPORTATION OFFICIALS, WASHINGTON, DC:
2,387,396. REN. 3-29-10. INT. CL. 9.
2,389,510. REN. 3-29-10. INT. CL. 9.

AMERICAN AXLE & MANUFACTURING, INC., DETROIT, MI:
2,336,380. REN. 3-31-10. INT. CL. 12.

AMERICAN BILTRITE INC., WELLESLEY HILLS, MA:
2,413,067. REN. 3-31-10. INT. CL. 17.

AMERICAN BUILDERS & CONTRACTORS SUPPLY CO., INC., BELOIT, WI, DBA ABC SUPPLY CO. INC.:
3,620,899, CANC. INT. CL. 9.

AMERICAN CITY BUSINESS JOURNALS, INC., CHARLOTTE, NC:
2,839,984, COR. INT. CL. 35.
3,785,931, MULTIPLE CLASS, INT. CLS. 38 AND 41.

AMERICAN CONTRACTING, INC., CHARLOTTE, NC:
3,786,427, INT. CL. 37.

AMERICAN DIABETES ASSOCIATION, INC., ALEXANDRIA, VA:
3,784,129, PUB. 2-16-2010. INT. CL. 44.
3,784,797, PUB. 2-16-2010. MULTIPLE CLASS, INT. CLS. 35, 36 AND 41.

AMERICAN EXPRESS MARKETING & DEVELOPMENT CORP., NEW YORK, NY:
3,785,716, INT. CL. 35.
3,785,717, INT. CL. 35.
3,785,718, INT. CL. 35.
3,785,719, INT. CL. 35.
3,786,027, INT. CL. 41.

AMERICAN FIDELITY ASSURANCE COMPANY, OKLAHOMA CITY, OK:
3,785,934, INT. CL. 36.

AMERICAN FILM INSTITUTE, LOS ANGELES, CA AND DISCOVERY COMMUNICATIONS, LLC, SILVER SPRING, MD:
3,784,679, PUB. 2-16-2010. INT. CL. 41.

AMERICAN FOUNDATION FOR THE BLIND, INC., NEW YORK, NY:
3,785,373, INT. CL. 42.

AMERICAN GIRL, LLC, EL SEGUNDO, CA:
2,272,583, CANC. INT. CL. 16.
2,752,432, CANC. INT. CL. 43.
2,752,483, CANC. INT. CL. 43.
2,752,552, CANC. INT. CL. 35.

AMERICAN GOLF CORPORATION, SANTA MONICA, CA:
2,753,381, CANC. MULTIPLE CLASS, INT. CLS. 36 AND 41.

AMERICAN HEALTHCARE RADIOLOGY ADMINISTRATORS, SUDBURY, MA:
1,552,819, CANC. INT. CL. 16.

AMERICAN ICE ENTERPRISES CORP., LOS ANGELES, CA:
2,751,867, CANC. MULTIPLE CLASS, INT. CLS. 3 AND 4.

AMERICAN INTERNATIONAL GROUP, INC., NEW YORK, NY:
1,553,269, CANC. INT. CL. 38.
3,783,152, PUB. 2-16-2010. INT. CL. 36.
3,783,153, PUB. 2-16-2010. INT. CL. 36.
3,783,154, PUB. 2-16-2010. INT. CL. 36.
3,783,155, PUB. 2-16-2010. INT. CL. 36.
3,783,156, PUB. 2-16-2010. INT. CL. 36.

AMERICAN LEBANESE SYRIAN ASSOCIATED CHARITIES, INC., MEMPHIS, TN:
2,754,506, CANC. MULTIPLE CLASS, INT. CLS. 25, 36, 41, 42 AND 44.
3,785,595, INT. CL. 38.

AMERICAN MEDIA SERVICES INTERACTIVE, LLC, MT. PLEASANT, SC, FORMERLY AMERICAN MEDIA SERVICES - INTERNET, LLC:
3,783,468, PUB. 2-16-2010. INT. CL. 35.
3,783,469, PUB. 2-16-2010. INT. CL. 35.

AMERICAN MINIATURE ZEBU ASSOCIATION INC., LANCASTER, TX:
3,784,082, PUB. 2-16-2010. INT. CL. 25.

AMERICAN MORTGAGE HOLDINGS LLC, BANNOCKBURN, IL:
3,786,373, INT. CL. 36.

AMERICAN MULTI-CINEMA, INC., KANSAS CITY, MO:
1,635,775. REN. 3-29-10. INT. CL. 41.

AMERICAN NEWLAND COMMUNITIES, LP, SAN DIEGO, CA:
2,338,624. REN. 3-29-10. INT. CL. 37.

AMERICAN PACKAGING CORPORATION, ROCHESTER, NY:
3,783,832, PUB. 2-16-2010. INT. CL. 40.

AMERICAN POP CORN COMPANY, SIOUX CITY, IA:
2,273,182, CANC. INT. CL. 31.

AMERICAN POWER CONVERSION CORPORATION, W. KINGSTON, RI:
2,752,955, CANC. INT. CL. 42.

AMERICAN PRODUCTS COMPANY, INC., CORONA, CA:
2,753,668, CANC. INT. CL. 12.

AMERICAN PUBLIC POWER ASSOCIATION, WASHINGTON, DC:
3,785,563, INT. CL. 35.

AMERICAN QUEEN LUXURY FURNISHINGS GROUP INC., SALT LAKE CITY, UT:
3,785,938, INT. CL. 20.

AMERICAN REALTY ADVISORS, GLENDALE, CA:
3,783,514, PUB. 2-16-2010. INT. CL. 36.

AMERICAN SOCIETY FOR QUALITY, INC., MILWAUKEE, WI:
3,785,414, INT. CL. 42.
3,785,781, MULTIPLE CLASS, INT. CLS. 16 AND 35.

AMERICAN SOCIETY OF CLINICAL ONCOLOGY, ALEXANDRIA, VA:
3,785,386, MULTIPLE CLASS, INT. CLS. 35, 38 AND 41.

AMERICAN SOCIETY OF FARM MANAGERS AND RURAL APPRAISERS, INC., DENVER, CO:
3,784,224, PUB. 2-16-2010. INT. CL. 41.

AMERICAN SOCIETY OF RADIOLOGIC TECHNOLOGISTS, THE, ALBUQUERQUE, NM:
2,342,735. REN. 4-1-10. MULTIPLE CLASS, INT. CLS. 41 AND 42.
2,342,736. REN. 4-1-10. MULTIPLE CLASS, INT. CLS. 41 AND 42.

AMERICAN SOYBEAN ASSOCIATION, ST. LOUIS, MO:
1,128,440. REN. 3-30-10. INT. CL. 42.

AMERICAN TELECONFERENCING SERVICES, LTD., ATLANTA, GA:
2,751,735, CANC. INT. CL. 38.
2,753,732, CANC. INT. CL. 38.

AMERICAN TRANSMISSION COMPANY, WAUKESHA, WI:
3,783,954, PUB. 2-16-2010. INT. CL. 39.

AMERICAN WOODMARK CORPORATION, WINCHESTER, VA:
2,304,566. REN. 3-27-10. INT. CL. 20.

AMERIFLEET TRANSPORTATION, INC., ALPHARETTA, GA:
3,784,444, PUB. 2-16-2010. INT. CL. 35.

AMERIGROUP CORPORATION, VIRGINIA BEACH, VA:
2,752,715, CANC. MULTIPLE CLASS, INT. CLS. 36 AND 44.

AMERIMAX BUILDING PRODUCTS, INC., DALLAS, TX:
2,752,081, CANC. INT. CL. 19.

AMERISPEC, INC., MEMPHIS, TN:
2,752,878, CANC. INT. CL. 42.

AMERISTAR CASINOS, INC., LAS VEGAS, NV:
3,785,266, INT. CL. 44.

AMERITRUST REALTY CORPORATION, HOWELL, MI:
2,337,883. REN. 3-31-10. INT. CL. 36.

AMERO FOODS MFG, CORP., LAUREL, MD:
3,784,496, PUB. 2-16-2010. INT. CL. 5.

- AMES TRUE TEMPER PROPERTIES, INC., WILMINGTON, DE:
2,423,821. REN. 3-26-10. INT. CL. 8.
- AMETEK, INC., PAOLI, PA:
2,403,472. REN. 3-26-10. INT. CL. 9.
- AMIR, INC, EAGAN, MN:
2,754,440. CANC. INT. CL. 3.
- AMIRSYS, INC., SALT LAKE CITY, UT:
3,785,908. INT. CL. 42.
- AMMELON COOKWARE, CO., ROSEMEAD, CA:
3,783,769. PUB. 2-16-2010. INT. CL. 21.
- AMPAC ENTERPRISES, INC., TACOMA, WA:
2,752,520. CANC. INT. CL. 19.
- AMPHENOL-TUCHEL ELECTRONICS GMBH, HEILBRONN 74080, FED REP GERMANY:
3,786,233. INT. CL. 9.
- AMROY EUROPE OY, LAHTI, FINLAND:
3,783,404. PUB. 2-16-2010. INT. CL. 1.
- AMS-ENGINEERING STICHT GESELLSCHAFT M.B.H., ATTNANG-PUCHHEIM, AUSTRIA:
1,599,215. REN. 3-26-10. MULTIPLE CLASS, INT. CLS. 7, 9, 37 AND 42.
- AMTECH SYSTEMS CORPORATION, DALLAS, TX TO TC LICENSE, LTD. HUMMELSTOWN, PA:
2,272,917. CANC. MULTIPLE CLASS, INT. CLS. 9 AND 36.
- AMTRYKE, LLC, HIGH POINT, NC, FORMERLY AMTRYKE, INC.:
3,784,503. PUB. 2-16-2010. INT. CL. 12.
- AMWAY CORPORATION, ADA, MI:
1,552,908. CANC. INT. CL. 20.
- AMY DEPUTY PHOTOGRAPHY, LLC., SPARKS, MD:
2,754,373. CANC. INT. CL. 42.
- ANAKAM, INC., SAN DIEGO, CA:
3,785,545. INT. CL. 9.
- ANALOG DEVICES, INC., NORWOOD, MA:
2,335,777. REN. 3-26-10. INT. CL. 9.
- ANAND SANWAL, NEW YORK, NY:
3,783,629. PUB. 2-16-2010. INT. CL. 35.
- ANCIENT MODERN ART, LLC, NEW YORK, NY:
2,331,641. REN. 3-27-10. INT. CL. 8.
2,354,787. REN. 3-27-10. INT. CL. 3.
- ANDAX INDUSTRIES, L.L.C., ST. MARY'S, KS:
2,304,203. REN. 3-30-10. INT. CL. 28.
- ANDE ROONEY INC., HIGHLAND, NY:
2,752,627. CANC. INT. CL. 28.
- ANDERSON AND VREELAND INC., FAIRFIELD, NJ:
2,336,011. REN. 3-26-10. MULTIPLE CLASS, INT. CLS. 7 AND 35.
2,336,011. CANC. MULTIPLE CLASS, INT. CLS. 1 AND 9.
2,338,527. REN. 3-26-10. MULTIPLE CLASS, INT. CLS. 1, 7, 9 AND 35.
- ANDERSON, KENT G, BISMARCK, ND:
2,352,479. REN. 3-31-10. INT. CL. 28.
- ANDERSON, KENT G, BISMARCK, ND:
2,356,622. REN. 3-31-10. INT. CL. 42.
- ANDERSON, KENT G., BISMARCK, ND:
2,392,040. REN. 3-30-10. INT. CL. 28.
- ANDERSON, KENT G., BISMARCK, ND:
3,431,641. CANC. MULTIPLE CLASS, INT. CLS. 35 AND 42.
- ANDIS COMPANY, STURTEVANT, WI:
1,603,618. REN. 4-1-10. INT. CL. 11.
- ANDREW JOSEPH MCDONNELL M.D., PAINTED POST, NY:
2,753,015. CANC. INT. CL. 42.
- ANDREW LLC, HICKORY, NC:
1,597,208. REN. 3-31-10. INT. CL. 8.
- ANDREW MORRISON, NEW ROCHELLE, NY:
3,786,365. INT. CL. 41.
- ANDREWS MCMEEL PUBLISHING, LLC, KANSAS CITY, MO:
3,785,459. INT. CL. 16.
- ANECOOP S. COOP., SPAIN:
3,785,053. PUB. 2-16-2010. INT. CL. 33.
- ANEO AB, MARSTA 195 60, SWEDEN:
2,751,796. CANC. INT. CL. 10.
- ANGHA, NADER, MÖNCHENGLADBACH, FED REP GERMANY:
3,783,168. PUB. 2-16-2010. INT. CL. 41.
- ANGIE'S SHOES AND LEATHER GOODS, INC., PALMYRA, NJ:
2,753,282. CANC. INT. CL. 25.
- ANI BIOTECH OY, 00100 HELSINKI, FINLAND:
3,786,341. MULTIPLE CLASS, INT. CLS. 5, 9 AND 10.
- ANITA FOOD S.A., LIMA, PERU:
3,786,050. INT. CL. 30.
- ANJON SYSTEMS, INC., SOUTH BEND, IN:
2,827,778. CANC. INT. CL. 44.
- ANN WILLIAMS GROUP LLC, BLOOMFIELD HILLS, MI:
3,785,428. INT. CL. 9.
- ANNE WON LEE, LA PALMA, CA:
3,784,485. PUB. 2-16-2010. INT. CL. 25.
- ANNIE FINK DESIGNS, LLC, MINNEAPOLIS, MN:
3,783,863. PUB. 2-16-2010. INT. CL. 25.
- ANNTE SHOES INC., BROOKLYN, NY:
3,784,687. PUB. 2-16-2010. INT. CL. 25.
- ANOK, LLC, SEATTLE, WA, DBA STUDSANDSPIKES.COM:
3,783,320. PUB. 2-16-2010. INT. CL. 6.
3,783,321. PUB. 2-16-2010. INT. CL. 6.
- ANOVA FINANCIAL CORPORATION, EDENTON, NC:
3,784,259. PUB. 2-16-2010. INT. CL. 36.
- ANTAGONIST, INC., SAN DIEGO, CA:
3,785,730. INT. CL. 25.
- ANTENNASYS, INC., PELHAM, NH:
3,784,289. PUB. 2-16-2010. INT. CL. 42.
- ANTHEM INSURANCE COMPANIES, INC., INDIANAPOLIS, IN:
2,753,575. CANC. MULTIPLE CLASS, INT. CLS. 35 AND 36.
- ANTHONY DIAZ, LAS VEGAS, NV AND LANI DIZON, LAS VEGAS, NV:
3,756,413. AM. MULTIPLE CLASS, INT. CLS. 5 AND 32.
- ANUVA VINOS LLC, WILMINGTON, DE:
3,785,194. INT. CL. 39.
- AOL INC., DULLES, VA:
3,785,907. INT. CL. 43.
3,785,991. INT. CL. 41.
3,785,992. INT. CL. 41.
- AOL LLC, DULLES, VA:
3,784,531. PUB. 2-16-2010. INT. CL. 42.
3,785,787. INT. CL. 41.
- AOYAMA, MAMORU ABRAHAM, LOS ANGELES, CA:
3,783,678. PUB. 2-16-2010. INT. CL. 35.
- APALEXO BIOTECHNOLOGIE GMBH, PLANEGG-MARTINSREIED, FED REP GERMANY:
2,751,837. CANC. INT. CL. 5.
- APD ENGINEERING AND ARCHITECTURE, PLLC, VICTOR, NY:
2,334,713. REN. 3-26-10. INT. CL. 42.
- APEM COMPONENTS, INC., HAVERHILL, MA:
2,752,529. CANC. INT. CL. 9.
- APEX SKYPARK, ANAHEIM, CA:
3,783,186. PUB. 4-29-2008. INT. CL. 7.
- APG GROEP N.V., NL-6411 EJ HEERLEN, NETHERLANDS:
3,784,903. PUB. 2-16-2010. MULTIPLE CLASS, INT. CLS. 35, 36, 42, 44 AND 45.
- APG GROEP N.V., NETHERLANDS:
3,784,904. PUB. 2-16-2010. MULTIPLE CLASS, INT. CLS. 35, 36, 42, 44 AND 45.
- APOLLO BANCSHARES, INC., CORAL GABLES, FL:
3,783,392. PUB. 2-16-2010. INT. CL. 36.
- APOLLO PRODUCTS, INC., KANSAS CITY, MO:
2,753,426. CANC. INT. CL. 42.
- APOSTILES OF COMEDY, LLC, NASHVILLE, TN:
3,785,173. INT. CL. 25.
- APOTHECARY PRODUCTS, INC., BURNSVILLE, MN:
3,784,804. PUB. 2-16-2010. INT. CL. 10.
- APOTHEKER WALTER BOUHON GMBH, DE-90427, NURNBERG, FED REP GERMANY:
2,752,072. CANC. INT. CL. 3.
- APPERIAN, INC., BOSTON, MA:
3,783,855. PUB. 2-16-2010. INT. CL. 42.

APPERON INC., NORTH YORK, ONTARIO M64 2A4, CANADA:
2,753,707, CANC. INT. CL. 5.

APPETITE FOR HEALTHY LIVING, NEW YORK, NY:
3,784,262, PUB. 2-16-2010. INT. CL. 5.

APPLANIX CORPORATION, RICHMOND HILL, ONTARIO, CANADA:
3,784,851, PUB. 2-16-2010. INT. CL. 9.
3,786,326, INT. CL. 9.

APPLE INC., CUPERTINO, CA:
2,336,753. REN. 3-29-10. INT. CL. 9.

APPLIED BIOSYSTEMS, LLC, FOSTER CITY, CA:
3,785,335, INT. CL. 9.

APPLIED BROADBAND INC., BOULDER, CO:
3,783,553, PUB. 2-16-2010. INT. CL. 42.
3,783,561, PUB. 2-16-2010. INT. CL. 9.

APPLIED SYSTEMS, INC., UNIVERSITY PARK, IL:
3,785,763, MULTIPLE CLASS, INT. CLS. 9 AND 42.
3,785,764, MULTIPLE CLASS, INT. CLS. 9 AND 42.

APSYS INTERNATIONAL, INC., LOS ANGELES, CA:
2,753,086, CANC. INT. CL. 18.

APTAKER COMPANY, LTD., CARROLLTON, TX:
2,272,562, CANC. INT. CL. 42.

APV, ARBEITSGEMEINSCHAFT FUR PHARMAZEUTISCHE VERFAHRENSTECHNIK E.V., MAINZ D-55118, FED REP GERMANY:
2,342,606. REN. 3-31-10. MULTIPLE CLASS, INT. CLS. 35 AND 41.

AQUA SELECT U.S.A. LTD., MISSISSAUGA, ONTARIO, CANADA:
1,573,184. REN. 3-27-10. INT. CL. 11.

AQUACLEANA TOILET & BIDET, LLC, SKY VALLEY, CA:
3,785,340, INT. CL. 11.

AQUAM SPECIALISTE AQUATIQUE INC., MONTREAL, QUEBEC, CANADA:
2,342,813. REN. 3-31-10. INT. CL. 35.

AQUANEERING, INC., SAN DIEGO, CA:
3,783,256, PUB. 2-16-2010. MULTIPLE CLASS, INT. CLS. 9, 11 AND 21.

AQUANOR MARKETING, INC., BOSTON, MA:
1,597,658. REN. 3-27-10. INT. CL. 29.

AQUAPHASE INC, GALLATIN, TN, AQUAPHASE LABORATORIES, INC., ADRIAN, MI:
883,914. REN. 3-26-10. U.S. CL. 100 (INT. CL. 42).

AQUARELLE KIDS LLC, CLERMONT, FL:
3,783,671, PUB. 2-16-2010. INT. CL. 41.

AQUASOURCE LTD., VANCOUVER, BRITISH COLUMBIA, CANADA:
1,553,150, CANC. INT. CL. 32.

AQUATRON INC., DELRAY BEACH, FL:
3,785,541, INT. CL. 7.

ARA SAFETY (US) INC., NEW YORK, NY:
3,786,415, MULTIPLE CLASS, INT. CLS. 1 AND 40.

ARAMARK CORPORATION, PHILADELPHIA, PA:
2,821,463, CANC. INT. CL. 35.

ARAMIS INC., NEW YORK, NY:
3,786,159, INT. CL. 3.

ARBIC, JOYCE E., MELBOURNE, FL:
2,272,376, CANC. INT. CL. 25.

ARBORWAY IMPORTS, INC., LEXINGTON, MA:
3,784,029, PUB. 2-16-2010. INT. CL. 33.

ARCADIA INC., NORCROSS, GA:
2,332,329. REN. 3-26-10. INT. CL. 3.

ARCH CAPITAL GROUP (U.S.) INC., NEW YORK, NY:
3,784,056, PUB. 2-16-2010. INT. CL. 36.
3,784,744, PUB. 2-16-2010. INT. CL. 36.

ARCH CHEMICALS, INC, NORWALK, CT:
2,754,376, CANC. INT. CL. 1.

ARCH CHEMICALS, INC., NORWALK, CT:
2,754,340, CANC. INT. CL. 40.

ARCHITECTS OF ACHIEVEMENT, LLC, MERCER ISLAND, WA:
3,783,911, PUB. 2-16-2010. INT. CL. 41.

ARDENT IMPRESSIONS INC., SAN CARLOS, CA, FORMERLY INSTAFOTOS INC.:
3,784,318, PUB. 2-16-2010. INT. CL. 35.

ARENGO 309 (PTY) LIMITED, PRIMROSE, GERMISTON, SOUTH AFRICA:
3,785,520, INT. CL. 7.

ARGUINDEGUI PUMP-N-SHOP, LTD., LAREDO, TX:
3,783,893, PUB. 2-16-2010. INT. CL. 35.

ARGUS RESEARCH GROUP, THE, NEW YORK, NY, ARGUS RESEARCH GROUP, THE, NEW YORK, NY:
2,374,852. REN. 3-31-10. MULTIPLE CLASS, INT. CLS. 16 AND 36.

ARGYLE DIAMONDS LIMITED, WEST PERTH, AUSTRALIA:
3,784,912, PUB. 2-16-2010. MULTIPLE CLASS, INT. CLS. 14 AND 35.
3,784,923, PUB. 2-16-2010. MULTIPLE CLASS, INT. CLS. 14 AND 35.

ARIEL WEST, INC., COSTA MESA, CA:
1,553,214, CANC. INT. CL. 35.

ARIS HORTICULTURE, INC., BARBERTON, OH:
3,785,757, INT. CL. 35.

ARISTEN GROUP, LLC, HOLLYWOOD, FL:
3,784,366, PUB. 2-16-2010. INT. CL. 41.

ARISTOCRAT TECHNOLOGIES AUSTRALIA PTY LTD., NORTH RYDE, NSW, AUSTRALIA:
3,783,393, PUB. 2-16-2010. INT. CL. 9.

ARISTOCRAT TECHNOLOGIES AUSTRALIA PTY LTD, NORTH RYDE, NSW, AUSTRALIA:
3,784,839, PUB. 6-3-2008. INT. CL. 9.

ARIZONA GRAND RESORT, LLC, PHOENIX, AZ:
3,784,683, PUB. 2-16-2010. MULTIPLE CLASS, INT. CLS. 43 AND 44.

ARIZONA MAIL ORDER COMPANY, INC., TUSCON, AZ:
3,783,780, PUB. 2-16-2010. INT. CL. 25.

ARJES CONFECÇÕES LTDA., SAO PAULO, BRAZIL:
2,754,359, CANC. INT. CL. 25.

ARMENA DIAMOND USA, INC., NEW YORK, NY:
2,754,113, CANC. INT. CL. 14.

ARMOR TEE INC., WEST PITTSSTON, PA:
3,684,658, CANC. INT. CL. 9.

ARMOURON LIMITED, UNITED KINGDOM:
3,784,880, PUB. 9-8-2009. MULTIPLE CLASS, INT. CLS. 9, 16 AND 28.

ARMSTRONG, BEVERLY, WASHINGTON, DC:
3,747,894, CANC. IIRN. RESTORED TO S.N. 77-061,222.

ARMSTRONG, DANIEL, LOS ANGELES, CA:
3,783,098, PUB. 2-16-2010. INT. CL. 16.

ARNIE T. DENOLO, ROWLAND HEIGHTS, CA:
2,753,487, CANC. INT. CL. 25.

ARNOLDO MONDADORI EDITORE S.P.A., 20110 MILAN (MI), ITALY:
2,751,857, CANC. MULTIPLE CLASS, INT. CLS. 9, 16, 35, 38 AND 41.

ARQUERO, ROBERT, SAN JOSE, CA:
3,784,567, PUB. 2-16-2010. INT. CL. 44.

ARQUEST, INC., CRANBURY, NJ:
2,753,418, CANC. INT. CL. 16.

ARRIVA PHARMACEUTICALS, INC., ALAMEDA, CA:
2,753,380, CANC. INT. CL. 5.

ARSTASIS, INC., SAN CARLOS, CA:
3,783,410, PUB. 2-16-2010. INT. CL. 10.

ARTE MESTIERE SRL, ITALY:
3,784,972, PUB. 2-16-2010. MULTIPLE CLASS, INT. CLS. 3, 9, 12, 14, 16, 18, 25, 28, 32, 33 AND 43.

ARTECHE LANTEGI ELKARTEA, S.A., MUNGIA (VIZCAYA), SPAIN:
2,273,130, CANC. INT. CL. 9.

ARTEMIS ENTERPRISES, LLC, LYNDHURST, NJ:
2,752,876, CANC. INT. CL. 45.

ARTEMIS SOLUTIONS GROUP, LLC, FREELAND, WA:
3,785,397, INT. CL. 9.

ARTHUR J. GREENE, M.D., MOORESTOWN, NJ:
2,752,052, CANC. INT. CL. 44.

ARTHUR SCHUMAN, INC., FAIRFIELD, NJ:
3,785,321, INT. CL. 29.

ARTIO GLOBAL INVESTORS INC., NEW YORK, NY:
3,785,275, INT. CL. 36.

ARTISTIC TATTOOING, INC., SAINT JAMES, NY:
3,783,503, PUB. 2-16-2010. INT. CL. 44.

- AS IP HOLDCO, LLC, BOSTON, MA:
2,754,469, CANC. INT. CL. 11.
- ASA PRODUCTS, INC., CITY OF INDUSTRY, CA, TA ASA PRODUCTS, INC.:
3,784,041, PUB. 2-16-2010. INT. CL. 12.
- ASC INCORPORATED, SOUTHGATE, MI, DBA AMERICAN SUNROOF CORP.:
1,552,772, CANC. INT. CL. 12.
1,552,773, CANC. INT. CL. 12.
- ASFORY, INC., PALO ALTO, CA:
2,752,057, CANC. INT. CL. 35.
- ASHEIM, DAVID C., SAN FRANCISCO, CA:
3,786,417, INT. CL. 38.
- ASHER'S CHOCOLATE/LEWISTOWN, INC., LEWISTOWN, PA:
2,752,184, CANC. INT. CL. 30.
- ASHIMORI INDUSTRY CO., LTD., OSAKA-SHI, OSAKA-FU, JAPAN:
1,604,969, REN. 3-26-10. INT. CL. 37.
- ASHLAND INC., LEXINGTON, KY TO ASHLAND LICENSING AND INTELLECTUAL PROPERTY LLC, DUBLIN, OH:
2,271,712, CANC. INT. CL. 3.
- ASHLAND LICENSING AND INTELLECTUAL PROPERTY LLC, DUBLIN, OH:
2,362,112, REN. 3-31-10. INT. CL. 4.
- ASHLOCK, HOWARD K., SAN FRANCISCO, CA:
2,272,315, CANC. INT. CL. 30.
- ASHTABULA RUBBER CO., ASHTABULA, OH:
888,578, REN. 3-29-10. MULTIPLE CLASS, U.S. CLS. 21 (INT. CLS. 7, 9, 11, 12 AND 15) AND 35 (INT. CL. 17).
- ASPECTA LEBENSVERSICHERUNG AG, 22309 HAMBURG, FED REP GERMANY:
2,752,206, CANC. MULTIPLE CLASS, INT. CLS. 35, 36 AND 42.
- ASSECO POLAND S.A., POLAND:
3,784,878, PUB. 2-16-2010. MULTIPLE CLASS, INT. CLS. 9, 35, 36, 37, 38, 41 AND 42.
- ASSET INTERTECH, INC., RICHARDSON, TX:
2,753,677, CANC. INT. CL. 42.
- ASSET VERIFICATION, LLC, BATAVIA, IL:
2,752,282, CANC. MULTIPLE CLASS, INT. CLS. 36 AND 45.
- ASSOCIATED ELECTRIC COOPERATIVE, INC., SPRINGFIELD, MO:
3,784,816, PUB. 2-16-2010. INT. CL. 35.
- ASSOCIATED MATERIALS, LLC, CUYAHOGA FALLS, OH, DBA ALSIDE:
1,552,496, CANC. INT. CL. 6.
- ASSOCIATION FOR RESEARCH AND ENLIGHTENMENT, INC., VIRGINIA BEACH, VA:
3,785,624, INT. CL. 16.
- ASSOCIATION OF CERTIFIED INDEPENDENT ENTREPRENEURS, MORENO VALLEY, CA:
3,785,265, U.S. CL. 200.
- ASSOCIATION OF PUBLIC SAFETY COMMUNICATIONS OFFICIALS INTERNATIONAL, INC., DAYTONA BEACH, FL:
3,757,255, COR. MULTIPLE CLASS, INT. CLS. 41 AND 42.
- ASSURANT, INC., NEW YORK, NY:
2,363,506, REN. 3-31-10. MULTIPLE CLASS, INT. CLS. 35 AND 42.
- ASTEIO CORPORATION, AUSTIN, TX:
2,751,793, CANC. INT. CL. 35.
- ASTELLAS PHARMA INC., TOKYO, JAPAN:
2,752,219, CANC. INT. CL. 5.
- ASTONISH RESULTS, LP, WARWICK, RI:
3,783,376, PUB. 2-16-2010. MULTIPLE CLASS, INT. CLS. 35 AND 42.
- ASTONISHING NEAL ENTERPRISES INC., LEHIGHTON, PA:
1,553,292, CANC. MULTIPLE CLASS, INT. CLS. 41 AND 42.
- ASTRAZENECA AB, SODERTALJE, SWEDEN:
2,751,972, CANC. INT. CL. 5.
- ASTRAZENECA AB, S-151 85 SODERTALJE, SWEDEN:
2,752,128, CANC. INT. CL. 5.
- ASTRAZENECA AB, SODERTALJE, SWEDEN:
3,783,213, PUB. 6-9-2009. INT. CL. 5.
3,783,214, PUB. 6-9-2009. INT. CL. 5.
- ASTRAZENECA UK LIMITED, LONDON, W1Y 6LN, ENGLAND:
2,751,762, CANC. INT. CL. 5.
- ASTRIUM GMBH, FED REP GERMANY:
3,784,895, PUB. 2-16-2010. MULTIPLE CLASS, INT. CLS. 9, 16, 38 AND 42.
- AT&T CORP., NEW YORK, NY:
1,552,680, CANC. INT. CL. 9.
- ATC FORMULATED POLYMERS INC., DRUMMOND-VILLE, QUEBEC:
1,626,477, REN. 3-31-10. INT. CL. 1.
- ATEECO, INC., SHENANDOAH, PA:
3,785,869, INT. CL. 30.
- ATLANTA ATTACHMENT COMPANY, LAWRENCEVILLE, GA:
2,260,442, AM. INT. CL. 7.
- ATLANTA NATIONAL LEAGUE BASEBALL CLUB, INC., ATLANTA, GA:
3,785,096, INT. CL. 28.
3,785,097, INT. CL. 25.
3,785,098, INT. CL. 41.
3,785,099, INT. CL. 16.
- ATLANTA WORLDWIDE TOURING COMPANY, ATLANTA, GA:
2,752,510, CANC. INT. CL. 41.
- ATLANTIC RICHFIELD COMPANY, LOS ANGELES, CA:
2,754,464, CANC. MULTIPLE CLASS, INT. CLS. 4 AND 37.
- ATLANTICA EXPORT MANAGEMENT COMPANY S.L., OVIEDO ASTURIAS, SPAIN:
2,753,586, CANC. INT. CL. 29.
- ATOTECH DEUTSCHLAND GMBH, D-10507 BERLIN, FED REP GERMANY:
2,339,271, REN. 3-30-10. INT. CL. 1.
- ATRICURE, INC., WEST CHESTER, OH:
3,785,660, INT. CL. 10.
- ATSI HOLDINGS, INC., LINCOLNSHIRE, IL:
3,784,544, PUB. 2-16-2010. INT. CL. 9.
- ATTAP TECHNOLOGIES, INC., NEW YORK, NY:
3,786,239, INT. CL. 9.
- ATTORNEY'S BRIEFCASE, INC., OAKLAND, CA:
1,630,506, REN. 3-29-10. INT. CL. 9.
- AUDIO VIDEO EXPERIENCE, INC., POMPONO BEACH, FL:
1,552,916, CANC. INT. CL. 20.
- AUDIOARTF/X, INC., LARGO, FL:
2,753,620, CANC. INT. CL. 9.
2,753,621, CANC. INT. CL. 9.
2,753,622, CANC. INT. CL. 9.
- AUDYSSEY LABORATORIES, INC., LOS ANGELES, CA:
3,786,164, INT. CL. 9.
- AUER LIGHTING GMBH, FED REP GERMANY:
3,784,965, PUB. 2-16-2010. MULTIPLE CLASS, INT. CLS. 9, 11, 21 AND 40.
- AUGUST STORCK KG, FED REP GERMANY:
3,784,928, PUB. 2-16-2010. INT. CL. 30.
- AUGUSTA ELECTRICAL SYSTEMS, INC., LAS VEGAS, NV:
2,754,236, CANC. INT. CL. 37.
- AUGUSTA JONES LIMITED, HONG KONG, HONG KONG:
3,783,190, PUB. 2-16-2010. MULTIPLE CLASS, INT. CLS. 18, 25 AND 35.
- AUGUSTIN, SUZY, MIAMI, FL:
3,783,124, PUB. 2-16-2010. INT. CL. 14.
- AURIOLES ERIC, SAN JUAN, PUERTO RICO:
3,783,206, PUB. 2-16-2010. INT. CL. 41.
- AUSTRALIA AND NEW ZEALAND BANKING GROUP LIMITED, MELBOURNE VIC 3000, AUSTRALIA:
3,784,946, PUB. 2-16-2010. MULTIPLE CLASS, INT. CLS. 9 AND 36.
- AUTEC SRL, 36030 CALDOGNO (VI), ITALY:
2,753,928, CANC. INT. CL. 9.
- AUTOCOUNT, INC., CASSELBERRY, FL:
2,752,414, CANC. MULTIPLE CLASS, INT. CLS. 16 AND 35.

AUTOMATION, PRESS AND TOOLING, AP&T AB, S-520 24
BLIDSBERG, SWEDEN:
2,384,417. REN. 3-26-10. INT. CL. 7.

AUTOMATISME ET TECHNIQUES AVANCEES, 13970 - LA
BARQUE, FRANCE:
2,337,506. REN. 3-31-10. INT. CL. 9.

AUTOMOBILE CLUB OF SOUTHERN CALIFORNIA,
COSTA MESA, CA:
3,785,792. INT. CL. 36.

AUXILIUM US HOLDINGS, LLC., WILMINGTON, DE:
3,785,074. INT. CL. 5.

AUXXANO INC., THORNWOOD, NY:
3,784,267. PUB. 2-16-2010. INT. CL. 32.

AVA DESIGN LLC, NEW YORK, NY:
3,783,337. PUB. 2-16-2010. INT. CL. 25.

AVB, INC., MILWAUKIE, OR:
3,784,283. PUB. 2-16-2010. INT. CL. 30.
3,784,666. PUB. 2-16-2010. INT. CL. 30.

AVEDA CORPORATION, MINNEAPOLIS, MN:
3,784,501. PUB. 2-16-2010. INT. CL. 3.
3,784,807. PUB. 2-16-2010. INT. CL. 44.

AVENTURA CROSSINGS, L.L.C., AVENTURA, FL:
2,753,772. CANC. INT. CL. 36.

AVFUEL CORPORATION, ANN ARBOR, MI:
3,785,110. INT. CL. 35.

AVIATION FACILITIES COMPANY, INC., MCLEAN, VA:
2,339,776. REN. 3-30-10. MULTIPLE CLASS, INT. CLS. 35,
36 AND 37.

AVILA, CARLOS, HILMAR, CA:
3,783,425. PUB. 2-16-2010. INT. CL. 25.

AVILES, KATHLEEN, LEVITTOWN, PA:
3,783,958. PUB. 2-16-2010. INT. CL. 41.

AVIVA LIFE INSURANCE COMPANY, QUINCY, MA:
2,752,771. CANC. INT. CL. 36.
2,752,772. CANC. INT. CL. 36.

AVNET, INC., PHOENIX, AZ:
2,271,383. CANC. MULTIPLE CLASS, INT. CLS. 9 AND
42.

AWARD HARDWOOD FLOORS, LLP, WAUSAU, WI:
2,415,353. REN. 3-27-10. INT. CL. 19.

AWARENESS TECHNOLOGY, INC., PALM CITY, FL:
1,615,520. REN. 3-26-10. INT. CL. 9.

AWNINGS UNLIMITED, INC., JESSUP, MD, PARAPLY-
MARTEN AKTIEBOLAG, S-214 58 MALMO, SWEDEN:
1,135,177. REN. 4-1-10. INT. CL. 22.

AXCELLENT, INC., LOS ANGELES, CA:
3,783,660. PUB. 2-16-2010. INT. CL. 25.

AXLETECH INTERNATIONAL IP HOLDING, L.L.C., TROY,
MI:
3,784,049. PUB. 2-16-2010. INT. CL. 12.

AXONLINK (BVI) CORPORATION, ROAD TOWN, TORTO-
LA, BR. VIRGIN ISLANDS:
2,753,853. CANC. INT. CL. 9.

AXOSOFT, LLC, SCOTTSDALE, AZ:
3,783,734. PUB. 2-16-2010. MULTIPLE CLASS, INT. CLS.
9, 38, 41 AND 42.

AXT, INC., FREMONT, CA:
2,753,494. CANC. INT. CL. 1.

AYALA, HANA, IRVINE, CA:
2,421,012. REN. 4-1-10. INT. CL. 42.
2,423,060. REN. 4-1-10. INT. CL. 42.
2,431,234. REN. 4-1-10. INT. CL. 42.

AYCAYIA, LLC, TAMPA, FL:
3,786,031. INT. CL. 3.

AYURVEDA HEALTH PEACE AND HAPPINESS LIMITED,
HORSHAM, UNITED KINGDOM:
2,752,892. CANC. MULTIPLE CLASS, INT. CLS. 5 AND
30.

AZALEA MICROELECTRONICS CORP., SANTA CLARA,
CA:
2,753,747. CANC. INT. CL. 9.

AZIENDA AGRICOLA L'OLIVAIA DI FABRIZIA CUSANI,
ITALY:
3,784,976. PUB. 2-16-2010. INT. CL. 29.

AZPB LIMITED PARTNERSHIP, PHOENIX, AZ:
2,272,550. CANC. INT. CL. 41.

AZTEK NETWORKS, INC., BOULDER, CO:
3,786,338. INT. CL. 9.

AZUKA-BOM LLC, MANASSAS, VA:
3,784,274. PUB. 2-16-2010. INT. CL. 41.
3,784,768. PUB. 2-16-2010. INT. CL. 41.

AZZIP, INC., GERMANTON, NC:
2,272,689. CANC. INT. CL. 21.

B & D, INC., NASHVILLE, TN:
3,786,335. INT. CL. 41.

B & R ERECTORS, INC., CRYSTAL LAKE, IL:
1,552,917. CANC. INT. CL. 20.

B&G FOODS, INC., PARSIPPANY, NJ, RJR FOODS, INC.,
WINSTON-SALEM, NC:
1,134,775. REN. 3-29-10. INT. CL. 30.
1,135,244. REN. 3-26-10. INT. CL. 30.

B-TECH GROUP, EL MONTE, CA:
2,753,773. CANC. INT. CL. 5.

BABLER, BARBARA, BEND, OR, DBA THINGS ANTIQUES
& ECCENTRICITIES:
2,752,734. CANC. INT. CL. 35.

BABY INNOVATIONS MARKETING E SERVICOS INTER-
NACIONAIS SA, ST. HELIER, JERSEY, CHANNEL IS-
LANDS, UNITED KINGDOM:
2,752,094. CANC. INT. CL. 10.

BABY SCHOOL COMPANY, INC., WEST CHESTER, PA:
2,335,251. REN. 3-27-10. INT. CL. 9.

BACCUS GLOBAL LLC, DEERFIELD BEACH, FL:
3,785,728. INT. CL. 9.

BACIO DIVINO CELLARS, LLC, RUTHERFORD, CA:
2,389,947. REN. 3-31-10. INT. CL. 33.

BADAPP, INCORPORATED, HOUSTON, TX:
3,785,483. INT. CL. 25.

BAER, CHRISTIAN, FRANKFURT/ MAIN, FED REP GER-
MANY:
2,751,732. CANC. MULTIPLE CLASS, INT. CLS. 11 AND
12.

BAGLA, KELLY, OCEANSIDE, CA:
3,784,130. PUB. 2-16-2010. INT. CL. 45.

BAGLIO, BEN M., LONDON, ENGLAND:
2,271,537. CANC. INT. CL. 16.

BAILEY, AMY, AUGUSTA, GA:
2,336,416. REN. 3-30-10. INT. CL. 25.

BAILEY, JOHN W., ANNANDALE, VA:
2,336,881. REN. 3-31-10. INT. CL. 42.

BAINS ULTRA INC., SAINT-NICOLAS, QUEBEC, CANADA:
3,786,370. INT. CL. 11.

BALANCE 360, L.L.C., SPRINGFIELD, MO:
3,785,809. INT. CL. 28.

BALCH, DARREN, EL CAJON, CA:
3,784,286. PUB. 2-16-2010. INT. CL. 16.

BALDWIN PIANO, INC., NASHVILLE, TN:
3,785,068. INT. CL. 15.

BALENT, JIM, BROADHEADSVILLE, PA:
2,429,831. REN. 3-27-10. INT. CL. 16.

BALL CHAIN MANUFACTURING CO., INC., MOUNT
VERNON, NY:
888,129. REN. 3-29-10. U.S. CL. 13 (INT. CL. 6).

BANCO BILBAO VIZCAYA ARGENTARIA, S.A., 28046
MADRID, SPAIN:
2,751,831. CANC. INT. CL. 36.

BANK OF AMERICA CORPORATION, CHARLOTTE, NC:
2,271,745. CANC. INT. CL. 35.
2,357,433. REN. 3-27-10. INT. CL. 36.

BANK OF AMERICA CORPORATION, CHARLOTTE, NC,
NATIONSBANK CORPORATION, CHARLOTTE, NC:
2,433,770. REN. 3-26-10. INT. CL. 36.

BANK OF AMERICA CORPORATION, CHARLOTTE, NC:
2,751,787. CANC. INT. CL. 36.
2,753,912. CANC. MULTIPLE CLASS, INT. CLS. 35 AND
36.
2,818,561. CANC. INT. CL. 16.

BANK OF AMERICA, NATIONAL ASSOCIATION, CHAR-
LOTTE, NC:
3,785,372. INT. CL. 36.

BANKERS LIFE AND CASUALTY COMPANY, CHICAGO,
IL:
3,785,577. INT. CL. 36.

BANKS, RUSSELL L., LAS VEGAS, NV:
2,753,439. CANC. INT. CL. 25.

- BANTREE FOUNDRIES, INC., ATLANTA, GA:
2,752,013, CANC. INT. CL. 9.
- BARCLAY PRODUCTS LIMITED, GURNEE, IL:
2,752,444, CANC. INT. CL. 11.
- BARCROFT, SUSAN, BARRINGTON, IL:
3,786,268, INT. CL. 16.
- BARDIN & MARSEE PUBLISHING, BIRMINGHAM, AL:
3,786,107, INT. CL. 16.
- BAREFOOT MOTORS, LLC, ASHLAND, OR:
3,785,805, INT. CL. 12.
- BAREFOOT SADDLE INC., BLACK DIAMOND, WA:
3,389,545, CANC. INT. CL. 18.
- BARK, HOP AND MEOW, INC., COLUMBIA, MO, DBA MY
DOG COLLARS:
3,785,693, INT. CL. 18.
- BARKIE, JOSEPH CHARLES JR., ANAHEIM HILLS, CA:
2,754,524, CANC. INT. CL. 5.
- BARKING PENGUINS, LLC, PINECREST, FL:
3,784,842, PUB. 4-24-2007. INT. CL. 28.
- BARNABY HEATING & AIR, LLC, ROWLETT, TX:
3,784,102, PUB. 2-16-2010. INT. CL. 36.
- BARNETT, NANCY B., LAWRENCEVILLE, GA:
2,753,186, CANC. MULTIPLE CLASS, INT. CLS. 16 AND
25.
- BARON PHILIPPE DE ROTHSCHILD S.A., PAUILLAC,
FRANCE:
1,553,177, CANC. INT. CL. 33.
- BARONESS SMALL ESTATES, INC., DENVER, CO:
3,783,867, PUB. 2-16-2010. INT. CL. 33.
- BARRIS, GEORGE, NORTH HOLLYWOOD, CA, DBA BAR-
RIS KUSTOM INDUSTRIES:
2,754,096, CANC. INT. CL. 28.
- BARRY E. MCGUIRE, CLOVIS, CA, DBA BARRY
MCGUIRE:
3,783,234, PUB. 9-8-2009. INT. CL. 41.
- BARSE & CO., INC., DALLAS, TX:
2,753,287, CANC. MULTIPLE CLASS, INT. CLS. 14 AND
18.
- BARSH, TONI, MEDIA, PA:
3,783,364, PUB. 2-16-2010. INT. CL. 35.
- BARTHOLOMEW, ROBERT, NEWPORT BEACH, CA:
2,439,236, REN. 4-1-10. INT. CL. 36.
- BARTLE BOGLE HEGARTY LIMITED, LONDON W1R 6DS,
ENGLAND:
2,751,788, CANC. MULTIPLE CLASS, INT. CLS. 9, 35
AND 41.
- BASCHIERI & PELLAGRI S.P.A., BOLOGNA, ITALY:
2,357,581, REN. 3-26-10. INT. CL. 13.
- BASIC BROWN BEARS, INC., SAN FRANCISCO, CA:
2,753,564, CANC. MULTIPLE CLASS, INT. CLS. 35 AND
41.
- BASICLUX RECORDS, LLC, ATLANTA, GA:
2,752,599, CANC. INT. CL. 9.
- BASS PRO INTELLECTUAL PROPERTY, L.L.C., SPRING-
FIELD, MO:
3,783,821, PUB. 2-16-2010. INT. CL. 25.
- BATH & BODY WORKS BRAND MANAGEMENT, INC.,
REYNOLDSBURG, OH:
2,754,445, CANC. MULTIPLE CLASS, INT. CLS. 3 AND 4.
3,786,204, INT. CL. 3.
- BATRUS HOLLWEG INTERNATIONAL SELECTION SER-
VICES, LTD., PLANO, TX:
3,783,339, PUB. 2-16-2010. INT. CL. 35.
- BATTAT INCORPORATED, PLATTSBURGH, NY:
2,272,779, CANC. INT. CL. 25.
- BATTERIES INCLUDED, INC., SPRINGFIELD, MA:
2,752,457, CANC. MULTIPLE CLASS, INT. CLS. 35 AND
38.
- BATTLE AND ASSOCIATES, INC., WINSTON-SALEM, NC:
2,754,083, CANC. INT. CL. 9.
- BATTLE FOAM, LLC, GILBERT, AZ:
3,784,117, PUB. 2-16-2010. INT. CL. 18.
3,784,118, PUB. 2-16-2010. INT. CL. 18.
3,784,120, PUB. 2-16-2010. INT. CL. 18.
- BAUSCH & LOMB INCORPORATED, ROCHESTER, NY:
2,336,671, REN. 3-29-10. INT. CL. 9.
- BAXI HEATING UK LIMITED, DERBYSHIRE, UNITED
KINGDOM:
3,783,164, PUB. 11-10-2009. INT. CL. 11.
- BAXTER II, JOHN HOLT, CLOVIS, CA:
2,316,496, REN. 3-29-10. INT. CL. 16.
- BAXTER INTERNATIONAL INC., DEERFIELD, IL:
3,785,218, INT. CL. 10.
- BAYER AKTIENGESELLSCHAFT, 51373 LEVERKUSEN,
FED REP GERMANY:
2,825,661, CANC. INT. CL. 40.
- BAYER AKTIENGESELLSCHAFT, LEVERKUSEN-BAYER-
WERK, FED REP GERMANY:
3,785,625, INT. CL. 5.
- BAYER HEALTHCARE LLC, PITTSBURGH, PA, MILES
LABORATORIES, INC., ELKHART, IN:
523,578, REN. 3-27-10. U.S. CL. 18 (INT. CL. 5).
- BAYER HEALTHCARE LLC, PITTSBURGH, PA:
3,785,412, MULTIPLE CLASS, INT. CLS. 5 AND 10.
- BAYERISCHE MOTOREN WERKE AKTIENGE-
SELLSCHAFT, D-80788 MUENCHEN, FED REP GER-
MANY:
2,826,976, CANC. MULTIPLE CLASS, INT. CLS. 12, 14, 16,
18, 21, 24 AND 25.
- BAYLIN, JEROME I., N. BETHESDA, MD, DBA WEST HILL
WINE AND SPIRITS:
2,753,588, CANC. INT. CL. 33.
- BB&T CORPORATION, WINSTON-SALEM, NC:
3,785,360, INT. CL. 36.
- BBR VT INTERNATIONAL LTD., SWITZERLAND:
3,784,901, PUB. 2-16-2010. MULTIPLE CLASS, INT. CLS.
6, 7 AND 19.
- BEACON LOOMS, INC., TEANECK, NJ:
3,785,957, INT. CL. 24.
- BEALE, THEODORE, ZUG, SWITZERLAND:
3,786,388, INT. CL. 9.
- BEARFOOT, INC., WESTVILLE, IN:
2,751,960, CANC. MULTIPLE CLASS, INT. CLS. 25 AND
28.
- BEARING SERVICE, INC., LIVONIA, MI:
2,343,448, REN. 3-29-10. INT. CL. 35.
- BEAUJOT, NORBERT, LANGBANK, SASKATCHEWAN,
CANADA:
2,751,610, CANC. INT. CL. 7.
- BEAUTE PRESTIGE INTERNATIONAL, 75783 PARIS CE-
DEX 16, FRANCE:
2,339,449, REN. 3-27-10. INT. CL. 3.
- BEAUTE PRESTIGE INTERNATIONAL, 75116 PARIS,
FRANCE:
2,751,596, CANC. INT. CL. 3.
- BEAUTY PLUS TRADING CO., INC., MOONACHIE, NJ:
3,786,440, INT. CL. 26.
- BEAUTY 21 COSMETICS, INC., RANCHO CUCAMONGA,
CA:
2,434,431, REN. 4-1-10. INT. CL. 3.
- BEAUVAIS, PIERRE, PALM SPRINGS, CA:
2,753,369, CANC. INT. CL. 21.
- BEBE STUDIO, INC., LOS ANGELES, CA:
3,786,035, MULTIPLE CLASS, INT. CLS. 18, 25 AND 35.
- BECKER, TINA, NAPA, CA AND BECKER, DAVID, NAPA,
CA:
3,786,104, INT. CL. 33.
- BEDDING EXPERTS, INC., THE, CAROL STREAM, IL:
1,613,341, REN. 3-26-10. INT. CL. 42.
- BEDNAR, MARK EDWARD, OLEAN, NY:
1,553,001, CANC. INT. CL. 28.
- BEECHWOOD REAL ESTATE, LP, HERNDON, VA:
2,753,286, CANC. MULTIPLE CLASS, INT. CLS. 41 AND
43.
- BEER, GERALD, GUYMON, OK:
3,783,882, PUB. 2-16-2010. INT. CL. 11.
3,783,890, PUB. 2-16-2010. INT. CL. 17.
- BEFUN BILGI TEKNOLOJILERI A.S., MENLO PARK, CA:
3,785,332, INT. CL. 9.
- BEGER, JULIE A, SAINT JOSEPH, MO, DBA HAIR FAIR
LTD. II, LLC:
3,783,573, PUB. 2-16-2010. INT. CL. 44.

BEHR, KENNETH A., BOCA RATON, FL, DBA FRONTLINE ENTERPRISES:
2,751,863, CANC. INT. CL. 35.

BEHRENS, WOLFGANG, D-27243 GROSS IPPENER, FED REP GERMANY:
2,824,392, CANC. INT. CL. 1.

BEIERSDORF AKTIENGESELLSCHAFT, 20245 HAMBURG, FED REP GERMANY:
2,751,928, CANC. MULTIPLE CLASS, INT. CLS. 5 AND 10.

BELA BALIKO PHOTOGRAPHY & PUBLISHING INC., CANMORE, CANADA:
3,783,236, PUB. 2-16-2010. INT. CL. 16.

BELCORP NC INC, MIAMI, FL:
3,784,676, PUB. 2-16-2010. INT. CL. 34.

BELDEN TECHNOLOGIES, INC., ST. LOUIS, MO, BELDEN MANUFACTURING COMPANY, CHICAGO, IL:
695,237. REN. 3-29-10. U.S. CL. 21 (INT. CL. 9).

BELIEVELAND LTD., MARIETTA, GA:
3,785,528, INT. CL. 21.

BELIEVELAND, LTD, MARIETTA, GA:
3,785,529, INT. CL. 20.

BELL HELICOPTER TEXTRON INC., FORT WORTH, TX:
3,786,279, MULTIPLE CLASS, INT. CLS. 35 AND 41.

BELL, BERT, MARGATE, NJ:
2,337,633. REN. 3-31-10. INT. CL. 25.

BELLATRUE.COM, LLC, NASHVILLE, TN:
3,785,671, MULTIPLE CLASS, INT. CLS. 14 AND 35.

BELLE STAR PRODUCTIONS, INC., GLENDALE, AZ:
3,785,754, INT. CL. 14.

BELLINO, GIOVANNINA JENNIFER, SANDS POINT, NY:
3,783,711, PUB. 2-16-2010. INT. CL. 25.

BELLS BEND NEIGHBORHOOD FARMS, NASHVILLE, TN:
3,783,394, PUB. 2-16-2010. INT. CL. 31.

BELMONT VILLAGE, L.P., HOUSTON, TX:
2,429,205. REN. 3-26-10. INT. CL. 42.

BELTONE ELECTRONICS CORPORATION, CHICAGO, IL:
1,553,359, CANC. INT. CL. 10.

BEMIS MANUFACTURING COMPANY, SHEBOYGAN FALLS, WI:
1,603,620. REN. 3-27-10. INT. CL. 11.

BEN HUGHES COMMUNICATION PRODUCTS COMPANY, CHESTER, CT:
2,337,870. REN. 3-31-10. INT. CL. 8.

BEN-BASSAT, JACKY, ATLANTA, GA:
3,784,359, PUB. 2-16-2010. INT. CL. 28.

BEN-E-LECT, INC., VISALIA, CA:
3,783,879, PUB. 2-16-2010. INT. CL. 36.

BENARD INDUSTRIES, INC., MIAMI, FL:
2,335,890. REN. 3-30-10. INT. CL. 5.

BENEFIT SOLUTIONS, INC., MARIETTA, GA:
2,752,435, CANC. MULTIPLE CLASS, INT. CLS. 35 AND 36.

BENEFITS RESOURCE, LLC, LAGUNA BEACH, CA, DBA BRLLC INSURANCE SERVICES:
3,783,634, PUB. 2-16-2010. INT. CL. 35.

BENEFITS SOLUTIONS, INC., MARIETTA, GA:
2,752,434, CANC. MULTIPLE CLASS, INT. CLS. 35 AND 36.

BENEO-REMY N.V., WIJGMAAL LEUVEN, BELGIUM:
2,364,116. REN. 3-31-10. INT. CL. 30.

BENHAM, ROGER, SAN DIEGO, CA:
2,754,393, CANC. INT. CL. 1.

BENJAMIN JOHN COLEMAN, PAWTUCKET, RI:
3,785,687, INT. CL. 16.

BENSIMON, PATRICK, BEVERLY HILLS, CA:
2,752,530, CANC. INT. CL. 25.

BENSRUN, INC., BURBANK, CA:
3,786,304, INT. CL. 41.

BERESKIN & PARR, TORONTO, ONTARIO, CANADA:
2,751,798, CANC. INT. CL. 42.

BERG EUROPIPE HOLDING CORP., PANAMA CITY, FL:
3,784,363, PUB. 2-16-2010. INT. CL. 40.
3,784,364, PUB. 2-16-2010. INT. CL. 6.

BERGHMAN, CARL S., ASSONET, MA:
2,752,212, CANC. INT. CL. 35.

BERGMANN, ANDREW I., HARTSDALE, NY:
2,753,196, CANC. MULTIPLE CLASS, INT. CLS. 9 AND 41.

BERKLEY INC., SPIRIT LAKE, IA:
1,592,181. REN. 3-26-10. INT. CL. 28.

BERKS PACKING COMPANY, INC., READING, PA:
2,330,875. REN. 3-26-10. INT. CL. 29.

BERKSHIRE CORPORATION, GREAT BARRINGTON, MA:
3,785,745, INT. CL. 21.

BERNARD DATA SOLUTIONS, LLC, HENDERSON, NV:
3,784,132, PUB. 2-16-2010. INT. CL. 9.

BERNARD FOOD INDUSTRIES, INC., EVANSTON, IL:
1,553,118, CANC. INT. CL. 30.

BEROL CORPORATION, FREEPORT, IL:
2,752,846, CANC. INT. CL. 9.

BERRIE, NICOLE ALANNA, NEW YORK, NY:
3,783,307, PUB. 2-16-2010. INT. CL. 36.

BERROCO, INC., UXBRIDGE, MA:
3,785,605, INT. CL. 23.

BERRY HAPPY, INC., ENCINITAS, CA:
3,783,804, PUB. 2-16-2010. INT. CL. 43.

BERTL, INC., FAIRFIELD, NJ:
3,784,276, PUB. 2-16-2010. INT. CL. 42.

BEST DRIVEN LIMITED, HONG KONG, HONG KONG:
2,272,173, CANC. INT. CL. 42.

BEST FRIENDS, LLC, ROYAL OAK, MI:
2,752,926, CANC. INT. CL. 12.
2,752,928, CANC. INT. CL. 12.

BEST YEAR YET, LLC, ASPEN, CO:
2,271,939, CANC. INT. CL. 41.

BETCO CORPORATION, TOLEDO, OH:
701,120. REN. 4-1-10. U.S. CL. 52 (INT. CL. 3).

BETWISER GAMES, LLC, LAS VEGAS, NV:
3,784,722, PUB. 2-16-2010. INT. CL. 28.

BEVERAGE MARKETING USA, INC., LARCHMONT, NY:
2,754,640, CANC. INT. CL. 32.

BEVERLEY D BURDEYNEY FITNESS INC., TORONTO, ONTARIO, CANADA:
2,751,545, CANC. INT. CL. 41.

BEWELL HEALTH PRODUCTS, INC., COLUMBIA, MO:
2,754,244, CANC. INT. CL. 10.

BEYOND THE CLINIC, P.C., MILWAUKIE, OR:
3,785,982, INT. CL. 44.

BEZALEL, MOSHE, NEW YORK, NY:
3,783,847, PUB. 2-16-2010. INT. CL. 14.
3,783,853, PUB. 2-16-2010. INT. CL. 14.

BF SUMA PHARMACEUTICALS INC., SAN GABRIEL, CA:
3,785,303, INT. CL. 5.
3,785,304, INT. CL. 5.

BGR CORPORATION PTY LTD., SYDNEY, NEW SOUTH WALES, AUSTRALIA:
2,753,809, CANC. INT. CL. 3.

BHA GROUP, INC., KANSAS CITY, MO:
2,335,456. REN. 3-26-10. INT. CL. 9.

BI-INVEST HOLDINGS S.A., LUXEMBOURG, LUXEMBOURG:
3,785,287, MULTIPLE CLASS, INT. CLS. 35 AND 36.

BI-LO, LLC, GREENVILLE, SC:
2,355,276. REN. 3-31-10. INT. CL. 35.

BI-LO, LLC, GREENVILLE, SC, BRUNO'S SUPERMARKETS, INC., BIRMINGHAM, AL:
2,383,950. REN. 3-31-10. MULTIPLE CLASS, INT. CLS. 1, 3, 4, 5, 6, 8, 9, 10, 11, 16, 21, 30 AND 31.

BI-LO, LLC, GREENVILLE, SC:
2,398,127. REN. 3-31-10. INT. CL. 35.
2,408,652. REN. 3-31-10. INT. CL. 35.
2,410,977. REN. 3-31-10. INT. CL. 16.

BIG ELITE INCORPORATED, ORLANDO, FL:
3,785,589, INT. CL. 42.

BIG FISH AMERICA, LLC, BEMIDJI, MN:
3,786,098, INT. CL. 28.

BIG SKY TRANSPORTATION CO., BILLINGS, MT:
2,751,854, CANC. INT. CL. 39.

BIG TREND, INC., SAN FRANCISCO, CA, DBA TREND INT'L MFG., INC.:
2,272,820, CANC. INT. CL. 26.

BINARY POETRY, INC., BREA, CA:
3,783,280, PUB. 2-16-2010. INT. CL. 38.

BINGA'S WINGAS, LLC, PORTLAND, ME:
3,783,664, PUB. 2-16-2010. INT. CL. 43.

- BIO-BOTANICA, INC., HAUPAUGGE, NY:
2,300,825. REN. 3-26-10. INT. CL. 1.
- BIO-PRO RESEARCH, LLC, HICKORY, NC:
3,786,232. MULTIPLE CLASS, INT. CLS. 3 AND 5.
- BIO-PRO RESEARCH, LLC, SARASOTA, FL:
3,786,237. MULTIPLE CLASS, INT. CLS. 3, 5 AND 35.
- BIO-RAD LABORATORIES, INC., HERCULES, CA:
1,552,629. CANC. INT. CL. 9.
- BIO-TECH PHARMACAL, INC., FAYETTEVILLE, AR:
3,783,625. PUB. 2-16-2010. INT. CL. 5.
3,783,626. PUB. 2-16-2010. INT. CL. 5.
- BIOBRIDGES, LLC, WELLESLEY, MA:
3,783,133. PUB. 2-16-2010. INT. CL. 35.
3,783,134. PUB. 2-16-2010. INT. CL. 35.
- BIOELECTRONICS CORPORATION, FREDERICK, MD:
3,783,316. PUB. 2-16-2010. INT. CL. 10.
- BIOLIFE, INC., LAS VEGAS, NV:
2,752,822. CANC. INT. CL. 5.
- BIOMARIN PHARMACEUTICAL INC., NOVATO, CA:
3,783,437. PUB. 2-16-2010. INT. CL. 5.
- BIOMED COMM, INC., SEATTLE, WA:
2,271,321. CANC. INT. CL. 5.
- BIONEUTRAL LABORATORIES CORPORATION USA,
NEWARK, NJ:
3,783,747. PUB. 1-12-2010. MULTIPLE CLASS, INT. CLS. 3
AND 5.
- BIOQUANT, INC., ANN ARBOR, MI:
1,552,656. CANC. MULTIPLE CLASS, INT. CLS. 9 AND
10.
- BIOSCRIPT, INC., ELMSFORD, NY:
2,751,919. CANC. MULTIPLE CLASS, INT. CLS. 35, 37, 39,
41 AND 42.
- BIOSIL TECHNOLOGIES, INC., ALLENDALE, NJ:
3,784,854. PUB. 4-21-2009. INT. CL. 1.
- BIOSTRATEGIES GROUP, INC., CHICAGO, IL:
3,783,641. PUB. 2-16-2010. INT. CL. 35.
- BIOTAGE AB, SE-753 18 UPPSALA, SWEDEN:
2,753,148. CANC. INT. CL. 42.
- BIRCHWOOD LABORATORIES, INC., EDEN PRAIRIE, MN:
895,876. REN. 3-26-10. U.S. CL. 16 (INT. CL. 2).
- BIRD BRAIN, INC., YPSILANTI, MI:
2,754,516. CANC. INT. CL. 11.
- BIRDPHOTOGRAPHERS.NET INC., VALRICO, FL:
3,783,735. PUB. 2-16-2010. INT. CL. 41.
- BIRDWORKS, INC., SHELTER ISLAND, NY:
2,273,099. CANC. INT. CL. 41.
- BITAR, PHILIP, ARLINGTON, WA AND BITAR, MARIE,
RICHMOND, CA:
1,552,850. CANC. INT. CL. 16.
- BITON, CORINA, MIAMI BEACH, FL:
3,785,751. INT. CL. 25.
- BIZNIK INC., SEATTLE, WA, DBA BIZNIK:
3,783,226. PUB. 1-6-2009. INT. CL. 35.
- BIZWORLD FOUNDATION, REDWOOD CITY, CA:
2,385,392. REN. 3-31-10. INT. CL. 41.
- BJ'S RESTAURANTS, INC., HUNTINGTON BEACH, CA:
3,786,004. INT. CL. 32.
- BJM ENTERPRISES, LLC, WESTLAKE VILLAGE, CA:
3,784,573. PUB. 2-16-2010. INT. CL. 35.
- BLAB GRAB LLC, MIAMI BEACH, FL:
3,784,554. PUB. 2-16-2010. INT. CL. 35.
- BLACK & DECKER CORPORATION, THE, TOWSON, MD:
2,352,269. REN. 3-30-10. INT. CL. 7.
2,753,744. CANC. INT. CL. 28.
- BLACK HALO PRODUCTIONS, LOS ANGELES, CA:
3,786,121. INT. CL. 25.
3,786,122. INT. CL. 25.
- BLACKDIVINE LLC, NEW YORK, NY:
3,784,106. PUB. 2-16-2010. INT. CL. 45.
- BLACKHAWK BIOSYSTEMS, INC., SAN RAMON, CA:
2,281,106. REN. 3-30-10. INT. CL. 5.
- BLACKSTONE, DAVID, NORTH MIAMI BEACH, FL:
2,754,653. CANC. INT. CL. 42.
- BLACKWELL HEATING & AIR CONDITIONING, INC.,
PENSACOLA, FL:
3,784,351. PUB. 2-16-2010. INT. CL. 37.
- BLANKINSHIP, JIM, SAN DIEGO, CA:
2,752,495. CANC. INT. CL. 41.
- BLANVER FARMOQUIMICA LTDA., CEP 06700, COTIA -
SP., BRAZIL:
2,272,016. CANC. INT. CL. 1.
- BLOCAL, INC., SEATTLE, WA:
2,753,561. CANC. INT. CL. 37.
- BLOCKBUSTER ENTERTAINMENT CORPORATION,
FORT LAUDERDALE, FL, DBA BLOCKBUSTER VIDEO:
1,553,293. CANC. INT. CL. 41.
- BLOOM INC., INDEPENDENCE, IA, DBA BLOOM MANU-
FACTURING INC.:
3,785,962. INT. CL. 7.
- BLRP, L.L.C., BANGOR, MI:
3,785,742. INT. CL. 17.
- BLUE BANNER COMPANY, INC., RIVERSIDE, CA:
535,954. REN. 3-27-10. U.S. CL. 46 (INT. CL. 31).
- BLUE COAT SYSTEMS, INC., SUNNYVALE, CA:
2,753,051. CANC. INT. CL. 9.
- BLUE GURUS, LLC, OVERLAND PARK, KS:
3,784,555. PUB. 2-16-2010. MULTIPLE CLASS, INT. CLS.
35 AND 42.
- BLUE RIDGE ATLANTIC, INC., OAKBORO, NC:
3,785,834. INT. CL. 11.
- BLUE RIDGE LEGAL SERVICES, INC., HARRISONBURG,
VA:
3,784,385. PUB. 2-16-2010. INT. CL. 45.
- BLUE RIDGE MOTION PICTURES, LLC, ASHEVILLE, NC:
2,751,942. CANC. INT. CL. 41.
- BLUEPRINT GROWTH INSTITUTE, INC., OVERLAND
PARK, KS:
3,785,344. INT. CL. 41.
- BLUESONIC USA INC., HENDERSON, NV:
3,785,082. INT. CL. 9.
- BLUESTAR ENERGY SERVICES, INC., CHICAGO, IL:
3,785,768. MULTIPLE CLASS, INT. CLS. 35 AND 42.
- BLUESTEM BRANDS, INC., EDEN PRAIRIE, MN:
3,786,170. INT. CL. 7.
- BM AUDIO LABS, INC., WILMINGTON, DE:
2,753,794. CANC. INT. CL. 9.
- BMH TECHNOLOGY OY, FINLAND:
3,784,991. PUB. 2-16-2010. INT. CL. 7.
- BNSF RAILWAY COMPANY, FORT WORTH, TX:
3,784,167. PUB. 2-16-2010. INT. CL. 39.
- BOARD OF GOVERNORS OF BRIDGEMONT COMMU-
NITY AND TECHNICAL COLLEGE, MONTGOMERY,
WV, DBA BRIDGEMONT COMMUNITY AND TECHNICAL COLLEGE:
3,783,862. PUB. 2-16-2010. INT. CL. 41.
- BOARD OF REGENTS OF THE UNIVERSITY SYSTEM OF
GEORGIA, ATLANTA, GA:
3,783,898. PUB. 2-16-2010. INT. CL. 41.
3,785,562. MULTIPLE CLASS, INT. CLS. 25, 28 AND 41.
- BOARD OF REGENTS, THE UNIVERSITY OF TEXAS
SYSTEM, AUSTIN, TX:
1,590,813. REN. 3-26-10. INT. CL. 16.
- BOARD OF TRUSTEES OF THE UNIVERSITY OF ARKAN-
SAS, THE, LITTLE ROCK, AR:
1,590,197. REN. 3-31-10. INT. CL. 41.
- BOARDS & MORE HOLDING S.A., MONTREUX, SWITZER-
LAND:
2,752,161. CANC. INT. CL. 3.
- BOB CURRAN & SONS, INC., DICKINSON, TX:
2,752,803. CANC. INT. CL. 2.
- BOB EVANS RESTAURANTS OF MICHIGAN, LLC, ANN
ARBOR, MI:
3,784,757. PUB. 2-16-2010. INT. CL. 43.
3,784,767. PUB. 2-16-2010. INT. CL. 30.
- BOB JONES UNIVERSITY, INC., GREENVILLE, SC:
3,784,331. PUB. 2-16-2010. INT. CL. 41.
- BOB'S SPACE RACERS, INC., DAYTONA BEACH, FL:
2,335,385. REN. 3-31-10. INT. CL. 28.
- BOBARRA, LLC, SAN FRANCISCO, CA:
3,785,883. MULTIPLE CLASS, INT. CLS. 9 AND 18.
- BOCOM HOLDINGS GROUP INC., SHENZHEN, GUANG-
DONG PROVINCE, CHINA:
2,752,849. CANC. INT. CL. 9.
- BODEGAS HUERTAS, S.A., JUMILLA MURCIA, SPAIN:
2,752,861. CANC. INT. CL. 33.

BODIE-HOOVER PETROLEUM CORPORATION, LEMONT, IL:
2,752,230, CANC. MULTIPLE CLASS, INT. CLS. 1 AND 4.

BODY IMAGE CLINIC, P.A., DUNN, NC:
2,751,866, CANC. INT. CL. 42.

BODY PLUS NUTRITIONAL PRODUCTS INC., SCARBOROUGH, CANADA:
3,783,182, PUB. 2-16-2010. INT. CL. 36.

BODY SOLID INC., FOREST PARK, IL:
2,340,817, REN. 3-31-10. INT. CL. 28.

BOECKHOLT, JOSEPH A., PRAIRIE VILLAGE, KS:
3,785,839, INT. CL. 3.

BOEHRINGER INGELHEIM INTERNATIONAL GMBH, 55216 INGELHEIM AM RHEIN, FED REP GERMANY:
2,752,125, CANC. INT. CL. 5.

BOEHRINGER INGELHEIM INTERNATIONAL GMBH, INGELHEIM AM RHEIN, FED REP GERMANY:
2,753,079, CANC. INT. CL. 5.
2,753,080, CANC. INT. CL. 5.
2,753,104, CANC. INT. CL. 5.

BOEHRINGER INGELHEIM VETMEDICA, INC., ST. JOSEPH, MO:
3,786,168, MULTIPLE CLASS, INT. CLS. 16, 35 AND 44.

BOEHRINGER MANUFACTURING CO., INC., REDDING, CA, DBA BARR BROTHERS CO.:
3,784,475, PUB. 2-16-2010. INT. CL. 21.

BOELTER, KYLE M., HUNTINGDON VALLEY, PA:
3,785,176, INT. CL. 25.

BOGARI HOLDINGS, INC., NEW YORK, NY:
3,783,708, PUB. 2-16-2010. INT. CL. 25.

BOHNER, LEE, CASTRO VALLEY, CA, DBA SPORTING ADVENTURES:
1,580,613, REN. 3-30-10. INT. CL. 39.

BOILING POINT CORPORATION, HACIENDA HEIGHTS, CA:
3,784,324, PUB. 2-16-2010. INT. CL. 43.
3,784,325, PUB. 2-16-2010. INT. CL. 43.
3,784,327, PUB. 2-16-2010. INT. CL. 43.

BOISE BUILDING SOLUTIONS MANUFACTURING, L.L.C., BOISE, ID:
3,783,594, PUB. 2-16-2010. INT. CL. 9.

BOLAND, DEL PRICE, NAPERVILLE, IL:
3,785,937, INT. CL. 9.

BOLAÑOS, ROBERTO GOMEZ, MEXICO, D.F, MEXICO:
3,786,195, INT. CL. 9.

BOLLORE, FRANCE:
3,785,006, PUB. 2-16-2010. MULTIPLE CLASS, INT. CLS. 9 AND 37.

BONE ZONE, INC., RUPERT, ID:
2,753,311, CANC. INT. CL. 25.

BONHAMS 1793 LIMITED, LONDON, UNITED KINGDOM:
2,751,827, CANC. MULTIPLE CLASS, INT. CLS. 35 AND 36.
2,751,828, CANC. MULTIPLE CLASS, INT. CLS. 35 AND 36.

BONIDE PRODUCTS, INC., ORISKANY, NY:
3,786,353, MULTIPLE CLASS, INT. CLS. 1 AND 5.

BONITA J YOUNG, CONYERS, GA, DBA SIMPLE DIY SOLUTIONS:
3,784,170, PUB. 2-16-2010. INT. CL. 24.

BONNEY, GRACE S, BROOKLYN, NY:
3,783,907, PUB. 2-16-2010. INT. CL. 41.

BONSAI NETWORKS, INC., HEMDON, VA:
2,752,174, CANC. INT. CL. 38.

BONTERRA, LLC, MARINA DEL REY, CA:
3,784,146, PUB. 2-16-2010. INT. CL. 37.

BOOKSPAN, GARDEN CITY, NY:
2,754,507, CANC. INT. CL. 35.

BOOMTOWN, INC., NEW YORK, NY:
2,325,720, REN. 3-26-10. INT. CL. 41.

BORGIONI LLC, TAMPA, FL:
3,783,607, PUB. 2-16-2010. INT. CL. 14.
3,783,608, PUB. 2-16-2010. INT. CL. 14.

BORN FREE NOW, LP, BROOKLYN, NY:
3,786,171, MULTIPLE CLASS, INT. CLS. 16 AND 25.

BORSA ITALIANA S.P.A., 20123 MILAN, ITALY:
2,751,797, CANC. MULTIPLE CLASS, INT. CLS. 35 AND 36.

BORYUNG MEDIENCE CO., LTD., SEOUL, REPUBLIC OF KOREA:
3,786,236, INT. CL. 21.

BOSCOV'S INVESTMENT COMPANY, INC., READING, PA:
3,784,091, PUB. 2-16-2010. MULTIPLE CLASS, INT. CLS. 14, 18, 20, 21, 24, 25 AND 26.

BOSTON CONSULTING GROUP GMBH, 80331 MUNICH, FED REP GERMANY:
2,334,454, REN. 3-27-10. MULTIPLE CLASS, INT. CLS. 16, 35 AND 41.

BOSTON DENTAL P.C., BOSTON, MA:
2,417,379, REN. 3-29-10. INT. CL. 42.

BOSTON FOUNDATION, INC., BOSTON, MA:
3,785,362, INT. CL. 41.

BOSTON PROPER, INC., BOCA RATON, FL:
3,785,735, MULTIPLE CLASS, INT. CLS. 9, 14, 18 AND 25.

BOSTON PROPERTIES LTD., BOSTON, MA:
2,753,356, CANC. MULTIPLE CLASS, INT. CLS. 36 AND 37.

BOSTON WOMEN'S SOCCER, LLC, WESTWOOD, MA:
3,786,206, MULTIPLE CLASS, INT. CLS. 18, 25 AND 41.

BOSTONLIMOUSINE.COM, INC., SOMERVILLE, MA:
2,906,809, CANC. INT. CL. 39.

BOSWORTH, PETER IVAN, MCLAREN VALE, AUSTRALIA AND BOSWORTH, ANETHA CAROLA, MCLAREN VALE, AUSTRALIA:
2,754,628, CANC. INT. CL. 33.

BOTTEGA DI LUNGAVITA S.R.L., ITALY:
3,184,087, COR. MULTIPLE CLASS, INT. CLS. 3 AND 5.

BOUNDLESS MEDIA CORPORATION, MONTREAL, QUEBEC, CANADA:
2,752,399, CANC. INT. CL. 43.

BOURGEOIS, GEORGE M., BATON ROUGE, LA, DBA BOURGEOIS ENTERPRISES:
3,783,716, PUB. 2-16-2010. INT. CL. 35.

BOURJOIS, 92200 NEUILLY SUR SEINE, FRANCE:
2,753,097, CANC. INT. CL. 3.

BOURJOIS, FRANCE:
3,785,050, PUB. 2-16-2010. INT. CL. 3.

BOURNE, ROBERT, BONITA SPRINGS, FL:
3,785,383, INT. CL. 41.

BOURNE, RUSS M., MEMPHIS, TN:
2,754,015, CANC. INT. CL. 35.

BOW B.V., AMSTERDAM, NETHERLANDS:
2,774,562, CANC. MULTIPLE CLASS, INT. CLS. 9 AND 14.

BOW PLUMBING GROUP INC., VILLE MONT-ROYAL, QC, CANADA:
3,783,293, PUB. 2-16-2010. MULTIPLE CLASS, INT. CLS. 17 AND 19.

BOWER-MCLAUGHLIN, GLORIA J., CLAREMONT, CA:
3,785,345, MULTIPLE CLASS, INT. CLS. 16, 35 AND 41.

BOWLING, MICHAEL, TUCSON, AZ:
3,785,076, INT. CL. 28.

BOWMAN, HAL K., CARY, NC:
2,753,507, CANC. MULTIPLE CLASS, INT. CLS. 3, 21 AND 28.

BOWTIE, INC., IRVINE, CA:
2,336,877, REN. 3-27-10. MULTIPLE CLASS, INT. CLS. 16 AND 42.
2,341,775, REN. 4-1-10. MULTIPLE CLASS, INT. CLS. 16 AND 42.
2,388,840, REN. 3-26-10. MULTIPLE CLASS, INT. CLS. 16 AND 42.
3,785,226, MULTIPLE CLASS, INT. CLS. 16 AND 44.

BOXOFFICE MEDIA, LLC, BEVERLY HILLS, CA:
3,783,540, PUB. 2-16-2010. MULTIPLE CLASS, INT. CLS. 35 AND 41.

BOXOFVISION, LLC, BEVERLY HILLS, CA:
3,786,096, INT. CL. 16.

BOYD GAMING CORPORATION, LAS VEGAS, NV:
3,784,213, PUB. 2-16-2010. INT. CL. 41.
3,784,697, PUB. 2-16-2010. INT. CL. 41.
3,784,787, PUB. 2-16-2010. INT. CL. 41.

BOYLAN GROUP, INCORPORATED, THE, CHANHASSEN, MN:
2,272,496, CANC. INT. CL. 9.

- BOYS & GIRLS CLUBS OF GREATER DALLAS, INC., DALLAS, TX:
3,785,806, INT. CL. 41.
- BOYT HARNESS COMPANY, L.L.C., OSCEOLA, IA:
2,837,981, CANC. INT. CL. 28.
- BPB, PLC., SLOUGH SL3 6DU, ENGLAND:
2,751,541, CANC. MULTIPLE CLASS, INT. CLS. 6, 16, 17 AND 19.
- BPH HOLDINGS PTY. LTD., JANDAKOT, WESTERN AUSTRALIA 6164, AUSTRALIA:
2,751,568, CANC. INT. CL. 3.
- BPI US PARTNERS LLC, CHICAGO, IL:
3,622,967, COR. INT. CL. 41.
- BPSI HOLDINGS LLC, WILMINGTON, DE:
2,344,277, REN. 3-29-10, INT. CL. 41.
- BRACEWELL & GIULIANI LLP, HOUSTON, TX:
3,408,001, COR. INT. CL. 35.
- BRAD ROSS, NEW YORK, NY:
3,785,972, INT. CL. 9.
- BRADLEY, TERRI, D., LAURELTON, NY:
2,752,854, CANC. INT. CL. 25.
- BRADY BRIDGES, FRESNO, CA:
3,783,405, PUB. 2-16-2010, INT. CL. 15.
- BRAEBON MEDICAL CORPORATION, KANATA, ONTARIO, CANADA:
3,783,227, PUB. 11-24-2009, INT. CL. 10.
- BRAILLE INSTITUTE OF AMERICA, INC., LOS ANGELES, CA:
3,784,227, PUB. 2-16-2010, MULTIPLE CLASS, INT. CLS. 9, 16, 35, 36 AND 41.
- BRAIN STATE TECHNOLOGIES, L.L.C., SCOTTSDALE, AZ:
3,783,953, PUB. 2-16-2010, INT. CL. 9.
- BRANDED LLC, DALLAS, TX:
3,785,263, MULTIPLE CLASS, INT. CLS. 20 AND 24.
- BRANDED, LLC, DALLAS, TX:
3,785,663, MULTIPLE CLASS, INT. CLS. 16 AND 21.
- BRANDHANDLING INTERNATIONAL LIMITED, DOUGLAS, ISLE OF MAN:
3,410,825, COR. INT. CL. 3.
- BRANDT, MARK R., DAYTON, OH:
2,753,902, CANC. INT. CL. 8.
- BRANDWISE, INC., LAKEWOOD, CO:
3,783,571, PUB. 2-16-2010, INT. CL. 42.
- BRANHAM, MARY, WEST COLUMBIA, SC:
3,783,946, PUB. 2-16-2010, INT. CL. 35.
- BRAUN AKTIENGESSELLSCHAFT, FRANKFURT AM MAIN, FED REP GERMANY:
1,552,526, CANC. INT. CL. 7.
- BRAVADO INTERNATIONAL GROUP MERCHANDISING SERVICES, INC., NEW YORK, NY:
3,785,944, INT. CL. 25.
- BRC IP PTY LTD, ULTIMO SYDNEY NSW, AUSTRALIA:
3,783,580, PUB. 2-16-2010, MULTIPLE CLASS, INT. CLS. 9, 35, 41 AND 44.
- BREAST CANCER ACTION, SAN FRANCISCO, CA:
2,400,245, REN. 3-29-10, INT. CL. 16.
- BREAST CANCER NETWORK OF STRENGTH, INC., CHICAGO, IL:
3,783,993, PUB. 2-16-2010, INT. CL. 36.
- BREWER, JO ANN, GREENVILLE, NC:
3,785,088, INT. CL. 25.
- BRIDGEFIVE SOLUTIONS, LLC, TRINITY, FL:
3,783,775, PUB. 2-16-2010, MULTIPLE CLASS, INT. CLS. 9, 38 AND 42.
3,783,776, PUB. 2-16-2010, MULTIPLE CLASS, INT. CLS. 9, 38 AND 42.
- BRIDGELINE DIGITAL, INC., WOBURN, MA:
2,752,441, CANC. MULTIPLE CLASS, INT. CLS. 9 AND 42.
- BRIDGETT, TANZANIA, HAMPTON, VA:
3,783,773, PUB. 2-16-2010, INT. CL. 25.
- BRIDGEWATER TECH, INC., FARIBAULT, MN:
3,785,338, MULTIPLE CLASS, INT. CLS. 6 AND 9.
- BRIDGFORD FOODS CORPORATION, ANAHEIM, CA:
1,553,086, CANC. INT. CL. 30.
- BRIDGING HEALTH OPTIONS, L.L.C., OCEAN SPRINGS, MS:
2,752,145, CANC. INT. CL. 35.
- BRIGADE CORPORATION, SAN FRANCISCO, CA:
2,754,109, CANC. INT. CL. 35.
- BRIGHT GLOW CANDLE COMPANY, VERNON, CA:
2,753,874, CANC. INT. CL. 4.
- BRIGHTER PLANET, INC., MIDDLEBURY, VT:
3,785,423, MULTIPLE CLASS, INT. CLS. 16, 35, 36, 38, 41 AND 42.
- BRINSON, JASTON T., LOS ANGELES, CA, DBA ADVANTAGE VENDING:
2,751,855, CANC. INT. CL. 28.
- BRISTOL-MYERS SQUIBB COMPANY, NEW YORK, NY:
2,753,083, CANC. INT. CL. 16.
3,785,141, INT. CL. 16.
3,786,257, INT. CL. 36.
- BRITE VOICE SYSTEMS, INC., WICHITA, KS:
1,552,540, CANC. INT. CL. 9.
- BRITTON BELL, NEW BERLIN, WI, DBA BRITTON'S UNIQUE BOUTIQUE:
3,785,491, INT. CL. 3.
- BRODA ENTERPRISES INC., KITCHENER, ONTARIO N2B3X9, CANADA:
2,330,533, REN. 3-26-10, INT. CL. 10.
- BRONOX LTD., MONROVIA, LIBERIA:
2,272,587, CANC. INT. CL. 25.
- BROOKSTONE COMPANY, INC., MERRIMACK, NH:
2,334,207, REN. 3-31-10, MULTIPLE CLASS, INT. CLS. 8, 9, 10, 11, 12, 14, 18, 20, 21, 25, 27, 28 AND 35.
- BROOM, PATRICK, BAINBRIDGE ISLAND, WA:
2,302,859, REN. 3-27-10, INT. CL. 28.
- BROTHER INDUSTRIES, LTD., MIZUHO-KU NAGOYA, JAPAN:
2,416,068, REN. 4-1-10, MULTIPLE CLASS, INT. CLS. 7 AND 9.
- BROTHERS BY CHOICE, LLC., SAN FRANCISCO, CA:
3,784,486, PUB. 2-16-2010, INT. CL. 35.
- BROWARD COUNTY COMMUNITY DEVELOPMENT INC., FORT LAUDERDALE, FL, DBA BROWARD HOUSING SOLUTIONS:
3,786,374, MULTIPLE CLASS, INT. CLS. 36 AND 37.
- BROWN LOAFERS SIZE 9, LLC, HILTON HEAD ISLAND, SC, DBA FENDERRODS:
3,784,602, PUB. 2-16-2010, INT. CL. 20.
3,784,604, PUB. 2-16-2010, INT. CL. 20.
- BROWN STOVE WORKS, INC., CLEVELAND, TN:
1,128,935, REN. 4-1-10, INT. CL. 11.
- BROWNLIN B.V., MEERKERK, NETHERLANDS:
3,755,127, CANC. IIRN. RESTORED TO S.N. 77-228,926.
- BRUCE, OSCAR, FREEPORT, NY:
3,784,323, PUB. 2-16-2010, INT. CL. 9.
- BRUNO PAILLARD, FRANCE:
3,785,028, PUB. 2-16-2010, INT. CL. 33.
- BRUNO, VANESSA VIRGINIE, PARIS, FRANCE:
2,825,144, CANC. MULTIPLE CLASS, INT. CLS. 3, 9 AND 14.
- BRUNSWICK BOWLING & BILLIARDS CORPORATION, LAEKE FOREST, IL:
2,272,053, CANC. INT. CL. 28.
- BRUNSWICK CORPORATION, LAKE FOREST, IL:
2,429,458, REN. 3-26-10, INT. CL. 25.
- BRUNSWICK CORPORATION, WILMINGTON, DE AND BRUNSWICK BILLIARDS RECREATION, INC., WILMINGTON, DE:
2,753,362, CANC. INT. CL. 12.
- BRUNSWICK CORPORATION, LAKE FOREST, IL:
3,785,216, MULTIPLE CLASS, INT. CLS. 6, 7, 9, 12 AND 21.
- BRUSHSTROKES FINE ART INC., RICHMOND HILL, ONTARIO, CANADA:
2,281,999, REN. 3-29-10, INT. CL. 16.
- BRY-AIR (ASIA) PVT. LTD., DELHI, INDIA:
3,783,456, PUB. 2-16-2010, INT. CL. 11.
3,783,457, PUB. 2-16-2010, INT. CL. 11.
- BRYCE, ERROL BRADSHAW, KEENE, TX:
3,785,451, INT. CL. 9.
- BRYN MAWR COMMUNICATIONS II, LLC, BRYN MAWR, PA:
2,754,412, CANC. MULTIPLE CLASS, INT. CLS. 9 AND 16.

BS&K HOLDING COMPANY, LLC, SYRACUSE, NY:
2,754,030, CANC. INT. CL. 9.

BSERV, INC., LAS VEGAS, NV, DBA BANKSERV, INC.:
3,783,856, PUB. 2-16-2010. MULTIPLE CLASS, INT. CLS.
36 AND 42.

BSH BOSCH UND SIEMENS HAUSGERAETE GMBH,
MUNICH, FED REP GERMANY:
3,783,288, PUB. 2-16-2010. INT. CL. 11.

BUBBLES INCORPORATED S.A., FRIBOURG, SWITZER-
LAND:
2,340,844, REN. 3-26-10. INT. CL. 16.

BUCHANAN, MYRON K., SAINT LOUIS, MO:
3,784,597, PUB. 2-16-2010. INT. CL. 16.

BUCK'S, INC., OMAHA, NE:
3,783,086, PUB. 2-13-2007. INT. CL. 35.

BUEGE, DENNIS, LODI, WI, DBA ONE STOP JERKY SHOP:
3,784,119, PUB. 2-16-2010. INT. CL. 35.

BUHLER, CRAIG F., KAYSVILLE, UT:
3,785,511, INT. CL. 44.

BUILD JAKE'S PLACE, INC., PENNSAUKEN, NJ:
3,783,420, PUB. 2-16-2010. INT. CL. 37.

BUILD-A-BEAR RETAIL MANAGEMENT, INC., ST. LOUIS,
MO:
2,752,997, CANC. INT. CL. 28.

BULLETPROOF ELECTRONICS, INC., BRADENTON, FL:
3,785,668, INT. CL. 9.

BULLOCK, LEILA ANN, VICTORVILLE, CA, DBA LOCAL
CHURCH 411:
3,783,920, PUB. 2-16-2010. INT. CL. 35.

BULOVA CORPORATION, WOODSIDE, NY:
2,273,048, CANC. INT. CL. 14.
2,753,116, CANC. INT. CL. 14.

BUNAC TRAVEL SERVICES LIMITED, LONDON, UNITED
KINGDOM:
2,359,445, REN. 3-26-10. MULTIPLE CLASS, INT. CLS. 35
AND 39.

BUNGALO RECORDS, INC., WOODLAND HILLS, CA:
2,753,953, CANC. INT. CL. 38.

BUNGE OILS, INC., ST. LOUIS, MO:
2,382,652, REN. 3-26-10. INT. CL. 29.
3,784,761, PUB. 2-16-2010. INT. CL. 29.

BUNTE, STEVEN RAY, SAN JOSE, CA:
3,783,329, PUB. 2-16-2010. INT. CL. 39.

BURBERRY LIMITED, LONDON SW1P 2AW, UNITED
KINGDOM:
1,133,122, REN. 3-26-10. INT. CL. 18.

BURHOP'S, INC., WILMETTE, IL:
2,421,420, REN. 3-26-10. INT. CL. 35.

BURNES HOME ACCENTS, LLC, ROUND ROCK, TX:
1,612,966, REN. 3-26-10. INT. CL. 20.

BUSINESS CARDS TOMORROW, INC., FORT LAUDER-
DALE, FL:
2,752,300, CANC. INT. CL. 16.

BUSINESS INTELLIGENCE SOLUTIONS SAFE B.V., AM-
STERDAM, NETHERLANDS:
3,783,485, PUB. 2-16-2010. INT. CL. 9.

BUSINESS RESOURCE GROUP, LOS ANGELES, CA:
2,754,646, CANC. INT. CL. 35.

BUSINESS-FOR-LIFE, INC., ROCKFORD, IL:
2,751,743, CANC. INT. CL. 35.

BUSTER MURPHY LLC, JACKSONVILLE, FL:
3,784,657, PUB. 2-16-2010. INT. CL. 35.

BUTLER PRODUCTS CORPORATION, FLORENCE, KY:
3,785,154, MULTIPLE CLASS, INT. CLS. 7, 8 AND 12.

BVS ENTERTAINMENT, INC., LOS ANGELES, CA:
2,754,358, CANC. INT. CL. 41.

BWA WATER ADDITIVES UK LIMITED, MANCHESTER,
UNITED KINGDOM, CIBA-GEIGY CORPORATION,
ARDSLEY, NY:
1,132,938, REN. 3-27-10. INT. CL. 1.

BWA WATER ADDITIVES UK LIMITED, MANCHESTER,
UNITED KINGDOM:
2,334,901, REN. 3-29-10. INT. CL. 1.

BY LILLA LLC, AVENTURA, FL:
3,784,568, PUB. 2-16-2010. INT. CL. 26.

BYK-GARDNER GMBH, FED REP GERMANY:
3,784,860, PUB. 2-16-2010. INT. CL. 9.

C I PRENDACOL S.A., ENVIGADO, ANTIOQUIA, COLOM-
BIA:
3,783,707, PUB. 2-16-2010. INT. CL. 25.

C. J. THEOBALD III, LOUISVILLE, KY:
3,786,128, INT. CL. 20.

C. V. STARR & CO., INC., NEW YORK, NY:
3,785,925, INT. CL. 36.
3,786,269, INT. CL. 36.

C.A.B., INC., LOUISVILLE, KY:
2,332,514, REN. 3-30-10. INT. CL. 20.

C.A.O. INTERNATIONAL, INC., NASHVILLE, TN:
2,387,276, REN. 3-29-10. INT. CL. 34.

C.P. PRIVATE EQUITY LTD, LONDON, UNITED KING-
DOM:
2,751,860, CANC. MULTIPLE CLASS, INT. CLS. 9, 14
AND 25.
2,753,893, CANC. MULTIPLE CLASS, INT. CLS. 9, 14
AND 25.

C.V.B. (CASA VINICOLA F. LLI BIXIO) S.R.L., 37047 SAN
BONIFACIO, ITALY:
2,754,616, CANC. INT. CL. 33.

C/HCA, INC., NASHVILLE, TN:
3,786,487, INT. CL. 44.

CABLE CENTER, INC., THE, DENVER, CO:
3,783,640, PUB. 2-16-2010. INT. CL. 41.

CABLE SCOPE, INC., NEW YORK, NY:
2,332,552, REN. 3-29-10. INT. CL. 35.

CAC AUSTRALIA PTY LTD, AUSTRALIA:
3,785,030, PUB. 2-16-2010. INT. CL. 28.

CACIQUE INC, INDUSTRY, CA:
3,783,792, PUB. 2-16-2010. INT. CL. 29.

CACO, DENNIS, SAN DIEGO, CA:
2,753,584, CANC. INT. CL. 25.

CADOGAN TATE GROUP LIMITED, LONDON, UNITED
KINGDOM:
3,585,343, COR. INT. CL. 39.

CAHILL, JONATHAN P, LONDON, UNITED KINGDOM:
3,783,609, PUB. 2-16-2010. INT. CL. 33.

CAI EXPORT AND IMPORT CO., LTD., NEW YORK, NY:
2,754,297, CANC. INT. CL. 25.

CAI INC, GEORGETOWN, MA:
2,754,491, CANC. INT. CL. 2.

CAKEBREAD CELLARS, RUTHERFORD, CA:
1,596,855, REN. 3-31-10. INT. CL. 41.

CAL-COMP ELECTRONICS & COMMUNICATIONS COM-
PANY LIMITED, TAIPEI CITY, TAIWAN:
3,785,642, MULTIPLE CLASS, INT. CLS. 9 AND 11.

CALDWELL CONSUMER HEALTH, LLC, MADISON, NJ,
DBA REVIVE PERSONAL PRODUCTS COMPANY:
3,785,974, INT. CL. 5.

CALEPS, BROOKLYN, NY:
3,784,490, PUB. 2-16-2010. INT. CL. 41.

CALGON CARBON CORPORATION, PITTSBURGH, PA:
2,339,949, REN. 3-31-10. INT. CL. 11.

CALIFORNIA ACADEMY OF SCIENCES, SAN FRANCIS-
CO, CA:
2,272,339, CANC. INT. CL. 16.

CALIFORNIA CAVIAR COMPANY, SAN FRANCISCO, CA:
3,784,596, PUB. 2-16-2010. INT. CL. 29.

CALIFORNIA GLASS COMPANY, OAKLAND, CA:
1,552,855, CANC. MULTIPLE CLASS, INT. CLS. 16 AND
20.

CALIFORNIA MATTRESS L.L.C., ESCONDIDO, CA, DBA
WICKLINE BEDDING L.L.C.:
2,271,721, CANC. INT. CL. 20.

CALIFORNIA PACIFIC LAB INC, NOVATO, CA, AKA CP
LAB SAFETY:
3,784,443, PUB. 2-16-2010. INT. CL. 42.

CALIFORNIA QUIVERS INC., SAN DIEGO, CA:
3,783,801, PUB. 2-16-2010. INT. CL. 32.

CALIFORNIA STATE LOTTERY, SACRAMENTO, CA:
3,785,771, INT. CL. 41.

CALIFORNIA STREET RODS, INC., HUNTINGTON
BEACH, CA:
2,751,640, CANC. INT. CL. 40.

CALISTRO CALIFORNIA BISTRO #1, LLC, SCOTTSDALE,
AZ:
3,785,571, INT. CL. 43.

- CALLOWAY, DONNA C., COCKEYSVILLE, MD:
3,783,419, PUB. 2-16-2010. INT. CL. 30.
- CALSOFT SYSTEMS, TORRANCE, CA:
3,783,701, PUB. 2-16-2010. INT. CL. 42.
- CAMBRIDGE SILICON RADIO LIMITED, CAMBRIDGE
CB40WH, UNITED KINGDOM:
3,786,212, INT. CL. 9.
- CAMDEN FINANCIAL CORPORATION, INC., SHAWNEE,
KS:
2,754,636, CANC. INT. CL. 36.
- CAMINATA, DANIEL, BUENOS AIRES, ARGENTINA:
2,754,396, CANC. INT. CL. 42.
- CAMPBELL, JR., JAMES G., MCCALL, ID:
1,553,011, CANC. INT. CL. 28.
- CAMZAK LLC, NEW YORK, NY:
3,742,338, COR. INT. CL. 43.
- CAN PRO PET PRODUCTS LTD., ABBOTSFORD, CANADA:
3,783,158, PUB. 2-16-2010. INT. CL. 31.
- CANADA WEST SHOE MANUFACTURING INC., WINNI-
PEG, MANITOBA R2X 2N6, CANADA:
2,272,780, CANC. INT. CL. 25.
- CANADELLE LIMITED PARTNERSHIP, MONTREAL,
QUEBEC, CANADA:
2,753,442, CANC. INT. CL. 25.
- CANADIAN IMPERIAL BANK OF COMMERCE, NEW
YORK, NY:
2,752,043, CANC. INT. CL. 35.
- CANADIAN NATIONAL RAILWAY COMPANY, MON-
TREAL, QUEBEC, CANADA:
2,751,587, CANC. MULTIPLE CLASS, INT. CLS. 9, 16, 35,
38, 39 AND 42.
- CANADIAN PACIFIC RAILWAY COMPANY, CALGARY,
ALBERTA TXP 4Z4, CANADA, CANADIAN PACIFIC
RAILWAY COMPANY, MONTREAL, QUEBEC, CANA-
DA:
903,621, REN. 3-30-10. U.S. CL. 105 (INT. CL. 39).
- CANADIAN PACIFIC RAILWAY COMPANY, CALGARY,
ALBERTA T2P 4ZR, CANADA:
3,783,083, PUB. 2-16-2010. MULTIPLE CLASS, INT. CLS.
14, 16 AND 28.
- CANFORD AUDIO LIMITED, WASHINGTON, TYNE &
WEAR, ENGLAND:
1,552,549, CANC. INT. CL. 9.
- CANNON, PETER, SEATTLE, WA:
2,752,447, CANC. INT. CL. 41.
- CANTINE GIACOMO MONTRESOR S.P.A., VERONA,
ITALY:
3,785,512, INT. CL. 33.
- CAPCOM ENTERTAINMENT, INC., SAN MATEO, CA:
3,785,379, INT. CL. 9.
- CAPCOM U.S.A., INC., SAN MATEO, CA:
3,785,228, INT. CL. 9.
- CAPITAL GOOD FUND, LOS ANGELES, CA:
3,784,066, PUB. 2-16-2010. INT. CL. 36.
- CAPITAL ONE FINANCIAL CORPORATION, RICHMOND,
VA:
3,784,702, PUB. 2-16-2010. INT. CL. 36.
- CAPITAL PROFESSIONAL ADVISORS, LLC, MINNEAPOLIS,
MN:
2,753,514, CANC. INT. CL. 36.
- CAPSTAR RADIO OPERATING COMPANY, SAN ANTONIO,
TX:
3,784,398, PUB. 2-16-2010. INT. CL. 41.
- CAPSTONE PRESS, INC., MANKATO, MN:
3,784,546, PUB. 2-16-2010. INT. CL. 35.
- CAR WASH ENTERPRISES, INC., SEATTLE, WA:
3,785,556, INT. CL. 35.
- CARAMBA TEQUILA, INC., PASADENA, CA:
3,785,211, INT. CL. 33.
- CARAVAN INGREDIENTS INC., LENEXA, KS:
2,271,669, CANC. INT. CL. 1.
- CARBO CERAMICS INC., HOUSTON, TX:
3,785,900, MULTIPLE CLASS, INT. CLS. 40 AND 42.
- CARD EXPRESS, INC., YORBA LINDA, CA:
3,784,835, PUB. 2-16-2010. MULTIPLE CLASS, INT. CLS. 9
AND 36.
- CARDINAL LABORATORIES, INC., BALDWIN PARK, CA:
3,783,897, PUB. 2-16-2010. INT. CL. 31.
- CARDSYNC PROCESSING, INC., NASHVILLE, TN:
2,804,575, CANC. INT. CL. 36.
- CARDWORKS, INC., WOODBURY, NY:
3,785,392, MULTIPLE CLASS, INT. CLS. 35 AND 36.
- CARECO PRODUCTIONS, INC., SAN ANTONIO, TX:
2,335,656, REN. 3-31-10. MULTIPLE CLASS, INT. CLS. 25
AND 41.
- CAREER CONTROL GROUP, INC., THE, DALLAS, TX:
2,752,050, CANC. MULTIPLE CLASS, INT. CLS. 35 AND
41.
- CAREER PARTNERS INTERNATIONAL LLC, CHAPEL
HILL, NC:
3,783,793, PUB. 2-16-2010. INT. CL. 41.
- CAREER SOLUTIONS INTERNATIONAL, INC., SANFORD,
FL:
3,783,599, PUB. 2-16-2010. INT. CL. 35.
- CAREGROUP, INC., BOSTON, MA:
2,364,133, REN. 3-31-10. INT. CL. 42.
- CARELINE (PHARMAGIS) LTD., BNEI BRAK, ISRAEL:
2,754,351, CANC. INT. CL. 5.
- CAREN PRODUCTS, LLC, ROSWELL, GA:
3,783,999, PUB. 2-16-2010. INT. CL. 3.
- CARGILL MEAT SOLUTIONS CORPORATION, WICHITA,
KS:
1,553,066, CANC. INT. CL. 29.
- CARGILL, INCORPORATED, WAYZATA, MN:
2,753,527, CANC. MULTIPLE CLASS, INT. CLS. 29 AND
30.
- CARIBBEAN CIGAR COMPANY, S.A., PANAMA CITY,
PANAMA:
2,335,094, REN. 3-27-10. INT. CL. 34.
- CARKHUFF THINKING SYSTEMS, INC., MCLEAN, VA:
2,273,114, CANC. MULTIPLE CLASS, INT. CLS. 35 AND
41.
- CARL KARCHER ENTERPRISES, INC., ANAHEIM, CA:
2,754,061, CANC. INT. CL. 42.
- CARL ZEISS AG, OBERKOCHEN, FED REP GERMANY:
3,786,275, INT. CL. 9.
- CARLA CARINI S.R.L., 46024 MOGLIA (MANTOVA),
ITALY:
2,751,532, CANC. INT. CL. 3.
2,751,534, CANC. MULTIPLE CLASS, INT. CLS. 3, 18
AND 25.
- CARLISLE FOODSERVICE PRODUCTS, INCORPORATED,
OKLAHOMA CITY, OK:
1,586,997, REN. 3-31-10. INT. CL. 30.
- CARMEL ROASTERS, INC., CARMEL, CA, DBA CARMEL
VALLEY COFFEE ROASTING COMPANY:
3,784,235, PUB. 2-16-2010. INT. CL. 30.
- CARMELINA ESTEVEZ, TEANECK, NJ:
3,785,903, INT. CL. 25.
- CARMELLA BARRETT PERRY DDS, P.C., FLOSSMOOR, IL:
3,784,609, PUB. 2-16-2010. INT. CL. 44.
- CARMEN OKHUYSEN, S.A. DE C.V., GUADALAJARA,
JALISCO, MEXICO:
2,341,460, REN. 3-29-10. INT. CL. 30.
- CARMOTIVE LLC, SACRAMENTO, CA:
2,754,088, CANC. INT. CL. 36.
- CARNEGIE MELLON UNIVERSITY, PITTSBURGH, PA:
2,272,484, CANC. MULTIPLE CLASS, INT. CLS. 9, 35
AND 36.
- CAROL DAUPLAISE, LTD., NEW YORK, NY:
3,785,090, INT. CL. 14.
- CAROL TUTTLE ENTERPRISES, L.L.C., DRAPER, UT:
3,786,277, INT. CL. 45.
- CAROLINA NURSERIES, INC., MONCKS CORNER, SC:
3,784,796, PUB. 2-16-2010. INT. CL. 31.
3,785,184, INT. CL. 31.
- CAROLINA SHAVINGS INC., CLINTON, SC:
2,752,513, CANC. INT. CL. 31.
2,752,514, CANC. INT. CL. 31.
- CARRARO S.R.L., 28040 PARUZZARO, ITALY:
2,753,604, CANC. MULTIPLE CLASS, INT. CLS. 3, 9, 18
AND 25.
- CARRIAGE FUNERAL HOLDINGS, INC., HOUSTON, TX:
2,422,453, REN. 3-29-10. INT. CL. 42.

CARROLL COMPANY, GARLAND, TX, GROW GROUP, INC., NEW YORK, NY:
1,637,332. REN. 3-29-10. INT. CL. 3.

CARROT MEDICAL, LLC, NEWTON, MA:
3,785,681. INT. CL. 9.

CARTER, DEBRA L., LAS VEGAS, NV:
2,753,709. CANC. INT. CL. 14.

CARTIER INTERNATIONAL, B.V., AMSTERDAM-C, NETHERLANDS:
1,552,635. CANC. INT. CL. 9.

CARTOON NETWORK LP, LLLP, THE, ATLANTA, GA:
2,753,631. CANC. INT. CL. 25.
2,753,653. CANC. INT. CL. 41.

CASCADE ENGINEERING, INC., GRAND RAPIDS, MI:
2,754,135. CANC. INT. CL. 20.

CASCO GROUP SOCIETATE IN COMANDITA SIMPLA (SCS), SUTA MARE, ROMANIA:
3,783,325. PUB. 2-16-2010. INT. CL. 9.

CASE DESIGN/REMODELING, INC., BETHESDA, MD:
3,421,500. AM. INT. CL. 41.

CASH MONEY CHEQUE CASHING INC., MISSISSUAGA, ONTARIO L4W 5A1, CANADA:
2,763,218. CANC. MULTIPLE CLASS, INT. CLS. 16, 38 AND 39.

CASILLAS BROS. INC., HOLLISTER, CA:
1,553,140. CANC. INT. CL. 31.

CASSEN, MELODY V., NEW YORK, NY:
3,785,871. INT. CL. 16.

CASSLEE CORPORATION, SAN DIEGO, CA, DBA CLEVER CLEAVER PRODUCTIONS:
3,784,218. PUB. 2-16-2010. INT. CL. 30.
3,784,222. PUB. 2-16-2010. INT. CL. 30.

CASUAL COOL INC., NEW YORK, NY:
2,754,097. CANC. INT. CL. 25.

CAT DESIGN AUSTRALIA PTY. LTD., BRUNSWICK, VICTORIA 3056, AUSTRALIA:
2,751,565. CANC. INT. CL. 3.

CATENA NETWORKS, INC., REDWOOD SHORES, CA:
2,753,807. CANC. INT. CL. 9.

CATERPILLAR, INC., PEORIA, IL:
551,623. AM. U.S. CL. 6.

CATRON, MOLLY W. AFTON, TN:
2,751,803. CANC. INT. CL. 41.

CATTLE BARON RESTAURANTS, INC., ROSWELL, NM:
2,342,718. REN. 3-30-10. MULTIPLE CLASS, INT. CLS. 25 AND 42.

CAVALLARO, ANN, CLIFFSIDE PARK, NJ:
2,334,222. REN. 3-30-10. INT. CL. 35.

CAVANNA S.P.A., ITALY:
3,785,055. PUB. 2-16-2010. INT. CL. 7.

CAVES ALIANCA, S.A., SANGALHOS-ANADIA, PORTUGAL:
2,271,792. CANC. INT. CL. 33.

CAVES DA RAPOSEIRA, S.A., LAMEGO, PORTUGAL:
2,263,791. REN. 3-31-10. INT. CL. 33.

CAY HOLDINGS LTD, WILMINGTON, DE:
2,753,106. CANC. INT. CL. 1.

CB TM LLC, MISSION VIEJO, CA:
3,786,028. INT. CL. 41.

CBJ, L.P., OVERLAND PARK, KS, CBJ, L.P., OVERLAND PARK, KS:
1,595,268. REN. 3-29-10. INT. CL. 16.

CBS BROADCASTING INC., NEW YORK, NY:
3,783,556. PUB. 2-16-2010. INT. CL. 41.

CBS RADIO HOLDINGS, INC., NEW YORK, NY:
2,326,615. REN. 3-31-10. INT. CL. 38.

CBS RADIO INC., NEW YORK, NY:
1,575,653. REN. 3-29-10. INT. CL. 41.
3,784,800. PUB. 2-16-2010. INT. CL. 38.

CDM RETIREMENT CONSULTANTS, INC., TOWSON, MD:
3,783,417. PUB. 2-16-2010. INT. CL. 36.

CE INTERACTIVE, INC., NEW YORK, NY:
3,785,262. MULTIPLE CLASS, INT. CLS. 35 AND 37.

CEC ENTERTAINMENT CONCEPTS, L.P., IRVING, TX:
2,753,365. CANC. INT. CL. 42.

CELANESE VENTURES GMBH, FRANKFURT AM MAIN, FED REP GERMANY:
2,752,944. CANC. MULTIPLE CLASS, INT. CLS. 1, 5 AND 42.

CELEMIAB SYSTEMS AB, 201 25 MALMO, SWEDEN:
2,340,257. REN. 4-1-10. INT. CL. 28.

CELL LINE GENETICS, LLC, MADISON, WI:
3,786,419. INT. CL. 42.

CELLHIRE PLC, YORK YO30 5PB, ENGLAND:
2,752,177. CANC. INT. CL. 37.

CENDANT PUBLISHING, INC., AURORA, CO TO AFFINION PUBLISHING, LLC., LAS VEGAS, NV:
2,271,820. CANC. MULTIPLE CLASS, INT. CLS. 35, 36 AND 39.

CENEX HARVEST STATES COOPERATIVES, INVER GROVE HEIGHTS, MN:
2,753,666. CANC. MULTIPLE CLASS, INT. CLS. 25, 35, 36, 39, 40 AND 42.

CENTER FOR ADVANCED TECHNOLOGY SOLUTIONS, INC., ATLANTA, GA:
2,754,374. CANC. MULTIPLE CLASS, INT. CLS. 41 AND 42.

CENTER FOR REPRODUCTIVE RIGHTS, INC., THE, NEW YORK, NY:
2,754,604. CANC. MULTIPLE CLASS, INT. CLS. 42 AND 44.

CENTER FOR SALES STRATEGY, INC., THE, TAMPA, FL:
2,410,837. REN. 3-26-10. INT. CL. 41.

CENTERSTONE OF TENNESSEE, INC., NASHVILLE, TN:
2,337,655. REN. 3-31-10. INT. CL. 42.

CENTOCOR ORTHO BIOTECH INC., HORSHAM, PA:
2,336,754. REN. 3-27-10. INT. CL. 5.

CENTRAL MELCO CORPORATION, TOKYO, JAPAN:
3,783,737. PUB. 12-29-2009. MULTIPLE CLASS, INT. CLS. 7, 9, 11 AND 20.

CENTRAL SPRINKLER COMPANY, LANSDALE, PA:
1,609,552. REN. 3-30-10. INT. CL. 6.

CENTRAL SPRINKLER HOLDINGS, INC., HOUSTON, TX:
2,410,839. REN. 3-26-10. INT. CL. 6.

CENTRAL STATES ENTERPRISES, INC, LAKE CITY, FL:
3,783,130. PUB. 2-16-2010. INT. CL. 31.

CENTRAL TEXAS INDUSTRIES, HOUSTON, TX:
3,785,546. INT. CL. 9.

CENTREX PLASTICS, LLC, FINDLAY, OH:
3,784,092. PUB. 2-16-2010. INT. CL. 21.
3,784,093. PUB. 2-16-2010. INT. CL. 40.

CENTRIC GROUP, LLC, ST. LOUIS, MO:
2,754,545. CANC. INT. CL. 32.

CENTRO CARDIOLOGICO S.P.A.; "FONDAZIONE MONZINO"; IN FORMA ABBREVIATA; CENTRO CARDIOLOGICO MONZINO S.P.A., ITALY:
3,784,900. PUB. 2-16-2010. MULTIPLE CLASS, INT. CLS. 5, 35, 41 AND 44.

CERAMICAS DIAGO, S.A., 12006 CASTELLON, SPAIN:
2,753,517. CANC. INT. CL. 19.

CEREBELLUM CORPORATION, LORTON, VA:
2,271,889. CANC. INT. CL. 9.

CERILLIANT CORPORATION, ROUND ROCK, TX:
2,752,814. CANC. INT. CL. 40.

CERTIFIED INVESTIGATIVE PROFESSIONALS INC., SAN DIEGO, CA:
2,752,116. CANC. INT. CL. 41.

CERTIFIED TECHNOLOGIES CORPORATION, EDEN PRAIRIE, MN:
1,552,896. CANC. INT. CL. 19.

CERULLO, WAYNE, CONCORD, CA:
3,784,076. PUB. 2-16-2010. INT. CL. 35.

CESTA, WENDY, D., WEST SAND LAKE, NY:
2,754,500. CANC. INT. CL. 44.

CEVN CORP., SOMERSET, NJ:
3,785,669. INT. CL. 19.

CHAD FORBUSH, AMERICAN HOME GUARDIAN, MESA, AZ:
3,783,809. PUB. 2-16-2010. INT. CL. 35.

CHAI OPTIC GMBH, OBERASBACH, FED REP GERMANY:
1,552,632. CANC. INT. CL. 9.

CHAMPION COOLER CORPORATION, LITTLE ROCK, AR:
2,273,014. CANC. INT. CL. 11.

CHAMPION POWER EQUIPMENT, INC., SANTA FE SPRINGS, CA, DBA CHAMPION POWER EQUIPMENT:
3,785,488. INT. CL. 7.

- CHAMPION SOLUTIONS GROUP, BOCA RATON, FL:
3,784,176, PUB. 2-16-2010. INT. CL. 42.
- CHANCELLOR MASTERS AND SCHOLARS OF THE UNIVERSITY OF OXFORD, OXFORD, OX2 6DP, UNITED KINGDOM, TA OXFORD UNIVERSITY PRESS, THE:
3,785,056, MULTIPLE CLASS, INT. CLS. 16 AND 41.
- CHANEY ENTERPRISES LIMITED PARTNERSHIP, WALDORF, MD:
2,394,585. REN. 4-1-10. MULTIPLE CLASS, INT. CLS. 35, 37 AND 42.
- CHANIN, WENDY NEWIRTH, NEW YORK, NY:
2,336,893. REN. 3-30-10. INT. CL. 41.
- CHANNEL BIO CORP., KENTLAND, IN:
2,271,614, CANC. INT. CL. 31.
- CHANNEL ONE, LLC, NEW YORK, NY:
3,783,490, PUB. 2-16-2010. MULTIPLE CLASS, INT. CLS. 38, 41 AND 42.
- CHAPIN SHEA MCNITT & CARTER, SAN DIEGO, CA:
2,752,805, CANC. INT. CL. 42.
2,752,806, CANC. INT. CL. 42.
- CHARACTER BEE, LLC, CLINTON, SC:
3,784,584, PUB. 2-16-2010. INT. CL. 25.
- CHARITABLE VENTURE FOUNDATION, CLIFTON PARK, NY:
2,754,577, CANC. INT. CL. 36.
- CHARITY GLOBAL, INC., NEW YORK, NY:
3,758,192, COR. INT. CL. 25.
- CHARLES H. AND RACHEL M. SCHWAB REHABILITATION CENTER, CHICAGO, IL:
1,553,378, CANC. INT. CL. 42.
- CHART HEAT EXCHANGERS LIMITED PARTNERSHIP, WOLVERHAMPTON, UNITED KINGDOM:
2,751,773, CANC. MULTIPLE CLASS, INT. CLS. 9 AND 11.
- CHARTER COMMUNICATIONS, INC., ST. LOUIS, MO:
1,553,274, CANC. INT. CL. 38.
- CHECK CASHING U.S.A., INC., MIAMI, FL:
1,553,235, CANC. INT. CL. 36.
- CHECK MARK SOFTWARE, INC., FORT COLLINS, CO:
3,784,547, PUB. 2-16-2010. INT. CL. 9.
- CHECK PLUS SYSTEMS, INC., CORPUS CHRISTI, TX:
2,752,097, CANC. INT. CL. 36.
2,752,098, CANC. INT. CL. 36.
- CHECKERS DRIVE-IN RESTAURANTS, INC., TAMPA, FL:
2,754,059, CANC. INT. CL. 30.
- CHECKFREE SERVICES CORPORATION, NORCROSS, GA:
1,552,575, CANC. INT. CL. 9.
- CHECKPOINT SYSTEMS, INC., THOROFARE, NJ:
2,753,722, CANC. INT. CL. 20.
- CHEF'S REQUESTED FOODS, OKLAHOMA CITY, OK:
2,337,281. REN. 3-26-10. INT. CL. 29.
- CHEIL INDUSTRIES INC., KYOUNGSANGBUK-DO, REPUBLIC OF KOREA:
2,751,888, CANC. INT. CL. 2.
- CHEMICAL ARTS INC, TORONTO, ONTARIO, CANADA, DBA CHEMICAL ARTS:
3,783,676, PUB. 2-16-2010. INT. CL. 21.
- CHEMICAL CONSULTANTS, INC, CORONA, CA:
2,356,548. REN. 3-27-10. INT. CL. 1.
- CHEMINDUSTRIAL SYSTEMS INC., CEDARBURG, WI:
2,754,406, CANC. MULTIPLE CLASS, INT. CLS. 1 AND 11.
- CHEMISCHE FABRIK BUDENHEIM RUDOLF A. OETKER, D-55257 BUDENHEIM, FED REP GERMANY:
2,752,099, CANC. INT. CL. 1.
- CHENELIA, DOMINIC, SAN DIEGO, CA:
3,785,169, INT. CL. 14.
- CHERNYAK, YEVGENY OLEKSANDROVYCH, ZAPORIZHZHYA, UKRAINE:
3,783,187, PUB. 2-16-2010. MULTIPLE CLASS, INT. CLS. 32, 33, 35 AND 43.
- CHEUNG, THOMAS, TEMPLE CITY, CA:
2,752,562, CANC. INT. CL. 9.
- CHEVRON INTELLECTUAL PROPERTY LLC, SAN RAMON, CA:
888,144. REN. 3-28-10. U.S. CL. 15 (INT. CL. 4).
2,753,262, CANC. MULTIPLE CLASS, INT. CLS. 35 AND 42.
- CHFA, INC., BALTIMORE, MD:
2,752,466, CANC. MULTIPLE CLASS, INT. CLS. 35 AND 36.
- CHICAGO FAUCET COMPANY, DES PLAINES, IL:
1,552,752, CANC. INT. CL. 11.
- CHICO'S BRANDS INVESTMENTS, INC., FORT MYERS, FL:
2,271,990, CANC. INT. CL. 16.
- CHICO'S BRANDS INVESTMENTS, INC., FT. MYERS, FL:
3,784,696, PUB. 2-16-2010. INT. CL. 25.
- CHIEN, CHIN L., HOUSTON, TX:
2,752,808, CANC. INT. CL. 43.
- CHILDREN'S LEARNING ADVENTURE LICENSING, LLC, PHOENIX, AZ:
3,785,117, MULTIPLE CLASS, INT. CLS. 16, 41 AND 43.
- CHILDREN'S MEDICAL CENTER CORPORATION, BOSTON, MA:
3,785,530, MULTIPLE CLASS, INT. CLS. 41 AND 44.
- CHILDREN'S NATIONAL MEDICAL CENTER, WASHINGTON, DC:
1,605,024. REN. 3-27-10. MULTIPLE CLASS, INT. CLS. 41 AND 42.
- CHIN FAMILY 1 LIQ CHUAN ASSOCIATION, PLEASANT VALLEY, NY:
3,783,330, PUB. 2-16-2010. MULTIPLE CLASS, INT. CLS. 9, 16, 25 AND 41.
- CHINA RESOURCES SNOW BREWERY; (LIAO NING) COMPANY LIMITED, CHINA:
3,784,968, PUB. 2-16-2010. INT. CL. 32.
- CHINA RESOURCES SNOW BREWERY; (LIAO NING) COMPANY LIMITED, TIEXI DISTRICT, SHENYANG, CHINA:
3,784,979, PUB. 2-16-2010. INT. CL. 32.
- CHINATRUST COMMERCIAL BANK, LTD., TAIPEI, TAIWAN:
3,785,622, INT. CL. 36.
- CHING HSING SHIH, CLOSTER, NJ, DBA SHING'S COMPANY:
2,751,641, CANC. INT. CL. 40.
- CHINOOK TRADING COMPANY, TIGARD, OR:
2,754,300, CANC. INT. CL. 25.
- CHIPVISION DESIGN SYSTEMS AG, OLDENBURG, FED REP GERMANY:
3,783,539, PUB. 2-16-2010. INT. CL. 9.
- CHIROTROPIC ASSOCIATES, LLC, ORLANDO, FL:
2,752,809, CANC. INT. CL. 44.
- CHIVAS HOLDINGS (IP) LIMITED, UNITED KINGDOM:
3,784,990, PUB. 2-16-2010. MULTIPLE CLASS, INT. CLS. 20 AND 33.
- CHOE, SOKWON, PARAMOUNT, CA:
2,753,233, CANC. INT. CL. 19.
- CHOICE USA BEVERAGE, INC., GASTONIA, NC:
1,553,161, CANC. INT. CL. 32.
- CHON, HYUN-SOO S., MILL VALLEY, CA, DBA TURTLE:
3,783,373, PUB. 2-16-2010. INT. CL. 25.
- CHONGQING RATO POWER CO., LTD., CHINA:
3,785,005, PUB. 2-16-2010. MULTIPLE CLASS, INT. CLS. 7 AND 12.
- CHOPARD (USA) LTD, NEW YORK, NY:
1,596,057. REN. 3-30-10. INT. CL. 14.
- CHOREN INDUSTRIES GMBH, FED REP GERMANY:
3,784,906, PUB. 2-16-2010. MULTIPLE CLASS, INT. CLS. 1, 4, 9, 35, 37, 39, 40 AND 42.
3,784,907, PUB. 2-16-2010. MULTIPLE CLASS, INT. CLS. 1, 4, 9, 35, 37, 39, 40 AND 42.
- CHOSEN GROUP, INC., THE WOODLANDS, TX:
2,754,203, CANC. INT. CL. 3.
- CHOUNG, ANDREW, SAN FRANCISCO, CA:
3,785,978, INT. CL. 45.
- CHR. HANSEN A/S, HORSHHOLM, DENMARK, PIONEER HI-BRED INTERNATIONAL, INC., DES MOINES, IA:
1,591,656. REN. 3-27-10. INT. CL. 5.
- CHR. HANSEN, INC., MILWAUKEE, WI:
2,331,800. REN. 3-26-10. INT. CL. 1.
- CHRIO AMERICA, INC., ANNANDALE, VA, DBA CHRIO:
3,783,270, PUB. 2-16-2010. MULTIPLE CLASS, INT. CLS. 3, 14 AND 28.

CHRISTENSEN, KURT L., SPRINGFIELD, NV:
2,754,040, CANC. INT. CL. 5.

CHRISTIAN CASEY LLC, NEW YORK, NY:
3,785,290, INT. CL. 3.
3,785,293, INT. CL. 3.

CHRISTOPHER & BANKS COMPANY, PLYMOUTH, MN:
3,786,177, MULTIPLE CLASS, INT. CLS. 14, 25 AND 35.
3,786,187, MULTIPLE CLASS, INT. CLS. 14, 25 AND 35.

CHRISTOPHER OLIE, EARLSFIELD, LONDON, UNITED KINGDOM:
3,784,963, PUB. 2-16-2010. MULTIPLE CLASS, INT. CLS. 9, 16 AND 18.

CHROME HEARTS LLC, HOLLYWOOD, CA:
3,784,392, PUB. 2-16-2010. INT. CL. 9.
3,784,780, PUB. 2-16-2010. INT. CL. 26.
3,784,781, PUB. 2-16-2010. INT. CL. 26.
3,784,782, PUB. 2-16-2010. INT. CL. 26.
3,784,783, PUB. 2-16-2010. INT. CL. 26.
3,784,784, PUB. 2-16-2010. INT. CL. 26.
3,784,785, PUB. 2-16-2010. INT. CL. 26.
3,784,786, PUB. 2-16-2010. INT. CL. 26.

CHROMOCELL CORPORATION, NORTH BRUNSWICK, NJ:
3,786,273, MULTIPLE CLASS, INT. CLS. 1 AND 30.

CHS INC., INVER GROVE HEIGHTS, MN, FARMERS UNION CENTRAL EXCHANGE, INCORPORATED, INVER GROVE HEIGHTS, MN:
1,635,924. REN. 3-27-10. INT. CL. 4.

CHS MARKETING, LLC, MT. PULASKI, IL:
2,754,493, CANC. INT. CL. 31.

CHU, HOWARD, SUNLAND, CA:
2,271,639, CANC. MULTIPLE CLASS, INT. CLS. 9, 25 AND 41.

CHUANG, JAIMY, TAIPEI, TAIWAN:
2,753,430, CANC. INT. CL. 20.

CHUCKWAGON SALLY, INC., CAMERON, TX, DBA CHUCKWAGON SALLY:
3,783,927, PUB. 2-16-2010. INT. CL. 30.

CHUGACH ALASKA CORPORATION, ANCHORAGE, AK:
2,236,617. REN. 3-30-10. MULTIPLE CLASS, INT. CLS. 16, 35, 36, 37, 39 AND 42.
2,236,617, CANC. INT. CL. 31.

CHUMBLEY, JAMES F, EDMONDS, WA:
2,753,042, CANC. INT. CL. 26.

CHUMBLEY, JAMES, F, EDMONDS, WA:
2,753,041, CANC. INT. CL. 26.

CHURCH & DWIGHT CO., INC., PRINCETON, NJ:
2,754,528, CANC. INT. CL. 21.
3,786,100, INT. CL. 3.
3,786,102, INT. CL. 3.
3,786,118, INT. CL. 21.

CHURCH & DWIGHT, CO. INC., PRINCETON, NJ:
3,783,861, PUB. 2-16-2010. INT. CL. 3.

CHURCHILL DOWNS INCORPORATED, LOUISVILLE, KY:
3,785,880, INT. CL. 41.

CIA WHEEL GROUP, CITY OF INDUSTRY, CA:
3,784,307, PUB. 2-16-2010. INT. CL. 12.

CIC, LTD., ALBROOK ANCON, PANAMA:
2,751,637, CANC. INT. CL. 42.

CICLOSPORT K.W. HOCHSCHORNER GMBH, KRAIL-LING, FED REP GERMANY:
2,828,676, CANC. MULTIPLE CLASS, INT. CLS. 12, 25 AND 28.

CILENTE, FRANK ANTHONY, SAYREVILLE, NJ:
3,784,590, PUB. 2-16-2010. INT. CL. 9.

CIMATRON LIMITED, GIVAT SHMUEL 54030, ISRAEL:
2,754,034, CANC. INT. CL. 9.

CIMBERIO VALVE CO. INC., MALVERN, PA:
3,785,369, INT. CL. 6.

CINCINNATI BELL TELEPHONE COMPANY LLC, CINCINNATI, OH:
2,752,837, CANC. INT. CL. 38.

CINCOTTA, LAWRENCE, PUNCHBOWL, NEW SOUTH WALES 2196, AUSTRALIA:
2,752,018, CANC. INT. CL. 25.

CINDEX HOLDINGS LIMITED, KOWLOON BAY, HONG KONG:
2,272,664, CANC. INT. CL. 26.

CINQUIEME SENS, MONCHY-HUMIERES, FRANCE:
3,784,874, PUB. 2-16-2010. MULTIPLE CLASS, INT. CLS. 3, 16, 28 AND 41.

CIPHERMAX, INCORPORATED, HOUSTON, TX:
2,753,817, CANC. INT. CL. 9.

CISCO TECHNOLOGY, INC., SAN JOSE, CA:
3,785,301, MULTIPLE CLASS, INT. CLS. 16, 35 AND 41.
3,786,351, MULTIPLE CLASS, INT. CLS. 38, 41 AND 42.

CITGO PETROLEUM CORPORATION, HOUSTON, TX, CITIES SERVICE COMPANY, TULSA, OK:
1,149,214. REN. 3-29-10. INT. CL. 42.

CITIGROUP INC., NEW YORK, NY:
691,815. REN. 3-31-10. U.S. CL. 102 (INT. CL. 36).

CITRIX ONLINE, LLC, GOLETA, CA:
3,783,572, PUB. 2-16-2010. MULTIPLE CLASS, INT. CLS. 38 AND 42.

CITY AND COUNTY OF DENVER, PARKS & RECREATION DEPARTMENT, DENVER, CO:
3,783,610, PUB. 2-16-2010. INT. CL. 41.

CITY BROKERS CORP., CORAL GABLES, FL:
2,754,543, CANC. INT. CL. 36.

CIVIX-M-R, LLC, SARASOTA, FL:
3,785,248, INT. CL. 37.

CIVOLUTION B.V., NETHERLANDS:
3,784,934, PUB. 2-16-2010. MULTIPLE CLASS, INT. CLS. 9, 37 AND 42.

CLABBER GIRL CORPORATION, TERRE HAUTE, IN:
3,785,759, INT. CL. 1.

CLAIRE'S GRAND RIVER WINERY, MIDDLEBURG, OH:
2,754,050, CANC. INT. CL. 35.

CLAREMONT GROUP, LLC, NEW YORK, NY:
3,784,628, PUB. 2-16-2010. MULTIPLE CLASS, INT. CLS. 36 AND 37.

CLARIAN HEALTH PARTNERS, INC., INDIANAPOLIS, IN:
3,785,603, INT. CL. 44.

CLARK EQUIPMENT COMPANY, WEST FARGO, ND:
2,332,705. REN. 3-29-10. INT. CL. 7.

CLARK INSURANCE, PORTLAND, ME:
3,784,370, PUB. 2-16-2010. INT. CL. 36.
3,784,371, PUB. 2-16-2010. INT. CL. 36.

CLARK, GINA, NEW YORK, NY:
3,784,288, PUB. 2-16-2010. INT. CL. 3.

CLARK, PATRICIA, WILLISTON, VT:
2,426,658. REN. 3-27-10. INT. CL. 42.

CLARKE POWER PRODUCTS, INC., PERRYSBURG, OH:
2,271,418, CANC. INT. CL. 18.

CLARUS MFG, LOS GATOS, CA:
3,783,367, PUB. 2-16-2010. INT. CL. 21.

CLASSROOM CONNECT OPERATING COMPANY, BOSTON, MA:
2,752,735, CANC. INT. CL. 41.

CLAUSING, WALTER, 7500 MORITZ, SWITZERLAND:
2,753,088, CANC. INT. CL. 28.

CLAY, JASON, PISCATAWAY, NJ:
3,785,628, INT. CL. 9.

CLAY, REBECCA E., GREENVILLE, SC, DBA THE BRACKETBOOK FOUNDATION:
3,783,575, PUB. 2-16-2010. INT. CL. 18.

CLAYBORNE, BERNADETTE, CORAL SPRINGS, FL:
2,752,571, CANC. INT. CL. 24.

CLEAN AIR FILTER COMPANY, DEFIANCE, IA:
2,370,092. REN. 3-31-10. MULTIPLE CLASS, INT. CLS. 7 AND 42.

CLEAN AND GREEN DRYER VENT EXPERTS, LLC, REDFORD, MI:
3,784,081, PUB. 2-16-2010. INT. CL. 37.

CLEAN HARBORS CATALYST TECHNOLOGIES, LLC, PASADENA, TX:
3,785,813, INT. CL. 37.

CLEANPHIRST, LLC, WENTZVILLE, MO:
3,784,570, PUB. 2-16-2010. INT. CL. 5.

CLEAR CHANNEL INTANGIBLES, INC., SAN ANTONIO, TX:
2,752,419, CANC. INT. CL. 35.

CLEAR ONE HEALTH PLANS, INC., BEND, OR:
3,784,211, PUB. 2-16-2010. INT. CL. 36.

CLEAR PEAK COMMUNICATIONS, LLC, NEW YORK, NY:
3,783,537, PUB. 2-16-2010. INT. CL. 38.

- CLEARPOINT FINANCIAL SOLUTIONS, INC., RICHMOND, VA:
3,786,215, MULTIPLE CLASS, INT. CLS. 36 AND 41.
- CLEATS LLC, MARLBOROUGH, MA:
3,786,209, INT. CL. 25.
- CLEVER DEVICES LTD., PLAINVIEW, NY:
3,786,297, INT. CL. 9.
3,786,298, INT. CL. 35.
3,786,299, MULTIPLE CLASS, INT. CLS. 37 AND 42.
- CLICK AND PARK, LLC, ORLANDO, FL:
3,783,140, PUB. 2-16-2010. INT. CL. 39.
3,783,239, PUB. 2-16-2010. INT. CL. 39.
- CLIMATE CULTURE, LLC, NEW YORK, NY:
3,785,614, INT. CL. 35.
- CLINICON CORPORATION, OCEANSIDE, CA:
2,325,261. REN. 3-29-10. INT. CL. 10.
- CLOCKWORK IP, LLC, SARASOTA, FL:
3,786,254, INT. CL. 37.
- CLOTHETIME STORES, INC., DALLAS, TX:
2,753,328, CANC. MULTIPLE CLASS, INT. CLS. 3, 14, 18,
25, 26 AND 35.
- CLOUD MACHINE CORPORATION, SKOKIE, IL TO
CLOUD PACKAGING SOLUTIONS LLC, DES PLAINES,
IL:
913,075, AM. U.S. CL. 23.
- CLOUD TOP, PASADENA, CA, AKA CLOUD TOP LLC, AKA
CLOUD TOP YOGURT:
3,785,314, INT. CL. 30.
- CLOUDLAND FILMWORKS, INC., NASHVILLE, TN:
2,259,086, CANC. INT. CL. 41.
- CLOUDSOFT CORPORATION LIMITED, UNITED KING-
DOM:
3,784,964, PUB. 2-16-2010. MULTIPLE CLASS, INT. CLS.
9, 38 AND 42.
- CLOUDTRADE LLC, LIVONIA, MI:
3,785,204, INT. CL. 38.
- CLUB MEDITERRANEE, 75019 PARIS, FRANCE:
2,753,533, CANC. INT. CL. 28.
- CLUBS OF AMERICA, INC., LAKEMOOR, IL:
2,752,682, CANC. INT. CL. 35.
- CLUSTER RESOURCES, INC., PROVO, UT:
3,786,426, MULTIPLE CLASS, INT. CLS. 9 AND 42.
- CM ENGINEERING CONSULTANTS LIMITED, UNITED
KINGDOM:
3,785,048, PUB. 2-16-2010. MULTIPLE CLASS, INT. CLS.
12 AND 17.
- CM PORCARO, INC., NORTH HOLLYWOOD, CA:
2,272,913, CANC. MULTIPLE CLASS, INT. CLS. 20 AND
24.
- CMG MAGNETICS CORPORATION, TAIPEI, TAIWAN:
2,751,669, CANC. INT. CL. 41.
- CMRG APPAREL, LLC, CANTON, MA:
1,553,379, CANC. INT. CL. 42.
- CMS SURGICAL, LLC, MURRIETA, CA:
2,753,463, CANC. INT. CL. 10.
- CMVY, INC., GORDONVILLE, TX:
2,385,437. REN. 3-31-10. INT. CL. 12.
2,385,438. REN. 3-31-10. INT. CL. 12.
- CNA FINANCIAL CORPORATION, CHICAGO, IL:
2,753,528, CANC. INT. CL. 36.
- CNCG, FLUSHING, NY:
2,827,459, CANC. INT. CL. 9.
- CND INTERNATIONAL LLC, ORLANDO, FL:
3,784,390, PUB. 2-16-2010. INT. CL. 5.
- CNOGA MEDICAL LTD., OR AKIVA, ISRAEL:
3,785,864, INT. CL. 10.
3,785,965, INT. CL. 10.
- COACH SERVICES, INC., NEW YORK, NY:
3,784,637, PUB. 2-16-2010. INT. CL. 36.
3,784,814, PUB. 2-16-2010. INT. CL. 9.
- COASTAL THERAPEUTICS, INC., SAN LUIS OBISPO, CA:
2,754,165, CANC. INT. CL. 5.
- COBEST ITALIA S.R.L. 20144 MILANO, ITALY:
3,670,666, COR. INT. CL. 25.
- COBHAM DEFENCE COMMUNICATIONS LIMITED, DOR-
SET, UNITED KINGDOM:
2,307,024. REN. 3-26-10. INT. CL. 9.
- COBURN CHEMICALS, INC., COCKEYSVILLE, MD:
3,786,026, INT. CL. 1.
- COCKRUM, JERRY, CARLSBAD, NM:
3,783,758, PUB. 2-16-2010. INT. CL. 9.
- COFFEE BY DESIGN, INC., PORTLAND, ME:
3,784,373, PUB. 2-16-2010. INT. CL. 30.
3,784,374, PUB. 2-16-2010. INT. CL. 43.
3,784,375, PUB. 2-16-2010. INT. CL. 43.
3,784,377, PUB. 2-16-2010. INT. CL. 30.
- COGEBI SOCIETE ANONYME, BRUSSELS, BELGIUM:
2,752,347, CANC. INT. CL. 17.
- COGENCY GROUP, INC., PHOENIX, AZ:
3,783,318, PUB. 2-16-2010. INT. CL. 16.
- COGNIGEN NETWORKS, INC., MOUNTLAKE TERRACE,
WA:
2,751,940, CANC. INT. CL. 35.
- COGNIS FRANCE, SAINT MARTORY, FRANCE:
3,786,213, INT. CL. 1.
- COGNIS IP MANAGEMENT GMBH, FED REP GERMANY:
3,784,932, PUB. 2-16-2010. MULTIPLE CLASS, INT. CLS. 1
AND 3.
- COGNISTAR INTERACTIVE CORPORATION, WESTBOR-
OUGH, MA:
2,753,571, CANC. INT. CL. 41.
- COGNITIVEDATA, INC., LITTLE ROCK, AR:
2,752,956, CANC. INT. CL. 35.
- COHERENT-DEOS, LLC, BLOOMFIELD, CT:
2,271,455, CANC. INT. CL. 9.
2,271,456, CANC. INT. CL. 9.
- COHESION LLC, NASHVILLE, TN:
2,752,759, CANC. INT. CL. 39.
- COINAMATIC CANADA INC., MISSISSAUGA, ONTARIO,
CANADA:
2,751,606, CANC. INT. CL. 35.
- COINMACH CORPORATION, PLAINVIEW, NY:
3,785,198, INT. CL. 37.
- COKER TIRE COMPANY, CHATTANOOGA, TN:
3,786,157, INT. CL. 12.
- COLASSOCIATES, HAWTHORNE, NJ:
3,784,114, PUB. 2-16-2010. INT. CL. 35.
- COLD CHAIN TECHNOLOGIES, INC., HOLLISTON, MA:
2,332,335. REN. 3-31-10. INT. CL. 1.
- COLD SPRING BREWING COMPANY, COLD SPRINGS,
MN:
3,784,008, PUB. 2-16-2010. INT. CL. 32.
- COLEMAN CABLE SYSTEMS, INC., WAUKEGAN, IL:
1,552,667, CANC. INT. CL. 9.
- COLEMAN COMPANY, INC., THE, WICHITA, KS:
1,552,522, CANC. INT. CL. 7.
- COLEMAN COMPANY, INC., THE, WICHITA, KS, COLE-
MAN CO. INC., THE, WICHITA, KS:
1,588,965. REN. 3-28-10. INT. CL. 25.
- COLIC-EASE, INC, SEAFORD, NY:
3,784,337, PUB. 2-16-2010. INT. CL. 5.
- COLLABRASPAC, INC, ARNOLD, MD:
2,752,961, CANC. INT. CL. 9.
- COLLAXA CORPORATION, REDWOOD SHORES, CA:
2,754,043, CANC. INT. CL. 9.
- COLLECTIVE LICENSING INTERNATIONAL, LLC, ENG-
LEWOOD, CO:
1,552,965, CANC. INT. CL. 25.
- COLLEGE CONTENT, LLC, COLUMBUS, OH:
2,272,757, CANC. INT. CL. 42.
- COLLEGE OF CHARLESTON, CHARLESTON, SC:
3,783,846, PUB. 2-16-2010. MULTIPLE CLASS, INT. CLS.
16, 25 AND 28.
3,783,868, PUB. 2-16-2010. MULTIPLE CLASS, INT. CLS.
25 AND 28.
3,783,876, PUB. 2-16-2010. MULTIPLE CLASS, INT. CLS.
6, 16, 18, 20, 21, 25 AND 28.
- COLLEGE OF DIPLOMATES OF THE AMERICAN BOARD
OF ORTHODONTICS, INC., ST. CHARLES, MO:
3,785,861, INT. CL. 35.
- COLLEGE OF NEW ROCHELLE, THE, NEW ROCHELLE,
NY:
2,835,845, CANC. INT. CL. 18.

COLLEGIATE FUNDING SERVICES, LLC, FREDERICKSBURG, VA:
2,752,086, CANC. MULTIPLE CLASS, INT. CLS. 35 AND 36.

COLLEGIATE SPORTS OF AMERICA, INC., WOODLAND HILLS, CA:
2,433,475. REN. 3-30-10. INT. CL. 16.

COLLEGIUM PHARMACEUTICAL, INC., CUMBERLAND, RI:
3,786,119, INT. CL. 5.

COLLINS, L. RODERICK, SPRING, TX:
2,751,615, CANC. INT. CL. 36.

COLLO FASHION LIMITED, LONDON SW17 7EE, UNITED KINGDOM:
2,751,977, CANC. INT. CL. 25.

COLONIAL REALTY LIMITED PARTNERSHIP, BIRMINGHAM, AL:
2,753,544, CANC. INT. CL. 36.

COLORADO RUNNER LLC, LITTLETON, CO:
3,786,468, INT. CL. 16.

COLUMBIA INSURANCE COMPANY, OMAHA, NE:
3,784,710, PUB. 2-16-2010. INT. CL. 41.

COMAU FRANCE, TRAPPES, FRANCE:
2,278,709. REN. 3-26-10. MULTIPLE CLASS, INT. CLS. 7, 9 AND 42.

COMBE INCORPORATED, WHITE PLAINS, NY, J.B. WILLIAMS COMPANY, THE, GLASTONBURY, CT:
269,143. REN. 4-1-10. U.S. CL. 51 (INT. CLS. 3 AND 5).

COMBE INTERNATIONAL LTD., WHITE PLAINS, NY:
2,752,225, CANC. MULTIPLE CLASS, INT. CLS. 3 AND 35.

COMBI WELLNESS CORPORATION, TOKYO, JAPAN:
1,552,732, CANC. MULTIPLE CLASS, INT. CLS. 10 AND 28.

COMCAST CORPORATION, PHILADELPHIA, PA:
3,783,530, PUB. 2-16-2010. INT. CL. 38.
3,783,531, PUB. 2-16-2010. INT. CL. 38.

COMDERA, LLC, ROCKFORD, MN:
2,752,781, CANC. INT. CL. 42.

COMEMON INTERNATIONAL CORPORATION LIMITED, NORTH POINT, HONG KONG:
2,753,804, CANC. INT. CL. 9.

COMERICA INCORPORATED, DETROIT, MI:
2,752,770, CANC. INT. CL. 36.

COMET CLEANERS HOLDINGS, INC, ARLINGTON, TX, JACK GODFREY & SONS, INC., ARLINGTON, TX:
1,139,473. REN. 3-31-10. INT. CL. 37.

COMITE INTERNATIONAL OLYMPIQUE, CH-1007 LAUSANNE, SWITZERLAND:
2,752,048, CANC. MULTIPLE CLASS, INT. CLS. 16, 35 AND 41.

COMMENCE CORPORATION, TINTON FALLS, NJ:
3,783,128, PUB. 2-16-2010. INT. CL. 9.

COMMODORE ENTERTAINMENT CORP., ST. PAUL, MN:
2,424,686. REN. 3-26-10. INT. CL. 41.

COMMON SENSE MEDIA, SAN FRANCISCO, CA:
3,786,287, INT. CL. 41.

COMMONWEALTH SOAP & TOILETRIES, INC., FALL RIVER, MA:
2,745,409, COR. INT. CL. 3.

COMMUNAUITE URBAINE DE LILLE, FRANCE:
3,784,872, PUB. 2-16-2010. MULTIPLE CLASS, INT. CLS. 9, 16, 18, 20, 28, 35, 41 AND 42.

COMMUNICATIONS SATELLITE CORPORATION, WASHINGTON, DC, DBA COMSAT TO COMSAT CORPORATION, WASHINGTON, DC:
1,553,273, CANC. INT. CL. 38.

COMMUNIFAX CORPORATION, CRANBERRY TWP., PA:
2,753,045, CANC. INT. CL. 28.

COMPAGNI, KIMBERLY A., HOLLADAY, UT:
2,754,423, CANC. INT. CL. 16.

COMPAGNIE EUROPEENNE DU ZIRCONIUM CEZUS, 92400 COURBEVOIE, FRANCE:
2,268,246, COR. MULTIPLE CLASS, INT. CLS. 1 AND 6.

COMPANIA ALIMENTICIA DEL NORTE, S.A. DE C.V., SAN NICOLAS DE LOS GARZA, N.L. MEXICO:
2,752,031, CANC. INT. CL. 30.

COMPANIA SUD AMERICANA DE VAPORES S.A., LAS CONDES SANTIAGO, CHILE:
3,784,424, PUB. 2-16-2010. INT. CL. 39.

COMPANY B, INC., KALISPELL, MT:
3,786,324, INT. CL. 28.

COMPASS BANCSHARES, INC., BIRMINGHAM, AL:
2,753,603, CANC. MULTIPLE CLASS, INT. CLS. 35, 39, 41 AND 42.

COMPASS GROUP USA, INC., CHARLOTTE, NC:
2,753,245, CANC. INT. CL. 44.
2,753,246, CANC. INT. CL. 44.
2,753,247, CANC. INT. CL. 44.
2,753,248, CANC. INT. CL. 44.
2,753,249, CANC. INT. CL. 44.

COMPASS MINERALS INTERNATIONAL, INC., OVERLAND PARK, KS:
3,783,690, PUB. 2-16-2010. INT. CL. 30.
3,783,827, PUB. 2-16-2010. INT. CL. 1.

COMPENSATION DESIGN GROUP, INC., NEW YORK, NY:
2,752,118, CANC. INT. CL. 35.

COMPETITIVE ADVANTAGE GROUP, INC., SAN CLEMENTE, CA:
3,784,265, PUB. 2-16-2010. INT. CL. 16.

COMPEX MEDICAL S.A., CH - 1024 ECUBLENS, SWITZERLAND:
2,752,334, CANC. MULTIPLE CLASS, INT. CLS. 10, 16 AND 28.

COMPLETE CLOTHING COMPANY, VERNON, CA:
3,783,807, PUB. 1-12-2010. INT. CL. 25.

COMPRESSION TECHNIQUES CORPORATION, HERTON, VA:
1,552,698, CANC. INT. CL. 9.

COMPSYCH CORPORATION, CHICAGO, IL, COMPREHENSIVE PSYCHOLOGICAL CENTERS, P.C., CHICAGO, IL:
1,633,547. REN. 3-30-10. INT. CL. 42.

COMPTAPAC LTEE, GRANBY (QUEBEC), CANADA:
1,552,675, CANC. INT. CL. 9.

COMPU-COLOR, INC., WEST LANGHORNE, PA:
1,552,560, CANC. INT. CL. 9.

COMPUTER ACCOUNTS, INC., SAN LEANDRO, CA:
2,751,858, CANC. INT. CL. 18.

COMPUTER MEDICS OF AMERICA, INC., WASILLA, AK:
2,287,873. REN. 3-31-10. INT. CL. 37.

COMPX INTERNATIONAL, INC., MAULDIN, SC:
2,336,828. REN. 3-30-10. INT. CL. 6.

COMSAT CORPORATION, WASHINGTON, DC:
1,553,272, CANC. INT. CL. 38.

COMWIRED, LLC, LOUISVILLE, KY:
3,783,997, PUB. 2-16-2010. INT. CL. 42.

CONAGRA FOODS FOOD INGREDIENTS COMPANY, INC., OMAHA, NE, ARMOUR AND COMPANY, CHICAGO, IL:
523,399. REN. 3-29-10. U.S. CL. 46 (INT. CL. 29).

CONAGRA FOODS PACKAGED FOODS, LLC, OMAHA, NE:
2,753,971, CANC. INT. CL. 30.

CONAIR CIP, INC., STAMFORD, CT:
2,754,413, CANC. INT. CL. 20.
2,754,478, CANC. INT. CL. 3.
2,754,479, CANC. INT. CL. 3.

CONAIR CORPORATION, STAMFORD, CT:
2,333,387. REN. 3-29-10. INT. CL. 11.
2,339,198. REN. 3-31-10. INT. CL. 11.
3,783,705, PUB. 2-16-2010. INT. CL. 20.
3,784,742, PUB. 2-16-2010. MULTIPLE CLASS, INT. CLS. 7, 11 AND 21.

CONCENTRICS, INC., WEST CHESTER, PA, CONCENTRICS, INC., WEST CHESTER, PA:
2,341,899. REN. 4-1-10. INT. CL. 35.

CONCEPT INTERNATIONAL UK LIMITED, SURREY RH7 6HN, UNITED KINGDOM:
3,783,095, PUB. 2-16-2010. INT. CL. 21.

CONCERNED WOMEN FOR AMERICA, WASHINGTON, DC:
2,751,892, CANC. INT. CL. 41.

CONCERTAS, LLC, AUSTIN, TX:
2,753,013, CANC. INT. CL. 35.

- CONCORDE ACCEPTANCE CORPORATION, DALLAS, TX:
2,752,835, CANC. INT. CL. 36.
- CONCRETE PREPARATION SERVICES, LLC, GRAND RAPIDS, MI:
3,783,365, PUB. 2-16-2010. MULTIPLE CLASS, INT. CLS. 37 AND 40.
- CONCRETE REINFORCING STEEL INSTITUTE, SCHAUMBURG, IL:
2,333,247. REN. 3-29-10. INT. CL. 42.
- CONDUTORES MONTERREY, S.A. DE C.V., NUEVO LEON, MEXICO:
2,393,963. REN. 3-31-10. INT. CL. 9.
- CONGRESSIONAL YOUTH LEADERSHIP COUNCIL, WASHINGTON, DC:
2,752,765, CANC. INT. CL. 41.
- CONKLIN COMPANY, INC., SHAKOPEE, MN:
1,138,171. REN. 3-29-10. INT. CL. 3.
1,138,544. REN. 3-27-10. INT. CL. 1.
- CONNER, W. NICHOLAS, JR., WICHITA, KS, DBA SHILOH PUBLISHING:
2,753,512, CANC. INT. CL. 35.
- CONNERY, COLLEEN, MARIE, SAN DIEGO, CA:
2,752,918, CANC. INT. CL. 35.
- CONNOR SPORT COURT INTRNATIONAL, INC., SALT LAKE CITY, UT:
2,374,528. REN. 4-1-10. INT. CL. 19.
- CONNTECT, INC., BROOKFIELD, CT:
2,353,375. REN. 3-31-10. MULTIPLE CLASS, INT. CLS. 1 AND 3.
- CONOCOPHILLIPS COMPANY, HOUSTON, TX, CONTINENTAL OIL COMPANY, PONCA CITY, OK:
888,923. REN. 3-31-10. U.S. CL. 15 (INT. CL. 4).
- CONOCOPHILLIPS COMPANY, HOUSTON, TX:
2,339,794. REN. 3-31-10. INT. CL. 4.
- CONSECO SERVICES, LLC, CARMEL, PA TO CDOC, INC., CARMEL, PA:
2,823,613, CANC. MULTIPLE CLASS, INT. CLS. 35 AND 41.
- CONSOLIDATE NUTRITION, L.C., OMAHA, NE:
1,552,461, CANC. INT. CL. 5.
- CONSOLIDATED PROPERTY HOLDINGS, INC., LAS VEGAS, NV:
2,753,530, CANC. INT. CL. 8.
3,785,124, MULTIPLE CLASS, INT. CLS. 11 AND 20.
- CONSORCIO COMEX S.A. DE C.V., MEXICO, MEXICO:
3,785,240, INT. CL. 1.
- CONSORZIO SERVIZI LEGNO-SUGHERO, ITALY:
3,784,971, PUB. 2-16-2010. MULTIPLE CLASS, INT. CLS. 19, 20, 22, 31, 37 AND 42.
- CONSORZIO VINO CHIANTI CLASSICO, I-53017 RADDA IN CHIANTI (SI), ITALY:
889,138. REN. 4-1-10. U.S. CL. 47 (INT. CL. 33).
- CONSTRUCTIVE RESOURCE, INC., LARGO, FL:
3,786,447, INT. CL. 41.
- CONSUMER ELECTRONICS ASSOCIATION, ARLINGTON, VA:
2,333,599. REN. 3-26-10. INT. CL. 35.
- CONSUMER ENERGY ALLIANCE, HOUSTON, TX:
3,783,620, PUB. 2-16-2010. INT. CL. 35.
- CONSUMER REVIEW, INC., WELLESLEY, MA:
2,754,534, CANC. INT. CL. 42.
- CONSUMERS FIRST, L.L.C., SALT LAKE CITY, UT:
2,753,294, CANC. INT. CL. 36.
- CONTEC MASCHINENBAU & ENTWICKLUNGSTECHNIK GMBH, 57518 ALSDORF, FED REP GERMANY:
3,252,005, COR. INT. CL. 7.
- CONTINENTAL RESOURCES, INC., BEDFORD, MA:
1,636,750. REN. 3-27-10. INT. CL. 9.
- CONTINENTAL TEVES AG & CO. OHG, FRANKFURT, FED REP GERMANY:
1,565,796. REN. 3-31-10. INT. CL. 12.
- CONTRACTORS REGISTER, INC., JEFFERSON VALLEY, NY:
3,786,147, INT. CL. 9.
- CONVENIENT VIDEO, INC., SHEBOYGAN, WI:
1,553,284, CANC. INT. CL. 41.
- CONVERTER TECHNOLOGY ENTWICKLUNGS- UND PRODUKTIONS GMBH, WIEN, AUSTRIA:
2,752,178, CANC. INT. CL. 7.
- CONWEST RESOURCES, INC., SAN FRANCISCO, CA:
2,753,779, CANC. INT. CL. 9.
- COOK THOMAS E, HAYDEN, ID, DBA UNTAMED TAXIDERMISTRY:
3,783,906, PUB. 2-16-2010. INT. CL. 40.
- COOK, JOHN F., YUMA, AZ AND COOK, LINDA H., YUMA, AZ:
1,556,249. REN. 3-26-10. INT. CL. 42.
1,566,487. REN. 3-26-10. INT. CL. 42.
- COOKE COMMUNICATIONS, L.L.C., MCLEAN, VA:
2,753,596, CANC. INT. CL. 42.
- COOL BOX PORTABLE EQUIPMENT RENTAL & SALES, L.L.C., TUCSON, AZ, DBA COOL BOX PORTABLE STORAGE:
3,783,565, PUB. 9-15-2009. INT. CL. 39.
- COOLIGY, INC., MOUNTAIN VIEW, CA:
3,785,135, INT. CL. 9.
- COONS, SUSAN A., NORTH BEND, OR:
3,786,244, INT. CL. 16.
- COOPER, MARIE LOUISE, SAN DIEGO, CA:
3,785,645, INT. CL. 36.
- COOPER, PH.D., EMMETT, SAN ANTONIO, FL:
2,751,991, CANC. INT. CL. 16.
- COOPERATING FOR FOOD SAFETY, INC., WASHINGTON, DC:
3,783,922, PUB. 2-16-2010. INT. CL. 42.
- COOPERATIVA CERAMICA D'IMOLA S.C., I-40026 IMOLA (BOLOGNA), ITALY:
2,334,837. REN. 4-1-10. INT. CL. 19.
- COOPERATIVE LEAGUE OF THE USA, WASHINGTON, DC, DBA NATIONAL COOPERATIVE BUSINESS ASSOCIATION:
2,752,844, CANC. INT. CL. 41.
- COPELAN, JAMES B., SANTA CLARITA, CA:
2,751,943, CANC. INT. CL. 10.
- COPPER DEVELOPMENT ASSOCIATION INC., NEW YORK, NY:
3,783,361, PUB. 2-16-2010. INT. CL. 35.
- CORBETT ACCEL HEALTHCARE GROUP CHICAGO INC., CHICAGO, IL:
3,783,784, PUB. 2-16-2010. INT. CL. 35.
- CORBIN RUSSWIN, INC., BERLIN, CT:
3,785,113, INT. CL. 6.
- CORD:USE CORD BLOOD BANK, INC., ORLANDO, FL:
3,786,225, MULTIPLE CLASS, INT. CLS. 39 AND 44.
- CORDIS CORPORATION, MIAMI LAKES, FL:
2,753,711, CANC. INT. CL. 10.
- CORE-MARK INTERNATIONAL, INC., SOUTH SAN FRANCISCO, CA:
2,752,187, CANC. MULTIPLE CLASS, INT. CLS. 35 AND 43.
- COREALCREDIT BANK AG, FED REP GERMANY:
3,784,867, PUB. 2-16-2010. MULTIPLE CLASS, INT. CLS. 35, 36 AND 38.
3,784,868, PUB. 2-16-2010. MULTIPLE CLASS, INT. CLS. 35, 36 AND 38.
- COREMETRICS, INC., SAN MATEO, CA:
3,784,794, PUB. 2-16-2010. INT. CL. 35.
- CORESTATES FINANCIAL CORP., PHILADELPHIA, PA:
1,553,245, CANC. INT. CL. 36.
- COREY DELTA, INC., BENICIA, CA, DBA COREY DELTA CONSTRUCTORS, INC.:
2,340,378. REN. 3-27-10. INT. CL. 37.
2,340,378, AM. INT. CL. 37.
- CORIN LIMITED, GLOUCESTERSHIRE, UNITED KINGDOM:
3,783,388, PUB. 2-16-2010. INT. CL. 10.
- CORINDUS LTD., HAIFA, ISRAEL:
3,786,259, INT. CL. 10.
- CORNELL, ALEX, SAN FRANCISCO, CA:
3,784,304, PUB. 2-16-2010. INT. CL. 42.
- CORNERSTONE BANK, WATONGA, OK:
3,785,285, INT. CL. 36.

CORNICHE/IPAC INTERNATIONAL, LLC, SIERRA MADRE, CA:
2,372,762. REN. 3-29-10. INT. CL. 16.

CORONADO, JOSE MANUEL ASTORGA, PICO RIVERA, CA:
2,752,750. CANC. INT. CL. 41.

CORONATION, INC., CANTON, OH:
2,753,091. CANC. INT. CL. 35.

CORPORATE COMEDY RESOURCE, INC., SARASOTA, FL:
3,786,475. INT. CL. 25.

CORPORATE PROFILE MEDIA LLC, NEW YORK, NY:
3,784,205. PUB. 2-16-2010. INT. CL. 36.

CORQUE, LLC, CHICAGO, IL:
2,752,802. CANC. INT. CL. 43.

CORREA, DENNIS, WAUKEGAN, IL:
3,784,497. PUB. 2-16-2010. INT. CL. 11.

CORRUGATED CHEMICALS, INC., CINCINNATI, OH:
1,552,404. CANC. INT. CL. 1.

CORTEC CORPORATION, ST. PAUL, MN:
2,754,362. CANC. INT. CL. 1.

COSENTINO, S.A., MACAEL (ALMERIA), SPAIN:
3,785,486. INT. CL. 19.

COSMETIC DERMATOLOGY, INC., MIAMI, FL:
2,918,186. AM. INT. CL. 3.

COSRICH GROUP, INC., SUN VALLEY, CA:
3,785,879. INT. CL. 5.

COST PLUS MANAGEMENT SERVICES, INC., OAKLAND, CA:
2,753,175. CANC. INT. CL. 33.
2,753,178. CANC. INT. CL. 33.

COSTUME SPECIALISTS, INC., COLUMBUS, OH:
2,752,518. CANC. INT. CL. 40.

COTAGESOFT, INC., REDWOOD CITY, CA:
2,751,686. CANC. MULTIPLE CLASS, INT. CLS. 9, 35 AND 42.

COTRONEO, PHILIP JOSEPH, ELIZABETH, NJ:
3,784,659. PUB. 2-16-2010. INT. CL. 41.

COTY DEUTSCHLAND GMBH, FED REP GERMANY:
3,784,863. PUB. 2-16-2010. INT. CL. 3.
3,784,864. PUB. 2-16-2010. INT. CL. 3.

COTY PRESTIGE LANCASTER GROUP GMBH, MAINZ, FED REP GERMANY:
3,783,888. PUB. 2-16-2010. INT. CL. 3.

COTY US LLC, NEW YORK, NY:
3,785,924. INT. CL. 3.

COUGAR PACKAGE DESIGNERS, INC., ELMHURST, IL:
1,552,874. CANC. INT. CL. 17.

COUGHLAN COMPANIES, INC., MANKATO, MN:
3,784,523. PUB. 2-16-2010. INT. CL. 16.

COUNTRY LIFE, LLC, HAUPPAUGE, NY:
3,786,127. INT. CL. 5.

COURIER ACQUISITION CORPORATION II, NORTH CHELMSFORD, MA:
2,343,031. REN. 4-1-10. INT. CL. 16.

COURIER GRAPHICS CORPORATION, CLAREMONT, CA:
2,752,358. CANC. INT. CL. 16.

COURTAULDS (UK) LIMITED, NOTTINGHAM, UNITED KINGDOM:
2,272,711. CANC. INT. CL. 25.

COURTESY BUILDING SERVICES, INC., DALLAS, TX:
2,338,305. REN. 3-31-10. INT. CL. 37.

COVENANT HEALTH, KNOXVILLE, TN:
3,785,307. INT. CL. 44.

COVENTOR, INC., CARY, NC:
3,784,131. PUB. 2-16-2010. INT. CL. 9.

COVIDIEN AG, NEUHAUSEN AM RHEINFALL, SWITZERLAND:
1,591,652. REN. 3-30-10. INT. CL. 5.

COX HOLDINGS, INC., ATLANTA, GA:
2,340,759. REN. 3-26-10. INT. CL. 38.

COX SMITH MATTHEWS INCORPORATED, SAN ANTONIO, TX:
3,784,562. PUB. 2-16-2010. INT. CL. 45.

CPAWRITER, INC., MARINE CITY, MI:
3,785,537. INT. CL. 9.
3,785,538. INT. CL. 9.

CPP HOLDINGS LIMITED, YORK, UNITED KINGDOM:
3,786,160. INT. CL. 36.

CRAFFORD-LASERSTAR TECHNOLOGIES CORPORATION, RIVERSIDE, RI:
3,785,267. INT. CL. 9.

CRAIGADOR CORPORATION, MINNETONKA, MN:
3,783,407. PUB. 2-16-2010. MULTIPLE CLASS, INT. CLS. 29, 30 AND 35.

CRAMER PRODUCTS, INC., GARDNER, KS:
527,062. REN. 3-30-10. U.S. CL. 18 (INT. CL. 5).
535,365. AM. U.S. CL. 18.

CRANBERG, LAWRENCE, AUSTIN, TX, DBA TEXAS FIRE-FRAME CO.:
1,590,750. REN. 3-28-10. INT. CL. 11.

CRANE COMPOSITES, INCORPORATED, CHANNAHON, IL:
2,334,279. REN. 3-26-10. INT. CL. 19.

CRANE PLASTICS COMPANY, COLUMBUS, OH:
874,992. CANC. U.S. CL. 12.

CRANEL INCORPORATED, COLUMBUS, OH:
2,754,041. CANC. MULTIPLE CLASS, INT. CLS. 35 AND 42.

CRANIUM INC., PAWTUCKET, RI:
2,308,019. REN. 3-30-10. INT. CL. 28.

CRANIUM INC., SEATTLE, WA:
2,322,465. REN. 3-26-10. INT. CL. 28.

CRASH RESCUE EQUIPMENT SERVICE, INC., DALLA, TX:
2,432,678. REN. 3-26-10. INT. CL. 9.

CREADOR PICTURES, LLC, JAMAICA, NY:
3,786,446. INT. CL. 41.

CREATIVE ASSOCIATES INTERNATIONAL, INC., WASHINGTON, DC:
3,783,645. PUB. 2-16-2010. INT. CL. 41.

CREATIVE CONTRABAND, INC., VENICE, CA:
3,784,439. PUB. 2-16-2010. INT. CL. 41.

CREATIVE SERVICES EVENT CO., CLERMONT, FL:
3,784,310. PUB. 2-16-2010. MULTIPLE CLASS, INT. CLS. 41 AND 43.

CREATIVE VENTURES, INC., TIGARD, OR:
2,376,259. REN. 3-31-10. INT. CL. 16.

CREDIT CARD PROCESSING USA, INC., UNION, NJ:
2,754,668. CANC. INT. CL. 36.

CREDIT SUISSE SECURITIES (USA) LLC, NEW YORK, NY:
3,785,334. MULTIPLE CLASS, INT. CLS. 36 AND 42.

CREDITVIEW AS, OSLO, NORWAY:
2,754,632. CANC. MULTIPLE CLASS, INT. CLS. 35 AND 36.

CREME GLACEE ITAL GELATI INC., ST-LEONARD, QUEBEC, CANADA:
2,336,383. REN. 3-31-10. INT. CL. 30.

CRESCENDO INTERACTIVE, INC., CAMARILLO, CA:
2,339,412. REN. 3-29-10. INT. CL. 9.

CRESCENT CONCEPTS, INC., CORDOVA, TN:
2,753,831. CANC. INT. CL. 3.

CRICK SOFTWARE LIMITED, MOULTON PARK, UNITED KINGDOM:
2,752,307. CANC. MULTIPLE CLASS, INT. CLS. 9 AND 16.

CRITIQUE ME.COM, INC., BROOKLYN, NY:
2,751,699. CANC. INT. CL. 41.

CROCKER-FELS COMPANY, THE, CINCINNATI, OH:
1,552,734. CANC. INT. CL. 10.

CROREY, DAVID J., CLINTON TOWNSHIP, MI:
3,785,767. INT. CL. 14.

CROSS MEDIA CORPORATION, CHARLOTTE, NC, DBA CROSS.TV:
3,783,366. PUB. 1-12-2010. INT. CL. 35.

CROSSMARK, INC., PLANO, TX:
2,753,343. CANC. INT. CL. 35.

CROWD FUSION, INC., PURCHASE, NY:
3,785,484. INT. CL. 41.

CROWN EQUIPMENT CORPORATION, NEW BREMEN, OH:
3,785,139. INT. CL. 12.
3,785,140. INT. CL. 12.

CROWN FANCY GOODS CO. LTD., CHIYODO-KU, TOKYO, JAPAN:
2,753,740. CANC. INT. CL. 25.

CROWN ROLL LEAF, INC., PATERSON, NJ:
2,367,150. REN. 3-31-10. INT. CL. 42.

- CRUISERS ENTERTAINMENT, INC., RIVIERA BEACH, FL:
2,434,859. REN. 3-30-10. INT. CL. 28.
- CRUZ, RICHARD, PINE HILL, NJ:
3,786,224. INT. CL. 41.
- CRYNTEL ENTERPRISES LTD., INC., HOLLYWOOD, FL:
2,272,011. CANC. INT. CL. 19.
- CRYOVAC, INC., ELMWOOD PARK, NJ:
3,785,953. INT. CL. 17.
- CRYSTAL CLEAR CONNEXIONS LLC, NEW YORK, NY:
3,783,840. PUB. 2-16-2010. MULTIPLE CLASS, INT. CLS.
35, 41 AND 45.
- CSC BRANDS LP, CAMDEN, NJ, CAMPBELL SOUP COM-
PANY, CAMDEN, NJ:
1,638,555. REN. 3-27-10. INT. CL. 30.
- CSC BRANDS LP, CAMDEN, NJ:
2,753,162. CANC. INT. CL. 29.
- CSFBDIRECT HOLDINGS INC., JERSEY CITY, NJ:
2,754,547. CANC. INT. CL. 36.
- CSG SYSTEMS, INC., ENGLEWOOD, CO:
2,336,775. REN. 3-26-10. INT. CL. 9.
2,337,606. REN. 3-31-10. INT. CL. 35.
2,337,678. REN. 3-31-10. INT. CL. 9.
- CSH ADORNED, INC., SAN FRANCISCO, CA:
3,783,341. PUB. 2-16-2010. INT. CL. 14.
- CTP GMBH, FED REP GERMANY:
3,385,755. COR. MULTIPLE CLASS, INT. CLS. 35 AND
42.
- CTV LIMITED, TORONTO, ONTARIO, CANADA:
2,751,707. CANC. INT. CL. 41.
- CULLEN, BILL, DUBLIN 10, IRELAND:
2,752,000. CANC. INT. CL. 25.
- CULLIGAN INTERNATIONAL COMPANY, NORTH-
BROOK, IL:
1,552,747. CANC. INT. CL. 11.
- CULLIGAN INTERNATIONAL COMPANY, ROSEMONT,
IL:
1,588,702. REN. 3-31-10. MULTIPLE CLASS, INT. CLS. 11
AND 32.
2,317,449. REN. 3-28-10. INT. CL. 11.
- CULTURAL CENTER FOR THE ARTS, INC., CANTON, OH:
1,553,317. CANC. INT. CL. 42.
- CUMA PRODUCTS, L.L.C., RIVERTON, UT:
2,752,449. CANC. INT. CL. 31.
- CUMMINGS, FABIAN, BRONX, NY:
3,783,916. PUB. 2-16-2010. INT. CL. 9.
- CUMMINS-ALLISON CORP., MT. PROSPECT, IL:
3,785,416. INT. CL. 36.
- CURASCRIP, INC., ORLANDO, FL:
2,752,785. CANC. INT. CL. 44.
2,752,786. CANC. INT. CL. 44.
2,752,789. CANC. INT. CL. 44.
- CURBELL ELECTRONICS, INC., ORCHARD PARK, NY:
2,370,344. REN. 3-27-10. INT. CL. 9.
- CURBGAMES, LLC, AUSTIN, TX:
3,750,386. COR. INT. CL. 41.
- CUSTOM BENEFIT PROGRAMS, INC., HAMMONTON, NJ,
DBA UNIVERS WORKPLACE SOLUTIONS:
3,783,374. PUB. 2-16-2010. INT. CL. 36.
- CUSTOM CLOSETS, INC., ELLISVILLE, MO:
2,752,388. CANC. MULTIPLE CLASS, INT. CLS. 37 AND
42.
- CUSTOM DIRECT, LLC, JOPPA, MD:
3,783,974. PUB. 2-16-2010. MULTIPLE CLASS, INT. CLS.
16 AND 40.
- CUSTOM DIRECT, LLC, JOPPA, MD, DBA IDENTITY
CHECK PRINTERS:
3,783,977. PUB. 2-16-2010. INT. CL. 16.
- CUSTOM DIRECT, LLC, JOPPA, MD, DBA UNIQUE PRO-
DUCTS:
3,783,990. PUB. 2-16-2010. INT. CL. 16.
- CUSTOM DIRECT, LLC, JOPPA, MD, DBA THE CHECK
GALLERY:
3,784,110. PUB. 2-16-2010. INT. CL. 16.
- CUSTOM DIRECT, LLC, JOPPA, MD, DBA ARTISTIC
CHECKS:
3,784,173. PUB. 2-16-2010. MULTIPLE CLASS, INT. CLS.
16 AND 40.
- CUSTOM DIRECT, LLC, JOPPA, MD, DBA LIFE CHECKS:
3,784,229. PUB. 2-16-2010. MULTIPLE CLASS, INT. CLS.
16 AND 40.
- CUSTOM DIRECT, LLC, JOPPA, MD, DBA IDENTITY
CHECK PRINTERS:
3,784,230. PUB. 2-16-2010. MULTIPLE CLASS, INT. CLS.
16 AND 40.
- CUSTOM HUNTING PRODUCTS, INC., EASLEY, SC:
2,752,655. CANC. INT. CL. 28.
- CUSTOM INDUSTRIAL MANUFACTURING INC., BUR-
LINGAME, CA:
2,304,605. REN. 3-27-10. INT. CL. 9.
- CUSTOM PRINTING COMPANY, NORTH LITTLE ROCK,
AR:
3,785,496. INT. CL. 35.
- CUSTOMIZED SERVICES ADMINISTRATORS, INCORPO-
RATED, SAN DIEGO, CA:
2,753,553. CANC. MULTIPLE CLASS, INT. CLS. 35, 36, 39
AND 42.
- CUTTER & BUCK INC., SEATTLE, WA:
3,786,007. INT. CL. 25.
- CVPH MEDICAL CENTER, PLATTSBURGH, NY:
3,785,064. INT. CL. 41.
- CW, INC., GARDINER, MT:
2,751,728. CANC. INT. CL. 35.
- CXRESEARCH, INC., PALM BEACH GARDENS, FL:
2,338,302. REN. 3-31-10. INT. CL. 5.
- CYBERLINK CORPORATION, TAIPEI 231, TAIWAN:
2,438,981. REN. 3-31-10. INT. CL. 9.
- CYBERSOFT, INC., CONSHOHOCKEN, PA:
2,422,687. REN. 3-26-10. INT. CL. 9.
- CYBERSTEEL LLC, PORTLAND, OR:
2,752,913. CANC. INT. CL. 37.
- CYCLACEL LIMITED, UNITED KINGDOM:
3,784,898. PUB. 2-16-2010. MULTIPLE CLASS, INT. CLS.
5, 41, 42 AND 44.
3,784,899. PUB. 2-16-2010. MULTIPLE CLASS, INT. CLS.
5, 41, 42 AND 44.
- CYRUS INTERNAIONAL, BATON ROUGE, LA:
3,783,781. PUB. 2-16-2010. INT. CL. 45.
- CYTEC TECHNOLOGY CORP., WILMINGTON, DE:
3,785,976. INT. CL. 1.
- CZ VETERINARIA, S.L., 36400-PORRINO, (PONTEVEDRA),
SPAIN:
2,340,308. REN. 3-26-10. INT. CL. 5.
- D & D COMMODITIES LIMITED, STEPHEN, MN:
3,784,427. PUB. 2-16-2010. INT. CL. 31.
3,784,806. PUB. 2-16-2010. INT. CL. 31.
- D & K GROUP, INC., ELK GROVE VILLAGE, IL:
3,785,823. INT. CL. 16.
- D & R TECHNOLOGY INC., CONROE, TX:
2,754,458. CANC. INT. CL. 1.
- D. LA PORTE SÖHNE GMBH, FED REP GERMANY:
3,785,010. PUB. 2-16-2010. MULTIPLE CLASS, INT. CLS.
6, 9, 20 AND 40.
- D. MICHAEL CORPORATION, INDIANAPOLIS, IN, DBA
AFTER MARKET SOLUTIONS:
2,754,650. CANC. INT. CL. 9.
- D.E.R. SALES, LLC, NORWALK, CT:
2,754,215. CANC. INT. CL. 21.
- D.O.R.C. DUTCH OPHTHALMIC RESEARCH CENTER
(INTERNATIONAL) B.V., ZUIDLAND, NETHERLANDS:
3,786,477. INT. CL. 5.
- D-GENERATION, INC., ORMOND BEACH, FL:
2,753,876. CANC. INT. CL. 14.
- D'ANDREA, NICOLE L., LINCOLN, RI:
3,785,286. INT. CL. 18.
- D'ARRIGO BROS. CO. OF CALIFORNIA, SALINAS, CA:
1,553,145. CANC. INT. CL. 31.
- D'ASCOLI, EDMONT P., TRUSTEE OF THE EDMONT P. D'
ASCOLI REVOCABLE LIVING TRUST DATED MAY 24,
1996, HALEIWA, HI:
3,785,057. MULTIPLE CLASS, INT. CLS. 18 AND 28.
- DAHL & ASSOCIATES, INC., IRVINE, CA, DBA AHHPU-
LENCE:
2,753,195. CANC. INT. CL. 20.
- DAIGNEAU, ROBERT J., HAMPSTEAD, NH:
3,783,323. PUB. 2-16-2010. INT. CL. 42.

DAIICHI ORIMONO CO., LTD., JAPAN:
3,785,026, PUB. 2-16-2010. INT. CL. 24.

DAILYLINE CORP., TAOYUAN CITY, TAOYUAN, TAIWAN:
2,376,099. REN. 3-31-10. INT. CL. 16.

DAIMLER AG, STUTTGART, FED REP GERMANY:
379,207. REN. 3-27-10. U.S. CL. 35 (INT. CLS. 7, 12 AND 17).
2,751,692, CANC. MULTIPLE CLASS, INT. CLS. 12, 36, 37 AND 39.
2,751,836, CANC. MULTIPLE CLASS, INT. CLS. 6, 7 AND 40.
2,751,849, CANC. MULTIPLE CLASS, INT. CLS. 12, 28 AND 37.
2,752,004, CANC. MULTIPLE CLASS, INT. CLS. 12, 28 AND 37.
2,752,202, CANC. MULTIPLE CLASS, INT. CLS. 11, 14, 16, 25 AND 28.

DAINTEE CHOCOLATE CONFECTIONERY COMPANY (BLACKPOOL) LIMITED, BLACKPOOL, ENGLAND:
1,553,114, CANC. INT. CL. 30.

DAIRY MANAGEMENT, INC., ROSEMONT, IL:
3,785,596, MULTIPLE CLASS, INT. CLS. 35, 41 AND 44.

DAISY BRAND, LLC, DALLAS, TX:
1,636,250. REN. 3-31-10. INT. CL. 29.

DAIWA-CORMORAN SPORTARTIKEL; VERTRIEB GMBH, FED REP GERMANY:
3,784,966, PUB. 2-16-2010. INT. CL. 28.

DALE MILLER, INC., DACULA, GA:
2,306,143. REN. 3-26-10. INT. CL. 5.

DALLAS AREA RAPID TRANSIT, DALLAS, TX:
2,320,257. REN. 3-30-10. INT. CL. 39.

DALLAS BASKETBALL LIMITED, DALLAS, TX:
2,753,701, CANC. INT. CL. 35.

DALLAS SMITH CORP., GREENCASTLE, IN:
3,783,889, PUB. 2-16-2010. INT. CL. 12.
3,783,908, PUB. 2-16-2010. INT. CL. 12.

DALLAS SYMPHONY ASSOCIATION, INC., DALLAS, TX:
1,625,292. REN. 3-31-10. INT. CL. 41.

DALTON WINERY, LTD., RAMAT GAN, ISRAEL:
3,783,728, PUB. 1-12-2010. INT. CL. 33.

DAMART-SERVIPOSTE, ROUBAIX, FRANCE, DESPARTURE, PAUL, MARC-EN-BARQUEL, NORD, FRANCE:
694,970. REN. 4-1-10. U.S. CL. 39 (INT. CLS. 10, 25 AND 26).

DAMIANI INTERNATIONAL B.V., AMSTERDAM, HOLLAND, NETHERLANDS:
2,322,869. REN. 3-26-10. INT. CL. 14.

DAMIEN CORPORATION, THE, NAPERVILLE, IL:
2,394,865. REN. 3-31-10. INT. CL. 16.

DAN-DEE INTERNATIONAL LIMITED, JERSEY CITY, NJ:
2,327,405. REN. 3-29-10. MULTIPLE CLASS, INT. CLS. 20 AND 24.

DANCERIA AG, 8001 ZURICH, SWITZERLAND:
2,752,153, CANC. INT. CL. 3.

DANE-ELEC MEMORY, BAGNOLET, FRANCE:
3,784,969, PUB. 2-16-2010. MULTIPLE CLASS, INT. CLS. 9, 38 AND 42.

DANIEL LANOIS, TORONTO, CANADA:
3,785,627, INT. CL. 9.

DANIEL S. SINCLAIR, JR., MANDEVILLE, LA:
3,785,425, INT. CL. 30.

DANIELSON ASSOCIATES, INC., LISLE, IL:
1,552,631, CANC. INT. CL. 9.

DANISON III, ARTHUR L., WEST PALM BEACH, FL, FL:
3,784,064, PUB. 2-16-2010. INT. CL. 1.

DANKS, DANIEL R., PORTLAND, OR:
2,754,339, CANC. INT. CL. 42.

DANZEY, W. PATRICK, AVON PARK, FL:
3,785,351, INT. CL. 10.

DAPPLE & BOURDEAUX ENTERPRISES, LLC, SAN DIEGO, CA:
2,753,913, CANC. MULTIPLE CLASS, INT. CLS. 16 AND 41.

DARDEN CONCEPTS, INC., ORLANDO, FL, GENERAL MILLS RESTAURANTS, INC., ORLANDO, FL:
1,589,182. REN. 3-31-10. INT. CL. 30.

DAS DISTRIBUTORS, PALMYRA, PA:
2,752,544, CANC. INT. CL. 9.

DATA BECKER CORPORATION, NEEDHAM, MA:
2,754,010, CANC. INT. CL. 9.

DATA PUBLISHING COMPANY, INC., HILTON HEAD, SC:
2,752,377, CANC. MULTIPLE CLASS, INT. CLS. 16 AND 35.

DATA;)COMM ELECTRONICS, INC., NORCROSS, GA:
2,752,428, CANC. INT. CL. 9.

DATATEAM SYSTEMS, INC., LAWRENCE, KS:
2,272,575, CANC. INT. CL. 9.

DATATEL, INC., FAIRFAX, VA:
2,752,191, CANC. INT. CL. 41.
2,752,192, CANC. INT. CL. 35.

DATAWAVE TECHNOLOGIES CORPORATION, LOVELAND, CO:
2,339,556. REN. 3-26-10. INT. CL. 9.

DATA2IMPACT LLC, ATLANTA, GA:
3,784,160, PUB. 2-16-2010. INT. CL. 42.

DAVE'S SODA & PET CITY, AGAWAM, MA:
3,784,461, PUB. 2-16-2010. INT. CL. 31.
3,784,469, PUB. 2-16-2010. INT. CL. 31.
3,784,472, PUB. 2-16-2010. INT. CL. 31.

DAVID BADOWICH & ASSOCIATES, INC., CATHEDRAL CITY, CA:
2,753,283, CANC. INT. CL. 14.

DAVID CORE, LLC., LANTANA, FL:
2,752,152, CANC. INT. CL. 36.

DAVID HONL, LOS ANGELES, CA:
3,784,778, PUB. 2-16-2010. MULTIPLE CLASS, INT. CLS. 9 AND 11.

DAVID MARSHALL RESCUE CONCEPTS LLC, BEVERLEY, GREAT BRITAIN:
3,783,350, PUB. 2-16-2010. INT. CL. 9.

DAVID MICHAEL & CO., INC., PHILADELPHIA, PA:
898,856. REN. 3-31-10. U.S. CL. 46 (INT. CL. 30).

DAVIS, BRUCE M., FORT WORTH, TX:
2,754,320, CANC. INT. CL. 36.

DAVIS, KATHY JAMES, CONROE, TX:
2,336,350. REN. 3-26-10. INT. CL. 41.

DAVIS, PETER, SAN DIEGO, CA:
1,553,351, CANC. U.S. CL. 200.

DAVIS, T. MICHAEL, ST. PAUL, MN:
3,783,382, PUB. 2-16-2010. INT. CL. 45.

DAVISON, CLIFTON O., FORT COLLINS, CO:
3,785,067, INT. CL. 25.

DAVITA INC., EL SEGUNDO, CA:
2,821,059, CANC. MULTIPLE CLASS, INT. CLS. 16, 42 AND 44.

DAY-GLO COLOR CORP., CLEVELAND, OH:
1,589,590. REN. 3-30-10. INT. CL. 2.

DAYSRING CARDS, INC., SILOAM SPRINGS, AR:
2,271,903, CANC. INT. CL. 16.

DAYSRING INTERNATIONAL HEADQUARTERS, VIRGINIA BEACH, VA:
3,784,420, PUB. 2-16-2010. INT. CL. 9.

DAYTON WHEEL CONCEPTS, INC., DAYTON, OH:
2,753,642, CANC. INT. CL. 12.
2,754,617, CANC. INT. CL. 12.

DC COMICS, NEW YORK, NY:
3,784,483, PUB. 2-16-2010. INT. CL. 28.
3,784,487, PUB. 2-16-2010. INT. CL. 28.

DCD COMPANY, IRVINE, CA:
1,552,647, CANC. INT. CL. 9.

DCH MANAGEMENT SERVICES INC., SOUTH AMBOY, NJ:
3,785,712, MULTIPLE CLASS, INT. CLS. 35 AND 41.
3,785,713, MULTIPLE CLASS, INT. CLS. 35 AND 41.
3,785,714, MULTIPLE CLASS, INT. CLS. 35, 37 AND 41.
3,785,715, MULTIPLE CLASS, INT. CLS. 35, 37 AND 41.

DD IP HOLDER LLC, CANTON, MA, DUNKIN' DONUTS OF AMERICA, INC., QUINCY, MA, DBA DUNKIN' DONUTS:
888,360. REN. 3-29-10. U.S. CL. 46 (INT. CLS. 1, 5, 29, 30, 31 AND 32).

DD IP HOLDER LLC, CANTON, MA:
2,366,396. REN. 3-30-10. INT. CL. 30.

DE SOUSA MICHELLE ELIZABETH, NAPLES, FL:
3,784,662, PUB. 2-16-2010. INT. CL. 25.

- DEAF LINK, INC., SAN ANTONIO, TX:
3,783,681, PUB. 2-16-2010. INT. CL. 9.
3,783,682, PUB. 2-16-2010. INT. CL. 41.
- DEAK GROUP, INC., THE, FT. LAUDERDALE, FL:
2,754,177, CANC. INT. CL. 35.
- DEALERTRACK, INC., LAKE SUCCESS, NY:
3,786,264, INT. CL. 42.
- DEARBORN MOVING AND STORAGE, INC., CANTON, MI:
3,783,970, PUB. 2-16-2010. MULTIPLE CLASS, INT. CLS.
35 AND 39.
3,783,971, PUB. 2-16-2010. MULTIPLE CLASS, INT. CLS.
35 AND 39.
- DEATON-KENNEDY COMPANY, JOLIET, IL:
3,783,528, PUB. 2-16-2010. INT. CL. 16.
- DEBBIE MUMM, INC., SPOKANE, WA:
2,754,240, CANC. INT. CL. 4.
- DEBRA WEISSER, TAMPA, FL:
3,783,666, PUB. 2-16-2010. INT. CL. 26.
- DEBS INFONET, INC., ANN ARBOR, MI:
3,784,543, PUB. 2-16-2010. INT. CL. 35.
- DECISIONONE CORPORATION, DEVON, PA:
3,786,490, MULTIPLE CLASS, INT. CLS. 35, 37, 39 AND
42.
- DECKER, LISA C., KENNESAW, GA:
3,784,507, PUB. 2-16-2010. INT. CL. 36.
- DECKERS OUTDOOR CORPORATION, GOLETA, CA:
3,785,618, INT. CL. 25.
- DECOR PRODUCTS INTERNATIONAL, INC., DONG-
GUAN, CHINA:
3,786,460, INT. CL. 16.
- DECORIZE, INC., SPRINGFIELD, MO:
2,752,142, CANC. INT. CL. 35.
- DEERE & COMPANY, MOLINE, IL:
2,343,533, REN. 3-26-10. INT. CL. 36.
- DEFALCO, TOM, MERRICK, NY:
2,754,330, CANC. INT. CL. 16.
2,754,331, CANC. INT. CL. 16.
- DEFINITIVE AUDIO, INC., BELLEVUE, WA:
3,783,738, PUB. 2-16-2010. INT. CL. 35.
3,783,739, PUB. 2-16-2010. INT. CL. 37.
3,783,742, PUB. 2-16-2010. INT. CL. 42.
- DEFYWIRE, INC., RESTON, VA:
2,752,317, CANC. INT. CL. 9.
- DEIMAN, S.A. DE C.V., MEXICO, D. F., MEXICO:
3,784,042, PUB. 2-16-2010. INT. CL. 30.
3,784,043, PUB. 2-16-2010. INT. CL. 32.
- DEL MONTE CORPORATION, SAN FRANCISCO, CA TO
SNAK KING CORP., CITY OF INDUSTRY, CA:
980,450 NEW CERT. 5-4-2010. U.S. CL. 46.
- DEL MONTE CORPORATION, SAN FRANCISCO, CA:
984,625, AM. U.S. CL. 46.
3,785,950, INT. CL. 29.
- DEL VALLE BRANDS, INC., MIAMI, FL:
2,754,290, CANC. INT. CL. 30.
- DELAVAL INC, KANSAS CITY, MO:
1,600,316, REN. 3-26-10. INT. CL. 5.
- DELAWARE CAPITAL FORMATION, INC., WILMINGTON,
DE:
2,272,551, CANC. INT. CL. 9.
- DELAWARE RIVER PORT AUTHORITY, CAMDEN, NJ:
2,752,238, CANC. MULTIPLE CLASS, INT. CLS. 39 AND
43.
2,752,241, CANC. INT. CL. 39.
- DELICIOUS BITE LLC, WEST CHESTER, PA, DBA DELI-
CIOUS BITE LLC:
3,785,786, INT. CL. 30.
- DELONG, MARSHA V, ABINGDON, VA:
2,754,670, CANC. INT. CL. 4.
- DELPHI TECHNOLOGIES, INC., TROY, MI, DELPHI TECH-
NOLOGIES, INC., TROY, MI:
2,381,811, REN. 3-26-10. INT. CL. 9.
- DELPHI TECHNOLOGIES, INC., TROY, MI:
2,833,482, CANC. INT. CL. 12.
- DELTA MEDICAL SYSTEMS, INC., ALPHARETTA, GA
AND DELTA MEDICAL SUPPLY GROUP, INC., WEST
CHESTER, PA:
3,785,131, MULTIPLE CLASS, INT. CLS. 9 AND 10.
- DELTEX (GUERNSEY) LIMITED, GUERNSEY, CHANNEL
ISLANDS:
2,752,070, CANC. INT. CL. 10.
- DEMARAY, LINDA, ARVADA, CO:
3,785,270, INT. CL. 45.
- DEMARINI SPORTS, INC., HILLSBORO, OR:
2,272,679, CANC. INT. CL. 25.
- DEMOTT, THALYA C., HONOLULU, HI, DBA WOMEN'S
NATURAL HEALTH, LLC:
3,783,925, PUB. 2-16-2010. INT. CL. 5.
- DEMPTOS GLASS COMPANY LLC, LOUISVILLE, KY TO
SAXCO-DEMPTOS, INC., HORSHAM, PA:
2,272,489, CANC. INT. CL. 21.
2,272,490, CANC. INT. CL. 21.
- DENROY GROUP LIMITED, COUNTY DOWN, UNITED
KINGDOM:
3,784,458, PUB. 2-16-2010. MULTIPLE CLASS, INT. CLS.
21 AND 26.
- DENTAL BENEFIT MANAGEMENT, INC., PHILADEL-
PHIA, PA, DBA BENECARE DENTAL PLANS:
3,784,347, PUB. 2-16-2010. INT. CL. 36.
3,784,745, PUB. 2-16-2010. INT. CL. 36.
3,784,746, PUB. 2-16-2010. INT. CL. 36.
3,784,747, PUB. 2-16-2010. INT. CL. 36.
3,784,748, PUB. 2-16-2010. INT. CL. 36.
- DENTAL DIRECTIONS, INC., TULSA, OK:
3,784,057, PUB. 2-16-2010. INT. CL. 41.
- DENTEK ORAL CARE, INC., MARYVILLE, TN:
2,752,076, CANC. INT. CL. 21.
- DENTSPLY INTERNATIONAL INC., YORK, PA:
3,784,762, PUB. 2-16-2010. INT. CL. 5.
3,784,779, PUB. 2-16-2010. INT. CL. 5.
- DENUNZIO, DUSTIN J., SOMERVILLE, MA:
3,785,080, INT. CL. 39.
- DENVER GOLD GROUP, INC., DENVER, CO:
3,783,470, PUB. 2-16-2010. INT. CL. 35.
3,783,471, PUB. 2-16-2010. INT. CL. 35.
3,783,472, PUB. 2-16-2010. INT. CL. 35.
- DEPASQUALE, CARMEN, FAIR LAWN, NJ:
3,783,378, PUB. 2-16-2010. INT. CL. 3.
- DEPHY TECHNOLOGIES INC., MONTREAL, QUEBEC,
CANADA:
2,753,445, CANC. INT. CL. 9.
- DEPRAVEL INTERNATIONAL, INC., TUXEDO, NY:
2,339,759, REN. 3-29-10. INT. CL. 3.
2,339,763, REN. 3-29-10. INT. CL. 3.
- DEPUY SPINE, INC., RAYNHAM, MA, BREMER ORTHO-
PEDICS, INC., JACKSONVILLE, FL:
1,559,681, REN. 3-26-10. INT. CL. 10.
- DESERTEC FOUNDATION, FED REP GERMANY:
3,784,998, PUB. 2-16-2010. MULTIPLE CLASS, INT. CLS.
35, 39 AND 42.
- DESIGN TRADITIONS, INC., DULUTH, GA:
2,271,583, CANC. MULTIPLE CLASS, INT. CLS. 37 AND
42.
- DESIGNER ALLEY LLC, MEDFORD, OR:
2,751,850, CANC. INT. CL. 25.
- DESIGNER SKIN, LLC, INDIANAPOLIS, IN:
3,785,698, INT. CL. 3.
- DESIGNER WATCHES, NORTH LAS VEGAS, NV:
3,786,361, INT. CL. 14.
- DESIGNERGIST, LITTLETON, CO:
3,784,246, PUB. 2-16-2010. INT. CL. 35.
- DESIGNINGWITHYOUINMIND.COM, LLC, LEXINGTON,
MI:
3,784,463, PUB. 2-16-2010. INT. CL. 41.
- DESIGNS FOR VISION, INC., RONKONKOMA, NY:
3,785,181, INT. CL. 10.
- DESTINATION SPA GROUP, INC., TUCSON, AZ:
2,332,466, REN. 3-29-10. INT. CL. 35.
- DESTRUCTO INDUSTRIES, INC., COSTA MESA, CA:
2,388,240, REN. 3-31-10. MULTIPLE CLASS, INT. CLS. 25
AND 28.
- DETECTION SYSTEMS, INC., FAIRPORT, NY:
2,754,349, CANC. INT. CL. 9.
- DETOTEC NORTH AMERICA, INC., STERLING, CT:
3,784,510, PUB. 2-16-2010. INT. CL. 20.

DETROIT DIESEL CORPORATION, DETROIT, MI:
 3,785,243, INT. CL. 12.
 DEUTSCHE EDELSTAHLWERKE GMBH, FED REP GER-
 MANY:
 3,715,497, COR. INT. CL. 6.
 DEUTSCHE POST AG, 53175 BONN, FED REP GERMANY:
 2,751,689, CANC. MULTIPLE CLASS, INT. CLS. 35, 36, 38,
 39, 41 AND 42.
 DEUTSCHE TELEKOM, BONN, FED REP GERMANY:
 3,783,243, PUB. 10-27-2009. INT. CL. 9.
 DEUTSCHE TELEKOM A.G., BONN, FED REP GERMANY:
 3,783,693, PUB. 12-1-2009. INT. CL. 35.
 DEUTSCHE TELEKOM AG, 53113 BONN, FED REP GER-
 MANY:
 2,921,902, AM. MULTIPLE CLASS, INT. CLS. 9, 16, 35, 36,
 38, 39, 41 AND 42.
 2,969,056, AM. MULTIPLE CLASS, INT. CLS. 9, 16, 35, 36,
 38, 41 AND 42.
 2,975,016, AM. MULTIPLE CLASS, INT. CLS. 9, 16, 35, 36,
 38, 39, 41 AND 42.
 DEUTSCHE TELEKOM AG, BONN, FED REP GERMANY:
 3,576,189, AM. MULTIPLE CLASS, INT. CLS. 9, 16, 35, 36,
 38, 39, 41 AND 42.
 3,580,499, AM. MULTIPLE CLASS, INT. CLS. 9, 16, 35, 36,
 38 AND 42.
 DEUTSCHE TELEKOM AG, 53113 BONN, FED REP GER-
 MANY:
 3,629,121, AM. MULTIPLE CLASS, INT. CLS. 9, 16, 35, 36,
 38, 41 AND 42.
 3,629,122, AM. MULTIPLE CLASS, INT. CLS. 9, 16, 35, 36,
 38, 39, 41 AND 42.
 DEUTSCHE TELEKOM AG, BONN, FED REP GERMANY:
 3,783,216, PUB. 10-20-2009. INT. CL. 42.
 DEVCYCLE, LLC, BIRMINGHAM, AL:
 2,752,496, CANC. INT. CL. 42.
 DEVELOPMENTAL NATURAL RESOURCES, INC., INDIA-
 NAPOLIS, IN:
 2,753,378, CANC. INT. CL. 1.
 DEVON ENERGY CORPORATION, OKLAHOMA CITY, OK:
 2,752,739, CANC. INT. CL. 42.
 DEVON SELF STORAGE HOLDINGS (US) LLC, EMERY-
 VILLE, CA:
 3,783,541, PUB. 2-16-2010. MULTIPLE CLASS, INT. CLS.
 6, 16, 35 AND 39.
 DEXTER-RUSSELL, INC., SOUTHBRIDGE, MA:
 2,362,332, REN. 3-31-10. INT. CL. 8.
 DHAN ENTERPRISES LLC, SEAVILLE, NJ:
 2,271,555, CANC. INT. CL. 35.
 DHP SHANNON, INC., PEORIA, AZ, FITNESSWAVE:
 2,428,803, REN. 3-26-10. INT. CL. 42.
 DIABETES NATION, SISTERS, OR:
 3,784,404, PUB. 2-16-2010. INT. CL. 44.
 DIADORA SPA, CAERANO DI SAN MARCO TV, ITALY:
 2,751,758, CANC. MULTIPLE CLASS, INT. CLS. 18, 25
 AND 28.
 2,751,759, CANC. MULTIPLE CLASS, INT. CLS. 18, 25
 AND 28.
 DIAGEO NORTH AMERICA, INC., NORWALK, CT:
 3,786,046, INT. CL. 33.
 DIAMANT QUELLE KLEE & JUNGBLUT GMBH & CO. KG,
 D-55767 SCHWOLLEN, FED REP GERMANY:
 2,753,537, CANC. INT. CL. 32.
 DIAMOND CHAIN COMPANY, INC., INDANAPOLIS, IN:
 703,898, REN. 4-1-10. U.S. CL. 23 (INT. CL. 7).
 DIAMOND CREATIONS, LTD., MCLEAN, VA:
 2,752,366, CANC. INT. CL. 35.
 DIAMOND FOOD CORPORATION, FOSTER CITY, CA:
 1,553,342, CANC. INT. CL. 42.
 DIAMOND RESORTS HOLDINGS,LLC, LAS VEGAS, NV:
 3,784,735, PUB. 2-16-2010. INT. CL. 16.
 DIAMOND RESORTS HOLDINGS, LLC, LAS VEGAS, NV:
 3,784,823, PUB. 11-3-2009. MULTIPLE CLASS, INT. CLS.
 36 AND 43.
 DIANE DAL LAGO LTD, TAMPA, FL:
 3,784,352, PUB. 2-16-2010. MULTIPLE CLASS, INT. CLS.
 25 AND 35.
 DIATRANZ LIMITED, AUCKLAND, NEW ZEALAND:
 2,932,183, COR. INT. CL. 5.
 DICKERSON, SANDRA K, LAS VEGAS, NV, DBA NOGINZ
 HEAD WEAR:
 3,783,679, PUB. 2-16-2010. INT. CL. 25.
 DIEBOLD, INCORPORATED, NORTH CANTON, OH:
 2,271,554, CANC. INT. CL. 9.
 DIETRICH, MICHAEL J., PHOENIX, AZ:
 3,783,279, PUB. 2-16-2010. INT. CL. 35.
 DIGI-BLOCK, INC., CAMBRIDGE, MA:
 2,344,076, REN. 3-27-10. INT. CL. 28.
 DIGITAL CONTRAST, INC., NORTH PORT, FL:
 2,752,577, CANC. INT. CL. 35.
 DIGITAL INTEGRITY, INC., ALPINE, CA:
 2,753,288, CANC. INT. CL. 9.
 DIGITAL KEYSTONE, INC., MOUNTAIN VIEW, CA:
 3,784,631, PUB. 2-16-2010. INT. CL. 9.
 DIGITAL STREAM TECHNOLOGY, INC., SEOUL, REPUB-
 LIC OF KOREA:
 2,751,678, CANC. INT. CL. 9.
 DIGITENNA, LLC, OOSTBURG, WI:
 3,785,150, INT. CL. 9.
 DIGITHONG, INC., LOS ANGELES, CA:
 2,752,546, CANC. INT. CL. 9.
 DIMARTINO, MARIANNE, WOODBURY, TN:
 2,752,939, CANC. INT. CL. 28.
 DIMENSION ONE SPAS, INC., VISTA, CA:
 3,786,457, INT. CL. 11.
 3,786,458, INT. CL. 11.
 DIMENSIONAL DOSING SYSTEMS, INC., NOKOMIS, FL:
 2,753,841, CANC. INT. CL. 42.
 DIMENSIONS CRAFTS LLC, READING, PA:
 2,272,959, CANC. INT. CL. 26.
 DINA MARTIN, THE WOODLANDS, TX:
 3,784,135, PUB. 2-16-2010. INT. CL. 35.
 DINGUS AND DAGA, INC., SHAKER HEIGHTS, OH:
 1,599,839, REN. 3-27-10. INT. CL. 35.
 DIPINTO, CHRISTOPHER F., PALMYRA, NJ:
 2,752,573, CANC. INT. CL. 41.
 DIRECT MARKETING ENTERPRISES, LTD., WESTBURY,
 NY:
 2,272,281, CANC. INT. CL. 35.
 DIRECTV, INC., EL SEGUNDO, CA:
 2,753,359, CANC. MULTIPLE CLASS, INT. CLS. 9, 16, 25,
 38 AND 41.
 3,786,334, INT. CL. 41.
 DIROCCO, SUSAN, BRAINTREE, MA AND MACPHERSON,
 CATHY L., NEWBURYPORT, MA:
 2,753,918, CANC. INT. CL. 41.
 DIRTY QUEEN RECORDS, LONG BEACH, CA:
 2,754,342, CANC. MULTIPLE CLASS, INT. CLS. 9, 16
 AND 25.
 DISCOVER SPANISH INC., KNOXVILLE, TN:
 3,784,579, PUB. 2-16-2010. INT. CL. 9.
 DISCOVERY COMMUNICATIONS, LLC, SILVER SPRING,
 MD:
 2,752,810, CANC. INT. CL. 25.
 2,753,557, CANC. INT. CL. 42.
 3,785,249, MULTIPLE CLASS, INT. CLS. 9, 38 AND 41.
 3,785,331, MULTIPLE CLASS, INT. CLS. 9, 38 AND 41.
 DISHMAN, KRISHEENA C., HERMITAGE, TN:
 3,785,626, INT. CL. 25.
 DISMEX FOOD, INC., MIAMI, FL:
 3,783,504, PUB. 2-16-2010. INT. CL. 5.
 DISNEY ENTERPRISES, INC., BURBANK, CA:
 3,584,465, COR. INT. CL. 9.
 3,740,338, COR. INT. CL. 16.
 3,785,125, INT. CL. 41.
 3,785,609, INT. CL. 9.
 3,786,172, INT. CL. 9.
 3,786,184, INT. CL. 16.
 DISPLAY PRODUCTS INC., EL SEGUNDO, CA:
 3,785,399, INT. CL. 11.
 DISTILLEERDERIJEN ERVEN LUCAS BOLS B.V., 2723 RB
 ZOETERMEER, NETHERLANDS:
 2,753,410, CANC. INT. CL. 33.
 DIVAGIRL, LLC, LOOMIS, CA:
 3,784,634, PUB. 2-16-2010. INT. CL. 28.

- DIVERSIFIED REALTY CENTRE, INC., INDIANAPOLIS, IN, DBA REAL ESTATE CAREER INSTITUTE:
2,337,965. REN. 3-31-10. INT. CL. 41.
- DIXIE CONSUMER PRODUCTS LLC, ATLANTA, GA:
3,785,352, MULTIPLE CLASS, INT. CLS. 16 AND 21.
- DJL VIDEO SECURITY SERVICE, INC., GREENSBORO, NC:
3,784,190, PUB. 2-16-2010. INT. CL. 9.
- DMA ASSOCIATES, INC., SACO, ME:
2,752,587, CANC. INT. CL. 9.
- DNC PARKS & RESORTS AT KSC, INC., BUFFALO, NY:
3,786,452, INT. CL. 41.
- DO-ALL TRAPS, LLC, NASHVILLE, TN:
2,752,488, CANC. INT. CL. 13.
- DOBBIE, MUNGO, JOHN, TORONTO, CANADA, DBA SPECTACULAR ATTACKS:
3,783,283, PUB. 2-16-2010. MULTIPLE CLASS, INT. CLS. 25 AND 41.
- DOBBS, GLEN, STUDIO CITY, CA:
2,370,915. REN. 3-30-10. INT. CL. 33.
- DOBBS, VAN A., ARAB, AL:
3,785,485, INT. CL. 25.
- DOBOY INC., NEW RICHMOND, WI:
2,752,903, CANC. MULTIPLE CLASS, INT. CLS. 16 AND 20.
- DOCTATIONS, INC., GARDEN CITY, NY:
3,785,568, INT. CL. 42.
- DOCTOR RECOMMENDED PRODUCTS, LLC, FEASTERVILLE, PA:
3,786,425, INT. CL. 5.
- DOCTORS' SELECT, INC., MUKILTEO, WA:
2,754,270, CANC. INT. CL. 5.
- DOCUMENTARY CHANNEL, INC., NASHVILLE, TN:
3,785,411, INT. CL. 35.
- DODGE & COX, SAN FRANCISCO, CA:
3,784,494, PUB. 2-16-2010. INT. CL. 36.
- DODGING DIABETES, INC., CHEVY CHASE, MD:
3,784,367, PUB. 2-16-2010. MULTIPLE CLASS, INT. CLS. 35, 36 AND 41.
3,784,369, PUB. 2-16-2010. MULTIPLE CLASS, INT. CLS. 35, 36 AND 41.
- DOELL, ADRIAN, OVERLAND PARK, KS:
3,784,378, PUB. 2-16-2010. INT. CL. 25.
- DOERR, ANGELINA BRUHN NEE, 30982 PATTENSEN, FED REP GERMANY:
1,552,430, CANC. INT. CL. 3.
- DOG DAY AFTERNOON, INC., ORLANDO, FL:
2,341,243. REN. 4-1-10. INT. CL. 42.
- DOGEARED, VENICE, CA:
2,345,225. REN. 3-26-10. INT. CL. 14.
2,345,225, CANC. INT. CL. 26.
- DOGS AFIELD, INC., ATLANTA, GA:
2,752,164, CANC. INT. CL. 35.
2,752,165, CANC. INT. CL. 35.
- DOKTOR KABOOM, LLC, YELLOW SPRINGS, OH:
3,784,115, PUB. 2-16-2010. INT. CL. 41.
- DOLE FOOD COMPANY, INC., WESTLAKE VILLAGE, CA:
3,783,892, PUB. 2-16-2010. INT. CL. 29.
- DOLLAR BANK, FEDERAL SAVINGS BANK, PITTSBURGH, PA:
1,589,296. REN. 3-27-10. INT. CL. 36.
- DOMESTIC LINEN SUPPLY & LAUNDRY CO., FARMINGTON HILLS, MI:
3,784,203, PUB. 2-16-2010. INT. CL. 45.
3,784,206, PUB. 2-16-2010. INT. CL. 45.
- DOMESTICATIONS, LLC, WEEHAWKEN, NJ:
3,785,692, MULTIPLE CLASS, INT. CLS. 20 AND 24.
- DOMINI SOCIAL INVESTMENTS LLC, NEW YORK, NY:
2,338,499. REN. 3-31-10. INT. CL. 36.
2,341,146. REN. 3-31-10. INT. CL. 36.
- DOMTAR INC., MONTREAL, CANADA:
2,754,510, CANC. MULTIPLE CLASS, INT. CLS. 16 AND 19.
- DONGWON F&B CO., LTD., SEOUL, REPUBLIC OF KOREA:
3,785,328, INT. CL. 30.
- DORMA PROPERTIES, INC., WILMINGTON, DE:
3,786,283, INT. CL. 37.
- DORRANI, ANDY, LAS VEGAS, NV, AKA FARZAD ANDY DORRANI:
3,785,778, INT. CL. 41.
- DORT FEDERAL CREDIT UNION, FLINT, MI:
2,336,257. REN. 3-30-10. INT. CL. 36.
- DORVAL TRADING COMPANY, LTD., NANUET, NY:
2,754,227, CANC. INT. CL. 30.
- DOTS, LLC, GLENWILLOW, OH:
3,785,217, MULTIPLE CLASS, INT. CLS. 25 AND 35.
- DOTSON, ELISE C., MCDONOUGH, GA:
3,785,667, INT. CL. 28.
- DOUBLE PRESS MFG., INC., HEMET, CA:
3,784,221, PUB. 2-16-2010. INT. CL. 7.
- DOUGHNUT CORPORATION OF AMERICA, SEATTLE, WA:
2,754,069, CANC. INT. CL. 30.
- DOVER MOTORSPORTS, INC., WILMINGTON, DE:
2,752,616, CANC. INT. CL. 41.
- DOVETAIL ORIGINALS, LTD., EGG HARBOR, WI:
2,271,667, CANC. INT. CL. 20.
- DOWN TO EARTH DESIGNS, INC., PORTLAND, OR:
3,783,443, PUB. 2-16-2010. INT. CL. 25.
3,783,444, PUB. 2-16-2010. INT. CL. 25.
- DOWN, LLC, LOS ANGELES, CA:
2,752,560, CANC. INT. CL. 41.
- DPI, INC., ST. LOUIS, MO:
2,753,679, CANC. INT. CL. 9.
2,753,693, CANC. INT. CL. 9.
- DR. ALEX LOYD SERVICES, LLC, NAPLES, FL:
3,784,691, PUB. 2-16-2010. MULTIPLE CLASS, INT. CLS. 9 AND 16.
- DR. JOHAN B.J.M. LANEN, SWITZERLAND:
3,784,982, PUB. 2-16-2010. MULTIPLE CLASS, INT. CLS. 9, 16, 38 AND 42.
- DR. ROBERT F. BRUNST M.D., PH.D., INC., ENCINITAS, CA:
2,754,205, CANC. INT. CL. 44.
- DR. SEUSS ENTERPRISES, L.P., LA JOLLA, CA:
3,786,200, MULTIPLE CLASS, INT. CLS. 16 AND 18.
3,786,205, MULTIPLE CLASS, INT. CLS. 16 AND 18.
- DR. SPOCK COMPANY, THE, MENLO PARK, CA:
2,751,820, CANC. INT. CL. 16.
- DRAFTWORLDWIDE, INC., CHICAGO, IL:
2,271,722, CANC. INT. CL. 35.
- DRAGONCON/ACE, INC., COLLEGE PARK, GA:
3,784,152, PUB. 2-16-2010. INT. CL. 35.
3,784,155, PUB. 2-16-2010. INT. CL. 41.
- DREAMPAK, ALEXANDRIA, VA:
3,783,836, PUB. 2-16-2010. INT. CL. 5.
- DREAMTOY INC, LOS ANGELES, CA:
2,753,616, CANC. MULTIPLE CLASS, INT. CLS. 28 AND 35.
- DREAMWELL, LTD., LAS VEGAS, NV:
3,785,779, INT. CL. 20.
- DREWERY, GIG, GARY, TX:
3,785,690, INT. CL. 11.
- DRM, INC., CHARLOTTE, NC:
1,552,440, CANC. INT. CL. 3.
- DRSOY NUTRITION, LLC, IRVINE, CA:
2,754,475, CANC. INT. CL. 5.
- DRY DOCK ENTERPRISES, INC., AURORA, CO, DBA DRY DOCK BREWING, CO.:
3,784,350, PUB. 2-16-2010. INT. CL. 32.
- DRYCLEAN OUTLET, INC., FAIRFAX STATION, VA:
2,753,757, CANC. INT. CL. 37.
- DRYMAX SPORTS, LLC, HICKORY, NC:
2,333,771. REN. 3-31-10. INT. CL. 25.
- DSM NUTRITIONAL PRODUCTS, INC., PARSIPPANY, NJ:
2,271,994, CANC. INT. CL. 42.
- DTE ENERGY COMPANY, DETROIT, MI:
2,345,667. REN. 4-1-10. INT. CL. 42.
- DUARTE DESIGN, INC., MOUNTAIN VIEW, CA:
2,329,054. REN. 3-26-10. INT. CL. 42.
3,784,647, PUB. 2-16-2010. INT. CL. 41.
- DUCKELS, THOMAS, LOUISVILLE, CO:
3,784,678, PUB. 2-16-2010. INT. CL. 41.

DUNCAN, KELVIN WINSTON, WAIHI BEACH, NEW ZEALAND:
2,346,342. REN. 3-31-10. INT. CL. 5.

DUNDEE CORPORATION, TORONTO, ONTARIO, CANADA:
3,783,081. PUB. 12-22-2009. INT. CL. 36.

DUNGAREES U.S.A., INC., MONTREAL QUEBEC, CANADA:
2,754,572. CANC. INT. CL. 25.

DUNLAP CODDING, P.C., OKLAHOMA CITY, OK:
3,784,593. PUB. 2-16-2010. INT. CL. 45.

DUNLAP, AMANDA, DECATUR, TX, DBA MOO'S ANGELS:
2,752,534. CANC. INT. CL. 16.

DUNN TECHNOLOGY INCORPORATED, VISTA, CA:
1,553,287. CANC. INT. CL. 41.

DURA-LINE CORPORATION, KNOXVILLE, KY:
1,579,002. REN. 3-26-10. INT. CL. 17.

DURABLE IDEAS LLC, GOLETA, CA:
3,783,864. PUB. 2-16-2010. INT. CL. 28.

DURALINE, LLC, PITTSBURGH, PA:
2,334,527. REN. 3-30-10. INT. CL. 2.

DUTCH BARNS, INC., GREENSBORO, NC:
2,753,576. CANC. INT. CL. 19.

DVSPORT, INC., PITTSBURGH, PA:
3,783,637. PUB. 2-16-2010. INT. CL. 9.

DXTERITY DIAGNOSTICS INC., MANAHTTAN BEACH, CA:
3,785,570. INT. CL. 42.

DYAX CORP., CAMBRIDGE, MA:
3,785,756. INT. CL. 42.

DYE PRECISION, INC., SAN DIEGO, CA:
3,783,176. PUB. 2-16-2010. INT. CL. 28.

DYNABRADE, INC., CLARENCE, NY:
3,785,516. INT. CL. 7.

DYNACRAFT BSC, INC., AMERICAN CANYON, CA:
3,786,024. INT. CL. 12.

DYNAFLEX, LTD., ST. ANN, MO:
2,318,115. REN. 3-30-10. INT. CL. 10.

DYNAMIC ESSENTIALS (DE), INC., BOHEMIA, NY:
2,752,398. CANC. INT. CL. 5.

DYNAMIC NETWORK SERVICES, INC., MANCHESTER, NH:
2,752,243. CANC. INT. CL. 42.

DYNAMIC SOLUTIONS CO., LTD., TOKYO, JAPAN:
2,853,439. CANC. INT. CL. 9.

DYNO SEASONAL SOLUTIONS, LLC, POMPANO BEACH, FL:
3,783,574. PUB. 2-16-2010. MULTIPLE CLASS, INT. CLS. 20 AND 22.

DYSON, AURELIA V., RICHMOND, VA:
2,753,411. CANC. INT. CL. 41.

DZGENES, L.L.C., ST. LOUIS, MO:
2,753,376. CANC. INT. CL. 42.

D2XCHANGE, LLC, GREENWOOD VILLAGE, CO:
3,783,257. PUB. 2-16-2010. INT. CL. 35.

E. & J. GALLO WINERY, MODESTO, CA:
3,786,360. INT. CL. 33.

E. & R. WHARTON, LLC, PERRYSBURG, OH:
3,785,981. INT. CL. 16.

E. MISSEL GMBH & CO., 70374 STUTTGART, FED REP GERMANY:
2,751,694. CANC. MULTIPLE CLASS, INT. CLS. 6, 11 AND 17.

E. MOCHILA, SAN FRANCISCO, CA, AKA EMOCHILA:
3,784,397. PUB. 2-16-2010. INT. CL. 42.

E. R. WAGNER MANUFACTURING COMPANY, MILWAUKEE, WI:
1,587,435. REN. 3-29-10. INT. CL. 6.

E. REMY MARTIN & CO S.A., 16100 COGNAC, FRANCE:
2,753,452. CANC. INT. CL. 33.

E.P. HENRY CORPORATION, WOODBURY, NJ:
2,878,046. AM. INT. CL. 35.

E&M ENGINEERING, INC, RICHMOND, VA, DBA FOLD-TUK KITCHENWARE:
3,786,478. INT. CL. 21.

E-RECRUITING ASSOCIATION, INC., INDIANAPOLIS, IN:
2,754,608. CANC. INT. CL. 35.

E-WEBSMART L.L.C., ROCHESTER, IL:
3,784,178. PUB. 2-16-2010. INT. CL. 35.

E-Z GROUT CORPORATION, WATERFORD, OH:
3,785,942. INT. CL. 7.

EACCELERATION CORP., POULSBO, WA:
2,754,647. CANC. INT. CL. 9.

EAGLEMED LLC, WEST PLAINS, MO:
3,784,639. PUB. 2-16-2010. MULTIPLE CLASS, INT. CLS. 35, 39 AND 44.

3,784,641. PUB. 2-16-2010. MULTIPLE CLASS, INT. CLS. 35, 39 AND 44.

EAMATECH CANADA INC., MISSISSAUGA, ONTARIO, CANADA:
3,783,421. PUB. 2-16-2010. INT. CL. 28.

EARNEST, ALLISON, COLORADO SPRINGS, CO:
3,784,384. PUB. 2-16-2010. MULTIPLE CLASS, INT. CLS. 16 AND 41.

EARTH FARE, INC., FLETCHER, NC:
2,329,721. REN. 3-31-10. MULTIPLE CLASS, INT. CLS. 35 AND 42.

EARTH FORCE, INC., ALEXANDRIA, VA:
2,272,456. CANC. MULTIPLE CLASS, INT. CLS. 16, 41 AND 42.

EARTH MAMA ANGEL BABY, LLC, CLACKAMAS, OR:
3,783,244. PUB. 2-16-2010. INT. CL. 30.

EARTH SHARE, BETHESDA, MD:
2,324,426. REN. 4-1-10. MULTIPLE CLASS, INT. CLS. 36 AND 42.

EARTHRENEW, INC., HALF MOON BAY, CA:
3,548,840. CANC. INT. CL. 1.

EAST MANUFACTURING CORP., RANDOLPH, OH:
2,412,243. COR. INT. CL. 40.

EAST MANUFACTURING CORPORATION, RANDOLPH, OH:
1,882,072. COR. INT. CL. 12.
2,433,003. REN. 3-30-10. INT. CL. 12.
2,433,003. COR. INT. CL. 12.
3,351,606. COR. INT. CL. 12.

EAST RIVER ENERGY, INC., GUILFORD, CT, FORMERLY EAST RIVER OIL COMPANY, INC.:
3,783,834. PUB. 2-16-2010. MULTIPLE CLASS, INT. CLS. 35, 36, 37 AND 39.

EAST SIDE RECORDS, INC., NORWALK, CA:
2,281,520. REN. 3-28-10. INT. CL. 9.
2,281,521. REN. 3-28-10. INT. CL. 9.

EASTER SEALS, INC., CHICAGO, IL:
2,406,129. REN. 3-27-10. INT. CL. 42.

EASTERN NATIONAL BANK, MIAMI, FL:
2,271,725. CANC. INT. CL. 36.

EASTERN STATES MARKETING, INC., WASHINGTON CROSSING, PA:
3,783,399. PUB. 2-16-2010. INT. CL. 29.

EASTMAN CHEMICAL COMPANY, KINGSPOUR, TN:
3,786,251. INT. CL. 1.

EASTMAN KODAK COMPANY, ROCHESTER, NY:
2,753,697. CANC. INT. CL. 9.

EASY RESERVATIONS, INC, SAN ANTONIO, TX, AKA EASYRESERVATIONS.COM:
3,783,529. PUB. 2-16-2010. INT. CL. 39.

EASYLITE, L.L.C, BOULDER, CO, DBA EASYLITE, L.L.C.:
2,752,995. CANC. INT. CL. 9.

EBONITE HOLDINGS, INC., HOPKINSVILLE, KY:
3,784,140. PUB. 2-16-2010. INT. CL. 3.

EC PURCHASING.COM, INC., SANTA BARBARA, CA:
2,752,454. CANC. INT. CL. 35.

ECA WORLD FITNESS ALLIANCE, LONG BEACH, NY:
3,784,232. PUB. 2-16-2010. INT. CL. 41.

ECARLIST, LLC, DALLAS, TX:
3,784,244. PUB. 2-16-2010. INT. CL. 35.

ECH, LLC, PITTSBURGH, PA:
2,752,173. CANC. INT. CL. 25.

ECLIPTIC ENTERPRISES CORPORATION, PASADENA, CA:
2,752,866. CANC. MULTIPLE CLASS, INT. CLS. 40 AND 42.

ECO FLUIDS, INC., HOUSTON, TX:
2,881,010. COR. INT. CL. 1.

- ECO-SNOW SYSTEMS LLC, LIVERMORE, CA:
3,786,068, INT. CL. 7.
- ECOLAB INC., ST. PAUL, MN:
2,753,121, CANC. INT. CL. 3.
- ECOLOGICAL RESEARCH & DEVELOPMENT GROUP, INC., LEWES, DE:
2,754,593, CANC. INT. CL. 35.
- EDDIE BAUER LICENSING SERVICES LLC, BELLEVUE, WA:
3,785,911, INT. CL. 35.
3,785,941, INT. CL. 25.
- EDELMAN, ABRA, LOS GATOS, CA:
2,753,166, CANC. INT. CL. 18.
- EDGECAST NETWORKS, INC., SANTA MONICA, CA:
3,785,138, MULTIPLE CLASS, INT. CLS. 38, 39 AND 42.
- EDGEWORTH, DONNA D., HOUSTON, TX:
2,754,401, CANC. INT. CL. 41.
- EDGYGEAR INC., PALOS VERDES, CA:
3,783,448, PUB. 2-16-2010. INT. CL. 18.
- EDIBLE ARRANGEMENTS, LLC, WALLINGFORD, CT:
3,783,718, PUB. 2-16-2010. INT. CL. 35.
- EDIE RAETHER ENTERPRISES, LLC, TERRELL, NC:
3,784,250, PUB. 2-16-2010. INT. CL. 16.
- EDISON GROUP, INC., DALLAS, TX TO CROSSBOW CONSULTING, L.P., DALLAS, TX:
2,057,087 NEW CERT. 5-4-2010. INT. CL. 42.
- EDISON INSTITUTE, THE, DEARBORN, MI:
2,751,954, CANC. INT. CL. 41.
- EDISON NATION HOLDINGS, LLC, CHARLOTTE, NC:
3,785,363, INT. CL. 21.
3,785,364, INT. CL. 9.
- EDM TECHNOLOGIES, INC., WOODSTOCK, GA:
2,382,796. REN. 3-26-10. INT. CL. 40.
- EDUCADIUM, INC., PORTLAND, OR:
3,785,507, MULTIPLE CLASS, INT. CLS. 41 AND 42.
- EDUCATION CENTER, INC., THE, GREENSBORO, NC:
2,826,254, CANC. INT. CL. 41.
- EDUCATION EXPERIENCES INC., LOS ANGELES, CA:
2,272,155, CANC. INT. CL. 41.
- EDUCATION MANAGEMENT LLC, PITTSBURGH, PA:
1,605,991, AM. INT. CL. 41.
- EDUCATIONAL PRODUCTS, INC., CARROLLTON, TX:
2,424,420. REN. 3-30-10. INT. CL. 16.
2,426,072. REN. 4-1-10. MULTIPLE CLASS, INT. CLS. 28, 35 AND 42.
2,426,073. REN. 4-1-10. MULTIPLE CLASS, INT. CLS. 28, 35 AND 42.
- EDUCATIONAL TESTING SERVICE, PRINCETON, NJ:
2,752,130, CANC. INT. CL. 41.
2,754,164, CANC. INT. CL. 9.
- EDUCATORS FOR SOCIAL RESPONSIBILITY, CAMBRIDGE, MA:
2,331,343. REN. 3-31-10. INT. CL. 41.
- EEFC, INC., BOTHELL, WA:
2,272,404, CANC. MULTIPLE CLASS, INT. CLS. 35, 39 AND 42.
- EFFECTIVE GROWTH TRAINING CORPORATION, IRVINE, CA:
2,753,267, CANC. INT. CL. 41.
- EIWEISS CHEMICAL CORPORATION, SHIZUOKA-KEN, JAPAN:
2,752,328, CANC. INT. CL. 1.
- EL MILENO RANCH INC., AUSTIN, TX:
3,783,369, PUB. 2-16-2010. MULTIPLE CLASS, INT. CLS. 6, 18, 20, 25, 26, 31 AND 44.
- EL TORITO RESTAURANTS, INC., CYPRESS, CA:
2,336,340. REN. 3-28-10. INT. CL. 30.
- ELAUT USA, INC., LAKEWOOD, NJ:
3,784,699, PUB. 2-16-2010. INT. CL. 28.
3,784,790, PUB. 2-16-2010. INT. CL. 28.
- ELDERHOSTEL, INC., BOSTON, MA:
3,785,476, MULTIPLE CLASS, INT. CLS. 39 AND 41.
- ELECTONE, INC., LONGWOOD, FL:
2,754,296, CANC. INT. CL. 10.
- ELECTRIC PRODUCTS, INC., EUGENE, OR, ECLECTIC PRODUCTS, INC., SAN PEDRO, CA:
1,591,541. REN. 3-27-10. INT. CL. 1.
- ELECTRIC VISUAL EVOLUTION, LLC, SAN CLAMENTE, CA:
3,785,146, INT. CL. 9.
- ELECTRICITY SECTOR COUNCIL, OTTAWA, CANADA:
3,783,173, PUB. 8-18-2009. INT. CL. 35.
3,783,174, PUB. 8-18-2009. INT. CL. 35.
- ELECTROHOME LIMITED, KITCHENER, ONTARIO N2G 4J6, CANADA:
815,737, CANC. U.S. CL. 21.
- ELECTRONIC ARTS INC., REDWOOD CITY, CA:
3,786,476, INT. CL. 9.
3,786,480, INT. CL. 41.
- ELECTRONIC DATABASE MARKETING, INC., GLEN ELLYN, IL:
2,752,643, CANC. INT. CL. 35.
- ELECTRONIC THEATRE CONTROLS, INC., MIDDLETON, WI:
2,349,369. REN. 3-26-10. INT. CL. 11.
- ELECTROVAC AG, 3400 KLOSTERNEUBURG, AUSTRIA:
3,784,840, PUB. 12-9-2008. MULTIPLE CLASS, INT. CLS. 1, 6 AND 9.
3,784,841, PUB. 12-9-2008. MULTIPLE CLASS, INT. CLS. 1, 6 AND 9.
- ELEKTRON DEVELOPMENT SARL, F-75009 PARIS, FRANCE:
2,339,103. REN. 3-26-10. INT. CL. 7.
- ELEVEN55 DESIGNS, LLC, LAFAYETTE HILL, PA, TA WAGS AND TAGS:
3,786,076, MULTIPLE CLASS, INT. CLS. 6 AND 14.
- ELICSON, WILLIAM J., SAN JOSE, CA:
2,272,280, CANC. INT. CL. 42.
- ELISABETH SCHÜBLER-KEMPER, 40883 RATINGEN, FED REP GERMANY:
3,784,911, PUB. 2-16-2010. MULTIPLE CLASS, INT. CLS. 11, 35 AND 42.
- ELISE E. SCOTT, WASHINGTON, DC, DBA PEARL FINE TEAS:
3,783,825, PUB. 2-16-2010. INT. CL. 16.
- ELIXIR TECHNOLOGIES CORPORATION, VENTURA, CA:
2,339,173. REN. 3-26-10. INT. CL. 9.
- ELIZABETH INTERNATIONAL, INC., OSAGE BEACH, MO:
2,753,348, CANC. MULTIPLE CLASS, INT. CLS. 3 AND 5.
- ELLA INTERNATIONAL, INC., TEMECULA, CA:
2,281,992. REN. 3-27-10. INT. CL. 3.
- ELLA'S KITCHEN (IP) LIMITED, LONDON, UNITED KINGDOM:
3,784,824, PUB. 9-15-2009. MULTIPLE CLASS, INT. CLS. 5, 29 AND 32.
- ELLIOTT BAY BOOK COMPANY LLC, SEATTLE, WA:
2,338,659. REN. 3-28-10. INT. CL. 35.
- ELLISON EDUCATIONAL EQUIPMENT, INC., LAKE FOREST, CA:
2,752,930, CANC. INT. CL. 9.
- ELSBERG, ELEAH S., DOVE CANYON, CA:
2,752,791, CANC. INT. CL. 5.
- ELSON, DAVID, SANTA CLARA, CA:
3,786,074, INT. CL. 9.
- ELUSEV, LLC, SALT LAKE CITY, UT:
3,785,157, INT. CL. 16.
- ELVIS PRESLEY ENTERPRISES, INC., MEMPHIS, TN:
2,335,947. REN. 3-29-10. INT. CL. 9.
- ELYNX TECHNOLOGIES, L.L.C., TULSA, OK:
3,783,729, PUB. 2-16-2010. INT. CL. 9.
- EMBERTON, NATHANIEL I., WEST JORDAN, UT:
2,403,313. REN. 3-26-10. INT. CL. 42.
- EMCOR GROUP, INC., NORWALK, CT:
2,753,922, CANC. MULTIPLE CLASS, INT. CLS. 35 AND 41.
3,783,783, PUB. 2-16-2010. INT. CL. 37.
- EMD CHEMICALS INC., GIBBSTOWN, NJ, CALBIOCHEM, LOS ANGELES, CA:
888,527. REN. 3-29-10. U.S. CL. 6 (INT. CL. 1).
- EMERALD AGROCHEMICALS COMPANY AW, PARANA, 86031-610, BRAZIL:
2,327,494. REN. 3-27-10. INT. CL. 1.
- EMERALD WEB SERVICES, PARK RIDGE, IL:
2,751,653, CANC. INT. CL. 35.

EMERGENCY NOTIFICATION SYSTEMS, INC., SANTA MONICA, CA:
2,752,329, CANC. INT. CL. 6.

EMERSON ELECTRIC CO., ST. LOUIS, MO:
1,552,506, CANC. INT. CL. 7.
2,753,333, CANC. MULTIPLE CLASS, INT. CLS. 7 AND 8.
3,785,294, INT. CL. 7.

EMERSON RADIO CORP., PARSIPPANY, NJ:
2,754,190, CANC. INT. CL. 9.

EMERY, ROBERT, PHOENIX, AZ:
3,786,272, INT. CL. 25.

EMHART GLASS S.A., CHAM, SWITZERLAND, EMHART GLASS S.A., CHAM, SWITZERLAND:
2,382,222, REN. 4-1-10, INT. CL. 7.

EMHART INC., NEWARK, NJ:
1,552,745, CANC. INT. CL. 11.

EMI (IP) LIMITED, UNITED KINGDOM:
3,785,034, PUB. 2-16-2010. MULTIPLE CLASS, INT. CLS. 35 AND 41.

EMISSARIES OF DIVINE LIGHT, CORONA, CA, DBA THE GLEN IVY CENTER:
3,783,805, PUB. 2-16-2010. INT. CL. 43.

EMMA FOX LEATHERWARE, LLC, NEW YORK, NY:
3,783,762, PUB. 2-16-2010. INT. CL. 18.

EMORY UNIVERSITY, ATLANTA, GA:
3,784,059, PUB. 2-16-2010. INT. CL. 41.

EMPIRE BONDING AGENCY INC., NEW YORK, NY:
3,783,343, PUB. 2-16-2010. INT. CL. 36.

EMPIRE COMFORT SYSTEMS, INC., BELLEVILLE, IL:
2,753,951, CANC. INT. CL. 4.

EMPIRE DIAGNOSTIC SOLUTIONS, INC., BROOKLYN, NY:
3,783,642, PUB. 2-16-2010. INT. CL. 44.

EMPLOYER FLEXIBLE HR INC., HOUSTON, TX:
3,784,193, PUB. 2-16-2010. INT. CL. 35.

EMPLOYERS ASSOCIATION, INC., PLYMOUTH, MN:
2,752,927, CANC. INT. CL. 35.

EMPOWERED YOUTH, INC., MIAMI, FL:
3,784,303, PUB. 2-16-2010. INT. CL. 41.

EMS TRAINING INSTITUTE, INC., SIMI VALLEY, CA:
3,783,875, PUB. 2-16-2010. INT. CL. 41.

EMU RIDGE HOLDINGS PTY LTD AS TRUSTEE OF THE EMU RIDGE TRUST, SOUTH GEELONG, AUSTRALIA:
3,783,248, PUB. 12-2-2008. INT. CL. 25.

EMUGE-WERK RICHARD GLIMPEL; GMBH & CO KG FABRIK FÜR; PRÄZISIONSWERKZEUGE, FED REP GERMANY:
3,784,936, PUB. 2-16-2010. MULTIPLE CLASS, INT. CLS. 7 AND 9.

EN THEOS, INC., MARION, IA:
3,785,970, INT. CL. 25.

ENCIRCLE HEALTHCARE MANAGEMENT LLC, OLD SAYBROOK, CT, DBA ENCIRCLE HEALTHCARE:
3,783,923, PUB. 2-16-2010. INT. CL. 42.

ENCORE ENCLOSURE SYSTEMS, INC., CHANDLER, AZ:
2,754,352, CANC. INT. CL. 40.

ENCORE MEDICAL ASSET CORPORATION, HENDERSON, NV:
2,753,706, CANC. INT. CL. 10.

ENCOUNTOUR LLC, GREAT NECK, NY:
3,784,228, PUB. 2-16-2010. INT. CL. 39.

ENDEAVOR MUSIC LLC, BOTHELL, WA:
3,089,748, CANC. INT. CL. 41.

ENDOCARE, INC., IRVINE, CA:
2,753,656, CANC. INT. CL. 10.

ENERGY AUTHORITY, INC., THE, JACKSONVILLE, FL:
2,439,118, REN. 3-30-10. MULTIPLE CLASS, INT. CLS. 35 AND 36.

ENERGYSAVE SOLUTIONS, INC., ADDISON, TX:
2,752,026, CANC. INT. CL. 1.

ENESCO BRANDS INC., WILMINGTON, DE:
1,558,147, REN. 3-31-10. MULTIPLE CLASS, INT. CLS. 25 AND 42.

ENGLANDER SLEEP PRODUCTS, L.L.C., BATON ROUGE, LA:
2,346,912, REN. 3-29-10. INT. CL. 20.

ENGLISH BAY ENTERPRISES INC., NEW WESTMINSTER, BRITISH COLUMBIA, CANADA:
2,754,343, CANC. INT. CL. 30.

ENKEBOLL COMPANY, CARSON, CA, DBA ENKEBOLL DESIGNS:
2,344,663, REN. 3-29-10. INT. CL. 20.

ENLIGHTENEERING, INC., ARLINGTON, VA:
2,752,881, CANC. INT. CL. 35.

ENOITALIA S.P.A., VERONA, ITALY:
2,754,016, CANC. INT. CL. 33.

ENTERBRAIN, INC., SETAGAYA-KU, TOKYO, JAPAN:
2,822,000, CANC. INT. CL. 35.

ENTERCOM COMMUNICATIONS CORP., BALA CYNWYD, PA:
3,784,625, PUB. 2-16-2010. MULTIPLE CLASS, INT. CLS. 38 AND 41.

ENTERGY CORPORATION, NEW ORLEANS, LA:
3,785,800, INT. CL. 35.

ENTERPRISE BROADCASTING CORPORATION, SCOTTS VALLEY, CA:
2,753,030, CANC. INT. CL. 38.

ENVIRONMENTAL FEDERATION OF AMERICA, WASHINGTON, DC:
2,324,426, COR. MULTIPLE CLASS, INT. CLS. 36 AND 42.

ENVIRONMENTAL GRAPHICS, LLC, HOPKINS, MN:
3,785,258, MULTIPLE CLASS, INT. CLS. 27, 35, 40, 41, 42 AND 45.

ENZO BIOCHEM, INC., NEW YORK, NY:
2,752,830, CANC. MULTIPLE CLASS, INT. CLS. 1 AND 5.

EPIC GAMES, INC., CARY, NC:
2,753,524, CANC. MULTIPLE CLASS, INT. CLS. 9 AND 16.

EPICUREAN FARMS, LLC, NEW OXFORD, PA:
3,784,484, PUB. 2-16-2010. INT. CL. 29.

EPIGENETIC ARCHETYPES, LLC, NEW CANAAN, CT:
3,784,582, PUB. 2-16-2010. INT. CL. 3.

EPOCH DESIGN, LLC, REDMOND, WA:
3,785,872, INT. CL. 6.

EPSON AMERICA, INC., LONG BEACH, CA:
2,753,824, CANC. INT. CL. 9.

EQ & I, LOS ANGELES, CA:
3,785,833, INT. CL. 25.

EQUIDEX INCORPORATED, CLOSTER, NJ, GOTTHELF, EDWARD B., NEW YORK, NY, DBA COMMODITY FUTURES FORECAST:
697,234, REN. 3-31-10. U.S. CL. 102 (INT. CL. 36).

EQUITY RESEARCH ONLINE, INC., NORTH ANDOVER, MA:
3,784,113, PUB. 2-16-2010. INT. CL. 36.

EQUITY TRUST COMPANY, ELYRIA, OH:
3,760,843, NEW CERT. 5-4-2010. INT. CL. 36.

EQUUMEN PTY LTD, AUSTRALIA:
3,784,960, PUB. 2-16-2010. INT. CL. 25.

ERESMAS INTERACTIVA, S.A., 28046 MADRID, SPAIN:
2,751,885, CANC. INT. CL. 38.

ERIC HELMS, NEW YORK, NY:
3,784,381, PUB. 2-16-2010. INT. CL. 32.

ERMANCO INCORPORATED, SPRING LAKE, MI:
1,552,609, CANC. INT. CL. 9.

ERMENEGILDO ZEGNA CORPORATION, ENGLEWOOD, NJ:
3,786,002, INT. CL. 25.

ERNST BENARY SAMENZUCHT GMBH, HANN.MÜNDEN, FED REP GERMANY:
3,783,327, PUB. 2-16-2010. INT. CL. 31.

EROSION PREVENTION PRODUCTS, LLC, HOUSTON, TX:
2,753,797, CANC. INT. CL. 19.

ERS ELECTRONIC GMBH, GERMERING/MUNICH 82110, FED REP GERMANY:
2,284,412, REN. 3-31-10. INT. CL. 9.

ESCALERA-BOULET, LLC, LOS OLIVOS, CA:
2,400,955, REN. 3-31-10. INT. CL. 33.

ESCOLAR, JULIO ALFREDO, MENDOZA, ARGENTINA:
3,783,947, PUB. 2-16-2010. INT. CL. 35.

ESCREEN, INC., OVERLAND PARK, KS:
2,754,667, CANC. INT. CL. 10.

- ESPRESSO PEOPLE, INC., FORT COLLINS, CO:
3,783,126, PUB. 2-16-2010. INT. CL. 43.
- ESPY, RENE, WOBURN, MA:
2,754,182, CANC. INT. CL. 30.
- ESSECO S.R.L., ITALY:
3,784,913, PUB. 2-16-2010. MULTIPLE CLASS, INT. CLS. 1, 4 AND 5.
- ESSENTIAL PUBLICATIONS U.S., NEW YORK, NY:
3,784,010, PUB. 2-16-2010. INT. CL. 16.
- ESSEX PROPERTY TRUST, INC., PALO ALTO, CA:
2,752,304, CANC. INT. CL. 36.
- ESSILOR INTERNATIONAL (COMPAGNIE GENERALE D'OPTIQUE), 94220 CHARENTON LE PONT, FRANCE:
2,751,778, CANC. INT. CL. 9.
- ESTARI, INC., HARRISBURG, PA:
2,752,661, CANC. INT. CL. 9.
- ESTAVAN CRUZ TOBACCO COMPANY, INC., RIDGE-FIELD PARK, NJ:
2,272,082, CANC. INT. CL. 34.
- ESTEE LAUDER INC., NEW YORK, NY:
2,330,151, REN. 3-30-10. INT. CL. 3.
- ESTELLE DANAN, MIAMI, FL:
2,753,198, CANC. INT. CL. 40.
- ESTERLINE TECHNOLOGIES CORPORATION, BELLEVUE, WA:
3,786,337, INT. CL. 6.
- ETHEL RUDOLPH, SAFETY HARBOR, FL:
3,786,081, INT. CL. 18.
- ETHERIDGE, DIANA C., MERRITT ISLAND, FL:
2,328,991, REN. 3-31-10. MULTIPLE CLASS, INT. CLS. 35 AND 38.
2,338,069, REN. 3-29-10. MULTIPLE CLASS, INT. CLS. 35 AND 38.
- ETHYPHARM, 92213 ST. CLOUD CEDEX, FRANCE:
2,342,338, REN. 3-26-10. INT. CL. 42.
- EURO-PRO CORPORATION, VILLE ST.-LAURENT, QUEBEC H4S 1A7, CANADA:
2,754,285, CANC. INT. CL. 7.
- EUROPASTRY, S.A., BARCELONA, SPAIN:
2,348,658, REN. 3-26-10. INT. CL. 30.
2,364,421, REN. 3-26-10. INT. CL. 30.
- EUROPEAN ASSOCIATION FOR THE STUDY OF THE LIVER, ZURICH, SWITZERLAND:
3,783,289, PUB. 12-1-2009. MULTIPLE CLASS, INT. CLS. 16 AND 41.
- EUROVITA HOLDING A/S, SOBORG, DENMARK:
2,334,274, REN. 3-26-10. INT. CL. 5.
- EUROW & O'REILLY CORPORATION, CAMARILLO, CA:
3,785,887, INT. CL. 24.
- EVANS, CHRIS, HURST, TX:
3,784,613, PUB. 2-16-2010. INT. CL. 25.
- EVERBRITE LLC, GREENFIELD, WI:
3,786,221, INT. CL. 11.
- EVEREADY BATTERY COMPANY, INC., ST. LOUIS, MO:
2,753,973, CANC. INT. CL. 11.
- EVERET MILNER, GLENDALE, CA:
3,786,472, MULTIPLE CLASS, INT. CLS. 41 AND 42.
- EVERGLO INTERNATIONAL, LLC, NEW HYDE PARK, NY:
3,784,848, PUB. 2-16-2010. INT. CL. 33.
- EVETS CORPORATION, CAMARILLO, CA, DBA DAN-ELECTRO:
3,784,549, PUB. 2-16-2010. INT. CL. 15.
- EVIROAG LTD., WANCHAI, HONG KONG:
3,783,401, PUB. 7-14-2009. INT. CL. 1.
- EVONIK CYRO LLC, PARSIPPANY, NJ:
2,335,412, REN. 3-30-10. INT. CL. 1.
- EVONIK ROEHM GMBH, 64293 DARMSTADT, FED REP GERMANY:
2,822,671, CANC. MULTIPLE CLASS, INT. CLS. 2 AND 17.
- EVOORGANIC, INC., LEXINGTON, KY:
3,783,628, PUB. 2-16-2010. MULTIPLE CLASS, INT. CLS. 11 AND 19.
- EVOTEC AG, FED REP GERMANY:
3,583,485, COR. MULTIPLE CLASS, INT. CLS. 9, 42 AND 44.
- EVOTRA, INC., FAIRFAX, VA:
2,754,372, CANC. MULTIPLE CLASS, INT. CLS. 35 AND 37.
- EXACT MARKETING, INC., LINDON, UT:
3,785,437, INT. CL. 12.
- EXAGRID SYSTEMS, INC., WESTBOROUGH, MA:
3,785,323, MULTIPLE CLASS, INT. CLS. 9 AND 42.
- EXALT COMMUNICATIONS, INC., CAMPBELL, CA:
3,784,291, PUB. 2-16-2010. INT. CL. 9.
- EXCEL ARCHIVES, LLC, STERLING, VA:
2,273,072, CANC. INT. CL. 39.
- EXCELLON AUTOMATION CO., TORRANCE, CA:
2,753,823, CANC. MULTIPLE CLASS, INT. CLS. 7, 35 AND 42.
- EXCHANGE SOLUTIONS, INC., WALTHAM, MA:
3,786,188, INT. CL. 35.
- EXCLUSIVE ENERGY CO., LLC, DOVE CANYON, CA:
3,785,848, INT. CL. 32.
- EXOLIVA, S.A., 9 10.600 PLASENCIA-CACERES, SPAIN:
2,751,816, CANC. INT. CL. 29.
- EXONERATED, LLC, STERLING HEIGHTS, MI:
3,783,668, PUB. 2-16-2010. INT. CL. 25.
- EXPAND BEYOND CORP., CHICAGO, IL:
2,751,959, CANC. INT. CL. 9.
- EXPEDIA, INC., BELLEVUE, WA:
3,785,471, MULTIPLE CLASS, INT. CLS. 35, 39, 42 AND 43.
- EXPONATION, L.L.C., ROSWELL, GA:
3,784,332, PUB. 2-16-2010. INT. CL. 35.
- EXPORT TRADE OF AMERICA, INC., LONG ISLAND CITY, NY:
2,280,658, REN. 3-31-10. MULTIPLE CLASS, INT. CLS. 29 AND 30.
- EXPRESSIONS IN WOOD, INC., ROCKFORD, IL:
1,630,075, CANC. INT. CL. 20.
- EXTENSIS, INC., WOODBRIDGE, NJ:
2,271,654, CANC. INT. CL. 35.
- EXTRAORTHO INC., MEMPHIS, TN:
3,786,055, INT. CL. 10.
3,786,057, INT. CL. 10.
- EXTYR, AUSTIN, TX:
2,754,060, CANC. INT. CL. 42.
- EXXONMOBIL OIL CORPORATION, IRVING, TX:
2,271,750, CANC. MULTIPLE CLASS, INT. CLS. 9 AND 36.
- EYE EXPERT LLC, GREENVILLE, NC:
2,751,974, CANC. INT. CL. 9.
- EYE ON SOLUTIONS, LLC, PITTSBURGH, PA:
2,752,340, CANC. MULTIPLE CLASS, INT. CLS. 42 AND 45.
- EYETIQUE CORPORATION, PITTSBURGH, PA:
2,343,053, REN. 3-31-10. MULTIPLE CLASS, INT. CLS. 35 AND 42.
- EZ CONTAINER DRAIN CORPORATION, AUSTIN, TX:
2,751,783, CANC. INT. CL. 19.
- EZEEBIKE USA, INC., RANCHO PALOS VERDES, CA:
3,783,416, PUB. 2-16-2010. INT. CL. 12.
- F Y D CORPORATION, WONMI-GU, BUCHEON-SI, KYEONGKI-DO, REPUBLIC OF KOREA:
2,751,723, CANC. INT. CL. 9.
- F. M. BROWN'S SONS, INC., SINKING SPRING, PA:
3,785,775, INT. CL. 31.
- F.W. BRYCE, INC., GLOUCESTER, MA:
3,785,260, INT. CL. 29.
- F&H TRADENAME LLC, CAMBRIDGE, MA:
1,559,207, REN. 4-1-10. INT. CL. 35.
1,560,114, REN. 4-1-10. INT. CL. 35.
- FABASOFT AG, LINZ, AUSTRIA:
2,751,949, CANC. MULTIPLE CLASS, INT. CLS. 9, 41 AND 42.
- FABBRI 1905 S.P.A., ITALY:
3,784,978, PUB. 2-16-2010. MULTIPLE CLASS, INT. CLS. 29 AND 32.
- FACEPLANT, INC., ANNA MARIA, FL:
3,784,431, PUB. 2-16-2010. INT. CL. 24.
- FACILITYDUDE.COM, INC., CARY, NC:
3,784,282, PUB. 2-16-2010. INT. CL. 42.

FAGE DAIRY INDUSTRIES, S.A., ATHENS, GREECE:
2,753,515, CANC. MULTIPLE CLASS, INT. CLS. 29 AND 30.
2,753,516, CANC. MULTIPLE CLASS, INT. CLS. 29 AND 30.

FAIRLEE FRUIT JUICE LIMITED, TORONTO, ONTARIO, CANADA:
1,553,160, CANC. INT. CL. 32.

FAIRLEIGH DICKINSON UNIVERSITY, TEANECK, NJ:
3,784,000, PUB. 2-16-2010. MULTIPLE CLASS, INT. CLS. 36 AND 41.
3,784,002, PUB. 2-16-2010. INT. CL. 41.
3,784,004, PUB. 2-16-2010. INT. CL. 41.

FAIRMONT HOLDINGS, INC., DANIA, FL:
3,783,820, PUB. 2-16-2010. INT. CL. 34.

FALCOFF LEARNING, L.L.C., BIRMINGHAM, MI:
2,753,071, CANC. INT. CL. 41.

FAMILIE PORSCHE AG BETEILIGUNGSGESELLSCHAFT, A-5020 SALZBURG, AUSTRIA:
2,752,971, CANC. INT. CL. 18.
2,752,972, CANC. INT. CL. 28.

FAMILIES FIRST, INC., CAMPBELL, CA, DBA EMQ FAMILIESFIRST:
3,783,510, PUB. 2-16-2010. MULTIPLE CLASS, INT. CLS. 41, 44 AND 45.

FAMILIES.COM LLC, AVILA BEACH, CA:
3,783,750, PUB. 2-16-2010. INT. CL. 9.
3,783,751, PUB. 2-16-2010. INT. CL. 38.

FAMILY DOLLAR STORES OF MICHIGAN, INC., MATTHEWS, NC:
3,786,211, INT. CL. 25.

FAMILY TIME SNACKS, INC., VALPARAISO, IN:
2,752,484, CANC. INT. CL. 31.

FAMOUS FOODS EXPRESS CORPORATION, SHARON, MA:
2,751,922, CANC. INT. CL. 30.

FAN MAN, INC., NEW HOPE, MN:
2,752,424, CANC. INT. CL. 35.

FANSTEEL INC., NORTH CHICAGO, IL:
2,753,672, CANC. INT. CL. 40.

FANTASTIC CARE SDN. BHD., KUALA LUMPUR, MALAYSIA:
3,785,494, INT. CL. 3.
3,785,495, INT. CL. 3.

FANTASTIC FOODS, INC., NAPA, CA:
2,396,643, REN. 3-30-10. INT. CL. 29.

FAPCO RETAIL, LLC, BUCHANAN, MI, DBA QUICK'S CANDY:
2,752,408, CANC. INT. CL. 30.

FARIENT ADVISORS, LLC, SAN MARINO, CA:
3,785,308, INT. CL. 35.

FARM PROGRESS COMPANIES, INC., CAROL STREAM, IL:
2,753,938, CANC. INT. CL. 16.

FARMERS GROUP, INC., LOS ANGELES, CA:
2,332,536, REN. 3-27-10. INT. CL. 36.

FARNAM COMPANIES, INC., PHOENIX, AZ:
2,384,130, REN. 3-27-10. INT. CL. 3.
2,384,334, REN. 3-27-10. INT. CL. 5.

FAROUKI, INGRID T., SPRINGFIELD, MO, DBA DESIGNS BY INGRID:
3,785,355, INT. CL. 20.

FARRELL, NOELEEN, NAPA, CA:
2,754,613, CANC. INT. CL. 29.

FASHION SEAL CORPORATION, LAS VEGAS, NV:
3,785,975, INT. CL. 35.

FASHIONOLOGY LLC, BEVERLY HILLS, CA:
3,664,532, COR. MULTIPLE CLASS, INT. CLS. 35 AND 37.

FASSELL, NOAH THOMAS, EMERYVILLE, CA, DBA DREAMAWAKE PRODUCTIONS:
3,784,655, PUB. 2-16-2010. INT. CL. 41.

FAST ENGINEERING LTD., ANTRIM, NORTHERN IRELAND, UNITED KINGDOM:
2,340,818, REN. 3-31-10. MULTIPLE CLASS, INT. CLS. 20 AND 21.

FAST PERFORMANCE, INC., BOCA RATON, FL:
2,751,824, CANC. INT. CL. 41.

FAZOLI'S SYSTEM MANAGEMENT, LLC, LEXINGTON, KY:
2,369,691, REN. 3-26-10. INT. CL. 30.

FEARSOME FIVESOME, LC, AUSTIN, TX, DBA MEDSTAR FUNDING:
3,785,703, INT. CL. 36.

FEDCHEM L.L.C., CLEVELAND, OH:
1,599,070, REN. 3-26-10. INT. CL. 1.

FEDERAL EXPRESS CORPORATION, MEMPHIS, TN:
2,754,254, CANC. INT. CL. 39.

FEDERAL NATIONAL MORTGAGE ASSOCIATION, WASHINGTON, DC, DBA FANNIE MAE:
2,330,955, REN. 3-29-10. INT. CL. 36.

FELDMAN, JAMES D., CHICAGO, IL:
1,589,288, REN. 3-27-10. INT. CL. 35.

FELDMAN, LAWRENCE E., JENKINTOWN, PA:
2,754,601, CANC. INT. CL. 41.

FENDER MUSICAL INSTRUMENTS CORPORATION, SCOTTSDALE, AZ:
2,400,057, REN. 3-30-10. INT. CL. 15.
2,400,057, CANC. INT. CL. 9.

FENDI ADELE S.R.L., ROME, ITALY:
2,751,830, CANC. INT. CL. 3.

FENLEY, JEFF G., VAN NUYS, CA:
3,784,297, PUB. 2-16-2010. INT. CL. 9.

FENNELL, MICHAEL, NAPA, CA:
3,785,747, INT. CL. 40.

FERAL GOLF, INC., NORTH CONWAY, NH:
2,752,578, CANC. INT. CL. 25.

FERNDALE CONFECTIONERY HOLDINGS PTY LIMITED, BALLARAT NORTH VICTORIA, AUSTRALIA:
2,752,413, CANC. INT. CL. 30.

FERNTRUST, INC., SEVILLE, FL:
2,752,402, CANC. INT. CL. 31.

FERRARI S.P.A., MODENA, ITALY:
3,783,212, PUB. 12-22-2009. INT. CL. 16.

FERRERO S.P.A., ALBA, CUNEO, ITALY:
2,752,264, CANC. INT. CL. 30.

FERRIS ENTERPRISES CORP., CIUDAD DE PANAMA, PANAMA:
2,754,563, CANC. INT. CL. 29.

FETCO HOME DECOR, INC., RANDOLPH, MA:
3,784,642, PUB. 2-16-2010. INT. CL. 20.

FEY INDUSTRIES, INC., EDGERTON, MN:
2,271,773, CANC. INT. CL. 12.

FFOODS, INC., PHILADELPHIA, PA:
2,272,171, CANC. INT. CL. 42.

FGM UK LTD, LONDON, UNITED KINGDOM, TA LULU AND LUSH:
3,783,576, PUB. 2-16-2010. INT. CL. 25.

FIDIA FARMACEUTICI S.P.A., ABANO TERME, ITALY:
3,783,224, PUB. 3-17-2009. INT. CL. 5.

FIELDING GROUP LIMITED, THE, BEDS LU5 4TS, UNITED KINGDOM:
2,751,679, CANC. MULTIPLE CLASS, INT. CLS. 18, 25 AND 28.

FIESTA, S.A., MADRID, SPAIN:
2,961,471, CANC. INT. CL. 30.

FILIPPONE, AL N., FAIRFIELD, CT, AKA PREMIER HOMES LLC:
3,784,204, PUB. 2-16-2010. INT. CL. 42.

FINAID PAGE, L.L.C., NEW YORK, NY:
2,395,002, REN. 3-27-10. INT. CL. 36.
2,395,003, REN. 3-27-10. INT. CL. 36.

FINAL DETAIL COMPANY, THE, NARBERTH, PA:
2,372,983, REN. 3-27-10. INT. CL. 3.

FINAL SCOOP DESIGNS, LTD., MACAU, CHINA, DBA READY TO PLAY GROUP LTD., R2P PET, LTD. & R2P PRODUCTS LTD.:
3,786,481, INT. CL. 28.

FINCH, DANIEL EUGENE, LAS FLORES, CA, DBA COW-ABUNGA MICRO ICE CREAMERY:
2,752,896, CANC. INT. CL. 42.

FINDERS KEEPERS, INC., KAHULUI, HI:
2,752,719, CANC. INT. CL. 35.

FINE ESTATES FROM SPAIN, DEDHAM, MA:
3,784,711, PUB. 2-16-2010. INT. CL. 33.

- FINEST THINGS ONLINE LLC, SOMERS, NY:
 2,753,854, CANC. INT. CL. 35.
- FINN CORPORATION, FAIRFIELD, OH:
 3,783,647, PUB. 2-16-2010. INT. CL. 31.
- FINN, CATHERINE, ESCONDIDO, CA:
 3,784,566, PUB. 2-16-2010. MULTIPLE CLASS, INT. CLS. 35 AND 41.
- FINNING TRACTOR & EQUIPMENT COMPANY LIMITED, VANCOUVER, BRITISH COLUMBIA, CANADA TO FINNING LTD., VANCOUVER, BRITISH COLUMBIA, CANADA:
 1,552,472, CANC. MULTIPLE CLASS, INT. CLS. 6 AND 17.
- FIRE KING INTERNATIONAL, LLC, NEW ALBANY, IN:
 2,388,560, REN. 3-31-10. INT. CL. 20.
- FIREHOUSE, LLC, WALLA WALLA, WA:
 2,404,858, REN. 3-29-10. INT. CL. 33.
- FIRMINICH SA, CH-1211 GENÈVE 8, SWITZERLAND:
 2,194,940, REN. 4-1-10. MULTIPLE CLASS, INT. CLS. 1 AND 3.
- FIRST ENERGY FIRST LLC, HOLLY, MI:
 3,785,234, INT. CL. 37.
- FIRST NATIONAL BANK OF OMAHA, OMAHA, NE:
 2,754,298, CANC. INT. CL. 36.
- FISCHBEIN LLC, STATESVILLE, NC:
 2,335,589, REN. 3-30-10. INT. CL. 7.
- FISH & RICHARDSON P.C., BOSTON, MA:
 3,786,230, INT. CL. 32.
- FISHER AND PAYKEL HEALTHCARE LIMITED, EAST TAMAKI, AUCKLAND, NEW ZEALAND:
 3,783,225, PUB. 2-16-2010. INT. CL. 10.
- FISZER, MITCHELL JEFFREY, EVANSTON, IL:
 2,753,064, CANC. INT. CL. 35.
- FITCH, JOHN GLEN, GRAND PRAIRIE, TX:
 2,751,833, CANC. INT. CL. 35.
- FITZBRADSHAWRACING, L.L.C., KELLER, TX:
 2,752,384, CANC. INT. CL. 41.
- FIVES, F-93100 MONTREUIL SOUS BOIS, FRANCE:
 3,784,924, PUB. 11-10-2009. MULTIPLE CLASS, INT. CLS. 6, 7, 9, 11, 37, 40 AND 42.
- FLAGSHIP SOFTWARE LTD., RICHMOND HILL, CANADA:
 3,784,419, PUB. 2-16-2010. INT. CL. 9.
- FLAGSTAR BANK, FSB, TROY, MI:
 3,783,538, PUB. 2-16-2010. INT. CL. 36.
- FLASHFOTO, INC., OAKLAND, CA:
 3,785,445, MULTIPLE CLASS, INT. CLS. 9 AND 42.
- FLAT OUT CRAZY, LLC, CINCINNATI, OH:
 2,336,283, REN. 3-27-10. INT. CL. 42.
- FLEETWOOD HOMES, INC., PHOENIX, AZ:
 1,565,806, REN. 3-29-10. INT. CL. 12.
- FLEURIMON, JEAN-PIERRE, 75016 PARIS, FRANCE:
 2,751,607, CANC. MULTIPLE CLASS, INT. CLS. 3, 41 AND 42.
- FLEXIBLE STEEL LACING COMPANY, DOWNERS GROVE, IL:
 1,618,442, REN. 3-31-10. INT. CL. 7.
- FLOESIE LINGERIE L.L.C., SANTA MONICA, CA:
 2,753,805, CANC. INT. CL. 25.
- FLORAL ACCOUNTING SERVICES, MEMPHIS, TN, DBA PUGH'S FLOWERS:
 3,784,272, PUB. 2-16-2010. INT. CL. 31.
- FLORIDA GEOLOGICAL FOUNDATION, INC., WALDO, FL:
 3,784,434, PUB. 2-16-2010. MULTIPLE CLASS, INT. CLS. 41 AND 42.
- FLOW APPAREL, LLC, ATLANTA, GA:
 3,784,249, PUB. 2-16-2010. INT. CL. 25.
- FLOW INTERNATIONAL CORPORATION, KENT, WA:
 2,375,714, REN. 3-26-10. INT. CL. 7.
- FLOWERS COMMUNICATIONS GROUP, CHICAGO, IL:
 3,785,111, INT. CL. 35.
- FLOWSERVE MANAGEMENT COMPANY, IRVING, TX, LIMITORQUE, NEW YORK, NY:
 267,316, REN. 3-31-10. U.S. CL. 23 (INT. CL. 7).
- FLUID TRADE, INC., BOSTON, MA:
 3,784,127, PUB. 2-16-2010. INT. CL. 9.
- FLYING CHRIS, INC., SANTA CLARITA, CA:
 2,751,609, CANC. MULTIPLE CLASS, INT. CLS. 25 AND 41.
- FLYTE TYME PRODUCTIONS, INC., EDINA, MN:
 2,385,023, REN. 3-31-10. INT. CL. 25.
- FMR LLC, BOSTON, MA:
 1,597,805, REN. 4-1-10. INT. CL. 36.
- FOAMEX L.P., LINWOOD, PA:
 2,753,024, CANC. MULTIPLE CLASS, INT. CLS. 20 AND 24.
- FOCUS FITWEAR, INC., MIAMI BEACH, FL:
 3,783,639, PUB. 2-16-2010. INT. CL. 25.
- FOLEY, SHARON, MARIE, STILLWATER, MN:
 3,785,434, MULTIPLE CLASS, INT. CLS. 25 AND 35.
- FOLEY, SHARON, MARIE, STILLWATER, MN:
 3,785,427, MULTIPLE CLASS, INT. CLS. 25 AND 35.
- 3,785,435, INT. CL. 25.
- FOLKMANIS, INC., EMERYVILLE, CA:
 2,356,261, REN. 3-27-10. INT. CL. 28.
- FOLSOM RESEARCH, INC., RANCHO CORDOVA, CA:
 2,754,441, CANC. INT. CL. 9.
- FONT BUREAU INC., THE, BOSTON, MA:
 2,337,124, REN. 3-30-10. INT. CL. 9.
- FOOD ART CATERED AFFAIRS, INC., MANCHESTER, MI:
 2,346,978, REN. 3-31-10. INT. CL. 42.
- FOOD EXPORT USA - NORTHEAST CORP., PHILADELPHIA, PA:
 2,339,388, REN. 3-26-10. INT. CL. 35.
- FOOD FAST CORPORATION, TYLER, TX, DBA FOOD FAST:
 2,432,636, REN. 3-26-10. INT. CL. 35.
- FOODSCIENCE CORPORATION, ESSEX JUNCTION, VT:
 2,428,088, REN. 3-30-10. INT. CL. 5.
- FOOFQUEENS, INC., JOHNSTON, IA:
 3,785,658, INT. CL. 16.
- FOONA-LAGOONA-BABOONA LLC, LENOX, MA:
 2,752,703, CANC. INT. CL. 43.
- FOOTSTAR CORPORATION, MAHWAH, NJ:
 2,272,896, CANC. INT. CL. 25.
- 2,272,901, CANC. INT. CL. 25.
- FOR ALL KIDS FOUNDATION, INC., THE, ALLENDALE, NJ:
 2,272,941, CANC. INT. CL. 36.
- FORBES, DAVID C, KIRKLAND, WA:
 3,785,168, INT. CL. 43.
- FORBES, DAVID C., KIRKLAND, WA:
 2,751,971, CANC. MULTIPLE CLASS, INT. CLS. 39 AND 43.
- FORD MOTOR COMPANY, DEARBORN, MI:
 2,335,900, REN. 3-26-10. INT. CL. 14.
- 2,751,564, CANC. INT. CL. 12.
- 2,751,571, CANC. INT. CL. 12.
- 2,754,335, CANC. INT. CL. 42.
- 3,785,297, INT. CL. 38.
- FORECAST ENGINEERING, LLC, CARSON CITY, NJ:
 2,754,576, CANC. INT. CL. 35.
- FORENSIC TECHNOLOGY WAI, INC., COTE SAINT-LUC, QUEBEC H4W 2W8, CANADA:
 2,753,488, CANC. INT. CL. 9.
- 2,753,489, CANC. INT. CL. 9.
- FOREVER CHEESE INC., LONG ISLAND CITY, NY:
 3,786,363, INT. CL. 29.
- FORJAS TAURUS S/A, RIO GRANDE DO SUL, BRAZIL:
 3,786,281, INT. CL. 13.
- FORMATE INDUSTRIAL CO., LTD., TAIPEI, TAIWAN:
 2,753,780, CANC. INT. CL. 29.
- FORT BLISS FEDERAL CREDIT UNION, EL PASO, TX:
 2,754,131, CANC. INT. CL. 36.
- FORT BOISE PRODUCE, PARMA, ID:
 3,784,314, PUB. 2-16-2010. INT. CL. 31.
- FORT JAMES OPERATING COMPANY, ATLANTA, GA:
 2,271,683, CANC. INT. CL. 16.
- FORT LAUDERDALE TAXI VAN CORPORATIONS, DANIA BEACH, FL:
 3,786,469, INT. CL. 35.
- FORT WORTH ZOO ASSOCIATION, FORT WORTH, TX:
 2,345,450, REN. 3-26-10. INT. CL. 41.

FORTA CORPORATION, GROVE CITY, PA:
701,579. REN. 3-29-10. U.S. CL. 1 (INT. CL. 1).

FORTIN, KATHRYN L., DALY CITY, CA, DBA FORTECH SOLUTIONS:
2,754,329. CANC. INT. CL. 42.

FORTRESS PARTICIPATIONS B.V., ROTTERDAM, NETHERLANDS:
3,783,253. PUB. 2-16-2010. MULTIPLE CLASS, INT. CLS. 35, 36 AND 37.

FORTUNE WATER TECHNOLOGIES, INC., ARCADIA, CA:
3,784,284. PUB. 2-16-2010. INT. CL. 40.

FOSECO INTERNATIONAL LIMITED, BARLBOROUGH LINKS, DERBYSHIRE, UNITED KINGDOM:
698,794. REN. 4-1-10. U.S. CL. 6 (INT. CL. 1).

FOSS ELECTRIC A/S, 3400 HILLEROD, DENMARK:
2,751,993. CANC. INT. CL. 9.

FOSS ENVIRONMENTAL SERVICES COMPANY, SEATTLE, WA TO BOWHEAD MANUFACTURING COMPANY, LLC, SEATTLE, WA:
2,271,398. CANC. INT. CL. 11.

FOSTER & SMITH, INC., RHINELANDER, WI:
2,357,734. REN. 3-31-10. INT. CL. 5.

FOSTER AND SMITH, INC., RHINELANDER, WI:
3,785,825. INT. CL. 5.

FOSTER PARTS, INC., CITY OF INDUSTRY, CA:
2,751,970. CANC. MULTIPLE CLASS, INT. CLS. 7 AND 12.

FOSTER'S WINE ESTATES AMERICAS COMPANY, NAPA, CA:
3,756,288. CANC. INT. CL. 33.

FOUNDATION MILLING CENTRE, LLC, BUFFALO, NY:
3,783,147. PUB. 2-16-2010. INT. CL. 5.

FOUNDATIONS DEVELOPMENTAL HOUSE, CHANDLER, AZ:
3,785,935. INT. CL. 44.

FOUNDERS BANK, WORTH, IL:
2,461,568. CANC. INT. CL. 39.

FOUR PAWS PRODUCTS LTD., HAUPPAUGE, NY:
2,335,461. REN. 3-30-10. INT. CL. 18.

FOUR SEASONS MANUFACTURING, INC., MIDDLEBURY, IN:
2,272,595. CANC. INT. CL. 19.

FOX PRODUCTS CORPORATION, SOUTH WHITLEY, IN:
903,013. REN. 4-1-10. U.S. CL. 36 (INT. CL. 15).

FOXSEMICON INTEGRATED TECHNOLOGY INC., MIAOLI HSIEN, TAIWAN:
3,785,162. MULTIPLE CLASS, INT. CLS. 9 AND 11.
3,785,163. MULTIPLE CLASS, INT. CLS. 9 AND 11.

FRAKIE, INC., COCONUT GROVE, FL, DBA LINEA LUXE:
3,785,498. INT. CL. 35.

FRAN WILSON CREATIVE COSMETICS, INC., NEW YORK, NY:
1,593,729. REN. 3-26-10. INT. CL. 3.

FRANESCA'S COLLECTIONS, INC., HOUSTON, TX:
3,784,306. PUB. 2-16-2010. INT. CL. 14.

FRANCHISE PAYMENTS NETWORK, LLC, ORLANDO, FL:
3,752,366. CANC. IIRN. RESTORED TO S.N. 78-908,713.

FRANCISCO H. ESPEJO, C. POR A., SANTIAGO, DOMINICAN REP:
2,272,998. CANC. INT. CL. 25.

FRANCISCO JOSE ROSAS, FRANCE:
3,784,877. PUB. 2-16-2010. MULTIPLE CLASS, INT. CLS. 3, 18, 24 AND 25.

FRANCK, LORENZ, D-70372 STUTTGART, FED REP GERMANY:
2,751,908. CANC. MULTIPLE CLASS, INT. CLS. 25 AND 28.

FRANCOTYP-POSTALIA, INC., LISLE, IL:
2,751,617. CANC. INT. CL. 9.

FRANGI S.P.A., I - 22029 UGGIATE THEVAN09, ITALY:
2,751,635. CANC. MULTIPLE CLASS, INT. CLS. 18 AND 24.

FRANK BRUNCKHORST CO., L.L.C., BROOKLYN, NY:
3,786,439. INT. CL. 29.

FRANKFURTER ALLGEMEINE ZEITUNG G.M.B.H., FED REP GERMANY:
2,753,538. CANC. MULTIPLE CLASS, INT. CLS. 16, 35 AND 41.

FRANKLIN ELECTRIC CO., INC., BLUFFTON, IN:
2,271,430. CANC. MULTIPLE CLASS, INT. CLS. 7, 11, 17, 20, 37 AND 42.

FRANKLIN FRANCHISING HOLDINGS LLC, RACINE, WI, BEN FRANKLIN STORES, INC., CAROL STREAM, IL:
1,590,260. REN. 3-31-10. INT. CL. 42.

FRANKLIN, CANDICE, NEW YORK, NY:
3,785,415. INT. CL. 41.

FRANS, MARK, SAN ANTONIO, TX:
3,786,405. INT. CL. 35.

FRANTZ MEDICAL DEVELOPMENT LTD., MENTOR, OH:
1,590,708. REN. 3-26-10. INT. CL. 10.

FRATERNITY OF PHI GAMMA DELTA, INC., THE, LEXINGTON, KY:
2,339,904. REN. 3-30-10. U.S. CL. 200.

FRED MARTIN MOTOR COMPANY, BARBERTON, OH:
2,753,574. CANC. INT. CL. 35.

FRED RICCI TOOL CO., INC., JOHNSTON, RI:
3,784,533. PUB. 2-16-2010. INT. CL. 45.

FREDRIKSON & BYRON, P.A., MINNEAPOLIS, MN:
3,785,514. INT. CL. 42.

FREEDOM LIGHTS OUR WORLD (FLOW), INC., AUSTIN, TX:
3,783,263. PUB. 7-7-2009. INT. CL. 41.
3,783,557. PUB. 8-18-2009. INT. CL. 41.

FRELIFE INTERNATIONAL HOLDINGS, LLC, PHOENIX, AZ:
2,752,536. CANC. MULTIPLE CLASS, INT. CLS. 5 AND 29.

FREENY, JEFFERY A., GREENSBORO, GA:
3,783,564. PUB. 2-16-2010. INT. CL. 41.

FREIBURG WIRTSCHAFT TOURISTIK; UND MESSE GMBH & CO. KG, FED REP GERMANY:
3,785,025. PUB. 2-16-2010. INT. CL. 35.

FRENCH TRANSIT, LTD, BURLINGAME, CA:
3,783,488. PUB. 2-16-2010. INT. CL. 3.

FRESENIUS MEDICAL CARE HOLDINGS, INC., WALTHAM, MA:
3,784,088. PUB. 2-16-2010. INT. CL. 44.
3,784,089. PUB. 2-16-2010. INT. CL. 44.

FRESH EXPRESS INCORPORATED, SALINAS, CA:
3,783,736. PUB. 2-16-2010. MULTIPLE CLASS, INT. CLS. 29 AND 35.

FRIEDMANN-BROOKS, INC., OVELAND PARK, KS TO CHILD ABUSE PREVENTION COALITION, OVERLAND PARK, KS:
1,552,834. CANC. INT. CL. 16.

FRIENDS OF THE HUNLEY, INC, NORTH CHARLESTON, SC:
2,848,092. CANC. INT. CL. 25.

FRIENDS OF THE HUNLEY, INC., CHARLESTON, SC:
2,848,093. CANC. INT. CL. 25.

FRIENDSHIP GESTURES, INC., ALPHARETTA, GA:
2,272,318. CANC. INT. CL. 16.

FRIESLAND BRANDS B.V., NETHERLANDS:
3,784,935. PUB. 2-16-2010. MULTIPLE CLASS, INT. CLS. 5, 29 AND 32.

FRIGGINRIGGIN, MAGNOLIA, TX:
3,784,440. PUB. 2-16-2010. INT. CL. 25.

FRITO-LAY NORTH AMERICA, INC., PLANO, TX:
2,753,403. CANC. MULTIPLE CLASS, INT. CLS. 29 AND 30.

FRIWO GERATEBAU GMBH, 48346 OSTBEVERN, FED REP GERMANY:
2,315,228. REN. 3-26-10. INT. CL. 9.

FRONT BURNER PRODUCTIONS, LLC, TIBURON, CA:
1,295,185. CANC. INT. CL. 42.

FRONTLINE COMMUNICATIONS CORP., PEARL RIVER, NY:
2,751,582. CANC. MULTIPLE CLASS, INT. CLS. 35, 38 AND 42.

FSB LEGAL COUNSEL, A FISHER BROYLES LLP, ATLANTA, GA:
3,784,749. PUB. 2-16-2010. INT. CL. 45.

FTI CONSULTING, INC., ANNAPOLIS, MD:
3,784,509. PUB. 2-16-2010. INT. CL. 9.

FTL SYSTEMS, INC., ROCHESTER, MN:
2,753,396. CANC. INT. CL. 9.

- FUCHS AUDIO TECHNOLOGY, LLC, BLOOMFIELD, NJ:
3,784,016, PUB. 2-16-2010. INT. CL. 9.
- FUGRO GRAVITY & MAGNETIC SERVICES INC., HOUSTON, TX:
3,784,342, PUB. 2-16-2010. INT. CL. 42.
- FUJIAN QUANZHOU PEAK SPORTS PRODUCTS CO., LTD., QUANZHOU, FUJIAN, CHINA:
3,784,694, PUB. 2-16-2010. INT. CL. 25.
- FUJITSU LIMITED, KANAGAWA, 211-8588, JAPAN:
3,783,223, PUB. 2-16-2010. MULTIPLE CLASS, INT. CLS. 9 AND 42.
- FUJITSU TEN LIMITED, KOBE-SHI, HYOGO-KEN, JAPAN:
2,337,983. REN. 3-30-10. INT. CL. 9.
- FULCRUM SUSPENSIONS PTY LTD, MOOROOKA, AUSTRALIA:
2,752,883, CANC. INT. CL. 12.
- FULFILLMENT FUND, LOS ANGELES, CA:
2,751,702, CANC. INT. CL. 36.
- FULHAM CO., INC., HAWTHORNE, CA:
3,785,502, INT. CL. 9.
- FULTON BOILER WORKS, INC., PULASKI, NY:
1,135,065. REN. 3-31-10. INT. CL. 11.
- FUNDACION ALAS, PANAMA CITY, PANAMA:
3,785,593, INT. CL. 41.
- FUNDACION ESPAÑOLA PARA LA CIENCIA Y LA TECNOLOGIA, MADRID, SPAIN:
3,783,412, PUB. 2-16-2010. INT. CL. 41.
- FUNTACTIX, INC., TEL AVIV 68012, ISRAEL:
3,785,278, INT. CL. 41.
- FUSCO, ANGELO J., PHILADELPHIA, PA AND RYAN, TERRY H., PHILADELPHIA, PA:
2,752,794, CANC. INT. CL. 41.
2,752,795, CANC. INT. CL. 41.
- FUTABA DENSHI KOGYO KABUSHIKI KAISHA, CHIBAKEN, JAPAN:
2,354,303. REN. 3-31-10. INT. CL. 7.
- FUTABA DENSHI KOGYO KABUSHIKI KAISHA (FUTABA CORPORATION), MOBARA CITY, CHIBA PREFECTURE, JAPAN:
1,552,574, CANC. MULTIPLE CLASS, INT. CLS. 9 AND 28.
- FUTURE MEDIA ARCHITECTS, INC., ROAD TOWN, TORTOLA, BR. VIRGIN ISLANDS:
3,786,216, MULTIPLE CLASS, INT. CLS. 35 AND 42.
- FUTUREBOY, LLC, LOS ANGELES, CA:
3,785,062, MULTIPLE CLASS, INT. CLS. 11 AND 25.
- FUTUREPAST, INC., ARLINGTON, VA:
3,784,329, PUB. 2-16-2010. INT. CL. 35.
- G & G MANHATTAN FRUITIER, INC., NEW YORK, NY, DBA MANHATTAN FRUITIER:
3,784,122, PUB. 2-16-2010. INT. CL. 30.
- G.D.S. PROFESSIONAL RESULTS, INC., CARMEL, IN:
2,333,545. REN. 3-26-10. INT. CL. 21.
- G.H. DIJKMANS BEHEER BV, NS WAALWIJK, NETHERLANDS:
2,753,820, CANC. INT. CL. 25.
- G.I. SKINCARE, LLC, NEW YORK, NY:
3,785,847, INT. CL. 3.
- G.I. TECH GROUP LLC BY: LAINE, JOHN O., PRESIDENT, EVANSVILLE, IN:
1,810,869, CANC. MULTIPLE CLASS, INT. CLS. 25 AND 28.
- G-BAGS LLC, LANCASTER, PA:
3,784,499, PUB. 2-16-2010. INT. CL. 9.
- GABRIELE FUCHS, GÖPPINGEN, FED REP GERMANY:
3,785,684, MULTIPLE CLASS, INT. CLS. 35, 38 AND 42.
- GAC CHEMICAL CORPORATION, HOLLAND, OH:
2,752,166, CANC. INT. CL. 1.
- GAGE, WILLIAM L., ALBUQUERQUE, NM:
1,553,365, CANC. INT. CL. 16.
- GAIA GINO AKESUAR TASARIM ANONIM SIRKETI, 34367 ISTANBUL, TURKEY:
3,786,242, INT. CL. 21.
- GALBREATH, JOHN A., REISTERSTOWN, MD:
2,335,348. REN. 3-27-10. INT. CL. 42.
- GALLIGAN, SANDRA, SANTA ANA, CA:
2,753,273, CANC. INT. CL. 16.
- GAME THEORY LIMITED, VALETTA, MALTA:
3,784,834, PUB. 10-27-2009. MULTIPLE CLASS, INT. CLS. 9, 25, 28 AND 41.
- GAMEFLY, INC., LOS ANGELES, CA:
3,784,445, PUB. 2-16-2010. INT. CL. 41.
3,784,447, PUB. 2-16-2010. INT. CL. 42.
3,784,449, PUB. 2-16-2010. INT. CL. 41.
- GAMELOFT S.A., PARIS, FRANCE:
3,785,465, INT. CL. 41.
- GAMESA CORPORACION TECNOLOGICA, S.A., SPAIN:
3,784,909, PUB. 2-16-2010. MULTIPLE CLASS, INT. CLS. 7, 9, 35, 37, 39, 40, 41 AND 42.
- GAMING LABORATORIES INTERNATIONAL, LLC, LAKEWOOD, NJ:
3,786,105, INT. CL. 42.
- GANDER MOUNTAIN COMPANY, ST. PAUL, MN:
3,785,177, INT. CL. 13.
- GANNETT SATELLITE INFORMATION NETWORK, INC., MCLEAN, VA:
2,754,546, CANC. INT. CL. 35.
- GANS, KIM, MINNEAPOLIS, MN:
3,786,207, INT. CL. 30.
- GAP (APPAREL), LLC, SAN FRANCISCO, CA:
2,753,007, CANC. INT. CL. 9.
- GARAN SERVICES CORP., NEW YORK, NY, GARAN, INCORPORATED, NEW YORK, NY:
1,589,056. REN. 3-31-10. INT. CL. 25.
- GARCIA, MICHAEL, PLACENTIA, CA:
3,784,039, PUB. 2-16-2010. INT. CL. 25.
- GARG, SHYAM S., MACON, GA:
3,784,693, PUB. 2-16-2010. INT. CL. 3.
- GARGOYLES, INC., AUBURN, WA:
1,552,708, CANC. INT. CL. 9.
- GARLAND ENERGY SYSTEMS, INC., CLEVELAND, OH:
3,785,309, MULTIPLE CLASS, INT. CLS. 35 AND 42.
- GARLANDS OF GRACE, ODESSA, MO:
3,784,733, PUB. 2-16-2010. INT. CL. 25.
- GARLOCK SEALING TECHNOLOGIES LLC, PALMYRA, NY:
2,272,020, CANC. INT. CL. 17.
- GARSON, MICHAEL K., PHILADELPHIA, PA:
3,783,220, PUB. 2-16-2010. INT. CL. 25.
- GARY CRITHFIELD, SPOKANE VALLEY, WA:
3,785,447, INT. CL. 21.
- GARY RICH, DENTON, TX:
3,785,952, INT. CL. 14.
- GARZA ENTERPRISES, INC., SAN ANTONIO, TX, DBA CONSOLIDATED OFFICE SYSTEMS:
2,416,868. REN. 3-29-10. INT. CL. 35.
- GAS ELECTRONICS, INC., PEORIA, IL:
2,405,798. REN. 3-26-10. INT. CL. 9.
2,410,314. REN. 3-26-10. INT. CL. 9.
- GATEWAY ENERGY SERVICES CORPORATION, MONTEBELLO, NY:
3,785,277, INT. CL. 39.
- GATEWAY GAMING, PIEDMONT, SC:
3,786,018, INT. CL. 9.
- GATEWAY, INC., POWAY, CA:
2,754,195, CANC. INT. CL. 41.
- GATOR HOSE LLC, TULSA, OK:
3,785,651, INT. CL. 17.
- GAU JIH FOOD CO., LTD., TAIPEI, TAIWAN:
2,843,468, CANC. INT. CL. 30.
2,917,663, CANC. INT. CL. 32.
2,919,301, CANC. INT. CL. 29.
- GAUMARD SCIENTIFIC COMPANY, INC., MIAMI, FL:
2,402,051. REN. 3-26-10. INT. CL. 20.
- GAUYAN, KRISTOFFERSON, JACKSONVILLE, FL:
3,785,920, INT. CL. 25.
- GAYLE F. BRICKMAN, MILWAUKEE, WI:
2,332,434. REN. 3-30-10. INT. CL. 41.
- GB TOOLS & SUPPLIES, LLC, BUTLER, WI, GARDNER BENDER, INC., MILWAUKEE, WI:
1,131,216. REN. 3-26-10. MULTIPLE CLASS, INT. CLS. 8 AND 9.
- GDG ENTERPRISES LLC, PHOENIX, AZ:
3,783,795, PUB. 2-16-2010. INT. CL. 36.

- GE BETZ, INC., TREVOSE, PA, BETZ PROCESS CHEMICALS, INC., THE WOODLANDS, TX:
1,603,284. REN. 4-1-10. INT. CL. 1.
- GEA PROCESS ENGINEERING A/S, DENMARK:
3,785,008, PUB. 2-16-2010. MULTIPLE CLASS, INT. CLS. 7 AND 17.
- GEBHART, DOUGLAS A., MARGATE, FL:
3,785,174, INT. CL. 28.
- GEE, PATRICK, WHITEHALL, MI:
3,786,062, INT. CL. 6.
- GEEKSPEED NETWORKS, LLC, POTOMAC FALLS, VA:
2,753,011, CANC. INT. CL. 38.
- GEIGER INTERNATIONAL, INC., ATLANTA, GA:
2,753,846, CANC. MULTIPLE CLASS, INT. CLS. 18 AND 20.
- GEKAKONUS TECHNOLOGIES GMBH, RHEINSTETTEN, FED REP GERMANY:
3,783,896, PUB. 2-16-2010. INT. CL. 11.
- GEMÜ GEBR. MÜLLER; APPARATEBAU GMBH & CO. KG, FED REP GERMANY:
3,784,910, PUB. 2-16-2010. MULTIPLE CLASS, INT. CLS. 6, 7, 9 AND 10.
- GENCORP INC., FAIRLAWN, OH:
1,553,017, CANC. INT. CL. 28.
- GENERAL BOARD OF HIGHER EDUCATION AND MINISTRY OF THE UNITED METHODIST CHURCH, NASHVILLE, TN:
3,783,250, PUB. 2-16-2010. INT. CL. 41.
- GENERAL CONFERENCE CORPORATION OF SEVENTH-DAY ADVENTISTS, SILVER SPRING, MD:
3,783,249, PUB. 2-16-2010. MULTIPLE CLASS, INT. CLS. 38 AND 41.
- GENERAL CONTAINER COMPANY, L.L.C., HILLSDALE, MI:
2,754,238, CANC. INT. CL. 30.
- GENERAL DYNAMICS C4 SYSTEMS, INC., SCOTTSDALE, AZ:
3,785,785, INT. CL. 9.
- GENERAL ELECTRIC COMPANY, SCHENECTADY, NY:
2,752,236, CANC. MULTIPLE CLASS, INT. CLS. 17 AND 19.
2,753,738, CANC. INT. CL. 36.
- GENERAL KINETICS INCORPORATED, HERNDON, VA:
1,552,630, CANC. INT. CL. 9.
- GENERAL MILLS FOODS ASIA LIMITED, KOWLOON, HONG KONG:
3,730,162, AM. INT. CL. 30.
- GENERAL MILLS IP HOLDINGS II, LLC, MINNEAPOLIS, MN:
3,785,940, INT. CL. 30.
- GENERAL PUBLIC LIMITED, LEICESTER, UNITED KINGDOM:
3,783,284, PUB. 2-16-2010. INT. CL. 25.
- GENERAL SCIENCES CORPORATION, LAUREL, MD:
1,553,311, CANC. INT. CL. 42.
- GENERAL SPORTS VENUE, LLC, ROCHESTER, MI:
3,783,578, PUB. 2-16-2010. INT. CL. 22.
- GENERATION OF PRAISE, INC., COCONUT CREEK, FL:
2,752,463, CANC. INT. CL. 41.
- GENERATION PLUS, INC., PHEONIX, AZ:
2,753,259, CANC. INT. CL. 5.
- GENESIS LIU, BOGOTA, NJ, DBA SNUKUMS N' SNUKS:
3,784,535, PUB. 2-16-2010. INT. CL. 16.
- GENESIS PHARMACEUTICAL, INC., PARSIPPANY, NJ:
3,783,162, PUB. 2-16-2010. INT. CL. 5.
- GENESIS TODAY, INC., AUSTIN, TX:
2,754,669, CANC. INT. CL. 5.
- GENETIX PHARMACEUTICALS, INC., CAMBRIDGE, MA:
2,336,830, REN. 3-27-10. INT. CL. 5.
- GENSTAR CONTAINER CORPORATION, SAN FRANCISCO, CA:
1,553,231, CANC. MULTIPLE CLASS, INT. CLS. 36 AND 39.
- GENUINE PARTS COMPANY, ATLANTA, GA:
3,784,849, PUB. 2-16-2010. INT. CL. 12.
- GENZYME CORPORATION, CAMBRIDGE, MA:
3,786,135, INT. CL. 36.
- GEO PLASTICS, LOS ANGELES, CA:
3,785,561, MULTIPLE CLASS, INT. CLS. 12, 20, 21 AND 28.
- GEOFFREY, LLC, WAYNE, NJ:
2,271,828, CANC. INT. CL. 41.
- GEOGRAPHIC SOLUTIONS, INC., PALM HARBOR, FL:
2,299,423, REN. 3-26-10. INT. CL. 42.
- GEORGE W. RADEBAUGH & SONS, INC., TOWSON, MD:
3,783,754, PUB. 2-16-2010. INT. CL. 31.
3,783,755, PUB. 2-16-2010. INT. CL. 35.
- GEORGE, LEROY JOSEPH, JR., LAKE CITY, FL:
2,753,211, CANC. INT. CL. 5.
- GEORGES MAGNIN, SWITZERLAND:
3,784,950, PUB. 2-16-2010. INT. CL. 43.
- GEORGETOWN WINERY, LLC, GEORGETOWN, TX:
3,783,699, PUB. 2-16-2010. INT. CL. 33.
- GEORGIA TELCO CREDIT UNION, ATLANTA, GA:
3,786,030, MULTIPLE CLASS, INT. CLS. 16, 25 AND 36.
3,786,060, MULTIPLE CLASS, INT. CLS. 16, 25 AND 36.
- GERACI, PETER F., CHICAGO, IL:
3,784,279, PUB. 2-16-2010. INT. CL. 45.
- GERALD KAMPEL, TAUFKIRCHEN, FED REP GERMANY:
3,785,536, INT. CL. 9.
- GERITREX, CORP., MOUNT VERNON, NY:
2,331,047, REN. 3-30-10. INT. CL. 3.
- GERNER, SHAUN R., SAN FRANCISCO, CA:
3,784,414, PUB. 2-16-2010. INT. CL. 41.
- GERSON, CHARLES D., NEW YORK, NY, DBA "MIND BODY DIGESTIVE CENTER" AND MARY-JOAN GERSON, NEW YORK, NY, DBA "MIND BODY DIGESTIVE CENTER":
2,332,182, REN. 3-26-10. INT. CL. 42.
- GISSI S.P.A., ITALY:
3,784,992, PUB. 2-16-2010. MULTIPLE CLASS, INT. CLS. 11, 20 AND 21.
- GESTIONS P.A.R.M.H. INC., SAINT-DAMIEN-DE-BUCKLAND (QUEBEC), CANADA:
2,753,425, CANC. INT. CL. 16.
- GET OUT OF DEBT AMERICA, INC., BURBANK, CA:
2,754,337, CANC. INT. CL. 36.
- GET OUTSIDE MEDIA LLC, GRAND RAPIDS, MN:
3,785,273, MULTIPLE CLASS, INT. CLS. 35 AND 41.
3,785,274, MULTIPLE CLASS, INT. CLS. 35 AND 41.
- GFK MEDIAMARK RESEARCH & INTELLIGENCE, LLC, NEW YORK, NY:
3,785,580, MULTIPLE CLASS, INT. CLS. 35 AND 42.
- GHOST RANCH SALOON, LLC, STEAMBOAT SPRINGS, CO:
3,786,178, MULTIPLE CLASS, INT. CLS. 41 AND 43.
- GIANT MANUFACTURING CO., LTD., TACHIA, TAI-CHUNG HSIEN, TAIWAN:
3,785,685, INT. CL. 12.
- GIFTS4BOATS.COM, LLC, SANTA CLARITA, CA:
2,754,537, CANC. INT. CL. 35.
- GILBERT, JUDITH, NEW YORK, NY:
2,273,055, CANC. INT. CL. 14.
- GILLETTE COMPANY, THE, BOSTON, MA:
2,754,456, CANC. INT. CL. 3.
- GILMARTIN, KAREN W, BOULDER, CO:
3,784,413, PUB. 2-16-2010. INT. CL. 5.
- GILO INDUSTRIES LIMITED, WILTSHIRE, UNITED KINGDOM:
3,784,988, PUB. 2-16-2010. INT. CL. 12.
- GIMMESOME CANDY LLC, STAMFORD, CT:
3,783,460, PUB. 2-16-2010. MULTIPLE CLASS, INT. CLS. 35 AND 36.
- GIRL SCOUTS OF THE UNITED STATES OF AMERICA, NEW YORK, NY:
1,142,666, REN. 3-29-10. INT. CL. 26.
1,142,666, AM. INT. CL. 26.
- GIRL SKATEBOARD COMPANY, INC., TORRANCE, CA:
2,336,272, REN. 3-31-10. INT. CL. 25.
- GIULIANI S.P.A., MILANO, ITALY:
3,786,404, MULTIPLE CLASS, INT. CLS. 5 AND 32.
- GIVAUDAN S.A., SWITZERLAND:
3,329,606, CANC. INT. CL. 35.

- GIVONE, LAURIE, PURCHASE, NY AND GIVONE, ROBERT, PURCHASE, NY:
3,785,103, INT. CL. 14.
- GLAMOUR KILLS CLOTHING, LLC, BEACON, NY:
3,783,111, PUB. 2-16-2010. INT. CL. 25.
- GLASFORMS, INC., SAN JOSE, CA:
2,753,462, CANC. INT. CL. 9.
- GLAUKOS CORPORATION, LAGUNA HILLS, CA:
3,784,386, PUB. 2-16-2010. INT. CL. 10.
- GLEDHILL, DALE C, SALT LAKE CITY, UT, DBA GRANDWAY USA CORP.:
2,754,318, CANC. INT. CL. 9.
- GLEMSER TECHNOLOGIES CORPORATION, BETHLEHEM, PA:
3,783,442, PUB. 2-16-2010. INT. CL. 9.
- GLENN ROBERTS, INC., NEW YORK, NY:
2,273,000, CANC. INT. CL. 14.
- GLOBAL DIRECT MARKETING, LLC, STUDIO CITY, CA, DBA VOLTRIDER:
3,783,477, PUB. 2-16-2010. INT. CL. 12.
- GLOBAL DOWN SYNDROME FOUNDATION, DENVER, CO:
3,784,223, PUB. 2-16-2010. INT. CL. 36.
- GLOBAL ELECTRIC MOTORCARS, LLC, FARGO, ND:
2,402,440, REN. 3-26-10. INT. CL. 12.
- GLOBAL GAMING GROUP INC., LAS VEGAS, NV:
3,785,820, INT. CL. 9.
- GLOBAL GREEN LED, INC, MERIDIAN, ID:
3,784,163, PUB. 2-16-2010. INT. CL. 11.
- GLOBAL INTERNATIONAL ENTERPRISE CO., LTD, HUNG HOM KOWLOON, HONG KONG:
3,785,877, INT. CL. 28.
- GLOBAL PRODUCTS, INC., BRENTWOOD, TN:
2,753,815, CANC. INT. CL. 21.
- GLOBAL SWEET POLYOLS, LLC, REHOBOTH, MA:
3,785,949, MULTIPLE CLASS, INT. CLS. 3 AND 5.
- GLOBAL TOTAL OFFICE, DOWNSVIEW ONTARIO, CANADA:
2,272,114, CANC. INT. CL. 20.
- GLOBAL VIDEO LLC, GREENVILLE, WI:
2,273,146, CANC. INT. CL. 16.
- GLOBALBIKE, INC., SPARTANBURG, SC:
3,783,955, PUB. 2-16-2010. INT. CL. 39.
- GLOBALUTIONS EUROPA, LDA, GUIMARAES, PORTUGAL:
3,607,155, CANC. INT. CL. 25.
- GLOBOMAX LLC, HANOVER, MD:
2,272,844, CANC. INT. CL. 42.
- GLOBOND INTERNATIONAL, INC., GLOUCESTER, MA:
2,752,355, CANC. INT. CL. 35.
- GN BIOSYSTEMS, INC., HAYWARD, CA:
3,785,464, INT. CL. 9.
- GNOMON, INC., HOLLYWOOD, CA:
3,783,683, PUB. 2-16-2010. INT. CL. 41.
- GOCHMAN, MOLLY, KATY, TX:
2,753,217, CANC. INT. CL. 9.
- GOEBEL PORZELLANMANUFAKTUR GMBH, RODENTAL, FED REP GERMANY:
2,753,389, CANC. MULTIPLE CLASS, INT. CLS. 20 AND 21.
- GOKO INDUSTRIAL COMPANY, LTD., SAIWAI-KU, KAWASAKI, JAPAN:
1,552,545, CANC. INT. CL. 9.
- GOLD EAST PAPER USA, LLC, LAKE OSWEGO, OR:
2,754,209, CANC. INT. CL. 16.
2,754,210, CANC. INT. CL. 16.
- GOLDEN CROWN CORPORATION, COEUR D'ALENE, ID:
2,752,124, CANC. INT. CL. 5.
- GOLDEN GATE NATIONAL SENIOR CARE LLC, FORT SMITH, AR:
3,784,189, PUB. 2-16-2010. INT. CL. 44.
3,784,191, PUB. 2-16-2010. INT. CL. 44.
3,784,813, PUB. 2-16-2010. INT. CL. 44.
- GOLDEN PROTECTIVE SERVICES, INC., SALEM, OR:
3,784,464, PUB. 2-16-2010. INT. CL. 10.
- GOLDHAMMER, RICHARD, HINGHAM, MA:
2,753,363, CANC. INT. CL. 16.
- GOLDILOCKS BAKE SHOP, INC., METRO, MANILA, PHILIPPINES:
2,414,152, REN. 3-31-10. INT. CL. 30.
2,414,152, CANC. INT. CL. 32.
- GOLDSBY, RENEE, BLOOMFIELD HILLS, MI:
2,800,786, CANC. INT. CL. 16.
- GOLITZ, BERNHARD, MUNICH, FED REP GERMANY:
3,783,188, PUB. 7-7-2009. MULTIPLE CLASS, INT. CLS. 35 AND 42.
- GONZALEZ AMARO, JOAQUIN-FAUSTINO, 32004 ORENSE (PONTEVEDRA), SPAIN AND IGLESIAS LOPEZ, MANUEL, 32004 ORENSE (PONTEVEDRA), SPAIN:
2,751,986, CANC. INT. CL. 21.
- GOODE, WILLIAM H., ROHNERT PARK, CA, DBA GPM PRINT MAIL SOLUTIONS:
3,784,489, PUB. 2-16-2010. MULTIPLE CLASS, INT. CLS. 35 AND 40.
3,784,492, PUB. 2-16-2010. MULTIPLE CLASS, INT. CLS. 35 AND 40.
- GOODMAN, LARRY K., PARAMOUNT, CA:
2,271,531, CANC. INT. CL. 7.
- GOODWAY TECHNOLOGIES CORPORATION, STAMFORD, CT:
3,786,354, INT. CL. 7.
- GOODWOOD FLOORING, INC., TEMPLE CITY, CA:
3,784,408, PUB. 2-16-2010. INT. CL. 19.
- GOODY PRODUCTS, INC., ATLANTA, GA, AMERICAN HARD RUBBER COMPANY, HEMPSTEAD, NY:
131,017, REN. 3-30-10. U.S. CL. 40 (INT. CL. 21).
- GOOGLE INC., MOUNTAIN VIEW, CA:
2,342,237, REN. 3-26-10. INT. CL. 35.
- GORDON SYSTEMS, INC., DEWITT, NY, DBA GSI PUBLICATIONS:
2,334,928, REN. 3-26-10. INT. CL. 16.
- GORDON, LAURENCE E., SAN DIEGO, CA AND GORDON, GAYLE, SAN DIEGO, CA, GORDON AND SMITH, INCORPORATED, SAN DIEGO, CA:
1,589,023, REN. 3-26-10. MULTIPLE CLASS, INT. CLS. 25 AND 28.
- GORDON, LAURENCE E., SAN DIGEO, CA AND GORDON, GAYLE, SAN DIGEO, CA, GORDON AND SMITH, INCORPORATED, SAN DIEGO, CA:
1,589,024, REN. 3-26-10. MULTIPLE CLASS, INT. CLS. 25 AND 28.
- GORDON, LAURENCE E., SAN DIEGO, CA AND GORDON, GAYLE, SAN DIEGO, CA, GORDON AND SMITH, INCORPORATED, SAN DIEGO, CA:
1,591,031, REN. 3-26-10. MULTIPLE CLASS, INT. CLS. 25 AND 28.
- GORDON, TRENESSE LASHAY, RICEBORO, GA:
3,785,765, INT. CL. 25.
- GORMAN-RUPP COMPANY, THE, MANSFIELD, OH:
2,316,046, REN. 3-29-10. INT. CL. 7.
- GOSI ENTERPRISES, LTD., EAST HILLS, NY:
3,784,017, PUB. 2-16-2010. INT. CL. 35.
- GOSPEL LANDMARKS OF UNICOI, INC., THE, UNICOI, TN, DBA THE LANDMARKS:
2,754,268, CANC. INT. CL. 41.
- GOSS INTERNATIONAL AMERICAS, INC., DURHAM, NH:
2,389,009, REN. 3-26-10. INT. CL. 7.
- GOSS,RADFORD LEE, HILO, HI, AKA BIG ISLAND MAFIA:
3,785,919, INT. CL. 25.
- GOSSEN GMBH, ERLANGEN, FED REP GERMANY TO GOSSEN-METRAWATT GMBH, NURNBERG, GERMANY D-8500, FED REP GERMANY:
1,552,606, CANC. INT. CL. 9.
- GOTV NETWORKS, INC., SHERMAN OAKS, CA:
3,783,790, PUB. 2-16-2010. INT. CL. 9.
- GOURMET MUSHROOM, INC., SEBASTOPOL, CA:
2,753,230, CANC. INT. CL. 31.
- GOYARD ST-HONORE, FRANCE:
3,785,011, PUB. 2-16-2010. MULTIPLE CLASS, INT. CLS. 18, 20, 21 AND 24.
- GRACIE, RORION, SANTA BARBARA, CA:
3,786,165, INT. CL. 9.
- GRACY TITLE COMPANY, LLC, AUSTIN, TX:
3,783,806, PUB. 2-16-2010. INT. CL. 45.

- GRAMM, RICHARD, BREMEN, IN:
2,322,285. REN. 3-26-10. INT. CL. 9.
- GRAMS, CHRISTOPHER D., RALEIGH, NC, DBA CHRIS GRAMS:
3,784,661, PUB. 2-16-2010. INT. CL. 35.
- GRAMSHAMMER, PEPI, VAIL, CO:
2,334,268. REN. 3-28-10. MULTIPLE CLASS, INT. CLS. 14, 21, 25, 27 AND 35.
2,339,672. REN. 3-26-10. INT. CL. 35.
- GRANBERG PUMP AND METER, LTD., VALLEJO, CA, DBA GRANBERG INTERNATIONAL, GRANBERG INDUSTRIES, INC., RICHMOND, CA:
1,132,080. REN. 3-31-10. INT. CL. 7.
- GRAND BOIS TRADING COMPANY, LTD., PORT AU PRINCE, HAITI:
2,752,925. CANC. INT. CL. 33.
- GRAND CENTRAL GAMES.COM, INC., BROOKLYN, NY:
2,931,221. CANC. INT. CL. 41.
- GRAND PLAY MEDIA, LLC, NEW YORK, NY:
3,784,164, PUB. 2-16-2010. INT. CL. 35.
- GRAND TRAVERSE DISTILLERY, L.L.C., TRAVERSE CITY, MI:
3,783,656, PUB. 11-10-2009. INT. CL. 33.
- GRANDAD'S SWEET TEA, LLC, WARREN, MI:
3,784,538, PUB. 2-16-2010. INT. CL. 30.
- GRANT BURGE WINES PTY LTD, SOUTH AUSTRALIA 5352, AUSTRALIA:
2,344,568. REN. 3-26-10. INT. CL. 33.
- GRANT THORNTON LLP, CHICAGO, IL, ARTHUR ANDERSEN & CO., CHICAGO, IL:
1,558,623. REN. 3-27-10. INT. CL. 16.
- GRANT, MOLLIE HUNTER, MT. PLEASANT, SC:
3,783,685, PUB. 11-10-2009. INT. CL. 3.
- GRAPE LINKS, INC., SANTA ROSA, CA:
2,753,977, CANC. INT. CL. 33.
2,753,997, CANC. INT. CL. 33.
- GRAPHENE, LLC, PALM COAST, FL:
3,783,939, PUB. 2-16-2010. MULTIPLE CLASS, INT. CLS. 35 AND 42.
- GRASSMERE PARTNERS, LLC, KANSAS CITY, MO:
3,786,014, INT. CL. 36.
- GRAY, STEVEN JOHN, CORONADO, CA:
2,753,251, CANC. INT. CL. 3.
- GRAYBAR SERVICES, INC., GLENDALE HEIGHTS, IL:
2,752,951, CANC. INT. CL. 42.
- GRAYHAIR SOFTWARE, INC., MT. LAUREL, NJ:
3,786,462, INT. CL. 35.
- GREAT AMERICAN INSURANCE COMPANY, CINCINNATI, OH:
2,751,642, CANC. INT. CL. 36.
- GREAT MINDS, LLC, CULVER CITY, CA:
3,784,684, PUB. 2-16-2010. INT. CL. 9.
- GREAT WRAPS, INC., ATLANTA, GA:
3,783,852, PUB. 2-16-2010. MULTIPLE CLASS, INT. CLS. 29 AND 43.
- GREATER BAY BANCORP, EAST PALO ALTO, CA:
2,753,057, CANC. INT. CL. 36.
- GREATER CLEVELAND PARTNERSHIP, CLEVELAND, OH:
3,784,300, PUB. 2-16-2010. INT. CL. 35.
- GREATER PHOENIX CHAMBER OF COMMERCE, PHOENIX, AZ:
2,377,248. REN. 3-29-10. INT. CL. 35.
- GREATER ROCHESTER VISITORS ASSOCIATION, INC., ROCHESTER, NY:
2,346,452. REN. 3-26-10. INT. CL. 41.
- GREEN AWARDS, LLC, FAIRFIELD, CT:
3,785,973, INT. CL. 41.
- GREEN BRIDGE INDUSTRIES, INC, SARANAC, MI:
3,784,210, PUB. 2-16-2010. INT. CL. 3.
- GREEN FOODS CORPORATION, OXNARD, CA:
2,334,238. REN. 3-26-10. MULTIPLE CLASS, INT. CLS. 5 AND 30.
2,342,173. REN. 3-30-10. MULTIPLE CLASS, INT. CLS. 5 AND 30.
2,349,780. REN. 3-30-10. INT. CL. 5.
- GREEN HILLS MEMORIAL PARK, RANCHO PALOS VERDES, CA:
2,287,833. REN. 3-26-10. INT. CL. 42.
- GREEN IMAGING TECHNOLOGIES INC., FREDERICTON, NB, CANADA:
3,783,292, PUB. 2-16-2010. INT. CL. 9.
- GREEN MOUNTAIN LLC, CHARLESTOWN, MA:
2,753,197, CANC. INT. CL. 35.
- GREEN THUMB ACQUISITION CORPORATION, MIAMI, FL:
2,356,107. REN. 3-27-10. MULTIPLE CLASS, INT. CLS. 19 AND 24.
- GREEN WHEEL BOOKS LLC, STERLING, VA:
3,784,576, PUB. 2-16-2010. INT. CL. 37.
- GREEN, ERIC L., HAMDEN, CT:
3,785,644, INT. CL. 41.
- GREEN, ERNEST, MONROE, MI:
3,786,483, INT. CL. 41.
- GREEN, MILDRED B., NEW BURN, NC:
2,754,211, CANC. INT. CL. 30.
- GREENE TOYS, LLC, NEW YORK, NY:
3,785,396, INT. CL. 25.
- GREENFIX AMERICA LLC, BRAWLEY, CA:
2,381,366. REN. 4-1-10. INT. CL. 31.
- GREENLEE TEXTRON INC., ROCKFORD, IL:
2,386,468. REN. 3-31-10. MULTIPLE CLASS, INT. CLS. 8 AND 9.
- GREENLIGHT, LONDON EC1A 9JU, UNITED KINGDOM:
3,557,740, COR. MULTIPLE CLASS, INT. CLS. 9, 35 AND 42.
- GREENSBORO MONTESSORI SCHOOL, THE, GREENSBORO, NC:
3,784,278, PUB. 2-16-2010. INT. CL. 41.
- GREENWAY GARDENS & NURSERY, INC., CHARLOTTE, NC:
1,553,338, CANC. INT. CL. 42.
- GREER, NILDA, ST. PAUL, MN:
3,784,516, PUB. 2-16-2010. INT. CL. 5.
- GREGORY L. CHAIN, ATLANTA, GA:
3,784,654, PUB. 2-16-2010. INT. CL. 30.
- GREYHOUND LINES, INC., DALLAS, TX:
888,503. REN. 3-26-10. U.S. CL. 3 (INT. CL. 18).
- GRIFFIN INTERNATIONAL COMPANIES, INC., MINNEAPOLIS, MN:
3,784,508, PUB. 2-16-2010. INT. CL. 9.
- GROHE AG, 58675 HEMER, FED REP GERMANY, FRIEDRICH GROHE ARMATURENFABRIK GMBH & CO., 587 HEMER, FED REP GERMANY:
1,134,021. REN. 3-29-10. INT. CL. 9.
- GROS EUGENE W., WHITE CITY, OR:
3,786,414, INT. CL. 12.
- GROUPS BAKERY CAFE, LONG BEACH, CA:
3,783,838, PUB. 2-16-2010. INT. CL. 43.
- GROUP LACASSE INC., ST-PIE, CANADA:
3,785,167, INT. CL. 20.
- GROUP O, MILAN, IL:
3,783,900, PUB. 2-16-2010. INT. CL. 41.
3,783,902, PUB. 2-16-2010. INT. CL. 41.
- GROUP PUBLISHING, INC., LOVELAND, CO:
3,785,095, INT. CL. 16.
3,785,100, INT. CL. 16.
- GROVER JR. M.D., FRED, DENVER, CO, DBA REVOLUTIONARYMD:
3,784,727, PUB. 2-16-2010. INT. CL. 44.
- GRUPO BIMBO, S.A. B DE C.V., MEXICO CITY, MEXICO:
3,783,611, PUB. 2-16-2010. INT. CL. 30.
- GRUPO BIMBO, S.A. B. DE C.V., MEXICO CITY, MEXICO:
3,783,767, PUB. 2-16-2010. INT. CL. 30.
3,783,785, PUB. 2-16-2010. INT. CL. 30.
3,783,796, PUB. 2-16-2010. INT. CL. 30.
3,783,797, PUB. 2-16-2010. INT. CL. 30.
3,783,798, PUB. 2-16-2010. INT. CL. 30.
3,783,818, PUB. 2-16-2010. INT. CL. 29.
- GRUPO CONSULTIVO DE SERVICIOS MEXICANOS, S.A. DE C.V., MONTERREY N.L. C.P., MEXICO:
3,786,302, INT. CL. 30.

- GRUPO INDUSTRIAL GP, S.A. DE C.V., TLAJOMULCO DE ZUÑIGA., MEXICO:
3,784,809, PUB. 2-16-2010. INT. CL. 33.
- GRUPO P.I. MABE, S.A. DE C.V., PUEBLA ESTADO DE PUEBLA, MEXICO:
2,753,038, CANC. INT. CL. 5.
- GS DEVELOPMENT AB, MALMO, SWEDEN, AIMPOINT AB, S-211 24 MALMO, SWEDEN:
1,134,464, REN. 3-29-10. INT. CL. 9.
- GS TELETECH INC., OVERLAND PARK, KS:
3,783,543, PUB. 2-16-2010. INT. CL. 9.
- GT MERCHANDISING & LICENSING CORP., NEW YORK, NY:
2,751,750, CANC. INT. CL. 3.
- GTECH RHODE ISLAND CORPORATION, PROVIDENCE, RI:
3,785,108, INT. CL. 9.
- GTLI, LLC, TRAVERSE CITY, MI, DBA KM NORTH AMERICA:
3,784,255, PUB. 2-16-2010. INT. CL. 6.
- GUARANTEED MERCHANDISE, INC, ALPINE, UT:
3,784,166, PUB. 2-16-2010. INT. CL. 35.
- GUDINO, MANUEL, MODESTO, CA, DBA FESTIMEX:
3,783,304, PUB. 2-16-2010. MULTIPLE CLASS, INT. CLS. 29 AND 30.
- GUIDANT CORPORATION, INDIANAPOLIS, IN:
2,272,377, CANC. INT. CL. 16.
2,272,378, CANC. INT. CL. 16.
- GUIDE LINE TECHNOLOGY INC., IRWINDALE, CA:
2,753,959, CANC. INT. CL. 28.
- GUINNESS UNITED DISTILLERS & VINTNERS AMSTERDAM B.V., 1014 BG AMSTERDAM, NETHERLANDS:
2,753,624, CANC. INT. CL. 33.
- GUIZHOU YIBAI; PHARMACEUTICAL COMPANY LIMITED, GUIZHOU PROVINCE, CHINA:
3,784,916, PUB. 2-16-2010. INT. CL. 5.
- GUNLUK, TUNCAY, CAMBRIDGE, MA:
2,906,417, CANC. INT. CL. 9.
- GUNTHER'S GRADES, LLC, RIVER FOREST, IL:
3,786,039, MULTIPLE CLASS, INT. CLS. 35 AND 44.
- GURROLA, LA SHON, OAK PARK, IL:
3,783,285, PUB. 2-16-2010. INT. CL. 45.
- GUSSCO MANUFACTURING LLC, NEW YORK, NY:
1,132,181, REN. 3-31-10. INT. CL. 16.
- GUSTAFSON, GWYNN MARIE, DOWNEY, CA:
2,406,040, REN. 3-26-10. INT. CL. 35.
- GUTTENTAG, JACK, VALLEY FORGE, PA:
2,754,590, CANC. INT. CL. 16.
- G4 MEDIA, INC., LOS ANGELES, CA:
3,783,272, PUB. 2-16-2010. INT. CL. 41.
- H & S MACHINE & SUPPLY CO., INC., CORAOPOLIS, PA:
1,552,497, CANC. INT. CL. 6.
- H.B. FULLER COMPANY, SAINT PAUL, MN:
2,752,553, CANC. INT. CL. 17.
- H.C. BRILL COMPANY, INC., TUCKER, GA:
3,785,988, INT. CL. 30.
- H.D. LEE COMPANY, INC., THE, WILMINGTON, DE:
2,272,939, CANC. INT. CL. 25.
- H.E.F., ANDREZIEUX BOUTHEON, FRANCE:
3,784,961, PUB. 2-16-2010. MULTIPLE CLASS, INT. CLS. 1 AND 6.
- H.W. SCHLICHTE STEINHAGER-UND KORNNRENEREI GMBH & CO., FED REP GERMANY:
703,659, REN. 3-30-10. U.S. CL. 49 (INT. CL. 33).
- H-D MICHIGAN, INC., ANN ARBOR, MI:
2,817,659, COR. INT. CL. 25.
- H-D MICHIGAN, LLC, ANN ARBOR, MI, HARLEY-DAVIDSON MOTOR COMPANY, MILWAUKEE, WI:
526,750, REN. 3-26-10. U.S. CL. 19 (INT. CLS. 7, 12, 22 AND 27).
- H-D MICHIGAN, LLC, ANN ARBOR, MI:
2,386,246, REN. 3-26-10. INT. CL. 22.
- HABITAT FUTURE ACT, FRANCE:
3,784,917, PUB. 2-16-2010. MULTIPLE CLASS, INT. CLS. 16, 36 AND 38.
- HACHETTE FILIPACCHI MEDIA U.S., INC., NEW YORK, NY:
2,272,336, CANC. INT. CL. 28.
- HADDAD, JEANNE, 75007 PARIS, FRANCE:
2,751,784, CANC. MULTIPLE CLASS, INT. CLS. 3, 24 AND 25.
- HAEMONETICS CORPORATION, BRAINTREE, MA:
3,784,530, PUB. 2-16-2010. INT. CL. 10.
- HAGEN METHOD PROPRIETARY LTD, ROAD TOWN, TORTOLA, BR.VIRGIN ISLANDS:
2,334,216, REN. 3-30-10. MULTIPLE CLASS, INT. CLS. 35, 41 AND 42.
- HALE CLINIC (LONDON) LTD., THE, LONDON WIN 3HE, UNITED KINGDOM:
2,753,340, CANC. INT. CL. 16.
- HALEAKALA RANCH COMPANY, MAKAWAO, HI:
3,783,623, PUB. 2-16-2010. INT. CL. 31.
- HALL, DAVID R., GANSEVOORT, NY:
1,559,018, REN. 3-31-10. INT. CL. 19.
- HALL, MATTHEW, RENO, NV:
2,752,505, CANC. INT. CL. 25.
- HALL, ROXANNE, LEADVILLE, CO:
3,784,186, PUB. 2-16-2010. INT. CL. 30.
- HALLIBURTON ENERGY SERVICES, INC., CARROLLTON, TX, HALLIBURTON ENERGY SERVICES, INC., CARROLLTON, TX:
2,425,439, REN. 3-30-10. INT. CL. 7.
- HALLMARK LICENSING, INC., KANSAS CITY, MO:
380,596, REN. 3-26-10. U.S. CL. 38 (INT. CLS. 9, 16 AND 28).
2,753,785, CANC. INT. CL. 20.
- HALLUM, INC, FLAGSTAFF, AZ, DBA HALLUM STORES:
3,786,103, INT. CL. 35.
- HALLUM, INC., FLAGSTAFF, AZ:
2,752,267, CANC. INT. CL. 35.
- HALOGEN GUIDES LLC, SAN FRANCISCO, CA:
3,784,636, PUB. 2-16-2010. INT. CL. 41.
- HALPERN, RICHARD, LOS ANGELES, CA:
2,752,880, CANC. INT. CL. 28.
- HALSEY LIDGARD SAILMAKERS, OLD MYSTIC, CT:
2,754,132, CANC. INT. CL. 22.
- HAMILTON WHITE GROUP IIA, LLC, PHOENIX, AZ:
3,708,662, COR. INT. CL. 41.
- HAMMACHER, SCHLEMMER & CO., INC., NEW YORK, NY:
1,124,251, CANC. INT. CL. 9.
- HAMMOND GROUP, INC., HAMMOND, IN:
2,752,797, CANC. INT. CL. 1.
- HAMMONDS TECHNICAL SERVICES, INC., HOUSTON, TX:
3,783,114, PUB. 2-16-2010. INT. CL. 12.
- HANATOUR SERVICE INC., SEOUL, REPUBLIC OF KOREA:
3,784,955, PUB. 2-16-2010. INT. CL. 39.
- HANCHETT PAPER COMPANY, AURORA, IL:
2,752,611, CANC. INT. CL. 35.
- HANDI-FOIL CORPORATION, WHEELING, IL:
3,785,923, INT. CL. 21.
- HANDS ON SCIENCE OUTREACH INC., SILVER SPRING, MD:
2,271,652, CANC. INT. CL. 41.
2,271,653, CANC. INT. CL. 41.
- HANDY STORE FIXTURES, NEWARK, NJ, DBA NU SHELF:
3,786,101, INT. CL. 20.
- HANIA BY ANYA COLE, L.L.C., NEW YORK, NY:
3,783,768, PUB. 2-16-2010. INT. CL. 25.
- HANLEY-WOOD, LLC, WASHINGTON, DC:
2,382,338, REN. 3-31-10. INT. CL. 42.
- HANNA, BEVERLY I., JACKSON, MI:
2,352,160, REN. 3-31-10. INT. CL. 28.
- HANS-JOACHIM UHLEMANN, HALTERN, FED REP GERMANY:
2,751,654, CANC. INT. CL. 10.
- HANSEN A. CHANG, L.L.C., STONE MOUNTAIN, GA:
3,783,309, PUB. 2-16-2010. MULTIPLE CLASS, INT. CLS. 5 AND 44.
- HANSEN BEVERAGE COMPANY, CORONA, CA:
3,785,527, MULTIPLE CLASS, INT. CLS. 5 AND 32.
- HANSON, ANDREW, LEE, HENDERSON, NV:
2,754,435, CANC. INT. CL. 25.

- HAPPY MONKEY HUMMUS, LLC, SALT LAKE CITY, UT:
3,784,139, PUB. 2-16-2010. INT. CL. 29.
- HAPPYFEET LEGENDS INTERNATIONAL, LENEXA, KS:
3,786,029, INT. CL. 41.
- HARAJUKU LOVERS, LLC, BEVERLY HILLS, CA:
3,785,424, INT. CL. 3.
- HARBOR SEAFOOD, INC., NEW HYDE PARK, NY:
3,785,737, INT. CL. 29.
- HARD CORE FITNESS, LLC, LOUISVILLE, KY:
3,784,668, PUB. 2-16-2010. INT. CL. 41.
- HARDAGE SUITE HOTELS, L.L.C., SAN DIEGO, CA:
2,272,194, CANC. INT. CL. 36.
- HARDEE'S FOOD SYSTEMS, INC., ST. LOUIS, MO:
3,784,022, PUB. 2-16-2010. INT. CL. 30.
3,784,435, PUB. 2-16-2010. INT. CL. 43.
3,784,436, PUB. 2-16-2010. INT. CL. 43.
3,784,437, PUB. 2-16-2010. INT. CL. 43.
3,784,438, PUB. 2-16-2010. INT. CL. 43.
- HARDIE'S FRUIT & VEGETABLE COMPANY, INC., DAL-
LAS, TX:
2,752,433, CANC. MULTIPLE CLASS, INT. CLS. 29 AND
30.
- HARDING, CHRISTINE, MISSION VIEJO, CA:
3,786,054, INT. CL. 14.
- HARDKORE, INC., CHEYENNE, WY:
3,785,171, INT. CL. 25.
- HARGRAVE, HOLLY, MONTCLAIR, NJ:
3,785,845, MULTIPLE CLASS, INT. CLS. 16 AND 41.
- HARLAND CLARKE CORP., SAN ANTONIO, TX:
3,786,455, MULTIPLE CLASS, INT. CLS. 16, 22 AND 35.
- HARLEYSVILLE MUTUAL INSURANCE COMPANY, HAR-
LEYSVILLE, PA:
3,784,336, PUB. 2-16-2010. INT. CL. 36.
- HARMONIC COMMUNICATION, SAN FRANCISCO, CA:
2,753,723, CANC. INT. CL. 35.
- HARMONY BIOSCIENCE, INC., SAN GABRIEL, CA:
3,784,245, PUB. 2-16-2010. INT. CL. 5.
- HAROLD STEVENS JEWELERS, INC., SAN DIEGO, CA:
1,552,795, CANC. INT. CL. 14.
- HARPER BRUSH WORKS, INC., FAIRFIELD, IA:
3,785,783, INT. CL. 21.
- HARRAHS LICENSE COMPANY, LLC, LAS VEGAS, NV:
3,784,830, PUB. 2-16-2010. INT. CL. 36.
- HARRIS PUBLICATIONS, INC., NEW YORK, NY:
3,785,678, INT. CL. 9.
- HARRIS-EXIGENT, INC., MELBOURNE, FL:
2,753,464, CANC. INT. CL. 9.
- HARRIS, FREDERICK J., NAALEHU, HI:
3,786,256, INT. CL. 38.
- HART, KARIN, VILLA PARK, CA:
2,754,271, CANC. INT. CL. 25.
- HARTFORD FIRE INSURANCE COMPANY, HARTFORD,
CT:
2,753,291, CANC. INT. CL. 36.
2,753,292, CANC. INT. CL. 36.
3,785,388, INT. CL. 36.
- HARTMAN OIL CO., INC., WICHITA, KS:
3,784,062, PUB. 2-16-2010. MULTIPLE CLASS, INT. CLS.
4, 42 AND 43.
- HARTMAN, BILL, COUNTY KERRY, IRELAND, DBA
GURU MUSIC:
2,753,319, CANC. MULTIPLE CLASS, INT. CLS. 9 AND
16.
- HARUKO KINASE-LEGGETT, URBANA, IL:
3,786,473, INT. CL. 14.
- HARVEY BALL SMILE LIMITED, SHINAGAWA-KU TO-
KYU, JAPAN:
3,785,723, INT. CL. 25.
3,785,724, INT. CL. 25.
3,785,725, INT. CL. 25.
3,785,726, INT. CL. 25.
3,785,772, MULTIPLE CLASS, INT. CLS. 14, 16, 18, 21
AND 28.
3,785,773, MULTIPLE CLASS, INT. CLS. 14, 16, 18, 21
AND 28.
3,785,774, MULTIPLE CLASS, INT. CLS. 14, 16, 18, 21
AND 28.
- HARVEY, WILLIAM T., CARSON CITY, NV:
1,553,023, CANC. INT. CL. 28.
- HASBRO, INC., PAWTUCKET, RI:
2,752,656, CANC. INT. CL. 28.
3,785,955, INT. CL. 28.
- HASKIN MARKETING, LLC, PEARLAND, TX:
3,784,296, PUB. 2-16-2010. INT. CL. 43.
- HATFIELD, CRAIG, MORGANTOWN, WV:
3,786,422, INT. CL. 28.
- HAV-A-GYRO, INC., SEVEN HILLS, OH:
2,379,623, REN. 3-31-10. INT. CL. 42.
- HAVEL'S INC., CINCINNATI, OH:
2,752,007, CANC. MULTIPLE CLASS, INT. CLS. 16 AND
35.
- HAWAII VISITORS AND CONVENTION BUREAU, HONO-
LULU, HI:
2,334,812, REN. 3-26-10. INT. CL. 35.
- HAWAII KINE INC., TORTOLA, BR. VIRGIN ISLANDS:
3,720,030, COR. INT. CL. 30.
- HAWKES RADIATOR, PHOENIX, AZ:
2,751,918, CANC. MULTIPLE CLASS, INT. CLS. 7 AND
35.
- HAWORTH PRESS, INC., THE, BINGHAMPTON, NY:
2,271,880, CANC. INT. CL. 16.
- HAYES BICYCLE GROUP, INC., MEQUON, WI:
2,343,931, REN. 3-30-10. INT. CL. 12.
- HAYES MICROCOMPUTER PRODUCTS, INC., ATLANTA,
GA:
1,552,587, CANC. INT. CL. 9.
- HAYES, RICARDO, ST. LOUIS, MO:
3,785,115, INT. CL. 31.
- HAYS, GARRY, GRESHAM, OR:
3,786,391, INT. CL. 25.
- HBH LIMITED PARTNERSHIP:
1,553,044, CANC. MULTIPLE CLASS, INT. CLS. 29 AND
30.
- HBI BRANDED APPAREL ENTERPRISES, LLC, WINSTON-
SALEM, NC:
2,754,462, CANC. INT. CL. 25.
- HBO & COMPANY OF GEORGIA, ATLANTA, GA:
2,271,313, CANC. INT. CL. 42.
- HEAD ACQUISITION, L.P., CHICAGO, IL:
2,751,675, CANC. MULTIPLE CLASS, INT. CLS. 35 AND
36.
2,751,677, CANC. MULTIPLE CLASS, INT. CLS. 35 AND
36.
- HEADCO INDUSTRIES, INC., BROADVIEW, IL, BEARING
HEADQUARTERS CO., BROADVIEW, IL:
892,822, REN. 3-28-10. U.S. CL. 23 (INT. CLS. 7 AND 8).
- HEADSTART CORPORATION, LTD, FREEPORT, BAHAMA-
S:
3,784,234, PUB. 2-16-2010. INT. CL. 35.
- HEALTH CARE SERVICE CORPORATION, CHICAGO, IL:
2,826,801, CANC. INT. CL. 35.
- HEALTH DEVICES CORPORATION, NORTH HOLLY-
WOOD, CA:
2,754,058, CANC. INT. CL. 10.
- HEALTH READY, INC., DANA POINT, CA:
2,272,622, CANC. INT. CL. 36.
- HEALTH SCIENCES LIBRARIES CONSORTIUM, PHILA-
DELPHIA, PA:
3,783,743, PUB. 2-16-2010. INT. CL. 38.
- HEALTHCORE LLC, CARLISLE, PA:
2,753,160, CANC. INT. CL. 35.
- HEALTHGRAM, INC., CHARLOTTE, NC, HEALTHGRAM,
INC., CHARLOTTE, NC:
2,386,580, REN. 3-31-10. INT. CL. 42.
- HEARST COMMUNICATIONS, INC., NEW YORK, NY,
HOUSE BEAUTIFUL PUBLISHING CORPORATION,
THE, BOSTON, MA:
273,427, REN. 4-1-10. U.S. CL. 38 (INT. CL. 16).
- HEARST COMMUNICATIONS, INC., NEW YORK, NY:
2,911,418, CANC. INT. CL. 31.
3,785,509, INT. CL. 25.
- HEARST HOLDINGS, INC., NEW YORK, NY AND
FLEISCHER STUDIOS, INC., BEVERLY HILLS, CA:
2,361,245, REN. 3-29-10. MULTIPLE CLASS, INT. CLS. 5,

- 14, 18, 20, 21, 24, 25 AND 28.
2,361,245, CANC. INT. CL. 11.
- HEART OF SUCCESS, INC, TUCSON, AZ:
3,784,071, PUB. 2-16-2010. INT. CL. 41.
- HEARTLAND COUNTRY CO-OP, WESTBY, WI:
3,783,108, PUB. 10-13-2009. MULTIPLE CLASS, INT. CLS.
35 AND 44.
- HEARTLAND FOODS, INC., ENID, OK:
2,753,484, CANC. INT. CL. 29.
- HEARTLAND PAYMENT SYSTEMS, INC., PRINCETON,
NJ:
3,786,316, INT. CL. 36.
- HEARTS ON FIRE COMPANY, LLC, BOSTON, MA:
2,273,133, CANC. INT. CL. 14.
- HEARTSTONE MERCANTILE LLC, HAYWARD, WI:
3,783,817, PUB. 2-16-2010. MULTIPLE CLASS, INT. CLS.
25 AND 35.
- HEAVENST SHOE INC., BRONX, NY:
2,436,216, REN. 3-27-10. INT. CL. 25.
- HEAVY DUTY REBUILDERS SUPPLY, INC., OZARK, MO:
2,422,712, REN. 3-30-10. INT. CL. 12.
- HEB GROCERY COMPANY, LP, SAN ANTONIO, TX:
2,753,289, CANC. INT. CL. 35.
- HEGSTAD, IVAR A., WELLESLEY HILLS, MA:
1,553,197, CANC. INT. CL. 35.
- HEIDELBERGER BRAUEREI GMBH, FED REP GER-
MANY:
3,784,943, PUB. 2-16-2010. MULTIPLE CLASS, INT. CLS.
16 AND 32.
- HEIDELBERGER DRUCKMASCHINEN AG, 69115 HEIDEL-
BERG, FED REP GERMANY:
2,752,014, CANC. INT. CL. 9.
- HELADOS VALLARTA, INC., FRESNO, CA:
3,785,912, INT. CL. 30.
3,785,913, INT. CL. 30.
- HELIX CONSULTING, LLC, MOUNT KISCO, NY:
3,786,301, INT. CL. 45.
- HELLER, DIANE, OMAHA, NE:
3,783,532, PUB. 2-16-2010. INT. CL. 39.
- HELLERMANN TYTON COPORATION, MILWAUKEE, WI,
TYTON CORPORATION, MILWAUKEE, WI:
1,132,069, REN. 4-1-10. INT. CL. 6.
- HELLERMANN TYTON CORPORATION, MILWAUKEE,
WI:
2,339,216, REN. 4-1-10. INT. CL. 7.
- HELPING HANDS MOVERS, INC., JACKSONVILLE, FL:
3,783,621, PUB. 11-10-2009. INT. CL. 35.
- HEMOPET, SANTA MONICA, CA:
1,608,786, REN. 3-26-10. MULTIPLE CLASS, INT. CLS. 5
AND 10.
- HENDELES, YDESSA, TORONTO, ONTARIO, CANADA:
2,336,373, REN. 3-30-10. INT. CL. 28.
- HENDERSON ENGINEERS, INC., LENEXA, KS:
3,785,863, INT. CL. 42.
- HENDERSON, ROBERT T, JR., MIAMI, FL:
2,753,092, CANC. INT. CL. 25.
- HENDRIX, HARVILLE, NEW YORK, NY:
3,785,531, INT. CL. 41.
- HENKEL AG & CO. KGAA, DUESSELDORF, FED REP
GERMANY:
3,786,223, INT. CL. 16.
- HENKEL CONSUMER GOODS INC., SCOTTSDALE, AZ:
3,785,914, INT. CL. 3.
- HENKEL CONSUMER GOODS, INC., SCOTTSDALE, AZ:
1,552,432, CANC. INT. CL. 3.
- HENRY ELLIOTT AND COMPANY INC., WELLESLEY, MA:
2,438,314, REN. 3-30-10. INT. CL. 35.
- HER ROYAL HIGHNESS PRINCESS SIRIVANNAVARI
NARIRATANA, BANGKOK, THAILAND:
3,785,215, INT. CL. 25.
- HEREFORD INDUSTRIES (PTY) LIMITED, ESTCOURT,
SOUTH AFRICA:
2,753,694, CANC. INT. CL. 22.
- HERLANDS, LEE, BEACHWOOD, OH:
3,786,284, INT. CL. 41.
- HERMANN HOLTkamp KG, REES HAFFEN, FED REP
GERMANY:
1,553,147, CANC. INT. CL. 31.
- HERO NUTRITIONALS, LLC, SAN CLEMENTE, CA:
3,783,340, PUB. 2-16-2010. INT. CL. 5.
- HERO-GEAR, LLC, WINCHESTER, TN:
3,786,112, INT. CL. 13.
- HERO/WHITEWAVE, LLC, BROOMFIELD, CO:
3,785,854, INT. CL. 32.
- HERSHEY CHOCOLATE & CONFECTIONERY CORPORA-
TION, WHEAT RIDGE, CO:
2,752,911, CANC. INT. CL. 9.
- HERTZ SYSTEM, INC., PARK RIDGE, NJ:
1,583,987, REN. 3-29-10. INT. CL. 39.
2,321,406, REN. 3-31-10. INT. CL. 39.
- HESTER INDUSTRIES, INC., MOOREFIELD, WV:
1,553,368, CANC. INT. CL. 29.
- HEUBACH, RAINER, A-5084 GROSSGMANN, AUSTRIA:
2,754,379, CANC. INT. CL. 2.
- HEWLETT-PACKAD DEVELOPMENT COMPANY, LP,
HOUSTON, TX:
2,341,672, REN. 3-26-10. INT. CL. 1.
2,341,672, CANC. INT. CL. 2.
- HH FARMWORKS, INC., SAN DIEGO, CA:
2,751,823, CANC. INT. CL. 42.
- HHH HOLDINGS, LLC, LAS VEGAS, NV:
3,785,788, INT. CL. 43.
- HI-DOW INTERNATIONAL, ST. LOUIS, MO:
3,784,054, PUB. 2-16-2010. INT. CL. 10.
- HICKSON, STEVE, SOUTH ORANGE, NJ:
3,784,551, PUB. 2-16-2010. INT. CL. 35.
- HIGGS, JONATHAN M., FRANKLIN, TN:
3,783,871, PUB. 2-16-2010. INT. CL. 9.
- HIGH SCOPE EDUCATIONAL RESEARCH FOUNDATION,
YPSILANTI, MI:
2,274,332, AM. INT. CL. 41.
- HIGH SCOPE EDUCATIONAL RESEARCH FOUNDATION,
YPSILANTI, MI:
2,274,331, AM. INT. CL. 16.
- HIGH SPEED WAX, INC., LAKE ELMO, MN:
2,752,297, CANC. INT. CL. 28.
- HIGHTECH FISHING LLC, MINNETRISTA, MN:
3,785,870, MULTIPLE CLASS, INT. CLS. 9 AND 16.
- HILL-ROM SERVICES PTE. LTD., SINGAPORE, SINGA-
PORE:
2,751,953, CANC. INT. CL. 10.
- HILL, CURTIS JOHN, GRAND RAPIDS, MN:
2,754,574, CANC. MULTIPLE CLASS, INT. CLS. 25 AND
28.
- HILLERICH & BRADSBY CO., LOUISVILLE, KY:
2,754,310, CANC. INT. CL. 29.
- HILLSBOROUGH RIVER REALTY CORP., TAMPA, FL:
2,336,591, REN. 3-26-10. INT. CL. 37.
- HINES, JAMES, SALISBURY, NC:
3,783,483, PUB. 2-16-2010. INT. CL. 41.
- HINES, MILLIE, GLEN COVE, NY:
2,341,940, REN. 3-31-10. INT. CL. 28.
- HINSBERGERS POLY INDUSTRIES LTD., MISSISSAUGA,
ONTARIO, ONTARIO:
2,753,597, CANC. INT. CL. 19.
- HIONIS, EVANGGELOS, CONCORDVILLE, PA:
2,751,808, CANC. INT. CL. 7.
- HISPANIC INFORMATION AND TELECOMMUNICA-
TIONS NETWORK, INC., BROOKLYN, NY:
3,786,380, INT. CL. 38.
- HISSONG DEVELOPMENT CORPORATION, KENNE-
BUNK, ME:
3,783,511, PUB. 2-16-2010. MULTIPLE CLASS, INT. CLS.
36, 37 AND 43.
- HIT PLAY LLC, VERONA, NJ:
3,785,710, INT. CL. 9.
- HIT PRODUCTS CORPORATION, LINDSAY, CA:
3,783,849, PUB. 2-16-2010. INT. CL. 7.
3,783,850, PUB. 2-16-2010. INT. CL. 7.
- HITACHI AMERICA, LTD., TARRYTOWN, NY:
3,785,269, INT. CL. 9.
- HITACHI MAXCO, LTD, KENNESAW, GA:
2,385,504, REN. 3-26-10. INT. CL. 6.
- HITMAN, INC., LAS VEGAS, NV:
3,784,682, PUB. 2-16-2010. INT. CL. 35.

HLS ECOLO INC., TORONTO, ONTARIO, CANADA, ECOLO ODOR CONTROL SYSTEMS INC., MISSISSAUGA, ONTARIO, CANADA:
1,587,387. REN. 3-31-10. INT. CL. 5.

HMT, INC., HOUSTON, TX:
2,754,367. CANC. INT. CL. 6.

HNI TECHNOLOGIES INC., MUSCATINE, IA:
3,785,694. INT. CL. 20.

HOBSONS, INC., CINCINNATI, OH:
3,783,129. PUB. 2-16-2010. INT. CL. 42.

HODGES, ROBERT, ARTESIA, NM:
2,754,284. CANC. INT. CL. 35.

HOEG EXPORTACIONES, S.A., 28034 MADRID, SPAIN:
2,752,736. CANC. INT. CL. 31.

HOEGANAES CORPORATION, CINNAMINSON, NJ:
2,397,170. REN. 4-1-10. INT. CL. 6.

HOFFMAN, CINDY, MEDIA, PA:
2,753,255. CANC. INT. CL. 41.

HOFFMANN-LA ROCHE INC., NUTLEY, NJ:
2,272,889. CANC. INT. CL. 42.

HOFFMANN, ISABELLA, WEST ALLIS, WI, DBA BEARLY COLLECTIBLES:
3,783,924. PUB. 2-16-2010. INT. CL. 16.

HOLDING PATTERN PRODCUTS LLC, MEDINA, OH:
3,783,615. PUB. 2-16-2010. INT. CL. 28.

HOLDINGS ACQUISITION COMPANY LP, CHICAGO, IL:
3,786,045. INT. CL. 41.

HOLE IN THE WALL GANG FUND, INC., NEW HAVEN, CT:
3,783,732. PUB. 2-16-2010. INT. CL. 36.
3,783,733. PUB. 2-16-2010. INT. CL. 36.

HOLLINGSWORTH & VOSE COMPANY, EAST WALPOLE, MA:
2,753,940. CANC. INT. CL. 11.

HOLLOMET GMBH, FED REP GERMANY:
3,784,994. PUB. 2-16-2010. MULTIPLE CLASS, INT. CLS. 1 AND 42.

HOLLY POULTRY, INC., BALTIMORE, MD:
3,783,984. PUB. 2-16-2010. INT. CL. 29.

HOLMES, AUDREY N., BROOKLYN, NY:
3,783,196. PUB. 11-10-2009. INT. CL. 41.

HOLOGIC, INC., BEDFORD, MA:
3,785,776. INT. CL. 10.

HOLSTED MARKETING INC., NEW YORK, NY:
2,754,561. CANC. INT. CL. 21.

HOLT TEXAS, LTD., SAN ANTONIO, TX:
3,783,090. PUB. 6-17-2008. INT. CL. 9.

HOLT, DAVID P., COCONUT CREEK, FL:
3,784,649. PUB. 2-16-2010. INT. CL. 39.

HOLTHE, DONALD F., VILLA PARK, CA:
2,751,618. CANC. MULTIPLE CLASS, INT. CLS. 9 AND 35.

HOLY MEASURES, LLC, CHICAGO, IL:
3,785,918. INT. CL. 35.
3,785,980. INT. CL. 42.

HOME BENEFICIAL LIFE INSURANCE COMPANY, RICHMOND, VA:
1,553,244. CANC. INT. CL. 36.

HOME BOX OFFICE, INC., NEW YORK, NY:
3,785,133. INT. CL. 38.

HOME GROWN LACROSSE, LLC, NORTH ANDOVER, MA:
3,368,803. CANC. INT. CL. 41.

HOME LEGEND INT'L INC., CHINO, CA:
3,785,071. MULTIPLE CLASS, INT. CLS. 16, 19, 20 AND 24.

HOME MEDIA STORES, L.C., MIDLOTHIAN, VA:
2,337,755. REN. 3-31-10. MULTIPLE CLASS, INT. CLS. 35, 37 AND 42.

HOME SOURCE INTERNATIONAL, ATLANTA, GA:
3,783,385. PUB. 2-16-2010. INT. CL. 40.

HOMEBRIDGE SECURITY, LLC, DEERFIELD BEACH, FL:
3,784,537. PUB. 2-16-2010. INT. CL. 45.

HOMEMADE PUBLICATIONS, KELSEYVILLE, CA:
3,784,086. PUB. 2-16-2010. INT. CL. 41.

HOMER TLC, INC., CLAYMONT, DE:
2,752,921. CANC. INT. CL. 8.

HOMEWISE, INC., SANTA FE, NM:
3,785,506. MULTIPLE CLASS, INT. CLS. 36 AND 37.

HONDA ELESYS CO., LTD., YOKOHAMA CITY KANAGAWA, JAPAN:
3,783,713. PUB. 2-16-2010. INT. CL. 9.

HONDA GIKEN KOGYO KABUSHIKI KAISHA (HONDA MOTOR CO., LTD.), MINATO-KU, TOKYO 107, JAPAN:
2,272,458. CANC. INT. CL. 12.

HONEY FASHIONS, LTD., NEW YORK, NY:
1,605,646. REN. 3-30-10. INT. CL. 25.

HONEY-BUTTER PRODUCTS CO., INC., MANHEIM, PA, DOWNEY'S HONEY BUTTER COMPANY, INC., ITHACA, NY:
696,157. REN. 3-30-10. U.S. CL. 46 (INT. CL. 30).

HONEYMOON ELEGANCE ETC. INC., BUFFALO, NY:
2,753,847. CANC. INT. CL. 16.

HONG KONG TRADE DEVELOPMENT COUNCIL, WAN-CHAI, HONG KONG:
2,327,982. REN. 3-26-10. INT. CL. 35.

HOODLOVE LIMITED LIABILITY COMPANY, EAST ORANGE, NJ:
3,786,293. INT. CL. 25.

HOOP PLANET, FORT WASHINGTON, MD:
3,784,764. PUB. 2-16-2010. INT. CL. 25.

HOORAY LLC, WHITE PLAINES, NY:
2,284,538. REN. 3-26-10. INT. CL. 28.

HOOVER MATERIALS HANDLING GROUP, INC., ALPHARETTA, GA:
2,753,529. CANC. MULTIPLE CLASS, INT. CLS. 6, 7 AND 20.

HOPE PROJECT, THE, DOUGLASVILLE, GA:
2,752,067. CANC. INT. CL. 41.

HORN INTERACTIVE, INC., CINCINNATI, OH:
2,752,516. CANC. INT. CL. 42.

HOSHINO GAKKI CO., LTD., HIGASHI-KU, NAGOYA 461-91, JAPAN:
1,133,090. REN. 3-26-10. INT. CL. 15.

HOSHOR, KATHRYN ANNE, CARMEL, CA:
1,553,092. CANC. INT. CL. 30.

HOSTESS BRANDS, INC., IRVING, TX:
521,717. REN. 4-1-10. U.S. CL. 46 (INT. CL. 30).
1,563,604. REN. 4-1-10. INT. CL. 30.

HOT HARRY'S FRESH BURRITOS, INC., PITTSFIELD, MA:
3,784,600. PUB. 2-16-2010. INT. CL. 43.

HOUBEN, LIGIA, MIAMI, FL:
3,785,963. INT. CL. 41.
3,785,967. INT. CL. 41.

HOUGHTON INTERNATIONAL, VALLEY FORGE, PA, D. A. STUART & CO., CHICAGO, IL:
134,443. REN. 3-31-10. U.S. CL. 15 (INT. CL. 4).

HOUGHTON MIFFLIN COMPANY, BOSTON, MA:
2,752,362. CANC. INT. CL. 16.

HOUSE LOANS MORTGAGE SERVICES CORP., SANTA ANA, CA, DBA LDS LENDERS:
3,784,624. PUB. 2-16-2010. INT. CL. 35.

HOUSE OF IMPORTS, INC., LAKEWOOD, CO:
2,424,995. REN. 3-29-10. INT. CL. 35.

HOWARD ENTERPRISES INC., LYNN, IN:
3,783,508. PUB. 2-16-2010. INT. CL. 7.

HOWARD, ROBERT, SCOTT, PHOENIX, AZ:
3,415,482. CANC. INT. CL. 9.

HPL TECHNOLOGIES, INC., SAN JOSE, CA:
2,752,139. CANC. MULTIPLE CLASS, INT. CLS. 9, 41 AND 42.

HR ASSESSMENT, INC., ALTAMONTE SPRINGS, FL:
2,753,004. CANC. INT. CL. 41.

HS TM, LLC, NEWARK, DE:
2,415,807. REN. 3-27-10. INT. CL. 36.
3,784,743. PUB. 2-16-2010. INT. CL. 5.
3,785,558. INT. CL. 9.

HSN LP, ST. PETERSBURG, FL:
3,785,500. INT. CL. 25.

HUBBELL INCORPORATED, ORANGE, CT:
2,751,594. CANC. INT. CL. 9.

HUERFANO FARM, INC., MCINTOSH, NM:
3,784,112. PUB. 2-16-2010. INT. CL. 29.

HUFF, JOHN R., FAIRFIELD, IA:
2,753,242. CANC. MULTIPLE CLASS, INT. CLS. 20 AND 22.

- HUGHES ENVIRONMENTAL ENGINEERING, INC., MONTVALE, NJ:
3,783,348, PUB. 2-16-2010. INT. CL. 37.
- HUGO BOSS TRADE MARKS MANAGEMENT GMBH & CO. KG, METZINGEN, FED REP GERMANY:
2,831,267, CANC. INT. CL. 23.
- HUHTAMAKI, INC., DESOTO, KS:
1,132,091. REN. 3-31-10. INT. CL. 7.
1,138,374. REN. 3-26-10. INT. CL. 16.
- HUIZHOU SHI NAWEISHI; SHITINGKEJI YOUXIANGONGSI, CHINA:
3,785,007, PUB. 2-16-2010. INT. CL. 9.
- HULU, LLC, LOS ANGELES, CA:
3,786,192, MULTIPLE CLASS, INT. CLS. 38, 41 AND 42.
- HUMAN RESOURCE DEVELOPMENT ENTERPRISES, ARLINGTON, VA:
2,752,396, CANC. INT. CL. 35.
- HUMANICS, INC., BETHEL, CT:
2,338,808. REN. 3-26-10. INT. CL. 35.
- HUNGRY FISH MEDIA, LLC, CAMBRIDGE, MA:
3,786,044, INT. CL. 5.
- HUNTER AMENITIES INTERNATIONAL LTD./LES ARTICLES D'CCUEIL HUNTER INTERNATIONALE LTEE, BURLINGTON, ONTARIO, CANADA TO HUNTER AMENITIES INTERNATIONAL LTD./LES ARTICLES D'CCUEIL HUNTER INTERNATIONALE LTEE, BURLINGTON, ONTARIO, CANADA:
2,391,788, AM. MULTIPLE CLASS, INT. CLS. 3, 25 AND 26.
- HUNTSMAN INTERNATIONAL LLC, SALT LAKE CITY, UT:
2,294,301. REN. 3-29-10. INT. CL. 17.
- HURON CONSULTING GROUP INC., CHICAGO, IL:
3,785,598, INT. CL. 35.
- HURTADO CHILE COMPANY, BOLINGBROOK, IL:
3,784,281, PUB. 2-16-2010. INT. CL. 30.
- HUSTON, HARRY, PALM DESERT, CA AND HUSTON, JEANETTE, PALM DESERT, CA:
2,433,582. REN. 3-31-10. INT. CL. 3.
- HUXTABLE'S KITCHEN, INC., VERNON, CA:
2,362,474. REN. 3-30-10. INT. CL. 30.
- HYDROHOIST MARINE GROUP, INC., CLAREMORE, OK:
2,271,500, CANC. INT. CL. 40.
- HYGIENE TECHNOLOGIES INTERNATIONAL, INC., TORRANCE, CA:
2,752,299, CANC. INT. CL. 42.
- HYMAN ENTERPRISES LLC, LENOX, MA:
3,785,121, INT. CL. 5.
- HYPERTECH, INC., BARTLETT, TN:
3,783,418, PUB. 2-16-2010. INT. CL. 9.
- HYPNOTIC HATS, LTD., NEW YORK, NY:
2,272,013, CANC. INT. CL. 25.
- HYPRED, DINARD, FRANCE:
2,752,935, CANC. MULTIPLE CLASS, INT. CLS. 3 AND 5.
- HYY (BVI) LIMITED, KOWLOON, HONG KONG:
3,785,145, INT. CL. 5.
- H3ENTERPRISES INC. (HTRE), WESTFIELD, NJ:
3,783,172, PUB. 2-16-2010. INT. CL. 43.
- I CARE SLEEP, LLC, HIGH POINT, NC:
3,785,318, INT. CL. 20.
- I MEDIAREACH, LLC, WINTER SPRINGS, FL:
3,786,067, INT. CL. 35.
3,786,126, INT. CL. 35.
- I PLAY, INC., ASHEVILLE, NC:
3,785,873, INT. CL. 5.
3,785,875, INT. CL. 8.
- I TO THE FUTURE, LTD., PARK RIDGE, NJ, DBA IMAGINE TOMORROW:
2,753,006, CANC. INT. CL. 41.
- I.C.E.D. MANAGEMENT, INC., WILMINGTON, DE:
2,751,815, CANC. INT. CL. 16.
- I.C.O.N. LINE, INC., NORTHRIDGE, CA:
3,084,021, CANC. INT. CL. 3.
- I.H.I., SALT LAKE CITY, UT:
2,340,689. REN. 3-27-10. MULTIPLE CLASS, INT. CLS. 41 AND 42.
- I-TEC ELECTRONICS INC., MIAMI, FL:
3,785,458, INT. CL. 9.
- I-TEK METAL MANUFACTURING CO., LTD., TAINAN 709, TAIWAN:
2,386,527. REN. 3-30-10. INT. CL. 6.
- IAC/INTERACTIVECORP, NEW YORK, NY:
3,783,301, PUB. 2-16-2010. INT. CL. 35.
- IBASIS, INC., BURLINGTON, MA:
3,786,449, INT. CL. 16.
- IBC GROUP, INC., FT. LAUDERDALE, FL:
3,785,722, INT. CL. 20.
- IBC USA CONFERENCES, INC., WESTBOROUGH, MA:
2,752,763, CANC. INT. CL. 35.
- IBCO SRL, ST. MICHAEL, BARBADOS:
3,786,347, INT. CL. 17.
- IBG HOLDINGS, INC., ALTADENA, CA:
3,785,185, INT. CL. 3.
- IBIS BIOSCIENCES, INC., CARLSBAD, CA:
3,786,331, INT. CL. 9.
3,786,332, MULTIPLE CLASS, INT. CLS. 42 AND 44.
- ICC EVALUATION SERVICE, INC., WHITTIER, CA:
3,784,316, PUB. 2-16-2010. INT. CL. 42.
3,786,438, INT. CL. 42.
- ICONOCLAST PRODUCTIONS, LLC, CINCINNATI, OH:
2,752,776, CANC. INT. CL. 41.
- ICTV, INC., LOS GATOS, CA:
2,754,504, CANC. INT. CL. 9.
- IDA CRUISES - GERMAN BRANCH OF SOCIETA DI CROCIERE MERCURIO S.R.L., ROSTOCK, FED REP GERMANY:
2,752,088, CANC. MULTIPLE CLASS, INT. CLS. 3, 12, 14, 16, 18, 25, 28, 30, 32, 33, 39, 41, 42, 43 AND 44.
- IDEA MANAGEMENT LLC, FORT WAYNE, IN:
2,752,563, CANC. INT. CL. 42.
- IDEAL INDUSTRIES, INC., SYCAMORE, IL:
890,829. REN. 3-29-10. MULTIPLE CLASS, U.S. CLS. 21 (INT. CLS. 7, 9, 11, 12 AND 15) AND 23 (INT. CLS. 6, 7, 8, 9, 11, 12, 16, 21 AND 28).
- IDENEC SOLUTIONS, INC., KELOWNA, BRITISH COLUMBIA:
2,751,710, CANC. INT. CL. 9.
- IDENTITY GROUP, LLC, SLATINGTON, PA:
3,783,901, PUB. 2-16-2010. INT. CL. 40.
- IDQ OPERATING, INC., IRVING, TX:
2,752,801, CANC. INT. CL. 1.
- IDYON, LLC, GREENSBORO, NC:
2,753,560, CANC. INT. CL. 14.
- IGLOO PRODUCTS CORP., HOUSTON, TX:
2,753,612, CANC. INT. CL. 21.
- IGNITE RESTAURANT GROUP, INC., HOUSTON, TX:
2,752,283, CANC. INT. CL. 43.
- IGO, INC., SCOTTSDALE, AZ:
3,783,726, PUB. 2-16-2010. INT. CL. 9.
- IGT, RENO, NV:
3,785,123, INT. CL. 9.
3,786,286, INT. CL. 9.
- IGUZZINI ILLUMINAZIONE S.P.A., RECANATI (MC), ITALY, IGUZZINI ILLUMINAZIONE S.P.A., RECANATI, PROVINCE OF MACERATA, ITALY:
1,595,180. REN. 3-29-10. INT. CL. 11.
- IKECOOL CORPORATION, LOS ANGELES, CA:
3,783,841, PUB. 2-16-2010. INT. CL. 9.
- ILIDS, LOS ANGELES, CA:
2,753,074, CANC. INT. CL. 25.
- ILLINOIS NATIONAL BANK, SPRINGFIELD, IL:
3,783,986, PUB. 2-16-2010. MULTIPLE CLASS, INT. CLS. 9 AND 36.
- ILLINOIS TOOL WORKS INC., GLENVIEW, IL, A.J. GERRARD & COMPANY, DES PLAINES, IL:
1,623,256. REN. 3-30-10. INT. CL. 6.
- ILLINOIS TOOL WORKS INC., GLENVIEW, IL:
2,271,573, CANC. INT. CL. 9.
2,272,006, CANC. INT. CL. 5.
2,272,095, CANC. INT. CL. 10.
2,272,097, CANC. INT. CL. 10.
- ILLINOIS TOOL WORKS INC., GLENVIEW, IL, ALLEN CODING SYSTEMS LIMITED, HERTFORDSHIRE AL7 1LD, ENGLAND:
2,293,898. REN. 4-1-10. INT. CL. 7.

ILLINOIS TOOL WORKS INC., GLENVIEW, IL:
2,753,795, CANC. INT. CL. 16.

IMAGIC NETWORK, INC., NORTON, OH:
2,753,680, CANC. INT. CL. 35.

IMAGINE AUDIO, HERMOSA BEACH, CA:
2,752,023, CANC. INT. CL. 9.

IMATION CORP., OAKDALE, MN:
909,557, REN. 3-26-10. U.S. CL. 26 (INT. CL. 9).

IMBERA ELECTRONICS OY, FINLAND:
3,784,882, PUB. 2-16-2010. INT. CL. 9.

IMD - INTERNATIONAL INSTITUTE FOR MANAGEMENT DEVELOPMENT, SWITZERLAND:
3,785,000, PUB. 2-16-2010. MULTIPLE CLASS, INT. CLS. 9, 16, 35 AND 41.

IMEGO INFINITY LIMITED, HONG KONG, HONG KONG:
3,784,478, PUB. 2-16-2010. INT. CL. 9.

IMI INTELLIGENT MEDICAL IMPLANTS AG, ZUG, SWITZERLAND:
3,786,348, MULTIPLE CLASS, INT. CLS. 42 AND 44.

IMMERSION CORPORATION, SAN JOSE, CA:
2,727,303, CANC. INT. CL. 9.

IMMUNETICS, INC., BOSTON, MA:
3,786,262, MULTIPLE CLASS, INT. CLS. 5 AND 9.

IMMUNITY TODAY, LLC, OLATHE, KS:
2,752,364, CANC. INT. CL. 5.

IMOTIONS - EMOTION TECHNOLOGY A/S, COPENHAGEN, DENMARK:
3,785,581, INT. CL. 9.

IMPLADENT LTD., HOLLISWOOD, NY:
3,783,597, PUB. 2-16-2010. INT. CL. 10.

IMULUS, BOULDER, CO:
3,785,426, INT. CL. 42.

IMURA INTERNATIONAL USA, INC., LENEXA, KS:
2,754,655, CANC. INT. CL. 21.

IN DEMAND, L.L.C., NEW YORK, NY:
2,752,478, CANC. INT. CL. 41.
2,752,479, CANC. INT. CL. 41.

IN JOY MEDIA, INC., FAIRFIELD, CA:
3,783,199, PUB. 7-1-2008. INT. CL. 9.

IN YOUR ELEMENT, SAN FRANCISCO, CA:
3,246,901, CANC. INT. CL. 35.

INCHCAPE SHIPPING SERVICES HOLDINGS LIMITED, ESSEX, UNITED KINGDOM:
2,828,526, CANC. INT. CL. 36.
2,828,526, AM. MULTIPLE CLASS, INT. CLS. 35 AND 39.

INCODE TELECOM GROUP, INC., ALPHARETTA, GA:
2,336,749, REN. 3-26-10. INT. CL. 42.

INDEPENDENT AUTO PARTS OF AMERICA, INC., GERMANTOWN, TN:
2,345,906, REN. 3-27-10. INT. CL. 37.

INDEPENDENT MEANS INC., SANTA BARBARA, CA:
2,334,844, REN. 3-26-10. INT. CL. 28.

INDEPENDENT SALT ALLIANCE, COLUMBUS, OH:
3,785,192, MULTIPLE CLASS, INT. CLS. 35, 36, 38 AND 41.

INDEPENDENT STAVE COMPANY, INC., LEBANON, MO:
3,785,674, INT. CL. 1.

INDIA GROCERS OF STERLING HEIGHTS, INC., STERLING HEIGHTS, MI:
2,751,933, CANC. INT. CL. 30.

INDIAN GROCERIES & SPICES, INC., SKOKIE, IL:
2,271,812, CANC. INT. CL. 29.

INDIAN SUMMER COOPERATIVE, INC., LUDINGTON, MI:
3,784,330, PUB. 2-16-2010. INT. CL. 29.

INDIANA NEWSPAPERS, INC., MCLEAN, VA:
2,272,671, CANC. INT. CL. 35.

INDIANA ORGAN PROCUREMENT ORGANIZATION, INC., INDIANAPOLIS, IN:
3,783,522, PUB. 2-16-2010. MULTIPLE CLASS, INT. CLS. 41 AND 44.

INDO-AMERICAN TRADE AND COMMERCE COUNCIL, WASHINGTON, DC:
2,754,570, CANC. INT. CL. 41.

INDRA SISTEMAS, S.A., 28108 ALCOBENDAS (MADRID), SPAIN:
2,752,474, CANC. INT. CL. 9.

INDUSTRIA DE DISEÑO TEXTIL, S.A., 15142 ARTEIXO, A CORUNA, SPAIN, GOASAM, S.A., ARTEIXO, LA CORUNA, SPAIN:
1,629,592, REN. 3-31-10. INT. CL. 42.

INDUSTRIA DE DISEÑO TEXTIL, S.A., 15142 ARTEIXO, A CORUNA, SPAIN, AKA INDITEX, S.A.:
2,382,430, REN. 3-31-10. MULTIPLE CLASS, INT. CLS. 9 AND 14.

INDUSTRIAL MATERIALS CORPORATION, HUNTINGTON BEACH, CA, DBA INTERNATIONAL VETERINARY SCIENCES, BIOGLAN, INC., LAGUNA HILLS, CA:
1,589,622, REN. 4-1-10. INT. CL. 3.

INDUSTRIAS ALEN, S.A. DE C.V., SANTA CATARINA, N.L., MEXICO, UDDO, JOSEPH F., NEW ORLEANS, LA, DBA F. UDDO & SONS COMPANY:
697,310, REN. 3-29-10. U.S. CL. 6 (INT. CL. 5).

INDYME ELECTRONICS, INC., SAN DIEGO, CA:
2,752,668, CANC. INT. CL. 9.
2,752,669, CANC. INT. CL. 9.

INEL COSMETICS CO., LTD., SEOUL, REPUBLIC OF KOREA:
3,783,542, PUB. 2-16-2010. INT. CL. 3.
3,783,545, PUB. 2-16-2010. INT. CL. 3.

INFEEL USA CORP., MEDLEY, FL:
3,783,569, PUB. 2-16-2010. INT. CL. 27.

INFERENCE CORPORATION, EL SEGUNDO, CA:
1,552,660, CANC. INT. CL. 9.

INFIMED, INC., LIVERPOOL, NY:
2,753,961, CANC. INT. CL. 10.
2,753,962, CANC. INT. CL. 10.

INFINEON TECHNOLOGIES AG, MUNCHEN, FED REP GERMANY:
2,751,731, CANC. INT. CL. 9.

INFLEXXION, INC., NEWTON, MA:
2,752,874, CANC. MULTIPLE CLASS, INT. CLS. 9 AND 42.

INFOASSURE.COM, INC., ARNOLD, MD:
2,753,625, CANC. INT. CL. 42.

INFOMAKERS SWEDEN AB, 131 37NACKA, SWEDEN:
2,751,681, CANC. MULTIPLE CLASS, INT. CLS. 35, 38 AND 42.

INFOR GLOBAL SOLUTIONS (MICHIGAN), INC., BINGHAM FARMS, MI:
2,326,161, REN. 3-27-10. INT. CL. 42.

INFORMATION PACKAGING INC., TORONTO, ONTARIO M4H 1M1, CANADA:
2,272,654, CANC. MULTIPLE CLASS, INT. CLS. 40 AND 42.

INFOSNAP, INC., BETHESDA, MD:
3,048,952, AM. MULTIPLE CLASS, INT. CLS. 9 AND 42.

INFOSTAF CONSULTING INC., CARROLLTON, TX, DBA SOURCEDIRECT.COM:
2,753,903, CANC. INT. CL. 9.

INFOWEAPONS, INC., DULUTH, GA:
3,783,464, PUB. 2-16-2010. INT. CL. 9.

INGE'S CHRISTMAS DECOR GMBH, NEUSTADT B. COBURG, FED REP GERMANY:
3,785,158, INT. CL. 28.

INGRAM INDUSTRIES INC., NASHVILLE, TN, DBA INGRAM AUDIO COMPANY:
1,588,303, REN. 3-31-10. INT. CL. 42.

INK ARMOR, LLC, LONG BEACH, CA:
3,784,270, PUB. 2-16-2010. INT. CL. 25.

INKTREE, INC., CHARLOTTESVILLE, VA:
3,785,322, INT. CL. 16.

INLAND PAPERBOARD & PACKAGING, INC., AUSTIN, TX:
2,754,410, CANC. INT. CL. 16.

INMOTION MUSCULOSKELETAL INSTITUTE, MEMPHIS, TN:
3,785,245, INT. CL. 42.

INNER LIGHT DESIGN, INC., NEDERLAND, CO, DBA THE NEW GREEN ECONOMY:
3,786,393, MULTIPLE CLASS, INT. CLS. 35, 41 AND 42.

INNER SIGHT, LLC, WHITEFISH, MT:
3,784,474, PUB. 2-16-2010. INT. CL. 9.

- INNER TRADITIONS INTERNATIONAL, LTD., ROCHESTER, VT:
1,552,639, CANC. INT. CL. 9.
- INNEROPTIC TECHNOLOGY, INC., HILLSBOROUGH, NC:
3,784,145, PUB. 2-16-2010. INT. CL. 10.
- INNOMEDIA PTE LTD., SINGAPORE SCIENCE PARK II, SINGAPORE:
2,272,705, CANC. INT. CL. 9.
2,272,706, CANC. INT. CL. 9.
- INNOTHERA TOPIC INTERNATIONAL, 94111 ARCUEIL, FRANCE:
2,751,576, CANC. MULTIPLE CLASS, INT. CLS. 5 AND 10.
- INNOVATECH, LLC, CHICAGO, IL:
1,589,376, REN. 3-29-10. INT. CL. 40.
- INNOVATION INTERACTIVE LLC, NEW YORK, NY:
2,753,090, CANC. MULTIPLE CLASS, INT. CLS. 35 AND 42.
- INNOVATIONS ASSOCIATES, INC., SUDBURY, MA, KIEFER, JR.; CHARLES F., SUDBURY, MA, DBA INNOVATION ASSOCIATES:
1,140,068, REN. 3-31-10. INT. CL. 35.
- INNOVATIVE CONSULTING, INC., BLUFFTON, SC:
3,783,601, PUB. 2-16-2010. INT. CL. 5.
- INNOVATIVE RESIN SYSTEMS, INC., WAYNE, NJ:
3,784,247, PUB. 2-16-2010. INT. CL. 1.
3,784,248, PUB. 2-16-2010. INT. CL. 1.
- INNOVENTOR ENGINEERING, INC., ST. LOUIS, MO:
2,334,412, REN. 3-31-10. MULTIPLE CLASS, INT. CLS. 40 AND 42.
- INSIDE TECHNOLOGIES, 69930 SAINT CLEMENT LES PLACES, FRANCE:
2,752,747, CANC. MULTIPLE CLASS, INT. CLS. 9 AND 42.
- INSIGHT I.P. HOLDINGS INC., CHEYENNE, WY:
3,783,753, PUB. 2-16-2010. INT. CL. 41.
- INSIGHTFUL CORPORATION, SEATTLE, WA:
2,753,715, CANC. INT. CL. 9.
- INSPIRE TOWER MEMORIAL, INC., CHARLOTTE, NC:
2,753,226, CANC. INT. CL. 36.
- INSPIRED TECHNOLOGIES, INC., LE SUEUR, MN:
3,783,491, PUB. 2-16-2010. INT. CL. 16.
3,783,492, PUB. 2-16-2010. INT. CL. 16.
3,783,493, PUB. 2-16-2010. INT. CL. 25.
- INSTALLERPOOL.COM LLC, KNOXVILLE, TN, AKA INSTALLERPOOL:
3,783,730, PUB. 2-16-2010. INT. CL. 42.
- INSTANTSERVICE.COM, INC., SEATTLE, WA:
3,783,091, PUB. 2-16-2010. INT. CL. 38.
- INSTINET, LLC, NEW YORK, NY:
2,338,502, REN. 3-26-10. INT. CL. 36.
- INSTITUT EUROPEEN D'ADMINISTRATION DES AFFAIRES (INSEAD), F-77305 FONTAINEBLEAU, FRANCE:
3,784,897, PUB. 2-16-2010. MULTIPLE CLASS, INT. CLS. 16, 35 AND 41.
- INSTITUTE FOR BUSINESS & HOME SAFETY, TAMPA, FL:
2,825,362, AM. U.S. CL. A.
- INSTITUTE FOR INTERNATIONAL ECONOMICS, WASHINGTON, DC:
3,783,087, PUB. 2-16-2010. MULTIPLE CLASS, INT. CLS. 16, 41 AND 42.
3,783,088, PUB. 2-16-2010. MULTIPLE CLASS, INT. CLS. 16, 41 AND 42.
3,783,089, PUB. 2-16-2010. MULTIPLE CLASS, INT. CLS. 16, 41 AND 42.
- INSTITUTE FOR PROFESSIONAL DEVELOPMENT, LTD., GOLDEN, CO, DBA CLINE/FAY INSTITUTE, INC.:
2,391,252, REN. 3-29-10. INT. CL. 16.
- INSTITUTE FOR THE FUTURE, THE, PALO ALTO, CA:
1,575,839, REN. 3-26-10. INT. CL. 42.
- INSTITUTE GUILFOYLE, BELMONT, MA:
1,803,765, CANC. INT. CL. 21.
- INSULASTICS, INC., PORTLAND, OR:
3,785,979, INT. CL. 42.
- INSUREGY AGENCY, INC., PURCHASE, NY:
3,784,025, PUB. 2-16-2010. INT. CL. 36.
- INTECHNO CONSULTING, BASEL, SWITZERLAND:
3,783,238, PUB. 9-29-2009. MULTIPLE CLASS, INT. CLS. 35, 41 AND 42.
- INTEL CORPORATION, SANTA CLARA, CA:
2,315,261, REN. 3-26-10. INT. CL. 9.
- INTELEMATICS AUSTRALIA PTY LTD, SYDNEY, NEW SOUTH WALES, 2000, AUSTRALIA:
2,753,569, CANC. MULTIPLE CLASS, INT. CLS. 39 AND 42.
- INTELLIGENT DOCUMENT REVIEW, INC., OVERLAND PARK, KS:
3,784,012, PUB. 2-16-2010. INT. CL. 45.
3,784,067, PUB. 2-16-2010. INT. CL. 45.
- INTELLISPACE, INC., NEW YORK, NY:
2,753,607, CANC. INT. CL. 38.
- INTELSAT CORPORATION, WILTON, CT:
2,272,516, CANC. INT. CL. 38.
2,272,517, CANC. INT. CL. 38.
- INTENZE PRODUCTS, INC., ROCHELLE PARK, NJ:
3,785,439, INT. CL. 2.
- INTERACTIVE EDGE, LLC, NEW YORK, NY:
2,752,022, CANC. INT. CL. 9.
- INTERAMERICAN MOTOR CORPORATION, CANOGA PARK, CA:
3,783,960, PUB. 2-16-2010. INT. CL. 35.
- INTERBRAND GROUP, LONDON, UNITED KINGDOM:
3,783,659, PUB. 2-16-2010. MULTIPLE CLASS, INT. CLS. 9, 35 AND 41.
3,785,022, PUB. 2-16-2010. MULTIPLE CLASS, INT. CLS. 9, 38 AND 42.
- INTERDENOMINATIONAL FOREIGN MISSION ASSOCIATION OF NORTH AMERICA, INC., WHEATON, IL:
2,372,999, REN. 3-26-10. INT. CL. 41.
- INTERDIGITAL COMMUNICATIONS CORPORATION, KING OF PRUSSIA, PA:
3,786,350, MULTIPLE CLASS, INT. CLS. 9 AND 42.
- INTERMOUNTAIN HEALTH CARE, INC., SALT LAKE CITY, UT:
2,752,365, CANC. INT. CL. 35.
- INTERNATIONAL ADHESIVES CORPORATION, PEMBROKE PARK, FL:
1,552,869, CANC. INT. CL. 16.
- INTERNATIONAL ASSOCIATION OF MACHINISTS AND AEROSPACE WORKERS, UPPER MARLBORO, MD:
1,133,886, REN. 3-29-10. U.S. CL. A.
- INTERNATIONAL BUSINESS MACHINES CORPORATION, ARMONK, NY:
1,552,866, CANC. INT. CL. 16.
- INTERNATIONAL BUSINESS MACHINES CORPORATION, ARMONK, NY, AKA IBM CORPORATION:
2,751,864, CANC. MULTIPLE CLASS, INT. CLS. 9, 35 AND 42.
- INTERNATIONAL BUSINESS MACHINES CORPORATION, ARMONK, NY, AKA IBM CORPORATION:
2,752,211, CANC. INT. CL. 9.
2,752,214, CANC. INT. CL. 42.
- INTERNATIONAL BUSINESS MACHINES CORPORATION, ARMONK, NY, AKA IBM CORPORATION:
3,783,150, PUB. 2-16-2010. INT. CL. 9.
- INTERNATIONAL BUSINESS MACHINES CORPORATION, ARMONK, NY:
3,785,127, MULTIPLE CLASS, INT. CLS. 9, 41 AND 42.
- INTERNATIONAL CENTER FOR LEADERSHIP IN EDUCATION, REXFORD, NY:
3,717,730, COR. INT. CL. 41.
- INTERNATIONAL CONTROLS AND MEASUREMENTS CORPORATION, CICERO, NY:
2,753,475, CANC. INT. CL. 9.
- INTERNATIONAL COUNCIL FOR LOCAL ENVIRONMENTAL INITIATIVES - CANADA., 53113 BONN, FED REP GERMANY:
2,334,859, REN. 3-31-10. INT. CL. 42.
- INTERNATIONAL COUNCIL FOR LOCAL ENVIRONMENTAL INITIATIVES, BONN, FED REP GERMANY:
2,337,693, REN. 3-31-10. INT. CL. 41.
- INTERNATIONAL DATA GROUP, INC., FRAMINGHAM, MA:
2,754,652, CANC. MULTIPLE CLASS, INT. CLS. 16, 41 AND 42.

INTERNATIONAL DIGITAL ENTERPRISE ALLIANCE, INC., ALEXANDRIA, VA:
2,752,841, CANC. INT. CL. 35.
2,752,842, CANC. INT. CL. 35.

INTERNATIONAL DRUG DEVELOPMENT INSTITUTE, CAMBRIDGE, MA:
2,753,008, CANC. INT. CL. 42.

INTERNATIONAL FLAVORS & FRAGRANCES INC., NEW YORK, NY:
2,329,278, REN. 3-26-10. MULTIPLE CLASS, INT. CLS. 1 AND 3.

INTERNATIONAL FOUNDATION OF EMPLOYEE BENEFIT PLANS, INC., BROOKFIELD, WI:
3,785,060, U.S. CL. B.

INTERNATIONAL HORTICULTURAL TECHNOLOGIES LLC, HOLLISTER, CA:
2,752,932, CANC. INT. CL. 1.

INTERNATIONAL INGREDIENTS, INC., SPARKS, MD:
3,784,407, PUB. 2-16-2010. MULTIPLE CLASS, INT. CLS. 29 AND 30.

INTERNATIONAL INSTITUTE OF TRADING MASTERY CORPORATION, CARY, NC:
3,784,557, PUB. 2-16-2010. INT. CL. 16.
3,784,621, PUB. 2-16-2010. INT. CL. 41.
3,784,623, PUB. 2-16-2010. INT. CL. 41.

INTERNATIONAL MASTERS PUBLISHERS AB, MALMO, SWEDEN:
2,753,295, CANC. INT. CL. 16.

INTERNATIONAL NEWS, INC., KENT, WA:
2,753,313, CANC. INT. CL. 25.

INTERNATIONAL PAIRS HOLDINGS LTD., HAMPSHIRE, UNITED KINGDOM:
3,785,253, MULTIPLE CLASS, INT. CLS. 35 AND 41.

INTERNATIONAL REINSURANCE MANAGERS, LLC, MIAMI, FL:
3,784,077, PUB. 2-16-2010. INT. CL. 36.

INTERNATIONAL SHIELD, INC., SAINT PAUL, MN:
2,752,113, CANC. INT. CL. 3.

INTERNATIONAL SOCIETY FOR PHARMACEUTICAL ENGINEERING, INC., TAMPA, FL:
2,823,110, CANC. INT. CL. 9.

INTERNATIONAL 3D SOCIETY, LLC, LOS ANGELES, CA:
3,784,577, PUB. 2-16-2010. MULTIPLE CLASS, INT. CLS. 35 AND 41.
3,784,578, PUB. 2-16-2010. MULTIPLE CLASS, INT. CLS. 35 AND 41.

INTEROCEAN INC., NEW YORK, NY:
2,754,124, CANC. INT. CL. 29.

INTERSOUND, INC., ROSWELL, GA:
1,552,655, CANC. INT. CL. 9.

INTERVARSITY CHRISTIAN FELLOWSHIP/USA, MADISON, WI, INTER-VARSITY CHRISTIAN FELLOWSHIP OF THE UNITED STATES OF AMERICA, CHICAGO, IL:
896,160, REN. 3-31-10. U.S. CL. 100 (INT. CL. 42).

INTERVARSITY CHRISTIAN FELLOWSHIP/USA, MADISON, WI:
897,506, REN. 3-31-10. U.S. CL. 100 (INT. CL. 42).

INTERVEST-CENTURION, L.L.C., DALLAS, TX:
2,272,754, CANC. INT. CL. 42.

INTEX RECREATION CORP., LONG BEACH, CA:
3,786,077, INT. CL. 11.

INTRACELL NUTRITION INC., HACKENSACK, NJ:
3,784,290, PUB. 2-16-2010. INT. CL. 5.

INTRAVERA WORLDWIDE, INC., GLENDALE, CA:
3,785,382, INT. CL. 5.

INVE TECHNOLOGIES, NAAMLOZE VENNOOTSCHAP, BELGIUM:
3,784,962, PUB. 2-16-2010. INT. CL. 5.

INVECTRA, INC., SPRING, TX:
3,784,542, PUB. 2-16-2010. INT. CL. 42.

INVENSYS SYSTEMS, INC., FOXBORO, MA:
2,751,639, CANC. INT. CL. 35.

INVENTIVE CONCEPTS INTERNATIONAL, ELK GROOVE VILLAGE, IL, DBA INVENTIVE CONCEPTS INTERNATIONAL:
3,786,064, MULTIPLE CLASS, INT. CLS. 9 AND 18.

INVER HOUSE DISTILLERS LIMITED, AIRDRIE, LANARKSHIRE, SCOTLAND:
3,783,218, PUB. 2-16-2010. INT. CL. 33.

INVESTORPLACE MEDIA, LLC, ROCKVILLE, MD:
2,434,717, REN. 3-31-10. INT. CL. 36.

INVIRTECH LLC, LIVONIA, MI:
3,784,328, PUB. 2-16-2010. INT. CL. 42.

INVISTA NORTH AMERICA S. A R.L., WILMINGTON, DE, CNA HOLDINGS, INC., SUMMIT, NJ:
2,433,932, REN. 3-31-10. INT. CL. 22.

IOA RE, INC., EAST NORRITON, PA:
2,349,133, REN. 3-26-10. MULTIPLE CLASS, INT. CLS. 35 AND 36.

IOMEDIX DEVELOPMENT INTERNATIONAL SRL, WORTHING, CHRIST CHURCH, BARBADOS:
2,332,868, REN. 3-29-10. INT. CL. 5.

IONIA HOT ROD SHOP, L.L.C., IONIA, MI:
3,783,306, PUB. 2-16-2010. INT. CL. 12.

IOWA LOTTERY COMMISSION, DES MOINES, IA:
3,785,461, MULTIPLE CLASS, INT. CLS. 28 AND 41.

IOWA 80 GROUP, INC., WALCOTT, IA:
3,784,275, PUB. 2-16-2010. INT. CL. 35.

IPC MEDIA LIMITED, LONDON, UNITED KINGDOM:
2,368,212, REN. 3-31-10. MULTIPLE CLASS, INT. CLS. 16 AND 42.

IPSEN PHARMA S.A.S., FRANCE:
3,784,942, PUB. 2-16-2010. INT. CL. 5.

IQINVISION, INC., SANTA ANA HEIGHTS, CA:
2,754,174, CANC. INT. CL. 9.

IQSOLUTIONS, INC., ROCKVILLE, MD:
2,751,741, CANC. INT. CL. 35.

IRAQ AND AFGHANISTAN VETERANS OF AMERICA, INC., NEW YORK, NY:
3,784,812, PUB. 2-16-2010. INT. CL. 35.

IRD MECHANALYSIS, INC., COLUMBUS, OH:
1,552,593, CANC. INT. CL. 9.

IREALMS, INC., DANA POINT, CA:
2,271,744, CANC. INT. CL. 9.

IREM CORPORATION, MATTO-SHI, ISHIKAWA, JAPAN:
1,553,013, CANC. INT. CL. 28.

IREQ MANAGEMENT I, LTD., PORT LOUIS, MAURITIUS:
3,783,502, PUB. 2-16-2010. INT. CL. 36.

IRON MOUNTAIN INCORPORATED, BOSTON, MA:
3,783,368, PUB. 2-16-2010. MULTIPLE CLASS, INT. CLS. 35, 38, 39 AND 42.

IROQUOIS HOLDING COMPANY, NASHVILLE, TN:
3,786,250, INT. CL. 18.

IRWIN INDUSTRIAL TOOL COMPANY, FREEPORT, IL:
2,753,825, CANC. INT. CL. 7.

ISEE SYSTEMS, INC., LEBANON, NH:
1,552,580, CANC. INT. CL. 9.

ISHIHARA SANGYO KAISHA, LTD., OSAKA, JAPAN:
1,586,392, REN. 3-31-10. INT. CL. 2.

ISHRED, LLC, BOSTON, MA:
3,785,126, MULTIPLE CLASS, INT. CLS. 20 AND 39.

ISI BRANDS, INC., GRAND RAPIDS, MI:
2,764,598, CANC. INT. CL. 25.

ISICRAN INC, MONEE, IL:
3,783,094, PUB. 2-16-2010. INT. CL. 11.

ISLAMIC SERVICES FOUNDATION, RICHARDSON, TX:
2,754,555, CANC. INT. CL. 16.

ISLAND MUSHROOMS INC., DUNCAN, B.C., CANADA:
3,783,255, PUB. 12-1-2009. MULTIPLE CLASS, INT. CLS. 1 AND 35.

ISO SERVICES, INC., JERSEY CITY, NJ:
2,823,207, CANC. INT. CL. 16.
2,842,936, CANC. INT. CL. 16.

ISPEECH INCORPORATED, NEWARK, NJ:
3,783,782, PUB. 2-16-2010. INT. CL. 9.

ISTITUTO ITALIANO; SICUREZZA DEI GIOCATTOLI S.R.L., ITALY:
3,784,873, PUB. 2-16-2010. MULTIPLE CLASS, INT. CLS. 28 AND 42.

ISURVEY AS, BILLINGSTAD, NORWAY:
3,785,120, INT. CL. 37.

IT SELLING, LLC, BETHESDA, MD:
2,752,635, CANC. INT. CL. 41.

- ITAYA, NAOMI, KITAMOROKATA-GUN, MIYAZAKI, JAPAN:
2,753,759, CANC. INT. CL. 24.
- ITEC ENTERTAINMENT CORPORATION, ORLANDO, FL:
2,366,254, REN. 3-26-10. INT. CL. 42.
- ITHURTS.COM INC., PARKER, CO:
3,785,236, MULTIPLE CLASS, INT. CLS. 35 AND 44.
- ITIPACK S.R.L., 36030 VILLAVERLA (VICENZA), ITALY:
2,337,985, REN. 4-1-10. INT. CL. 7.
- ITRITION, LLC, WINSTON SALEM, NC:
3,784,607, PUB. 2-16-2010. INT. CL. 5.
3,784,667, PUB. 2-16-2010. INT. CL. 5.
- ITRON, INC., LIBERTY LAKE, WA:
3,786,311, INT. CL. 38.
- ITRON, INC., SPOKANE, WA:
3,786,312, INT. CL. 42.
- ITT CORPORATION, WHITE PLAINS, NY, INTERNATIONAL TELEPHONE AND TELEGRAPH CORPORATION, NEW YORK, NY:
1,146,412, REN. 3-26-10. INT. CL. 11.
- ITT MANUFACTURING ENTERPRISES, INC., WILMINGTON, DE:
3,785,795, MULTIPLE CLASS, INT. CLS. 9, 35 AND 42.
3,785,796, MULTIPLE CLASS, INT. CLS. 9, 35 AND 42.
3,785,797, MULTIPLE CLASS, INT. CLS. 9, 35 AND 42.
- ITX CORP., PITTSFORD, NY:
2,897,094, CANC. INT. CL. 41.
- IVANNA S. PANKIN, SAN DIEGO, CA:
3,783,638, PUB. 2-16-2010. INT. CL. 41.
- IVOCLAR VIVADENT, INC., AMHERST, NY:
3,783,810, PUB. 2-16-2010. INT. CL. 5.
3,783,829, PUB. 2-16-2010. INT. CL. 5.
- IVY ACRES, INC., BAITING HOLLOW, NY:
2,752,109, CANC. INT. CL. 31.
- IWASAKI TRADING CO. LTD., KAGOSHIMA-SHI, JAPAN:
2,754,626, CANC. INT. CL. 30.
- IXE GRUPO FINANCIERO S.A.B. DE C.V., MEXICO CITY, MEXICO:
3,785,661, MULTIPLE CLASS, INT. CLS. 9 AND 16.
- IXOS GROUP, 1180 UCCELLE, BELGIUM:
2,336,582, REN. 3-31-10. INT. CL. 33.
- IZA-BOA S.A.S. DI GREGORELLI A. E. C., 37121 VERONA (VR), ITALY:
2,752,323, CANC. INT. CL. 25.
- I2S MICRO IMPLANTABLE SYSTEMS, LLC, SALT LAKE CITY, UT:
3,783,661, PUB. 2-16-2010. MULTIPLE CLASS, INT. CLS. 41 AND 42.
3,783,662, PUB. 2-16-2010. INT. CL. 9.
3,783,663, PUB. 2-16-2010. MULTIPLE CLASS, INT. CLS. 9, 10, 41, 42 AND 44.
- I3E HOLDINGS, LLC, SAN DIEGO, CA:
2,754,365, CANC. INT. CL. 35.
- J & B DISTRIBUTING CO., CHICAGO, IL:
2,752,126, CANC. INT. CL. 32.
- J & B WHOLESALE DISTRIBUTING, INC., ST. MICHAEL, MN:
1,601,126, REN. 3-31-10. INT. CL. 29.
- J & M DAVIS ENTERPRISES, LLC., BOSSIER CITY, LA:
1,138,555, REN. 3-31-10. INT. CL. 3.
- J & S FRANKLIN LTD, LONDON, UNITED KINGDOM AND TERRAM LIMITED, GWENT, UNITED KINGDOM:
3,783,157, PUB. 12-1-2009. MULTIPLE CLASS, INT. CLS. 6, 17, 19, 24, 37, 42 AND 45.
- J GIRL, INC., WESTLAKE VILLAGE, CA:
3,783,584, PUB. 2-16-2010. INT. CL. 35.
3,783,585, PUB. 2-16-2010. INT. CL. 3.
3,783,590, PUB. 2-16-2010. INT. CL. 44.
- J. & P. COATS, LIMITED, GLASGOW, SCOTLAND, UNITED KINGDOM:
3,786,034, INT. CL. 23.
- J. C. BROCK CORP., BUFFALO, NY:
1,553,049, CANC. MULTIPLE CLASS, INT. CLS. 29 AND 31.
- J. C. PENNEY COMPANY, INC., PLANO, TX:
1,552,797, CANC. INT. CL. 14.
- J. RETTENMAIER & SOHNE GMBH + CO., 73494 ROSENBERG, FED REP GERMANY:
2,353,430, REN. 3-27-10. INT. CL. 1.
- J. ROY PARCELS ASSOCIATES, LLC, COLUMBUS, NJ:
2,823,682, CANC. INT. CL. 42.
- J.B. SPEED ART MUSEUM, LOUISVILLE, KY, DBA THE SPEED ART MUSEUM:
2,271,984, CANC. INT. CL. 41.
- J.C. CANNISTRARO, LLC, WATERTOWN, MA:
3,783,813, PUB. 2-16-2010. MULTIPLE CLASS, INT. CLS. 37, 42 AND 45.
- J.G. STAREW INNOVATIVE SOLUTIONS, L.L.C., TOMAHAWK, WI:
3,785,214, INT. CL. 17.
- J&B WHOLESALE DISTRIBUTING, INC., ST. MICHAEL, MN:
3,785,441, INT. CL. 29.
- J&H FOODS, INC., TULSA, OK:
3,784,421, PUB. 2-16-2010. INT. CL. 43.
- J&M PRODUCTS, ST. LOUIS, MO:
2,283,777, REN. 3-31-10. INT. CL. 21.
- JACK IN THE BOX INC., SAN DIEGO, CA:
3,783,515, PUB. 2-16-2010. MULTIPLE CLASS, INT. CLS. 29, 30 AND 43.
- JACKSON PRODUCTS, INC., CHESTERFIELD, MO:
3,784,681, PUB. 2-16-2010. INT. CL. 9.
- JACO ENTERPRISES, INC., PHOENIX, AZ:
3,784,098, PUB. 2-16-2010. INT. CL. 9.
- JACOB KORTHUIS, KISSIMMEE, FL:
2,752,370, CANC. INT. CL. 16.
- JACOBSON, MICHAEL, LEESBURG, VA:
2,754,583, CANC. INT. CL. 9.
- JACQUARD ASSOCIATES, INC., ROUND LAKE BEACH, IL:
2,271,360, CANC. INT. CL. 41.
- JADE DISTRIBUTION, INC., RENO, NV:
3,783,931, PUB. 2-16-2010. INT. CL. 3.
- JADE INCONSTRADING, INC., PASADENA, CA:
2,752,175, CANC. INT. CL. 1.
- JADE LIQUEURS, LLC, PRAIRIEVILLE, LA:
3,785,578, INT. CL. 33.
- JADE, LLC, NEEDHAM, MA:
3,785,089, INT. CL. 16.
- JAFFERSON, INC., IRVING, TX:
3,785,810, INT. CL. 25.
- JAGUAR CARS LIMITED, COVENTRY, UNITED KINGDOM:
1,614,147, REN. 3-29-10. MULTIPLE CLASS, INT. CLS. 35, 37 AND 42.
2,334,171, REN. 3-29-10. INT. CL. 16.
- JAH INNOVATIONS INC., ATLANTA, GA:
3,785,072, INT. CL. 18.
- JAKAFELLA ENTERTAINMENT LLC, CORINTH, TX:
3,783,101, PUB. 2-16-2010. INT. CL. 41.
- JAKE'S FIREWORKS INC., PITTSBURG, KS:
3,783,982, PUB. 2-16-2010. INT. CL. 13.
- JAMALI, MASOUD, CALABASAS, CA AND AMIRGHASSEMI, ALIREZA, CALABASAS, CA:
3,784,852, PUB. 2-16-2010. INT. CL. 16.
- JAMES GAMES INC., SANTA ANA, CA:
3,785,298, INT. CL. 28.
- JAMES HARDIE TECHNOLOGY LIMITED, DUBLIN 2, IRELAND:
2,752,194, CANC. INT. CL. 19.
- JAMES L. NEELY, MEMPHIS, TN:
3,783,424, PUB. 2-16-2010. INT. CL. 43.
- JAMES N. FREEHOF AND ONKAL K. GUZEY, GREAT FALLS, VA:
1,552,836, CANC. MULTIPLE CLASS, INT. CLS. 16 AND 41.
- JAMESTOWN ONE TIMES SQUARE, L.P., ATLANTA, GA:
2,272,785, CANC. INT. CL. 33.
- JAMESTOWN ONE TIMES SQUARE, L.P., ATLANTA, GA TO JAMESTOWN ONE TIMES SQUARE, L.P., ATLANTA, GA:
2,272,786, CANC. INT. CL. 14.
- JAN ANDREW PRESS, PALM HARBOR, FL:
3,784,548, PUB. 2-16-2010. INT. CL. 45.

JAN FORMAN, GREAT FALLS, VA:
3,783,936, PUB. 2-16-2010. MULTIPLE CLASS, INT. CLS. 18 AND 35.

JAN MARINI SKIN RESEARCH, INC., SAN JOSE, CA:
3,783,413, PUB. 2-16-2010. INT. CL. 3.
3,783,414, PUB. 2-16-2010. INT. CL. 3.
3,783,533, PUB. 2-16-2010. INT. CL. 3.
3,783,534, PUB. 2-16-2010. INT. CL. 3.

JANASHAK, ROBERT J., BURBANK, CA:
3,786,136, INT. CL. 12.

JANET MOORE COMMUNICATIONS, INC., HOUSTON, TX,
AKA JANET MOORE INTERNATIONAL:
3,786,411, MULTIPLE CLASS, INT. CLS. 35 AND 41.

JANKET, MICHAEL, D.M.D., PUTNAM, CT:
2,753,735, CANC. INT. CL. 31.

JANSON, HAROLD, ST. AUGUSTINE, FL:
2,753,611, CANC. INT. CL. 41.

JANUS INTERNATIONAL HOLDING LLC, DENVER, CO:
2,272,511, CANC. INT. CL. 36.

JARED ALLEN 69, LLC, SCOTTSDALE, AZ:
3,783,386, PUB. 2-16-2010. INT. CL. 25.

JARIN, STEPHANIE, BEVERLY HILLS, CA:
3,786,381, INT. CL. 25.

JARROW FORMULAS, INC., LOS ANGELES, CA:
3,785,902, INT. CL. 5.

JASON COURT, NAPA, CA, DBA EVIDENCE WINES:
3,785,564, INT. CL. 33.

JAYCO, INC., MIDDLEBURY, IN:
3,784,269, PUB. 2-16-2010. INT. CL. 12.

JC SOFTWARE HOLDINGS, INC., ANN ARBOR, MI:
2,752,755, CANC. INT. CL. 9.
2,752,756, CANC. INT. CL. 9.

JCBT GLOBAL, FALLBROOK, CA:
3,786,013, INT. CL. 25.

JD NORMAN METAL TECHNOLOGIES, INC., ADDISON,
IL:
2,272,720, CANC. MULTIPLE CLASS, INT. CLS. 35, 40
AND 42.

JDHUNTR.COM, LOS ANGELES, CA:
3,785,620, INT. CL. 35.

JDL WINES, ST. MORILLON, FRANCE:
3,783,310, PUB. 2-16-2010. INT. CL. 33.
3,783,311, PUB. 2-16-2010. INT. CL. 33.

JEAN-CLAUDE DUFOUR CONSEIL S.A., 75014 PARIS,
FRANCE, DBA JCD CONSEIL S.A.:
2,752,853, CANC. MULTIPLE CLASS, INT. CLS. 35, 39
AND 42.

JEB INDUSTRIES, GARDEN GROVE, CA:
2,752,412, CANC. INT. CL. 25.

JEEPERS! INC., WALTHAM, MA:
2,272,459, CANC. INT. CL. 41.

JEFF CHRISTIAN PRODUCTIONS, INC., BRENTWOOD,
TN, DBA REEL SHORTS.:
2,337,571, REN. 3-30-10. INT. CL. 41.

JELD-WEN, INC., KLAMATH FALLS, OR:
2,753,552, CANC. INT. CL. 19.

JEM WOOD DESIGN, INC., WEST CHARLOTTEVILLE,
VA, DBA JONATHAN VIRGINIA, INC.:
2,272,881, CANC. INT. CL. 21.

JENKINS, KEVIN B., MURFREESBORO, TN, DBA THE
GUN TAILOR:
2,752,197, CANC. INT. CL. 37.

JEREMY HILMO, MISSOULA, MT:
3,784,393, PUB. 2-16-2010. INT. CL. 25.

JESSICA P GILL, WORTHING, UNITED KINGDOM, DBA
KARN GILL ASSOCIATES:
3,783,778, PUB. 2-16-2010. INT. CL. 14.

JET SOLUTIONS, L.L.C., RICHARDSON, TX:
2,336,384, REN. 3-27-10. MULTIPLE CLASS, INT. CLS. 35,
37 AND 39.

JET-ALLIANCE INC., WESTLAKE VILLAGE, CA:
2,932,159, AM. INT. CL. 36.

JETBLUE AIRWAYS CORPORATION, FOREST HILLS, NY:
3,786,241, INT. CL. 41.

JEWISH HOSPITAL & ST. MARY'S HEALTHCARE, INC.,
LOUISVILLE, KY:
2,374,678, REN. 3-31-10. INT. CL. 9.

JFC, INC., ST. CLOUD, MN:
2,751,987, CANC. INT. CL. 29.

JH & AH ENTERPRISES, INC., DALLAS, TX:
3,783,973, PUB. 2-16-2010. INT. CL. 44.

JH BIOTECH, INC., VENTURA, CA:
3,783,956, PUB. 2-16-2010. INT. CL. 5.

JIFFY LUBE INTERNATIONAL, INC, HOUSTON, TX:
3,786,198, INT. CL. 36.

JIM KARAS INDUSTRIES, INC., CHICAGO, IL:
2,752,623, CANC. MULTIPLE CLASS, INT. CLS. 41 AND
44.

JJI LIGHTING GROUP, INC., GREENWICH, CT, EDWIN F.
GUTH COMPANY, THE, ST. LOUIS, MO:
694,856, REN. 3-29-10. U.S. CL. 21 (INT. CL. 11).

JMB/CM VILLAGE ASSOCIATES, CORTE MADERA, CA:
1,553,222, CANC. INT. CL. 36.

JMJ DEVELOPMENT COMPANY, INC., SAN DIEGO, CA:
2,499,251, COR. INT. CL. 10.

JOE DAVIDSON'S GRILL CAMP, LLC, WASHINGTON, DC:
3,783,786, PUB. 2-16-2010. INT. CL. 35.

JOE, DON W., DALLAS, TX:
2,753,159, CANC. INT. CL. 36.

JOE'S SWEEPING, INC., NORWALK, CA:
3,783,764, PUB. 2-16-2010. INT. CL. 37.

JOHANSON CONSULTING, INC., FAYETTEVILLE, AR,
DBA JOHANSON GROUP:
3,784,541, PUB. 2-16-2010. INT. CL. 35.

JOHANSSON, NICOLAS F., GUTENBERG, FED REP GER-
MANY, DBA MYTRIPGURU.COM:
3,784,074, PUB. 2-16-2010. INT. CL. 39.

JOHN COWLES, VENICE, CA, DBA ALL SPICE CAFE:
3,783,765, PUB. 2-16-2010. INT. CL. 30.

JOHN H. WARFORD, JR., DDS, P.C., BISMARCK, ND, DBA
WARFORD ORTHODONTICS:
3,784,453, PUB. 2-16-2010. INT. CL. 44.

JOHN HANCOCK LIFE INSURANCE COMPANY (U.S.A.),
BOSTON, MA:
2,751,766, CANC. INT. CL. 36.
2,753,690, CANC. INT. CL. 36.

JOHN MIDDLETON CO., LIMERICK, PA, R.J. REYNOLDS
TOBACCO COMPANY, WINSTON-SALEM, NC:
1,132,832, REN. 3-29-10. INT. CL. 34.

JOHN MOORE SERVICES INC., HOUSTON, TX:
3,785,619, INT. CL. 19.

JOHN P. DAVEY III, ATHERTON, CA, DBA THE GOOD
DOG COMPANY:
3,783,741, PUB. 2-16-2010. INT. CL. 25.

JOHN SCOTT HARRISON, LEAWOOD, KS:
3,786,410, INT. CL. 9.

JOHN ZINK COMPANY, L.L.C., TULSA, OK:
2,753,536, CANC. INT. CL. 11.

JOHNS HOPKINS UNIVERSITY, THE, BALTIMORE, MD:
2,482,830, COR. INT. CL. 9.

JOHNSON & JOHNSON, NEW BRUNSWICK, NJ:
522,717, REN. 3-31-10. U.S. CL. 44 (INT. CL. 5).
1,583,293, REN. 3-29-10. INT. CL. 5.
2,347,521, REN. 4-1-10. INT. CL. 5.
3,783,505, PUB. 2-16-2010. INT. CL. 21.
3,783,506, PUB. 2-16-2010. INT. CL. 44.
3,785,521, INT. CL. 5.
3,785,662, INT. CL. 5.
3,786,333, INT. CL. 5.

JOHNSON & JOHNSON, INC., MADISON, FL:
3,786,400, INT. CL. 43.
3,786,403, INT. CL. 21.

JOHNSON HEATER CORP., MARYLAND HEIGHTS, MO:
1,626,390, REN. 3-29-10. INT. CL. 42.

JOHNSON MATTHEY, INC., WAYNE, PA:
2,752,019, CANC. INT. CL. 40.

JOHNSON PUBLISHING COMPANY, INC., CHICAGO, IL:
3,783,278, PUB. 2-16-2010. INT. CL. 16.

JOHNSON, BARRY, LOS ANGELES, CA:
2,752,773, CANC. INT. CL. 3.

JOHNSON, BRYCE, MATTHEWS, NC:
3,786,420, INT. CL. 41.

JOHNSON, KENT, CARLSBAD, CA:
3,785,317, INT. CL. 25.

- JOHNSON, MICHAEL, MILL VALLEY, CA:
3,786,322, INT. CL. 25.
- JOJO LLC, LOS ANGELES, CA:
3,784,460, PUB. 2-16-2010. MULTIPLE CLASS, INT. CLS.
22 AND 28.
- JOLLY, CHARLES N., SPENCER, TN:
2,753,350, CANC. INT. CL. 5.
- JONES INVESTMENT CO., INC., WILMINGTON, DE, JONES
APPAREL GROUP, INC., BRISTOL, PA:
1,592,094, REN. 3-26-10. INT. CL. 25.
- JONES MEDICAL INSTRUMENT COMPANY, OAK
BROOK, IL:
2,385,848, REN. 3-26-10. INT. CL. 10.
- JONES, BENJAMIN C., NOBLESVILLE, IN:
2,752,080, CANC. INT. CL. 8.
- JONES, DAVID R., NEW YORK, NY, DBA JONES MUSIC:
2,753,337, CANC. INT. CL. 41.
- JONES, JORGE B, SAN DIEGO, CA:
3,784,412, PUB. 2-16-2010. INT. CL. 25.
- JONMOR INVESTMENTS, INC., WILMINGTON, DE:
3,786,203, INT. CL. 29.
- JOSEF FRIEDERICH WEINGUTER-WEINKELLEREIEN
GMBH & CO. KG, D-56851 ZELL/MOSEL, FED REP
GERMANY:
1,553,181, CANC. INT. CL. 33.
- JOSEFEK, KIRT L., FRAMINGHAM, MA:
3,785,077, INT. CL. 42.
- JOSEPH PERRIER FILS & CIE, 5100 CHALONS EN CHAM-
PAGNE, FRANCE:
2,363,774, REN. 3-28-10. INT. CL. 33.
- JOSEPH SAYEGH, CORONA DEL MAR, CA:
3,785,591, MULTIPLE CLASS, INT. CLS. 11, 19 AND 21.
3,785,634, MULTIPLE CLASS, INT. CLS. 11, 19, 21 AND
35.
- JPC, NEW DELHI- 110 001, INDIA:
3,783,084, PUB. 12-26-2006. MULTIPLE CLASS, INT. CLS.
18 AND 25.
- JPMORGAN CHASE & CO., NEW YORK, NY:
1,375,020, CANC. MULTIPLE CLASS, INT. CLS. 35 AND
36.
3,783,581, PUB. 2-16-2010. INT. CL. 41.
3,783,860, PUB. 2-16-2010. INT. CL. 36.
3,784,771, PUB. 2-16-2010. INT. CL. 36.
3,784,772, PUB. 2-16-2010. INT. CL. 36.
- JSJ FURNITURE CORPORATION, GRAND HAVEN, MI:
2,330,047, REN. 3-26-10. INT. CL. 20.
- JT&A, INC., CHANTILLY, VA:
2,271,774, CANC. INT. CL. 16.
- JUBES FIREHOUSE BBQ, LLC, PRESCOTT, AZ, DBA JUBE'S
FIREHOUSE BBQ:
3,784,403, PUB. 2-16-2010. INT. CL. 30.
- JUDAULF TRADEMARK PARTNERSHIP, DES PLAINES,
IL:
892,363, REN. 3-31-10. U.S. CL. 21 (INT. CL. 9).
- JUDGE, CHARLES A., HUNTINGTON, MD:
2,426,304, REN. 3-31-10. INT. CL. 9.
- JULIAN SAROKIN, BEVERLY HILLS, CA:
3,783,872, PUB. 2-16-2010. INT. CL. 35.
- JUMPSTART TECHNOLOGIES, LLC, CAMBRIDGE, MA:
2,752,907, CANC. INT. CL. 42.
- JUNIOR LEAGUE OF DALLAS, INC., DALLAS, TX:
2,346,262, REN. 4-1-10. INT. CL. 42.
- JUSTIN ORR, SAN DIEGO, CA, DBA IRON ORR FITNESS:
3,784,480, PUB. 2-16-2010. INT. CL. 41.
- JVC AMERICAS CORP., WAYNE, NJ:
3,783,265, PUB. 2-16-2010. INT. CL. 9.
- J2 GLOBAL COMMUNICATIONS, INC., HOLLYWOOD, CA:
3,786,047, INT. CL. 38.
- K AND M ELECTRONICS, INC., WEST SPRINGFIELD, MA:
2,271,956, CANC. INT. CL. 9.
- K. HANSOTIA & CO., INC., MIAMI, FL:
3,785,896, INT. CL. 34.
- K. HOV IP, II, INC., RED BANK, NJ:
3,786,278, INT. CL. 37.
- K. ROPER, INC., KENNESAW, GA:
2,271,445, CANC. INT. CL. 35.
- KABLE ENTERPRISE CO., LTD., NEI-HU, TAIPEI, TAI-
WAN:
3,786,016, MULTIPLE CLASS, INT. CLS. 7 AND 9.
- KABUSHIKI KAISHA BANDAI, TAITO-KU 111-8081, TO-
KYO, JAPAN:
2,330,156, REN. 3-30-10. INT. CL. 28.
- KABUSHIKI KAISHA BSP, TOKYO, JAPAN:
2,350,385, REN. 3-31-10. MULTIPLE CLASS, INT. CLS. 9
AND 16.
- KABUSHIKI KAISHA BSP, TOKYO, JAPAN, AKA BSP INC.:
2,751,966, CANC. INT. CL. 16.
2,751,967, CANC. INT. CL. 16.
- KABUSHIKI KAISHA LADONNA; (LADONNA CO., LTD.),
JAPAN:
3,784,986, PUB. 2-16-2010. MULTIPLE CLASS, INT. CLS. 9
AND 16.
- KABUSHIKI KAISHA LEVEL - 5, CHUO-KU, FUKUOKA,
JAPAN, DBA LEVEL-5 INC.:
3,785,246, MULTIPLE CLASS, INT. CLS. 9 AND 16.
- KABUSHIKI KAISHA RALLIART, MINATO-KU, TOKYO,
JAPAN:
1,552,777, CANC. INT. CL. 12.
- KABUSHIKI KAISHA SEGA, TOKYO 144-0043, JAPAN, DBA
SEGA CORPORATION:
2,751,680, CANC. INT. CL. 9.
- KABUSHIKI KAISHA SEGA, OHTA-KU, TOKYO 144-8531,
JAPAN, DBA SEGA CORPORATION:
2,753,868, CANC. INT. CL. 9.
- KABUSHIKI KAISHA SEGA, TOKYO, JAPAN, DBA SEGA
CORPORATION:
2,835,893, CANC. INT. CL. 28.
2,835,893, AM. INT. CL. 9.
- KADIA PRODUKTION GMBH + CO., NURTINGEN, FED
REP GERMANY:
1,591,704, REN. 4-1-10. INT. CL. 7.
- KAHLE AUTOMATION S.R.L., MINEOLA, NY:
1,631,317, REN. 3-26-10. INT. CL. 7.
- KAINDL FLOORING GMBH, AUSTRIA:
3,785,002, PUB. 2-16-2010. MULTIPLE CLASS, INT. CLS.
19 AND 27.
- KAITEN SUSHI FRANCHISING, INC., KENT, WA:
3,785,849, MULTIPLE CLASS, INT. CLS. 30 AND 43.
- KALEI HOGAN, LOGAN, UT:
3,785,807, INT. CL. 41.
- KALISTA, RON, MANITOWOC, WI:
2,751,932, CANC. INT. CL. 41.
- KAMA GLOBAL LLC, ALPHARETTA, GA:
3,786,459, INT. CL. 2.
- KAMPGROUNDS OF AMERICA, INC., BILLINGS, MT:
2,272,761, CANC. INT. CL. 39.
2,752,487, CANC. INT. CL. 36.
- KAMTEX USA, INC., LAUDERDALE LAKES, FL:
3,783,082, PUB. 2-16-2010. INT. CL. 25.
- KANEMITSU, GEORGE SHIGEMI, KAUNAKAKAI, MOLO-
KAI, HI:
2,272,535, CANC. INT. CL. 30.
- KANEMITSU, GEORGE SHIGEMI, MOLOKAI, HI:
2,272,536, CANC. INT. CL. 30.
- KANEMITSU, GEORGE SHINGEMI, KAUNAKAKAI, MO-
LOKAI, HI:
2,272,537, CANC. INT. CL. 30.
- KANTOR, KAREN, PORTLAND, OR AND DORN, MAR-
GARET, NEW YORK, NY:
3,786,163, MULTIPLE CLASS, INT. CLS. 9 AND 41.
- KAO KABUSHIKI KAISHA, CHUO-KU, TOKYO 103-8210,
JAPAN, TA KAO CORPORATION:
2,754,587, CANC. INT. CL. 3.
- KAPLAN, ANDREW S., YONKERS, NY:
2,754,471, CANC. INT. CL. 16.
- KAPLAN, SHEILA, BROOKLYN, NY:
3,785,915, INT. CL. 41.
- KAPLAN, SHEILA L., BROOKLYN, NY:
3,785,749, INT. CL. 41.
- KAPP & PETERSON LIMITED, SALLYNOGGIN, COUNTY
DUBLIN, IRELAND:
2,751,851, CANC. INT. CL. 34.
- KARA R. HAAS, CPA, PA, SARASOTA, FL:
3,784,192, PUB. 2-16-2010. INT. CL. 42.

KARDEX AG, ZURICH, SWITZERLAND:
1,573,410. REN. 4-1-10. INT. CL. 20.

KARL MAYER TEXTILMASCHINENFABRIK GMBH, FED REP GERMANY:
3,784,908. PUB. 2-16-2010. INT. CL. 7.

KARLHAUS LLC, PORT ORANGE, FL, AKA KARLHAUS REALTY:
3,784,656. PUB. 2-16-2010. INT. CL. 36.

KARMAN, INC., AURORA, CO:
3,785,462. INT. CL. 25.

KARSTEN MANUFACTURING CORP., PHOENIX, AZ:
1,633,477. REN. 3-31-10. INT. CL. 41.

KARSTEN MANUFACTURING CORPORATION, PHOENIX, AZ:
3,785,984. INT. CL. 9.
3,785,985. INT. CL. 24.
3,785,986. MULTIPLE CLASS, INT. CLS. 18 AND 28.
3,786,155. INT. CL. 28.

KASEGUMA, GALE M., BROOKLYN, NY:
2,752,879. CANC. MULTIPLE CLASS, INT. CLS. 16 AND 25.

KATAI, NOELLE C., ENCINITAS, CA:
3,786,175. MULTIPLE CLASS, INT. CLS. 3, 4, 5 AND 11.

KATE'S HOMEMADE BUTTER, INC., OLD ORCHARD BEACH, ME:
3,322,116. CANC. INT. CL. 29.

KATHY DAVIS DESIGNS, INC., AMBLER, PA, DBA KATHY DAVIS STUDIOS:
3,786,362. INT. CL. 16.

KATZ, BRUCE E., NEW YORK, NY:
2,352,780. REN. 4-1-10. INT. CL. 42.

KATZENBACH PARTNERS LLC, NEW YORK, NY:
2,752,511. CANC. INT. CL. 35.

KAUFFMAN, KELLI, PACIFIC PALISADES, CA:
3,786,069. INT. CL. 30.

KAYABA INDUSTRY CO., LTD., MINATO-KU, TOKYO, JAPAN, AKA KAYABA KOGYO KABUSHIKI KAISHA:
3,783,535. PUB. 2-16-2010. MULTIPLE CLASS, INT. CLS. 9 AND 37.
3,783,536. PUB. 2-16-2010. MULTIPLE CLASS, INT. CLS. 9 AND 37.

KAYDON CORPORATION, MUSKEGON, MI, KEENE CORPORATION, NEW YORK, NY:
1,127,423. REN. 3-26-10. INT. CL. 7.

KAYLER, JENNIFER D., SAN DIEGO, CA:
3,786,434. INT. CL. 36.

KAYSER-ROTH CORPORATION, GREENSBORO, NC:
2,754,200. CANC. INT. CL. 25.

KBC MUSIC, INC., KEOKUK, IA:
3,784,040. PUB. 2-16-2010. INT. CL. 35.

KC INTELLECTUAL PROPERTY, LLC, PITTSBURGH, PA:
3,783,951. PUB. 2-16-2010. INT. CL. 9.

KCI LICENSING, INC., SAN ANTONIO, TX:
3,785,818. INT. CL. 44.

KDS CORPORATION, MINAMI-KU, KYOTO-SHI, KYOTO, JAPAN, KDS CORPORATION, MINAMI-KU, KYOTO-SHI, KYOTO, JAPAN:
2,358,030. REN. 3-30-10. INT. CL. 9.

KEARNEY, JAMES, ALLENTOWN, PA:
3,783,845. PUB. 2-16-2010. INT. CL. 42.

KEENAN, MAYNARD JAMES, LOS ANGELES, CA, DBA PUSCIFER:
3,785,161. MULTIPLE CLASS, INT. CLS. 10, 16, 18 AND 30.

KEEP IT PUSHIN, INC., INGLEWOOD, CA:
3,785,118. INT. CL. 35.

KEFGEN, KEITH, NEW YORK, NY:
2,271,935. CANC. INT. CL. 42.

KEITH D. BARDWELL, HARVEY, IL:
3,785,436. INT. CL. 41.

KEIWA INC., OSAKA, JAPAN:
3,784,922. PUB. 2-16-2010. MULTIPLE CLASS, INT. CLS. 9 AND 17.

KELIIKIPI, JOSEPH G, LOS ANGELES, CA:
3,784,169. PUB. 2-16-2010. INT. CL. 41.

KELIX HEAT TRANSFER SYSTEMS, LLC, TULSA, OK:
3,785,084. INT. CL. 11.

KELLER, ROBERT, CLAREMONT, CA:
3,783,844. PUB. 2-16-2010. INT. CL. 9.

KELLEY BEAN CO., INC., SCOTTSBLUFF, NE:
2,824,649. CANC. INT. CL. 30.

KELLEY FOX WINES LLC, PORTLAND, OR:
3,785,702. INT. CL. 33.

KELLOGG SUPPLY, INC., CARSON, CA:
3,783,935. PUB. 2-16-2010. INT. CL. 1.

KELLOM INDUSTRIES, INC., GERMANTOWN, WI:
1,552,919. CANC. INT. CL. 20.

KEMIRA OYJ, HELSINKI, FINLAND:
3,783,375. PUB. 2-16-2010. MULTIPLE CLASS, INT. CLS. 1, 40 AND 42.

KEMP, RUSSELL, NEW YORK, NY:
3,785,101. INT. CL. 25.

KEN BRATNEY CO., THE, DES MOINES, IA:
3,783,904. PUB. 2-16-2010. MULTIPLE CLASS, INT. CLS. 35 AND 42.

KENNEDY, LINDA, MIDWAY, UT:
2,752,680. CANC. INT. CL. 16.

KENNEL-AIRE, LLC, NEENAH, WI, TOP DOG INVESTMENTS, INC., PLYMOUTH, MN:
2,308,995. REN. 4-1-10. INT. CL. 20.

KENNETH COLE PRODUCTIONS (LIC), INC., NASSAU, BAHAMAS:
2,752,581. CANC. MULTIPLE CLASS, INT. CLS. 18 AND 25.

KENNIK INNOVATIONS, L.L.C., FORT DODGE, IA:
3,785,579. INT. CL. 21.

KENNY, HOLLY A. WESTBOROUGH, MA, DBA ELSIE KAYE GLASSWORKS:
3,785,631. INT. CL. 14.

KEREN KAYEMETH LEISRAEL, JERUSALEM, ISRAEL:
3,784,844. PUB. 2-16-2010. INT. CL. 36.

KESSLER, JOSHUA, BROOKLYN, NY:
3,784,126. PUB. 2-16-2010. INT. CL. 41.

KEVMAR VENTURES, LLC, SPEARFISH, SD:
3,784,180. PUB. 2-16-2010. INT. CL. 35.

KEYSTONE LABORATORIES, INC., MEMPHIS, TN:
2,334,699. REN. 3-29-10. INT. CL. 3.

KFAR CAMPING CO., INC., BELGRADE, ME:
3,783,450. PUB. 2-16-2010. INT. CL. 41.

KFORCE INC., TAMPA, FL:
3,784,502. PUB. 2-16-2010. INT. CL. 35.
3,784,504. PUB. 2-16-2010. INT. CL. 36.

KHANNA INTERNATIONAL TRADING INC., RICHMOND, BRITISH COLUMBIA:
3,784,846. PUB. 11-25-2008. INT. CL. 30.

KIBBECHEM, INC., ELKHART, IN:
3,783,877. PUB. 2-16-2010. INT. CL. 1.

KID-A-PEEL INC., INVER GROVE HEIGHTS, MN:
2,272,263. CANC. INT. CL. 16.

KIDDE INDUSTRIES, INC., ISELIN, NJ:
1,552,525. CANC. INT. CL. 7.

KIDKRAFT, L.P., DALLAS, TX:
3,785,449. MULTIPLE CLASS, INT. CLS. 20 AND 28.

KIDOS, INC., NEW YORK, NY:
3,783,878. PUB. 2-16-2010. INT. CL. 9.

KIDS GO SHOPPING, INC., SCRANTON, PA:
2,338,294. REN. 3-30-10. INT. CL. 35.

KIDS INTERNATIONAL CORP., NEW YORK, NY:
1,552,822. CANC. INT. CL. 16.

KIDS THINK BIG LLC, GREENWICH, CT:
3,783,286. PUB. 2-16-2010. INT. CL. 41.

KIDS'S GYM, INC., PORTAGE, MI:
3,783,788. PUB. 2-16-2010. INT. CL. 41.

KIDVID, INC., ALPHARETTA, GA:
2,273,017. CANC. INT. CL. 41.

KIEFEL EXTRUSION GMBH, D-67547 WORMS, FED REP GERMANY:
2,751,894. CANC. MULTIPLE CLASS, INT. CLS. 7, 9 AND 42.

KIGHT II, NATHAN M., TAKOMA PARK, MD, DBA SOULUSA INTERNATIONALE:
3,785,432. INT. CL. 25.

KILLER BEE INC., BILOXI, MS:
3,784,061. PUB. 2-16-2010. INT. CL. 28.

- KILOGRAM INC, NEW YORK, NY, DBA KILOGRAM INC:
3,785,947, INT. CL. 25.
- KIM, JOO DEOK, GARDEN GROVE, CA AND CHEH,
BYUNG JOE, LOS ANGELES, CA:
3,784,488, PUB. 2-16-2010. INT. CL. 3.
- KIM, KYUNG YUEL, LOS ANGELES, CA:
2,752,389, CANC. INT. CL. 41.
- KIM, YOUNG K., ORLANDO, FL:
3,783,624, PUB. 2-16-2010. INT. CL. 41.
- KIMBERLY-CLARK WORLDWIDE, INC., NEENAH, WI:
2,754,303, CANC. INT. CL. 5.
- KIMBLE KONTES ASSET MANAGEMENT INC., VINE-
LAND, NJ:
2,272,112, CANC. INT. CL. 9.
- KINETICS, S.A., 28035 MADRID, SPAIN:
2,751,799, CANC. MULTIPLE CLASS, INT. CLS. 3, 5 AND
38.
- KING BROADCASTING COMPANY, SEATTLE, WA:
2,280,694, REN. 3-27-10. INT. CL. 41.
- KING MILLING COMPANY, LOWELL, MI:
1,601,207, REN. 3-30-10. INT. CL. 30.
- KING TECHNOLOGY OF MISSOURI, INC., O'FALLON,
MO:
3,783,123, PUB. 2-16-2010. INT. CL. 17.
- KING W. SMITH, SACRAMENTO, CA:
3,785,409, INT. CL. 35.
3,785,410, INT. CL. 30.
- KINGDOM OF GOD EVANGELISTIC OUTREACH MINIS-
TRY, INC., THE, ATLANTA, GA:
3,784,159, PUB. 2-16-2010. INT. CL. 45.
- KINGLAND SYSTEMS CORPORATION, CLEAR LAKE, IA:
3,785,182, INT. CL. 35.
- KINGMAN INTERNATIONAL CORPORATION, BALDWIN
PARK, CA:
3,785,408, INT. CL. 28.
- KINGSDOWN, INC., MEBANE, NC:
2,335,767, REN. 3-31-10. INT. CL. 20.
- KIRUSA INC, NEW PROVIDENCE, NJ:
3,786,078, MULTIPLE CLASS, INT. CLS. 38 AND 42.
3,786,079, MULTIPLE CLASS, INT. CLS. 38 AND 42.
- KISS THE GIRL CLOTHING COMPANY LLC, SCOTTS-
DALE, AZ:
3,785,395, INT. CL. 25.
- KJELL ENGSTRÖM, SWEDEN:
3,785,049, PUB. 2-16-2010. INT. CL. 28.
- KKIQ, INC., SAN JOSE, CA:
2,415,867, REN. 3-27-10. INT. CL. 38.
- KLEIN BANK, KLEIN, TX:
2,754,389, CANC. INT. CL. 36.
- KLEIN TOOLS, INC., LINCOLNSHIRE, IL:
3,785,906, INT. CL. 8.
- KLEIN, DYANN, EASTHAMPTON, NY:
3,785,083, INT. CL. 35.
- KLEINMAN, KELLY, SANTA MONICA, CA:
2,752,379, CANC. INT. CL. 28.
- KMC MUSIC, INC., BLOOMFIELD, CT:
2,754,062, CANC. INT. CL. 15.
- KNEAD MARKETPLACE, LAGRANGE, IL:
3,785,519, MULTIPLE CLASS, INT. CLS. 30 AND 43.
- KNIGHT MANUFACTURING CO., INC., TYLER, TX:
2,428,476, REN. 3-31-10. INT. CL. 28.
- KNIGHT ROSE PRODUCTIONS, LLC, TRUMANSBURG,
NY, DBA KNIGHT ROSE PRODUCTIONS:
3,785,734, INT. CL. 42.
- KNIGHTS APPAREL, INC., OAK BROOK, IL:
2,752,465, CANC. INT. CL. 25.
2,754,250, CANC. INT. CL. 25.
- KNIGHTS OF COLUMBUS, NEW HAVEN, CT:
1,596,950, REN. 3-30-10. U.S. CL. 200.
- KNN COMPANY, SAN FRANCISCO, CA:
2,754,291, CANC. INT. CL. 30.
- KNOWCLICK LLC, BRYN MAWR, PA, DBA KNOWCLICK:
3,784,389, PUB. 2-16-2010. INT. CL. 35.
- KNOWLEDGE BASE MARKETING, INC., HOUSTON, TX:
2,364,604, REN. 3-30-10. INT. CL. 35.
- KNOWLEDGEOPOLIS, INC., LOS ANGELES, CA:
2,272,184, CANC. INT. CL. 9.
- KNOWLES, BEYONCE, BEVERLY HILLS, CA:
3,785,610, INT. CL. 9.
- KNOX MCLAUGHLIN GORNALL & SENNETT, P.C., ERIE,
PA:
3,786,453, INT. CL. 41.
- KOBE STEEL, LTD., TOKYO, JAPAN:
2,368,743, REN. 4-1-10. INT. CL. 11.
- KOEHLER-BRIGHT STAR LLC, HANOVER TOWNSHIP,
PA, KOEHLER MANUFACTURING COMPANY, MARL-
BOROUGH, MA:
523,051, REN. 3-29-10. U.S. CL. 21 (INT. CL. 11).
- KOELNMESSE GMBH, 50679 KOELN, FED REP GER-
MANY:
3,785,629, MULTIPLE CLASS, INT. CLS. 35 AND 41.
3,785,630, MULTIPLE CLASS, INT. CLS. 35 AND 41.
- KOELNMESSE GMBH, KOELN, FED REP GERMANY:
3,785,670, MULTIPLE CLASS, INT. CLS. 35 AND 41.
- KOHL'S ILLINOIS, INC., AURORA, IL:
2,754,184, CANC. INT. CL. 25.
3,785,116, INT. CL. 21.
3,785,688, MULTIPLE CLASS, INT. CLS. 9, 14, 25 AND 26.
- KOIKE ARONSON, INC., ARCADE, NY:
3,785,983, INT. CL. 7.
- KOKOMO'S FAMILY FUN CENTER, INC., SAGINAW, MI:
2,334,249, REN. 3-31-10. INT. CL. 41.
- KONAMI DIGITAL ENTERTAINMENT CO., LTD., TOKYO,
JAPAN:
2,339,276, REN. 3-26-10. INT. CL. 28.
3,785,567, MULTIPLE CLASS, INT. CLS. 9 AND 41.
- KONAMI GAMING, INC., LAS VEGAS, NV:
3,785,594, INT. CL. 9.
- KONG COMPANY LLC, THE, GOLDEN, CO:
2,754,206, CANC. INT. CL. 5.
- KONICA MINOLTA PHOTO IMAGING, INC., TOKYO,
JAPAN:
2,273,030, CANC. INT. CL. 9.
- KONINKLIJKE PHILIPS ELECTRONICS N.V., EINDHO-
VEN, NETHERLANDS:
3,784,987, PUB. 2-16-2010. MULTIPLE CLASS, INT. CLS. 9
AND 11.
- KOOLATRON, INC., BRIDGETOWN, BARBADOS:
2,754,077, CANC. INT. CL. 11.
2,754,414, CANC. INT. CL. 11.
- KOP-FLEX, INC., HANOVER, MD:
1,588,536, REN. 3-29-10. INT. CL. 7.
- KOSMIX CORPORATION, MOUNTAIN VIEW, CA:
3,783,312, PUB. 2-16-2010. MULTIPLE CLASS, INT. CLS.
41 AND 42.
- KOVAR, ADAM B., SAN FRANCISCO, CA:
2,753,498, CANC. MULTIPLE CLASS, INT. CLS. 16 AND
25.
- KOVISS SPORTS CO., LTD., GYUNGGI-DO, REPUBLIC OF
KOREA AND LEE, SUNG-EUN, SEOUL, REPUBLIC OF
KOREA AND LEE, HYUNG-CHOON, SEOUL, REPUBLIC
OF KOREA:
3,786,280, INT. CL. 28.
- KOWA COMPANY, LTD., NAKA-KU, NAGOYA, JAPAN:
2,754,163, CANC. INT. CL. 9.
- KOWA COMPANY, LTD., NAGOYA, JAPAN:
3,783,688, PUB. 2-16-2010. INT. CL. 5.
- KOZLOVA, OLGA, HONOLULU, HI:
3,784,580, PUB. 2-16-2010. INT. CL. 25.
- KRAFT FOODS GLOBAL BRANDS LLC, NORTHFIELD, IL:
3,785,515, INT. CL. 30.
- KRALOVEC, OTTO J., III, GRANVILLE, OH:
3,783,139, PUB. 1-1-2008. INT. CL. 41.
- KRATOS DEFENSE & SECURITY SOLUTIONS, INC., SAN
DIEGO, CA:
3,785,199, INT. CL. 37.
- KRAUSE'S SOFA FACTORY, FOUNTAIN VALLEY, CA:
1,553,331, CANC. INT. CL. 42.
- KRESH, MIRIAM, OLD CITY, TSFAT 13205, ISRAEL:
2,751,973, CANC. INT. CL. 3.
- KRETEK INTERNATIONAL, INC., MOORPARK, CA:
3,783,252, PUB. 5-26-2009. INT. CL. 34.
- KRISTI G. COMPANY, LAWRENCEVILLE, GA:
3,784,252, PUB. 2-16-2010. INT. CL. 20.

KRISTINE A. KEVORKIAN, ENCINO, CA:
3,785,442, INT. CL. 41.

KROGER CO. OF MICHIGAN, THE, NOVI, MI:
2,352,100, REN. 3-29-10, INT. CL. 30.

KRONOTEX U.S.A. HOLDINGS, INC., BARNWELL, SC:
3,786,051, INT. CL. 19.

KRUEGER HOLDINGS LLC, HOUSTON, TX:
3,783,631, PUB. 2-16-2010, INT. CL. 41.

KRUEGER INTERNATIONAL, INC., GREEN BAY, WI:
2,754,121, CANC. INT. CL. 24.

KRUGER INC., MONTREAL, CANADA:
3,785,499, INT. CL. 16.

KRYSTLE HARB CORPORATION, SPEONK, NY, DBA A
GRAPE PEAR WINE BOUTIQUE:
3,784,236, PUB. 2-16-2010, INT. CL. 35.

KS INTERNATIONAL, INC., GREENVILLE, SC:
2,368,919, REN. 3-30-10, INT. CL. 22.

KS MARINE PRODUCTS, INC., FARMINGTON, IL:
3,783,848, PUB. 2-16-2010, INT. CL. 12.
3,783,851, PUB. 2-16-2010, INT. CL. 12.

KT IP MANAGEMENT, L.L.C., MESA, AZ:
3,783,112, PUB. 2-16-2010, INT. CL. 41.

KUM GMBH & CO. KG KUNSTSTOFF- UND METALL-
WARENFABRIK, D 91054 ERLANGEN, FED REP GER-
MANY:
2,271,368, CANC. MULTIPLE CLASS, INT. CLS. 3 AND
16.

KUMHO TIRE CO., INC., SEOUL, REPUBLIC OF KOREA:
3,785,346, INT. CL. 12.

KURASHIKI BOSEKI KABUSHIKI KAISHA, OKAYAMA-
KEN, JAPAN, TA KURABO INDUSTRIES LTD.:
2,336,629, REN. 3-29-10, INT. CL. 7.

KURRAT, JENS, BERLIN, FED REP GERMANY:
2,752,945, CANC. INT. CL. 9.

KUTE KUTS, INC., MIAMI, FL:
3,784,585, PUB. 2-16-2010, INT. CL. 44.

KUTZNER, DAMIAN, IRVINE, CA:
3,786,061, INT. CL. 25.

KUYKENDALL, JAMES, EDWARD, ALLEN, TX:
2,754,642, CANC. INT. CL. 19.

KUYPERS, WILLIAM, GAINESVILLE, FL:
3,784,005, PUB. 2-16-2010, INT. CL. 9.

KWC AG, SWITZERLAND:
3,785,033, PUB. 2-16-2010, INT. CL. 11.

KYOSHO CORPORATION, TOKYO 102-0093, JAPAN:
2,752,311, CANC. INT. CL. 28.
2,752,312, CANC. INT. CL. 28.

L & L FRANCHISE, INC., HONOLULU, HI:
3,784,326, PUB. 2-16-2010, INT. CL. 43.

L G PERFORMANCE, ARLINGTON, TX:
3,210,804, CANC. INT. CL. 35.

L.C. INDUSTRIES, INC., CHICAGO, IL:
2,754,070, CANC. MULTIPLE CLASS, INT. CLS. 20 AND
25.

L.W.G., INC., NORTHBROOK, IL:
2,754,044, CANC. INT. CL. 42.

L'ISOLANTE K-FLEX S.R.L., RONCELLO (MILANO),
ITALY:
3,783,432, PUB. 2-16-2010, INT. CL. 17.
3,783,433, PUB. 2-16-2010, INT. CL. 17.

L'OREAL, PARIS CEDEX, FRANCE:
1,552,425, CANC. INT. CL. 3.

L'OREAL, PARIS, FRANCE:
3,785,566, INT. CL. 3.
3,785,697, INT. CL. 3.

LA PANTERA ROSA RESTAURANT, INC., DORAVILLE,
GA:
2,876,849, CANC. INT. CL. 43.

LA-CO INDUSTRIES, INC., ELK GROVE VILLAGE, IL:
1,614,863, REN. 3-27-10, INT. CL. 16.

LAB SAFETY SUPPLY, INC., JANESVILLE, WI:
3,783,644, PUB. 2-16-2010, MULTIPLE CLASS, INT. CLS.
16 AND 35.

LABEL VISION SYSTEMS, INC., PEACHTREE CITY, GA:
2,331,126, REN. 3-31-10, INT. CL. 9.

LABELSON, ROSS, WESTBURY, NY, DBA BUCKLE DOWN:
2,337,829, REN. 3-31-10, INT. CL. 28.

LABELTAPE MEDITECT INC., GRAND RAPIDS, MI:
1,552,728, CANC. INT. CL. 10.

LABORATOIRE GARNIER & CIE, 75008 PARIS, FRANCE:
2,751,744, CANC. INT. CL. 3.

LABORATOIRE GARNIER & CIE, PARIS, FRANCE:
3,783,512, PUB. 2-16-2010, INT. CL. 3.

LABORATOIRES INNEOV, COURBEVOIE, FRANCE:
2,752,064, CANC. MULTIPLE CLASS, INT. CLS. 3 AND 5.

LABORATOIRES WILSON, 77330 OZOIR-LA-FERRIERE,
FRANCE:
2,753,920, CANC. INT. CL. 3.
2,753,921, CANC. INT. CL. 3.

LABORATORIO CUENCA S.A., BUENOS AIRES, ARGEN-
TINA:
3,377,827, REN. 3-26-10, INT. CL. 3.

LABORATORIO MAVER LTDA., SANTIAGO, CHILE:
3,783,479, PUB. 2-16-2010, INT. CL. 5.

LABORATORIOS NORUEL, SANTO DOMINGO OESTE,
DOMINICAN REP:
3,311,413, CANC. INT. CL. 3.

LABRADA BODYBUILDING NUTRITION, INC., HOUS-
TON, TX:
2,351,620, REN. 3-27-10, INT. CL. 5.

LACROSSE FOOTWEAR, INC., PORTLAND, OR:
2,344,299, REN. 3-30-10, INT. CL. 25.
2,353,912, REN. 3-30-10, INT. CL. 25.

LADY LUX SWIMWEAR CORPORATION, NEWPORT
BEACH, CA:
3,784,165, PUB. 2-16-2010, INT. CL. 25.

LAGARDERE SCA, PARIS, FRANCE:
3,784,869, PUB. 2-16-2010, MULTIPLE CLASS, INT. CLS.
3, 6, 9, 14, 16, 18, 20, 21, 22, 24, 25, 28, 34, 35, 36, 38, 39,
41, 42, 43, 44 AND 45.

LAGUNA AND HALEY CORPORATION, SANTA MARIA,
CA:
2,328,591, REN. 4-1-10, INT. CL. 35.

LAMINA LIGHTING, INC., WESTAMPTON, NJ:
3,783,178, PUB. 2-16-2010, INT. CL. 9.

LAMININ PRODUCTIONS, INC., CAPE CORAL, FL:
3,783,459, PUB. 2-16-2010, INT. CL. 41.

LAMONT, MICHAEL, EUGENE, OR:
2,753,344, CANC. INT. CL. 30.

LANCASTER COLONY CORPORATION, COLUMBUS, OH:
3,784,586, PUB. 2-16-2010, INT. CL. 4.

LANCE ARMSTRONG FOUNDATION, AUSTIN, TX:
3,783,474, PUB. 2-16-2010, INT. CL. 35.
3,783,475, PUB. 2-16-2010, INT. CL. 35.

LANCE, INC., CHARLOTTE, NC:
1,553,102, CANC. INT. CL. 30.

LANCEL INTERNATIONAL SA, VILLARS-SUR-GLANE,
SWITZERLAND:
2,753,136, CANC. INT. CL. 18.
2,753,137, CANC. INT. CL. 18.

LANCOME PARFUMS ET BEAUTE & CIE, 75008 PARIS,
FRANCE:
2,751,963, CANC. INT. CL. 3.

LAND FINDERS, INC., ANNAPOLIS, MD:
2,754,552, CANC. INT. CL. 36.

LANDAMERICA FINANCIAL GROUP, INC., RICHMOND,
VA:
3,783,458, PUB. 2-16-2010, MULTIPLE CLASS, INT. CLS.
35, 36 AND 42.

LANDESK SOFTWARE, INC., SOUTH JORDAN, UT:
3,783,944, PUB. 2-16-2010, INT. CL. 9.

LANDRESS, CARY, SAN DIEGO, CA:
3,786,110, INT. CL. 43.

LANDRUM, KEVIN, BARTLETT, TN:
3,786,456, INT. CL. 41.

LANDSPEED UNLIMITED, SALT LAKE CITY, UT:
3,784,671, PUB. 2-16-2010, INT. CL. 25.

LANGLAIS, MICHEL, WATER MILL, NY:
3,785,175, INT. CL. 32.

LANGUAGE LINE, LLC, MONTEREY, CA:
2,751,664, CANC. INT. CL. 42.

LANSKY BROTHERS, INC., MEMPHIS, TN:
2,382,073, REN. 3-26-10, MULTIPLE CLASS, INT. CLS. 25
AND 35.

- LAPEYROUSE, CARL J, SHREVEPORT, LA:
3,611,684 NEW CERT. 5-4-2010. INT. CL. 44.
- LAREDO PAINT & DECORATING INC, LAREDO, TX:
3,744,241, CANC. INT. CL. 35.
- LARRANCE DOPSON, CULVER CITY, CA, DBA LARRANCE DOPSON PRODUCTIONS, LLC:
3,783,387, PUB. 2-16-2010. MULTIPLE CLASS, INT. CLS. 25 AND 41.
- LATIN ENTERTAINMENT GROUP, LLC, FORDS, NJ:
3,784,239, PUB. 2-16-2010. INT. CL. 38.
3,784,241, PUB. 2-16-2010. INT. CL. 38.
- LAUREN MANUFACTURING COMPANY, NEW PHILADELPHIA, OH:
3,785,569, INT. CL. 17.
- LAURIN PUBLISHING CO., INC., PITTSFIELD, MA:
2,752,272, CANC. MULTIPLE CLASS, INT. CLS. 35 AND 42.
- LAVALA, JAMES, NEW YORK, NY:
3,783,558, PUB. 2-16-2010. INT. CL. 40.
- LAVALLEY, WILLIAM, AUSTIN, TX:
3,785,789, INT. CL. 44.
- LAWAMERICA, INC., PALM DESERT, CA:
2,272,973, CANC. INT. CL. 36.
- LAWN & GARDEN PRODUCTS, INC., FRESNO, CA:
3,786,431, INT. CL. 5.
- LAWNLAB, INC., SEAGOVILLE, TX:
3,783,593, PUB. 2-16-2010. INT. CL. 44.
- LAWRENCE GROUP INC., THE, ST. LOUIS, MO, AKA THE LAWRENCE GROUP, INCORPORATED:
2,334,943, REN. 3-26-10. INT. CL. 42.
2,334,943, AM. INT. CL. 42.
- LAWRENCE GROUP, THE, MINNEAPOLIS, MN:
2,271,656, CANC. INT. CL. 42.
- LAW29 A PROFESSIONAL CORPORATION, NORTH HOLLYWOOD, CA:
3,783,132, PUB. 2-16-2010. INT. CL. 45.
- LAZARUS, GARY AND LEVIN, S. MONTE, BOSTON, MA, AKA THE DREAM MERCHANTS:
3,783,548, PUB. 2-16-2010. INT. CL. 36.
- LBC ACQUISITIONS, LLC, ANNISTON, AL:
515,316, REN. 3-30-10. U.S. CL. 13 (INT. CL. 6).
- LBH GROUP LTD., THE, HAWTHORNE, CA:
2,753,570, CANC. INT. CL. 25.
- LE BARON OUTDOOR PRODUCTS LTD., MONTREAL, QUEBEC, CANADA:
2,332,425, REN. 3-31-10. INT. CL. 35.
- LE PIGEON, PORTLAND, OR:
3,784,285, PUB. 2-16-2010. INT. CL. 43.
- LE SUMMIT INDUSTRIAL CO., LTD., TAIPEI, TAIWAN:
2,752,285, CANC. INT. CL. 9.
- LEADERSHIP CONFERENCE ON CIVIL RIGHTS EDUCATION FUND, WASHINGTON, DC:
2,304,105, REN. 3-26-10. INT. CL. 42.
- LEADERSHIP IN INTERNATIONAL MANAGEMENT LLC, FRIENDSWOOD, TX:
3,783,709, PUB. 2-16-2010. INT. CL. 35.
- LEAH SEE TRADERS, INC., RANCHO CUCAMONGA, CA:
2,754,609, CANC. INT. CL. 21.
- LEANIN' TREE INC., BOULDER, CO:
3,786,072, INT. CL. 16.
- LEARNING FOR LIFE RESOURCE CENTER, PHOENIX, AZ:
3,783,789, PUB. 2-16-2010. INT. CL. 9.
- LEASESTAR LTD., ROSLYN HEIGHTS, NY:
1,552,683, CANC. MULTIPLE CLASS, INT. CLS. 9 AND 35.
- LEASURE, SUSAN L., TUCSON, AZ:
3,784,037, PUB. 2-16-2010. INT. CL. 9.
- LEBLON HOLDINGS LLC, NEW YORK, NY:
3,783,397, PUB. 2-16-2010. INT. CL. 33.
- LEBUA HOTELS & RESORTS COMPANY LIMITED, BANGKOK, THAILAND:
3,783,145, PUB. 2-16-2010. MULTIPLE CLASS, INT. CLS. 35, 43 AND 44.
- LEDEBOER SEEDS LLC, AURORA, OR:
3,785,632, INT. CL. 31.
- LEDLUMINA TECHNOLOGY A/S, STRUER, DENMARK:
3,785,059, MULTIPLE CLASS, INT. CLS. 6, 9 AND 11.
- LEE UNIVERSITY, CLEVELAND, TN:
3,783,600, PUB. 2-16-2010. INT. CL. 41.
- LEE, THOMPSON & FAWCETT COMPANY, PENN, PA:
1,613,084, REN. 3-30-10. MULTIPLE CLASS, INT. CLS. 29 AND 30.
- LEE, WON CHUL, SEOUL, REPUBLIC OF KOREA:
3,784,023, PUB. 2-16-2010. INT. CL. 9.
- LEFKOWITZ, PATRICIA SMITH, SUFFERN, NY:
2,272,506, CANC. INT. CL. 25.
- LEGAL AID OF WESTERN MISSOURI, KANSAS CITY, MO:
3,786,310, INT. CL. 42.
- LEGEND GROUP CO., BEIJING 100080, CHINA:
2,272,784, CANC. INT. CL. 9.
- LEGENDS IN OUR OWN MINDS, LLC, AUSTIN, TX:
2,374,578, REN. 3-29-10. INT. CL. 41.
- LEGRAND CHARLES, CAEN, FRANCE:
3,784,921, PUB. 2-16-2010. MULTIPLE CLASS, INT. CLS. 5 AND 29.
- LEHMAN, GRETCHEN M., LITTLETON, CO, DBA PORTA-VIOLA DESIGN:
3,784,027, PUB. 2-16-2010. INT. CL. 42.
- LEICHLITER ASSOCIATES, LLC, NEW YORK, NY:
3,784,491, PUB. 2-16-2010. INT. CL. 35.
- LEIGHT, DAVID ELLIOTT, SAN DIEGO, CA, DBA LEIGHTWORKS:
3,783,720, PUB. 2-16-2010. INT. CL. 14.
- LEIGHTON, DANIEL, HACIENDA HEIGHTS, CA:
3,785,472, INT. CL. 9.
- LENEHAN, PETER JOHN, MISSION VIEJO, CA, DBA LENEHAN RESEARCH, INC.:
2,753,122, CANC. INT. CL. 9.
- LENMAR ENTERPRISES, INC., CAMARILLO, CA:
2,367,185, REN. 3-26-10. INT. CL. 9.
- LENOX CORPORATION, BRISTOL, PA, FORMERLY LENOX, INCORPORATED:
3,783,761, PUB. 2-16-2010. INT. CL. 35.
- LEONARD HOLDINGS, LLC, LONGBOAT KEY, FL:
3,783,453, PUB. 2-16-2010. MULTIPLE CLASS, INT. CLS. 35 AND 37.
- LES CHOCOLATS DE L'IRIS SA/NV, BELGIUM:
3,784,891, PUB. 2-16-2010. INT. CL. 30.
- LES PRODUCTEURS LAITIERS DU CANADA / DAIRY FARMERS OF CANADA, MONTREAL, QUEBEC, CANADA:
2,752,224, CANC. U.S. CL. A.
- LETICA RESOURCES, INC., ROCHESTER, MI, DBA LETICA FREIGHT LINES:
2,369,971, REN. 3-31-10. INT. CL. 39.
- LEUPOLD & STEVENS, INC., BEAVERTON, OR:
3,783,500, PUB. 2-16-2010. INT. CL. 9.
3,785,844, INT. CL. 9.
- LEV LEYTZAN: THE COMPASSIONATE CLOWN ALLEY, INC., LAWRENCE, NY:
3,783,237, PUB. 2-16-2010. INT. CL. 41.
- LEVEL 7 LLC, ALISO VIEJO, CA:
3,786,228, MULTIPLE CLASS, INT. CLS. 9, 38 AND 41.
- LEVENGER COMPANY, DELRAY BEACH, FL:
2,344,605, REN. 3-27-10. INT. CL. 16.
2,345,789, REN. 3-26-10. INT. CL. 11.
2,370,139, REN. 3-27-10. INT. CL. 16.
2,752,252, CANC. INT. CL. 9.
- LEVENTHAL, ANN Z., HARTFORD, CT:
2,754,648, CANC. INT. CL. 16.
- LEVIN, PETER A., PHILADELPHIA, PA:
1,552,691, CANC. INT. CL. 9.
- LEXCYCLE, INC., PORTLAND, OR:
3,783,551, PUB. 2-16-2010. MULTIPLE CLASS, INT. CLS. 9 AND 42.
- LEXICON MARKETING, LLC, LOS ANGELES, CA:
3,783,980, PUB. 2-16-2010. INT. CL. 9.
- LEXINGTON FURNITURE INDUSTRIES, INC., LEXINGTON, NC:
2,272,948, CANC. INT. CL. 20.
- LEXION MEDICAL, LLC, SAINT PAUL, MN:
3,783,102, PUB. 2-16-2010. INT. CL. 10.
- LF FOOD CORP, REPUBLIC OF KOREA:
3,784,945, PUB. 2-16-2010. INT. CL. 43.

LF, LLC, WILMINGTON, DE:
3,785,197, INT. CL. 11.

LFP IP, LLC, BEVERLY HILLS, CA:
3,785,946, INT. CL. 10.

LG HOUSEHOLD & HEALTH CARE LTD., SEOUL, REPUBLIC OF KOREA:
3,741,495, AM. INT. CL. 3.

LG VERWALTUNGS, GMBH, DORTMUND, FED REP GERMANY:
3,478,987, COR. INT. CL. 16.
3,494,729, COR. INT. CL. 11.
3,514,826, COR. INT. CL. 9.

LI & FUNG (B.V.I.) LIMITED, ROAD TOWN, TORTOLA, BR. VIRGIN ISLANDS:
3,783,665, PUB. 2-16-2010. INT. CL. 25.

LIBERTY HARDWARE MFG. CORP., WINSTON-SALEM, NC:
2,753,654, CANC. INT. CL. 21.

LICKERPOPS LLC, PROVIDENCE, RI:
3,786,372, INT. CL. 30.

LIDL STIFTUNG & CO. KG, D-74167 NECKARSULM, FED REP GERMANY:
2,751,719, CANC. MULTIPLE CLASS, INT. CLS. 29 AND 30.
2,751,800, CANC. INT. CL. 30.

LIDL STIFTUNG & CO. KG, NECKARSULM, FED REP GERMANY:
2,753,009, CANC. INT. CL. 25.

LIFE ACTION MINISTRIES, NILES, MI:
2,752,888, CANC. INT. CL. 16.

LIFE IS NOW, INC., RANCHO SANTA FE, CA:
3,783,336, PUB. 2-16-2010. INT. CL. 41.

LIFE TECHNOLOGIES CORPORATION, CARLSBAD, CA:
2,715,133, CANC. MULTIPLE CLASS, INT. CLS. 1 AND 5.

LIFECARE, INC., WESTPORT, CT:
2,272,862, CANC. INT. CL. 42.

LIFECARE, INC., SHELTON, CT:
3,785,178, MULTIPLE CLASS, INT. CLS. 16 AND 28.

LIFETIME BRANDS, INC., GARDEN CITY, NY:
3,784,759, PUB. 2-16-2010. INT. CL. 21.

LIFETIME REPAIR, LLC, NORTON, OH:
3,783,494, PUB. 2-16-2010. INT. CL. 2.

LIGGETT GROUP LLC, MEBANE, NC:
2,754,308, CANC. INT. CL. 34.

LIGHTHOUSE LIVING SERVICES, INC., SACRAMENTO, CA:
2,752,499, CANC. INT. CL. 44.

LIGHTHOUSE PRODUCTIONS, INC., HOUSTON, TX:
2,752,352, CANC. INT. CL. 41.

LIGHTMACHINERY INC., ALMONTE, ONTARIO, CANADA:
1,125,455, REN. 3-26-10. INT. CL. 9.

LIKWIDART USA INC., PLEASANT GROVE, UT:
2,752,471, CANC. INT. CL. 16.

LIL' DRUG STORE PRODUCTS, INC., CEDAR RAPIDS, IA:
3,785,968, MULTIPLE CLASS, INT. CLS. 5 AND 35.
3,785,977, INT. CL. 5.

LIMARCORP, INC., PISCATAWAY, NJ:
2,753,509, CANC. INT. CL. 42.

LIN, TIANXIANG, ZHONGSHAN, GUANGDONG, CHINA:
3,786,227, INT. CL. 30.

LINCOLN ELECTRIC HOLDING, INC., CLEVELAND, OH:
2,280,640, REN. 3-31-10. MULTIPLE CLASS, INT. CLS. 7 AND 9.

LINCOLN GLOBAL, INC., CLEVELAND, OH:
1,579,838, REN. 3-27-10. INT. CL. 9.

LINCOLN GLOBAL, INC., SANTA FE SPRINGS, CA:
2,324,838, REN. 3-27-10. INT. CL. 7.

LINCOLN GLOBAL, INC., CITY OF INDUSTRY, CA:
3,785,288, INT. CL. 6.
3,785,289, INT. CL. 6.

LINDA LITZINGER BECK, JACKSON, CA, DBA MAKE MY DAY BEAUTIFUL:
3,783,831, PUB. 2-16-2010. INT. CL. 44.

LINK DEPOT CORP., WALNUT, CA:
2,752,418, CANC. INT. CL. 9.

LINN PRODUCTS LIMITED, GLASGOW G76 0EP, UNITED KINGDOM:
2,751,927, CANC. INT. CL. 9.

LINNANE, DENIS, NORTH READING, MA, DBA LINNANE & COMPANY:
2,754,265, CANC. INT. CL. 29.

LINOTYPE GMBH, BAD HOMBURG V.D.H., FED REP GERMANY:
2,752,409, CANC. MULTIPLE CLASS, INT. CLS. 9 AND 16.

LINWOOD HOMES, LTD., DELTA, CANADA:
3,785,281, MULTIPLE CLASS, INT. CLS. 19, 36 AND 37.

LION BIOSCIENCE AG, 69123 HEIDELBERG, FED REP GERMANY:
2,271,528, CANC. MULTIPLE CLASS, INT. CLS. 1, 9 AND 42.

LION, MARKUS, BREISACH, FED REP GERMANY:
3,786,011, INT. CL. 33.

LIPOSCIENCE, INC., RALEIGH, NC:
2,339,201, REN. 3-27-10. INT. CL. 42.

LIPPINCOTT, LLC, NARBERTH, PA:
3,785,367, INT. CL. 36.

LIPSHOP.COM, INC., PHOENIX, AZ:
2,753,760, CANC. INT. CL. 3.

LIPSTICK BAIL BONDS INC., STANTON, CA:
3,783,570, PUB. 2-16-2010. INT. CL. 36.

LIQUENT INC., HORSHAM, PA:
3,785,711, INT. CL. 42.

LIQUID SUN RAYZ, LLC, NORTH BEND, OH, DBA LIQUID SUN RAYZ:
3,784,024, PUB. 2-16-2010. INT. CL. 44.

LIQUIDUS MARKETING, INC., CHICAGO, IL:
3,785,675, INT. CL. 42.
3,785,676, INT. CL. 42.
3,785,677, INT. CL. 42.

LISA C. DECKER, KENNESAW, GA:
3,783,949, PUB. 2-16-2010. INT. CL. 41.

LITERIE PRIMO INC./PRIMO BEDDING COMPANY INC., MONTREAL, QUÉBEC, CANADA:
3,783,251, PUB. 2-16-2010. INT. CL. 20.

LITHOS BOUW B.V., NETHERLANDS:
3,591,398, COR. MULTIPLE CLASS, INT. CLS. 6, 9, 19, 35, 37 AND 42.

LITTLE GENIE PRODUCTIONS, LLC, SEATTLE, WA:
3,783,675, PUB. 2-16-2010. INT. CL. 28.

LITTLE RICKY SOFTWARE, LLC, SAN FRANCISCO, CA:
3,784,589, PUB. 2-16-2010. INT. CL. 9.

LITTLEFUSE, INC., CHICAGO, IL, LITTLEFUSE INCORPORATED, CHICAGO, IL:
443,861, REN. 3-27-10. U.S. CL. 21 (INT. CL. 9).

LITTLEJOHN, JEANETTE, DEERFIELD BEACH, FL:
2,753,082, CANC. INT. CL. 42.

LITTON SYSTEMS, INC., BEVERLY HILLS, CA:
1,552,394, CANC. MULTIPLE CLASS, INT. CLS. 1, 7, 9 AND 16.

LIU, YUAN, VANCOUVER, BC, CANADA:
3,785,295, INT. CL. 11.
3,785,296, INT. CL. 21.

LIV VENTURES INC., OMAHA, NE:
3,784,632, PUB. 2-16-2010. INT. CL. 43.

LIVE THE LIFE MINISTRIES, INC., TALLAHASSEE, FL:
3,783,945, PUB. 2-16-2010. MULTIPLE CLASS, INT. CLS. 9, 41 AND 45.

LIVIBRANCE CENTER, LLC, ST. PETERSBURG, FL:
3,786,173, MULTIPLE CLASS, INT. CLS. 16, 41, 44 AND 45.
3,786,181, MULTIPLE CLASS, INT. CLS. 16, 41, 44 AND 45.

LIVING MEDIA INDIA LIMITED, NEW DELHI-110001, INDIA:
3,786,235, MULTIPLE CLASS, INT. CLS. 38 AND 41.

LIVINGSTONE, IAN, LONDON, SW13 OND, UNITED KINGDOM:
2,344,271, REN. 3-27-10. INT. CL. 9.
2,344,271, CANC. INT. CL. 41.

LIZ CLAIBORNE, INC., NEW YORK, NY:
3,783,673, PUB. 11-10-2009. INT. CL. 14.

- LIZARDTECH, INC., SEATTLE, WA:
2,335,428. REN. 3-30-10. INT. CL. 9.
- LJ LAROCCA, INC., STUDIO CITY, CA:
3,785,547. INT. CL. 3.
- LJK COMPANIES, INC., MINNETONKA, MN:
3,783,099. PUB. 2-16-2010. INT. CL. 35.
- LLEWELLYN, GARY, INDIANAPOLIS, IN:
3,690,813. COR. INT. CL. 35.
- LLOYD, LISA VITINA, TUCSON, AZ:
2,752,882. CANC. INT. CL. 42.
- LOCKMAN, KIA, MIDDLETOWN, DE AND CONNALLY,
SEAN B., MIDDLETOWN, DE:
3,785,851. INT. CL. 35.
- LOEWEN GROUP INTERNATIONAL INC., CINCINNATI,
OH:
2,753,982. CANC. MULTIPLE CLASS, INT. CLS. 39 AND
42.
- LOEWS HOTELS, INC., NEW YORK, NY:
1,601,550. REN. 3-26-10. INT. CL. 42.
- LOGIGEAR CORPORATION, SAN MATEO, CA:
2,398,564. REN. 3-29-10. MULTIPLE CLASS, INT. CLS. 9
AND 42.
- LOGOS@WORK, LLC, DAYTON, OH:
2,328,817. REN. 3-31-10. INT. CL. 42.
- LOMIC INCORPORATED, STATE COLLEGE, PA:
2,388,453. REN. 4-1-10. INT. CL. 9.
- LONDONDERRY FREEZER WAREHOUSE, L.L.C., LON-
DONDERRY, NH:
2,342,779. REN. 3-27-10. INT. CL. 39.
- LONE STAR INDUSTRIES, INC., INDIANAPOLIS, IN:
2,754,155. CANC. INT. CL. 39.
- LONG & FOSTER REAL ESTATE, INC., FAIRFAX, VA:
1,552,846. CANC. INT. CL. 16.
- LONGABERGER COMPANY, THE, NEWARK, OH:
2,345,649. REN. 3-30-10. INT. CL. 41.
- LOOR, JORGE, BRIDGEPORT, CT, DBA GARAGE PCS:
3,783,229. PUB. 2-16-2010. INT. CL. 37.
- LORD CORPORATION, CARY, NC, LORD CORPORATION,
CARY, NC:
2,333,842. REN. 3-26-10. INT. CL. 17.
- LORENZO VILLORESI, ITALY:
3,785,027. PUB. 2-16-2010. INT. CL. 3.
- LORIS HEALTHCARE SYSTEM, LORIS, SC:
2,752,342. CANC. INT. CL. 44.
- LORO PIANA S.P.A., ITALY:
3,784,980. PUB. 2-16-2010. MULTIPLE CLASS, INT. CLS.
24 AND 25.
- LORUS THERAPEUTICS INC., MARKHAM, ONTARIO,
CANADA:
2,751,563. CANC. MULTIPLE CLASS, INT. CLS. 5, 35, 40
AND 42.
- LOS ANGELES ART GLASS COMPANY, BURBANK, CA,
DBA LAAGCO SALES COMPANY:
1,588,449. REN. 3-29-10. INT. CL. 2.
- LOS ANGELES POLICE REVOLVER AND ATHLETIC
CLUB, LOS ANGELES, CA:
3,786,325. INT. CL. 20.
- LOS ANGELES TIMES COMMUNICATIONS LLC, LOS
ANGELES, CA:
2,332,390. REN. 3-30-10. INT. CL. 35.
- LOSMA S.P.A., CURNO, ITALY:
2,409,952. REN. 3-31-10. MULTIPLE CLASS, INT. CLS. 7
AND 11.
- LOST WITHOUT JESUS MINISTRIES, LIBERTY, NC:
3,783,680. PUB. 2-16-2010. INT. CL. 45.
- LOTTA LUV, LLC, NEW YORK, NY:
2,753,099. CANC. INT. CL. 3.
- LOTTE CO., LTD., JAPAN:
3,785,001. PUB. 2-16-2010. MULTIPLE CLASS, INT. CLS.
25 AND 28.
- LOTTE LIQUOR BG CO., LTD., SEOUL, REPUBLIC OF
KOREA:
2,751,819. CANC. INT. CL. 33.
- LOVELAND PRODUCTS, INC., GREELEY, CO:
2,754,057. CANC. INT. CL. 1.
- LT OVERSEAS NORTH AMERICA, INC., IRVINE, CA:
2,342,491. REN. 3-31-10. INT. CL. 30.
- LTP TRADE LIMITED, LONDON WIS 3EH, UNITED KING-
DOM:
2,752,968. CANC. INT. CL. 35.
- LU, TOMMY, HONOLULU, HI:
2,306,567. REN. 3-29-10. INT. CL. 14.
- LUBRIZOL CORPORATION, THE, WICKLIFFE, OH:
2,353,954. REN. 3-26-10. INT. CL. 1.
- LUCASFILM ENTERTAINMENT COMPANY LTD., SAN
FRANCISCO, CA:
3,786,318. MULTIPLE CLASS, INT. CLS. 9 AND 41.
- LUCASFILM LTD., SAN FRANCISCO, CA:
2,331,642. REN. 3-26-10. INT. CL. 9.
2,331,643. REN. 3-26-10. INT. CL. 9.
3,785,058. INT. CL. 16.
3,785,573. INT. CL. 33.
- LUCASOIL PRODUCTS, INC. CORONA, CA:
3,784,349. PUB. 2-16-2010. INT. CL. 4.
- LUCKY STRIKE ENTERTAINMENT, LLC, SHERMAN
OAKS, CA:
3,785,552. MULTIPLE CLASS, INT. CLS. 28 AND 43.
- LUCKY 11, INC., FRISCO, TX:
3,784,838. PUB. 12-11-2007. INT. CL. 3.
- LUISI, JANET M., PITTSBURGH, PA:
2,754,404. CANC. INT. CL. 41.
- LUMMUS TECHNOLOGY INC., BLOOMFIELD, NJ:
3,785,142. INT. CL. 11.
- LUNARI CONSULTING LLC, SEATTLE, WA, DBA LUNARI
CONSULTING:
3,783,692. PUB. 2-16-2010. INT. CL. 42.
- LUNARTRANS, LLC, DEADWOOD, SD, AKA NEXT GIANT
LEAP:
3,785,648. INT. CL. 42.
- LUNDQUIST, RICHARD O., FREDONIA, NY:
2,352,212. REN. 3-30-10. INT. CL. 41.
- LUPETTI, CHRIS JUDE, MAYWOOD, NJ:
2,752,467. CANC. INT. CL. 16.
- LUSH YOGURT, INC., WALNUT, CA:
3,783,919. PUB. 2-16-2010. INT. CL. 43.
- LUTHER BURBANK SAVINGS, MANHATTAN BEACH, CA:
3,783,706. PUB. 2-16-2010. INT. CL. 36.
- LUTHERAN CHURCH - MISSOURI SYNOD, THE, ST.
LOUIS, MO:
2,334,178. REN. 3-26-10. MULTIPLE CLASS, INT. CLS. 16,
36, 41 AND 42.
- LUTRON ELECTRONICS CO., INC., COOPERSBURG, PA:
3,786,088. INT. CL. 9.
- LUU, THANH, SAN JOSE, CA:
2,397,298. REN. 3-31-10. INT. CL. 42.
2,401,605. REN. 3-31-10. INT. CL. 42.
- LUX PRODUCTS CORPORATION, MT. LAUREL, NJ:
2,349,968. REN. 3-31-10. INT. CL. 9.
- LVD ACQUISITION, LLC, COLUMBUS, OH:
1,552,761. CANC. INT. CL. 11.
- LYND PROPERTIES INC., REYNOLDSBURG, OH:
1,552,935. CANC. INT. CL. 21.
- LYNN, MICHAEL W., NAPERVILLE, IL:
2,753,155. CANC. INT. CL. 32.
- LYTHIC SOLUTIONS, INC., VANCOUVER, WA:
3,783,380. PUB. 2-16-2010. INT. CL. 1.
- M. FABRIKANT & SONS, INC., NEW YORK, NY:
2,752,579. CANC. INT. CL. 14.
- M. GHIATH TATARI, D-65428 RUSSELSHEIM, FED REP
GERMANY:
2,922,878. CANC. MULTIPLE CLASS, INT. CLS. 9, 14, 18
AND 25.
- M. LAWRENCE PARKER, KALAMAZOO, MI:
3,784,343. PUB. 2-16-2010. INT. CL. 22.
- M.C. DEAN, INC., DULLES, VA:
2,389,700. REN. 3-26-10. MULTIPLE CLASS, INT. CLS. 37
AND 42.
- M.C.F.T.Y. NATIONAL, LAS VEGAS, NV:
2,751,923. CANC. MULTIPLE CLASS, INT. CLS. 35 AND
39.
- M.D. NATURALS, LTD., BETHESDA, MD:
2,753,227. CANC. INT. CL. 5.
- M.D. WRIGHT, INC., CASEY, IL:
2,752,937. CANC. INT. CL. 9.

- M.O.R.E. INVEST MANAGEMENT AG, FED REP GERMANY:
3,784,893, PUB. 2-16-2010. MULTIPLE CLASS, INT. CLS. 35 AND 36.
- M.T. ASSOCIATES, INC., HARRISONVILLE, MO:
1,552,781, CANC. INT. CL. 12.
- M.V. PEDULLA GUITARS, INC., ROCKLAND, MA:
3,784,261, PUB. 2-16-2010. INT. CL. 15.
- MÜLLER-BBM VIBROAKUSTIK SYSTEME GMBH, FED REP GERMANY:
3,785,036, PUB. 2-16-2010. INT. CL. 9.
- MAANAVI, JENNIFER, NEW YORK, NY:
3,785,639, INT. CL. 41.
- MACDERMID ACUMEN, INC., WATERBURY, CT, OLIN HUNT SUB III CORP., WEST PATERSON, NJ:
1,624,287, REN. 3-28-10. INT. CL. 1.
- MACHAT, MICHAEL, BEVERLY HILLS, CA:
2,229,496, CANC. INT. CL. 33.
- MACHINE CLOUD LLC, NEW ALBANY, OH:
3,784,268, PUB. 2-16-2010. INT. CL. 42.
- MACHINING & WELDING BY OLSEN, INC., MINNEAPOLIS, MN:
1,591,842, REN. 3-31-10. INT. CL. 9.
- MACK'S LURE, INC, WENATCHEE, WA:
3,784,271, PUB. 2-16-2010. INT. CL. 28.
3,784,273, PUB. 2-16-2010. INT. CL. 28.
- MACROMAVENS, LLC, NEW YORK, NY:
3,784,638, PUB. 2-16-2010. INT. CL. 36.
- MACROVISION EUROPE LIMITED, BERKSHIRE RG5 3JP, ENGLAND:
2,751,569, CANC. MULTIPLE CLASS, INT. CLS. 9, 16 AND 42.
- MACSPECIALISTS, INC., EAST GREENWICH, RI:
2,272,674, CANC. INT. CL. 9.
- MACULA VISION RESEARCH FOUNDATION, WEST CONSHOHOCKEN, PA:
2,337,433, REN. 3-31-10. MULTIPLE CLASS, INT. CLS. 36 AND 42.
- MADESA, INC., HIALEAH, FL, DBA RANA FURNITURE:
3,784,060, PUB. 2-16-2010. INT. CL. 35.
- MADTRAVELERS, LLC, BROOKLYN, NY:
3,784,107, PUB. 2-16-2010. INT. CL. 39.
- MAGASCHONI APPAREL GROUP, INC., NEW YORK, NY:
2,754,242, CANC. INT. CL. 25.
- MAGCO INCORPORATED, CLARKS SUMMIT, PA:
3,784,198, PUB. 2-16-2010. INT. CL. 1.
3,784,200, PUB. 2-16-2010. INT. CL. 1.
- MAGIC LU PROMOCOES E EVENTOS, LTDA., BARUERI, SAO PAULO, BRAZIL:
3,785,201, INT. CL. 41.
- MAGICAMP INC., CORAL GABLES, FL:
3,784,072, PUB. 2-16-2010. INT. CL. 41.
- MAGNESITAS NAVARRAS S.A., ZUBIRI (NAVARRA), SPAIN:
3,785,998, INT. CL. 19.
- MAGNESIUM ELEKTRON LIMITED, MANCHESTER M50 3SP, UNITED KINGDOM:
3,784,905, PUB. 2-16-2010. MULTIPLE CLASS, INT. CLS. 6 AND 10.
- MAGNETIC ARTS, LLC, NEW YORK, NY:
3,785,647, MULTIPLE CLASS, INT. CLS. 9, 16 AND 41.
- MAGNUM CUSTOM TRAILER MFG. CO., INC., AUSTIN, TX, DBA MAGNUM TRAILERS AND DBA MAGNUM CUSTOM TRAILERS:
2,399,031, REN. 3-27-10. INT. CL. 12.
- MAHA MASCHINENBAU; HALDENWANG GMBH & CO. KG., FED REP GERMANY:
3,784,985, PUB. 2-16-2010. INT. CL. 9.
- MAHROUG, ERWIN, POORTUGAAL, NETHERLANDS:
3,785,850, INT. CL. 25.
- MAINLINE TECHNOLOGY, INC., ANN ARBOR, MI:
2,752,531, CANC. INT. CL. 5.
- MAIZE, INC., SPANISH FORK, UT:
3,786,015, INT. CL. 38.
- MAJOR LEAGUE BASEBALL PLAYERS ASSOCIATION, NEW YORK, NY:
3,784,751, PUB. 2-16-2010. INT. CL. 25.
- MAKE IT HAPPEN CONSULTING LLC, PARKER, CO:
3,783,426, PUB. 2-16-2010. MULTIPLE CLASS, INT. CLS. 35 AND 41.
- MAKO SURGICAL CORP., HOLLYWOOD, FL:
3,256,819, COR. INT. CL. 10.
- MAKSIMOW, LORENZA, BOULDER, CO:
2,753,181, CANC. INT. CL. 20.
- MALAYSIAN AIRLINE SYSTEM BHD, EL SEGUNDO, CA:
2,295,274, REN. 3-29-10. INT. CL. 39.
- MALIK SIGMA PSI FRATERNITY, INC., ROSELLE, NJ:
2,752,615, CANC. INT. CL. 45.
- MALKIN HOLDINGS LLC, NEW YORK, NY:
3,785,078, INT. CL. 36.
- MALLINCKRODT BAKER, INC., PHILLIPSBURG, NJ:
3,784,033, PUB. 2-16-2010. INT. CL. 1.
- MAMACITA, INC., CAMDEN, NJ:
1,553,091, CANC. INT. CL. 30.
- MAMBO SEAFOOD #1, INC., HOUSTON, TX:
3,785,061, INT. CL. 43.
- MAMMOTH BEVERAGES, INC., CERRITOS, CA:
2,754,508, CANC. INT. CL. 30.
- MANEN LLC, N. PALM BEACH, FL:
2,752,698, CANC. INT. CL. 35.
- MANHATTAN INSTITUTE FOR POLICY RESEARCH, NEW YORK, NY:
3,783,702, PUB. 2-16-2010. MULTIPLE CLASS, INT. CLS. 16, 35 AND 41.
- MANNEK, SHARMIN J., SALT LAKE CITY, UT:
2,752,657, CANC. INT. CL. 44.
- MANNKIND CORPORATION, DANBURY, CT:
2,753,399, CANC. INT. CL. 5.
- MANREX PTY LIMITED, LEICHHARDT, NSW, 2040, AUSTRALIA:
3,784,821, PUB. 2-3-2009. MULTIPLE CLASS, INT. CLS. 9, 35 AND 42.
- MANSOUR JAFARI, BEVERLY HILLS, CA, DBA MANSOURMUSIC CO.:
3,784,231, PUB. 2-16-2010. INT. CL. 41.
- MANTEC SERVICES INC., SEATTLE, WA:
2,337,758, REN. 3-27-10. MULTIPLE CLASS, INT. CLS. 20 AND 35.
- MANTECH INFORMATION SYSTEMS & TECHNOLOGY CORPORATION, CHANTILLY, VA:
2,751,907, CANC. MULTIPLE CLASS, INT. CLS. 9, 35, 41 AND 42.
- MANUFACTURAS INTERNACIONALES K, S.A. DE C.V., GUADALAJARA, JALISCO, MEXICO:
3,783,760, PUB. 2-16-2010. INT. CL. 33.
- MANUFACTURERS' SERVICES LIMITED, CONCORD, MA:
2,752,407, CANC. MULTIPLE CLASS, INT. CLS. 35, 39, 40 AND 42.
- MANUFACTURING INFORMATION EXCHANGE SOLUTIONS, INC., GARDEN GROVE, CA, AKA MIE SOLUTIONS:
3,783,587, PUB. 2-16-2010. INT. CL. 9.
3,783,588, PUB. 2-16-2010. INT. CL. 9.
3,783,589, PUB. 2-16-2010. INT. CL. 9.
- MAPLE CHASE COMPANY, DOWNERS GROVE, IL:
1,588,614, REN. 3-26-10. INT. CL. 9.
- MAPLE LEAF DISTILLERS INC., WINNIPEG, MANITOBA R3E 2K3, CANADA:
2,751,682, CANC. INT. CL. 33.
- MAPLE LEAF FOODS INC., TORONTO, ONTARIO, CANADA:
2,754,235, CANC. INT. CL. 29.
- MAR AND COMPANY, INC., GLENDALE, CA:
1,552,950, CANC. INT. CL. 25.
- MARC D. SOREL, RUMFORD, RI AND RACHEL NOAH, RUMFORD, RI:
3,785,398, INT. CL. 25.
- MARCAS DE RENOMBRE, S.A. DE C.V., MEXICO, D.F., MEXICO:
3,783,358, PUB. 2-16-2010. INT. CL. 3.
- MARCH ISLAND COMPANY, ALAMO, CA:
2,752,679, CANC. INT. CL. 35.
- MARCH V ADVENTURES, SAN DIEGO, CA:
3,786,421, INT. CL. 41.

- MARFIONE, ANTHONY, BRADFORD, PA:
3,785,063, INT. CL. 8.
- MARGARITA FARMS, LLC, HOLUALOA, HI:
3,785,503, INT. CL. 30.
- MARIE DENEZ LLC, OAKLAND, CA:
3,783,774, PUB. 2-16-2010. INT. CL. 35.
- MARILYN A. WESTLAKE, LOCKE, NY:
3,784,564, PUB. 2-16-2010. INT. CL. 45.
- MARIN MOUNTAIN BIKES, INC., NOVATO, CA:
3,783,273, PUB. 2-16-2010. INT. CL. 12.
- MARINA DEL REY CONVENTION AND VISITORS BUREAU, MARINA DEL REY, CA:
3,783,749, PUB. 2-16-2010. INT. CL. 35.
- MARIO CHIODO STUDIO, INC., OAKLAND, CA:
2,754,192, CANC. INT. CL. 25.
2,754,299, CANC. INT. CL. 14.
- MARIO INDUSTRIES OF VIRGINIA, INC., ROANOKE, VA:
3,784,376, PUB. 2-16-2010. INT. CL. 11.
- MARITZ INC., FENTON, MO:
2,753,592, CANC. INT. CL. 35.
- MARK E. INDUSTRIES, INC., CLEARWATER, FL:
2,340,978, REN. 3-31-10. INT. CL. 19.
- MARK MILES CONSULTING INC., SAN FRANCISCO, CA:
3,785,137, INT. CL. 9.
- MARKER VÖLKL INTERNATIONAL GMBH, SWITZERLAND:
3,784,855, PUB. 4-4-2006. MULTIPLE CLASS, INT. CLS. 18, 25 AND 28.
- MARKET CENTRAL, INC., PITTSBURGH, PA:
2,390,873, REN. 3-31-10. INT. CL. 9.
- MARKET CENTRAL, INC., NORCROSS, GA:
2,753,429, CANC. MULTIPLE CLASS, INT. CLS. 9 AND 42.
- MARKET FINDERS BROKERAGE, INC., SOUTH ORANGE, NJ:
3,786,022, INT. CL. 29.
- MARKET MOSAIC, INC., WASHINGTON, DC:
2,753,729, CANC. INT. CL. 42.
- MARKETFITZ, INC., SEATTLE, WA:
2,342,725, REN. 3-31-10. INT. CL. 35.
- MARKETCITY INC., COLUMBIA, IL, FORMERLY RON SCHERER & COMPANY:
3,784,450, PUB. 2-16-2010. INT. CL. 35.
- MARKETING CONFIGURATIONS, INC., APOPKA, FL:
3,786,445, INT. CL. 41.
- MARKETING MIRACLES, INC., WINDHAM, NH:
3,783,352, PUB. 2-16-2010. MULTIPLE CLASS, INT. CLS. 35 AND 42.
- MARKETRON INTERNATIONAL, INC., BURLINGAME, CA:
2,753,128, CANC. INT. CL. 42.
- MARKETS & LANGUAGES INTERNATIONAL CORP, CLEARWATER, FL:
3,784,196, PUB. 2-16-2010. MULTIPLE CLASS, INT. CLS. 9, 35 AND 42.
- MARKEY'S VIDEO IMAGES, LLC, INDIANAPOLIS, IN:
3,784,063, PUB. 2-16-2010. INT. CL. 38.
- MARKO SWAN, GLENDALE, CA:
3,785,172, INT. CL. 35.
- MARKVA, NEIL F., SPRINGFIELD, VA:
2,753,637, CANC. INT. CL. 41.
- MARLOTH, GILLIAN, LOS ANGELES, CA:
2,752,330, CANC. INT. CL. 41.
- MARNA INCORPORATED, SAINT PAUL, MN, DBA REFERENT VODKA:
3,785,958, INT. CL. 33.
- MARQUEZ BROTHERS INTERNATIONAL, INC., SAN JOSE, CA:
3,785,066, INT. CL. 29.
- MARQUEZ INVESTMENTS, CHIPLEY, FL:
3,785,433, INT. CL. 39.
- MARQUIS WHO'S WHO LLC, NEW PROVIDENCE, NJ, MARQUIS-WHO'S WHO, INC., CHICAGO, IL:
696,098, REN. 3-26-10. U.S. CL. 38 (INT. CL. 16).
- MARQUIS WHO'S WHO LLC, NEW PROVIDENCE, NJ, MARQUIS-WHO'S WHO, INC., CHICAGO 11, IL:
696,100, REN. 3-27-10. U.S. CL. 38 (INT. CL. 16).
- MARRIOTT INTERNATIONAL, INC., BETHESDA, MD:
2,380,065, REN. 3-29-10. INT. CL. 42.
3,783,791, PUB. 2-16-2010. INT. CL. 43.
3,783,933, PUB. 2-16-2010. INT. CL. 43.
3,783,934, PUB. 2-16-2010. INT. CL. 43.
3,783,975, PUB. 2-16-2010. INT. CL. 43.
3,783,995, PUB. 2-16-2010. INT. CL. 43.
3,784,396, PUB. 2-16-2010. INT. CL. 43.
- MARS, INCORPORATED, MCLEAN, VA:
3,785,339, INT. CL. 30.
- MARS, MICK, WEST HOLLYWOOD, CA:
3,786,243, INT. CL. 41.
- MARSHA PLAFKIN-HURWITZ, LAKE OSWEGO, OR:
3,783,353, PUB. 2-16-2010. INT. CL. 40.
- MARSHMALLOW FUN COMPANY, LLC, TALLAHASSEE, FL:
3,784,240, PUB. 2-16-2010. INT. CL. 28.
3,784,242, PUB. 2-16-2010. INT. CL. 28.
3,784,243, PUB. 2-16-2010. INT. CL. 28.
3,784,698, PUB. 2-16-2010. INT. CL. 28.
- MARSILLI & CO. S.P.A., CASTELLEONE (CREMONA), ITALY:
3,473,595, COR. INT. CL. 7.
- MARSTELLER, WILLIAM R., BEL AIR, MD:
2,753,617, CANC. INT. CL. 30.
- MARTHA HEINEMAN PIEPER, CHICAGO, IL AND WILLIAM J. PIEPER, CHICAGO, IL:
3,785,518, INT. CL. 41.
- MARTIN LIMESTONE, INC., BLUE BALL, PA:
2,408,437, REN. 3-27-10. INT. CL. 19.
- MARTIN OPERATING PARTNERSHIP L.P., KILGORE, TX:
3,783,180, PUB. 2-16-2010. INT. CL. 39.
3,783,183, PUB. 2-16-2010. INT. CL. 39.
- MARTIN ROTHMANN, EBSDORFERGRUND, FED REP GERMANY AND DIRK WEBER, EBSDORFERGRUND, FED REP GERMANY:
3,783,258, PUB. 2-16-2010. INT. CL. 7.
- MARTIN-BROWER COMPANY, THE, ROSEMONT, IL:
2,754,169, CANC. INT. CL. 39.
- MARTIN, THOMAS B., SR., EL DORADO HILLS, CA:
2,753,989, CANC. INT. CL. 7.
- MARTINI, ANTHONY, NEWPORT BEACH, CA:
3,783,185, PUB. 2-16-2010. INT. CL. 25.
- MARVEL CHARACTERS, INC., MANHATTAN BEACH, CA:
3,785,155, INT. CL. 25.
- MARVELOUS ENTERTAINMENT INC., TOKYO, JAPAN:
3,732,603, COR. INT. CL. 9.
- MARY BAKER EDDY LIBRARY FOR THE BETTERMENT OF HUMANITY, INC., THE, BOSTON, MA:
2,845,545, CANC. INT. CL. 42.
- MARY PULLIG SCHATZ M.D., NASHVILLE, TN:
3,786,132, INT. CL. 9.
3,786,133, INT. CL. 9.
- MASIMO CORPORATION, IRVINE, CA:
3,786,366, INT. CL. 10.
- MASON-MCDUFFIE REAL ESTATE, INC., PLEASANTON, CA:
2,753,073, CANC. INT. CL. 36.
- MASONITE CORPORATION, TAMPA, FL:
3,786,394, INT. CL. 19.
- MASONITE INTERNATIONAL CORPORATION, MISSISSAUGA, ONTARIO L4W 1J2, CANADA:
2,832,827, AM. MULTIPLE CLASS, INT. CLS. 6 AND 19.
- MASONITE INTERNATIONAL CORPORATION, MISSISSAUGA, CANADA:
3,785,292, INT. CL. 19.
- MASSACHUSETTS TEACHERS ASSOCIATION, BOSTON, MA:
3,783,636, PUB. 2-16-2010. INT. CL. 35.
- MASSO, ROBIN, NORTH SCITUATE, RI AND MASSO, STEVEN, NORTH SCITUATE, RI:
2,753,244, CANC. INT. CL. 18.
- MASTER CONTROL SYSTEMS, INC., LAKE BLUFF, IL:
2,752,666, CANC. INT. CL. 9.
- MASTER SANG'S TNT, INC., COOPER CITY, FL:
3,783,449, PUB. 2-16-2010. MULTIPLE CLASS, INT. CLS. 9 AND 41.

MASTERBRAND CABINETS, INC., JASPER, IN:
 3,786,323, MULTIPLE CLASS, INT. CLS. 19 AND 20.
 MASTERCARD INTERNATIONAL INCORPORATED, PURCHASE, NY:
 2,350,658, REN. 3-26-10, INT. CL. 36.
 3,784,754, PUB. 2-16-2010, INT. CL. 36.
 MASTERFUL LIVING, L.L.C., APPLE VALLEY, CA:
 2,752,674, CANC. INT. CL. 44.
 MASTERS, DARRELL, CINCINNATI, OH:
 3,785,652, INT. CL. 36.
 MASTEY DE PARIS, INC., VALENCIA, CA:
 1,597,055, AM. INT. CL. 3.
 MATERIAL ALTERATION CO., INC., HOUSTON, TX:
 3,784,322, PUB. 2-16-2010, INT. CL. 6.
 MATHER FEDERAL CREDIT UNION, SACRAMENTO, CA:
 1,553,223, CANC. INT. CL. 36.
 MATÉRIAUX SPÉCIALISÉS LOUISEVILLE INC., LOUISEVILLE, CANADA:
 3,783,146, PUB. 2-16-2010, MULTIPLE CLASS, INT. CLS. 19 AND 20.
 MATRIX SEMICONDUCTOR, INC., SANTA CLARA, CA:
 2,753,763, CANC. INT. CL. 9.
 MATSUHISA, NOBUYUKI, BEVERLY HILLS, CA:
 2,338,877, REN. 4-1-10, INT. CL. 30.
 2,341,583, REN. 4-1-10, MULTIPLE CLASS, INT. CLS. 25 AND 42.
 2,357,815, REN. 3-26-10, MULTIPLE CLASS, INT. CLS. 25 AND 42.
 MATT, PAMELA H., PRESCOTT, AZ:
 3,784,658, PUB. 2-16-2010, INT. CL. 41.
 MATTEL, INC., EL SEGUNDO, CA:
 2,754,333, CANC. INT. CL. 28.
 2,754,627, CANC. INT. CL. 28.
 3,785,222, INT. CL. 28.
 MATTHEW SCHUPPEL COMPANY, LLC, SANTA MONICA, CA, DBA SHOOPS:
 3,784,090, PUB. 2-16-2010, INT. CL. 43.
 MATTRESS CAPITAL, WAKE FOREST, NC:
 3,784,539, PUB. 2-16-2010, INT. CL. 35.
 MAUI JIM, INC., PEORIA, IL:
 2,272,932, CANC. INT. CL. 9.
 MAX FASHION GROUP, CORP., NEW YORK, NY:
 3,784,753, PUB. 2-16-2010, INT. CL. 25.
 MAX-TRAC TIRE CO., INC., STOW, OH:
 2,338,373, REN. 3-30-10, INT. CL. 12.
 MAXIMA MANUFACTURING COMPANY MEINEL VERWALTUNGES GMBH & CO. KG, GERETSRIED, FED REP GERMANY:
 3,785,264, INT. CL. 28.
 MAXIMILIEN SOAP COMPANY, ALAMEDA, CA:
 3,784,121, PUB. 2-16-2010, INT. CL. 3.
 MAXWOOD FURNITURE, INC., BRIDGEPORT, CT:
 3,784,428, PUB. 2-16-2010, INT. CL. 20.
 MAYES, BRETT, GILBERT, AZ:
 3,703,492, AM. INT. CL. 34.
 MAZUNTE LLC, SANTA MONICA, CA, DBA CIRCLE OF FRIENDS:
 2,752,437, CANC. INT. CL. 3.
 MAZZA, GRAZIANO, PORTO SAN GIORGIO (FERMO), ITALY:
 2,335,000, REN. 3-31-10, INT. CL. 25.
 2,335,000, CANC. INT. CL. 18.
 MBL/TONI&GUY PRODUCTS, L.P., CARROLLTON, TX:
 2,751,574, CANC. INT. CL. 3.
 MCAFEE, INC., SANTA CARLA, CA:
 2,753,214, CANC. INT. CL. 9.
 MCBW RENTALS, LLP, WATERTOWN, WI:
 3,785,193, MULTIPLE CLASS, INT. CLS. 29 AND 35.
 MCCABE, TERRILL, CARLSBAD, CA:
 3,785,190, INT. CL. 28.
 MCCAIN CITRUS INC., OAK BROOK, IL:
 1,553,169, CANC. INT. CL. 32.
 MCCAIN FOODS USA, INC., OAK BROOK, IL:
 2,753,812, CANC. INT. CL. 29.
 MCCAULEY BROTHERS, INC., VERSAILLES, KY:
 3,786,049, INT. CL. 31.
 MCCLUNG, JR., JACK ALLEN, ASH FORK, AZ:
 3,785,832, INT. CL. 14.
 MCF TECHNOLOGY SOLUTIONS, LLC, CLEVELAND, OH:
 3,784,111, PUB. 2-16-2010, INT. CL. 42.
 MCFAUL, JAMES M., JR., NOTTINGHAM, MD:
 2,752,718, CANC. INT. CL. 41.
 MCGARRY BAIR PC, GRAND RAPIDS, MI:
 3,784,473, PUB. 2-16-2010, INT. CL. 45.
 MCGEE, MICHAEL ROBERT, OAKLAND, CA:
 2,754,490, CANC. INT. CL. 16.
 MCGLADREY & PULLEN, MINNEAPOLIS, MN:
 1,552,676, CANC. INT. CL. 9.
 MCGOWIN, CHRISTOPHER LEE, NEW ORLEANS, LA:
 3,785,490, INT. CL. 42.
 MCI COMMUNICATION CORPORATION, ASHBURN, VA, TELECONNECT COMPANY, CEDAR RAPIDS, IA:
 1,558,455, REN. 3-27-10, INT. CL. 38.
 MCIVER, MICHEIL, UPPER MARLBORO, MD:
 3,785,279, INT. CL. 25.
 MCKELVEY, MIGUEL ANGEL, BROOKLYN, NY:
 3,784,452, PUB. 2-16-2010, MULTIPLE CLASS, INT. CLS. 36 AND 42.
 MCLANE COMPANY, INC., TEMPLE, TX:
 3,785,635, INT. CL. 35.
 MCLEAN, JAMES, RIVERSIDE, IL:
 3,784,346, PUB. 2-16-2010, INT. CL. 9.
 MCNEIL NUTRITIONALS, LLC, FORT WASHINGTON, PA:
 3,785,878, INT. CL. 30.
 MCO PROPERTIES INC., FOUNTAIN HILLS, AZ:
 2,373,773, REN. 3-26-10, INT. CL. 37.
 MCT ACQUISITIONS, INC., WARREN, MI:
 1,588,529, REN. 3-31-10, MULTIPLE CLASS, INT. CLS. 7 AND 8.
 MCTIER, WILLIAM A., LAWRENCEVILLE, GA, DBA LIFE-PURPOSES:
 2,753,228, CANC. INT. CL. 41.
 MEAD CORPORATION, THE, DAYTON, OH:
 2,753,883, CANC. INT. CL. 16.
 MEAD JOHNSON & COMPANY, EVANSVILLE, IN:
 3,785,102, INT. CL. 5.
 MEADOW HOMES, INC., DENVER, CO:
 2,271,588, CANC. MULTIPLE CLASS, INT. CLS. 36 AND 37.
 MEARTHANE PRODUCTS CORPORATION, CRANSTON, RI:
 3,784,515, PUB. 2-16-2010, INT. CL. 28.
 MECS, INC., CHESTERFIELD, MO:
 3,785,583, INT. CL. 42.
 MEDAIRE, INC., TEMPE, AZ:
 2,325,149, REN. 3-29-10, MULTIPLE CLASS, INT. CLS. 16 AND 41.
 MEDALLION STUDIOS INC., GREENWOOD, SC:
 2,271,793, CANC. INT. CL. 41.
 MEDASSIST-OP, INC., PALM HARBOR, FL:
 2,272,162, CANC. INT. CL. 10.
 MEDECO SECURITY LOCKS, INC., SALEM, VA:
 2,271,944, CANC. INT. CL. 41.
 MEDENET, INC., SAINT PETERSBURG, FL:
 3,784,674, PUB. 2-16-2010, MULTIPLE CLASS, INT. CLS. 9 AND 35.
 MEDIACORP PTE. LTD., SINGAPORE:
 3,784,926, PUB. 2-16-2010, INT. CL. 41.
 3,784,927, PUB. 2-16-2010, INT. CL. 41.
 MEDIKAT, LLC, PHILADELPHIA, PA:
 2,336,607, REN. 3-30-10, MULTIPLE CLASS, INT. CLS. 16 AND 42.
 MEDIAWHIZ HOLDINGS, INC., NEW YORK, NY:
 3,783,194, PUB. 2-16-2010, INT. CL. 35.
 3,783,215, PUB. 2-16-2010, INT. CL. 35.
 MEDICA CORPORATION, BEDFORD, MA:
 2,336,060, REN. 3-29-10, MULTIPLE CLASS, INT. CLS. 1, 5 AND 10.
 MEDICAL BRIDGES, INC., HOUSTON, TX:
 3,784,853, PUB. 2-16-2010, INT. CL. 35.
 MEDICAL COMMUNICATION CONSULTANTS, LLC, CINCINNATI, OH:
 3,783,721, PUB. 2-16-2010, MULTIPLE CLASS, INT. CLS. 35, 41 AND 42.
 3,783,722, PUB. 2-16-2010, MULTIPLE CLASS, INT. CLS. 35, 41 AND 42.

- MEDICAL CONSULTANTS, INC., OKLAHOMA CITY, OK:
1,597,793. REN. 3-26-10. INT. CL. 35.
- MEDICAL MUTUAL INSURANCE COMPANY, RALEIGH, NC:
2,271,498. CANC. INT. CL. 36.
- MEDICAL PHYSICS SERVICES, LLC, TAMPA, FL:
3,783,843. PUB. 2-16-2010. INT. CL. 44.
3,783,914. PUB. 2-16-2010. INT. CL. 44.
- MEDICAL PROTECTIVE COMPANY, THE, FORT WAYNE, IN:
3,786,342. INT. CL. 35.
- MEDICAL RESEARCH LABORATORIES, INC., BUFFALO GROVE, IL:
2,753,391. CANC. INT. CL. 10.
- MEDICAL STAFFING SOLUTIONS, INC., ROCKLEDGE, FL:
3,785,936. MULTIPLE CLASS, INT. CLS. 35 AND 44.
- MEDICREA INTERNATIONAL, FRANCE:
3,785,051. PUB. 2-16-2010. INT. CL. 10.
3,785,052. PUB. 2-16-2010. INT. CL. 10.
- MEDILAB RESEARCH + TRADING GMBH & CO., ESTENFELD, FED REP GERMANY:
3,785,259. INT. CL. 10.
- MEDITECH INFORMATION SYSTEMS LTD., CHAPPAQUA, NY:
2,753,409. CANC. INT. CL. 14.
- MEDITECNIC S.A., 1024 ECUBLENS, SWITZERLAND:
2,751,813. CANC. INT. CL. 10.
- MEDITERRANEAN GARDEN SOCIETY, THE, 190 02 PEANIA, ATTICA, GREECE:
2,347,893. REN. 3-29-10. INT. CL. 16.
- MEDPEDIA, INC., SAN FRANCISCO, CA:
3,783,303. PUB. 2-16-2010. INT. CL. 44.
- MEDSYNERGIES, INC., IRVING, TX:
2,753,048. CANC. INT. CL. 35.
- MEDTRONIC, INC., MINNEAPOLIS, MN:
2,338,906. REN. 3-31-10. INT. CL. 10.
2,754,356. CANC. INT. CL. 9.
- MEDZONE CORPORATION, SUN CITY, AZ:
2,754,348. CANC. INT. CL. 5.
- MEEKS, MARY GROSSMAN, CORONA, CA:
3,783,344. PUB. 2-16-2010. INT. CL. 3.
- MEESE, INC., SADDLE BROOK, NJ:
2,336,745. REN. 3-30-10. INT. CL. 28.
- MEGALO MEDIA, INC., NEW YORK, NY:
2,754,381. CANC. INT. CL. 42.
- MEGATRADE INTERNATIONAL, INC., NASHVILLE, TN:
2,355,578. REN. 3-26-10. INT. CL. 21.
- MEIJER, INC., GRAND RAPIDS, MI:
1,552,532. CANC. MULTIPLE CLASS, INT. CLS. 8, 11 AND 21.
2,754,183. CANC. INT. CL. 30.
- MEISSNER, MARK E., SAN LUIS OBISPO, CA:
3,783,439. PUB. 2-16-2010. INT. CL. 30.
- MELANIE PETERS AND ASSOCIATES, INC., SANTA FE, NM:
3,785,375. MULTIPLE CLASS, INT. CLS. 35 AND 36.
- MELISSA A. YOUNG, ATLANTA, GA:
3,786,253. INT. CL. 41.
- MELROSE VINEYARDS, INC., ROSEBURG, OR, DBA MELROSE VINEYARDS:
3,784,534. PUB. 2-16-2010. INT. CL. 33.
- MELTEBEKE, RENETTE, SHERWOOD, OR:
1,553,344. CANC. INT. CL. 42.
- MEMORIAL HEALTH SYSTEM, INC., SOUTH BEND, IN:
2,272,275. CANC. INT. CL. 42.
- MEMRY CORP., BETHEL, CT:
2,753,998. CANC. INT. CL. 42.
- MEN'S SENIOR BASEBALL LEAQUE, INC., MELVILLE, NY:
2,272,028. CANC. INT. CL. 41.
- MENDIT CHEMICAL INCORPORATED, BRIDGEPORT, PA:
2,300,611. REN. 3-26-10. INT. CL. 11.
- MENLEY & JAMES LABORATORIES, INC.:
1,552,451. CANC. INT. CL. 5.
- MENTAL HEALTH AMERICA OF FRANKLIN COUNTY, INC., COLUMBUS, OH:
2,754,032. CANC. INT. CL. 16.
- MERCADO LATINO, INC., LOS ANGELES, CA, DBA FARAON FOODS:
1,592,197. REN. 3-26-10. MULTIPLE CLASS, INT. CLS. 29 AND 30.
- MERCADO, RALPH III, CLIFFSIDE PARK, NJ:
2,752,659. CANC. INT. CL. 41.
- MERCER GLOBAL ADVISORS INC., SCOTTSDALE, AZ:
2,272,119. CANC. INT. CL. 36.
- MERCHANDISE MART INC., ROCKVILLE, MD:
1,553,028. CANC. INT. CL. 28.
- MERCHANT PROCESSING, INC., TIGARD, OR:
2,752,712. CANC. INT. CL. 36.
- MERCHANTS INFORMATION SOLUTIONS, INC., PHOENIX, AZ:
3,785,394. INT. CL. 42.
- MERCHSOURCE LLC, FOOTHILL RANCH, CA:
3,786,376. INT. CL. 9.
- MERCK SHARP & DOHME CORP., WHITEHOUSE STATION, NJ:
3,786,306. INT. CL. 5.
- MERCK SHARP & DOHME CORP., WHITEHOUSE, NJ:
3,786,307. INT. CL. 5.
- MERCK SHARP & DOHME CORP., WHITEHOUSE STATION, NJ:
3,786,308. INT. CL. 5.
- MERCURY FULFILLMENT SYSTEMS, INC., SOUTHFIELD, MI:
2,753,646. CANC. INT. CL. 35.
- MEREDITH CORPORATION, DES MOINES, IA:
2,331,618. REN. 3-29-10. INT. CL. 38.
2,334,811. REN. 3-28-10. INT. CL. 16.
2,753,455. CANC. INT. CL. 16.
3,784,773. PUB. 2-16-2010. INT. CL. 41.
3,784,774. PUB. 2-16-2010. INT. CL. 42.
3,784,775. PUB. 2-16-2010. INT. CL. 44.
- MERGENTHALER TRANSFER & STORAGE CO., HELENA, MT:
3,786,106. INT. CL. 39.
3,786,108. INT. CL. 39.
- MERIDIAN RETAIL, INC., TROY, MI:
2,753,058. CANC. INT. CL. 35.
- MERITECH, INC., BROOKLYN HTS., OH:
2,752,721. CANC. MULTIPLE CLASS, INT. CLS. 35 AND 37.
- MERLE ASSOCIATES, LLC., W. NEWTON, MA:
2,753,581. CANC. MULTIPLE CLASS, INT. CLS. 35 AND 42.
- MERLINE, THOMAS, DENVER, CO AND SANDRIN, COLLEEN, DENVER, CO:
3,784,430. PUB. 2-16-2010. INT. CL. 31.
- MERLYN ASSOCIATES, INC., TUSTIN, CA:
3,785,557. INT. CL. 10.
- MERRICK PET CARE, INC., AMARILLO, TX:
3,784,334. PUB. 2-16-2010. INT. CL. 31.
- MERRILL LYNCH & CO., INC., NEW YORK, NY:
2,751,938. CANC. INT. CL. 36.
2,754,581. CANC. INT. CL. 36.
- MERTENS, MILES A., FOND DU LAC, WI, DBA MERTENS TACKLE:
2,338,745. REN. 3-29-10. INT. CL. 28.
- MERU NETWORKS, INC., SUNNYVALE, CA:
3,785,191. INT. CL. 9.
- MESH CITY WIRELESS, LLC, GRAND PRAIRIE, TX:
3,783,228. PUB. 2-16-2010. MULTIPLE CLASS, INT. CLS. 9 AND 38.
- MESTEK, INC., WESTFIELD, MA:
3,785,405. INT. CL. 11.
- METAFORM LTD., GIVAT SHMUEL, ISRAEL:
2,754,535. CANC. INT. CL. 9.
- METALLICA, SAN FRANCISCO, CA:
2,753,501. CANC. INT. CL. 25.
- METAVANTE CORPORATION, MILWAUKEE, WI:
2,334,326. REN. 3-30-10. MULTIPLE CLASS, INT. CLS. 35, 36 AND 40.

METEOROLOGICAL SERVICE OF NEW ZEALAND LIMITED, WELLINGTON, NEW ZEALAND AND METRA INFORMATION LIMITED, WELLINGTON, NEW ZEALAND:
3,783,184, PUB. 11-24-2009. MULTIPLE CLASS, INT. CLS. 9, 35 AND 42.

METRO ONE TELECOMMUNICATIONS, INC., BEAVERTON, OR:
2,751,937, CANC. INT. CL. 42.

METROPOLITAN LIFE INSURANCE COMPANY, NEW YORK, NY:
2,753,222, CANC. MULTIPLE CLASS, INT. CLS. 35 AND 36.
2,754,395, CANC. INT. CL. 36.

METROPOLITAN TRANSPORTATION AUTHORITY, NEW YORK, NY:
3,785,160, INT. CL. 39.

METZ, JOSHUA, I., SANTA BARBARA, CA:
2,754,420, CANC. INT. CL. 42.

METZNER, TED, JR., WOODBRIDGE, NJ:
2,752,593, CANC. INT. CL. 35.

MEYER, KELLY, IRVING, TX:
3,786,063, MULTIPLE CLASS, INT. CLS. 16 AND 41.

MEYERS, ROBERT S., BAYSIDE, NY:
2,753,379, CANC. INT. CL. 42.

MFM INDUSTRIES, INC., REDDICK, FL:
1,609,995. REN. 3-30-10. INT. CL. 31.

MGA ENTERTAINMENT, INC., VAN NUYS, CA:
3,786,182, INT. CL. 28.
3,786,183, INT. CL. 28.

MICARD, L.L.C., SCOTTSDALE, AZ:
3,785,549, INT. CL. 9.
3,785,550, INT. CL. 9.

MICASA TRADING CORP., MIAMI, FL, DBA IMPEX SYSTEMS GROUP, INC.:
3,783,103, PUB. 2-16-2010. INT. CL. 6.

MICHAEL BARTON ENTERPRISES, DUNNELLON, FL:
3,786,428, INT. CL. 25.

MICHAEL C. RIDDLE, HOUSTON, TX:
3,784,026, PUB. 2-16-2010. INT. CL. 36.

MICHAEL J. HUDGINS, DDS, P.C. / SUN ORTHODONTICS DENTAL BRACES, EL PASO, TX:
2,752,671, CANC. INT. CL. 44.

MICHAEL LAHART, LITCHFIELD, CT:
2,340,126. REN. 3-31-10. INT. CL. 25.

MICHAEL THOMAS FURNITURE, INC., LIBERTY, NC:
2,752,443, CANC. INT. CL. 40.

MICHAEL WELKE, FED REP GERMANY:
3,784,925, PUB. 11-10-2009. MULTIPLE CLASS, INT. CLS. 12, 25, 35 AND 36.

MICHIANA YOUTH MINISTRIES, INC., SOUTH BEND, IN:
3,783,940, PUB. 2-16-2010. INT. CL. 45.
3,783,941, PUB. 2-16-2010. INT. CL. 45.
3,783,943, PUB. 2-16-2010. INT. CL. 45.

MICHIGAN COMMERCIAL INSURANCE MUTUAL, LANSING, MI:
3,783,619, PUB. 2-16-2010. INT. CL. 36.

MICHIGAN ECONOMIC DEVELOPMENT CORPORATION, LANSING, MI:
3,785,679, INT. CL. 35.
3,785,701, INT. CL. 35.

MICRO DEPOT, INC, NORCROSS, GA:
3,784,847, PUB. 6-19-2007. INT. CL. 9.

MICRO STAR CO., INC., JESSUP, MD:
1,552,623, CANC. INT. CL. 9.

MICRO-STAR INTERNATIONAL CO., LTD., JUNG-HE CITY, TAIPEI HSIEN, TAIWAN:
2,753,781, CANC. INT. CL. 9.

MICROBLEND TECHNOLOGIES, INC., GILBERT, AZ:
2,336,727. REN. 3-26-10. INT. CL. 2.

MICROPOWER, S.A. DE C.V., 05500 CUAJIMALPA DE MORELOS, D.F. MEXICO, MEXICO:
2,752,231, CANC. INT. CL. 9.

MICROPUMP, INC., VANCOUVER, WA:
3,783,441, PUB. 2-16-2010. INT. CL. 9.

MICROSOFT BUSINESS SOLUTIONS APS, REDMOND, WA:
2,271,648, CANC. INT. CL. 9.

MICROSOFT CORPORATION, REDMOND, WA:
2,342,096, REN. 3-31-10. INT. CL. 35.
2,754,317, CANC. INT. CL. 41.
3,785,954, MULTIPLE CLASS, INT. CLS. 9 AND 41.

MID-AMERICA CONSULTING GROUP INC., CLEVELAND, OH:
3,783,563, PUB. 2-16-2010. INT. CL. 35.

MID-ATLANTIC ASSOCIATION OF MUSEUMS, WASHINGTON, DC:
3,783,175, PUB. 2-16-2010. INT. CL. 41.

MIDLAND DESIGN INC., KELOWNA, BRITISH COLUMBIA, CANADA:
2,754,042, CANC. INT. CL. 8.

MIDWEST HALLOWELL DISTRIBUTORS, INC., CLEVELAND, OH:
3,785,443, INT. CL. 20.

MIDWEST INDUSTRIAL SUPPLY, INC., CANTON, OH:
3,783,703, PUB. 2-16-2010. INT. CL. 4.

MIDWEST MOTORCYCLE SUPPLY DISTRIBUTORS CORP., PEVELY, MO:
3,786,012, INT. CL. 12.

MIGRATION SOFTWARE SYSTEMS LIMITED, SAN JOSE, CA:
2,754,536, CANC. INT. CL. 42.

MIHIR MODY, HOUSTON, TX:
3,785,239, INT. CL. 35.

MIKEGYVER COMPUTER & TECHNOLOGY, INC., ALTAMONTE SPRINGS, FL:
3,784,257, PUB. 2-16-2010. MULTIPLE CLASS, INT. CLS. 9 AND 35.

MIKEN SPORTS, LLC, CALEDONIA, MN:
3,786,008, INT. CL. 28.

MIKKEN ENTERPRISES WORLDWIDE, LLC, FARMINGTON HILLS, MI:
3,785,315, INT. CL. 35.
3,785,316, INT. CL. 35.

MILES, GARY, SALISBURY, MA:
3,783,591, PUB. 2-16-2010. INT. CL. 16.

MILEY, ROBERT J., PHOENIX, AZ:
2,754,382, CANC. INT. CL. 41.

MILIDAK USA INC., BROOKLYN, NY, DBA TONEKA:
3,784,368, PUB. 2-16-2010. INT. CL. 25.

MILK SOURCE LLC, KAUKAUNA, WI:
2,752,039, CANC. MULTIPLE CLASS, INT. CLS. 29 AND 30.

MILLENNIA PRODUCTIONS, INC., TAMPA, FL:
3,784,704, PUB. 2-16-2010. INT. CL. 41.
3,784,736, PUB. 2-16-2010. INT. CL. 41.

MILLENNIUM CUSTOM FOODS, INC., ARLINGTON HEIGHTS, IL:
2,753,658, CANC. INT. CL. 29.

MILLENNIUM INSTITUTE, ARLINGTON, VA:
2,345,874. REN. 3-26-10. MULTIPLE CLASS, INT. CLS. 16 AND 42.
2,345,875. REN. 3-26-10. MULTIPLE CLASS, INT. CLS. 16 AND 42.

MILLER INTERNATIONAL, INC., DENVER, CO:
3,786,169, INT. CL. 25.

MILLER, DAVID, BRIDGEPORT, CT:
3,783,319, PUB. 2-16-2010. INT. CL. 41.

MILLER, DAVID, JACKSON, TN, DBA MILLERBEES MANUFACTURING:
3,784,237, PUB. 2-16-2010. INT. CL. 20.

MILLER, DRAYTON GRANVILLE, MOBILE, AL:
3,785,450, INT. CL. 20.

MILLER, MOSES, OAK PARK, MI:
1,552,685, CANC. INT. CL. 9.

MILLIKEN & COMPANY, SPARTANBURG, SC:
3,784,766, PUB. 2-16-2010. INT. CL. 24.
3,785,650, INT. CL. 5.

MILLS INDUSTRIES, INC., LACONIA, NH:
2,386,101. REN. 3-27-10. INT. CL. 20.

MILLS LIMITED PARTNERSHIP, THE, CHEVY CHASE, MD:
2,374,362. REN. 3-26-10. INT. CL. 36.

MILT SPARKS HOLSTER, INC., BOISE, ID:
1,622,388. REN. 4-1-10. INT. CL. 13.

- MILTON, BRADLEY R., OMAHA, NE, DBA CYBEREUNION:
2,271,311, CANC. INT. CL. 42.
- MILWAUKEE BREWERS BASEBALL CLUB, MILWAUKEE, WI:
2,789,452, COR. INT. CL. 9.
- MINDING YOUR BUSINESS, INC., CHICAGO, IL:
3,784,162, PUB. 2-16-2010. INT. CL. 35.
- MINISTRY OF COMMERCE AND INDUSTRY OF THE REPUBLIC OF CYPRUS, THE, 1421 NICOSIA, CYPRUS:
1,591,489. REN. 3-26-10. U.S. CL. A.
- MINSURG CORPORATION, CLEARWATER, FL:
3,783,149, PUB. 2-16-2010. INT. CL. 5.
- MIOSOFT CORPORATION, MADISON, WI:
3,784,095, PUB. 2-16-2010. INT. CL. 9.
- MIOTEC OY, FIN-02770 ESPOO, FINLAND:
2,751,738, CANC. MULTIPLE CLASS, INT. CLS. 9, 16, 40 AND 42.
- MIPS TECHNOLOGIES, INC., MOUNTAIN VIEW, CA:
2,753,404, CANC. INT. CL. 9.
- MIRKA ABRASIVES, INC., TWINSBURG, OH:
3,786,320, INT. CL. 3.
3,786,321, INT. CL. 3.
- MIRO INDUSTRIES, INC., SALT LAKE CITY, UT:
3,783,259, PUB. 2-16-2010. MULTIPLE CLASS, INT. CLS. 6 AND 19.
- MIS - MACDONALD INDUSTRIAL SERVICES, CROMWELL, CT:
2,435,330. REN. 3-26-10. INT. CL. 12.
- MISSISSIPPI RIVER HILLS ASSOCIATION, SAINTE GENEVIEVE, MO:
3,784,143, PUB. 2-16-2010. INT. CL. 35.
- MISSY ENTERPRISES, INC., STREAMWOOD, IL:
3,786,398, INT. CL. 21.
- MIT MONGKOL INDUSTRY CO., LTD., BANGKOK 10150, THAILAND:
3,783,772, PUB. 2-16-2010. INT. CL. 3.
- MITCHELL GOLF EQUIPMENT COMPANY, CENTERVILLE, OH:
2,272,399, CANC. INT. CL. 28.
- MITCHELL, JOHN S., RUTHERFORD, CA:
3,786,139, INT. CL. 33.
- MITSUBISHI ELECTRIC CORPORATION, TOKYO, JAPAN:
2,752,001, CANC. INT. CL. 9.
- MITSUBISHI ELECTRIC CORPORATION, CHIYODA-KU, TOKYO, JAPAN:
3,785,196, INT. CL. 9.
- MITSUBOSHI KASEIHIN CO., LTD., AICHI, JAPAN:
3,784,930, PUB. 2-16-2010. INT. CL. 40.
- MIZUNO CORPORATION, OSAKA, 541-8538, JAPAN:
3,783,315, PUB. 2-16-2010. INT. CL. 25.
- MJ WILMAN INC., LOS ANGELES, CA:
3,786,020, INT. CL. 14.
- MM USA, FULLERTON, CA:
3,785,391, INT. CL. 31.
- MN AIRLINES, LLC, MENDOTA HEIGHTS, MN:
3,785,170, INT. CL. 39.
- MOATWARE LLC, LOUISVILLE, KY:
2,753,189, CANC. INT. CL. 9.
- MOBILE CLIMATE CONTROL INDUSTRIES INC., TORONTO, ONTARIO, CANADA:
2,272,843, CANC. INT. CL. 7.
- MOBILE PAINT MANUFACTURING COMPANY OF DELAWARE, INC., THEODORE, AL, DBA MOBILE PAINT MANUFACTURING CO., INC.:
376,615. REN. 3-29-10. U.S. CL. 16 (INT. CL. 2).
- MOBILITY RESOURCE ASSOCIATES, INC., ST. CLAIR SHORES, MI:
2,330,601. REN. 3-31-10. MULTIPLE CLASS, INT. CLS. 35, 36 AND 39.
- MODAVORE INC., PARK RIDGE, IL:
3,784,643, PUB. 2-16-2010. INT. CL. 35.
- MODERN'OPTIQUE, OYONNAX, FRANCE:
2,328,887. REN. 3-29-10. INT. CL. 9.
- MODOVELOP PARTNERS, AUSTIN, TX:
3,786,109, INT. CL. 35.
- MOELLEKEN, BRENT R.W., BEVERLY HILLS, CA:
3,785,700, INT. CL. 44.
- MOEN INCORPORATED, NORTH OLMSTED, OH:
2,336,736. REN. 3-31-10. INT. CL. 11.
- MOGREET, INC., VENICE, CA:
3,786,180, MULTIPLE CLASS, INT. CLS. 35, 38 AND 42.
- MOHAT, SAN LUIS OBISPO, CA:
2,752,969, CANC. INT. CL. 9.
- MOHAWK BRANDS, INC., CALHOUN, GA:
3,785,587, INT. CL. 22.
3,785,615, MULTIPLE CLASS, INT. CLS. 19 AND 27.
- MOHAWK BRANDS, INC., CALHOUN, DE:
3,785,617, INT. CL. 27.
- MOHAWK CARPET DISTRIBUTION, INC, CALHOUN, GA:
694,624. REN. 3-29-10. U.S. CL. 42 (INT. CL. 27).
- MOHAWK MANUFACTURING & SUPPLY CO., INC., NILES, IL:
2,327,912. REN. 3-26-10. INT. CL. 17.
- MOJIX, INC., LOS ANGELES, CA:
3,786,378, INT. CL. 9.
- MOLINO S.R.L., 20122, MILANO, ITALY:
2,751,592, CANC. MULTIPLE CLASS, INT. CLS. 41 AND 42.
- MOLLERSON, URVE, BRONX, NY:
3,784,527, PUB. 2-16-2010. INT. CL. 30.
- MOLLICONE, ANTHONY R., SANTA CLARITA, CA:
3,783,577, PUB. 2-16-2010. INT. CL. 25.
- MOM'S PRIDE, INC., PEORIA, AZ:
2,753,130, CANC. INT. CL. 16.
2,753,131, CANC. INT. CL. 41.
- MONACOR INTERNATIONAL GMBH & CO. KOMMANDITGESELLSCHAFT, 28307 BREMEN, FED REP GERMANY:
2,751,599, CANC. MULTIPLE CLASS, INT. CLS. 9, 11 AND 15.
2,751,600, CANC. MULTIPLE CLASS, INT. CLS. 9, 11 AND 15.
- MONAHAN SFI, LLC, MIDDLEBURY, VT:
2,754,180, CANC. INT. CL. 21.
- MONARCH PRODUCTIONS, LLC, CALHOUN, GA:
3,786,231, INT. CL. 25.
- MONAVIE, LLC, SOUTH JORDAN, UT:
3,786,017, INT. CL. 32.
3,786,021, INT. CL. 32.
- MONCLER S.R.L., ITALY:
3,784,896, PUB. 2-16-2010. MULTIPLE CLASS, INT. CLS. 3, 9, 14, 16, 18, 22, 24, 25 AND 28.
- MONDY, KERTIOUS, MIAMI, FL:
2,753,775, CANC. INT. CL. 25.
- MONESSEN HEARTH SYSTEMS COMPANY, PARIS, KY:
2,753,758, CANC. INT. CL. 6.
- MONIKKER PTY LTD, MELBOURNE VIC 3000, AUSTRALIA:
3,567,815, COR. MULTIPLE CLASS, INT. CLS. 38 AND 41.
- MONITAL SIGNAL CORPORATION, MANASQUAN, NJ:
1,553,206, CANC. INT. CL. 35.
- MONKEYMEDIA, INC., AUSTIN, TX:
3,784,765, PUB. 2-16-2010. MULTIPLE CLASS, INT. CLS. 41 AND 45.
- MONSIEUR BENGANA ABDELHAMID, FRANCE:
3,784,861, PUB. 2-16-2010. MULTIPLE CLASS, INT. CLS. 9, 10, 42 AND 45.
- MONTGOMERY MOTOR SPORTS, INC., CLAYTON, OH:
3,784,612, PUB. 2-16-2010. INT. CL. 25.
- MONTONE, PAUL, DEERFIELD BEACH, FL:
3,784,079, PUB. 2-16-2010. INT. CL. 24.
- MONTY'S PLANT FOOD CO., INC., LOUISVILLE, KY:
2,753,239, CANC. INT. CL. 1.
- MONZO ALBERT, RAFAEL, SPAIN:
3,785,031, PUB. 2-16-2010. MULTIPLE CLASS, INT. CLS. 18, 25 AND 39.
- MOOD AUSTRALIA PTY LTD, LEICHHARDT NSW 2040, AUSTRALIA:
3,785,359, INT. CL. 20.
- MOODIE, PHILLIP, MYRTLE BEACH, SC:
2,754,489, CANC. INT. CL. 9.
- MOODS OF NORWAY DA, NORWAY:
3,784,993, PUB. 2-16-2010. MULTIPLE CLASS, INT. CLS. 9, 25, 29, 32 AND 33.

MOORE NORTH AMERICA, INC., GRAND ISLAND, NY:
2,753,567, CANC. MULTIPLE CLASS, INT. CLS. 35 AND 42.
2,754,322, CANC. MULTIPLE CLASS, INT. CLS. 35, 39 AND 40.

MOORE, GREGORY ALLEN, JACKSONVILLE, NC, DBA SMITHFIELD'S CHICKEN'N BAR-B-Q TO SF INVESTMENTS, INC., WILMINGTON, DE:
1,530,259, CANC. INT. CL. 42.

MOOSE INTERNATIONAL, INC., MOOSEHEART, IL:
2,356,549, REN. 3-30-10. INT. CL. 42.
2,359,124, REN. 3-30-10. INT. CL. 42.

MOOSE MOUNTAIN TOYMAKERS LTD., TSIMSHATSUI EAST, KOWLOON, HONG KONG:
2,754,216, CANC. INT. CL. 28.

MORAN TOWING CORPORATION, NEW CANAAN, CT:
533,220, REN. 3-26-10. U.S. CL. 105 (INT. CL. 39).

MOREHOUSE JR., DONALD, HEATHROW, FL:
3,783,988, PUB. 2-16-2010. INT. CL. 25.

MORGAN STANLEY, NEW YORK, NY:
2,753,741, CANC. INT. CL. 36.

MORRIS BOOK PUBLISHING, LLC, AUGUSTA, GA:
2,379,085, REN. 3-28-10. INT. CL. 16.

MORRIS NATIONAL, INC., AZUSA, CA:
2,754,179, CANC. INT. CL. 30.

MORRIS SYSTEMS INC., PLANO, TX, DBA M-SYSTEMS, INC.:
3,783,633, PUB. 2-16-2010. INT. CL. 9.

MORSELS, L.P., AUSTIN, TX:
3,783,811, PUB. 2-16-2010. INT. CL. 35.
3,785,601, MULTIPLE CLASS, INT. CLS. 35, 43 AND 44.

MORTAN, INC., MISSOULA, MT:
2,432,505, REN. 3-29-10. INT. CL. 10.

MORTON, CARI RISA, TALLAHASSEE, FL:
3,786,032, INT. CL. 42.

MOSES & SINGER LLP, NEW YORK, NY:
2,334,930, REN. 3-26-10. INT. CL. 42.

MOSES MIRACLE, LLC, BROOKLINE, MA:
3,783,983, PUB. 2-16-2010. INT. CL. 17.

MOSS, JOHN, JR., FONTANA, CA:
3,785,575, INT. CL. 25.

MOSS, ROGER J., STOCKBRIDGE, GA:
3,785,075, MULTIPLE CLASS, INT. CLS. 25 AND 30.

MOST, HANNOVER, FED REP GERMANY:
1,553,082, CANC. INT. CL. 30.

MOST MASSMEDIA, INC., RYE, NY:
2,430,518, REN. 4-1-10. INT. CL. 35.

MOSTELLER, DAVID, DENVER, CO:
2,429,125, REN. 3-26-10. INT. CL. 30.

MOTENG, INC., POWAY, CA:
2,754,065, CANC. INT. CL. 8.

MOTIVATION MEDIA, INC., GLENVIEW, IL:
1,553,193, CANC. MULTIPLE CLASS, INT. CLS. 35, 39, 41 AND 42.

MOTLEY CRUE, INC., BEVERLY HILLS, CA:
3,784,818, PUB. 3-10-2009. MULTIPLE CLASS, INT. CLS. 16 AND 25.

MOTOR AND EQUIPMENT MANUFACTURERS ASSOCIATION, RESEARCH TRIANGLE PARK, NC:
2,349,144, REN. 3-29-10. INT. CL. 42.

MOTOR TRIKE, INC., TROUP, TX:
2,334,644, REN. 3-26-10. INT. CL. 12.

MOTOROLA, INC., SCHAUMBURG, IL:
3,785,829, INT. CL. 9.

MOTORSPORTS MANAGEMENT, INC., FT. MYERS, FL, DBA MOTORSPORTS SOLUTIONS:
3,785,748, INT. CL. 35.

MOTT'S INC., STAMFORD, CT:
1,553,159, CANC. INT. CL. 32.

MOUNT OTTIMA SYSTEM, INC., TEMPLE CITY, CA:
2,752,260, CANC. INT. CL. 9.

MOUNTAIN VIEW HARVEST COOPERATIVE, LONGMONT, CO:
2,753,405, CANC. INT. CL. 30.

MOUNTVILLE MILLS, INC., LAGRANGE, GA:
3,786,090, INT. CL. 27.

MOVADO LLC, WILMINGTON, DE:
3,785,542, INT. CL. 14.
3,785,543, INT. CL. 14.

MOVIUS INTERACTIVE CORPORATION, DULUTH, GA:
2,754,066, CANC. MULTIPLE CLASS, INT. CLS. 9, 38 AND 42.

MOXY LLC, CHANDLER, AZ:
3,784,630, PUB. 2-16-2010. INT. CL. 35.
3,784,640, PUB. 2-16-2010. INT. CL. 35.

MPB CORPORATION, KEENE, NH:
2,320,693, REN. 4-1-10. INT. CL. 40.
2,320,693, CANC. INT. CL. 7.
2,359,353, REN. 4-1-10. MULTIPLE CLASS, INT. CLS. 7 AND 40.

MPGREEN INC., CHULA VISTA, CA:
3,785,085, INT. CL. 1.

MPR REVOCABLE TRUST, LAS VEGAS, NV:
2,273,056, CANC. INT. CL. 14.

MPS MICRO PRECISION SYSTEMS AG, CH - 2504 BIEL/BIENNE, SWITZERLAND:
3,786,218, MULTIPLE CLASS, INT. CLS. 7, 9 AND 14.

MPV-TRUMA GESELLSCHAFT FUR MEDIZINTECHNISCHE PRODUKTE GMBH, 85640 PUTZBRUNN, FED REP GERMANY:
2,751,573, CANC. INT. CL. 10.

MR DUWAYNE DZIBINSKI, ANNA MARIA, FL:
2,271,879, CANC. INT. CL. 21.

MR. SERGIY GRYGOROVYCH, KYIV, UKRAINE:
2,754,257, CANC. MULTIPLE CLASS, INT. CLS. 9, 16 AND 42.

MRKOHN LLC, OCOEE, FL:
3,784,701, PUB. 2-16-2010. INT. CL. 41.

MRS. BEASLEY'S BAKERY, LLC, CARSON, CA, MISS GRACE LEMON CAKE COMPANY, INC., ENCINO, CA:
1,149,209, REN. 3-26-10. INT. CL. 42.

MRS. GROSSMAN'S PAPER COMPANY, PETALUMA, CA:
2,754,160, CANC. INT. CL. 16.

MS ELECTRONICS LLC, OVERLAND PARK, KS:
3,785,840, INT. CL. 9.

MSP TECHNOLOGIES, LLC, MERIDIAN, ID:
2,284,502, REN. 3-29-10. INT. CL. 12.

MSPOT, INC., PALO ALTO, CA:
3,784,006, PUB. 2-16-2010. MULTIPLE CLASS, INT. CLS. 9 AND 38.

MSR HOTELS & RESORTS, INC., BOSTON, MA:
2,341,049, REN. 3-31-10. MULTIPLE CLASS, INT. CLS. 41 AND 42.

MTC LIGHTING LLC., CUMBERLAND, RI:
2,752,051, CANC. INT. CL. 11.
2,752,058, CANC. INT. CL. 11.

MTI WHIRLPOOLS, INC., SUGAR HILL, GA:
3,784,425, PUB. 2-16-2010. INT. CL. 11.

MUDD (USA) LLC, NEW YORK, NY:
2,754,312, CANC. INT. CL. 25.

MUHAMMAD ALI ENTERPRISES LLC, BERRIEN SPRINGS, MI:
3,786,196, MULTIPLE CLASS, INT. CLS. 9 AND 16.

MUHAMMAD, SABURUDIN, EL MONTE, CA:
3,785,377, INT. CL. 25.

MULTI-PLASTICS, INC., LEWIS CENTER, OH:
2,409,448, REN. 3-31-10. INT. CL. 17.

MUNDER CAPITAL MANAGEMENT, BIRMINGHAM, MI:
3,785,466, INT. CL. 36.

MURPHY, BRIAN MICHAEL, CHANTILLY, VA:
3,783,787, PUB. 2-16-2010. INT. CL. 41.

MURPHY, PHILIP M., III, SOUTHPORT, CT:
2,754,476, CANC. INT. CL. 36.

MURPHY'S WAVES LIMITED, GLASGOW, UNITED KINGDOM:
3,783,254, PUB. 2-16-2010. MULTIPLE CLASS, INT. CLS. 7 AND 28.

MURRAY, KIM L., MODESTO, CA AND MURRAY, CRISTI E., MODESTO, CA, DBA VISION MEDIA AND VISION MEDIA INTERNATIONAL:
2,752,626, CANC. INT. CL. 35.

MURRAY'S BARGAIN CENTER, INC., REDFORD, MI:
2,752,155, CANC. INT. CL. 35.

- MUSEUM OF AFRICAN AMERICAN HISTORY, INC., DETROIT, MI:
2,334,126. REN. 3-31-10. MULTIPLE CLASS, INT. CLS. 16, 35 AND 41.
- MUSIC RESOURCE GROUP, LLC, MONTCLAIR, NJ:
3,783,167. PUB. 2-16-2010. INT. CL. 35.
- MUSIC SCHOOL INTERNATIONAL PTY LTD, WAHROONGA, AUSTRALIA:
3,785,492. MULTIPLE CLASS, INT. CLS. 16 AND 41.
- MUSICALFARE THEATRE COMPANY, INC., AMHERST, NY:
2,754,606. CANC. INT. CL. 41.
- MUTUAL SALES CORP., LONG ISLAND CITY, NY, DBA ALCONE COMPANY:
2,753,412. CANC. INT. CL. 3.
- MY ALUMNI LINK LLC, LOUISVILLE, CO:
3,783,865. PUB. 2-16-2010. INT. CL. 35.
3,784,055. PUB. 2-16-2010. INT. CL. 41.
- MY COMPANY 4, INC., ATLANTA, GA:
3,785,838. INT. CL. 43.
- MY LIVE ADS, LLC, TIERRA VERDE, FL:
3,783,346. PUB. 2-16-2010. MULTIPLE CLASS, INT. CLS. 35, 38 AND 42.
3,783,347. PUB. 2-16-2010. MULTIPLE CLASS, INT. CLS. 35, 38 AND 42.
- MY-BAG CARES LLC, NEW YORK, NY:
3,786,358. INT. CL. 18.
- MY-HAMMER AG, BERLIN, FED REP GERMANY:
3,784,843. PUB. 12-9-2008. MULTIPLE CLASS, INT. CLS. 9, 35, 36, 38, 41 AND 42.
- MYMAJORCOMPANY, FRANCE:
3,784,915. PUB. 2-16-2010. MULTIPLE CLASS, INT. CLS. 9, 16, 25, 28, 35, 38, 41, 42 AND 45.
- MYRIAD GREEYN LLC, VIRGINIA BEACH, VA:
3,784,650. PUB. 2-16-2010. INT. CL. 35.
3,784,651. PUB. 2-16-2010. INT. CL. 35.
- MYSURF, INC., MONTARA, CA:
3,783,712. PUB. 2-16-2010. INT. CL. 28.
- MYTEXTSPIRATIONALS, LLC, EAGLE, ID:
3,785,882. INT. CL. 38.
- MZINGA, INC., BURLINGTON, MA:
3,784,357. PUB. 2-16-2010. INT. CL. 42.
- M3 TECHNOLOGY, INC, HOUSTON, TX:
3,784,603. PUB. 2-16-2010. INT. CL. 9.
- N-TONIC, INC., PASADENA, CA:
3,786,097. INT. CL. 9.
- NAC VITAMIN COMPANY, INC., HICKSVILLE, NY:
2,752,775. CANC. INT. CL. 5.
- NACCME, LLC, MILLSTONE TOWNSHIP, NJ:
3,786,482. INT. CL. 41.
- NACOGDOCHES REHABILITATION GROUP, INC, NACOGDOCHES, TX:
3,784,365. PUB. 2-16-2010. INT. CL. 44.
- NADAMISA, INC., WINDSOR, CANADA:
3,785,244. INT. CL. 43.
- NADER ANGHA, FED REP GERMANY:
3,784,957. PUB. 2-16-2010. MULTIPLE CLASS, INT. CLS. 16, 41 AND 44.
3,784,958. PUB. 2-16-2010. MULTIPLE CLASS, INT. CLS. 16, 41 AND 44.
- NADER ANGHA, 41239 MÖNCHENGLADBACH, FED REP GERMANY:
3,784,959. PUB. 2-16-2010. MULTIPLE CLASS, INT. CLS. 16, 41 AND 44.
- NADER ANGHA, FED REP GERMANY:
3,784,973. PUB. 2-16-2010. MULTIPLE CLASS, INT. CLS. 16, 41 AND 45.
- NADER ANGHA, 41239 MÖNCHENGLADBACH, FED REP GERMANY:
3,784,974. PUB. 2-16-2010. MULTIPLE CLASS, INT. CLS. 16, 41 AND 45.
3,784,975. PUB. 2-16-2010. MULTIPLE CLASS, INT. CLS. 16, 41 AND 45.
- NAF NAF, 93800 EPINAY SUR SEINE, FRANCE:
3,783,197. PUB. 2-16-2010. INT. CL. 25.
- NAIGAI CO., LTD., TOKYO, JAPAN:
3,786,146. INT. CL. 25.
- NALCO CHEMICAL COMPANY, NAPERVILLE, IL:
884,854. REN. 3-30-10. MULTIPLE CLASS, U.S. CLS. 6 (INT. CL. 1), 13 (INT. CL. 6), 15 (INT. CL. 4), 38 (INT. CL. 16), 52 (INT. CL. 3) AND 100 (INT. CL. 40).
- NALCO COMPANY, NAPERVILLE, IL:
1,505,898. CANC. INT. CL. 16.
1,545,951. CANC. INT. CL. 1.
2,334,997. REN. 3-27-10. INT. CL. 1.
- NAMASTE LABORATORIES, L.L.C., BLUE ISLAND, IL:
3,784,714. PUB. 2-16-2010. INT. CL. 3.
- NAMCO BANDAI GAMES INC., SANTA CLARA, CA:
2,336,614. REN. 3-31-10. MULTIPLE CLASS, INT. CLS. 9 AND 28.
- NAME RITE, L.L.C., TEMECULA, CA:
2,281,756. REN. 3-27-10. INT. CL. 42.
- NANAL INC., LAS VEGAS, NV:
3,784,320. PUB. 2-16-2010. INT. CL. 35.
- NANCY BELLEY, WILLISTON PARK, NY:
3,784,598. PUB. 2-16-2010. INT. CL. 14.
- NANO-OR TECHNOLOGIES LTD., LOD 71277, ISRAEL:
2,751,903. CANC. INT. CL. 9.
- NANOPHASE TECHNOLOGIES CORPORATION, ROMEOVILLE, IL:
2,272,286. CANC. INT. CL. 3.
- NANOSTATICS, LLC, CIRCLEVILLE, OH:
3,786,274. INT. CL. 1.
- NAPLES AREA BOARD OF REALTORS, INC., NAPLES, FL:
3,784,556. PUB. 2-16-2010. MULTIPLE CLASS, INT. CLS. 35 AND 36.
- NARADA PRODUCTIONS, INC., MILWAUKEE, WI:
1,552,649. CANC. INT. CL. 9.
- NASACO ELECTRONICS PTE LIMITED, SINGAPORE 486056, SINGAPORE:
2,272,498. CANC. INT. CL. 9.
- NASDAQ STOCK MARKET, INC., THE, WASHINGTON, DC:
2,753,885. CANC. INT. CL. 36.
- NATASUDHARMA, JAKARTA, INDONESIA, DBA EASY-CARPORTAL:
3,784,706. PUB. 2-16-2010. INT. CL. 9.
- NATASUDHARMA, JAKARTA, INDONESIA, DBA EASY-ESTATERENTAL:
3,784,707. PUB. 2-16-2010. INT. CL. 9.
- NATEL & CO., INC., CARLSBAD, CA:
1,552,551. CANC. INT. CL. 9.
- NATHAN CONNOLLY, GARY LIGHTBODY, JONATHAN QUINN, TOM SIMPSON, PAUL WILSON, LONDON, UNITED KINGDOM, DBA SNOW PATROL:
3,784,883. PUB. 2-16-2010. MULTIPLE CLASS, INT. CLS. 16, 25 AND 41.
- NATICK AUTO SALES, INC., MARLBOROUGH, MA:
3,783,909. PUB. 2-16-2010. MULTIPLE CLASS, INT. CLS. 35 AND 37.
- NATIONAL ACADEMY OF RECORDING ARTS & SCIENCES, INC., SANTA MONICA, CA:
2,831,458. CANC. INT. CL. 25.
- NATIONAL ADMINISTRATIVE SOLUTIONS CORP., DUBLIN, OH:
2,753,577. CANC. INT. CL. 36.
- NATIONAL AIR CARGO, INC., ORCHARD PARK, NY:
2,285,270. REN. 3-31-10. INT. CL. 39.
- NATIONAL AIR TRAFFIC CONTROLLERS ASSOCIATION, WASHINGTON, DC:
3,783,452. PUB. 2-16-2010. INT. CL. 41.
- NATIONAL ASSOCIATION OF SCHOOL NURSES, INCORPORATED, SILVER SPRINGS, MD:
3,785,969. INT. CL. 35.
- NATIONAL ASSOCIATION OF STATE FORESTERS, WASHINGTON, DC:
2,340,477. REN. 3-26-10. INT. CL. 42.
- NATIONAL ASSOCIATION OF THEATRE OWNERS, INC., WASHINGTON, DC:
3,786,485. INT. CL. 35.
- NATIONAL AUDUBON SOCIETY, INC., NEW YORK, NY:
2,338,646. REN. 3-30-10. INT. CL. 9.
3,786,249. MULTIPLE CLASS, INT. CLS. 6, 9 AND 21.

NATIONAL COALITION FOR CANCER SURVIVORSHIP, SILVER SPRING, MD:
2,331,606. REN. 3-30-10. INT. CL. 9.

NATIONAL CRAFT INDUSTRIES, INC., LIN KO HSIAN, TAIPEI, TAIWAN:
3,785,104. INT. CL. 17.

NATIONAL DIVERSIFIED SALES, INC., LINDSAY, CA:
3,783,436. PUB. 2-16-2010. MULTIPLE CLASS, INT. CLS. 11 AND 17.

NATIONAL FLUID MILK PROCESSOR PROMOTION BOARD, WASHINGTON, DC:
3,783,866. PUB. 2-16-2010. INT. CL. 35.

NATIONAL GEOGRAPHIC SOCIETY, WASHINGTON, DC:
2,754,158. CANC. MULTIPLE CLASS, INT. CLS. 16 AND 35.

NATIONAL HERITAGE ACADEMIES, INC., GRAND RAPIDS, MI:
2,753,428. CANC. MULTIPLE CLASS, INT. CLS. 9 AND 41.

NATIONAL INDUSTRIES FOR THE BLIND, ALEXANDRIA, VA:
2,364,030. REN. 3-26-10. MULTIPLE CLASS, INT. CLS. 3 AND 5.
2,364,031. REN. 3-26-10. MULTIPLE CLASS, INT. CLS. 3 AND 5.

NATIONAL INSTRUMENTS CORPORATION, AUSTIN, TX:
2,754,214. CANC. INT. CL. 36.

NATIONAL MARROW DONOR PROGRAM, MINNEAPOLIS, MN:
3,785,729. MULTIPLE CLASS, INT. CLS. 35 AND 36.

NATIONAL MOLDING, LLC, MIAMI LAKES, FL:
2,353,471. REN. 3-26-10. INT. CL. 26.

NATIONAL MULTIPLE SCLEROSIS SOCIETY, NEW YORK, NY:
1,553,248. CANC. INT. CL. 36.

NATIONAL OUTDOOR LEADERSHIP SCHOOL, LANDER, WY:
2,752,278. CANC. INT. CL. 41.

NATIONAL PHYSIQUE COMMITTEE OF THE U.S.A., INC., PITTSBURGH, PA. AKA NPC:
1,590,982. REN. 3-30-10. INT. CL. 25.

NATIONAL PRESORT, INC., DALLAS, TX:
3,786,038. INT. CL. 7.

NATIONAL RESTAURANT ASSOCIATION EDUCATIONAL FOUNDATION, THE, CHICAGO, IL:
2,271,541. CANC. MULTIPLE CLASS, INT. CLS. 9, 16 AND 41.

NATIONAL SCIENTIFIC COMPANY, DULUTH, GA:
2,313,361. REN. 3-31-10. INT. CL. 9.
2,313,364. REN. 3-31-10. INT. CL. 9.

NATIONAL SHOOTING SPORTS FOUNDATION, INC., NEWTOWN, CT:
2,341,656. REN. 3-27-10. INT. CL. 42.

NATIONAL SPIRITUAL ASSEMBLY OF THE BAHAI'S OF THE UNITED STATES, WILMETTE, IL:
2,370,596. REN. 3-31-10. INT. CL. 42.

NATIONAL STARCH LLC, BRIDGEWATER, NJ:
2,754,501. CANC. INT. CL. 30.

NATIONAL TANK COMPANY, HOUSTON, TX:
3,784,035. PUB. 2-16-2010. INT. CL. 7.
3,784,036. PUB. 2-16-2010. INT. CL. 7.

NATIONAL TRUST FOR HISTORIC PRESERVATION IN THE UNITED STATES, WASHINGTON, DC:
3,784,540. PUB. 2-16-2010. MULTIPLE CLASS, INT. CLS. 41 AND 43.

NATURAL CAPITAL GROUP, FORT LAUDERDALE, FL:
3,785,655. MULTIPLE CLASS, INT. CLS. 35 AND 36.

NATURAL CONFIDENCE, INC., BEVERLY HILLS, CA:
2,753,210. CANC. INT. CL. 35.

NATURAL LIVING, APOPKA, FL:
3,783,885. PUB. 2-16-2010. INT. CL. 5.

NATURAL THOUGHTS, INC., SAN DIEGO, CA, DBA BIOTONE:
3,783,338. PUB. 2-16-2010. INT. CL. 3.

NATURALI PRO, LLC, SARASOTA, FL:
3,785,743. INT. CL. 1.

NATURE'S BOUNTY INC., BOHEMIA, NY:
2,752,053. CANC. INT. CL. 5.

NATURE'S WAY PRODUCTS, INC., GREEN BAY, WI:
3,785,761. INT. CL. 5.

NAUTILUS, INC., VANCOUVER, WA:
3,783,324. PUB. 2-16-2010. INT. CL. 28.

NAVIGATORMD, INC., KNOXVILLE, TN:
3,785,899. INT. CL. 9.

NAWAB, AKHTAR, NEW YORK, NY:
3,784,595. PUB. 2-16-2010. INT. CL. 43.

NAZDAR COMPANY, SHAWNEE, KS:
1,629,933. REN. 3-27-10. INT. CL. 9.

NBA DEVELOPMENT LEAGUE, LLC, SECAUCUS, NJ:
2,754,013. CANC. INT. CL. 25.

NBA PROPERTIES, INC., NEW YORK, NY:
2,272,494. CANC. INT. CL. 14.

ND SATCOM AG, 88039 FRIEDRICHSHAFEN, FED REP GERMANY:
2,337,242. REN. 3-31-10. INT. CL. 9.

NDEV TECHNOLOGIES, INC., PHOENIX, AZ:
2,752,960. CANC. INT. CL. 9.

NE FOODS INC., NORTH EAST, PA:
2,271,844. CANC. INT. CL. 30.

NEA'S MEMBER BENEFITS CORPORATION, GAITHERSBURN, MD:
2,378,318. REN. 3-27-10. INT. CL. 36.

NEA'S MEMBER BENEFITS CORPORATION, GAITHERSBURG, MD:
2,378,319. REN. 3-27-10. INT. CL. 36.

NEASI-WEBER INTERNATIONAL, NORTHRIDGE, CA:
1,552,665. CANC. INT. CL. 9.

NEBRASKA PLASTICS, INC., COZAD, NE:
2,310,861. REN. 3-30-10. INT. CL. 19.

NEBRASKALAND INC., BRONX, NY:
3,783,131. PUB. 2-16-2010. INT. CL. 30.

NED, 93230 ROMAINVILLE, FRANCE:
2,286,897. REN. 3-26-10. INT. CL. 25.
2,286,897. CANC. MULTIPLE CLASS, INT. CLS. 3 AND 18.

NEELY'S INTELLECTUAL PROPERTIES, LLC, MEMPHIS, TN:
3,783,495. PUB. 2-16-2010. MULTIPLE CLASS, INT. CLS. 29, 30, 35 AND 43.

NEILL CORPORATION, HAMMOND, LA:
3,783,121. PUB. 2-16-2010. INT. CL. 41.
3,783,122. PUB. 2-16-2010. INT. CL. 41.

NEK ADVANCED SECURITIES GROUP, INC., COLORADO SPRINGS, CO:
3,783,870. PUB. 2-16-2010. INT. CL. 41.

NEKTON, INC., DANVILLE, NH:
1,553,030. REN. 3-26-10. INT. CL. 28.

NELSON OUTDOORS, LLC, HORICON, WI:
2,752,114. CANC. INT. CL. 28.

NEMCO FOOD EQUIPMENT, LTD., HICKSVILLE, OH:
1,599,231. REN. 3-26-10. INT. CL. 7.

NEPTUNE TECHNOLOGY GROUP, INC., TALLASSEE, AL:
2,752,965. CANC. MULTIPLE CLASS, INT. CLS. 9 AND 38.

NESTE OIL OYJ, ESPOO, FINLAND:
3,786,234. MULTIPLE CLASS, INT. CLS. 1, 4, 39, 40 AND 42.

NETCALLCENTER LTDA, 249/22, SANTANA DO PARNAI-BA - SP, BRAZIL:
2,754,558. CANC. INT. CL. 42.

NETFACTOR CORPORATION, GREENWOOD VILLAGE, CO, FORMERLY MERIDIAN DIGITAL MARKETING:
3,783,314. PUB. 2-16-2010. INT. CL. 9.

NETWORK SOFTWARE ASSOCIATES, INC., LAGUNA HILLS, CA TO NETSOFT, LAGUNA HILLS, CA:
1,552,666. CANC. INT. CL. 9.

NETWORK SOLUTIONS, LLC, HERNDON, VA:
3,783,513. PUB. 2-16-2010. INT. CL. 42.

NETWORKING GUY, LLC, THE, SCOTTSDALE, AZ:
2,752,675. CANC. INT. CL. 16.

NETWORLDD ALLIANCE, LLC, LOUISVILLE, KY:
2,753,150. CANC. MULTIPLE CLASS, INT. CLS. 35 AND 38.

NEUMANN COLLEGE, ASTON, PA:
3,786,389. MULTIPLE CLASS, INT. CLS. 9 AND 41.

- NEUROGESX, INC., SAN MATEO, CA:
3,786,343, INT. CL. 5.
- NEUROSTEM, INC., GAINESVILLE, FL:
2,754,575, CANC. INT. CL. 42.
- NEUTROGENA CORPORATION, LOS ANGELES, CA:
1,597,057, REN. 3-26-10. INT. CL. 3.
- NEVER SUMMER INDUSTRIES, INC., DENVER, CO:
2,752,002, CANC. MULTIPLE CLASS, INT. CLS. 25 AND 28.
2,752,003, CANC. MULTIPLE CLASS, INT. CLS. 25 AND 28.
- NEW ALBERTSON'S, INC., EDEN PRAIRIE, MN:
3,786,033, INT. CL. 30.
- NEW BALANCE ATHLETIC SHOE, INC., BOSTON, MA:
3,784,451, PUB. 2-16-2010. INT. CL. 25.
- NEW CLAIRVAUX VINEYARD, LLC, CHICO, CA:
3,785,107, INT. CL. 33.
- NEW GLOBAL SOLUTIONS, INC., MIAMI LAKES, FL:
3,784,599, PUB. 2-16-2010. MULTIPLE CLASS, INT. CLS. 37 AND 42.
- NEW HAMPSHIRE CHARITABLE FOUNDATION, CONCORD, NH:
2,752,017, CANC. MULTIPLE CLASS, INT. CLS. 35 AND 36.
- NEW MEXICO CHIROPRACTIC ASSOCIATION, ALBUQUERQUE, NM:
3,783,963, PUB. 2-16-2010. U.S. CL. 200.
3,783,964, PUB. 2-16-2010. INT. CL. 44.
- NEW MEXICO STATE UNIVERSITY BOARD OF REGENTS, LAS CRUCES, NM:
2,751,776, CANC. INT. CL. 41.
- NEW ORGANICS COMPANY, THE, BRAINTREE, MA:
2,751,620, CANC. MULTIPLE CLASS, INT. CLS. 29, 30 AND 32.
- NEW PIG CORPORATION, TIPTON, PA:
2,338,357, REN. 4-1-10. MULTIPLE CLASS, INT. CLS. 16 AND 41.
- NEW SCALE TECHNOLOGIES, INC., VICTOR, NY:
3,785,508, INT. CL. 9.
- NEW WORLD PASTA COMPANY, HARRISBURG, PA:
2,752,319, CANC. INT. CL. 30.
- NEW WORLD RESOURCES N.V., NL-1081 KM AMSTERDAM, NETHERLANDS:
3,785,023, PUB. 2-16-2010. MULTIPLE CLASS, INT. CLS. 1, 4, 7, 9, 35, 36, 37, 39, 40, 42 AND 44.
- NEW YORK AIR BRAKE CORPORATION, WATERTOWN, NY:
3,784,058, PUB. 2-16-2010. INT. CL. 9.
- NEW YORK CITY ECONOMIC DEVELOPMENT CORPORATION, NEW YORK, NY:
3,783,643, PUB. 11-10-2009. INT. CL. 35.
- NEW YORK COLLEGE OF HEALTH PROFESSIONS, SYOSSET, NY:
3,785,376, INT. CL. 3.
- NEW YORK INSURANCE ASSOCIATION, INC., ALBANY, NY:
2,433,569, REN. 3-31-10. INT. CL. 42.
- NEW YORK STATE DEPARTMENT OF AGRICULTURE, ALBANY, NY:
1,553,354, CANC. U.S. CL. A.
- NEW YORK STATE'S BEST TASTING WATER, LLC, GUILFORD, NY:
3,784,133, PUB. 2-16-2010. INT. CL. 32.
- NEW YORK SWEETS BAKERY CAFE, INC., NEW YORK, NY:
3,786,432, INT. CL. 30.
- NEW YORK TIMES COMPANY, THE, NEW YORK, NY:
2,337,486, REN. 3-31-10. INT. CL. 16.
3,784,692, PUB. 2-16-2010. INT. CL. 41.
3,784,717, PUB. 2-16-2010. MULTIPLE CLASS, INT. CLS. 16 AND 41.
- NEW ZAPMEDIA, LLC, ATLANTA, GA:
2,753,485, CANC. INT. CL. 42.
- NEWBAY MEDIA LLC, NEW YORK, NY:
3,785,326, INT. CL. 19.
- NEWBOLD CORPORATION, ROCKY MOUNT, VA:
3,785,836, INT. CL. 9.
- NEWELL INTERNATIONAL, INC., SALT LAKE CITY, UT:
3,232,137, COR. MULTIPLE CLASS, INT. CLS. 8, 9 AND 18.
- NEWELL OPERATING COMPANY, ATLANTA, GA:
3,786,289, INT. CL. 20.
- NEWELL PORCELAIN CO., INC., NEWELL, WV:
1,609,076, REN. 3-31-10. INT. CL. 17.
- NEWMAN, 49300 CHOLET, FRANCE, PERRET-JAUNET S.A., LYON (RHONE), FRANCE:
891,625, REN. 3-26-10. U.S. CL. 39 (INT. CL. 25).
- NEWMAN, NEIL A, OMRO, WI:
2,381,889, REN. 3-31-10. INT. CL. 21.
- NEWMAN, SYLVIA, SEDONA, AZ, DBA SACRED CIRCLE TRANSFORMATIONAL COACHING:
3,784,569, PUB. 2-16-2010. INT. CL. 41.
- NEWPORT MEDICAL INSTRUMENTS, INC., COSTA MESA, CA:
3,785,801, INT. CL. 10.
3,785,802, INT. CL. 10.
- NEWTETTER, MARK A., SAN FRANCISCO, CA:
3,785,623, INT. CL. 41.
- NEWTON PROSTHODONTICS, NEWTON, MA:
3,784,277, PUB. 2-16-2010. INT. CL. 44.
- NEXANS, 75008 PARIS, FRANCE:
2,752,205, CANC. INT. CL. 9.
- NEXARK, INC., INDUSTRY, CA:
3,784,479, PUB. 2-16-2010. INT. CL. 9.
- NEXNAV, INC., WILLIAMSBURG, VA:
3,449,127, CANC. INT. CL. 9.
- NEXT LEVEL GUITAR, INC., CARDIFF, CA:
3,783,996, PUB. 2-16-2010. INT. CL. 9.
3,783,998, PUB. 2-16-2010. INT. CL. 41.
3,784,001, PUB. 2-16-2010. INT. CL. 41.
3,784,003, PUB. 2-16-2010. INT. CL. 9.
- NEXT LEVEL SECURITY SYSTEMS, INC., CARLSBAD, CA:
3,786,113, INT. CL. 9.
- NEXT, INC., NEW YORK, NY:
2,752,011, CANC. INT. CL. 41.
- NEXTCARE, INC., MESA, AZ:
3,785,732, INT. CL. 44.
- NEXTERNA, INC., OMAHA, NE:
2,753,730, CANC. INT. CL. 9.
- NEXUS HOLIDAYS CHICAGO INC., CHICAGO, IL:
3,783,189, PUB. 2-16-2010. INT. CL. 39.
- NEZON MARKETING PTE, LTD, TANJONG, PAGAR, SINGAPORE:
2,753,459, CANC. INT. CL. 3.
- NHA, INC., BRISTOL, PA:
3,786,317, INT. CL. 34.
- NHC COMMUNICATIONS, INC., MOUNT-ROYAL, QUEBEC, CANADA:
2,752,158, CANC. INT. CL. 9.
- NICCA CHEMICAL CO., LTD., FUKUI-KEN, JAPAN:
2,751,944, CANC. INT. CL. 3.
- NICHE FOODS LLC, WALNUT CREEK, CA:
3,784,633, PUB. 2-16-2010. INT. CL. 29.
- NIELSEN BUSINESS MEDIA, INC., NEW YORK, NY:
3,785,341, INT. CL. 41.
- NIKE, INC., BEAVERTON, OR:
2,751,539, CANC. MULTIPLE CLASS, INT. CLS. 9, 18, 25 AND 28.
- NIKKEN, INC., IRVINE, CA:
2,754,017, CANC. INT. CL. 3.
- NIKON CORPORATION, TOKYO 100, NY:
2,330,693, REN. 3-31-10. MULTIPLE CLASS, INT. CLS. 9, 16, 21 AND 28.
2,330,693, CANC. MULTIPLE CLASS, INT. CLS. 12, 14 AND 20.
- NINA FOOTWEAR CORP., NEW YORK, NY:
3,784,536, PUB. 2-16-2010. INT. CL. 25.
- NINJAI GANG, LLC, KAILUA, HI:
3,786,295, INT. CL. 25.
- NINTENDO OF AMERICA INC., REDMOND, WA:
3,783,138, PUB. 2-16-2010. INT. CL. 9.
- NIOXIN RESEARCH LABORATORIES, INC., LITHIA SPRINGS, GA:
2,753,400, CANC. INT. CL. 3.

NISENSEN, PATRICIA M, NEW YORK, NY, AKA TRICIA NISENSEN:
 3,784,724, PUB. 2-16-2010. INT. CL. 41.
 NISHIMOTO TRADING CO., LTD., SANTA FE SPRINGS, CA:
 2,356,234. REN. 4-1-10. INT. CL. 30.
 NIXON, INC., ENCINITAS, CA:
 2,336,701. REN. 3-30-10. MULTIPLE CLASS, INT. CLS. 14 AND 25.
 NIXON, JOE, SANTA CRUZ, CA:
 2,753,770, CANC. INT. CL. 41.
 2,753,771, CANC. INT. CL. 41.
 NO KA OI FRAGRANCES OF HAWAII, INC., HONOLULU, HI:
 2,272,421, CANC. INT. CL. 3.
 NO-TILL FARMS, INC., KALISPELL, MT:
 3,785,808, INT. CL. 1.
 NOAX TECHNOLOGIES AG, EBERSBERG, FED REP GERMANY:
 3,785,342, MULTIPLE CLASS, INT. CLS. 9 AND 42.
 NOBLE GRACE LLC, NEW YORK, NY:
 2,752,654, CANC. INT. CL. 16.
 NOBLE SYSTEMS CORPORATION, ATLANTA, GA:
 3,783,968, PUB. 2-16-2010. INT. CL. 38.
 NOELWERKS, INC., STEVENS POINT, WI:
 3,786,006, INT. CL. 42.
 NOKIA CORPORATION, 02150 ESPOO, FINLAND:
 2,751,667, CANC. MULTIPLE CLASS, INT. CLS. 9 AND 42.
 NOKIA CORPORATION, FI-02150 ESPOO, FINLAND:
 3,786,003, INT. CL. 9.
 NOLAN, DONALD J., CHICAGO, IL:
 2,342,017. REN. 3-29-10. INT. CL. 42.
 NOLAR024, LLC, MIDDLEBURY, CT:
 3,785,572, INT. CL. 10.
 NOMA INC., SCARBOROUGH, ONTARIO, CANADA:
 1,552,763, CANC. INT. CL. 11.
 NONA BRITTON, EAGLE, ID:
 3,784,215, PUB. 2-16-2010. INT. CL. 26.
 NONINO S.P.A., 33050 PAVIA DI UDINE (UDINE), ITALY, NONINO SRL, PERCOTO (UD), ITALY:
 1,609,293. REN. 3-26-10. INT. CL. 33.
 NOODLE TIME, INC., MIAMI, FL:
 3,784,161, PUB. 2-16-2010. INT. CL. 21.
 NOOR HERBAL SUPPLEMENTS LLC DBA NOOR HERBALS, BEAR, DE:
 2,752,898, CANC. INT. CL. 5.
 NORANDEX BUILDING MATERIALS DISTRIBUTION, INC., HUDSON, OH:
 1,552,902, CANC. INT. CL. 19.
 NORCROSS CORPORATION, NEWTON, MA:
 3,785,956, INT. CL. 9.
 NORDYNE, LLC, O'FALLON, MO, INTERTHERM, INC., ST. LOUIS, MO:
 887,886. REN. 3-29-10. U.S. CL. 34 (INT. CL. 11).
 NORMAN, MICHELLE, LA JOLLA, CA:
 3,786,056, INT. CL. 3.
 NORMANDY SHIPPING, L.L.C., OKLAHOMA CITY, OK:
 3,784,101, PUB. 2-16-2010. INT. CL. 39.
 NORTH AMERICAN ASSOCIATION OF STATE AND PROVINCIAL LOTTERIES, INC., WILLOUGHBY HILLS, OH:
 2,754,498, CANC. INT. CL. 35.
 NORTH AMERICAN COMPANY FOR LIFE AND HEALTH INSURANCE, CHICAGO, IL:
 2,271,771, CANC. INT. CL. 36.
 NORTH AMERICAN HEALTH DEVELOPMENT INSTITUTES, INC., FRIENDSWOOD, TX:
 3,785,865, MULTIPLE CLASS, INT. CLS. 41, 42 AND 44.
 NORTH AMERICAN NUTRITION COMPANIES, INC., LEWISBURG, OH:
 2,752,875, CANC. INT. CL. 5.
 NORTH CAPE PUBLICATIONS, TUSTIN, CA:
 2,343,348. REN. 3-26-10. INT. CL. 16.
 NORTHEAST ENGINEERS AND CONSULTANTS, INC., MIDDLETOWN, RI:
 2,337,836. REN. 3-30-10. INT. CL. 42.
 NORTHERN LABS, INC., MANITOWOC, WI:
 3,783,686, PUB. 2-16-2010. INT. CL. 40.
 NORTHERN TOOL & EQUIPMENT COMPANY, INC., BURNSVILLE, MN:
 3,786,019, INT. CL. 7.
 NORTHERN TRUST CORPORATION, CHICAGO, IL:
 2,329,665. REN. 3-29-10. INT. CL. 41.
 2,331,564. REN. 3-30-10. INT. CL. 36.
 NORTHERN UNITED BREWING COMPANY, LLC, ANN ARBOR, MI:
 3,785,837, INT. CL. 32.
 3,785,885, INT. CL. 33.
 NORTHWEST AIRLINES, INC., EAGAN, MN:
 2,273,101, CANC. INT. CL. 39.
 NORTHWEST COATINGS, INC., MARYSVILLE, CA:
 1,552,414, CANC. INT. CL. 2.
 NORTHWEST NATURAL GAS COMPANY, PORTLAND, OR, DBA NW NATURAL:
 2,752,040, CANC. MULTIPLE CLASS, INT. CLS. 35 AND 39.
 NORTON, JOSEPH J., BRIGHTON, MI:
 3,786,339, INT. CL. 32.
 NORWOOD PROMOTIONAL PRODUCTS, LLC, SHELTON, CT:
 3,784,734, PUB. 2-16-2010. INT. CL. 16.
 NOVARTIS AG, BASEL, SWITZERLAND:
 2,752,887, CANC. INT. CL. 5.
 2,752,940, CANC. INT. CL. 5.
 2,753,022, CANC. INT. CL. 5.
 NOVARTIS AG, HANOVER, NJ:
 2,753,023, CANC. INT. CL. 5.
 NOVARTIS AG, BASEL, SWITZERLAND:
 2,753,052, CANC. INT. CL. 5.
 3,183,596, AM. INT. CL. 5.
 3,785,901, INT. CL. 5.
 NOVITEC VERTRIEB VON AUSRUSTUNGEN FUR KRAFTFAHRZEUGE UND ENERGIEVERSORGUNGSANLAGEN GMBH, 66115 SAARBRUCKEN, FED REP GERMANY:
 2,753,930, CANC. INT. CL. 9.
 NOVO NORDISK HEALTH CARE AG, SWITZERLAND:
 3,785,046, PUB. 2-16-2010. INT. CL. 5.
 3,785,047, PUB. 2-16-2010. INT. CL. 5.
 NOVODIETA, S.L., 12006 CASTELLON, SPAIN:
 2,752,016, CANC. MULTIPLE CLASS, INT. CLS. 5 AND 35.
 NOVOZYMES A/S, BAGSVAERD, DENMARK, NOVO INDUSTRI A/S, BAGSVAERD, DENMARK:
 1,588,426. REN. 3-31-10. INT. CL. 1.
 NOVOZYMES A/S, BAGSVAERD, DK-2880, DENMARK:
 2,272,208, CANC. INT. CL. 1.
 NOW SOLUTIONS LLC, FORT WORTH, TX:
 2,754,006, CANC. INT. CL. 9.
 NPC, INC., CLAYSBURG, PA:
 3,786,199, INT. CL. 40.
 NSE PRODUCTS, INC., PROVO, UT:
 2,394,310. REN. 3-31-10. INT. CL. 3.
 NTERAS CORPORATION, AMERICAN FORK, UT:
 2,753,924, CANC. INT. CL. 9.
 NTH, INC., BARRON, WI:
 1,593,827. REN. 3-31-10. INT. CL. 7.
 NTK ENTERPRISES, INC., PLANO, TX:
 3,786,430, INT. CL. 44.
 NTN WIRELESS COMMUNICATIONS, INC., CARLSBAD, CA:
 2,753,094, CANC. INT. CL. 9.
 NU THOUGHT MEDIA, INC., CLEVELAND, OH:
 2,753,184, CANC. MULTIPLE CLASS, INT. CLS. 16 AND 45.
 NU-CALGON WHOLESALE, INC., ST. LOUIS, MO:
 2,345,248. REN. 3-27-10. INT. CL. 3.
 3,783,655, PUB. 2-16-2010. INT. CL. 3.
 NUCAM CORPORATION, TAIPEI COUNTY, 235, TAIWAN:
 2,752,404, CANC. INT. CL. 9.
 NUCLEUS COMMUNICATIONS, INC., KALAMAZOO, MI:
 2,753,204, CANC. INT. CL. 35.
 NUDELMAN, JOSEPH, NEW YORK, NY:
 1,552,796, CANC. INT. CL. 14.
 NUEVA ESPERANZA INC., PHILADELPHIA, PA:
 3,783,389, PUB. 2-16-2010. INT. CL. 41.

- NUMERO PRESSE, FRANCE:
3,784,939, PUB. 2-16-2010. INT. CL. 9.
- NUPLEX RESINS B.V., BERGEN OP ZOOM, NETHERLANDS:
2,332,518, REN. 3-30-10. INT. CL. 2.
- NURRIESTEARNS, RICK, MUSKOGEE, OK:
2,754,520, CANC. INT. CL. 35.
- NUTRABOLICS, INC., RICHMOND, BC, CANADA:
3,785,888, INT. CL. 5.
- NUTRAGENETICS, LLC, REDONDO BEACH, CA:
3,783,824, PUB. 2-16-2010. INT. CL. 5.
- NUTREX RESEARCH, INC., OVIEDO, FL:
3,784,626, PUB. 2-16-2010. INT. CL. 5.
- NUTRIAG CC, JOHANNESBURG, SOUTH AFRICA:
2,316,933, REN. 4-1-10. INT. CL. 1.
- NUVOX, INC., CHESTERFIELD, MO:
2,753,842, CANC. MULTIPLE CLASS, INT. CLS. 38 AND 42.
2,753,843, CANC. INT. CL. 38.
- NW DISTRIBUTORS LLC, BOTHELL, WA:
2,754,488, CANC. INT. CL. 25.
- NYBLIN, ART, ALGONQUIN, IL:
3,784,219, PUB. 2-16-2010. INT. CL. 24.
- NYCE CORPORATION, WOODCLIFF LAKE, NJ:
2,333,108, REN. 3-26-10. INT. CL. 36.
- NYKO TECHNOLOGIES, INC., LOS ANGELES, CA:
2,751,715, CANC. INT. CL. 9.
2,754,282, CANC. INT. CL. 9.
- NYSE GROUP, INC., NEW YORK, NY:
2,752,503, CANC. MULTIPLE CLASS, INT. CLS. 18, 21 AND 25.
- N2 BROADBAND, INC., DULUTH, GA:
2,753,731, CANC. INT. CL. 9.
- O-RINGS, INCORPORATED, LOS ANGELES, CA:
2,752,200, CANC. INT. CL. 17.
- O'NEAL DISTRIBUTING, INC., CHATSWORTH, CA:
2,753,027, CANC. INT. CL. 9.
2,753,028, CANC. INT. CL. 28.
- O'REILLY MEDIA, INC., SEBASTOPOL, CA:
3,786,222, MULTIPLE CLASS, INT. CLS. 9 AND 41.
- OAKLAND COUNTY, PONTIAC, MI:
3,783,759, PUB. 2-16-2010. INT. CL. 45.
- OAKLEY, INC., FOOTHILL RANCH, CA:
3,785,868, INT. CL. 9.
- OAKLIEF, PAT, CHICAGO, IL:
3,785,790, INT. CL. 35.
- OASIS MICRO NETWORKS, INC., KNOXVILLE, TN:
2,753,241, CANC. INT. CL. 37.
- OASIS PRODUCTIONS LIMITED, TORONTO, ONTARIO, CANADA:
2,751,631, CANC. INT. CL. 9.
- OATSVALL, KEVIN, NASHVILLE, TN:
3,784,319, PUB. 2-16-2010. INT. CL. 41.
- OBERKOTTER FOUNDATION, PHILADELPHIA, PA:
2,902,952, AM. INT. CL. 41.
- OBERON MEDIA, INC., NEW YORK, NY:
3,785,817, MULTIPLE CLASS, INT. CLS. 9 AND 41.
- OBJECTS & IMAGES, INC., BRONXVILLE, NY:
3,783,717, PUB. 2-16-2010. INT. CL. 25.
- OCCK, INC., SALINA, KS:
3,783,354, PUB. 2-16-2010. MULTIPLE CLASS, INT. CLS. 35, 41 AND 45.
- OCE-TECHNOLOGIES B.V. CA VENLO, NETHERLANDS:
2,824,326, CANC. MULTIPLE CLASS, INT. CLS. 37 AND 42.
- OCE-TECHNOLOGIES B.V., 5914 CA VENLO, NETHERLANDS:
2,760,693, CANC. MULTIPLE CLASS, INT. CLS. 37 AND 42.
2,793,555, CANC. MULTIPLE CLASS, INT. CLS. 37 AND 42.
2,824,327, CANC. MULTIPLE CLASS, INT. CLS. 37 AND 42.
2,824,328, CANC. MULTIPLE CLASS, INT. CLS. 37 AND 42.
- OCEAN CITY PROPERTIES, LTD., DELRAY BEACH, FL:
2,334,966, REN. 3-30-10. INT. CL. 36.
- OCEAN SEA SWIM & SPORTSWEAR, INC., MILPITAS, CA:
2,754,081, CANC. INT. CL. 25.
- OCEAN STAR INTERNATIONAL, INC., SNOWVILLE, UT:
1,553,135, CANC. INT. CL. 31.
- OCUCEPT PTY LTD, CHATSWOOD, NSW, AUSTRALIA, APPLIED LIFE AUSTRALIA PTY. LTD., CHATSWOOD, AUSTRALIA:
1,131,700, REN. 3-26-10. INT. CL. 10.
- OCULAR CONCEPTS, L.L.C., LAKE OSWEGO, OR:
2,350,329, REN. 3-31-10. INT. CL. 10.
- ODEN CORPORATION, TONAWANDA, NY:
2,343,992, REN. 3-31-10. INT. CL. 7.
- OE REMAN DIRECT LLC, REDFORD, MI:
3,783,478, PUB. 2-16-2010. INT. CL. 35.
- OEM SYSTEMS COMPANY, INC., SPARKS, NV:
2,751,865, CANC. INT. CL. 9.
- OFFICE DEPOT (M) SDN. BHD., SELANGOR DARUL EHSAN, MALAYSIA:
3,785,374, INT. CL. 9.
- OFFICEBLOC PTY LTD., WARRIEWOOD, NEW SOUTH WALES, AUSTRALIA:
2,752,855, CANC. MULTIPLE CLASS, INT. CLS. 35, 38 AND 42.
- OFFICEWARE CORPORATION, IRVING, TX, DBA FILE-SANYWHERE.COM:
3,784,387, PUB. 2-16-2010. INT. CL. 42.
- OFFICIAL PILLOWTEX LLC, COLUMBUS, OH:
2,754,045, CANC. INT. CL. 20.
- OHAYON, EDO, RAANANA, ISRAEL:
3,785,136, MULTIPLE CLASS, INT. CLS. 42 AND 45.
- OHMEGA TECHNOLOGIES, INC., CULVER CITY, CA:
3,783,115, PUB. 2-16-2010. INT. CL. 6.
3,783,116, PUB. 2-16-2010. INT. CL. 6.
3,783,117, PUB. 2-16-2010. INT. CL. 6.
3,783,118, PUB. 2-16-2010. INT. CL. 6.
3,783,119, PUB. 2-16-2010. INT. CL. 6.
- OKAMOTO CORPORATION, NARA, 635-8550, JAPAN:
3,783,093, PUB. 2-16-2010. INT. CL. 25.
- OKI ELECTRIC INDUSTRY CO., LTD., MINATO-KU, TOKYO, JAPAN:
3,459,919, COR. MULTIPLE CLASS, INT. CLS. 2, 9, 16, 36, 38, 41 AND 42.
- OKLAHOMA LIQUID FEED, L.L.C., ALVA, OK:
2,751,746, CANC. INT. CL. 31.
- OLD CHATHAM SHEEPHERDING COMPANY, INC., THE, OLD CHATHAM, NY:
2,423,161, REN. 3-27-10. INT. CL. 29.
2,423,162, REN. 3-29-10. INT. CL. 29.
- OLD TIME POTTERY, INC., MURFREESBORO, TN:
2,754,554, CANC. INT. CL. 42.
- OLDCASTLE ARCHITECTURAL, INC., ATLANTA, GA:
3,785,599, INT. CL. 19.
- OLDCASTLE PRECAST, INC., AUBURN, WA:
2,752,368, CANC. MULTIPLE CLASS, INT. CLS. 6, 19 AND 20.
2,753,855, CANC. MULTIPLE CLASS, INT. CLS. 19 AND 20.
- OLDEMARK LLC, BURLINGTON, VT:
3,784,311, PUB. 2-16-2010. INT. CL. 43.
- OLEOTEC S.R.L., L-21100 VARESE, C.P. 187, ITALY:
1,552,479, CANC. MULTIPLE CLASS, INT. CLS. 6, 9 AND 17.
- OLIVEDA NETWORK S.L., E-07350 BINISSALEM (BALEARES), SPAIN:
3,223,279, COR. MULTIPLE CLASS, INT. CLS. 29, 30 AND 31.
- OLMSTEAD HEALTH CARE SERVICES, LLC, ALBUQUERQUE, NM:
3,785,147, INT. CL. 41.
- OLY-OLA EDGINGS, INC., VILLA PARK, IL:
1,630,876, REN. 3-31-10. INT. CL. 19.
- OLYMPUS ADVISORS V, LLC, STAMFORD, CT:
3,783,731, PUB. 1-12-2010. INT. CL. 36.
- OLYMPUS AMERICA INC., MELVILLE, NY:
2,754,272, CANC. INT. CL. 41.
- OLYMPUS CORPORATION, TOKYO, JAPAN:
3,785,894, INT. CL. 9.
3,785,895, INT. CL. 9.

OMAHA STEAKS INTERNATIONAL, INC., OMAHA, NE:
3,785,784, INT. CL. 35.

OMEGA IP CO., WATERLOO, IA:
1,552,925, CANC. INT. CL. 20.

OMEGA THERMO PRODUCTS, L.L.C., STRATFORD, WI:
2,383,953, REN. 3-31-10. INT. CL. 11.
2,383,954, REN. 3-31-10. INT. CL. 11.

OMI INTERNATIONAL CORPORATION, WARREN, MI TO
ENTHON-OMI, INC., WEST HAVEN, CT:
1,552,409, CANC. MULTIPLE CLASS, INT. CLS. 1 AND 2.

OMNIGEN CORP., LONG BEACH, NY:
2,282,124, REN. 3-29-10. INT. CL. 42.

OMNOVIA TECHNOLOGIES, INC., HOUSTON, TX:
3,783,677, PUB. 2-16-2010. MULTIPLE CLASS, INT. CLS. 9
AND 38.

OMP, INC., LONG BEACH, CA:
3,785,353, INT. CL. 5.

OMS, INVESTMENTS, INC., LOS ANGELES, CA:
3,786,489, INT. CL. 31.

ON OPTIMUM NUTRITION LIMITED, KILKENNY CITY,
IRELAND:
3,784,716, PUB. 2-16-2010. INT. CL. 5.

ON TRACK INNOVATIONS LTD., ROSH-PINA 1200, IS-
RAEL:
2,324,981, REN. 3-29-10. INT. CL. 9.

ONCE INNOVATIONS, PLYMOUTH, MN, FORMERLY
SCIENTOID TECHNOLOGIES:
3,784,622, PUB. 2-16-2010. INT. CL. 9.
3,784,635, PUB. 2-16-2010. INT. CL. 9.

ONDRE SELTZER, CAVE CREEK, AZ:
3,784,084, PUB. 2-16-2010. INT. CL. 3.

ONE CARD, NV, CURACAO, NETHERLD ANTILLES:
3,786,252, INT. CL. 36.

ONE DID IT OY, FI-00560 HELSINKI, FINLAND:
3,784,417, PUB. 2-16-2010. INT. CL. 42.

ONE EYED SPARK PRODUCTIONS, INC., LAUDERDALE
BY THE SEA, FL:
3,783,763, PUB. 2-16-2010. INT. CL. 41.

ONE TOUCH INTELLIGENCE, LLC, GREENWOOD VIL-
LAGE, CO:
3,783,313, PUB. 11-10-2009. INT. CL. 35.

ONE WORLD HEART INSTITUTE, INC., CORAL SPRINGS,
FL:
3,784,148, PUB. 2-16-2010. INT. CL. 16.

ONE31 MEDIA HOLDINGS LIMITED, BIRMINGHAM,
ENGLAND:
3,252,939, CANC. MULTIPLE CLASS, INT. CLS. 9, 16, 21,
25, 28 AND 41.

OPA! OPA! LLC, SACRAMENTO, CA:
3,784,263, PUB. 2-16-2010. INT. CL. 43.

OPEN FIELD CAPITAL LLC, NEW YORK, NY:
3,785,065, INT. CL. 36.

OPEN SOCIETY INSTITUTE, NEW YORK, NY:
3,786,377, MULTIPLE CLASS, INT. CLS. 16, 35 AND 41.

OPENPEAK INC., BOCA RATON, FL:
3,786,040, INT. CL. 9.

OPHTHONIX, INC., VISTA, CA:
3,785,122, INT. CL. 9.

OPPENHEIMERFUNDS, INC., NEW YORK, NY:
2,752,991, CANC. INT. CL. 36.

OPPORTUNE RISK BRIDGING, LLC, JOHNSTON, IA:
3,783,694, PUB. 2-16-2010. INT. CL. 35.

OPTICAL DYNAMICS CORPORATION, LOUISVILLE, KY:
2,752,462, CANC. INT. CL. 35.

OPTICOS S.R.L., 24030 BREMBATE DI SOPRA (BERGAMO),
ITALY:
2,317,919, REN. 4-1-10. INT. CL. 9.

OPTION COMMUNICATION LLC, CHICAGO, IL:
2,754,151, CANC. INT. CL. 16.

OPTISCAN BIOMEDICAL CORPORATION, HAYWARD,
CA:
3,786,059, INT. CL. 10.

ORALABS, INC., ENGLEWOOD, CO:
2,754,063, CANC. INT. CL. 20.

ORALVA INTERNATIONAL GROUP, CORP., MIAMI, FL:
2,753,299, CANC. INT. CL. 14.

ORANGE JULIUS OF AMERICA, EDINA, MN:
1,553,171, CANC. INT. CL. 32.

ORBOGRAPH LTD., 81102, YAVNE, ISRAEL:
2,880,691, CANC. INT. CL. 9.

ORE PHARMACEUTICALS INC., CAMBRIDGE, MA:
3,785,232, INT. CL. 42.

ORECK HOLDINGS, LLC, NASHVILLE, TN:
3,785,604, INT. CL. 11.

OREGON BREWING COMPANY, NEWPORT, OR:
3,786,470, INT. CL. 35.

ORFEVRERIE CHRISTOFLE, PARIS, FRANCE:
1,552,530, CANC. INT. CL. 8.

ORGANIC ENVIRONMENTAL SERVICES INC., LAKE
VIEW TERRACE, CA:
3,783,859, PUB. 2-16-2010. INT. CL. 1.

ORGANIC EVOLUTION PTY LTD, AUSTRALIA:
3,784,956, PUB. 2-16-2010. MULTIPLE CLASS, INT. CLS. 8
AND 9.

ORIDIAN CONSTRUCTION SERVICES, LLC, PHOENIX,
AZ:
3,783,486, PUB. 2-16-2010. INT. CL. 35.

ORIENTAL HEALING ARTS ASSOCIATION, PLAISTOW,
NH:
3,785,403, INT. CL. 41.
3,785,404, INT. CL. 41.

ORIENTAL RUG HOSPITAL CORP., GARDEN CITY, NY:
2,271,797, CANC. INT. CL. 37.

ORIGINAL MAN WEAR, INC., PLANO, TX:
2,752,491, CANC. INT. CL. 25.

ORION PICTURES CORPORATION, LOS ANGELES, CA:
3,783,169, PUB. 11-10-2009. MULTIPLE CLASS, INT. CLS.
9 AND 41.

ORLANDO SCIENCE CENTER, INC., ORLANDO, FL:
2,272,623, CANC. INT. CL. 41.

ORTHO ORGANIZERS, INC., CARLSBAD, CA:
1,588,684, REN. 3-30-10. INT. CL. 10.

ORTIVUS, INC., DECORAH, IA:
3,156,085, COR. INT. CL. 42.

OSG TAP AND DIE, INC., GLENDALE HEIGHTS, IL:
1,614,640, REN. 3-28-10. INT. CL. 7.

OSRAM GESELLSCHAFT MIT BESCHRANKTER HAF-
TUNG, D-81543 MUENCHEN, FED REP GERMANY:
1,552,753, CANC. INT. CL. 11.

OSRAM SYLVANIA INC., DANVERS, MA:
2,340,144, REN. 3-31-10. INT. CL. 36.

OSTEOTECH, INC., EATONTOWN, NJ:
3,785,909, INT. CL. 5.

OTENASEK COMMUNICATIONS, INC., BEL AIR, MD:
2,753,764, CANC. INT. CL. 9.

OTTAWA UNIVERSITY, OTTAWA, KS:
3,783,697, PUB. 2-16-2010. INT. CL. 41.

OTTENHEIMER, CHARLES J., AIEA, HI:
2,753,534, CANC. INT. CL. 17.

OTTERBEIN, ROBERT L., BELLE MEAD, NJ, DBA THE
HOME GOURMET:
2,753,061, CANC. MULTIPLE CLASS, INT. CLS. 29 AND
30.

OTTLITE TECHNOLOGIES, INC., TAMPA, FL:
3,786,392, INT. CL. 11.

OUR LOVE WILL TURN YOU ON, LLC, HOLLYWOOD, FL:
3,784,301, PUB. 2-16-2010. INT. CL. 14.
3,784,302, PUB. 2-16-2010. INT. CL. 14.

OUT O' SITE, LLC, SPRINGFIELD, MO:
3,783,297, PUB. 2-16-2010. MULTIPLE CLASS, INT. CLS.
6, 12 AND 28.

OUTCOMES HEALTH INFORMATION SOLUTIONS, LLC,
CHARLOTTESVILLE, VA:
3,785,657, INT. CL. 42.

OUTDOOR ENVY, LLC, SMITHS STATION, AL:
3,785,200, INT. CL. 25.

OUTLOOK RESOURCE COMPANY, PINK HILL, NC:
3,785,497, INT. CL. 41.

OUTLOOK WINDOW FASHIONS CORPORATION, GUR-
NEE, IL:
3,785,672, MULTIPLE CLASS, INT. CLS. 20 AND 24.

OUTSOURCING SERVICES GROUP LLC, WOODCLIFF
LAKE, NJ:
2,752,244, CANC. INT. CL. 42.
2,752,245, CANC. INT. CL. 42.
2,752,246, CANC. INT. CL. 42.

- OVERBREAK, LLC, SUN VALLEY, CA:
2,754,036, CANC. INT. CL. 16.
- OVERTONE, INC., SAN FRANCISCO, CA:
3,785,731, INT. CL. 42.
- OWEN BIOSCIENCES, INC., BATON ROUGE, LA:
3,784,031, PUB. 2-16-2010. INT. CL. 5.
3,784,034, PUB. 2-16-2010. INT. CL. 5.
3,784,046, PUB. 2-16-2010. INT. CL. 3.
3,784,052, PUB. 2-16-2010. INT. CL. 3.
3,784,552, PUB. 2-16-2010. INT. CL. 3.
- OWENS CORNING INTELLECTUAL CAPITAL, LLC, TOLEDO, OH, OWENS-CORNING FIBERGLAS CORPORATION, TOLEDO, OH:
1,593,026. REN. 4-1-10. INT. CL. 17.
- OWNER ON CALL, LLC, AUSTIN, TX:
3,784,251, PUB. 2-16-2010. INT. CL. 36.
- OXBRIDGE GROUP, LTD., THE, PHILADELPHIA, PA:
2,272,133, CANC. INT. CL. 35.
- OXFORD BARIATRIC, GENERAL AND METABOLIC SURGERY, PLLC, OXFORD, MS:
3,784,194, PUB. 2-16-2010. INT. CL. 44.
- OXY-DRY CORPORATION, ITASCA, IL:
524,366. REN. 3-26-10. U.S. CL. 21 (INT. CL. 9).
- OY CENTRAL PHARMA LTD, 02200 ESPOO, FINLAND:
2,751,657, CANC. INT. CL. 5.
2,751,658, CANC. INT. CL. 5.
- P.R. INDUSTRIES, INC., CHASKA, MN, PROTECTIVE KNITTING, INC., CHASKA, MN:
1,613,037. REN. 3-27-10. INT. CL. 25.
- PABST BREWING COMPANY, MILL VALLEY, CA:
1,553,163, CANC. INT. CL. 32.
- PACANA, GENEVIEVE D., GLENDALE, CA:
3,786,294, INT. CL. 16.
- PACHMAYR LTD., MONROVIA, CA:
1,552,793, CANC. INT. CL. 13.
- PACIFIC AG RENTALS, LLC, SALINAS, CA:
3,784,627, PUB. 2-16-2010. INT. CL. 44.
- PACIFIC ASIA TRAVEL ASSOCIATION, BANGKOK, THAILAND:
2,430,990. REN. 3-29-10. INT. CL. 16.
- PACIFIC COAST FEATHER COMPANY, SEATTLE, WA:
2,752,550, CANC. INT. CL. 24.
- PACIFIC CRANE MAINTENANCE COMPANY, L.P., LONG BEACH, CA:
3,783,562, PUB. 2-16-2010. INT. CL. 37.
- PACIFIC ENZYMES, INC., SACRAMENTO, CA:
3,784,154, PUB. 2-16-2010. INT. CL. 1.
- PACIFIC JEANSWEAR, INC., CITY OF INDUSTRY, CA:
3,784,019, PUB. 2-16-2010. INT. CL. 25.
- PACIFICHEALTH LABORATORIES, INC., MATAWAN, NJ:
3,785,094, MULTIPLE CLASS, INT. CLS. 5 AND 32.
- PACK HAPPY LLC, LOS ANGELES, CA:
2,754,426, CANC. INT. CL. 18.
- PACKSTAFF, LLC, OOSTBURG, WI:
2,751,841, CANC. INT. CL. 35.
- PACKY PODA INC., HSIN HWA, TAINAN HSIEN, TAIWAN:
2,753,548, CANC. INT. CL. 27.
- PAIDGAMEPLAYER.COM, LLC, DENVER, CO:
3,786,463, INT. CL. 41.
- PAIGE ELECTRIC CO, LP, UNION, NJ:
3,783,905, PUB. 2-16-2010. INT. CL. 16.
- PALETERIA Y NEVERIA GUANATOS, INC., CONCORD, CA, DBA GUANATOS ICE CREAM:
3,785,446, INT. CL. 30.
- PALMER, ROB, SCOTTSDALE, AZ, DBA GROUT & TILE MAGIC:
3,783,962, PUB. 2-16-2010. INT. CL. 37.
- PALOMBINO, ANTHONY, LOUISVILLE, KY:
2,333,813. REN. 3-26-10. INT. CL. 42.
- PALOTAI OLSON PRUKOP INDUSTRIES, INC., ROSEBURG, OR:
3,783,826, PUB. 2-16-2010. INT. CL. 33.
- PAMELA HELMINSKI, CHICAGO, IL:
2,752,613, CANC. INT. CL. 35.
- PAMPLIN COMMUNICATIONS CORPORATION, PORTLAND, OR:
2,752,497, CANC. INT. CL. 41.
- PANASONIC CORPORATION OF NORTH AMERICA, SECAUCUS, NJ:
3,786,345, MULTIPLE CLASS, INT. CLS. 7 AND 9.
- PANATTU, BASIL VARKEY, GLENDALE, CA:
3,785,183, INT. CL. 44.
- PANATTU, BASIL VARKEY, GLENDALE, CA, DBA EARTH SQUAD:
3,785,186, INT. CL. 44.
- PANGORA GMBH, 76185 KARLSRUHE, FED REP GERMANY:
3,784,920, PUB. 2-16-2010. MULTIPLE CLASS, INT. CLS. 9, 35, 38 AND 42.
- PANINI AMERICA, INC., ARLINGTON, TX:
2,754,557, CANC. INT. CL. 16.
- PANIZ INC., NEW YORK, NY:
3,785,393, INT. CL. 25.
- PANTHER GAMES PTY LTD, FISHER ACT, AUSTRALIA:
2,754,451, CANC. INT. CL. 9.
- PAPARELLA, JOSE, BUENOS AIRES, ARGENTINA:
2,753,724, CANC. INT. CL. 3.
- PAPERG, INC., NEW HAVEN, CT:
3,786,423, INT. CL. 35.
- PARACHUTE PRESS, INC., NEW YORK, NY:
2,753,427, CANC. MULTIPLE CLASS, INT. CLS. 9, 16 AND 41.
- PARADIGM COMPANIES, LLC, NEW YORK, NY:
2,751,730, CANC. INT. CL. 36.
- PARADISE GALLERIES, INC., SAN DIEGO, CA:
2,273,085, CANC. INT. CL. 28.
- PARAMETRIC TECHNOLOGY CORPORATION, NEEDHAM, MA:
1,552,712, CANC. INT. CL. 9.
2,272,667, CANC. INT. CL. 9.
2,752,836, CANC. INT. CL. 9.
- PARAMOUNT BEVERAGE, INC., SALT LAKE CITY, UT:
2,753,315, CANC. INT. CL. 32.
- PARAMOUNT FARMS, INC., LOS ANGELES, CA:
3,784,763, PUB. 2-16-2010. INT. CL. 29.
- PARAMOUNT GROUP, LLC, OMAHA, NE:
2,753,860, CANC. INT. CL. 41.
- PARAMOUNT INDUSTRIES, INC., CROSWELL, MI:
904,192. REN. 4-1-10. U.S. CL. 21 (INT. CL. 11).
- PARAMOUNT INTERNATIONAL EXPORT, LTD., LOS ANGELES, CA:
3,785,291, INT. CL. 32.
- PARAMOUNT PARKS INC., CHARLOTTE, NC:
2,754,643, CANC. INT. CL. 41.
- PARAMOUNT PICTURES CORPORATION, HOLLYWOOD, CA:
3,786,486, INT. CL. 25.
- PARELLI NATURAL HORSEMANSHIP, INC., PAGOSA SPRINGS, CO:
3,783,445, PUB. 2-16-2010. INT. CL. 41.
- PARFUMS CARON, 75008 PARIS, FRANCE:
890,596. REN. 3-26-10. U.S. CL. 51 (INT. CL. 3).
- PARFUMS NINA RICCI, PARIS, FRANCE:
1,132,528. REN. 3-26-10. INT. CL. 3.
- PARIS PRESENTS INCORPORATED, GURNEE, IL:
2,753,109, CANC. INT. CL. 3.
- PARK WEST GALLERIES, INC., SOUTHFIELD, MI:
2,752,533, CANC. INT. CL. 35.
- PARK, JEREMY JAY, DEL MAR, CA:
3,784,665, PUB. 2-16-2010. INT. CL. 41.
- PARKER, SARAH SPRINGER, SINGER ISLAND, FL:
3,783,113, PUB. 2-16-2010. INT. CL. 41.
- PARLAY INTERNATIONAL, EMERYVILLE, CA:
1,553,361, CANC. INT. CL. 16.
- PARSUS LLP, SAN FRANCISCO, CA:
3,784,511, PUB. 2-16-2010. INT. CL. 45.
- PARTICIPANT MEDIA, LLC, BEVERLY HILLS, CA:
3,785,241, MULTIPLE CLASS, INT. CLS. 9, 16, 35, 36, 38, 41 AND 42.
- PARTY JUICE, INC., LAYTON, UT:
2,753,231, CANC. INT. CL. 32.
- PARTY PLANK, LLC, MADISON, WI:
3,784,525, PUB. 2-16-2010. INT. CL. 21.
- PARTYLITE WORLDWIDE, INC, PLYMOUTH, MA:
2,762,405, CANC. INT. CL. 26.

PARTYLITE WORLDWIDE, INC., PLYMOUTH, MA:
2,754,120, CANC. INT. CL. 4.

PASQUALE VALLI S.A.S. DI VALLI CARLO EDOARDO,
RENATE (MILANO), ITALY:
2,751,814, CANC. MULTIPLE CLASS, INT. CLS. 11, 20
AND 21.

PASS IT ON CENTER, CRESTWOOD, IL, PASS IT ON
CENTER, CRESTWOOD, IL:
2,394,251. REN. 3-29-10. INT. CL. 35.

PASSION WORLD WINES, BERNARDINA BEACH, FL, DBA
LLC:
3,786,086, INT. CL. 33.

PAST TIME PARTNERS, LLC, BRIDGEPORT, CT:
2,376,375. REN. 3-26-10. INT. CL. 25.

PASTAZIOS PIZZA, INC., ADDISON, TX:
2,427,103. REN. 3-30-10. INT. CL. 42.

PAT RAWSON DESIGNS, INC., HALEIWA, HI:
2,332,640. REN. 3-31-10. MULTIPLE CLASS, INT. CLS. 25
AND 28.

PATCUD INVESTMENTS, INC., WILMINGTON, DE:
3,786,266, INT. CL. 29.

PATENTS360, INC., ELK GROVE VILLAGE, IL:
3,785,454, MULTIPLE CLASS, INT. CLS. 9 AND 35.

PATRICIAN PRODUCTS, INC., HICKSVILLE, NY:
2,291,867. REN. 3-27-10. INT. CL. 20.

PATRICK HOLDINGS, LACONIA, NH:
3,785,533, INT. CL. 25.

PATRICK, GEORGE C., CHICAGO, IL, DBA NEFARIOUS
RECORDS:
2,753,218, CANC. INT. CL. 41.

PATRIOT SENSORS & CONTROLS CORPORATION, CLAW-
SON, MI:
2,336,009. REN. 3-31-10. INT. CL. 9.

PATRON SPIRITS INTERNATIONAL AG, 8200 SCHAFF-
HAUSEN, SWITZERLAND:
3,785,086, INT. CL. 33.

PATTERN SYSTEMS INTERNATIONAL, INC., MT. AR-
LINGTON, NJ:
2,271,734, CANC. INT. CL. 9.

PAUL R. ABRAMSON, SANTA BARBARA, CA:
3,783,371, PUB. 2-16-2010. INT. CL. 41.

PAUL, CURTIS, WASHINGTON, DC:
3,785,948, INT. CL. 28.

PAUL, JONATHAN A., SAN DIEGO, CA, DBA SAILHAWK:
3,785,505, INT. CL. 36.

PAUL, WEISS, REFKIND, WHARTON & GARRISON LLP,
NEW YORK, NY:
2,347,174. REN. 3-31-10. INT. CL. 42.

PAULO PRODUCTS COMPANY, ST. LOUIS, MO:
2,335,851. REN. 3-31-10. INT. CL. 40.

PAWLINKS, LLC, NEW YORK, NY:
3,785,853, INT. CL. 44.

PAXAR AMERICAS, INC., MIAMISBURG, OH:
1,604,060. REN. 3-29-10. INT. CL. 37.

PAXTON AUTOMOTIVE CORP., OXNARD, CA:
2,353,464. REN. 3-31-10. INT. CL. 7.

PAYMER, INC., BEVERLY HILLS, CA:
2,752,687, CANC. MULTIPLE CLASS, INT. CLS. 9 AND
36.

PAYSYS INTERNATIONAL, INC., MAITLAND, FL:
2,280,226. REN. 3-30-10. INT. CL. 9.

PAYTON, PAUL MAX, SAN FRANCISCO, CA:
3,786,238, INT. CL. 16.

PCM LIMITED, STOUFFVILLE L4A 1A4 ONTARIO, CANA-
DA:
2,751,768, CANC. INT. CL. 9.

PD INDUSTRIES, INC., COCONUT CREEK, FL:
2,752,981, CANC. INT. CL. 12.

PDR NETWORK, LLC, NEW YORK, NY:
3,783,654, PUB. 2-16-2010. INT. CL. 44.

PEACEHEALTH, BELLEVUE, WA:
3,785,582, MULTIPLE CLASS, INT. CLS. 35 AND 44.

PEACOCK NINE LLC, CHICAGO, IL:
3,786,065, INT. CL. 28.

PEAFIELD PRODUCTS, INC., PLAINFIELD, IN:
3,783,434, PUB. 2-16-2010. INT. CL. 16.

PEAVEY ELECTRONICS CORPORATION, MERIDIAN, MS:
2,754,594, CANC. INT. CL. 9.

PECHENIK, JAN A., CAMBRIDGE, MA, DBA SCISPARK.-
COM:
3,783,653, PUB. 11-10-2009. INT. CL. 16.

PEEKABOO PHOTO BOOTH, LLC, EUSTIS, FL:
3,783,384, PUB. 2-16-2010. INT. CL. 41.

PEERLESS SYSTEMS CORPORATION, EL SEGUNDO, CA:
2,272,238, CANC. INT. CL. 9.

PEET SHOE DRYER, INC., ST. MARIES, ID:
1,589,854. REN. 3-30-10. INT. CL. 11.

PEGASUS INTERNATIONAL, INC., FORT WASHINGTON,
PA:
2,752,677, CANC. INT. CL. 3.

PEI LICENSING, INC., MIAMI, FL:
3,785,206, INT. CL. 25.

PEKAR, VLADISLAV, 460 02 LIBEREC, CZECH REPUBLIC:
2,337,816. REN. 3-31-10. INT. CL. 9.

PELLE PELLE, INC., ROCHESTER HILLS, MI:
2,823,598, CANC. INT. CL. 3.

PELLETT, TIMOTHY NEWELL, STATE COLLEGE, PA:
2,752,859, CANC. MULTIPLE CLASS, INT. CLS. 40 AND
42.

PEM AMERICA, INC., NEW YORK, NY:
3,785,205, INT. CL. 17.

PEN AR LAN SA, 35380 MAXENT, FRANCE:
2,349,338. REN. 3-31-10. INT. CL. 31.

PEN-LINK, LTD., LINCOLN, NE:
3,785,656, INT. CL. 9.

PENDUM LLC, DENVER, CO:
3,784,108, PUB. 2-16-2010. MULTIPLE CLASS, INT. CLS.
35 AND 36.

PENGUEN GIDA SANAYI ANONIM SIRKETI, TURKEY:
3,784,862, PUB. 2-16-2010. MULTIPLE CLASS, INT. CLS.
29, 30 AND 31.

PENGUIN GROUP (USA) INC., NEW YORK, NY:
2,389,549. REN. 3-29-10. INT. CL. 16.

PENNWELL CORPORATION, TULSA, OK:
2,752,337, CANC. INT. CL. 16.
3,784,695, PUB. 2-16-2010. MULTIPLE CLASS, INT. CLS.
35 AND 44.

PENNY-FARTHING PRESS, INC., HOUSTON, TX:
3,785,129, INT. CL. 16.

PENTAIR POOL PRODUCTS, INC., MOORPARK, CA:
2,754,605, CANC. INT. CL. 11.

PENTE OF AMERICA, LTD., TORRANCE, CA:
2,256,114. REN. 3-26-10. INT. CL. 16.

PENTON BUSINESS MEDIA, INC., NEW YORK, NY:
3,785,758, INT. CL. 41.

PEO MANAGEMENT GROUP, INC., TAMPA, FL:
3,784,207, PUB. 2-16-2010. INT. CL. 36.

PEOPLES EDUCATION, INC., SADDLE BROOK, NJ:
3,783,854, PUB. 2-16-2010. INT. CL. 41.

PEPPERDINE UNIVERSITY, MALIBU, CA:
2,829,501, CANC. INT. CL. 24.

PEPSICO, INC., PURCHASE, NY:
2,752,938, CANC. INT. CL. 32.
2,752,946, CANC. INT. CL. 32.
2,752,947, CANC. INT. CL. 32.

PERCUSSIONAIRE CORPORATION, SANDPOINT, ID:
1,560,701. REN. 3-30-10. INT. CL. 10.

PERFETTI VAN MELLE S.P.A., 20020 LAINATE (MI),
ITALY:
1,553,107, CANC. INT. CL. 30.

PERFUMANIA, INC., SUNRISE, FL:
3,783,440, PUB. 2-16-2010. INT. CL. 35.

PERLSTEIN, ELIZABETH, HUNTINGTON, NY:
3,785,475, INT. CL. 10.

PERMAFOOD AG, ZUG, SWITZERLAND:
3,784,940, PUB. 2-16-2010. INT. CL. 42.

PERRY, DAVID, SHERMAN OAKS, CA:
2,820,962, CANC. INT. CL. 25.

PERRY, DOUGLAS O., LEO, IN:
1,602,903. REN. 3-30-10. INT. CL. 40.

PERRY'S ICE CREAM COMPANY, INC., AKRON, NY:
2,754,126, CANC. INT. CL. 30.

PERSHING INVESTMENTS LLC, NEWARK, DE:
2,272,308, CANC. INT. CL. 16.
2,753,684, CANC. INT. CL. 36.

- PERSONAL COMPUTER RENTAL CORPORATION, PRINCETON, NJ:
2,752,059, CANC. INT. CL. 42.
- PERSONAL SELLING POWER, INC., FREDERICKSBURG, VA:
2,328,221. REN. 3-29-10. INT. CL. 16.
- PERTESIS, NICHOLAS J., OLD SAYBROOK, CT:
2,752,439, CANC. INT. CL. 43.
- PER4MANCE PLUS, LLC, ORLANDO, FL:
3,785,769, INT. CL. 41.
- PESEK, DAVID JAMES, WAYNESVILLE, NC:
1,589,502. REN. 3-29-10. INT. CL. 42.
- PESI, LLC, EAU CLAIRE, WI:
2,751,968, CANC. MULTIPLE CLASS, INT. CLS. 9, 16 AND 41.
- PET HOLDINGS, INC., SEATTLE, WA:
3,783,770, PUB. 2-16-2010. INT. CL. 41.
- PET KING BRANDS, INC., WESTMONT, IL:
2,345,148. REN. 3-31-10. INT. CL. 16.
- PET TRICKS LLC, HAMPTON, MN:
2,752,989, CANC. INT. CL. 9.
- PETER BEATON, INC., NANTUCKET, MA:
2,828,985, CANC. MULTIPLE CLASS, INT. CLS. 9 AND 25.
- PETER PEPPER PRODUCTS, INC., COMPTON, CA:
2,331,266. REN. 3-26-10. INT. CL. 35.
- PETERSON, ANN, BUFFALO, NY:
3,783,559, PUB. 2-16-2010. INT. CL. 16.
- PETRA PET, INC., DBA PETRAPPORT, CARLSTADT, NJ:
2,754,657, CANC. INT. CL. 31.
- PETRON CORPORATION, NEW BERLIN, WI:
1,591,626. REN. 4-1-10. INT. CL. 4.
- PETSMART STORE SUPPORT GROUP, INC., PHOENIX, AZ, PACIFIC COAST DISTRIBUTING, INC., PHOENIX, AZ, DBA PETSMART:
1,559,337. REN. 4-1-10. INT. CL. 42.
- PETSTAGES, INC., NORTHBROOK, IL, DBA PETSTAGES:
3,783,100, PUB. 2-16-2010. MULTIPLE CLASS, INT. CLS. 21 AND 28.
- PETT, GWYNETH CHRISTINE, ALTADENA, CA, TA YOU CAN DIG IT !:
3,784,097, PUB. 2-16-2010. INT. CL. 7.
- PEX CONNECTION, INC., OKLAHOMA CITY, OK:
3,785,311, INT. CL. 35.
- PEZZINO, DAVID M., ATLANTA, GA:
3,785,091, MULTIPLE CLASS, INT. CLS. 16 AND 41.
3,785,092, MULTIPLE CLASS, INT. CLS. 16 AND 41.
- PFIZER INC, NEW YORK, NY:
3,785,143, INT. CL. 5.
3,785,144, INT. CL. 5.
3,785,219, INT. CL. 5.
- PGW AUTO GLASS LLC, PITTSBURGH, PA:
2,753,115, CANC. INT. CL. 35.
- PHARM-A-CARE LABORATORIES PTY. LIMITED, WARRIEWOOD NSW, AUSTRALIA, AKA PHARMACARE LABORATORIES PTY LIMITED:
2,336,942. REN. 3-27-10. INT. CL. 5.
- PHARMACEUTICAL CARE NETWORK, SACRAMENTO, CA:
2,283,003. REN. 3-26-10. MULTIPLE CLASS, INT. CLS. 9 AND 35.
- PHARMACHEM LABORATORIES, INC, KEARNY, NJ:
3,785,231, INT. CL. 5.
- PHARMACIA & UPJOHN COMPANY LLC, PEAPACK, NJ:
3,235,057, COR. MULTIPLE CLASS, INT. CLS. 5, 10 AND 11.
- PHARMIDEAS USA, INC., AMHERST, NY:
3,785,384, INT. CL. 42.
- PHAT FASHIONS LLC, NEW YORK, NY:
2,272,181, CANC. INT. CL. 25.
- PHIL WALDREP EVANGELISTIC ASSOCIATION, TRINITY, AL:
3,785,927, INT. CL. 41.
- PHILADELPHIA CONSOLIDATED HOLDING CORPORATION, BALA CYNWYD, PA, DBA PHILADELPHIA INSURANCE COMPANIES:
3,783,972, PUB. 2-16-2010. INT. CL. 36.
- PHILIP MORRIS USA INC., RICHMOND, VA:
3,783,883, PUB. 2-16-2010. INT. CL. 34.
3,783,884, PUB. 2-16-2010. INT. CL. 34.
3,783,886, PUB. 2-16-2010. INT. CL. 34.
3,783,887, PUB. 2-16-2010. INT. CL. 34.
- PHILIPS SOLID-STATE LIGHTING SOLUTIONS, INC., BURLINGTON, MA:
2,753,608, CANC. INT. CL. 28.
2,753,609, CANC. INT. CL. 9.
2,753,667, CANC. INT. CL. 9.
- PHILLIPS INTERNATIONAL, INC., HALLANDALE, FL:
3,784,105, PUB. 2-16-2010. INT. CL. 14.
- PHILLIPS STEEL COMPANY, LONG BEACH, CA:
2,401,801. REN. 3-31-10. INT. CL. 35.
- PHILOSOPHY, INC., PHOENIX, AZ:
3,785,843, INT. CL. 3.
- PHOENIX INTANGIBLES HOLDING COMPANY, GREENVILLE, DE, PHOENIX INTANGIBLES HOLDING COMPANY, GREENVILLE, DE:
2,416,477. REN. 3-30-10. INT. CL. 35.
- PHOENIX INTANGIBLES HOLDING COMPANY, GREENVILLE, DE:
3,785,220, MULTIPLE CLASS, INT. CLS. 9 AND 36.
3,785,227, MULTIPLE CLASS, INT. CLS. 9 AND 36.
- PHOENIX PHARMACEUTICAL, INC., ST. JOSEPH, MO:
2,751,625, CANC. INT. CL. 5.
- PHOENIX SOFTWARE INTERNATIONAL, INC., EL SEGUNDO, CA, SCAN-OPTICS, INC., MANCHESTER, CT:
2,385,947. REN. 3-30-10. INT. CL. 9.
2,385,948. REN. 3-31-10. INT. CL. 9.
- PHONETICS, INC., ASTON, PA:
2,334,810. REN. 3-31-10. INT. CL. 9.
- PHOTOCURE ASA, N-0377, OSLO, NORWAY:
2,751,780, CANC. INT. CL. 5.
- PHOTONICS INDUSTRIES INTERNATIONAL, INC., BOHEMIA, NY:
2,282,321. REN. 3-26-10. INT. CL. 9.
- PHUSION, LLC, STOWE, VT:
3,784,712, PUB. 2-16-2010. INT. CL. 41.
- PHYSICIANS FORMULA, INC., AZUSA, CA:
3,785,683, INT. CL. 3.
- PHYSICIANS MUTUAL INSURANCE COMPANY, OMAHA, NE:
3,756,091, AM. INT. CL. 36.
- PI LAMBDA THETA, INC., BLOOMINGTON, IN:
3,784,014, PUB. 2-16-2010. INT. CL. 16.
- PIANETTO, NICHOLAS, DES PLAINES, IL:
3,784,266, PUB. 2-16-2010. INT. CL. 9.
- PIAZZA SEMPIONE S.P.A., MILAN, ITALY:
2,826,839, CANC. MULTIPLE CLASS, INT. CLS. 3, 9 AND 16.
- PICCIONELLI, GREGORY A., LOS ANGELES, CA:
2,753,407, CANC. INT. CL. 9.
- PICCOLINA BABY COLLECTION, INC., ATLANTA, GA:
2,754,548, CANC. INT. CL. 35.
- PICTURE ME HAPPY, EDGEWOOD, KY:
3,785,793, INT. CL. 41.
- PIERCE BIOTECHNOLOGY, INC., ROCKFORD, IL:
1,597,031. REN. 3-31-10. INT. CL. 1.
- PIGEON MOUNTAIN INDUSTRIES, INC., LAFAYETTE, GA:
2,434,314. REN. 3-30-10. INT. CL. 22.
- PILEPRO, LLC, RAPID CITY, SD:
3,785,070, INT. CL. 6.
- PILGRIM TELEPHONE, INC., LEXINGTON, MA:
3,785,539, INT. CL. 45.
- PINE STREET INN, INC., BOSTON, MA:
3,783,606, PUB. 2-16-2010. INT. CL. 43.
- PINK LOTUS, DOYLESTOWN, PA, DBA PINK LOTUS:
3,783,246, PUB. 2-16-2010. INT. CL. 14.
- PINK MUSHROOM B.V., 6424 DJ BERGEN OP ZOOM, NETHERLANDS:
3,783,159, PUB. 12-15-2009. MULTIPLE CLASS, INT. CLS. 9, 35, 36, 38 AND 42.
- PINKROCCADE N.V., 2275 AA VOORBURG, NETHERLANDS:
2,751,845, CANC. MULTIPLE CLASS, INT. CLS. 35, 38, 41 AND 42.

PINSON, KENNETH D., PHOENIX, AZ:
3,783,583, PUB. 10-20-2009. INT. CL. 36.

PIONEER DRILLING COMPANY, SAN ANTONIO, TX:
3,785,522, MULTIPLE CLASS, INT. CLS. 37 AND 42.
3,785,523, INT. CL. 42.
3,785,524, INT. CL. 42.
3,785,525, INT. CL. 42.

PIONEER MEDICAL, INC., LAKELAND, FL, DBA PIONEER HUNTING PRODUCTS:
2,752,500, CANC. INT. CL. 25.

PITA PIT, INC., COEUR D'ALENE, ID:
3,785,251, MULTIPLE CLASS, INT. CLS. 32 AND 43.

PITTSBURGH MERCY HEALTH SYSTEM, INC., PITTSBURGH, PA:
3,785,855, INT. CL. 41.
3,785,856, INT. CL. 44.
3,785,858, INT. CL. 44.
3,785,859, INT. CL. 41.

PIVOT POINT INTERNATIONAL, INC., CHICAGO, IL:
2,753,388, CANC. INT. CL. 28.

PIVOTAL SIMON HOTEL XXIV, L.L.C., PHOENIX, AZ:
2,753,762, CANC. INT. CL. 36.

PIZZERIA UNO CORPORATION, WILMINGTON, DE:
3,785,166, INT. CL. 43.

PKL CORPORATION, LOS ANGELES, CA:
2,335,508, REN. 3-28-10. INT. CL. 1.
2,335,509, REN. 3-28-10. INT. CL. 1.
2,335,510, REN. 3-29-10. INT. CL. 1.
3,784,356, PUB. 2-16-2010. INT. CL. 19.

PLAID ENTERPRISES, INC., NORCROSS, GA:
3,785,105, MULTIPLE CLASS, INT. CLS. 2 AND 16.

PLAN B MEDIA LLC, DURHAM, NC:
3,786,451, INT. CL. 16.

PLANET CANIT, LLC, HIGHLAND PARK, IL:
3,783,598, PUB. 2-16-2010. INT. CL. 40.

PLANET EARTH FOUNDATION, SEATTLE, WA:
2,340,204, REN. 3-31-10. INT. CL. 35.
2,340,235, REN. 3-31-10. INT. CL. 35.

PLANT PRODUCTS CO. LTD., BRAMPTON, ONTARIO L6T G 1, CANADA:
2,333,291, REN. 3-29-10. INT. CL. 1.

PLANTATION FOODS, INC., WACO, TX:
1,553,053, CANC. INT. CL. 29.

PLASTIMAYD, LLC, NEWMARKET, NH, AKA VYN-ALL POOL PRODUCTS:
3,783,930, PUB. 2-16-2010. INT. CL. 19.

PLATFORM, INC., SEATTLE, WA, TA FAITH&HUSTLE:
3,785,921, INT. CL. 25.

PLATINUM PRINTING, INC., REDDING, CA:
2,753,216, CANC. MULTIPLE CLASS, INT. CLS. 40 AND 42.

PLATT LUGGAGE, INC., CHICAGO, IL:
2,411,713, REN. 4-1-10. INT. CL. 6.

PLAY UNIVERSAL SOFTBALL FEDERATION, INC., FRANKLIN PARK, IL:
3,785,960, INT. CL. 41.

PLAYSTAR, INC., JANESVILLE, WI:
2,332,090, REN. 3-26-10. INT. CL. 28.

PLEASANT HOLIDAYS, LLC, WESTLAKE VILLAGE, CA:
3,786,375, INT. CL. 39.

PLIANT CORPORATION, SCHAUMBURG, IL:
2,753,941, CANC. INT. CL. 20.
2,753,972, CANC. INT. CL. 20.
2,754,091, CANC. INT. CL. 16.

PLUMB BETTER, INC., PANAMA CITY, FL:
3,784,138, PUB. 2-16-2010. INT. CL. 37.

PLUMBING-HEATING-COOLING CONTRACTORS-NATIONAL ASSOCIATION, FALLS CHURCH, VA:
2,281,603, REN. 3-26-10. MULTIPLE CLASS, INT. CLS. 16, 41 AND 42.

PLUNKERT, ROBERT W., WESTMINSTER, MD:
2,753,947, CANC. INT. CL. 41.

PNC FINANCIAL SERVICES GROUP, INC., THE, PITTSBURGH, PA:
2,271,869, CANC. INT. CL. 36.

POARCH BAND OF CREEK INDIANS, ATMORE, AL, DBA PCI GAMING AUTHORITY:
3,784,811, PUB. 2-16-2010. MULTIPLE CLASS, INT. CLS. 41 AND 43.

POILANE, APOLLONIA, MS., PARIS (75007), FRANCE AND POILANE, ATHENA, MS., PARIS (75007), FRANCE:
2,768,598, CANC. MULTIPLE CLASS, INT. CLS. 3, 4, 8, 24 AND 25.

POISON DIARIES LTD, LONDON, UNITED KINGDOM:
3,783,357, PUB. 2-16-2010. MULTIPLE CLASS, INT. CLS. 9, 16, 38 AND 41.

POLAR THERMAL PRODUCTS LIMITED, WARMINSTER, UNITED KINGDOM:
3,783,232, PUB. 2-16-2010. INT. CL. 11.
3,783,233, PUB. 2-16-2010. MULTIPLE CLASS, INT. CLS. 17 AND 21.

POLARDENE CORPORATION, E PALO ALTO, CA:
3,783,771, PUB. 2-16-2010. INT. CL. 42.

POLARIS INDUSTRIES INC., MEDINA, MN:
3,786,137, INT. CL. 12.

POLICY IMPACT STRATEGIC COMMUNICATIONS, INC., WASHINGTON, DC, DBA POLICY IMPACT COMMUNICATIONS:
3,784,505, PUB. 2-16-2010. INT. CL. 35.
3,784,506, PUB. 2-16-2010. INT. CL. 35.

POLYGLASS S.P.A., TREVISO, ITALY:
2,752,284, CANC. INT. CL. 19.

POLYMER CHEMISTRY INNOVATIONS, INC., TUCSON, AZ:
2,335,847, REN. 3-31-10. INT. CL. 2.

POLYMER DIAGNOSTICS INC., AVON LAKE, OH:
2,313,072, REN. 3-30-10. INT. CL. 42.

POMMERY S.A., 51100 REIMS, FRANCE:
2,272,686, CANC. INT. CL. 33.

PONIARD PHARMACEUTICALS, INC., SEATTLE, WA:
2,752,829, CANC. MULTIPLE CLASS, INT. CLS. 1, 5, 40 AND 42.

PONTIS MEBTECHNIK GMBH, 192521 SCHWARZENFELD, FED REP GERMANY:
2,753,543, CANC. MULTIPLE CLASS, INT. CLS. 9 AND 42.

POOLIA AB, SE-101 20 STOCKHOLM, SWEDEN:
2,751,821, CANC. MULTIPLE CLASS, INT. CLS. 16, 35 AND 41.

POPSCREEN, INC., HOUSTON, TX:
3,785,695, INT. CL. 38.

POP3 MEDIA, LLC, NEW YORK, NY:
2,751,939, CANC. INT. CL. 38.

PORCO, CARMEN R, SAN LUIS OBISPO, CA:
2,754,519, CANC. INT. CL. 9.

PORTASOFT COMPANY, INC., THE, WESTFIELD, NJ:
2,334,377, REN. 3-26-10. INT. CL. 11.

PORTLAND BEAU COMPANY LLC, PORTLAND, OR:
3,785,892, INT. CL. 26.

POSILLICO, LEO, SANTA ROSA, CA:
2,438,298, REN. 3-31-10. INT. CL. 16.

POSITEC GROUP LIMITED, HONG KONG ADM. REGION, CHINA:
3,785,324, INT. CL. 8.

POW WOW, INC., NEW YORK, NY:
2,410,849, REN. 3-26-10. INT. CL. 25.

POWER SERVICE PRODUCTS, INC., WEATHERFORD, TX:
2,394,276, REN. 4-1-10. INT. CL. 1.

POWER SYSTEMS ENGINEERING, P.S., COVINGTON, WA:
2,271,857, CANC. INT. CL. 42.

POWER WINDOWS AND SIDING, INC., BROOKHAVEN, PA:
3,783,193, PUB. 2-16-2010. INT. CL. 37.

POWERS FASTENERS, INC., BREWSTER, NY:
3,786,037, INT. CL. 6.

PPG INDUSTRIES OHIO, INC., CLEVELAND, OH, COLUMBIA-SOUTHERN CHEMICAL CORPORATION, PITTSBURGH, PA:
708,599, REN. 3-29-10. U.S. CL. 6 (INT. CL. 1).

PPG INDUSTRIES OHIO, INC., CLEVELAND, OH:
1,605,437, REN. 3-29-10. INT. CL. 12.

PRACTICEMATCH, INC., ST. LOUIS, MO:
2,272,022, CANC. INT. CL. 35.

PRADO, ALEJANDRO, FOREST HILLS, NY:
3,785,242, INT. CL. 9.

- PRAESIDIUM, INC., ARLINGTON, TX:
2,752,565, CANC. INT. CL. 36.
- PRAIRIE ISLAND INDIAN COMMUNITY, THE, RED WING, MN:
2,328,362, REN. 3-29-10. MULTIPLE CLASS, INT. CLS. 41 AND 42.
- PRAIRIE PACKAGING, INC., LAKE FOREST, IL:
3,784,075, PUB. 2-16-2010. INT. CL. 20.
- PRAXIS ENGINEERS, INC., MILPITAS, CA:
2,751,884, CANC. INT. CL. 9.
- PRECISE POWER CORPORATION, BRADENTON, FL:
2,271,376, CANC. INT. CL. 7.
- PRECISION ALLOYS COMPANY, SCOTTOWN, OH:
1,552,484, CANC. MULTIPLE CLASS, INT. CLS. 6, 8 AND 9.
1,552,485, CANC. MULTIPLE CLASS, INT. CLS. 6, 8 AND 9.
- PRECISION DYNAMICS CORPORATION, SAN FERNANDO, CA:
2,752,400, CANC. INT. CL. 18.
- PRECISION REFLEX, INC., NEW BRENNAN, OH:
3,786,399, INT. CL. 13.
- PRECISION WIRE COMPONENTS, LLC, TUALATIN, OR:
3,783,687, PUB. 2-16-2010. MULTIPLE CLASS, INT. CLS. 6 AND 42.
- PREFERRED HOSPICE OF OKLAHOMA, INC., OKLAHOMA CITY, OK:
2,753,101, CANC. INT. CL. 44.
- PREFERRED TOOL AND DIE, INC, COMSTOCK PARK, MI:
2,336,504, REN. 3-31-10. INT. CL. 7.
- PREMIER MARKETING SERVICES, L.L.C., MIDDLEFIELD, CT:
2,271,578, CANC. INT. CL. 35.
- PREMIERE EXECUTIVE SUITES LIMITED, MISSISSAUGA ONTARIO, CANADA, DBA PREMIERE EXECUTIVE SUITES:
3,783,913, PUB. 2-16-2010. INT. CL. 36.
- PREMIUM NUTRITIONAL PRODUCTS, INC., SHAWNEE, KS:
2,897,578, CANC. INT. CL. 28.
- PRENATAL CRADLE INC., LAKE, MI:
2,328,623, REN. 3-26-10. INT. CL. 18.
- PRENATAL S.P.A., GRANDATE, COMO, ITALY:
3,783,242, PUB. 9-15-2009. MULTIPLE CLASS, INT. CLS. 3, 10, 12, 28 AND 35.
- PREPAKIT INC., LONDON, ONTARIO, N6A 5N6, CANADA:
2,751,546, CANC. INT. CL. 5.
- PRESSPART GMBH & CO.KG, MARSBERG, FED REP GERMANY:
2,928,500, COR. INT. CL. 6.
- PRESTOLITE WIRE LLC, SOUTHFIELD, MI:
3,783,198, PUB. 2-16-2010. MULTIPLE CLASS, INT. CLS. 7, 8 AND 9.
- PRETTY THINGS BOUTIQUE, LLC, LAKE HAVASU CITY, AZ:
3,784,605, PUB. 2-16-2010. INT. CL. 35.
- PRETTY UGLY LLC, EDISON, NJ AND HORVATH, DAVID, EDISON, NJ AND KIM, SUN-MIN, EDISON, NJ:
3,786,001, INT. CL. 28.
- PREVISITE, SURESNES, FRANCE:
3,784,984, PUB. 2-16-2010. MULTIPLE CLASS, INT. CLS. 9, 35, 36, 38 AND 40.
- PRIAMUS SYSTEM TECHNOLOGIES AG, CH-8207 SCHAFFHAUSEN, SWITZERLAND:
2,751,950, CANC. INT. CL. 42.
- PRICE, STEPHEN A., FAIRFAX STATION, VA:
2,753,937, CANC. INT. CL. 12.
- PRICewaterhouseCOOPERS LLP, NEW YORK, NY:
2,752,190, CANC. MULTIPLE CLASS, INT. CLS. 35 AND 41.
- PRIDE MOBILITY PRODUCTS CORPORATION, EXTER, PA:
2,371,611, REN. 3-31-10. INT. CL. 12.
- PRIMARK HOLDINGS, DUBLIN 1, IRELAND:
3,784,819, PUB. 9-1-2009. INT. CL. 25.
- PRIMARY INVESTMENTS GROUP LIMITED, ROAD TOWN, TORTOLA, BR.VIRGIN ISLANDS:
3,786,407, INT. CL. 5.
- PRIME GLOBAL PRODUCTS, INC., WOODSTOCK, GA:
3,786,114, INT. CL. 7.
3,786,115, INT. CL. 7.
- PRIMETOOLS, CLACKAMAS, OR:
2,752,924, CANC. INT. CL. 35.
- PRINCE LIONHEART, INC., SANTA MARIA, CA:
2,751,764, CANC. MULTIPLE CLASS, INT. CLS. 11, 12, 20, 21, 27 AND 28.
- PRINCETON GRAPHICS SYSTEMS, INC., SANTA ANA, CA:
2,753,480, CANC. INT. CL. 9.
- PRINT RECOVERY CONCEPTS, INC., STANDISH, ME:
3,786,371, INT. CL. 2.
- PRIVACASH.COM, INC., TOLEDO, OH:
2,753,710, CANC. INT. CL. 9.
- PRIVACYHARBOR, INC., VANCOUVER, WA, DBA PRIVACYHARBOR.COM:
3,784,524, PUB. 2-16-2010. INT. CL. 42.
- PRIVITY VENTURES, INC., CARSON CITY, NV:
2,432,280, REN. 3-26-10. INT. CL. 42.
- PRL USA HOLDINGS, INC., WILMINGTON, DE:
3,785,400, INT. CL. 3.
- PRO-FORMULA LABORATORIES, INC., FORT LAUDERDALE, FL:
2,335,504, REN. 3-27-10. INT. CL. 5.
- PRO-PET, LLC, ST. MARY'S, OH:
1,553,141, CANC. INT. CL. 31.
2,752,528, CANC. INT. CL. 31.
- PRO-TROLL, CONCORD, CA:
3,784,103, PUB. 2-16-2010. MULTIPLE CLASS, INT. CLS. 16 AND 28.
- PROCAS, LLC, COLUMBIA, MD:
2,360,596, REN. 3-30-10. INT. CL. 9.
- PROCESS WEAVER INC, FREMONT, CA:
3,786,466, INT. CL. 9.
- PROCTOR FINANCIAL, INC., TROY, MI:
1,579,903, REN. 3-30-10. INT. CL. 9.
- PRODEN ENTERPRISES INC., ST-LAURENT, QC, CANADA:
3,785,473, INT. CL. 7.
- PRODESSE, INC., WAUKESHA, WI:
2,752,819, CANC. INT. CL. 1.
- PRODUCERS EDGE, INC., CASA GRANDE, AZ:
3,785,448, INT. CL. 36.
- PRODUCT QUEST, HOLLY HILL, FL:
2,751,846, CANC. INT. CL. 3.
- PRODUCTOS MEXICANOS, S.A. DE C.V., MONTERREY, MEXICO:
3,784,422, PUB. 2-16-2010. INT. CL. 30.
- PRODUCTOS REGIONALES DE ATOTONILCO SA DE CV, ATOTONILCO, MEXICO:
3,785,831, INT. CL. 33.
- PROFESSIONAL BOWHUNTERS SOCIETY, INC., MOORESVILLE, NC:
3,783,950, PUB. 2-16-2010. INT. CL. 35.
- PROFESSIONAL BULL RIDERS, INC., PUEBLO, CO:
3,785,420, MULTIPLE CLASS, INT. CLS. 35 AND 41.
3,785,421, MULTIPLE CLASS, INT. CLS. 35 AND 41.
3,785,422, MULTIPLE CLASS, INT. CLS. 35 AND 41.
- PROFESSIONAL CLIMBING GUIDES INSTITUTE, BISHOP, CA:
3,783,891, PUB. 2-16-2010. U.S. CL. B.
3,784,729, PUB. 2-16-2010. U.S. CL. B.
3,784,730, PUB. 2-16-2010. U.S. CL. B.
- PROFESSIONAL CONVENTION MANAGEMENT ASSOCIATION, CHICAGO, IL:
3,783,454, PUB. 2-16-2010. MULTIPLE CLASS, INT. CLS. 35 AND 43.
3,783,455, PUB. 2-16-2010. MULTIPLE CLASS, INT. CLS. 35 AND 43.
- PROFESSIONAL PHOTOGRAPHERS INSTITUTE OF NEW ENGLAND, WARWICK, RI:
3,784,085, PUB. 2-16-2010. INT. CL. 41.
- PROFESSIONAL TOXICOLOGY SERVICES, INC., LENEXA, KS:
3,783,106, PUB. 2-16-2010. INT. CL. 1.
- PROFESSIONAL'S CHOICE SPORTS MEDICINE PRODUCTS, INC., SPRING VALLEY, CA:
2,753,224, CANC. INT. CL. 18.

PROGRESS INVESTMENT MANAGEMENT COMPANY, LLC, SAN FRANCISCO, CA:
3,783,447, PUB. 2-16-2010. INT. CL. 42.

PROGRESS MARKET CONSULTING SARL, LE CANNET ROCHEVILLE, FRANCE:
3,785,479, MULTIPLE CLASS, INT. CLS. 9 AND 28.
3,785,480, MULTIPLE CLASS, INT. CLS. 9 AND 28.

PROGRESSIVE GOURMET, INC., WILMINGTON, MA:
3,783,400, PUB. 2-16-2010. MULTIPLE CLASS, INT. CLS. 29 AND 30.

PROJECT EVERGREEN FOUNDATION, INC., NEW PRA-GUE, MN:
3,785,893, INT. CL. 36.

PROJECTIONS RESEARCH INC, PHOENIXVILLE, PA:
3,783,808, PUB. 2-16-2010. INT. CL. 42.

PROLIANCE ENERGY LLC, INDIANAPOLIS, IN:
2,286,564, REN. 3-27-10. INT. CL. 42.
2,286,564, CANC. MULTIPLE CLASS, INT. CLS. 35, 36 AND 39.

PROMETHEAN LIMITED, BLACKBURN, LANCASHIRE, UNITED KINGDOM:
3,783,466, PUB. 2-16-2010. MULTIPLE CLASS, INT. CLS. 9, 37 AND 42.

PROMETHEUS LABORATORIES INC., SAN DIEGO, CA:
3,785,532, INT. CL. 44.

PROMO LOGIC, LLC, CONCORD, NC:
3,783,446, PUB. 8-4-2009. INT. CL. 40.

PROQUEST LLC, ANN ARBOR, MI:
1,597,882, REN. 3-31-10. INT. CL. 42.

PROS ENTERTAINMENT SERVICE, INC., THE, HUNTING-DON VALLEY, PA, SOUND ENTERTAINMENT DJS, INC., PHILADELPHIA, PA:
1,583,093, REN. 3-26-10. INT. CL. 42.

PROSOUND COMMUNICATIONS, INC., SAN FERNANDO, CA:
3,786,386, INT. CL. 15.

PROSPECTION, LLC, INDEPENDENCE, OH, INSPECT-IT 1ST FRANCHISE CORP., SCOTTSDALE, AZ:
2,388,517, REN. 3-26-10. INT. CL. 42.

PROSPECTIV DIRECT, INC., WAKEFIELD, MA:
3,784,470, PUB. 2-16-2010. INT. CL. 42.
3,784,471, PUB. 2-16-2010. INT. CL. 35.

PROSPERITY BANK, EL CAMPO, TX:
2,846,330, AM. INT. CL. 36.

PROTEAM, INC., BOISE, ID:
2,754,434, CANC. INT. CL. 7.

PROTECTIVE LIFE CORPORATION, BIRMINGHAM, AL:
2,752,619, CANC. INT. CL. 42.

PROTEKTORWERK FLORENZ MAISCH GMBH & CO. KG, D-76571 GAGGENAU, FED REP GERMANY:
2,752,006, CANC. INT. CL. 6.

PROTON ENERGY SYSTEMS, INC., WALLINGFORD, CT:
2,272,644, CANC. INT. CL. 9.

PROVATION MEDICAL, INC., MINNEAPOLIS, MN:
2,752,111, CANC. INT. CL. 9.

PROVEDORES Y SOLUCIONES DAC S.A., SAN JOSE, COSTA RICA:
3,786,010, INT. CL. 39.

PROVEN WINNERS NORTH AMERICA LLC, CAMPBELL, CA:
3,784,476, PUB. 2-16-2010. INT. CL. 31.
3,785,706, INT. CL. 31.
3,785,707, INT. CL. 31.
3,785,708, INT. CL. 31.
3,785,709, INT. CL. 31.
3,785,736, INT. CL. 31.

PROVIDE BERRIES, INC., SAN DIEGO, CA:
3,783,282, PUB. 2-16-2010. MULTIPLE CLASS, INT. CLS. 30 AND 35.

PROVIDENT BANK, THE, CINCINNATI, OH:
2,272,240, CANC. INT. CL. 36.

PROVVISTA SPECIALTY FOODS, INC., PORTLAND, OR:
2,343,089, REN. 3-27-10. INT. CL. 30.

PRUDENTIAL ASSURANCE COMPANY LIMITED, THE, LONDON, ENGLAND:
1,591,236, REN. 3-30-10. INT. CL. 36.

PRWT SERVICES, INC., PHILADELPHIA, PA:
3,783,428, PUB. 2-16-2010. MULTIPLE CLASS, INT. CLS. 35 AND 37.
3,783,429, PUB. 2-16-2010. MULTIPLE CLASS, INT. CLS. 35, 40 AND 42.
3,783,430, PUB. 2-16-2010. MULTIPLE CLASS, INT. CLS. 35, 40 AND 42.
3,783,431, PUB. 2-16-2010. MULTIPLE CLASS, INT. CLS. 35, 40 AND 42.

PS PUBLICATIONS, REDMOND, WA:
2,337,908, REN. 3-26-10. INT. CL. 16.

PSYCHOLOGICAL ASSESSMENT RESOURCES, INC., LUTZ, FL:
3,786,201, INT. CL. 16.

PTC HOLDINGS LIMITED, KWUN TONG, KOWLOON, HONG KONG:
3,786,130, INT. CL. 2.

PTI TECHNOLOGIES INC., NEWBURY PARK, CA:
1,552,767, CANC. INT. CL. 12.

PUBLIC BROADCASTING SERVICE, ARLINGTON, VA:
2,272,528, CANC. INT. CL. 9.

PUBLIC PRIVATE ENTERPRISES, INC., MINNEAPOLIS, MN, DBA STATE OF HEALTH PRODUCTS:
2,753,020, CANC. INT. CL. 16.

PUBLIC RELATIONS SOCIETY OF AMERICA, INC., NEW YORK, NY:
3,783,501, PUB. 2-16-2010. MULTIPLE CLASS, INT. CLS. 9 AND 16.

PUBLIC STORAGE, GLENDALE, CA:
2,363,327, REN. 3-30-10. MULTIPLE CLASS, INT. CLS. 16 AND 39.

PUBLIC WORDS INC., ARLINGTON, MA:
2,753,767, CANC. INT. CL. 41.

PUBLICIS GROUPE SA, 75008 PARIS, FRANCE:
2,284,867, REN. 3-27-10. INT. CL. 35.

PUBLICIS GROUPE SA, FRANCE:
3,784,933, PUB. 9-15-2009. MULTIPLE CLASS, INT. CLS. 35, 38 AND 41.

PUBMATIC, INC., PALO ALTO, CA:
3,784,601, PUB. 2-16-2010. INT. CL. 35.

PUENTE BAGELS, INC., SAN FRANCISCO, CA:
3,786,479, INT. CL. 35.

PULSE DATA INC., CALGARY, ALBERTA, CANADA:
3,784,829, PUB. 12-9-2008. MULTIPLE CLASS, INT. CLS. 9, 16 AND 42.

PULSE NETWORK LLC, HOUSTON, TX:
2,754,125, CANC. INT. CL. 36.

PULSE VETERINARY TECHNOLOGIES, LLC, ALPHARETTA, GA:
3,786,123, INT. CL. 10.
3,786,124, INT. CL. 10.

PUMP HOLDINGS, LLC, NEW YORK, NY, DBA THE PUMP ENERGY FOOD:
3,784,353, PUB. 2-16-2010. INT. CL. 43.
3,784,355, PUB. 2-16-2010. INT. CL. 43.
3,784,361, PUB. 2-16-2010. INT. CL. 43.

PUNAHOU SCHOOL, HONOLULU, HI:
3,783,331, PUB. 2-16-2010. MULTIPLE CLASS, INT. CLS. 12, 14, 16, 18, 21, 25, 26 AND 41.

PUPPY TUBS, INC., PEACHTREE CITY, GA:
2,754,607, CANC. INT. CL. 44.

PURDUE PRODUCTS L.P., STAMFORD, CT:
3,783,833, PUB. 2-16-2010. INT. CL. 44.

PURE & NATURAL COMPANY, SCOTTSDALE, AZ:
2,273,070, CANC. INT. CL. 3.

PURE FISHING, INC., SPIRIT LAKE, IA:
1,592,183, REN. 3-26-10. INT. CL. 28.

PURE REIKI, INC., CINCINNATI, OH:
3,783,874, PUB. 2-16-2010. INT. CL. 41.

PURINA MILLS, INC., ST. LOUIS, MO:
2,271,950, CANC. INT. CL. 5.

PUTNAM COMPANY, INC., WALWORTH, WI:
2,346,705, REN. 3-27-10. INT. CL. 28.

PUTNAM COURIER, LLC, COLD SPRING, NY:
2,272,415, CANC. INT. CL. 16.

PVH NECKWEAR, INC., NEW YORK, NY:
2,334,579, REN. 3-31-10. INT. CL. 25.

PWB HEALTH LIMITED, DUMBARTON, G82 3PW, UNITED KINGDOM:
3,786,368, MULTIPLE CLASS, INT. CLS. 5 AND 10.

- PWS, INC., LOS ANGELES, CA:
2,272,233, CANC. INT. CL. 37.
- PYLON MANUFACTURING CORP., DEERFIELD BEACH, FL:
1,673,386, AM. INT. CL. 12.
- PYROGIDIGAL CONSULTANTS, INC., PEBBLE BEACH, CA:
2,428,507, REN. 4-1-10. INT. CL. 13.
- PYROLYZER LLC, BOCA RATON, FL:
3,783,518, PUB. 2-16-2010. INT. CL. 35.
- PYROTENAX CABLES LIMITED, WOKINGHAM BERKSHIRE RG40 2QE, UNITED KINGDOM:
2,751,626, CANC. INT. CL. 9.
- Q-LAB CORPORATION, CLEVELAND, OH:
1,628,082, REN. 3-30-10. INT. CL. 9.
- Q-MED AB, S-752 28 UPPSALA, SWEDEN:
2,753,628, CANC. MULTIPLE CLASS, INT. CLS. 5 AND 10.
- QINETIQ LIMITED, LONDON, UNITED KINGDOM:
2,400,153, REN. 3-27-10. INT. CL. 9.
2,400,154, REN. 3-29-10. INT. CL. 9.
- QINGWEN XU, LOS ANGELES, AR:
3,783,205, PUB. 2-16-2010. INT. CL. 18.
- QPCOM, INC., DORAL, FL:
3,783,976, PUB. 2-16-2010. INT. CL. 9.
- QRI GROUP, LLC, HOUSTON, TX:
3,785,487, INT. CL. 42.
- QUADRUS TECHNOLOGY LIMITED, HONG KONG, HONG KONG, AKA QUADRUS:
3,783,435, PUB. 2-16-2010. INT. CL. 9.
- QUALITY COLOR DESIGN INC, NEW YORK, NY:
3,785,597, INT. CL. 14.
- QUALITY COPY ACQUISITION CORPORATION, MIAMI, FL TO QUALITY COPY ACQUISITION CORPORATION, MIAMI, FL:
2,272,646, CANC. MULTIPLE CLASS, INT. CLS. 9 AND 41.
- QUALITY DOOR AND HARDWARE, INC., BOHEMIA, NY:
2,361,428, REN. 3-27-10. INT. CL. 35.
- QUALITY DOOR AND HARDWARE, INC., WEST BABYLON, NY:
2,387,373, REN. 3-26-10. INT. CL. 35.
- QUALITY FOOD GROUP S.P.A., MARTIGNACCO (UDINE), ITALY:
2,753,158, CANC. INT. CL. 30.
- QUALITY SALES, INC., CROWLEY, LA:
2,754,433, CANC. INT. CL. 30.
- QUANTERRA, INC., HARVARD, MA:
2,339,434, REN. 3-31-10. INT. CL. 9.
- QUANTEX CORPORATION, ROCKVILLE, MD:
1,552,718, CANC. INT. CL. 9.
- QUANTITATIVE SERVICES GROUP LLC, NAPERVILLE, IL:
3,785,640, INT. CL. 36.
- QUANTUM FOODS, LLC, BOLINGBROOK, IL:
3,785,235, INT. CL. 29.
- QUANTUM LEADERS, INC., IRVINE, CA:
3,784,100, PUB. 2-16-2010. INT. CL. 35.
- QUANTUM LEARNING NETWORK, OCEANSIDE, CA:
1,600,005, REN. 3-31-10. INT. CL. 42.
- QUARTO CHILDREN'S BOOKS LIMITED, LONDON N7 9QP, ENGLAND:
2,271,314, CANC. INT. CL. 16.
- QUESTIONMARK COMPUTING LIMITED, LONDON N19 5NA, UNITED KINGDOM:
2,337,058, REN. 3-27-10. INT. CL. 9.
- QUICK SPORTS INTERNATIONAL B.V., STRIJEN, NETHERLANDS:
2,751,958, CANC. MULTIPLE CLASS, INT. CLS. 25 AND 28.
- QUICK'S CANDY, INC., BUCHANAN, MI:
1,553,121, CANC. INT. CL. 30.
- QUIKBOOK, INC., NEW YORK, NY:
3,784,312, PUB. 2-16-2010. INT. CL. 43.
- QUILL, NISSA T., CLARKSBURG, MD:
2,752,894, CANC. INT. CL. 41.
- QUIMBY & COLLINS, PLLC, SALISBURY, NC:
2,752,585, CANC. INT. CL. 44.
- QUINN MANAGEMENT SERVICES, INC., WINCHESTER, MA:
3,783,362, PUB. 2-16-2010. INT. CL. 35.
- QUON, STEPHEN A., FOSTER CITY, CA:
2,337,669, REN. 3-31-10. INT. CL. 42.
- QUY T. TON, BATON ROUGE, LA:
3,784,051, PUB. 2-16-2010. INT. CL. 44.
- QVC, INC., WEST CHESTER, PA:
2,754,150, CANC. INT. CL. 21.
- QVL PHARMACY HOLDINGS, INC., DALLAS, TX:
3,784,708, PUB. 2-16-2010. INT. CL. 35.
3,784,709, PUB. 2-16-2010. INT. CL. 35.
- QWEST COMMUNICATIONS INTERNATIONAL INC., DENVER, CO:
2,751,663, CANC. INT. CL. 42.
2,753,169, CANC. INT. CL. 38.
- QWEST COMMUNICATIONS INTERNATIONAL, INC., DENVER, CO:
2,383,937, REN. 3-26-10. INT. CL. 38.
2,406,899, REN. 3-26-10. MULTIPLE CLASS, INT. CLS. 38 AND 42.
- QWIK-COOK, INC., ROCHESTER, NY, DBA HOME TRENDS:
3,785,202, INT. CL. 35.
- R 525 ENTERPRISES LTD., SASKATOON, SASKATCHEWAN, CANADA:
3,784,826, PUB. 2-16-2010. MULTIPLE CLASS, INT. CLS. 9, 10, 16, 35, 42 AND 44.
- R. R. BOWKER, L.L.C., NEW PROVIDENCE, NJ, REED PUBLISHING (USA) INC., NEWTON, MA:
1,594,157, REN. 3-26-10. INT. CL. 16.
- R. T. VANDERBILT COMPANY, INC., NORWALK, CT:
892,625, REN. 3-26-10. U.S. CL. 1 (INT. CL. 1).
- R.B. IDEAS, L.L.C., SHERWOOD, OR:
2,754,167, CANC. INT. CL. 21.
- R.I.E.M.PP ELEKTROTECHNIK GMBH, 72644 OBERBOIHINGEN, FED REP GERMANY:
2,751,581, CANC. MULTIPLE CLASS, INT. CLS. 7, 9, 11, 37 AND 42.
- R.K. DIXON COMPANY, DAVENPORT, IA:
2,753,437, CANC. MULTIPLE CLASS, INT. CLS. 38 AND 39.
- R-SQUARED SERVICES AND SOLUTIONS, LLC, PRINCETON JUNCTION, NJ:
3,786,355, INT. CL. 42.
- RACIAL HARMONY, BELLEVILLE, IL:
2,317,388, REN. 3-31-10. INT. CL. 41.
2,317,388, COR. INT. CL. 41.
2,342,904, REN. 3-31-10. INT. CL. 41.
2,342,904, COR. INT. CL. 41.
- RACINE INDUSTRIES, INC., RACINE, WI:
2,330,648, REN. 3-31-10. INT. CL. 7.
- RADCO CHEMICAL SOLUTIONS, INC., COMMACK, NY:
3,784,341, PUB. 2-16-2010. INT. CL. 5.
- RADENSKA D.D. RADENCI, 9502 RADENCI, SLOVENIA, ZDRAVILISCE RADENSKA S TREMI SRCI N.SOLO., RADENCI, YUGOSLAVIA:
1,536,036, REN. 3-30-10. INT. CL. 32.
- RADIANT, LLC, BOUNTIFUL, UT:
3,784,409, PUB. 2-16-2010. INT. CL. 35.
- RADIATION PROTECTION PRODUCTS, INC., WAYZATA, MN:
2,338,013, REN. 3-29-10. INT. CL. 9.
- RADICIFIN S.P.A., 24100 BERGAMO, ITALY:
2,337,845, REN. 3-31-10. INT. CL. 1.
- RADICINOVACIPS S.P.A., CHIGNOLO D'ISOLA (BG), ITALY:
1,594,782, REN. 3-31-10. INT. CL. 1.
- RADIO-ACTIVE MEDIA, INC., NEW YORK, NY:
2,315,276, REN. 3-26-10. INT. CL. 16.
- RADIONIC INDUSTRIES, CHICAGO, IL:
2,753,579, CANC. INT. CL. 9.
- RADKE, FLORIAN, PLEASANT HILL, CA:
3,784,410, PUB. 2-16-2010. INT. CL. 35.
- RADLE, DAVID I., SLIDELL, LA:
2,753,107, CANC. INT. CL. 42.
- RAGEN, KENT, LOS ALTOS, CA:
3,783,627, PUB. 2-16-2010. INT. CL. 35.

RAGONESE, REGINA A., BOXFORD, MA:
 2,752,459, CANC. INT. CL. 30.
 RAHMEL, SEBASTIAN, KÖLN, FED REP GERMANY:
 3,784,941, PUB. 2-16-2010. MULTIPLE CLASS, INT. CLS.
 35 AND 42.
 RALEY, WILLIAM GREENE, SEAL BEACH, CA:
 2,752,823, CANC. INT. CL. 41.
 RALPH MALTBY ENTERPRISES, INC., NEWARK, OH:
 2,273,154, CANC. INT. CL. 28.
 RALPHS GROCERY COMPANY, COMPTON, CA:
 2,271,453, CANC. INT. CL. 35.
 RAMASUBRAMANIAN, REMESH, LOS ALTOS, CA:
 2,753,467, CANC. INT. CL. 42.
 RAMEX RECORDS, INC., HOUSTON, TX:
 2,752,998, CANC. MULTIPLE CLASS, INT. CLS. 9 AND
 41.
 RAMIUS CORPORATION, OTTAWA, CANADA:
 3,783,698, PUB. 2-16-2010. INT. CL. 42.
 RAMSEEKER INC., HAMILTON ONTARIO, CANADA:
 2,752,468, CANC. INT. CL. 35.
 RAMSEY, NATHAN M., DENVER, CO:
 3,784,195, PUB. 2-16-2010. INT. CL. 25.
 RAMSEY, TED S., DIAMOND BAR, CA:
 2,753,946, CANC. INT. CL. 32.
 RAMSEY, THEODORE L., II, CHINA GROVE, NC:
 2,273,067, CANC. INT. CL. 30.
 RANCH HAND DISTRIBUTION, LLC, SHINER, TX:
 3,784,256, PUB. 2-16-2010. INT. CL. 6.
 3,784,258, PUB. 2-16-2010. INT. CL. 6.
 RANCOURT, JACQUES, SAINT-THÉRÈSE, QUEBEC, CA-
 NADA:
 3,786,229, INT. CL. 12.
 RANDA LUGGAGE, INC., TOTOWA, NJ:
 1,552,882, CANC. INT. CL. 18.
 RANDALL INTERNATIONAL LLC, CARLSBAD, CA:
 2,273,043, CANC. INT. CL. 3.
 RANDALL'S FOOD & DRUGS, LP, HOUSTON, TX:
 2,357,234, REN. 4-1-10. INT. CL. 35.
 RANDOM HOUSE, INC., NEW YORK, NY:
 3,784,776, PUB. 2-16-2010. INT. CL. 16.
 3,784,777, PUB. 2-16-2010. INT. CL. 16.
 RANGE SYSTEMS, NEW HOPE, MN:
 3,783,274, PUB. 2-16-2010. INT. CL. 17.
 RANI HANCOCK, BROOKLYN, NY AND CAMUS CELLI,
 BROOKLYN, NY:
 3,785,333, INT. CL. 41.
 RANKIN CORPORATION, EDGEMONT, PA:
 2,753,258, CANC. INT. CL. 9.
 RAPID CITY PROFESSIONAL HOCKEY, LLC, RAPID CITY,
 SD, DBA RAPID CITY RUSH:
 3,784,561, PUB. 2-16-2010. MULTIPLE CLASS, INT. CLS.
 16, 25, 28 AND 41.
 RAPID REFILL CORP., CHANHASSEN, MN:
 3,626,960, COR. MULTIPLE CLASS, INT. CLS. 2, 35 AND
 40.
 RARE INSIGHT, LLC, NEW ORLEANS, LA:
 3,784,615, PUB. 2-16-2010. INT. CL. 41.
 RARE LIMITED, WARSICKSHIRE, ENGLAND:
 2,183,213, CANC. MULTIPLE CLASS, INT. CLS. 9 AND
 28.
 RARE METAL CO., LTD., MINATO-KU, TOKYO 105-0012,
 JAPAN:
 1,552,703, CANC. INT. CL. 9.
 RASCHHOFER, HEINER, A-5020 SALZBURG, AUSTRIA:
 2,751,696, CANC. INT. CL. 42.
 RATH, MATTHIAS, NL-7609 KL ALMELO, NETHER-
 LANDS:
 2,751,713, CANC. MULTIPLE CLASS, INT. CLS. 5, 16
 AND 32.
 RATH, MATTHIAS DR., NL-7609 KL ALMELO, NETHER-
 LANDS:
 2,752,073, CANC. MULTIPLE CLASS, INT. CLS. 5, 30
 AND 32.
 2,752,074, CANC. MULTIPLE CLASS, INT. CLS. 5, 30
 AND 32.
 RATHBURN, WILLIAM FREDERICK, DALLAS, TX:
 2,752,415, CANC. INT. CL. 37.
 RAUCH, HOWARD S., TENAFLY, NJ:
 1,590,134, REN. 3-30-10. INT. CL. 35.
 RAULAND-BORG CORPORATION, MT. PROSPECT, IL:
 3,785,766, INT. CL. 9.
 RAVENSYARD PUBLISHING, LTD., OAKTON, VA:
 2,411,292, REN. 4-1-10. INT. CL. 41.
 RAY PRODUCTS COMPANY, INC., ONTARIO, CA:
 2,752,216, CANC. INT. CL. 40.
 RAYCOM MEDIA, INC., MONTGOMERY, AL:
 2,752,180, CANC. INT. CL. 38.
 RAYSPAN CORPORATION, SAN DIEGO, CA:
 3,759,025, AM. INT. CL. 9.
 RAZCAL CORPORATION, SUDBURY, MA:
 1,553,168, CANC. INT. CL. 32.
 RAZOR USA LLC, CERRITOS, CA:
 2,753,845, COR. INT. CL. 28.
 RCN TELECOM SERVICES, INC., HERNDON, VA:
 2,752,381, CANC. MULTIPLE CLASS, INT. CLS. 38 AND
 42.
 RDF MEDIA GROUP LIMITED, LONDON, UNITED KING-
 DOM:
 3,767,709, COR. MULTIPLE CLASS, INT. CLS. 9, 16, 25,
 28, 38 AND 41.
 RE/MAX INTERNATIONAL, INC., DENVER, CO, RE/MAX
 INTERNATIONAL, INC., DENVER, CO:
 1,595,678, REN. 3-31-10. INT. CL. 36.
 RE:AB, INC., NEW YORK, NY:
 2,752,576, CANC. INT. CL. 25.
 READER'S DIGEST ASSOCIATION, INC., THE PLEASANT-
 VILLE, NY:
 2,333,807, REN. 3-26-10. INT. CL. 16.
 REAL IMAGE MEDIA TECHNOLOGIES PVT. LTD., BALA-
 JINAGAR, CHENNAI, INDIA:
 3,783,294, PUB. 2-16-2010. INT. CL. 9.
 3,783,295, PUB. 2-16-2010. INT. CL. 9.
 3,783,296, PUB. 2-16-2010. INT. CL. 9.
 REAL WORKS, INC., TAMPA, FL:
 2,752,784, CANC. INT. CL. 36.
 REAL-TIME MARKETING, LTD., DALLAS, TX:
 3,784,214, PUB. 2-16-2010. INT. CL. 6.
 REASER, DONNIE D, LOST CREEK, WV:
 2,753,143, CANC. INT. CL. 8.
 REAY, GAVIN, LONDON SW151DQ, UNITED KINGDOM:
 3,785,560, INT. CL. 7.
 REBECCA CHACKO, TUCSON, AZ, DBA CHACKO-HERTZ
 FINANCIAL SOLUTIONS:
 3,784,015, PUB. 2-16-2010. INT. CL. 36.
 RECIPROCAL, NORTH HOLLYWOOD, CA:
 3,784,513, PUB. 2-16-2010. MULTIPLE CLASS, INT. CLS. 9
 AND 41.
 RECONDO TECHNOLOGY, INC., CENTENNIAL, CO:
 3,784,123, PUB. 2-16-2010. INT. CL. 42.
 RECORDED BOOKS, LLC, PRINCE FREDERICK, MD:
 3,783,912, PUB. 2-16-2010. INT. CL. 9.
 RECOVERCARE, LLC, RADNOR, PA:
 3,783,217, PUB. 2-16-2010. MULTIPLE CLASS, INT. CLS.
 35 AND 44.
 RECREATIONAL EQUIPMENT, INC., SUMNER, WA:
 3,785,705, INT. CL. 35.
 RECTICEL, 1200 SINT-LAMBRECHTS-WOLUWE, BEL-
 GIUM:
 2,271,346, CANC. INT. CL. 17.
 RECTOR, THOMAS, SAN FRANCISCO, CA:
 2,751,792, CANC. INT. CL. 41.
 RECYCLINE, INC., WALTHAM, MA:
 3,785,664, MULTIPLE CLASS, INT. CLS. 8, 9 AND 21.
 RED ARME, LLC, NEW YORK, NY:
 3,786,041, INT. CL. 25.
 RED BIRD FARMS DISTRIBUTION COMPANY, ENGLE-
 WOOD, CO:
 3,783,602, PUB. 2-16-2010. INT. CL. 29.
 3,783,603, PUB. 2-16-2010. INT. CL. 29.
 RED BULL GMBH, FUSCHL AM SEE, AUSTRIA:
 2,752,369, CANC. INT. CL. 41.
 RED CARD SYSTEMS, LLC, ST. LOUIS, MO:
 3,786,441, INT. CL. 9.
 RED DISTRIBUTION, LLC, NEW YORK, NY:
 3,783,262, PUB. 2-16-2010. INT. CL. 35.

- RED JACKET MOUNTAIN VIEW, LLC, SOUTH YARMOUTH, MA:
2,753,279, CANC. INT. CL. 43.
- RED KAP APPAREL CORP., WILMINGTON, DE:
2,753,297, CANC. INT. CL. 25.
- RED.COM, INC., LAKE FOREST, CA:
3,786,150, INT. CL. 9.
- REDBANK LONG PADDOCK PTY LTD, ANGASTON, SOUTH AUSTRALIA, AUSTRALIA:
2,752,294, CANC. INT. CL. 33.
- REDER, MILTON, BROOKLINE, MA:
2,328,655, REN. 3-26-10. INT. CL. 41.
- REDMOND, MICHELE, SCOTTSDALE, AZ:
3,784,038, PUB. 2-16-2010. INT. CL. 44.
- REED ELSEVIER PROPERTIES INC., WILMINGTON, DE:
1,553,320, CANC. INT. CL. 42.
- REED, BUCK D., GILBERTSVILLE, PA, DBA REED ENTERPRISES:
3,783,370, PUB. 2-16-2010. INT. CL. 41.
- REED, MARK, JEFFERSON, TUCSON, AZ:
2,754,455, CANC. INT. CL. 42.
- REFILL MANAGER, LLC, NEW YORK, NY:
3,785,608, INT. CL. 35.
- REGAN, STEVEN, LEXINGTON, NC:
3,784,581, PUB. 2-16-2010. INT. CL. 41.
- REGENT HOSPITALITY WORLDWIDE, INC., MINNEAPOLIS, MN:
2,271,781, CANC. INT. CL. 39.
- REGENT UNIVERSITY, VIRGINIA BEACH, VA:
3,786,385, INT. CL. 41.
- REGINA REGIS S.R.L., ITALY:
3,785,045, PUB. 2-16-2010. INT. CL. 25.
- REGIONS ASSET COMPANY, WILMINGTON, DE:
1,553,230, CANC. INT. CL. 36.
- REGIS COLLEGE, WESTON, MA:
2,752,411, CANC. INT. CL. 41.
- REHAB UNITED SPORTS MEDICINE & PHYSICAL THERAPY, INC., SAN DIEGO, CA:
3,785,299, INT. CL. 28.
- REHRIG PACIFIC COMPANY, A DELAWARE CORPORATION, LOS ANGELES, CA:
1,588,930, REN. 3-27-10. INT. CL. 20.
- REICHHOLD, INC., DURHAM, NC, REICHHOLD CHEMICALS, INC., WHITE PLAINS, NY:
1,132,015, REN. 3-31-10. INT. CL. 2.
- REID WITLIN LTD, NORTHRIDGE, CA, DBA TREND GREEN:
3,783,857, PUB. 2-16-2010. INT. CL. 24.
- REIKER, JOSHUA C., MR., DESTIN, FL:
2,753,956, CANC. INT. CL. 11.
- REILLY, KAREN L., KNOXVILLE, MD:
2,752,993, CANC. INT. CL. 41.
- REINING HORSE SPORTS FOUNDATION, OKLAHOMA CITY, OK:
2,754,612, CANC. MULTIPLE CLASS, INT. CLS. 35, 41 AND 44.
- REKHA INC., SMYRNA, DE:
2,393,222, REN. 4-1-10. INT. CL. 42.
- RELIANCE STANDARD LIFE INSURANCE COMPANY, PHILADELPHIA, PA:
3,785,929, INT. CL. 36.
- REMARKABLE TECHNOLOGIES, INC., UNIONVILLE, CT:
2,754,664, CANC. INT. CL. 35.
- REMED PHARMA, UCCLLE, BELGIUM:
2,752,905, CANC. INT. CL. 10.
- REMESAS COSTAMAR, INC., ELIZABETH, NJ:
2,752,760, CANC. INT. CL. 36.
- REMODELERS GUILD CORPORATION, RICHMOND, VA:
2,752,343, CANC. INT. CL. 37.
- RENATO SALERNO, GUY CARIONE, AND SANDRO D'ALIMONTE PARTNERSHIP, THE, TORONTO ONTARIO, CANADA, DBA POWER BOXX:
2,753,858, CANC. INT. CL. 41.
- RENEWAFUEL, LLC, MINNEAPOLIS, MN:
3,786,270, INT. CL. 4.
- RENTALMAX L.L.C., WHEATON, IL:
2,320,464, REN. 3-26-10. MULTIPLE CLASS, INT. CLS. 35, 37, 39, 41 AND 42.
- RENTOKIL INITIAL 1927 PLC, LONDON, SW1W 9RF, UNITED KINGDOM:
2,753,076, CANC. INT. CL. 45.
- REO PROPERTY ADVISORS, LLC, YARMOUTH PORT, MA:
3,783,899, PUB. 2-16-2010. INT. CL. 36.
- REPAIR WIZARD, EAST STROUDSBURG, PA:
2,752,135, CANC. INT. CL. 37.
- REPOWER SYSTEMS AG, FED REP GERMANY:
3,784,914, PUB. 2-16-2010. MULTIPLE CLASS, INT. CLS. 7, 9 AND 37.
- REPUTATION NETWORKS, INC., OAKLAND, CA:
3,785,327, INT. CL. 35.
- RESCUE 3 INTERNATIONAL, INC., WILTON, CA:
3,784,558, PUB. 2-16-2010. INT. CL. 41.
- RESEARCH & EDUCATION ASSOCIATION, INC., PISCATAWAY, NJ:
1,139,222, REN. 3-31-10. INT. CL. 16.
- RESHARE COMMERCE, LLC, MINNEAPOLIS, MN:
3,784,011, PUB. 2-16-2010. INT. CL. 9.
- RESMED LIMITED, BELLA VISTA NSW, AUSTRALIA:
3,783,622, PUB. 12-8-2009. INT. CL. 10.
- RESOLUTE RACING SHELLS, LLC, BRISTOL, RI:
2,308,370, REN. 3-30-10. INT. CL. 12.
- RESOLUTION STRATEGIES LLP, PORTLAND, OR:
3,786,412, INT. CL. 45.
- RESPONDR, LLC, CHICAGO, IL:
3,784,455, PUB. 2-16-2010. INT. CL. 9.
- RETHINK LIGHTING, INC., RALEIGH, NC:
3,785,897, INT. CL. 11.
- RETSSEL CORPORATION, MCCAMMON, ID:
3,783,605, PUB. 2-16-2010. MULTIPLE CLASS, INT. CLS. 7 AND 21.
- RETURNBUY, INC., ASHBURN, VA:
2,751,727, CANC. INT. CL. 35.
- REVENUE STORM CORPORATION, VERNON HILLS, IL:
2,752,871, CANC. MULTIPLE CLASS, INT. CLS. 9, 16 AND 35.
- REVLON CONSUMER PRODUCTS CORPORATION, NEW YORK, NY:
2,752,954, CANC. INT. CL. 3.
- REXAM DELTA INC., HOT SPRINGS, AR:
2,330,988, REN. 3-26-10. INT. CL. 20.
- REYNOLDS INNOVATIONS INC., WINSTON-SALEM, NC:
3,785,828, INT. CL. 34.
- REYNOLDS, CYNTHIA, CHARLOTTESVILLE, VA, DBA SLEEPEE-TIME:
2,271,536, CANC. INT. CL. 20.
- REYNOLDS, ELIZABETH MARIA, ELMONT, NY:
2,753,873, CANC. INT. CL. 25.
- RGM PRODUCTS, INC., FRESNO, CA:
2,754,047, CANC. INT. CL. 19.
- RHODIA ACETOW GMBH, FED REP GERMANY:
3,784,997, PUB. 2-16-2010. MULTIPLE CLASS, INT. CLS. 16 AND 22.
- RIC INVESTMENTS, INC., WILMINGTON, DE:
2,752,792, CANC. INT. CL. 10.
2,752,793, CANC. INT. CL. 10.
- RICHARD BAGDASARIAN, INC., MECCA, CA:
1,628,534, REN. 3-26-10. INT. CL. 31.
- RICHARD D MORRILL, LITTLETON, CO:
3,784,660, PUB. 2-16-2010. INT. CL. 21.
- RICHARD L. AND SHAUNA CHARLES PARTNERSHIP, THE, HOUSTON, TX:
2,751,586, CANC. INT. CL. 43.
- RICHARD PICOLLI, RUTHERFORD, NJ:
3,783,381, PUB. 2-16-2010. INT. CL. 9.
- RICHARD W. BROWN LLC, MONTE SERENO, CA, DBA SILICON VALLEY GLOBAL LLC:
3,786,073, INT. CL. 9.
- RICHFIELD INVESTMENT CORPORATION, HOUSTON, TX, WOODLANDS LAND DEVELOPMENT COMPANY, L.P., THE, THE WOODLANDS, TX:
2,348,895, REN. 3-30-10. INT. CL. 37.
- RICHLIN GROUP, INC., THE, CHAPIN, SC:
2,413,212, REN. 3-29-10. INT. CL. 16.
- RICHMOND WHOLESALE MEAT CO., RICHMOND, CA:
3,785,256, INT. CL. 29.

RICOH COMPANY, LTD., TOKYO, JAPAN:
3,576,283, CANC. MULTIPLE CLASS, INT. CLS. 35 AND 42.

RICOH ELEMEX CO.,LTD., NAGOYA-SHI, AICHI, JAPAN:
2,751,757, CANC. INT. CL. 14.

RIDGID, INC. WILMINGTON, DE, EMERSON ELECTRIC CO., ST. LOUIS, MO:
1,617,312, REN. 3-26-10. INT. CL. 6.

RIEMANN TRADING APS, DENMARK:
3,784,952, PUB. 2-16-2010. MULTIPLE CLASS, INT. CLS. 3 AND 5.
3,784,953, PUB. 2-16-2010. MULTIPLE CLASS, INT. CLS. 3 AND 5.

RIEMANN TRADING APS, DK-3400 HILLERØD, DENMARK:
3,784,954, PUB. 2-16-2010. MULTIPLE CLASS, INT. CLS. 3 AND 5.

RIENZI & RIENZI COMMUNICATIONS INC., MONTVILLE, NJ:
1,608,446, REN. 3-29-10. INT. CL. 35.

RIGHT ASCENSION, INC., WARRENDALE, PA:
2,752,189, CANC. INT. CL. 35.

RIGHTEOUS KUNG FU, LLC, MATTESON, IL:
3,783,379, PUB. 2-16-2010. INT. CL. 25.

RINCONES & COMPANY DANCE THEATER, WASHINGTON, DC:
2,752,710, CANC. INT. CL. 41.

RIORDAN, BRIAN K., EUREKA, CA:
2,753,005, CANC. INT. CL. 35.

RIPPHONE, INC., PASADENA, CA:
3,784,313, PUB. 2-16-2010. INT. CL. 35.

RIPPLES LIMITED, CHRIST CHURCH, BARBADOS:
2,272,172, CANC. INT. CL. 25.

RISING STAR TELECOMMUNICATIONS, INC., ORLANDO, FL:
2,752,702, CANC. INT. CL. 41.

RISSOLO, BOB, DEL MAR, CA, DBA BOB RISSOLO SOUNDS AND BARRENA, EDWARD, PACIFIC BEACH, CA AND MURRAY, CHRISTOPHER, SAN DIEGO, CA AND FRITSCH, JUSTIN, PACIFIC BEACH, CA AND HEITERT, FOREST, SAN DIEGO, CA:
3,783,326, PUB. 2-16-2010. INT. CL. 41.

RIVER POINT RESORT, INC., ELY, MN:
2,350,004, REN. 3-31-10. MULTIPLE CLASS, INT. CLS. 39 AND 42.

RIVEREDGE, LLC, VOORHEES, NJ:
3,784,340, PUB. 2-16-2010. INT. CL. 32.

RIVERIDGE PRODUCE MARKETING, INC., SPARTA, MI:
2,754,293, CANC. INT. CL. 29.

RIVERSET CREDIT UNION, PITTSBURGH, PA:
3,785,079, MULTIPLE CLASS, INT. CLS. 35 AND 36.

RKY, INC., HOLLYWOOD, FL:
2,751,898, CANC. INT. CL. 42.

RLE MARKETING, TEMECULA, CA:
2,753,790, CANC. INT. CL. 35.

ROADWAY PROTECTION AUTO CLUB, INC., ARLINGTON HEIGHTS, IL:
2,271,405, CANC. MULTIPLE CLASS, INT. CLS. 35, 36, 37 AND 39.

ROBERT A. CLAIR COMPANY, INC., NEW YORK, NY:
1,552,970, CANC. INT. CL. 25.

ROBERT BOSCH TOOL CORPORATION, MOUNT PROSPECT, IL:
2,753,665, CANC. INT. CL. 9.

ROBERT L. O'BLOCK REVOCABLE TRUST, SPRINGFIELD, MO:
3,783,349, PUB. 2-16-2010. U.S. CL. B.

ROBERT THOMAS METALL-; UND ELEKTROWERKE GMBH & CO. KG, FED REP GERMANY:
3,784,894, PUB. 2-16-2010. MULTIPLE CLASS, INT. CLS. 3 AND 7.

ROBERT WAXMAN, INC., DENVER, CO:
1,553,253, CANC. MULTIPLE CLASS, INT. CLS. 37, 40 AND 42.

ROBERT'S SURFBOARDS, INC., VENTURA, CA:
3,784,360, PUB. 2-16-2010. INT. CL. 28.

ROBERTS, JOHN P., PLANO, TX, DBA TYKE-SPORTS:
3,784,528, PUB. 2-16-2010. INT. CL. 41.

ROBINS, MICHAEL D., RESEDA, CA AND BRANDES, DIANE M., RESEDA, CA:
3,785,553, INT. CL. 8.

ROBINSON RADIO, INC., GLEN ALLEN, VA:
3,786,418, INT. CL. 41.

ROBINSON, MARCENE D., BUFFALO, NY:
2,753,777, CANC. INT. CL. 9.

ROCA INDUSTRY AB, SWEDEN:
3,784,967, PUB. 2-16-2010. INT. CL. 12.

ROCHON, KEVIN J., NEW IBERIA, LA:
2,752,430, CANC. INT. CL. 41.

ROCK MOUNTAIN CORP. LTD., NOOSA HEADS Q1D, AUSTRALIA:
2,753,448, CANC. INT. CL. 41.

ROCK-IT CARGO USA LLC, HUNTINGDON VALLEY, PA:
3,783,351, PUB. 2-16-2010. INT. CL. 35.

ROCKALL DATA, LLC, CAMBRIDGE, MA:
3,784,441, PUB. 2-16-2010. INT. CL. 42.

ROCKETT, JOHN, CORONA, CA:
3,785,964, INT. CL. 20.

ROCKLINE INDUSTRIES, INC., SHEBOYGAN, WI:
3,785,238, INT. CL. 3.

ROCKWELL COLLINS SIMULATION AND TRAINING SOLUTIONS LLC, CEDAR RAPIDS, IA:
2,753,336, CANC. INT. CL. 9.
3,786,246, INT. CL. 9.

RODALE INC., EMMAUS, PA, RODALE INC., EMMAUS, PA:
2,344,140, REN. 3-26-10. INT. CL. 42.

RODAN & FIELDS, LLC, SAN FRANCISCO, CA:
2,754,159, CANC. MULTIPLE CLASS, INT. CLS. 3 AND 5.

RODECK, SANDRA L., WARRENVILLE, IL:
3,783,928, PUB. 2-16-2010. INT. CL. 45.

RODGVELLER, CATHI, BRIER, WA:
3,785,164, MULTIPLE CLASS, INT. CLS. 9, 16, 35, 38 AND 41.

RODRIGUEZ ENTERPRISE, INC., ESCONDIDO, CA:
3,783,604, PUB. 2-16-2010. INT. CL. 41.

RODRIGUEZ, JOSE MARTIN ENCINAS, EL MONTE, CA AND CABRERA, REGULO COTA, EL MONTE, CA:
2,752,199, CANC. INT. CL. 41.

RODRIGUEZ, PABLO HECTOR, BUENOS AIRES, ARGENTINA:
3,784,073, PUB. 2-16-2010. INT. CL. 39.

ROGERS BLUE JAYS BASEBALL PARTNERSHIP, TORONTO, ONTARIO, CANADA:
1,588,505, REN. 3-27-10. MULTIPLE CLASS, INT. CLS. 6 AND 16.
1,588,505, CANC. MULTIPLE CLASS, INT. CLS. 14 AND 24.

ROGERS SPORTS MANAGEMENT GROUP, INC., FINDLAY, OH:
3,786,154, INT. CL. 14.

ROHM AND HAAS ELECTRONIC MATERIALS LLC, MARLBOROUGH, MA:
2,822,236, CANC. INT. CL. 7.

ROHO, INC., BELLEVILLE, IL:
3,786,023, INT. CL. 10.

ROHRBACH, LAURIE MACK, PALO ALTO, CA, DBA LOBIRD:
3,783,396, PUB. 2-16-2010. INT. CL. 16.

ROKR VENTURES, INC., SCOTTSDALE, AZ:
2,753,346, CANC. INT. CL. 9.

ROLAND, CONRAD, UNITED STATES:
3,537,199, COR. MULTIPLE CLASS, INT. CLS. 3 AND 44.

ROLLOMATIC INC, MUNDELEIN, IL:
2,361,834, REN. 3-31-10. MULTIPLE CLASS, INT. CLS. 7 AND 9.

ROLLOVER SYSTEMS, INC., CHARLOTTE, NC:
3,784,500, PUB. 2-16-2010. INT. CL. 36.

ROMANCE CONVENTIONS, INC., EATON, CO:
3,784,648, PUB. 2-16-2010. INT. CL. 35.
3,784,652, PUB. 2-16-2010. INT. CL. 41.

ROMANELLI, MICHAEL, PINE BROOK, NJ:
3,786,319, INT. CL. 43.

RONALD M. SOHR, NASHVILLE, TN, DBA EDUCATION CONCEPTS INTERNATIONAL CORPORATION:
3,785,212, INT. CL. 41.

- RONALD MARK ASSOCIATES, INC., HILLSIDE, NJ:
2,409,441. REN. 3-26-10. INT. CL. 1.
- ROOT, STEVE, CANTON, GA:
2,752,697, CANC. INT. CL. 37.
- ROPESPORT LLC, BURBANK, CA:
2,752,709, CANC. INT. CL. 41.
- ROSE PLASTIC GMBH, D 88138 HERGENSWEILER/LIN-
DAU, FED REP GERMANY:
2,358,782. REN. 3-26-10. INT. CL. 20.
- ROSEN PERFECT FOODS, INC., ORLANDO, FL:
3,786,093, INT. CL. 30.
- ROSENBERG, JOAN, NEW YORK, NY:
2,753,605, CANC. INT. CL. 14.
- ROSENTHAL, HERBERT, BOCA RATON, FL:
2,335,468. REN. 3-31-10. MULTIPLE CLASS, INT. CLS. 35
AND 42.
- ROSEWOOD HOTELS AND RESORTS, LLC, DALLAS, TX:
3,785,607, INT. CL. 35.
- ROSKAM BAKING COMPANY, GRAND RAPIDS, MI:
2,753,526, CANC. INT. CL. 30.
- ROSSI VINCENZO, ITALY:
3,468,168, CANC. INT. CL. 18.
- ROTHMAN, EDWARD, HALEIWA, HI:
3,785,431, INT. CL. 25.
- ROTO ZIP TOOL CORPORATION, CROSS PLAINS, WI:
2,751,763, CANC. INT. CL. 7.
- ROTON PRODUCTS, INC., ST. LOUIS, MO:
3,783,816, PUB. 2-16-2010. INT. CL. 42.
- ROUNDSTONE PROPERTIES INC., DANVILLE, CA:
3,785,815, INT. CL. 36.
- ROXIO, INC., NOVATO, CA:
2,754,620, CANC. INT. CL. 9.
- ROY D. MCQUEEN & ASSOCIATES, LTD., STERLING, VA:
3,783,461, PUB. 2-16-2010. INT. CL. 35.
3,783,462, PUB. 2-16-2010. INT. CL. 37.
3,783,463, PUB. 2-16-2010. INT. CL. 35.
- ROYAL CARIBBEAN CRUISES LTD., MIAMI, FL:
3,784,563, PUB. 2-16-2010. INT. CL. 39.
- ROYAL GROUP, INC., WOODBRIDGE, ONTARIO, CANA-
DA:
1,621,210. REN. 3-27-10. INT. CL. 17.
3,783,499, PUB. 2-16-2010. INT. CL. 19.
- ROYAL MAX ENTERPRISES INC., BROOKLYN, NY:
3,786,156, INT. CL. 25.
- ROYAL PURPLE, INC., PORTER, TX:
2,754,275, CANC. INT. CL. 4.
- ROYAL ROBBINS, INC., MODESTO, CA:
2,350,360. REN. 4-1-10. INT. CL. 25.
- ROYAL SILK PRODUCTS, INC., WEST NEW YORK, NJ:
1,435,217, CANC. INT. CL. 3.
- ROYALE INTERNATIONAL BEVERAGE COMPANY, DA-
VENPORT, IA:
1,586,010. REN. 3-26-10. INT. CL. 32.
- RPC FINANCIAL SERVICES, INC., SAN DIEGO, CA, DBA
21ST CENTURY LEASING:
2,753,420, CANC. MULTIPLE CLASS, INT. CLS. 35 AND
42.
- RPM RACING, INC., NAPLES, FL:
3,783,517, PUB. 2-16-2010. INT. CL. 41.
- RS BERKELEY INC, SCOTCH PLAINS, NJ:
3,783,579, PUB. 1-12-2010. INT. CL. 15.
- RS PLANES, INC., RADNOR, PA:
3,784,020, PUB. 2-16-2010. INT. CL. 35.
3,784,021, PUB. 2-16-2010. INT. CL. 35.
- RSIGNIA, INC., COLUMBIA, MD:
3,784,769, PUB. 2-16-2010. INT. CL. 9.
- RT GROUP, INC., PROVIDENCE, RI:
2,752,038, CANC. MULTIPLE CLASS, INT. CLS. 37 AND
42.
- RUBBERMAID INCORPORATED, WOOSTER, OH:
1,552,993, CANC. INT. CL. 27.
- RUBIO, RON, SHOKAN, NY, DBA BODYKI:
2,752,157, CANC. INT. CL. 41.
- RUBY'S DINER, INC., IRVINE, CA:
1,591,014. REN. 3-31-10. INT. CL. 25.
- RUDE HEALTH FOODS LIMITED, LONDON, UNITED
KINGDOM:
3,783,305, PUB. 2-16-2010. MULTIPLE CLASS, INT. CLS.
29 AND 30.
- RUDIE, DAVE, SAUSALITO, CA:
2,372,833. REN. 3-29-10. MULTIPLE CLASS, INT. CLS. 28
AND 36.
- RUDNICK, ARNOLD H., SHERMAN OAKS, CA:
3,786,340, INT. CL. 16.
- RUDOLF STEINER FOUNDATION, INC., SAN FRANCIS-
CO, CA:
3,784,209, PUB. 2-16-2010. INT. CL. 41.
- RUGBY LABORATORIES, INC., ROCKVILLE CENTRE, NY:
1,552,453, CANC. INT. CL. 5.
- RULE 66, LLC, ESCONDIDO, CA:
3,783,895, PUB. 2-16-2010. MULTIPLE CLASS, INT. CLS.
18, 28 AND 35.
- RUMBLE AUTOMATION INC., MISSISSAUGA, ONTARIO,
CANADA:
2,751,720, CANC. MULTIPLE CLASS, INT. CLS. 9 AND
40.
2,751,721, CANC. MULTIPLE CLASS, INT. CLS. 9 AND
40.
2,751,722, CANC. MULTIPLE CLASS, INT. CLS. 9 AND
40.
- RUNNING CENTRAL, INC., PEORIA, IL:
3,783,595, PUB. 2-16-2010. INT. CL. 41.
3,783,596, PUB. 2-16-2010. INT. CL. 41.
- RUSH BEVERAGE COMPANY, BLUE ISLAND, IL:
3,786,261, INT. CL. 32.
- RUSSELL ARMSTRONG, EDGEWOOD, FL:
3,783,812, PUB. 2-16-2010. INT. CL. 31.
- RUSSO J. MICHAEL, RICHMOND HILL, CANADA:
3,785,444, INT. CL. 25.
- RUSSONIELLO, FABIO M., BAKERSFIELD, CA, DBA ESYS,
THE ENERGY CONTROL COMPANY:
2,339,546. REN. 3-31-10. MULTIPLE CLASS, INT. CLS. 1
AND 9.
- RUSTON ENTERPRISES, INC., CLIFTON, NJ:
1,552,786, CANC. INT. CL. 12.
- RUTTER'S HOLDINGS, INC., YORK, PA:
3,784,175, PUB. 2-16-2010. INT. CL. 35.
- RVI TECHNOLOGY CORPORATION, BRIDGEWATER, NJ:
1,132,059. REN. 3-31-10. INT. CL. 5.
- RYE PHYSICAL THERAPY & REHABILITATION, INC.,
RYE, NY:
2,753,808, CANC. INT. CL. 42.
- RYERCO, INC., PALOS HEIGHTS, IL:
2,751,752, CANC. INT. CL. 36.
- RYKOFF-SEXTON, INC., LOS ANGELES, CA:
1,553,071, CANC. MULTIPLE CLASS, INT. CLS. 29 AND
30.
- RYPHON G. GRAY, CROZET, VA:
3,783,937, PUB. 2-16-2010. INT. CL. 3.
- S. C. JOHNSON & SON, INC., RACINE, WI:
1,596,048. REN. 3-29-10. INT. CL. 5.
2,754,309, CANC. MULTIPLE CLASS, INT. CLS. 4 AND 5.
- S. FASSBIND AG, SWITZERLAND:
3,785,016, PUB. 2-16-2010. MULTIPLE CLASS, INT. CLS.
32 AND 33.
3,785,017, PUB. 2-16-2010. MULTIPLE CLASS, INT. CLS.
32 AND 33.
- S. FREEDMAN AND SONS, LANDOVER, MD, DBA THE
PAPER STORE:
1,552,863, CANC. MULTIPLE CLASS, INT. CLS. 16 AND
21.
- S. M. ARNOLD, INC., ST. LOUIS, MO:
524,085. REN. 3-31-10. U.S. CL. 29 (INT. CL. 21).
- S. W. BAKER & ASSOCIATES, WAYZATA, MN:
3,785,780, INT. CL. 42.
- S.A. MAXWELL CO., MUNDELEIN, IL:
2,752,665, CANC. INT. CL. 16.
- S.B.S. TEKSTIL SANAYI VE TICARET ANONIM SIRKETI,
ISTANBUL, TURKEY:
3,785,207, INT. CL. 25.
- S&K GARMENTS, INC., NEW YORK, NY:
3,785,535, INT. CL. 25.
- S-N MERGER CORP., RESTON, VA:
2,751,945, CANC. INT. CL. 38.
- SABLE NETWORKS, INC., SANTA CLARA, CA:
3,783,837, PUB. 2-16-2010. INT. CL. 9.

- SAE INTERNATIONAL, WARRENDALE, PA:
3,174,171, CANC. INT. CL. 35.
- SAES GETTERS S.P.A., MILANO, ITALY:
2,753,618, CANC. MULTIPLE CLASS, INT. CLS. 7 AND 9.
- SAFARILAND, LLC, JACKSONVILLE, FL:
3,783,828, PUB. 2-16-2010. INT. CL. 9.
- SAFE HOME PRODUCTS, INC., IOWA CITY, IA:
3,784,065, PUB. 2-16-2010. INT. CL. 35.
- SAFE HOMES INTERNATIONAL INC., MCLEANSVILLE, NC:
3,784,188, PUB. 2-16-2010. INT. CL. 6.
- SAFETY TECHNOLOGY INTERNATIONAL, INC., WATERFORD, MI:
1,593,639, REN. 3-31-10. INT. CL. 9.
- SAFETY-KLEEN SYSTEMS, INC., PLANO, TX:
2,282,526, REN. 3-26-10. INT. CL. 35.
- SAFEWAY INC., PLEASANTON, CA:
2,752,701, CANC. INT. CL. 29.
- SAFEWORKS, LLC, TUKWILA, WA:
2,754,432, CANC. MULTIPLE CLASS, INT. CLS. 7 AND 12.
- SAGAMY LLC, BELLEVUE, WA:
3,784,675, PUB. 2-16-2010. INT. CL. 42.
- SAGARIN, JEFFREY S., BLOOMINGTON, IN:
2,377,640, REN. 3-27-10. INT. CL. 41.
- SAGE APPAREL, INC., KEW GARDENS, NY:
2,753,610, CANC. INT. CL. 25.
- SAGE COLLEGES, THE, TROY, NY:
2,754,474, CANC. INT. CL. 41.
- SAGE INNOVATIONS GRBH, 80538 MUNCHEN, FED REP GERMANY:
2,751,705, CANC. MULTIPLE CLASS, INT. CLS. 25 AND 42.
- SAGE SOFTWARE HEALTHCARE, INC., TAMPA, FL:
1,553,196, CANC. MULTIPLE CLASS, INT. CLS. 35 AND 41.
- SAGENTIA LTD, CAMBRIDGESHIRE, UNITED KINGDOM:
3,786,328, MULTIPLE CLASS, INT. CLS. 35, 42 AND 45.
- SAIF AUTO INC., SILVERDALE, WA:
3,783,724, PUB. 2-16-2010. INT. CL. 35.
3,783,725, PUB. 2-16-2010. INT. CL. 35.
- SAILUN CO., LTD., 266500, SHANDONG, CHINA:
3,783,467, PUB. 2-16-2010. INT. CL. 12.
- SAKINA DESIGN, LLC, IRVINE, CA:
3,784,225, PUB. 2-16-2010. INT. CL. 16.
- SALADIN, TANVEER, INDIANAPOLIS, IN:
3,783,727, PUB. 2-16-2010. INT. CL. 38.
- SALES & MARKETING TECHNOLOGIES, LTD., ALTA-MONTE SPRINGS, FL:
3,786,443, INT. CL. 42.
- SALLY, MARTINA, SPRINGFIELD, MO:
3,784,664, PUB. 2-16-2010. INT. CL. 25.
- SALOMON SMITH BARNEY INC., NEW YORK, NY TO MORGAN STANLEY SMITH BARNEY HOLDINGS LLC, PURCHASE, NY:
2,272,929, CANC. INT. CL. 41.
- SALTON, INC., LAKE FOREST, IL:
2,753,413, CANC. INT. CL. 41.
2,753,414, CANC. INT. CL. 9.
2,754,634, CANC. INT. CL. 9.
- SALVO INC., SHERWOOD PARK, ALBERTA, CANADA:
3,784,836, PUB. 5-12-2009. MULTIPLE CLASS, INT. CLS. 9 AND 28.
- SALZMAN AG, ST. GALLEN, SWITZERLAND:
3,784,099, PUB. 2-16-2010. INT. CL. 36.
- SAM J. DAVIS, HOMESTEAD, FL TO KENDALL MANAGEMENT CORPORATION, GOULDS, FL:
370,288, CANC. U.S. CL. 46.
- SAM'S SEAFOOD HOLDINGS LTD., HAMILTON, QUEENSLAND, AUSTRALIA:
2,752,335, CANC. MULTIPLE CLASS, INT. CLS. 29 AND 31.
- SAMARITAN HOSPICE, INC., MARLTON, NJ:
3,783,839, PUB. 2-16-2010. MULTIPLE CLASS, INT. CLS. 44 AND 45.
- SAMBA GLOW, PALO ALTO, CA:
3,784,495, PUB. 2-16-2010. INT. CL. 44.
- SAMBA LLC, NEW YORK, NY:
2,362,541, REN. 3-26-10. INT. CL. 42.
- SAMPSON-BLADEN OIL COMPANY, INC., RALEIGH, NC:
3,784,104, PUB. 2-16-2010. INT. CL. 35.
- SAMSUNG ELECTRONICS CO., LTD., KYUNGKI-DO, REPUBLIC OF KOREA:
2,751,629, CANC. INT. CL. 9.
- SAMSUNG ELECTRONICS CO., LTD., SUWON-CITY KYUNGKI-DO, REPUBLIC OF KOREA:
2,751,708, CANC. INT. CL. 35.
- SAMSUNG ELECTRONICS CO., LTD., SUWON-SI, GYEONGGI-DO, REPUBLIC OF KOREA:
3,783,247, PUB. 2-16-2010. INT. CL. 9.
3,785,739, INT. CL. 9.
- SAMUEL HEATH & SONS PLC, BIRMINGHAM, UNITED KINGDOM:
3,785,727, INT. CL. 11.
- SAMUEL SMITH & SON PTY LTD, SOUTH AUSTRALIA, AUSTRALIA:
3,783,567, PUB. 2-16-2010. INT. CL. 33.
- SAMUEL WAGNER, MIDDLEBOURNE, WV, DBA WAGNER MEDICAL:
3,784,750, PUB. 2-16-2010. INT. CL. 10.
- SAN BARTOLO FARMS, INC., EL MIRAGE, AZ:
3,785,827, INT. CL. 33.
- SAN DIEGO ASSOCIATION OF GOVERNMENTS, SAN DIEGO, CA:
3,784,732, PUB. 2-16-2010. INT. CL. 39.
- SAN DIEGO CONVENTION & TOURIST BUREAU, SAN DIEGO, CA, DBA SAN DIEGO CONVENTION AND VISITORS BUREAU:
2,348,568, REN. 3-26-10. INT. CL. 35.
- SAN FRANCISCO REAL ESTATE BOARD, SAN FRANCISCO, CA:
3,786,267, MULTIPLE CLASS, INT. CLS. 35 AND 41.
- SANDEEP DIAMOND CORPORATION, NEW YORK, NY:
2,753,590, CANC. INT. CL. 14.
- SANDSTONE MARKETING, INC., BRAWLEY, CA:
1,553,143, CANC. INT. CL. 31.
- SANFORD J. GREENBERG, M.D., PALM DESERT, CA:
2,752,249, CANC. INT. CL. 44.
- SANITECH SYSTEMS, INC., LAKELAND, FL:
2,752,351, CANC. INT. CL. 3.
- SANJIU MEDICAL & PHARMACEUTICAL CO., LTD., SHENZHEN CITY, GUANGDONG PROVINCE, CHINA:
2,357,226, REN. 3-30-10. INT. CL. 5.
2,359,852, REN. 3-27-10. INT. CL. 5.
- SANOFI-AVENTIS, 75013 PARIS, FRANCE:
2,753,077, CANC. INT. CL. 5.
- SANOFI-SYNTHELABO, PARIS, FRANCE:
2,753,595, CANC. INT. CL. 42.
- SANOY INCORPORATED, NEW YORK, NY, DBA MADE-MOISELLE DE PARIS:
2,343,009, REN. 3-27-10. INT. CL. 14.
2,343,009, CANC. INT. CL. 26.
- SANSONE, PETER, BEAVERCREEK, OR:
3,785,313, INT. CL. 1.
- SANTA CRUZ, ARTHUR W., LANSING, MI:
3,784,315, PUB. 2-16-2010. INT. CL. 43.
- SANTA ROSA CAMPWAY, INC., SANTA ROSA, CA, DBA TRUCK TOPS USA:
2,272,346, CANC. INT. CL. 35.
- SANTA ROSA CAMPWAY, INC., SANTA ROSA, CA, DBA CAMPWAY'S TRUCK ACCESSORY WORLD:
2,272,347, CANC. INT. CL. 35.
- SANTEGRA INC., HOLMDEL, NJ:
3,785,904, INT. CL. 5.
- SANWIN INDUSTRIES LTD, HONG KONG, HONG KONG:
3,783,142, PUB. 2-16-2010. INT. CL. 14.
- SARA WEINREB, MONSEY, NY:
3,785,544, INT. CL. 29.
- SARAMAR CORPORATION, DOWNERS GROVE, IL:
1,553,155, CANC. INT. CL. 32.
- SARATI INTERNATIONAL INC., LOS FRESNOS, TX:
2,754,449, CANC. INT. CL. 5.
- SARDINIAN CHEESE, INC., SEYMOUR, CT:
2,348,099, REN. 4-1-10. INT. CL. 29.

- SARKISOV, TIGRAN, MOSCOW, RUSSIAN FED. AND LOGUINOV, YURI, MOSCOW, RUSSIAN FED.:
2,608,022, CANC. INT. CL. 9.
- SARPINO'S USA, INC., LINCOLNSHIRE, IL:
3,783,700, PUB. 2-16-2010. INT. CL. 35.
- SAS INSTITUTE INC., CARY, NC:
2,327,429. REN. 3-29-10. INT. CL. 9.
- SASSY, INC., NORTHBROOK, IL:
1,552,736, CANC. INT. CL. 10.
- SATAKE USA, INC., STAFFORD, TX:
3,784,032, PUB. 2-16-2010. INT. CL. 9.
- SATENSTEIN JOSHUA, MONTREAL, QUEBEC:
3,785,370, INT. CL. 25.
- SAUERWEIN SYSTEM-TECHNIK GMBH, HAAN, FED REP GERMANY:
1,552,642, CANC. INT. CL. 9.
- SAVE-A-LOT FOOD STORES, LTD., EARTH CITY, MO:
2,272,412, CANC. INT. CL. 29.
- SAVOGRAN COMPANY, THE, NORWOOD, MA:
695,817. REN. 3-29-10. U.S. CL. 52 (INT. CL. 3).
700,354. REN. 3-31-10. U.S. CL. 12 (INT. CL. 19).
1,600,233. REN. 3-29-10. INT. CL. 3.
- SAX ADVERTISING, INC., MIAMI, FL, DBA VAN GALZ:
3,783,926, PUB. 2-16-2010. INT. CL. 14.
- SBE ENTERTAINMENT GROUP, LOS ANGELES, CA:
3,786,396, INT. CL. 16.
- SBE ENTERTAINMENT GROUP, LLC, LOS ANGELES, CA:
3,786,395, INT. CL. 16.
- SBROCCO, LESLIE, PETALUMA, CA, DBA THIRSTY GIRL:
3,783,799, PUB. 2-16-2010. MULTIPLE CLASS, INT. CLS. 39, 41 AND 43.
- SCALABLE NETWORK TECHNOLOGIES, INC., LOS ANGELES, CA:
2,754,026, CANC. INT. CL. 9.
- SCALE COMPUTING, INC., GREENWOOD, IN:
3,786,454, INT. CL. 42.
- SCARBOROUGH, DANE, MALIBU, CA:
3,786,217, INT. CL. 28.
- SCARPE & SCARPE S.P.A., ITALY:
3,784,983, PUB. 2-16-2010. MULTIPLE CLASS, INT. CLS. 14, 18 AND 25.
- SCBT, N.A., USING THE MARK IN COMMERCE THROUGH ITS OPERATING DIVISION, NCBT, COLUMBIA, SC:
3,785,680, INT. CL. 36.
- SCHAEFER WERKE GMBH, D-57290 NEUNKIRCHEN, FED REP GERMANY:
2,751,656, CANC. MULTIPLE CLASS, INT. CLS. 6, 9, 11 AND 20.
- SCHAEFFER INDUSTRIES, MIRA LOMA, CA:
3,785,073, INT. CL. 6.
- SCHAEFFER'S INVESTMENT RESEARCH, INC., CINCINNATI, OH:
3,785,866, MULTIPLE CLASS, INT. CLS. 16 AND 41.
- SCHARING, MARTIN A., SAN DIEGO, CA, DBA MAS CO.:
2,272,850, CANC. INT. CL. 20.
- SCHECHTL MASCHINENBAU GMBH, FED REP GERMANY:
3,757,786, COR. MULTIPLE CLASS, INT. CLS. 7, 9 AND 42.
- SCHELCHEN GMBH, FED REP GERMANY:
3,784,856, PUB. 8-22-2006. MULTIPLE CLASS, INT. CLS. 3 AND 25.
- SCHICK, SASA, SANTA MONICA, CA:
1,552,804, CANC. INT. CL. 14.
- SCHLOTTERBECK & FOSS COMPANY, PORTLAND, ME:
3,785,755, INT. CL. 5.
- SCHMID, RALF, FED REP GERMANY:
3,335,373, COR. MULTIPLE CLASS, INT. CLS. 3, 7, 12, 35, 36, 39, 40 AND 42.
- SCHMITT MEASUREMENT SYSTEMS, INC., PORTLAND, OR:
3,647,409, COR. INT. CL. 9.
- SCHNUCK MARKETS, INC., ST. LOUIS, MO:
3,783,328, PUB. 2-16-2010. INT. CL. 16.
- SCHOELLER TEXTIL AG, SWITZERLAND:
3,112,173, AM. MULTIPLE CLASS, INT. CLS. 17, 24 AND 25.
- SCHOLASTIC INC., NEW YORK, NY:
2,433,658, REN. 3-31-10. INT. CL. 16.
2,751,597, CANC. MULTIPLE CLASS, INT. CLS. 12 AND 28.
3,784,799, PUB. 2-16-2010. INT. CL. 38.
3,786,131, INT. CL. 16.
- SCHOOLDUDE.COM, INC., CARY, NC:
3,784,280, PUB. 2-16-2010. INT. CL. 42.
- SCHOOLHOUSE LEARNING COMMUNITIES, INC., FRANKLIN, MI:
3,784,308, PUB. 2-16-2010. INT. CL. 35.
3,784,338, PUB. 2-16-2010. MULTIPLE CLASS, INT. CLS. 35, 38 AND 41.
- SCHOOLGY LLC, NEW YORK, NY:
3,752,806, COR. INT. CL. 41.
- SCHOPPMAN INNOVATIONS, INC., VALRICO, FL:
2,753,374, CANC. INT. CL. 9.
- SCHOTT GLAS, D-55122 MAINZ, FED REP GERMANY:
2,751,868, CANC. MULTIPLE CLASS, INT. CLS. 9 AND 21.
- SCHOTT, RICHARD N., MURFREESBORO, TN:
3,785,087, INT. CL. 3.
- SCHULZE & BURCH BISCUIT COMPANY, CHICAGO, IL:
1,627,804, REN. 3-31-10. INT. CL. 42.
- SCHULZE AND BURCH BISCUIT CO., CHICAGO, IL:
880,111, REN. 3-31-10. U.S. CL. 46 (INT. CL. 30).
- SCHULZE AND BURCH BISCUIT COMPANY, CHICAGO, IL, GENERAL FOODS CORPORATION, WHITE PLAINS, NY:
901,872, REN. 3-31-10. U.S. CL. 46 (INT. CL. 30).
902,296, REN. 3-31-10. U.S. CL. 46 (INT. CL. 30).
- SCHWAN'S IP, LLC, MARSHALL, MN, SCHWAN'S IP, LLC, MARSHALL, MN:
2,330,208, REN. 3-29-10. INT. CL. 30.
- SCHWEID, JONATHAN EDWARD, PEPPER PIKE, OH:
2,754,419, CANC. INT. CL. 28.
- SCHWEIZERISCHE BUNDESBAHNEN SBB, BERN 65, SWITZERLAND:
2,406,036, REN. 3-31-10. INT. CL. 14.
- SCI INTERNATIONAL INC., FREDERICK, MD:
3,786,220, INT. CL. 5.
- SCIENTIFIC GAMES INTERNATIONAL, INC., ALPHARETTA, GA:
3,784,755, PUB. 2-16-2010. MULTIPLE CLASS, INT. CLS. 35, 41 AND 45.
- SCIOLOG, INC., MIDDLETON, WI:
3,784,616, PUB. 2-16-2010. INT. CL. 7.
- SCOTT'S PRESERVES LIMITED, KINGSTON 11, JAMAICA:
2,271,790, CANC. MULTIPLE CLASS, INT. CLS. 29 AND 30.
- SCP ENTERPRISES, INC., WEST VALLEY CITY, UT:
1,592,107, REN. 3-27-10. INT. CL. 25.
- SCRIP, INC., BOLINGBROOK, IL:
3,783,451, PUB. 2-16-2010. MULTIPLE CLASS, INT. CLS. 10, 12, 20 AND 24.
- SDI, INC., BRISTOL, PA:
2,427,906, REN. 3-27-10. INT. CL. 9.
- SEAGATE TECHNOLOGY LLC, SCOTTS VALLEY, CA:
2,824,540, CANC. MULTIPLE CLASS, INT. CLS. 35 AND 42.
3,785,312, MULTIPLE CLASS, INT. CLS. 35, 36 AND 42.
- SEASE, R. GREGG, AURORA, CO:
3,784,171, PUB. 2-16-2010. INT. CL. 17.
- SEATRIDE INTERNATIONAL CO., INC., PORTSMOUTH, NH:
2,398,052, REN. 3-30-10. INT. CL. 29.
- SEATTLE HOME CAKES, LLC., MILL CREEK, WA:
2,751,897, CANC. INT. CL. 30.
- SEC ASSOCIATES, INC., RALEIGH, NC:
2,752,469, CANC. INT. CL. 42.
- SECO/WARWICK OF DELAWARE, INC., MEADVILLE, PA:
2,414,627, REN. 3-26-10. INT. CL. 11.
- SECOND LICENSE APPLICATION CORPORATION, D/FW AIRPORT, TX:
3,785,165, MULTIPLE CLASS, INT. CLS. 9, 16, 35 AND 41.
- SECURE CONNECTIONS, LLC, MCLEAN, VA:
2,752,104, CANC. INT. CL. 16.

- SECURITIES AMERICA, INC., LA VISTA, NE:
1,553,202, CANC. INT. CL. 35.
- SECURITIES AMERICA, INC., LAVISTA, NE:
1,553,203, CANC. INT. CL. 35.
- SECURITY ATLANTIC LEASING, LLC, PHILADELPHIA, PA:
3,786,052, INT. CL. 43.
- SECURITY CONTRACTOR SERVICES, INC., NORTH HIGHLANDS, CA:
2,431,397. REN. 3-31-10. INT. CL. 6.
- SECURITY EQUIPMENT CORPORATION, FENTON, MO:
3,785,966, INT. CL. 13.
- SEIDEL, JAMES D., BOULDER, CO:
2,343,442. REN. 4-1-10. INT. CL. 42.
- SEIPLER, SHAWN, ORLANDO, FL:
3,784,610, PUB. 2-16-2010. INT. CL. 37.
- SEITZ, PETER, MÜNCHEN, FED REP GERMANY:
3,786,260, MULTIPLE CLASS, INT. CLS. 9, 10, 16, 35 AND 42.
- SEJUS CORPORATION, LAKE OSWEGO, OR:
1,553,259, CANC. INT. CL. 37.
- SELA PRODUCTS, LLC, EDMOND, OK:
3,785,666, INT. CL. 9.
- SELCO S.R.L., TOMBOLO FRAZIONE ONARA (PADOVA), ITALY:
2,282,787. REN. 3-26-10. MULTIPLE CLASS, INT. CLS. 7 AND 9.
- SELECT JEWELRY INC., LONG ISLAND CITY, NY:
3,785,276, INT. CL. 14.
- SELECTA PRODUCTS, INC., TEHACHAPI, CA:
2,752,327, CANC. INT. CL. 35.
- SELKIRK L.L.C., DALLAS, TX:
2,754,172, CANC. INT. CL. 11.
- SELLERS MFG., INC., MILFORD, IN:
2,970,285, COR. INT. CL. 12.
- SEMCO ENERGY, INC., PORT HURON, MI:
2,753,469, CANC. INT. CL. 37.
- SEMCO INCORPORATED, COLUMBIA, MO:
3,785,704, INT. CL. 6.
- SEMINOLE TRIBE OF FLORIDA, HOLLYWOOD, FL:
3,785,389, INT. CL. 35.
- SEMMEL, NEIL S., BEAR, DE:
3,785,361, INT. CL. 41.
- SEMPIO FOODS COMPANY, SEOUL, REPUBLIC OF KOREA:
2,337,685. REN. 3-27-10. INT. CL. 30.
- SEMTECH CORPORATION, CAMARILLO, CA:
3,785,791, INT. CL. 9.
- SENARIO LLC, WOODSTOCK, IL:
3,786,134, INT. CL. 28.
- SENORET CHEMICAL COMPANY, ST. LOUIS, MO:
2,753,432, CANC. INT. CL. 5.
- SENSORY ARTS & SCIENCE, LLC, KING OF PRUSSIA, PA:
2,754,185, CANC. INT. CL. 9.
- SENTINEL BENEFITS GROUP, INC., WAKEFIELD, MA:
2,752,910, CANC. INT. CL. 36.
- SENTRANA, INC., BETHESDA, MD:
3,784,174, PUB. 2-16-2010. MULTIPLE CLASS, INT. CLS. 35 AND 42.
- SENZEYE INDUSTRIES, LLC, EAST GREENWICH, RI:
3,785,534, INT. CL. 12.
- SEQUOIA CAPITAL OPERATIONS, LLC, MENLO PARK, CA:
3,784,007, PUB. 2-16-2010. INT. CL. 41.
3,784,009, PUB. 2-16-2010. INT. CL. 41.
- SEQUOYAH INFORMATION SYSTEMS, LTD., EDMOND, OK:
3,783,748, PUB. 2-16-2010. INT. CL. 45.
- SERANOA NETWORKS, INC., SOUTHBOROUGH, MA:
2,753,671, CANC. INT. CL. 9.
- SERICOL LIMITED, BROADSTAIRS, KENT CTIO 2LE, ENGLAND:
2,349,560. REN. 3-26-10. INT. CL. 2.
- SERRES, JOHN P., SONOMA, CA, DBA SERRES RANCH:
3,785,576, MULTIPLE CLASS, INT. CLS. 31 AND 33.
- SERVICE ALL, INC., OMAHA, NE:
3,783,317, PUB. 2-16-2010. INT. CL. 37.
- SERVICE EMPLOYEES INTERNATIONAL UNION, WASHINGTON, DC:
2,753,173, CANC. INT. CL. 35.
- SERVICE GUARD INSURANCE AGENCY, AUSTIN, TX:
2,754,556, CANC. INT. CL. 36.
- SERVICE PAINT & COATINGS, INC., FAYETTEVILLE, TN:
2,272,077, CANC. INT. CL. 2.
- SERVICE WEST, INC., OAKLAND, CA:
3,784,264, PUB. 2-16-2010. INT. CL. 42.
- SET EDITIONS, HUDSON, NY:
3,784,134, PUB. 2-16-2010. INT. CL. 16.
- SETAC CORPORATION, LAFAYETTE, LA:
3,784,685, PUB. 2-16-2010. INT. CL. 1.
- SEVILLANA IMPORTS, INC., MIAMI, FL:
2,754,660, CANC. INT. CL. 33.
- SF INVESTMENTS, INC., WILMINGTON, DE:
1,553,072, CANC. INT. CL. 29.
- SG STRUCTURED PRODUCTS, INC., NEW YORK, NY:
2,752,625, CANC. INT. CL. 36.
- SGD S.A., FRANCE:
3,784,947, PUB. 2-16-2010. INT. CL. 21.
3,784,948, PUB. 2-16-2010. INT. CL. 21.
3,784,949, PUB. 2-16-2010. INT. CL. 21.
- SGF SÜDDEUTSCHE GELENKSCHWEIBENFABRIK; GMBH & CO. KG, FED REP GERMANY:
3,784,876, PUB. 2-16-2010. MULTIPLE CLASS, INT. CLS. 7 AND 12.
- SHAMIM FOODS, INC., LOS ANGELES, CA:
2,752,690, CANC. INT. CL. 29.
- SHANDONG HENGYU RUBBER CO.,LTD., DONGYING, SHANDONG, CHINA:
3,784,168, PUB. 2-16-2010. INT. CL. 12.
- SHANDONG SEARSPORT FOODS CO., LTD., CHINA:
3,784,996, PUB. 2-16-2010. MULTIPLE CLASS, INT. CLS. 29 AND 31.
- SHANE ENTERPRISES, LLC, VAN NUYS, CA:
2,330,911. REN. 3-26-10. MULTIPLE CLASS, INT. CLS. 9, 16 AND 25.
- SHANE HUNTER, INC., ANDERSON, SC:
3,783,179, PUB. 2-16-2010. INT. CL. 25.
- SHANGHAI GIANT NETWORK TECHNOLOGY CO., LTD., SHANGHAI CITY, CHINA:
3,783,211, PUB. 1-13-2009. INT. CL. 41.
- SHANKMAN, JAY, FARMINGVILLE, NY:
2,754,116, CANC. INT. CL. 11.
- SHANNON GREENFIELD, LAS VEGAS, NV:
3,785,696, INT. CL. 18.
- SHAO YANPING, CHINA:
3,784,870, PUB. 2-16-2010. INT. CL. 6.
- SHAPIRO, DAVID FRANKLIN, DENVER, CO:
2,753,021, CANC. INT. CL. 41.
- SHAPIRO, MEIRA, M., NEW YORK, NY, AKA MOET:
2,753,123, CANC. INT. CL. 41.
- SHARI'S MANAGEMENT CORPORATION, BEAVERTON, OR, SHARI'S MANAGEMENT CORPORATION, PORTLAND, OR:
1,591,479. REN. 3-31-10. INT. CL. 42.
- SHARP KABUSHIKI KAISHA, OSAKA 545-8522, JAPAN, TA SHARP CORPORATION:
2,752,356, CANC. INT. CL. 7.
- SHEAD, ALEX, LAWRENCEVILLE, GA:
2,754,400, CANC. INT. CL. 41.
- SHENANDOAH PUBLISHING HOUSE, INC., STRASBURG, VA:
2,752,537, CANC. INT. CL. 16.
2,752,538, CANC. INT. CL. 16.
- SHENZHEN EVERSUN GROUP CO., LTD, CHINA:
3,785,032, PUB. 2-16-2010. INT. CL. 10.
- SHENZHEN SHENCHUANG ELECTRICAL APPLIANCE CO. LTD, SHENZHEN, CHINA:
3,785,438, MULTIPLE CLASS, INT. CLS. 8, 9 AND 11.
- SHEPLERS, INC., WICHITA, KS:
2,342,054. REN. 3-26-10. INT. CL. 42.
- SHERMAN, CLAY & CO., SAN BRUNO, CA:
2,754,085, CANC. INT. CL. 15.
- SHERPA PET GROUP, LLC, ROCKAWAY, NJ:
3,783,695, PUB. 2-16-2010. INT. CL. 39.

- SHIMANO INC. JAPAN:
3,785,004, PUB. 2-16-2010. INT. CL. 28.
- SHIMANO, INC., SAKAI CITY, OSAKA, JAPAN, SHIMANO INDUSTRIAL COMPANY LIMITED, OSAKA, JAPAN:
1,591,099. REN. 3-29-10. INT. CL. 28.
- SHINE CORPORATION, OCEANSIDE, NY:
2,280,031. REN. 3-29-10. INT. CL. 3.
- SHINE WITH HIM, WETUMPKA, AL:
3,784,187, PUB. 2-16-2010. INT. CL. 25.
- SHINPO CO., LTD., NAGOYA, JAPAN:
2,361,767. REN. 4-1-10. INT. CL. 11.
- SHIRAZI, LOREE D., SAN DIEGO, CA:
2,271,618, CANC. MULTIPLE CLASS, INT. CLS. 35 AND 42.
- SHISEIDO COMPANY LTD., TOKYO, JAPAN:
3,785,606, INT. CL. 3.
- SHOE ETI-KIT, INC, TINLEY PARK, IL:
3,783,221, PUB. 2-16-2010. INT. CL. 25.
- SHOEMAKER'S CANDIES, INC., SANTA FE SPRINGS, CA:
2,754,127, CANC. INT. CL. 30.
- SHONEY'S NORTH AMERICA CORPORATION, NASHVILLE, TN:
3,783,613, PUB. 2-16-2010. INT. CL. 43.
- SHOOK, WILLIAM B., TAMPA, FL AND KAST, ELLEN, TAMPA, FL:
3,785,686, INT. CL. 25.
- SHOP-VAC CORPORATION, WILLIAMSPORT, PA:
2,752,522, CANC. INT. CL. 7.
- SHOPKO STORES OPERATING CO., LLC, GREEN BAY, WI:
3,784,156, PUB. 2-16-2010. INT. CL. 25.
- SHOPLOCAL, LLC, CHICAGO, IL:
2,753,664, CANC. INT. CL. 35.
- SHOP2EARN NET, LAS VEGAS, NV, DBA SHOPTO EARN:
3,784,080, PUB. 2-16-2010. INT. CL. 38.
3,784,335, PUB. 2-16-2010. INT. CL. 38.
3,784,758, PUB. 2-16-2010. INT. CL. 41.
- SHORTY SMALL'S DESIGNS L.C., OKLAHOMA CITY, OK, RESTAURANT CONCEPTS AND DESIGNS, INC., LITTLE ROCK, AR:
1,590,276. REN. 3-29-10. INT. CL. 42.
- SHOWTIME NETWORKS INC., NEW YORK, NY:
2,754,522, CANC. INT. CL. 41.
2,754,523, CANC. INT. CL. 38.
- SHRT/CTS, INC., SANDS POINT, NY:
2,752,077, CANC. INT. CL. 25.
- SHUKOOR, SHABINA, JERSEY CITY, NJ, DBA THE JAZZ MANAGEMENT COMPANY:
2,752,170, CANC. INT. CL. 35.
- SHURTAPE TECHNOLOGIES, LLC, HICKORY, NC:
3,786,255, INT. CL. 17.
- SIBLING THRIVALRY, LLC, HOMEWOOD, IL:
3,785,649, INT. CL. 28.
- SICHUAN CEREALS, OILS AND FOODSTUFFS IMPORT & EXPORT CORPORATION, CHENGDU, CHINA:
1,553,050, CANC. INT. CL. 29.
- SIEMENS AKTIENGESELLSCHAFT, MUNICH, FED REP GERMANY:
2,348,160. REN. 3-31-10. INT. CL. 9.
2,359,300. REN. 3-26-10. INT. CL. 9.
2,359,301. REN. 3-27-10. INT. CL. 9.
2,361,359. REN. 3-26-10. INT. CL. 9.
2,369,965. REN. 3-27-10. INT. CL. 9.
2,382,225. REN. 3-31-10. MULTIPLE CLASS, INT. CLS. 7 AND 9.
2,382,225, CANC. INT. CL. 42.
2,401,284. REN. 3-27-10. INT. CL. 9.
- SIEMENS AKTIENGESELLSCHAFT, MUNCHEN, FED REP GERMANY:
2,751,880, CANC. MULTIPLE CLASS, INT. CLS. 35 AND 41.
- SIEMENS AKTIENGESELLSCHAFT, FED REP GERMANY:
3,785,039, PUB. 2-16-2010. INT. CL. 9.
3,785,042, PUB. 2-16-2010. MULTIPLE CLASS, INT. CLS. 9, 37 AND 42.
- SIEMENS AUDIOLOGISCHE TECHNIK GMBH, ERLANGEN, FED REP GERMANY:
2,752,288, CANC. INT. CL. 10.
- SIEMENS INDUSTRY, INC., ALPHARETTA, GA, I-T-E CIRCUIT BREAKER COMPANY, PHILADELPHIA, PA:
685,808. REN. 3-30-10. U.S. CL. 21 (INT. CL. 9).
- SIEMENS MILLTRONICS PROCESS INSTRUMENTS, PETERBOROUGH, ONTARIO, CANADA:
2,349,656. REN. 4-1-10. INT. CL. 9.
- SIEMON COMPANY, THE, WATERTON, CT:
1,552,713, CANC. INT. CL. 9.
- SIENHUA GROUP (NORTH AMERICA) INC., MARIETTA, GA, DBA DI ARMERIA EQUIPMENT:
3,786,043, INT. CL. 20.
- SIERRA LODGINGS, INC., GLENDALE, CA:
3,785,554, INT. CL. 43.
- SIEWICK, EDWARD, ARLINGTON, VA:
2,272,480, CANC. INT. CL. 38.
- SIGMA-TAU INDUSTRIE FARMACEUTICHE RIUNITE S.P.A, I 00144 ROME, ITALY:
2,751,941, CANC. MULTIPLE CLASS, INT. CLS. 1, 5 AND 42.
- SIGNAL INVESTMENT & MANAGEMENT CO., WILMINGTON, DE:
3,785,916, INT. CL. 5.
- SIGNATURE BRANDS LLC, OCALA, FL:
2,754,178, CANC. INT. CL. 28.
- SIGNATURE INFORMATION SOLUTIONS LLC, EWING, NJ:
2,413,673. REN. 3-26-10. INT. CL. 42.
- SIGNATURE STYLES, LLC, NEW YORK, NY:
2,753,634, CANC. INT. CL. 21.
- SIGNET ARMORLITE EUROPE LIMITED, GLOUCESTER, UNITED KINGDOM:
3,783,200, PUB. 2-16-2010. INT. CL. 5.
3,783,201, PUB. 2-16-2010. INT. CL. 9.
3,783,202, PUB. 2-16-2010. INT. CL. 35.
3,783,203, PUB. 2-16-2010. INT. CL. 40.
- SIKA AG, 6341 BAAR, SWITZERLAND:
2,753,482, CANC. MULTIPLE CLASS, INT. CLS. 1, 16, 17, 19, 20 AND 37.
- SILBERSTEIN, ALAIN, CHATILLON LE DUC, FRANCE:
2,334,479. REN. 3-30-10. INT. CL. 14.
- SILERGY CORP., GEORGE TOWN, G.C., CAYMAN ISLANDS:
3,786,053, INT. CL. 9.
- SILESIA GERHARD HANKE GMBH & CO KG, D-41469 NEUSS, FED REP GERMANY:
2,752,393, CANC. MULTIPLE CLASS, INT. CLS. 3, 29, 30, 32 AND 33.
2,752,394, CANC. MULTIPLE CLASS, INT. CLS. 3, 29, 30, 32 AND 33.
- SILICON SENSING SYSTEMS LIMITED, DEVON PL6 6DE, UNITED KINGDOM:
2,751,774, CANC. MULTIPLE CLASS, INT. CLS. 9 AND 16.
- SILICON VALLEY BUSINESS INK, SAN JOSE, CA:
2,753,236, CANC. INT. CL. 16.
2,753,238, CANC. INT. CL. 16.
- SILICYCLE INC., QUEBEC (QUEBEC), CANADA:
2,377,310. REN. 4-1-10. INT. CL. 1.
- SILKIENCE HOLDINGS INC., BRAMPTON, ONTARIO, CANADA:
3,784,820, PUB. 7-21-2009. INT. CL. 3.
- SILTECH LLC, DACULA, GA:
3,783,917, PUB. 2-16-2010. INT. CL. 1.
- SILVER CLOUD ESTATES, LLC, HALETHORPE, MD:
3,784,815, PUB. 6-10-2008. INT. CL. 30.
- SILVER, CHARLES, OVIEDO, FL:
3,784,362, PUB. 2-16-2010. MULTIPLE CLASS, INT. CLS. 9 AND 41.
- SILVERSON MACHINES LIMITED, BUCKS HP5 IPQ, ENGLAND:
2,384,814. REN. 3-30-10. INT. CL. 7.
- SILVERTON CASINO, LLC, LAS VEGAS, NV, SILVERTON CASINO, LLC, LAS VEGAS, NV:
2,427,218. REN. 4-1-10. INT. CL. 41.
- SILVON SOFTWARE, INC., WESTMONT, IL:
1,588,665. REN. 3-31-10. INT. CL. 9.

SIMEX INTERNATIONAL, INC., GURNEE, IL, DBA COM-FORTAGE INDUSTRIES:
2,752,637, CANC. INT. CL. 20.
2,752,638, CANC. INT. CL. 20.

SIMMONS CORPORATION, RICHARDSON, TX:
1,552,586, CANC. INT. CL. 9.

SIMMONS, DAVID, HALF MOON BAY, CA:
2,751,812, CANC. INT. CL. 9.

SIMON & SCHUSTER, INC., NEW YORK, NY:
3,784,617, PUB. 2-16-2010. INT. CL. 16.
3,784,618, PUB. 2-16-2010. INT. CL. 16.
3,784,619, PUB. 2-16-2010. INT. CL. 16.

SIMPATA GROUP, THE, SAN FRANCISCO, CA:
2,753,443, CANC. MULTIPLE CLASS, INT. CLS. 36 AND 42.
2,753,456, CANC. MULTIPLE CLASS, INT. CLS. 36 AND 42.

SIMPLE GROUP, LLC, SANTA MONICA, CA:
3,783,245, PUB. 2-16-2010. INT. CL. 35.

SIMPLE SERENITY SPA & WELLNESS, LLC, EL DORADO HILLS, CA:
3,786,089, INT. CL. 3.

SIMPLICITY PRODUCTS INTERNATIONAL, INC., LOS ANGELES, CA:
3,786,285, INT. CL. 3.

SIMPLY INTERNET LIMITED, LONDON, UNITED KINGDOM:
2,752,860, CANC. INT. CL. 42.

SIMPLYH, LLC, ORANJESTAD, ARUBA:
2,752,440, CANC. INT. CL. 5.

SIMPSON DOOR COMPANY, SEATTLE, WA:
2,754,540, CANC. INT. CL. 35.

SINCLAIR CATTLE COMPANY, INC., COCKEYSVILLE, MD:
2,418,712, REN. 3-26-10. INT. CL. 31.

SINCLAIR PHARMACEUTICALS LIMITED, GODALMING, SURREY, UNITED KINGDOM:
3,783,260, PUB. 8-18-2009. MULTIPLE CLASS, INT. CLS. 3 AND 5.

SINCLAIR TECHNOLOGIES INC., AURORA, ONTARIO, CANADA:
3,785,874, MULTIPLE CLASS, INT. CLS. 9 AND 19.

SINCLAIR TELEVISION GROUP, INC., COCKEYSVILLE, MD:
3,784,050, PUB. 2-16-2010. INT. CL. 41.

SINCLAIRE, STEFONAY B., BELLEVUE, WA:
2,752,992, CANC. INT. CL. 3.

SINDOH CO., LTD., SEOUL, REPUBLIC OF KOREA:
3,785,452, MULTIPLE CLASS, INT. CLS. 2 AND 9.

SINGER, JONATHAN I., CINCINNATI, OH:
3,786,240, INT. CL. 28.

SINISTER DESIGN, CHICAGO, IL:
3,783,520, PUB. 2-16-2010. INT. CL. 9.

SINO-ASIA PHARMACEUTICAL SUPPLIES LTD., CHAI WAN, HONG KONG:
3,783,465, PUB. 2-16-2010. INT. CL. 5.

SINTEK INTERNATIONAL AB, STOCKHOLM, SWEDEN:
2,752,984, CANC. INT. CL. 20.

SINY CORP., MILWAUKEE, WI:
2,272,293, CANC. INT. CL. 21.

SIRION THERAPEUTICS, INC., TAMPA, FL:
3,784,208, PUB. 2-16-2010. INT. CL. 5.

SIRIUS XM RADIO INC., NEW YORK, NY:
3,785,884, INT. CL. 41.

SIX CONTINENTS HOTELS, INC., ATLANTA, GA:
2,329,074, REN. 3-26-10. INT. CL. 42.

SIX STAR, INC., WINTER PARK, FL:
3,786,152, MULTIPLE CLASS, INT. CLS. 12, 35 AND 39.

SIX50, INC., CORDOVA, TN:
2,753,105, CANC. INT. CL. 41.

SJI, INC., ST. LOUIS, MO:
2,891,491, AM. INT. CL. 35.

SKADDEN, ARPS, SLATE, MEAGHER & FLOM LLP, NEW YORK, NY:
2,403,683, REN. 4-1-10. INT. CL. 42.

SKAGFIELD CORPORATION, TALLAHASSEE, FL, DBA SKANDIA INDUSTRIES:
2,331,970, REN. 3-31-10. INT. CL. 19.

SKILLSOFT CORPORATION, NASHUA, NH:
2,752,554, CANC. INT. CL. 42.

SKINDINAVIA, INC., CANTON, MA, DBA SKINDINAVIA:
3,783,965, PUB. 2-16-2010. INT. CL. 3.

SKLOFF, MICHAEL, WEST HOLLYWOOD, CA:
2,751,873, CANC. MULTIPLE CLASS, INT. CLS. 9 AND 25.

SKY BLUE TECHNOLOGIES, INC., LAFAYETTE, IN:
3,786,382, MULTIPLE CLASS, INT. CLS. 9, 41 AND 42.

SKYDIVE ALABAMA, INC., HARTSELLE, AL:
3,783,360, PUB. 6-30-2009. INT. CL. 41.

SKYHAWKS SPORTS ACADEMY, INC., MEAD, WA:
2,341,270, REN. 3-29-10. MULTIPLE CLASS, INT. CLS. 25, 28 AND 41.

SKYHAWKS SPORTS ACADEMY, INC., MEAD, WA, SKY-HAWKS SPORTS ACADEMY, INC., MEAD, WA:
2,356,512, REN. 3-31-10. INT. CL. 41.

SKYLINE CHILI, INC., FAIRFIELD, OH:
2,365,353, REN. 3-29-10. INT. CL. 29.

SKYLINE CORPORATION, ELKHART, IN:
1,552,898, CANC. INT. CL. 19.
1,552,899, CANC. INT. CL. 19.

SKYPORT DEVELOPMENT COMPANY LLC, DENVER, CO:
2,272,334, CANC. INT. CL. 35.

SLANGUAGE GAMEZ, MARKHAM, IL:
3,783,957, PUB. 2-16-2010. INT. CL. 28.

SLAP N TICKLE PTY LTD, GOLD COAST MC QLD 9726, AUSTRALIA:
3,784,884, PUB. 5-12-2009. MULTIPLE CLASS, INT. CLS. 5, 9, 10, 16, 25, 28, 35, 38, 41 AND 45.

SLATERPAULL ARCHITECTS, DENVER, CO:
3,783,814, PUB. 2-16-2010. INT. CL. 42.

SLAVO ENTERPRISES, L.L.C., LITCHFIELD PARK, AZ:
3,784,559, PUB. 2-16-2010. INT. CL. 30.

SLEEP MULTIMEDIA INC., SCARSDALE, NY:
2,346,934, REN. 3-26-10. INT. CL. 9.

SLG PRODUCTIONS, INC., NEW YORK, NY:
3,785,210, INT. CL. 33.

SLIMBOLICS, LLC, NEW HOPE, PA:
3,784,382, PUB. 2-16-2010. INT. CL. 5.

SLIMGENICS, LLC, CENTENNIAL, CO:
3,786,120, MULTIPLE CLASS, INT. CLS. 5, 16, 35 AND 44.

SLIP PARTNERSHIP, THE, PROVIDENCE, RI:
2,272,338, CANC. INT. CL. 41.

SLIZ, KEN, SAN ANTONIO, TX:
3,785,493, INT. CL. 29.

SMALL ACT NETWORK, LLC, MCLEAN, VA:
3,785,540, MULTIPLE CLASS, INT. CLS. 36 AND 42.

SMALL TOUCHES, INC., ATLANTA, GA:
2,753,035, CANC. INT. CL. 35.

SMART ERP SOLUTIONS, INC., PLEASANTON, CA, DBA SMART ERP SOLUTIONS:
3,785,413, INT. CL. 42.

SMARTERVILLE PRODUCTIONS LLC, BALTIMORE, MD:
2,348,348, REN. 3-27-10. INT. CL. 16.
2,355,758, REN. 3-27-10. INT. CL. 16.
2,419,481, REN. 3-27-10. INT. CL. 16.

SMARTHEALTH, INC., PHOENIX, AZ, DBA SMARTPRAC-TICE, INC.:
2,382,499, REN. 4-1-10. INT. CL. 35.

SMARTRAC IP B.V., NL-1077 DE AMSTERDAM, NETHERLANDS:
3,302,678, COR. MULTIPLE CLASS, INT. CLS. 7, 9 AND 17.

SMARTX, INC., ORCHARD PARK, NY:
2,332,317, REN. 3-31-10. INT. CL. 9.

SMC CORPORATION, TOKYO, JAPAN:
1,591,693, REN. 3-31-10. MULTIPLE CLASS, INT. CLS. 7 AND 9.

SMITH & NEPHEW, INC., MEMPHIS, TN:
2,352,537, REN. 3-26-10. INT. CL. 5.

SMITH, ALAN W, DALLAS, TX AND HERNANDEZ, JORGE, MESQUITE, TX AND MORRIS, JERRED, PLANO, TX AND KALICH, ALLAN, DALLAS, TX:
2,753,067, CANC. INT. CL. 41.

SMITH, JOHN ALFRED, ESSEX SS16 6RB, UNITED KINGDOM:
3,783,085, PUB. 12-20-2005. INT. CL. 9.

- SMITH, JULIE, AVONDALE ESTATES, GA AND SAXON, JUAN, BIRMINGHAM, AL:
3,786,179, INT. CL. 28.
- SMITH, KEVIN J., YORK, PA AND MAYER, HOLLY A., YORK, PA AND LIDDLE, JAMES C., YORK, PA:
3,784,477, PUB. 2-16-2010. INT. CL. 36.
- SMITH, ROBERT DUNLOP, MR. DARTMOUTH, CANADA:
2,753,118, CANC. INT. CL. 14.
- SMITH'S NUTRITION PRODUCTS INC., LAS VEGAS, NV:
3,785,526, INT. CL. 5.
- SMITHERS-OASIS COMPANY, CUYAHOGA FALLS, OH:
2,842,245, CANC. INT. CL. 17.
- SMITHLINE, RICKY, NEW YORK, NY:
3,785,584, INT. CL. 25.
- SMITHS MEDICAL INTERNATIONAL LIMITED, ASHFORD, KENT, UNITED KINGDOM:
3,785,187, INT. CL. 10.
- SMITHSYSTEMS, INC., VENICE, CA:
2,753,153, CANC. INT. CL. 38.
- SMS DIRECT, INC., MANASSAS, VA:
2,753,708, CANC. INT. CL. 16.
- SMURFIT SOCAR, 94160 SAINT-MANDE, FRANCE:
2,752,873, CANC. INT. CL. 9.
- SNAKE RIVER ROASTING COMPANY, JACKSON, WY:
3,785,280, INT. CL. 30.
- SNOKIST GROWERS, YAKIMA, WA:
1,553,059, CANC. INT. CL. 29.
- SNYDER, LAVINIA BRANCA, NEW YORK, NY:
2,754,315, CANC. INT. CL. 28.
- SOCIAL SERVICE COORDINATORS, INC., MIAMI LAKES, FL:
3,784,620, PUB. 2-16-2010. INT. CL. 36.
- SOCIEDADE AGRÍCOLA; DA QUINTA DA LAGOALVA DE CIMA, S.A., PORTUGAL:
3,785,012, PUB. 2-16-2010. INT. CL. 33.
- SOCIETA' PER AZIONI CHIANTI RUFFINO ESPORTAZIONE VINICOLA TOSCANA, BRESCIA, ITALY:
2,752,858, CANC. INT. CL. 33.
- SOCIETE DES HOTELS MERIDIEN, FRANCE:
3,785,054, PUB. 2-16-2010. INT. CL. 43.
- SOCIETE DES PRODUITS NESTLE S.A., 1800 VEVEY, SWITZERLAND:
1,125,955, REN. 4-1-10. INT. CL. 11.
- SOCIETE DES PRODUITS NESTLE S.A., VEVEY, SWITZERLAND:
2,753,601, CANC. INT. CL. 31.
- SOCIETE DES PRODUITS NESTLE S.A., 1800 VEVEY, SWITZERLAND:
3,786,185, MULTIPLE CLASS, INT. CLS. 29 AND 32.
- SOCIETY FOR INDUSTRIAL AND APPLIED MATHEMATICS, PHILADELPHIA, PA:
1,590,289, REN. 3-27-10. INT. CL. 42.
- SOCIETY FOR PEDIATRIC RADIOLOGY, RESTON, VA:
3,785,255, INT. CL. 35.
- SOCIETY OF GOVERNMENT MEETING PROFESSIONALS, INC., ALEXANDRIA, VA:
3,784,158, PUB. 2-16-2010. INT. CL. 35.
- SODEXO OPERATIONS, LLC, GAITHERSBURG, MD:
2,754,511, CANC. INT. CL. 16.
- SOFTWARE SERVICES INTERNATIONAL, INC., NEW YORK, NY:
2,753,676, CANC. MULTIPLE CLASS, INT. CLS. 9 AND 42.
- SOFTWARE TECHNIQUES, INC., WINTER PARK, FL:
2,754,663, CANC. INT. CL. 9.
- SOILMOISTURE EQUIPMENT CORP., GOLETA, CA:
2,752,367, CANC. INT. CL. 9.
- SOKKIA COMPANY, LIMITED, KANAGAWA, JAPAN:
3,785,319, INT. CL. 9.
- SOKOL & COMPANY, COUNTRYSIDE, IL:
1,130,948, REN. 3-28-10. INT. CL. 29.
- SOL SURFERS SURF CAMP, LLC, MOUNT PLEASANT, SC:
3,784,354, PUB. 2-16-2010. INT. CL. 41.
- SOLE CHOICE, INC., PORTSMOUTH, OH:
2,335,657, REN. 3-27-10. INT. CL. 26.
- SOLETECH, INC., SALEM, MA:
2,753,623, CANC. INT. CL. 10.
- SOLIANCE, POMACLE, FRANCE:
3,783,390, PUB. 2-16-2010. INT. CL. 1.
- SOLID CLOTHING, INC., LOS ANGELES, CA:
2,754,048, CANC. INT. CL. 25.
2,754,199, CANC. INT. CL. 25.
- SOLIDFX, LLC, FOXBORO, MA:
3,786,083, INT. CL. 9.
- SOLIX INTERNET, INC., SANTA CLARA, CA:
2,753,375, CANC. INT. CL. 9.
- SOLORZANO, MARIO, LOS ANGELES, CA, DBA THE MARSO GROUP:
3,783,519, PUB. 2-16-2010. INT. CL. 35.
- SOLOW, NEIL DAVID, MIDDLETOWN, NJ:
2,309,002, REN. 3-30-10. INT. CL. 25.
- SOLURIS INC., CONCORD, MA:
2,754,194, CANC. INT. CL. 9.
- SOLVAY PHARMACEUTICALS B.V., 1381 CP WEESP, NETHERLANDS:
3,783,632, PUB. 2-16-2010. INT. CL. 5.
3,783,635, PUB. 2-16-2010. INT. CL. 5.
- SOLVAY, (SOCIETE ANONYME), 33, B-1050 BRUSSELS, BELGIUM:
2,337,294, REN. 3-31-10. INT. CL. 1.
- SOMATO HYGIENICS, INC., ESCONDIDO, CA:
2,754,076, CANC. INT. CL. 3.
- SOMETHING SILVER, INC., SHORELINE, WA:
2,343,205, REN. 3-31-10. INT. CL. 14.
- SOMFY SAS, CLUSES, FRANCE:
3,783,674, PUB. 2-16-2010. MULTIPLE CLASS, INT. CLS. 7 AND 9.
- SONAFI, FRANCE:
3,784,892, PUB. 2-16-2010. INT. CL. 30.
- SONEXIS TECHNOLOGY, INC., MONROEVILLE, PA:
2,752,609, CANC. MULTIPLE CLASS, INT. CLS. 37, 38 AND 42.
2,752,610, CANC. MULTIPLE CLASS, INT. CLS. 37, 38 AND 42.
- SONOVA HOLDING AG, SWITZERLAND:
3,785,044, PUB. 2-16-2010. MULTIPLE CLASS, INT. CLS. 9 AND 10.
- SONY COMPUTER ENTERTAINMENT AMERICA INC., FOSTER CITY, CA:
3,785,993, MULTIPLE CLASS, INT. CLS. 9 AND 41.
- SONY ELECTRONICS INC., PARK RIDGE, NJ:
2,753,457, CANC. INT. CL. 9.
- SONY PICTURES HOME ENTERTAINMENT INC., CULVER CITY, CA:
3,783,476, PUB. 2-16-2010. INT. CL. 9.
- SONY PICTURES TELEVISION INC., CULVER CITY, CA:
3,785,501, INT. CL. 41.
- SORA KOZMETIK VE KIMYA; SANAYI VE TICARET LIMITED SIRKETI, TURKEY:
3,784,890, PUB. 2-16-2010. MULTIPLE CLASS, INT. CLS. 3 AND 5.
- SORT A TOOL INC., CARSON CITY, NV:
3,784,094, PUB. 2-16-2010. INT. CL. 20.
- SORTEX LIMITED, LONDON, ENGLAND:
1,552,503, CANC. INT. CL. 7.
- SOS PRODUCTIONS, INC., COLUMBUS, OH:
2,754,371, CANC. MULTIPLE CLASS, INT. CLS. 41 AND 42.
- SOUND KITCHEN STUDIOS, LLC, FRANKLIN, TN:
3,783,135, PUB. 2-16-2010. INT. CL. 41.
3,783,136, PUB. 2-16-2010. INT. CL. 41.
- SOUNDTAG, INC., BRAINTREE, MA:
3,785,230, INT. CL. 9.
- SOUTH CAROLINA EDUCATION LOTTERY COMMISSION, COLUMBIA, SC:
2,754,592, CANC. INT. CL. 41.
- SOUTH JERSEY INDUSTRIES, FOLSOM, NJ:
3,783,192, PUB. 2-16-2010. INT. CL. 42.
- SOUTHERN AFRICA WILDLIFE TRUST, ANNAPOLIS, MD:
2,281,598, REN. 3-26-10. INT. CL. 42.
- SOUTHERN GROUTS & MORTARS, INC., POMPANO BEACH, FL:
2,754,212, CANC. INT. CL. 19.

SOUTHWALL TECHNOLOGIES INC., PALO ALTO, CA:
1,574,066. REN. 3-30-10. INT. CL. 19.
1,574,066. COR. INT. CL. 19.

SOUTHWEST PROGRESSIVE ENTERPRISES, INC., DALLAS, TX:
3,785,179. MULTIPLE CLASS, INT. CLS. 19, 37 AND 42.

SOUTHWESTERN/GREAT AMERICAN, INC., NASHVILLE, TN, DBA THE SOUTHWESTERN COMPANY:
3,783,148. PUB. 2-16-2010. INT. CL. 41.

SOVEREIGN BANK, WYOMISSING, PA:
2,753,923. CANC. INT. CL. 36.

SPACEMEN, INC., NEW YORK, NY:
2,753,225. CANC. INT. CL. 35.

SPACIOUS SKIES LLC, VENICE, CA:
3,783,869. PUB. 2-16-2010. INT. CL. 20.
3,783,903. PUB. 2-16-2010. INT. CL. 20.

SPAISSIMO PURE SPA COLLECTION, LLC., NAPLES, FL:
3,784,791. PUB. 2-16-2010. INT. CL. 4.

SPARK MOBILE, LLC, TAMPA, FL:
3,785,842. INT. CL. 9.

SPARK NETWORKS LIMITED, BEVERLY HILLS, CA:
3,786,158. INT. CL. 45.

SPARRENBERGER, KATHY, LAKE FOREST, IL:
3,783,948. PUB. 2-16-2010. INT. CL. 3.

SPARTAN TOOL, L.L.C., LISLE, IL, CONCO ENGINEERING WORKS, INC., MENDOTA, IL:
710,213. REN. 3-26-10. U.S. CL. 23 (INT. CL. 7).

SPECIAL K PROPERTIES, LLC, MANHATTAN BEACH, CA:
3,785,180. INT. CL. 37.

SPECIAL OLYMPICS, INC., WASHINGTON, DC:
3,784,770. PUB. 2-16-2010. MULTIPLE CLASS, INT. CLS. 35 AND 41.

SPECIALTY CORPORATION, ALBUQUERQUE, NM:
1,586,107. REN. 3-29-10. MULTIPLE CLASS, INT. CLS. 37 AND 42.

SPECTORSOFT CORPORATION, VERO BEACH, FL:
3,783,746. PUB. 2-16-2010. INT. CL. 9.

SPECTRA - PHYSICS LASERPLANE, INC., DAYTON, OH:
1,552,669. CANC. INT. CL. 9.

SPECTRUM AERONAUTICAL, LLC, CARDIFF BY THE SEA, CA:
2,753,408. CANC. INT. CL. 12.

SPECTRUM ASSOCIATES, INC., MILFORD, CT:
1,136,056. REN. 3-31-10. INT. CL. 9.

SPEECH MATTERS LLC, TUCSON, AZ:
2,753,046. CANC. INT. CL. 41.

SPEED PART RP AB, 431 37 MÖLNDAL, SWEDEN:
2,751,634. CANC. INT. CL. 9.

SPENCER, FRANK B., CLEVELAND, OH:
2,336,694. REN. 3-27-10. INT. CL. 41.

SPERIAN PROTECTIVE APPAREL LTD./SPERIAN VETEMENTS DE PROTECTION LTEE, MONTREAL, QUEBEC, CANADA:
2,751,817. CANC. INT. CL. 9.

SPHEREMANIA LTD., LONG EATON, UNITED KINGDOM:
3,783,171. PUB. 2-16-2010. MULTIPLE CLASS, INT. CLS. 9, 28 AND 41.

SPIEGEL, MARGARET S., PORT WASHINGTON, NY:
3,786,091. INT. CL. 9.

SPIN MASTER LTD., TORONTO, ONTARIO, CANADA:
3,783,143. PUB. 2-16-2010. INT. CL. 28.

SPIRALOCK CORPORATION, MADISON HEIGHTS, MI:
2,751,999. CANC. INT. CL. 28.

SPIRIS, INC., LAFAYETTE, IN:
3,786,151. INT. CL. 36.

SPIRITS OF NEW MERCED, LLC, NORTHRIDGE, CA:
3,785,109. INT. CL. 32.

SPLASH PRODUCTS, INC., EAGAN, MN:
2,335,719. REN. 3-31-10. INT. CL. 3.

SPLENDID PRODUCTS LLC, BURLINGAME, CA:
2,273,177. CANC. INT. CL. 31.

SPLIT ENGINEERING, LLC, TUCSON, AZ:
2,307,456. REN. 4-1-10. INT. CL. 9.
2,307,457. REN. 4-1-10. INT. CL. 9.

SPORT & SPINE S.A.S. REHABILITATION SERVICES LTD., ABBOTSFORD, BRITISH COLUMBIA, CANADA:
2,807,773. CANC. INT. CL. 10.

SPORTS GIANT, LLC, SAN DIEGO, CA:
2,752,556. CANC. INT. CL. 35.
2,752,557. CANC. INT. CL. 35.

SPORTSPLAY, LLC, KENNESAW, GA:
3,785,746. INT. CL. 42.

SPORTSMEN'S NATIONAL LAND TRUST, INC., AGAWAM, MA:
3,783,271. PUB. 2-16-2010. MULTIPLE CLASS, INT. CLS. 35 AND 36.

SPOTLIGHT STORES PTY LTD, VICTORIA, 3205, AUSTRALIA:
2,751,612. CANC. INT. CL. 16.

SPREAD THE LOVE, LLC, NASHVILLE, TN:
3,784,673. PUB. 2-16-2010. INT. CL. 29.

SPRINGS GLOBAL US, INC., FORT MILL, SC:
2,339,257. REN. 4-1-10. INT. CL. 20.

SPRINGS WINDOW FASHIONS LP, MIDDLETON, WI:
2,754,196. CANC. INT. CL. 20.

SPRINT PUBLISHING & ADVERTISING, INC., CARY, NC:
2,753,284. CANC. INT. CL. 35.

SPRITE INDUSTRIES, INC., CORONA, CA:
3,785,551. INT. CL. 11.

SPROUT FOODS, INC., NEW YORK, NY:
3,786,214. INT. CL. 5.
3,786,248. INT. CL. 5.

SPSS INC., CHICAGO, IL:
2,271,357. CANC. INT. CL. 9.

SPX COOLING TECHNOLOGIES, INC., OVERLAND PARK, KS:
2,753,939. CANC. INT. CL. 11.

SQUARE D COMPANY, PALATINE, IL:
2,751,924. CANC. INT. CL. 9.

SQUARE 1 FINANCIAL, INC., DURHAM, NC:
3,783,291. PUB. 2-16-2010. INT. CL. 36.

SQUARE-H BRANDS, INC., LOS ANGELES, CA, DBA "SQUARE-H BRANDS":
3,379,938. AM. INT. CL. 29.

SQUIRE TECH SOLUTIONS, LLC, THE COLONY, TX:
3,783,481. PUB. 2-16-2010. MULTIPLE CLASS, INT. CLS. 12 AND 38.
3,783,482. PUB. 2-16-2010. MULTIPLE CLASS, INT. CLS. 12 AND 38.

SQUIRELL'S LLC, VIRGINIA BEACH, VA:
3,784,096. PUB. 2-16-2010. INT. CL. 35.

SRC, LLC, ORANGE, CA:
3,783,177. PUB. 2-16-2010. MULTIPLE CLASS, INT. CLS. 9, 35 AND 39.

SRI INTERNATIONAL, MENLO PARK, CA:
3,783,803. PUB. 2-16-2010. MULTIPLE CLASS, INT. CLS. 35 AND 41.

SRI INTERNATIONAL, INC., MENLO PARK, CA:
3,786,162. MULTIPLE CLASS, INT. CLS. 35, 36 AND 41.

ST. BARTH PROPERTIES, INC., FRANKLIN, MA:
2,343,427. REN. 3-27-10. INT. CL. 42.

ST. CATHERINE UNIVERSITY, ST. PAUL, MN:
3,783,423. PUB. 2-16-2010. INT. CL. 41.

ST. CLAIRE, JANE, HEALDSBURG, CA:
3,784,690. PUB. 2-16-2010. INT. CL. 35.

ST. JUDE MEDICAL, INC., ST. PAUL, MN:
3,785,306. INT. CL. 41.

ST. LUKE'S EPISCOPAL HOSPITAL, HOUSTON, TX TO LIFETOUGH INC., EDEN PRAIRIE, MN:
2,271,437. CANC. INT. CL. 42.

ST. PIERRE MANUFACTURING CORPORATION, WORCESTER, MA:
2,344,902. REN. 3-27-10. INT. CL. 28.
2,344,904. REN. 3-27-10. INT. CL. 28.

STA-RITE INDUSTRIES, LLC, DELAVAN, WI, EXPERT CORPORATION, CHICAGO, IL:
1,132,991. REN. 3-27-10. INT. CL. 7.

STA-RITE INDUSTRIES, LLC, DELAVAN, WI:
2,272,033. CANC. INT. CL. 7.

STAAB FUNERAL HOME, LTD., SPRINGFIELD, IL:
2,352,084. REN. 3-26-10. INT. CL. 42.

STAIRLIGHTING SYSTEM, LLC, NORTH EAST, MD:
3,785,283. INT. CL. 9.
3,785,284. INT. CL. 11.

- STAND-N-FISH, LLC, SARASOTA, FL:
3,786,402, INT. CL. 12.
- STANDARD CAR TRUCK COMPANY, PARK RIDGE, IL:
3,785,203, INT. CL. 20.
- STANDARD INNOVATION CORPORATION, OTTAWA, CANADA:
3,784,018, PUB. 2-16-2010. INT. CL. 10.
- STANDARD MOTOR PRODUCTS, INC., LONG ISLAND CITY, NY:
2,437,981. REN. 4-1-10. INT. CL. 7.
- STANDARD PARKING CORPORATION, CHICAGO, IL:
3,785,225, INT. CL. 45.
- STANLEY CAPITAL MORTGAGE COMPANY, INC., ENGLEWOOD CLIFFS, NJ:
2,752,024, CANC. INT. CL. 36.
- STANLEY LOGISTICS, L.L.C., NEW BRITAIN, CT:
3,786,344, INT. CL. 18.
- STANLEY WORKS, THE, NEW BRITAIN, CT:
1,552,481, CANC. MULTIPLE CLASS, INT. CLS. 6 AND 20.
1,552,912, CANC. INT. CL. 20.
- STAPLES THE OFFICE SUPERSTORE, LLC, FRAMINGHAM, MA:
2,272,367, CANC. INT. CL. 35.
- STAR PLUMBING PRODUCTS, INC., SUNNY ISLES BEACH, FL:
3,784,411, PUB. 2-16-2010. INT. CL. 19.
- STARBUZZ TOBACCO, INC., ANAHEIM, CA:
3,783,438, PUB. 2-16-2010. INT. CL. 35.
- STARCOM MEDIAVEST GROUP, INC., CHICAGO, IL:
3,783,544, PUB. 2-16-2010. INT. CL. 35.
- STARMAX RESOURCE LLC, CLEVELAND, OH:
2,347,550. REN. 3-26-10. INT. CL. 21.
- STARPHARMA PTY LIMITED, AUSTRALIA:
3,784,858, PUB. 2-16-2010. MULTIPLE CLASS, INT. CLS. 5 AND 10.
- STARS2TRUST LLC, FLORHAM PARK, NJ:
3,785,481, MULTIPLE CLASS, INT. CLS. 35 AND 42.
- STATCARD.COM INC., NORWALK, CT:
2,753,871, CANC. INT. CL. 9.
- STATE INDUSTRIES, INC., ASHLAND CITY, TN:
2,753,826, CANC. INT. CL. 11.
- STATE OF CALIFORNIA SECRETARY, DEPT. OF FOOD AND AGRICULTURE, SACRAMENTO, CA:
1,553,326, CANC. INT. CL. 42.
- STATE STREET CORPORATION, BOSTON, MA:
3,784,837, PUB. 2-16-2010. INT. CL. 42.
- STATIC 2358 LIMITED, LONDON, UNITED KINGDOM:
2,752,850, CANC. MULTIPLE CLASS, INT. CLS. 9 AND 38.
- STAVIN INCORPORATED, SAUSALITO, CA:
2,433,238. REN. 4-1-10. INT. CL. 31.
- STEER DAVIES GLEAVE LIMITED, LONDON, ENGLAND, UNITED KINGDOM:
2,751,614, CANC. MULTIPLE CLASS, INT. CLS. 39 AND 41.
- STEIN MART BUYING CORP., JACKSONVILLE, FL:
2,398,312. REN. 3-30-10. INT. CL. 25.
- STEINBERG, ALLAN, CLARENCE, NY:
2,752,452, CANC. INT. CL. 20.
- STEINER ELECTRIC COMPANY, ELK GROVE VILLAGE, IL:
3,783,332, PUB. 2-16-2010. MULTIPLE CLASS, INT. CLS. 35, 37, 40, 41, 42 AND 45.
3,783,333, PUB. 2-16-2010. MULTIPLE CLASS, INT. CLS. 35, 37, 40, 41, 42 AND 45.
3,783,334, PUB. 2-16-2010. MULTIPLE CLASS, INT. CLS. 35, 37, 40, 41 AND 42.
- STEMMANN-TECHNIK GMBH, 48465 SCHUTTORT, FED REP GERMANY:
2,751,601, CANC. INT. CL. 9.
- STEPHEN W. FRIED, BROOKLYN, NY, DBA LUNAR OFFENSIVE PRESS:
2,754,467, CANC. INT. CL. 16.
- STEVEN SCOTT PLEDGER, LEXINGTON, GA, DBA WACK-EM CRAZY BAITS:
3,783,355, PUB. 2-16-2010. INT. CL. 28.
- STEVENS, JODY, NASHVILLE, TN AND HARRISON, JAMES, NASHVILLE, TN:
3,786,066, MULTIPLE CLASS, INT. CLS. 9, 25 AND 41.
- STEVENS, ROBERT D., MILWAUKEE, WI:
2,753,958, CANC. INT. CL. 13.
- STEWART LENDER SERVICES, INC., HOUSTON, TX:
2,751,619, CANC. INT. CL. 36.
- STEWARTS RESTAURANTS INCORPORATED, LUMBERTON, NJ:
3,784,047, PUB. 2-16-2010. INT. CL. 30.
3,784,741, PUB. 2-16-2010. INT. CL. 35.
- STIBBS & CO., P.C., SPRING, TX:
3,784,380, PUB. 2-16-2010. INT. CL. 45.
- STM TECHNOLOGIES S.R.L, MILAN, ITALY:
2,302,034. REN. 3-27-10. INT. CL. 7.
- STMICROELECTRONICS, INC., CARROLLTON, TX:
2,781,742, AM. INT. CL. 9.
- STOKELY-VAN CAMP, INC., CHICAGO, IL:
3,784,456, PUB. 2-16-2010. INT. CL. 38.
- STOLLER VINEYARDS, INC., DUNDEE, OR:
3,783,342, PUB. 2-16-2010. MULTIPLE CLASS, INT. CLS. 33 AND 39.
- STOLLER, DEBORAH S, BROOKLYN, NY:
3,786,148, INT. CL. 23.
- STONEGATE BUSINESS CONSULTING, LTD., GOLDEN VALLEY, MN, DBA STONEGATE GROWTH STRATEGIES, LTD.:
3,783,710, PUB. 2-16-2010. INT. CL. 42.
- STONEWICK, INC., DALLAS, TX:
3,786,364, INT. CL. 21.
- STONEWOOD GROUP LIMITED, DORSET, UNITED KINGDOM:
3,783,546, PUB. 2-16-2010. INT. CL. 9.
- STOP CANCER, LOS ANGELES, CA:
2,337,610. REN. 3-31-10. INT. CL. 36.
- STORAGENETWORKS, INC., WALTHAM, MA:
2,753,798, CANC. MULTIPLE CLASS, INT. CLS. 35 AND 39.
- STORYROCK, INC., SALT LAKE CITY, UT:
2,752,691, CANC. INT. CL. 9.
2,752,693, CANC. INT. CL. 9.
- STRANDBERG, TERRY A., OCONOMOWOC, WI AND ZWIEG, MILO D., OCONOMOWOC, WI:
2,271,282, CANC. INT. CL. 28.
- STRANGE INVISIBLE PERFUMES, LLC, BEVERLY HILLS, CA:
3,785,782, INT. CL. 3.
- STRATEGIC INTEGRATION LLC, LONG BEACH, CA:
2,752,994, CANC. INT. CL. 20.
- STRATO TRADING GROUP, INC., NEW YORK, NY:
2,753,368, CANC. INT. CL. 25.
- STRAUSS, LEVI & CO., SAN FRANCISCO, CA, LEVI STRAUSS AND COMPANY, SAN FRANCISCO, CA:
695,380. REN. 3-27-10. U.S. CL. 39 (INT. CLS. 10, 25 AND 26).
- STRAUSS, MADISON, WILTON MANORS, FL:
3,786,433, INT. CL. 35.
- STREAMLINE DYNAMICS, INC., FALLBROOK, CA:
3,785,646, INT. CL. 39.
- STRICTLY ADDITIONS, INC., PLANTATION, FL:
2,752,122, CANC. INT. CL. 37.
2,752,123, CANC. INT. CL. 37.
- STRIX SYSTEMS, INC., NEWBURY PARK, CA:
3,786,290, INT. CL. 9.
3,786,291, INT. CL. 9.
3,786,292, INT. CL. 9.
- STRONGWALL INDUSTRIES, INC., RIDGEWOOD, NJ:
2,751,956, CANC. INT. CL. 19.
- STRUMEIER, DAVID, MORGANVILLE, NJ:
2,753,525, CANC. MULTIPLE CLASS, INT. CLS. 35 AND 42.
- STUDENT DIRECTION, LLC, SCOTTSDALE, AZ, DBA STUDENT DIRECTION, LLC:
3,784,572, PUB. 2-16-2010. INT. CL. 35.
- STUDENTS FIRST, LLC, MOBILE, AL:
3,784,109, PUB. 2-16-2010. INT. CL. 41.
- STUDIO DAD, LLC, MEDINA, OH:
3,785,643, INT. CL. 25.

STUDIO PEYO S.A., GENÈVE, SWITZERLAND:
2,701,891, AM. MULTIPLE CLASS, INT. CLS. 9, 14, 16, 20,
25, 28 AND 41.

STUDIO SB, LLC, SANTA BARBARA, CA:
3,785,153, INT. CL. 35.

STUDYBLUE, INC., MIDDLETON, WI:
3,785,653, INT. CL. 42.

STUTZMAN ENVIRONMENTAL PRODUCTS, INC., CAN-
BY, OR:
2,754,398, CANC. INT. CL. 20.

STX FRANCE S.A., FRANCE:
3,784,918, PUB. 2-16-2010. MULTIPLE CLASS, INT. CLS.
12, 37, 40 AND 42.

STYLESPT, LLC, ARLINGTON, VA:
3,783,219, PUB. 8-26-2008. INT. CL. 41.

SUASION RESOURCES INC., NORTH CALDWELL, NJ:
2,271,942, CANC. INT. CL. 35.

SUB-URBAN INDUSTRIES, INC., LOS ANGELES, CA:
2,754,411, CANC. INT. CL. 25.

SUBARU INVESTMENT, INC., CHERRY HILL, NJ, SUB-
ARU OF AMERICA, INC., CHERRY HILL, NJ:
1,602,140, REN. 4-1-10. INT. CL. 12.

SUCCESSORIES.COM, LLC, BOCA RATON, FL:
2,271,351, CANC. INT. CL. 19.

SUCKAFREE, INC., SANTA CLARA, CA, D & D APPAREL,
INC., SANTA CLARA, CA:
2,383,902, REN. 3-31-10. INT. CL. 25.

SUISSE PROGRAMME LIMITED, CASEMATES SQUARE,
GIBRALTAR:
3,783,181, PUB. 2-16-2010. INT. CL. 35.

SUKAYLO, JENNIFER, WINNIPEG, MANITOBA, CANA-
DA:
2,751,742, CANC. INT. CL. 42.

SUKUP MANUFACTURING COMPANY, SHEFFIELD, IA:
2,363,978, REN. 3-31-10. MULTIPLE CLASS, INT. CLS. 6
AND 7.

SULLIVAN CORPORATION, BLOOMFIELD HILLS, MI:
1,125,290, REN. 3-28-10. MULTIPLE CLASS, INT. CLS. 4
AND 21.

SULZER ORTHOPEDICS LTD., 6340 BAAR, SWITZER-
LAND:
2,754,567, CANC. MULTIPLE CLASS, INT. CLS. 41 AND
42.

SUMITOMO JUKIKAI KOGYO KABUSHIKI KAISHA, TO-
KYO, JAPAN, AKA SUMITOMO HEAVY INDUSTRIES,
LTD.:
1,552,501, CANC. INT. CL. 7.

SUMMIT ENTERTAINMENT, LLC, SANTA MONICA, CA:
3,783,356, PUB. 2-16-2010. INT. CL. 20.

SUMMIT LABORATORIES, INC., HARVEY, IL:
2,335,493, REN. 3-31-10. INT. CL. 3.
2,335,493, CANC. MULTIPLE CLASS, INT. CLS. 16 AND
26.
2,754,222, CANC. INT. CL. 3.

SUMNER GROUP, INC., ST. LOUIS, MO, SUMNER GROUP,
INC., ST. LOUIS, MO, DBA DATAMAX OFFICE SYS-
TEMS:
1,638,689, REN. 3-26-10. INT. CL. 42.

SUMNER HARRINGTON LTD., MINNETONKA, MN:
2,753,133, CANC. INT. CL. 36.

SUN GRO HORTICULTURE CANADA LTD., SEBA BEACH
ALBERTA, CANADA:
2,299,184, REN. 3-27-10. INT. CL. 1.

SUN WORLD INTERNATIONAL, LLC, BAKERSFIELD, CA:
3,784,141, PUB. 2-16-2010. INT. CL. 31.
3,784,144, PUB. 2-16-2010. INT. CL. 31.

SUNBEAM PRODUCTS, INC., BOCA RATON, FL, DBA
JARDEN CONSUMER SOLUTIONS:
3,785,621, MULTIPLE CLASS, INT. CLS. 7 AND 21.

SUNBURST PRODUCTS, INC., NEW YORK, NY:
2,358,207, REN. 3-31-10. INT. CL. 14.

SUNFIRE TRADING CORPORATION, SANTE FE SPRINGS,
CA AND SHINN, YOUNG KYO, SANTE FE SPRINGS, CA:
2,752,843, CANC. INT. CL. 4.

SUNFLOWER CORPORATION, LONGMONT, CO:
3,786,296, INT. CL. 11.

SUNFLOWER MEDICAL L.L.C., ELLIS, KS:
2,329,172, REN. 3-26-10. INT. CL. 10.

SUNHILLO CORPORATION, BERLIN, NJ:
2,754,341, CANC. INT. CL. 9.

SUNKIST GROWERS, INC., SHERMAN OAKS, CA:
3,783,170, PUB. 2-16-2010. INT. CL. 32.

SUNMARKS, INC., WILMINGTON, DE:
1,552,572, CANC. INT. CL. 9.

SUNNY COVE CITRUS LLC, REEDLEY, CA:
3,784,423, PUB. 2-16-2010. INT. CL. 31.

SUNNY ISLE INDUSTRIES, INC., ROCHELLE PARK, NJ:
2,272,156, CANC. INT. CL. 25.

SUNNY MERCHANDISE CORP., VERNON, CA:
3,786,153, INT. CL. 9.

SUNRIDER CORPORATION, THE, TORRANCE, CA, DBA
SUNRIDER INTERNATIONAL:
2,272,055, CANC. INT. CL. 3.
3,139,392, AM. MULTIPLE CLASS, INT. CLS. 5 AND 29.

SUNRISE TELECOM INCORPORATED, SAN JOSE, CA:
2,272,149, CANC. INT. CL. 9.

SUNSET INDUSTRIES INC., MILTON, CANADA:
3,783,151, PUB. 2-16-2010. INT. CL. 19.

SUNSETS, INC., HARBOR CITY, CA:
3,784,429, PUB. 2-16-2010. INT. CL. 25.

SUPER DUPER INC., GREENVILLE, SC, DBA SUPER
DUPER PUBLICATIONS:
2,754,514, CANC. INT. CL. 28.

SUPERIOR HEATING & AIR INC., BLUFFTON, SC:
3,784,575, PUB. 2-16-2010. INT. CL. 37.

SUPERIOR OPTICAL LABS, INC., OCEAN SPRINGS, MS:
3,785,994, INT. CL. 2.
3,785,995, INT. CL. 2.

SUPERORO S.P.A., VICENZA, ITALY:
2,752,228, CANC. INT. CL. 14.

SUPREME CORPORATION, GOSHEN, IN:
2,345,913, REN. 4-1-10. INT. CL. 12.

SURFACE IGNITER, INC., CHAGRIN FALLS, OH:
2,753,562, CANC. INT. CL. 9.

SURFJAR, INC., SHERWOOD, OR:
3,785,325, MULTIPLE CLASS, INT. CLS. 9 AND 35.

SURFLIGHT HAWAII, INC., WAIALUA, HI:
2,341,506, REN. 3-31-10. MULTIPLE CLASS, INT. CLS. 25
AND 28.

SURTECO CANADA LTD., ST. LEONARD, CANADA:
2,339,913, REN. 3-31-10. MULTIPLE CLASS, INT. CLS. 17
AND 19.

SURVEYCLUB.COM, LLC, DENVER, CO:
3,786,464, INT. CL. 35.

SUSAN EISEN, INC., EL PASO, TX:
2,404,973, REN. 3-31-10. INT. CL. 14.

SUSAN L. FENIGER TRUST, SANTA MONICA, CA AND
SCHWEITZER/MILLIKEN TRUST, SANTA MONICA, CA:
2,359,331, REN. 3-29-10. INT. CL. 42.

SUSIDKO, LYNN DRENNON, MORGAN HILL, CA:
2,752,948, CANC. INT. CL. 43.

SUZUKI-ORFF SCHOOL FOR YOUNG MUSICIANS, CHI-
CAGO, IL:
2,345,132, REN. 3-26-10. INT. CL. 41.

SWAROVSKI AKTIENGESELLSCHAFT, FL-9495 TRIESEN,
LIECHTENSTEIN:
2,752,863, CANC. INT. CL. 14.

SWCS MARKETING GROUP, INC., CRYSTAL, MN:
2,428,574, REN. 3-26-10. INT. CL. 37.

SWEET EDDIE'S, INC., SMYRNA, GA:
2,360,811, REN. 3-30-10. MULTIPLE CLASS, INT. CLS. 30
AND 35.

SWEET REPUBLIC INCORPORATED, SCOTTSDALE, AZ,
DBA SWEET REPUBLIC:
3,784,217, PUB. 2-16-2010. INT. CL. 30.

SWEETON, MICHAEL, WARWICK, NY AND SWEETON,
DEBORAH, WARWICK, NY:
2,753,474, CANC. MULTIPLE CLASS, INT. CLS. 35 AND
42.

SWEETS FROM HEAVEN FRANCHISE (PTY) LTD., SAND-
TON 2148, SOUTH AFRICA:
2,333,665, REN. 3-31-10. INT. CL. 25.

SWIG EQUITIES, LLC, NEW YORK, NY:
3,718,444, CANC. MULTIPLE CLASS, INT. CLS. 36 AND
37.

- SWIMC, INC., NEWARK, DE:
1,591,582. REN. 3-31-10. INT. CL. 2.
3,783,408. PUB. 2-16-2010. INT. CL. 4.
- SWIMC, NIC., NEWARK, DE:
2,343,379. REN. 3-26-10. INT. CL. 16.
- SWISSBIKE VERTRIEBS GMBH, STANS, SWITZERLAND:
2,751,542. CANC. MULTIPLE CLASS, INT. CLS. 9, 14, 18
AND 25.
- SWISSLOG MANAGEMENT AG, CH-5033 BUCHS/AARAU,
SWITZERLAND:
2,753,755. CANC. MULTIPLE CLASS, INT. CLS. 6, 7, 9, 12,
20, 35, 37, 41 AND 42.
2,753,756. CANC. MULTIPLE CLASS, INT. CLS. 6, 7, 9, 12,
20, 35, 37, 41 AND 42.
- SWR MEDIA LTD., LONDON, UNITED KINGDOM, DBA
LUSSO MAGAZINE:
3,784,028. PUB. 2-16-2010. MULTIPLE CLASS, INT. CLS.
16 AND 41.
- SYCLIPSE TECHNOLOGIES, INC., SAN JOSE, CA:
3,785,951. MULTIPLE CLASS, INT. CLS. 9, 37, 42 AND 45.
- SYLVIA GÄDEKE (MS.), FED REP GERMANY:
3,784,937. PUB. 2-16-2010. MULTIPLE CLASS, INT. CLS.
36 AND 43.
- SYMBIO HERBORN GROUP GMBH & CO., D-35746 HER-
BORN, FED REP GERMANY:
2,751,561. CANC. MULTIPLE CLASS, INT. CLS. 5, 29
AND 30.
- SYMBIOS CAPITAL, S.L., MADRID, SPAIN:
2,751,613. CANC. MULTIPLE CLASS, INT. CLS. 35, 36, 38
AND 42.
- SYMBOL TECHNOLOGIES, INC., HOLTSVILLE, NY TO
REDPRAIRIE CORPORATION, WAUKESHA, WI:
2,272,546. CANC. INT. CL. 9.
- SYMMETRICS MARKETING CORPORATION, SCOTTS-
DALE, AZ:
2,753,053. CANC. INT. CL. 35.
- SYMRISE GMBH & CO. KG, HOLZMINDEN, FED REP
GERMANY:
3,785,354. INT. CL. 1.
- SYMTALK, LLC, ST. PAUL, MN:
2,430,010. REN. 3-26-10. MULTIPLE CLASS, INT. CLS. 16
AND 28.
- SYNCADA LLC, MINNEAPOLIS, MN:
3,785,330. MULTIPLE CLASS, INT. CLS. 9, 35, 36 AND 38.
- SYNCUP, INC., DANVILLE, CA:
3,785,112. INT. CL. 42.
- SYNERGENZ BIOSCIENCE LIMITED, ROAD TOWN,
BR. VIRGIN ISLANDS:
3,783,230. PUB. 9-15-2009. MULTIPLE CLASS, INT. CLS. 5
AND 44.
- SYNGENTA PARTICIPATIONS AG, BASEL, SWITZER-
LAND:
2,438,890. REN. 3-31-10. INT. CL. 5.
- SYNOVA, INC., SOUTHFIELD, MI:
2,336,400. REN. 3-30-10. INT. CL. 42.
2,336,400. CANC. INT. CL. 41.
- SYNTEC INDUSTRIES LLC, ROME, GA:
2,341,443. REN. 3-31-10. INT. CL. 24.
- SYRATECH ACQUISITION CORPORATION, GARDEN
CITY, NY, TOWLE MANUFACTURING COMPANY,
NEWBURYPORT, MA:
522,618. REN. 3-26-10. U.S. CL. 28 (INT. CLS. 8 AND 14).
- SYRATECH CORPORATION, EAST BOSTON, MA:
2,753,935. CANC. INT. CL. 8.
- SYSTEMFORWARD AMERICA, INC., LAFAYETTE, LA:
3,785,093. MULTIPLE CLASS, INT. CLS. 37, 40 AND 45.
- SYSTEMS TECHNOLOGY FORUM, LTD., FREDERICKS-
BURG, VA:
3,786,424. INT. CL. 41.
- SZWED, JASON, ST. CHARLES, MI:
3,784,465. PUB. 2-16-2010. INT. CL. 25.
- S2S DESIGN, WESTLAKE VILLAGE, CA:
3,784,358. PUB. 2-16-2010. INT. CL. 10.
- S4 CONSULTING, INC., COLUMBUS, OH:
3,786,471. INT. CL. 38.
- T & G CREW LLC, NEW YORK, NY:
3,785,835. INT. CL. 35.
- T. W. BURLESON & SON, INC., WAXAHACHIE, TX:
2,348,492. REN. 4-1-10. INT. CL. 30.
- T.F.H PUBLICATIONS, INC., NEPTUNE CITY, NJ:
2,346,167. REN. 3-31-10. INT. CL. 31.
- T.R.P. COMPANY, INC., RENO, NV:
3,786,383. INT. CL. 5.
3,786,384. INT. CL. 5.
- T.S. ROBERTS, PONTE VEDRA BEACH, FL:
3,785,665. INT. CL. 25.
- T.T.I., INC., BERKELEY, CA, DBA CLEARFLOW VALVES,
INC.:
1,588,694. REN. 3-27-10. INT. CL. 11.
- T-MOBILE USA, INC., BELLEVUE, WA:
3,785,699. INT. CL. 35.
- T-REX TECHNOLOGY, INC., ODESSA, TX:
2,279,799. REN. 3-26-10. INT. CL. 7.
- T-REX TRUCK PRODUCTS INC., CORONA, CA, AKA T-
REX GRILLES:
3,784,399. PUB. 2-16-2010. INT. CL. 12.
- T-SHIRT INTERNATIONAL, INC., CULLODEN, WV:
3,786,111. INT. CL. 25.
- TABATA CO., LTD. (KABUSHIKI KAISHA TABATA), SU-
MIDA-KU, TOKYO, JAPAN:
2,353,066. REN. 3-31-10. MULTIPLE CLASS, INT. CLS. 9,
25 AND 28.
- TABLETOPS UNLIMITED, INC., CARSON, CA:
3,785,337. MULTIPLE CLASS, INT. CLS. 8 AND 21.
- TACHBULOS-STRATEGIES, INC., FAR ROCKAWAY, NY:
3,784,383. PUB. 2-16-2010. INT. CL. 35.
- TAISEN FOUNDRY INC., TAO-YUAN CITY, TAO-YUAN
HSIEN, TAIWAN:
2,753,926. CANC. INT. CL. 10.
- TAIWAN STOCK EXCHANGE CORPORATION, TAIPEI,
TAIWAN:
3,783,276. PUB. 10-13-2009. MULTIPLE CLASS, INT. CLS.
35 AND 36.
- TAIZHOU ZHENPENG OVERRUNNING CLUTCH CO.,
LTD., ZHEJIANG PROVINCE, CHINA:
3,785,029. PUB. 2-16-2010. INT. CL. 12.
- TAKARA BIO INC., OTSU CITY, SHIGA, JAPAN:
3,786,036. INT. CL. 1.
- TAKEYA USA CORPORATION, HUNTINGTON BEACH,
CA:
3,785,857. INT. CL. 21.
- TALENTGENESIS, INC., FOX POINT, WI:
2,335,496. REN. 3-30-10. MULTIPLE CLASS, INT. CLS. 16
AND 41.
- TALISAM, LLC, EDISON, NJ:
2,339,092. REN. 3-26-10. MULTIPLE CLASS, INT. CLS. 35
AND 41.
- TALLMADGE SPINNING & METAL COMPANY, AKRON,
OH:
3,783,929. PUB. 2-16-2010. INT. CL. 6.
- TALX CORPORATION, ST. LOUIS, MO:
2,753,549. CANC. INT. CL. 35.
- TAMANONI, INC., TAMPA, FL:
2,752,774. CANC. INT. CL. 5.
- TAMBRANDS INC., CINCINNATI, OH:
2,754,429. CANC. INT. CL. 5.
- TAMIR LINHART SOCCER TRAINING LLC, MCLEAN, VA:
3,785,890. INT. CL. 41.
- TANDY LEATHER FACTORY, INC., FORT WORTH, TX,
TANDYCRAFTS, INC., FT. WORTH, TX:
1,133,005. REN. 3-29-10. INT. CL. 8.
- TANTATANARA BEVERAGE GROUP, LTD., LILBURN,
GA:
1,553,166. CANC. INT. CL. 32.
- TARDIEU GROUP, INC., MIAMI, FL:
3,783,910. PUB. 2-16-2010. INT. CL. 25.
- TARGET BRANDS, INC., MINNEAPOLIS, MN:
3,786,202. MULTIPLE CLASS, INT. CLS. 3, 4, 5 AND 6.
- TARGET TRAINING INTERNATIONAL, LTD., SCOTTS-
DALE, AZ, TARGET TRAINING INTERNATIONAL,
LTD., SCOTTSDALE, AZ:
2,391,893. REN. 3-29-10. INT. CL. 9.
- TARGET VISION, INC., PITTSFORD, NY:
2,754,355. CANC. INT. CL. 9.

TARGETED GENETICS CORPORATION, SEATTLE, WA:
2,751,690, CANC. INT. CL. 5.

TASA GROUP, INC., THE, BLUE BELL, PA:
1,637,782. REN. 3-27-10. INT. CL. 35.

TATE & LYLE INGREDIENTS AMERICAS INC., DECATUR,
IL:
3,786,210, INT. CL. 30.

TATE ACCESS FLOORS LEASING, INC., WILMINGTON,
DE:
2,418,158. REN. 3-26-10. INT. CL. 6.

TATSEY, RICHARD, MOOSUP, CT:
3,784,053, PUB. 2-16-2010. INT. CL. 20.

TAURUS AEROSPACE GROUP, INC., EVERETT, WA:
3,785,803, MULTIPLE CLASS, INT. CLS. 37, 40 AND 42.
3,785,804, MULTIPLE CLASS, INT. CLS. 37, 40 AND 42.

TAWARAYA LIMITED, CHARLESTOWN, ST. CHRIST-NE-
VIS:
3,785,151, INT. CL. 42.

TAYBILL, INC, GLENDALE, OR:
3,785,252, INT. CL. 9.

TAYMOUR, HILLARY A., ROLLING HILLS ESTATES, CA:
3,785,654, INT. CL. 18.

TC DIGITAL GAMES LLC, WILMINGTON, DE:
3,785,482, MULTIPLE CLASS, INT. CLS. 16 AND 28.

TC SPECIALTY BRANDS, LLC, HENDERSON, NV:
3,785,156, INT. CL. 33.

TC 72 CORP., NEW YORK, NY:
1,553,048, CANC. INT. CL. 29.

TCBC ENTERPRISES, LLC, SPRINGFIELD, VA:
3,786,359, INT. CL. 28.

TEAM EXPRESS DISTRIBUTING, LLC, CHICAGO, IL:
3,783,880, PUB. 2-16-2010. INT. CL. 35.
3,783,881, PUB. 2-16-2010. INT. CL. 35.

TEAM FAIR HOLDINGS LIMITED, ROAD TOWN, BR. VIR-
GIN ISLANDS:
2,280,942. REN. 3-30-10. INT. CL. 8.

TEAM HOUSING SOLUTIONS, INC., NEW BRAUNFELS,
TX:
3,784,415, PUB. 2-16-2010. INT. CL. 36.

TECHNANOLOGY, L.L.C., IRVINE, CA:
2,752,361, CANC. INT. CL. 6.

TECHNETIX GROUP LIMITED, WEST SUSSEX, UNITED
KINGDOM:
3,783,195, PUB. 7-7-2009. MULTIPLE CLASS, INT. CLS. 9
AND 38.

TECHNICOLOR TRADEMARK MANAGEMENT SAS, ISSY-
LES-MOULINEAUX CEDEX, FRANCE, TECHNICOLOR
MOTION PICTURE CORPORATION, BOSTON, MA:
267,288. REN. 3-27-10. U.S. CL. 26 (INT. CL. 9).

TECHNICOLOR TRADEMARK MANAGEMENT SAS, ISSY-
LES-MOULINEAUX CEDEX 92443, FRANCE:
2,413,837. REN. 3-26-10. INT. CL. 39.

TECHNIQUEX, LLC, TEMPE, AZ:
3,786,436, INT. CL. 37.

TECHNOGENIA S.A, SAINT-JORIOZ, FRANCE:
1,552,482, CANC. INT. CL. 6.

TECHNOLINE L.L.C., CLIFTON, NJ:
3,784,591, PUB. 2-16-2010. INT. CL. 9.
3,784,608, PUB. 2-16-2010. INT. CL. 35.

TECHNOLOGIES HOLDINGS CORP., HOUSTON, TX:
2,350,205. REN. 4-1-10. MULTIPLE CLASS, INT. CLS. 6
AND 9.

TECHNOVARE SYSTEMS, INC., COSTA MESA, CA:
3,785,272, INT. CL. 9.

TECHONOGY4KIDS LIMITED PARTNERSHIP, LITTLE-
TON, MA:
2,754,553, CANC. INT. CL. 35.

TECKADEMICS, INC., SANTA BARBARA, CA:
2,754,263, CANC. INT. CL. 25.

TECNON ORBICHEM LIMITED, BATTERSEA, LONDON
SW11 3TN, ENGLAND:
2,752,090, CANC. MULTIPLE CLASS, INT. CLS. 35 AND
41.

TEFAL, FRANCE:
3,785,018, PUB. 2-16-2010. MULTIPLE CLASS, INT. CLS.
11 AND 21.

TEGENERO AG, WURZBURG, FED REP GERMANY:
2,751,883, CANC. MULTIPLE CLASS, INT. CLS. 5, 35
AND 42.

TEJADA ABREU, ROBERTO E., WEST HENRIETTA, NY:
3,786,092, INT. CL. 32.

TEK-TOOLS, INC., DALLAS, TX:
2,754,344, CANC. INT. CL. 9.

TEKNOCREATIONS, ALBUQUERQUE, NM:
3,785,305, INT. CL. 9.

TEKNOFANGHI S.R.L., (PROVINCE OF MILAN), ITALY:
2,271,403, CANC. INT. CL. 11.

TELCO SYSTEMS, INC., FOXBORO, MA:
2,430,714. REN. 3-31-10. INT. CL. 9.

TELE ENVIRONMENTAL SYSTEMS, RIFLE, CO:
2,753,837, CANC. INT. CL. 17.

TELEBRANDS CORP., FAIRFIELD, NJ:
2,754,181, CANC. INT. CL. 17.

TELECHECK INTERNATIONAL, INC., HOUSTON, TX:
2,272,997, CANC. INT. CL. 36.

TELECOMMUNICATION SYSTEMS, INC., ANNAPOLIS,
MD:
3,785,760, INT. CL. 38.

TELEFLORA LLC, LOS ANGELES, CA:
2,275,651. REN. 3-31-10. MULTIPLE CLASS, INT. CLS. 9,
35, 36 AND 42.

TELEFONICA, S.A., 28013 MADRID, SPAIN:
2,751,781, CANC. INT. CL. 35.

TELEMATE HOLDINGS, LLC, NORCROSS, GA:
2,752,895, CANC. MULTIPLE CLASS, INT. CLS. 9 AND
42.

TELETRACKING TECHNOLOGIES, INC., PITTSBURGH,
PA:
3,786,327, INT. CL. 9.

TELEVES, S.A., SPAIN:
3,784,999, PUB. 2-16-2010. INT. CL. 9.

TELEVISION WISCONSIN, INC., MADISON, WI:
2,753,716, CANC. INT. CL. 41.

TELISPARK, INC., ARLINGTON, VA:
2,751,704, CANC. INT. CL. 42.

TELLME NETWORKS, INC., MOUNTAIN VIEW, CA:
2,424,132. REN. 3-30-10. INT. CL. 35.

TELLURIDE CLOTHING COMPANY, INC., NATICK, MA
TO TELLURIDE CLOTHING COMPANY, INC., NATICK,
MA:
2,729,361, CANC. INT. CL. 18.

TELOS CORPORATION, ASHBURN, VA:
2,327,739. REN. 3-29-10. INT. CL. 9.
2,327,739, AM. INT. CL. 9.

TELSMITH, INC., MEQUON, WI, SMITH ENGINEERING
WORKS, MILWAUKEE, WI:
523,684. REN. 3-31-10. U.S. CL. 23 (INT. CLS. 6, 7, 8, 9, 11,
12, 16, 21 AND 28).

TEMPRESS PRODUCTS, L.P., DALLAS, TX:
2,331,545. REN. 3-30-10. MULTIPLE CLASS, INT. CLS. 20
AND 21.

TEMPSTAFF, INC., JACKSON, MS:
2,420,115. REN. 3-31-10. INT. CL. 35.

TEN HOEVE, CHER L, SEATTLE, WA:
2,754,641, CANC. INT. CL. 9.

TEN WEAR INC., SANTA MONICA, CA:
3,786,429, INT. CL. 35.

TENCENT HOLDINGS LIMITED, GEORGE TOWN, CAY-
MAN ISLANDS:
3,785,467, MULTIPLE CLASS, INT. CLS. 9 AND 41.
3,785,468, MULTIPLE CLASS, INT. CLS. 9 AND 41.

TENNANT COMPANY, MINNEAPOLIS, MN:
3,783,566, PUB. 2-16-2010. INT. CL. 7.

TENNANT COMPANY, GOLDEN VALLEY, MN:
3,785,741, INT. CL. 7.

TENNRICH INTERNATIONAL CORP., TAOYUAN HSIEN,
TAIWAN:
3,783,630, PUB. 2-16-2010. INT. CL. 9.

TENTH PLANET PRODUCTIONS INC., LOS ANGELES, CA:
2,422,505. REN. 3-26-10. INT. CL. 41.

TEPPER-NEAL, JOAN ELLEN, LOUISVILLE, KY:
2,752,684, CANC. INT. CL. 21.

TEQUILA ORENDAIN DE JALISCO, S.A. DE C.V., CP 45017
JALISCO, MEXICO:
2,753,493, CANC. INT. CL. 33.

- TERME DI SATURNIA S.R.L., GROSSETO, ITALY AND NET WORKING S.R.L., BOLOGNA, ITALY:
2,751,795, CANC. INT. CL. 41.
- TERRAFIRMA FOUNDATION REPAIR, INC., WINCHESTER, OR:
3,783,398, PUB. 2-16-2010. INT. CL. 37.
- TERRAGO TECHNOLOGIES, INC., ATLANTA, GA:
2,754,633, CANC. INT. CL. 9.
- TERREDORA DI PAOLO SOCIETÀ SEMPLICE AGRICOLA O PIÙ BREVEMENTE TERREDORA S.S.A. O TDDP S.S.A., MONTEFUSCO (AV), ITALY:
3,784,153, PUB. 2-16-2010. INT. CL. 33.
- TERRIFIC PETS, INC., NEW BERN, NC:
3,783,489, PUB. 2-16-2010. INT. CL. 35.
- TESSENDERLO KERLEY, INC., PHOENIX, AZ:
2,387,190. REN. 3-31-10. INT. CL. 1.
- TESTAMERICA LABORATORIES, INC., ASHEVILLE, NC:
2,752,584, CANC. INT. CL. 9.
- TETRA HOLDING (US), INC., BLACKSBURG, VA:
1,600,301. REN. 3-29-10. INT. CL. 5.
2,363,092. REN. 3-26-10. INT. CL. 11.
- TEXAS AGRILIFE EXTENSION SERVICE, COLLEGE STATION, TX:
2,434,550. REN. 3-31-10. INT. CL. 41.
- TEXAS CAPITAL BANKSHARES, INC., DALLAS, TX:
2,585,668, COR. INT. CL. 36.
- TEXAS FARM PRODUCTS COMPANY, NACOGDOCHES, TX:
691,007. REN. 3-26-10. U.S. CL. 46 (INT. CLS. 1, 5, 29, 30, 31 AND 32).
- TEXAS INSTRUMENTS INCORPORATED, DALLAS, TX:
2,753,734, CANC. INT. CL. 9.
- TEXAS SHARPS RIFLE CO., ROCKWALL, TX:
2,751,832, CANC. INT. CL. 13.
- TEXDOT AB, S-431 53 MOLNDAL, SWEDEN:
2,752,870, CANC. INT. CL. 7.
- TEXTURED COATINGS OF AMERICA, INC., LOS ANGELES, CA:
1,618,274. REN. 3-31-10. INT. CL. 2.
2,754,280, CANC. INT. CL. 2.
- TFS FRANCHISE CORPORATION, ROCKLAND, MA:
2,751,737, CANC. MULTIPLE CLASS, INT. CLS. 29 AND 32.
- TGT THREAD GUARD TECHNOLOGY GMBH, D-29525 UELZEN, FED REP GERMANY:
2,349,258. REN. 3-26-10. MULTIPLE CLASS, INT. CLS. 6 AND 21.
- THACO RESEARCH, LTD., MARIETTA, OH:
2,752,133, CANC. INT. CL. 42.
- THAI KEE TRADING CO., INC., SAN JOSE, CA:
2,753,138, CANC. INT. CL. 29.
- THANE INTERNATIONAL, INC., LA QUINTA, CA:
3,786,387, INT. CL. 28.
- THANEXUS, INCORPORATED, MANASQUAN, NJ:
2,753,659, CANC. INT. CL. 35.
2,753,660, CANC. INT. CL. 42.
- THE AMERICAN OUTDOORSMAN, INC., KANSAS CITY, MO:
3,785,221, INT. CL. 41.
- THE ANDERSONS, INC., MAUMEE, OH:
3,784,789, PUB. 2-16-2010. INT. CL. 35.
3,784,793, PUB. 2-16-2010. INT. CL. 9.
- THE ARGENTO WINE COMPANY LIMITED, LONDON, UNITED KINGDOM:
3,785,996, INT. CL. 33.
- THE ARIZONA BREAD FRANCHISE CORPORATION, SCOTTSDALE, AZ:
2,752,374, CANC. MULTIPLE CLASS, INT. CLS. 35 AND 43.
- THE ASH FOX GROUP LLC, LONGMONT, CO:
3,784,233, PUB. 2-16-2010. INT. CL. 25.
- THE ATEK COMPANIES, PLYMOUTH, MN:
3,786,300, MULTIPLE CLASS, INT. CLS. 35, 40 AND 42.
- THE AVALANCHE GROUP, LLC, NEW YORK, NY:
3,785,188, INT. CL. 14.
3,785,189, INT. CL. 14.
- THE BABY NURSE-WHERE BABIES ARE OUR BUSINESS, BROOKLYN, NY:
3,783,549, PUB. 2-16-2010. INT. CL. 45.
- THE BEAR STEARNS COMPANIES INC., NEW YORK, NY:
2,754,595, CANC. INT. CL. 16.
- THE BERTON GROUP LLC, CORAL GABLES, FL:
3,783,383, PUB. 2-16-2010. INT. CL. 9.
- THE BINDING SITE, LTD., BIRMINGHAM, ENGLAND:
3,786,189, INT. CL. 5.
- THE BOLDT GROUP, INC., APPLETON, WI:
3,784,672, PUB. 2-16-2010. MULTIPLE CLASS, INT. CLS. 37 AND 42.
- THE BRAVER CAPITAL GROUP, LLC, MIAMI, FL TO CIGARETTE RACING TEAM, LLC, MIAMI, FL:
2,798,095, CANC. INT. CL. 16.
- THE BROADWAY LEAGUE INC., NEW YORK, NY:
3,783,740, PUB. 2-16-2010. MULTIPLE CLASS, INT. CLS. 35 AND 41.
- THE CAREY GROUP INC., SANTA BARBARA, CA:
3,783,335, PUB. 2-16-2010. INT. CL. 39.
- THE CHARLES W. BOWERS MUSEUM CORPORATION, SANTA ANA, CA:
3,783,507, PUB. 2-16-2010. INT. CL. 41.
- THE CHOCOLATE BAR RESTAURANTS INC., BUFFALO, NY:
3,783,560, PUB. 2-16-2010. INT. CL. 30.
- THE CHRISTIAN REFORMED CHURCH IN NORTH AMERICA, GRAND RAPIDS, MI:
3,783,987, PUB. 2-16-2010. INT. CL. 45.
- THE COLD SPRING FISH AND SUPPLY COMPANY, CAPE MAY, NJ:
3,783,582, PUB. 2-16-2010. INT. CL. 43.
- THE COLORADO PREVENTION CENTER, DENVER, CO:
3,783,961, PUB. 2-16-2010. INT. CL. 42.
- THE CROSBY GROUP, INC., TULSA, OK:
2,358,700. REN. 3-26-10. INT. CL. 6.
- THE DELFIELD COMPANY LLC, WILMINGTON, DE:
1,639,355. REN. 3-27-10. INT. CL. 11.
- THE DREAM MERCHANT COMPANY KFT., BUDAPEST, HUNGARY:
2,900,961. CANC. MULTIPLE CLASS, INT. CLS. 14, 18 AND 24.
- THE DRYER PROS, L.L.C., PHOENIX, AZ:
3,786,461, INT. CL. 11.
- THE DURHAM BULLS BASEBALL CLUB, INC., DURHAM, NC:
3,785,132, MULTIPLE CLASS, INT. CLS. 25 AND 28.
- THE EUROPEAN UNION, REPRESENTED BY THE EUROPEAN COMMISSION, BELGIUM:
3,784,919, PUB. 2-16-2010. MULTIPLE CLASS, INT. CLS. 9, 38, 41 AND 42.
- THE EXPRESS CAFE & BAKERY, LLC, SAVANNAH, GA:
3,786,082, INT. CL. 43.
- THE FURUKAWA ELECTRIC CO., LTD., JAPAN:
3,784,929, PUB. 2-16-2010. MULTIPLE CLASS, INT. CLS. 6, 9, 12, 17 AND 35.
- THE GORDIAN GROUP, INC., MAULDIN, SC:
3,785,489, INT. CL. 35.
- THE HAMPSHIRE COMPANIES LLC, MORRISTOWN, NJ:
3,783,496, PUB. 2-16-2010. MULTIPLE CLASS, INT. CLS. 36 AND 37.
3,783,497, PUB. 2-16-2010. MULTIPLE CLASS, INT. CLS. 36 AND 37.
- THE HAMPTON DOOR COMPANY, INC., WESTFIELD, MA:
3,784,116, PUB. 2-16-2010. INT. CL. 6.
- THE HAPPY TEACHER CAMPAIGN, LLC, GRAND PRAIRIE, TX, DBA THE HAPPY TEACHER CAMPAIGN:
3,783,657, PUB. 2-16-2010. INT. CL. 41.
3,783,667, PUB. 2-16-2010. INT. CL. 41.
- THE HARTZ MOUNTAIN CORPORATION, SECAUCUS, NJ:
2,272,924, CANC. INT. CL. 18.
- THE HOUSE OF TERENCE PROPRIETARY LIMITED, AUSTRALIA:
3,784,865, PUB. 2-16-2010. MULTIPLE CLASS, INT. CLS. 3, 26, 43 AND 44.
- THE HUGHES GROUP, COLUMBIA, MD:
3,785,453, INT. CL. 24.

- THE HUMMINGBIRD SOCIETY, NEWARK, DE:
2,754,602, CANC. INT. CL. 41.
- THE INSTITUTE FOR WORSHIP STUDIES FLORIDA CAMPUS, INC., ORANGE PARK, FL:
3,783,969, PUB. 2-16-2010. INT. CL. 41.
- THE JAM WAREHOUSE SOFTWARE (PTY) LTD, CAPE TOWN, SOUTH AFRICA:
3,288,194, CANC. INT. CL. 9.
- THE JAZZ GROUP, INC., CELEBRATION, FL:
3,784,560, PUB. 2-16-2010. INT. CL. 41.
- THE KINSEY INSTITUTE FOR RESEARCH IN SEX, GENDER, AND REPRODUCTION, INC., BLOOMINGTON, IN:
3,785,417, INT. CL. 16.
3,785,418, INT. CL. 16.
3,785,419, INT. CL. 16.
- THE LIFE SHOP PTE LTD, SINGAPORE, SINGAPORE:
3,784,857, PUB. 2-16-2010. MULTIPLE CLASS, INT. CLS. 20 AND 24.
- THE LIVINGSTON GROUP FOR MARKETING, INC., LONDONDERRY, NH:
3,785,638, MULTIPLE CLASS, INT. CLS. 16 AND 41.
- THE LONGABERGER COMPANY, NEWARK, OH:
2,817,040, CANC. INT. CL. 4.
- THE MARMARA, INC., NEW YORK, NY, DBA MARMARA HUNTINGTON:
2,330,213. REN. 3-26-10. INT. CL. 42.
- THE MCGRAW-HILL COMPANIES, INC., NEW YORK, NY:
2,335,937. REN. 3-26-10. INT. CL. 41.
- THE MEN'S CLUB, INC., CHICAGO, IL:
3,784,177, PUB. 2-16-2010. INT. CL. 35.
- THE NATIONAL GUITAR MUSEUM, LLC, FAIRFIELD, CT:
3,786,390, INT. CL. 41.
- THE NEW YORK STATE WINE AND CULINARY CENTER, INC., CANANDAIGUA, NY:
3,785,612, MULTIPLE CLASS, INT. CLS. 35 AND 41.
- THE ODD COUPLE, LLC, EAST GREENWICH, RI:
3,783,985, PUB. 2-16-2010. INT. CL. 9.
- THE ONTARIO KNIFE COMPANY, FRANKLINVILLE, NY:
3,785,770, INT. CL. 8.
- THE ORIGINAL WINDHOME, INC., BOTHELL, WA:
2,753,272, CANC. INT. CL. 43.
- THE PIG BOYS, INC., SALT LAKE CITY, UT, DBA CHARLOTTE'S BAKERY:
3,783,794, PUB. 2-16-2010. INT. CL. 30.
- THE PILLSBURY COMPANY, LLC, MINNEAPOLIS, MN:
3,786,194, INT. CL. 30.
- THE PNC FINANCIAL SERVICES GROUP, INC., PITTSBURGH, PA:
3,785,310, INT. CL. 36.
3,785,365, INT. CL. 36.
3,785,366, INT. CL. 36.
- THE POLLIN GROUP LLC, CHEVY CHASE, MD:
3,783,277, PUB. 2-16-2010. INT. CL. 41.
- THE PROCTER & GAMBLE COMPANY, CINCINNATI, OH:
3,785,930, INT. CL. 5.
- THE RAY CHARLES FOUNDATION, LOS ANGELES, CA:
3,786,176, INT. CL. 41.
- THE READING STAGE, LLC, NEW YORK, NY, DBA PHONICS FANTASY THEATER:
3,783,689, PUB. 2-16-2010. INT. CL. 9.
3,783,691, PUB. 2-16-2010. INT. CL. 41.
- THE RIDGEFIELD'S BRAND CORPORATION, MONTGOMERY VILLAGE, MD:
2,752,569, CANC. INT. CL. 32.
- THE ROBERTS LAW FIRM, A PROFESSIONAL CORPORATION, TYLER, TX, DBA ROBERTS & ROBERTS:
3,784,379, PUB. 2-16-2010. INT. CL. 45.
3,784,752, PUB. 2-16-2010. INT. CL. 45.
- THE RONALD REAGAN PRESIDENTIAL LIBRARY FOUNDATION, SIMI VALLEY, CA:
3,786,245, INT. CL. 43.
- THE SENIOR FINANCIAL CENTER, INC., ROCKVILLE CENTRE, NY:
3,783,484, PUB. 2-16-2010. INT. CL. 36.
- THE SHERWIN-WILLIAMS COMPANY, CLEVELAND, OH:
3,785,933, INT. CL. 4.
- THE SMEAD MANUFACTURING COMPANY, HASTINGS, MN:
3,785,636, INT. CL. 16.
- THE SOUTHERN POVERTY LAW CENTER, INC., MONTGOMERY, AL:
3,785,752, MULTIPLE CLASS, INT. CLS. 41 AND 45.
- THE SPORTSMAN'S GUIDE, INC., SOUTH ST. PAUL, MN:
3,786,406, MULTIPLE CLASS, INT. CLS. 6 AND 12.
- THE SPORTSMAN'S GUIDE, INC., SOUTH ST. PAUL, MN:
3,786,409, MULTIPLE CLASS, INT. CLS. 6 AND 12.
- THE STANDISH WINE COMPANY PTY LTD, AUSTRALIA:
3,784,931, PUB. 2-16-2010. INT. CL. 33.
- THE STEPS PARTNERSHIP, AUSTIN, TX:
3,784,442, PUB. 2-16-2010. INT. CL. 9.
- THE STOCKROOM, INC., LOS ANGELES, CA:
3,784,069, PUB. 2-16-2010. MULTIPLE CLASS, INT. CLS. 41 AND 42.
- THE SUSAN G. KOMEN BREAST CANCER FOUNDATION, INC., DALLAS, TX:
3,783,800, PUB. 2-16-2010. INT. CL. 35.
- THE TIMKEN COMPANY, CANTON, OH:
3,785,592, INT. CL. 7.
- THE TORN CURTAIN LLC, HARTSELLE, AL:
3,784,013, PUB. 2-16-2010. INT. CL. 41.
- THE TORO COMPANY, BLOOMINGTON, MN:
3,785,237, INT. CL. 7.
- THE TRAVELERS INDEMNITY COMPANY, HARTFORD, CT:
3,785,247, INT. CL. 36.
- THE TRIZETTO GROUP, INC., NEWPORT BEACH, CA:
2,751,703, CANC. MULTIPLE CLASS, INT. CLS. 35 AND 36.
- THE TRUSTEE OF THE STUART FAMILY TRUST, A TRUST COMPRISING RON CURTIS A UNITED STATES CITIZEN, NEW YORK, NY:
3,785,250, INT. CL. 3.
- THE TRUSTEES OF THE JAMES BRYSON SHEPHERD TRUST, ARLINGTON, TX:
2,754,565, CANC. INT. CL. 11.
- THE TRUSTEES OF THE SUZANNE C. SAPERSTEIN LIVING TRUST, CULVER CITY, CA:
3,785,945, INT. CL. 41.
- THE TRUSTEES OF THE TELDX AUSTRALIA TRUST, AN AUSTRALIAN TRUST, THE TRUSTEES COMPRISING OF TELDX HOLDING PTY LTD., AN AUSTRALIAN COMPANY, ZILLMERE, 4034, QLD, AUSTRALIA:
3,783,391, PUB. 2-16-2010. INT. CL. 35.
- THE TRUSTEES OF THE THE SAMSON HOLDING TRUST, DATED DECEMBER 12, 2005, BEVERLY HILLS, CA:
3,783,752, PUB. 2-16-2010. INT. CL. 41.
- THE UNIVERSITY OF KANSAS, LAWRENCE, KS:
3,783,427, PUB. 2-16-2010. MULTIPLE CLASS, INT. CLS. 42 AND 44.
- THE VENUS PROJECT, INC., VENUS, FL:
3,784,705, PUB. 2-16-2010. INT. CL. 35.
- THE VILLAGE COMPANY, LLC, CHASKA, MN:
2,338,710. REN. 3-26-10. INT. CL. 3.
2,338,710, CANC. INT. CL. 28.
- THE VILLAGE TAVERN, INC., WINSTON-SALEM, NC:
3,783,802, PUB. 2-16-2010. INT. CL. 43.
- THE WEATHER CHANNEL, INC., ATLANTA, GA:
3,785,081, INT. CL. 41.
- THE WICKLES COMPANY, BIRMINGHAM, AL:
3,783,696, PUB. 2-16-2010. INT. CL. 30.
- THE WILDLIFE EXPERIENCE, INC., PARKER, CO:
2,752,986, CANC. INT. CL. 41.
- THE WINE GROUP LLC, LATHROP, CA TO THE WINE GROUP LLC, LATHROP, CA:
2,754,175, CANC. INT. CL. 33.
- THE WINERY AT WILCOX, INC., WILCOX, PA:
3,784,295, PUB. 2-16-2010. MULTIPLE CLASS, INT. CLS. 25 AND 41.
3,784,299, PUB. 2-16-2010. MULTIPLE CLASS, INT. CLS. 25 AND 41.
- THE WIZ QUIZ, LLC, SILVER SPRING, MD:
3,784,462, PUB. 2-16-2010. INT. CL. 44.

- THE WONDER FORGE, LLC, SEATTLE, WA:
3,784,663, PUB. 2-16-2010. INT. CL. 28.
3,784,739, PUB. 2-16-2010. INT. CL. 28.
- THE WORD FOR TODAY, SANTA ANA, CA:
3,783,402, PUB. 2-16-2010. INT. CL. 16.
3,783,403, PUB. 2-16-2010. INT. CL. 9.
- THE WRESTLING ZONE, INC., NEW YORK, NY:
3,783,275, PUB. 2-16-2010. INT. CL. 9.
- THE WRITTEN WORD INC., RENTON, WA, DBA PORTENT INTERACTIVE:
2,753,335, CANC. MULTIPLE CLASS, INT. CLS. 25 AND 28.
- THEN MASCHINEN GMBH, SCHWABISCH HALL, FED REP GERMANY:
3,784,828, PUB. 7-3-2007. MULTIPLE CLASS, INT. CLS. 7, 9 AND 11.
- THEORY LLC, NEW YORK, NY:
2,338,012, AM. INT. CL. 25.
2,802,700, COR. MULTIPLE CLASS, INT. CLS. 18, 25 AND 35.
3,004,691, COR. INT. CL. 14.
- THERAGENICS CORPORATION, BUFORD, GA:
1,603,353, REN. 3-31-10. INT. CL. 5.
- THERMAL CORP., WILMINGTON, DE:
2,754,482, CANC. INT. CL. 11.
- THERMO KING CORPORATION, MINNEAPOLIS, MN:
522,496, REN. 3-26-10. U.S. CL. 31 (INT. CL. 11).
- THERMOGENESIS CORPORATION, RANCHO CORDOVA, CA:
3,785,282, INT. CL. 10.
- THERMOS L.L.C., ROLLING MEADOWS, IL:
2,330,063, REN. 3-30-10. INT. CL. 21.
- THICKER THAN WATER, FENTON, MI:
3,784,592, PUB. 2-16-2010. INT. CL. 41.
- THINGS 4 STRINGS, LLC, WEST ORANGE, NJ:
3,785,460, INT. CL. 15.
- THINKING VENTS, INC., MAMARONECK:
1,552,585, CANC. MULTIPLE CLASS, INT. CLS. 9 AND 11.
- THIRD FEDERAL SAVINGS AND LOAN ASSOCIATION OF CLEVELAND, CLEVELAND, OH, DBA THIRD FEDERAL SAVINGS:
2,386,800, REN. 3-26-10. INT. CL. 36.
- THIS WORKS LIMITED, NEWPORT, UNITED KINGDOM:
3,783,191, PUB. 12-9-2008. MULTIPLE CLASS, INT. CLS. 3 AND 21.
- THOMAS & BETTS INTERNATIONAL, INC., WILMINGTON, DE:
2,342,687, REN. 3-31-10. INT. CL. 8.
- THOMAS & BETTS INTERNATIONAL, INC., SPARKS, NV:
2,753,508, CANC. INT. CL. 9.
- THOMAS & THOMAS RODMAKERS, INC., TURNER FALLS, MA:
2,753,636, CANC. INT. CL. 28.
- THOMAS AND KING, INC., LEXINGTON, KY:
3,785,350, INT. CL. 43.
- THOMAS M. COOLEY LAW SCHOOL, LANSING, MI:
1,587,177, REN. 3-26-10. INT. CL. 41.
- THOMAS ROBERT KAEMMERLING, MENOMONEE FALLS, WI:
3,783,322, PUB. 2-16-2010. INT. CL. 12.
- THOMAS, JAMES. (J.R.) III, PORT HUENEME, CA:
2,754,551, CANC. INT. CL. 25.
- THOMAS, LORRIE, SANTA BARBARA, CA:
3,785,633, INT. CL. 35.
- THOMPSON, TED A., WOODINVILLE, WA:
3,785,841, INT. CL. 25.
- THOMSON SAVAGE & CO (PTY) LIMITED, DURBAN, SOUTH AFRICA:
2,753,909, CANC. INT. CL. 25.
- THOR TECH, INC., SAGINAW, MI:
2,367,813, REN. 3-26-10. INT. CL. 12.
- THORSTEINN GARDARSSON, ICELAND:
3,785,038, PUB. 2-16-2010. INT. CL. 16.
- THQ INC., AGOURA HILLS, CA:
3,784,760, PUB. 2-16-2010. INT. CL. 9.
- THREE DOG BAKERY, INC., KANSAS CITY, MO:
3,785,821, INT. CL. 31.
3,785,822, INT. CL. 31.
- THUMB WORLD PRODUCTIONS LLC, NEW YORK, NY:
3,786,305, INT. CL. 25.
- THUNDERWEAR, INC., SAN CLEMENTE, CA:
1,552,975, CANC. INT. CL. 25.
- THURELLA AG, 9322 EGNACH, SWITZERLAND:
2,751,772, CANC. INT. CL. 32.
- THURSTON MFG. CO., SMITHFIELD, RI:
139,645, REN. 3-26-10. U.S. CL. 23 (INT. CL. 7).
- TI GOLF HOLDINGS INC., NEW YORK, NY:
2,754,064, CANC. INT. CL. 16.
- TIANJIN DAWNING; COMPUTER INDUSTRY CO., LTD., TIANJIN, CHINA:
3,785,024, PUB. 2-16-2010. MULTIPLE CLASS, INT. CLS. 9, 37, 38 AND 42.
- TIARE TECHNOLOGY, INC., CHERRY HILL, NJ:
2,752,741, CANC. INT. CL. 9.
- TIBCO SOFTWARE INC., PALO ALTO, CA:
2,753,705, CANC. INT. CL. 9.
3,786,346, INT. CL. 41.
- TICKLES, SAN ANTONIO, TX:
2,753,347, CANC. INT. CL. 14.
- TIFFARA INTERNATIONAL, INC., HIALEAH GARDEN, FL:
1,552,962, CANC. INT. CL. 25.
- TIGER AIR SERVICES, INC., LARGO, FL:
2,752,442, CANC. INT. CL. 37.
- TIGER STYLE LLC, SHELDON, VT:
3,784,292, PUB. 2-16-2010. INT. CL. 9.
3,784,294, PUB. 2-16-2010. INT. CL. 9.
- TIMBERLAND COMPANY, THE, STRATHAM, NH:
2,884,510, CANC. INT. CL. 14.
- TIMBREN INDUSTRIES INCORPORATED, WHITBY ONTARIO, CANADA, AEON PRODUCTS (LONDON) LIMITED, LONDON, N.W. 2, ENGLAND:
684,651, REN. 3-26-10. U.S. CL. 13 (INT. CL. 20).
- TIMCO, INC., BUCHANAN, NY:
3,783,719, PUB. 2-16-2010. INT. CL. 17.
- TIME INC., NEW YORK, NY:
2,405,161, REN. 3-31-10. INT. CL. 16.
3,785,390, INT. CL. 41.
- TIMELINES, INC., CHICAGO, IL:
3,784,720, PUB. 2-16-2010. INT. CL. 42.
- TIMEX GROUP B.V., 1075 AD AMSTERDAM, NETHERLANDS:
2,754,261, CANC. INT. CL. 14.
- TIN INC., AUSTIN, TX:
3,784,467, PUB. 2-16-2010. INT. CL. 1.
- TINUBU, GLORIA BROMELL, ATLANTA, GA:
3,785,128, MULTIPLE CLASS, INT. CLS. 35 AND 36.
- TINY SLEEPER, LLC, HUMBLE, TX:
3,783,921, PUB. 2-16-2010. INT. CL. 20.
- TIPPMANN SPORTS, LLC, BUFFALO GROVE, IL:
3,785,750, INT. CL. 28.
- TIRE GUARD USA, FULLERTON, CA:
2,752,221, CANC. INT. CL. 9.
- TISHCON CORP., WESTBURY, NY:
2,322,335, REN. 3-31-10. INT. CL. 5.
2,404,811, REN. 3-31-10. INT. CL. 5.
- TISHMAN SPEYER PCVST MANAGEMENT, L.L.C., NEW YORK, NY:
3,783,264, PUB. 2-16-2010. MULTIPLE CLASS, INT. CLS. 38 AND 41.
- TL MALONE ENTERPRISES, INC., MENDON 14506, NY:
3,786,356, INT. CL. 44.
- TLSP TRADEMARKS, INC., KING OF PRUSSIA, PA:
2,754,020, CANC. INT. CL. 35.
- TMF HEALTH QUALITY INSTITUTE, AUSTIN, TX:
3,784,181, PUB. 2-16-2010. INT. CL. 35.
3,784,184, PUB. 2-16-2010. INT. CL. 41.
3,784,185, PUB. 2-16-2010. MULTIPLE CLASS, INT. CLS. 42 AND 44.
3,784,199, PUB. 2-16-2010. INT. CL. 35.
3,784,201, PUB. 2-16-2010. INT. CL. 41.
3,784,202, PUB. 2-16-2010. MULTIPLE CLASS, INT. CLS. 42 AND 44.

TNEMEC COMPANY, INC., KANSAS CITY, MO:
3,784,715, PUB. 2-16-2010. INT. CL. 2.

TNT APPAREL, INC., SEWAREN, NJ:
3,784,172, PUB. 2-16-2010. INT. CL. 25.

TOBY NYC CORP., NEW YORK, NY:
2,752,464, CANC. MULTIPLE CLASS, INT. CLS. 18 AND 24.

TOCAD ENERGY CO., LTD., OTA-KU, TOKYO, JAPAN, SUNPAK CORPORATION, SHIBUYA-KU, TOKYO, JAPAN:
888,229. REN. 3-26-10. U.S. CL. 26 (INT. CL. 9).

TOCRIS COOKSON INC., ELLISVILLE, MO:
2,752,458, CANC. INT. CL. 1.

TODD, TODD SHANNE, MCCALL CREEK, MS, DBA PINK-NECK UNLIMITED:
3,786,408, INT. CL. 25.

TOI CORPORATION, RENO, NV:
1,552,938, CANC. INT. CL. 21.

TOILEFRESH, INC., MARION, MS:
1,552,750, CANC. INT. CL. 11.

TOJ ENTERPRISES, LLC, NEW YORK, NY:
3,785,910, INT. CL. 44.

TOKUYAMA DENTAL CORPORATION, TOKYO, JAPAN:
2,878,274, CANC. MULTIPLE CLASS, INT. CLS. 3, 10 AND 11.

TOLEDO ARENA SPORTS INC., TOLEDO, OH, DBA TOLEDO WALLEY CORPORATION:
3,784,669, PUB. 2-16-2010. MULTIPLE CLASS, INT. CLS. 25 AND 41.

TOLEDO ARENA SPORTS, INC., TOLEDO, OH, DBA TOLEDO WALLEYE:
3,784,670, PUB. 2-16-2010. INT. CL. 41.

TOLEDO GEARMOTOR COMPANY, INC., SYLVANIA, OH:
1,598,201. REN. 3-31-10. INT. CL. 7.

TOLOMATIC, INC., HAMEL, MN:
3,203,603, AM. INT. CL. 7.
3,214,929, AM. INT. CL. 7.

TOM & NICOLE TROLI REALTY, INC., CLAREMONT, CA:
3,783,981, PUB. 2-16-2010. INT. CL. 36.

TOM JENKINS' BAR-B-Q, INC., FORT LAUDERDALE, FL:
2,387,652. REN. 3-30-10. INT. CL. 42.

TOM'S OF MAINE, INC., KENNEBUNK, ME:
3,785,106, INT. CL. 3.

TOMAS ANTHONY, BROOKLYN, NY:
3,784,238, PUB. 2-16-2010. INT. CL. 41.

TOMAS SANDOVAL & MATIAS R. MEZA PARTNERSHIP, THE, GLENDORA, CA:
2,752,676, CANC. MULTIPLE CLASS, INT. CLS. 9 AND 41.

TOMKATS, INC., NASHVILLE, TN:
2,279,608. REN. 3-29-10. INT. CL. 25.

TOMMY R. HARDY, DULUTH, GA:
3,785,613, INT. CL. 35.

TOMS GRUPPEN A/S, BALLERUP, DENMARK:
2,751,616, CANC. INT. CL. 30.

TOOLCO, INC., UNION, MO:
3,784,400, PUB. 2-16-2010. INT. CL. 8.

TOOTSIE ROLL INDUSTRIES, LLC, CHICAGO, IL, CHARMS MARKETING COMPANY, CHICAGO, IL:
2,433,949. REN. 3-27-10. INT. CL. 30.

TOOTSIE ROLL INDUSTRIES, LLC, CHICAGO, IL:
3,784,831, PUB. 2-16-2010. INT. CL. 30.

TOP DECK SYSTEMS, INC., CLINTON TOWNSHIP, MI:
2,752,242, CANC. MULTIPLE CLASS, INT. CLS. 6 AND 19.

TOP FORM, DRAPER, UT:
3,783,989, PUB. 2-16-2010. INT. CL. 5.

TOP THAT PUBLISHING PLC, WOODBRIDGE, IP12 1AP, UNITED KINGDOM:
2,753,859, CANC. INT. CL. 16.

TORAY KABUSHIKI KAISHA, CHUO-KU, TOKYO, JAPAN, TA TORAY INDUSTRIES, INC.:
2,752,386, CANC. MULTIPLE CLASS, INT. CLS. 22 AND 23.

TORONTO-DOMINION BANK, THE, TORONTO, ONTARIO:
2,750,706, CANC. INT. CL. 36.

TOSHIBA DENCHI KABUSHIKI KAISHA, SHINAGAWA-KU, TOKYO, JAPAN, DBA TOSHIBA BATTERY CO., LTD.:
2,751,893, CANC. INT. CL. 9.

TOSHIBA INTERNATIONAL CORPORATION, HOUSTON, TX:
3,785,682, INT. CL. 9.

TOSYALI INTERNATIONAL INC., TUSCALOOSA, AL:
3,785,971, INT. CL. 14.

TOUCHDOWN MARKETING CORP., MIAMI, FL:
2,753,657, CANC. INT. CL. 3.

TOUPS, SHARON, SALVATO, BRYAN, TX:
2,753,003, CANC. INT. CL. 41.

TOWER GROUP, INC., NEW YORK, NY:
3,786,435, INT. CL. 36.

TOWERS, PERRIN, FORSTER & CROSBY, INC., PHILADELPHIA, PA:
1,552,704, CANC. INT. CL. 9.

TOWHAUL CORPORATION, BOZEMAN, MT:
2,335,109. REN. 3-29-10. INT. CL. 7.
2,335,110. REN. 3-27-10. INT. CL. 7.
2,335,111. REN. 3-27-10. INT. CL. 40.

TOY WORKS, INC., THE, MIDDLE FALLS, NY:
2,754,148, CANC. INT. CL. 24.

TOYO BOSEKI KABUSHIKI KAISHA, KITA-KU, OSAKA, JAPAN, DBA TOYOBO CO., LTD.:
1,132,233. REN. 3-31-10. INT. CL. 22.

TOYODA GOSEI CO., LTD., KIYOSU-SHI, AICHI-KEN, JAPAN:
2,339,523. REN. 4-1-10. INT. CL. 11.

TPI ACQUISITION SUBSIDIARY, INC., SOMERVILLE, NJ, AMERACE CORPORATION, NEW YORK, NY:
1,132,212. REN. 3-31-10. INT. CL. 17.

TPI HOLDINGS, INC., NORFOLK, VA:
3,783,670, PUB. 2-16-2010. INT. CL. 16.

TR-BIZ, L.L.C., LAS VEGAS, NV:
3,783,298, PUB. 2-16-2010. INT. CL. 9.
3,783,299, PUB. 2-16-2010. INT. CL. 9.

TRAC-WORK, INC., ENNIS, TX:
2,432,894. REN. 3-30-10. INT. CL. 37.

TRACKER MARINE, L.L.C., SPRINGFIELD, MO:
3,785,407, MULTIPLE CLASS, INT. CLS. 12 AND 35.

TRADE FIXTURES, LLC, LITTLE ROCK, AR:
2,332,595. REN. 3-26-10. INT. CL. 21.

TRADERISING CORPORATION, ARLINGTON, VA:
3,785,456, INT. CL. 9.
3,785,457, INT. CL. 9.

TRADERPLANET.COM, LLC, WESLEY CHAPEL, FL:
3,785,830, INT. CL. 42.

TRAFFIC PLANNING AND DESIGN, INC., POTTSTOWN, PA:
2,328,899. REN. 3-26-10. INT. CL. 42.

TRAFFICMARKETPLACE, INC., EL SEGUNDO, CA:
3,784,150, PUB. 2-16-2010. INT. CL. 35.

TRAIL BLAZERS, INC., PORTLAND, OR:
2,752,900, CANC. INT. CL. 35.

TRANS CALIFORNIA, INC., WOODLAND HILLS, CA:
2,335,759. REN. 3-27-10. INT. CL. 39.

TRANSCO, INC., WEST COLUMBIA, SC:
2,273,016, CANC. INT. CL. 9.

TRANSGENOMIC, INC., OMAHA, NE:
3,784,689, PUB. 2-16-2010. INT. CL. 42.

TRANSGLOBAL COMMUNICATIONS GROUP INC., EDMONTON, ALBERTA, CANADA:
2,751,840, CANC. INT. CL. 16.
2,751,842, CANC. INT. CL. 16.

TRANSMISSION DEVELOPERS INC., TORONTO, CANADA:
3,785,673, INT. CL. 9.

TRANSMONTAIGNE INC., DENVER, CO:
3,783,938, PUB. 2-16-2010. MULTIPLE CLASS, INT. CLS. 35, 39 AND 40.

TRANSPERFECT TRANSLATIONS INTERNATIONAL INC., NEW YORK, NY:
3,786,379, MULTIPLE CLASS, INT. CLS. 35, 39, 40 AND 42.

TRANSWORLD PLUSH TOYS, INC., LOS ANGELES, CA:
2,753,856, CANC. INT. CL. 18.

- TRANSZAP, INC., DENVER, CO:
3,786,369, INT. CL. 35.
- TRAVEL TAINMENT AG, 52146 WÜRSELEN/AACHEN,
FED REP GERMANY:
3,784,981, PUB. 2-16-2010. MULTIPLE CLASS, INT. CLS.
9, 35, 38, 39 AND 42.
- TRAVERSE CITY CONVENTION & VISITORS BUREAU,
TRAVERSE CITY, MI:
2,273,093, CANC. INT. CL. 35.
- TREJO, ANDY, PALATINE, IL:
3,784,405, PUB. 2-16-2010. INT. CL. 45.
- TREK BICYCLE CORPORATION, WATERLOO, WI:
3,784,030, PUB. 2-16-2010. INT. CL. 25.
- TREND-LINES, INC., CHELSEA, MA:
1,553,312, CANC. INT. CL. 42.
- TREVILON CORPORATION, OAK HILL, VA:
2,752,336, CANC. INT. CL. 9.
- TREVINO, LEOBARDO, HIDALGO, TX:
3,786,174, INT. CL. 30.
- TRI-FORM POLY INC., WINNIPEG, MANITOBA, CANADA:
3,783,210, PUB. 2-16-2010. INT. CL. 7.
- TRI-TRONICS, INC., TUCSON, AZ:
3,784,481, PUB. 2-16-2010. INT. CL. 9.
- TRIAGE FIRST, INC., FAIRVIEW, NC:
3,784,433, PUB. 2-16-2010. INT. CL. 41.
3,784,446, PUB. 2-16-2010. INT. CL. 41.
3,784,448, PUB. 2-16-2010. INT. CL. 41.
3,784,512, PUB. 2-16-2010. INT. CL. 16.
- TRIANTECH TECHNOLOGIES (2005) INC., VANCOUVER B.C.,
CANADA:
2,271,304, CANC. MULTIPLE CLASS, INT. CLS. 9 AND
42.
- TRIARCO INDUSTRIES, INC., WAYNE, NJ:
3,785,378, INT. CL. 5.
3,785,406, INT. CL. 5.
- TRIBUTES, INC., BOSTON, MA:
3,784,817, PUB. 2-16-2010. MULTIPLE CLASS, INT. CLS.
35, 36 AND 45.
- TRICAT, INCORPORATED, HUNT VALLEY, MD:
2,752,481, CANC. INT. CL. 1.
- TRIM CLASSIC BARBER, LLC, NASHVILLE, TN:
2,335,486, REN. 3-26-10. INT. CL. 42.
2,335,487, REN. 3-26-10. INT. CL. 42.
2,335,488, REN. 3-26-10. INT. CL. 42.
- TRIMNELL, MARILYN GRATIA, BRANKSOME PARK, UNI-
TED KINGDOM:
3,783,166, PUB. 2-16-2010. MULTIPLE CLASS, INT. CLS.
1, 4 AND 21.
- TRINITY SAFETY SUPPLY, INC., FORT WORTH, TX, DBA
TRINITY SAFETY SUPPLY:
3,784,426, PUB. 2-16-2010. INT. CL. 9.
- TRIPLE NET PROPERTIES, L.L.C., SANTA ANA, CA:
2,752,348, CANC. MULTIPLE CLASS, INT. CLS. 35 AND
36.
- TRIPLE 7 GLOBAL, INC., LOS ANGELES, CA:
3,784,688, PUB. 2-16-2010. INT. CL. 18.
- TRITON PRESTIGE PRODUCTS, INC., ALPHARETTA, GA:
2,752,269, CANC. INT. CL. 30.
- TROPICAL KEY, INC., MIAMI, FL:
2,753,043, CANC. MULTIPLE CLASS, INT. CLS. 30 AND
35.
- TROPICANA PRODUCTS, INC., BRADENTON, FL:
1,553,149, CANC. INT. CL. 32.
- TROUBADOUR, INC., CHESNUT HILL, MA:
1,619,840, REN. 3-31-10. INT. CL. 16.
- TRS QUALITY, INC., FORT WORTH, TX:
2,753,016, CANC. INT. CL. 9.
- TRU CORPORATION, PEABODY, MA:
2,341,770, REN. 3-31-10. INT. CL. 9.
- TRUCKING DUCK LIMITED, LONDON EC3M 1JP, UNI-
TED KINGDOM:
2,752,115, CANC. INT. CL. 36.
- TRUE SPIRIT TRIO, CLARKSVILLE, TN:
3,785,852, INT. CL. 41.
- TRUE VALUE COMPANY, CHICAGO, IL:
3,785,343, INT. CL. 11.
3,785,356, INT. CL. 9.
3,785,357, INT. CL. 20.
3,785,358, INT. CL. 22.
- TRUESHOPPING, INC., DULUTH, GA:
2,753,370, CANC. INT. CL. 9.
- TRUESLANT, INC., NEW YORK, NY:
3,785,689, INT. CL. 41.
3,785,691, INT. CL. 41.
- TRUGREEN LIMITED PARTNERSHIP, MEMPHIS, TN:
3,785,720, INT. CL. 37.
3,785,721, INT. CL. 37.
- TRULITE, INC., HOUSTON, TX:
3,785,134, INT. CL. 9.
- TRULY TUBULAR FITTING CORPORATION, MOUNT
VERNON, NY:
2,389,074, REN. 3-31-10. INT. CL. 6.
- TRUMEDIA NETWORKS, INC., BOSTON, MA:
3,785,600, INT. CL. 42.
- TRUOX, INC., MCCLELLAN, CA:
3,786,465, INT. CL. 1.
- TRUPER HERRAMIENTAS, S.A. DE C.V., JILOTEPEC, EDO.
MÉXICO, MEXICO:
3,784,517, PUB. 2-16-2010. INT. CL. 8.
3,784,700, PUB. 2-16-2010. INT. CL. 11.
- TRUST U/W WILLIAM J. BASIE F/B/O DIANE L. BASIE,
NEW YORK, NY:
3,783,822, PUB. 2-16-2010. MULTIPLE CLASS, INT. CLS. 9
AND 41.
3,783,823, PUB. 2-16-2010. MULTIPLE CLASS, INT. CLS. 9
AND 41.
- TRUSTEES OF THE URANTIA FOUNDATION TRUST,
COMPRISED OF RICHARD KEELER, MO SIEGEL, E.
KWAN CHOI AND F. GARD JAMESON, ALL U.S.
CITIZENS AND GEORGES MICHELSON-DUPONT, A
FRENCH CITIZEN, CHICAGO, IL:
2,753,539, CANC. INT. CL. 18.
- TRX, INC., ATLANTA, GA:
3,785,208, MULTIPLE CLASS, INT. CLS. 9, 35 AND 42.
- TSA STORES, INC., ENGLEWOOD, CO:
2,753,632, CANC. INT. CL. 25.
- TSCO, INCORPORATED, OXNARD, CA, DBA PINK PEP-
PERCORN PRESS:
3,784,686, PUB. 2-16-2010. INT. CL. 41.
- TST/IMPRESSO, INC., COPPELL, TX:
1,552,848, CANC. INT. CL. 16.
- TSUMURA & CO., MINATO-KU, TOKYO, JAPAN:
3,783,616, PUB. 2-16-2010. INT. CL. 5.
3,783,617, PUB. 2-16-2010. INT. CL. 5.
- TUCCIARONE, JOSEPH W., WOODBURY, NY:
3,784,048, PUB. 2-16-2010. INT. CL. 36.
- TUCKER FOOD PRODUCTS, INC., ST. LOUIS, MO:
2,288,269, REN. 3-29-10. INT. CL. 30.
- TUI NEDERLAND N.V., NETHERLANDS:
3,785,037, PUB. 2-16-2010. MULTIPLE CLASS, INT. CLS.
35, 38, 39, 41 AND 43.
- TULIP BOUTIQUE, INC., CALABASAS, CA:
2,752,395, CANC. INT. CL. 3.
- TULIP INTERNATIONAL, INC., SEOUL, REPUBLIC OF
KOREA:
3,783,105, PUB. 2-16-2010. INT. CL. 32.
- TUMI, INC., SOUTH PLAINFIELD, NJ:
2,433,970, REN. 3-31-10. INT. CL. 18.
- TUPPERWARE PRODUCTS S.A., FRIBOURG CH-1700,
SWITZERLAND:
3,786,048, INT. CL. 21.
- TURFGRASS MANAGEMENT, INC., ALBION, ID, DBA
GRIGG BROS.:
3,784,850, PUB. 2-16-2010. INT. CL. 1.
- TURIN NETWORKS, INC., PETALUMA, CA:
2,751,789, CANC. INT. CL. 9.
2,751,790, CANC. INT. CL. 9.
- TURNBERRY DEVELOPMENT, LLC, AVENTURA, FL:
2,335,547, REN. 3-26-10. INT. CL. 36.

- TUSKEGEE AIRMEN NATIONAL HISTORICAL MUSEUM, THE, DETROIT, MI:
3,783,096, PUB. 2-16-2010. INT. CL. 41.
3,783,097, PUB. 2-16-2010. INT. CL. 41.
- TUSKER TRAIL & SAFARI CO., INCLINE VILLAGE, NV:
2,753,135, CANC. INT. CL. 39.
- TUTHILLTOWN SPIRITS, LLC, GARDINER, NY:
3,783,516, PUB. 2-16-2010. INT. CL. 33.
- TWA AIRLINES, LLC, DFW AIRPORT, TX:
2,751,957, CANC. INT. CL. 16.
- TWENTIETH CENTURY FOX FILM CORPORATION, LOS ANGELES, CA:
3,783,568, PUB. 2-16-2010. INT. CL. 41.
3,784,518, PUB. 2-16-2010. INT. CL. 41.
3,784,725, PUB. 2-16-2010. INT. CL. 16.
- TWINSTRATA, INC., NATICK, MA. AKA TWINSTRATA:
3,785,876, MULTIPLE CLASS, INT. CLS. 9 AND 42.
- TWO BICYCLES AND A MAP, LTD, MADISON, WI:
2,282,261. REN. 3-26-10. INT. CL. 35.
- TYBOOK INC., KANSAS CITY, KS:
3,786,080, INT. CL. 16.
- TYCO ELECTRONICS CORPORATION, BERWYN, PA:
702,493. REN. 3-26-10. U.S. CL. 21 (INT. CL. 11).
2,374,752. REN. 3-26-10. INT. CL. 9.
- TYCO ELECTRONICS CORPORATION, BERWYN, PA,
TYCO ELECTRONICS CORPORATION, BERWYN, PA:
2,380,022. REN. 3-26-10. INT. CL. 17.
- TYCO ELECTRONICS CORPORATION, BERWYN, PA:
3,783,842, PUB. 2-16-2010. INT. CL. 16.
- TYCO HEALTHCARE GROUP LP, MANSFIELD, MA:
2,283,253. REN. 3-26-10. INT. CL. 10.
2,341,390. REN. 3-31-10. INT. CL. 10.
- TYLER CO., INC., THE, HUDSON, MA:
3,784,147, PUB. 2-16-2010. INT. CL. 9.
- TYR SPORT, INC., HUNTINGTON BEACH, CA:
3,786,397, INT. CL. 28.
- TYRA LOPEZ, STAMFORD, CT:
3,786,444, INT. CL. 37.
- TYSON FOODS, INC., SPRINGDALE, AR:
3,785,574, INT. CL. 29.
- TZENG SHYNG INDUSTRIES CORP., TAINAN HSIEN, TAIWAN:
3,785,371, MULTIPLE CLASS, INT. CLS. 9, 11, 16, 20, 21 AND 28.
- T3 REALTY ADVISORS, LLC, WALTHAM, MA:
2,753,257, CANC. INT. CL. 36.
- U.C COATINGS CORPORATION, BUFFALO, NY:
3,784,339, PUB. 2-16-2010. INT. CL. 2.
3,784,344, PUB. 2-16-2010. INT. CL. 2.
- U.S BANK NATIONAL ASSOCIATION, MINNEAPOLIS, MN:
2,754,161, CANC. INT. CL. 30.
2,754,294, CANC. INT. CL. 30.
2,754,544, CANC. INT. CL. 30.
- U.S. INTERACTIVE CORP., SANTA CLARA, CA:
2,359,736. REN. 3-31-10. MULTIPLE CLASS, INT. CLS. 35 AND 42.
- U.S. PROPERTIES GROUP, INC., GAHANNA, OH:
3,784,719, PUB. 2-16-2010. INT. CL. 36.
- U.S. TRAVEL ASSOCIATION, WASHINGTON, DC:
2,363,412. REN. 3-26-10. INT. CL. 38.
- U.S. VISION, INC., GLENDORA, NJ:
3,785,455, INT. CL. 9.
3,785,565, INT. CL. 9.
- UBELONG LLC, WASHINGTON, DC, DBA UBELONG:
3,784,522, PUB. 2-16-2010. INT. CL. 35.
- UBIEST SPA, ITALY:
3,784,902, PUB. 2-16-2010. MULTIPLE CLASS, INT. CLS. 35, 38, 42 AND 45.
- UBIQUITY RECORDINGS, INC., COSTA MESA, CA:
2,351,787. REN. 4-1-10. INT. CL. 9.
- UBM MEDICA LLC, JERSEY CITY, NJ:
3,785,257, INT. CL. 44.
- UCB PHARMA, S.A., 1070 BRUSSELS, BELGIUM:
3,785,989, INT. CL. 42.
- UC4 SOFTWARE GMBH, A-3012 WOLFSGRABEN, AUSTRIA:
2,368,822. REN. 3-31-10. INT. CL. 9.
- UGS URLA GIDA VE TARIM URUNLERI SANAYI VE TICARET LIMITED SIRKETI, IZMIR, TURKEY:
3,785,209, INT. CL. 29.
- UHS OF DELAWARE, INC., KING OF PRUSSIA, PA:
3,785,590, INT. CL. 44.
- UINTA GOLF, INC., SALT LAKE CITY, UT:
3,786,288, MULTIPLE CLASS, INT. CLS. 35, 37 AND 41.
- ULLA POPKEN GMBH, FED REP GERMANY:
3,785,020, PUB. 2-16-2010. INT. CL. 25.
- ULRICH HARLAN, MIAMI, FL:
3,784,309, PUB. 2-16-2010. INT. CL. 41.
- ULTRAFRAME (UK) LIMITED, CLITHEROE, LANCA-SHIRE, BB7 IPE, UNITED KINGDOM:
2,751,756, CANC. MULTIPLE CLASS, INT. CLS. 6 AND 19.
- ULYSSES BOONE, FARMINGTON HILLS, MI:
3,783,487, PUB. 2-16-2010. INT. CL. 6.
- UMB FINANCIAL CORPORATION, KANSAS CITY, MO:
2,754,054, CANC. INT. CL. 36.
- UMBEL, JONATHAN S., WASHINGTON, DC:
3,784,703, PUB. 2-16-2010. INT. CL. 43.
- UMG RECORDINGS, INC., SANTA MONICA, CA:
3,786,314, INT. CL. 9.
3,786,315, INT. CL. 41.
- UMICORE, 1000 BRUSSELS, BELGIUM:
2,340,563. REN. 3-26-10. INT. CL. 6.
- UNDER ARMOUR, INC., BALTIMORE, MD:
3,786,197, INT. CL. 25.
- UNDER THE GINGKO, INC., KANSAS CITY, MO:
3,084,828, CANC. INT. CL. 3.
3,144,385, CANC. INT. CL. 3.
- UNDERWRITERS LABORATORIES INC., NORTHBROOK, IL:
2,391,140. REN. 3-26-10. U.S. CL. A.
- UNFINISHED FURNITURE ASSOCIATION, MT. LAUREL, NJ:
2,752,222, CANC. INT. CL. 42.
- UNI-SELECT INC., BOUCHERVILLE, PROVINCE OF QUEBEC, CANADA:
2,363,691. REN. 3-26-10. INT. CL. 35.
- UNICHEMA CHEMIE BV, GOUDA, NETHERLANDS:
2,752,559, CANC. INT. CL. 1.
- UNICREDIT BANCA MOBILIARE S.P.A., MILANO, ITALY:
2,751,859, CANC. MULTIPLE CLASS, INT. CLS. 16 AND 36.
- UNIFIED BRANDS, INC., JACKSON, MS:
3,784,808, PUB. 2-16-2010. INT. CL. 11.
- UNIFIED MARINE, INC., NEWPORT, TN:
3,785,846, MULTIPLE CLASS, INT. CLS. 12 AND 20.
- UNIFY CORPORATION, ROSEVILLE, CA:
3,783,409, PUB. 2-16-2010. MULTIPLE CLASS, INT. CLS. 9 AND 42.
- UNILEVER N.V., 3013 AL ROTTERDAM, NETHERLANDS:
2,681,659, CANC. INT. CL. 35.
- UNILEVER PLC, MERSEYSIDE, UNITED KINGDOM:
2,753,535, CANC. INT. CL. 42.
- UNILEVER SUPPLY CHAIN, INC., CLINTON, CT:
840,129, CANC. U.S. CL. 46.
2,754,152, CANC. INT. CL. 3.
2,754,154, CANC. INT. CL. 3.
- UNILIN FLOORING NC, LLC, CALHOUN, GA:
2,331,608. REN. 3-30-10. INT. CL. 19.
- UNILUX AG, 54528 SALMTAL, FED REP GERMANY:
3,784,881, PUB. 2-16-2010. MULTIPLE CLASS, INT. CLS. 6 AND 19.
- UNILUX, INC., SADDLE BROOK, NJ:
3,785,881, INT. CL. 9.
- UNIMAX TOYS LTD., TSIM SHA TSUI, KOWLOON, HONG KONG:
2,754,277, CANC. INT. CL. 28.
- UNIMED PHARMACEUTICALS, INC., BUFFALO GROVE, IL:
2,753,334, CANC. INT. CL. 5.
- UNIMIN CORPORATION, NEW CANAAN, CT, INTERNATIONAL MINERALS & CHEMICAL CORPORATION, SKOKIE, IL:
695,463. REN. 3-26-10. U.S. CL. 1 (INT. CL. 1).

- UNIPRISE, INC., HARTFORD, CT:
2,752,248, CANC. MULTIPLE CLASS, INT. CLS. 36 AND 44.
- UNIQUE DESIGN, INC., LAKEWOOD, NJ:
2,352,624. REN. 3-31-10. INT. CL. 28.
- UNIQUE METAL SOLUTIONS, LLC, LABADIE, MO:
3,783,815, PUB. 2-16-2010. INT. CL. 6.
3,783,873, PUB. 2-16-2010. INT. CL. 6.
- UNIQUE SPORTS PRODUCTS INC., ALPHARETTA, GA:
1,602,500. REN. 3-30-10. INT. CL. 28.
- UNISEN, INC., IRVINE, CA, DBA STAR TRAC:
2,754,189, CANC. INT. CL. 28.
- UNISEN, INC., IRVINE, CA:
3,786,247, MULTIPLE CLASS, INT. CLS. 16 AND 28.
- UNITED ABRASIVES, INC., WILLIMANTIC, CT:
1,594,883. REN. 3-29-10. INT. CL. 7.
1,594,884. REN. 3-29-10. INT. CL. 7.
- UNITED AIR LINES, INC., CHICAGO, IL:
1,553,277, CANC. MULTIPLE CLASS, INT. CLS. 39 AND 42.
- UNITED BENEFITS ADVISORS, LLC, INDIANAPOLIS, IN:
3,784,588, PUB. 2-16-2010. MULTIPLE CLASS, INT. CLS. 9 AND 16.
- UNITED BUSINESS MEDIA LLC, MANHASSET, NY:
2,271,502, CANC. INT. CL. 42.
3,783,208, PUB. 2-16-2010. INT. CL. 35.
3,783,209, PUB. 2-16-2010. INT. CL. 35.
- UNITED CAMERA & BINOCULAR CORP, LLC, BENSENVILLE, IL:
3,784,137, PUB. 2-16-2010. INT. CL. 37.
- UNITED CHARITIES INTERNATIONAL, INC., CLEARWATER, FL:
3,784,179, PUB. 2-16-2010. INT. CL. 12.
- UNITED FEATURE SYNDICATE, INC., NEW YORK, NY, DBA UNITED MEDIA:
3,783,835, PUB. 2-16-2010. INT. CL. 41.
- UNITED GENERAL SUPPLY CO., INC., HOUSTON, TX:
3,786,005, INT. CL. 21.
- UNITED GOVERNMENT SERVICES, LLC, MILWAUKEE, WI:
2,751,767, CANC. MULTIPLE CLASS, INT. CLS. 35 AND 45.
- UNITED HEALTHCARE SERVICES, INC., EDINA, MN:
2,752,509, CANC. INT. CL. 36.
- UNITED LEGWEAR CO., L.L.C., NEW YORK, NY:
3,783,110, PUB. 2-16-2010. INT. CL. 25.
- UNITED OF OMAHA LIFE INSURANCE COMPANY, OMAHA, NE:
3,783,779, PUB. 2-16-2010. INT. CL. 36.
- UNITED PARCEL SERVICE OF AMERICA, INC., ATLANTA, GA:
1,552,840, CANC. INT. CL. 16.
2,343,371. REN. 3-26-10. INT. CL. 39.
2,348,287. REN. 3-26-10. MULTIPLE CLASS, INT. CLS. 35, 38 AND 39.
- UNITED PET GROUP, INC., CINCINNATI, OH:
2,329,525. REN. 3-30-10. INT. CL. 20.
- UNITED RETAIL INCORPORATED, ROCHELLE PARK, NJ:
534,076. REN. 3-26-10. U.S. CL. 39 (INT. CL. 25).
- UNITED SERVICES AUTOMOBILE ASSOCIATION, SAN ANTONIO, TX, DBA USAA:
1,590,157. REN. 3-27-10. INT. CL. 36.
- UNITED SERVICES AUTOMOBILE ASSOCIATION, SAN ANTONIO, TX:
2,752,539, CANC. INT. CL. 36.
- UNITED SOURCING ALLIANCE, LLC, HICKORY, NC:
3,784,287, PUB. 2-16-2010. INT. CL. 35.
- UNITED STATES AFFORDABLE HOMES CORPORATION, PATTISON, TX:
2,754,589, CANC. INT. CL. 37.
- UNITED STATES CELLULAR CORPORATION, CHICAGO, IL:
2,380,731. REN. 3-26-10. INT. CL. 35.
- UNITED STATES NUTRITION, INC., RONKONKOMA, NY:
2,403,090. REN. 3-26-10. INT. CL. 5.
- UNITED STATES OF AMERICA AS REPRESENTED BY THE SECRETARY OF THE NAVY, ORLANDO, FL, DBA NAVAL AIR WARFARE CENTER TRAINING SYSTEMS DIVISION:
3,784,521, PUB. 2-16-2010. INT. CL. 41.
- UNITED STATES POSTAL SERVICE, WASHINGTON, DC:
3,786,161, INT. CL. 18.
- UNITED STATES SALES SERVICE, CHANDLER, AZ:
2,271,343, CANC. INT. CL. 30.
- UNITED STATES TENNIS ASSOCIATION INCORPORATED, WHITE PLAINS, NY, UNITED STATES LAWN TENNIS ASSOCIATION, NEW YORK, NY:
888,099. REN. 3-26-10. U.S. CL. 107 (INT. CL. 41).
- UNITED WIRE LTD., EDINBURGH, EH5 1HT, SCOTLAND:
2,344,661. REN. 4-1-10. INT. CL. 7.
- UNITEDHEALTH GROUP INCORPORATED, MINNETONKA, MN:
3,784,801, PUB. 2-16-2010. MULTIPLE CLASS, INT. CLS. 35, 36 AND 44.
- UNITES STATES SHOE CORPORATION, THE, PORT WASHINGTON, NY, UNITES STATES SHOE CORPORATION, THE, PORT WASHINGTON, NY:
2,354,646. REN. 3-26-10. INT. CL. 9.
- UNITRONIX DATA SYSTEMS, INC., RARITAN, NJ:
1,630,652. REN. 3-26-10. INT. CL. 9.
- UNIVERSAL AUTOMOTIVE, INC., CHICAGO, IL:
2,273,164, CANC. INT. CL. 12.
- UNIVERSAL CITY STUDIOS LLLP, UNIVERSAL CITY, CA:
3,785,430, INT. CL. 41.
- UNIVERSAL CITY STUDIOS, INC., UNIVERSAL CITY, CA:
1,553,327, CANC. INT. CL. 42.
- UNIVERSAL CLASS, INC., TAMPA, FL:
3,784,260, PUB. 2-16-2010. INT. CL. 41.
- UNIVERSAL DRILLING AND CUTTING EQUIPMENT LIMITED, DARNALL, SHEFFIELD, GREAT BRITAIN:
2,359,876. REN. 3-26-10. INT. CL. 7.
- UNIVERSAL ELECTRONICS INC., CYPRESS, CA:
3,785,548, INT. CL. 9.
- UNIVERSAL MIND, INC., WESTFIELD, MA:
3,784,606, PUB. 2-16-2010. INT. CL. 42.
- UNIVERSITY ATHLETIC ASSOCIATION, INC., GAINESVILLE, FL:
2,349,246. REN. 3-31-10. MULTIPLE CLASS, INT. CLS. 25 AND 41.
- UNIVERSITY COLLEGE OF CHAPMAN UNIVERSITY, ORANGE, CA:
3,786,488, INT. CL. 41.
- UNIVERSITY OF AKRON, THE, AKRON, OH:
2,341,004. REN. 3-26-10. INT. CL. 41.
- UNIVERSITY OF CENTRAL FLORIDA, ORLANDO, FL:
2,752,652, CANC. INT. CL. 41.
- UNIVERSITY OF HOUSTON SYSTEM, THE, HOUSTON, TX:
2,403,386. REN. 3-31-10. INT. CL. 38.
- UNIVERSITY OF MASSACHUSETTS LOWELL, LOWELL, MA:
2,751,853, CANC. INT. CL. 40.
- UNIVERSITY OF SOUTHERN CALIFORNIA, THE, LOS ANGELES, CA:
1,564,659. REN. 3-27-10. INT. CL. 25.
- UNIWELD PRODUCTS, INC., FORT LAUDERDALE, FL:
2,436,768. REN. 4-1-10. INT. CL. 35.
- UNMANIFESTED, LLC, NEW YORK, NY:
3,783,915, PUB. 2-16-2010. INT. CL. 35.
- UNRULY MEDIA LTD, LONDON, UNITED KINGDOM:
3,783,942, PUB. 2-16-2010. MULTIPLE CLASS, INT. CLS. 35 AND 42.
- UPLANDERS WAREHOUSE LLC, BOZEMAN, MT, DBA UPLANDERS WAREHOUSE:
3,784,083, PUB. 2-16-2010. INT. CL. 35.
- URBAN AGENT TEAM, LLC, BOISE, ID:
3,786,413, MULTIPLE CLASS, INT. CLS. 35 AND 36.
- URBAN CANTEEN LLC, ELLICOTT CITY, MD:
3,783,372, PUB. 2-16-2010. INT. CL. 21.
- URBAN HOMES AND INVESTMENTS, SAN DIEGO, CA:
3,783,932, PUB. 2-16-2010. MULTIPLE CLASS, INT. CLS. 35 AND 39.

URBAN TELEVISION NETWORK, INC., MARINA DEL REY, CA:
2,753,323, CANC. INT. CL. 36.

URBAN TRUTH LLC, MESA, AZ:
3,783,120, PUB. 2-16-2010. INT. CL. 41.

URETEK USA, INC., TOMBALL, TX:
3,783,345, PUB. 2-16-2010. INT. CL. 37.

UROLOGIX, INC., MINNEAPOLIS, MN, TECHNOMED INTERNATIONAL, PARIS, FRANCE:
1,623,355. REN. 3-29-10. MULTIPLE CLASS, INT. CLS. 9 AND 10.

URREA HERRAMIENTAS PROFESIONALES, S.A. DE C.V., EL SALTO, JALISCO, MEXICO:
3,783,125, PUB. 2-16-2010. MULTIPLE CLASS, INT. CLS. 8, 9 AND 12.

US AIRWAYS, INC., TEMPE, AZ:
2,337,561. REN. 3-29-10. INT. CL. 39.

US DATANET CORPORATION, SYRACUSE, NY:
2,753,072, CANC. INT. CL. 38.

US PREMIUM BEVERAGES, LLC, SAN LUIS OBISPO, CA:
3,785,917, INT. CL. 32.

USA TAX ADVISORS, INC., PALM HARBOR, FL:
2,752,341, CANC. INT. CL. 9.

USA WIRELESS SOLUTIONS, WOOD DALE, IL:
3,785,811, INT. CL. 9.

USENIX ASSOCIATION, BERKELEY, CA:
2,413,380. REN. 4-1-10. INT. CL. 41.

USS MISSOURI MEMORIAL ASSOCIATION, INC., HONOLULU, HI:
2,770,421, CANC. MULTIPLE CLASS, INT. CLS. 21 AND 28.

USTOV, INC., HAYWARD, CA:
2,272,387, CANC. INT. CL. 30.

UVERSA PRESS, WESTMINSTER, CO:
2,368,968. REN. 3-31-10. INT. CL. 41.

U4RIK VODKA, EL CAJON, CA:
3,785,504, INT. CL. 33.

V. FAUCHEUX, LLC, LOS ANGELES, CA:
3,785,261, INT. CL. 18.

V.G.'S FOOD CENTER, INC., FENTON, MI:
3,783,308, PUB. 2-16-2010. INT. CL. 43.

V.S.P.I., LAKE ELSINORE, CA:
2,754,477, CANC. INT. CL. 35.

VACATION TOGETHER, INC., MILWAUKEE, WI:
1,635,740. REN. 3-29-10. MULTIPLE CLASS, INT. CLS. 39 AND 42.

VAFIADIS, DEAN C., NEW YORK, NY, DBA NEW YORK SMILE INSTITUTE:
3,785,320, INT. CL. 3.

VALENTINO FASHION GROUP S.P.A., MILANO, ITALY:
2,753,044, CANC. INT. CL. 25.

VALKRE SOLUTIONS, INC., CHICAGO, IL:
3,783,422, PUB. 2-16-2010. MULTIPLE CLASS, INT. CLS. 35, 41 AND 42.

VALLEY RESEARCH, INC., SOUTH BEND, IN:
2,753,191, CANC. INT. CL. 1.

VALMONT ELECTRIC, INC., DANVILLE, IL:
1,552,662, CANC. INT. CL. 9.
1,552,663, CANC. INT. CL. 9.

VALOR COMMUNICATION, INC., CITY OF INDUSTRY, CA:
3,785,959, INT. CL. 9.

VALSPAR CORPORATION, THE, MINNEAPOLIS, MN:
2,332,063. REN. 3-29-10. INT. CL. 2.

VALSPAR SOURCING, INC., MINNEAPOLIS, MN:
2,326,618. REN. 3-29-10. INT. CL. 21.

VALUECLICK, INC., WESTLAKE VILLAGE, CA:
3,785,474, INT. CL. 42.

VALUEMD, LLC, SAINT CLOUD, FL:
3,783,592, PUB. 2-16-2010. INT. CL. 41.

VALUES JOURNEY PTY LTD, MELBOURNE, VICTORIA, AUSTRALIA:
3,784,871, PUB. 2-16-2010. MULTIPLE CLASS, INT. CLS. 9, 16 AND 41.

VAN DER AUWERMEULEN, THIBAUT FÉLIX BÉATRICE JEAN JOSEPH MARIE, B-1390 GREZ-DOICEAU, BELGIUM AND VAN KERCKHOVE, PASCALE, B-1390 GREZ-DOICEAU, BELGIUM:
3,785,019, PUB. 2-16-2010. MULTIPLE CLASS, INT. CLS. 35 AND 42.

VAN DIJK, VIVIAN, NEW YORK, NY:
2,834,842, CANC. INT. CL. 41.

VAN HORN, MARY JO, BISMARCK, ND AND BLUMHAGEN, TAMMY, BISMARCK, ND:
3,786,116, MULTIPLE CLASS, INT. CLS. 9 AND 42.
3,786,117, MULTIPLE CLASS, INT. CLS. 9 AND 42.

VAN AIR MANUFACTURING, INC., MICHIGAN CITY, IN:
3,783,658, PUB. 2-16-2010. MULTIPLE CLASS, INT. CLS. 7 AND 9.

VANCOUVER PRODUCTIONS, INC., VANCOUVER, B.C., CANADA:
2,753,994, CANC. INT. CL. 20.

VANDERMEERSCH, WILLEM FREDERIK, MCLEAN, VA:
3,784,466, PUB. 2-16-2010. INT. CL. 16.

VANDYKE SOFTWARE, INC., ALBUQUERQUE, NM:
2,423,099. REN. 3-31-10. INT. CL. 9.

VANDYKE SOFTWARE, INC., ALBUQUERQUE, NM:
2,429,080. REN. 3-30-10. INT. CL. 9.

VANTAGE POINT ASSOCIATES LLC, BEDFORD HILLS, NY:
2,752,429, CANC. INT. CL. 16.

VARCANO WORLDWIDE LIMITED, KOWLOON, HONG KONG:
3,786,330, INT. CL. 25.

VARIAN MEDICAL SYSTEMS HAAN GMBH, BERLIN, FED REP GERMANY:
1,591,874. REN. 3-31-10. INT. CL. 10.

VARIETY CHILDREN'S HOSPITAL, MIAMI, FL, DBA MIAMI CHILDREN'S HOSPITAL:
2,273,104, CANC. INT. CL. 42.

VARNEY, LOUIE R., JR., LEXINGTON, MI:
3,035,680, CANC. INT. CL. 41.

VASTERA, INC., DULLES, VA:
2,753,908, CANC. MULTIPLE CLASS, INT. CLS. 35 AND 42.

VBH REALM B.V., 1079 LH AMSTERDAM, NETHERLANDS:
2,751,646, CANC. INT. CL. 3.
2,751,647, CANC. INT. CL. 3.

VCFO HOLDINGS, INC., AUSTIN, TX:
3,785,611, INT. CL. 35.

VECTAIR SYSTEMS LTD, BASINGSTOKE, HAMPSHIRE, UNITED KINGDOM:
3,786,042, INT. CL. 11.

VECTOR PRODUCTS, INC., FT. LAUDERDALE, FL:
2,344,865. REN. 3-31-10. INT. CL. 9.

VECTREN CORPORATION, EVANSVILLE, IN:
2,432,276. REN. 3-30-10. INT. CL. 39.

VEER CORPORATION, CALGARY, CANADA:
3,786,329, MULTIPLE CLASS, INT. CLS. 38 AND 45.

VEGE-KURL, INC., GLENDALE, CA:
1,588,439. REN. 3-31-10. INT. CL. 1.

VELA PHARMACEUTICALS INC., EWING, NJ:
2,753,647, CANC. INT. CL. 42.

VELOCITIS INC., MASON, TX:
2,753,520, CANC. INT. CL. 9.

VELOCITY INTERNATIONAL, INC., PITTSBURGH, PA:
3,785,440, INT. CL. 41.

VELOCITY WINE CELLARS, LLC, ASHLAND, OR:
3,783,757, PUB. 2-16-2010. INT. CL. 33.

VENDARIA, INC., SEATTLE, WA, FORMERLY BROADCASTZONE, INC.:
2,753,635, CANC. MULTIPLE CLASS, INT. CLS. 35, 41 AND 42.

VENTURA FOODS, LLC, BREA, CA:
3,785,195, INT. CL. 29.

VENTUREMASH LLC, PORTLAND, OR:
3,784,321, PUB. 2-16-2010. INT. CL. 35.

VENTYX INC., ATLANTA, GA:
2,271,294, CANC. MULTIPLE CLASS, INT. CLS. 37, 41 AND 42.

- VERACITY PAYMENT SOLUTIONS, INC., ATLANTA, GA:
3,785,513, INT. CL. 36.
- VERANDAH DEVELOPMENT LLC, BONITA SPRINGS, FL:
2,272,451, CANC. MULTIPLE CLASS, INT. CLS. 36 AND
37.
- VERGE RECORDS INTERNATIONAL LLC, BROOKLYN,
NY:
3,785,149, MULTIPLE CLASS, INT. CLS. 35 AND 41.
- VERGHESE, GILBERT, TORONTO, ONTARIO M4V 1H4,
CANADA:
2,751,674, CANC. INT. CL. 9.
- VERGISLA SOLAR, S.L., VALENCIA, SPAIN:
2,822,220, CANC. INT. CL. 9.
- VERICARE OF CALIFORNIA MEDICAL GROUP, SAN
DIEGO, CA:
2,754,188, CANC. INT. CL. 44.
- VERIDIEN CORPORATION, ST. PETERSBURG, FL:
2,753,718, CANC. INT. CL. 5.
- VERILUX, INC., WAITSFIELD, VT, VERILUX CORPORA-
TION, NEW YORK, NY:
695,669, REN. 3-31-10. U.S. CL. 34 (INT. CL. 11).
- VERIZON TRADEMARK SERVICES LLC, ARLINGTON,
VA:
3,786,208, INT. CL. 36.
- VERMEER MANUFACTURING COMPANY, PELLA, IA:
2,336,214, REN. 3-30-10. INT. CL. 7.
- VERQUIN CONFISEUR, 59960 NEUVILLE-EN-FERRAIN
(NORD), FRANCE:
2,752,146, CANC. INT. CL. 30.
- VERSACE, FRANCESCA, LONDON, UNITED KINGDOM:
3,783,207, PUB. 6-9-2009. MULTIPLE CLASS, INT. CLS.
18, 24 AND 25.
- VERSANI SILVER JEWELRY LTD., NEW YORK, NY:
2,753,331, CANC. INT. CL. 18.
- VERSO PAPER L.L.C., MEMPHIS, TN:
2,331,367, REN. 3-29-10. INT. CL. 16.
- VERSUS, L.P., PHILADELPHIA, PA:
3,786,450, INT. CL. 41.
- VERTEX STANDARD USA, INC., CYPRESS, CA:
2,378,101, REN. 3-31-10. INT. CL. 9.
2,418,424, REN. 3-31-10. INT. CL. 9.
- VESTAL TILE DISTRIBUTORS, INC., VESTAL, NY:
3,784,298, PUB. 2-16-2010. INT. CL. 35.
- VESTAS WIND SYSTEMS A/S, DK-8900 RANDERS, DEN-
MARK:
2,751,786, CANC. MULTIPLE CLASS, INT. CLS. 7, 9, 11,
16, 35, 37 AND 42.
- VESTIGO, INC., PEORIA, AZ:
3,783,266, PUB. 2-16-2010. MULTIPLE CLASS, INT. CLS.
9, 35, 37 AND 45.
- VETECH LABORATORIES, INC., GUELPH, ONTARIO,
CANADA:
1,589,660, REN. 3-27-10. INT. CL. 5.
- VGM GROUP, INC., WATERLOO, IA:
2,338,600, REN. 3-30-10. INT. CL. 35.
- VIACOM INTERNATIONAL INC., NEW YORK, NY:
2,754,369, CANC. INT. CL. 41.
- VIALLE, JOSEPH ENGELBERT CHRISTIAAN, VENLO,
NETHERLANDS, DBA VIALLE MINERALS:
1,552,439, CANC. MULTIPLE CLASS, INT. CLS. 3 AND 5.
- VICTOR J. MURAUSKOS, NEW HYDE PARK, NY, DBA
SLEIGHRIDE:
3,784,459, PUB. 2-16-2010. INT. CL. 24.
- VICTORIA'S SECRET STORES BRAND MANAGEMENT,
INC., REYNOLDSBURG, OH:
3,785,932, INT. CL. 3.
3,786,141, INT. CL. 25.
3,786,142, INT. CL. 25.
3,786,143, INT. CL. 25.
3,786,144, INT. CL. 25.
3,786,145, INT. CL. 25.
- VICTORY BOULEVARD CORPORATION, SAN ANTONIO,
TX:
3,783,918, PUB. 2-16-2010. INT. CL. 35.
- VIDEO GAMING TECHNOLOGIES, INC., BRENTWOOD,
TN:
3,785,816, INT. CL. 9.
- VIDEO MONITORING SERVICES OF AMERICA, L.P., NEW
YORK, NY:
3,784,149, PUB. 2-16-2010. INT. CL. 35.
3,784,157, PUB. 2-16-2010. INT. CL. 35.
- VIDEO PROFESSOR, INC., LAKEWOOD, CO, DATA LINK
RESEARCH SERVICES, INC., GOLDEN, CO:
1,574,578, REN. 3-31-10. INT. CL. 9.
- VIDEOLOGY IMAGING SOLUTIONS, INC., GREENVILLE,
RI:
3,784,845, PUB. 8-7-2007. INT. CL. 9.
- VIDISOLUTIONS, INC., NEW YORK, NY:
2,754,035, CANC. INT. CL. 38.
- VIEWOLUX PHOTOGRAPHY, LLC, MENDHAM, NJ:
3,785,990, INT. CL. 41.
- VIGNOBLE LE MAINE PERTUBAUD S.A.R.L., 16120 BON-
NEUIL, FRANCE:
2,752,315, CANC. MULTIPLE CLASS, INT. CLS. 32 AND
33.
2,752,316, CANC. MULTIPLE CLASS, INT. CLS. 32 AND
33.
- VIGO MAK, QUARRY BAY, HONG KONG:
3,783,672, PUB. 2-16-2010. INT. CL. 25.
- VIKING RIVER CRUISES S.A., 1325 LUXEMBOURG, LUX-
EMBOURG:
2,753,201, CANC. INT. CL. 43.
- VILLA NOVA PIZZA INC, LEMONT, IL:
3,783,652, PUB. 2-16-2010. INT. CL. 43.
- VILLANO, MARY, WRIGHTSTOWN, NJ:
3,783,745, PUB. 2-16-2010. INT. CL. 35.
- VILLAVICENCIO, LEONARD W., SAN DIEGO, CA:
2,251,465, REN. 3-30-10. INT. CL. 25.
- VILLEROY & BOCH AG, 66688 METTLACH, FED REP
GERMANY:
2,751,862, CANC. MULTIPLE CLASS, INT. CLS. 11, 21
AND 28.
- VIMAR CORPORATION, HUGO, CO:
1,557,880, REN. 3-26-10. INT. CL. 14.
- VINA CONCHA Y TORO S.A., SANTIAGO, CHILE:
2,343,890, REN. 3-31-10. INT. CL. 33.
- VINA SAN PEDRO S.A., SANTIAGO, CHILE:
2,754,448, CANC. INT. CL. 33.
- VINCE CARUSO, BRADENTON, FL:
3,783,766, PUB. 2-16-2010. MULTIPLE CLASS, INT. CLS.
20, 40 AND 42.
- VINCI, RUEIL-MALMAISON, FRANCE:
2,751,838, CANC. INT. CL. 39.
- VINCI INC., BELLAIRE, TX, DBA VINCI USA:
2,753,040, CANC. INT. CL. 9.
- VINCI, INC., BELLAIRE, TX, DBA VINCI USA:
2,753,037, CANC. INT. CL. 9.
- VINEYARD BRANDS, INC., CHESTER, VT:
1,553,180, CANC. INT. CL. 33.
- VINEYARD MUSIC USA, STAFFORD, TX:
2,751,982, CANC. INT. CL. 41.
- VINSON, AUDREY, ATLANTA, GA:
3,783,614, PUB. 2-16-2010. INT. CL. 9.
- VINTAGE FOOD CORP., BROOKLYN, NY:
3,785,867, INT. CL. 32.
- VINTAGE WINE ESTATES, INC., WINDSOR, CA:
3,783,830, PUB. 2-16-2010. INT. CL. 33.
- VIOLA NETWORKS LTD., YOKNEAM ELLIT, ISRAEL:
2,752,886, CANC. INT. CL. 9.
- VIP CONNECTION, LLC, NEW YORK, NY:
3,785,826, INT. CL. 41.
- VIPER INTERNATIONAL LIMITED, COOKSTOWN, CO.
TYRONE, IRELAND:
2,751,538, CANC. INT. CL. 7.
- VIRAX HOLDINGS LIMITED, KEW, VICTORIA, 3101,
AUSTRALIA:
2,305,785, REN. 3-31-10. INT. CL. 42.
- VIRBAC S.A., CARROS CEDEX, FRANCE:
2,751,777, CANC. INT. CL. 5.
- VIRGINIA ADVNTAGE REALTY INC, FREDERICKS-
BURG, VA, DBA Q REAL ESTATE:
3,784,553, PUB. 2-16-2010. INT. CL. 36.

VIRGINIA CAROLINA CORPORATION, INC., CONWAY, SC:
2,752,148, CANC. INT. CL. 34.
2,752,149, CANC. INT. CL. 34.

VIRTUAL ACCESS PLC, ASCOT, BERKSHIRE, GREAT BRITAIN:
2,751,638, CANC. INT. CL. 9.

VIRTUAL TRAINING SYSTEMS, INC., MIAMI, FL:
3,783,509, PUB. 2-16-2010. INT. CL. 41.

VIRTUAL WORLD TECHNOLOGIES, INC., VALDOSTA, GA:
3,786,467, MULTIPLE CLASS, INT. CLS. 9 AND 42.

VISANT HOLDING CORPORATION, ARMONK, NY:
3,786,219, INT. CL. 14.

VISCOUNT PLASTICS (NSW) LTD., MINTO, NSW 2566, AUSTRALIA:
2,754,087, CANC. INT. CL. 20.

VISION SERVICE PLAN, RANCHO CORDOVA, CA, DBA VSP:
3,786,138, INT. CL. 36.

VISIONERING MARKETING LLC, LOS ANGELES, CA:
3,784,726, PUB. 2-16-2010. INT. CL. 25.

VITA-MIX CORPORATION, CLEVELAND, OH:
3,786,058, INT. CL. 7.

VITACOST HOLDINGS, INC., ARLINGTON, VA:
2,335,966, REN. 3-29-10. INT. CL. 42.

VITAL LIVING, INC., TEMPE, AZ:
2,754,264, CANC. INT. CL. 5.

VITAL PHARMACEUTICALS, INC., DAVIE, FL:
3,786,263, INT. CL. 5.

VITAMIN C60: BIORESEARCH CORPORATION, JAPAN:
3,784,989, PUB. 2-16-2010. MULTIPLE CLASS, INT. CLS. 1 AND 3.

VITAMINS PLAYWEAR, LTD., NEW YORK, NY:
2,968,340, COR. INT. CL. 25.

VIVENDI, PARIS, FRANCE:
3,785,348, INT. CL. 38.

VIVENDI UNIVERSAL, 75008 PARIS, FRANCE:
2,751,779, CANC. MULTIPLE CLASS, INT. CLS. 9, 12, 37, 38, 39, 41 AND 42.

VOCERA COMMUNICATIONS, SAN JOSE, CA:
2,754,003, CANC. INT. CL. 9.

VOICE OF GOD RECORDINGS, INC., JEFFERSONVILLE, IN:
2,341,000, REN. 3-26-10. MULTIPLE CLASS, INT. CLS. 9 AND 16.

VOICELINK, INC., NORCROSS, GA:
2,751,548, CANC. INT. CL. 38.

VOITH PATENT GMBH, 89522 HEIDENHEIM, FED REP GERMANY, VOITH SULZER PAPIERTECHNIK PATENT GMBH, D-89522 HEIDENHEIM, FED REP GERMANY:
2,291,289, REN. 3-26-10. INT. CL. 7.

VOLANS VENTURES LTD, LONDON, ENGLAND:
3,783,231, PUB. 2-16-2010. MULTIPLE CLASS, INT. CLS. 9, 16, 35, 41 AND 42.

VOLKEWAGEN AKTIENGESELLSCHAFT, D-38436 WOLFSBURG, FED REP GERMANY:
2,754,530, CANC. MULTIPLE CLASS, INT. CLS. 7, 12 AND 27.

VOLKSWAGEN AKTIENGESELLSCHAFT, WOLFSBURG, FED REP GERMANY:
2,751,662, CANC. MULTIPLE CLASS, INT. CLS. 12, 28 AND 37.
2,754,531, CANC. MULTIPLE CLASS, INT. CLS. 7, 12 AND 28.

VOLVO TRUCKS NORTH AMERICA, INC., GREENSBORO, NC:
2,751,745, CANC. INT. CL. 12.

VORNADO AIR, LLC, ANDOVER, KS:
3,784,087, PUB. 2-16-2010. INT. CL. 11.

VOT, LLC, WARSAW, IN:
3,783,991, PUB. 2-16-2010. INT. CL. 10.

VOX MEDICA, INC., PHILADELPHIA, PA:
3,785,922, INT. CL. 35.

VOXELOGIX CORPORATION, SAN ANTONIO, TX:
3,785,860, INT. CL. 10.

VP CONSULTANTS, INC, OSPREY, FL:
3,786,094, INT. CL. 44.
3,786,095, INT. CL. 16.

VP RACING FUELS, INC., SAN ANTONIO, TX:
3,786,336, INT. CL. 1.

VPLUS CORPORATION, TAMPA, FL:
2,334,340, REN. 3-30-10. INT. CL. 9.

VSEE LAB INC, SAN JOSE, CA, DBA VSEE LAB INC:
3,785,602, INT. CL. 9.

VSPRING CAPITAL, LLC, SALT LAKE CITY, UT:
3,784,737, PUB. 2-16-2010. MULTIPLE CLASS, INT. CLS. 16 AND 35.
3,784,738, PUB. 2-16-2010. MULTIPLE CLASS, INT. CLS. 16 AND 35.

VT LEEBOY, INC., LINCOLNTON, NC:
2,752,151, CANC. INT. CL. 7.

VTECH HOLDINGS LIMITED, TAI PO, NEW TERRITORIES, HONG KONG:
2,753,372, CANC. INT. CL. 28.

VULKAN FIGHT COMPANY CONFECÇÕES LTDA, SAO PAULO, BRAZIL:
3,784,402, PUB. 2-16-2010. INT. CL. 25.

VURV TECHNOLOGY, INC., JACKSONVILLE, FL:
2,272,196, CANC. INT. CL. 9.

VUZE, INC., SAN MATEO, CA:
3,785,559, MULTIPLE CLASS, INT. CLS. 9, 25, 38, 41 AND 42.

V3 INSURANCE PARTNERS LLC, WASHINGTON CROSSING, PA:
3,784,756, PUB. 2-16-2010. INT. CL. 36.

W. C. BRADLEY/ZEBCO HOLDINGS, INC., TULSA, OK:
2,753,149, CANC. INT. CL. 28.

W.C. BRADLEY COMPANY, COLUMBUS, GA:
2,753,925, CANC. INT. CL. 11.

WABASH NATIONAL L.P., LAFAYETTE, IN:
3,785,939, INT. CL. 12.

WABASH VALLEY POWER ASSOCIATION, INDIANAPOLIS, IN:
3,783,550, PUB. 2-16-2010. MULTIPLE CLASS, INT. CLS. 35 AND 37.

WACKADOOS GRUB AND BREW, LLC, ORLANDO, FL:
2,753,832, CANC. MULTIPLE CLASS, INT. CLS. 21 AND 30.

WACKER CHEMIE AG, MÜNCHEN, FED REP GERMANY:
3,784,938, PUB. 2-16-2010. MULTIPLE CLASS, INT. CLS. 1 AND 17.

WACO MANUFACTURING, INC, NORTH LITTLE ROCK, AR:
3,784,532, PUB. 2-16-2010. INT. CL. 12.

WAGGIN' TRAIN, LLC, ANDERSON, SC:
3,783,281, PUB. 2-16-2010. INT. CL. 31.

WAKEFERN FOOD CORPORATION, KEASBEY, NJ:
897,927, REN. 3-26-10. U.S. CL. 45 (INT. CL. 32).

WAKUNAGA OF AMERICA CO., LTD., MISSION VIEJO, CA:
1,553,111, CANC. INT. CL. 30.

WALGREEN CO., DEERFIELD, IL:
2,754,304, CANC. MULTIPLE CLASS, INT. CLS. 10 AND 21.

WALKO, JOSEPH, EVANSTON, IL:
3,784,565, PUB. 2-16-2010. INT. CL. 45.

WALL, BILL, MALIBU, CA, DBA/ BILL WALL LEATHER:
2,337,085, REN. 3-31-10. MULTIPLE CLASS, INT. CLS. 14, 18 AND 25.
2,337,085, CANC. INT. CL. 20.

WALL, BILL, MALIBU, CA, DBA BILL WALL LEATHER:
2,337,086, REN. 3-31-10. MULTIPLE CLASS, INT. CLS. 14, 18 AND 25.

WALLACE, CHRISTINA, NEW YORK, NY:
3,784,212, PUB. 2-16-2010. INT. CL. 44.

WALLACH, JOEL, CHULA VISTA, CA:
2,372,400, REN. 3-26-10. INT. CL. 5.

WALLGREN, SYLVIA, BELMONT, CA:
2,753,139, CANC. INT. CL. 16.

WALRUS, INC., BERKELEY, CA TO WALNUS, INC., SEATTLE, WA:
1,552,924, CANC. INT. CL. 20.

- WALTER, TOMMY, LOS ANGELES, CA:
2,753,965, CANC. INT. CL. 41.
- WALTON & POST, INC., MIAMI, FL:
2,341,884. REN. 3-31-10. INT. CL. 16.
- WALTS, WILLIAM SHANE, CHARLOTTE, NC:
3,783,521, PUB. 2-16-2010. INT. CL. 42.
- WANG, ROGER H., SANTA ANA, CA:
3,784,827, PUB. 2-16-2010. INT. CL. 16.
- WARD, RAMONE, BABYLON, NY:
3,785,753, INT. CL. 9.
- WARM & FUZZY INC., OCEANPORT, NJ:
2,753,840, CANC. INT. CL. 41.
- WARNACO U.S., INC., MILFORD, CT:
2,753,468, CANC. INT. CL. 25.
- WARNER BROS. ENTERTAINMENT INC., BURBANK, CA:
2,754,483, CANC. INT. CL. 41.
2,778,603, CANC. INT. CL. 16.
- WARNER CHILCOTT COMPANY, LLC, FAJARDO, PUERTO RICO, F. H. FAULDING & CO. LTD., THEBARTON, STATE OF SOUTH AUSTRALIA, AUSTRALIA:
1,134,417. REN. 3-29-10. INT. CL. 5.
- WARNER SPECIAL PRODUCTS, BURBANK, CA:
1,552,554, CANC. INT. CL. 9.
- WARRIOR SPORTS, INC., WARREN, MI:
3,786,193, INT. CL. 25.
- WARSTEINER BRAUEREI HAUS CRAMER KG, DOMRING, WARSTEIN, FED REP GERMANY:
2,753,906, CANC. INT. CL. 32.
- WASATCH PREFERRED, LLC, DRAPER, UT:
3,785,926, INT. CL. 36.
- WASHINGTON BUSINESS INFORMATION, INC., ARLINGTON, VA:
1,552,814, CANC. INT. CL. 16.
- WASIAK, MICHAEL, D., TOWSON, MD:
3,785,744, INT. CL. 16.
- WASSAIL, LLC, PORTLAND, ME, DBA MAINE MEADWORKS:
3,785,762, INT. CL. 33.
- WATER ENVIRONMENT RESEARCH FOUNDATION, ALEXANDRIA, VA:
3,784,571, PUB. 2-16-2010. MULTIPLE CLASS, INT. CLS. 9 AND 35.
- WATER WORKS CLEANING SYSTEMS, LLC, SLEEPY HOLLOW, IL:
2,754,144, CANC. INT. CL. 7.
- WATKIN OPTICAL ON-LINE, LLC, HENDERSON, NV:
3,785,898, INT. CL. 35.
- WATKINS INCORPORATED, WINONA, MN:
3,785,368, INT. CL. 5.
- WATTS REGULATOR CO., NORTH ANDOVER, MA:
2,751,910, CANC. INT. CL. 11.
- WAVE INDUSTRIES, LTD., PORTLAND, OR:
2,752,748, CANC. INT. CL. 9.
- WAYEL SRL, ITALY:
3,785,043, PUB. 2-16-2010. MULTIPLE CLASS, INT. CLS. 12, 18, 25, 37 AND 42.
- WAYLAND, ROBERT, ORLANDO, FL:
3,784,070, PUB. 2-16-2010. INT. CL. 41.
- WEALTHSTONE, INC., COLUMBUS, OH:
3,785,429, MULTIPLE CLASS, INT. CLS. 35 AND 36.
3,785,585, INT. CL. 36.
- WEAREVER-PROCTORSILEX, INC., GLEN ALLEN, VA TO HAMILTON BEACH BRANDS, INC., GLEN ALLEN, VA:
1,552,512, CANC. INT. CL. 7.
- WEATHER GAUGE, LLC, GREEN BAY, WI:
3,784,677, PUB. 2-16-2010. INT. CL. 45.
- WEATHERFORD/LAMB, INC., HOUSTON, TX:
3,783,894, PUB. 2-16-2010. INT. CL. 7.
- WEATTRACT.COM, INC., SAN FRANCISCO, CA:
2,754,319, CANC. INT. CL. 42.
- WEBB, CHRIS A., LOUISVILLE, KY AND YELICH, JAMES JOSEPH, NASHVILLE, TN:
3,783,240, PUB. 2-16-2010. INT. CL. 38.
3,783,241, PUB. 2-16-2010. INT. CL. 38.
- WEBBOLT COMPANY LIMITED, MIAMI, FL:
2,754,049, CANC. INT. CL. 35.
- WEBEQUITY SOLUTIONS, LLC, ST. PAUL, MN:
3,783,269, PUB. 2-16-2010. INT. CL. 42.
- WEBER, PAUL, GOLD BEACH, OR AND WEBER, JANICE, GOLD BEACH, OR:
3,785,268, INT. CL. 9.
- WEBMAGIC, INC., PASADENA, CA:
2,377,532, REN. 3-31-10. MULTIPLE CLASS, INT. CLS. 35, 36, 37, 38, 41 AND 42.
- WEBMASTERS PRO SHOP, GRAND RAPIDS, MI, DBA FOR SALE BY MEMBER:
3,786,401, INT. CL. 35.
- WEBROOT SOFTWARE, INC., BOULDER, CO:
2,753,268, CANC. INT. CL. 9.
2,753,269, CANC. INT. CL. 9.
2,753,270, CANC. INT. CL. 9.
2,753,274, CANC. INT. CL. 9.
2,753,275, CANC. INT. CL. 9.
2,753,276, CANC. INT. CL. 9.
2,753,277, CANC. INT. CL. 9.
2,753,301, CANC. INT. CL. 9.
2,753,302, CANC. INT. CL. 9.
2,753,303, CANC. INT. CL. 9.
2,753,304, CANC. INT. CL. 9.
2,753,306, CANC. INT. CL. 9.
2,753,307, CANC. INT. CL. 9.
2,753,308, CANC. INT. CL. 9.
- WEBSVILLE INTERNATIONAL, INC., WINTER HAVEN, FL:
2,752,916, CANC. INT. CL. 16.
- WEBTOOLS, L.L.C., JACKSON, MO:
2,341,531. REN. 3-27-10. INT. CL. 36.
2,345,679. REN. 3-29-10. INT. CL. 36.
2,353,751. REN. 3-27-10. INT. CL. 36.
- WEDRON SILICA COMPANY, WEDRON, IL:
1,552,392, CANC. INT. CL. 1.
- WEIDER PUBLICATIONS, LLC, BOCA RATON, FL:
2,823,993, CANC. INT. CL. 25.
- WEIDMUELLER INTERFACE GMBH & CO. KG, DETMOLD, FED REP GERMANY:
1,133,010. REN. 3-26-10. INT. CL. 8.
- WEIDNER, FRANK, 71272 RENNINGEN, FED REP GERMANY:
2,824,290, CANC. INT. CL. 9.
- WEIGHT WATCHERS INTERNATIONAL, INC., NEW YORK, NY:
3,785,223, INT. CL. 41.
3,785,224, INT. CL. 44.
- WEIMER SKIN CLINIC, P.A., MYRTLE BEACH, SC, DBA WEIMER SKIN CLINIC, P.A.:
3,786,149, INT. CL. 44.
- WEIMIN, CHEN, GUANGZHOU, GUANGDONG, CHINA:
2,754,005, CANC. INT. CL. 18.
- WEINBERG, DAVID SAMUEL, FREEPORT, ME:
3,783,819, PUB. 2-16-2010. INT. CL. 41.
- WEIR, JOE A., CHARDON, OH:
3,785,777, INT. CL. 28.
- WELL DONE EXPERIENCE, LTD., NEW YORK, NY:
3,783,141, PUB. 7-8-2008. MULTIPLE CLASS, INT. CLS. 14, 23 AND 26.
- WELL LANE COMMERCE ENTERPRISE CO., TAICHUNG, TAIWAN:
2,752,521, CANC. INT. CL. 7.
- WELLIVING CORPORATION, SAN JOSE, CA, DBA MVP INTERACTIVE SPORTS:
3,784,645, PUB. 2-16-2010. MULTIPLE CLASS, INT. CLS. 35 AND 41.
- WELLQUEST INTERNATIONAL, INC., NEW YORK, NY:
3,785,862, MULTIPLE CLASS, INT. CLS. 3 AND 21.
- WELLS & YOUNGS BREWING; COMPANY LIMITED, UNITED KINGDOM:
3,785,035, PUB. 2-16-2010. INT. CL. 33.
- WELLS FARGO & COMPANY, MINNEAPOLIS, MN:
2,272,298, CANC. INT. CL. 36.
2,754,011, CANC. INT. CL. 36.
2,754,228, CANC. INT. CL. 36.
- WELLS FARGO & COMPANY, SAN FRANCISCO, CA:
2,754,288, CANC. INT. CL. 36.
- WELLS FARGO BANK, NATIONAL ASSOCIATION, ATLANTA, GA:
2,752,523, CANC. INT. CL. 12.

WELLS FARGO BANK, NATIONAL ASSOCIATION, AS ADMINISTRATIVE AGENT, SAN FRANCISCO, CA:
2,752,309, CANC. MULTIPLE CLASS, INT. CLS. 37 AND 42.

WELLS LAMONT INDUSTRY GROUP LLC, NILES, IL, BETTCHER INDUSTRIES, INC., VERMILION, OH:
1,133,571. REN. 4-1-10. INT. CL. 9.

WELLS LAMONT INDUSTRY GROUP LLC, NILES, IL:
3,786,265, MULTIPLE CLASS, INT. CLS. 9 AND 10.

WENGER, JACQUELINE, NEW YORK, NY:
2,753,156, CANC. INT. CL. 25.

WERNICK, RHONDA POLEN, NASHVILLE, TN:
2,752,967, CANC. INT. CL. 16.

WEST BEND MUTUAL INSURANCE COMPANY, WEST BEND, WI:
3,783,684, PUB. 2-16-2010. INT. CL. 36.

WEST PHARMACEUTICAL SERVICES, INC., LIONVILLE, PA:
2,752,746, CANC. INT. CL. 20.

WEST, RENEE, CENTRALIA, IL:
3,783,204, PUB. 2-16-2010. INT. CL. 41.

WESTERN FIBERNET, LLC, SALT LAKE CITY, UT:
3,784,482, PUB. 2-16-2010. INT. CL. 38.

WESTERN RESEARCH 3000, INC., THOUSAND OAKS, CA:
3,786,416, INT. CL. 5.

WESTERN STATES ENVELOPE COMPANY, BUTLER, WI:
2,412,978. REN. 3-26-10. INT. CL. 16.

WESTERN SUPPORT SYSTEMS, SALT LAKE CITY, UT:
1,552,494, CANC. INT. CL. 6.

WESTINGHOUSE ELECTRIC CORPORATION, PITTSBURGH, PA:
2,753,776, CANC. INT. CL. 11.

WESTLINK CORPORATION LIMITED, CENTRAL, HONG KONG:
2,752,949, CANC. MULTIPLE CLASS, INT. CLS. 9 AND 42.

WGN CONTINENTAL BROADCASTING COMPANY, CHICAGO, IL:
3,783,473, PUB. 2-16-2010. INT. CL. 41.

WHA DAT WEAR, LLC, BRIDGEPORT, CT:
2,753,717, CANC. INT. CL. 25.

WHEEL SPECIALTIES, INC., BASSETT, WI:
2,336,857. REN. 3-27-10. INT. CL. 12.

WHEELER MANUFACTURING CO., INC., LEMMON, SD:
2,751,992, CANC. INT. CL. 14.

WHEELSURE LIMITED, OXFORDSHIRE OX25 SHD, UNITED KINGDOM:
2,752,163, CANC. INT. CL. 12.

WHIRLPOOL PROPERTIES, INC., ST. JOSEPH, MI, KITCHENAID, INC., SAINT JOSEPH, MI:
1,585,508. REN. 3-30-10. INT. CL. 11.

WHITE, JOHN, E., III, MENLO PARK, CA, DBA SUSPENSION OF DISBELIEF:
2,753,103, CANC. INT. CL. 42.

WHITE, PAUL, BELLEAIR, FL:
3,784,182, PUB. 2-16-2010. INT. CL. 45.

WHITFORD CORPORATION, WEST CHESTER, PA:
2,825,349, CANC. INT. CL. 24.

WHOLE FOODS MARKET IP, L.P., AUSTIN, TX:
3,784,788, PUB. 2-16-2010. INT. CL. 35.

WICKEN, ERIC, EVERETT, WA AND GOETZ, STEVE, EVERETT, WA:
2,751,988, CANC. INT. CL. 25.

WIEGEL, BETTY JANE, RIO RANCHO, NM:
2,272,406, CANC. INT. CL. 3.

WIESMAN, JON P., YORK, PA:
2,327,316. REN. 3-30-10. INT. CL. 5.

WIGGIN & DANA, NEW HAVEN, CT:
2,753,559, CANC. INT. CL. 42.

WIGGINS, LAURIE J., RENTON, WA:
2,753,573, CANC. INT. CL. 25.

WIH HOTELS L.L.C., NEW YORK, NY:
2,752,345, CANC. INT. CL. 43.

WILBAR INTERNATIONAL, INC., HAUPPAUGE, NY:
3,784,680, PUB. 2-16-2010. MULTIPLE CLASS, INT. CLS. 6 AND 19.

WILBUR CURTIS CO., INC., MONTEBELLO, CA:
2,370,229. REN. 3-30-10. INT. CL. 11.

WILCOX, KELLY KAY, SANTA BARBARA, CA, AKA KELLY TRAVERS:
3,786,258, INT. CL. 41.

WILD PLANET TOYS, INC., SAN FRANCISCO, CA:
2,754,450, CANC. INT. CL. 28.
2,754,472, CANC. INT. CL. 28.

WILDBEAR, REBECCA, TORREY, UT:
3,783,952, PUB. 2-16-2010. INT. CL. 41.

WILDECK, INC., WAUKESHA, WI:
1,586,502. REN. 3-31-10. INT. CL. 6.

WILDERNESS LOG AND TIMBER COMPANY LLC, PLYMOUTH, WI:
1,552,889, CANC. INT. CL. 19.

WILDERNESS SOCIETY, THE, WASHINGTON, DC:
3,784,078, PUB. 2-16-2010. INT. CL. 16.
3,784,545, PUB. 2-16-2010. INT. CL. 36.

WILDTHINGS SNAP-ONS, INC., FAIRFAX, CA:
2,330,581. REN. 3-31-10. INT. CL. 25.

WILEN PRESS, LC, DEERFIELD BEACH, FL, DBA WILEN DIRECT:
3,783,415, PUB. 2-16-2010. INT. CL. 9.

WILHELMI WERKE AG, 35633 LAHNAU, FED REP GERMANY:
2,753,503, CANC. MULTIPLE CLASS, INT. CLS. 6 AND 19.

WILIAN HOLDING COMPANY, DES MOINES, IA:
1,604,621. REN. 3-29-10. INT. CL. 16.

WILKUS, GERALD, A., BEL AIR, MD:
2,754,468, CANC. INT. CL. 28.

WILLERT HOME PRODUCTS, INC., ST. LOUIS, MO:
1,635,942. REN. 3-31-10. INT. CL. 5.

WILLIAM ABRAMS, EAST LANSING, MI:
3,786,084, INT. CL. 35.

WILLIAM BOUNDS, LTD., TORRANCE, CA:
2,272,544, CANC. INT. CL. 21.

WILLIAM CARTER COMPANY, THE, SHELTON, CT:
1,552,944, CANC. MULTIPLE CLASS, INT. CLS. 24 AND 25.

WILLIAM SCOTT CARTER, NORWALK, CT:
3,785,463, INT. CL. 18.

WILLIAM THOMAS DESIGNS INC., FALLBROOK, CA:
3,783,547, PUB. 2-16-2010. INT. CL. 37.

WILLIAMS FOOD GROUP, LLC, MOBILE, AL:
2,753,221, CANC. INT. CL. 1.

WILLIAMS TONY A., BESSEMER, AL:
3,785,905, INT. CL. 32.

WILLIAMS, NICOLE S, DECATUR, GA:
3,785,300, INT. CL. 3.

WILLIAMS, THERESA LAVERNE, PORTSMOUTH, VA:
3,784,646, PUB. 2-16-2010. INT. CL. 45.

WILLIN LLC, LAS VEGAS, NV:
3,786,226, INT. CL. 3.

WILSEY FOODS, INC., CITY OF INDUSTRY, CA:
1,553,055, CANC. INT. CL. 29.

WILSON OPTICAL LABORATORIES, INC., MENTOR, OH, TA NORTH AMERICAN COATING LABORATORIES:
1,614,300. REN. 3-31-10. INT. CL. 40.

WILSON, BETH, MOUNTAIN VIEW, CA:
3,786,070, INT. CL. 41.

WINANS, RUSSELL MERLE, MT. AUBURN, IL:
2,437,196. REN. 3-29-10. INT. CL. 35.

WINDMILL HEALTH PRODUCTS, LLC., WEST CALDWELL, NJ:
3,784,740, PUB. 2-16-2010. INT. CL. 5.

WINDOW-FIX, INC, BROOKLYN, NY:
3,784,125, PUB. 2-16-2010. MULTIPLE CLASS, INT. CLS. 6, 19 AND 37.

WINDRIDGE DESIGN, INC., WEST CHESTER, PA, WINDRIDGE DESIGN, INC., WEST CHESTER, PA:
2,407,516. REN. 3-29-10. INT. CL. 25.

WINERY EXCHANGE, INC., NOVATO, CA:
3,785,114, INT. CL. 32.

WING TSUN CHICAGO, INC., CHICAGO, IL:
3,784,345, PUB. 2-16-2010. INT. CL. 41.

WINGLER, GERRY, SIOUX FALLS, SD:
3,785,069, INT. CL. 37.

WINGSONIC LTD., TAOYUAN COUNTY, TAIWAN:
3,784,519, PUB. 2-16-2010. INT. CL. 9.

- WINKLER + DÜNNEBIER AG, FED REP GERMANY:
3,784,885, PUB. 2-16-2010. MULTIPLE CLASS, INT. CLS. 7, 35, 37 AND 42.
3,784,886, PUB. 2-16-2010. MULTIPLE CLASS, INT. CLS. 7, 35, 37 AND 42.
3,784,887, PUB. 2-16-2010. MULTIPLE CLASS, INT. CLS. 7, 35, 37 AND 42.
3,784,888, PUB. 2-16-2010. MULTIPLE CLASS, INT. CLS. 7, 35, 37 AND 42.
- WINKLER, STEPHEN M, MARIETTA, GA:
3,785,130, INT. CL. 25.
- WINN, FREDERICK, MEMPHIS, TN:
3,784,142, PUB. 2-16-2010. INT. CL. 37.
- WINNEBAGO INDUSTRIES, INC., FOREST CITY, IA:
3,783,104, PUB. 2-16-2010. INT. CL. 12.
- WINTER EQUIPMENT COMPANY, INC., WILLOUGHBY, OH:
3,783,669, PUB. 2-16-2010. INT. CL. 7.
- WINTOUSKY PHILIPPE, F-94310 ORLY, FRANCE:
3,784,879, PUB. 2-16-2010. MULTIPLE CLASS, INT. CLS. 16, 18, 24, 25, 27, 28, 35 AND 41.
- WINZELER STAMPING COMPANY, MONTPELIER, OH:
2,754,345, CANC. INT. CL. 42.
- WISH ATLANTA, LLC, ATLANTA, GA:
3,783,165, PUB. 2-16-2010. MULTIPLE CLASS, INT. CLS. 25 AND 35.
- WIX FILTRATION CORP., GASTONIA, NC:
2,753,349, CANC. INT. CL. 7.
- WIZ KOREA CO., LTD., GYEONGGI-DO, REPUBLIC OF KOREA:
3,786,282, INT. CL. 41.
- WIZARD INDUSTRIES, INC., VAN NUYS, CA:
2,754,618, CANC. INT. CL. 9.
- WIZKIDS, INC., BELLEVUE, WA:
2,752,410, CANC. INT. CL. 16.
- WM K. WALTHERS, INC., MILWAUKEE, WI:
3,784,611, PUB. 2-16-2010. INT. CL. 28.
- WMS GAMING INC., WAUKEGAN, IL:
2,754,409, CANC. INT. CL. 9.
- WOHLER TECHNOLOGIES, INC., HAYWARD, CA:
3,783,411, PUB. 2-16-2010. INT. CL. 9.
- WOHLGEMUTH, DEANNA, SANTA BARBARA, CA:
3,783,978, PUB. 2-16-2010. INT. CL. 43.
- WOLF DESIGNS, INC., WEST LOS ANGELES, CA, SARACEN, INC., MALIBU, CA:
2,331,518, REN. 3-26-10. INT. CL. 20.
- WOLF-GANG & ASSOCIATES, INC., ST. LOUIS, MO TO WOLF-GANG & ASSOCIATES, INC., ST. LOUIS, MO:
2,272,594, CANC. INT. CL. 3.
- WOLF, SUSAN, JANESVILLE, WI:
3,783,959, PUB. 2-16-2010. MULTIPLE CLASS, INT. CLS. 3 AND 5.
- WOLFE, DAVID STEPHEN, EL CAJON, CA:
2,752,055, CANC. INT. CL. 44.
- WOLFGANG ASTNER, 81247 MUNICH, FED REP GERMANY:
3,783,363, PUB. 2-16-2010. MULTIPLE CLASS, INT. CLS. 7, 8, 11, 19 AND 21.
- WOLFGANG PUCK LICENSING LLC, LAS VEGAS, NV:
2,754,187, CANC. INT. CL. 43.
- WOLVERINE WORLD WIDE, INC., ROCKFORD, MI:
2,339,615, REN. 3-27-10. INT. CL. 9.
- WOMACK, RICHARD, WOODGATE, NY AND WOMACK, MICKEY, WOODGATE, NY:
3,784,644, PUB. 2-16-2010. INT. CL. 25.
- WOMAN'S HOSPITAL FOUNDATION, BATON ROUGE, LA:
2,310,586, REN. 3-31-10. INT. CL. 42.
- WOMEN WORK! THE NATIONAL NETWORK FOR WOMEN'S EMPLOYMENT, WASHINGTON, DC:
2,752,541, CANC. INT. CL. 35.
- WONDER NANNIES, LLC, HOLLYWOOD, FL:
3,784,728, PUB. 2-16-2010. INT. CL. 35.
- WONG, YONG MING, ARCADIA, CA:
2,754,460, CANC. INT. CL. 29.
- WOODS & GRAY, LTD., NEW YORK, NY:
2,754,380, CANC. MULTIPLE CLASS, INT. CLS. 18 AND 25.
- WOODSTREAM CORPORATION, LITITZ, PA:
2,433,595, REN. 3-31-10. INT. CL. 7.
2,752,186, CANC. INT. CL. 21.
- WOODWAY USA, INC., WAUKESHA, WI:
3,785,961, INT. CL. 28.
- WOOGIE WORLD ENTERPRISES LLC, LOS ANGELES, CA:
2,752,988, CANC. INT. CL. 25.
- WORKING CAREGIVER INITIATIVE, BIRMINGHAM, MI:
3,783,498, PUB. 2-16-2010. INT. CL. 41.
- WORKMAN, LARRY EDWARD, WEST HOLLYWOOD, CA:
2,754,473, CANC. INT. CL. 25.
- WORKSPACE DEVELOPMENT LLC, SEATTLE, WA, DBA BANK & OFFICE INTERIORS:
1,149,205, REN. 3-26-10. INT. CL. 42.
- WORLD CHAMPION SPORTS GROUP, INC., BEAR, DE:
3,785,889, INT. CL. 41.
- WORLD ENGINES, INC., CINCINNATI, OH TO INDY R/C SALES, INC., INDIANAPOLIS, IN:
1,553,015, CANC. INT. CL. 28.
- WORLD GOLF FOUNDATION, INC., ST. AUGUSTINE, FL:
2,345,967, REN. 3-31-10. INT. CL. 42.
- WORLD GOURMET MARKETING LLC, BUTLER, NJ:
3,784,468, PUB. 2-16-2010. INT. CL. 30.
- WORLD HOPE INTERNATIONAL INC., ALEXANDRIA, VA:
3,784,418, PUB. 2-16-2010. INT. CL. 35.
- WORLD INTELLECTUAL PROPERTY ORGANIZATION, GENEVE 20, SWITZERLAND:
3,784,520, PUB. 2-16-2010. INT. CL. 45.
- WORLD MARKET CENTER VENTURE, LLC, LAS VEGAS, NV:
3,785,798, INT. CL. 43.
3,785,814, INT. CL. 35.
- WORLD NUTRITION, INC., SCOTTSDALE, AZ:
3,783,555, PUB. 2-16-2010. INT. CL. 5.
- WORLD WIDE IMPORTS ENTERPRISES, INC., FORT LAUDERDALE, FL:
2,328,373, REN. 3-26-10. INT. CL. 19.
- WORLD WIDE WOOD NETWORK, LTD., YELM, WA:
2,753,739, CANC. INT. CL. 36.
- WORLD WRESTLING ENTERTAINMENT, INC., STAMFORD, CT:
3,785,401, INT. CL. 41.
3,785,402, INT. CL. 9.
- WORLDDATWORK, SCOTTSDALE, AZ:
2,426,036, REN. 4-1-10. U.S. CL. B.
- WORLDWIDE FINANCIAL SERVICES, INC., SOUTHFIELD, MI:
2,753,506, CANC. INT. CL. 36.
- WORLDWIDE J. R. WOOD, L.L.C., AUSTIN, TX, DBA JOHN CHRISTIAN:
2,272,972, CANC. INT. CL. 14.
- WORLDWIDEFLOREST.NET N.V., 1431 GB AALSMEER, NETHERLANDS:
2,751,810, CANC. MULTIPLE CLASS, INT. CLS. 35 AND 39.
- WORLDWISE INC., SAN RAFAEL, CA:
3,786,276, INT. CL. 18.
- WOUND CARE EDUCATION INSTITUTE, INC, LAKE GENEVA, WI:
3,786,437, U.S. CL. B.
- WRANGLER APPAREL CORP, WILMINGTON, DE:
2,361,033, REN. 3-27-10. INT. CL. 25.
- WRANGLER APPAREL CORP., WILMINGTON, DE:
3,786,191, INT. CL. 25.
- WRIGHT STATE UNIVERSITY, DAYTON, OH:
3,784,583, PUB. 2-16-2010. MULTIPLE CLASS, INT. CLS. 44 AND 45.
- WRITE TO SUCCEED, INC., ARLINGTON, TX:
2,752,877, CANC. INT. CL. 41.
- WRYMARK, INC., ST. LOUIS, MO:
3,784,721, PUB. 2-16-2010. INT. CL. 10.
- WSG WEINGÄRTNER SERVICEGESELLSCHAFT MBH, MÖGLINGEN, FED REP GERMANY:
3,784,977, PUB. 2-16-2010. INT. CL. 33.
- WTB TECHNOLOGY CORPORATION, BAKERSFIELD, CA:
3,545,600, CANC. INT. CL. 32.
3,660,184, CANC. INT. CL. 32.

WU, QINCHAO, GUANGDONG, CHINA:
3,785,740, INT. CL. 9.

WWRD IPCO LLC, WILMINGTON, DE:
2,753,325, CANC. INT. CL. 24.

WYLA, INC., JACKSONVILLE, FL:
2,753,266, CANC. INT. CL. 24.

WYLIE, MICHAEL T., TUCSON, AZ:
3,785,385, INT. CL. 41.

WYNDHAM VACATION RESORTS, INC., ORLANDO, FL:
2,753,600, CANC. MULTIPLE CLASS, INT. CLS. 35, 39 AND 42.

WYOMING WEST DESIGNS II, INC., THAYNE, WY:
3,783,092, PUB. 2-16-2010. INT. CL. 16.

WYSE TECHNOLOGY, SAN JOSE, CA TO WYSE TECHNOLOGY, INC., SAN JOSE, CA:
1,552,558, CANC. INT. CL. 9.

X-I-M PRODUCTS, INC., WESTLAKE, OH:
2,336,559. REN. 3-31-10. INT. CL. 2.

X-SCREAM VIDEO PRODUCTIONS INC., OTTAWA, ONTARIO, CANADA:
3,783,300, PUB. 12-1-2009. INT. CL. 35.

XANDER MEDIA GROUP, INC., WAYNE, PA:
3,783,268, PUB. 2-16-2010. INT. CL. 16.

XAVIANT, LLC, CUMMING, GA:
3,786,166, INT. CL. 42.

XDI CONSULTING CORP., DENVER, NJ:
2,751,589, CANC. INT. CL. 42.

XEL PHARMACEUTICALS, INC., DRAPER, UT:
3,785,659, INT. CL. 42.

XERIPAVE, LLC, VANCOUVER, WA:
3,784,388, PUB. 2-16-2010. INT. CL. 19.

XEROX CORPORATION, NORWALK, CT:
2,333,520. REN. 3-31-10. INT. CL. 9.

XIAMEN INTERNATIONAL TRADE & INDUSTRIAL CO., LTD., CHINA:
3,785,015, PUB. 2-16-2010. INT. CL. 29.

XIGMA STYLE CORP., TAN-SHUI-CHEN, TAIPEI HSIEN, TAIWAN:
2,753,905, CANC. INT. CL. 18.

XIM PRODUCTS, INC., WESTLAKE, OH:
3,783,714, PUB. 2-16-2010. INT. CL. 2.

XINPHONN TRADING CO., LTD., KWANGJIN-KU, SEOUL, REPUBLIC OF KOREA:
2,754,157, CANC. INT. CL. 25.

XPLORE SOFTWARE CONSULTING, INC., LEWES, DE:
3,784,216, PUB. 2-16-2010. MULTIPLE CLASS, INT. CLS. 35 AND 42.

XS MEDICAL SUPPLY, INC., DAYTONA BEACH, FL:
3,785,997, INT. CL. 35.

XTRA CORPORATION, BOSTON, MA:
1,553,375, CANC. INT. CL. 39.

XTRACT OY, HELSINKI, FINLAND:
3,783,554, PUB. 2-16-2010. MULTIPLE CLASS, INT. CLS. 9, 35 AND 42.

XYLECO, INC., WOBURN, MA:
3,785,336, MULTIPLE CLASS, INT. CLS. 1 AND 4.

XYLOS CORPORATION, LANGHORNE, PA:
3,785,477, INT. CL. 10.
3,785,478, INT. CL. 10.

XYSTUS, COOPER CITY, FL:
3,785,380, MULTIPLE CLASS, INT. CLS. 9, 25 AND 41.
3,785,381, MULTIPLE CLASS, INT. CLS. 9, 25 AND 41.

X10 LTD., HUNGHOM, KOWLOON, HONG KONG:
2,751,602, CANC. INT. CL. 9.

YACHT CLUB ENTERPRISES, LTD., BLUFFTON, SC:
3,786,271, INT. CL. 24.

YACHTBLUE, LLC, FORT LAUDERDALE, FL:
3,783,127, PUB. 2-16-2010. INT. CL. 35.

YACHTRONICS, INC, FT. LAUDERDALE, FL:
2,395,549. REN. 3-31-10. MULTIPLE CLASS, INT. CLS. 35 AND 37.

YAHOO! INC., SUNNYVALE, CA:
3,785,637, INT. CL. 9.

YALE UNIVERSITY, NEW HAVEN, CT:
2,271,288, CANC. INT. CL. 24.
2,753,673, CANC. INT. CL. 35.

YAMAHA HATSUDOKI KABUSHIKI KAISHA, SHIZUOKA-KEN, JAPAN:
2,272,964, CANC. INT. CL. 12.

YANKEE SPIRITS INC., STURBRIDGE, MA:
2,271,301, CANC. MULTIPLE CLASS, INT. CLS. 33 AND 42.

YANLORD INDUSTRY (THAILAND) CO., LTD, BANGKOK, THAILAND:
3,784,401, PUB. 2-16-2010. INT. CL. 20.

YARA PHOSPHATES OY, FINLAND:
3,784,889, PUB. 2-16-2010. MULTIPLE CLASS, INT. CLS. 1 AND 31.

YARD HOUSE USA, INC., IRVINE, CA:
3,785,999, INT. CL. 36.

YARD HOUSE USA, INC., IRVINE, CA:
3,786,009, INT. CL. 36.

YARDVILLE NATIONAL BANK, HAMILTON, NJ:
2,752,540, CANC. INT. CL. 36.

YARGER, STEVEN EDWARD, CHICAGO, IL:
3,783,979, PUB. 2-16-2010. INT. CL. 39.

YARNBIRD INCORPORATED, PASADENA, CA:
2,753,992, CANC. INT. CL. 9.

YARNBIRD, INC., PASADENA, CA:
2,753,145, CANC. INT. CL. 9.

YBRAVO.COM, LLC, LIVERMORE, CA:
3,786,075, INT. CL. 35.

YENSON, JAYCE, SANTA ANA, CA:
2,751,724, CANC. INT. CL. 29.

YES TO LTD., TEL AVIV, ISRAEL:
3,783,160, PUB. 6-9-2009. INT. CL. 3.
3,783,161, PUB. 6-9-2009. INT. CL. 3.

YINUGO, LLC, SIMPSONVILLE, SC, DBA YINUGO, LLC:
3,786,129, INT. CL. 9.

YKK CORPORATION, TOKYO 101-8642, JAPAN:
3,784,136, PUB. 2-16-2010. INT. CL. 26.

YOO, TAE WOO, CHUNGCHEONGNAM-DO, REPUBLIC OF KOREA:
2,348,876. REN. 3-31-10. MULTIPLE CLASS, INT. CLS. 10, 16 AND 41.

YOOX SPA, ITALY:
3,785,040, PUB. 2-16-2010. INT. CL. 25.
3,785,041, PUB. 2-16-2010. INT. CL. 25.

YORK WALLCOVERINGS, INC., YORK, PA:
2,754,103, CANC. INT. CL. 27.

YOSHINO, JASON, SIOUX FALLS, SD:
3,784,406, PUB. 2-16-2010. INT. CL. 41.

YOTOGA, LLC, WASHINGTON, DC:
3,785,799, INT. CL. 9.

YOU DON'T KNOW JACK, INC., ANCHORAGE, AK:
2,271,503, CANC. INT. CL. 42.

YOUNG DRIVERS OF CANADA CORPORATION, HAMILTON, ONTARIO:
1,553,377, CANC. INT. CL. 41.

YOUNG LIFE, COLORADO SPRINGS, CO:
2,336,314. REN. 3-29-10. INT. CL. 41.
2,336,315. REN. 3-29-10. INT. CL. 41.
2,336,321. REN. 3-29-10. INT. CL. 42.
2,412,066. REN. 4-1-10. INT. CL. 42.

YOUNG, GREG, MODESTO, CA:
2,752,506, CANC. INT. CL. 41.

YOUR MARKETING DEPT., INC., LINCOLN, NE:
3,786,071, INT. CL. 35.

YOUTHFRONT, INC., SHAWNEE MISSION, KS:
2,327,341. REN. 3-29-10. MULTIPLE CLASS, INT. CLS. 9, 16 AND 25.

YUMMY DENTAL, LTD., CHICAGO, IL:
3,784,348, PUB. 2-16-2010. INT. CL. 44.

YUMMY MIAMI, INC., MIAMI, FL:
2,752,281, CANC. MULTIPLE CLASS, INT. CLS. 29 AND 35.

YUPAO CHEN. SAN JOSE, CA, AKA DICK CHEN:
3,786,125, INT. CL. 9.

YUTAKA ENGINEERING CORPORATION, OHTA-KU, TOKYO, JAPAN:
2,335,818. REN. 3-29-10. INT. CL. 9.
2,335,819. REN. 3-29-10. INT. CL. 9.
2,350,170. REN. 3-27-10. INT. CL. 9.

- Z-PRO INTERNATIONAL, INC., PORTLAND, OR:
2,754,459, CANC. INT. CL. 16.
- ZACHARY CONFECTIONS INC., FRANKFORT, IN:
1,553,105, CANC. INT. CL. 30.
- ZACKIN PUBLICATIONS, OXFORD, CT:
3,784,614, PUB. 2-16-2010. INT. CL. 41.
- ZADI FOODS LIMITED, BRAMPTON, ONTARIO:
2,753,377, CANC. INT. CL. 29.
- ZAPPA, LUCIANO JORGE, REPUBLICA, ARGENTINA:
2,753,606, CANC. INT. CL. 42.
- ZAPPOS.COM, INC., HENDERSON, NV:
3,785,233, INT. CL. 25.
3,785,349, INT. CL. 9.
- ZAXBY'S FRANCHISING, INC., ATHENS, GA:
3,783,618, PUB. 2-16-2010. INT. CL. 29.
- ZAXEL SYSTEMS, INC., LOS ALTOS HILLS, CA:
2,752,201, CANC. INT. CL. 9.
- ZB IMPORTING, INC., CICERO, IL:
2,271,366, CANC. INT. CL. 30.
- ZEBRA PEN CORP., EDISON, NJ:
2,753,733, CANC. INT. CL. 16.
- ZEBROWSKI, MARIA CECILE, MANHATTAN BEACH, CA:
2,754,512, CANC. INT. CL. 16.
- ZELDIN, JEFFREY, A., TORONTO, ONTARIO, CANADA:
3,784,825, PUB. 5-26-2009. MULTIPLE CLASS, INT. CLS. 3 AND 10.
- ZEOLYST INTERNATIONAL, HOUSTON, TX:
3,784,128, PUB. 2-16-2010. INT. CL. 1.
- ZERDOUN, BRUNO, MIAMI, FL:
3,786,000, INT. CL. 18.
- ZERO260 INCORPORATED, SEATTLE, WA:
3,784,594, PUB. 2-16-2010. MULTIPLE CLASS, INT. CLS. 9 AND 42.
- ZEUGMA SYSTEMS INC., RICHMOND, CANADA:
3,784,832, PUB. 2-16-2010. MULTIPLE CLASS, INT. CLS. 9 AND 37.
- ZHANG WEI WEN, GUANG DONG PROVINCE, CHINA:
3,784,457, PUB. 2-16-2010. INT. CL. 33.
- ZHEN DISTRIBUTION, INC., SEATTLE, WA:
3,785,347, MULTIPLE CLASS, INT. CLS. 10 AND 35.
- ZHENG ZHANG USA, INC., NEW YORK, NY:
2,373,787, REN. 3-30-10. INT. CL. 24.
- ZHONGSHAN HIGHYES ELECTRONICS, CO., LTD., SHAXI ZHONGSHAN, CHINA, DBA KINGNEED:
3,786,099, INT. CL. 9.
- ZHONGSHAN K-MATE; GENERAL ELECTRONICS CO., LTD., CHINA:
3,785,009, PUB. 2-16-2010. INT. CL. 9.
- ZIABICKI IMPORT CO., INC., RACINE, WI:
2,752,641, CANC. INT. CL. 20.
- ZICKGRAF HARDWOOD FLOORING COMPANY, LLC, FRANKLIN, NC:
2,753,627, CANC. INT. CL. 40.
- ZIMBERG, ARNOLD, NEW YORK, NY:
2,753,219, CANC. INT. CL. 25.
- ZIMMERMAN ARMS LLC, PRESCOTT, AZ:
3,784,395, PUB. 2-16-2010. INT. CL. 13.
- ZIMMERMANN-GRAEFF & MULLER GMBH & CO., ZELL/ MOSEL, FED REP GERMANY:
3,786,448, INT. CL. 33.
- ZIRB ENTERPRISES, INC., WATERTOWN, SD:
2,754,494, CANC. INT. CL. 35.
- ZIRC COMPANY, BUFFALO, MN:
3,784,587, PUB. 2-16-2010. INT. CL. 10.
- ZOLTAN, SZEKELY, DALY CITY, CA:
2,846,484, CANC. INT. CL. 41.
- ZON ENERGY INC., SPRING, TX:
3,784,391, PUB. 2-16-2010. INT. CL. 36.
3,784,394, PUB. 2-16-2010. INT. CL. 36.
- ZOTTER HOLDING GMBH, AUSTRIA:
3,784,995, PUB. 2-16-2010. MULTIPLE CLASS, INT. CLS. 16, 29 AND 30.
- ZOX, KATHRYN, SLINGERLANDS, NY:
3,783,552, PUB. 2-16-2010. INT. CL. 41.
- ZUB WEAR, LLC, FAYETTEVILLE, AR:
2,754,146, CANC. INT. CL. 25.
- ZUMI COLLECTION, DES MOINES, IA:
3,784,514, PUB. 2-16-2010. INT. CL. 35.
- ZUREL GROUP B.V., 1431 GB AALSMEER, NETHERLANDS:
2,751,995, CANC. INT. CL. 31.
2,751,996, CANC. INT. CL. 31.
- ZYMETIS, INC., COLLEGE PARK, MD:
3,785,254, MULTIPLE CLASS, INT. CLS. 1, 4, 40 AND 42.
- ZZZ INTECH LLC, MINDEN, NV:
3,785,329, MULTIPLE CLASS, INT. CLS. 16, 28 AND 41.
- 0824373 B.C. LTD., WINFIELD, CANADA:
3,783,235, PUB. 2-16-2010. MULTIPLE CLASS, INT. CLS. 31 AND 35.
- 1-800-HOSTING.COM, INC., DALLAS, TX:
2,754,532, CANC. INT. CL. 42.
2,754,533, CANC. INT. CL. 42.
- 1,4 GROUP, INC., MERIDIAN, ID:
2,383,234, REN. 3-27-10. INT. CL. 1.
- 1ST USA REALTY PROFESSIONALS, INC., MESA, AZ:
2,752,046, CANC. INT. CL. 36.
- 1142786 ONTARIO INC., ETOBICOKE, ONTARIO M9L 5H5, CANADA:
2,751,555, CANC. MULTIPLE CLASS, INT. CLS. 5, 10, 35 AND 40.
- 2ND C A/S, 3450 ALLEROD, DENMARK:
2,753,630, CANC. MULTIPLE CLASS, INT. CLS. 9 AND 42.
- 2R-HEALTH, INC., VERO BEACH, FL:
3,784,254, PUB. 2-16-2010. INT. CL. 30.
- 2XL GAMES, INC., PHOENIX, AZ:
3,783,994, PUB. 2-16-2010. INT. CL. 9.
- 20/20 SPEECH LIMITED, MALVERN, WORCESTERSHIRE, UNITED KINGDOM:
2,751,672, CANC. INT. CL. 9.
- 21ST CENTURY URBAN SCHOOLS, CHICAGO, IL:
2,336,543, REN. 3-31-10. INT. CL. 41.
- 3RND, FONTANA, CA:
3,249,165, CANC. INT. CL. 25.
3,250,964, CANC. INT. CL. 25.
- 300 E-6, INC., CONSHOHOCKEN, PA:
2,752,545, CANC. INT. CL. 43.
- 3091287 CANADA INC., QUEBEC, CANADA:
3,783,302, PUB. 12-8-2009. INT. CL. 32.
- 314321 ONTARIO LIMITED, SUDBURY, CANADA, DBA BULL INDUSTRIAL SUPPLY:
3,783,222, PUB. 12-1-2009. MULTIPLE CLASS, INT. CLS. 7, 12 AND 37.
- 338 PARTNERS, LLC, MILWAUKEE, WI:
3,783,107, PUB. 2-16-2010. MULTIPLE CLASS, INT. CLS. 5, 29 AND 32.
- 360 GRC, INC., FOREST HILLS, NY:
3,784,044, PUB. 2-16-2010. INT. CL. 9.
- 4 WILD WITCHES INC., NORTH PROVIDENCE, RI, DBA WILD WITCHES:
3,783,704, PUB. 2-16-2010. INT. CL. 41.
- 4-C ECONOMIC DEVELOPMENT AUTHORITY, BECKLEY, WV:
3,785,891, INT. CL. 35.
- 4SEVENS, LLC, TUCKER, GA:
3,784,574, PUB. 2-16-2010. INT. CL. 11.
- 407 ENTERPRISES, LTD., L.L.P., AUSTIN, TX:
3,783,163, PUB. 11-10-2009. INT. CL. 43.
- 4490673 CANADA INC., VERDUN, QUEBEC, CANADA:
3,785,824, INT. CL. 25.
- 4522958 CANADA INC., CANDIAC, QUEBEC:
3,783,723, PUB. 2-16-2010. INT. CL. 7.
- 500 LUX LLC, SWANSEA, MA, DBA 500 LUX:
3,784,653, PUB. 2-16-2010. INT. CL. 25.
- 5060 GROUP, INC., THE LAKE WORTH, FL:
2,753,206, CANC. INT. CL. 41.
- 7 DIAMONDS CLOTHING CO. INC., TUSTIN, CA:
3,785,886, INT. CL. 25.
- 7ATE9 INC., HOLLYWOOD, CA:
3,783,359, PUB. 2-16-2010. INT. CL. 41.
- 80STEEES.COM, INC., NORTH HUNTINGDON, PA:
3,488,097, COR. MULTIPLE CLASS, INT. CLS. 25 AND

MAY 4, 2010

U.S. PATENT AND TRADEMARK OFFICE

TMI 107

35.

* * * * *